

# METAL DETECTOR HANDBOOK FOR HUMANITARIAN DEMINING

Authors: Dieter Guelle, Andy Smith, Adam Lewis, Thomas Bloodworth



EUROPEAN  
COMMISSION

**A book about  
metal detectors,  
covering detection procedures  
in the field, and the  
testing and evaluation  
of metal detectors  
for humanitarian demining**



# Metal detector handbook for humanitarian demining

A book about metal detectors, covering detection procedures  
in the field, and the testing and evaluation of metal detectors  
for humanitarian demining



## Authors

*Dieter Guelle, Andy Smith, Adam Lewis, Thomas Bloodworth*

## Acknowledgements

We acknowledge help, advice and invaluable input from the following individuals. While they share in any merit this book may deserve, any errors and failings remain the authors' alone.

For advice and assistance with technical aspects, special thanks to Yogadhis Das. For help and advice on a wide variety of other aspects, our thanks to Jacky D'Almeda, Roger Hess, Tim Lardner, Russell Gasser, Ken O'Connell, Franciska Borry, Marta Garotta, Gian Luigi Ruzzante, J. T. (Theo) van Dyk, Edgardo Maffia, Pete Hindy, and Chris Leach.

Many other people have helped in small ways — too many to mention by name. Our thanks to you all.

© All photographs and diagrams are copyright of the authors unless otherwise acknowledged.

***Europe Direct is a service to help you find answers to your questions about the European Union***

**New freephone number:**

**00 800 6 7 8 9 10 11**

A great deal of additional information on the European Union is available on the Internet. It can be accessed through the Europa server (<http://europa.eu.int>).

Cataloguing data can be found at the end of this publication.

Luxembourg: Office for Official Publications of the European Communities, 2003

ISBN 92-894-6236-1

© European Communities, 2003

Reproduction is authorised provided the source is acknowledged. All photographs and diagrams are copyright of the authors unless otherwise acknowledged.

*Printed in Italy*

# Foreword

Working in a research environment, it is always of concern when I am confronted with statements, like 'To date, technology has had only a marginal impact on mine action equipment.' Therefore, it was a very rewarding moment when, earlier this year, I was able to communicate the results of the European Committee for Standardisation (CEN) working group on an agreement by an international community of experts on how to test and evaluate metal detectors to be used in humanitarian mine clearance.

During the work on the establishment of this workshop agreement, it became obvious that there are at least two areas related to metal detectors that need further research. The first one is the electromagnetic characterisation of soils and terrain in general terms, in order to predict the performance of metal detectors in different mined areas. The second one is the assessment of the performance of mine detection on the basis of reliable statistical testing. Work in both demanding areas of research is now in progress.

In order to ensure that our research efforts will make an impact in humanitarian mine clearance, it is vital that the results can be implemented by those working in the field. To achieve this, it is important to communicate the results achieved, through training sessions and presentations in a digestible way. It is therefore important to have hand-

books available, which present the actual state of knowledge and which are written by experts in both mine clearance and technical development in easily understandable language. The handbook in front of you is such an example combining these vital ingredients.

An interesting point that arises from the handbook is that deminers working in the field can provide useful information to researchers and developers by making simple measurements to record the conditions that they meet, for example, by measuring the soil properties.

I am pleased that the Joint Research Centre (JRC) has been able to contribute to the production of this handbook and I hope that it will soon become a reference for those who are confronted with the challenging task of mine clearance.

Dr Alois J. Sieber  
Head of Unit, 'Humanitarian Security'  
Institute for the Protection and Security  
of the Citizen (IPSC)  
Joint Research Centre, European Commission,  
Ispra (VA), Italy



# Introduction

Dear readers,

I have been using metal detectors of one kind or another for over 20 years. First with the US Army, and for the last five years while establishing and managing humanitarian clearance programmes in the Balkans, Asia and Africa. Part of my role has been to train local deminers in how to use a range of different detectors in both shallow and deep-level searches.

Over the last 10 years, detector designs have changed and the features available have become more sophisticated. With this, I have had to learn constantly about the strengths and weaknesses of the new equipment. Manufacturers have usually done their best to assist, but they rarely understand exactly what we need in the field or the conditions we will be using it in. So I have usually had to find my own ways of getting the answers I was looking for.

Over the past 10 years, accidents have occurred because deminers and their supervisors have not understood the limitations of the detector they were using. It is essential for the user to know the real detection depth that can be achieved at the task site and what is a safe rate of forward advance. Both of these depend on what the deminer is searching for, but fortunately the smallest target that may be present in a particular area can usually be predicted.

This handbook instructs the reader on how to confidently assess their detector's ability in the place where they must work. The problem of electro-magnetic ground is addressed in detail, including advice on how to predict the clearance-depth that will be possible in other areas. The book also includes detailed advice on how to conduct comparative trials of metal detectors.

None of this is theoretical. It is all based on genuine hands-on experience and the solutions are practical to use in the field. The book includes a quick field-user index and is even printed on tough, washable paper so that it will survive field-use.

For those who want to understand how detectors work in more detail, there is a technical chapter. Even this is written in simple language so that most people will be able to understand it.

I recommend all trainers to read this book and all site managers to carry a copy into the field. If the rules outlined in this book are followed and adapted when necessary, deminers/operators will be safer and we will all be able to have greater confidence in the depth and thoroughness of clearance that has been achieved.

Cheers,

Roger Hess  
Demining and Explosive Ordnance Disposal Technical  
Consultant





# Abbreviations and acronyms

Throughout this book, the following abbreviations and acronyms are used.

<b>ADP</b>	Accelerated Demining Programme	<b>EMI</b>	electromagnetic interference
<b>AG</b>	anti-group (mine)	<b>EOD</b>	explosive ordnance disposal
<b>AP</b>	anti-personnel (mine)	<b>ERW</b>	explosive remnants of war
<b>AT</b>	anti-tank (anti-vehicle) (mine)	<b>FFE</b>	free from explosive
<b>CCW</b>	United Nations Convention on Conventional Weapons	<b>FNA</b>	fast neutron analysis
<b>CEN</b>	European Committee for Standardisation	<b>GC</b>	ground compensating (of metal detectors)
<b>CWA</b>	European Committee for Standardisation workshop agreement	<b>GICHD</b>	Geneva International Centre for Humanitarian Demining
<b>DDAS</b>	Database of Demining Accidents	<b>GPR</b>	ground-penetrating radar
<b>DNT</b>	dinitroluene	<b>GPS</b>	Global Positioning System
<b>EDD</b>	explosive detecting dog	<b>GRH</b>	ground reference height
<b>EDR</b>	explosive detecting rat	<b>HD</b>	humanitarian demining
<b>EIT</b>	electrical impedance tomography	<b>HE</b>	high explosive
<b>EM</b>	electromagnetic	<b>ICBL</b>	International Campaign to Ban Landmines
		<b>IMAS</b>	International Mine Action Standards
		<b>IPPTC</b>	<b>International</b> Pilot Project for Technical Cooperation

<b>IR</b>	infrared	<b>UXO</b>	unexploded ordnance
<b>ITEP</b>	International Test and Evaluation Programme	<b>WWI</b>	World War One
<b>ITOP</b>	International Test Operational Procedures standards	<b>WWII</b>	World War Two
<b>NATO</b>	North Atlantic Treaty Organisation		
<b>NGO</b>	non-governmental organisation		
<b>NQR</b>	nuclear quadrupole resonance		
<b>PE</b>	plastic explosive		
<b>QA</b>	quality assurance		
<b>RDX</b>	Research Department Explosive (cyclonite)		
<b>SD</b>	self-destruct		
<b>SDA</b>	self-deactivate		
<b>TNA</b>	thermal neutron analysis		
<b>TNT</b>	trinitrotoluene (explosive)		
<b>UN</b>	United Nations		
<b>UNADP</b>	United Nations Accelerated Demining Programme		
<b>UNMAS</b>	United Nations Mine Action Service		

# Definitions

To prevent constant repetition, the authors have adopted some simple definitions that the reader should understand before reading the book. Each follows what we believe is the 'normal' field-use of terminology.

**Contaminated ground:** The expression 'contaminated ground' is used to refer to ground with pieces of manufactured metallic material in it. The metallic material may be fragments from explosive devices, bullets, casings or discarded material with a metallic content.

**Detector sensitivity:** The expression 'detector sensitivity' is used to refer to the metal detector's ability to locate a target at varying depths, so is directly related to the distance from the search-head at which a target can be

detected. The greater the distance between the search-head and the target at which a detector signals, the greater its 'sensitivity'.

**Magnetic ground:** The expression 'magnetic ground' is used throughout this book to indicate ground that has electro-magnetic properties that make a metal detector signal. The cause may be spread throughout the ground over a wide area, or may be erratic such as when some rocks, stones or building blocks make the detector signal.

**Search-heads or coils:** Metal detector search-heads are sometimes called the 'coil' or 'coils'. Throughout this book the terms are used to refer to the same part of the metal detector.



# Contents

<b>Chapter 1: Background to humanitarian demining</b>	15	<b>2.3.3. Batteries</b>	34
<b>1.1. The development of mines</b>	18	<b>2.3.4. Locating metal/mines</b>	35
<b>1.2. Detecting mines</b>	20	<b>2.4. Using metal detectors appropriate for the threat</b>	38
<b>1.2.1. Manual detection using metal detectors</b>	21	<b>2.4.1. Tripwires</b>	38
<b>1.2.2. Manual detection using area excavation</b>	22	<b>2.4.2. Minimum metal mines</b>	40
<b>1.2.3. Explosive detecting dogs and manual methods</b>	22	<b>2.4.3. Fragmentation mines</b>	40
<b>1.2.4. Mechanical and manual methods</b>	23	<b>2.4.4. Anti-vehicle mines</b>	41
<b>1.3. Treaties controlling mine use</b>	23	<b>2.4.5. Detecting deep-level explosive remnants of war</b>	41
<b>Chapter 2: The role of metal detectors in humanitarian demining</b>	27	<b>2.5. Targets for routine metal detector checks</b>	44
<b>2.1. Types of mined areas</b>	28	<b>2.6. Real mined areas</b>	45
<b>2.2. Using metal detectors during surveys</b>	29	<b>2.6.1. Grassland</b>	46
<b>2.3. Using metal detectors in area demining</b>	30	<b>2.6.2. Woodland</b>	47
<b>2.3.1. Daily routines</b>	30	<b>2.6.3. Open hillside</b>	48
<b>2.3.2. Test-pieces</b>	32	<b>2.6.4. Unsurfaced roads and tracks</b>	49
		<b>2.6.5. Surfaced roads, railway tracks</b>	50
		<b>2.6.6. Urban (town or city)</b>	51
		<b>2.6.7. Village</b>	52
		<b>2.6.8. Mountain (high altitude, steep gradient)</b>	53
		<b>2.6.9. Desert</b>	54
		<b>2.6.10. Paddy field</b>	55

2.6.11. Semi-arid savannah	56	3.6.4. Miscellaneous tests	68
2.6.12. Bush	57	3.7. Output of other tests/trials	68
<b>Chapter 3: Detector standards and detector test standards</b>	59	3.8. Do current detectors match the needs in humanitarian demining?	72
3.1. International standards for metal detectors	59	3.9. Lessons for future tests/trials	73
3.2. International standards for metal detectors in humanitarian demining	60	3.9.1. Data collection/analysis during field tests/trials	74
3.3. European Committee for Standardisation workshop agreement (CWA 14747:2003)	61	<b>Chapter 4: Metal detector technology</b>	77
3.3.1. What is covered by the detector test agreement?	61	4.1. How metal detectors work	77
3.4. Previous metal detector tests in humanitarian demining	62	4.2. Electromagnetic properties of materials	79
3.4.1. Why so many field trials?	64	4.3. Metal detector working principles	80
3.5. The output of humanitarian demining detector trials	64	4.3.1. Pulsed induction versus continuous wave	80
3.6. Output of the international pilot project for technical cooperation trials	66	4.3.2. Frequency-domain versus time-domain	83
3.6.1. Tests in air	66	4.3.3. Single coil versus separate excite/receive coils	83
3.6.2. Tests in the ground	67	4.3.4. Static and dynamic modes	83
3.6.3. Tests in the field	67	4.3.5. Single receive coil versus double-D (differential) receive coils	84
		4.3.6. Bipolar pulse versus unipolar pulse	85

4.3.7.	How are metal detectors designed for demining different from other types	86	5.2.	Training in the use of metal detectors	99
4.3.8.	What is important from the user's point of view?	86	5.3.	Recommendations for trainers	100
4.4.	Suppression of electromagnetic interference	87	5.3.1.	Self preparation	100
4.5.	Ground compensation	88	5.3.2.	Trainee assessment	100
4.6.	How the electromagnetic properties of materials are quantified	91	5.3.3.	Structuring your training	102
4.6.1.	Conductivity and resistivity	91	5.4.	The training content	104
4.6.2.	Magnetic susceptibility and permeability	92	5.4.1.	Assuring trainee competency	105
4.7.	Factors that affect detection	92	5.4.2.	Search-head sensitivity profile (footprint)	105
4.7.1.	The metal object or 'target'	93	5.4.3.	Determining a field-accurate sensitivity profile (footprint)	108
4.7.2.	Distance between the detector's search-head and the metal object	93	5.4.4.	Discriminating adjacent targets	109
4.7.3.	Ground properties	95	5.4.5.	Stacked signals	109
4.8.	Metal detectors, radar and radio waves	96	5.4.6.	Linear metal targets	109
			5.4.7.	Electromagnetic disturbance	110
			5.4.8.	Pinpointing targets	110
			5.5.	Work in 'prepared' and 'unprepared' areas	111
			5.6.	Rescue/evacuation using metal detectors	112
<b>Chapter 5: Training</b>		97	<b>Chapter 6: The use of metal detectors in mined areas</b>		115
5.1.	Deminers and their basic training requirements	97	6.1.	The detector 'set-up'	116
			6.2.	Adjusting for different ground	118

6.3. Adjusting to specific targets	120	<b>Annex A:</b> Explosive detecting dogs (EDDs)	131
6.4. Discrimination of 'innocent' metal	121	<b>Annex B:</b> Other explosive remnants of war detection methods	135
6.5. Action on getting a detector signal	122	<b>Annex C:</b> Explosive content of mines	151
<b>Chapter 7: The way forward</b>	127	<b>Annex D:</b> CWA 14747:2003 test overview	157
7.1. Lies, damned lies and statistics	127	<b>Annex E:</b> Calibration of the Schiebel AN19/2 M7	159
7.2. Reducing false alarms	128	<b>Annex F:</b> Suggested further reading	161
7.3. Incremental improvements	129		
7.3.1. Incremental advances in metal detection	129		
7.3.2. Incremental advances in other technologies	130		
		<b>INDEX</b>	
		Quick reference index for field users	163
		Main index	165



# Chapter 1: Background to humanitarian demining

While aspects of mine clearance have been a part of military procedures for more than 80 years, the specialised clearance of all explosive remnants of war (ERW) only began in the late 1980s when civilian organisations started humanitarian demining (HD) in Afghanistan and Cambodia. HD involves clearing ground that has no military significance and where all explosive items must be removed or destroyed to a recorded depth. This is done in order to support peacetime activities and protect civilians from ERW injury. By contrast, military demining is usually carried out for strategic purposes and under pressure to work quickly. Often, only a route through a mined area is cleared. In return for speed, the military may find it acceptable to use armoured vehicles or take losses among their soldiers. Well-equipped forces will usually clear routes mechanically, avoiding putting personnel on the ground. Land 'cleared' in this way is not safe for civilians to use. In humanitarian demining, the deployment of people to clear the ground is routine — and it is not acceptable to take losses among deminers or among the civilians who will use the land at a later time.

Still in its adolescence, HD was started by charity-funded non-governmental organisations (NGOs). Their lead was quickly followed by United Nations (UN) supported programmes largely staffed by seconded military personnel. Before long, commercial demining companies had sprung up, offering more cost-effective clearance to the donors. Huge variations in working speed and methods raised questions over the quality of the work and opinion over safety varied widely. The need for the industry to adopt agreed minimum standards became obvious at the UN-sponsored International Conference on Mine Clearance Technology <sup>(1)</sup> held in July 1996, in Copenhagen. The process of defining and implementing international standards began. In 1997, the first international standards for humanitarian demining were published. The move towards adopting international standards continued with the United Nations Mine Action Service (UNMAS) publication of greatly revised International Mine Action Standards (IMAS) in 2001 <sup>(2)</sup>.

The IMAS defines 'demining' in the HD context as: 'the clearance of contaminated land by the detection, removal

---

<sup>(1)</sup> <http://www.un.org/Depts/dha/mct/>

<sup>(2)</sup> <http://www.mineactionstandards.org/imas.htm>

or destruction of **all** mine and unexploded ordnance (UXO) hazards' <sup>(3)</sup>.

With the ink still wet on the international standards there is some way to go before they are universally adopted. In such a young 'industry', it is not surprising that there are very few specialist publications dealing with particular aspects of HD. What is published is often of more interest to scientists and researchers than to the men and women actually clearing the ground. This book is primarily written for those training deminers but may also be of use to scientists and researchers.

In Cambodia and Afghanistan, where formal HD began, the ERW problem was the result of protracted conflicts resulting from the East–West divide and the cold war. Similarly, communist–capitalist ideologies fuelled the long-term conflicts in Angola and Mozambique and led to the widespread contamination of ground. In the Balkans, it was the politics surrounding the end of the cold war that fuelled conflicts in what had been a weapons-producing area. Again, mines and other ordnance were often used without concern for the long-term threat. From Lebanon to Namibia, Bosnia and Herzegovina to Vietnam, and Guatemala to Peru, the ERW left over after conflicts takes a steady toll on lives and limbs, and prevents safe reconstruction. Actual numbers of dangerous items on the ground are not known, but it is known that huge areas of land are

abandoned and that this inhibits the transition to peace in many ways, crippling the lives of many in the process.

The ERW that has received most publicity are mines and booby traps that are **designed** to be victim activated and so pose a great threat to post-conflict civilians. But many civilians are also injured by unexploded ordnance and by munitions that may have been poorly stored and have become unstable. Sometimes the civilians are injured when trying to recycle the explosive and metal content of ERW in order to earn a little money.

Humanitarian deminers do not only clear mines. They must also clear all ERW and leave the area safe for its intended use. Sometimes this means that an area must be searched to a considerable depth to find all unexploded ordnance. This is usually necessary when there are plans to carry out construction on the site of a former battle or bombing site.

To date, the manual deminer has usually relied on a metal detector to help locate concealed ERW. Until recently, the detectors used had all been designed for military use because the HD market did not warrant the investment required to develop new models. This meant that the detectors often had features that were not necessary or desirable in HD, but those features sometimes increased the price. For example, some detectors are supplied with

---

<sup>(3)</sup> Annex A of the International Mine Action Standards (IMAS), Section 01.10, Paragraph A1.2. <http://www.mineclearancestandards.org>, the text in bold is the authors'.

a case that is infrared (IR) invisible allowing it to be back-packed in a conflict without showing up on the enemy's IR night-sights. This expensive feature is entirely irrelevant in HD. Most of the detectors were primarily designed to be used for short periods while standing. In HD, it is increasingly common for short detectors to be used while kneeling, squatting or bending — and to be switched on for six hours or longer every working day.

Manufacturers of many of the latest generation of metal detectors have listened to the needs of HD and tried to design for its needs as well as the military. Many newer designs are intended to be used while kneeling, squatting or bending and most now have the option of a speaker instead of headphones. The best are simple and robust enough for fairly constant use in difficult conditions.

Perhaps of most importance, detector designers have increasingly listened to the HD need for a detector capable of locating small metal pieces in ground that has electromagnetic properties that can make detectors signal as if metal were present <sup>(4)</sup>. This feature is also of occasional benefit to military purchasers, although the higher sensitivity may slow down the process of crossing a mined area. When the military have to use metal detectors, it can be a high priority to minimise the number of detector signals that would slow down the process of crossing the

mined area. When operating under fire or with a tight time constraint, tiny scraps of rusted metal are often seen as 'false alarms'. While minimising false alarms is also a concern in HD, any piece of metal is generally not seen as a 'false alarm' at all. In areas cleared by metal detectors, it is common for the quality assurance (QA) check to require that the area be metal-free, so every scrap of metal must be removed. In HD, it is always better to spend time digging up a nail than to suffer an injury.

In some cases, demining groups may choose to tune **down** a sensitive detector so that it does not signal on very small metal pieces. This is done when the devices in the area are known to include relatively large amounts of metal, and when other hazards can be confidently excluded. If this is done, any QA checks carried out with detectors on that ground must be carried out with the same detector tuned to the same level of sensitivity. In these circumstances, some groups prefer to use explosive detecting dogs (EDDs) for QA.

Despite the desire of many detector manufacturers to supply what is needed in HD, the commercial reality requires that they also try to sell for military use. As with other equipment used in HD, the potential market is just not big enough to warrant the development of models designed solely to meet humanitarian demining needs.

---

(4) Very few detectors had ground-compensating features between WW II and the beginning of the 1990s.

## 1.1. The development of mines

Victim-initiated explosive devices, placed under, on, or near the ground, have been used in war for centuries <sup>(5)</sup>. The earliest 'mines' were probably underground tunnels packed with explosive and detonated beneath the enemy. This is how they got their name. Today we understand 'mines' to mean containers filled with explosive that are initiated by the victims or their vehicles. Developed during World War One (WWI), these began to be widely used during World War Two (WWII). Seen as a 'force-multiplier', they allowed the users to:

- (a) provide a defensive barrier around vulnerable sites and utilities. The initiation of the mines would provide early warning of attack and, if dense enough, the mined area might stop an attack in its tracks;
- (b) channel enemy troops and vehicles into an unmined area where they themselves would be vulnerable to attack;
- (c) deny the enemy safe access to utilities they might need, even after those placing the mines had withdrawn;
- (d) assist in surprise attacks and ambushes.

Some of these uses required that the enemy knew the mines were there, others relied on surprise. The nature of

the conflict and the professionalism of those engaged have affected the way in which mines are used. In conflicts where the opponents have large differences in military equipment and capability, such as insurgency wars, the less well-equipped groups have tended to make maximum use of unmarked 'surprise' mines. In conflicts where one side has no desire permanently to occupy the territory, the use of unmarked minefields is common.

With the increased use of mines, methods of detecting them began to emerge. Early mines were usually cased in metal, so the development of metal detectors as mine-detectors began.

The early detectors were relatively crude devices requiring a lot of power. To minimise their metal content, the detector heads were first made using wood, then hard plastic (Bakelite). Often heavy and awkward to use, they allowed paths to be cleared through areas sown with metal-cased mines.

Anxious to maximise their military effectiveness, mine designers responded to the use of metal detectors by reducing the mines' metal content. They used wood and Bakelite to make the mine bodies and they began to reduce the metal content in the firing mechanism. This coincided with the rapid development of a wide range of small mass-produced mines designed to be initiated by a person's weight — anti-personnel (AP) blast mines — and

---

<sup>(5)</sup> Those interested in the history might like to read the accounts by Schneck, Grant, McGrath, and McCracken (see Annex F).

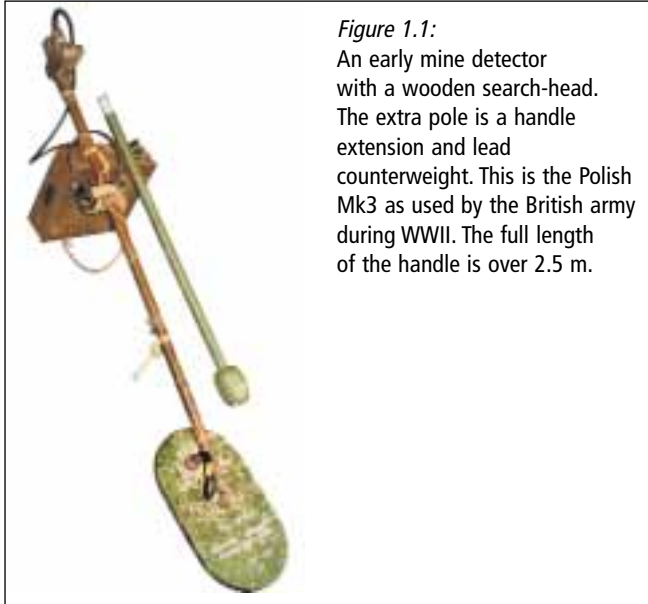

*Figure 1.1:*  
An early mine detector with a wooden search-head. The extra pole is a handle extension and lead counterweight. This is the Polish Mk3 as used by the British army during WWII. The full length of the handle is over 2.5 m.

anti-personnel fragmentation mines, sometimes called anti-group (AG) mines, that were often tripwire initiated. Since WWI, early versions of these mines had been deployed to inhibit infantry movements in the same way as anti-tank (AT) mines were used to restrict the use of vehicles. During WWII, AP mines were increasingly used to protect AT mines so that a person attempting to clear them with an insensitive metal detector would step on an AP mine laid nearby.

Some old designs of AP blast mine were still in widespread use recently, notably the PMN and GYATA-64. These will usually remain functional for **at least** 25 years after being placed. Many other early designs are no longer used and so are rarely found, but they may remain in military stores and so remain a threat. The earlier mines usually contained significant metal in the parts of their firing mechanism and also between 100 and 300 g of high explosive. Later AP blast mines (such as the M14, PMA-3 and Type 72 AP) contained much less explosive, which allowed them to be smaller, cheaper to produce and easier to conceal. The increased reluctance to risk foot-soldiers in conflict led to the development of 'scatterable' AP blast mines that were dispersed from vehicles, helicopters or as submunitions dispersed from a canister in the air. These were used in such numbers that enemy soldiers were denied use of the target area. Ignoring earlier conventions, these mined areas could not be easily mapped or marked and are almost always poorly defined.

Some of the simplest early fragmentation mines are still found widely, notably the POMZ-2 and POMZ-2M which are easily reproduced locally. A more complex and (in military terms) more effective fragmentation mine is the **bounding** type. These mines are propelled above the ground before exploding and sending lethal fragments in all directions. While many of the early designs of bounding fragmentation mines have been abandoned, the OZM range is still found in many areas and the later generation PROM-1 and Valmara-69 are infamous for having claimed the lives of more humanitarian deminers than any other mines.

Another category of fragmentation mine is the 'directional fragmentation' or 'off-route' mine. On detonation, these spread pre-cut metal fragments in a limited arc from one side. Designed to be used by people who remain behind the mine, they are often detonated by a soldier at the appropriate time (as in an ambush). When fitted with a command-detonation fuze, these devices are not technically 'mines' according to the definition agreed in the convention to limit use of AP mines (see Section 1.3).

Scatterable fragmentation mines have also been developed, sometimes deployed with remotely placed AT mines as submunitions dispensed from cluster bombs. As with scatterable blast mines, the method of remote deployment means that the mined area is usually unmarked and poorly defined.

## 1.2. Detecting mines

In humanitarian demining, the common methods of detection in current use are:

- manual, using metal detectors;
- manual, using area excavation;
- dogs and manual;
- mechanical and manual.

Notice that all include the use of manual deminers. This is because, to date, the industry has not accepted that any fully mechanised method of ground processing can find and remove **all** ERW. The machines have not yet matched the mental and physical attributes of the deminers.



*Figure 1.2:*  
The photograph shows two metal detectors used in humanitarian demining and illustrates the way that metal detectors have developed. On the left is the Schiebel AN19 introduced in the 1980s, for years the workhorse of the industry. More modern instruments are now available from several manufacturers (including Schiebel themselves). On the right is an example, the Foerster Minex 2FD 4.500, which features an extendable one-piece design and ground compensation (GC).

### 1.2.1. Manual detection using metal detectors

All deminers know that their most reliable detection tools are their eyes and brains. It is often evident where mines are placed, and in many cases parts of the device are visible after the undergrowth has been removed. This is often true with recently placed AP mines of all types, and sometimes true of AT mines. But when mines were placed a decade or more ago, they have often become more deeply concealed. Even when partly exposed, their cases have weathered and may be impossible to see. Where land erosion or the deposit of alluvial sediment occurs, mines can move from their original place or become buried deeply beneath 'new' soil. New alluvial soil is very fertile and can be thick with roots that the mine is tangled inside. Apart from those areas, deeply buried AP pressure mines are usually only found in areas that were mined many years ago. In a few cases, AP mines were deeply buried on placement, despite the fact that this made it less likely that they would explode as designed. The presence of deeply buried mines, or the belief that they **may** be present, can slow demining down a great deal and so increase the cost.

As long as the ground is not too naturally magnetic or contaminated by scrap metal, manual deminers rely on metal detectors to locate the metallic parts of mines and UXO that cannot be seen.

The metal content of fragmentation mines is so high that they do not normally present a detection problem. Also,

most of them are designed to be laid with their fuze mechanism above ground, and many are placed with half their body exposed, so they are often easy to see after the undergrowth has been removed.

The reduction of metal content in AP blast mines over the years has led to a few modern mine designs having no metal content. Thankfully, very few of these mines have found their way into use and their manufacture and sale is now restricted by the terms of the 1997 Mine Ban Treaty (see Section 1.3). Some have been found during HD using dogs or excavation. Of those known to the authors (notably the M1 APD 59 found in Lebanon and Angola) the detonators appear to have deteriorated and become non-functional after a decade in the ground. It is to be hoped that similar problems occur with other non-metallic fuze systems.

The detection and fairly accurate location of metal in the ground is essential for deminer safety. It is not only necessary to get a signal, the deminer must also be able to centre the reading and place a marker almost exactly where the metal is. This allows the deminer to start probing or excavating a safe distance away from the reading. The deminer probes or digs sideways towards the reading so as to approach the device from the side and avoid pressing directly onto the pressure plate of a mine. But mines are not always lying flat in the ground. If they have tilted, a cautious deminer can still set the mine off. Detonating a mine while exposing it is the most common accident in HD. When adequately protected, most deminers survive this without disabling injury.

### 1.2.2. Manual detection using area excavation

In areas where magnetic ground or scrap metal contamination is so high that a detector signals constantly, the deminers may have to put the detectors aside and excavate the entire top-surface of the ground to an appropriate clearance depth. This 'difficult' ground may be a naturally occurring high level of magnetic ground interference or may be caused by mankind. In many areas, no natural magnetic ground occurs, but in all areas that have been occupied by people, some scrap metal contamination occurs. In the experience of the authors, and as a crude 'rule of thumb', if more than three pieces of metal are found per square metre, it can be faster to excavate the entire area than safely to excavate the metal pieces separately. The excavation process is so slow that it is usually only done in very limited areas where there are known to be mines, although it has been done over long stretches of road. Explosive detecting dogs may be used to reduce the suspect area to a minimum before starting to excavate.

If a mine has been deliberately buried deeply, as with an AT mine on an unsurfaced road, the removal of the top of the road may reveal where a deeper hole has been previously dug and so allow the mine to be unearthed. However, this is not always the case and the use of dogs to locate the well-spaced mines on roads is usually preferred.

### 1.2.3. Explosive detecting dogs and manual methods

Explosive detecting dogs may be used to reduce an area prior to manual clearance, and occasionally for precise mine detection. To increase confidence, it is normal for **at least** two dogs to be run over the same piece of suspect ground. It is generally accepted that dogs cannot reliably pinpoint the source of the explosive in a densely mined area where the scent from more than one source may combine. Dogs can only be used to pinpoint mines when the mines are widely scattered. Where dogs are used to pinpoint explosives, one common method is to 'box' the area into 8–10 metre squares. The dogs are then run inside each boxed area from which any dense undergrowth must have already been cleared (usually using an armoured machine). When the dogs signal, a manual deminer then clears (using a metal detector and/or excavation techniques) an area extending several metres around the spot where the dog indicated. Sometimes the deminer must clear the entire marked 'box' in which the dog indicated the presence of explosives. This is because it is recognised that the dog's ability to pinpoint the position of the explosive (and to discriminate two readings within a few metres of each other) may not be reliable.

Dogs are also used as a quality control check on land that has been cleared, especially if the devices found have not been detonated where they were found. Destroying the devices *in situ* can spread the explosive scent over a wide area, which means that there must be a time interval before dogs can be reliably used to check the ground.



In all cases, the dog acts as a 'detector' and anything it detects is investigated by manual deminers <sup>(6)</sup>. For more about the use of dogs, see 'Annex A: Explosive detecting dogs (EDDs)'. For an indication of the variety of types of high explosive (HE) that a dog may have to locate, see 'Annex C: Explosive content of mines'.

#### 1.2.4. Mechanical and manual methods

Machines are increasingly being used to assist in the manual demining process. The most common use is to cut the undergrowth before the deminers start work. Other uses include the use of back-hoes to remove and spread out building rubble or the collapsed sides of trenches. On roads and in open areas, they are increasingly being used to carry one or another means of detection. This usually allows an array of detectors to be used, so potentially increasing speed <sup>(7)</sup>. More controversially, ground milling machines, flails and rollers are sometimes used to detonate or destroy mines where they lie.

In all cases, to have confidence that **all** ERW has been removed, manual deminers must follow the machines. Sometimes they may use dogs as detectors, often metal detectors.



*Figure 1.3:*  
A mechanically prepared area being marked out for searching by dogs.

### 1.3. Treaties controlling mine use

Two major international treaties control the use of landmines: Protocol II to the Convention on Conventional Weapons (CCW) of 3 May 1996 and the Ottawa

---

<sup>(6)</sup> At the time of writing, the GICHD does not have a dedicated website recording the research it is organising into the use of dogs. There are several relevant papers on the GICHD site, for example, <http://www.gichd.ch/docs/studies/dogs.htm>

<sup>(7)</sup> Currently, there are several vehicle-based metal detector arrays in existence and several prototype multi-sensor systems combining other detection techniques such as GPR and NQR with metal detection (see 'Annex B: Other explosive remnants of war detection technologies').

Convention or Mine Ban Treaty of 3 December 1997. The full names of these treaties are respectively:

Protocol on Prohibitions or Restrictions on the Use of Mines, Booby-Traps and Other Devices as Amended on 3 May 1996 (Protocol II as amended on 3 May 1996) annexed to the Convention on Prohibitions or Restrictions on the Use of Certain Conventional Weapons Which May Be Deemed to Be Excessively Injurious or to Have Indiscriminate Effects <sup>(8)</sup>; and

Convention on the Prohibition of the use, stockpiling, production and transfer of anti-personnel mines and on their destruction <sup>(9)</sup>.

Under the CCW, the manufacture of completely non-metallic anti-personnel mines is banned and other restrictions are placed on anti-tank mines and booby traps as well as anti-personnel mines. Mines designed to be activated by metal detectors are banned. It is forbidden to use mines against other than military objectives. Almost all countries with a significant arms production capability are State parties to the CCW or have signed it.

Under the Ottawa Convention, anti-personnel mines are essentially banned completely. Its provisions do not apply to anti-tank mines. Many arms-producing countries have signed it but those who have not include such major arms

producers as the United States, Russia and China. At the time of writing, the existing, new and applicant Member States of the EU have signed and ratified it with the exception of Greece and Poland (signed but not ratified), and Finland, Latvia, Estonia and Turkey (not signed).

AP mines are often seen as the greatest threat to civilians after conflicts have ended, and the Ottawa Convention was built around them. The Ottawa Convention (and the public campaigning that surrounded it) has had an obvious effect on AP mine production and deployment. The development of metal-free mines has virtually ceased. Although there is continued disagreement about the military utility of AP mines, some of those who have not signed the Ottawa Convention have agreed to increase the metal content of their stocks of minimum metal mines so that they can be more readily detected. Others are seeking to perfect mines that self-deactivate (SDA) or self-destruct (SD) after a set period of time, so theoretically removing the **persistence** of their threat to non-combatants. Currently, there is mixed opinion over whether SD and SDA mines will perform as designed. There are also concerns about clearing up SDA mines that have deactivated, but still contain a detonator and high explosive and so remain a threat to civilians.

One unintentional effect of the Mine Ban Treaty may be the increased use of other munitions that have an

---

<sup>(8)</sup> The text of CCW Protocol II can be found at <http://www.unog.ch/frames/disarm/distreat/mines.htm>

<sup>(9)</sup> The text of the Ottawa Convention can be found at <http://www.icbl.org/treaty/text.php3>

area-denial effect similar to mines, but that are not **designed** as mines. An example of this is the BLU-97 submunition that has a high failure rate on impact and an inertia fuze system that can be sensitive to any later movement. Where these have been used (most recently in Iraq, Afghanistan, Kosovo and Kuwait), both deminers and civilians have been killed by them in relatively large numbers. The BLU-97 is not the only submunition that causes these problems. The BL-755, M118 'Rockeye', BLU-61, BLU-62 and KB1 are others. Some campaigners are currently seeking to limit their use or change their design so that they pose less of a threat when the conflict has ceased. At the time of writing, new protocols restricting or banning these devices are being prepared for consideration as additions to amended Protocol II of the CCW. The

change in the public attitude to the use of indiscriminate and persistent weapons coincided loosely with the end of the cold war and the consequent reduction in ideological wars that were fought by proxy on foreign soils. In those wars, mines were often seen as cheap and effective force-multipliers, and were provided in huge numbers to the combatants by outside agencies. The scale of the mine problem in Mozambique, Angola, Afghanistan and Cambodia dates from this time.

While the use of AP mines has declined, their continued acceptance and use in non-signatory States such as Azerbaijan, Myanmar (Burma), Chechnya, China, India, Korea, Nepal, Pakistan, Russia, Sri Lanka and Uzbekistan indicate that the 'ban' is far from complete.



# Chapter 2: The role of metal detectors in humanitarian demining

The process of demining can be crudely divided into five general stages. Metal detectors may be used during stages 1, 2, 3, and 5.

1. Locate the mined areas.
2. Determine where the mines are within the suspect area.
3. Locate each individual mine/UXO.
4. Destroy each individual item.
5. Check that the area is really clear before release to the public.

Until recently, these were often referred to as:

1. Survey Level 1 — Country survey including impact survey
2. Survey Level 2 — Technical survey, area reduction
3. Mine detection/Demining
4. Demolition
5. Survey Level 3 — Quality control/Sampling

A further survey level (Survey Level 4), is sometimes used to describe the subsequent searching of the area for deep-level ordnance that would not be found without a specialist deep-level detector (see Section 2.4.5, 'Detecting deep-level explosive remnants of war').

The first version of the UN's International Mine Action Standards (IMAS) recognised the distinctions in survey levels listed above. The 2002 revision of the IMAS uses the term 'General mine action assessment' to cover what was referred to in the earlier IMAS as 'Survey Levels 1 to 3', along with 'Impact studies', 'Post clearance inspection' and 'Sampling'. The activities are combined under one heading because this allows the survey and mine clearance process to be seen as integrated and continuous, rather than as a series of tasks that should be completed sequentially<sup>(10)</sup>. For example, information that may be part of a general Survey Level 1 may only be discovered during a Level 2 technical survey or actual demining, but provision should still be made for it to be recorded and used during future planning and prioritisation tasks. No survey task should be thought of as being 'finished' until the clearance is completed and the land returned to the users.

---

<sup>(10)</sup> See <http://www.mineclearancestandards.org/links.htm>

The term ‘Survey Levels 1 to 3’ is still widely used, but what it actually involves varies in different parts of the world and may be surprisingly limited. In most areas, a Level 1 survey does **not** involve placing perimeter signs around a suspect area — so does not include any means of warning the population that a danger exists. It is only during a Level 2 technical survey that perimeter markings are placed. In many areas a technical survey is not carried out separately, but as part of ‘area reduction’ immediately prior to clearance, so the area may be left unmarked for years.

The elements of ‘General mine action assessment’ (described in IMAS 08.10) can be crudely expressed as:

1. emergency threat assessment/survey;
2. technical survey and clearance (including impact survey) — IMAS 08.20;
3. post-clearance documentation (including QA inspections) — IMAS 08.30.

## 2.1. Types of mined areas

The use of a metal detector can be influenced by the place where the mines are situated.

While every mined area is unique, common characteristics are sometimes identified in order to reach generalised conclusions. The following generic mined area ‘scenarios’ are taken from the Geneva International Centre for Humanitarian Demining’s (GICHD) study of global operational needs <sup>(1)</sup>.

Grassland	Open (flat or rolling) land
Woodland	Heavily wooded land
Hillside	Open hillside
Routes	Unsurfaced roads and tracks, including 10 m on either side
Infrastructure	Surfaced roads, railway tracks (to 10 m on both sides)
Urban	Large town or city
Village	Rural population centre
Mountain	Steep and high altitude
Desert	Very dry, sandy environment
Paddy field	Land allocated for the growing of rice
Semi-arid savannah	Dry, open and flat, little vegetation
Bush	Significant vegetation and possible rock formations

A scenario is assigned to each mined area. The scenario is then refined by assigning defining characteristics, such as a description of the ground type, the level of magnetic interference and/or scrap metal contamination,

<sup>(1)</sup> Geneva International Centre for Humanitarian Demining, *Mine action equipment: Study of global operational needs*, Geneva, 2002, ISBN 2-88487-004-0.

vegetation, slope, the presence of trenches and ditches, fences and walls, buildings and building debris, watercourses, ease of site access and the mine/UXO hazard. This was done as part of an exercise to find out which HD activities could most effectively be improved (see also Section 2.6, 'Real mined areas'.)

Of special relevance to the use of metal detectors is the level of naturally occurring magnetic interference and of scrap metal that may be present. The level of metal detector 'disturbance' that results can be recorded using the GICHD method as 'none', 'low', 'medium' or 'high'. The definition of 'medium' includes a reduction in the ability to detect minimum metal mines and 'an impact on safety and the rate of clearance'. The definition of 'high' is that the disturbance prevents 'the use of conventional mine-detectors'. These conditions can occur in any of the listed scenarios.

The GICHD study allows a variety of conditions to be assessed as part of the HD planning process. The anticipated threat is an integral part of this. For example, it may be that the area has a medium level of ground 'disturbance' but that minimum metal mines were not used there, so reliance on appropriately tuned/adjusted metal detectors may still be safe. However, there is not currently an industry-wide agreement about how the level of 'disturbance' should be measured.

It may not be quite so obvious that the practicalities of demining with metal detectors can also be influenced by other factors. Examples are listed below.

(a) The terrain — steep and irregular land can make it impossible or unsafe to use a detector in the way described in a group's operating procedures. For example, the deminers may need to change their normal safety distances, or change the normal working position of deminers.

(b) Rocky ground — which can make it impossible to use the group's 'normal' marking procedures during detection and clearance.

(c) Wet ground — which can inhibit the operation of some detectors and change the apparent level of what the GICHD study called ground 'disturbance'.

## 2.2. Using metal detectors during surveys

The way in which mined areas are surveyed varies widely around the world. At some stage during the planning of clearance, there should be a detailed survey in order for the planning authority to decide which demining methods and resources are appropriate to use in the suspect area. During this, a metal detector can be used to gain some indication of its ability to locate the target mines under local conditions.

In some areas, a sloping cutting in the side of a trench can be used to get a reasonable indication of a particular

detector's ability to locate particular mines at various depths. This can be important when a clearance contract specifies the depth to which the deminers must work. The cavity around the mine may affect performance, so the result should be checked by burying a target mine at the maximum detection depth.



*Figure 2.1:*  
The picture on the left shows Fredrik Pålsson using a cutting in the side of a trench during detector selection trials in Afghanistan during 1999.

## 2.3. Using metal detectors in area demining

Area demining is the clearance of ERW from land under given conditions. Some indication of how varied those conditions can be has already been given. To begin to understand how that variability can affect the use of a metal detector, the reader may like to look around the vicinity of their own homes assuming that everywhere is mined. If they were to take a detector onto the nearest patch of grass, it is likely that they would get very many signals from buried metal that has accumulated over the years. In real mined areas, the vegetation, moisture, magnetic ground, ground incline and many other features affect detector use.

Metal detectors cannot be used as mine-detectors everywhere, but the latest GC models can be used in most mined areas. Where they are used, some rules should be followed to make their use as safe as possible.

### 2.3.1. Daily routines

The group's operating procedures are approved routines for the deminer to follow. The daily detector routines are standing (or standard) operating procedures (SOPs) like any other and should be documented. As a general rule, it is very important to follow the instructions provided in the manufacturer's manual when setting any detector up for optimal use.



While the manual may specify further checks, the following routines are the minimum checks that should be made before using any metal detector in a mined area.

- (a) **Checking the detector's general condition.** Check that the battery connections are tight and reliable, and (when possible) that the batteries retain a suitable charge level. Check the detector for visible damage, loose screws or connections, and any other parts known to fail or identified in the detector manual. Only after a detector has passed these checks should its functions be checked.
- (b) **Checking the detector's functions.** After assembling the detector, it must be checked to ensure that it is working properly. This process has various names, but it is often called the 'set-up' or the 'warm-up'. Detector manufacturers usually provide a sample target for the detector to signal on. This is often called a 'test-piece'. Most test-pieces are not only designed to show that the detector signals on metal. They are also designed to indicate whether the detector signals on the target at a set distance from the detector-head (usually in air). This is usually referred to as measuring the detector's 'sensitivity'. After this test, the deminer knows whether the detector is functional. The time needed to conduct a 'set-up' test varies by detector type, but is generally not more than a few minutes.
- (c) **Adjusting the detector to the ground conditions.** Checks (a) and (b) are usually carried out in

strict accordance with the instructions found in the detector's manual. Adjustment to the ground conditions may also be adequately explained in the manual, but is often extended with the experience of the users.

A detector without a GC facility may simply be 'tuned down' by reducing its sensitivity until it no longer signals on the patch of pre-cleared ground used as a test area. Detectors with a GC facility may be adjusted automatically, or manually. **In both cases, the detector's ability to detect at depth is frequently reduced by the adjustment.**

- (d) **Adjusting the detector to the target.** This is the most important check because it can make the work both safer and easier but it is not carried out by all demining groups. It involves reducing the danger to one that is **known**. This is achieved by checking that the detector can find what the deminers are looking for. The most difficult target to find is selected. This will often be a minimum metal mine but may be a bigger metal target buried at a greater depth. Some demining groups use real mines that have been rendered safe. Some demining groups use test-pieces that simulate the detectability of the target mine. The target is buried at the maximum clearance depth required and the detector is used to locate it.

This check is not only of the detector's ability to do the job required. It can also be used to check the

deminers's ability to use the detector in the way required. By carrying it out, the deminers are given confidence in the equipment and in their ability to use it. When it includes measuring the 'sensitivity area' of the detector beneath the ground, it can also provide vital information about how far to advance the detector-head on each sweep (see Section 5.4.2, 'Search-head sensitivity profile (footprint)'). By including this routine before work, the deminers are shown that those in charge care about their safety. The authors recommend that this check always be successfully completed before deminers are allowed to work in the mined area.

Routines while working in the mined area are listed below.

- (e) **Maintaining confidence.** After check (d) above, the deminers start to use the detectors to search for metal in the mined area. Many models of detector make a sound to show that they are working normally. This is often called a 'confidence click'. Although the sound should be enough to give confidence, deminers usually feel a need to make their own regular check that the detector is working. This is done by routinely presenting the detector to a visible metallic target, such as tools or the eyelets on the user's boots.
- (f) **Repeating 'set-up' for changed conditions.** Working hours vary, but on average a metal detector is used for about six hours a day in HD. If the detector is

turned off during that time, checks (a) to (d) should be repeated when it is turned back on. The ambient conditions in the work area will also change over a six-hour period. For example, the temperature and the level of humidity may rise a great deal. Also, the condition of the detector and its batteries can change. As a result, all detectors should be 'set up' again after a predetermined time. At the very least, set-up checks (a) to (d) should be repeated if there is a temperature change of 10°C.

- (g) **End-of-day check.** The last routine at the end of the working day is to clean and disassemble the detector, repeating check (a) in the process. The detector can then be packed away ready for use the next day.

### 2.3.2. Test-pieces

Two kinds of detector test-piece are recommended: the 'manufacturer's test-piece' and a 'confidence test-piece'. The manufacturer's test-piece is usually supplied with a specific detector. These test-pieces are small pieces of metal, often encased in plastic. They are used with a distance scale to check that the detector is working properly and achieving its design 'sensitivity'.

The 'confidence test-piece' is either an original mine (free from explosive) or a surrogate designed to be a substitute for the metal content of a mine. Some surrogates attempt to simulate a generic mine type rather than a particular

mine model. Some attempt to simulate a specific mine, and may be called 'simulants'. The distinction between the use of the terms 'surrogate' and 'simulant' is not universal and the words are often used to mean the same thing. Both surrogates and simulants may be designed to have detection characteristics similar to those of real mines and so be used as substitutes for them when testing detectors.

While we follow field-use and make no strict distinction between 'simulant' and 'surrogate' in this book, a standardised naming convention for mine targets exists as one of the four-nation international test operational procedures standards (ITOP 4-2-521) and has been recognised by the North Atlantic Treaty Organisation (NATO) (Stanag 4587) <sup>(12)</sup>. This convention defines 'types' in the following way.

- Type 1: Production mine — a fully 'live' mine.
- Type 1a: Production mine — a mine with an active fuze but the main HE charge removed.
- Type 2: Surrogate mine — a production mine with a disabled fuze.
- Type 3a: Surrogate mine — a production mine that is free from explosive (FFE), air-filled.

- Type 3b: Surrogate mine — a production mine that is FFE and filled with an inert material.
- Type 4a: Reproduction mine — a model of a specific type of real mine (air-filled).
- Type 4a: Reproduction mine — a model of a specific type of real mine (inert-material-filled).
- Type 4c: Reproduction mine — a model of a specific type of real mine (explosive-filled).
- Type 5a: Simulant mine — a generic model of a class of mine, with significant explosive fill.
- Type 5b: Simulant mine — as 5a with an active fuze but without a main charge.
- Type 5c: Simulant mine — as 5a but with no fuze and only trace amounts of explosive.
- Type 6: Simulant mine — a generic model of a class of mine that is FFE.
- Type 7: Instrumented mine — as may be used for testing mechanical clearance equipment.
- Type 8: Calibration target — for example, a metal test-piece.

---

<sup>(12)</sup> For more details, see Target standardisation for demining testing, 20 December 1999, <http://www.itep.ws/standards/pdf/TSFDTnon4.2.521.pdf>

A range of ITOP surrogates <sup>(13)</sup> that can be used for testing radar, metal detectors and mechanical equipment are available commercially with restrictions. However, they are expensive and the authors know of no NGO or commercial demining clearance organisation that uses them in the field.

It is usually accepted that the best 'confidence test-piece' is an original mine taken from the area to be cleared, or from a mined area of a similar age nearby. After removal, the mine is rendered free from explosive (FFE) and clearly marked so that no one can confuse it with a live mine. The FFE process usually involves removing the detonator, which is sometimes replaced by a similar-sized piece of metal but is often left absent. This 'confidence test-piece' now contains metal of the same type and in the same condition as the metal in the mines that must be found. Some groups prefer to remove the metal from a mine and use that metal to make a test-piece that does not look like a mine at all. Effective 'confidence test-pieces' can also be made using any piece of metal that the detector reacts to at the same depth and with the same strength as the target mine. However, one advantage of using FFE targets that still look like mines is psychological. When the deminer uses a test-piece that looks exactly like what he <sup>(14)</sup> wants to find, his confidence in the detector and his own abilities is enhanced.

**Caution:** Some demining groups prohibit rendering any device FFE in their SOPs. Others only allow some kinds of mine to be rendered FFE. Dismantling and removing the high explosive from some designs of mine is always unsafe. Mines that have been in the ground for long periods can become unstable. In the authors' opinion, a suitably experienced person should always carry out the FFE process and no attempt should ever be made to FFE any obviously damaged device.

### 2.3.3. Batteries

Every metal detector used in HD requires batteries. (Research into clockwork and inertia-charged batteries has not resulted in a fieldable product at the time of writing.) Most manufacturers recommend a battery type to use. For example, some of the European and Australasian manufacturers recommend alkaline batteries. Unfortunately, when demining for long periods in remote areas, specific batteries may not be easily available. If the right voltage batteries of the wrong type are used, the metal detector will still work. However, it will be unlikely to work for the number of operational hours claimed by the manufacturer. Some demining groups routinely use the cheapest batteries, others go to great lengths to maintain supply of the recom-

---

<sup>(13)</sup> For more details, see 'Scientific and technical report — Simulant mines (SIMs)', 21 October 1998  
<http://www.uxocoe.brtrc.com/TechnicalReps/misc1.htm>

<sup>(14)</sup> We use 'he' rather than 'he/she' not as a value judgement, but to reflect the fact that most deminers are male, and so that the text flows more easily.

mended type and brand. Still others use rechargeable batteries. As long as the performance of the detector is checked regularly and the batteries are replaced as soon as performance falls-off, the decision over which batteries to use is a matter of opinion. In the authors' experience, the option that looks cheapest may not really save money.

Detector manufacturers tend to design their equipment to use batteries of a readily available physical size and voltage. This is convenient, of course, but also means that the batteries can be used to power other equipment. To prevent batteries being 'secretly' discharged by powering radios, music systems, flashlights, etc., a strict control over the use of batteries is advisable.

Most modern detectors include a battery-check circuit to warn the user when the power state is low. Some demining groups routinely change their detector batteries before the detector warns of a low-battery state. This may be done to simplify logistics by replacing all batteries at the same time. Some groups believe that it enhances safety to replace batteries before the need is indicated, but the manufacturers of modern detector models deny this. The authors questioned many manufacturers about this and all claimed that their detectors lost no sensitivity before the point when they began to warn of severely depleted power in the batteries. At the time of writing, no independent test of the battery check-circuit against the battery-state of leading detectors has been published. The authors recommend instigating the battery replacement regime that feels safest.

Rechargeable batteries are used by some groups but should not be used with standard chargers and power from generators. Some specialist charging systems are available. Ideally these have a charging time of not more than four hours and can use a wide range of power inputs so that an unstable mains power supply, generator or a vehicle may be reliably used as a power source.

In one prototype detector tried in Mozambique, a photovoltaic solar collector was connected to the detector pole. The solar-panel charged an accumulator in the detector. This worked in field trials but was not developed and marketed commercially. While such a power source would be undesirable in a detector developed for military use, it could have potential in HD. Anyone with experience of purchasing detector batteries in HD is aware of the cost savings that could result from a 'battery-free' solar-power source.

#### **2.3.4. Locating metal/mines**

When a detector signals the presence of metal, the deminer must always assume that the signal is from a mine. Although signal strength may vary, this cannot be used reliably to discriminate the signals from a crushed beer can and a grenade, or a ring-pull and a minimum metal mine. If the signal occurs in a place that is consistent with the pattern of mines already located, or where mines have been specifically reported, the deminer may have extra reason to believe it is the signal from a mine. In other cases, the deminer has to believe that every detec-

tor signal **could** be. It is not always easy to maintain a suitable level of deminer caution because deminers spend most of their time locating metal that is not part of a dangerous item.

To illustrate this point, a recent report about Afghan deminers stated that they expect to investigate 1 000 detector readings for each mine found. In 1999, the deminers at the United Nations accelerated demining programme (UNADP) in Mozambique, had an average of 550 detector readings for each mine. During 2000, that number was reduced to 330 by increasing the use of explosive detecting dogs to reduce the search area. Even the reduced average number of 330 to 1 means that deminers commonly investigate hundreds of innocent objects for each metal piece connected with ERW.

To maintain concentration and adherence to SOPs at a level that prevents accidents, a combination of self-discipline and strict supervision is required.

As a crude average, in around 50 % of cases the source of the signal is visible. When the metal is not visible, the deminer must start an excavation procedure. This procedure varies according to the demining group's SOPs.

What follows is a generic example that may not cover all possible excavation procedures.

(a) The deminer uses the detector to find the signal again, approaching from different directions. This gives more information about the size of the reading and its precise

position (for a description of 'pinpointing' a detector reading, see Section 5.4.8, 'Pinpointing targets'). With some detectors, the detector-head can be turned onto its side and the edge of the head used to find the 'centre' of a shallow reading (the authors do not recommend this). Some groups place a marker in the centre of the reading.

(b) Most important is that the detector should then be used to determine precisely where the signal starts and a marker should be placed at the closest point of the signal to the deminer.

(c) In a two-man drill, the deminer with the detector then withdraws and the excavating deminer comes forward. In a one-man drill, the deminer puts down his detector and starts to prod/excavate at least 20 cm back from the closest marker. Some groups measure the distance back from the reading by using the width of the detector's search-head. Other demining groups use a stick or a purpose-made measure. The deminer then uses his tools to excavate a hole at least 10 cm wide approaching the signal. If the area over which the detector signalled was wider than 10 cm, the excavation should be at least 5 cm wider than the area. The depth of the excavation varies according to the mined area, but is usually at least 10 cm and may be much deeper. Generally, when making a deeper excavation the deminer must start further away from the signal.

For all prodding and excavation, the authors recommend using tools that are designed so that they will

not break up in a detonation and that will keep the user's hands 30 cm from any blast.

- (d) When no closer than 5 cm to the nearest marker, the deminer should start to probe forward with a prod, trying to feel the side of any obstruction. The probe should be inserted at intervals spaced to reflect the size of the target and at a low angle to the ground (usually 30° or less). The low angle reduces the risk of pressing onto a mine's pressure plate but also reduces the risk of injury if a mine is initiated. If the ground is severely compacted or contains a lot of roots or stones, it may be necessary to vary the prodding angle in order to define the outline of any concealed object. In very hard ground, it may be impossible to prod forward without applying extreme pressure. In this case the hole must be cautiously extended towards the signal by scraping away the face of the excavation. Alternatively, water may be used to soften the ground. (Those using water should be aware that water can alter the ground's properties and affect the sensitivity of some detectors.) If the prodder locates no obstruction that could be a mine, the hole is extended towards the signal and the metal located. If the prodding indicates an obstruction that could be a mine, the ground is further loosened with the probe and carefully removed until a part of the device is visible.

Deminers using a one-man drill usually have the detector close to them as they excavate. This allows the deminer to use his detector to pause and re-check

the position of the detector reading as he works. When no obstruction is found with the prodder, having the detector close by can also make it far easier to locate the metal piece that caused the signal. In a typical example, the deminer may prod and loosen the ground where the detector made a reading. He then checks that the reading is still in the same place, and starts gently to remove the loose ground, checking the detector reading constantly. When the detector reading moves, the deminer knows that the fragment was in the last bit of ground he moved. If all the loosened ground is put aside and the detector continues to signal in the original place, the deminer must move back to the start of his excavation and work forward again at greater depth. This usually means that the deminer must make the first excavation wider to allow him to use his tools properly.

- (e) When a deminer has exposed enough of the device to be sure that it is a mine or UXO, the information is usually passed to a supervisor. If the demining group routinely moves the type of device located for remote demolition, the deminer may have to expose the entire device before calling the supervisor.
- (f) When the supervisor arrives, he either decides how much of the device needs to be exposed in order to guarantee a safe and effective demolition, or disarms the device and it is removed for remote demolition. Disarming usually involves removing the fuze, detonator and/or booster charge. Decisions over whether to

destroy devices *in situ* or move them for bulk demolition may be influenced by the desire to use explosive detecting dogs in the area, or by a desire not to have to close working lanes pending an *in situ* demolition. Some fragmentation mines may be disarmed and moved to prevent the risk of spreading metal fragments over the working area when they are destroyed. Most groups recognise that there are a few especially sensitive mines that should never be disarmed, and that damaged devices should always be destroyed *in situ*. Although all disarming procedures involve some risk, there is also a small risk involved in laying charges for *in situ* demolition. The authors of this book recommend destroying mines *in situ* unless there is a compelling reason to do otherwise.

Some demining groups use a shaped hook to lift and turn a mine prior to disarming. This is done using a long rope from a safe distance. Many mines can be fitted with anti-handling devices and all can be booby-trapped to hinder clearance. This can be relatively common in areas where rapid clearance was anticipated, such as parts of the Balkans. By moving the mine remotely, any functional anti-disturbance device will be initiated and the mine will detonate at a safe distance from the deminers.

In general, UN-controlled demining groups carry out *in situ* demolitions of mines at the end of the working day. Some NGOs and commercial groups withdraw their deminers and destroy devices *in situ* as soon as

they are found. From their observations, the authors believe that most demining groups (including those under UN control) routinely move common UXO such as mortar bombs and remove fuzes from common fragmentation mines to allow remote demolition.

## 2.4. Using metal detectors appropriate for the threat

Many of the older metal detectors with no ground-compensating (GC) characteristics are still in use in HD at the time this book is being written. Depending on the conditions where they are being used, these older designs may be able to locate the threat reliably. For this reason, some of the commercial companies and NGOs retain some old models and use newer GC detectors only when ground conditions make this necessary.

### 2.4.1. Tripwires

Tripwires are commonly used with fragmentation mines. A tripwire may activate the mine when the wire is pulled (pull-mode) or when the wire is cut (tension-release mode). Pull-mode is far more common. Mines could be placed at both ends of a tripwire, so the deminers must check both ends. Tripwire-activated fragmentation mines are also often laid with AP pressure mines around them or



beside the wire. When placed, the fragmentation mine and its tripwire is visible, so the AP pressure mines are placed to prevent the enemy moving into the area and cautiously disarming them.

With the passage of time, tripwires may rust, break or be burned off during vegetation fires. A broken tripwire is not safe. Parts of the tripwire may litter the ground, confusing the deminer as he searches for buried AP pressure mines. The end of the wire attached to the mine may be caught among undergrowth and so may still initiate the mine if walked into. Some of the fuzes used with tripwire mines are also pressure and tilt-sensitive, so must be approached with great caution even when the tripwire itself has gone.

Using a metal detector in a fragmentation mine area is further complicated by the fact that some mines will probably have detonated. The wires can be pulled by animals passing through the area, and sometimes by becoming caught in growing vegetation. Any detonation will have spread metal fragments over a wide area. Immediately after detonation the fragments are almost all on (or very near) the ground surface but after the passage of time they can become buried.

Tripwire detection drills usually start by using a 'feeler' (usually a stiff wire or thin stick) to reach into the uncut overgrowth ahead of the deminer to a depth of about 30 cm at ground level. The stick is then gently lifted and any obstruction investigated. This works well in sparse

vegetation but in heavily overgrown areas the stick is constantly snagged by undergrowth and the process takes a very long time.

In long grass, some groups run the metal detector over the top of the grass before carrying out a 'feeler' drill. Other groups report that their detectors do not reliably signal on tripwires.

When the deminer is confident that there are no tripwires in the area immediately ahead, he can cautiously cut and remove the undergrowth. While doing this, the deminer must constantly look out for the fuzes of tripwire mines that may be above ground. He should pass his detector over each layer of vegetation before cutting. Striking the fuze with a vegetation cutting tool can initiate it, and several deminers have died as a result of accidentally striking such a fuze. With the undergrowth removed, a metal detector can then be used to check whether any metal is buried in the area.

In recent years, many groups have developed armoured machines to cut the undergrowth ahead of the deminers so that tripwire risks are reduced. Increasingly, demining groups are issuing deminers with light magnets with which to sweep the ground surface when fragment contamination is high. The magnet is used between cutting the vegetation and using the detector, so removing surface fragments and reducing detector signals.

There is a need for further research into why some metal detectors have apparent difficulty locating tripwires. The cause may be a basic technology limitation, the type of

metal in the tripwire, a feature of the detector design, a mistake in the way the user makes adjustments, a result of the way in which the detector is actually moved, or a combination of one or more of these. **It is reported that even purpose-designed tripwire detectors do not work well.**

### 2.4.2. Minimum metal mines

The term 'minimum metal' is used to describe a mine in which the metal content is so small that it is difficult to detect with a metal detector. In some, the PMA-2 for example, the only metal is a small aluminium tube around the detonator. Others, such as the M14, also include a firing pin. Still others also include a spring (Type 72 AP), and tiny ball bearings (R2M2) (see Figure 2.3).

The type of metal is significant. For example, some detectors fail to signal on high-chrome stainless steel or high-carbon spring metal. Some also have difficulty finding the heavily rusted steel in older mines.

The depth of the metal is also significant. All metal detectors have a sensitivity range, and the maximum detection depth of a target can be significantly reduced when a detector is used in GC mode. Fortunately, most minimum metal AP mines were not designed to be deeply buried.

Some have become deeply buried over time, but most are very close to the surface.

**This is not true of minimum metal AT mines.** The detonator in an AT mine is bigger than in an AP mine. Sometimes the pin and spring are also bigger, but not much. AT mines may be buried far deeper than AP mines. They have been found at a metre below the surface. Some metal detectors can locate a metal-cased AT mine at that depth in easy ground. No metal detector known to the authors can reliably detect a minimum metal AT mine at that depth. Mine detecting dogs have done so, but it is not known how reliably. A working group at the GICHD is currently engaged in a study of explosive detecting dogs that is intended to clarify their abilities, effective training methods and the context in which they can be reliably used <sup>(15)</sup>.

### 2.4.3. Fragmentation mines

The presence of metal fragments (usually cast-iron or mild steel) in a fragmentation mine is generally easy to locate with a metal detector. The common POMZ and PMR fragmentation mines are stake mounted. If mounted on wooden stakes, they will often fall over. On metal stakes, this is less likely except in soft ground. When still on their stakes, they can be located by eye. If they have fallen over,

---

<sup>(15)</sup> At the time of writing, the GICHD working group does not have a dedicated website recording its research into the use of dogs. There are several relevant papers on the GICHD site, for example, at <http://www.gichd.ch/docs/studies/dogs.htm>

they present a large metal signature to the metal detector. Bounding fragmentation mines either contain pre-cut metal fragments inside a metal jacket that may have a plastic outer (as with the Valmara-69), or have thick walls that shatter into fragments on initiation (as with the OZM-4). These mines are frequently placed with half of the body above ground. Their fuze is always exposed. If ground movement, falling vegetation or floodwater sediment bury them later, they have a large metal signature that is usually simple to find with a metal detector.

See Section 2.4.1, 'Tripwires', where the use of AP pressure-initiated mines alongside fragmentation mines is discussed.

#### **2.4.4. Anti-vehicle mines**

Many of the anti-vehicle or anti-tank mines found around the world are old designs encased in metal (such as the TM-46 and TM-57). The large steel case and metal fuzes are generally easy to detect at a reasonable depth even in magnetic ground. Often, AP pressure mines are used to protect the outer edge (or every mine) in an AT minefield. This is intended to discourage the enemy from trying to breach the minefield by removing or defusing the AT mines. Conventionally, three AP pressure mines are placed close to three sides of the AT mine. The fourth side is the side closest to the defenders and it is left without a mine so that they can approach the AT mine to maintain the integrity of the minefield when necessary.

When an AP blast mine is placed close to a large metal-cased AT mine, a metal detector should be able to discriminate between the two signals and allow both to be precisely located. If the AP pressure mine is of a minimum metal type, some detectors are unable to distinguish or pinpoint the smaller signal (see Section 2.4.2, 'Minimum metal mines').

#### **2.4.5. Detecting deep-level explosive remnants of war**

Explosive remnants of war can frequently become buried at depths beyond the range of conventional metal detectors. This may be due to natural events that deposit spoil on top of the devices. More frequently, ERW that have a 'delivery method' which involves ground impact can be deeply buried on arrival. Examples range from mortars and artillery to air-delivered bombs. Opinion varies over the average percentage of munitions that fail to detonate as designed but the authors accept that 15 % is probably a low estimate.

Most conventional detectors used in demining have a normal working depth of not more than 20 cm. Optimised to find small metal objects that are near the surface, they may find large devices at a deeper level but few can reliably locate a large metal-cased AT mine at depths over 40 cm. When an area is cleared using ordinary metal detectors, deeply buried ERW will be missed. Those issuing demining clearance contracts recognise this and

specify a depth to which clearance must be carried out. In magnetic ground, this depth may be as little as 10 cm.

Deeply buried ERW does not normally present a threat to pedestrians, but does present a threat to heavy vehicles and to anyone seeking to build on the affected land. It can also present a threat to farmers who plan to level and plough the land. As a result, responsible mine action centres are beginning to deploy 'deep-search' teams in areas where deeply buried ERW presents a high risk. Deep-search methods are usually only used **after** conventional demining methods have declared the area clear. This is because a detector optimised to search deeply may miss small metal signatures on or close to the ground surface.

Two categories of technology are commonly used in deep-search: 'active' and 'passive' instruments. The distinction between active and passive instruments is that an active instrument applies energy in some form to the region of investigation while a passive sensor makes do with whatever energy happens to be naturally present.

Active instruments work on the same principles as those used in the metal detectors used in conventional demining but have a much larger search-head (coil). The search-heads can be a metre in diameter. The sensitivity of a metal detector falls the further away from the search-head the target is. This 'range' is generally about two or three search-head diameters. Making the search-head larger increases the maximum detection depth so that a 1 m diameter coil may have an effective range of up to



*Figure 2.2:*  
A fluxgate magnetometer. The two sensors of the gradiometer are mounted at opposite ends of the vertical black tube.

3 m. But increasing the search-head size also reduces the sensitivity to small targets because the large coil spreads the magnetic field over a wide area, which reduces its local intensity and allows small targets to be missed. So an active instrument is a conventional metal detector optimised to search deeply for larger metal targets.

Passive instruments are 'magnetometers', which measure the natural magnetic field of the earth. The presence of a large magnetic object, such as a steel-cased bomb, disturbs the pattern of this field. Because they rely on magnetism, they cannot locate non-magnetic metals. The user makes

detailed measurements with the magnetometer and infers the location and depth of any magnetic objects from the shape of the disturbance, which is referred to as an 'anomaly'. Magnetometers cannot detect plastic mines with only minimal magnetic content but can detect steel-cased mines and mines containing steel fragmentation. A magnetometer may be able to detect large targets at depths of up to 5 m.

The conventional instrument for passive UXO detection is called the fluxgate magnetometer <sup>(16)</sup>. A fluxgate is a special material whose magnetisation is very sensitive to the magnetic field in its vicinity. A small piece is contained inside the instrument, surrounded by a measuring coil connected to an electronic circuit.

The magnetometer read-out is usually in the form of a meter showing positive and negative values in nanotesla units (nT). The earth's natural field varies between 25 000 and 50 000 nT, depending on where you are. A good UXO detector has a sensitivity of about 1 nT, so the anomalies that it is capable of detecting are extremely subtle.

UXO magnetometers are usually constructed with two fluxgate sensors connected in opposite directions at either

end of a tube about half a metre or so long. Uniform fields which affect both sensors equally do not give a signal. Only fields which are stronger at one end of the tube than another cause a signal. This arrangement is referred to as a 'gradiometer'. Its advantage is that the strong uniform background field of the earth is removed, which makes it easier to show the anomalies.

Also available commercially for UXO detection are alkali-metal vapour magnetometers <sup>(17)</sup>. These instruments make use of the light spectra of potassium or caesium vapours, which are very sensitive to magnetic fields. The authors do not have experience in their use and cannot comment on their merits with respect to the established fluxgate technology.

When the magnetic ground disturbance allows a free choice on which instrument to use, active systems are usually preferred when searching for ERW that is not very deep. This is likely to include projectiles from shoulder-fired weapons, mortars, small- to mid-range artillery, and cluster-bombs. Passive instruments are the best choice if the area has been subjected to aerial bombardment or large calibre artillery (above 200 mm) because of their

---

<sup>(16)</sup> The fluxgate magnetometer was invented by H. Aschenbrenner and G. Goubau in 1936, and developed by V. Vacquier and, independently, F. Foerster. For its history, see <http://www-ssc.igpp.ucla.edu/personnel/russell/ESS265/History.html>  
For more information you may like to contact companies selling fluxgate magnetometers, such as at <http://www.foerstergroup.com>  
<http://www.vallon.de> <http://www.ebingermbh.de> <http://www.bartington.com>

<sup>(17)</sup> For more information, you may like to contact companies selling alkali metal vapour magnetometers, such as those at <http://www.scintrextltd.com> <http://www.gemsys.ca>

increased detection depth. When the required depth of clearance exceeds 5 m, boreholes can be used to increase the detection depth.

The most effective method of detecting deeply buried items is by using geo-mapping and data-logging equipment along with the search instrument(s). This method can help to eliminate human error caused by an operator walking erratically and swinging a detector to the right and left while searching. It can also provide an accurate record for later analysis and verification. Because the previously cleared land is safe to walk on during the search, there is not a need for 'real-time' detection.

Geo-mapping involves using a simple assembly to hold the detector in a level, straight position while it is moved across the search area. This usually means that it is mounted on a vehicle. The data-logger records the signals. The search swathes can be either manually recorded or plotted by differential GPS systems for greater accuracy.

Maintaining the detector-head(s) in steady and parallel lines during the search provides signals that the computer can readily analyse to construct an image of them that is very easy to read. Expressed simply, when analysed by computer, the user can often reliably estimate the size and depth of the object detected (some hand-held operators claim they can do this accurately, but the claim is not verified). When looking for large, air-dropped munitions this information is essential in order to decide how large an area should be evacuated (for safety) during the excavation task.

## 2.5. Targets for routine metal detector checks

The targets used by deminers who want to check that their detector can find the threat in their area should match that threat. They may be actual examples of the mines (that have been rendered safe), substitutes made using the metal content from the target mines, or simulants that have a similar effect on a metal detector. These simulants may not have a metal content that copies the metal in the targets as long as a metal detector reacts similarly to it.

Figure 2.3 shows the metal content of some common anti-personnel blast mines. The presence of a number of metal



Figure 2.3:  
The metal content of some commonly found mines

parts does not necessarily mean that a mine will be easy to locate even if it is not deeply buried.

The GYATA 64 contains a large firing pin, coil- and leaf-springs, a circlip, a small piece of chopped lead and a detonator. The metal tends to rust and can be far more difficult to detect after it has corroded than it is when 'new'.

The R2M2 contains a stainless steel spring and ball bearings than can be very hard to detect. The pin is cut from a steel sewing needle and is very thin. So it is often only the aluminium-alloy of the small detonator shell that makes a metal detector signal.

The Type 72a has two small aluminium-alloy detonator shells one on top of the other, a steel-alloy pin and small spring that is part of the arming mechanism. The spring is made of a metal that may not signal even when held against a search-head. The pin is above the stacked detonators, so it is that tiny stack that a metal detector must find.

The only metal in the PMA-2 is the small aluminium-alloy detonator shell. Fortunately it is usually laid with its pressure 'spider' above ground and so the detonator is very close to the surface.

The PMN has a large firing pin, springs, a piece of chopped lead and a circlip. It is usually located by detecting the large aluminium-alloy band that clamps the rubber top in place. Metal detectors locate 'rings' of metal more easily than other shapes.

## 2.6. Real mined areas

The scenarios described in the GICHD 'Study of global operational needs' (see Section 2.1, 'Types of mined areas') were simplified in order to limit the variables to a manageable number and reach generalised conclusions. They serve the purpose of the study well, but should not be thought of as comprehensive. In fact, all mined areas are unique and present unique challenges and few fall neatly into any one of the categories the study has adopted. The photographs in this section are intended to provide readers with an idea of how varied the demining context can be.

### 2.6.1. Grassland

The three pictures below show deminers working on what might be defined as 'grassland' but each scenario is very different.



Mined area 'A' shows the clearance of a border minefield in Africa. The long grass is a small patch in dense bush. The mined area stretches hundreds of kilometres and passes through terrain from mountains to jungle.



Mined area 'B' shows clearance in the garden of houses inside a city in the Balkans. The clearance was complicated by burned out vehicles, possible booby traps and the discovery of corpses.



Mined area 'C' shows grassland around a pylon in Afghanistan. Unusually for Afghanistan, the ground was saturated and unstable.



### 2.6.2. Woodland

The nature of 'woodland' varies significantly according to your geographic location. The density of plant growth is perhaps the most obvious variation but some plants are also very fibrous and difficult to cut — and some woodland is the habitat of snakes and other dangerous wildlife.

As the GICHD study recognised, demining in these two environments are very different activities for many reasons other than the variation in vegetation but the vegetation variation is also significant.



Mined area 'A' shows woodland in the Balkans. The undergrowth between the trees is relatively low.



Mined area 'B' shows woodland in southern Africa. The undergrowth is dense and matted.

### 2.6.3. Open hillside

An 'open hillside' may imply the absence of an undergrowth problem but this may depend on the time of year, and also on what is thought of as 'open'. In some areas, the term 'hillside' may also imply a need for the deminers to have climbing skills.

Any description of a landscape is to some extent subjective. Our description of the road bridge in 'D' as 'heavily overgrown' might be challenged by someone working in a jungle area.



Mined areas 'B' and 'C' show deminers working on open hillsides in Afghanistan.



Mined area 'A' shows a hillside in the Balkans. The mined area crossed the hills but additional mines were placed in the gully where attackers might take cover.



Picture 'D' shows an open hillside in Africa. The heavily overgrown road bridge has been mined and the suspect area extends among the baobab trees where goats are allowed to graze.

#### 2.6.4. Unsurfaced roads and tracks

If a route is defined as including 10 m on both sides of the road (as it was for the GICHD study) the variation in what this can actually involve is as varied as mine-clearance itself.



Mined area 'A' shows a rough dirt road running through dense bush. Clearing the sides took far longer than clearing the road.



Mined area 'B' shows a dirt road near the coast where the ground is sandier and the undergrowth less dense. A mine is just visible in the picture (lower right).



Mined area 'C' <sup>(18)</sup> shows a dirt road that is mined and has been abandoned but is still used as a path. The belief that a person could not set off an anti-vehicle mine is very common but not always true. Anti-personnel mines are sometimes placed on top of an anti-vehicle mine.



Mined area 'D' <sup>(19)</sup> shows a dirt road that is being reclaimed by undergrowth. This is common and dirt road clearance can be complicated by difficulties locating the original route of the road. In extreme cases, the route is located by aerial survey.

<sup>(18)</sup> Photograph reproduced courtesy of Menschen gegen Minen (MgM), a German demining NGO.

<sup>(19)</sup> Photograph reproduced courtesy of Menschen gegen Minen (MgM), a German demining NGO.

### 2.6.5. Surfaced roads, railway tracks

Surfaced roads and railway tracks are part of a country's infrastructure that can be high demining priorities, along with power lines, bridges, dams, airports, etc. The variation in condition of the roads or railway lines can make it impossible to make general assumptions about the clearance that work worldwide.



Picture 'A' shows a broken road surface. Mines are often concealed in the potholes. They may also be concealed under the thin tar by melting areas and putting the soft tar back on top of mines.



Picture 'B' <sup>(20)</sup> shows a surfaced road that has become so damaged that it cannot be traversed in an ordinary vehicle.



Picture 'C' shows a railway line. Clearance is complicated by the presence of wrecked carriages and by the fact that the line has been turned upside down, then booby-trapped.

---

<sup>(20)</sup> Photograph reproduced courtesy of Menschen gegen Minen (MgM), a German demining NGO.

### 2.6.6. Urban (town or city)

Urban mined areas vary dramatically from town to town and country to country.



Mined area 'A' shows a suburb of a Balkan city. The building has been booby-trapped to prevent the return of the people who lived there.



Mined area 'B' shows a building in an abandoned part of an African city. Undergrowth is now a real problem for the deminers. The building is not booby-trapped but there are unexploded munitions around and the area around the building has been mined.



Picture 'C' shows a suburb in the same city where unexploded munitions are lying within metres of houses among rat-infested refuse. The difficulties deminers face are very different from those in the Balkans.



Picture 'D' shows a pile of ordnance in the foreground. The munitions have been moved by people anxious to rebuild after a conflict has ended. On this site, some people have built alongside the mined area and over the top of munitions.

### 2.6.7. Village

In different countries, a 'village' may mean anything from a group of stone houses with street lights and tarred roads to a cluster of reed huts.



Mined area 'A' shows the edge of a rural village in Africa. The suddenly dense undergrowth marks where a defensive minefield was placed. This village is still occupied and the mined area is used as a rubbish dump.



Mined area 'B' shows a village of brick and concrete that has been abandoned and so has become heavily overgrown.



Mined area 'C' shows mine clearance in a village in Cambodia. The village is occupied and the deminers have to work around the children and the chickens.

### 2.6.8. Mountain (high altitude, steep gradient)

Terms such as 'steep' and 'high altitude' allow a good deal of latitude depending on which country you are in.



Mined area 'A' shows a mountain gorge in Afghanistan where the road was defensively mined. The area around the road was actually quite readily accessible, but deminers did have to change the way that they worked in order to clear safely in a confined space.



Mined area 'B' shows a mountainous area in the Balkans. The mountains are not quite on the scale of those in Afghanistan. The area being cleared is not on the steep slopes, but it was still called 'mountain clearance' locally.



Mined area 'C' shows demining on what the Afghans call a 'hill' but would probably be called a 'mountain' in most other countries.

### 2.6.9. Desert

Deserts are not only rolling sand dunes sculpted by the wind — although these do pose special problems in demining because the depth of devices can vary overnight. Most areas of desert that are prioritised for clearance are used by people, so they are not entirely inhospitable.



Mined area 'A' is high in the mountains and the ground is not sand, but baked clay. The site is hard to get to and the ground is too hard to safely excavate.



Picture 'B' shows a common post-war problem, whether in the desert or the jungle. The abandoned tank contains a variety of ammunition and may be booby-trapped. Deminers have to clear around and inside it before it can be removed. Sometimes abandoned military assets also contain corpses that must be removed and disposed of with dignity.

Mined area 'C' shows another problem that deminers may find in remote areas of deserts. A nomad family has camped in the suspect area and the deminers must try to encourage the family to move before starting work.





### 2.6.10. Paddy field

A paddy field is usually part of a water management system that allows fields to be flooded in sequence. Because the land is regularly and deliberately immersed, mines inside the paddies can be especially difficult to clear. When the paddy is underwater, demining cannot be conducted. When the paddy is drained, it often dries to hard clay very quickly, so complicating the safe excavation of any metal detector signals.



Mined area 'A' shows paddies that are in use, but some of the walls between them are believed to have been mined. The walls are used as paths.



Mined area 'B' shows a road flanked by paddy fields. Mines were placed close to the trees to prevent sneak attacks on the village beyond. Notice the crude bridge made using rough timber. No heavy vehicle could cross that without it breaking.



Mined area 'C' is among the terraces on the right of this picture. The terraces are all paddy fields and the picture illustrates the way that paddy fields are not all on low ground or close to rivers.

## 2.6.11. Semi-arid savannah

Defined as having little vegetation, the circumstances that deminers face in arid grassland can also be very varied.



Mined area 'A' is an area of sparse grassland that was mined to prevent the movement of tanks across it. The ground is very hard and stony, and the grass never grows more than 20 cm high. The small bush that can be seen to the right of the deminer's head is very tough and can only be easily cut using wire-cutters.



Mined area 'B' is an area of arid grassland around the base of power lines which were mined to prevent attack. The deminer is checking how the sensitivity of his detector is affected close to the electromagnetic lines.



Mined area 'C' shows the same power line. Each pylon was mined, and some areas between them were also mined.



Picture 'D' shows a termite mound close to the pylon shown in 'C'. These are common obstacles in some countries. In many places, deminers have to cope with biting insects and venomous snakes.

### 2.6.12. Bush

'Bush' is the term used throughout Africa for the light forest that covers a significant proportion of the continent. It usually comprises well-spaced trees without dense undergrowth beneath. The height of the trees depends on the rainfall and the soil quality.



Mined area 'A' shows bush on the approaches to a reservoir. The area was mined to prevent attacks on the water supply.

Mined area 'B' is part of a border minefield. It shows how conditions in the bush vary according to the season — and also the way that wildlife may find sanctuary in mined areas. The presence of a healthy giraffe does not prove the area is safe, the bones of less lucky animals are further inside the minebelt.



Mined area 'C' shows an area where bush has been reclaiming farmed land for 20 years. The deminer has just cut the small tree he is carrying out of the way. When bush is growing up, the area between the trees tends to be densely overgrown.



Mined area 'D' was taken further along the border in the same minefield as picture 'B'. The land in these areas is often very irregular, including ravines and massive obstructions like these boulders.



# Chapter 3: Detector standards and detector test standards

The first metal detectors to be used as mine-detectors were developed for the military. Following military custom, a written instruction was produced for their use and this provided a 'standard' for the users. Since then, other 'standards' for metal detector use have been developed by organisations that use detectors in their work (such as police, customs and security organisations). The most comprehensive of these 'standards' cover design and manufacturing features as well as performance specifications/expectations.

## 3.1. International standards for metal detectors

In recent years, a need for a metal detector standard that is relevant to humanitarian demining has been recognised. This need became urgent as detector manufacturers began to offer products with widely varying capabilities. Today's purchasers need independently derived and universally applied 'benchmarks' to help them select which metal detectors to buy.

Because military forces can be directly involved in breaching through minefields, some of their needs are shared

with HD, so the existing standards of most immediate relevance to HD are those used by military forces. The standard documents in this area are the National Institute of Justice (NIJ) Standard 0602.02 (September 2000), and Performance Specification MIL-PRF-23359H (November 1997). The latter has been widely adopted/adapted for use by the armed forces in countries other than the United States. The 'International test operational procedures standards' (ITOP) was another document adopted in 1999 by France, Germany, the United Kingdom and the United States. The Performance Specification MIL-PRF-23359H and its variations all include a detailed specification of military needs that includes many elements that are of no relevance in humanitarian demining. For example, there are general requirements that the detectors have a 'camouflage' colour, that they be hardened against nuclear, biological, chemical (NBC) agents, and that they operate without visible or audible emissions. Some performance specifications are not only unnecessary, but are inadequate for HD. For example, the MIL standard states that a detector should 'have a greater than 92 % probability of detecting standard metallic military mines ... and mines containing small metallic content'. This level of detector performance is inadequate for HD. Also, the scope of the MIL standard does not cover the many variables that affect detector performance so

does not lend itself to adaptation for HD purposes. Similarly, the ITOP (which has been adopted by NATO) defines detection standards and testing requirements from a military perspective that is only partially applicable to HD and cannot be readily adapted.

The UN's International Mine Action Standards include a standard for the 'Test and evaluation of mine action equipment' (IMAS 03.40), which outlines basic principles for test and evaluation techniques. Being a document with wide applicability, it does not provide specific content of relevance to testing and evaluating metal detectors, but it does provide a basic template that could be used to build a standard.

### **3.2. International standards for metal detectors in humanitarian demining**

When this book was in preparation, the first agreement over standards for metal detectors in HD was reached. The process began when the European Commission mandated the European Committee for Standardisation (CEN)

(<sup>21</sup>) to make progress in standardisation within humanitarian demining. In response, CEN BT/WG 126 was established. WG 126 recommended that CEN workshops should be established to work on the test and evaluation of both metal detectors and mechanical equipment for use in HD. The international test and evaluation programme (ITEP) (<sup>22</sup>) also requested a CEN workshop on metal detector testing and evaluation.

Before European standards are formally adopted, they must go through a ratification process that can take several years. However, a CEN workshop agreement is similar to a 'draft' standard and can be used pending achievement of a formal European standard. Any European standard on metal detectors that is produced may or may not be based on the CEN workshop agreement.

The UNMAS has agreed to reference the CEN workshop agreement in its IMAS.

Adoption of the CEN workshop agreement will allow test and evaluation of metal detectors in HD to be made in an internationally standardised way. Like IMAS documents, the agreement will be subject to revision over time. The early adoption of this agreement allows purchasers to understand better what they are buying and this should increase safety by ensuring that deminers are using the

---

(<sup>21</sup>) The CEN is the European standardisation organisation that establishes common standards for industry and science and of which almost all European countries are members.

(<sup>22</sup>) The ITEP develops standards for testing and evaluating all kind of humanitarian demining equipment.

best tools for the job. The CEN agreement also provides manufacturers with procedures that make it easier for them to evaluate their own products. CWA 14747:2003 (the agreement from CEN workshop 07), was formally published on 18 June 2003 <sup>(23)</sup>.

### 3.3. European Committee for Standardisation workshop agreement (CWA 14747:2003)

The CWA 14747:2003 lists the metal detector tests that are of greatest relevance in HD. It details how the detectors should be tested, so allowing manufacturers to know what is expected from their products. It is hoped that this will make it easier for manufacturers to respond to the needs in HD. The manufacturers will know what they should do to characterise their detector's performance, its different technical functions, durability, ergonomics, and maintenance. They will have the added advantage of knowing the tests that will be applied to their competitors' equipment, and so be better able to estimate the relative success of their products. It is not expected that this will result in all detectors becoming the same because the agreement only provides a **minimum** test and evaluation

regime. Manufacturers can make their detectors do more, and the agreement includes suggestions for additional tests and specialist goals that are not 'standard' requirements. The agreement specifies the minimum information that manufacturers should supply with their products and states how that information should be derived.

#### 3.3.1. What is covered by the detector test agreement?

The tests are divided into those specified by the user, those carried out in air and in the ground, and field tests (which may be in air or in the ground). Some can only be done under controlled conditions in laboratories while others can only be done in the field. Advice and directions on how to carry them out are given, along with indications of the kind of measurements to be made and how to record and analyse the results.

The tests of detectors carried out in laboratories under controlled conditions should be identical in order for their results to be replicable and directly comparable. The results will provide an overview of technical details and performance characteristics that makes it easier for a prospective purchaser to pre-select a shortlist of potential products.

---

<sup>(23)</sup> CEN workshop agreement, 'Humanitarian mine action — Test and evaluation — Metal detectors', CWA 14747:2003, published 18 June 2003.

Currently, purchasers may have to test many makes and models of detector in their working area before they can choose which model to buy. With CWA 14747:2003 in place, the purchaser should get enough information to start to make informed judgements over which detectors are suitable for the proposed area of use. When coupled with some of the information given in this book, the authors believe that end-users will be able to carry out a pre-selection that refines possible choices to just a few models (or possibly only one) before any field trials.

The CEN agreement cannot be retrospective, so there will be no information about many detectors that are in use but have been superseded in manufacture. This information may be essential when the end-users are trying to determine the possible advantages of upgrading the metal detectors they use. At present there are unconfirmed plans for tests of the currently used detector fleet to be made under the neutral auspices of the ITEP.

The matrix in Annex D gives an overview of the CWA 14747:2003 tests. We have designed the structure to aid understanding rather than to reflect any internal structure of the agreement itself. Similarly, we have sometimes used naming conventions to assist understanding rather than those used in the agreement. Despite these minor changes, we are confident that the reader will have no difficulty locating relevant tests in the formal document.

Some of the user and miscellaneous tests are not finely detailed. This is because they are intended to cover the users'

unique needs in their own area. For example, the targets used in miscellaneous tests must match the anticipated threat in the area where the detector will be used. It is recommended that such targets include 'difficult' mines and commonly found mined-area scrap metal pieces. The inclusion of scrap metal may help the deminer to gain confidence about the detector's ability and detection depth. It will also make the deminer familiar with the varied audible signals that the detector may make. The combination of targets used and the ground in which they are concealed will make each purchaser's miscellaneous testing unique. Unlike the laboratory tests, the results are unlikely to be directly relevant to a different purchaser in another area.

### **3.4. Previous metal detector tests in humanitarian demining**

Armed forces all over the world have carried out selection tests in order to decide which equipment to purchase. Anecdotal evidence suggests that commercial interests may occasionally have outweighed the interests of the end-users. For example, a particular detector's performance may have been adopted as the benchmark, which makes it unlikely that any other detector would 'beat' it in all areas. But in most cases a genuine attempt has been made to make an unbiased selection. However, as previously mentioned, the requirements of armed forces are not the same as the needs in HD.



During the 1990s, metal detector manufacturers selling to the HD market found that there was a demand for some performance characteristics that had not been needed by their military and ‘treasure-hunter’ customers. Using a detector for six hours every day, for example, led to a long and reliable battery-life having a high priority. It was no longer acceptable simply to advise that new batteries be used each time the detector was used. Despite a relatively small number of potential customers in HD, many manufacturers have invested heavily in the refinement and revision of their detectors to meet HD needs. This may be because they recognise that a selectable performance level and improved ergonomics would also be attractive to their military market. The commitment and the interest involved in detector development over the past decade leaves the authors convinced that a ‘smart detector’ <sup>(24)</sup> will soon be available. In this context, ‘soon’ may be as early as next year. There is already one ‘dual-sensor’ detector (see Annex B, Section B2.8.1, ‘Metal detection and ground-penetrating radar’) combining metal detection with a ground-penetrating radar in military use, and this may be improved and refined for appropriate HD use within the next few years.

During the period of rapid metal detector development, formal HD evaluation of some models was carried out in Cambodia, Afghanistan, Mozambique and Bosnia and Herzegovina. Most of these field trials made direct per-

formance comparisons between the available detectors but the full results were not published. The ‘trials’ became internal ‘selection’ procedures and although the results were shared informally, the testing itself varied and the results were often of little relevance to a demining group working on another continent.

The Cambodia trials were carried out in the mid-1990s. The Bosnia and Herzegovina trials were carried out in 1997. Trials in Afghanistan were carried out in 1999, 2000 and 2002. Preliminary and final trials were carried out in Mozambique in 1999 and 2000. In each place, the detail of the testing varied, and in most places, the models of detector tested also varied. There were many variations in testing protocols, models of detector and the way that results were recorded. Apart from learning from each other about how field trials should be conducted, the results from each trial could not be usefully shared. For similar reasons, the results of many smaller trials carried out by individual demining groups cannot be usefully shared with others.

The most sophisticated and expensive series of detector trials/tests was started by the international pilot project for technical cooperation (IPPTC) <sup>(25)</sup> in December 1998. This was a brave attempt to achieve an objective comparison of 29 different models of metal detector and included laboratory and field tests on three continents. It took

---

<sup>(24)</sup> ‘Smart’ metal detector — A detector capable of reducing ‘false’ alarms by providing reliable information about the size, shape and/or type of metal detected.

<sup>(25)</sup> Participants — Canada, European Commission, the Netherlands, United Kingdom, United States.

21 months to complete the trials and a further eight months to publish the results. Some criticisms of the range of tests and the models 'selected' were made <sup>(26)</sup> but the major weakness of the results was the time it took for them to be made available. Almost three years after the detectors were selected for test, a whole new generation of untested detectors were already on the market. A substantial amount of time, effort and money had been spent in an attempt to make it easy for a purchaser to choose the **best** detector for his needs, but the value of the results was compromised by the late publication. Much of the delay in this project was due to protracted discussions about what tests to conduct and how to report the results. It is hoped that the existence of CWA 14747 reduces this problem in subsequent similar trials.

### 3.4.1. Why so many field trials?

There are several reasons for the rush of metal detector trials in recent years. Chief among these is the fact that organisations in HD subject their detectors to heavy use, and even the most robust usually need replacement every three to five years. Some HD organisations also update their detectors regularly to improve the clearance output or the safety of the deminer. In other cases, sponsors,

donors or controlling agencies may have required that equipment trials be carried out. Whatever the reason for replacing an old detector, it was the range of new models that dictated that the user should not simply buy more of what he had last time. Without the help of repeatable tests and a standard that allowed the purchaser to predict how a particular detector would perform, comparative field trials had to be carried out. Even when CWA 14747:2003 has been in use for some time, a purchaser cannot accurately predict how a detector will actually perform in the local ground conditions. This is largely because local mined area survey groups have no simple and scientifically rigorous way of measuring and recording those conditions. This problem has been recognised and research into defining and resolving it is currently under way. In the meantime, CWA 14747:2003 should mean that the users only have to field trial a few models.

## 3.5. The output of humanitarian demining detector trials

Since the trial in Bosnia and Herzegovina <sup>(27)</sup>, all major HD field trials have had a structure similar to that adopted by

---

<sup>(26)</sup> Sometimes detector users did not understand the practical value of the tests, why some of their concerns were not covered, or why they included tests of detectors that had never been used in HD.

<sup>(27)</sup> Full title, 'Hand-held metal detector trial conducted in the Former Republic of Yugoslavia', January 1997 (Bosnia and Herzegovina, Sarajevo, Mostar), for the UN Mine Action Centre Sarajevo.

CWA 14747:2003. They have involved tests in air, in the ground and to meet the specific needs of HD in the area. Over the same period, small demining organisations and institutes also conducted independent tests — either for purchasing detectors or for special research aims. Generally, the aim was to determine the **best** overall detector, but this objective was not achieved — possibly because a universal detector has not yet been made. Most of the well-known detectors have advantages and weaknesses, performing better and worse than their competitors in varied contexts.

The results were intended to provide an overview of:

- (a) the basic detection capability of the detectors;
- (b) the detectors' reaction to the metals used in mines;
- (c) what influenced the detector's signal <sup>(28)</sup>; and
- (d) whether it was possible to detect targets in magnetic ground conditions, and if so, how best to do this.

Tests (a) to (c) are 'general' tests while (d) is specific to the user group's requirements. This does not imply that (a) to (c) are less important, although the decision over which detector to purchase will depend heavily on a positive result for (d). This is because in test (d) detectors are tested against the greatest threat in the area. In most cases,

this will be a mine with a minimum metal content. Minimum metal mines are not always the main cause of civilian casualties, but they are usually the targets most likely to be missed when using a metal detector. It is not possible for an outsider to reliably state which mine will be most difficult to detect because mines deteriorate in various ways and may become more difficult to detect with the passage of time. An example is the GYATA-64, which has a large metal content, but can become very hard to detect when the metal corrodes (see Figure 2.3).

The tests of detection capability in air and in the ground are also important. Their results provide a ready comparison of each detector's general ability to detect metal, ease of use and ability to work in the relevant ground conditions. Most detectors sold for use in HD today have a GC capability intended to filter out magnetic interference from the ground. Their designers have developed different technologies to achieve this end. Some detectors automatically and constantly search the ground for changes in the background magnetic 'noise' in order to filter it out. Others have to be manually 'set up' to compensate for magnetic ground. Still others compensate semi-automatically with the user applying some procedures. The relevant method is described in the detector's user manual and should be followed strictly. The various processes involved in achieving ground compensation mean that some detectors maintain their detection

---

<sup>(28)</sup> See Section 2.3, 'Using metal detectors in area demining'.

sensitivity while others have a reduced detection capability when in GC mode. A loss of detection sensitivity means a reduced depth at which targets can be detected.

The sensitivity of some detectors cannot be reduced. Others can be reduced, but this facility must be limited so that detection capability is never reduced to zero without switching off the detector. An erratic or automatic reduction of sensitivity must be avoided for obvious reasons. The sensitivity tests (a) to (c) will help to reveal a detector's general strengths and weaknesses.

The tests include other features such as the ability to differentiate between two targets, to detect along linear targets (metal fences, railways, gates, etc.), to detect tripwires, and to determine the shape and position of targets (pinpointing). These special tests may vary for the region but they are of great importance in building deminer confidence in the equipment.

### 3.6. Output of the international pilot project for technical cooperation trials

The IPPTC trials were the most comprehensive and scientifically sophisticated trials of metal detectors to date. New testing equipment was developed and a new approach towards ease of test replication was adopted,

although some of the trials could only be done with special measuring instruments that are not commonly available. The following examples briefly describe the IPPTC approach — from which many lessons have been learned and many aspects have been incorporated into the CWA 14747:2003.

The results of the IPPTC trials were recorded in a neutral manner and made widely available. The readers of the results are presumed to have knowledge of detectors and the ability to analyse the conclusions to meet their own needs. Unfortunately, the results had been superseded by new detector developments even before they were published. The IPPTC trials began in 1999. By December 2000 (when the Mozambique accelerated demining programme (ADP) trials began), six new or varied models were available for inclusion. At the time of writing (three years later), the authors are aware of a further six models that would be included in any current assessment.

#### 3.6.1. Tests in air

The following tests were conducted in air and in laboratories under controlled environmental conditions. The same tests could be carried out in the field but they would be less controlled and environmental variables could influence the results.

- **Calibration test.** The calibration test established the repeatability of the detector's set-up routine. The

distance was measured at which a specific target could be detected after each detector was set up to the manufacturer's specifications. The practical results showed differences between the types of detector, with the distance fluctuating up to 8 cm. These differences could be life-threatening in a mined area if the check against a 'confidence target' is not done.

- **Drift test.** The drift test measured the detector's ability to locate the same target over a 30-minute period. The detector was set up as specified for the start of the test, and not adjusted during the test. The results showed a fluctuation of up to 9 cm. Fluctuations of this magnitude could lead to mines being missed.
- **Moisture test.** This test checked whether the presence of moisture on the search-head affected the detection capability. A detector head may be wet after rain or when there is dew on the ground (it is not 'normal' for deminers to work in the rain). The results showed that the presence of moisture could reduce the detection distance by up to 11 cm.
- **Sweep speed test.** This test was to determine whether a particular speed of detector-head movement gave the best detection capability. The results identified the optimum speeds and should also alert users that the sweep-speed can be important.
- **Scan profile test.** This was the first time that a 'scan profile test' to determine the 'footprint' of a detector had been included in any formal trials. A standard tar-

get was used and the magnetic search field was measured at different depths between it and the search-head. The results showed that all the detectors tested had a crudely conical footprint (widest at the top), although some of the manufacturers have previously stated that this is not really so. Depending on the detector, the target and its position, the results showed each detector's sensitivity in air. The practical use of this test is explained in Section 5.4.2, 'Search-head sensitivity profile (footprint)'.

### 3.6.2. Tests in the ground

The in-ground tests were intended to establish the detectors' ability to locate standard and other targets at varied depths and in magnetic ground. Targets were selected and placed, with detailed records of the time of placement and their precise position recorded.

### 3.6.3. Tests in the field

The IPPTC field tests were carried out in Cambodia and Croatia. After the publication of the results, another test was conducted in Central America. In each of these tests, varied ground was used to help define the detection capability. The conductivity of each ground type was measured vertically and horizontally. The magnetic susceptibility was also measured. Unfortunately, these measurements have not provided an answer to the question

'what has direct influence on the performance of the detector'. This means that, at present, only a test in the place of use can provide an accurate indication of how a detector will perform there.

Comparing the detection of the same targets in air and in the ground gave an indication of how severely the influence of magnetic ground could affect performance. The results can be summarised as:

- All detectors were influenced by the reaction between magnetism in the ground and the detector's electro-magnetic field. Manufacturers' attempts to reduce the influence used varied approaches, some of which were more effective than others.
- Some detectors that could not be set up to compensate for ground magnetism were unable to detect mines with a minimum metal content in magnetic ground. Some of those detectors could not reliably detect mines in non-magnetic ground at depths of 20 cm.
- Some detectors could be set up to compensate for difficult ground but lost detection sensitivity as a result.
- Some detectors could be set up to compensate for difficult ground while maintaining a normal detection sensitivity in air.

---

<sup>(29)</sup> The US army are reported to have used a graded system defining magnetic properties of soil in the 1960s. This knowledge was lost and was not known to participants in the ADP when their test area was devised.

### 3.6.4. Miscellaneous tests

The mine action centres responsible for providing support and personnel for the tests added the miscellaneous tests. The targets were almost all the problem mines (or parts of the mines) that were found in the country where the testing occurred.

## 3.7. Output of other tests/trials

Most other international tests were carried out under the control of (or on behalf of) the UNMAS. In these, groups of specialists carried out tests to determine the detectors' suitability for purchase for use in UN-directed mine clearance operations. The detectors under test varied from trial to trial but the structure and content of all the trials was generally similar. An exception was the test/trial carried out in Mozambique by the UN accelerated demining programme. This test/trial differed because it included measuring the detector's reaction to magnetic ground <sup>(29)</sup>, and because all the short-listed detectors were used in different mined areas ('live') for several weeks.

The ADP quality assurance team that conducted the tests established their own method of measuring the magnetic ground interference in their varied working areas. The tool

used to make the measurements was the most common metal detector available to the ADP. It was used because it was available and because it was a static detector that gave a constant reading when held stationary above a target and/or magnetic ground.

The detector was set at a particular sensitivity and lifted above the ground to the level where the audible detector signal stopped. See Annex E, 'Calibration of the Schiebel AN19/2 M7', for a description of how to calibrate the detector before doing this. The distance from the search-head

to the ground was measured. This gave a crudely repeatable measure by which a magnetic ground interference 'reference' could be determined. By testing all types of detector used by the ADP on ground with measured levels of magnetic interference, it was possible to usefully predict each type of detector's performance in ground with similar magnetic properties. Later, using dedicated measuring instruments, it was confirmed that the 'reference' results from the Schiebel detector were accurate enough to be reliably used to anticipate the increased detection difficulty as the ground reference height (GRH) increased.

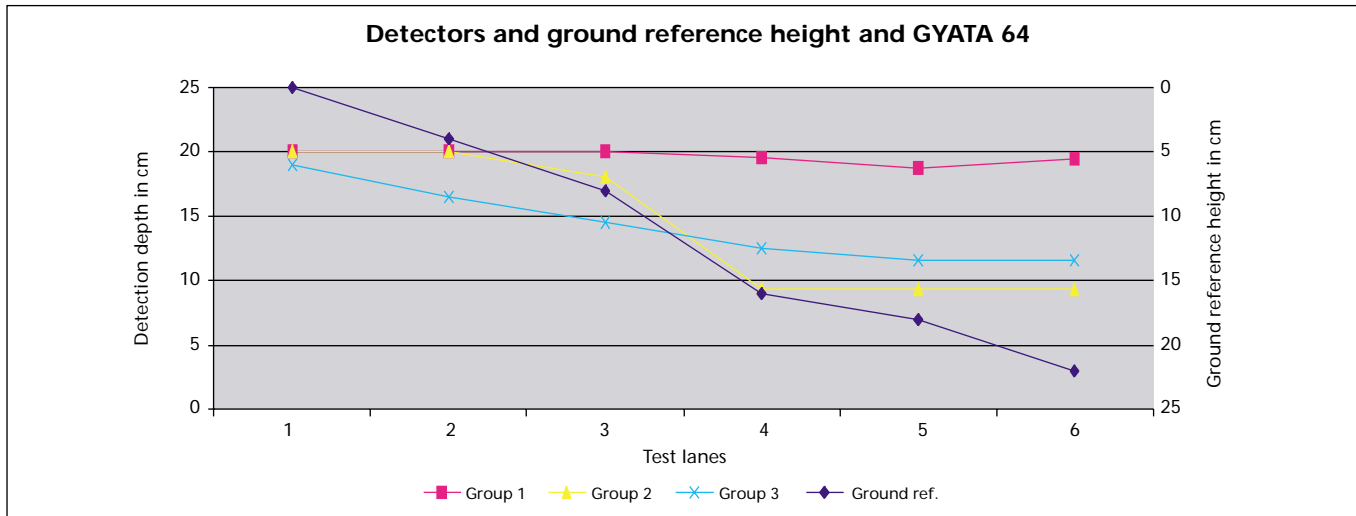

Figure 3.1: Summarised results using a Gyata-64 AP blast mine as the target

To carry out the tests, the ADP built protected lanes filled with varied reference ground in their dedicated training area. This facility was unique at the time, and is still available for others to use. Their results showed a clear link between magnetic ground interference and the depth at which targets could be detected.

The left vertical axis shows detection depth in centimetres. The horizontal axis shows the test lane in which the target was concealed. The right vertical axis shows the reversed GRH to illustrate how it affects the detection

ability. Each lane has a different magnetic ground reference, with increased magnetic ‘disturbance’ as you read from left to right. See Figure 2.3 for a picture of the GYATA-64 showing its large metal content.

Group 1 comprised the ADP’s preferred detectors, all of which had a GC capability. Group 2 comprised ground compensating detectors that lost significant sensitivity when the GC feature was used. Group 3 comprised detectors that had no GC capability.

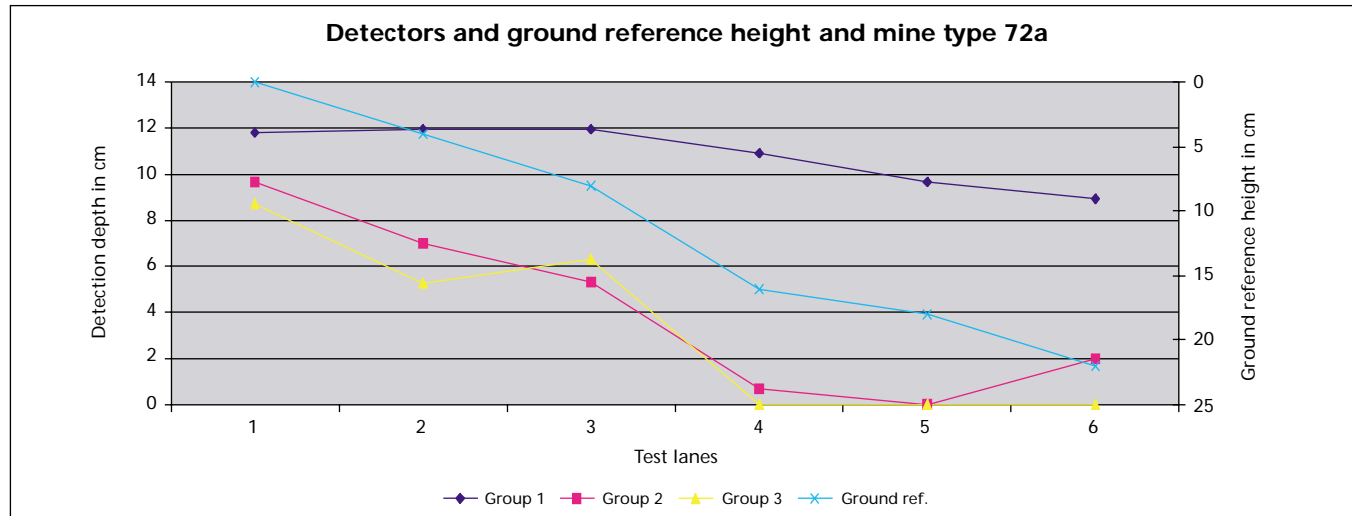

Figure 3.2: Summarised results using a Type 72A blast mine as the target



The graph illustrates the reaction of the detectors to the increasing magnetic interference in the test lanes. With the increase of the magnetic interference, Groups 2 and 3 lost sensitivity by around half or became entirely incapable of detecting the target (depending on the target's metal content). A certain stabilisation of performance occurred in Test Lane 4, which was defined as the 'medium' magnetic ground reference.

The left vertical axis shows detection depth in centimetres. The horizontal axis shows the test lane in which the target was concealed. The right vertical axis shows the reversed GRH to illustrate how it affects the detection ability. Each lane has a different magnetic ground reference, with increased magnetic 'disturbance' as you read from left to right.

The ADP found the performance of the detectors in Groups 2 and 3 unacceptable when the magnetic ground reference was higher than 8 cm (which was the measured benchmark for the third lane (TL 3) in the training area). See Figure 2.3 for a picture of Type 72a showing its small metal content.

Since the completion of the test/trial, some detector manufacturers have used the ADP test lanes for internal assessments of their detectors. The ADP continues to use its make-shift measuring method to get a crude record of magnetic interference during technical surveys because it

allows them to determine which model of detector to use in that area. While it may not be 'scientifically rigorous', they are in no doubt that it is useful when planning the deployment of their detector fleet.

In their test conclusion in 2000, representatives of the ADP stated that the:

'ADP knows of no instrument that measures the level of magnetic interference ground reference. Our approach is one simple way, but not a solution. The issue of being able to measure a ground reference will gain importance when the IMSMA (information management system for mine action) database is available worldwide. It will then become important to have a worldwide standard. Survey can define the ground reference level in numbers and the detectors will be easy to assess against specified targets, under equal conditions.'

Later in the IPPTC report's abstract and conclusions, a similar statement recommended that mined-area surveyors should conduct simple conductivity and susceptibility measurements<sup>(30)</sup>. Specialist equipment to do this does exist. Called 'susceptibility meters', the HD community has yet to fully recognise their potential value.

While laboratory testing provides a high-level quality check, it cannot cover practical concerns such as how easily the deminers can set up the detector or how much it is

---

<sup>(30)</sup> CCMAT Canada carried out measurements of the magnetic properties of the ground before the IPPTC trial.



*Figure 3.3:*  
A Bartington meter for measuring magnetic ground disturbance. Notice the way that it resembles a conventional metal detector.

setting 'drifts' during real use. Neither can tests in air give results that can be used to reliably infer a metal detector's performance in real ground conditions. Laboratory tests are invaluable but must still be followed by field trials in the area of use. After successful trials, deminers should always perform a 'confidence' test against a realistic target directly before entering each mined area. This final test must always be conducted as close as possible to the area where the detector will be employed.

### 3.8. Do current detectors match the needs in humanitarian demining?

If an experienced deminer were asked, 'Do the detectors on the market match the needs in the field?' the usual answer would probably include, 'yes', 'if' and 'but'.

The deminer would only answer 'no' when the detector was being used at its technical limits. Although work is constantly ongoing to improve detectors, the work is constrained by the fact that the effects of varying ground conditions on detector performance are not clearly understood.

A detector's limitations can be defined by reference to three performance areas. The first is its ability to detect a range of different kinds of sizes of metal targets. This 'advantage' may be complicated by the 'disadvantage' of an increased alarm rate if tiny metal targets are then detectable. The second performance area is the sensitivity or detection depth, which is dependent on the target and the user's skills. The third performance area is the detector's ability to compensate for the magnetic interference from the ground — and the effect the compensation may have on the first two.

If manufacturers are to improve their detectors further, more information is needed from the field. It would, for example, be possible for existing geological data to be combined with information gained during mined-area surveys, and those data to be included in the IMSMA

database. To achieve this, standard tools and procedures for collecting ground samples and magnetic reference data would have to be agreed. The results would be useful for planning the appropriate clearance resources to use in an area, and could also give scientists a better idea of the range of magnetic ground problems that could be expected within a particular country.

### 3.9. Lessons for future tests/trials

Summarised reports of previous detector tests/trials are available on various websites. While lacking detail, these give the basic test structure and the general conclusions of the test/trials. Some general lessons that may be of use to anyone planning detector tests/trials can be derived from them. In brief, these are listed below.

1. Begin by clearly defining the aim and objectives of the test/assessment — including the type of target and the context in which it must be found.
2. Select the detectors to test with reference to the aims and objectives. Narrow down the selection to meet the particular need.
3. Devise tests that can be repeated in the future — so allowing the results to be updated without the need to conduct complete retrials. Be aware of import restrictions and try to ensure that no restricted equipment is used.
4. Describe the tests and how the data will be collected and assessed as clearly as possible before starting any part of the tests.
5. Tell the manufacturers your aims and objectives and ask them to advise which of their detectors are most likely to meet your needs.
6. Give the manufacturers the opportunity to include prototype models of new developments in the range of detectors for test/trial.
7. Prepare a test area that includes a range of typical soil/ground from the mined areas where you will work.
8. Include 'end-users' in the testing. Prepare questionnaires designed to record the end-user's opinions on ease-of-use, ergonomics, training, durability, etc.
9. Include as many real targets in your test/trial as possible. These should represent the main threat from the areas where the detector will be used. (Remember that the 'main threat' is defined as the device(s) most likely to be missed with a detector.)
10. Be aware that individuals influence results. The result of the same test with the same detector may vary according to the operator. Devise your tests/trials to overcome this by repeating them with as many operators as is practical. Also, before the test/trial, you should decide how any conflict or contradictions in the results will be evaluated.

11. Define how you will assess the training and maintenance package that will be available.
12. Decide how to calculate the potential detectors' running costs.
13. Establish contacts enabling you to ask other organisations about their experiences with the detectors that perform well.

### **3.9.1. Data collection/analysis during field tests/trials**

Decisions over what data to collect and how to record that information should be made at the same time as deciding the aims and objectives of the test/trial. These decisions should lead to the preparation of simple data-record sheets that will be filled out during the test/trial. The easier the data-record sheets are to understand and complete, the fewer mistakes will be made. A well-designed record sheet will require the recorder to frequently mark a 'Hit/Miss' or 'Yes/No' choice that minimises subjective judgement. The design of the data-record sheets should also allow easy comparison between recorded results, such as: the sensitivity in air to the same target; differentiation between two targets; the detection of targets close to large linear metal targets; etc. For consistency between trials, distances and depths should be measured in millimetres. With enough forward planning, field test/trial data can be measured and recorded by peo-

ple without any special qualifications as long as they pay attention to detail.

Depending on the country and the clearance depth required, the targets should be buried at several depths that reflect the depth of mines actually found. For the sensitivity measurement, the targets should be buried at the maximum clearance depth required. When measuring a target's depth, all targets (mines, simulants or surrogates) must be measured to the top of the target. If targets are placed some time before the test/trials, a check should be made to ensure that the depth of each target has not changed. This check must not disturb the ground in a way that could affect the detectability of the targets. We recommend using a thin, stiff wire to penetrate the ground directly above the target, then measuring the depth at which the obstruction is encountered. Do not place targets inside plastic tubes in magnetic ground because the presence of the tube influences some detectors and can make detectors signal (in a similar way to false readings from cracks in sun-baked ground). We recommend that small targets are set in a larger resin casting or made a part of a bigger target that is easier to deploy accurately and to find later.

The following information should be collected before and during the test/trial. More data may be included, but they are unlikely to affect the result and may confuse the analysis. If no specialist measuring instruments are available this is unlikely to affect the test/trial results but it may make them less useful or compelling to others.

We recommend that the following general information about each test/trial be recorded.

- Ideally, the magnetic ground properties should be recorded so that the test/trial results can be compared with those from other tests where the same magnetic measurements were made. Such a comparison may be more useful after the completion of further research into the way that various ground conditions affect detector performance, but the data should be gathered now.
- Information about the test area, the targets and their placement should be noted, including a geo-reference for the site and details of controls and inspections.
- Fully detail the make, model and year of manufacture of the detectors involved as well as the used targets.
- Record the meteorological conditions in the test area regularly during the test/trial. This should include a record of the temperature (or the air and ground), ground moisture, humidity, and the wind speed and direction.
- Describe the ground conditions accurately. This should vary for lanes that have been made using difficult soil/ground brought to the test area. Record the various magnetic properties and include details of how these measurements were obtained. Record the scrap metal content (if any), composition, texture, distribution of stones/rock, moisture content and vegetation that is present for each lane in the test area.

- Record all the test/trial results as accurately as possible using prepared data sheets designed for ease of use.
- Describe the conduct of the tests/trials in detail, covering the start/stop times and those requirements made in relevant demining group SOPs.

As well as actual performance data, we recommend that the following information about detectors be recorded during the actual test/trials. This will make the subsequent evaluation easier.

- Record any reliability and compatibility events experienced during preparation.
- Make a safety assessment of each model, including ergonomic and human health aspects.
- Record the training required before first use, and assess the ease of training for general use for each model.
- Record any apparent effects of the climate on each model.
- Examine and record any transportation and handling issues.
- Examine each model for apparent durability and record notes on the 'supportability' of the equipment in the field.

After analysis, the data collected should be presented in a way that makes them easy to understand. This may be in

text, tables, photographs, video, charts, and/or graphs. The data should be described in sufficient detail to enable the reader to understand the basis for the analysis and conclusions. For more information the reader should consult CWA 14747:2003.

# Chapter 4: Metal detector technology

This chapter introduces the technology on which current metal detectors rely. The principles are explained, and some of the science is introduced so that you can better understand why the metal detector is the most commonly used detection tool in demining. A better understanding of why detectors work can significantly increase safety and efficiency.

## 4.1. How metal detectors work

This section explains the principle of electromagnetic induction.

When a metal detector is switched on, an electric current is passed around the windings of a coil which is contained in the search-head. Electric currents always produce **magnetic fields**, that is to say, they can exert a force on iron (and certain other materials) and can align a compass needle, just like an ordinary magnet or the natural north-south field of the earth. <sup>(31)</sup>.) The expression 'magnetic field' means an area of space where there is a magnetic effect with significant strength, pointing in a definite direction.

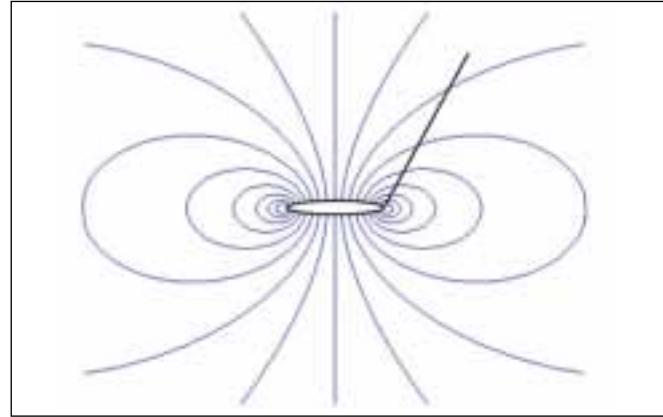

Figure 4.1: The primary magnetic field of a metal detector

The magnetic field generated by the current flowing in the search-head is called the 'primary magnetic field'. The direction of the field is along the lines, which are called 'lines of flux', shown in Figure 4.1. The strength of the field is proportional to the density of the lines of flux. The field is strongest near to the wires of the coil where the lines of flux are concentrated, and the direction of the field is so that the lines of flux make loops around the wires of the coil.

<sup>(31)</sup> The generation of magnetic fields by electric currents was discovered by H. C. Ørsted of the University of Copenhagen in 1820 and developed in detail by D. F. J. Arago and A. Ampère in Paris in the same year.

The electronic circuit of the detector is designed to provide the current in the coil either in the form of pulses or in the form of a smoothly varying wave. In both cases the current repeats, usually at between 1 000 times and 50 000 times a second. As a result, the magnetic field of the metal detector varies rapidly in time as well as in space — which is unlike the field of any ordinary magnet or the magnetic field of the planet itself.

The laws of electromagnetic induction <sup>(32)</sup> state the following.

1. A time-varying magnetic field induces an electric voltage which is proportional to the rate of change of the magnetic flux.
2. The induced voltage is in a direction, positive or negative, so that it opposes the change that produced it.

Metals conduct electricity. This means that electric currents flow in them when an electric voltage is applied.

When a piece of metal is put in the changing magnetic field of a detector's search-head, the following happens.

- (a) If the metal is magnetic (such as ordinary mild steel), it will become magnetised. The magnetised metal will produce its own magnetic field.

- (b) Whether or not the metal is magnetic, the electric voltage induced by the changing magnetic field makes currents flow around in the metal (following the first law of electromagnetic induction). The currents tend to flow around the lines of flux in patterns like eddies in a river, so they are called 'eddy currents'. The eddy currents also produce their own magnetic field.

For both reasons, metal objects generate a 'secondary magnetic field'. It spreads out in space and reaches back to the wires of the coil in the search-head. This secondary field varies in time along with the primary field. Again, according to the first law, an electric voltage is then induced in the coil. Following the second law, this voltage will tend to oppose the efforts of the circuit to vary the current.

An electronic circuit measures the induced voltage in the coil. This voltage consists of a fixed part, induced by the primary magnetic field, and a part induced by the secondary magnetic field which only occurs when a metal object is present. The circuit is constructed to sound an alarm when the induced voltage rises above a chosen threshold. The threshold is adjusted until the detector remains quiet in the absence of metal and signals only when metal is present.

---

<sup>(32)</sup> The first law of electromagnetic induction was discovered by M. Faraday of the Royal Institution, London, in 1831 and the second law by H. F. E. Lenz of the St Petersburg Academy of Science, in 1833.



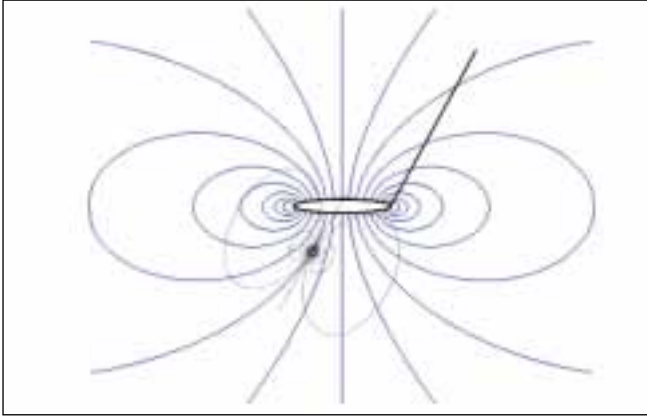

Figure 4.2: The presence of a secondary magnetic field

The primary field is shown in blue, and the secondary magnetic field produced by a small metal object, in black.

The strength of the secondary field will depend on the properties of the object. In general, on the surface of the object it is of the same order of magnitude as the primary field. In Figure 4.2, the black secondary field flux lines are shown more concentrated than the blue primary field flux lines, to make the shape of the fields clear.

## 4.2. Electromagnetic properties of materials

To discuss this topic, we pose some questions that are frequently asked and then give answers.

### ***Are all metals magnetic?***

No. Some metals are (mild steel, cast iron) and some are not (aluminium, copper, brass).

### ***Do all metals conduct electricity?***

Yes. However, some metals have quite low conductivity which makes them more difficult to detect, especially if they are also non-magnetic. See Section 4.6 for details of how the electromagnetic properties of materials are quantified.

### ***Can metal detectors find both types of metal?***

Yes. In a magnetic metal, both magnetism and the flow of eddy currents generate a secondary magnetic field that can be detected. In a non-magnetic metal, only the eddy current mechanism operates. But in all types of metal, a secondary magnetic field is generated and therefore a metal detector can find them.

### ***What are ferrous materials?***

Ferrous materials are materials which contain iron. This includes all kinds of steel and cast-iron and iron-bearing minerals like magnetite and haematite.

### ***Are all ferrous materials magnetic?***

No. Some stainless steel alloys (usually with a large percentage of chromium) are almost completely non-magnetic in spite of containing a large percentage of iron. These are often called 'austenitic'. Austenitic alloys are sometimes used in mines and can be hard to detect because they also have quite low conductivity.

### ***Are all magnetic materials ferrous?***

No. Apart from iron, some other elements which can be significantly magnetic are nickel, cobalt and manganese (these elements may be alone or in compounds). For example, the copper-nickel alloys used in some coins are magnetic.

### ***Are metal detectors affected by materials which do not conduct electricity?***

Yes. They can be affected by materials that are magnetic but do not conduct electricity. A familiar example is ordinary rust. Such materials do not support eddy currents but do generate secondary magnetic fields and can make a metal detector signal. This is important because iron oxide and other magnetic minerals occur naturally in some soils and rocks and can affect metal detectors even when there is no man-made metal debris present.

## **4.3. Metal detector working principles**

The principle of electromagnetic induction is common to all metal detectors but there are many variations in the way it is used. A substantial number of patents<sup>(33)</sup> have been filed and each manufacturer advocates the advantages of their particular technical approach. It is wise to view claims of technical superiority sceptically because good quality instruments using quite different working principles are available. It has not yet been established which, if any, approach is really the best. In any case, the practical merits of a particular detector will not rely solely on its working principle. The experience of the designers with certain types of circuit or coil can be very relevant, as can the availability of good components or the ease of manufacture.

### **4.3.1. Pulsed induction versus continuous wave**

In all metal detectors the magnetic field must vary in time. This may be achieved either by generating it in the form of short pulses with periods between where the current is zero (Figure 4.3), or by varying smoothly in the form of one or more sine waves (Figure 4.4).

Some pulsed induction metal detectors are: Ebinger 420GC, Guartel MD8, Minelab F1A4 and F3, Schiebel AN19 (PSS12), Vallon 1620 and VMH2. Some continuous wave

---

<sup>(33)</sup> See the survey by Sigrist and Bruschini in Annex F, 'Suggested further reading'.

This is a pulsed induction detector with a bipolar field, having a 370  $\mu\text{s}$  pulse width and 225 Hz repetition frequency.

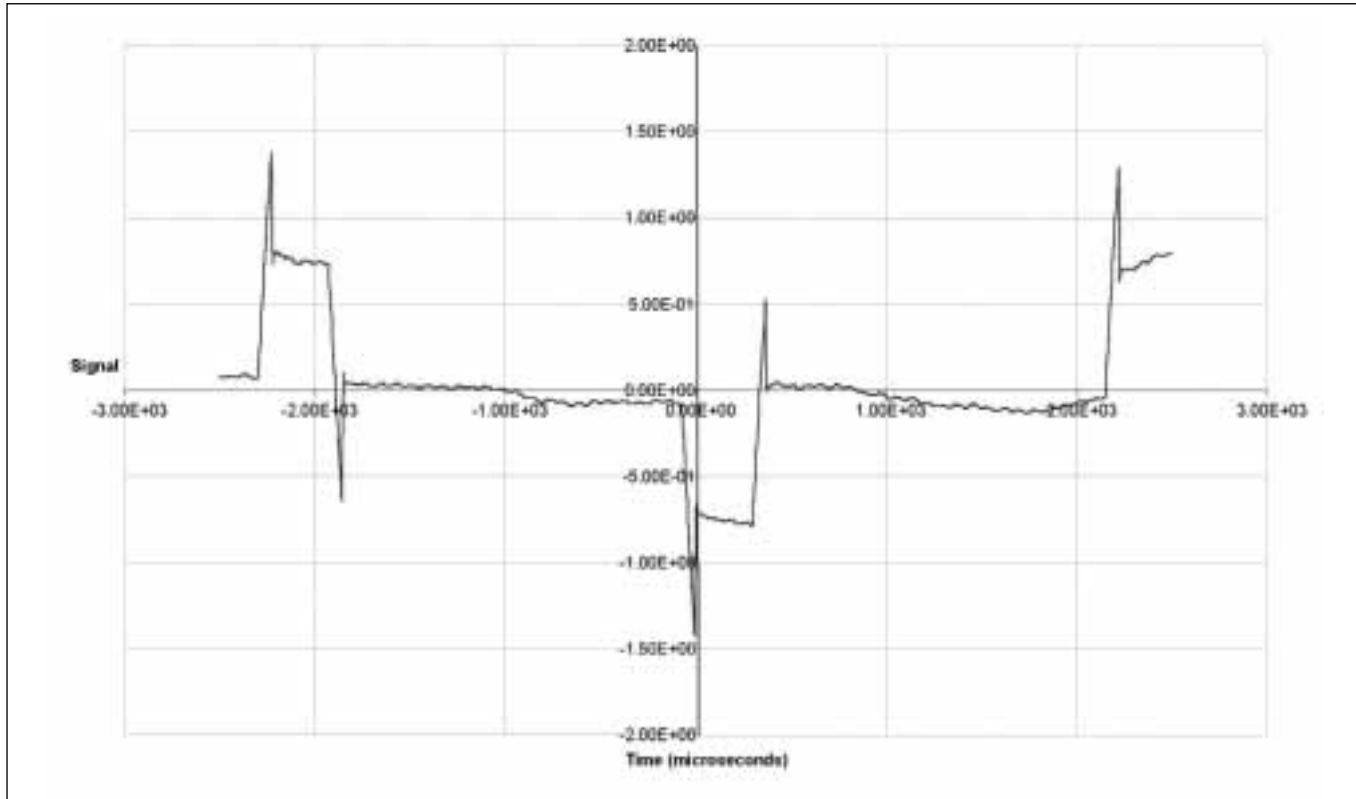

Figure 4.3: Magnetic field measured from a Vallon VMH2 detector

This is a continuous wave detector employing one sine wave signal at 2 400 Hz and another smaller one at 19 200 Hz.

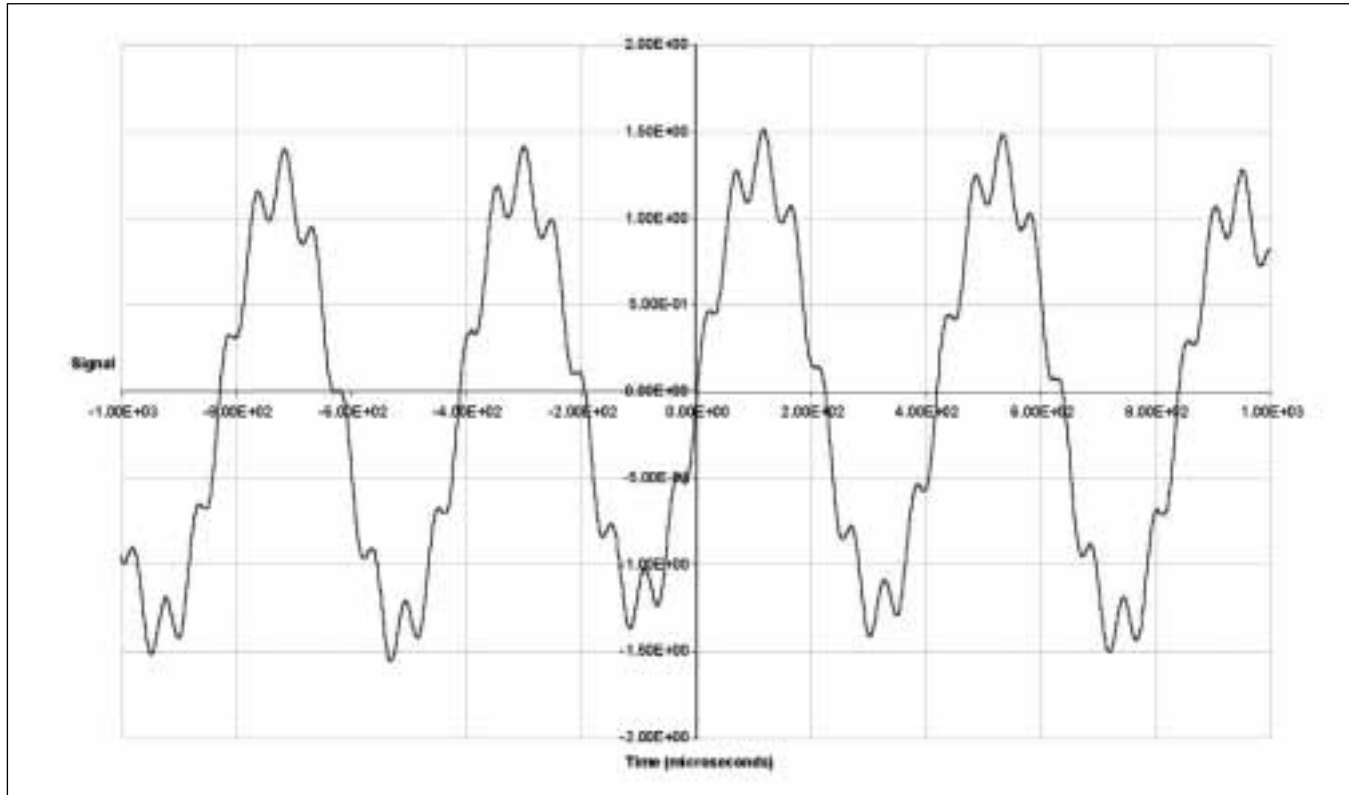

Figure 4.4: Magnetic field measured from a Foerster Minex 2FD 4.500 detector

metal detectors are: CEIA MIL D1, Foerster Minex 2FD and Ebinger 420SC.

### 4.3.2. Frequency-domain versus time-domain

In frequency-domain detectors, the circuit measures the induced voltage as sine waves of one or more individual frequencies. Both the **amplitude** (the height of the sine wave) and the **phase** (the extent to which the induced voltage sine wave lags behind or leads the current wave) may be measured.

In time-domain detectors, measurements are made at certain times after each pulse. The direct effect of the primary magnetic field occurs within the first microsecond or so but the secondary magnetic fields may last for tens of microseconds. The detection circuit reads the coil voltage after the effect of the primary field has died away, when any remaining voltage is due to the secondary field, for example, at 35 microseconds. In many designs, the receive circuit is switched off completely during the pulse, to avoid being swamped by the strong effect of the primary magnetic field.

Time-domain detectors always have pulsed fields. Frequency-domain detectors usually have continuous wave fields, but may not always do so. A frequency-domain

detector can be constructed with a pulsed field because any periodically repeating signal can always be broken down into a sum of sine waves of different frequencies<sup>(34)</sup>. So equivalent sine waves can be extracted even from a pulsed field detector and it can be made to work in the frequency-domain.

### 4.3.3. Single coil versus separate excite/receive coils

In some detectors, the induced voltage is measured across the same coil that is used to produce the primary magnetic field. In others, it is measured across a separate coil. For example, the Schiebel AN19 has two concentric coils, one to excite and one to receive. By contrast, the Ebinger 420GC uses a single-coil search-head design.

### 4.3.4. Static and dynamic modes

When a detector search-head is held still above a metal object and the alarm sounds continuously, the detector is working in 'static mode'. In 'dynamic mode' detectors, the alarm turns off after a few seconds because the circuit compares the induced voltage with its value a few seconds earlier and only sounds the alarm if the voltage has changed.

---

<sup>(34)</sup> This is a mathematical fact which is true of all sorts of phenomenon, not just electromagnetic fields. It was discovered in Grenoble in 1807 by Jean-Baptiste Joseph Fourier, who was working on heatwaves.

Both modes have strengths and weaknesses. Dynamic mode can help when working in the presence of some constant background disturbance, such as alongside a metal rail or fence or when attempting to locate a small AP mine in the vicinity of a large metal-cased AT mine. Static mode allows the operator to move the search-head very slowly without missing the mine and is sometimes thought simpler to understand.

The Guartel MD8, Minelab F1A4 and Vallon detectors are dynamic mode detectors. Static mode is used in the Foerster Minex 2FD 4.500 and Schiebel AN/19. A recent version of the Ebinger 421GC detector allows the operator to select between static and dynamic modes.

Some very simple dynamic mode detectors actually have a static primary magnetic field and rely on the movement of the search-head to generate the time variation, but this type of design is not used in high-sensitivity instruments of the quality required for demining.

#### **4.3.5. Single receive coil versus double-D (differential) receive coils**

In some detectors, the receive coil is split into two D-shaped halves, one of which is 'backwards', so making a shape like . The two halves are connected in such a way that the voltage induced in one is subtracted from the voltage induced in the other. The detector signals when there is a difference between what is 'seen' by the two

halves of the receive-coil, and this is why it is called a 'differential design'.

Because differential coil detectors respond to the difference between the properties of the objects sensed by the two Ds, they do not respond to factors that influence both sides of the coil equally. This means that they are relatively insensitive to the magnetic properties of the ground itself when those properties are evenly spread.

As the search-head passes over the object, the detector signals when the metal is under one D, goes briefly silent when the metal is equally under both Ds and sounds again when the metal is under the other D. The metal can be located with some precision using the position of the 'null' between the two Ds. This design allows superior pinpointing of a target but at the price of 'blind-spots' in front of and behind the entire search-head. However, these blind-spots mean that the design can also be used beside rails and metal fences. If the detector search-head is swept parallel to a linear metal object, with the line dividing the two halves of the coil perpendicular to the object, both sides of the coil will be affected approximately equally and the presence of a rail or fence can be cancelled out.

So it is important that double-D search-heads should always be swept from side to side. If it is used by moving the search-head back and forth in a push-pull movement, this could lead to missing mines in the blind spots.

The double-D design is used in the CEIA MIL D1, Foerster Minex 2FD and Guartel MD8 detectors.



Figure 4.5:  
A Guartel MD8 search-head <sup>(35)</sup>

In Figure 4.5, the top of a PROM-1 bounding fragmentation mine can be seen in front of the search-head. The mine is just to one side of the centre line, in the null area. If the detector is used correctly, by sweeping from left to right, the mine will be detected when it is nearer one D than the other. If it used incorrectly, by sweeping forward, the mine could be missed, or even activated.

<sup>(35)</sup> Photo courtesy of F. Littmann.

<sup>(36)</sup> This has not been the cause of any incidents recorded in the DDAS.

### 4.3.6. Bipolar pulse versus unipolar pulse

In pulsed-induction detectors, the pulses can be ‘unipolar’ or ‘bipolar’. A unipolar pulse means that the pulsed current in the coil only flows in one direction. A bipolar pulse means that in alternate pulses the current flows in opposite directions (as in Figure 4.3). With bipolar pulses, the average current (and therefore the magnetic field) over many pulses is zero, but it is not zero for a unipolar pulse train. This may be relevant for those who feel concern over the risk that the small constant magnetic field produced by metal detectors could trigger a magnetic influence fuze.

A demining organisation must decide whether or not it is safe to select a detector with unipolar pulses. Activation of magnetic influence fuzes by metal detectors is a theoretical possibility but has not been a recorded cause of accidents in humanitarian demining <sup>(36)</sup>. Magnetic influence fuzes are used in a minority of AT mines and some booby traps, but they have a limited field life and the few that are known to have been found during humanitarian demining have been ‘inert’ (with dead batteries). In the opinion of the authors, it is acceptable to use a detector with a unipolar field in an area where the risk-assessment is that active magnetic influence fuzes are unlikely to be found.

### 4.3.7. How are metal detectors designed for demining different from other types?

Metal detectors are used in many other applications including the body-search of persons (either as walk-through or hand-held), for treasure-hunting, for pipe and cable detection and on industrial production lines. The coil (search-head) size and shape are dictated by the application.

The effective range of a detector depends to a large extent on the diameter of the coils used in the search-heads. Detectors with bigger coils have better detection capability at greater distances. This raises the question: why do not all detectors have large coils in their search-heads? The main reason is that the sensitivity of the detector to small objects is reduced by making the coil larger, so a 1 m-diameter coil would not be able to find a small mine even if it was not far below the surface. This is because the large coil spreads the magnetic field over a wide area, so the local field intensity is reduced.

So there is a trade-off. All other things being equal, a detector with a small coil will show a relatively high detection capability for metal objects that are close to it, but a poor long-range performance. Detectors with larger coils generally have a better detection capability at distance, but poorer detection capability for nearby metal objects. There are two other reasons why large coils would be unsuitable for detecting small mines. Interference from magnetic or conducting ground (see Section 4.5) is proportionally

greater for a large diameter coil and it is also harder to pinpoint a small mine with a large coil. The diameter of a demining detector coil is usually around 20 cm and that of a UXO detector coil about a metre.

Access to the place to be searched may also affect the choice of coil. Demining detectors usually have flat coils, either circular or elliptical in shape. The Guartel MD8 has an option for a cylindrical wand coil for use in narrow gaps.

Design of detectors is a trade-off between cost and quality factors: sensitivity, effectiveness of ground compensation and electromagnetic interference suppression, reliability, weight, balance, ease of use, robustness and battery life. Those designed for treasure-hunting are similar in layout to demining detectors, and may have ground compensation, but are usually much cheaper and not as sensitive, robust or well-made. Some treasure-hunting detectors are fitted with visual displays. These are undesirable in demining detectors because it is important not to distract the deminer from visual clues on the ground.

### 4.3.8. What is important from the user's point of view?

As explained above, there are considerable differences in the details of how metal detectors are designed. From the user's point of view, some of these differences matter a lot more than others. Whether a detector is frequency-domain or time-domain, has a single-coil or separate



receive-transmit coils does not change the practicalities very much, if at all. On the other hand, a detector with a double-D coil behaves very differently from one with a simple circular coil and it is dangerous to confuse the two. Similarly, a detector that operates in static mode behaves very differently from one that operates in dynamic mode. Accurate pinpointing cannot be achieved unless the operator is aware of these things. Training should emphasise those factors that really matter to the deminer with a detector in his hands.

#### 4.4. Suppression of electromagnetic interference

Electromagnetic interference (EMI) arises when a signal from an external source induces a voltage in the detector coil, making the detector signal without metal being present. It is also possible for the detector's electronics to be affected directly by an electromagnetic signal, rather than via the coil. A detector affected by electromagnetic interference will often make a sound which is obviously different from the signal it makes when it has detected metal in normal use.

The main EMI sources are:

- high-voltage power lines and substations;
- radio transmitters;

- electric motors;
- other metal detectors.

Some detectors are equipped with filters to suppress radio signals and signals with the frequency of electric power transmission (50 Hz in Europe and most of the world, 60 Hz in the United States and a few other countries). Some detectors allow selection between 50 and 60 Hz filters. EMI suppression is important in humanitarian demining because it may be necessary to work close to electric power lines, radio masts or industrial facilities in circumstances where it is inconvenient or impractical to arrange to have them switched off.

Metal detectors will only interfere with each other if they are close together, but the interference distance varies from 1 and 20 m depending on the detector model. When two different models of detector are brought close together, it is possible that only one of the detectors would be affected by the other.

Some detectors such as the Vallon VMH2, CEIA MIL D1 and Minelab F1A4 have circuits which can be adjusted or synchronised to allow two detectors to operate on different channels, so that they do not interfere with each other. Interference between detectors is not a routine problem in humanitarian demining because deminers usually work at a safety distance from each other of 25 m. Interference between detectors becomes a safety issue when a deminer has been injured but his detector is still switched on. A rescue team must then approach the

casualty using another detector before carrying out an evacuation.

## 4.5. Ground compensation

One of the main limitations of metal detectors is that they can be affected by the ground itself, which limits how high the sensitivity of the detector can be adjusted. This happens because the ground also conducts electricity to some extent and can also be magnetic. The same mechanisms that allow the detector to find metal may also make it respond to the ground. It is also relevant that while the metal components of mines are often very small, the ground fills all the space under the search-head. So even when the ground's electric and magnetic properties are much weaker than those of the metal, they can still complicate detection.

Metal detector manufacturers have devoted a great deal of research and development effort to overcoming this problem. High-quality modern detectors are equipped with special systems called 'ground compensation' (see p. 20) circuits which reduce their sensitivity to the ground without reducing the sensitivity to metal very much. Except in the very best of detectors, however, there may still be **some** reduction in sensitivity to metal when used in GC mode.

It is usually necessary to make a preliminary adjustment to the ground conditions in the place where the deminers are working. This typically involves holding the detector in the air and moving the search-head down to the soil whilst either activating an automatic learning sequence using a push-button or adjusting the circuit manually using a dial. Ground compensation procedures generally vary between models of detector, so particular attention should be paid to the details given in the instruction manual.

Ground compensation in a time-domain detector can be achieved by identifying a characteristic decay time for the ground and programming the receiver circuit so that the alarm does not sound when the detector encounters a target with this particular decay time. In most cases, the decay time for ground is shorter than that of all but the smallest metal objects, so the detector can reject the ground signal without missing metal items unless they are very small (Figure 4.6). Because of this, any pulse induction design which samples a few tens of microseconds after the pulse automatically has a degree of ground compensation. In severe cases, however, where the decay time of the ground is long, sensitivity to metal will be reduced if the detector is adjusted to reject the ground signal. One way to get around this is to use current pulses of different lengths<sup>(37)</sup>. These can give rise to different decay times in the same object. It is very unlikely that the ground and the metal object will have the same decay time for **all**

---

<sup>(37)</sup> Bruce, H., Candy, US Patent 5 537 041 (1996).

pulse lengths so the circuit can be programmed to distinguish the ground signal and reject it.

Ground compensation in a frequency-domain detector works in more or less the same way. The detector identifies the phase-change of the signal, i.e. the time lag of the induced signal behind the current (Figure 4.7) and is adjusted to ignore signals with the phase-change characteristic of the ground. To avoid rejecting metal by mis-

take, additional variables can be introduced by using more than one sine-wave frequency, which is rather like using variable pulse lengths in a time-domain detector.

If the signal is sampled after about 20 microseconds, the soil signal in this case is negligible. Even better ground compensation can be achieved by measuring the decay time of the signal and/or using excitation pulses of different lengths.

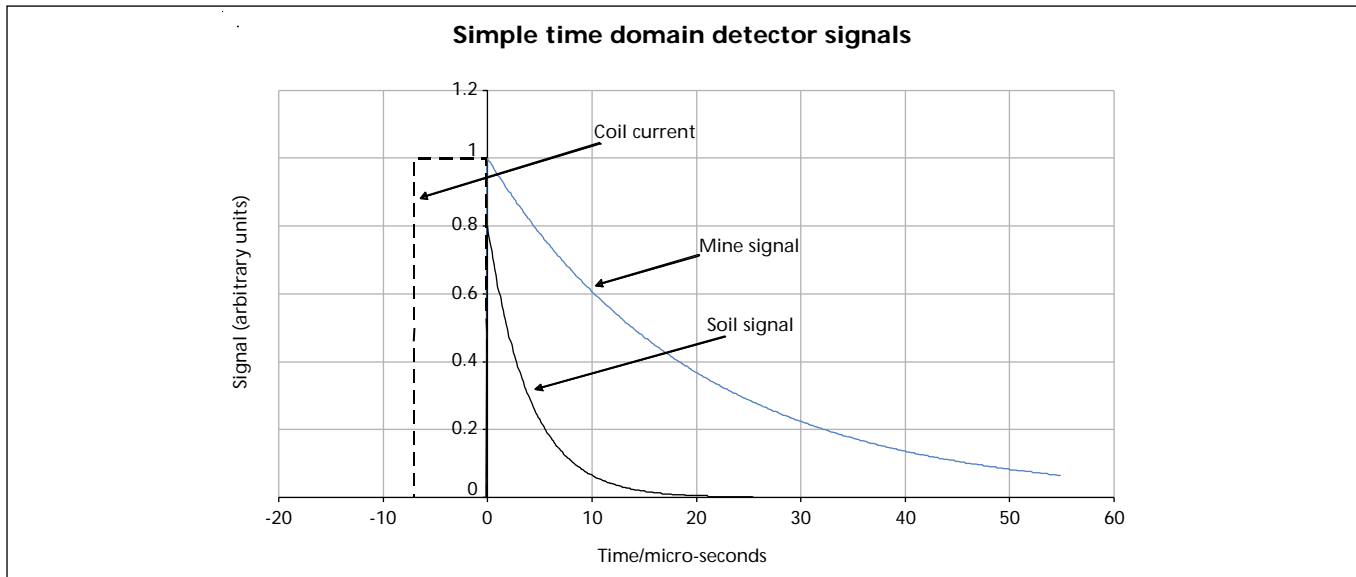

Figure 4.6: Soil and mine signals in a time-domain detector

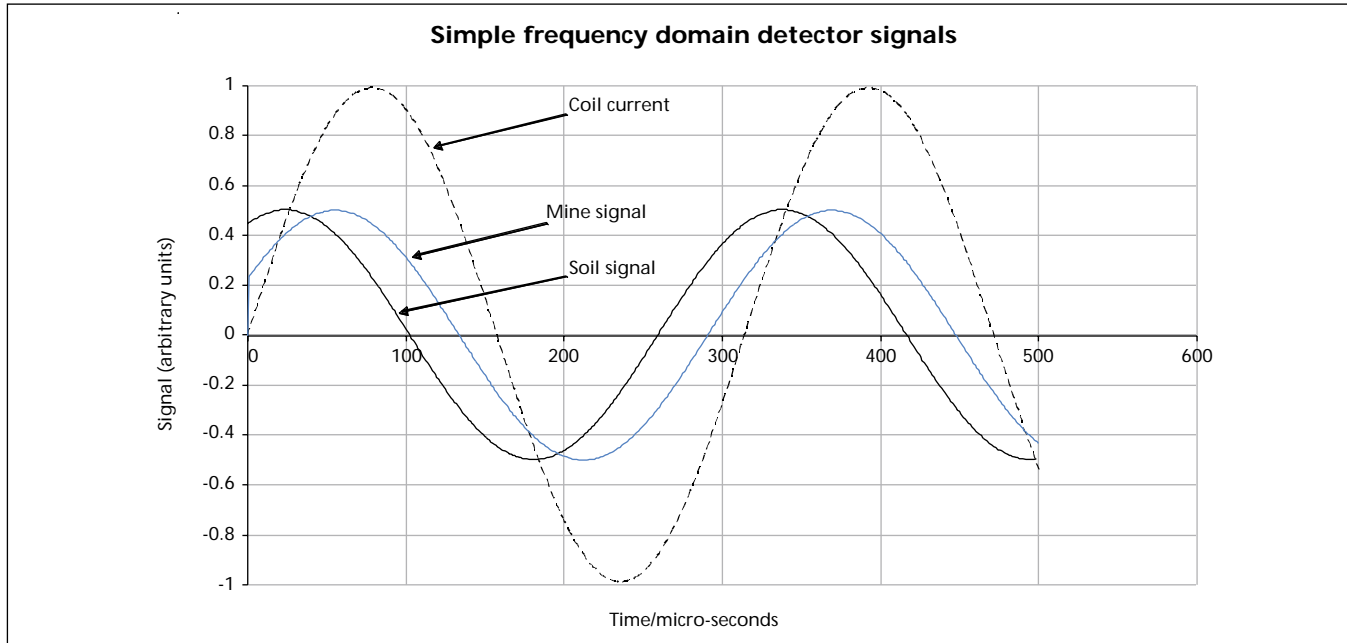

Figure 4.7: Soil and mine signals in a frequency-domain detector

If the receiver is set up to reject signals of a certain phase (i.e. which lead the current by a certain fraction of a wave) the soil signal in this case will be ignored. Even better ground compensation can be achieved by using two or more frequencies.

The double-D coil design gives a degree of suppression of ground effects automatically because the ground is underneath both Ds and the signals from the two approximately balance out. It is not completely effective because, if the ground is not exactly flat, the amount under each D may be

different. The ground properties may also vary from point to point and so be different under one D to under the other.

'Noisy' or 'uncooperative' magnetic ground is common. A high proportion of iron oxide or other ferrous minerals in the ground is often the cause. Red clay soils such as the 'laterite' of Cambodia and Angola, and the bauxite soils of the Dalmatian coast of Croatia are examples. Ground with the black iron-bearing mineral magnetite may also be 'noisy'. However, the presence of magnetic minerals does not always give rise to a long decay time and the exact conditions that affect metal detector use are still the subject of research. What is known is that a combination of high electrical conductivity and high magnetic effects is the worst situation of all.

Exposure to high temperatures by burning may adversely change the ground properties. Volcanic minerals may also affect detectors. Individual stones and rocks may give signals even when the soil itself does not. Conversely, the soil can give signals but contain rocks which do not — a situation that is also undesirable because the properties will then vary from point to point. Ground which is very saline, for example on a beach, may conduct electricity unusually well and so may make a detector signal as if it were metal.

## 4.6. How the electromagnetic properties of materials are quantified

### 4.6.1. Conductivity and resistivity

Some metals conduct electricity better than others. This is important because, in general, the better the metal conducts, the easier it is to detect. Soils and water also conduct electricity but nothing like as well as any metal.

The electric conductivity of a material can be expressed as a number which measures how much current a piece of the material conducts, allowing for its size and shape and what voltage has been applied to it <sup>(38)</sup>. It is expressed in 'siemens per metre', written S/m or  $S\ m^{-1}$ . Some people prefer other names: 'per ohm per metre', which is written  $\Omega^{-1}\ m^{-1}$ , and 'mho per metre', but they all mean the same thing.

Resistivity is the opposite of conductivity. It describes the ability of the material to resist the flow of electrical current. To calculate it, just divide 1 by the conductivity. It is expressed in 'ohm metres' written  $\Omega\ m$ . For example, high purity copper has a resistivity of:

$$1 \div 59 \times 10^6\ S/m = 1.7 \times 10^{-8}\ \Omega\ m\ (0.000\ 000\ 017\ \Omega\ m)$$

---

<sup>(38)</sup> A formal definition is, 'the current per unit cross sectional area per unit electric field' (the electric field is the gradient of the voltage). See *Electromagnetic fields and waves: including electric circuits* by P. Lorrain, D. Corson, F. Lorrain, W. H. Freeman, 3rd edition, 1988 — ISBN: 0-716-71823-5.

**Table of conductivity values for various materials:**

Pure silver	61 million S/m
High purity copper	59 million S/m
Aluminium	40 million S/m
Lead	4.8 million S/m
Stainless steel	1 to 1.75 million S/m
Graphite	130 000 S/m
Silicon	0.3 to 15 000 S/m
Sea water	3 to 5 S/m
Freshwater	0.001 S/m
Wet soil	0.01 to 0.001 S/m
Dry soil	0.0001 to 0.00001 S/m

To avoid such very small numbers, some people express resistivity of metals in ‘micro-ohm centimetres’ or  $\mu\Omega$  cm.  $1 \mu\Omega \text{ cm} = 10^{-8} \Omega \text{ m}$ .

<sup>(39)</sup> *Système international* — the international system of measurement units that has been adopted worldwide. We note that the SI convention is used here because there is an older unit system known as the ‘cgs’ or centimetre-gram-second system. In the ‘cgs’ system the susceptibility is also just a scale factor (scientists call such quantities ‘dimensionless’), but its values are different from the values in the SI system.

## 4.6.2. Magnetic susceptibility and permeability

The simplest way to describe the magnetic quality of a material is to use a measure of its ‘relative magnetic permeability’. This is a measure of how much the material magnifies the effect of the magnetic field. For steel, this can be as high as a few hundred times. For non-magnetic materials (and for air), the ‘relative magnetic permeability’ is 1. Because it is just a relative scale, there are no special units to remember.

Materials which are very slightly magnetic have a relative magnetic permeability just slightly greater than 1. It is then often more convenient to use the difference from 1, which is called the ‘système international (SI) magnetic susceptibility’ <sup>(39)</sup>.

Example: A particular soil has an SI magnetic susceptibility of 0.002. Its relative magnetic permeability is  $1 + 0.002 = 1.002$ .

## 4.7. Factors that affect detection

Modern metal detectors are extremely sensitive devices with the capacity to detect small amounts of metal.

However, it is worth remembering all of the factors that can influence detection capability when a metal detector is used in a real situation.

#### **4.7.1. The metal object or 'target'**

The characteristics of a metal object govern whether or not it can be detected. The size of a target is important, but more important is its shape and orientation with respect to the detector coil. Objects are easier to detect if the detector can easily generate eddy currents in the metal.

For example, a complete ring of metal parallel to the detector coil is much easier to detect than a broken ring or loop which currents cannot circulate around. Turning a ring so that its axis is perpendicular to that of the coil will reduce the signal it produces in a metal detector. So a PMN mine (see Figure 2.3) with its large metal ring around the rubber top will be an easy target when lying horizontal. If the same mine is placed on its side, detection will be more difficult.

In the past, detection capabilities have been expressed in terms of the mass of metal detectable. Without any definition of the shape and orientation of the metal object, this is not a helpful approach. One gram of aluminium in the form of a flat foil parallel to the detector coil is much easier to detect than a gram of aluminium in the form of a very thin, long pin with its axis parallel to that of the coil.

The metal from which the object is made also has an important effect. As previously mentioned, metals with high conductivity are easier to detect than those with low conductivity, and magnetic metals are easier than non-magnetic ones.

#### **4.7.2. Distance between the detector's search-head and the metal object**

The strength of the magnetic field produced by the metal detector diminishes with distance from the coil, as can be seen clearly in Figure 4.1. Similarly, detection capability reduces rapidly the further a metal object is away from the search-head. At three or four coil diameters, even very large metal objects do not trigger a signal.

The interplay between the target characteristics and the distance at which it can be detected is the normal way of defining detection capability. In particular, people use the maximum height in air or maximum depth in the ground beneath a detector's search-head at which a given target can be detected.

The detection capability is not constant at all points under a search-head. Small metal objects at a given depth may only be detected when located precisely on the coil axis. But a large object at the same depth may produce an alarm when the detector coil is some distance to the side of the object.

To measure this spatial variation in detection capability, a sensitivity profile (footprint) measurement is often made.

Figure 4.8 shows one way in which such measurements can be presented. A detector has been swept from side to side over a metal target, moving the search-head forward between each sweep, so producing an area scan. The audio signal from the detector alarm has been recorded and plotted for each point in the scan as a colour corresponding to the signal strength. Dark blue indicates a low or zero signal. Red indicates a high signal strength. The scan has been repeated with the target held at three different depths below the detector coil and the results have been plotted together.

At 20 mm below the detector, the signal is very strong over a circular area of about 300 mm in diameter under the detector coil. At 110 mm below the detector, the signal strength is reduced and it is clear that maximum signal only occurs in the centre of the footprint, on the coil axis. At 200 mm below the detector, the target gives only a very weak signal.

For **all** detectors, the sensitive area of the footprint always gets smaller as depth increases. This variation with depth is often described as a sensitivity or detection 'cone'. For different detectors, the patterns are slightly different, particularly for those with differential designs, but the basic principle is the same. It is very important that users are aware of this effect. For example, imagine that a detector is being used to search for a target at a depth at which it is only just detectable (in a small area on the coil axis). The search-head needs to be moved forward between sweeps in steps small enough to ensure that the

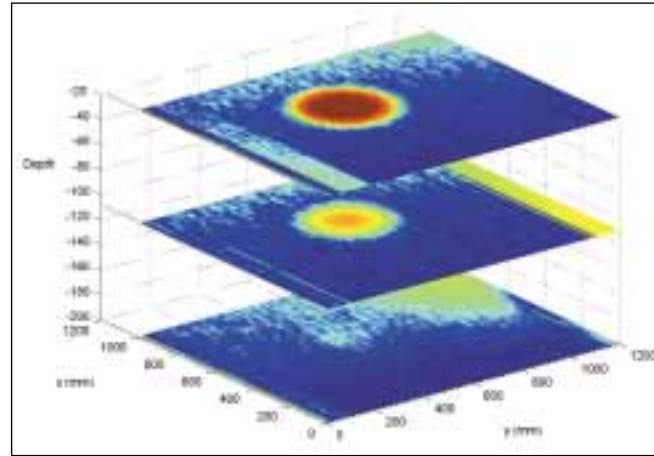

Figure 4.8: False-colour sensitivity profile at three different values of the detector height above a metal target (Minelab F3 measured at JRC, Ispra)

high sensitivity 'spot' covers all of the ground. If the search-head is moved forward by too large a step (moving forward by a set distance is often a 'rule') the mine may easily be missed.

An alternative way of presenting the sensitivity profile is in diagrams showing contours defined by the limiting case of detection for particular targets. Figure 4.9 shows an example of this approach, with the contours for three different targets, 3, 5, and 10 mm-diameter steel balls. At the detector settings for which the diagram was



produced, the target can be detected within the contour but not outside it. The contours for the 10 mm and 5 mm balls show that the maximum detection depth is achieved on the coil axis. At a given depth, it is possible to estimate the width of the region over which these targets can be detected.

In the case illustrated, the maximum detection depth for the very small (3 mm-diameter) ball is under the windings of the coil rather than on the coil axis. For some detectors, it is noticeable that the most sensitive region at very close

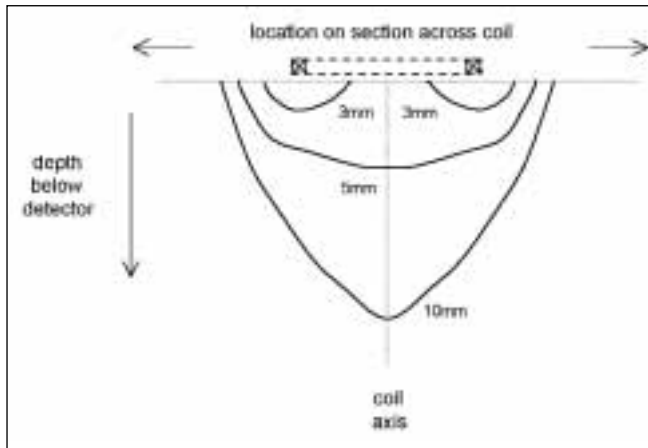

Figure 4.9: Schematic view of a sensitivity profile on a section through a metal detector coil showing contours of detection limits for 3, 5 and 10 mm steel balls

range does occur under the windings. This fact is sometimes used in the procedures for locating very small metal objects that are close to the ground surface.

Diagrams showing detection limit contours can be produced for any section through a detector coil. For example, plots of the contours in a horizontal plane (parallel to the coil) are often made. For a method of determining the profile of a detector for a target while in the field, see Section 5.4.3, 'Determining a field-accurate sensitivity profile (footprint)'.

### 4.7.3. Ground properties

In demining operations, the ground properties will often have an influence on metal detectors. For simple detectors, this may require the sensitivity to be reduced to avoid signals from the ground. Even if ground compensation functions are used, the detection capability may be reduced. This means that for a given target the maximum detection depth can be reduced, sometimes significantly. Another way of expressing this is that at the area under the detector giving the required detection, capability can shrink, or even disappear.

One important aspect of such 'noisy' ground is that it is often heterogeneous, that is the ground properties vary from place to place. This heterogeneity may be caused, for example, by magnetic stones in a relatively benign soil, or by non-magnetic stones in a magnetic soil. The

ground compensation methods of some detectors cope well with this. Other detectors have problems with such situations. One example of such heterogeneity is the cracking that can occur in dried earth. Some detectors (notably some differential designs) have been known to signal on such cracks.

The fact that some detectors can give a signal from cracks or other voids in magnetic ground may actually help their detection capability in some situations. A buried minimum metal mine displaces a volume of soil and replaces it with materials that for the most part have no influence on a metal detector so can be considered as a void in magnetic ground. The apparent 'void' may make a detector signal. However, relying on this phenomenon for detection is not recommended!

## 4.8. Metal detectors, radar and radio waves

The electromagnetic fields used by metal detectors are not quite the same thing as radio waves. Radio waves are the result of another law under which a changing electric field generates a magnetic field — almost the mirror image of the first law of electromagnetic induction stated above. The effect of the two laws working together is that the electric and magnetic fields sustain each other and can spread out to huge distances, which is why radio

is an excellent means of communication. But this can only happen if there is an antenna big enough to support the wave at the start of its journey. How big an antenna is needed depends on the 'frequency' of the signal. The 'frequency' is the number of times that it is repeated each second. The lower the frequency, the bigger the antenna necessary. To broadcast a significant amount of radio power at the frequencies used in metal detectors would require an antenna hundreds of metres long. A metal detector search-head is too small to broadcast much radio power and the electromagnetic fields it generates are of a different kind (called 'near-field') which have a restricted range, at most a few times the diameter of the search-head. It is possible to transmit radio waves of higher frequencies up to hundreds of millions of times a second from a small antenna suitable for use as a hand-held mine-detector and this is exactly what happens in a ground penetrating radar detector.

# Chapter 5: Training

Well-planned and executed training can have a profound influence on self-discipline and safety in mined areas. Demining is inherently dangerous and, when using a metal detector in a mined area, the deminer will face that danger on his own. A deminer's training must be good enough to mean that he always acts safely regardless of whether a supervisor is watching. Because deminers are human, they will forget detail and can even forget to be cautious. Nothing is more dangerous than a deminer who is overconfident or begins to believe that he is somehow immune to danger.

A training inadequacy was identified as a possible cause in more than 20 % of the accidents recorded in the database of demining accidents (DDAS) <sup>(40)</sup>.

Here is a short example of extended experience leading to over-confidence. The UNADP, Mozambique, has a low mine accident rate despite having about 380 surveyors and deminers working in mined areas. In 1999, for the first time in five years, a UNADP deminer had an accident while excavating a detector reading. About a year later, a second deminer initiated a mine with a prodder. Both deminers had excellent records and had worked as deminers for more than four years. They had

become over-confident and had begun to break established rules as they worked. The cause of the accidents was identified and refresher training was improved. At the time of writing, more than three years have passed without any further excavation accidents.

Ongoing training can bring people down to earth and remind them that there are sensible rules they have to follow. A mine does not respect experience. It treats soldiers, civilians, diplomats, animals, journalists and deminers in the same way. Despite the dangers inherent in mine clearance, adequate training and appropriate caution can make it relatively safe. In professional demining organisations, many more staff are the victims of traffic accidents and disease than of accidents with explosive ERW.

## 5.1. Deminers and their basic training requirements

People who choose to become deminers often have no other way to earn a living. Humanitarian mine clearance usually begins immediately after the end of a national

---

<sup>(40)</sup> A searchable collection of accident reports and inquiries authored by Andy Smith, published by the GICHD and available on CD. Contact [p.ellis@gichd.ch](mailto:p.ellis@gichd.ch)

conflict which may have gone on for decades. During the conflict, the people will have had little opportunity to get a formal education or enter a career path other than as soldiers. So it is not surprising that immediately after the end of a conflict many deminers will be ex-soldiers. Sometimes they are recruited as a deliberate policy to reduce the number of ex-soldiers who are unemployed and seen as a threat to peace.

Many demining organisations like to recruit ex-soldiers. The structure of demining organisations is often similar to that of the military and both require firm discipline, so a well-trained soldier can be an ideal deminer candidate. As time passes after a conflict, fewer ex-soldiers are available and more civilians are recruited. The job is attractive to civilians because it usually pays a relatively high wage (for the area) and generally inspires respect from the community. Most of the people recruited have few skills or qualifications that would enable them to get other jobs commanding respect.

The qualifications needed to become a basic deminer are not high. Good general health, hearing and sight are the only physical requirements. Any specific skills and qualifications are a bonus and may help a person gain rapid promotion. Depending on the employer, people with good education and leadership skills can get further training and move into supervisory, survey, training or management roles.

While a deminer need not be well-educated, he must learn to be competent with the tools he relies on. Most



*Figure 5.1:*  
A typical range of demining equipment that a deminer must learn to use

are low-tech, such as tools for excavation and vegetation cutting. The only hi-tech tool he must master is his metal detector. A deminer who wanted to become a surveyor would usually have to learn to use computers, GPS (Global Positioning System) and total stations (theodolites) for minefield mapping and documentation. Others might aspire to specialising in communications equipment, medical support or logistical support where other hi-tech equipment is used.

Well-established country demining programmes generally have some kind of career path allowing a deminer to advance. Smaller organisations often do not. Globally, the average age of the basic deminer is below 30. The

deminers' life in the field is often hard with few luxuries. He must be prepared to spend extended periods away from home and family. It is not surprising that many move into other occupations after acquiring saleable skills or amassing some savings.

A basic deminer training course should last about four to six weeks (the authors are concerned by the fact that many small organisations reduce this). The most important parts of the training cover the technical skills needed to use the equipment and the safety rules that must be applied. This training involves the inculcation of drills that should become 'automatic' so that everyone knows what they (and others) should do. Examples of such drills are the investigation of a metal detector reading, what to do when a mine is found, and how to respond to an accident in the minefield.

## **5.2. Training in the use of metal detectors**

This section deals only with the training that is directly connected with metal detectors and the detection of ERW. It does not attempt to cover other training needs in humanitarian demining, but some of the approaches may be applicable to broader training needs.

Although a deminer's training is not extensive, some parts are critical. Appropriate training in the use of their

metal detector can save their life, so should be as simple and direct as possible. If it is unnecessarily complicated, it can cause confusion and result in mistakes being made. Most of the manufacturers of modern detectors understand the importance of making the detector easy to use. Many of the latest models are designed to limit the possibility of deminer error, or of the deminer reducing sensitivity to a dangerous level. Many are supplied with both a manual and a summarised 'field-card' that shows the main features of the detector and its use. The manufacturers often use pictures to carry the message on the 'field-card', so avoiding language problems. Increasingly, the manufacturers include a CD-based training course. Unfortunately these courses are usually in English (or another European language) and the computers needed to show them are not always available. The manuals are also usually in a European language. Many deminers do not read and write easily in their own language so, if the instructions are complicated, the user is unlikely to discover how to get the best from the detector. From his knowledge of the manual, the field-card and his additional instruction, the deminer must be able to work independently in a mined area. It is not enough to know a simple drill. A change in the environmental conditions or the variation from one mined area to another can mean that the deminer must adjust the detector appropriately. The training must give the deminer full knowledge of how to use the detector in all the possible clearance situations that he may be confronted with. It must also give him complete confidence that he knows everything that he may need to know.

## 5.3. Recommendations for trainers

When a group is purchasing a number of detectors, responsible manufacturers usually provide a package of training, maintenance, and spares with their delivery. Under this arrangement, the manufacturer's staff will train the deminer trainers. In a few cases, the manufacturers take over the training of actual deminers. This is not ideal because it means that the expensive outsiders would have to return each time that new deminers need to be trained or when refresher training is needed. Ideally, the manufacturer's staff will instruct the deminer trainers and should provide them with a clear explanation of the technical attributes of the detector and how best to use it.

While this gives the deminer trainers a good background, it should not be simply passed on to the deminers. The reason for this is that the manufacturer's trainer will not have been a deminer. He will usually have very limited knowledge about the trainees, the areas where the detector will be used, and of the working routines of those who will use it. The deminer trainers should use the manufacturer's training as a starting point. From the very beginning they should think about what they will adopt from this training, what they will leave out, and what must be added to adequately prepare the deminers for their work. The deminer trainer should consider the types of targets to be used, the different ground conditions in the area of responsibility and other environmental conditions that may influence the de-

tor. If he has prepared a list of these considerations in advance, he can ask the manufacturer's trainer for advice and training recommendations.

### 5.3.1. Self preparation

Before the first practical lessons with deminers, we recommend that the trainer completes the following. The trainer should spend at least one day using the detector:

- getting completely familiar with the detailed set-up and specific functions;
- practising setting the detector up to locate selected targets in the ground;
- determining the maximum detection depth of the main threat in the area;
- checking for possible EMI that might arise when working (from fences, railways, power lines, working radar and radio stations etc.);
- practising pin-pointing with different targets (point, linear, and polygon targets).

### 5.3.2. Trainee assessment

First it must be determined whether the training is aimed at experienced deminers (experienced with a different

detector) or for new trainee deminers who have not used any kind of detector before.

#### **New deminers** (without field experience)

You, the trainer, must allow time to introduce the concept of metal detection and how a detector works. The trainer should consider very carefully what details to cover and what may be interesting but could confuse the deminer. In addition to an introduction to the technology, the trainees must learn all the things that are described below. Do not explain the difference between this detector and others because **they do not need** to know this and it may simply confuse them.

#### **Experienced deminers**

When the trainees have previous experience with another detector(s) the main differences between the old and the new should be covered. Concentrate on the following points.

**Working principles** — static or dynamic detector. If the new detector works on a dynamic principle and the previous detector worked on the static principle, the training will take more time than when the change is from dynamic to static.

**NB:** A dynamic detector can only signal the presence of metal if the detector head is moved above the metal. A static detector can signal the presence of metal without moving the detector head.

Depending on the length of time that the trainees have used their old detector, it will take them more or less time

to get accustomed to any new version. When changing from static to dynamic, the deminer must understand that when a dynamic detector is held stationary over a target it will stop signalling. If the deminer was previously well trained, his use of the detector will have become habitual. He will want to hold the detector head over the signal and change the height to help find the centre of the reading. To break this habit and establish a new one, allow extra training time in safe areas.

**The sensitivity** — in terms of the ability to detect a specific target at depth. The trainer should know the new detector well enough to answer any questions clearly. He should demonstrate the real ability of the detector in different places under different conditions so that the trainees start to want this detector instead of the previous model. If the experienced deminer ends up saying, 'I want my old one', either the trainer has failed or the new detectors were poorly selected.

**The detector signal(s)** — the varied signals that a detector can make in the presence of a target are almost as important as its sensitivity. People with a 'musical ear' and some technical understanding may get far more information from the variety of signals than just an indication that metal is present. Some detector manuals include a description of the sounds that may be made but we have not yet seen a manual that included actual recordings. This is unfortunate because recordings would be of real help while training and be of great assistance to those technical advisors without genuine hands-on experience.

The way the sounds vary with the targets can be used to make the training interesting. A simple competition can be devised to engage interest and gain better performance from the deminers (this is known to have worked well in some organisations). Deminers with a natural flair combined with field experience can become extremely good at interpreting the sound made by their metal detectors. Even beginners can progress beyond simply 'target' and 'no target' and this raises their self-confidence. As a minimum, the deminer should learn to use the signal to differentiate between targets that are 'point', 'linear' and 'polygon' shaped.

**Other 'special' signals** — as well as signalling on the presence of metal, detectors may make a sound to give the user confidence that the detector is working. The 'confidence tone' is usually made at regular intervals and may be called the 'confidence click'. Some manufactures say that their detector's internal controls are so foolproof that a 'confidence tone' is not needed. Most detectors also have one or more warning sounds to indicate that something in the detector has 'failed'. The sounds warning of detector failure must be recognised before the detector is relied upon, so it is important that they are familiar to the user. There are usually two warning tones, one of which is the 'battery low' signal that warns the user that the detector can only work adequately for a limited time. The second warning sound indicates that another failure has occurred and the detector is not functional. The batteries may have become too close to exhaustion for the detection circuit to operate or there

may have been a failure in a component. In most cases the 'failure tone' is a continuous signal that cannot be turned off without switching off the detector. Any other signals will be explained in the manual and the deminers should be familiar with them all. The 'failure tone' signals occur very rarely, so most deminers will not hear them unless they are included in their training. During every training and refresher course, the trainer should make the deminers familiar with the sounds and ensure that they know how they should react. It may not be necessary to stop work immediately when a 'battery low' warning is heard, although most demining groups either replace batteries early or stop as soon as there is a warning of low battery capacity. When other 'failure tones' are heard, it is critical that the deminer stops using the detector immediately.

To simulate a 'battery low' situation during training, either use old batteries, a mixture of old and new batteries, or follow the instructions in the manual. To simulate a detector 'failure', it is often possible to unfasten the cable or connection to the search-head. **Do not forget that if the batteries are not connected to the electronic unit, the detector will not signal at all.**

### 5.3.3. Structuring your training

It will take less time and thought to structure training appropriately if you are familiar with the detector (Section 5.3.1) and know the group to be trained (Section



5.3.2). Two general rules may be worth mentioning. The first is that repetition is important so that the use of the detector becomes habitual, so generally you should not change the exercises covered without good reason. The second is that it is a good teaching principle to progress from the general to the detailed, moving from simple to more complicated points. We recommend the following topics to be covered.

1. Introduce the general components of the detector (assembly and disassembly).
2. Demonstrate the working principle (static or dynamic).
3. Set up the detector to find varied targets in different ground/soils.
4. Demonstrate detection signals and allow time for learning signals. Use different visible targets (point, linear, polygon-shaped with small and large metal content).
5. Demonstrate all possible warning signals.
6. Show the maximum detection distance with the targets in-air and in-ground (use FFE mines as targets when possible in order to help build confidence). When the trainees are deminers experienced with another detector, show the comparative advantages of the new detector. It may be appropriate to compare the in-air detection performance with the test results from comparative trials (such as the IPPTC).
7. Explain the area of sensitivity under the search-head (sometimes called the 'sensitivity profile', 'footprint' or 'sensitivity cone'). Understanding the footprint area is essential if the user is to cover the complete search area in sensitivity range and clearance depth (see Sections 4.7.2 and 5.4.3).
8. Teach how to pinpoint the targets — demonstrate the different ways and train the deminers to do it in the way that is most efficient with their detectors (see Section 5.4.8).
9. Organise a small competition in which the trainees find the targets (use FFE mines if possible). Although time penalties may be appropriate, be careful not to turn the competition into a race.

**Additional personnel and logistical support** — When the structure and content of the training has been decided, it is necessary to decide what personnel and technical support will be needed to carry it out. Bear in mind that every trainee should be kept busy all of the time. Decide how many detectors and other tools are required. Estimate a time schedule remembering that the smaller the group of trainees, the more intensive the training can be. Estimate transportation needs, food and accommodation requirements and any additional manpower that will be needed. Remember that communication and medical support staff will be required at the site.

**The preparation of the training area** — This is the most important part of the preparation. Prepare the sites

in a way that allows optimal and varied training. Training should take place in training lanes and in simulated mined areas (which may sometimes be the same places). When training areas close to real mined areas are selected, this can make it easier to access FFE mines to use as targets. By planning carefully, it may be possible to economise on movement from one place to another while still giving the trainees experience in different ground conditions. Use a variety of training sites and a range of targets to increase competence and confidence. It is not as important that experienced deminers do their training close to real mined areas as it is for novices, but it is always useful.

## 5.4. The training content

The authors cannot attempt to cover the detailed use of all the different makes of metal detector. The trainer must take those details from the relevant user manual. Our objective here is to give generic advice on detector training. To do this, we will concentrate on special targets and unusual situations that require special skills and experience. Other useful information can be found throughout this book, and especially in Chapter 2, 'The role of detection in humanitarian demining'.

When devising the training areas, the trainer must use his imagination to provide exercises that are as realistic as

possible. Some of the exercises described later in this section can only be done close to real objects (railway or electrical supply lines). Others such as target proximity exercises can be simulated. Still others may never occur in some countries and may be omitted. The list covers the basic requirements but the trainer should consider the working area and alter them or add other exercises as appropriate. Crucially, the trainer should always study all available accident reports (with all demining groups) and ensure that relevant lessons are incorporated.

The way in which each aspect of the training is actually conducted should reflect the normal working practices within the demining group so that good minefield behaviour is reinforced.

The first contact between the deminer and the detector will be during their training. The trainer should try to make the introduction like 'love at first sight'. Some will like the colour, the shape, the sounds it makes. But if the trainer has difficulty getting it out of its case and assembled or has other problems preparing it for use, this will give the deminers a bad first impression. That will mean that the trainer must overcome the bad impression during the training, so adding to his work.

The introduction to the parts of the detector and its working principle can be done with the trainees in large groups when convenient. All the other activities listed in Section 5.3.3, 'Structuring your training', should be carried out in small groups. The smaller the group the easier it

will be for the trainer to ensure that every deminer understands and has plenty of time for hands-on practice. The trainer must be sure that all the trainees understand fully and should allow questions to be asked at any time. He should answer those questions as carefully and patiently as possible in order to bring all of the trainees to the same level of understanding and competence. By regularly changing between demonstration, questioning, discussion and then practise, the trainer can maintain the trainees' concentration. Whatever the teaching style, the trainees must have the opportunity to practise finding the different targets as often as possible. They should progress from targets laid on the surface to targets concealed below the ground, from big targets to smaller up to the limits of the detector. At the end of the training the trainee must be confident that he will find the targets at the required depth in every mined area. To achieve this, the targets used **must** include FFE mines or credible simulants hidden at the maximum required clearance depth.

NB: The trainees may be allowed to excavate targets in training lanes without following excavation drills. However, whenever training takes place in a simulated mined area, the targets should always be excavated following approved excavation drills.

The correct use of the equipment should become 'automatic', so the training should include a large element of repetition. This can be disguised by repeating similar practical exercises in different simulated search-lanes.

### 5.4.1. Assuring trainee competency

To achieve full competency, the training must go beyond the ability to determine whether a target's shape is 'point, linear or polygon'. It should cover how to decide the safe distance to advance the detector search-head on each sweep, how to discriminate between two targets close together, and how best to exclude interference from materials or electromagnetic fields that may be around. Such disturbance may result from the properties of minerals in the ground, or man-made devices such as radios, power lines or radar stations. Some of these disturbances may be rare but if there is any chance of them occurring the training should cover what a deminer must do when they happen. Our experience is that the 'unusual' can happen with surprising frequency, especially if the deminers are unprepared for it!

The training should cover all situations that are known and that could realistically occur within the region(s) where the trainees will work. It should always cover the situation where there are two mines (or signals) close together.

### 5.4.2. Search-head sensitivity profile (footprint)

Knowing about the detectors and their working principles is not enough. It is essential that the user fully understand the footprint, sensitivity profile or cone beneath the detector head because this is the area that is actually searched.

Assessment of the sensitivity profile (footprint) was introduced in the IPPTC detector tests <sup>(41)</sup>. The detection area was scanned at different heights from a target and the result for **every** metal detector using current principles was a crude 'cone' shape.

The data for the following drawing were taken from the ADP international detector trial showing average figures for four metal detectors (the 'best' ones). For demonstration purposes, we have used the simplest illustration available.

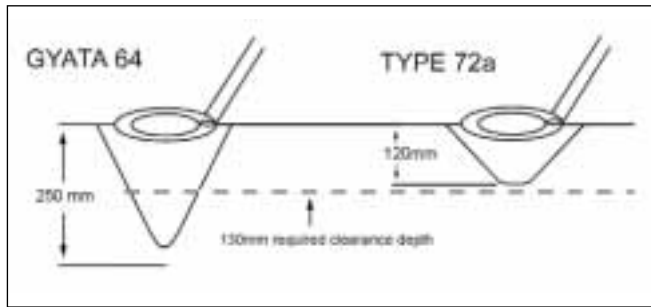

Figure 5.2: Example of sensitivity cones for two specified mines

Expressed simply, the length of the cone depends on three things:

1. the model of detector in use;
2. the sensitivity setting necessary to search successfully for a specific target, or the sensitivity achieved after using the ground compensation facility (when available);
3. the metal content of the target.

It is known that other factors also influence the cone, but to a lesser extent. For example, the influence of the ground can be important. You can find the original explanation of ground influence on the ADP tests in their final report on the ITEP website <sup>(42)</sup>.

The drawing shows the way that a detector's footprint varies according to the target and its depth. Determining the footprint for a particular target allows you to know how far you can safely advance the search-head on each sweep without missing that target at the established depth. If the GYATA-64 cone is 250 mm long you can see that at a 130 mm clearance depth the area covered by each sweep is more than half the size of the search-head. That means that the deminer may safely move his detector half a search-head forward on each sweep — as long

<sup>(41)</sup> See <http://demining.jrc.it/ipptc/index.htm> or <http://www.itep.ws>

<sup>(42)</sup> See <http://www.itep.ws>, click on 'Reports' and in the search area insert 'Final Report'.

as the required clearance depth is only 130 mm. If he moves it more than this, he will miss some areas.

Figure 5.2 shows that to achieve the same search-head advance when looking for the much smaller target (Type 72a), it would be necessary to remove 70 mm from the top surface of the ground. This is because the Type 72a would have to be no deeper than 60 mm to ensure detection when moving the search-head forward by half its width. In this case, it would not be enough to move the search-head forward in very small advances because the profile shows that this mine could not be found at the required depth.

Failure to understand the importance of the sensitivity profile (footprint) may explain why some mines have been missed in the past. Many groups do not determine the search-head footprint even when they do check the detector's ability to find the target at the required depth. Failure to do this means that users cannot be certain that they are advancing at a safe rate.

Here is a way to train deminers to understand the sensitivity profile.

1. Measure the maximum detection distance of your target in air (doing this in ground beside the working area is described later in this section).
2. Make a sketch with the search-head length/diameter as the base-line and draw a line from the centre of the base lane extending the length of the detection distance.

3. Join the ends of the base-line to the maximum detection distance. The result is a pointed cone. While this is a 'simplified' profile, it errs on the safe side.
4. From the centre of the base-line, measure along the maximum detection distance to the required detection distance, and draw a line parallel to the base-line that meets the sides of the cone. The length of that line is the footprint for that target at your given clearance depth.
5. Decide the possible advance of the search-head with every new sweep, which should be less than the footprint to allow an overlap.

This method works with most detectors but can be difficult if the detector works in dynamic mode or has a double-D search-head and the ground is very magnetic.

It has already been stressed that it is always best to test the detector's effectiveness in conditions that are as close as possible to those in the working area. This is not possible during demonstrations of detection theory and introductions to assessing the detector's capabilities, but nothing gives deminers more confidence than personal experience in a realistic setting. After the first mine has been successfully detected using the correct sweep-advance, you can often see the confidence of the deminer increase. When a deminer has done one sensitivity profile he will never forget it. Confident that he understands the detector's abilities and limitations, he will be very careful to ensure that he covers the entire clearance lane with the detector's footprint.

Using the explanation above, the trainer should get groups of two to four trainees to produce a more accurate detector search-head sensitivity profile (footprint) for field use. The working principle of the detector has an influence but it is quite easy to do accurately for static and dynamic mode detectors.

### 5.4.3. Determining a field-accurate sensitivity profile (footprint)

This section describes how to define the search-head sensitivity profile (footprint) in length and width using the search-head on realistic ground.

Set up the detector to the ground as described in Section 6.2, 'Adjusting for different ground'. A place free of vegetation with a sloping hole must be prepared. The hole should be deep enough for the search-head to be presented horizontally to the vertical wall of the hole as shown in the drawing below.

If the detectors are adjustable to the local conditions, the detector should make no noise or other disturbance when in place as shown above.

Now the target/mine should be held in the same orientation to the search-head as it would be if it were beneath the ground and the search-head were being used to find it. Move the target/mine parallel to the centre of the bottom of the search-head. Start close to the search-head and move

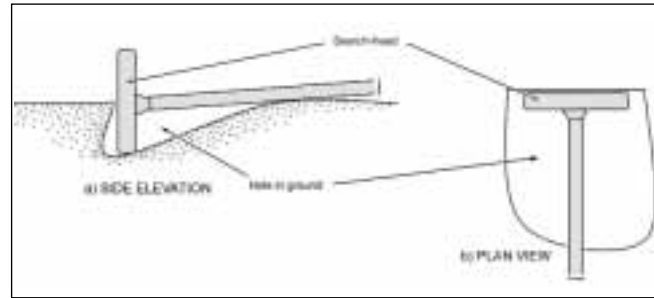

Figure 5.3: Determining the search-head footprint in the field

the target away in 20 mm increments. Mark the place where the detector signal becomes uncertain or ends. This is the maximum sensitivity depth. Now, scratch a 'centre-line' on the ground from the centre of the detector head to the maximum depth. Move the target towards this from one side, marking the place where the detector signal begins. Repeat this at 20 mm intervals, moving the target from each side towards the centre-line. Make a mark each time the detector starts to signal. The marks you make show the limit of the sensitivity area. Turn the detector search-head 90° and repeat. You must turn the detector head to allow for different search-head geometry.

The outline you have marked on the ground will be close to a cone. It will be specific to the target, so the smallest target mine expected in the area should be used.

To show how the cone varies according to the metallic signature of the target, repeat this again using a larger

target. With large targets such as UXO, the cone may extend beyond the sides of the search-head.

When several deminers are collaborating to do this test, it should be repeated with each deminer taking a turn to move the target and to define the place where the signal starts/stops. Slight differences will occur but the general shape should not change.

#### 5.4.4. Discriminating adjacent targets

The trainees must know the detector's discrimination limits, and how to pinpoint readings that are close together in the best way possible. This should be practised from two directions, extending and contracting the distance between the targets. In this way the deminers will not only **be told** the limitations, they will experience them and so will be confident about the point at which two signals merge into one. As in other aspects of the training, it can help to concentrate the minds of the trainees if the trainer explains the possible consequences of getting it wrong. In this case, the trainer should explain how two devices close together may both explode if one is initiated. This could dramatically increase the risk of severe injury even if the deminer is wearing very good protective equipment.

#### 5.4.5. Stacked signals

In many theatres, there are instances when a large AT mine has a much smaller AP mine (or mines) placed above

it. If the AT mine has a metal case its large signal can easily mask the smaller signal from the AP mine(s). Similarly, it is also common for AP blast mines to be laid around fragmentation mines or their tripwires. The trainer should set up examples so that the trainees experience the limitations of the detector and so **know** when there may be signals that have been missed and can excavate with appropriate caution.

In these situations it can be advantageous to use a detector with a double-D search-head. By keeping the centre-line of the search-head directed towards the stronger signal the user can stop it making the detector signal. The signal from the smaller mine can then be found by sweeping the search-head from side to side while keeping the centre-line towards the large signal.

#### 5.4.6. Linear metal targets

Sometimes there are conditions that the deminer has to clear alongside linear metal targets such as railways, metal fences, concrete walls reinforced with steel, pipes and pipelines, etc. The training should include examples so that the trainees learn the limitations of the detector and how close they can reliably work. The targets should be FFE examples of the mines in the region or credible surrogates because the detector's ability will vary depending on the target. Only by training in a way that closely mirrors reality can the trainer prepare the trainees appropriately for what they will find when they work.

### 5.4.7. Electromagnetic disturbance

Detectors may be influenced by electromagnetic waves that are transmitted by different sources. Electricity supply lines are commonly mined by both sides in a conflict, so are a common source of disturbance. Other sources may be radio or radar stations. The electromagnetic disturbance may make the detector signal constantly, but may cause them to compensate for the disturbance and so lose sensitivity. A mine that was easy to locate at the required depth outside the influence of the power line may become impossible to detect beneath them. The trainer must ensure that the trainees know how the detector will react and what they should do. More importantly, the trainees must know what they should **not** do.

### 5.4.8. Pinpointing targets

Pinpointing the source of the detector signal increases efficiency and safety, but the accuracy of pinpointing is not just dependent on the deminer's skills. The metal content of the target, the particular detector, and the operator's ability all affect the potential for accuracy. In laboratory conditions a well-trained technician may achieve an accuracy of a few millimetres but it may not be realistic to pinpoint with an accuracy greater than 40 mm with the same detector in the field. This level of accuracy is usually still acceptable because it is within the radius of the smallest mine. A double-D search-head can increase pinpointing accuracy for reasons described in Section 4.3.5, 'Single

receive coil versus double-D (differential) receive coils'. With other detectors, approaching from each side is usually enough to allow the centre of the target to be determined as shown below.

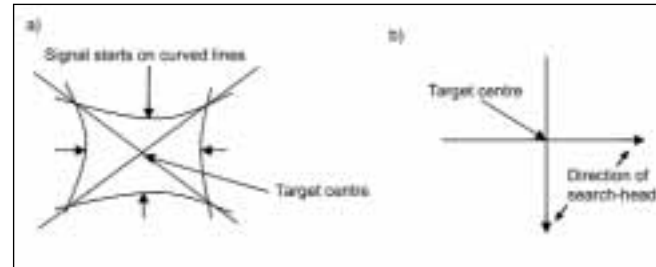

Figure 5.4: Pinpointing: (a) with normal search-heads; (b) with double-D

It should also be remembered that a mine may give more than one signal. This can be because the metal content is spread out within the device. For example, the PMD-6 anti-personnel blast mine has a large fuse and detonator at one end and small hinge pins at the other. A good detector may define both ends as separate indications. Deminers with experience of the PMD-6 can often use the signals to tell the mine's orientation beneath the ground, which can make the excavation approach safer. This is one reason why it is important for deminers to know the metal configuration in the mines they must deal with. Most mines have their metal parts close to each other. In most cases they are either concentrated in the centre, pass through the centre, or extend outward from the centre.



Only a few are 'offset', but these include common mines such as the PMN-2. When deminers know that the metal may extend to the furthest side of the mine, they can understand why it is essential to start an excavation a safe distance from the reading.

## 5.5. Work in 'prepared' and 'unprepared' areas

In this context, a 'prepared' area means a dedicated training area in which all of the possible detector signals will be on targets that were deliberately placed. The area may include lanes using varied ground samples brought from other places and with targets that have been placed for extended periods of time. An 'unprepared' area more accurately reflects the general conditions that will be found in the mined areas. Often close to a real mined area, it will contain natural scrap metal, undergrowth and obstructions. The trainer must also hide targets at recorded depths, so some preparation is still necessary. The experience that the trainees get in the unprepared areas should provide a bridge linking the artificial training area and the real mined areas.

The training in prepared areas should be used to cover the reaction of the detector to all the content listed in the previous section. The trainer will need to spend less time over preparation in unprepared areas but there are real

advantages to having well prepared permanent training areas. In both, the trainer should start with visible targets and progress to the detection of buried targets at a depth that shows the limit of the detection ability.

At all times, the trainer should remember that the requirements of experienced deminers are different from those of inexperienced newcomers. When the trainees are experienced, it may be appropriate to limit the work on prepared areas and move to unprepared areas more quickly. The area will contain realistic scrap metal and have ground conditions that closely resemble those in the mined area. If the trainees are newcomers, or if the new detector's abilities vary considerably from the old, more time should be spent in a prepared training area practising detection, pinpointing and determining the depth of a target. Of course, all relevant SOPs regarding mined-area actions must be enforced during the training. For example, targets should be excavated as if they were 'live'. This helps to reinforce other aspects of deminer training and avoids the trainees adopting bad habits.

The lanes in a prepared area can be set up with a wide range of different targets at various depths in varied ground so that in each lane the trainee has a new challenge. This allows the range of potential problems to be presented very quickly. But training lanes in a prepared area are essentially artificial and the trainees will understand that they are learning how to find targets — not mines. Inexperienced trainees will find the transition to an unprepared area more challenging, and not just

because there are additional scrap metal targets. Experienced deminers will know that they are safe and may find the transition less challenging.

When selecting and establishing an unprepared training area, the trainer should select the site long before the training is scheduled to start. This will allow targets to be placed and 'settle in' so that their position is not obvious. If time is limited, it may be appropriate to disturb the ground in many places where targets are not placed. FFE mine targets (or credible surrogates) should be positioned in a pattern that is known from real mined areas. Add some details from personal experience, such as booby traps, UXO (also FFE, of course), tripwires, stakes and other mined-area ephemera so that you will keep the trainee's concentration high for the first day at least. Let them experience what it is like to cut vegetation and find nothing more dangerous than scrap metal later in the training. It is essential that newcomers experience this so that they realise how often they will investigate scrap metal before they find a real explosive target. Do not forget to ensure that each trainee experiences situations where targets with a large and small metal content are close together.

It is a mistake to make experienced deminers bored, so do not keep them away from their work longer than necessary. On the other hand do not release them into a live area before you are sure that they are properly trained to cope with all situations that may arise. The experienced deminers may feel that they know all they need to very

quickly, so the trainer should stress that adequate training for one situation may be dangerously inadequate for another. Give examples from recorded accidents when possible, and ensure that the trainees understand the significance of the more difficult exercises they have to do. It may be appropriate for us to observe that, if the training is not comprehensive, the deminers will need more 'refresher' courses when they move to different working areas.

## **5.6. Rescue/evacuation using metal detectors**

Trainers must always keep in mind that, no matter how good the training, accidents will occur and deminers must be prepared to cope with them.

We hope that no readers will ever be involved in the rescue of an injured person from a live area. The situation is rare, but the need does arise. The most common case is when a civilian is injured by a mine and deminers are called to evacuate them. Methods for doing this should be covered in the demining group's SOPs. When the injured person is a deminer, it is possible that his detector will still be switched on and functioning. This is rare, but there are several recorded examples in the DDAS.

In humanitarian demining, detectors are generally used at a distance of at least 25 m from each other in accordance

with the UN's International Mine Action Standards. The only situation in which detectors may have to work very closely together is when a person must be rescued from a mined area. This is not because two deminers approach the victim with detectors, but because the victim's detector may be switched on. In the worst case the victim's detector is pointing towards the rescuers.

Because this is the 'worst case', it is the one that the training should cover. In most cases, only one type of metal detector is available to the rescuers and this will be the same model as that used by the victim. This is bad because both detectors will operate at the same frequency and so may interfere with each other at distances of up to 20 m, depending on the model. Newer designs sometimes have a 'noise cancelling' capability designed to eliminate interference between detectors, and this may work reasonably well. If the demining group uses different models of metal detector, a test should be done to determine the minimum interference distance between them. In some cases this may be as low as 0.75 m which would allow the victim and other detector to be removed from the area without a problem. This should be demonstrated to the trainees.

To establish the possible working distance between the same model of detector, simply switch them on, set them to their highest sensitivity and listen to the noise they make as they are moved closer together. Hold the detectors in the air with their detector heads facing each other. When the noise changes, their distance apart is the closest

that they can be safely used. This test will result in a 'worst case' safe distance. In reality, the detectors are unlikely to be facing each other and may not be adjusted to maximum sensitivity. However, remember that an accident is a stressful situation and the deminer using the detector may not be thinking as clearly as usual. He may want to work too quickly and be unable to make a clear judgement, so the rules should protect them. This is one of the situations where everybody should carry out the drill automatically and in accordance with their training.

Usually, it is the closest deminer(s) who must go to the accident site with a detector and the field supervisor. The trainer should set up a worst case simulated accident in which the victim has fallen into the mined area with his detector. The victim's detector is switched on and pointing towards the rescuers. There is no easy way to approach it safely or to pull it out. The trainer can vary this, creating different and complex situations but must never forget to demonstrate the solutions.

A possible solution is to always have another model of detector on site and have this written into the SOPs. Another is to use a hook and line (perhaps a fishing line) to try to remove the detector. Depending on the safe distance for detector use, it may be possible to begin the approach and then use a long stick with a hook to reach the detector. Of course, whatever method is used should not further endanger the victim by risking detonating another mine. When no dedicated equipment is available, the trainer should improvise using whatever is available on site.



# Chapter 6: The use of metal detectors in mined areas

After deminers have learned how to use a metal detector in different situations they are **theoretically** ready for employment in mined areas. If their trainer has used the advice in this book, the deminers should be confidently able to use the detector in all predictable situations, and should be clear about when it is **not** safe to use the detector.

What follows are two examples intended to show how deminers work, and how they rely on their detectors. The first illustrates the point that competence with a detector is not enough to ensure that a deminer can do the job.

During seven years' field experience I only experienced one occasion when a deminer was not able to move from training to the live area. In this case, he was able to use the detector as well as anybody. It was not obvious during his training that he was suppressing a deep fear. Shortly after his training ended and he was working in a mined area, his supervisor noticed that he was working very slowly and investigating a detector reading in the wrong way. The supervisor corrected him and watched to see whether the deminer had understood correctly. It became obvious that the deminer did not want to investigate the place where the detector was signalling. The supervisor corrected him for a

second time. As he did so the deminer suddenly started to beat the ground close to the place where the detector was signalling and cried 'Is that OK?' That was his last minute in a mined area.

His fear and the stress he suffered could have led to injury or death. As I mentioned, this has only happened once and I have never heard of people in other organisations having similar experiences — but that may only be because people are reluctant to talk about it.

The second example illustrates the way that deminers gain confidence in their detectors, and quickly learn their limitations.

During a long-term detector trial, some deminers used the trial detectors in live mined areas. Selected and experienced deminers were trained in how to use the detectors for two days. The training took place within the areas they had just cleared and verified, and used defused mines as targets. Detector models capable of finding the targets were selected and used for further clearance in the live area. For the first two days back in the live area, each deminer was under close supervision (one supervisor for each deminer). All the mines found

during that time were checked with all the detectors under field trial and it was possible to see the deminers' confidence grow each time it was confirmed that the different detectors signalled on the mine. Sometimes it took 10 minutes to walk to the place where the mine was found. On the first day, nobody complained about this as they walked. On the second day, deminers started to ask, 'Why should I walk there when I know that I can get it with my detector?' After using the detectors and discussing their performance between themselves for three weeks, the deminers established a 'ranking order' for the detectors they were testing. They had not seen any of the rest of the tests but their 'ranking order' was very close to the eventual trial results. They were also able to give advice to the manufacturers about ergonomics and other practical hints for daily use.

Deminers must know a detector's strengths and limitations because it is often the only tool standing between them and a severe accident.

The rest of this chapter covers the use of metal detectors in the field, how to prepare them for a specific area and how the 'set-up' may vary.

## 6.1. The detector 'set-up'

The normal detector 'set-up' and daily routines are described in Chapter 2. The information given in Chapter

2 is not repeated here but as a reminder, we wrote about using two test-pieces — one from the manufacturer and one representing the main threat in the actual mined areas.

It can be critical that everyone in the command chain knows the detector and the difference between it and other models. The following example illustrates this.

The clearance in an area had been started using a model of detector that could not reliably detect the expected mines at the required clearance depth. These detectors had to be used with their search-heads very close to the ground, and at a sensitivity setting at which they made a constant sound. Even then, tests showed that they might miss mines at the required depth. Two new detectors with improved sensitivity were deployed in the area as part of detector trials.

One of the trial detectors was sufficiently sensitive that it could detect the particular mine at the required depth when set to its lowest sensitivity. By using the lowest sensitivity, the user avoided getting detection signals on tiny pieces of metal that were too small to be the mine. The demining group used SOPs that required deminers to double-check each other's work. The deminer who double-checked used a different detector and it signalled on the tiny pieces of metal that the first detector had ignored.

The organisation was clearing 'metal-free', which meant that no metal signal should be found in the

cleared area. The supervisor had been on holiday and although he had trained with the new detectors he had not been told how the use of the new detector had affected the 'metal-free' rule. Where that detector was used, the presence of very small metal pieces was not a clearance failure because there was complete confidence that the detector was able to detect the target at the required depth.

The supervisor suspended use of the new detector, and was correct to do so. His doing so started a debate among the deminers about how the new detector could affect their safety. At the end, the deminers understood that the issue was not of safety, but of inadequate communication between managers. The suspension was lifted and work with the detector continued. That area is now in full agricultural use.

Geologists and other experienced people can sometimes predict the mineral content of the ground and its magnetic properties by simply looking at its colour. Occasionally, such predictions are accurate but one should not rely on guesswork when the safety of deminers is involved. The magnetic properties of the ground can change significantly over a few metres — and completely over 100 metres. As an example, when the Schiebel AN-19 was used to get a magnetic ground reference in Mozambique it was not uncommon for that reference to vary by a third within 100 metres. In the absence of any generally accepted rules, experience shows that there may be very significant changes in the magnetic characteristics of the ground within even rela-

tively small mined areas so it is essential that frequent checks on detector performance are made.

Having understood the previous chapters in this book, the reader should understand how to set up the detector to perform optimally on varied ground. The set-up depends essentially on the following factors:

- whether the detector is adjustable to the properties of the ground and, if so, the procedure to compensate for the ground's influence while minimising any reduction in detection depth;
- the metal content of the main threat (defining the 'main threat' as the mine that may be missed during clearance rather than the most common mine). First, ensure that the target can be detected in air, then at the required depth in the ground at regular intervals inside cleared parts of the mined area.

Magnetic ground is not the only thing that can influence detector performance. Other factors can have an effect, often in conjunction with each other. From experience, the reduction of detection depth they can cause is usually not more than 20 mm, but it can be far worse. These other influences include:

- In tidal areas the salt water in the ground may make a metal detector signal (see Section 4.6) and (depending on the model) can make it impossible to use the detector. When the tide recedes and the ground dries out, it may be possible to use the detector again.

- The ambient temperature can affect the electronics of some detectors, requiring adjustments to be made as the temperature changes during the day.
- Atmospheric humidity should not affect well-sealed detectors, but when humidity levels are very high it is wise to check that performance has not changed.
- The compactness of the ground can influence its magnetic properties, and so the detector's performance. This may be especially relevant when mechanical assets have been used to prepare an area. In compacted areas, such as well-used paths or the tracks of heavy vehicles, older designs of detector may give readings when moved across the line between compacted and uncompacted ground.

Newer, more sensitive detector models may react to other ground variations. For example, detectors with double-D search-heads may signal on the kind of crazy-paving cracks that occur as any ground dries out. Sometimes such false readings can be avoided by simply changing the sweep direction.

## 6.2. Adjusting for different ground

Most of the currently available detectors lose some sensitivity when using GC to compensate for magnetic ground conditions. At the time of writing, this is true for all except a very few detectors. Some exhibit other problems in GC mode and may give an unacceptably high number of false positive <sup>(43)</sup> readings.

It is easy to check whether a detector's GC capability should be used at a site. First, set the detector to maximum sensitivity as described in the manufacturer's manual. When GC features are available, their use is always explained in detail in the detector's manual and should be followed strictly. If the detector works in static mode, put the detector down so that the search-head is touching the ground. If the detector works in dynamic mode, sweep the search-head close to the ground. On magnetic ground, the detector will make a noise that can be reduced by turning down the sensitivity or by using the detector's GC capability.

Ground compensation is generally achieved by either tuning the GC control, by pressing a GC button, or by using a screwdriver. The process can take anything from a few seconds to 10 minutes depending on the design and on the technical understanding of the user. Some models

---

<sup>(43)</sup> 'False positive' readings include readings from magnetic ground because the metal oxides that cause the signals are not actually metals.



require the search-head to be brought into a specific position during tuning. Other models require the search-head to be moved to varying heights from the ground. After adjustment, some models automatically adjust their compensation to the ground, others will need readjustment as ground conditions change. When the GC adjustment has been completed (and unless the detector adjusts its GC settings automatically) check the detector's sensitivity to the target in air. Sometimes the detector does not react at the usual distance from the target, so indicating a reduction in potential detection depth.

The following generic rules can be used to confidently assess a detector's performance in GC mode.

- A target representing the main threat in the area should be buried at the required clearance depth. The place of burial should be not more than 50 m from the clearance lane of the deminer — the closer the better. (When possible, check whether there are big differences in ground disturbance between one section and another by using a static detector as described under Section 6.3, 'Adjusting to specific targets'.)
- The detector should be adjusted to the ground as described in the manufacturer's manual, using a place where there are no pieces of metal in the ground.
- Then the detector should be used to detect the buried target. If the detector only signals on the presence of the target, the GC adjustment has been successful.

These procedures allow the detector to 'cancel' the magnetic signal from the ground as described in Chapter 4. If the clearance area has 'hot stones' (highly magnetic stones) they will still make the detector signal. To reduce these false positive signals, try placing a layer of those stones on the ground where the GC adjustment takes place. When the difference between the hot stones and the ground is not too great, this can sometimes help. Personal experience shows that this is most effective when a single stone larger than the search-head is used. However, if the adjustment causes such a reduction in sensitivity that the target mines cannot be located at the correct depth, you may have to live with false positives from hot stones. Another effective way to reduce the effect of hot stones is to lift the detector higher above the ground by a few centimetres. This can sometimes reduce the signal from the stone while leaving the signal from a target clear. The effectiveness of these approaches depends on the sensitivity of the detector and the metal content of the target. A little trial and error with your own target and detector (in the right context) should be very helpful. However, these assessments should be made in a controlled manner by the supervisor, and not left to individual deminers.

When conducting 'metal-free' clearance, remember that it is important to record the detector settings accurately, and record exactly which areas were cleared using those settings. If this is not done, problems can arise when quality assurance checks are made using different settings or different detectors. As detector capabilities and settings

become more varied, it may be appropriate to consider the use of dogs or other means of QA.

### 6.3. Adjusting to specific targets

In an ideal situation, the deminer knows what kind of mine is in the area he must clear. This knowledge makes the work a lot easier and several times faster than when the threat is not known. The efficiency of demining assets is almost always increased when the surveyors confidently identify the threat in the area to be cleared.

The main targets of HD are mines, but deminers must also clear UXO. In former combat/battle areas, there may be far more UXO than mines and the UXO may pose a greater threat to civilians. After a conflict has ended and the movement of displaced people has stopped, most mined areas are known to the local population so they can be avoided. But it can be much harder to avoid the UXO problem, which tends to be widely spread and often tantalisingly visible in a way that attracts the young and curious.

A surveyor should make close contact with the people living in the area to be cleared before making any decision about the extent of contamination. In some countries, survey teams undertake simple explosive ordnance disposal (EOD) tasks. This can make the survey team very popular. Popularity is not much good in itself, but it can lead to

relevant survey information being made more readily available so it is always valuable. In most cases, people living in mined areas know where the danger lies. When the mined areas were put there to **protect** them, local people were sometimes involved in mine laying. Even when they were not involved, they have had to learn which areas to avoid. If any of them were involved in placing the mines (or present when they were placed) their information can be invaluable.

The level of confidence that the surveyors have in their results has a direct influence on how the deminers approach the threat in the mined area, and on which demining assets are deployed.

While survey can often achieve a high level of confidence in determining the types of mines and where they are, it is limited unless it also includes some information about the magnetic properties of the suspect ground. Only when survey also includes a means of assessing how well the available metal detectors can perform in the area, can better-informed decisions about the deployment of demining assets be made.

Recently, an improvised ground-property measuring instrument has been compared with purpose-designed instruments and shown to perform very well. The Schiebel AN-19 (a static metal detector) was used to give a reasonably accurate measure of the magnetic influence of the ground, so providing a crude guide to the use of all metal detectors in the measured areas (see Section 3.7, 'Output

of other tests/trials', also 'Annex E: Calibration of the Schiebel AN19/2 M7').

In almost all demining contracts, clearance to a specified depth must be achieved. So all demining groups must be sure that they can detect the target mines at the depth dictated by the national mine action authority. To apply for a demining contract, the demining group should be able to demonstrate that they have a detection tool/method that can safely locate the targets to the required depths, and also that their methods will not miss other explosive items that may also be in the area. To be confident of this, the demining group must understand the strengths and weaknesses of the available metal detectors and know the magnetic properties of the ground in the area.

When the survey includes a measure of the magnetic properties of the ground, the demining group can have a clear idea of the detectors they must use. Some detectors are easy to adjust to targets by increasing or reducing the sensitivity, others have fixed settings or permanently work at their highest level of sensitivity. Using the right detector that is set up for optimum performance against the threat can sometimes allow demining organisations to reduce the false readings and to speed up the clearance without affecting safety. For example, where the threat of mines has a large metal signature it may not be necessary to work strictly 'metal-free'. This is only an option when the demining groups have complete confidence in the ability of their detector and fully understand its strengths and limitations.

Detector manufacturers are increasingly offering sophisticated sensitivity adjustments that allow the user to adjust the detector's software. These adjustments allow the detector to perform optimally in a particular area and can lead to a small reduction in 'false positive' signals. It is essential for demining groups to provide effective training so that the deminers can regularly make appropriate adjustments.

## 6.4. Discrimination of 'innocent' metal

Although some discrimination between innocent metal and metal associated with explosives can be made by adjusting the detector to 'miss' very small metal indications, currently available metal detectors are generally unable to discriminate between innocent metal and metal connected with explosive devices. Other technologies are needed to make this kind of discrimination possible (see 'Annex B: Other ERW detection technologies'). To date, millions of euro and dollars have been spent on research into completely separate methods, or methods that can be combined with metal detection to increase target discrimination. These programmes are ongoing and may yield useful results soon, although developers would do well to remember that any solution must be both usable and affordable. In the meantime, deminers are not waiting because **clearance must be done now**.

Ignoring innocent metal can currently be achieved by using EDDs. This usually gives a confidence level that is

accepted in the demining community although there is some disagreement about how effective EDDs really are. For more on the use of dogs, see 'Annex A: Explosive detecting dogs (EDDs)'. Research is also going on into the use of other biosensors as described in 'Annex B: Other ERW detection technologies'.

Some demining groups use ground-engaging mechanical equipment to provide confirmation that an area is free of mines, or even as a primary clearance tool. This also effectively ignores 'innocent' metal but confidence in these methods is not widespread because the performance of these machines varies widely on different ground. Also, a high percentage of mines laid decades ago will no longer function as designed but are still very dangerous and must be removed. Mechanical ground clearance is not an accepted method within humanitarian demining. Any method of mechanically 'proving' an area (for area reduction or for QA) should be assessed in the appropriate context and with the correct targets to ensure thorough coverage before being approved for use.

## 6.5. Action on getting a detector signal

A 'reading', a 'detection alarm', or a 'detector signal' are some of the names used to describe the noise made when a metal detector reacts on metal within its detection range.

A detector signal is often a highpoint in the deminer's life — if not quite as pleasant as some other highpoints. A deminer may investigate hundreds of detector signals before he discovers a really dangerous item. Nonetheless, he must approach each signal as if it were dangerous. He must not feel entirely safe until he has either uncovered the mine/UXO or the innocent metal piece, and has checked the site again to ensure that there are no further signals. Behind this simple rule there are complex procedures that must be followed.

Before these procedures are required, the deminer is usually confronted with an area where no one has wanted to go for some time, and where nature has had a free hand. Various assets, from machines to judicious burning, may be used to cut the undergrowth ahead of the deminer but often he has to do some vegetation removal by hand. When appropriate, the deminer may use his detector during vegetation cutting. He may sweep the undergrowth at different heights to try to detect tripwires. Some groups use tripwire detection sticks instead or as well as metal detectors. If non-metal 'tripwires' are suspected, the undergrowth may be burnt off in order to destroy them.

After the undergrowth (and any mobile obstructions) are removed, the deminer starts to search using a metal detector. When there is a detector signal, he must investigate the cause.

What follows are generic procedures for a deminer to follow when his detector makes a signal. Not every group

works in the same way, but this description is of an 'adequate' and 'proven' procedure.

- (a) The search-head must be used to approach the signal from different angles to help 'pinpoint' the signal source. This also helps to determine whether there is more than one signal source close together. If the deminer finds that there is more than one signal, he must pinpoint and mark the signal closest to him and place a marker. A marker should usually be light-weight, non-metallic and a bright colour. Unless the signal is from a single 'point' source, we recommend using two markers, one marking the point nearest to the deminer at which the detector starts to signal, the other marking what seems to be the centre of that signal reading.
- (b) While working, the deminer should look at the ground surface carefully to see whether there is anything obviously metallic. Some groups carry small magnets with which they can sweep above the ground and attract small items of scrap metal.

If there is metal present, the deminer can often retrieve it, then check with the detector whether there is another signal. If the metal is not loose and entirely on the surface, he should never try to pull it from the ground.

- (c) Usually, the next step is to start to excavate at a distance from the reading. When AP mines are suspected, the excavation should be started at least 200 mm

back from the marker closest to the deminer. The deminer should dig a hole about 200 mm deep and at least 100 mm wide. Starting from this small pit, he will be able to prod and excavate forward with a very low chance of putting pressure on the top of the mine. The excavation is started on safe ground and the danger area starts beyond the first marker. The prodder and other tools should not be used at an angle greater than 30° to the ground surface. The lower to the ground that a deminer can keep his excavation tools, the lower the risk of accidentally initiating a mine.

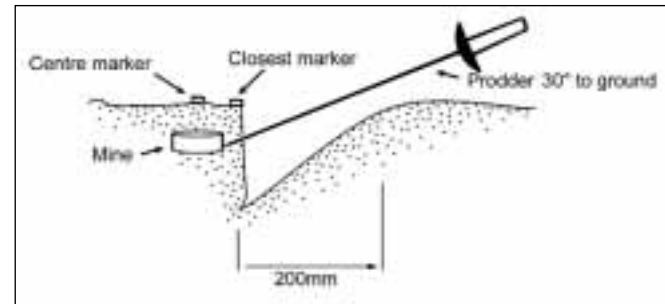

Figure 6.1: Excavating a detector signal

- (d) Using the small pit he has excavated, the deminer should use a prodder to 'feel' forward towards the closest marker. Loosened soil should be removed with another tool. If the ground is very hard, the deminer may have to scrape forward, but always cautiously. In

many cases, experienced deminers have a 'feeling' about the situation and seem to know when they are close to a mine.

- (e) Working forward with increased caution after passing the closest marker, the deminer will reach the area where the detector signalled and locate the signal source. If it is not a mine, he may have to use his detector to help search the loosened soil for the metal.
- (f) When there was more than one signal, the excavation should be extended (or started again) whether or not a mine was located at the first signal.

This sounds easy and it is easy to describe but really the variety of ground conditions make it difficult. Often there is significant vegetation in the mined area and, even after it has been cut down, the roots remain and can surround mines. The force needed to cut them is often more than enough to initiate a mine. Pulling on a root could also initiate a mine.

The properties of the ground also affect the excavation process. Ground hardness, stones, bedrock and moisture content all complicate the excavation process.

But perhaps what makes it most hazardous is the number of false positive signals in an area. Those placing the mines may have spread scrap metal around deliberately or accidentally, and known defensive mine-belts are often used as rubbish dumps. In these areas, the number of false positive alarms can make a deminer impatient and careless.

The lowest clearance rate that we are aware of was in a mined area close to military barracks that were no longer used. A power transformer and the surrounding area were mined and fenced. Local villagers were told about the danger and nobody entered the area. The years went by and the villagers got into the habit of throwing rubbish over the fence. When the deminers went to clear the area they found a 2 m-high layer of rubbish close to what remained of a barbed wire fence. The demining group had no armoured excavator to help prepare the area so the deminers had to take away the rubbish by hand — including old stoves, bicycles, plastic bags, beer cans, etc. Water had to be used to loosen the rubbish and make it possible to move. The overall clearance rate achieved was less than 0.5 m<sup>2</sup> per deminer per day. Mines were found and the area is now used for house building.

**NB:** The authors do not recommend storing fuzed devices in the way shown in Figure 6.3. We include the picture merely as an example of the range of devices that a deminer may expect to encounter in a single mined area.

Combined with the rest of this book, the authors feel that they have written enough in this chapter. We hope that everybody who depends on a metal detector will use this book to provide background knowledge — and hope that it will help them to cope safely in whatever situations they may encounter.



*Figure 6.2:*  
Scrap metal removed  
from mined areas





*Figure 6.3:*  
ERW content of a mined  
area



# Chapter 7: The way forward

Manual demining with a metal detector and excavation tools is still the most common way of clearing ground. This is the case because it results in the greatest confidence that the deminers will locate anything that later users of the ground will encounter. As well as having been proven effective, it is also relatively inexpensive and locally sustainable.

The authors believe that the way forward must take account of the current state of the industry, its technology and skills, and build on them. But if any change is to be a real 'advance', it must not reduce safety for the deminers or for the end-users of the land.

## 7.1. Lies, damned lies and statistics

Those engaged in research into alternative ERW detection methods are rarely experienced deminers and often have very little relevant field experience. This may explain why many of the published reports on the research effort are prefaced by a justification for the work that relies on ill-informed statistical estimates of the need for their efforts.

But the way forward should not be based on ignorance or misrepresentation of the true situation.

Exaggerated estimates of the time it will take to clear the ERW from post-conflict countries (450 to 500 years<sup>(44)</sup>, for example) make people believe that anything has to be an improvement over the intolerably slow current methods using metal detectors and excavation tools. In fact, there is no real evidence that it will take centuries to do the job using current techniques. In Europe, after WWII, there was a very high density of ERW in many areas, but it was quickly reduced to a minimal threat and is still being worked on as the need arises (Belgium is still estimated to have 4 500 000 000 buried UXOs, mostly WWI shells).

Learning from the experience in Europe, many argue that 'speed' is not really a major issue. They argue that the creation of a sustainable local capacity to deal with long-term residual threats is what really matters, and that it is not at all clear that investment in very sophisticated tools and equipment would help this at all.

Whatever your opinion on that, it is wrong to assume that current methods are always 'slow'. The speed of most clearance has increased dramatically over the past 10

---

<sup>(44)</sup> *Alternatives for landmine detection*, RAND Science and Policy Institute, 2003 (<http://www.rand.org/publications/MR/MR1608/index.html>).

years. Techniques have evolved along with the tooling, often with significant increases in efficiency. Machines are often used to prepare the ground. Dogs are widely used, and modern metal detectors are much improved over those available only five years ago.

Unacceptable injuries to deminers may also be cited as the justification for a research effort. Yet accidents using current demining efforts are very rare <sup>(45)</sup> and fatalities even rarer. When civilian mine accidents are cited, those doing so frequently ignore the fact that mines are not always the cause and often not the main problem. At least as many civilians are injured by unconcealed ERW other than mines as they deliberately interact with them. There is compelling evidence that improving deminer and civilian training would reduce unnecessary injury — and this could be achieved without the delay and speculative investment involved in research.

But, while the above is true, conflicts continue and some of the devices used in new wars present a greater danger to deminers and the public than conventional mines (some submunitions, for example). While conflicts continue, it is never going to be possible to predict accurately the amount of time or the technologies that may be needed to clear up after them.

However ill-informed the justification for some research efforts may be, a lot of effort is going into looking for

alternative methods of detecting concealed ERW and these may eventually prove invaluable to the humanitarian effort. Research efforts have involved extending the use of existing technologies and the development of new technologies. The aim of many is to increase the speed and efficiency of ground clearance by reducing the number of ‘false alarms’.

## 7.2. Reducing false alarms

Alternative detection systems are often presented as ways of reducing the number of ‘false alarms’ that occur with metal detection technology. This is especially true of multi-sensor systems, where one method is used to ‘confirm’ an indication by another. While reducing ‘false alarms’ would increase the speed of operations, a greater understanding of what constitutes a false alarm may be required.

There are three typical false alarms:

- false indication — where nothing is present;
- false positive — where the article present is not an ERW item;
- false negative — where an item of ERW is present but the detection system fails to indicate this.

---

<sup>(45)</sup> Smith, Andy, ‘What use is a database of demining accidents?’, James Madison University, *Journal of Mine Action*, Issue 6.2, Summer 2002 (<http://maic.jmu.edu/journal/index/index.htm>).

Of these, the false indication and false positive result in extra work, but do not have a direct impact on safety. If they make the operator 'careless', they may have an **indirect** impact on safety but this can be controlled by adequate supervision (and better area reduction). A false negative is a major safety issue, with missed items resulting in deminer and civilian injury. This already happens (rarely) and any new technology cannot be allowed to risk increasing the number of these incidents.

Because safety is supposed to be the prime concern in HD, concerns to limit false positives must start with a requirement that false negatives be reduced to zero (or as close to zero as possible).

Many multi-sensor approaches appear to be driven by the desire to limit false positives without paying significant attention to false negatives. Increasing confidence that an item is present prior to its excavation is good, but developers must understand that if all uncertain readouts are treated as negatives, there will be a truly negative effect on safety. If they are all treated as possible positives, the promised gains in speed will often disappear.

### 7.3. Incremental improvements

In the past, successful developments in demining technologies and demining techniques have occurred in small steps, requiring minor changes in the proven working

method. The authors believe that future successes are likely to follow the same pattern. The detection technologies we believe most likely to be adopted widely and improve performance in HD are those that take account of current working methods and equipment and move forward by a single step at a time. As a result, the single most likely developments that we anticipate are improvements using current metal detection technologies.

#### 7.3.1. Incremental advances in metal detection

With the increased ability to tune a detector to cancel electromagnetic signals from the ground and to cancel tiny signals in areas where items with a significant metal content are expected, there have already been significant steps forward in metal detector sophistication. In many cases this requires a leap forward in operator sophistication as well, and some problems with getting the best from those detectors exist, but enhanced training and simplification of the operator controls are addressing these issues. This book is part of that effort.

In addition to the technological advances being made by metal detector manufacturers, a research programme funded by the German Government is scheduled to start in Autumn 2003. Designed to support metal detector research and accelerate technological advance, the research will cover:

- tomography
- improved signal analysis

- development of soil/ground and target databases.

This work will provide much needed support for the development of improved hand-held and vehicle-based systems.

### **7.3.2. Incremental advances in other technologies**

Of the 'new' technologies, most promising may be the hand-held ground-penetrating radar (GPR) and GPR multi-sensor systems, in which the new is married to the old and trusted technology. While acknowledging reservations about reliability/safety, these could (if proven) enhance speed after safe working practices have been developed. Their high cost may be expected to fall dramatically if an eventually proven utility were to drive commercial cloning and a high demand.

Next most likely to prove useful are those explosive-vapour detection systems that could be used to perform area reduction, as long as they are proved to work reli-

ably. Because these methods would introduce a new technology to HD, they cannot be seen as merely a step forward, but their user interface must be familiar and the indications must be unequivocal. The development of biological systems (plants and micro-organisms) or further electronic means of 'explosive sniffing' seem most likely to lead to products for field assessment in the short to medium term.

It has been proposed that hand tools able to 'detect' the article encountered and/or to record the forces being applied would be useful. Field experience makes it hard to see how the introduction of excavation tools with a sensing element could increase the safety or speed of current demining methods. The complexity of such a tool could decrease safety by rendering it frangible in a blast and by confusing the user. However, the further development of simple purpose-designed hand tools with blast-resistance may make the deminer's work both easier and safer without significant additional cost.

An introduction to many areas of detection research is given in 'Annex B: Other ERW detection methods'.

# Annex A: Explosive detecting dogs (EDDs)

Humanitarian deminers have used dogs since the late 1980s in Cambodia and Afghanistan. Today, they are still the only alternative to a metal detector in regular field use. EDDs are routinely used in area reduction, so identifying areas where there is no ERW and reducing the perimeter of the area that must be searched with another method. They are also widely used for QA to check an area that has been declared clear using another method of detection. The use of EDDs to detect individual items in a suspect mined area continues despite some misgivings about how appropriate they are for actual mine-field clearing tasks. Improvements in the manner in which they are run, and increasing the number of animals working the same area, have increased the confidence of some users. In areas with sparse contamination, or where individual booby-traps are anticipated, most experienced deminers accept that well-trained dogs can be used to reliably detect individual items (or their vicinity).

Two broad categories of EDD use can be distinguished. These are to run dogs over the suspect area, or to take air sample filters in a suspect area and present the filters to dogs later. The latter is sometimes called 'remote sensing'. For an indication of the range of high explosive that a dog may be looking for, see 'Annex C, Explosive content of mines'.

Although opinion varies, it is generally agreed that the dog does not operate alone. Each dog and its handler make up

a detector between them. The dog must be physically fit and want to please its handler, and the handler must know how to 'read' his dog. Dogs may indicate a signal by sitting or lying down, or by standing still. The handler must know what the dog's movements mean at all times. This is true whether the handler controls a dog (or dogs) in the field, or is in charge of several animals in a remote laboratory.

Currently, there is no general agreement over precisely how EDDs locate ERW, or why they sometimes fail to do so. As a result, opinions over how best to use them or their general reliability vary widely. That said, there are some relatively uncontroversial observations that may be made about them. It is widely accepted that the performance of a single dog should not be relied on. In the field, it is usual to run two or three dogs over the same area. If any dogs signal, the area should then be investigated manually. Some demining groups ignore a signal from a single dog. When 'remote sensing' in the laboratory, it may be easy to present filters to as many as a dozen dogs, and the significance of a reaction may be weighted. For example, if only one dog signals, those in charge may decide that this is a 'negative' and the area is uncontaminated. Outside the EDD community, opinion varies widely about how effective dogs are at detection, especially when used to detect individual items. From experience, the authors believe that an average 90 % detection rate in real mined areas would be unusually high.

The most varied and controversial aspect of EDD use is their training. Some dogs are trained to signal on trip-wires, bullets, grenades, mortars and the empty plastic cases of mines. Others are specifically trained to ignore items that are seen as distractions, such as bullets or wires. Still others are trained using samples of various HE outside containers. While disagreements about how best to train are profound, it is widely agreed that whenever possible the training should reflect what you want the dog to find, and that training should be continuously updated.

Many EDD users accept that a dog is not simply looking for the smell of explosive, but for the mixture of odour that may emanate from ERW. The smell will be of the HE combined with the munition's case and will include odours from the ground and from plants in the immediate area. This mixture of smells is sometimes called a 'cocktail'. The cocktail associated with different ERW in different places will vary significantly. Many accept that this means that a dog will be most effective if its continuous training ends by searching for the actual devices that are expected in the suspect area. When dogs are used for QA, samples actually taken from the mined area can be used. They are placed in adjacent soil and left for as long

as possible to 'settle', the cocktail from the sample will then closely resemble what the dog must search for.

Odours permeate from concealed objects in unpredictable ways, which means that many demining groups accept that dogs cannot be reliably used to pinpoint the precise location of the ERW. They may reliably indicate the point where the odour cocktail starts or is most intense, but that may not be directly over the concealed ERW. Current research suggests that dogs should indicate within a metre radius of an object, but this is still a controversial view. When there are many mines or explosive items in close proximity, the animals can become confused and may be unreliable. For these reasons, most groups do not use dogs in densely contaminated areas, and manual deminers generally search a fairly large area (up to 100 m<sup>2</sup>) around the site indicated by a dog.

The GICHD has recently published an overview of the state-of-the-art of MDDs which may be downloaded from [http://www.gichd.ch/publications/MDD\\_index.htm](http://www.gichd.ch/publications/MDD_index.htm). Included in this document is a detailed scientific study<sup>(46)</sup> indicating that dog performance is still not properly understood.

---

<sup>(46)</sup> Phelan, J. M., and Webb, S. W., *Chemical sensing for buried landmines, fundamental processes influencing trace chemical detection*.

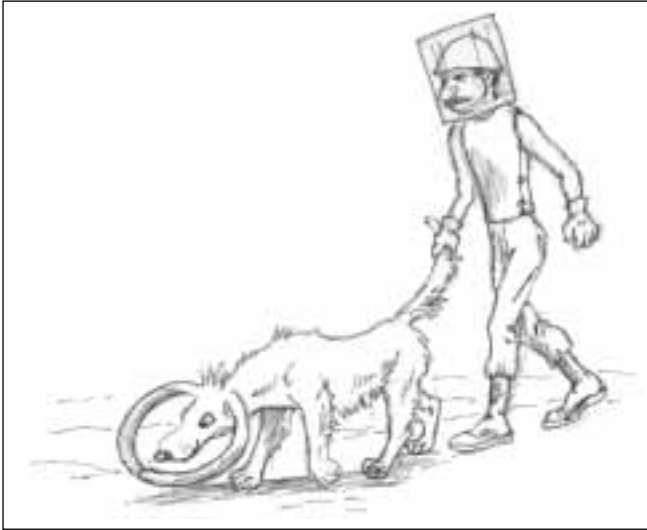

*Figure A1:* A dog is not a machine and is much harder to learn to use than a metal detector. An outsider cannot check the set-up of the dog or the handler, or the way they are working together <sup>(47)</sup>.

---

<sup>(47)</sup> The drawing is reproduced courtesy of Theo van Dyk.





# Annex B: Other explosive remnants of war detection methods

This annex introduces some of the main areas of research into ERW detection that are not reliant solely on metal detection. This annex is not comprehensive or highly detailed because that would go beyond the scope of this book. We start by looking at various bio-detection methods (Section B1), then at other approaches (Section B2).

## B1. Bio-sensors in humanitarian demining

When searching for mines and ERW, metal detectors are used to try to locate the metallic parts of the device. It can be very difficult to reliably detect devices in which the metallic content has been minimised, especially when those devices are in magnetic ground that affects the metal detector's sensitivity. In HD, entirely non-metallic mines are so rarely encountered that they need not be considered.

Almost all ERW have a metallic content. But all ERW has an explosive content. The interest in using bio-sensors to locate the ERW, stems from the sensors' potential to locate

the presence of small traces of HE and so find the ERW regardless of its metal content or other characteristics.

The known biosensor methods are discussed but access to details of some research and development efforts has been so restricted that we have found no useful details on which to comment. For example, we have no information about the use of biomimetic robots, or the use of rats with behaviour-controlling implants. Some details of other research areas are known but ignored, such as the use of trained dolphins to detect underwater mines where the relevance of the research to HD is not clear. Only those technologies with obvious intended HD relevance are discussed.

### B1.1. Detecting high explosive

The term 'bio-sensor' covers sensing by any living thing — the sensor may be an animal, insect, plant or micro-organism — and may include mechanical, electrical or electro-chemical means of measuring the reaction of living tissue to traces of HE.

Unfortunately, ERW does not all contain the same or similar HE, so the idea that there is a single target to find can be misleading.

The most common HE found in mines is trinitrotoluene (TNT). Research Department Explosive (RDX), sometimes also called hexagen or cyclonite, is common, too, sometimes mixed with TNT and sometimes with other explosives. Although TNT is common, it is far from universal, even when you only consider the content of landmines.

In the lists in Annex C, you will find that while most mines have a TNT content, some of those that are well-known (and have caused significant accidents) do not. For example, the PMA-3, M14 and P2-Mk-2 all have Tetryl charges.

The chemicals present are not always necessary constituents of the actual explosive. As a minimum, a useful sensor of high explosive would have to be able to locate a variety of grades of plastic explosives (with and without a TNT content), DNB, DNT, HMX, PETN, RDX and Tetryl as well as TNT.

This leads us to observe that the location of man-made mine-casings (metal or plastic) might be simpler than using a single method to try to locate all the possible chemicals that may emanate from HE.

Dogs used in HD may be trained to seek the smell of an entire object, including its casing, but the authors are not aware of other bio-sensor research directed towards detecting casings on their own. This could be useful. For example, the detection of the presence of certain plastics could sometimes be as useful as the detection of metal. While we are unaware of any documented research in this area, we have heard of dog-handlers using 'clean'

casings for training in an attempt to get the dogs to signal on the casing rather than the HE content. The results of these attempts have not been published. It is generally agreed that no one is 100 % certain quite what an all-purpose explosive detecting dog actually detects when it works — and that the dog is probably reacting to a combination of 'clues'. See 'Annex A: Explosive detecting dogs (EDDs)'.

The belief that all mines allow explosive vapour to migrate through the casing may be wrong. It seems that some mines (plastic or metal-cased) are hermetically sealed and so may not release any HE vapours for detection. There is evidence that breaking the seal to disarm these mines before using them as training aids renders them detectable by dogs, but the animals will not signal on the same mines that have their seals intact. Further research into this is required.

## **B1.2. Advantages and disadvantages of bio-sensors**

The potential advantage of using bio-sensors is their apparent ability to locate very small traces of high explosive. In theory, a bio-sensor could be trained to locate non-metallic mines and metallic-cased ERW with equal ease. If the device were very deeply buried but had been there for some time, a bio-sensor should react to its presence despite it being at depths far greater than those accessible to conventional metal detectors.

Dogs can do this, and may be trained to search for more than simply the HE content. But the main disadvantage of using animals is that the animal has no gauge that can be checked to see whether it is working well today. This means that the individual animal's performance can never be guaranteed. The quality of the training is also hard to measure with complete confidence. These problems could possibly be overcome with improved research but the continued variation in training methods used with dogs and their handlers indicates a lack of general agreement over what is most effective. It is possible that what can be achieved is so dependent on context that general rules could never be universally applied.

It is generally agreed that dogs and their handlers work as a team and so must be 'compatible'. This may be by 'bonding', 'friendship', by 'discipline' or by a combination of all three. Cultural variations in the attitude of people, to animals in general, and dogs in particular, can have a significant effect of the way dogs are trained and how the EDD team works.

The use of insects can take advantage of their instinctive or 'hard-wired' behaviour. This avoids any complex training requirement and can give confidence that they should act predictably in all circumstances, (see Section B1.4). Similarly, the use of live animal tissue that has a mechanistic reaction to the presence of HE overcomes concerns about training but brings its own problems in terms of

keeping the tissue alive and presenting it with suitable samples of air that are not contaminated with other substances that may cause a tissue reaction.

The generation of simple fungi, moulds or plants that react to the presence of HE may also be a way of 'hard-wiring' the desired mechanistic reaction. Genetic modifications to make organisms change in the presence of HE molecules could, theoretically, be more reliable than any other detection method (see Section B1.5).

That said, the other major problem with the specific use of bio-detectors to detect a particular explosive is the range of high explosives that are commonly used in modern munitions. This gives the versatile ability of dogs — capable of detecting more than just the HE — a distinct advantage over many proposed alternatives (see 'Annex A: Explosive detecting dogs (EDDs)').

### **B1.3. Explosive detecting rats (EDRs)**

Research into the use of rats for detecting explosives has been going on for several years. APOPO <sup>(48)</sup>, the main group engaged in this, uses large 'cane' or 'pouched' rats. Apart from its funders, the APOPO research is supported by at least two well-known demining NGOs. Some of their early work was reported to involve automated training regimes using a Pavlovian reward system that involved no

---

<sup>(48)</sup> See <http://www.apopo.org/>

human interaction. In early 2003, the authors were told that this line of research had not been as successful as had been hoped, and that more conventional training methods were being used. Recent tests on the rats' ability to detect TNT suggested that they could reliably detect smaller traces of TNT than dogs.

The rats have been trained to work in a 'hamster wheel' that is pushed over the ground, while running between two handlers tethered on a harness, and in laboratories for the remote sensing of HE presented on air filters.

The advantages that EDRs may have over EDDs have been reported to include very fast training, fast reproduction, resistance to disease, low cost and very high sensitivity. Disadvantages are believed to include a limited learning capacity, confusing reaction signals, inability to cope with extended exposure to sunlight, sensitivity to changes of environment, and their small stature making it difficult for them to traverse suspect areas thoroughly. All these disadvantages may be much less important when using the animals for 'remote sensing'.

At the time of writing, no field trial results have been published.

#### **B1.4. Insects**

The US Government has sponsored some well-publicised research <sup>(49)</sup> into the use of bees to locate explosives. Press releases from other sources have covered research into the use of wasps. Research into the use of other insects may be being made.

The use of bees is taking two directions. In one, the bee is 'untrained' but advantage is taken of its natural foraging behaviour. Sensors scan the bees on their return to the hive, checking for specific chemicals. The second research direction involves taking advantage of the bees' ability to 'learn' behaviour patterns to make them associate HE vapour with food (sugar). By 'training' them with suitably laced bowls of sugar, the bees learn to be attracted to the explosive vapour. After training, the bees are intended to be attracted to any real sources of HE vapour that may be in their area.

Theoretically, by swarming over the HE source in search of the sugar, the bees pick up traces of HE on their 'furry' bodies. Any explosive molecules they carry can then be detected when the bee returns to the hive. Research into 'scanning' the bee for molecules of HE is ongoing. Also, research is under way into miniaturising transmitters so that each bee could be 'tagged' and its flight-path and swarm sites recorded. Present recording of the bee's flight-path appears to be limited to recording a direction of flight from the hive.

---

<sup>(49)</sup> At the Pacific Northwest National Laboratory, and separately, at the Sandia National Laboratory, both in the United States.

As currently formulated, it seems that the research into bees could lead to a method of area reduction. When no molecules of explosive were present in a hive, the area in the search radius of the bees would be declared clear. However, it needs to be proved that the bees would **always** collect some molecules of the entire range of possible HE if any were present. A reliable way of recording the precise area visited by the bees would also be required before the method could have any real potential.

As is common when new ideas become public, there is some scepticism about this area of research. Commonly asked questions are listed below.

- When trained, does the insect always respond to its training appropriately?
- How long does it take for the insect to 'unlearn' the association of HE vapour with sugar?
- How are existing HE molecules removed from the bees and the hive?
- How is the extent of the hive's foraging area recorded, and how could it be controlled?

It is not clear whether a particular type of bee is being studied, or whether a variety of bees from around the world are included in the research. The 'learning' and retention of different species may vary significantly. If a single type of bee is the subject of the research, it may not be compatible with the area where it could be used.

An alien bee in Africa, for example, may be mobbed by aggressive local species, or may upset the local ecosystem.

Limitations on the operating temperature of bees and their inability to search in dense vegetation mean that, even if existing challenges are solved, their potential utility is uncertain.

### **B1.5. Plants**

Research into the use of genetically modified simple plants that change colour in response to the presence of HE is being carried out in Europe and is nearing the stage of field trials. The area to be checked is first cleared of undergrowth and then sprayed with the seeds in a growth slurry. Within four to six weeks, the plants are mature and any that are in contact with tiny traces of HE have changed colour. After six weeks, the plants die without producing seeds.

In addition to a possible use in the detection of mines during demining, the system is believed to have potential utility as a tool for the objective QA of areas that have been cleared by another method (and so is already free from significant undergrowth).

### **B1.6. Bacteria**

Research into the use of modified bacterium that fluoresces in response to the presence of HE was undertaken

some years ago. Reportedly, the fieldable product releases bacteria in a slurry that adheres to vegetation. The bacteria absorb the molecules from HE that are concentrated in any vegetation growing over an HE source. The bacteria that have absorbed HE molecules fluoresce and can be seen using a special filter. Within a short time, all the bacteria die.

Early trials on a US farm showed that the bacteria fluoresced as desired, but that any HE that was on the ground surface or without any vegetation growing above it went undetected.

The current bacterium (or method of deployment) is reported to require the ground to be moist. It is also reported that the hand-held fluorescence detection tool may need to be improved, and that further research to reduce false alarms may be needed <sup>(50)</sup>.

### **B1.7. Reactive antibody detection**

The antibody technique <sup>(51)</sup> relies on the fact that antibodies react predictably and reliably in the presence of specific chemicals. The technology is reported to be capable of

measuring the change in fluorescence wavelength on an antibody bio-sensor when explosive vapour in parts as low as one in 1.5 billion are present. Sample air is drawn between sensor plates and any explosive molecules that are present react with the antibodies on the plates, temporarily reducing the fluorescent light from the plates. The light reduction is detected and the operator alerted.

In addition to confirmation of the system's ability to detect the full range of HE, testing is needed to determine whether, in areas where explosive devices have detonated, the system is able to discriminate between explosive residue and explosive devices. Also it needs to be confirmed whether the system can operate reliably in real-world conditions without signalling falsely on common natural chemicals.

Questions over the frequency of antibody replacement after signals raise issues over the practicality and the running cost of the equipment.

### **B1.9. Artificial (bio) nose**

Several efforts to reproduce a dog's olfactory capabilities are known to have occurred. Only one known to the

---

<sup>(50)</sup> For further information about genetically modified bacteria, see *Oak Ridge National Laboratory Review*, Volume 32, Number 2, 1999, and Fliermans, C. B., *Microbial mine detection system*, June 2000, Euroem Conference Edinburgh, United Kingdom. Also the paper by Fliermans, C. B., and Lopez-de-Victoria, G., 'Microbial mine detection system' in *Detection and remediation technologies for mines and minelike targets VII*, SPIE Proceedings, Vol. 3392, Paper #: 3392-141 pp. 462-468.

<sup>(51)</sup> See: [http://www.bioapp.se/eng-tekprod\\_intro.html](http://www.bioapp.se/eng-tekprod_intro.html)

authors relied on the use of a biological component, although it is possible that other parallel research is taking place. As long as a decade ago, researchers at a UK university found that live cow-gut responded to the presence of traces of explosive in a measurable way. It was reported that the response occurred with tiny amounts of explosive vapour in the air. There were problems with keeping the tissue alive and replacing dying tissue with live substitutes.

It is not known whether the research has continued. No fieldable product has been reported.

## **B.2. Other detection methods**

This section introduces research areas based on physical methods of detection.

### **B.2.1. Ground-penetrating radar (GPR)**

Ground-penetrating radar works by sending radio waves into the ground and subjecting the signals that return to analysis. The returned signal depends on the presence of an object which is different from the background, and in particular on certain 'dielectric' properties of that object. For plastic-cased mines buried in dry sand there is almost no dielectric contrast. Plastic-cased mines in wet soil show up far better but the short-wavelength radar waves

needed to find small mines (over 800 MHz frequency) do not penetrate wet soil very well.

The reflected signal is processed to present the user with some kind of 'readout' (that may be visual or by sound) that provides information about what has been encountered and where it is positioned. In many cases, the return signal is analysed by reference to a library of 'known' signals to allow discrimination to be enhanced. Discrimination detail is dependent on the wavelength, and the depth of ground penetration is reduced as detail is increased.

GPR has been used successfully for pipeline detection and in archaeology for some years. These uses have required detection of relatively large objects or cavities and used large detection apparatus. Confidence in the potential of GPR stems from its success in these other applications, but this confidence may not be well founded. The detection of plastic-cased mines and ERW present other problems, particularly when they may be concealed amid similarly sized clutter at shallow depths in wet or dry ground. Detection of metal-cased mines or ERW by radar is generally considered to be far easier.

### **B.2.2. Electrical impedance tomography detection**

Electrical impedance tomography (EIT) is a method of mapping electrical conductivity. Electrodes are connected to a delineated target area and current is applied to them in

pairs. For each pair of driving electrodes, the voltage on all electrodes is measured. The conductivity may then be computed from the measurements. Its proposed application to HD involves placing grids of electrode spikes into damp ground. Water jets have also been used instead of spikes to carry the current. Hidden objects disturb the natural conductivity and can be discriminated. The grid makes the mapping of their position reasonably accurate, although the definition of the concealed object is currently poor.

While applying water to the ground before use might cause a problem in some areas, for anyone involved in HD the main problem with the system is obvious. The electrodes have to be in contact with, or beneath, the ground surface. This makes it likely that the grid would detonate mines when being placed in a mined area. Whether steel or water probes are used, sufficient pressure to penetrate the ground has to be applied, and detonations could follow.

Questions remain over the accuracy and efficiency of data analysis, methods of vegetation removal, use on irregular ground and eventual cost-effectiveness.

### **B2.3. X-ray backscatter detection**

While we all know that medical x-rays that are recorded after passing through the medium to be interrogated can produce detailed images, interrogating from one side only means that it is only the 'backscattered' x-rays that can be used to build a picture. These can be used to build

an image, but the image resolution and penetration depth are severely limited by practical constraints on a system's size.

Hand-held systems can be achieved using photons from low-energy sources (with low shielding needs), but such a system cannot interrogate the ground to acceptable clearance depths or in real-time and the output is unlikely to result in a resolution that could allow the reliable discrimination of mines from clutter.

X-ray backscatter has a particular application for the *in situ* analysis of possible chemical or biological weapons, such as mustard gas shells from WWI.

### **B2.4. Infrared and multi-spectral detection**

Infrared and multi-spectral detection of mines relies on imaging variations in 'heat' and 'light' radiating from mines on the surface or from the ground covering concealed mines. It can be broadly divided into two research areas, those using thermal variations and those interrogating the reflected light from the suspect area. Multi-spectral cameras operate over multiple wavelengths, visible, near-infrared and lower frequency thermal infrared, and so can gather more information than those with narrower sensitivity.

The thermal variation principle relies on the fact that the mine gains or loses heat at a different rate from its



surroundings. Thermal imaging during a time of temperature change can make it possible to determine where an object with 'different' thermal properties is located. That temperature change may be natural or may be stimulated by an external heat source.

The reflected light principle relies on the fact that mines reflect light in a way that varies from their surroundings mostly due to polarisation. This is obvious if the mine is exposed and smooth-surfaced. If the mine is concealed, the disturbance of the soil during its concealment is also reported to reflect light in a way that will be at variance with its surroundings. More controversially, the moisture variation in vegetation growing over the mine is also claimed to cause variations in reflected light.

While surface mines and those recently concealed could theoretically be detected using infrared methods from the air, most HD is carried on in areas where mines have been in place for long periods. Soil variations over them have dissipated and vegetation above them may have roots that are not impeded by the presence of the mines and so have 'normal' moisture content. Prototype systems have shown that rapid variations in natural temperature can make the thermal image processing unreliable, and time alone is enough to make the reflected light systems unreliable unless the mines are on (or breach) the surface — and so are visible to the human eye.

An infrared sensor formed the basis of the airborne stand-off mine detection system (Astamids). This programme

failed to meet US Government requirements because of the poor performance of the IR sensor, and was renamed the light airborne mine detector (LAMMD). Its current status is not known. An infrared and high-power microwave detection system is currently under development in Canada. The developers claim that the system can work in cloudy or wet conditions, but false alarm rates and limitations on deployment have yet to be investigated in a real context.

We have heard of plans to develop an IR system that interrogates an area for an extended period (perhaps days) in the belief that this would have potential uses in area reduction where its cost was not an issue.

## **B2.5. Acoustic detection**

Acoustic detection methods measure the properties of the interface between the mine case and the soil, the properties of the mine case or the acoustic properties of the mine. In general, when sound is generated above the mine, some of it penetrates the ground and is reflected back, creating vibrations at the ground surface. The vibrations at the ground surface are measured and tests have shown that buried objects can be discriminated. The advantage over other systems is that objects such as mines are made from materials that have different structural properties (different modulus) from soil and most clutter, or resonate in a particular way due to the materials, and their construction and cavities.

Non-contact microphones are adversely affected by the presence of significant vegetation and it is not yet clear what depths can be achieved over varied soil and in different soil moisture levels.

## **B2.6. Detecting explosives**

The technologies discussed under this heading have been developed to detect the high explosive within ERW, not tiny traces of it that may have escaped into the surrounding environment (see Section B2.7, 'Physical/chemical detection of explosive traces'). They rely on detecting radiation emitted by interaction of high explosive with neutrons, thermalisation (slowing) of backscattered neutrons by the explosive and plastic mine case, or molecular resonance techniques like NQR in the nitrogen contained in high explosive.

Developed largely for security applications, it has been suggested that they may be useful as 'confirmation sensors', used to confirm the presence of explosives when another detection method has indicated a suspect area.

### **B2.6.1. Nuclear quadrupole resonance (NQR)**

Research and development on NQR for demining has centred in the United States, with work also in the United Kingdom, Russia and Slovenia. Despite its name, NQR uses high-frequency radio waves and does not exploit a radioactive source so does not produce potentially harm-

ful radiation. It 'detects' by stimulating the resonance from nuclei that have 'electric quadrupole moments' and detecting the resulting faint radio signal.

Research with RDX and Tetryl has produced results very quickly, but RDX and Tetryl are apparently much easier to confirm with this method than TNT (when confirmation may take several minutes). Even more problematic is the fact that frequency used to identify TNT is in the AM radio band, and broadcasts in that band can 'jam' successful detection. Also, we understand that the technology cannot currently search to a 20 cm depth (except for RDX), cannot confirm any device that is metal-cased (the system can locate a metal-cased device but cannot confirm if explosive is present), and seems to rely on a precise relationship between the HF wave source and the ground surface.

### **B2.6.2. Thermal neutron analysis (TNA)**

This method relies on finding the high concentrations of nitrogen present in most HE. Detection is achieved by irradiation with thermal neutrons and detecting the characteristic gamma emissions from nitrogen that is present in most HE. Thermal neutrons are generated by slowing down fast neutrons that have been emitted from a radioisotope source or electronic neutron generator. The deceleration may take place in a deliberately designed moderator, or in the ground itself.

The technology is limited by the need to generate high densities of neutrons to 'illuminate' the mine, and

especially by the gamma waves generated by nitrogen and especially silicon in the soil. This is a fundamental physical limitation. Ultra-selective detectors can help to overcome the problem with silicon, but are very expensive and require cryogenic cooling. Analysis of more than one gamma energy may allow some improvement in the future.

This method is known to have been fielded by the Canadian military as a confirmation sensor in the detection of large AT mines. The system is large and very heavy, so is vehicle-mounted, and is apparently either not sensitive or not fast enough to reliably detect smaller anti-personnel mines. It seems to be incapable of working at an adequate depth (20 cm).

TNA systems have also been used for inspecting mail and airport baggage — with significant false alarms reported from innocent items. Work on what input to reject and refining filter algorithms is known to be ongoing in both the United States and Russia.

Concerns about user irradiation, or incidental irradiation during an accident may be reduced by the use of electrically pulsed sources. The recent heightened security climate may make it unlikely that any equipment using a neutron source and/or particle accelerator would be cleared for use in ‘unstable’ countries. Regardless of whether it might really be possible to use such equipment as a ‘trigger’ in a nuclear bomb or the filling of a ‘dirty bomb’, there is concern that it could be abused and this would almost certainly limit the deployment of any system that was made effective.

### **B2.6.3. Fast neutron analysis (FNA)**

Fast neutron analysis (FNA) is not necessarily ‘fast’. The name is used to distinguish higher energy ‘fast’ neutrons from slower ‘thermal’ neutrons. It is used to determine the elementary composition of the target area by irradiating the area with fast neutrons and recording the characteristic gamma-lines of the main elements that are present. The result is compared with the elementary composition of HE, and when the proportions of the elements match, this is presented as an ‘indication’.

As with TNA, FNA exploitation is limited by the method(s) used to detect the gamma output, and by the significant presence of all four elements (hydrogen, carbon, nitrogen, oxygen) of military explosive in the soil. Although in FNA the data-gathering requirement is complex, the potential to identify a wider range of HE exists. It is claimed that improvements in the data capture and processing could increase the sensitivity, detection depth and speed of operation.

### **B2.6.4. Neutron backscatter**

The neutron backscatter method is used to confirm the presence of concealed materials with low atomic numbers, principally hydrogen, and so it detects the plastic mine case if there is one. TNT has the same amount of hydrogen as fairly wet soil (about 30 % moisture) so the technique is only likely to be reliable in deserts. A low-strength radiation source is usually used (and may be

electrically fired), which limits the necessary operator shielding, but may still require operators to be a few metres away. In the prototype proposal we have seen, the results were presented as an image (on an X-ray monitor) and interpreted by the user, but it could take several minutes for enough data to be gathered and we understand that detecting small mines at a depth of 5 cm in moist soil cannot be guaranteed. The presence of substances containing hydrogen (such as water) can produce constant false alarms which cannot be successfully filtered because it is effectively a hydrogen detector, and filtering out a signal from water would filter out any signal from the mine. Variations in the distance from the ground to the source, and to the 'neutron detector' are also reported to produce false alarms.

While the use of one of the low-power electronic neutron sources under development in Canada and several places in Europe might realistically reduce weight to a man-portable level, the high power requirements make this unlikely. Neutron backscatter has been shown to be unable to detect small mines because the return signal is far less than natural variation in the soil moisture.

## **B2.7. Physical/Chemical detection of explosive traces**

The term 'physical/chemical' is used to discriminate these methods from the biological methods of explosive trace detection described in Section B1.

Almost by definition, mechanistic explosive vapour detection methods must be slow. Seeking tiny traces of explosive, they may need time to accumulate samples and may need time to analyse what they find. For this reason, they are frequently spoken of as 'confirmation sensors', used to confirm the presence of explosives when another detection method has indicated a suspect area.

All the technologies under this heading share some basic limitations specific to their use in HD. The first is that comprehensive research into trace-vapour leakage from devices has not been conducted — and it is not certain that all devices will 'leak' detectable vapours. The second is that the traces of explosive that may be found need not be directly over the device from which they emanate, so the ability to pinpoint them is likely to be limited. This may make their proposed use to 'confirm' a reading from another detection device inappropriate because any vapour traces may be offset from that reading.

### **B2.7.1. Ion drift spectrometers (ion mobility spectrometers (IMS))**

Ion drift spectrometers are capable of identifying a variety of chemical vapours in small traces. Used in security applications for checking samples from suspect places, they are reported to be fast to use. Some questions over false alarms have been raised. However, it is claimed that the technology can be 1 000 times more sensitive than a mass spectrometer, capable of detecting in the parts per billion range. Within limits, it can not only measure the

presence of a single family of chemicals (i.e. it detects an entire family of explosives), but it also gives some indication of the quantity present. When a mix of chemicals are present, IMS do not offer selectivity. This may be an advantage in HD because all explosives (including uncommon ones) are reported to be readily detected.

The equipment is delicate. The sample is ionised in a special chamber and the movement of the ions measured to determine the chemical and its quantity. Despite research into developing this technology for hand-held use in the United States and Russia, the authors can find no reports of field application or actual trials of hand-held systems in HD to date.

In theory, the system could identify the presence of tiny traces of a wide range of explosives. However, it has been suggested that the range of naturally occurring chemicals in the air and the ground **may** be too great to allow the system to achieve the required reliability.

### **B2.7.2. Fluorescent polymer detection**

Similar to the 'Reactive antibody detection' system outlined in Section B1.7, the fluorescent polymer technique relies on the fact that certain fluorescent polymers react

predictably and reliably in the presence of specific chemicals. The technology is reported to be capable of measuring the change in fluorescence brightness on a polymer-coated sensor when HE traces in very low concentrations are present.

Commercial prototypes have been produced that are human-portable and have low energy requirements. Sample air is drawn between sensor plates and any explosive molecules that are present bind with the polymer, temporarily reducing the fluorescent light from the plates. The light reduction is detected and the operator alerted.

In addition to confirmation of the system's ability to detect the full range of HE, testing is needed to determine whether, in areas where explosive devices have detonated, the system is able to discriminate between explosive residue and explosive devices. Also it needs to be confirmed whether the system can operate reliably in real-world conditions, (such as mixed metal- and plastic-cased mines in high humidity and very dry or very wet environments) without signalling falsely on common natural chemicals.

Questions over cleaning/replacing polymers after a signal raise questions over practicality and the running cost of the equipment <sup>(52)</sup>.

---

<sup>(52)</sup> See Ia Grone, Marcus, J.; Fisher, Mark, E.; Cumming, Colin J., 'Investigation of an area reduction method for suspected minefields using an ultrasensitive chemical vapor detector' in *Detection and remediation technologies for mines and minelike targets VII*, Eric Towers, Proc. SPIE Vol. 4742, pp. 550–561.

### **B2.7.3. Electro-chemical ‘sniffing’**

Sometimes named the ‘electronic nose’, several different technologies are used including measuring the change in electrical resistance of certain polymers or the change in resonant frequency of quartz micro-crystals coated with antigens which bind to explosive molecules. With the latter, replacement of the electrode is necessary at regular intervals. Research into electrode sensitivity is known to be ongoing in Germany, Sweden and the United States.

Research using polymer films has shown that the method can be very effective at detecting DNT in very low concentrations (DNT is present in military grade TNT). Questions over cleaning/replacing polymer films after a signal raise questions over practicality and the running cost of the equipment.

The sensor’s ability to detect the full range of HE without signalling falsely on other chemicals needs to be confirmed because the antigen technique appears to be highly specific to just one type of explosive at a time. Other potential limitations are similar to those listed for fluorescent polymers, and include questions over the sensor’s ability to discriminate between explosive residue and explosive devices and its reliability under varied real-world conditions.

Subject to the constraints on any trace-vapour sensor outlined in the introduction to this section, the technology has the advantage of being ‘mechanistic’, so not subject to the vagaries of training and behaviour that apply when animals are used for explosive detection.

### **B2.8. Sensor fusion — Multi-sensor detection**

This section is limited to introducing the principles of sensor fusion and multi-sensor systems. One hand-held multi-sensor system that is in military use at the time of writing is discussed in Section 2.8.1.

The multi-sensor approach relies on the idea that using several different detection systems to ‘interrogate’ the same piece of ground should increase the probability of a successful detection. While this makes some sense, especially when the methods used vary widely, if none of them have a high probability of detecting an item on their own, the combined output is not guaranteed to be any better than the best single method. They may reduce the number of false alarms that there would be with any one system, but reducing false alarms is not as desirable as keeping ‘false negatives’ (where items are missed) as low as possible.

In a basic multi-sensor system, two or more different methods are used on the same piece of ground. The simplest example of this is the use of a deminer’s eyesight, metal detector and excavation tools. More complex examples use two or more detection technologies over the same piece of ground. The detection technologies may be applied entirely independently — or may have their results linked in some kind of ‘sensor-fusion’.

When a deminer works, information from his tools and the context is automatically combined with experience and subjected to ‘data-fusion’ in his mind. In a

sensor-fusion system, two or more detection technologies are used and the data from each method are combined automatically before being presented to the operator. In theory, this increases detection probability, but in fact it is limited by the abilities of each detection technology used and can introduce software errors that originated with the authors of the sensor-fusion methods.

Sensor fusion efforts usually aim to reduce the false alarm rate while maintaining a detection rate that is as good or better than a single sensor. Most aim to achieve increases in speed of ground clearance, rather than increases in thoroughness of clearance — although some new technologies may achieve the latter.

Sensor-fusion sometimes requires the physical technologies to be combined, which causes problems because manufacturers are not set up to work together and their systems may interfere with each other. Separate detection technologies may be mounted on the same platform and used in sequence — with the slowest system acting as a ‘confirmation sensor’ for other systems. When the first system used is a sensitive metal detector well-adjusted for the ground conditions, this should mean that the combination results in enhanced detection. In fact, if the confirmation sensor is only used where there is metal, the probability of detecting concealed devices is no better than it was when the metal detector was used on its own. If the confirmation detector is less than 100 % accurate (or may err by indicating false negatives) there is a higher chance of leaving mines in the ground and reducing safety.

### **B2.8.1. Metal detection and ground-penetrating radar**

Dual-sensor systems combining metal detectors and GPR have been developed to the point of field trials in both the United Kingdom and the United Kingdom. The US system is undergoing trials with the US army in Afghanistan at the time of writing and some information has been made publicly available.

The US army countermine programme has developed a system that combines (currently) a MineLab F3 metal detector and a GPR. They named the system the handheld standoff mine detection system (HSTAMIDS) when the research was intended to include a more significant ‘standoff’ element. The name remains, despite the simplification of the effort. The system is undergoing further refinement so may be further enhanced, but the following describes the functionality of the HSTAMIDS in use in Afghanistan.

The metal detector and GPR on this model were hard-wire linked. The user could not turn on the GPR on its own, but could turn the GPR signal off to use the system as a stand-alone metal detector when desired. So in this configuration, the system could not be used to search for any non-metallic target. An experienced operator reported that it was not possible to discriminate the shape of small objects such as anti-personnel mines, but that it was possible to gauge the crude shape of large objects concealed at shallow depths.

When the MineLab F3 metal detector signalled, the metal indication triggered the audio output from the GPR. So

the user interface was by interpreting varying sounds, and the difference in sound was easy to hear.

Normal use would be that a GPR signal accompanying a metal detection would always be investigated, and metal indications without an associated GPR reading would be ignored. This is intended to speed the clearance process by allowing metal fragments to be left in the ground.

Questions over reliability in real contexts still need to be addressed, along with realistic detection depths. Its performance in very dry or wet soils remains uncertain, along with its utility in real ground with clutter ranging from stones and roots to pockets of moisture. If the system and its operator are less than 100 % reliable at either identifying a mine-like object or indicating that they cannot

determine whether a mine-like object is there, it can be argued that the system reduces 'safety' over the use of the MineLab on its own (when all metal indications would be investigated as potential mines).

This system could not increase the number of devices located using current metal detector methods. Therefore, while it may increase speed by allowing some metal to be left in the ground, it would not improve detection rates. It could add increased speed, but if that is achieved at the expense of missing mines, this is not an appropriate tool outside a military context (where speed may be more important than occasional missed devices).

There are plans to start commercial production of the HSTAMIDS system during 2003.



# Annex C: Explosive content of mines

The range of explosive and incendiary chemicals that may be included in munitions is very broad. For practical reasons, this annex only introduces the explosive content of mines, and does that in general terms for those mines commonly encountered. Readers should be aware that the range of chemicals within modern munitions is very extensive indeed.

NB: Readers should be aware that although a device may be recorded as having a particular explosive content, there is no guarantee that some examples did not have alternative fillings.

Purpose-designed landmines (AT or AP) contain a high explosive charge. The HE is initiated by a shock wave at the end of an explosive train that may include a 'booster' (primer) and a detonator, but always includes a detonator. Particularly sensitive HE may also be initiated by a shock, such as an impact.

## C1. High explosive (HE)

High explosive is defined as an explosive that generates a shock wave (blast front). These explosives all (we believe) include a 'nitro group' ( $\text{NO}_2$ ) chemical as part of the molecule. On detonation, the energy bound by the molecule is re-

leased and the constituents are rearranged to form carbon dioxide, water vapour and nitrogen. Detonation produces a shock wave with an initial velocity that varies from explosive to explosive, but always exceeds 2000 m/s. Anything that produces a lower velocity shock wave is a 'low explosive'.

The most common HE found in mines is TNT. RDX is also common, sometimes mixed with TNT and sometimes with other explosives. Although TNT is common, it is far from universal, even when you only consider mines.

## C2. Common HE main charges in mines

There are many more types of HE than those listed here. Some other types are mixes that may include RDX or TNT, but not all. Only the content of common mines are listed below. The mines made in some countries that have not distributed them widely, such as India, have not been included.

### C2.1. TNT, also called trinitrotoluene, tri, tolit or trotyl

The Western military grade of TNT is reported to be 99 % TNT and 1 % DNT, with an initial shock-wave velocity of

6 800 to 6 950 m/s. Crystalline and light yellow in colour, it is safe to handle. When detonated, it does not contain enough oxygen for complete combustion. With low sensitivity it can be melted and cast into casings. DNT, dinitrotoluene, is not an HE in itself.

### **Sample mines** (and country of origin)

PMN (AP blast, 240 g, former USSR); Gyata-64 (AP blast, 300 g, Hungary); PMD-6 (AP blast, 200 g, former USSR); MAI-75 (AP blast, 120 g, Romania); PPM-2 (AP blast, 110 g, Germany); Type 72 (AP blast, 50 g, China); PMA-1A (AP blast, 200 g TNT, former Yugoslavia); PMA-2 (AP blast, 100 g TNT, former Yugoslavia); DEM-11 (AP blast, 122g, Germany); MI AP DV 59 — 'Inkstand' 9 (AP blast, 70 g, France); Type 58 (AP blast, 240 g, China); NR 409 (AP blast, 80 g, Belgium) also known as M409 (AP blast, 80 g, Portugal); MD-82B (AP blast, 28g, Vietnam); MAPS or M/411 (AP blast, 85 g, Portugal); PMD-7 (AP blast, 75 g, former USSR); MS3 (AP blast, 310 g, former USSR); APP M-57 (AP blast, 200 g, North Korea); No 4 (AP blast, 188 g, Israel); No 10 (AP blast, 50 g, Israel); PP Mi-D (AP blast, 200 g, former Czechoslovakia); PP Mi-Ba (AP blast, 152g, former Czechoslovakia); PRB M35 (AP blast, 100 g TNT and potassium nitrate, Belgium); P-4-A/B (AP blast, 100 g TNT/PETN/wax 93:6:1, Spain).

POMZ-2 and 2M (AP fragmentation, 75g, former USSR); PMR-1 (AP fragmentation, 75g, former Yugoslavia); PMR-2 (AP fragmentation, 75g, former Yugoslavia); PMR-2A (AP fragmentation, 100 g, former Yugoslavia); PMR-3 (AP

fragmentation, 410 g, former Yugoslavia); OZM-3 (AP fragmentation, 75g, former USSR); OZM-4 (AP fragmentation, 170 g, former USSR); OZM-72 (AP fragmentation, 500 g, former USSR); PP Mi-Sr (AP fragmentation, 360 g, former Czechoslovakia); Type 69 (AP fragmentation, 105 g, China); MON-100 (AP fragmentation, 2 kg, former USSR); MON-200 (AP fragmentation, 12 kg, former USSR); M/966-B (AP fragmentation, 400 g, Portugal); P-40 (AP fragmentation, 480 g, Italy); M2 (AP fragmentation, 154 g, United States); M3 (AP fragmentation, 410 g, United States); M16 and M16A1 (AP fragmentation, 575 g, United States); M16A2 (AP fragmentation, 600 g, United States); PMR-4 (AP fragmentation, 200 g, former Yugoslavia); DEM-31 (AP fragmentation, 540 g, Germany); S-Mine 35 (AP fragmentation, 182 g, Germany); Type 59 (AP fragmentation, 75 g, China); MBV-78A1 (AP fragmentation, 75 g, Vietnam); MBV-78A2 (AP fragmentation, 65 g, Vietnam); MDH-10 (AP fragmentation, 2 kg, Vietnam); NO-MZ 2B (AP fragmentation, 65 g, Vietnam); P-40 (AP fragmentation, 120 g, Vietnam); Type 58 (AP fragmentation, 75g, China); M/966 (AP fragmentation, 154 g, Belgium); P-S-1 (AP fragmentation, 450 g, Spain).

TM(N)-46 (AT blast, 5.7 kg, former USSR); TM-57 (AT blast, 6.34 kg, former USSR); TMM-1 (AT blast, 5.6 kg, former Yugoslavia); TMRP-6 (AT blast, 5.1 kg, former Yugoslavia); TMA-1A (AT blast, 5.4 kg, former Yugoslavia); TMA-2 (AT blast, 6.5 kg, former Yugoslavia); TMA-3 (AT blast, 6.5 kg, former Yugoslavia); TMA-4 (AT blast, 5.5 kg, former Yugoslavia); TMA-5 (AT blast, 5.5 kg, former Yugoslavia); TM-62B (AT blast, 7.5kg, former USSR); TM62 series (AT

blast, 7.5kg, may be RDX mix, former USSR); TMK-2 (AT shaped charge, 6 kg, former USSR); PT Mi-Ba-111 (AT blast, 7.2 kg, former Czechoslovakia); P2/3 Mk 2 (AT blast, 5 kg, Pakistan); MAT-76 (AT blast, 9.5 kg, Romania); PT Mi-D (AT blast, 6.2 kg, former Czechoslovakia); TMD-1 and 2 (AT blast, 5.5 kg, former Yugoslavia); PT Mi-K (AT blast, 5 kg, former Czechoslovakia); SACI (AT blast, 7 kg, Italy); No 6(AT blast, 6 kg, Israel); M/71 (AT blast, 6.25 kg, Egypt); M6A2 (AT blast, 4.45 kg, United States); PT Mi-Ba-11 (AT blast, 6 kg, former Czechoslovakia); 'AT-8' (AT blast, 8 kg, Cuba); PM-60 (AT blast, 7.5 kg, Germany); Mk-5 (AT blast, 3.7 kg, United Kingdom); Mk-7 (AT blast, 8.9 kg, United Kingdom); M1 and M1A1 (AT blast, 2.75 kg, United States); Tellermine 35 (AT blast, 5.5 kg, Germany); Tellermine 42 (AT blast, 5.5 kg, Germany); Tellermine 43 (AT blast, 5.5 kg, Germany); Riegel Mine 43 (At Blast, 4 kg, Germany).

## **C2.2. RDX: also called hexogen and cyclonite; trinitro 1, 3, 5; triazo cyclohexane; T4**

RDX is white and crystalline in appearance. It is thermally stable but shock-sensitive so requires some desensitisation for safe use. It has an initial shock-wave velocity of around 8 500 m/s.

The mines listed immediately below include some with a mixed RDX fill that does **not** include TNT. Mines with RDX and TNT mixed in them are listed under a separate heading.

### **Sample mines (and country of origin):**

VS-50 (AP blast, 43 g, Italy); TS-50 (AP blast, 50 g, Italy); VS-MK2 (AP blast, 33 g RDX/wax, Italy); VAR/40 (AP blast, 40 g, Italy); SB-33 (AP blast, 35 g RDX and HMX, Italy); R2M1 (AP blast, 58 g RDX/wax, South Africa); R2M2 (AP blast, 58 g RDX/wax, South Africa); Goradze (AP blast — shaped charge, 5 g, former Yugoslavia); Gravel mines (AP blast, 11–30 g RDX/lead azide or chlorate/phosphorus, United States); RAP No 1 and 2 (AP blast, 140 g PETN/RDX — Pentolite, Zimbabwe).

MON-90 (AP fragmentation, 6.2 kg (PVV-5A, RDX/PE), former USSR); BLU-91/B Gator (AP fragmentation, 585 g RDX/Estane 95:5, United States); PSM-1 (AP fragmentation, 170 g, Bulgaria); Model 123 (AP fragmentation, 250 g, Thailand); ZAPS (AP fragmentation, 500 g PETN/RDX — Pentolite, Zimbabwe).

## **C2.3. RDX/TNT mixed**

There are various mixes and names, including **Cyclotol**; **TG40**; **Composition B**, including a desensitiser, but all have TNT and RDX in the mix. When known the ratio of the mix is given in percentages (i.e. 20:80 = 20 and 80 %).

### **Sample mines (and country of origin)**

PMN-2 (blast, 100 g, former USSR); MAPS or M/411 (AP blast, 85 g Composition B, Portugal); VAR/40 (AP blast, 40 g Composition B, Italy); NR 409 (AP blast, 80 g,

Belgium) also known as M409 (AP blast, 80 g, Portugal); FIM-1 (AP blast, 152 g, Argentina).

Valmara 69 (AP fragmentation, 420 g Composition B, Italy); PMOM-1 (AP fragmentation, 425 g TNT/RDX 50:50, former Yugoslavia); MON-50 (AP fragmentation, 700 g (PVV-5A, RDX/PE), former USSR); AUPS (AP fragmentation, 115 g Composition B, Italy); BLU-92/B Gator (AP fragmentation, 421 g RDX/TNT 60:40, United States); Claymore (AP fragmentation, 700 g, Egypt); NR-413 (AP fragmentation, 100 g Composition B, Belgium); M421 (AP fragmentation, 100 g Composition B, Portugal); L1-12 (AP fragmentation, 3 kg TNT/RDX 60:40, Sweden); Mk-2 (AP fragmentation, 500 g TNT/ammonium nitrate — Amotol, United Kingdom); M26 (AP fragmentation, 170 g Composition B, United States).

TM-72 (AT shaped charge, 2.5 kg, former USSR); Type 72 (AT blast, 5.4 kg, China); TMK-2 (AT shaped charge, 6.5 kg, former USSR); VS-2.2 (AT blast, 2.2 kg Composition B, Italy); VS-1.6 (AT blast, 1.85 kg Composition B, Italy); M15 (AT blast, 10.3 kg Composition B, United States); M19 (AT blast, 9.5 kg Composition B, United States); TC/3.6 (AT blast, 36 kg Composition B, Italy); TC/6 (AT blast, 6 kg Composition B, Italy); Barmine (AT blast, 8.1 kg, United Kingdom); SH-55 (AT blast, 5.5 kg Composition B, Italy); SB-81 (AT blast, 2.2 kg TNT/RDX/HMX — 84:125:1, Italy); No 8 (AT blast, 7 kg RDX/TNT 60:40, South Africa); PRB M3 (AT blast, 6 kg, Belgium); PRB M3A1 (AT blast, 6 kg, Belgium); FIM-3 (AT blast, 6.1 kg, Argentina); C-3-A/C-3-B (AT blast, 5 kg RDX/TNT/aluminium 50:30:20, Spain).

## C2.4. Tetryl

With an initial shock-wave velocity of 7 500–7 850 m/s and high sensitivity, tetryl is often used as a ‘booster’ to initiate less sensitive explosives, but is also the main HE charge in some mines.

### Sample mines (and country of origin)

M14 (AP blast, 29 g, United States); P2 Mk 2 (AP blast, 30 g, Pakistan); P4 Mk 1 (AP blast, 30 g, Pakistan); PMA-3 (AP blast, 35 g, former Yugoslavia). M7 A2 (AP fragmentation — anti-vehicle, 1.62 kg, United States).

## C2.5. Picric acid

### Sample mines (and country of origin)

TMD-44 (AT blast, 5–7 kg TNT or picric acid, former USSR); TMD-B (AT blast, 5–7 kg TNT or picric acid, former USSR).

## C2.6. Plastic explosive (PE)

PE is a general term used for high-powered explosives — sometimes any mixture containing RDX and/or PETN, or Semtex. (Semtex: 45 % RDX, 41 % Petn, 11 % HC oil (paraffin), 1.8 % Butadien.) All PE contains a binder with suitable elastic properties, usually made up of a polymer and plasticizer. Polymers used may be polyisobutylene,

polystyrene, polyacronitrile, polyethylene (or others). Typical plasticisers are dioctylphtalate, dibutylphtalate and dioctylsebacate.

**Sample mines** (and country of origin)

MINI-MS-803 (AP fragmentation, 460 g PE9, South Africa); M18A1 (AP fragmentation, 682 g C4, United States); Shrapnel Mine No 2 (AP fragmentation, 680 g PE9, South Africa); MRUD (AP fragmentation, 900 g PETN- or RDX-based plastic, former Yugoslavia); PMR-U (AP fragmentation, 100 g commercial PE, former Yugoslavia); PPMP-2

(AP fragmentation, 150 g commercial PE, former Yugoslavia); P5-MK1 and 2 (PE-3A, AP fragmentation, Pakistan); Type 66 (AP fragmentation, 680 g PE, China); PFM1 (AP blast, 37 g liquid PE (VS6-D or VS-60D) former USSR); PGMDM/PTM-1S (AT blast, 1.1 kg PE, former USSR).

## **C2.7. Nitromethane/Nitroethane**

**Sample mines** (and country of origin)

Dragon's tooth (AP blast, 9 g, United States).



# Annex D: CWA 14747:2003 test overview

Name	Objective and content	Preferred to apply				Type of test				Info from manufacturers (*)	Remarks
		Locality				Consumer	Acceptance	Blind	Open		
		Lab	Field	In air	In soil						
IN AIR TESTS	Stability/Drift of sensitivity	<input checked="" type="checkbox"/>	<input type="checkbox"/>	<input checked="" type="checkbox"/>	<input type="checkbox"/>	<input checked="" type="checkbox"/>	<input type="checkbox"/>	<input type="checkbox"/>	<input checked="" type="checkbox"/>	<input type="checkbox"/>	Defined standard test target As consumer test
	• After set-up	<input checked="" type="checkbox"/>	<input type="checkbox"/>	<input checked="" type="checkbox"/>	<input type="checkbox"/>	<input checked="" type="checkbox"/>	<input type="checkbox"/>	<input type="checkbox"/>	<input checked="" type="checkbox"/>	<input checked="" type="checkbox"/>	
	• During operation	<input checked="" type="checkbox"/>	<input type="checkbox"/>	<input checked="" type="checkbox"/>	<input type="checkbox"/>	<input checked="" type="checkbox"/>	<input type="checkbox"/>	<input type="checkbox"/>	<input checked="" type="checkbox"/>	<input checked="" type="checkbox"/>	
	Optimal sweep speed	<input checked="" type="checkbox"/>	<input type="checkbox"/>	<input checked="" type="checkbox"/>	<input type="checkbox"/>	<input checked="" type="checkbox"/>	<input type="checkbox"/>	<input type="checkbox"/>	<input checked="" type="checkbox"/>	<input type="checkbox"/>	
	Maximum detection height										
	• Standard targets	<input checked="" type="checkbox"/>	<input checked="" type="checkbox"/>	<input checked="" type="checkbox"/>	<input type="checkbox"/>	<input checked="" type="checkbox"/>	<input type="checkbox"/>	<input type="checkbox"/>	<input checked="" type="checkbox"/>	<input checked="" type="checkbox"/>	
	• Different metals	<input checked="" type="checkbox"/>	<input checked="" type="checkbox"/>	<input checked="" type="checkbox"/>	<input type="checkbox"/>	<input checked="" type="checkbox"/>	<input type="checkbox"/>	<input type="checkbox"/>	<input checked="" type="checkbox"/>	<input checked="" type="checkbox"/>	
	• Specific targets	<input checked="" type="checkbox"/>	<input checked="" type="checkbox"/>	<input checked="" type="checkbox"/>	<input type="checkbox"/>	<input checked="" type="checkbox"/>	<input type="checkbox"/>	<input type="checkbox"/>	<input checked="" type="checkbox"/>	<input type="checkbox"/>	
Sensitivity profile (footprint)	<input checked="" type="checkbox"/>	<input type="checkbox"/>	<input checked="" type="checkbox"/>	<input type="checkbox"/>	<input checked="" type="checkbox"/>	<input type="checkbox"/>	<input type="checkbox"/>	<input checked="" type="checkbox"/>	<input type="checkbox"/>		
Miscellaneous may be included here	<input checked="" type="checkbox"/>	<input type="checkbox"/>	<input checked="" type="checkbox"/>	<input type="checkbox"/>	<input checked="" type="checkbox"/>	<input type="checkbox"/>	<input type="checkbox"/>	<input checked="" type="checkbox"/>	<input type="checkbox"/>		
USER-SPECIFIED TESTS	Effect of sensor head orientation	<input checked="" type="checkbox"/>	<input checked="" type="checkbox"/>	<input checked="" type="checkbox"/>	<input checked="" type="checkbox"/>	<input checked="" type="checkbox"/>	<input type="checkbox"/>	<input type="checkbox"/>	<input checked="" type="checkbox"/>	<input checked="" type="checkbox"/>	Time before alarm signal  With other detectors Where possible
	Moisture on sensor head	<input checked="" type="checkbox"/>	<input type="checkbox"/>	<input checked="" type="checkbox"/>	<input type="checkbox"/>	<input type="checkbox"/>	<input checked="" type="checkbox"/>	<input type="checkbox"/>	<input checked="" type="checkbox"/>	<input type="checkbox"/>	
	Temperature extremes/shock	<input checked="" type="checkbox"/>	<input type="checkbox"/>	<input checked="" type="checkbox"/>	<input type="checkbox"/>	<input checked="" type="checkbox"/>	<input type="checkbox"/>	<input type="checkbox"/>	<input checked="" type="checkbox"/>	<input checked="" type="checkbox"/>	
	Effect on EM/RF interference	<input checked="" type="checkbox"/>	<input checked="" type="checkbox"/>	<input checked="" type="checkbox"/>	<input checked="" type="checkbox"/>	<input checked="" type="checkbox"/>	<input type="checkbox"/>	<input type="checkbox"/>	<input checked="" type="checkbox"/>	<input checked="" type="checkbox"/>	
	Sensitivity during battery life	<input checked="" type="checkbox"/>	<input type="checkbox"/>	<input checked="" type="checkbox"/>	<input type="checkbox"/>	<input type="checkbox"/>	<input checked="" type="checkbox"/>	<input type="checkbox"/>	<input checked="" type="checkbox"/>	<input checked="" type="checkbox"/>	
	Shock and bump test	<input checked="" type="checkbox"/>	<input type="checkbox"/>	<input checked="" type="checkbox"/>	<input type="checkbox"/>	<input type="checkbox"/>	<input checked="" type="checkbox"/>	<input type="checkbox"/>	<input checked="" type="checkbox"/>	<input type="checkbox"/>	
	Drop test	<input checked="" type="checkbox"/>	<input checked="" type="checkbox"/>	<input checked="" type="checkbox"/>	<input checked="" type="checkbox"/>	<input type="checkbox"/>	<input checked="" type="checkbox"/>	<input type="checkbox"/>	<input checked="" type="checkbox"/>	<input checked="" type="checkbox"/>	
	Mutual interference of detectors	<input checked="" type="checkbox"/>	<input checked="" type="checkbox"/>	<input checked="" type="checkbox"/>	<input checked="" type="checkbox"/>	<input checked="" type="checkbox"/>	<input type="checkbox"/>	<input type="checkbox"/>	<input checked="" type="checkbox"/>	<input checked="" type="checkbox"/>	
	Interchangeability of parts	<input checked="" type="checkbox"/>	<input type="checkbox"/>	<input checked="" type="checkbox"/>	<input type="checkbox"/>	<input type="checkbox"/>	<input checked="" type="checkbox"/>	<input type="checkbox"/>	<input checked="" type="checkbox"/>	<input checked="" type="checkbox"/>	

(\*) For more details, see Annex C of the CWA 14747:2003 agreement.

Name	Objective and content	Preferred to apply				Type of test				Info from manufacturers (*)	Remarks		
		Locality				Consumer	Acceptance	Blind	Open				
		Lab	Field	In air	In soil								
<b>IN SOIL AND FIELD TESTS</b>	<b>In soil</b>	Detection depth in different soils	<input type="checkbox"/>	<input checked="" type="checkbox"/>	<input type="checkbox"/>	<input checked="" type="checkbox"/>	<input type="checkbox"/>	<input type="checkbox"/>	<input type="checkbox"/>	<input checked="" type="checkbox"/>	<input type="checkbox"/>	Measurements of soil As in air As in air Chosen by end-user	
		• Standard targets	<input type="checkbox"/>	<input checked="" type="checkbox"/>	<input type="checkbox"/>	<input checked="" type="checkbox"/>	<input type="checkbox"/>	<input type="checkbox"/>	<input type="checkbox"/>	<input checked="" type="checkbox"/>	<input type="checkbox"/>		
		• Different metals	<input type="checkbox"/>	<input checked="" type="checkbox"/>	<input type="checkbox"/>	<input checked="" type="checkbox"/>	<input type="checkbox"/>	<input type="checkbox"/>	<input type="checkbox"/>	<input checked="" type="checkbox"/>	<input type="checkbox"/>		
		• Specific targets	<input type="checkbox"/>	<input checked="" type="checkbox"/>	<input type="checkbox"/>	<input checked="" type="checkbox"/>	<input type="checkbox"/>	<input type="checkbox"/>	<input checked="" type="checkbox"/>	<input type="checkbox"/>	<input type="checkbox"/>		
	Reliability tests	<input type="checkbox"/>	<input checked="" type="checkbox"/>	<input type="checkbox"/>	<input checked="" type="checkbox"/>	<input type="checkbox"/>	<input type="checkbox"/>	<input checked="" type="checkbox"/>	<input type="checkbox"/>	<input type="checkbox"/>			
	<b>Miscellaneous</b>	Locating accuracy (pinpointing)	<input checked="" type="checkbox"/>	<input checked="" type="checkbox"/>	<input type="checkbox"/>	<input type="checkbox"/>	<input type="checkbox"/>	<input checked="" type="checkbox"/>	<input checked="" type="checkbox"/>	<input type="checkbox"/>	<input checked="" type="checkbox"/>	<input type="checkbox"/>	Not above mines
		Shape determination of targets	<input checked="" type="checkbox"/>	<input checked="" type="checkbox"/>	<input type="checkbox"/>	<input type="checkbox"/>	<input type="checkbox"/>	<input checked="" type="checkbox"/>	<input checked="" type="checkbox"/>	<input type="checkbox"/>	<input type="checkbox"/>	<input type="checkbox"/>	Point, linear, polygon
		Resolution of adjacent targets	<input checked="" type="checkbox"/>	<input checked="" type="checkbox"/>	<input type="checkbox"/>	<input type="checkbox"/>	<input type="checkbox"/>	<input checked="" type="checkbox"/>	<input checked="" type="checkbox"/>	<input checked="" type="checkbox"/>	<input type="checkbox"/>	<input type="checkbox"/>	AP and AT mines
		Influence of specific media	<input checked="" type="checkbox"/>	<input checked="" type="checkbox"/>	<input type="checkbox"/>	<input type="checkbox"/>	<input checked="" type="checkbox"/>	<input type="checkbox"/>	<input type="checkbox"/>	<input checked="" type="checkbox"/>	<input type="checkbox"/>	<input type="checkbox"/>	
		Detection near large linear metal	<input checked="" type="checkbox"/>	<input checked="" type="checkbox"/>	<input type="checkbox"/>	<input type="checkbox"/>	<input checked="" type="checkbox"/>	<input type="checkbox"/>	<input checked="" type="checkbox"/>	<input checked="" type="checkbox"/>	<input type="checkbox"/>	<input type="checkbox"/>	Railway, fence
Effect of EM/RF interference		<input checked="" type="checkbox"/>	<input checked="" type="checkbox"/>	<input type="checkbox"/>	<input type="checkbox"/>	<input checked="" type="checkbox"/>	<input type="checkbox"/>	<input type="checkbox"/>	<input checked="" type="checkbox"/>	<input checked="" type="checkbox"/>	<input checked="" type="checkbox"/>	Power lines, radio	
Mutual interference of detectors	<input checked="" type="checkbox"/>	<input checked="" type="checkbox"/>	<input type="checkbox"/>	<input type="checkbox"/>	<input checked="" type="checkbox"/>	<input type="checkbox"/>	<input type="checkbox"/>	<input checked="" type="checkbox"/>	<input checked="" type="checkbox"/>	<input checked="" type="checkbox"/>	Recovery test		

(\*) For more details, see Annex C of the CWA 14747:2003 agreement.



# Annex E: Calibration of the Schiebel AN19/2 M7

This annex describes how to calibrate the Schiebel metal detector AN19/2 M7 before measuring the GRH. This process should be done before measuring the GRH at each site.

The calibration is used to set the detectors to a repeatable sensitivity for measuring the GRH. This is necessary for two reasons. First, the detector must always be set up in the same way if the GRH readings are to be meaningful. Secondly, the electronic units of these detectors are 'individual' and must be set to a common benchmark for their results to be interchangeable when different detectors are used.

The targets to be used for this process are the Schiebel test-piece (delivered with each detector) or a 10 mm diameter chrome steel ball <sup>(53)</sup>.

There are two ways to achieve the same sensitivity settings.

- (a) The Schiebel test-piece is held 100 mm away from the centre of the search-head in air. The sensitivity knob is then moved clockwise to a point where a reading starts. This should be repeated several times for confirmation. The distance to the Schiebel test-piece

should not be measured from the real position of the metal piece but from the bottom of the arrow on the plastic cover (base of the arrow).

- (b) A 10 mm diameter chrome steel ball is placed 140 mm away from the centre of the search-head in air. The sensitivity knob is then moved clockwise to a point where a reading starts. This should be repeated several times for confirmation.

Use the marking and add another 50 mm for the Schiebel test-piece, or use a 10 mm Ø chrome steel ball at 140 mm distance to the centre of the search-head.

**NB:** Using the instructions above, whether the Schiebel test-piece or the steel ball is used, the results in terms of setting a benchmark sensitivity will be similar enough to give interchangeable results.

After calibration, the measurement of the GRH (the height at which the detector signals to the ground) is to be made when the detector makes the same sound as it did during the calibration procedure. At least five GRH measurements should be made at each place where a reading is taken and the results should normally be within  $\pm 5$  mm of each other. This level of accuracy is both achievable in field conditions

---

<sup>(53)</sup> Chrome steel designations; UNS G52986, AISI 52100, UNI 100 Cr 6, DIN 1.3505.

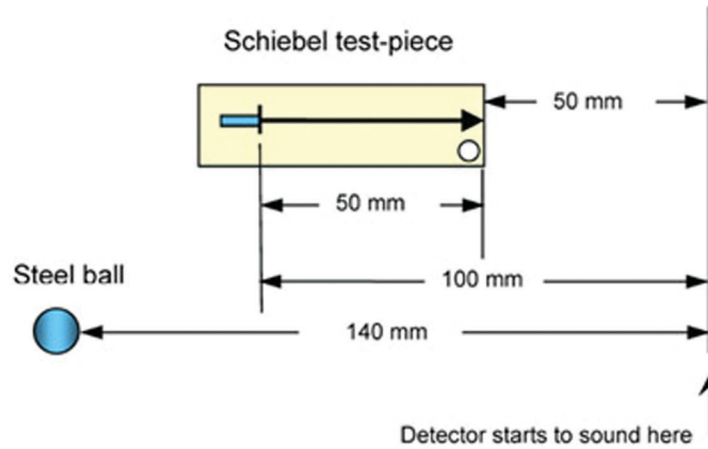

and useful. The final GRH result is then calculated as an average of the five readings.

The search-head of early versions of the Schiebel AN19 may be particularly sensitive to ground and atmospheric moisture. When it was the most widely used metal detector in HD, deminers in some countries were advised to wrap the search-head in a plastic bag before using the detector on wet grass or in damp conditions.

# Annex F: Suggested further reading

## General

- Brown, G. I., *The Big Bang — a history of explosives*, Sutton publishing, United Kingdom, 1998, ISBN 0 7509 1878 0 (hb)
- GICHD, *Mine action equipment: Study of global operational needs*, Geneva, 2002, ISBN 2-88487-004-0
- Grant, Tim, *The History of Landmines*, <http://members.iinet.net.au/~pictim/mines/history/history.html>
- Human Rights Watch, *Landmine monitor report* (annual publication), International Campaign to Ban Landmines, [www.hrw.org](http://www.hrw.org) [www.icbl.org](http://www.icbl.org)
- James Madison University, *Journal of Mine Action* (periodical), Virginia, United States, <http://maic.jmu.edu>
- McCracken, D., 'Historical Development and Use of Landmines' paper in *The Landmine Action Smart Book*, Eds. Barlow, D.; Buse, M.; and Stephan, C., Mine Action Information Center — James Madison University, <http://www.hdic.jmu.edu/Products/items/Smartbook/1Introduction.pdf>
- McGrath, Rae, *Landmines and unexploded ordnance: A resource book*, Pluto Press, United Kingdom, 2000.
- Monim and Gallimore, *The Devil's Gardens: A History of Landmines*, Random House, London, United Kingdom, 2002, ISBN 0-7126-6859-4.
- Schneck, William C., 'The Origins of Military Mines', *Engineer Bulletin*, July 1998, <http://www.fas.org/man/dod-101/sys/land/mines.htm> or <http://tewton.narod.ru/history/istor-min-sneck.html>
- Smith, Andy (originator/editor), *Database of Demining Accidents (DDAS)*: software and data, GICHD, 2001: on request from [p.ellis@gichd.ch](mailto:p.ellis@gichd.ch)
- US State Department, 'Milestones in Humanitarian Demining', *Fact sheet*, 22 February 2002, <http://usinfo.state.gov/topical/pol/arms/minechron.htm>

## Technical

- APOPO giant pouched rat research, <http://www.apopo.org/>
- CEN workshop agreement, *CWA 14747:2003 Humanitarian Mine Action — Test and evaluation — Metal detectors*, published 18 June 2003, <http://humanitarian-security.jrc.it/demining/cw07/index.htm>

Das, Y.; Dean, J. T.; Lewis, D.; Roosenboom, J. H. J.; Zaczewsky, G. (editors), *International Pilot Project for Technology Cooperation*, Final Report, EUR 19719, EN — 2001, European Commission, JRC, 2001, <http://demining.jrc.it/ipptc/>

Fernandes, M., Lewis, A., and Littmann, F., 'PROM 1 anti-personnel landmines (Possibility of activation by physical contact with a metal detector)', *Technical note* No S.P.I. 01.29.

Garrett, Charles, *Modern metal detectors* (Second edition), Ram Publishing Company, 1995, ISBN 0-915920-75-1.

Havard Bach, *Biosensors Report:* [http://www.biosensor.se/dokument/biosensor\\_tech.pdf](http://www.biosensor.se/dokument/biosensor_tech.pdf)

King, Colin (Ed), *Jane's Mines and Mine Clearance* (annual publication), Jane's Information Group, United Kingdom, <http://www.janes.com>

RAND Science and Policy Institute, *Alternatives for Landmine Detection*, 2003, <http://www.rand.org/publications/MR/MR1608/index.html>

Schubert, Hiltmar, and Kuznetsov, Andrey (editors), *Detection of explosives and landmines — methods and field experience*, NATO Science series, II Mathematics, Physics and Chemistry — Vol. 66, Dordrecht, Boston, London, Kluwer Academic Publishers, 2002.

Sigrist, Christian, and Bruschini, Claudio, *Metal Detectors for Humanitarian Demining: a Patent Search and Analysis*, revised December 2002, <http://www.eudem.vub.ac.be/publications/files/MDPatentSearch/readme.htm>

UNMAS, *International Mine Action Standards*, 2001, updated, 2003, <http://www.mineactionstandards.org/imas.htm>

# Index

## Quick reference index for field users

Question	Answer in section(s)
What is the minimum you should know about a detector before you enter a mined area with it?	2.3; 5.3.2; 5.3.3; 5.4.2; 5.4.4; 5.4.5
How does a metal detector work?	4.1
What is electromagnetic induction?	4.1; 4.3
What is the difference between 'static' and 'dynamic' detectors?	4.3.4
What is the difference between 'pulse' and 'continuous wave' detectors?	4.3
What kinds of search-head exist?	4.3.3; 4.3.5
What has to be checked before/after use?	2.3.1
What range of signals from a detector should you know?	2.3.1; 5.3.2; 4.4.5; 5.4.6; 5.4.7
What does 'detector set-up' mean?	6.1–3
What does the test-piece of the manufacture tell you?	2.3.2
What is a confidence test-piece?	2.3.2
What does ground compensation mean and how does it work?	4.5
How do you establish the safe advance for the detector sweep?	5.4.2; 5.4.3

<b>Question</b>	<b>Answer in section(s)</b>
What influences detector performance?	5.4.2; 6.1
How do you pinpoint a target?	5.4.8
How do you safely investigate a detector signal in a mined area?	2.3.4; 6.5
How do you set up a detector to a specific target?	2.3.1(d); 6.5
How do you establish the depth you can reliably clear to?	6.2-4

# Main index

## A

- Accident · 21, 97, 99, 104, 113, 116, 145
- Acoustic · 143
- Action on getting a detector signal · 122
- Adjacent targets · 109, 158
- Adjustment, detector · 99, 118, 119, 121
- ADP, UNADP · 8, 36, 97
- Alluvial soil · 21
- Anti-group mine (AG) · 7, 19
- Antibody · 140, 147
- Anti-personnel mine (AP) · 7, 18, 19, 20, 21, 24, 25, 38, 39, 40, 41, 84, 109, 123, 151, 152, 153, 154, 155, 158
- Anti-vehicle or anti-tank mine (AT) · 7, 19, 20, 21, 22, 40, 41, 84, 85, 109, 145, 151, 152, 153, 154, 155, 158
- Area-denial effect · 24
- Area excavation · 20, 22

## B

- Backscatter, neutron · 145, 146
- Backscatter, x-ray · 142
- Bacteria · 139, 140
- Bartington · 72
- Batteries · 31, 32, 34, 35, 63, 85, 102
- Battery-life · 63
- Bees · 138
- Biosensors · 122, 162
- Blast mine · 18, 19, 20, 21, 41, 44, 109, 110
- BLU · 25, 153, 154
- Booby traps · 16, 24, 46, 85, 112
- Bounding mines · 85

## C

Calibration test · 66

CEIA · 83, 84, 87

CEN workshop agreement · 60, 61

Chemical methods · 59, 132, 144, 146, 147, 148

Conductivity · 67, 71, 79, 91, 93, 141, 142

Confidence test-piece · 32, 34, 143

Continuous wave · 80, 83, 163

Convention on Conventional Weapons (CCW) · 7, 23

Copenhagen · 15

CWA 14747:2003 · 61, 62, 64, 65, 66, 76, 157, 161

## D

Data fusion · 148

DDAS · 7, 97, 112, 161

Deeply buried ERW · 42

Detection capability · 65, 66, 67, 86, 93, 95, 96

Detection, factors affecting · 29, 84, 87, 92, 93, 106, 117

Detector performance · 59, 72, 75, 117, 164

Detector signal · 9, 17, 22, 31, 35, 36, 39, 45, 55, 59, 80, 84, 87, 91, 96, 101, 108, 109, 110, 111, 117, 119, 122, 124, 149, 159, 164

Detector signal, action on getting · 109, 116, 122, 129

Detector test-piece · 32

Dog handler · 136

Dogs · 17, 20, 21, 22, 23, 36, 38, 40, 120, 122, 128, 131, 132, 136, 137, 138

Drift test · 67

## E

Ebinger · 80, 83, 84

Eddy currents · 78, 79, 80, 93

EIT · 7, 141

Electro-chemical · 135, 148



Electromagnetic induction · 77, 78, 80, 96, 163

Electromagnetic interference (EMI) · 87

ERW · 7, 15, 16, 20, 23, 30, 36, 41, 42, 43, 97, 99, 121, 122, 127, 128, 130, 131, 132, 135, 136, 141, 144

European Commission · 3, 60, 162

Evacuation · 88, 112

Excavate · 22, 36, 37, 105, 109, 123

Excavation procedures · 36

Explosive content of mines · 23, 131, 151

Explosive detecting dogs (EDDs) · 17, 23, 122, 131, 136, 137

Explosive detecting rats (EDRs) · 137, 138

## F

False alarms · 17, 128, 140, 145, 146, 148

Fast neutron · 7, 145

Field trials · 35, 62, 63, 64, 72, 139, 149

Flails · 23

Fluorescent polymer · 147

Fluxgate magnetometer · 43

Foerster · 82, 83, 84

Footprint · 32, 67, 93, 94, 95, 103, 105, 106, 107, 108, 157

Fragmentation mine · 19, 20, 39, 40, 85

Frequency-domain · 83, 86, 89

Fusion, data · 148

## G

Ground compensation · 65, 86, 88, 89, 90, 95, 96, 106, 118, 163

Ground-penetrating radar (GPR) · 130, 141

Guartel. · 80, 84, 86

Gyata · 19, 45, 65, 70, 106, 152

## H

Handler,dog · 136

Hexogen (RDX) · 94

High explosive · 7, 19, 23, 24, 34, 131, 135, 136, 137, 144, 151

High voltage power lines · 54

HSTAMIDS · 149, 150

## I

IMAS · 7, 15, 27, 28, 60

Impedance · 7, 141

IMSMA · 71, 72,

Induction · 77, 78, 80, 85, 88, 96, 163

Influence on the performance · 68

Infrared · 8, 17, 142, 143

Injured person · 112

Insects · 137, 138

Interference, electromagnetic · 86, 87

Interference, magnetic ground · 22, 69, 70

Ion drift spectrometer · 146

IPPTC · 7, 63, 66, 67, 71, 103, 106

ITEP · 8, 60, 62, 106

ITOP · 8, 33, 34, 59, 60

## J

Joint Research Centre (JRC) of European Commission · 3, 94, 106, 161, 162

## L

Laterite · 91

Latest generation · 17

Linear targets · 66

Lines of flux · 77, 78

## M

M1 APD · 21

M14 · 19, 40, 136, 154

Machines · 20, 23, 39, 122, 128

Magnetic ground · 5, 9, 20, 30, 41, 42, 43, 65, 67, 68, 69, 70, 71, 73, 74, 75, 91, 96, 117, 118, 135

Magnetometer · 42, 43

Metal detector · 9, 16, 19, 22, 28, 29, 30, 31, 32, 34, 39, 40, 41, 42, 44, 45, 55, 59, 60, 61, 62, 63, 64, 65, 69, 72, 77, 78, 79, 80, 88, 91, 93, 96, 97, 98, 99, 104, 106, 113, 115, 117, 120, 122, 124, 127, 129, 131, 135, 148, 149, 150, 159, 160, 162, 163

Metal detector standard · 59

Meteorological conditions · 75

Methods of detection · 20, 141

MIL standard · 59

Military use · 16, 17, 35, 63, 148

Mine Ban Treaty · 21, 24

Mine simulants · 17, 24, 46, 64

Mined area · 46, 47, 48, 51, 52, 53, 54, 55, 56, 57

Minelab · 80, 84, 87

Minimum metal mines · 40, 41, 65

Moisture test · 67

Mostar · 64

Multi-sensor · 148

## N

National Institute of Justice (NIJ) · 59

Neutron · 145, 146

Nitroethane · 155

Nitromethane · 155

Nuclear quadrupole resonance (NQR) · 144

## O

Ottawa Convention · 24

## P

Performance characteristics · 61, 63

Permeability, magnetic · 92

PETN · 136, 152, 153, 154, 155

Picric acid · 154

Pinpointing · 36, 66, 84, 87, 110, 111, 158

Planning detector tests/trials · 73

Plants, detection by · 130, 132, 137, 139

PMA-1 · 152

PMA-2 · 40, 45, 152

PMA-3 · 19, 136, 154

PMN · 19, 45, 93, 111, 152, 153

Polymer, fluorescent · 147, 148

POMZ · 19, 40, 152

Primary magnetic field · 77, 78, 83, 84

Process of demining · 27

Prodder · 37, 97, 123

PROM · 19, 85, 162

Protocol II of the Convention on Conventional Weapons ·  
23, 24, 25

Pulsed induction · 80

## Q

QA · 8, 17, 28, 120, 122, 131, 132, 139

## R

R2M2 · 40, 45, 153

Radio transmitters · 87

Rats · 135, 137, 138

RDX · 8, 136, 144, 151, 153, 154, 155

Remote sensing method for explosive detection · 131, 138

Rescue · 87, 112

Research and development · 88, 135, 144

Rollers · 23

## S

Safe distance · 21, 38, 105, 111, 113

Safety · 15, 21, 29, 32, 35, 44, 60, 64, 75, 77, 87, 97, 99,  
110, 117, 121, 127, 129, 130, 149, 150

Sarajevo · 64

Scan profile test · 67

Scatterable fragmentation mines · 20

Schiebel · 69, 80, 83, 84, 117, 120, 121, 159, 160

SD · 8, 24

SDA · 8, 24

Secondary magnetic field · 78, 79

Selection tests · 62

Semtex · 154

Sensitivity cone · 103

Sensitivity profile, field measurement · 32, 67, 93, 94, 95,  
103, 105, 106, 107, 108

Set-up, detector · 31, 32, 66, 100, 116, 117, 157, 163

Simulant mines · 33, 34, 44, 74, 105

Specific targets, adjusting to · 120

Spectrometer · 146

Submunition · 25

Surrogate mines · 32, 33, 34, 74, 109, 112

Survey · 27, 28, 64, 71, 98, 120, 121

Susceptibility · 67, 71, 92

Sweep speed test · 67

## T

Tetryl · 136, 144, 154

Time domain · 12, 83, 86, 88, 89

TNT · 8, 136, 138, 144, 145, 148, 151, 152, 153, 154

Tomography · 7, 129, 141

Trainee competency · 105

Training · 3, 16, 40, 70, 71, 73, 74, 75, 87, 97, 98, 99, 100,  
101, 102, 103, 104, 105, 109, 111, 112, 113, 115, 121,  
128, 129, 132, 136, 137, 138, 139, 148

Content · 9, 16, 18, 21, 23, 24, 32, 40, 43, 44, 59, 60, 65, 68, 70, 71, 75, 103, 104, 106, 110, 111, 112, 117, 119, 124, 129, 131, 135, 136, 137, 143, 151, 157, 158

Preparation · 60, 74, 75, 100, 103, 111

Recommendations for trainers · 100

Requirements · 59, 60, 62, 75, 103, 104, 109, 143, 146, 147

Treaties · 23, 24

Trinitrotoluene · 8, 136, 151

Tripwire detection · 39, 122

Tripwires · 38, 39, 41, 66, 109, 112, 122, 132

Type 72 · 19, 40, 152, 154

## U

UNMAS · 8, 15, 60, 68, 162

UXO · 8, 16, 21, 27, 29, 37, 38, 43, 86, 109, 112, 120, 122

## V

Vallon · 80, 84, 87

Valmara · 19, 41, 154

## X

X-ray · 142, 146







European Commission

**EUR 20837 METAL DETECTOR HANDBOOK FOR HUMANITARIAN DEMINING**

Luxembourg: Office for Official Publications of the European Communities

2003 — 172 pp. — 15 x 23 cm

ISBN 92-894-6236-1



# Venta • Salg • Verkoop • Πωλησιες • Sales • Vente • Verkoop • Vendita • Myynti • Försäljning http://eur-op.eu.int/general/en/s-ad.htm

<b>BELGIOUE/BELGIE</b>	<b>NERDLAND</b>	<b>EESTI</b>	<b>CANADA</b>	
<b>Jean De Lamoy</b> Avenue du Roi, 202/Koninglaan 202 Tel. (32-2) 73 58 43 06 Fax (32-2) 73 58 43 06 Tel. (32-2) 735 08 41 E-mail: jean.de.lamoy@lindeboard.be URL: http://www.lamoy-de-lamoy.be	<b>SOU Servicecentrum Uitgevers</b> Christoffelplanstraat 2 Postbus 20014 Postcode 6500 CA Tel. (31-70) 378 98 80 Tel. (31-70) 378 98 80 Fax (31-70) 378 97 83 E-mail: sch@sdur.nl URL: http://www.sdur.nl	<b>Esti Kaubandus-Tööstuskoda</b> (Estonian Chamber of Commerce and Industry) Põhlevägi 11 EE-10130 Tallinn Tel. (372) 646 02 44 Tel. (372) 646 02 44 Fax (372) 646 02 46 E-mail: info@estkoda.ee URL: http://www.koda.ee	<b>Les éditions La Liberté inc.</b> 4408 Sainte-Foy, Québec G1Y 3V6 Tel. (1-418) 659 37 63 Fax (1-800) 557 54 49 E-mail: libere@liberedit.com URL: http://www.libere.com	
<b>DANMARK</b>	<b>PORTUGAL</b>	<b>HRVATSKA</b>	<b>RENOUR PUBLISHING CO. LTD</b>	
<b>J. H. Schultz Information AS</b> Hersingsvej 4 DK-2620 Albertslund Tel. (45) 43 63 19 60 Fax (45) 43 63 19 60 E-mail: schultz@schultz.dk URL: http://www.schultz.dk	<b>Distribuidora de Livros Bertrand Lt.*</b> Grupo Bertrand, SA Rua das Flores dos Vales, 4-A P-2700 Amadora Tel. (351) 214 56 87 87 Tel. (351) 214 56 87 87 Fax (351) 214 56 02 55 E-mail: info@bpl.pt; bpl@bpl.pt	<b>Molhacete Priz Zagreb</b> HR-10000 Zagreb Tel. (385-1) 860 09 40 Tel. (385-1) 860 09 40 E-mail: molhacete@hininet.hr URL: http://www.molhacete.com	5938 Chemin Carotek Road Unit 1 Canton 1 Tel. (1-613) 745 28 83 Fax (1-613) 745 60 80 E-mail: info@renourbooks.com URL: http://www.renouropublishing.com	
<b>DEUTSCHLAND</b>	<b>REPUBLICA ITALIANA</b>	<b>MACYARORSZÁG</b>	<b>EGYPT</b>	
<b>Bundesanzeiger Verlag GmbH</b> Vertriebsstelle Amersbacher Straße 192 D-53093 Bornheim Tel. (49-221) 97 66 80 Fax (49-221) 97 66 82 78 E-mail: vertreib@bundesanzeiger.de URL: http://www.bundesanzeiger.de	<b>Atakamistia Kirjakauppa/Atakamistia Bookshoppin</b> Ke-skuskatu 1/Centralgatan 1 P/Box 28 Tel. (358-9) 121 44 35 P/fax (358-9) 121 44 35 E-mail: tbj@pub-tub.com URL: http://www.tbj.se	<b>Euro Info Service</b> Szl. István utca 12 H-1111 Csepel P/Box 150 Tel. (36-1) 329 21 70 Tel. (36-1) 329 21 70 Fax (36-1) 349 20 53 E-mail: info@euroinfo.hu URL: http://www.euroinfo.hu		
<b>ESPANA</b>	<b>ISLAND</b>	<b>ROMANIA</b>	<b>MEXICO</b>	
<b>Boletín Oficial del Estado</b> Trinidad, 27 Tel. (34) 915 28 21 11 (líbero), 913 84 17 15 (suscripción) Tel. (34) 915 28 21 11 (líbero), 913 84 17 14 (suscripción) E-mail: clientes@com.boe.es URL: http://www.boe.es	<b>Bólubak Lansar Böndli</b> SÍ 105 Reykjavík Tel. (354) 552 55 40 Fax (354) 552 55 60 E-mail: books@lansar.is URL: http://www.lansar.is	<b>Mundi Prensa México, SA de CV</b> Rio Planco, 141 Colonia Cuauhtémoc P.O. Box 5740 Tel. (52-5) 533 95 58 Fax (52-5) 514 97 99 E-mail: 101546.z81@compuserve.com		
<b>FRANCE</b>	<b>IRLAND</b>	<b>SOUTH KOREA</b>	<b>SLOVENIA</b>	
<b>Journal officiel</b> Service des publications des CE F-67272 Paris, Cedex 15 Tel. (33) 140 57 31 31 Tel. (33) 140 57 31 31 Fax (33) 140 58 77 00 E-mail: publications@journal-officiel.gov.fr URL: http://www.journal-officiel.gov.fr	<b>Alexander Knappe/Schwaiger</b> Newick NR3 1GN Northwood, Middlesex TW9 3EX Tel. (44-187) 80 05 333 E-mail: book.orders@mesco.co.uk URL: http://www.iso.co.uk	<b>The European Union Chamber of Commerce in Korea</b> Suite 2004, Kyobo Bldg. Chung-Ang University, Chongro-Gu Tel. (82-2) 726-9880-05 Tel. (82-2) 726-9880-05 Fax (82-2) 726-9888-06 Fax (82-2) 726-9888-06 URL: http://www.euccok.org		
<b>ALAN HAMM'S BOOKSHOP</b> 270 Lower Rathmines Road Dublin 6 Tel. (353-1) 496 73 98 Tel. (353-1) 496 73 98 E-mail: hanna@tdi.ie URL: http://www.licosa.com	<b>Europa Info Centro Schweiz</b> c/o OSSEC Business Network Switzerland Sternplatz/Steinbühlstrasse 85 PF 483 CH-8152 Zieflikon Tel. (41) 1 365 53 15 Tel. (41) 1 365 54 11 Fax (41) 1 365 54 11 E-mail: eics@ossec.ch URL: http://www.ossec.ch/eics	<b>EBIC Sri Lanka</b> Trans Asia Hotel 128, Colonnade Road, A. Gardner Mawatha Colombo 2 Tel. (886-2) 57 12 88 86 Tel. (886-2) 57 12 88 86 Fax (886-2) 57 12 87 87 E-mail: eblca@transa.net.lk URL: http://www.transa.net.lk	<b>UNITED STATES OF AMERICA</b> <b>Berth Associates</b> 4811 F Assembly Drive Lanham, MD 20740-4391 Tel. (1-800) 665 34 50 (toll free fax) E-mail: query@berth.com URL: http://www.berth.com	
<b>LUXEMBOURG</b>	<b>REPUBLIQUE FRAANÇAISE</b>	<b>SLOVAKIA</b>	<b>ARGENTINA</b>	
<b>Messagerie du livre SARL</b> 5, rue de Luxembourg L-2411 Luxembourg Tel. (352) 40 10 20 Tel. (352) 40 10 20 E-mail: mall@mdli.lu URL: http://www.mdli.lu	<b>Swets Blackwell AS</b> Hans Nielsen Hauges gt. 39 Boks 4801 Nydalen Tel. (47) 23 40 00 00 Tel. (47) 23 40 00 00 Fax (47) 23 40 00 01 E-mail: info@no.swetsblackwell.com URL: http://no.swetsblackwell.com	<b>GV Zlatoba d.o.o.</b> Šišmova ulica 5 SI-1000 Ljubljana Tel. (386) 13 09 1800 Tel. (386) 13 09 1805 Fax (386) 13 09 1805 E-mail: gv@zlatoba.si URL: http://www.gvzlatoba.si	<b>World Publications SA</b> Av. Córdoba 1 877 C170 AAA Buenos Aires Tel. (54-11) 84 17 53 61 Tel. (54-11) 48 18 81 56 Fax (54-11) 48 18 81 56 E-mail: wpbbooks@infoline.com.ar URL: http://www.wpbbooks.com.ar	
	<b>NORGE</b>	<b>UKRAINE</b>	<b>UNITED STATES OF AMERICA</b>	
	<b>Støytorg Services</b> PO Box 29 Norwich NR3 1GN Tel. (44-1603) 80 05 252 E-mail: book.orders@mesco.co.uk URL: http://www.iso.co.uk	<b>TURKYE</b> <b>Dunya Aktuel AS</b> Gökus Dünnya Basirevi 100. Yil Mahallesi 34440 TR-34060 Başkent-Ankara Tel. (90-312) 54 81 84 Tel. (90-312) 54 81 84 Fax (90-312) 440 23 67 E-mail: aktuel.info@dunya.com URL: http://www.dunya.com.tr	<b>UNITED STATES OF AMERICA</b> <b>Berth Associates</b> 4811 F Assembly Drive Lanham, MD 20740-4391 Tel. (1-800) 665 34 50 (toll free fax) E-mail: query@berth.com URL: http://www.berth.com	
	<b>ISLAND</b>	<b>UKRAINE</b>	<b>UNITED STATES OF AMERICA</b>	
	<b>Bobak Lansar Böndli</b> SÍ 105 Reykjavík Tel. (354) 552 55 40 Fax (354) 552 55 60 E-mail: books@lansar.is URL: http://www.lansar.is	<b>Argentine Bookings</b> PO Box 404 Cruz Bittencourt da Silva, 12 C 20043-900 Rio de Janeiro Tel. (55-21) 262 47 76 Tel. (55-21) 262 47 76 E-mail: livra@com.com.br URL: http://www.incm.com.br	<b>UNITED STATES OF AMERICA</b> <b>Berth Associates</b> 4811 F Assembly Drive Lanham, MD 20740-4391 Tel. (1-800) 665 34 50 (toll free fax) E-mail: query@berth.com URL: http://www.berth.com	
	<b>IRLAND</b>	<b>BRASIL</b>	<b>UNITED STATES OF AMERICA</b>	
	<b>Alan Hamms's Bookshop</b> 270 Lower Rathmines Road Dublin 6 Tel. (353-1) 496 73 98 Tel. (353-1) 496 73 98 E-mail: hanna@tdi.ie URL: http://www.licosa.com	<b>Brasil Bookings</b> PO Box 404 Cruz Bittencourt da Silva, 12 C 20043-900 Rio de Janeiro Tel. (55-21) 262 47 76 Tel. (55-21) 262 47 76 E-mail: livra@com.com.br URL: http://www.incm.com.br	<b>UNITED STATES OF AMERICA</b> <b>Berth Associates</b> 4811 F Assembly Drive Lanham, MD 20740-4391 Tel. (1-800) 665 34 50 (toll free fax) E-mail: query@berth.com URL: http://www.berth.com	
	<b>ESPANA</b>	<b>REPUBLIQUE FRAANÇAISE</b>	<b>UNITED STATES OF AMERICA</b>	
	<b>Boletín Oficial del Estado</b> Trinidad, 27 Tel. (34) 915 28 21 11 (líbero), 913 84 17 15 (suscripción) Tel. (34) 915 28 21 11 (líbero), 913 84 17 14 (suscripción) E-mail: clientes@com.boe.es URL: http://www.boe.es	<b>Swets Blackwell AS</b> Hans Nielsen Hauges gt. 39 Boks 4801 Nydalen Tel. (47) 23 40 00 00 Tel. (47) 23 40 00 00 Fax (47) 23 40 00 01 E-mail: info@no.swetsblackwell.com URL: http://no.swetsblackwell.com	<b>UNITED STATES OF AMERICA</b> <b>Berth Associates</b> 4811 F Assembly Drive Lanham, MD 20740-4391 Tel. (1-800) 665 34 50 (toll free fax) E-mail: query@berth.com URL: http://www.berth.com	<b>UNITED STATES OF AMERICA</b> <b>Berth Associates</b> 4811 F Assembly Drive Lanham, MD 20740-4391 Tel. (1-800) 665 34 50 (toll free fax) E-mail: query@berth.com URL: http://www.berth.com
	<b>FRANCE</b>	<b>ESPANA</b>	<b>UNITED STATES OF AMERICA</b>	
	<b>Journal officiel</b> Service des publications des CE F-67272 Paris, Cedex 15 Tel. (33) 140 57 31 31 Tel. (33) 140 57 31 31 Fax (33) 140 58 77 00 E-mail: publications@journal-officiel.gov.fr URL: http://www.journal-officiel.gov.fr	<b>Boletín Oficial del Estado</b> Trinidad, 27 Tel. (34) 915 28 21 11 (líbero), 913 84 17 15 (suscripción) Tel. (34) 915 28 21 11 (líbero), 913 84 17 14 (suscripción) E-mail: clientes@com.boe.es URL: http://www.boe.es	<b>UNITED STATES OF AMERICA</b> <b>Berth Associates</b> 4811 F Assembly Drive Lanham, MD 20740-4391 Tel. (1-800) 665 34 50 (toll free fax) E-mail: query@berth.com URL: http://www.berth.com	<b>UNITED STATES OF AMERICA</b> <b>Berth Associates</b> 4811 F Assembly Drive Lanham, MD 20740-4391 Tel. (1-800) 665 34 50 (toll free fax) E-mail: query@berth.com URL: http://www.berth.com
	<b>FRANCE</b>	<b>FRANCE</b>	<b>UNITED STATES OF AMERICA</b>	
	<b>Journal officiel</b> Service des publications des CE F-67272 Paris, Cedex 15 Tel. (33) 140 57 31 31 Tel. (33) 140 57 31 31 Fax (33) 140 58 77 00 E-mail: publications@journal-officiel.gov.fr URL: http://www.journal-officiel.gov.fr	<b>Swets Blackwell AS</b> Hans Nielsen Hauges gt. 39 Boks 4801 Nydalen Tel. (47) 23 40 00 00 Tel. (47) 23 40 00 00 Fax (47) 23 40 00 01 E-mail: info@no.swetsblackwell.com URL: http://no.swetsblackwell.com	<b>UNITED STATES OF AMERICA</b> <b>Berth Associates</b> 4811 F Assembly Drive Lanham, MD 20740-4391 Tel. (1-800) 665 34 50 (toll free fax) E-mail: query@berth.com URL: http://www.berth.com	<b>UNITED STATES OF AMERICA</b> <b>Berth Associates</b> 4811 F Assembly Drive Lanham, MD 20740-4391 Tel. (1-800) 665 34 50 (toll free fax) E-mail: query@berth.com URL: http://www.berth.com
	<b>FRANCE</b>	<b>FRANCE</b>	<b>UNITED STATES OF AMERICA</b>	
	<b>Journal officiel</b> Service des publications des CE F-67272 Paris, Cedex 15 Tel. (33) 140 57 31 31 Tel. (33) 140 57 31 31 Fax (33) 140 58 77 00 E-mail: publications@journal-officiel.gov.fr URL: http://www.journal-officiel.gov.fr	<b>Swets Blackwell AS</b> Hans Nielsen Hauges gt. 39 Boks 4801 Nydalen Tel. (47) 23 40 00 00 Tel. (47) 23 40 00 00 Fax (47) 23 40 00 01 E-mail: info@no.swetsblackwell.com URL: http://no.swetsblackwell.com	<b>UNITED STATES OF AMERICA</b> <b>Berth Associates</b> 4811 F Assembly Drive Lanham, MD 20740-4391 Tel. (1-800) 665 34 50 (toll free fax) E-mail: query@berth.com URL: http://www.berth.com	<b>UNITED STATES OF AMERICA</b> <b>Berth Associates</b> 4811 F Assembly Drive Lanham, MD 20740-4391 Tel. (1-800) 665 34 50 (toll free fax) E-mail: query@berth.com URL: http://www.berth.com
	<b>FRANCE</b>	<b>FRANCE</b>	<b>UNITED STATES OF AMERICA</b>	
	<b>Journal officiel</b> Service des publications des CE F-67272 Paris, Cedex 15 Tel. (33) 140 57 31 31 Tel. (33) 140 57 31 31 Fax (33) 140 58 77 00 E-mail: publications@journal-officiel.gov.fr URL: http://www.journal-officiel.gov.fr	<b>Swets Blackwell AS</b> Hans Nielsen Hauges gt. 39 Boks 4801 Nydalen Tel. (47) 23 40 00 00 Tel. (47) 23 40 00 00 Fax (47) 23 40 00 01 E-mail: info@no.swetsblackwell.com URL: http://no.swetsblackwell.com	<b>UNITED STATES OF AMERICA</b> <b>Berth Associates</b> 4811 F Assembly Drive Lanham, MD 20740-4391 Tel. (1-800) 665 34 50 (toll free fax) E-mail: query@berth.com URL: http://www.berth.com	<b>UNITED STATES OF AMERICA</b> <b>Berth Associates</b> 4811 F Assembly Drive Lanham, MD 20740-4391 Tel. (1-800) 665 34 50 (toll free fax) E-mail: query@berth.com URL: http://www.berth.com
	<b>FRANCE</b>	<b>FRANCE</b>	<b>UNITED STATES OF AMERICA</b>	
	<b>Journal officiel</b> Service des publications des CE F-67272 Paris, Cedex 15 Tel. (33) 140 57 31 31 Tel. (33) 140 57 31 31 Fax (33) 140 58 77 00 E-mail: publications@journal-officiel.gov.fr URL: http://www.journal-officiel.gov.fr	<b>Swets Blackwell AS</b> Hans Nielsen Hauges gt. 39 Boks 4801 Nydalen Tel. (47) 23 40 00 00 Tel. (47) 23 40 00 00 Fax (47) 23 40 00 01 E-mail: info@no.swetsblackwell.com URL: http://no.swetsblackwell.com	<b>UNITED STATES OF AMERICA</b> <b>Berth Associates</b> 4811 F Assembly Drive Lanham, MD 20740-4391 Tel. (1-800) 665 34 50 (toll free fax) E-mail: query@berth.com URL: http://www.berth.com	<b>UNITED STATES OF AMERICA</b> <b>Berth Associates</b> 4811 F Assembly Drive Lanham, MD 20740-4391 Tel. (1-800) 665 34 50 (toll free fax) E-mail: query@berth.com URL: http://www.berth.com
	<b>FRANCE</b>	<b>FRANCE</b>	<b>UNITED STATES OF AMERICA</b>	
	<b>Journal officiel</b> Service des publications des CE F-67272 Paris, Cedex 15 Tel. (33) 140 57 31 31 Tel. (33) 140 57 31 31 Fax (33) 140 58 77 00 E-mail: publications@journal-officiel.gov.fr URL: http://www.journal-officiel.gov.fr	<b>Swets Blackwell AS</b> Hans Nielsen Hauges gt. 39 Boks 4801 Nydalen Tel. (47) 23 40 00 00 Tel. (47) 23 40 00 00 Fax (47) 23 40 00 01 E-mail: info@no.swetsblackwell.com URL: http://no.swetsblackwell.com	<b>UNITED STATES OF AMERICA</b> <b>Berth Associates</b> 4811 F Assembly Drive Lanham, MD 20740-4391 Tel. (1-800) 665 34 50 (toll free fax) E-mail: query@berth.com URL: http://www.berth.com	<b>UNITED STATES OF AMERICA</b> <b>Berth Associates</b> 4811 F Assembly Drive Lanham, MD 20740-4391 Tel. (1-800) 665 34 50 (toll free fax) E-mail: query@berth.com URL: http://www.berth.com
	<b>FRANCE</b>	<b>FRANCE</b>	<b>UNITED STATES OF AMERICA</b>	
	<b>Journal officiel</b> Service des publications des CE F-67272 Paris, Cedex 15 Tel. (33) 140 57 31 31 Tel. (33) 140 57 31 31 Fax (33) 140 58 77 00 E-mail: publications@journal-officiel.gov.fr URL: http://www.journal-officiel.gov.fr	<b>Swets Blackwell AS</b> Hans Nielsen Hauges gt. 39 Boks 4801 Nydalen Tel. (47) 23 40 00 00 Tel. (47) 23 40 00 00 Fax (47) 23 40 00 01 E-mail: info@no.swetsblackwell.com URL: http://no.swetsblackwell.com	<b>UNITED STATES OF AMERICA</b> <b>Berth Associates</b> 4811 F Assembly Drive Lanham, MD 20740-4391 Tel. (1-800) 665 34 50 (toll free fax) E-mail: query@berth.com URL: http://www.berth.com	<b>UNITED STATES OF AMERICA</b> <b>Berth Associates</b> 4811 F Assembly Drive Lanham, MD 20740-4391 Tel. (1-800) 665 34 50 (toll free fax) E-mail: query@berth.com URL: http://www.berth.com
	<b>FRANCE</b>	<b>FRANCE</b>	<b>UNITED STATES OF AMERICA</b>	
	<b>Journal officiel</b> Service des publications des CE F-67272 Paris, Cedex 15 Tel. (33) 140 57 31 31 Tel. (33) 140 57 31 31 Fax (33) 140 58 77 00 E-mail: publications@journal-officiel.gov.fr URL: http://www.journal-officiel.gov.fr	<b>Swets Blackwell AS</b> Hans Nielsen Hauges gt. 39 Boks 4801 Nydalen Tel. (47) 23 40 00 00 Tel. (47) 23 40 00 00 Fax (47) 23 40 00 01 E-mail: info@no.swetsblackwell.com URL: http://no.swetsblackwell.com	<b>UNITED STATES OF AMERICA</b> <b>Berth Associates</b> 4811 F Assembly Drive Lanham, MD 20740-4391 Tel. (1-800) 665 34 50 (toll free fax) E-mail: query@berth.com URL: http://www.berth.com	<b>UNITED STATES OF AMERICA</b> <b>Berth Associates</b> 4811 F Assembly Drive Lanham, MD 20740-4391 Tel. (1-800) 665 34 50 (toll free fax) E-mail: query@berth.com URL: http://www.berth.com
	<b>FRANCE</b>	<b>FRANCE</b>	<b>UNITED STATES OF AMERICA</b>	
	<b>Journal officiel</b> Service des publications des CE F-67272 Paris, Cedex 15 Tel. (33) 140 57 31 31 Tel. (33) 140 57 31 31 Fax (33) 140 58 77 00 E-mail: publications@journal-officiel.gov.fr URL: http://www.journal-officiel.gov.fr	<b>Swets Blackwell AS</b> Hans Nielsen Hauges gt. 39 Boks 4801 Nydalen Tel. (47) 23 40 00 00 Tel. (47) 23 40 00 00 Fax (47) 23 40 00 01 E-mail: info@no.swetsblackwell.com URL: http://no.swetsblackwell.com	<b>UNITED STATES OF AMERICA</b> <b>Berth Associates</b> 4811 F Assembly Drive Lanham, MD 20740-4391 Tel. (1-800) 665 34 50 (toll free fax) E-mail: query@berth.com URL: http://www.berth.com	<b>UNITED STATES OF AMERICA</b> <b>Berth Associates</b> 4811 F Assembly Drive Lanham, MD 20740-4391 Tel. (1-800) 665 34 50 (toll free fax) E-mail: query@berth.com URL: http://www.berth.com
	<b>FRANCE</b>	<b>FRANCE</b>	<b>UNITED STATES OF AMERICA</b>	
	<b>Journal officiel</b> Service des publications des CE F-67272 Paris, Cedex 15 Tel. (33) 140 57 31 31 Tel. (33) 140 57 31 31 Fax (33) 140 58 77 00 E-mail: publications@journal-officiel.gov.fr URL: http://www.journal-officiel.gov.fr	<b>Swets Blackwell AS</b> Hans Nielsen Hauges gt. 39 Boks 4801 Nydalen Tel. (47) 23 40 00 00 Tel. (47) 23 40 00 00 Fax (47) 23 40 00 01 E-mail: info@no.swetsblackwell.com URL: http://no.swetsblackwell.com	<b>UNITED STATES OF AMERICA</b> <b>Berth Associates</b> 4811 F Assembly Drive Lanham, MD 20740-4391 Tel. (1-800) 665 34 50 (toll free fax) E-mail: query@berth.com URL: http://www.berth.com	<b>UNITED STATES OF AMERICA</b> <b>Berth Associates</b> 4811 F Assembly Drive Lanham, MD 20740-4391 Tel. (1-800) 665 34 50 (toll free fax) E-mail: query@berth.com URL: http://www.berth.com
	<b>FRANCE</b>	<b>FRANCE</b>	<b>UNITED STATES OF AMERICA</b>	
	<b>Journal officiel</b> Service des publications des CE F-67272 Paris, Cedex 15 Tel. (33) 140 57 31 31 Tel. (33) 140 57 31 31 Fax (33) 140 58 77 00 E-mail: publications@journal-officiel.gov.fr URL: http://www.journal-officiel.gov.fr	<b>Swets Blackwell AS</b> Hans Nielsen Hauges gt. 39 Boks 4801 Nydalen Tel. (47) 23 40 00 00 Tel. (47) 23 40 00 00 Fax (47) 23 40 00 01 E-mail: info@no.swetsblackwell.com URL: http://no.swetsblackwell.com	<b>UNITED STATES OF AMERICA</b> <b>Berth Associates</b> 4811 F Assembly Drive Lanham, MD 20740-4391 Tel. (1-800) 665 34 50 (toll free fax) E-mail: query@berth.com URL: http://www.berth.com	<b>UNITED STATES OF AMERICA</b> <b>Berth Associates</b> 4811 F Assembly Drive Lanham, MD 20740-4391 Tel. (1-800) 665 34 50 (toll free fax) E-mail: query@berth.com URL: http://www.berth.com
	<b>FRANCE</b>	<b>FRANCE</b>	<b>UNITED STATES OF AMERICA</b>	
	<b>Journal officiel</b> Service des publications des CE F-67272 Paris, Cedex 15 Tel. (33) 140 57 31 31 Tel. (33) 140 57 31 31 Fax (33) 140 58 77 00 E-mail: publications@journal-officiel.gov.fr URL: http://www.journal-officiel.gov.fr	<b>Swets Blackwell AS</b> Hans Nielsen Hauges gt. 39 Boks 4801 Nydalen Tel. (47) 23 40 00 00 Tel. (47) 23 40 00 00 Fax (47) 23 40 00 01 E-mail: info@no.swetsblackwell.com URL: http://no.swetsblackwell.com	<b>UNITED STATES OF AMERICA</b> <b>Berth Associates</b> 4811 F Assembly Drive Lanham, MD 20740-4391 Tel. (1-800) 665 34 50 (toll free fax) E-mail: query@berth.com URL: http://www.berth.com	<b>UNITED STATES OF AMERICA</b> <b>Berth Associates</b> 4811 F Assembly Drive Lanham, MD 20740-4391 Tel. (1-800) 665 34 50 (toll free fax) E-mail: query@berth.com URL: http://www.berth.com
	<b>FRANCE</b>	<b>FRANCE</b>	<b>UNITED STATES OF AMERICA</b>	
	<b>Journal officiel</b> Service des publications des CE F-67272 Paris, Cedex 15 Tel. (33) 140 57 31 31 Tel. (33) 140 57 31 31 Fax (33) 140 58 77 00 E-mail: publications@journal-officiel.gov.fr URL: http://www.journal-officiel.gov.fr	<b>Swets Blackwell AS</b> Hans Nielsen Hauges gt. 39 Boks 4801 Nydalen Tel. (47) 23 40 00 00 Tel. (47) 23 40 00 00 Fax (47) 23 40 00 01 E-mail: info@no.swetsblackwell.com URL: http://no.swetsblackwell.com	<b>UNITED STATES OF AMERICA</b> <b>Berth Associates</b> 4811 F Assembly Drive Lanham, MD 20740-4391 Tel. (1-800) 665 34 50 (toll free fax) E-mail: query@berth.com URL: http://www.berth.com	<b>UNITED STATES OF AMERICA</b> <b>Berth Associates</b> 4811 F Assembly Drive Lanham, MD 20740-4391 Tel. (1-800) 665 34 50 (toll free fax) E-mail: query@berth.com URL: http://www.berth.com
	<b>FRANCE</b>	<b>FRANCE</b>	<b>UNITED STATES OF AMERICA</b>	
	<b>Journal officiel</b> Service des publications des CE F-67272 Paris, Cedex 15 Tel. (33) 140 57 31 31 Tel. (33) 140 57 31 31 Fax (33) 140 58 77 00 E-mail: publications@journal-officiel.gov.fr URL: http://www.journal-officiel.gov.fr	<b>Swets Blackwell AS</b> Hans Nielsen Hauges gt. 39 Boks 4801 Nydalen Tel. (47) 23 40 00 00 Tel. (47) 23 40 00 00 Fax (47) 23 40 00 01 E-mail: info@no.swetsblackwell.com URL: http://no.swetsblackwell.com	<b>UNITED STATES OF AMERICA</b> <b>Berth Associates</b> 4811 F Assembly Drive Lanham, MD 20740-4391 Tel. (1-800) 665 34 50 (toll free fax) E-mail: query@berth.com URL: http://www.berth.com	<b>UNITED STATES OF AMERICA</b> <b>Berth Associates</b> 4811 F Assembly Drive Lanham, MD 20740-4391 Tel. (1-800) 665 34 50 (toll free fax) E-mail: query@berth.com URL: http://www.berth.com
	<b>FRANCE</b>	<b>FRANCE</b>	<b>UNITED STATES OF AMERICA</b>	
	<b>Journal officiel</b> Service des publications des CE F-67272 Paris, Cedex 15 Tel. (33) 140 57 31 31 Tel. (33) 140 57 31 31 Fax (33) 140 58 77 00 E-mail: publications@journal-officiel.gov.fr URL: http://www.journal-officiel.gov.fr	<b>Swets Blackwell AS</b> Hans Nielsen Hauges gt. 39 Boks 4801 Nydalen Tel. (47) 23 40 00 00 Tel. (47) 23 40 00 00 Fax (47) 23 40 00 01 E-mail: info@no.swetsblackwell.com URL: http://no.swetsblackwell.com	<b>UNITED STATES OF AMERICA</b> <b>Berth Associates</b> 4811 F Assembly Drive Lanham, MD 20740-4391 Tel. (1-800) 665 34 50 (toll free fax) E-mail: query@berth.com URL: http://www.berth.com	<b>UNITED STATES OF AMERICA</b> <b>Berth Associates&lt;/</b>

