



January 2020

Bio-Regenerative Life Support Systems Functional Stability And Limitations, A Theoretical Modeling Approach

Curt I. Holmer

Follow this and additional works at: <https://commons.und.edu/theses>

Recommended Citation

Holmer, Curt I., "Bio-Regenerative Life Support Systems Functional Stability And Limitations, A Theoretical Modeling Approach" (2020). *Theses and Dissertations*. 3377.
<https://commons.und.edu/theses/3377>

This Thesis is brought to you for free and open access by the Theses, Dissertations, and Senior Projects at UND Scholarly Commons. It has been accepted for inclusion in Theses and Dissertations by an authorized administrator of UND Scholarly Commons. For more information, please contact und.common@library.und.edu.

Bio-Regenerative Life Support Systems Functional Stability and Limitations, a Theoretical Modeling Approach

By

Curt Holmer

Bachelor of Science, Strayer University, 2005

Master of Science, The George Washington University, 2007

Master of Science Candidate, University of North Dakota, 2020

A Thesis

Submitted to the Graduate Faculty

of the

University of North Dakota

in partial fulfillment of the requirements

for the degree of

Master of Science
Space Studies

Grand Forks, North Dakota

December

2020

Name: Curt Holmer
Degree: Master of Science

This document, submitted in partial fulfillment of the requirements for the degree from the University of North Dakota, has been read by the Faculty Advisory Committee under whom the work has been done and is hereby approved.

DocuSigned by:
Pablo de León
B7E99EAE7B242B...
Dr. Pablo de León

DocuSigned by:
Dr. Mike Gaffey
B73941EEE1BB4FD...
Dr. Mike Gaffey

DocuSigned by:
Jeffery Carmichael
4C2B74EFD3CF4CB...
Dr. Jeffery Carmichael

This document is being submitted by the appointed advisory committee as having met all the requirements of the School of Graduate Studies at the University of North Dakota and is hereby approved.

DocuSigned by:
Chris Nelson
2E0A7088C733403...
Chris Nelson
Dean of the School of Graduate Studies

12/3/2020

Date

PERMISSION

TITLE: Bio-Regenerative Life Support Systems Functional Stability and Limitations, a Theoretical Modeling Approach

Department of Space Studies

Degree Master of Science

In presenting this thesis in partial fulfillment of the requirements for a graduate degree from the University of North Dakota, I agree that the Library of this University shall make it freely available for inspection. I further agree that permission for extensive copying for scholarly purposes may be granted by the professor who supervised my thesis work or, in his absence, by the Chairperson of the department or the Dean of the School of Graduate Studies. It is understood that any copying or publication or other use of this thesis or part thereof for financial gain shall not be allowed without my written permission. It is also understood that due recognition shall be given to me and to the University of North Dakota in any scholarly use which may be made of any material in my thesis.

Curt Holmer

December 2020

Contents

Abstract.....	1
Introduction	2
Major problems anticipated in advance	3
The difficulty of problem scope and description	3
Other issues and obstacles	3
Constraints and Limiting Factors.....	6
History and Background.....	7
Early ‘Space Age’ Experiments	9
Efforts in the United States.....	11
Efforts in Russia.....	30
Efforts in Europe	37
Efforts by Japan.....	41
Efforts by China.....	42
Definitions and Terminology.....	44
Stability	44
Efficiency	45
Biosphere	45
Biocenosis	45
Materially Closed Ecosphere.....	46
Closed-loop and Bio-Regenerative Systems	46
Controlled Ecological Life Support Systems and Closed Ecological Life Support Systems (CELSS)/Biological Life Support System (BLSS).....	47
Biospheric Systems	47
Phytotron	48
Modeling and Simulation of Advanced Life Support Systems	48
Hypothesis.....	48
Material and Methods	48
Phase I – Model Research	48
Phase II – Model Construction and Evaluation	49
Phase III – Outcome Analysis	49
Model Research	50
Existing Mathematical Modeling	50

Applicability of Stability Consideration to Bio-Regenerative Life Support Systems	52
Model Examination and stability	53
System Modeling	54
Model Analysis and Interpretations.....	58
Correlation between Closure Degree, Tropic Network Complexity, and Stability Level	58
Stability Theoretical Conclusions	60
Additional Theories and Models for consideration	61
Critical Transitions.....	62
Tipping Point Theory.....	63
Slow down and symptoms	63
Fold Catastrophe Model (Scheffer, Carpenter, Foley, Foke, & Walker, 2001)	64
Skewness and Flickering	67
Spatial Correlation	67
Indicators in cyclic and chaotic systems	67
Methods for detecting critical transitions	68
Fast-slow systems: critical transitions	68
Generalized Modeling.....	68
Calculation of early warning signals.....	69
Example Studies of applications in ecology and biology	70
Applications to Closed-loop Ecological Systems	73
Example Generalized Model for CELSS	74
Application	77
Model Development	78
Simulation Software.....	78
BioSim Overview	78
Simulation Configuration	82
BioSim Modifications	83
Results and Analysis.....	90
Methods of Analysis.....	90
Simulation Executions and Resulting Analysis	90
BioSim Validation	90
Stability Simulation Execution	114
Conclusions	125

Future Directions and Research.....	126
Appendix A: Simulation Configuration Files	127
A1 – Lunar-Mars Life Support Test Project Phase I.....	127
A2 – Lunar Mars Life Support Test Project Phase III.....	132
A3 – Continuous LMLSPT Phase I.....	143
A4 – Continuous LMLSTP Phase III.....	148
Appendix B: Simulation Analysis Results	159
B1 – Validation LMLSTP Phase I Results.....	159
B2 – Validation LMLSTP Phase III Results.....	159
B3 – Continuous LMLSTP Phase I Results.....	160
Summary Results Run 1	160
Summary Results Run 2	162
Summary Results Run 3	165
Summary Results Run 4	168
Summary Results Run 5	171
Summary Results Run 6	174
Summary Results Run 7	177
Summary Results Run 8	180
Summary Results Run 9	183
Summary Results Run 10	186
B4 – Continuous LMLSTP Phase III Results.....	190
Summary Results Run 1	190
Summary Results Run 2	193
Summary Results Run 3	196
Summary Results Run 4	200
Summary Results Run 5	203
Summary Results Run 6	206
Summary Results Run 7	209
Summary Results Run 8	212
Summary Results Run 9	215
Summary Results Run 10	218
Appendix C: Simulation Procedures.....	221
C1 – Simulation Run Process.....	221

Run Configuration Parameters	221
C2 – Simulation Log Format and Analysis Process.....	222
C2 – BioSim Components Used for Analysis	229
References	232

Bio-Regenerative Life Support Systems Functional Stability and Limitations, a Theoretical Modeling Approach

Curt I. Holmer¹

University of North Dakota Department of Space Studies, Grand Forks, ND, 58202

Abstract

Experiments with Ecological Closed Life Support Systems (ECLSS) for moderate sized crews have shown instability when supporting crews over long periods of time required for deep space travel. Tests such as Russia's BIOS series, NASA's Lunar-Mars Life Support Test Project (LMLSTP), ESA's Micro-Ecological Life Support System Alternative (MELISSA), and Japan's Closed Ecology Experiment Facilities (CEEF) have shown that microalgae and higher plants combined with physical-chemical material converters can be a successful part of a Biological Life Support System or a Closed Ecological Life Support System. LMLSTP, MELISSA, and CEAS experiments as well as commercial Ecosphere products have proven stability at small-scale with direct dependence, closed-loop systems for both short and extended time periods. This shows that when the dependencies and factors are known and understood creating a small-scale stable environment with known measuring points can be easily accomplished.

However, the larger experiments, such as Biosphere2 or Bios3, have shown that the more complex environment, the more stability issues arise and give way to critical transitions. Further, instability in one subsystem or cycle can cause a cascading effect through multiple subsystems. These transitions are sudden and often irreversible, leading to the collapse of the system. Given the time and scale required to test these dependencies and conditions, knowing the precursors of an impending transition or being able to predict critical transitions in these systems is highly desirable. Generalized models can achieve this and may even reduce the amount of time series data required to validate the stability of a given system.

The objective of this research is to defining stability for these complex systems as linked through closure degree and trophic network complexity, examine possible early warning signs of critical transactions, and gain further insight into the stability of these complex systems. This link is explored mathematically and then demonstrated by comparing overall observed closure levels of the NASA Johnson Space Center (LMLSTP) with the proposed closure index and stability level calculations. To demonstrate the applicability of the closure index and stability level calculations, they are examined with longer duration closure simulations. Additionally, a generalized framework model is constructed to attempt to detect early warning signals of critical transitions and demonstrate the overall stability or instability of the system under observation. These models are tested and demonstrated using computer simulation of theoretical Ecological Closed Life Support Systems (ECLSS) habitats based on the LMLSTP experiments.

¹ Post Graduate Student, University of North Dakota, Department of Space Studies

Introduction

Since we only have a single example of a functioning, self-contained, bio-regenerative system: the Earth, smaller scale models are necessary to study how such systems function and what the minimum sustainable size is along with other factors such as sustainable organism mix, gas ratios, and other materials.

An accelerated approach is required for preliminary research, given the time spans, and cost necessary to construct, observe, and assess biological systems. Complex mathematical and statistical models have been developed for both vast multi-variable systems, such as for star/planetary system development and at the smaller end of the scale, virtual ecosystems for personal entertainment, using popular open-source code bases and off the shelf computer hardware. Additionally, environmental, and climatic science has been exploring the use of Ordinary Differential Equations (ODEs) with bifurcation theory for observing and predicting critical transitions in complex ecosystems and food webs. Most traditional experiments in ecology are conducted in open natural ecosystems. Unfortunately, this means that very few have investigated the role that the biosphere plays in the biological exchange of matter and the anthropogenic influences upon the enclosed ecosystem. (Gitelson, Lisovsky, & MacElroy, 2003, p. 5) Computer model research using mathematical techniques to simulate BLSS have been done since the late 1970s and continued into the 1980s (Averner, 1981; Babcock, Auslander, & Spear, 1984; Stahr, Auslander, Spear, & Young, 1982; Rummel & Volk, 1987). In the late 1980s, this work was leveraged with modern object-oriented techniques to create distributed systems that would allow for easier modification and spread of workload to multiple platforms if necessary. These efforts have continued into the modern day with programming languages such as Java and C++. (Kortenkamp & Bell, 2003; Traclabs Inc, 2017)

The use of bifurcation theory allows for the inclusion of a characteristic of 'living things' into these models to examine how they may react to rather small changes in the environment. These small changes can be the introduction of a new species, the absence of a co-dependent organism or even the failure of another part of the bio-web. This effort will allow for the examination and exploration of many of the parameters and boundary conditions that cannot be predicted in a large complex system where small changes are critical. (Gitelson, Lisovsky, & MacElroy, 2003, p. 5) By using and leveraging these methods, a reliable computer model can be developed to accurately predict the species interaction and probable lifespan of a mix of organisms. Given the advances in both hardware and software technology, these simulations can be run in an accelerated manner to allow for the testing of multiple generations in a short period using readily available and easily accessible hardware. (Ting, Chao, & Giacomelli, 1997; Rodriguez, Kang, & Ting, 2003) This has continued to evolve with technology and has been expanded on to include contemporary machine learning and AI techniques for control. (Kortenkamp & Bell, 2003; Traclabs Inc, 2017)

Major problems anticipated in advance

The difficulty of problem scope and description

Part of the problem with examining the issues of closed ecosystems is that it is a that creates a complex adaptive system where all elements are interdependent . The description of an ecosystem is incomplete without the knowledge and explanation of the other parts, even though each part or process can be actually described on their own. One apt description characterized this problem as "...that of a dog playing with a big round ball – it's too large to put into the mouth as it is, but when torn to pieces, it is no longer round." (Gitelson, Lisovsky, & MacElroy, 2003) Failing to keep the larger picture in context will lead to incorrect or incompatible conclusions once the entire system is considered. The inverse is true as well, keeping a constant view of the whole system of systems, one will lose sight of the necessary components and interactions of subsystems.

Some experiments have seen this issue of 'looking at the forest without seeing the trees.' These have chosen to isolate part or parts of the Earth's biosphere; while including as much complexity in structure and as the rich diversity of species as possible to get a good sampling. In the end, these could not close the biospheric material cycle even though it outwardly resembles the original biosphere of Earth. For this reason, the Russian approach with the 'Bios' experiments was to keep this in mind from the beginning, with the overall goal of learning to construct and operate such a system. (Salsbury, Gitelson, & Lisovsky, 1997) The difficulty and complexity of closing the material cycle were clearly seen with the design of Biosphere 2 where there were much complexity and diversity. (Gitelson, Lisovsky, & MacElroy, 2003, p. 51) The complexity of Biosphere 2 should not be seen as a failure, rather as a reminder that the smaller cycles and interactions are just as necessary, if not critical, to the overall larger cycles. Biosphere 2 did eventually reach stability, but the process took over ten years, not the year to 18 months initially estimated. (Poynter, 2009, pp. 298-299)

Other issues and obstacles

Small-scale experiments that have been conducted since the 1920s to modern times have shown that small, sealed desktop systems can be created and maintained for years on end. (Gitelson, Lisovsky, & MacElroy, 2003, p. 51; Eckart, 1994; Folsom & Hanson, 1986) These systems, while functional at their scale, are not stable or expandable when scaled to include more complex organisms and cycles. When examining the larger picture of stability versus volume (Figure 1 Closed Ecological System Stability and System Linear size), this correlation becomes clear. Here we see the systems compared in logarithmic scale with the theoretical stability (blue diamond) compared with the actual observed results (red square) ranging from the desktop (0,0) to the largest scale known (Earth, assumed to be stable). Most Man-Made Closed Ecological Systems (CES) are in the five meter in size on the volume (horizontal) axes indicating high potential closure for autonomous operation (0.9 – 0.97) compare to practically achieved stability and closure indexes (red squares). (Rygalov & Holmer, 2014)

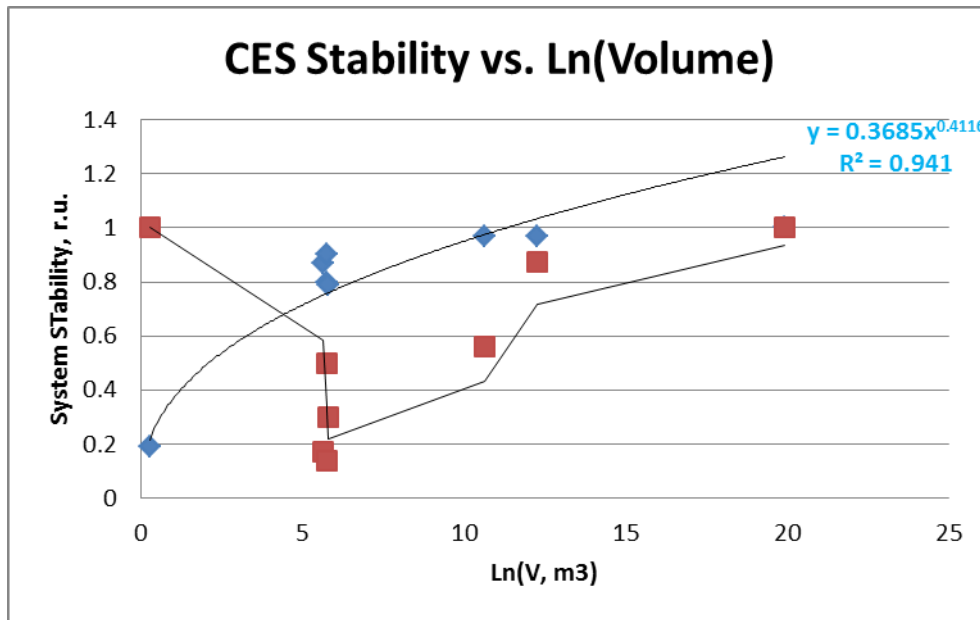

Figure 1 Closed Ecological System Stability and System Linear size (Rygalov & Holmer, 2014)

The main issue and conclusion are that the origin, evolution, and limits of stability mechanisms not yet fully understood. Compounded by the effect that the dynamic cycling equilibrium of material exchange in a system cannot set spontaneously. Early research with closed systems yielded unsatisfactory results, in part because they did not attain a stable, state. These experiments surmised that this confirmed the theoretical deductions of ecologists, and the instability or unreliability was due to not understanding the complexity of controlling biological regenerative systems which were based on monocultures of unicellular organisms. (Gitelson, Lisovsky, & MacElroy, 2003, p. 37) Systems that relied on self-organization like Biosphere 2, significantly underestimated the time required for this organization to occur. (Poynter, 2009, pp. 298-299) These instances do not mean that the systems failed, but rather means that designer of the analog of the biosphere did not consider the needed mechanisms for maintaining or reaching steady-state dynamic equilibrium. (Gitelson, Lisovsky, & MacElroy, 2003, p. 51; Rygalov & Holmer, 2014)

This issue of the mechanisms of steady-state dynamics is compounded by the lack of data to support and validate the species and species mixes in mathematical models. Only six large-scale experiments have been conducted to date with a complex mix of organisms that either included humans or were capable of supporting humans. These are Biosphere-2 and LMLSTP in the US, BIOS-3 in Russia, MELISSA in Europe, CEEF in Japan, and the Lunar PALACE in China. Data from these experiments is widely distributed and difficult to correlate.

The Earth Biosphere is used as a system for continuous references for all artificial Closed Ecological Systems (CES). The Earth has been functioning for over a billion years and for the consideration of this work, is stable. However, the principles of system functioning are quite different when compared to man-made ecosystems: relative stability here is provided by statistical regulations and evolutionary processes which eliminate any links in a total system material processing cycle which lose their

efficiency and decrease the rate of material transformation. Here Earth Biosphere is taken for comparison only as a standard which provided the idea of recycling for long-duration space travel. (Rygalov & Holmer, 2014)

Results of different system stability estimates are presented in Table 1 and plotted in Figure 1. (Note, a correction has been made to properly reference the Lunar Mars Life Support Test Project (LMLSTP) not BIOplex) Here we see how the stability of each Closed Ecological System (CES) differs based on size and structure as well as the difference between the calculated theoretical stability and the stability index which is based on total system functionality observed over time. (Rygalov & Holmer, 2014) The formulation is explained in the Model Research section under the heading ‘Correlation between Closure Degree, Tropic Network Complexity, and Stability Level’ on page 58. Here, t = time of the slowest cycle in the system, in days; T = time of system closure observation, in days; Stability, index = system functional stability determined through the time of total closure observations; Stability, theoretical = system functional stability determined through Tf = theoretical buffer time by Equation 16.

Closed Ecological System	t - cycle time, duration (days)	T - system time, duration (days)	Stability, index	Stability, theoretical.
Micro-CES (Lisovsky & Rygalov, 1992)	~ 0.1	~3600	~1.0	~ 0.19
LMHM (~ 30	10-30	~ 0.167	~ 0.61
BIOS-3 (Lisovsky G. M., 1979; Chernigovsky, 1975)	90	180	0.5	0.9-0.93
LMLSTP (Lane, Sauer, & Feeback, 2002)	~ 90	91	0.17	0.8-0.87
MELiSSA (Churchill (ed.), 1997, p. 364)	~ 90	~ 120	~ 0.3	0.7-0.79
CEEF (Tako, Shinohara, Komatusbara, & Nitta, 2001)	~ 90	~ 160	~ 0.56	0.9-0.97
Lunar PALACEPALACE (Liu & et al., 2014)	~ 90	~ 105	~ 0.14	0.79-0.8
Biosphere 2 (Allen & Nelson, Space Biospheres, 1986, p. 89; Alling & Nelson, Life Under Glass, 1993, p. 254)	~ 90	~ 720	~ 0.875	0.9-0.97
Earth Biosphere (Veradesky, 1986, p. 86)	~ 90	>0.3*10 ⁹	~ 1.0	0.99-1.0

Table 1 Comparison of stability characteristics for different CES (Rygalov & Holmer, 2014)

Constraints and Limiting Factors

One of the most obvious limiting factors when examining Figure 1 is the effect of size on system stability. Current efforts are stable at the micro level and very large end of the scale. Current human efforts in space require efficiencies in the use of mass, power, volume, and human labor (Gitelson, Lisovsky, & MacElroy, 2003, p. 38) for life support systems to be practical. To date, to maintain a constant presence in orbit, this has been accomplished by purely physio-chemical means with supply from Earth. (Nelson & Soffen, 1990, p. VII), While this is practical in earth orbit and possibly in sys-lunar space for the short term, the role of a sustainable biologically recycling system will dramatically alter the ability for humans to sustain life on a permanent, evolving basis either in orbit or further out to other planets and beyond. Large-scale efforts like Biosphere 2 may be practical for equally large-scale efforts on planetary bodies, the issue of initial construction and population at that scale remains questionable both technically and economically. Economic issues aside, mass and volume remain the biggest limitations faced.

Current mass estimates for a practical biological system for a small crew (6-8) are equal to or slightly larger than the physio-chemical mass estimates for a round trip mission to Mars (Gitelson J. , 1992; Tikhomirov, et al., 2007). Current efforts in with these mass and volume sizes, while having high theoretical stability figures, have resulted in low stability indexes when considered for long periods. (Rygalov & Holmer, 2014)

The question of the efficiency of human labor must also be considered when examining the trade between stored resources and a regenerative one. Biosphere 2 showed that almost half of the crew time was required for food production and processing. (Allen & Nelson, 1999; Alling & Nelson, 1993, pp. 18-25; Poynter, 2009, p. 186) It is possible that this may be sustainable and perhaps psychologically necessary for long-term space missions (Gitelson, Lisovsky, & MacElroy, 2003, p. 74; Botella, Baños, Etchemendy, García-Palacios, & Alcañiz, 2016; Palinkas, 2001), it may not be practical in terms of crew time (Committee on the Engineering Challenges to the Long-Term Operation of the International Space Station, 2000). This trade-off necessary psychological aspect and mission planning will need to be performed.

Any consideration of autonomy or adaptation of the principles of intelligent human control on the life support system to be implemented for bio-regenerative space life support system design cannot rely on the principle of ecosystem assembling based on the extraction of major biomes from the existing Earth Biosphere. As Biosphere 2 showed, the lengthy cycle times, high resource consumption rates and increasing process instability as the number of cycles increases (Rygalov & Holmer, 2014), will make using biome extraction and mimicry impractical for small-scale applications that are currently technically feasible by human technology. While both air and water have been successfully regenerated in prototype systems, little is known about constructing reliable biospheres that can be depended upon to supply food and fiber. (Paine, 1989)

History and Background

One of the early references for the inclusion of plants for an off-world journey comes from one of the early works of science fiction, Jules Verne's "From the Earth to the Moon," wherein the planning stages of the Columbiad; the Gun Club discussed at length what would be necessary for the journey. After pondering what could be included all the way up to what could be considered 'Noah's Ark,' the Club decided to confine their possibilities and packaged enough provisions for a year plus "Several packets of seeds were also included among the necessaries. Michael Ardan, indeed, was anxious to add some sacks full of earth to sow them in; as it was, he took a dozen shrubs carefully wrapped up in straw to plant...". (p. 148; Verne, 1865) While these plants were not meant to provide a breathable atmosphere, Verne did acknowledge the need to provide an environment in transit by producing via a "chemical process" (Verne, 1865, p. 117).

The first recorded attempts to create closed ecosystems, and what may have influenced Vern's account of the debate at the Gun Club, was by Chemist Robert Warington in the mid-1800s. His work in the early 1850s which expanding on one of the Victorian era's latest crazes, the Wardian case. (Brunner, 2011, p. 70; Gitelson, Lisovsky, & MacElroy, 2003, p. 20) Here he expanded on Anne Thynne's observations and experiments in keeping Madreporas (corals) alive for three years in London. (Thynne & Goose, 1859) Warington used a 13-gallon container, in which he placed goldfish, eelgrass, and snails and kept balanced twelve months, observing "...we have that admirable balance sustained between the animal and vegetable kingdoms, and that in a liquid element." And further observed, "The fish, in its respiration, consumes the oxygen held in solution by the water as atmospheric air; furnishes carbonic acid; feed on the insects and young snails, and excretes material well adapted to a rich food to the plant, and well fitted for its luxuriant growth." (Warington, 1851)

The first person to write about the concept of the Biosphere as a whole and coin the term was Vladimir I. Vernadsky (1863-1945) in his 1926 book "The Biosphere" (Veradesky, 1986; Allen & Nelson, 1999; Salsbury, Gitelson, & Lisovsky, 1997). This work serves as one of the foundations for bio-regenerative life support. In his book, he brought forth two laws that appear to have been borne out in many recent experiments. These were:

1. The movement of chemical elements by genetic means in the biosphere tends to the largest population. Specifically by two types of migration of elements; "by the movements of the mass of living material and by anthropogenic material movements, especially ever-increasing human, technical systems." (Veradesky, 1986; Allen & Nelson, 1999)
2. "...the evolution of species, intending towards the creation of new forms of life, must always move in the direction of increasing biogenic migration of the atoms in the biosphere" (Veradesky, 1986; Allen & Nelson, 1999)

In the last decades of the 19th century, Konstantin E. Tsiolkovsky was conjecturing not only about the physics needed to break the bonds of the Earth but also about the possibility of designing a biological life support system. (Salsbury, Gitelson, & Lisovsky, 1997, p. 576) However, the detailed experimental study would not begin until the threshold of humanity's imminent expansion into open space during the 1950s. (Gitelson, Lisovsky, & MacElroy, 2003, p. 5) Figure 2, Timeline of Bio-regenerative Life Support

(BLS) Research (Porterfield, 2015; Wheeler R. M., 2016), shows the overall timeline of the large bio-regenerative projects focusing on algae or plants and their country of origin over time. (Porterfield, 2015; Wheeler R. M., 2016)

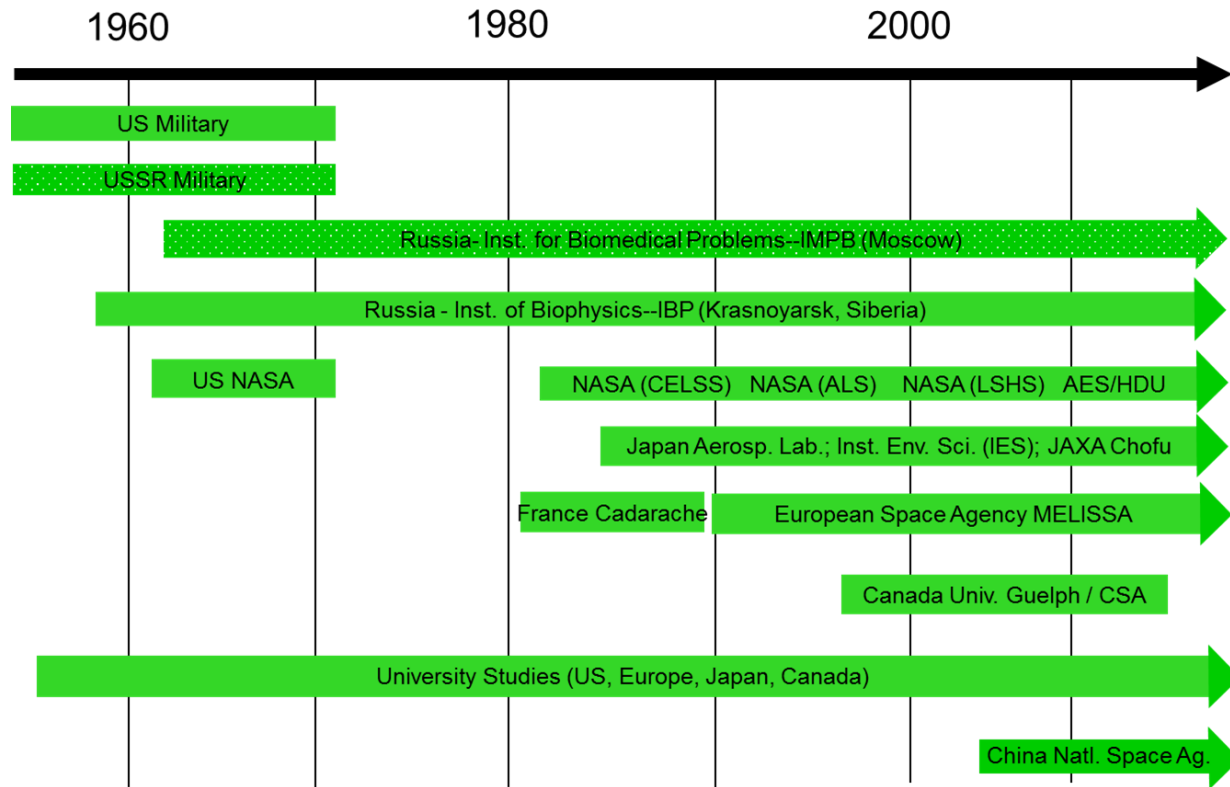

Figure 2 Timeline of Bio-regenerative Life Support (BLS) Research (Porterfield, 2015; Wheeler R. M., 2016)

Since Tsiolkovsky’s time, closed-loop and bio-regenerative systems have been studied and proven effective through several experiments in several countries. Russian efforts have been slow, but methodical and steady. NASA, while organized has not been consistent (Salsbury, Gitelson, & Lisovsky, 1997). These experiments include the ‘Bios’ experiments in Russia (Gitelson, Lisovsky, & MacElroy, 2003), the Lunar Mars Life Support Test Project (LMLSTP) at NASA Johnson Space Center in the United States (Eckart, 1994; Gitelson, Lisovsky, & MacElroy, 2003), ESA’s Micro-Ecological Life Support System Alternative (MELISSA) (Hendrickx, et al., 2006), and the Japanese Closed Ecology Experiment Facilities (CEEF) (Nitta, Otsubo, & Ashida, 2000). Each one of these experiments focused on different sections of life support; most had the commonality of components of microalgae and higher plants. Except for CEEF, while some of these did include humans, most did not include animals other than humans-in-the-loop. ESA’s MELISSA only had human beings simulated and did not directly experiment with animals. These experiments proved that not only is a bio-regenerative system is possible, but also provided critical evidence that such systems would not be simple and would need to be made up of many different components (Eckart, 1994; Gitelson, Lisovsky, & MacElroy, 2003).

System	Investigator, Project	Characteristics
Algae-based Systems (Chlorella)	US (1961)	Monkey/algae gas exchange Duration up to 50 hours
Small closed ecological systems (microbes)	USSR(1961)	Rats and Dogs, up to 7 days First human/algae system (BIOS 1 & 2) 15 to 30 Days
	C. Folsom, University of Hawaii (1967)	Sealed flasks (100 ml – 5 l) Multicultural aquatic solutions (biosynthetic decomposer) Energy + Information Exchange
Higher Plants	BIOS-3, USSR (1972-84)	Two-three people, up to six months Food Production (30-50%) Water recovery (transpiration: Filter, boil)
	CELSS-US, Japan, ESA (1977-1990)	Controlled environment plant growth (light, carbon dioxide, temperature, photoperiod) Focus on increased yield
	Biosphere 2 Space Biosphere Ventures (1984-present)	Eight people, up to two years Complete ecological systems, including livestock, for food production, water recovery and air purification
	CELSS-US, LMLSTP Phase 1 and III (1995-1998)	One person 15 days – Gas Regeneration only Four people, 91 days – Full closure Gas and water, partial food and waste
	ESA, MELISSA (1989-present)	Gas, Solid Waste, Water, Food cycle studies
	Japan – CEEF (1994 – 2007)	Humans, livestock, plants, gas, solid waste, water. 2 persons for 1-week, 2-week, or 4-week tests,
	Lunar PALACEPALACE 1, China (2014-present)	Three-four people 105 days, 200-day closure started May 2017 Complete ecological systems for food production, water recovery and air purification

Table 2 Significant closed bio-regenerative research projects (Eckart, 1994; Barta D. J., 2016; Barta D. , 2020; Lok-ye & Fei, 2014; AFP, 2017; Tako, et al., 2008; Tako, et al., 2010)

Early 'Space Age' Experiments

Biologically based systems for life support are not the sole domain of astronauts and space systems. The advent of high-altitude flight and long duration submarines where crew members would spend extended periods of time sealed away from the harsh environments that their vehicles were in, provided a proving ground for early research. The first spaceflight accelerated this research spearheaded by efforts in both the United States and Russian (at the time Soviet) space agencies. (Nelson & Soffen, 1990) Russian literature gives equal emphasis to both K. Tsiolkovsky and V. Vernadsky for early thought research and basis for considering that biosphereic systems would be a factor in humanities ability to explore past the bonds of earth. (Allen J. P., 1989)

Early US experiments with biological systems began in 1961 with the Air Force School of Aviation Medicine. These experiments included monkeys connected to algae tanks for gas exchange. At the same time in the former Soviet Union, experimenters at the Institute of Plant Physiology and the Institute of Biomedical Problems conducted similar gas exchange experiments with rats and dogs. (Eckart, 1994, p. 142; Nelson M. , 1993) Evgenii Shepelev of the Moscow Institute for Biomedical Problems became the first modern human to test this direct link. Shepelev used a sealed steel casket large enough for himself and eight gallons of *Chlorella* algae with sodium lighting. Calculations showed that there should be sufficient material exchange to sustain both. (Kelly, 1995) The initial test lasted only 24 hours, and while oxygen and carbon dioxide exchange went well, trace gasses such as carbon monoxide, methane, hydrogen sulfide, and ammonia did not. Further testing revealed that mechanical filtering could control these and experiments extended out to 30 days. (Kelly, 1995; Beyers & Odum, Chapter 19: Human Microcosms and Space, 2012)

Beginning in 1967, Clair E. Folsom, Joe A. Hanson, and Bassett Maguire at the University of Hawaii, Manoa began studying desktop and laboratory sized systems by sealing test tubes and small flasks typically 100 ml – 5 L in size with a complete functioning complement of microbes, liquid medium, and gases. (Folsom & Hanson, 1986; Nelson, Pechurkin, Allen, Somova, & Gitelson, 2010; Sagan, 2013; Allen J. P., 1989; Sagan, 2013; Eckart, 1994; Beyers & Odum, 1993). This approach differed from the preceding micro- and mesocosm studies in that their only inputs were energy from sunlight or artificial light, their gas and nutrient loops were (except for the leak rates and information exchange through sensors) closed off from interaction with the outside world. (Nelson, Pechurkin, Allen, Somova, & Gitelson, 2010; Gitelson, Lisovsky, & MacElroy, 2003) These showed that they would eventually establish an equilibrium and continue to function for extended periods of time. (Folsom & Hanson, 1986; Nelson, Pechurkin, Allen, Somova, & Gitelson, 2010; Sagan, 2013; Allen J. P., 1989; Beyers & Odum, Ecological Microcosms, 1993) As of 2013 some of the original flasks created by Folsom in the early 1970s were still functioning and showed no sign of instability or decay. (Sagan, 2013)

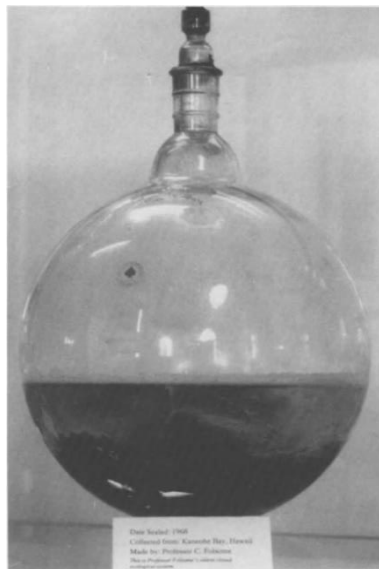

Figure 3 A single microcosm captured by C. Folsom, in the Biosphere 2 library in 1990. (Beyers & Odum, 1993)

The early biological experiments focused on two different approaches, one focused on photosynthesis with algae (primarily *Chlorella*) and the other using chemosynthesis using 'hydrogen' bacteria (mainly *Hydrogenomonas*). (Gitelson, Lisovsky, & MacElroy, 2003, p. 34 & 37) The algae approach worked on the assumption that the algae would remove CO₂ expelled by humans. The algae would utilize the captured energy to from photosynthesis and split the CO₂ into carbon in their structures and release the O₂. This process includes splitting water into Hydrogen (as NADH₂) and free Oxygen which would form O₂. The NDAH₂ would be used to chemically reduce the Carbon (in the form of CO₂) to a form more usable by the Algae for reproduction and cellular materials. The hydrogen bacteria approach assumed that a process would be in place to produce hydrogen, most likely from a fuel cell approach. Here the O₂ would be made available for human atmospheric consumption and H₂ used as a mechanical fuel and provided to the bacteria. The bacteria would then use the waste CO₂ and some of the O₂ from the atmosphere while consuming the H₂ as their energy source with CO₂ for reproductive and cellular materials. (Gitelson, Lisovsky, & MacElroy, 2003, p. 34; Nelson & Soffen, 1989) During this period of the late 60s, NASA conducted studies on the controlled growth of hydrogen bacteria and metabolic investigations ranging from cell composition to behavior of enzyme control systems (Ballard & MacElroy, 1971; Gitelson, Lisovsky, & MacElroy, 2003, p. 35)

There was a widespread assumption during this period that the algae from these systems could be used as a primary food source. This assumption based on as far back as 2000 years ago, populations in China were using stocks of microalgae to survive famine. (Spolare, Joannis-Cassin, Duran, & Isambert, 2006; Priyadarshani & Rath, 2012; Milledge, 2011) However, researchers discovered that feeding both green algae and hydrogen bacteria to animals and humans both caused digestive disturbances even when composed of a small fraction of the edible mass (less than 1%). (Gitelson, Lisovsky, & MacElroy, 2003, p. 35; Calloway & Margen, 1968) Additional studies have indicated that humans and animals have issues when consuming raw algae in large quantities (Powell, Nevels, & McDowell, 1961; Krauss, 1962; Gitelson, Lisovsky, & MacElroy, 2003, p. 78). Further research has shown that processing of these algae for easier consumption loses much of the beneficial nutritional components (Powell, Nevels, & McDowell, 1961; Spolare, Joannis-Cassin, Duran, & Isambert, 2006).

Efforts in the United States

The first U.S. laboratory experiments on the characteristics of a balanced, closed system were conducted by Eley and Myers where chlorella was studied in a gas loop with mice (Eley & Myers, 1964). Efforts with a human in the loop regenerative systems began the following year in 1965 Huntington Beach, California and was moved to Santa Monica in 1968. The program, run by the McDonnell Douglas Astronautics Company, conducted tests in three phases with progressively longer durations lasting 30, 60 and 90 days. (Pearson & Jackson, 1971; Eckart, 1994, p. 147; Drake, King, Johnson, & Zuraw, 1966). At each phase, the hardware was updated to incorporate lessons learned with the overall objective to operate a regenerative system without resupply. The test facility was a double walled horizontal, cylindrical chamber that was pressurized to prevent any inward leakage. Two systems were used for water reclamation for drinking; a Vacuum Distillation Vapor Filtration system that was heated by radioisotope, and a wick air evaporation system as a backup. Wastewater electrolysis unit was used to produce oxygen with Carbon Dioxide collected with a solid amine system. A toxin burner with a catalyst

controlled the Carbon Monoxide, and other atmospheric contaminants. (Eckart, 1994, p. 148) The 60-day test marked the first use of reclaimed potable water from urine in closed testing. (Eckart, 1994, p. 148) The 90-day test was completed in September of 1970 with a crew of four with no resupply. All food, makeup water, spare parts, and tools were stored inside at the beginning of the test. (Pearson & Jackson, 1971) While this used physio-chemical means for regenerating the atmosphere and materials, the experiment proved that a regenerative system could be accomplished. This provided the confirmation of the concept that biologics could be used in performing the same function.

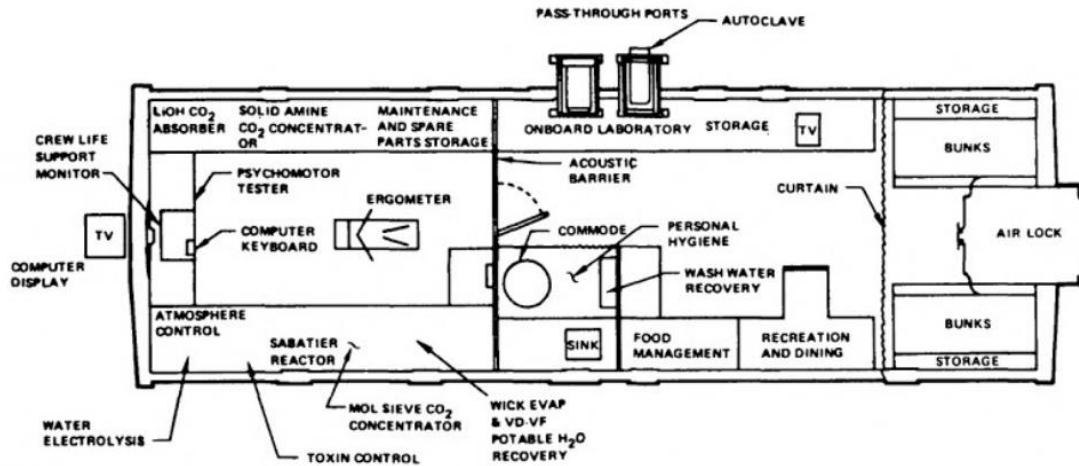

Figure 4 McDonnell Douglas Long-Duration Life Support Test Facility - 90 Day Configuration (Pearson & Jackson, 1971)

Biological systems research continued at the University level. However, researchers became disappointed with microalgae and chemosynthetic bacteria during the 1960s and 1970s. The disappointment was primarily due to the problem of biomass disposal without using it as a nutritional source due to the gastrointestinal issues experienced with using algae in the diet (Gitelson, Lisovsky, & MacElroy, 2003, p. 38; Eckart, 1994, p. 273). NASA began to focus its attention on crops, specifically to higher plants. University research was consolidated and combined into integrated systems with the Controlled Ecological Life Support System (CELSS) Program in the 1980s. As well as in follow-up activities, such as the Advanced Life Support System (ALSP) — closed system cultivation occupied a central position among the major research directions. (Gitelson, Lisovsky, & MacElroy, 2003, p. 38).

The NASA CELSS Program and Test Facility

The CELSS Program was structured so that NASA controlled the research objectives and directions and provided funding at the higher levels through NASA Centers. NASA centers would then make the research funding available on a competitive basis to academia and industry. The physical requirements for plant growth developed through this research would then be consolidated and tested through at the facilities available at NASA Centers. Once the initial approach and objectives of this new interdisciplinary approach were established, the planning and priorities were set by the research and industry communities through a Science Working Group. The Working Group's working assumptions for bio-regenerative systems that considered when evaluating proposals were the following: (Gitelson, Lisovsky, & MacElroy, 2003, pp. 38, 42; MacElroy & Averner, 1978; MacElroy, Tremor, Bubenheim, & Gale, 1989)

1. That a regenerative space life support system would be an ecosystem, but that the ecosystem would resemble a terrestrial form, rather than a typically isolated ecosystem;
2. These would be used on orbit or during transit to and possibly on the surface of other planets
3. Would require significant amounts of power either from the Sun or other sources, possibly nuclear
4. That humans would be a major component of the ecosystem
5. Dedicated heat dissipation devices would need to be a key part of any system
6. Needs to be efficient in its use of mass, power, human labor, and be as reliable as a non-biological system.
7. That an ecological life support system would have a goal, unlike a natural ecosystem, namely the support and sustenance of its human beings

With these assumptions, the initial proposals were selected to examine higher plants focusing on food crops in a closed system. F. Salisbury conducted these early studies at Utah State University for wheat, T. Tibbitts at the University of Wisconsin for Wheat and Potatoes, D. Raper at North Carolina State University for Soybeans, R. Huffaker at the University of California at Davis for Nitrogen Metabolism, (Gitelson, Lisovsky, & MacElroy, 2003, pp. 38-39) and C. Mitchell at Purdue University for Lettuce (Wilkenson, 1980; Porterfield, 2015; Wheeler R. M., 2016). Results and experience from these experiments would later be included in both on-orbit experiments and in larger scale, integrated experiments at NASA Centers.

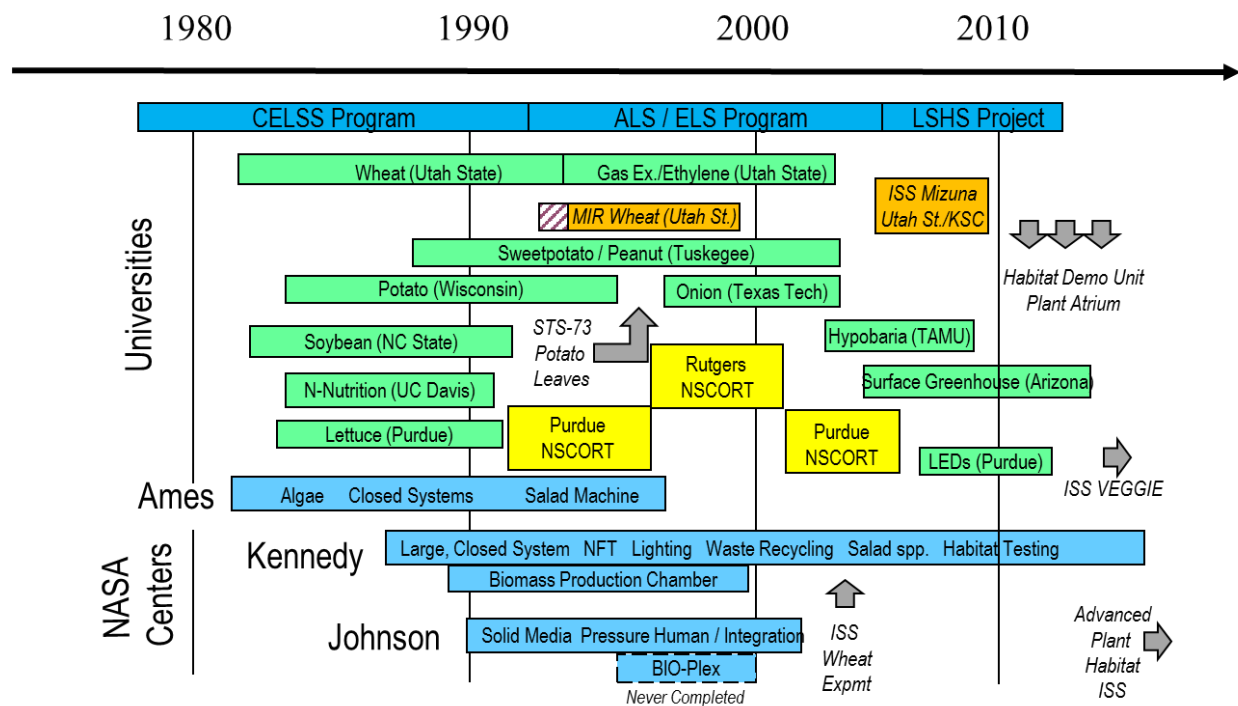

Figure 5 Recent History of US Bio-regenerative Testing and Programs (Porterfield, 2015)

Small- and large-scale hardware projects were located at Ames Research Center (ARC), Johnson Space Center (JSC), and Kennedy Space Center (KSC). The goal of this was to validate the requirements and approaches to be used for equipment that could be used on the International Space Station (ISS) with the end goal to gather specific data about the growth of higher food producing plants in the space environment. The initial CELSS Test Facility at ARC design was developed by C. Straight and R. MacElroy in 1988 and was further developed under the direction of M. Kliss, B. Borchers, and C. Blackwell. (Gitelson, Lisovsky, & MacElroy, 2003, p. 42; Eckart, 1994, p. 149; Wheeler R. M., 2016; Tremor & MacElroy, 1986)

By the mid-to-late- 1980s the important research and technology development thrust of the CELSS program were identified. In summary, these were (Gitelson, Lisovsky, & MacElroy, 2003, p. 40):

- To conduct research as if a mission using CELSS system had been approved
- To continuously refine system requirements to meet foreseeable mission constraints (mass, power volume, human labor in space);
- To maximize higher plant productivity of food based on the efficient use of power and volume;
- To understand and exploit the linkage between environment control and plant productivity;
- To increase the extent of material recycling by maximally utilizing reduced carbon (potential food)
- To efficiently oxidize (to CO₂) materials that could not be further used;
- To develop rapid and efficient methods for water purification to provide for human drinking water;
- To develop the tools necessary to conduct plant productivity experiments in the space environment;
- To enlarge the size of the various functional units (e.g., plant growth, waste processing, etc.) to human process human-sized flows;
- To link the various production units (e.g., plant growth with waste process with water purification, etc.) to evaluate stable operation;
- To make use of future long-term human flights employing conventional life support systems by supplementing them with facilities for the growth of consumable salad vegetables;
- To maintain cognizance of past and current activities associated with the development of closed recycling life support systems.

Activities supporting these principles of research were carried out at Johnson Space Center through the Advanced Life Support (ALS) System Test Bed. This facility was the largest of the NASA life support test systems. The ALS facility supported several different full-scale experiments including, the Lunar-Mars Life Support Test Project (LMLSTP), the Advanced Life Support System Test Bed (ALSSTB), the Variable Pressure Growth Chamber (VPGC) and the Integrated Life Support Systems Test Facility (ILSSTF). (Gitelson, Lisovsky, & MacElroy, 2003, p. 47; Barta D. , et al., 2006; Barta D. J., 2016; Barta D. , 2020) This facility was based on the Skylab Medical Experiments Altitude Test (SMEAT) and built in the same vacuum chamber. (Mohanty, Fairburn, Imhof, Ransom, & Vogler, 2008). This facility was planned to be expanded into a larger facility called the Biological Planetary Life Support Systems Test Complex

(BIOplex), but due to changing priorities at NASA and budget constraints; this was never completed and no experiments were ever conducted in this facility. (Kennedy, 2006; Barta D. , 2020)

Recent activities for CELSS have centered around the Life Support and Habitation Systems (LSHS). The technical work for LSHS is performed across seven NASA field centers (Porterfield, 2015; Barta & McQuillan, 2011; Wheeler R. M., 2016):

- Johnson Space Center (JSC)
- Ames Research Center (ARC)
- Marshall Space Flight Center (MSFC)
- Kennedy Space Center (KSC)
- Glenn Research Center (GRC)
- Langley Research Center (LaRC)
- Jet Propulsion Laboratory (JPL)

Ames Research Center

Efforts for the CELSS program at Ames have been focused primarily on Research and Development, System Integration and Control, and Space Flight Experiment portions. Conducted from the early 1980s through the 1990s, Ames developed new methods and technologies for air revitalization, biomass production, food processing, waste processing, and water purification. Plant systems were examined determine the response times and flexibility of the system for optimum water use, carbon utilization, oxygen and biomass production. Processing and recycling of human waste, trash, and inedible biomass, including inorganic minerals, into forms that could be utilized by plant systems, were also explored. Many experiments took on multiple avenues such as the use of duckweed as a biomass producer, dietary component, and a waste treatment component. Additional studies on waste recycling and processing focused on the extraction cellulose sugars and the use of supercritical water to oxidize organics for use as inputs to other plant systems. The Crop Growth Research Chamber (CGRC,

Figure 6) was used to examine new species and systems for both dietary nutritional examination as well as overall CELSS Suitability. System Control and Integration reviewed the management and orchestration of biological, physical and chemical components for optimal system health. (Bubenheim, 1989; Porterfield, 2015; MacElroy, Tremor, Bubenheim, & Gale, 1989)

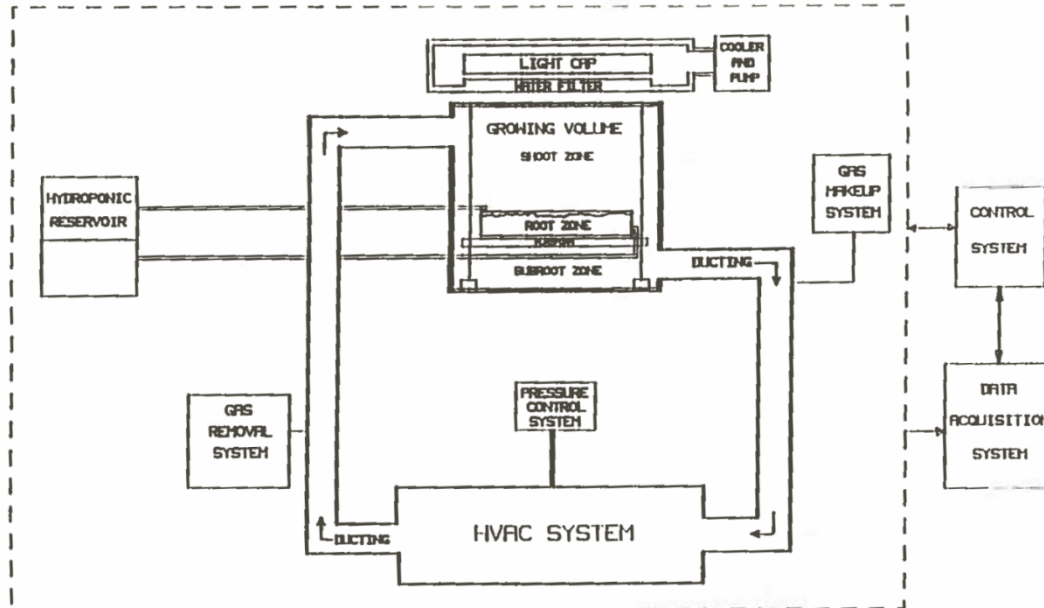

Figure 6 Component block diagram of the Crop Growth Research Chamber (Bubenheim, 1989)

While space flight experiments were planned to test these components and systems in a microgravity environment (see Figure 7 Early conceptual drawing of a 'Salad Machine' for use on the ISS (Bubenheim, 1989)). However, changes in priorities and funding shut down most CELSS experiments and projects in the mid-1990s before flight tests could be conducted. (Bubenheim, 1989; MacElroy, Tremor, Bubenheim, & Gale, 1989; Porterfield, 2015)

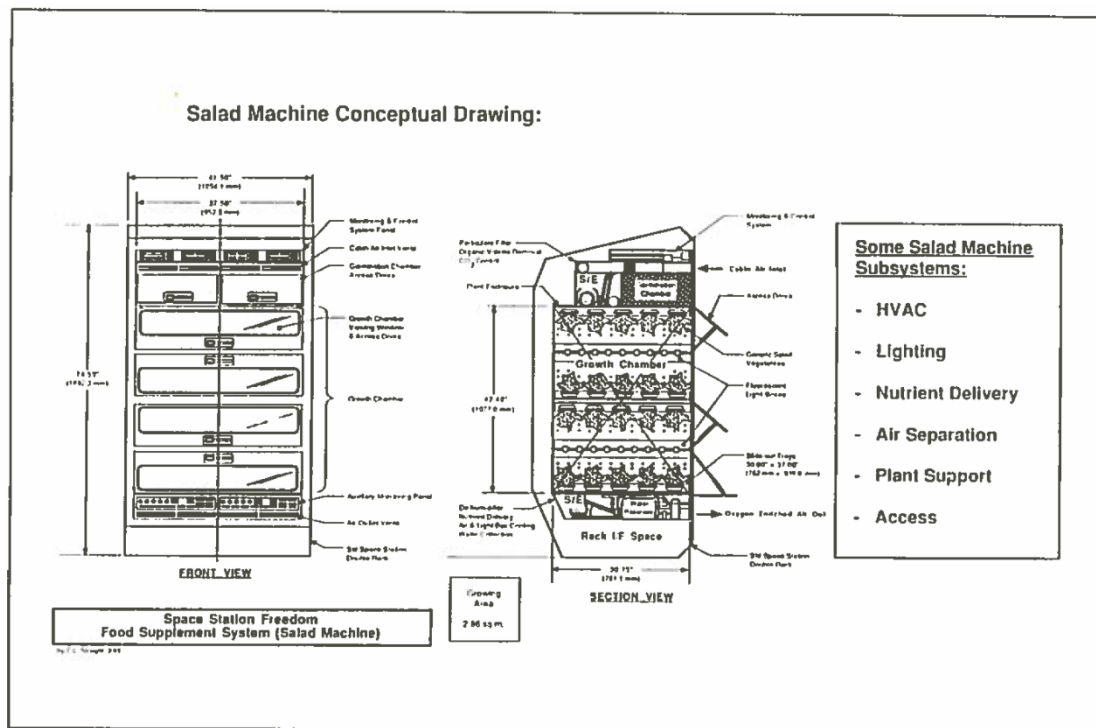

Figure 7 Early conceptual drawing of a 'Salad Machine' for use on the ISS (Bubenheim, 1989)

Kennedy Space Center - 'Breadboard Project.'

In 1985, W. Knott and J. Sager began a project at Kennedy Space Center in support of the CELSS program called 'the Breadboard Project' and were later joined by R. Prince and R. Wheeler (Gitelson, Lisovsky, & MacElroy, 2003, p. 42). The project's goal was to provide a facility in which to scale up and integrate research of specific subsystems of CELSS into a complete whole. These subsystems include biomass production, food processing, resource recovery and crew habitat (See Figure 8 NASA CELSS Project General Subsystem Flow (Prince & Knott, 1989)). This modular subsystem approach had the effect of creating interfaces between the components where they could be studied as independent data sets before being integrated. The Breadboard Project was NASA's first attempt at a full-scale CELSS system. (Prince & Knott, 1989)

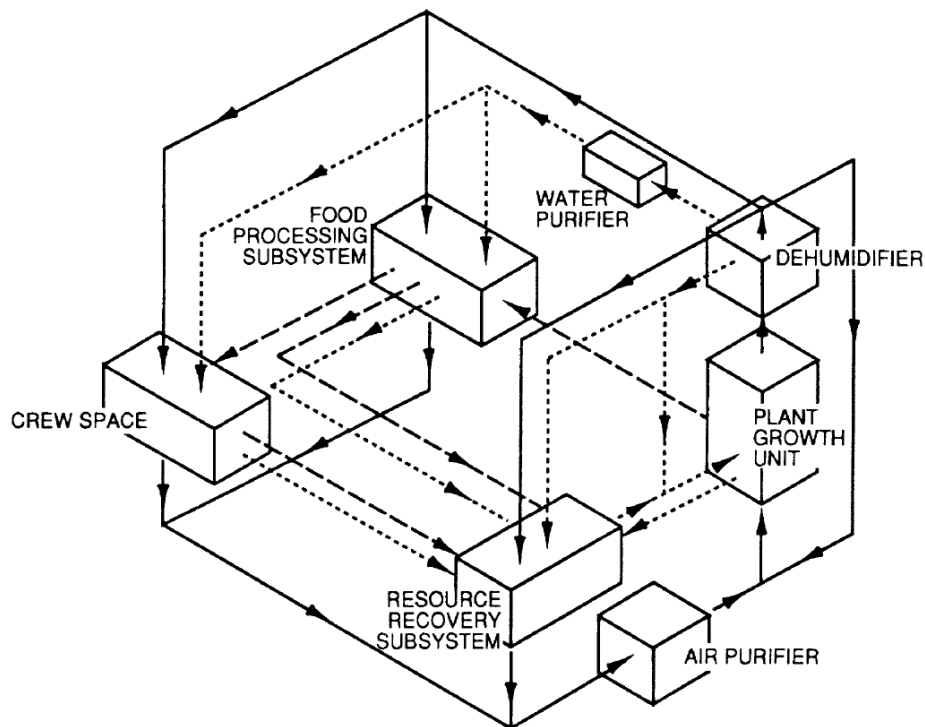

Figure 8 NASA CELSS Project General Subsystem Flow (Prince & Knott, 1989)

The centerpiece of this project is the large, closed, and contained Biomass Production Chamber (BPC). Originally used for the Mercury program for hyperbaric testing, the chamber has been refurbished to provide laboratory sized studies into the production of food for human life support, water recycling, and atmospheric gas control. (Eckart, 1994, p. 149; Porterfield, 2015; Wheeler R. M., 2016) The BPC provides 20 m² of plant growing area over eight plant racks, with 16 trays on two different levels in a closed 113 m³ volume. (Wheeler R. M., 2014) 96 400-W high-pressure sodium lamps provide lighting, except for three experiments 1990 in 1990 where 400-W metal halide lamps were used (Eckart, 1994, p. 150; Gitelson, Lisovsky, & MacElroy, 2003, p. 42). Air handling is provided through two 30-kW blowers, providing circulation near 400 m³/Min with speeds at the plant level near 0.5 to 1 m/s, turning over the air inside the chamber approximately three times per minute. The atmospheric conditions of temperature and humidity are controlled using a chilled water system. The composition is controlled

through compressed gas delivery. The overall leak rate reported was 5% - 10% of the volume per day. (Eckart, 1994, p. 150; Gitelson, Lisovsky, & MacElroy, 2003, p. 42; Prince & Knott, 1989; Wheeler R. M., 2014)

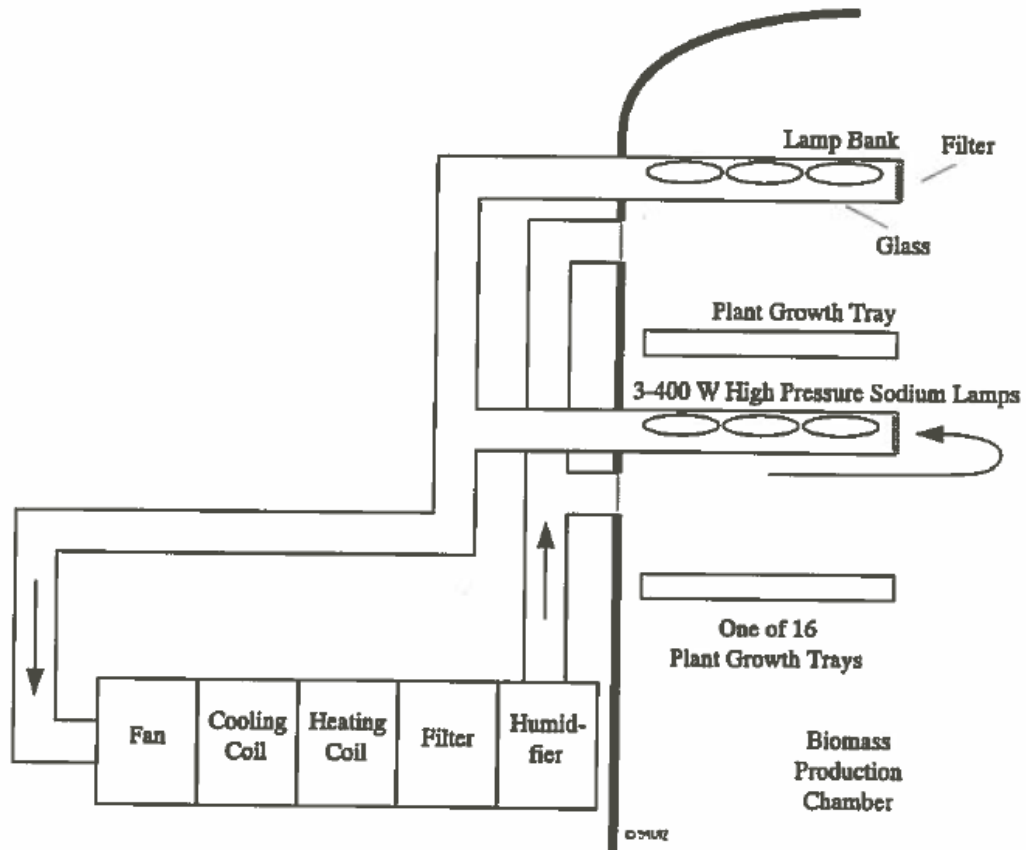

Figure 9 KSC Biomass Production Chamber Mechanical Flow (Eckart, 1994)

Plants are bedded and fed using a recirculating nutrient film technique. (Eckart, 1994, p. 150; Wheeler R. M., 2014) As of 2014 (Wheeler R. M., 2014), six tests with wheat, eight tests with potato, four tests with soybean, five tests with lettuce, two tests with tomato, and one test with rice (Gitelson, Lisovsky, & MacElroy, 2003) have been conducted. One potato test ran continuously through 418 days (four plantings), and a mixed crop test with wheat and potatoes ran continuously for 339 days. These studies have provided data samples of crop production for ALS analysis along with direct measurements of photosynthesis, respiration, transpiration, and production of volatile organic compounds (e.g., ethylene) and how changes in these effects both plant health and crop yield. (Prince & Knott, 1989; Wheeler, et al., 1996; Wheeler, Corey, Sager, & Knott, 1993; Gitelson, Lisovsky, & MacElroy, 2003, p. 43; Wheeler R. M., 2014)

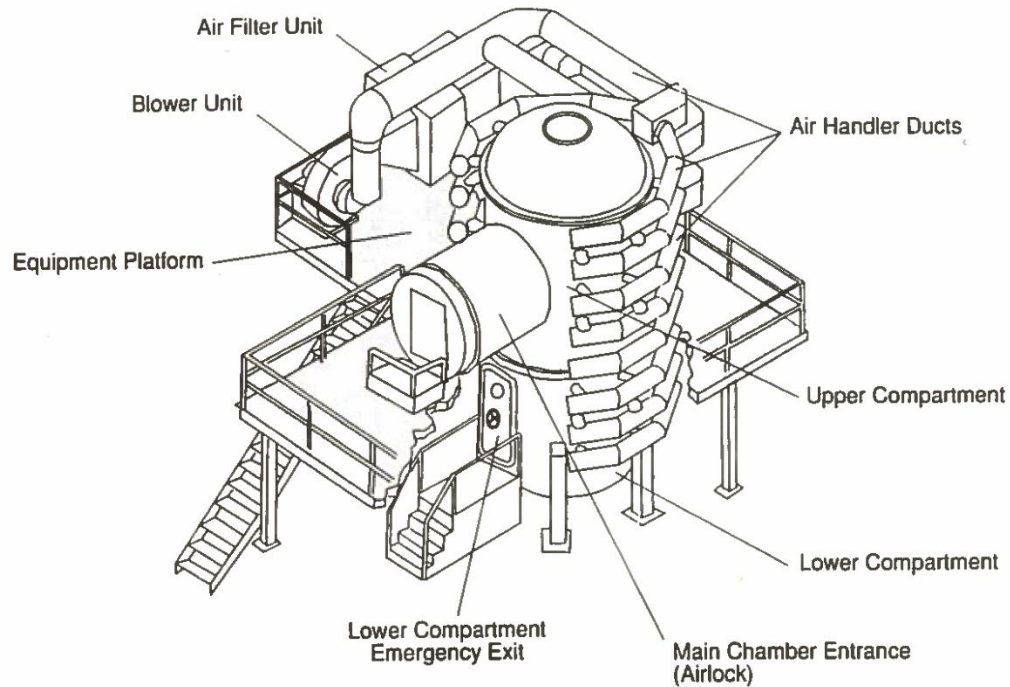

Figure 10 The Biomass Production Chamber at Kennedy Space Center, exterior (Eckart, 1994; Prince & Knott, 1989)

Other research conducted at KSC with the Breadboard Project has included biological waste treatment and resource recovery. The treatment and restoration projects have focused on recovery of minerals from inedible biomass for recycling and examination of their use in alternative food production options such as cultivating fungus, yeast, and fish. Mineral recovery methods included aerobic and anaerobic liquid tank reactors as well as composting. Additional studies on mineral cycling have included the direct use of liquid waste streams from the crew space gray water that contains soap and urine. The results of these studies have suggested that predictable life support components can be biological as long as the proper conditions are maintained. (Prince & Knott, 1989; Wheeler, et al., 1993; Wheeler, et al., 1996; Gitelson, Lisovsky, & MacElroy, 2003, p. 43)



Figure 11 KSC Biomass Production Chamber (BPC) (Porterfield, 2015; Wheeler R. M., 2014)

Johnson Space Center - The Advanced Life Support System Test Bed

The Advanced Life Support System (ALS) Test Bed, was a series of closure experiments conducted at Johnson Space Center with human test subjects. These tests included the Lunar-Mars Life Support Test Project (LMLSTP), the Advanced Life Support System Test Bed (ALSSTB), the Variable Pressure Growth Chamber (VPGC) and the Integrated Life Support Systems Test Facility (ILSSTF). These were a series of experiments with both bioreactors and higher plants. (Gitelson, Lisovsky, & MacElroy, 2003, p. 43; Barta D. J., 2016) The longest duration of undisturbed closure achieved was 91 days with a total system functional volume of approximately 275 m³. (Rygalov & Holmer, 2014)

Started as the Regenerative Life Support System (RLSS) Test Bed, the ALS test bed was originally a vacuum chamber for the Crew and Thermal Systems Division's early work with testing of hardware at reduced atmospheric pressures. The chamber was originally human-rated and referred to as the '10 foot chamber', was converted in 1989 to be the Variable Pressure Growth Chamber (VPGC). The chamber is divided into two compartments, an airlock and main compartment. The main compartment, which was

used for plant growth, has a volume of 27m³ and is limited to 34.5 kPa vacuum operations. During its early stages of development in 1990 and 1991, the growth chamber tested automated plant growth in ambient pressures. In 1992 – 1993 the ability to operate at reduced pressures was added, and the Ambient Pressure Growth Chamber (APGC) was constructed to provide a control for the reduced atmosphere tests. Each chamber contains eight growing areas, stacked in pairs with each area able to support up to 1.4m² of plant growth. (Barta & Henninger, 1999) In 1995, the Airlock was modified to include support for Phase I of the Lunar-Mars Life Support Test Project which included a human metabolic simulator for testing, physicochemical air revitalization subsystems, and improved lighting and nutrient delivery systems for plant growth. (Barta & Henderson, SAE Technical Paper 981704, 1998; Barta & Henninger, 1999)

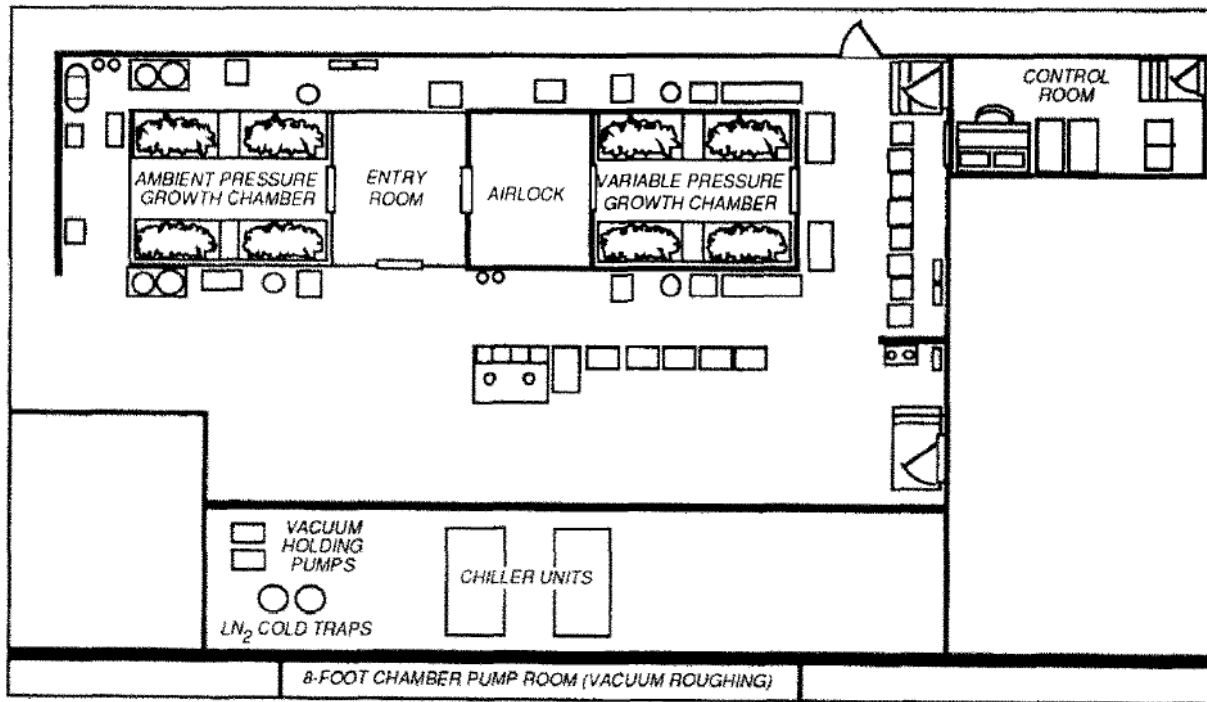

Figure 12 JSC early ALS test bed - the Regenerative Life Support System layout 1992-1993 (Barta & Henderson, 1998)

The Lunar-Mars Life Support Test Project was the first project at NASA that combined large-scale crop testing, human test subjects, a closed atmosphere, and integration of physicochemical and biological technologies in a single experiment. These began with atmospheric revitalization and progressively added water, nutritional, and solid waste loop closures with durations lasting 15 to 91 days in length between 1995 and 1998. (Barta, Dominick, & Kallberg, 1995; Barta & Henderson, 1998; Edeen & Pickering, 2000; Barta & Henninger, 1999; NASA Johnson Space Center, 2002; Gitelson, Lisovsky, & MacElroy, 2003, p. 43; Henninger, Tri, & Packham, 1996; Edeen & Pickering, 2000)

Test		Phase I	Phase II	Phase IIA	Phase III
Duration		15 days	30 days	60 days	91 days
	Crew SIZE	1	4	4	4
Types of Systems		Biological (Wheat)	Physicochemical (Advanced)	Physiochemical (ISS Regenerative ECLSS)	Integrated Physicochemical & Biological (Advanced)
SubSystem Closure Level	Full	Air	Air & Water	Air & Water	Air & Water
	Partial Open Loop	Water, Food, & Waste	Food & Waste	Food & Waste	Food & Waste

Figure 13 Lunar-Mars Life Support Test Summary (Edeen & Pickering, 2000; Barta D. J., 2016)

For the Phase I test, a single researcher was enclosed for 15 days while an 11.2 m² crop of wheat provided air revitalization. While carbon dioxide removal and oxygen production by the wheat was expected to and did exceed the crew member's respiration requirements, unexpected trends in ethylene, carbon monoxide, and microbial growth levels did occur. These were investigated and mitigated for phase II and III. (Barta, Dominick, & Kallberg, 1995; Barta D. J., 2016; Gitelson, Lisovsky, & MacElroy, 2003, p. 43 & 46; Mohanty, Fairburn, Imhof, Ransom, & Vogler, 2008; Nelson, Pechurkin, Allen, Somova, & Gitelson, 2010, p. 526)



Figure 14 Crew and Growth Chambers for the LMLST Phase I (Barta D. J., 2016)

Phase II involved the outfit and modification of the Skylab Medical Experiments Altitude Test (SMEAT) simulator to support a crew of four for extended durations beginning in 1993. This chamber was 6 meters in diameter (20 feet) and contained three levels for a total atmospheric volume of 900 m³. (Mohanty, Fairburn, Imhof, Ransom, & Vogler, 2008) The initial Phase II test lasted 30 days evaluating the effectiveness of advanced mechanical and chemical systems to recycle air and water. Phase IIA lasted 60 days while evaluating mechanical and chemical systems for air and water that function like those planned for use aboard the International Space Station. (Barta & Henninger, 1999; Gitelson,

Lisovsky, & MacElroy, 2003, p. 46; Mohanty, Fairburn, Imhof, Ransom, & Vogler, 2008; Nelson, Pechurkin, Allen, Somova, & Gitelson, 2010, p. 526)

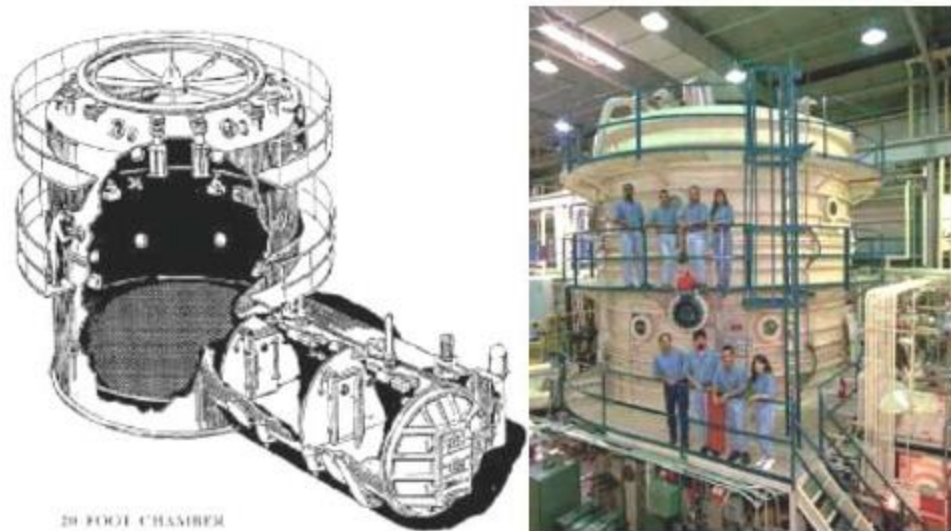

Figure 15 LMLST Phase II 4 Crew Chamber (Mohanty, Fairburn, Imhof, Ransom, & Vogler, 2008)

Phase III began in 1997 combined the 20-foot crew chamber with the VPGC to provide up to 25% of the atmosphere reconditioning and provided both wheat grain as well as lettuce for crew consumption. A water recovery system used microbial cell bioreactors as the primary treatment step for water recovery. An incinerator was employed for the incineration of human feces and the oxidization of inedible materials. (Gitelson, Lisovsky, & MacElroy, 2003, p. 46; Mohanty, Fairburn, Imhof, Ransom, & Vogler, 2008; Barta D. J., 2016)

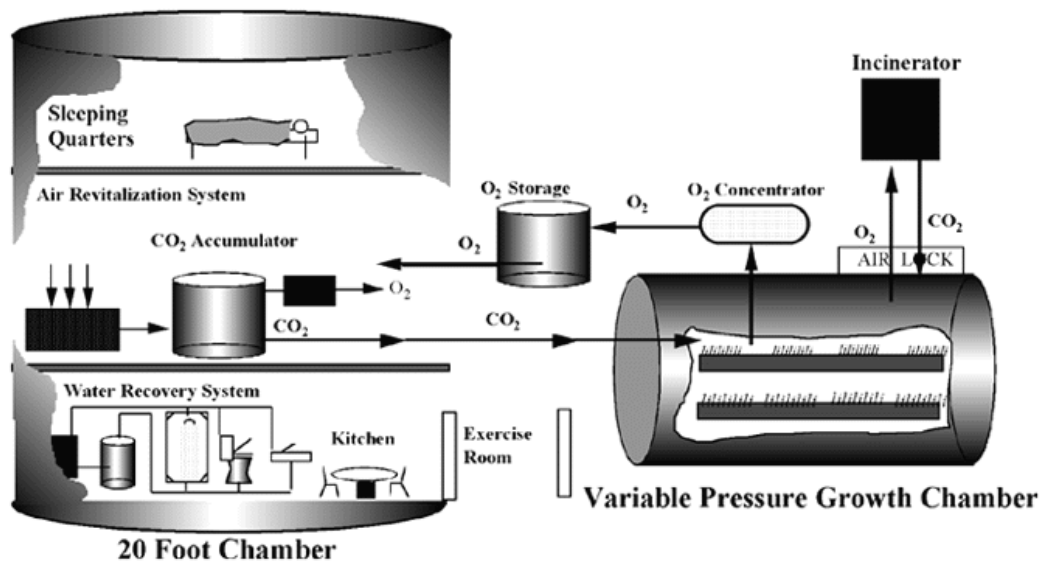

Figure 16 LMLST Phase III Combined chambers and subsystems (Malin, 1999)

While these experiments at JSC proved that biological systems could indeed be a reliable part of regenerative life support systems, they also highlighted that prediction of faults and better recognition of root causes would aid in overall system performance. (Edeen & Pickering, 2000) Key findings and conclusion were that an integrated control system that took faults into account and made automatic adjustments while supporting overall subsystem management would be necessary to maximize both crew and ground support time management. (Edeen & Pickering, 2000; Barta D. J., 2016; Barta & Henderson, 1998; Barta & McQuillan, 2011; Gitelson, Lisovsky, & MacElroy, 2003)

A planned expansion of the scale and complexity of the facility to be called the Biological Planetary Life Support Systems Test Complex (BIOplex) was proposed in the late 1990s that would expand the functionality to a full planetary life support testbed. (Henninger, Tri, & Packham, 1996) Work on this expansion of the facility was started and stopped several times due to changing priorities and budgeting constraints in the Agency. The facility only achieved an approximate 60% of its planned capability before being completely decommissioned and placed in storage in early 2000 (Porterfield, 2015; Wheeler R. M., 2016; Kennedy, 2006). No experiments were ever conducted with this facility. (Barta D. , 2020)

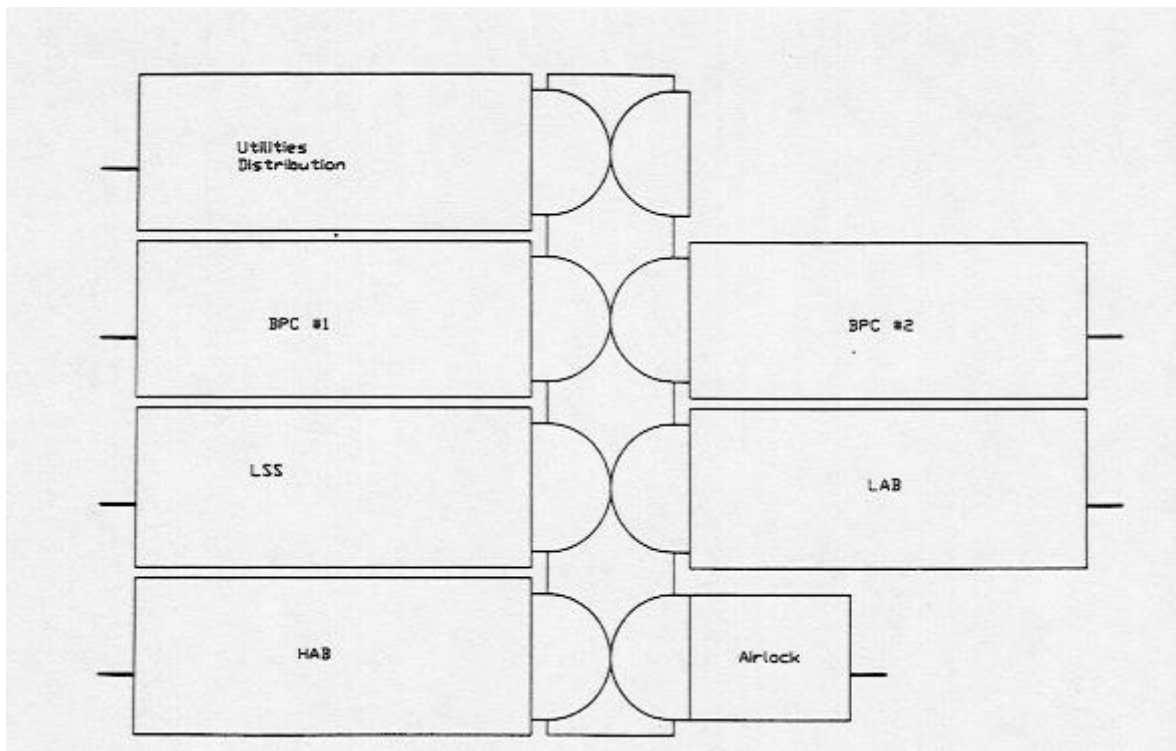

Figure 17 BIOplex Proposed layout (Vodovotz, Bourland, & Rappole, 1997)

BioSphere 2

Biosphere 2 is one of the most famous and infamous closed CELSS experimental studies located in Oracle Arizona. Created by Space Biosphere Ventures (SBV), a private company, as an experiment to prove that a large scale CELSS is possible and could support eight people for two years. (Alling & Nelson, 1993; Poynter, 2009, p. 100; Allen J. P., 1989; Allen J. , 2009, p. 111) The facility was the realization of a lifelong dream of John P. Allen, who envisioned a large scale laboratory to study the interactions of

ecosystems and technics, a discipline he called 'ecotechnics. (Allen J. , 2009, pp. 9, 33) The principal hypothesis of the system was based self-organization as seen in the Earth's ecology, rather than the reductionist approach that had been taken so far by NASA (Allen J. , 2009, p. 112). This was to be achieved by mimicking multiple biomes, standard biological units in the Earth's Biosphere with distinct characteristics that would automatically provide functional stability. (Rygalov & Holmer, 2014) Planning began in 1983 (Nelson, Gray, & Allen, 2015; Allen J. , 2009, p. 111) with an idea for a self-sustaining greenhouse and a challenge from Buckminster Fuller "If you guys don't build a biosphere, who will?" (Poynter, 2009, pp. 19-20). A little over three years later, the biosphere concept was realized with a small test facility with a volume of 480 cubic meters, Figure 18. (Alling, Leigh, MacCallum, & Alvarez-Romo, 1989) This facility would then be scaled to one of the largest, most complex habitat closure experiments ever seen. Biosphere 2 enclosed 3.14 acres with a volume of over 203 thousand cubic meters (7.2 million cubic feet) that mimicked five major biomes of the earth; Tropical rain forest, savannah, marine, marsh, and dessert, plus a 2000 m² area for intensive agriculture and human habitat. (Allen J. P., 1989; University of Arizona, 2016; Gitelson, Lisovsky, & MacElroy, 2003; Allen J. , 2009; Silverstone & Nelson, 1996) During the initial two-year closure, many instabilities in system functionality were encountered ranging in scale from the micro to macro levels.

The Biosphere 2 Test Facility

The Biosphere 2 Test Facility was completed in 1986. This proof of concept demonstrated the sealing and structural engineering along with the operational procedures for the full-scale facility. (Allen J. P., 1989) The module included food and oxygen producing plants, human habitat quarters including a shower, sink and toilet, air and water recycling systems. The Test facility connected to an expandable 'lung' via an underground tunnel that would allow for the expansion and contraction of the atmosphere with temperatures. The double paned glass roof and truss support system allowed 65% of ambient photosynthetic active radiation to penetrate the interior of the facility. The measured leak rate in 1989 was 24% per annum, which when expanded to the full-scale Biosphere 2 facility, projected a leak rate of about three percent per year. (Alling, Leigh, MacCallum, & Alvarez-Romo, 1989) Sized for a single individual closure testing occurred with three, five and 21-day tests in 1989. (Allen J. P., 1989; Poynter, 2009, pp. 85-97)

Air revitalization was accomplished with a combination of plant respiration and active soil bed reactors to remove and control trace gasses.

The water recycling system treated of all water in the habitat including effluent, gray water, and plant irrigation water. The system provided treatment of all human waste; no waste was removed from or sequestered in the habitat. The system was sized to treat 5-15 gallons of wastewater per day using both anaerobic and aerobic processes and operated effectively during all three closure tests. Potable water was obtained by a dehumidification system and finished with UV sterilization. Run-off water from this process was used for irrigation and was held in a reservoir to be pumped to irrigation zones through computer control. (Alling, Leigh, MacCallum, & Alvarez-Romo, 1989; Poynter, 2009, p. 85)

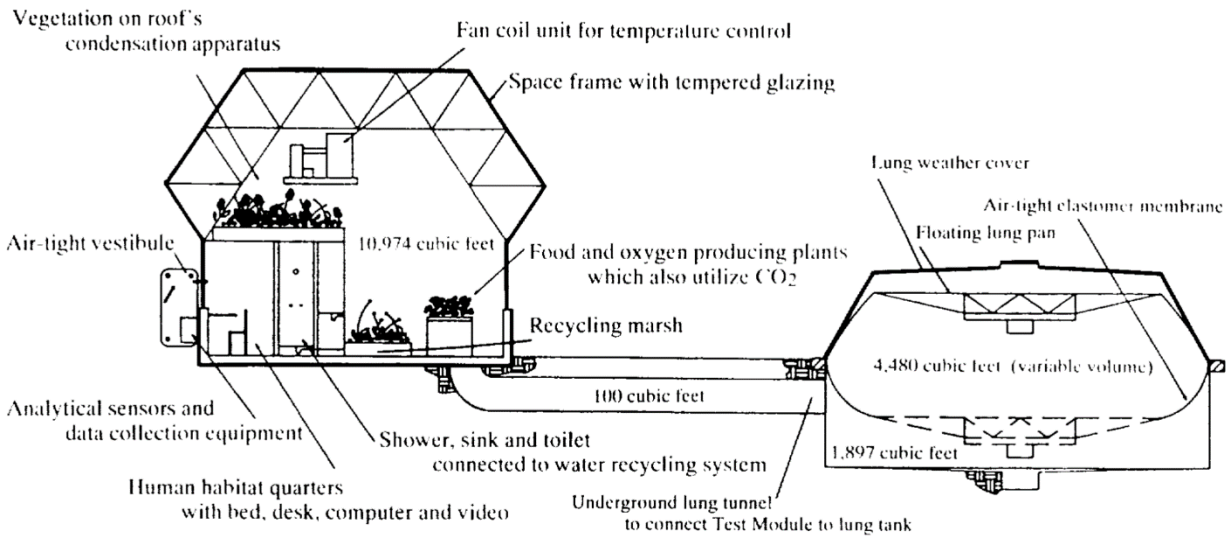

Figure 18 Biosphere 2 Test Module System Schematic (Alling, Leigh, MacCallum, & Alvarez-Romo, 1989)

Biosphere 2 – Full Scale

Construction of the full-scale facility commenced in 1987 after the successful closure tests of the Test Module in 1986. (Allen J. P., 1989; Allen J. , 2009, p. 153) Regarded by some as a triumph of American engineering genius (Gitelson, Lisovsky, & MacElroy, 2003, p. 51) and a May 1987 Discover Magazine article called it “the most exciting scientific project to be undertaken in the U.S. since President Kennedy launched us toward the moon.” (Smith, 2010), it was completed in 1991 with a total cost reported at \$200 Million (McGraw-Hill, 2007; Smith, 2010; Alling & Nelson, 1993). SBV designed the facility to have a minimum 100-year lifespan with its five biomes of the Earth; miniature desert, steppe, tropical forest, ocean, field and farm, and human habitat, all based on the positive results of the Test Module and work SBV had done with mesocosms. All the necessary elements were present to create and sustain interactions of all the types of phenomena associated with the current biosphere, and that dynamic equilibrium could be achieved. (Allen J. P., 1989; Gitelson, Lisovsky, & MacElroy, 2003, p. 51; Nelson, Gray, & Allen, 2015).

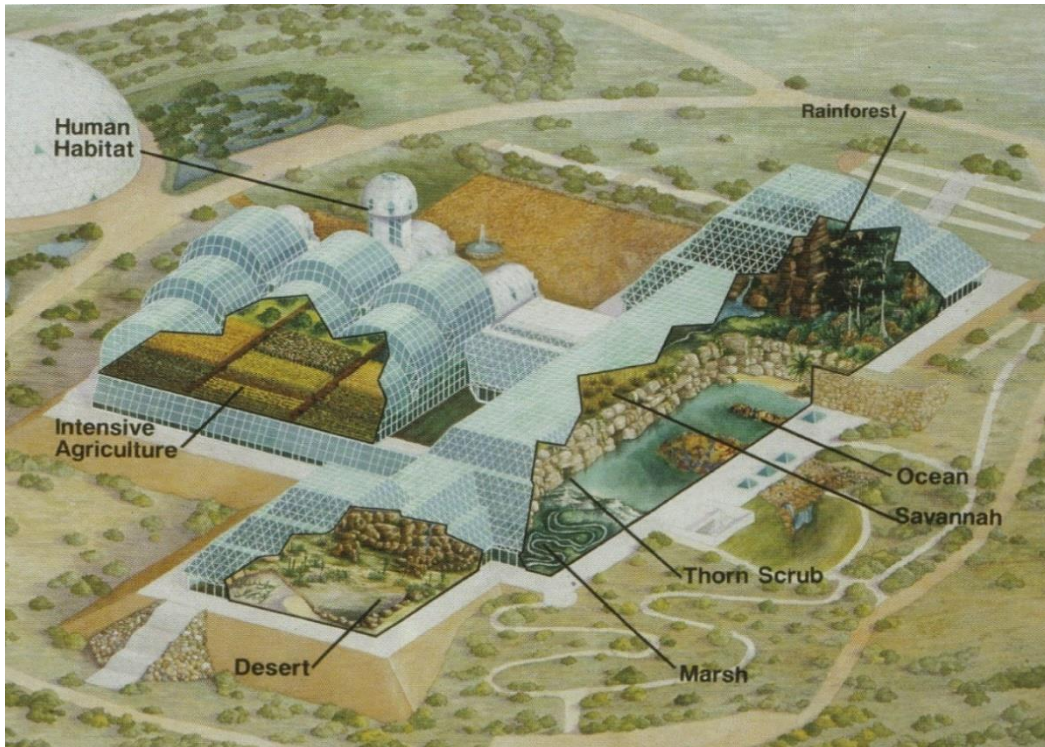

Figure 19 Biosphere 2 full facility (Allen J. , 2009, p. 164)

This confidence was created after a yearlong consolidation and design phase that incorporated the approaches and experience gained by SBV members from the Institute of Ecotechnics and the input of other consultants on the project into the design. The design team worked out a 12-level hierarchy scheme of ecology that included microbes, multicellular species, populations, food web niche guilds, functional systems, patches, phases, communities, ecosystems, bioregions, biomes and the biosphere itself. (Allen J. P., 1989) However, despite this optimism, Thomas Paine, in a paper presented at the “Workshop on Biological Life Support Technologies” at Biosphere 2 in 1989, stated that the ‘... the goal of a closed-ecology biosphere remains the least understood and the most challenging.’ (Nelson & Soffen, 1990) This foreshadowed the results of the subsequent first closure experiment.

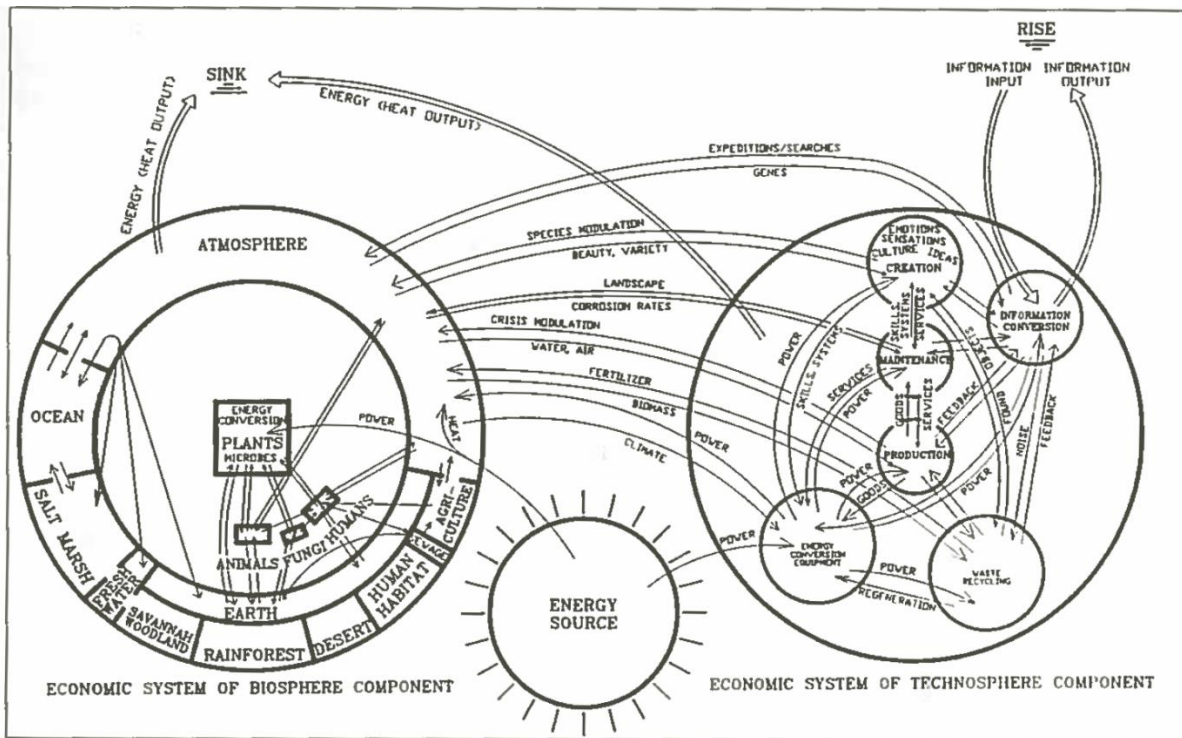

Figure 20 Biosphere 2 Block exchange model (Allen J. P., 1989)

Following a 3-month check out of the completed facility, two full closure experiments were conducted. The first, the much reported on and maligned two-year experiment beginning in 1991 and the second, lesser-known began in 1994.

The first closure had a crew of eight members and ran September 26, 1991, to September 26, 1993. (Alling & Nelson, 1993; Gitelson, Lisovsky, & MacElroy, 2003). This was to be a shakedown test of the entire system in an all-up configuration (Poynter, 2009, p. 81) and some turbulence was expected (Nelson, Gray, & Allen, 2015). However, during this test, the system did not behave per expectations or intuition. The closure began with the construction just been completing earlier in the year, and completed with equilibrium not being established with the overall system. Which resulted in oxygen eventually having to be added to the enclosure to allow for the completion of the experiment at its planned full two-year length. (Highfield, 2004; Gitelson, Lisovsky, & MacElroy, 2003, p. 51; Alling & Nelson, 1993, pp. 106-109; Poynter, 2009) Additional tribulations occurred such as collapse of many of the animal and insect communities including all the pollinator species, explosions of unwanted insect populations, and crop failures in the human habitat (Alling & Nelson, 1993, pp. 55, 67, 70, 71, 73-76, 136, 161-164, 172, 188, 220; Highfield, 2004; Poynter, 2009, pp. 179-182, 191, 192, 297, 298). Unanticipated psychological and group dynamics also occurred including depression, food hoarding, and stealing, post-traumatic stress syndrome. Divisions were created between the crew such as social valence, personality conflicts and cabin fever (Poynter, 2009, pp. 146-147, 207-210, 213, 215-216, 219, 231, 234-236, 239-240, 246, 249, 251, 267-268, 271, 288-289, 290, 302, 321; Nelson, Gray, & Allen, 2015). Many conflicts and tensions were similar to those encountered by both long duration scientific expedition and Antarctic research teams (Nelson, Gray, & Allen, 2015). These stresses resulted in frictions both internally with the

participants and the outside operations control group (Gitelson, Lisovsky, & MacElroy, 2003, pp. 51-52; Highfield, 2004; Poynter, 2009, pp. 220-223, 225, 265-266, 269-271, 290; Nelson, Gray, & Allen, 2015). The press seized and focused on these problems concluding the overall experiment a failure. (Gitelson, Lisovsky, & MacElroy, 2003, p. 51; Highfield, 2004; Poynter, 2009, pp. 119, 128, 143, 146, 155, 171-172, 247-250, 263, 270; Alling & Nelson, 1993, pp. 149, 177, 219; Veggeberg, 1996).

Following a five-and-a-half-month transition in which several modifications were made as a result of the first closure (Allen & Nelson, 1999; Nelson, Gray, & Allen, 2015), the second closure test began with a crew of seven members on March 5, 1994. This was planned to end after ten months in January 1995. However, after only a month, on April 1st, a hostile takeover ensued at mission control of SBV under direction from Ed Bass, the group's primary benefactor and underwriter. During this incident, most of the management and operational staff were legally removed from the facility and property. Following this shake-up in the management staff, a break into the main facility occurred early in the morning on April 5th that opened all the airlocks. This direct intervention was led by two members of the first closure Abigail Alling and Mark Van Thillo. (Poynter, 2009, pp. 327-328) The current closure crew informed that no members were remaining on staff who knew how to run the closed facility. Ed Bass gave the crew the option to terminate the closure experiment. The 2nd crew decided to stay and resealed the facility. (Poynter, 2009, p. 329)

Officially on 1 June 1994, a change of ownership occurred for SBV. The new management terminated all current and planned human missions in Biosphere 2 (Nelson, Gray, & Allen, 2015). The second closure ended on 6 September 1994, after only 6 and a half months of closure. (Biosphereics, 2016, pp. 328, 329; Allen & Nelson, 1999; Nelson, Gray, & Allen, 2015) Unlike the first crew, this crew was able to grow 100% of its needed caloric values and did not need to rely on stored materials (Nelson, Gray, & Allen, 2015; Biosphereics, 2016).

While the media may have written off both the first and second closure experiments as a failure, a more sensible conclusion examines these outcomes to be more like lessons to be learned. Gitelson, Lisovsky, and MacElroy in *Manmade Closed Ecological Systems* concluded '...isolation of an arbitrarily chosen part of the Earth biosphere, complex in structure and rich in diversity of species, even outwardly resembling the biosphere, cannot automatically close its material cycle.'

Many small but possibly significant successes did occur with regards to monitoring and management of a large scale CELSS, crop production scheduling, long-term crew meal planning and calorie budgets, as well as proof of large-scale use of microbes in a soil bed reactor for control of trace gasses. One relatively unexplored area for successful results is the psychological and group dynamics portion of the experiment. There was some news coverage of the frictions and tensions that arose with the crew and mission control, only two publications have focused on this aspect of the experiment and how the environment helped or hindered. Jayne Poynter's book "The Human Experiment: Two Years and Twenty Minutes Inside Biosphere 2" published in 2007 and a Journal Article published in 2015 in *Life Sciences in Space Research* by Mark Nelson, Kathelin Gray, and John Allen. These findings are consistent with those of other high performing, but isolated crews such as on-orbit astronauts, Antarctic researchers, and

submarine crews (Nelson, Gray, & Allen, 2015), the psychological, social and medical findings from this experiment cannot be written as a one-off.

In November 1996, Columbia University took over operations and maintenance of Biosphere 2 (Veggeberg, 1996) until it abdicated its lease in 2003. (Biosphereics, 2016; Poynter, 2009, p. 331)

Current Status

Biosphere 2 is currently under management by the University of Arizona since 2011. The five biomes continue to operate as a research facility to study large-scale experimentation ecosphere and climatology changes including experiments to examine the effects and consequences of global climate change. The human habitat and operations facility has been converted to a conference center. The intensive agriculture area has been refitted as the Landscape Evolution Observatory. The observatory consists of three physical models of mountain slopes examine and relationships among geology, hydrology, chemistry, ecology, and atmospheric science at a large scale. (University of Arizona, 2016; University of Arizona, 2016b; DeLong, 2011)

Efforts in Russia

The Institute of Biomedical Problems (IBMP) was founded in Moscow in 1963 on the initiative by the S.P. Korolev and M.V. Keldysh. (Contemporary Educational Programmes, 2003) The founding of the IBMP centralized the teams of physicians and biologists studying biomedical activities in the first space flights in the Soviet Union including both animals and cosmonauts. The group had a diverse set of backgrounds whose specialties included biology, chemical engineering, and agronomy. The Chief Designer for the IBMP was Boris G. Kovrov, who had a physics background but later became a biologist. (Salsbury, Gitelson, & Lisovsky, 1997, p. 576) The staff included O.G. Gazenko, A.M. Genin, Ye.Ya Shepelev, and G.I. Meleshko and others that would later found and lead specialized departments to work out the biotechnical foundations of CELSS investigations. (Gitelson, Lisovsky, & MacElroy, 2003, pp. 52-53).

Programs of study known collectively as the 'Bios Experiments' were a series of experiments carried out over a 30-year period beginning in the late 1960s (Gitelson, Lisovsky, & MacElroy, 2003, p. 577; Eckart, 1994, p. 143; Salsbury, Gitelson, & Lisovsky, 1997). The total time of all the full closure experiments is over two years. (Salsbury, Gitelson, & Lisovsky, 1997, p. 577) These included experiments with only atmospheric regeneration (Bios 1) and atmospheric and water regeneration with microalgae (Bios 2). With Bios 3, higher plants were introduced to include nutritional components and longer durations (2 – 6 months) of closure were conducted. Unlike Biosphere 2, Bios 3 was specifically designed as part of the Soviet space program (Salsbury, Gitelson, & Lisovsky, 1997, p. 576). The facility is still in use today and conducts experiments at various scales. (Contemporary Educational Programmes, 2003; Institute of Biophysics, 2019)

Bios 1

Before and in parallel with C. Folsom's work at the University of Hawaii, B. Kovrov, at the Institute of Physics (Biophysics), in Krasnoyarsk, Siberia worked to create and study small sealed systems. Some system that Kovrov created were still functioning as of 2003. (Gitelson, Lisovsky, & MacElroy, 2003, p. 20) This work with algal systems and specific strains of algae, particularly *Chlorella Vulgaris* laid the

foundations for bioreactors that would be used throughout Soviet CELSS Experiments. (Gitelson, Lisovsky, & MacElroy, 2003, p. 52; State Space Agency of Ukraine, 2005, p. 9; Salsbury, Gitelson, & Lisovsky, 1997) The first closed gas exchange experiments were conducted between 1964 and 1965 by the IBMP. These human-microalgae two-link experiments were also referred to as 'Bios 1'. Five separate experiments that ran between 29-32 days using three, 15-liter cultivars to provide atmospheric regeneration for a human closed in a 5-cubic meter enclosure. Some experiments also included supplementing the subject's food rations with up to 10% by weight with algae from the cultivars. Gas closure approached 90% with these experiments and with stable atmospheres serving as proof of concept for further development and expansion (Gitelson, Lisovsky, & MacElroy, 2003, pp. 53-54). Overall the system achieved 20% total closure (Salsbury, Gitelson, & Lisovsky, 1997, p. 576).

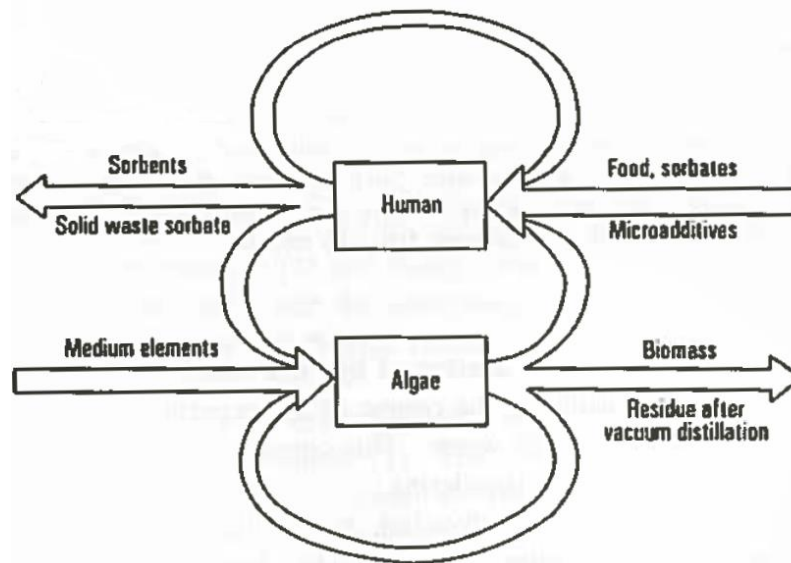

Figure 21 Mass Exchange in a two-link system between humans and microalgae (Gitelson, Lisovsky, & MacElroy, 2003, p. 206)

In the mid-1960s, the ration supplementation experiments were expanded to include higher plants within the IBMPs Ground Experimental Complex (GEC aka NEK) by Yevgeny Ya, Shpelev, and Gana I. Melesko (Salsbury, Gitelson, & Lisovsky, 1997, p. 577). Isolation experiments were conducted up to one year at a time (Gitelson, Lisovsky, & MacElroy, 2003, p. 53; Salsbury, Gitelson, & Lisovsky, 1997, p. 577). Atmospheric regeneration was primarily accomplished using physiochemical means with a 15-cubic meter greenhouse providing fresh vegetables, grains and other edible biomass to the subjects. When combined with algae, the edible biomass made up 26% of the mass and 19% of caloric value needed for individual requirements as calculated at the time. (Gitelson, Lisovsky, & MacElroy, 2003, p. 53).

In 1968 Bios-1 added water recycling which increased the total closure to 80-85%. (Salsbury, Gitelson, & Lisovsky, 1997)

Bios 2

In 1969, the successes of the GEC and Bios-1, the staff in Krasnoyarsk combined the two concepts to provide a proof of concept for stable, balanced gas-water exchange with steady edible vegetable

biomass. An additional chamber was added to Bios-1 for growing both vegetables and wheat. (Salsbury, Gitelson, & Lisovsky, 1997) Atmospheric conditioning was accomplished through both the higher plants in the new chamber and the algal cultivator with an approximate split of 25%/75%. This combined with three links became known as Bios-2 and consisted of microalgae, higher plants, and humans for closure experiments lasting up to 90 days. (Salsbury, Gitelson, & Lisovsky, 1997; Gitelson, Lisovsky, & MacElroy, 2003)

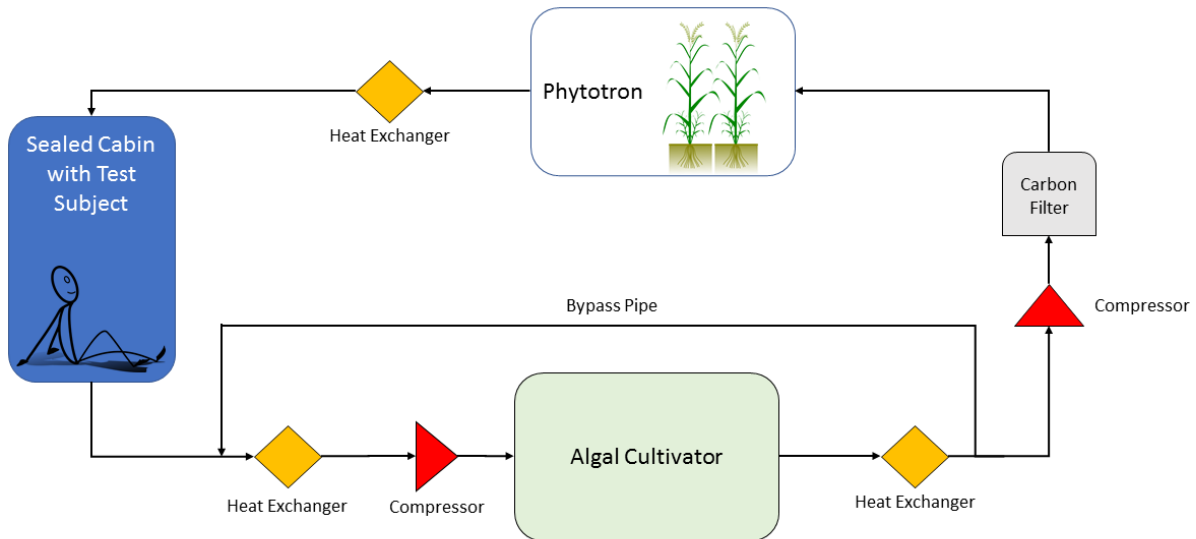

Figure 22 Bios-2 Schematic diagram of gas exchange in the three-link system (Gitelson, Lisovsky, & MacElroy, 2003, p. 221)



Figure 23 Bios-2 Algal Cultivator and Phytotron (Sohail, 2015)

Bios 3

Full on CELSS experiments began in Krasnoyarsk with the construction of Bios 3 in 1970 by the Bio-Physics Division of the Institute of the Siberian Branch of the Soviet Academy of Sciences (Later renamed Institute of Bio-Physics). The facility is 315 square meters overall, subdivided into four, sealable 79 square meter compartments, at the cost of 1 million rubles (approx. \$1M US), and completed in 1972. (Salsbury, Gitelson, & Lisovsky, 1997, p. 576) Agricultural experiments utilized two compartments. One compartment housed the algal cultivators. The human habitat comprised the fourth compartment. One of the main differentiators of Bios 3 from other closure facilities is that it was designed for complete control by the inhabitants of the system. (Gitelson, Lisovsky, & MacElroy, 2003, pp. 55, 232)

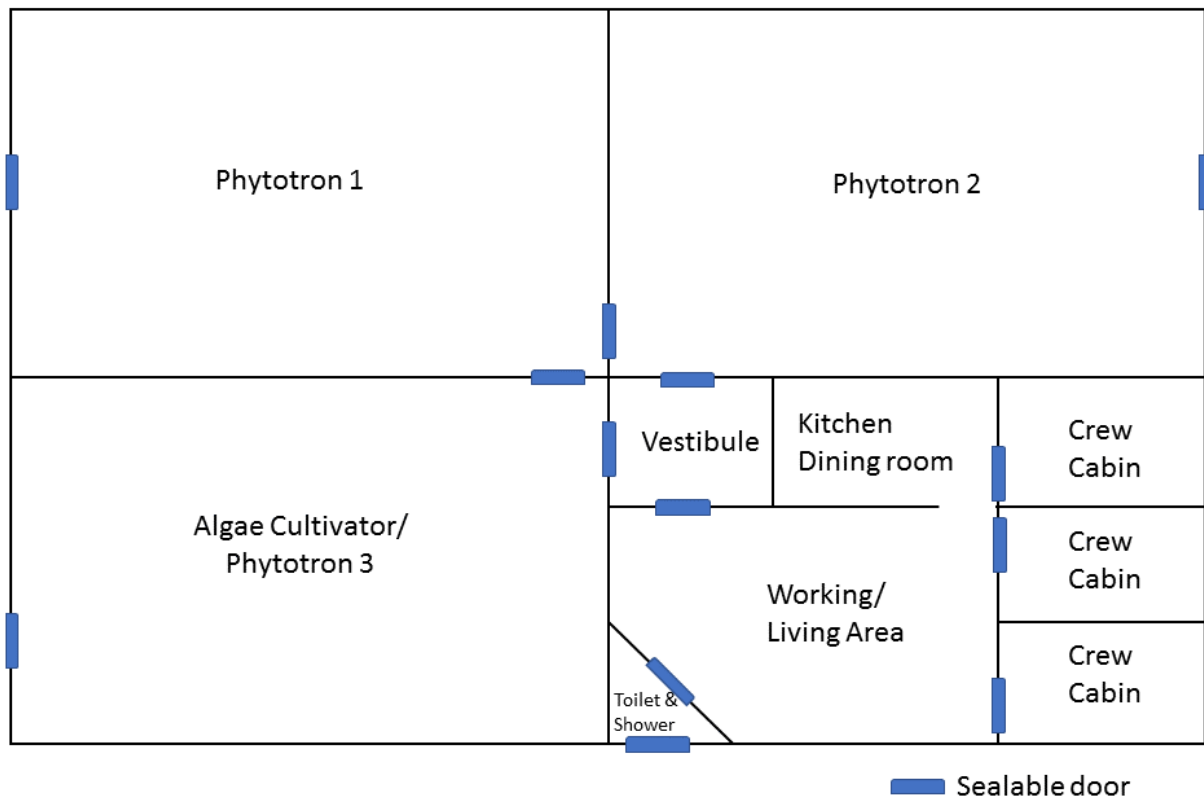

Figure 24 Bios 3 compartment layout (Gitelson, Lisovsky, & MacElroy, 2003, p. 236)

Other than the scale and volume difference, four major points differentiated Bios-3 from Bios-1 and 2 (Gitelson, Lisovsky, & MacElroy, 2003, p. 244):

1. Increase in crew capacity from 1 to 2-3.
2. System automation and autonomy, many systems were now automated requiring only governance and occasional service by the crew.
3. Internal food production increased overall system closure.
4. First experiments that examined microflora and their role in system stability.

The increase from a single crew member to multiples introduced the new concept of microflora dynamics and the exchange of microflora between humans. The introduction of multiple human subjects also introduced a possible new pathogen vector to the system. While this change also alleviated some of the physiological issues of loneliness, it also presented the problem of crew compatibility and task distribution. (Gitelson, Lisovsky, & MacElroy, 2003, p. 244)



Figure 25 Scale model of Bios 3, Phytotrons are in front, crew quarters are in the upper left (Institute of Biophysics, 2019)

Light for each Phytotron was accomplished using 20 cylindrical, vertical 6kW xenon lamps. Lamps were contained with a double walled glass jacket with cooling water circulated in-between to remove heat from the lights. In 1991, the number of lamps was doubled by placing two lamp elements in each water jacket. (Salsbury, Gitelson, & Lisovsky, 1997, p. 577)



Figure 26 Wheat crops in a Bios-3 Phytotron (Institute of Biophysics , 2016)

Atmospheric recycling was accomplished by circulating air between the Phytotrons and crew quarters. Partial purification was accomplished using the plants, and a secondary thermocatalytic filter (catalytic converter) was used to remove organic compounds. The thermocatalytic filter was used to remove organic compounds. It operated between 600-650 °C oxidizing organic molecules to carbon dioxide and water. Water was purified through both evaporation and transpiration through the plants. Water vapor was condensed and recirculated mainly through the nutrient solutions for the plants, but some were

diverted and boiled for the crew's use in cooking, cleaning, and hygiene. Drinking water was further treated with ion-exchange filters before adding electrolytes for taste as well as some trace minerals for health. (Salsbury, Gitelson, & Lisovsky, 1997, p. 578)

Bios-3 designers examined having livestock as part of the facility design, but with a nutritional production efficiency of as low as 10%, versus the ease of storage of pre-processed supplies, supply from the outside was the best option. No consideration or attempt was made to study a strictly vegetarian diet; all animal products were lyophilized (freeze-dried) meats that were reconstituted using water from inside the facility. Fresh vegetables and grains were left to the discretion of the crew based on what was on hand from the vegetable Phytotrons. While the crews were not able to predict yields with accuracy, there were challenged to consume as much as they could from what was produced. (Salsbury, Gitelson, & Lisovsky, 1997, pp. 580-581)

Human wastes were for the most part, not recycled inside the facility. Feces were dried and stored in the installation with the water vapor later reclaimed. Urine apart from the third closure was concentrated and removed. During the third closure, it was returned to the nutrient solutions for the wheat since the 'fruit' does not come in contact with the solution. (Salsbury, Gitelson, & Lisovsky, 1997, p. 581)

Early testing began in 1971 and continued through the end of 1972 which resulted in several incremental system improvements were made for reliability and safety. Length of test closures ranged from a few hours to weeks. The first full closure test began on December 24, 1972, with three test subjects for 180 days. This was followed by two more closure tests in 1977 and 1983/84, each with three crew members. (Gitelson, Lisovsky, & MacElroy, 2003, p. 245; Hooke, Donaldson, Teeter, Garshnek, & Rowe, 1988, p. 47) Closure tests were purposely scheduled to begin in the winter months to minimize the chance of pathogen contamination. (Salsbury, Gitelson, & Lisovsky, 1997, p. 578)

With a total experiment time, of just over a year, no experiment was terminated early no serious difficulties with respect to psychological issues were reported. Significant changes were observed in the microflora, mucous membranes, and intestines of the crew members, but had not pathological consequences. (Salsbury, Gitelson, & Lisovsky, 1997, p. 578) Although the second closure saw one subject depart early, none of the experiments were terminated early due to an unwillingness to continue on the part of the test subjects. (Gitelson, Lisovsky, & MacElroy, 2003, p. 246; Gitelson & Okladnikov, 1997; Salsbury, Gitelson, & Lisovsky, 1997, p. 578) Unlike other human closure experiments, all of the Bios-3 crews held their weights within ± 830 g. (Salsbury, Gitelson, & Lisovsky, 1997, p. 572)

First Closure

From the winter of 1972 – 1973, the first full closure test was conducted with two male and one female and lasted for six months. (Salsbury, Gitelson, & Lisovsky, 1997) This test consisted of three phases in with the primary goal to test atmospheric and wastewater cycling with higher plants and microalgal systems. The gray water processing was only included in the nutrient flow for the grains. The higher plants were used to support the fresh portion of the crew's nutritional needs. The crew's diet was supplemented with food stores of animal protein and processed foods. Solid waste was removed from

the facility after the water was recovered. The first phase consisted of only grain and vegetables in the loop. The second phase removed one of the higher plant phytotrons and added microalgal cultivars containing *Chlorella*. This phase shifted the primary responsibility for atmospheric processing to the cultivars, gray water continued to be processed by the phytotron in the wheat nutrient solution. The third phase removed the grain component leaving only the vegetables in the remaining phytotron. The edible plant mass provided approximately 1/5th of the caloric requirements for the crew (Gitelson, Lisovsky, & MacElroy, 2003, pp. 247-248; Salsbury, Gitelson, & Lisovsky, 1997, p. 578)

During phase 2, the increase of the gray water concentration into the nutrient flow for the grains in the remaining phytotron was problematic and eventually lead to the destruction of the crops. The design of the experiment did not allow for the determination that the increased gray water was the sole reason for the failure of the wheat in the phytotron. (Gitelson, Lisovsky, & MacElroy, 2003, pp. 247-248; Salsbury, Gitelson, & Lisovsky, 1997, p. 578)

During Phase 3, a vegetable only phytotron containing beet, potato, tomato, carrot, dill, turnip, kale, radish, cucumber, onion, and sorrel crops was connected after the system had been processing the atmosphere only through the *Chlorella* cultivars for 65 days. Although no reports of human issues occurred during the 65-day period, the vegetables showed signs of distress within 2-3 days including increased toxicity and in the case of the cucumbers yellowing leaves and no flowers. Once the phytotron was disconnected and vented to the outside, many plants lost all signs of toxicity after 2-4 days, and the cucumber started to flower after 5-8 days. Repeated tests of re-joining confirmed that the re-generated atmosphere was toxic to the vegetables. While the particular toxin was not definitively identified; subsequent testing was able to duplicate the results with low ethylene concentrations. (Gitelson, Lisovsky, & MacElroy, 2003, pp. 249-251)

Second Closure

The second closure was conducted beginning in the winter of 1976 and lasted for four months into 1977 with three male crew members. One of the crew members did part early for reasons outside the experiment. The overall goal of this experiment was to test the ability of the facility to supply food for the crew. (Lisovsky G. , 1979; Salsbury, Gitelson, & Lisovsky, 1997, p. 578)

The second closure saw the biggest imbalance of chemicals in the facility environment. Some metals (Ni, Al, Cr, and Pb) were 10-20 times higher in the plants and nutrient solutions at the end as compared with the base values at the start of the experiment. Others (Sn, Ti and Zn) had increases of two to four times. The root source for these was determined to be construction materials from solder, drain netting, and untreated steel. Other contributors where a porous water filter and the catalysts in the thermocatalytic converter. These did not reach toxic levels and did not seem to affect plant growth. (Salsbury, Gitelson, & Lisovsky, 1997, p. 582)

Third Closure

The third closure was conducted between 1983 and 1984 for four months with two male crew members. The goal was again to examine food production during closure and to test remediation of the removal of sources from the previous chemical imbalance. The closure was completed successfully and

the crops grown were continued to be observed for an additional two months without any attempt to control the closure during this additional time. The chemical imbalance seen during the second closure was not repeated. (Salsbury, Gitelson, & Lisovsky, 1997, p. 578)

Gas concentrations in Bios-3 remained much more stable than in other closure experiments. Bios-3 research concluded that this suggested a close metabolic balance between the crew and crops. Concentrations were variable with the activity and productivity of the crops in the Phytotrons. Incineration of inedible biomass had the anticipated effect of increases in CO² with a minor drop in Oxygen. (Salsbury, Gitelson, & Lisovsky, 1997, p. 581; Gitelson, Lisovsky, & MacElroy, 2003)

An additional deadlock in the Bios-3 facility was the ash from the thermocatalytic converter when inedible biomass was incinerated. No attempt was made to return these elements to the nutrient solutions (Salsbury, Gitelson, & Lisovsky, 1997, p. 582) which would have involved grinding the residue to the molecular level or engaging in a bio/chemical process with organisms that were not considered for inclusion into the facility. (Rygalov Y. , 2015)

Current Status

Currently, the Bios-3 facility is under the management of the Institute of BioPhysics in association with the Russian Academy of Sciences, Siberian Branch as the 'International Center for Enclosed Environmental Systems' (Institute of Biophysics, 2019). It's most recent large scale project was BIOSMHARS, a two-year project from 2011-2013 in partnership with the European Union to examine issues related to bio-contamination inside manned spacecraft (MEDES- Institut de Médecine et de Physiologie Spatiales, 2013).

Efforts in Europe

MELISSA

The Micro-Ecological Life Support System Alternative (MELISSA) is the European Space Agency's (ESA) CELSS project with a goal of closing the material cycle to regenerate food while recycling human wastes (Gitelson, Lisovsky, & MacElroy, 2003, p. 56) for long-term space missions to lunar bases or flights to Mars. (the Melissa Foundation, 2017) Started in 1989, and originally conceived as an aquatic system, it has added components to more directly address to fulfill anticipated crew nutritional needs (Poughon, Farges, Dussap, Godia, & Lasseur, 2009). One of the driving factors in creating MELISSA was that the efficacy of mineralization of feces suggested that both anaerobic methods and aerobic methods under consideration early in LSS studies were not sufficient enough (Posadskaya, 1976) or were too slow for use in LSS. (Gitelson, Lisovsky, & MacElroy, 2003; Gitelson, et al., 1976) This attempt to address what on the surface seems to be an easily isolatable problem underscores the complexity and interdependence of the CELSS problem.

Over its almost 30-year history, the project has evolved into a mechanical engineering approach to CELSS. When the crew compartment is included, the system consists of five different compartments, all of which can have varying degrees of interconnectivity and closure. The MELISSA Project is currently managed by the European Space Agency (ESA) European Space Research and Technology Center (ESTEC) Thermal and Environmental Control Section (TEC-MCT). (European Space Agency, 2015; the Melissa

Foundation, 2017) Experimentation, development and research objectives are set by the MELISSA consortium, a partnership of over 40 different organizations from 13 different countries. (European Space Agency, 2015)

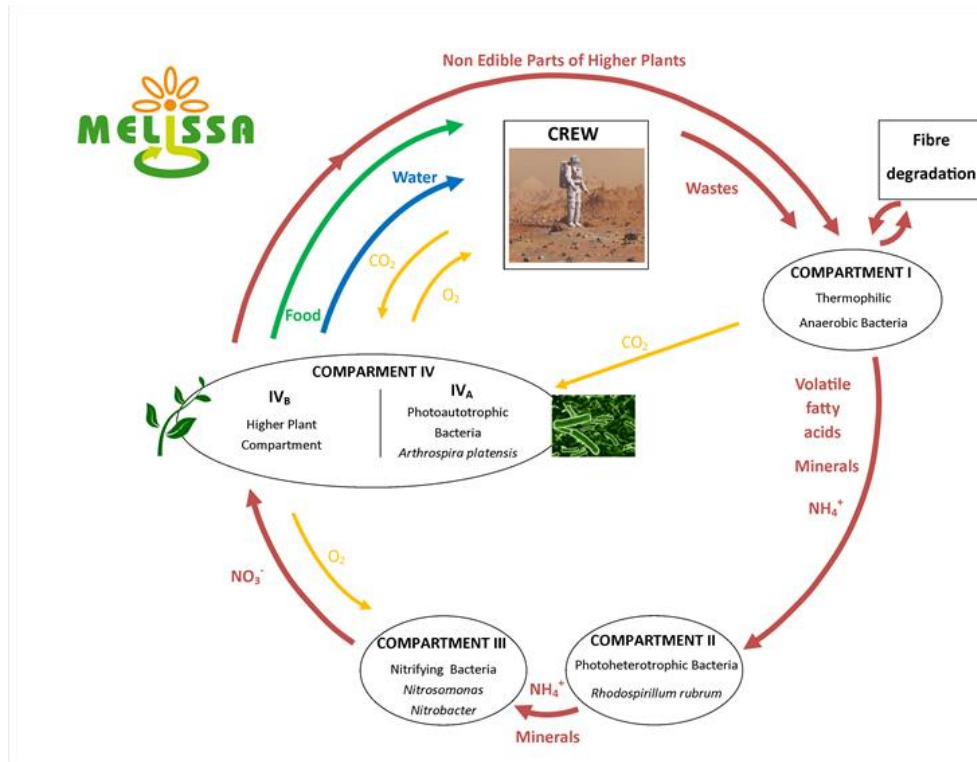

Figure 27 MELISSA Gas and Mass Block exchange model (the Melissa Foundation, 2017)

MELISSA is made up of five compartments; the liquefying compartment(I) , the photoheterotrophic anoxygenic compartment (II), the nitrifying compartment(III), the photoautotrophic compartment (IV), and the crew compartment(s). In a process that is similar to the process that occurs in a freshwater lake, wastes are collected in the first compartment and cycled through each compartment to the final compartment where the materials are used to generate food and oxygen for the crew. (European Space Agency, 2015)

In the liquefying compartment, solid wastes from the crew compartment and inedible biomass from compartment IV is collected and degraded by anaerobic fermentation by thermophilic anaerobic bacteria into a form that can be processed by the second compartment. This includes both intra- and extracellular protein degradation by enzymes (CO₂ produced by this breakdown process is fed directly to compartment IV for use by both higher plants and blue-green algae to produce oxygen (O₂)).

The fatty acids, minerals, and ammonia (NH₄) are moved to the second compartment where carbon compounds are removed by photoheterotrophic bacteria, Rhodospirillum rubrum. Originally conceived a two-stage process with separate compartments due to expected high hydrogen (H₂) production in the first stage. This was simplified when Rhodospirillum rubrum was found to metabolize well in the

presence of one or several carbon sources, and the light transfer model was improved. (European Space Agency, 2015)

In the nitrifying compartment (compartment III), the minerals and ammonium (NH_4^+) from compartment II are combined with liquid waste from the crew compartment and Oxygen (O_2). Here, the oxidation of ammonium (NH_4^+) to nitrite/nitrogen dioxide (NO_2^-) and nitrates (NO_3^-) is accomplished using a mix Nitrosomonas and Nitrobacter using a fixed bed reactor. A pilot reactor has been built and has been running since 2014 to define the physical characterizes of the reactors and to establish the proper kinetics and stoichiometries to ensure the optimal configuration is understood. (European Space Agency, 2015)

The fourth compartment, the photoautotrophic compartment, is subdivided into two sub-compartments; (IVa) that contain algae for gas exchange and diet supplementation and (IVb) a higher plant compartment for food, gas exchange, and potable water production.

The algae compartment (IVa) contains cyanobacteria, *Arthrospira platensis*, which has been used throughout human history as a dietary supplement due to its high protein content. This compartment takes in Minerals and Nitrates (NO_3^-) from the Nitrifying Compartment, and Carbon Dioxide (CO_2) from the Liquifying Compartment and Crew Compartments and using photosynthesis produces Oxygen (O_2) that is cycled back to the Nitrifying Compartment and Crew Compartments.

The Higher Plant Compartment (HPC IVb) contains human food production crops and takes in Minerals and Nitrates (NO_3^-) from the Nitrifying Compartment (III) and Carbon Dioxide (CO_2) from the Liquifying Compartment (I) and Crew Compartments (V) and using photosynthesis produces Oxygen (O_2) that is cycled back to the Nitrifying Compartment (III) and Crew Compartments (V). Potable water through condensed vapor and food are also provided to the Crew Compartment (V) while the non-edible biomass is sent for breakdown in the Liquifying Compartment (I). Currently, eight crops are under study for use the HPC and include wheat, tomato, potato, soybean, rice, spinach, onion, and lettuce. Due to the interdependence of metabolic pathways and reactions, environmental parameters needed to be investigated for each of the eight crops, ongoing research is being conducted. (European Space Agency, 2015)

Currently, full closed-loop test with animals is planned to use the MELISSA Pilot Plant in Barcelona, Spain in the early 2020s and humans around 2025. (European Space Agency, 2013) Gray water recycling is currently operating at scale for over a decade at the French-Italian Antarctic outpost, Concordia base. (European Space Agency, 2015; European Space Agency, 2013) Partial closure experiments using rodents were carried out in 2016 (Zhang, 2016) and are planned for on orbit with the ISS in 2017. (European Space Agency, 2013; Zhang, 2016)

Closed Equilibrated Biological Aquatic System (C.E.B.A.S.)

The Closed Equilibrated Biological Aquatic System (C.E.B.A.S.) is a Ruhr-University of Bochum (RUB) partnership with the German Aerospace Center – Deutsche Zenitrum für Luft-und Raumfahrt (DLR) and combined the DLR AQUATRAC with CEBAS to create a three-component system that combines a microalgal bioreactor, a higher plant module and a higher animal module into a closed system that is

stabilized and equilibrated by a process control system. (Eckart, 1994; Ijiri, 2003, p. 206; Blüm V. , 2001; Blum, Andriske, Ludwig, Paaßen, & Voeste, 2003). Together with plants, pond snails (*Biopolaria glabrata*) and both juvenile and adult swordtail fish (*Xiphophorus helleri*) both ground and space experiments were conducted aboard STS-89, aboard *Neuroloab* as part of the STS-90 mission, and on the ill-fated STS-107 mission.

C.E.B.A.S. was an attempt to solve the inedible biomass issue that will need to be solved for Biological Life Support Systems to become a reality. BIOS-3 solved this by using a smokeless combustion process that produces additional CO₂ and mineral ash. Biosphere 2 solved this by feeding these stocks to herbivorous animals which were then used as additional protein for the crew in the form of milk and meat. Management issues for herbivores in a space environment and issues with resource locking of mineral ash make these solutions probably untenable, (Blüm V. , 2001) hence the C.E.B.A.S. approach.

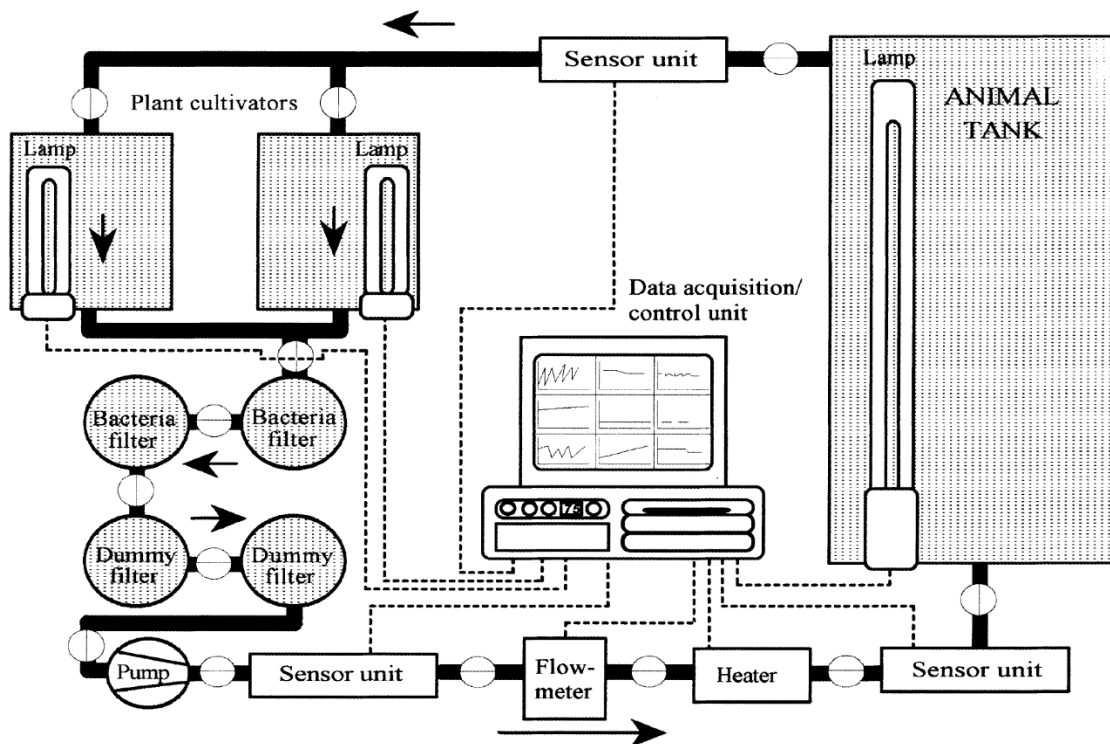

Figure 28 C.E.B.A.S Subsystem flow diagram (Blum, Hollander-Czytko, & Voeste, 1997)

C.E.B.A.S. consisted of an animal tank, two higher plant cultivars, two bacterial filters, and several sensor systems and environmental control units. The animals consume food provided and take up Oxygen (O₂) dissolved in the water. Here they produce carbon dioxide (CO₂) and Amomum (NH₄⁺) components which flow along with nitrites (NO₂⁻) into the plant cultivars containing hornwort (*Ceratophyllum demersum*). The plants utilize light and photosynthesize the Carbon Dioxide (CO₂), Nitrites(NO₂⁻), Nitrates (NO₃⁻) and Water (H₂O) into Oxygen (O₂) and Carbohydrates (CH₂O) in the form of cellulose. The level of Oxygen (O₂) produced is regulated by turning on and off the lights in the chambers. The Oxygenated water is passed along with the unused ammonium products (NH₄⁺) into the bacterial filters where a mixture of

laboratory strains of ammonium-oxidizing bacteria species, cultivated on lava granules was used to oxidize the ammonium (NH_4^+) to nitrite/nitrogen dioxide (NO_2^-) and nitrates (NO_3^-). The refreshed water is then passed back to the animal tank through sensors and environmental controls. (Blum V. , 2003; Blum, Andriske, Ludwig, Paaßen, & Voeste, 2003; Blum, Hollander-Czytko, & Voeste, 1997; Blüm V. , et al., 1998; Blüm V. , 2001)

These sensors and environmental controls recorded pH, temperature, redox potential, conductivity, and oxygen concentration. Environmental regulatory controls were a temperature approximately 25 °C and a range of oxygen concentrations between 4.5 and 6.5 mg. The amount of oxygen dissolved in the water is directly correlated to the light provided and plant mass in the higher plant compartment, the number of animals in the system. Measurements for ammonium (NH_4^+), ammonia (NH_3), nitrite/nitrogen dioxide (NO_2^-) and nitrates (NO_3^-), phosphates (PO_4), sulfates (SO_4), and chlorine (Cl) were made at the beginning and end of short term experiments and at intervals during long-term tests. (Blum, Hollander-Czytko, & Voeste, 1997)

the C.E.B.A.S. was developed in two different versions: one with a total volume of approximately 150 liters and the CEBAS-MINI MODULE which initially had only 10 liters of total volume. The mini-module was used to plan for the construction of the space flight hardware with 8.6 liters total volume incorporated into a space-shuttle mid-deck locker. (Blum, Hollander-Czytko, & Voeste, 1997; Blum V. , 2003)

This proved the concept of using a biological filter to convert ammonium (NH_4^+) to nitrite/nitrogen dioxide (NO_2^-) to nitrates (NO_3^-) under zero gravity conditions. (Blum, Andriske, Ludwig, Paaßen, & Voeste, 2003; Blüm V. , et al., 1998; Blüm V. , 2001; Blüm V. , Andriske, Kreuzberg, & Schreibman, 1995; Ijiri, 2003, p. 206; Eckart, 1994, p. 347; Blum V. , 2003)The flight article of CEBAS was lost aboard STS-107 when the vehicle broke up upon re-entry. (Columbia Disaster, 2003)

Efforts by Japan

The Closed Ecology Experiment Facilities (CEEF) in Japan was constructed between 1994 and 1999. It consists of three separate facilities; a plant installation – Closed Plant Experimentation Facility (CPEF), an animal facility – Closed Animal and Human habitation Experiment Facility (CAHEF), and a geo/hydrosphere facility – Closed Geo-Hydrosphere Experiment Facility (CGHEF). Each of these establishments has a support structure with controls and material handling internal to each facility. However, each can be connected to the other facilities to examine direct interactions between systems and interdependencies. In addition to studying BLSS concepts, the stated goals of the facility are to research issues relating to the evolution of chemical and radioactive contaminants, global change and to further solutions for a zero-emission society. (Gitelson, Lisovsky, & MacElroy, 2003, p. 58; Tako, et al., 2010; Rygalov & Holmer, 2014)

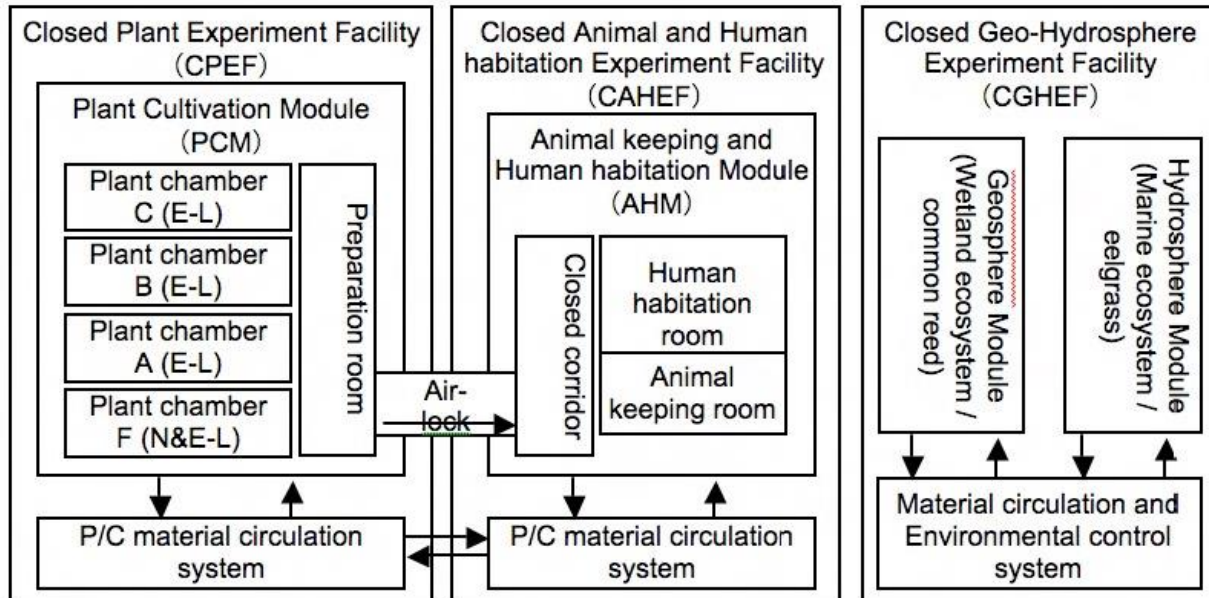

Figure 29 Configuration of the Closed Ecology Experiment Facilities. Arrows denote material flows. E-L and E&N-L denote Electric lighting, and Electric and natural lighting, respectively. (Tako, et al., 2010, p. 16)

Closed habitations were conducted in 2005 and continued through 2007 lasting from one to four weeks. Material circulation was demonstrated by connecting the plant facility (CPEF) with the animal facility (CAHEF). Two crew members stayed in the human habitat and two goats in the animal habitat. Atmospheric regeneration was accomplished by air circulation between the CAHEF and CPEF in all closure experiments. 82-95% of the food for the crew and 100% of the animal feed was produced by the 23 crops in the CPEF. Water exchange was added in the 2006 and in 2007 waste circulation was added to the material circulation. (Tako, et al., 2010)

Efforts by China

Lunar PALACE 1

In 2014, China unveiled its Integrative Experimental Facility for Permanent Astrobase Life-Support Artificial Closed Ecosystem Research, (in short, "Lunar PALACE 1") in Beijing. This facility is the newest in long-duration life support for space and one of the most advanced (Lok-ye & Fei, 2014; David, 2014). The system volume is approximately 300 m³ (similar to Russian BIOS-3 system). The facility has the capacity for up to four crew members and has the capability to grow food, recycle waste (both solid and liquid) and raise insect protein. (Liu & et al., 2014; Lok-ye & Fei, 2014)

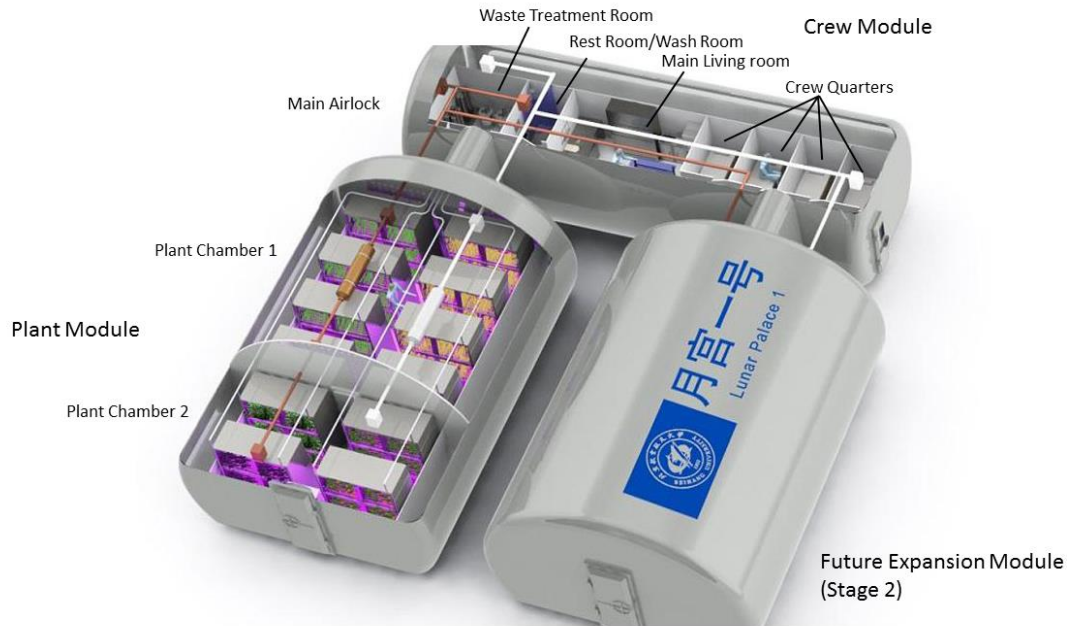

Figure 30 Lunar PALACE 1 layout (Credit: CMSE) (China Daily, 2017)

First Closure occurred during February – May 2014 for 105 days. (Liu & et al., 2014; Lok-ye & Fei, 2014) Three crew members grew twenty crops including five grains and 15 varieties of vegetables and one type of fruit. The crews main source of protein was from yellow mealworms which were raised inside the habitat. Overall 55 percent of the food was generated within the facility during the closure.



Figure 31 Views of Lunar PALACE 1 (Lok-ye & Fei, 2014)

Current Status

The second closure started in May of 2017 and is scheduled to be one year in length that spans two crews of four that will consist of graduate students from Beijing University. (China Daily, 2017)

Definitions and Terminology

The emerging science of biospheres and the fluidity of the field of life support systems science and research has led to some confusion with terms and definitions of types of systems. The following are the terms and explanations of these systems in the context of this work.

Stability

Stability as defined refers to the 'quality, state or degree of being stable; as the strength to stand or endure, the property of a body that causes it when disturbed from a condition of equilibrium or steady motion to develop forces or moments that restore the original condition, or resistance to a chemical change or to physical disintegration' (Merriam-Webster, 2020). It is that quality of 'disturbance from equilibrium' that will be focused on for this research.

In general, the concept of stability has both simple as well as complex views when applied to both biospheric and life support systems. On the simple end, stability is a balance between each of the components and their environment. Each of these components takes one or more output products from other processes and uses these outputs for their own support and internal processes. The cycling operates with relative efficiency in an endless loop. At the more complex end of the spectrum are a web of interconnected dependencies. The failure of any one of which can cause a cascading effect that can collapse the entire system or end in a deadlock for materials that will require that one or more of the inputs be replenished from the outside. The critical understanding of the behavior of these elements that allow for the predictable reliability. The reliability of the system can extend over long periods of time from months to years and even decades. (MacElroy, Tremor, Smernoff, Knott, & Prince, 1987)

When the concept of stability is applied to a working system, the concept implies that the system will function, as long as the overall system is maintained. This functionality is predicated on the conditions that power is supplied in a predictable and sustainable manner, all mechanical systems must operate continuously, and that sufficient materials are on hand for all required physicochemical reactions. (MacElroy, Tremor, Smernoff, Knott, & Prince, 1987) Redundancy must be introduced to allow for the graceful failure and possible repair of one or more parts of the system while the overall system continues to run and achieve its macro objectives while the micro portions operate in a degraded state.

Two large experiments are good examples of the use of both micro and macro elements to form stability. Bios 3 achieved short-term stability for periods under a year (Gitelson, Lisovsky, & MacElroy, 2003). While Biosphere 2 had hoped to achieve equilibrium in 18 months (Allen J. P., 1989), achieving this end state took considerably longer. "Examination of the ecosystem within Biosphere 2, after 26 months of self-organization...[showed] features of self-organization...the self-organizing system appeared to be reinforcing the species that collect more energy (maximum power principle)...species diversity of plants was approaching normal biodiversity...the observed successional trend of carbon dioxide absorption by carbonates and high net production of "weed species vegetation") if allowed to continue, was in a direction that would eventually generate enough gross production to match

respiration of the soil, which was gradually declining. Thus the self-organizational development of a human life support was successfully underway...the smaller, faster Biosphere 2 is a good model for studying the biogeochemical dynamics of our earth.” (Odum, 1996; Allan, Nelson, & Alling, 2003)

The concept of stability for this work includes all constituents within a system to include physical, biological, chemical, and mechanical as well as active and passive elements. Taking these factors into consideration in the section ‘Correlation between Closure Degree, Tropic Network Complexity, and Stability Level’ (page 58), a new mathematical definition of stability is put forth that relates system stability to the systems complexity, overall closure capability (closure index) and length of operation.

Efficiency

Efficiency is defined as ‘the quality or degree of being efficient’ (Merriam-Webster, 2020) with ‘efficient’ being defined as ‘productive of desired effects, capable of producing desired results with little or no waste (as of time or materials.’ (Merriam-Webster, 2020). Efficiency for Life Support Systems and Closed Ecological Life Support Systems is typically expressed as a minimization of the power, mass, and volume required for the growth of organisms that will produce full life support capabilities within the constraints of a mission. (MacElroy, Tremor, Smernoff, Knott, & Prince, 1987; Porterfield, 2015)

Biosphere

Depending on one’s discipline or background, the word ‘biosphere’ can have different meanings and connotations. In this work the term ‘biosphere’ refers to “the part of the earth's crust, waters, and atmosphere that supports life.” or “the ecosystem comprising the entire earth and the living organisms that inhabit it.” (Dictionary.com, 2016).

Originally coined by the Austrian Geologist Eduard Suess in a discussion of the various envelopes of the earth in the final chapter of a book on the genesis of the Alps in 1875, ‘Die Entstehung der Alpen’ or ‘The emergence of the Alps.’ He only used the term once and did not expound on it. (Hutchinson, 1970; Vernadsky, 1998, p. 91) It was not until 1926 when Vladimir Vernadsky developed the modern concept of the biosphere as a full concept. His concepts were first published in Russian in 1926, in French in 1929, and then in English in 1977. (Hutchinson, 1970; Vernadsky, 1998, p. 33) These form the foundations of most of the theory and conceptual thinking around the term ‘Biosphere’. In his book ‘Biosfera’ [The Biosphere] , Vernadsky expanded on Suess’s envelopes/geospheres describing the biosphere as forming ‘the envelope or upper geosphere of one of these great concentric regions – the crust” (Vernadsky, 1998, p. 91) Despite his early work and international publication, most in the west were not familiar with these concepts until the 1970 special issue of Scientific American on the topic. (Hutchinson, 1970)

Biocenosis

The living community, its properties, and the number of species of a particular area. Including the chemical and physical characteristics of the medium as well as all the organisms, both plant, and animal, that inhabit the defined area. (Leveque, 2003, p. 23)

Materially Closed Ecosphere

These are systems that are closed or nearly closed so that no accumulation of deadlock products or a change in the population counts that constituted the biocenosis. (Kovrov, 1992; Gitelson, Lisovsky, & MacElroy, 2003) These are open to energetic input in the form of light and heat, as well as information exchange in the form of sensors and observation (Nelson M. , Bioregenerative Life Support for Space Habitation and Extended Planetary Missions, 1997). These are referred to as 'micro CES' and are typically desktop to laboratory sized environments that can maintain mixed populations that include microbial interaction. While they can include higher forms of aquatic or animal life, they are not suitable or intended to include human life. They are used as models for fundamental closure observations and explanation. (Lisovsky & Rygalov, 1992; Gitelson, Lisovsky, & MacElroy, 2003, p. 536; Rygalov & Holmer, 2014) Commercially available 'EcoSpheres' from Echosphere Associates Inc. are the best example of a small scale materially closed system. These sealed desktop level containers have 'active micro-organisms, small shrimp, algae, and bacteria, each existing in filtered sea water' (Echosphere Associates Inc., 2016) and can maintain stability for over a period of years.

A Life Support System is a system that can ensure the biological autonomy of man when isolated from his original biosphere and provide a physiologically acceptable environment for the crew that includes (Eckart, 1994, p. 79; Tamponnet, Binot, Lasseur, & Savage, 1991):

- Atmospheric Management
- Water Management
- Waste Management
- Food production and storage
- Environmental Controls

There are two classifications of life support systems: regenerative or non-regenerative. Non-regenerative systems refer to those that do not try to recycle or recover any materials. Regenerative systems involve trying to reclaim resources such as water, oxygen, and food that may potentially be reused. (Eckart, 1994, p. 80)

Closed-loop and Bio-Regenerative Systems

A closed-loop life support system would be entirely self-sufficient materially and would require no external support or re-supply. In this type of system, all materials would be recycled either through physio-chemical and or biological processes.

These types of systems have been referred to by a variety of monikers:

- Sealed (Gitelson, Lisovsky, & MacElroy, 2003, p. 22; Myers, 1954; Oswald, 1965; Nelson & Soffen, 1990)
- Closed (Grinevald, 1998, p. 29)
- Closed-looped (Eckart, 1994, p. 80)
- Autonomous (Vernadsky, 1998, pp. 85, 97, 98, 104)
- Systems of material cycling (Rygalov V. Y., 1996)

While the phrase “eco-systems with a closed material cycle” seems to be the most accurate in its description (Gitelson, Lisovsky, & MacElroy, 2003, p. 22), the term ‘closed loop’ and ‘Bio-regenerative’ are used interchangeably in this work to refer to these types of systems. Hybrid systems include both physiochemical and biological processes. (Eckart, 1994, p. 81; Nelson M. , 1997)

Currently, the International Space Station (ISS) operates for periods as a Closed-loop system, using many different physio-chemical processes to regenerate materials. However, the ISS does receive materials from outside during re-supply to make up for materials lost to deadlock and leakage.

Controlled Ecological Life Support Systems and Closed Ecological Life Support Systems (CELSS)/Biological Life Support System (BLSS)

Controlled or Closed Ecological Life Support Systems (CELSS) and Closed Loop Ecological System (CLES) are those systems in which at least a portion of the elements cycled through the system are converted using biological regenerative methods and technologies. In addition to a portion of the necessary materials drawn from existing stores or using physiochemical methods for recycling, the remaining will use biological methods for converting and recycling the needed items for atmospheric concentrations, nutrient delivery, and waste management. (Nelson M. , 1997) These focus on very targeted reactions and processes to create an efficient system focused on just those items needed for life support of the target organisms. The Bios-3 in Russia and LMLSTP in the US are perhaps the best examples of Human scale CELSS experiments in which much of the atmospheric and a good portion of the nutrition were produced in the environment. (Gitelson, Lisovsky, & MacElroy, 2003; Gitelson, et al., 1989; Eckart, 1994)

A Biological Life Support System (BLSS) are those systems where biological processes are leveraged to provide some life support to a crew or group of constituents but are not focused on closure. BLSS is sometimes used interchangeably with CELSS. BLSS will have material loops that are not entirely closed and will have a significant deadlock of material and require immense reserves of materials to assist with those parts of the cycle that are not satisfied with either the waste materials produced or the results of the processes within the system.

Biospheric Systems

Biospheric Systems, unlike CELSS, are those systems that attempt to re-create a broad range of interdependent ecological systems. While the end goal may be the same as CELSS, to keep a target population alive, Biospheric Systems aim to keep multiple communities alive and thriving. Biosphere 2 is an example in which several different internal ecosystems were recreated. (Nelson M. , 1997) Each of the Earth’s different biomes was recreated, including rainforest, ocean, wetlands, grassland, and desert in addition to the human habitation area. (Alling & Nelson, 1993; Nelson M. , 1997)

In 1989 participants at the second International closed system workshop in Krasnoyarsk, Russia issued a resolution recommending that the name “biosphereics” should be used to title the scientific discipline, that studies this system of systems and includes:

- The study of, creation, and management of closed ecological systems including CELSS-type systems
- Systems that are closed objects and have one ecosystem (an “eco-sphere”)

- Biospheric closed objects that have two or more ecosystems with ecotone interaction, both small human-made (such as Biosphere 2 or Bios3) and large natural biospheres such as the Earth as a whole. (Allen J. P., 1989)

Phytotron

A term coined in Jest in the late 1940s by James Bonner and Samuel Wildman in the 1940s to show that botanists could create something as imposing as a cyclotron being constructed at UC Berkley at that time. (Salsbury, Gitelson, & Lisovsky, 1997, p. 577) This term found permanence in the Russian CELSS community and is used to reference an enclosed space used for growing plants without outside material exchange except energy using artificial light sources. (Gitelson, Lisovsky, & MacElroy, 2003; Gitelson, et al., 1976; Gitelson, et al., 1989; Gitelson & Okladnikov, 1997; Salsbury, Gitelson, & Lisovsky, 1997)

Modeling and Simulation of Advanced Life Support Systems

Hypothesis

Stability overall is correlated with scale, depth, and efficiency of material processing. Stability can be linked through closure degree and tropic network complexity. A stability index can be calculated to allow for comparison of systems regardless of scale. Further, an overall general model can be built and serve as a model to calculate early warning signals for impending instability or determine that the system under observation is in a stable state.

Material and Methods

To adequately address the hypothesis, a three-phase approach was considered; Model Research, and Model Construction and Evaluation followed by Model Execution and Outcome analysis.

Phase I – Model Research

Examine and survey existing models and model research to build from existing research and determine viable approaches.

- 1) Theories and Models
 - a) Critical Transitions
 - b) Fast-Slow Systems
 - c) Tipping Point Theory
 - i) Slow down and symptoms
 - ii) Fold Catastrophe Model
 - iii) Skewness and Flickering
 - iv) Indicators in cyclic and chaotic systems
 - d) Bifurcation Theory
- 2) Methods
 - a) Fast-slow systems and critical transitions
 - b) Calculation of Early Warning Signals
 - c) Generalized Modeling

3) Automation and Tools

Phase II – Model Construction and Evaluation

This phase will primarily be focused on model construction, testing, and evaluation. To assist with testing and evaluation, detailed review of previous real world ECLSS experiments will be conducted to develop a validation data set to use for testing the models and findings. The overall goal for this phase is to develop a validation data set to use for testing the models and findings

Examine in detail, results from previous studies:

- BIOS3
- LMLSTP
- Biosphere-2
- CEEEF
- Closed Equilibrated Biological Aquatic System (C.E.B.A.S)
- MELISSA

Determine the availability of major data variables from each study and their applicability to models identified in Phase I.

Examine the viability of each of the studies as it relates to the ability to apply the models. Where applicable, run the models to validate that the outcomes match those outcomes observed from the studies.

Phase III – Outcome Analysis

This phase will develop and configure a simulation with needed outputs for system monitoring for stability and transitions. Use the data from this simulator to feed the models to examine system stability while varying the system composition and interventions. Specifically examine:

- Overall stability
- Detection of possible critical transition point (s)
- Detection of possible warning signals for impending stability
- Determine appropriate levels of buffers needed for countermeasures

A secondary objective of this phase is to attempt to determine what size/ratio is needed to create an environment that could be balanced or sustained by utilizing buffers to improve overall stability while decreasing complexity or size.

Model Research

Existing Mathematical Modeling

Energy exchange and in particular the human element in this exchange, have been studied intensively beginning in the 2nd half of the 19th century. This was made possible by developing physical, chemical, and psychological methods of observation and evidence. Many of the premises and tenants that were established during this period were confirmed and detailed during the mid-20th century, particularly in the 1950s and 60s when the development of underwater, aviation, and space medicines fields as those technologies progressed. Much of the work conducted in the later part of the 20th and early parts of the 21st century was heavily based on research, data, and documentation created during these formative times in human external exchange and support. (Gitelson, Lisovsky, & MacElroy, 2003, p. 63)

Search campaigns were conducted leveraging materials and resources found in the UND Chester Fritz Library stacks as well as the Gelman Library at The George Washington University. Research campaigns additionally used electronic services such as the NASA Technical Reports Server (NTRS) provided by the NASA Scientific and Technical Information (STI) Program, Google Scholar, and Elsevier information services. Campaigns focused on finding information related to any published mathematical models and/or model data on the interaction of species and reactions or cycles inside major CELSS programs, including:

- BIOS3
- LMLSTP
- Biosphere-2
- CEEEF
- Closed Equilibrated Biological Aquatic System (C.E.B.A.S)
- MELISSA

Research results were disappointing for the previous actual experiments.. As was found by Rummel and Volk in research surveys prior to 1987 (Rummel & Volk, 1987), the models uncovered by these contemporary experiments were often limited to either the scope of the original experiment or limited to a specific area of the design of the experiment. Published data between the projects was spotty and inconsistent, which resulted in data that could not be correlated and compared across projects in any meaningful or coherent way. Due to the disparity of data collected, none of the models found could be applied to the other experiments, to examine common material flows, examine stability or be used to compare results and outcomes.

John Rummel and Tyler Volk, in a set of papers published in 1987, defined an early mathematical and computer model which simulated a Biological Life Support System. This model used a modular design to break the BLSS into sections to allow for growth and changing concepts of BLSS where changes in one level or module do not necessitate changes in the rest of the model. The simulation was coded using the Pascal computer language on a VAX 11-785 computer system at Ames Research Center. (Rummel & Volk, 1987; Volk & Rummel, 1987).

In 1996 New Jersey NASA Specialized Center of Research and Training (NJ-NSCORT) for Bioregenerative Life Support Systems (BLSS) was established at Rutgers University, with participation from Stevens Institute of Technology (Ting, Chao, & Giacomelli, 1997). This group expanded on this computer model by converting it to the modern computer language of JAVA and further refined the design using object-oriented design increasing the abstractions, and system extensibility. This was initially called an integrated automation-culture-environment analysis cyber environment (ACEsys) (Ting, Chao, & Giacomelli, 1997). This allowed the creation of a top-level model of an Advanced Life Support System that could be easily adapted to multiple subsystems, scenarios, and use cases. With this model, the authors were able to model the proposed JSC BIOplex project and expand the simulation to include separate modules for each subsystem including crew support, biomass production, waste processing and resource recovery, food process and nutrition, and the interconnecting space. (Rodriguez, Kang, & Ting, 2003) In addition to successfully modeling the integration and control of each of these subsystems, additional development was conducted to successfully model malfunctions and stochastic processes. (Kortenkamp & Bell, 2003) This model became known as BIOSim and has been maintained to “create a portable simulation of a typical integrated advanced life support system in a typical mission scenario with malfunctions and perturbations.” (Traclabs Inc, 2017) The models in BIOSim were validated using data from JSC’s Lunar-Mars Life Support Test Project (LMLSTP) (Traclabs Inc, 2017) and has been used in trade studies for CELSS/Hybrid studies and for studies examining automated control of systems. (Jang, Rodriguez, Bell, & D. Kortenkamp, 2008) Currently, BIOSim is used in examining machine learning and mission analysis for advanced habitats. (Traclabs, 2018)

Other research results also revealed work on Closed Ecological Life Support Systems (CELSS) and Closed EcoSystem (CES) models for general conceptual mathematical approaches. These results were completed by Lisovsky, et al. (Liscovsky, Kovrov, Terskov, & Gitelson, 1969), Chernigovsky (Chernigovsky, 1975), MacElroy and Averner (MacElroy & Averner, 1978), Haken (Haken, 1978), Svirezhev & Logophet, 1978), Arverner (Averner, 1981), Stahr, Auslander Spear and Young (Stahr, Auslander, Spear, & Young, 1982), Babcock, Auslander, and Spear (Babcock, Auslander, & Spear, 1984), Rummel and Volk (Rummel & Volk, 1987), Rygalov (Rygalov V. Y., 1996; Holubnyak & Rygalov, 2009; Rygalov Y. , 2015; Rygalov & Holmer, 2014), Jones (Jones H. , 2008), and Nelson, et al. (Nelson, Pechurkin, Allen, Somova, & Gitelson, 2010). However, most of these works did not address the flow of materials through a BLSS or CELSS system.

Additional models were uncovered for mass balance and carbon flow within closed systems based both on theoretical as well as observations from actual closure experiments such as the KSC Biomass chamber in the USA and BIOS-3 in Russia. Work was examined from Garland (Garland, 1989), MacElroy and Averner (MacElroy & Averner, 1978), Volk and Rummell (Volk & Rummell, 1987), Tikhomirov, et al (Tikhomirov, et al., 2003; Tikhomirov, et al., 2007; Tikhomirov, et al., 2011), S.I. Bartsev, .V.V. Mezhevikin, and V.A. Okhonin (Bartsev, Mezhevikind, & Okhonin, 2003). The conclusion of these surveys was that while the mass balance and carbon flows were important factors in CELSS modeling, additional research was needed to include these models into an overall CELSS model.

Applicability of Stability Consideration to Bio-Regenerative Life Support Systems

Results of the analysis of the initial conceptual model approaches showed many similarities despite their varied approaches. A matrix comparing these works is shown in Table 3.

General Area Covered	Material Balance and Circulation	Mission Duration and level of Control	Human Control, Reaction time, and overall stability	General interaction of all materials in the system	Critical equilibrium points within the system	Specific Control responses and effects on the system
Theoretical Analysis and Modeling Work						
Space Ecosynthesis: An Approach to the Design of Closed Ecosystems for Use in Space (MacElroy & Averner, 1978)	✓	✓	✓	✓	✓	✓
An approach to the mathematical modelling of a controlled ecological life support system (Averner, 1981)	✓					
An approach to the preliminary evaluation of Closed Ecological Life Support System (CLESS) scenarios and control Strategies (Stahr, Auslander, Spear, & Young, 1982)	✓	✓				
Dynamic considerations for control of closed life support systems (Babcock, Auslander, & Spear, 1984)	✓	✓				
A modular BLSS simulation model (Rummel & Volk, 1987)	✓	✓				
A Simple, Mass Balance Model of Carbon Flow in A Controlled Ecological Life Support System (Garland, 1989)	✓	✓	✓	✓	✓	✓
Historical Overview of the Biosphere 2 Project (Allen J. P., 1989)	✓	✓	✓	✓	✓	✓
Systematic approach to life support system analyses and integration (Bartsev, Mezhevikind, & Okhonin, 2003)	✓	✓				
Manmade Closed Ecological Systems (Gitelson, Lisovsky, & MacElroy, 2003)	✓	✓	✓	✓	✓	

General Area Covered	Material Balance and Circulation	Mission Duration and level of Control	Human Control, Reaction time, and overall stability	General interaction of all materials in the system	Critical equilibrium points within the system	Specific Control responses and effects on the system
Theoretical Analysis and Modeling Work						
Mass exchange in an experimental new-generation life support system model based on biological regeneration of environment (Tikhomirov, et al., 2003)		✓	✓	✓		✓
Biological life support systems for a Mars mission planetary base: Problems and prospects (Tikhomirov, et al., 2007)		✓	✓	✓	✓	✓
Theoretical Analysis for Long-Term Space Life Support Reliability (Holubnyak & Rygalov, 2009)		✓	✓	✓	✓	
Closed Ecological Systems, Space Life Support and Biospherics (Nelson, Pechurkin, Allen, Somova, & Gitelson, 2010)				✓		
Assessment of the possibility of establishing material cycling in an experimental model of the bio-technical life support system with plant and human wastes included in mass exchange (Tikhomirov, et al., 2011)		✓				
Theoretical Analysis for Long-Term Space Life Support Reliability (Rygalov V. , 2016)		✓	✓	✓	✓	✓

Table 3 Matrix of Similarities between analysis papers

Model Examination and stability

The mathematical modeling work of Averner, Rummel, and Volk on algal growth and simulation (Averner, 1981; Rummel & Volk, 1987; Gitelson, Lisovsky, & MacElroy, 2003) and the simulation of closed-loop systems focusing on balance by Auslander and Spear with their students (Babcock, Auslander, & Spear, 1984; Stahr, Auslander, Spear, & Young, 1982) showed the importance and need for balance to overall system stability and examined in detail the cascading results of subsystem underperformance and outright failure on overall system effectiveness which in some cases could lead to overall system failure. Of particular note, for both works, is an examination and proof of a seemingly insignificant fault could, over time, cause total failure of the entire system (Averner, 1981; Babcock,

Auslander, & Spear, 1984; Rummel & Volk, 1987; Gitelson, Lisovsky, & MacElroy, 2003). This had been postulated in previous works but never proven out through mathematical means or addressed in previous experiments (MacElroy & Averner, 1978; Averner, 1981; Gitelson, Lisovsky, & MacElroy, 2003), ACEsys and its later incarnation BIOSim, were one of the first full simulations to take advantage of this work and integrate the ability to inject faults over time and observe the cumulative effects on the overall system. (Kortenkamp & Bell, 2003).

In addition to the examination of faults and their propagation, BIOSim also addressed how to compensate for these faults and avoid overall system failure using material reserves. On Earth, material flows through the biosphere are coordinated and are enabled by large natural material reservoirs. Without adequate sizing any closed system will be faced with acute issues in stability since its ability to buffer processes will be severely limited. (Rummel & Volk, 1987; Holubnyak & Rygalov, 2009) This has been demonstrated and observed in actual experiments such as BioSphere2 with carbon dioxide (Allen J. P., 1989), LMLSTP with ethylene and carbon monoxide (Gitelson, Lisovsky, & MacElroy, 2003, p. 46), and Bios3 with stability issues from incineration of biomass (Gitelson, Lisovsky, & MacElroy, 2003, p. 304).

System Modeling

To examine the role of buffers, their place in the models and the effect on the overall balance of the system, we must first examine a theoretically balanced system in which both producers and consumers are in balance. This was examined in detail by Holubanyak and Raglov in 2009 in the paper “Theoretical Analysis for Long-Term Space Life Support Reliability” published in the Proceedings of the 39th International Conference on Environmental Systems. The concepts presented there were further detailed by Rgaylov in an unpublished paper titled “Theoretical Analysis for Long-Term Space Life Support Reliability” in 2016 in which closed systems based on recirculation of essential elements between the producers and consumers in a simplified two-level closed food pyramid-network could be described by the model (Rygalov V. , 2016; Holubnyak & Rygalov, 2009):

Equation 1

$$\frac{dX}{dt} = \alpha SX - P$$

Equation 2

$$\frac{dS}{dt} = -\frac{Q}{V} \times \alpha SX + \frac{Q}{V} P$$

Where,

- X = primary producer of (plant) biomass in CES;
- S = limiting plant growth factor of CES environment (for example, carbon);
- α = specific plant growth rate coefficient;
- P = human-caused removal of plant biomass (food consumption, for example);
- Q = limiting factor (carbon, for example) containment in the plant biomass;
- V = system volume.

The multiplication of the first equation by (Q/V) and the following summation for both equations leads to:

Equation 3

$$\frac{Q}{V} \times \frac{dX}{dt} + \frac{dS}{dt} = 0$$

Where, $QX + VS = Const = M$ is the material conservation principle in a closed system, where, M is the total amount stored inside the system mass of limiting plant growth factor (carbon, available minerals, etc.). From this equation, we can express S through X and substitute into Equation 1 for biomass dynamics X. This results in the following form:

Equation 4

$$\frac{dX}{dt} = \alpha \left(\frac{M_0}{V} \right) X \times \left[1 - \frac{X}{(M_0/Q)} \right] - P$$

This is the primary producer biomass dynamic model in a perfectly closed system with complete material recirculation of resources for life support. Now we introduce destabilizing system factor in the form:

Equation 5

$$\frac{dX}{dt} = \alpha \left(\frac{M_0}{V} \right) X \times \left[1 - \frac{X}{(M_0/Q)} \right] - P + \varepsilon \Phi$$

New variables:

Φ = destabilizing system functioning factor, assuming the process similar to 'white noise' (Svirezhev & Logophet, The Stability of Biological Conglomerates, 1978);

ε = small parameter describing amplitude of destabilizing system factor Φ .

Adding the assumption that human subjects inside the system can counteract this process but will have a delay τ in time due to observation, confirmation, and reaction time periods. Thus, the effect of summation for destabilizing factor in Equation 5 and human-operator counteractions can be represented as:

Equation 6

$$\varepsilon \Phi - \varepsilon \Phi(\tau + t);$$

τ = operator response (to the system deviation) delay time.

Presenting human-operator counter activity $-\varepsilon \Phi(\tau + t)$ through Taylor series with an approximation for the first-degree terms gives us:

Equation 7

$$-\varepsilon\Phi - \frac{\varepsilon t d\phi}{dt}$$

Substituting this into Equation 5:

Equation 8

$$\frac{dX}{dt} = \alpha \left(\frac{M_0}{V} \right) X \times \left[1 - \frac{X}{(M_0/Q)} \right] - P - \frac{\varepsilon t d\phi}{dt}$$

In Equation 8, $d\Phi/dt = \Phi$, is used for 'white noise' (Svirezhev & Logophet, The Stability of Biological Conglomerates, 1978).

Equation 8 could be represented in the unitless form by normalizing biomass X by its potential maximum M/Q:

Equation 9

$$\frac{dX}{dt} = \alpha \left(\frac{M_0}{V} \right) X \times [1 - X] - \frac{P}{M_0/Q} - \frac{\varepsilon\Phi}{\frac{M_0}{Q}}$$

A phase diagram can be created from Equation 9. Figure 32 Biomass dynamics in CES shows this specifically for the visualization purposes, where the two steady-state solutions for X on horizontal axes (Rygalov V. , 2016):

- the smaller arc, in red, which is apparently not stable (any deviations from this steady-state lead to further even more deviations);
- and the larger arc, in blue, shows the stable one, this represents the amount of system plant biomass, that is required for a functional system and, which is always less than maximumly achievable (M/Q).

However, if the human load $\frac{P}{M_0/Q}$ increases or if the destabilizing factor $\frac{\varepsilon\Phi}{\frac{M_0}{Q}}$ increases in power, those two steady-states get closer and under certain value for P could merge and become unstable, which would indicate the system stability limit toward human recirculation load.

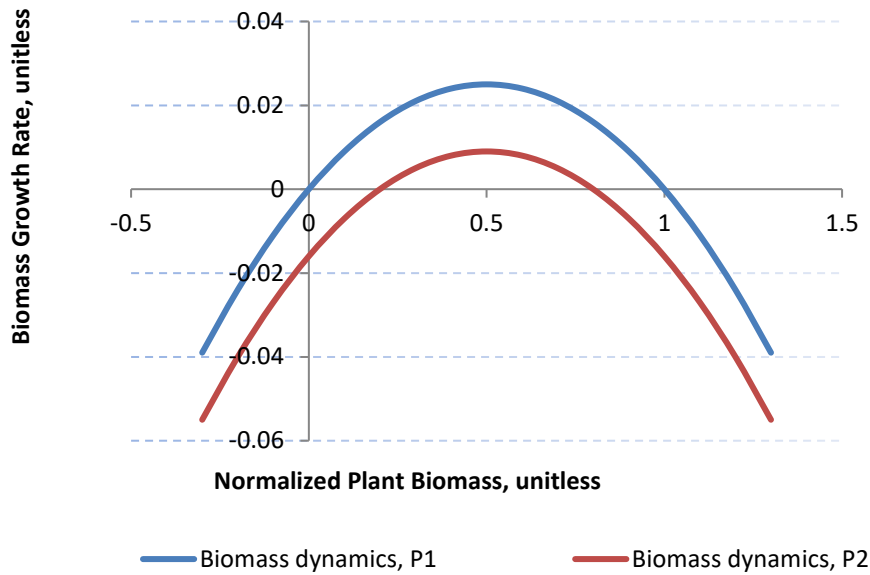

Figure 32 Biomass dynamics in CES (Rygalov V. , 2016)

Figure 32 describes the biomass dynamics in a CES: if human material recirculation load P ($P_2 > P_1$) or/and system instability is increasing, then the system becomes less stable. Finally, if $(P + \epsilon\Phi)$ exceeds the value $\frac{(\alpha/4)M^2}{V}$, then both equilibriums disappear, and the system fails. The maximal plant biomass growth rate always has to be at the $X = 0.5(M_0/Q)$ for this specific model consideration. (Rygalov V. , 2016)

Counteraction System Deviations from Nominal Functioning

Steady state solutions for Equation 9 is found from algebraic equation (Rygalov V. , 2016):

Equation 10

$$\alpha \left(\frac{M_0}{V} \right) X \times \left[1 - \frac{X}{(M_0/Q)} \right] - P - \epsilon\tau\Phi = 0$$

The formal expression for those solutions is:

Equation 11

$$X = \left(\frac{1}{2} \right) * \frac{M}{Q} + / - \sqrt{\frac{1}{4} * (M/Q)^2 - \left(\frac{V}{\alpha Q} \right) * (P + \epsilon\tau F)}$$

Signs +/- indicates bigger and smaller solutions which are stable/unstable at the same time. The conditions of existence for both solutions follow from requirements for expression under square root in Equation 11 to be not less than 0. It gives us inequality (Rygalov V. , 2016):

Equation 12

$$P + \epsilon * \tau * \phi \leq \alpha * \frac{1}{4} * \frac{Q}{V} * \left(\frac{M}{Q}\right)^2$$

Model Analysis and Interpretations

Last inequality from Equation 12 can be interpreted as (Rygalov V. , 2016):

Equation 13

$$M \geq 2 * Q * \sqrt{\left(\frac{V}{\alpha Q}\right) * (P + \epsilon \tau \phi)}$$

or {**Mass of Recirculating Materials**} \geq [**System Constant**]*(**Rate of Recirculation + Human Control**)^{1/2}. That means system material buffer is determined not only human requirements on (Rate of Recirculation) but also general mode of system instabilities and (Human Control) capabilities. This fact was actually confirmed in Closed Ecosystem tests of BIOS-3, Biosphere2 and NASA LMLSTP (Rygalov Y. , 2015; Rygalov V. , 2016). Unfortunately, those experimental systems did not function in a steady state for enough duration of time to be considered stable. (Rygalov V. , 2016; Chernigovsky, 1975; Jones H. , 2008; Lisovsky G. M., 1979)

Some additional notes and assumptions for this model

- An assumption is that the CES is functioning at its maximum of plant productivity (where equilibrium is unstable)
- Any deviations from normal operational mode are counteracted with minimal delay in time
- If mass M becomes less and biomass growth rates α is increasing, then the load on human operators and, consequently, system control will become harder (in terms of decrease of human consumption rate P, which will impact the crew performance level);
- If the system/environment uncertainty ($\Delta\alpha$) grows in terms of potential plant biomass growth rate decrease, the system control level will need to increase
- If the system monitoring delay (τ) itself experiences a delay (increases), when the same consequences are expected: the system control level will need to increase

Correlation between Closure Degree, Tropic Network Complexity, and Stability Level

As seen both with theoretical mass balance models (Ulanowicz, 1972; MacElroy & Averner, 1978; Haken, 1978; Tikhomirov, et al., 2003; Tikhomirov, et al., 2007; Tikhomirov, et al., 2011) and with some of the larger scale experiments like Biosphere2 and Bios3, stability is correlated with scale, depth, and efficiency of material processing (Allen & Nelson, 1999; Allan, Nelson, & Alling, 2003; Nelson & Soffen, 1990; Gitelson, Lisovsky, & MacElroy, 2003; MacElroy & Averner, 1978; Rygalov V. Y., 1996; Holubnyak & Rygalov, 2009; Rygalov & Holmer, 2014). This linkage needs to be included in any generalized model that

is created to examine stability. The general schematics for material flows and their transformations in closed environments could be presented in a relatively simple version (See Figure 33) (Rygalov & Holmer, 2014). This general model of material conversion was confirmed by observations made in BIOS-3 (Lisovsky G. , 1979; Chernigovsky, 1975; Churchill (ed.), 1997; Rygalov & Holmer, 2014).

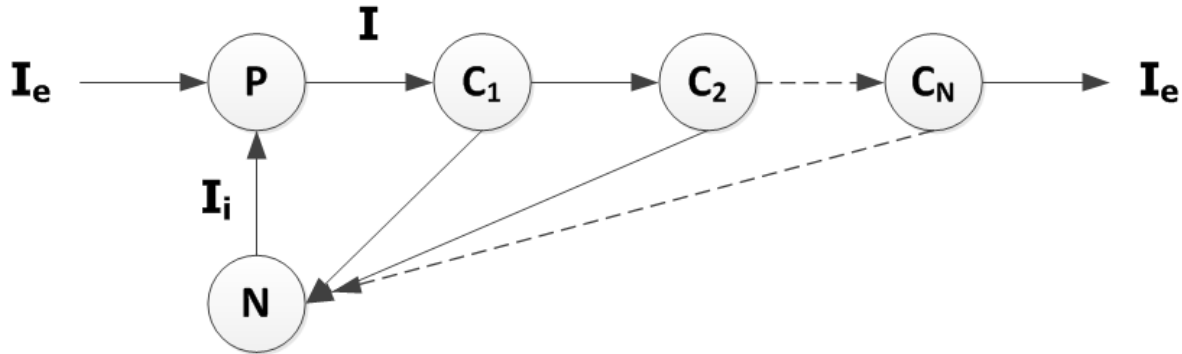

Figure 33 Materials conversion in a bio-regenerative system (Rygalov & Holmer, 2014)

In Figure 33; I_e materials flow between converters, P = primary biomass producer (plants), C_1 = biomass converter 1 (usually human), I = total materials in flow, C_2 = subsequent biomass converter 2, etc., C_N = subsequent biomass converter, N = reservoir with nutrients after conversion.

Here we see the use and reuse of materials within the closed system depicted the fact that plant biomass 'P' (as well as oxygen and water) is first consumed by man, 'C₁', then the inedible plant biomass is processed by the second converter, 'C₂', (in Bios-3 it was biomass catalytic incinerator which returned material back to the cycle water and CO₂, or could be another bio-converter), the remnants of which (in the case of Bios 3, ash from the biomass incineration) has to be processed further by next converter to the molecular level of nutrients absorbed by plants or processed further by yet another converter 'C_N'. This final processing was not done in Bios-3 but would probably be necessary for complex systems. (Rygalov & Holmer, 2014; MacElroy & Averner, 1978) In the case of Biosphere 2, bio-converters C₂-C₄ took the form of chickens, goats, pot belly pigs and composting. (Alling & Nelson, Life Under Glass, 1993; Poynter, 2009; Allan, Nelson, & Alling, 2003) The overall efficiency is determined by totaling the efficiency of material processing in every converter along with the chain of transformations and dividing by the total number of converters in Figure 33 and represented by 'q' in Equation 15 - Equation 20.

The total flow of all materials (air, water, nutrient, etc.) moving from P (Plant Biomass) to Converter 1 (Human) is represented by 'I.' Materials moving from a storage location for plant nutrients (N) forms the internally recycled flow 'I_i.' 'I_e' is the flow of materials from an external source that compensates for the losses of vital materials within the system (supplementation, backup storage, etc.).

Building on work from the previously closed system in both China (Liu, et al., 2014) and Russia (Lisovsky G. M., 1979), Rygalov and Holmer, 2014 defined CES closure index (CI) as:

Equation 14

$$CI = \frac{I_i}{I} = \frac{I_i}{I_i + I_e}$$

To include the efficiency of conversions (q) at every internally recycled flow, they produced:

Equation 15

$$\begin{aligned} I_i &= q * I + q(1 - q) * I + q(1 - q)^2 * I + \dots = \\ &= qI * \frac{[1 - (1 - q)^N]}{[1 - (1 - q)]} = qI * \frac{[1 - (1 - q)^N]}{q} = \\ &= I[1 - (1 - q)^N] \end{aligned}$$

Applying geometric progression sum, Rygalov and Holmer derives the final expression Equation 15. 'q' is always assumed varying between 0 and 1. (Rygalov & Holmer, 2014)

By substituting Equation 15 into Equation 14, this creates the expression for Closure Index (CI) in the form (Rygalov & Holmer, 2014):

Equation 16

$$C = CI = \frac{I_i}{I} = 1 - (1 - q)^N$$

Equation 16 reflects on system complexity through efficiency of conversions (q) and a total number of converters (N). The larger q and N are, and as the value of C approaches 1, the higher the efficiency of material recycling in the system. CI = C = 1 is an indication of the highest efficiency of material recycling (Liu & et al., 2014; Lisovsky G. M., 1979; Rygalov & Holmer, 2014)

Stability Theoretical Conclusions

When you examine Equation 14, Equation 15, and Equation 16, one can see the correlation between the higher the CES complexity, the higher system closure is by the relationship of q and N. Using this defines the buffer time or time of functionality (Tf) for maintenance within the system before stability will be affected (Rygalov & Holmer, 2014):

Equation 17

$$Tf = \frac{M}{I_e} = \frac{M}{I - I_i}$$

In Equation 17, M is the amount of stored materials inside the system required for full life support (air, water, and food). With a closed system, this is the mass of the materials in a bio-regenerative cycle which includes; a mass of plants, the mass of circulating materials, all N converters, and stores including air and water.

Substituting Equation 15 into Equation 17:

Equation 18

$$Tf = \frac{M}{[I(1 - q)^N]}$$

Equation 18 demonstrates that system buffer time (in the case of termination for all external supplies I_e) increases with q and N increases nonlinearly (Rygalov & Holmer, 2014).

To examine overall system stability, S could be defined as (Rygalov & Degermendji, 1991) :

Equation 19

$$S = 1 - \frac{t}{T}$$

In Equation 19- t is the duration of the slowest cycle in the system. This is usually the food cycle duration or the plant biomass reproduction cycle. $T = T_f$ is system functionality maintenance time, buffer time determined from Equation 17 and Equation 18; or T could also be determined independently through a total time of system closure experimental observation.

With this definition for system stability, it indicates that the longer amount of time that the CES is functioning (observation) the closer S is to 1.

If we substitute T_f as determined by Equation 18 into Equation 19, results in an expression for stability (Rygalov & Holmer, 2014):

Equation 20

$$S = 1 - \left(\frac{t}{M}\right) * I * (1 - q)^N = 1 - \frac{t(1 - q)^N}{\frac{M}{I}} = 1 - (1 - q)^N = CI$$

With $t = M/I$, it is easy to see from Equation 20 that in this definition system stability S is equal system closure $C = CI$. The equation confirms the above-introduced assumptions about S metric as system stability.

Both versions for T are applied to characterize and compare stability characteristics for different CES around the globe in Table 1 Comparison of stability characteristics for different CES and plotted in Figure 1 Closed Ecological System Stability and System Linear size (Rygalov & Holmer, 2014); see page 4.

Additional Theories and Models for consideration

Given the unfortunate lack of models available from past experiments, examination of the hypothesis will continue using the application of stability suggested by works in both the ecological and mathematical disciplines to the base works previously reviewed. These examined complex, dependent systems using combinations of:

- Critical Transition Identification
- Tipping Point Theory
- Bifurcation Theory
- System Cycle Speed and Fluctuation
- Fold Catastrophe Model

Critical Transitions

Critical transitions, in a system sense, are sudden changes in a complex system that affects the whole over the long term, occurring once a threshold is crossed (Lade & Gross, 2012; Scheffer, et al., 2009). The resulting contrast in system state is referred to as a bifurcation of the system (Kuznetsov, 2004). In many instances, this seems to happen without warning since the system in question may show little or no change before the tipping point of the transition is reached. The terms “Critical transition” or “tipping point” have often been used to describe these changes. From a mathematical point of view, it can be said that a critical transition is when “a parameter evolves slowly until the tipping point is reached” (Kuehn, 2011). As this phenomenon has been observed and studied in a wide variety of fields from ecology and finance to physical medicine and psychology (Lade & Gross, 2012; Kuehn, 2011; Scheffer, Carpenter, Foley, Foke, & Walker, 2001; Lenton T. , et al., 2008; Lenton T. , et al., 2008; Brock, 2006; Millennium Ecosystem Assessment Board, 2005; Scheffer, et al., 2009; Gladwell, 2000), certain generalities have been observed as precursors (Schroeder, 2009) and have been proven to be related. Catastrophic bifurcation occurs when a threshold is exceeded, and the resulting feedback propels the system through a phase of directional change to an opposite extreme state (Figure 34 Fold Catastrophe Models). (Scheffer, et al., 2009) This can be seen, for example, in the transition of grasslands to desert. Despite the diverse nature of the fields, critical transitions in all areas share common traits (Kuehn, 2011):

- An abrupt qualitative change in the system occurs
- The change occurs rapidly in comparison to the rest of the system functioning
- The system crosses a definable threshold before the transition (normally easily identified post-transition)
- The new ‘normal’ of the system is very different from its previous state

Due to their nature, critical transitions are hard if not impossible to reverse. (Scheffer, Carpenter, Foley, Foke, & Walker, 2001; Scheffer, et al., 2009; Lade & Gross, 2012) However, the system can be kept in a steady state if steps are taken to reverse or stabilize critical factors before reaching the threshold. Given accurate mathematical models of systems, the identification of these thresholds and key factors are easy to identify and manipulate. Accurate models for real-world systems are normally not available either due to their complexity or limited knowledge of working components (Groffman, et al., 2006; Lade & Gross, 2012). Therefore, recent research has focused on extracting precursors and early warnings from time series data (Lade & Gross, 2012; Scheffer, et al., 2009). Two of the most widely accepted approaches are autocorrelation (Carpenter & Brock, 2006; Lade & Gross, 2012) and increasing variance (Dakos, et al., 2008; Lade & Gross, 2012). Both approaches are functions caused by the critical

slowdown of a system (Lade & Gross, 2012; Wissel, 1984). Other methods used for examining precursors of critical transition are skewness (V Guttal, 2008), flickering (WA Brock, 2010), and spatial correlation (Lade & Gross, 2012; Dakos, Nes, Donangelo, Fort, & Scheffer, 2010).

Tipping Point Theory

Slow down and symptoms

One of the seeming best proposed leading indicators of an impending critical threshold is the related circumstance known in systems theory as 'critical slowing down' (Wissel, 1984). This describes the system's ability to recover from small perturbations and return to its original state. A system in a steady state of equilibrium will easily return to that state if disturbed by one or more factors. Systems that are in a state that is close to a critical transition or a permanent change in state will be slower to respond to these changes or may even force the change to occur. This has been observed in multiple different system contexts both the natural and man-made, enough to consider proposing this as a natural law (Wissel, 1984).

While 'critical slowing down' of a system describes the impending state, the actual point of transition is the 'fold catastrophe' model. The fold catastrophe model captures the very basics of a system shift at a 'tipping point.' (Figure 34 Fold Catastrophe Models) The rate of change around these fold points, slows and becomes close to zero as the event unfolds. This is the 'critical slowing down' period referred to by Wissel and can be used as a predictor of an impending transition or fold. (Scheffer, Carpenter, Foley, Foke, & Walker, 2001; Scheffer, et al., 2009; Wissel, 1984; Nes & Scheffer, 2007) The inverse of this is also true, in that the recovery rate after the reversal of a disturbance in a system can be used as a gauge to indicate how close to a system is to a bifurcation point (Nes & Scheffer, 2007; Scheffer, et al., 2009).

In natural systems, it has been shown that as a bifurcation point is near, there are specific changes in patterns of fluctuations occur. These fluctuations lead to the indicator that as a system slows down, it is expected that these patterns of fluctuations should increase (Ives, 1995). This autocorrelation can be shown mathematically (see Critical slow down increased autocorrelation and increased variance page 66) but is also obvious to the casual observer. As the system slows down, it begins to look more and more like its past state developing a form of 'memory.' The increase in this 'memory' of the system can be measured proportionally to the frequency spectrum of the system (Kleinen, Held, & Petschel-Held, 2003; Livina & Lenton, 2007; Scheffer, et al., 2009)

Examination of stochastic simulation models has shown that there is a significant and measurable increase in the autocorrelation before the critical point. The autocorrelation has been observed in both simple (Dakos, et al., 2008; Scheffer, et al., 2009) and highly complex, almost realistic, models of spatially complex systems (Lenton, et al., 2009).

The variance of the fluctuation parameters as the slowdown occurs is another indicator of approaching transitions (Biggs, Carpenter, & Brock, 2009; Scheffer, et al., 2009) (see Critical slow down increased autocorrelation and increased variance page 66). Even though the system is slowing, the effects of the deviations in the system are not diminished and increase the variance of the state of the variable.

Fold Catastrophe Model (Scheffer, Carpenter, Foley, Foke, & Walker, 2001)

Critical Transitions

From Scheffer, Carpenter, Foley, Foke, & Walker's 2001 paper "Catastrophic shifts in ecosystems" - "The equilibrium state of a system can respond in different ways to changes in conditions such as exploitation pressure or temperature rise (Figure 34 charts a, b, c). If the equilibrium curve is folded backward (Figure 34 charts c, d), three equilibria can exist for a given condition. The gray dotted arrows in the plots indicate the direction in which the system moves if it is not in equilibrium (that is, not on the curve). It can be seen from these arrows that all curves represent stable equilibria, except for the dashed middle section in Figure 34 charts c, d. If the system is driven slightly away from this part of the curve, it will move further away instead of returning. Hence, equilibria on this part of the curve are unstable and represent the border between the basins of attraction of the two alternative stable states on the upper and lower branches. If the system is very close to a fold bifurcation point (for example point F_1 or point F_2), a tiny change in the condition may cause a large shift in the lower branch (Figure 34 Figure c). Also, close to such a bifurcation, a small perturbation can drive the system across the boundary between the attraction basins (Figure 34 chart d). Thus, those bifurcation points are tipping points at which a tiny perturbation can produce a large transition. Small perturbations can also cause large changes in the absence of true bifurcations, provided that the system is very sensitive in a certain range of conditions (Figure 34 chart b). Finally, a shift in system state may simply be caused by a sudden large external force (Figure 34 chart a). Early-warning signals tend to arise as systems approach a bifurcation point such as in Figure 34 chart c, d, and also if systems approach a non-catastrophic threshold such as the one shown in Figure 34 chart b.

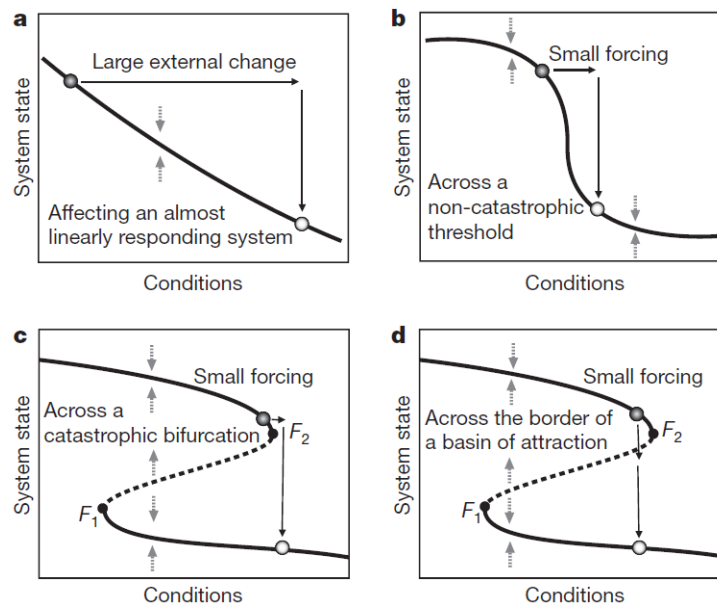

Figure 34 Fold Catastrophe Models (Scheffer, Carpenter, Foley, Foke, & Walker, 2001)

Critical Slowdown example

To see why the rate of recovery rate after a small perturbation will be reduced and will approach zero when a system moves towards a catastrophic bifurcation point, consider the following simple dynamical system, where a and b are parameters of the conditions or system state:

Equation 21

$$\frac{dx}{dt} = \gamma(x - a)(x - b)$$

This model has two equilibria, $\bar{x}_1 = a$ and $\bar{x}_2 = b$, of which one is stable, and the other is unstable. If the value of parameter a is equal to that of b , the equilibria collide and exchange stability (in a transcritical bifurcation). Assuming that \bar{x}_1 is the stable equilibrium, we can now study what happens if the state of the equilibrium is perturbed slightly ($x = \bar{x}_1 + \varepsilon$):

Equation 22

$$\frac{d(\bar{x}_1 + \varepsilon)}{dt} = f(\bar{x}_1 + \varepsilon)$$

Here $f(x)$ is the right-hand side of Equation 21. Linearizing this equation using a first-order Taylor expansion yields

Equation 23

$$\frac{d(\bar{x}_1 + \varepsilon)}{dt} = f(\bar{x}_1 + \varepsilon) \approx f(\bar{x}_1) + \frac{\partial f}{\partial x_{\bar{x}_1}} \varepsilon$$

Which simplifies to

Equation 24

$$f(\bar{x}_1) + \frac{d\varepsilon}{dt} = f(\bar{x}_1) + \frac{\partial f}{\partial x_{\bar{x}_1}} \varepsilon \Rightarrow \frac{d\varepsilon}{dt} = \lambda_1 \varepsilon$$

With eigenvalues λ_1 and λ_2 in this case, we have

Equation 25

$$\lambda_1 = \frac{\partial f}{\partial x_a} = -\gamma(b - a)$$

And, for the other equilibrium

Equation 26

$$\lambda_2 = \frac{\partial f}{\partial x_b} = -\gamma(b - a)$$

If $b > a$, then the first equilibrium has a negative eigenvalue, λ_1 , and is thus stable (as the perturbation goes exponentially to zero; see Equation 24). Moving from Equation 25 to Equation 26 it can be seen that at the bifurcation ($b=a$) the recovery rates λ_1 and λ_2 are both zero and perturbations will not recover. Farther away from the bifurcation, the recovery rate in this model is linearly dependent on the size of the basin of attraction ($b-a$).

Critical slow down increased autocorrelation and increased variance

Critical slowing down will tend to lead to an increase in the autocorrelation and variance of the fluctuations in a stochastically forced system approaching a bifurcation at a threshold value of a control parameter. The example described here illustrates why this is so. We assume that there is a repeated disturbance of the state variable after each period Δt (that is, additive noise). Between disturbances, the return to equilibrium is approximately exponential with a certain recovery speed, λ . In a simple autoregressive model this can be described as follows:

Equation 27

$$x_{n+1} - \bar{x} = e^{\lambda\Delta t}(x_n - \bar{x}) + \sigma\varepsilon_n$$

$$y_{n+1} + 1 = \alpha y_n + \sigma\varepsilon_n$$

Here y_n is the deviation of the state variable x from the equilibrium, ε_n is a random number from a standard normal distribution and σ is the standard deviation.

If λ and Δt are independent of y_n , this model can also be written as a first-order autoregressive (AR(1)) process:

Equation 28

$$y_{n+1} + 1 = \alpha y_n + \sigma\varepsilon_n$$

The autocorrelation $\alpha \equiv e^{\lambda\Delta t}$ is zero for white noise and close to one for red (auto correlated) noise. Here 'c' is a positive scaling factor. The expectation of an AR(1) process $y_{n+1} + 1 = c + \alpha y_n + \sigma\varepsilon_n$ is (Ives, 1995):

Equation 29

$$E(y_{n+1}) = E(c) + \alpha E(y_n) + E(\sigma\varepsilon_n) \Rightarrow \mu = c + \alpha\mu + 0 \Rightarrow \mu = \frac{c}{1 - \alpha}$$

For $c=0$, the mean equals zero, and the variance is found to be

Equation 30

$$Var(y_{n+1}) = E(y_n^2) - \mu^2 = \frac{\sigma^2}{1 - \alpha^2}$$

Close to the critical point, the return speed of equilibrium decreases, implying that λ approaches zero and the autocorrelation α tends to one. Thus, the variance tends to infinity. These early-warning signals are the result of critical slowing down near the threshold value of the control parameter.

Skewness and Flickering

The asymmetry of the fluctuations can be examined as a possible indicator of a tipping point being reached. While this change is not caused by the systems decrease in speed, rather the unstable point at which the system holds the end point of the curve before swinging back. (see Critical Transitions page 64) The rate of change is very low as this point is reached and, holds at zero for a short period. The skewness of the distribution of states is expected to increase as this point is reached.

Flickering is also observed at critical transition points in bifurcations. Flickering is caused when assumed forces are strong enough to move the system quickly between two key factors as the system enters the region just before the critical bifurcation. 'Statistically, it can be observed in the frequency of distribution of states as in increased variance and skewness as well as bimodality' (Scheffer, et al., 2009; Carpenter & Brock, 2006)

Spatial Correlation

Spatial correlation as an indicator of critical transition is an examination of the spatial distribution of organisms in their environment. Studies have shown a correlation of the distribution and density of an organism with impending transitions (Dakos, Nes, Donangelo, Fort, & Scheffer, 2010) . This has led to the proposal to use this as an early warning indicator. While this has definite implications in ecology and environmental sciences, given that in general organisms are specifically placed in Closed-loop Ecological Systems, this technique has limited use in this context.

Indicators in cyclic and chaotic systems

Unfortunately for CLES, critical transitions in cyclic and chaotic systems are less well studied from the point of view of precursor and early warning indicators. These systems are normally associated with three different types of bifurcations (Kuznetsov, 2004; Scheffer, et al., 2009):

- Hopf bifurcation
- Non-local bifurcation
- Phase Locking

Hopf bifurcation marks the change from stable to oscillating systems (Strogatz, 1994; Scheffer, et al., 2009) or more precisely from a single center of change (a fold, limit point, or saddle-node bifurcation) $\lambda_1 = 0$ to a range of possibilities $\lambda_{1,2} = \pm i\omega_0$, $\omega_0 > 0$ (Kuznetsov, 2004, p. 78). Like most bifurcations, this is heralded by the critical slow down (Chisholm & Filotas, 2009). The disturbances in the systems lead to long temporary swings before settling to a steady state. This is much like the final short bounces of a ball or final vibrations of an Euler's disk.

Non-local bifurcations are those rhythms that are caused by natural properties that bring the system close to a different state. The different state is not correlated with stable or unstable points that can be analytically defined (Scheffer, et al., 2009). No known research has been done on precursors or early warnings of nonlocal bifurcations (Scheffer, et al., 2009).

Phase locking between coupled oscillators (Schroeder, 2009) occurs when outside forces push the system into a bifurcation associated with a critical slowdown. (Leung, 2000; Scheffer, et al., 2009). This hints directly at early warning signals that should be explored.

Methods for detecting critical transitions

Given that critical transitions occur in a multitude of diverse conditions and situations and as were noted earlier, share common traits. When multiple time scale dynamics are incorporated into bifurcation theory, the resulting data suggest that the theory of fast-slow systems provides a fitting definition of a critical transition (Kuehn, 2011). Applying this definition, a generalized model can be created using ordinary differential equations (ODEs). Once this model is constructed, bifurcation theory can be applied to examine the system for precursors of a critical transition.

Fast-slow systems: critical transitions

Systems by their very nature are always changing (Sterman & Sterman, 2000). Systems have components that will have measurable fluctuations around a central point when functioning properly. These fluctuations normally occur over the as short period scale and are referred to as fast timescale. Systems also tend to respond slowly over time to external factors. This is referred to as slow timescale. (Lade & Gross, 2012; Gross, Rudolf, Levin, & Dieckmann, 2009; Kuehn, 2011)

Kuehn 2011 describes the creation of a fast-slow system with a critical transition as a parameterized set of ordinary differential equations.

Equation 31

$$\frac{dx}{dt} = x' = f(x; y)$$

Where the variables $x \in \mathbf{R}^m$ are the fast variables and $y \in \mathbf{R}^m$ are the slow variables. The parameter ϵ (element of) describes the time scale that separates the parameters. Using Fenichel's Theorem, these can be transformed into hyperbolic manifolds to anticipate the critical transitions (Kuehn, 2011). Once this mathematical description of the fast-slow system has been created, a general model of the overall system can be created to incorporate into the parameters into the fast-slow model.

Generalized Modeling

System models and specifically computerized models, by their nature, require detailed, explicit, and accurate variables to provide simulation and repeatable results. In this situation, critical transitions and tipping points can be easily predicted by numerical simulation or direct computation (Lade & Gross, 2012). Even when systems do not have detailed variable analyses, have complex interdependent processes, and have little specific information available, the dynamics of the system can still be acquired using a generalized model (Gross, Rudolf, Levin, & Dieckmann, 2009; Lade & Gross, 2012).

A generalized model is created using a three-step process before calculating the early warning signals (Lade & Gross, 2012). These are:

1. Identify important system variables and processes (i.e., an abundance of biomass for each member of the population of a system, growth rates, carbon dioxide absorption, ammonia conversion, etc.)
2. Create a graphical model or causal loop diagram of the system (Sterman & Sterman, 2000)
3. Create a mathematical representation of the model

Once the variables have been identified and their relationships diagrammed in the graphical representation, a mathematical model is created by making a dynamical equation for each variable in the model. This can be accomplished using either ordinary differential equations or as discrete time maps (Lade & Gross, 2012).

For example, to create a general model for a population (X_1), this population is composed of the Gains (G) and Losses (L) over time. Written as an ordinary differential equation, this population model looks like:

Equation 32

$$\frac{d}{dt}X_1 = G(X_1) - L(X_1)$$

As a discrete-time map, it could be written as

Equation 33

$$X_{1,t+1} = G(X_{1,t}) - L(X_{1,t})$$

While normally models would need to be expanded to include the actual functions of G and L before the model could be worked, here we only use the unspecified functions of G() and L() as placeholders (Lade & Gross, 2012).

When constructing this model, all efforts should be made to include all known parameters of the system including those data that are relevant and measurable or whose magnitude can be deduced from other more observable processes. The model should allow for bifurcations that pertain to the system otherwise the model cannot be used to predict those changes (Lade & Gross, 2012).

Calculation of early warning signals

An assumption is made that a system is in or near a stable state or at rest at the point in time under question in an overall sense. This does not mean that there are not any fluctuations that are occurring internally or externally at both fast and slow periods (Lade & Gross, 2012).

To link the fast and slow measurements to a possible bifurcation, a Jacobian matrix is created using the differential equations or time maps of the model (Lade & Gross, 2012; Kuehn, 2011; Kuznetsov, 2004). This will give a view of the system as it fluctuates around a central point allowing us to examine the

system for stability. While the Jacobian matrix can be computed directly from the generalized model, it is the eigenvalues that serve as the precursors or early warnings in the system (Lade & Gross, 2012).

Using the differential equations in the matrix, if the eigenvalues have negative real parts or if the eigenvalues of the time map equations have an absolute value of less than one, the system can be said to be stable (Lade & Gross, 2012). A critical transition will be signaled by a change to the external parameter that causes at least one of the eigenvalues to cross the imaginary axis of the differential equations or a unit circle around the origin of the time map. Therefore the early warning signal should be if one of those eigenvalues trends towards the stability boundary, this can be seen as the dotted line, plotted in Figure 36 chart (b) of the fishery simulation. (Lade & Gross, 2012).

Example Studies of applications in ecology and biology

Tri-trophic food chain

Lade and Gross, 2012, reported the results of the comparison between a generalized model and a course-grained established a model of a tri-trophic food chain. The generalized model was created derived using a Jacobian matrix with continuous time map.

Data for the models were generated using three differential equations; one for top producer biomass (X_1), predator biomass (X_2), and top predator biomass (X_3). Included were additive noise terms that suppressed the noise once a population's biomass reached zero to keep the population extinct. The simulation was run while increasing the mortality rate (m) of the top predator. This generated a time series with a fast fluctuation of the individual biomasses and a slow, steady, changing rate for the top predator. This resulted in a steady equilibrium followed by a sudden transition to large of oscillations and a sudden collapse of all three populations.

The generalized model was able to successfully predict not only the collapse of the system but the onset of the Hopf bifurcation that lead to the onset of oscillatory dynamics of the system prior to collapse (Kuznetsov, 2004; Lade & Gross, 2012).

Fishery Simulation

A simulation with a generalized model was also reported in Lade and Gross based on a fishery model created by Biggs et al. (Lade & Gross, 2012; Biggs, Carpenter, & Brock, 2009). This model is shown in causal loop form (Figure 35) which models the transition between a high-piscivore/low-planktivore regime to a low-piscivore/high-planktivore regime as harvesting of piscivores is increased (Lade & Gross, 2012; Biggs, Carpenter, & Brock, 2009). A generalized model was built describing the populations at the end of each year.

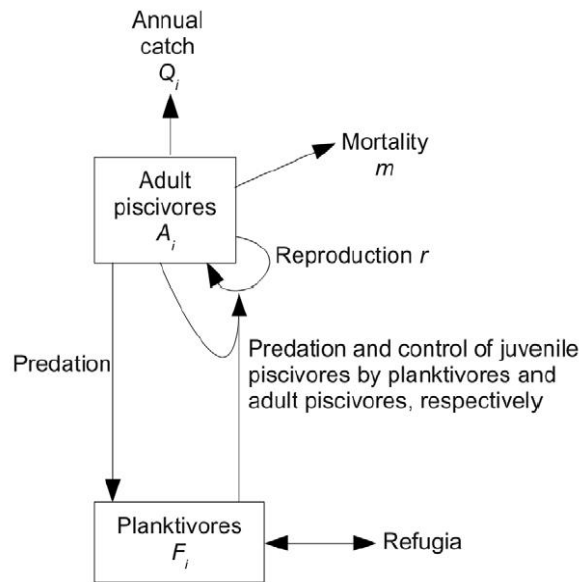

Figure 35 Example Causal Loop Diagram – fishery knowledge (Lade and Gross 2012)

Using this causal loop diagram, Lade and Gross constructed the generalized model:

Equation 34

$$\frac{d}{dt}X = B(X) - M(X, \mu)$$

In Equation 34, X is the population under observation, B is the observed birth rate of the population, and M is the mortality rate of the population as influenced by the external factor μ that is influencing the population (harvest, predation, natural death, etc). B can also be the death rate or another observable change in the population at time t . (Lade & Gross, 2012)

From the generalized model in Equation 34, Lade and Gross constructed the 1-D Jacobian system model to calculate the eigenvalue of the system at each observation point:

Equation 35

$$\lambda = B'(X) - M'(X, \mu)$$

In Equation 35, Lade and Gross had direct observations of both the Birth rate B_i and the population X_i and could calculate the value for B'_i as $B'_i = \Delta B_i / \Delta X$. The values for M' could not be calculated in the same

way since M depends on μ , which necessitated the assumption that $M(X, \mu)$ is linear in the population X . This allows the estimation of the change in the population to be the ratio $M'_i = M_i / X_i$, which allows for the calculation of the eigenvalue to be: (Lade & Gross, 2012)

Equation 36

$$\lambda_i = \frac{\Delta B_i}{\Delta X_i} - \frac{M_i}{X_i}$$

Which can be also written as:

Equation 37

$$\lambda_i = B'_i - M'_i$$

To test their model, Lade and Gross generated data from the Biggs et al model. This model differed greatly from the generalized model that was built since it was based on results from whole-lake experiments. While the generalized model avoided intra-annual dynamics by only using annualized data, the Biggs model included this as well as additional state variables for the juvenile piscivore populations. To better reflect noise that would be injected in real-world data, this information was included. The results of this model are shown in Figure 36, chart (a), showing a transition from high-piscivore to high-planktivore regimes.

The results of the generalized model are rather striking. These results are shown in Figure 36 chart (b). This clearly shows the expected rise in the eigenvalues (dotted plot) to one as the system approaches critical transition (Lade & Gross, 2012). Even with the less dense data than the Biggs model, a signal of similar quality is produced, even earlier.

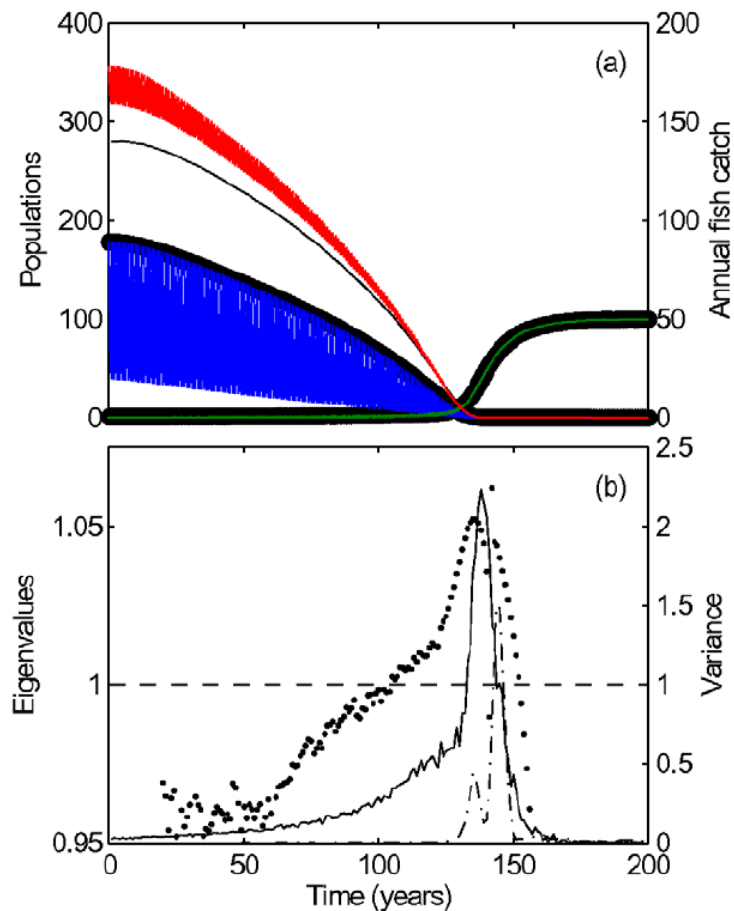

Figure 36 Fishery Models - (a) detailed model Biggs et al (b) generalized model (Lade and Gross, 2012)

Applications to Closed-loop Ecological Systems

Currently, CLES and CELSS experiments tend to be limited to small-scale tests with well-defined variables and known dependencies or large-scale experiments. Large, real world test environments like BIOS (Gitelson, Lisovsky, & MacElroy, 2003, p. 54; Eckart, 1994, p. 143), Biosphere2 (Alling & Nelson, Life Under Glass, 1993), LMLSTP (Gitelson, Lisovsky, & MacElroy, 2003, p. 43) and The Closed Ecology Experiment Facilities (CEEF) (Gitelson, Lisovsky, & MacElroy, 2003, p. 58), have large inter-dependent webs with hundreds of variables and processes that are hard to model and even harder to monitor. Additionally, these large-scale experiments are time and funding intensive.

As seen in both examples from Lade and Gross, generalized models can handle both internal and external pressures that influence system performance even with processes that are complex and with dependencies that are not fully understood. Additionally, they produce results that are as accurate and sometimes timelier than a more specific than the heavily sampled complete models.

Generalized modeling can not only help with the intermediate steps between small and large-scale experiments by allowing for the mixing of interdependencies without intimate or exact knowledge of the interactions, but it can also assist with monitoring of early warning signals in large experiments.

Creating a generalized model will allow for better intermediate testing with fewer time data prior to ramping up to full-size long-term testing.

Example Generalized Model for CELSS

To create a generalized model for CELSS, it will help to first start with a simplified stable arrangement. Using the three-step process defined in Lade & Gross, 2012 (page 68), we can create a generalized model for the commercially available EcoSphere. Examining the full relationship model as depicted in Figure 37, we can determine the important variables and processes, the Shrimp and the Algae, While the bacteria are certainly important members, for the purposes of our general model, keeping track of their population isn't quite as important as our major players of the shrimp and algae.

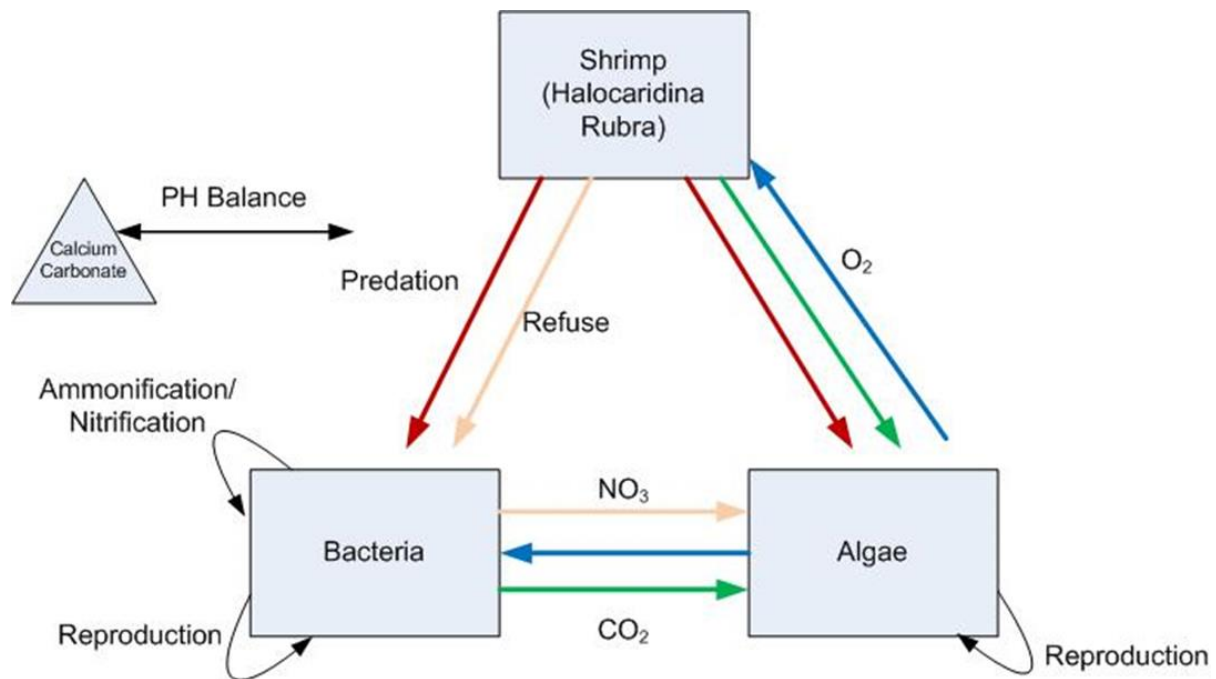

Figure 37 Full relationship and exchange model for an EcoSphere

The resulting causal/relationship loop diagram, Figure 38, looks a lot like the fisheries model produced by Lade and Gross (Figure 35). However, unlike the fisheries model, the algae does not predate on the juvenile shrimp population, but we do have two different time-dependent populations. A slow growth population, the shrimp, and a faster growing population, the algae.

We then simplify this into a general model would be determined by those variables that could be easily observed. Given the closed nature of the EcoSphere, this would be the shrimp population since the algae population can only be observed through approximation, i.e. additional algae accumulation on materials. These models are almost

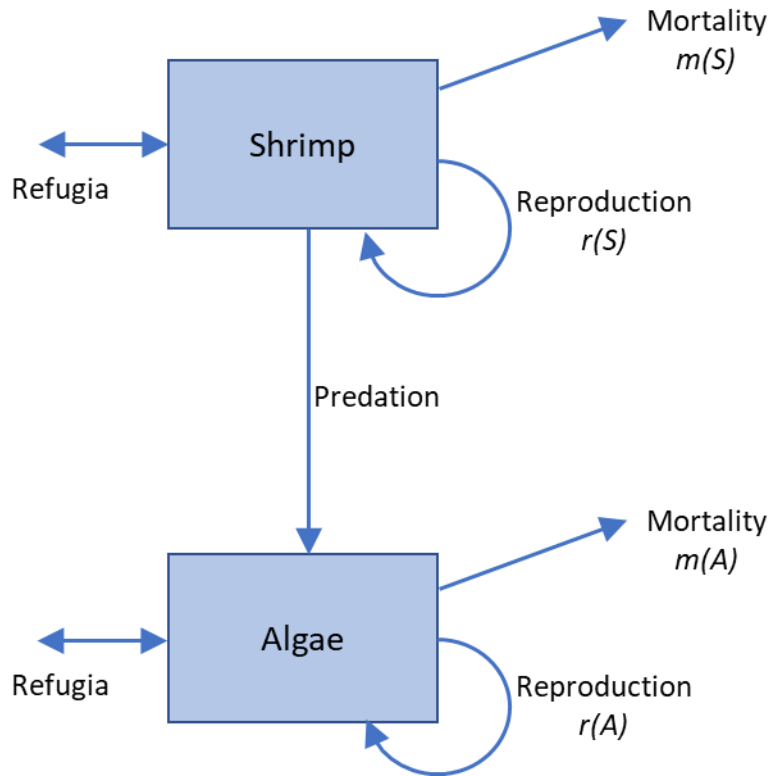

Figure 38 General model causal loop diagram for an EcoSphere featuring Shrimp and Algae

Using Equation 31 and Equation 32, the shrimp population (S) and the algae population (A) can be modeled as:

$$\begin{array}{ll} S(t) - \text{Shrimp} & A(t) - \text{Algae} \\ \frac{dS}{dt} = aS - bAS & \frac{dA}{dt} = aA - bAS \end{array}$$

Figure 39 Algae and Shrimp population models as ODEs, one dependent on the other

Following this process for a CLESS we would get a general model causal loop diagram that is fairly close to that of the EcoSphere and that of ESA's MELiSSA (Figure 27). This resulting general model, while useful to observe the overall material cycles in the system, individual reactions need to be examined to evaluate the overall stability of the system in an actual CLESS system. For simplicity in explanation, we are going to focus on the gas exchange portion between the plants and crew. This is both easily quantifiable through sensors and includes both fast and slow systems.

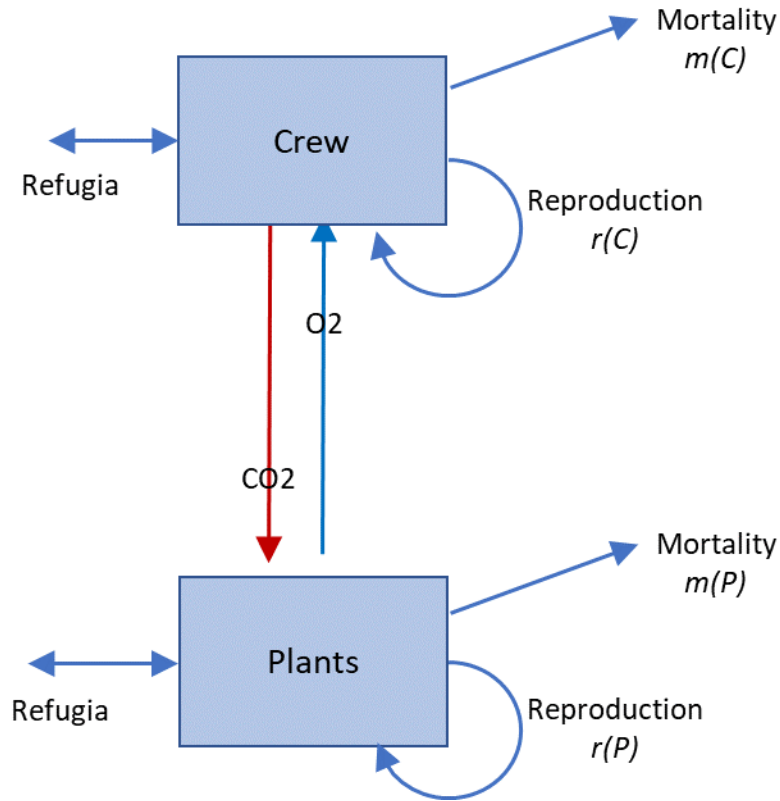

Figure 40 General Gas Exchange Model for a CLESS

Here we focus on the population of gas molecules or the level of gas amounts in the environment that are exchanged between the two groups. Using Equation 32 and the principles from Equation 34 - Equation 36 we can get the general gas exchange models for Oxygen and Carbon Dioxide to measure the eigenvalues:

$$\lambda_o = \frac{\Delta O}{O'} - \frac{cO}{O'} \qquad \lambda_{CO_2} = \frac{\Delta CO_2}{CO_2'} - \frac{pCO_2}{CO_2'}$$

Figure 41 General Gas Exchange Models for the dependent populations in CLESS

The model to compute the eigenvalue for Oxygen (λ_o) at a given point in time is the ratio of the change in Oxygen (ΔO) (oxygen created by plants or other physio-chemical systems) over all of the Oxygen in the environment (O') minus the ratio of the Oxygen used by the Crew (cO) over all of the Oxygen in the environment (O').

The model for the eigenvalue of Carbon Dioxide (λ_{CO_2}) at any given point in time is similar but focusing on the plants interaction with the system. A ratio of the total change in Carbon Dioxide (ΔCO_2) (CO_2 created by the crew or other systems in the environment) over all the CO_2 in the environment (CO_2') minus the ratio of the CO_2 used by the Plants (pCO_2) over all of the CO_2 in the environment (CO_2').

Application

With the assumption that the 'Crew' population should be stable with no reproduction or mortality and that the crew population is wholly dependent on the success or failure of the crop 'Plant' populations; modeling the 'Crew' population is frivolous. We will assume stability at the outset

If successful, monitoring the crop Plants system for early warning signs of critical transition will give the best indications for a simulation failure in a real-world scenario for the overall simulation. Given that failure of one system may not necessarily indicate failure overall for the entire simulation

Model Development

The original plan was to develop a model that could be used to compare the execution and outcomes of major CELSS experiments that have been conducted. Unfortunately, research confirmed contemporary experiments, similarly identified by Rummell and Volk (Rummel & Volk, 1987) and those conducted since, do not have uniform documentation or consistent data. Therefore, modeling the outcomes of these experiments is not possible in most cases.

Reevaluation of existing models and software automation showed that one simulation model was actively being maintained and had successfully modeled a previous live simulation. The underlying models for BioSim were validated using components of the JSC Advanced Life Support System project (Traclabs Inc, 2017; Kortenkamp & Bell, 2003) and has significant mass and interaction models. BioSim uses modern a programming language, Java, and a modular approach that will allow for the addition of components, without a large restructuring effort.

Simulation Software

BioSim Overview

BioSim began as a research project being developed at NASA Johnson Space Center with the objective to create a portable simulation of a typical integrated advanced life support system that runs in a typical mission scenario with malfunctions and perturbations. The simulation is written entirely in Java with each component using Common Object Request Broker Architecture (CORBA) for communication. This means that any language with an Object Request Broker (ORB) can interface with the simulation. The simulation has been tested on Windows, Linux and Mac platforms. The simulation provides a user interface showing the internals of the simulation and a logging facility. (TraCLabs Inc., 2017)

This simulation was selected to test the hypothesis of this thesis since it provides a good working model for an integrated CELSS that is modularized and has enough detail surrounding crew, water, waste, and plant interactions to determine stability.

Code Organization

The base code organization for BioSim divides the code into five different areas:

1. Client
2. Framework
3. IDL
4. Server
5. Util

The Client Code base is all the packages that are required to run the Graphical User Interface (GUI) and provide real-time updates and control of the simulation during execution.

The Framework code base contains the packages needed for simulation execution outside of an Integrated Development Environment such as Eclipse. This allows for BioSim to be executed on a computer with only the Java Virtual Runtime Environment (VRE) installed

The Interface Definition Language (IDL) packages contains the configuration elements needed to implement the Common Object Request Broker Architecture (CORBA). CORBA is a language-neutral Interface definition language which enables interoperability and connectivity with heterogeneous objects. (Oracle Corp., 2018) The idl file in the BioSim code allows CORBA objects to be created and communicate across servers and allow for a distributed operation of the simulation across multiple computers.

The Server code base contains all the packages required for the simulation to execute and function. This contains all the objects, attributes, and methods the simulation will execute.

The 'util' packages are all the common 'utility' packages that are needed by the other code base areas. These utility packages contain routes for communicating and manipulating object broker items, eXtensible Markup Language (XML) files and interact with the file system.

Logical Configuration of Simulation Elements

The code for the BioSim integrated simulation consists of ten different configurable modules:

1. Environment
2. Crew
3. Water
4. Air
5. Biomass
6. Food processing
7. Waste
8. Power
9. Accumulators
10. Injectors

The configuration of these modules is controlled by startup configuration and can be varied in its size, connections to other modules, malfunction rate, and exchange rate. A typical setup of the simulator and its resource flows is shown in Figure 42.

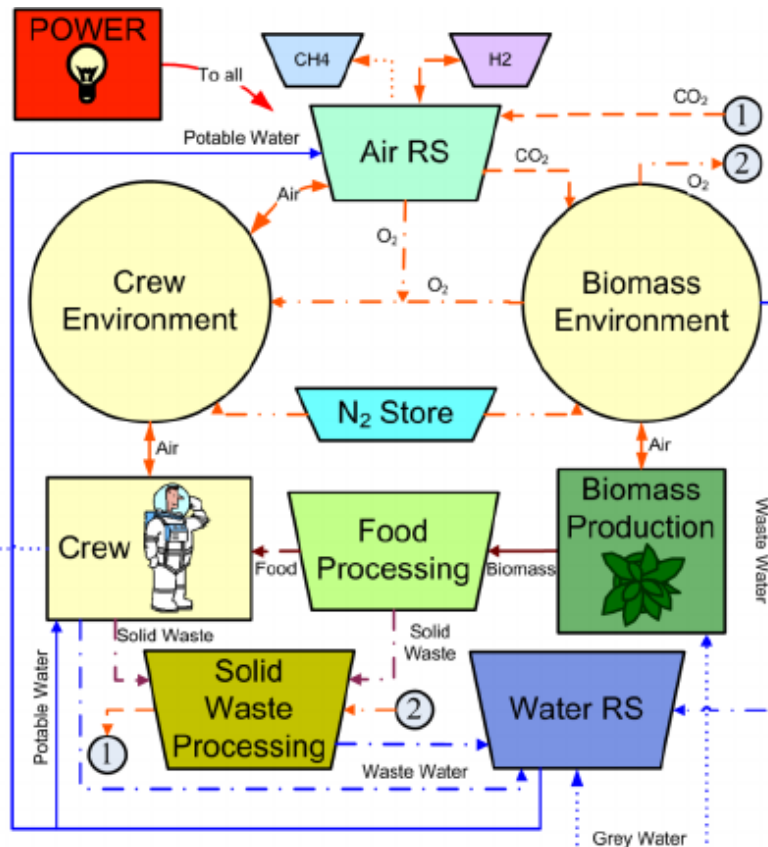

Figure 42 BIOSim modules, typical configuration (Metrica Inc.; S&K Technologies, 2005)

The environment module represents the atmosphere that is consumed by either people or crops in the simulation. The atmosphere contains a mixture of gases, in this simulation we use oxygen (O₂), carbon dioxide (CO₂), nitrogen (N), water vapor (H₂O), and other trace gasses. Storage is provided for all gasses to allow for buffering. The initial composition of the gases is set by the configuration at simulation initialization. The initial size and gas composition is set through the input parameters. The default is 1:54893x106liters with an atmosphere equivalent to sea level air. As the simulation runs modules may consume air from the simulation and replace it with air of a different composition, depending on the activities and actions of the module. Thus, the composition of gases and pressure in the air change over time. These can be measured by environment sensors, and actions performed to increase or decrease levels or just log the levels as is. As with all modules, there can be multiple environments. For example, it is common for crew members and crops to have different air compositions since plants typically thrive in an environment where more CO₂ is available. (Metrica Inc.; S&K Technologies, 2005, p. 5)

The crew module represents the crew individuals and their assigned roles. The number, gender, age, and weight of the crew are set as input parameters in the configuration at simulation initialization. The default configuration has four crew members, two males and two females. The crew has a set of actions and activities that it cycles through during days in the simulation such as sleep, maintenance, recreation, and others. Each activity has an effect as to how the individual uses O₂, food and water and what products they produce; CO₂, dirty water, and solid waste. The amount of resources consumed and produced varies according to crew member attributes and their activities. A schedule of these activities

is provided to the crew module which assigns tasks and tracks the activities. A default schedule can also be used. (Metrica Inc.; S&K Technologies, 2005, p. 5)

The water recovery module consumes dirty water, grey water, and power and produces potable water. This was modeled on the water recovery system (WRS) developed at Johnson Space Center (JSC), used during the Lunar-Mars Life Support Test Project (LMLSTP) was the basis for what is currently used onboard the ISS. (Kortenkamp & Bell, 2003) The water recovery module has of four subsystems that process the water. The biological water processing (BWP) subsystem removes organic compounds. The water passes to a reverse osmosis (RO) subsystem, that results in 85% of the water passing through it being classified as grey. The remaining 15% of water is passed to the air evaporation subsystem (AES), which recovers the rest producing a slurry remainder also classified as gray. These two streams of grey water (from the RO and the AES) are passed through a post-processing subsystem (PPS) to create potable water. An external controller can turn on or off various subsystems. For example, all water can pass through the AES at a higher power cost. (Metrica Inc.; S&K Technologies, 2005, p. 6)

The air revitalization module takes in excess CO₂ and produces O₂ as long as there is enough power being provided to the system. This module is modeled on various Air Revitalization System (ARS) work at NASA JSC (Kortenkamp & Bell, 2003). There are three interacting air subsystems that make up the module: the Variable Configuration Carbon Dioxide Removal (VCCR) System in which CO₂ is removed from the air stream; the Carbon Dioxide Reduction System (CRS), which also removes CO₂ from the air stream using a different process and producing different gases than the VCCR; and the Oxygen Generation System (OGS) in which O₂ is added to the air stream by breaking water down into hydrogen and oxygen. This system is similar to the one that is currently installed on the ISS (Kortenkamp & Bell, 2003) and is in addition to any air revitalization/recirculation that is done in the Biomass production Module. (Metrica Inc.; S&K Technologies, 2005, pp. 6-7)

The Biomass Production Module is where crops are grown and produces both biomass, which can be turned into food, and regenerates atmospheric components. The Module consumes: Power, Potable Water, Grey Water, and Air. It produces: Air (with more O₂), Biomass, Dirty Water, and Potable Water. The system is modeled after the preliminary designs of the BIOplex Biomass Production System (BPS) (Kortenkamp & Bell, 2003) as shelves that contain plants, lights, and water. Shelves are planted and harvested and there is growth cycle for each shelf. Currently, ten crops are modeled which can be planted in any ratio. (Metrica Inc.; S&K Technologies, 2005, p. 7)

The Food Processor module simulates the necessary steps of processing raw source ingredients into food. The food processing component takes biomass, power and crew time and produces food and solid waste. This is one of the model activities for the crew as this process as it is labor intensive. (Metrica Inc.; S&K Technologies, 2005, p. 7)

The waste module consumes power, O₂ and solid waste and produces CO₂. This module is modeled on an incinerator used in the LMLST Phase III test in 1997 (Kortenkamp & Bell, 2003). Incineration can be scheduled. (Metrica Inc.; S&K Technologies, 2005, p. 7)

The power module supplies power to all the other modules that need it. There are two choices for power in the simulation. Nuclear power, which supplies a steady amount throughout the lifetime of the simulation or solar power. Solar power supplies a varying amount (day/night cycle) of power to each component. (Metrica Inc.; S&K Technologies, 2005, p. 7)

The accumulator and injector modules can take a resource from any store or environment and place it into another environment or store. Both are functionally equivalent and are specified depending on what is needed for the module. (Metrica Inc.; S&K Technologies, 2005, p. 7)

Thermal regulation is not actively computed in this simulation, it is assumed that all modules are properly regulated. (Metrica Inc.; S&K Technologies, 2005)

Modifications will be required to test the hypothesis of this thesis including:

- Addition of stability monitoring probes and measurements
- Modification of the logging capability to include stability monitoring measurements
- Addition of resource logging aggregators to record the total consumed or produced of a resource across a group of resources (i.e. crew or biomass)

Simulation Configuration

BioSim execution is controlled by two main elements: the configuration file and the controller code. The configuration file is an XML Configuration file that sets the operating parameters for the simulation's environment, modules, crew, and equipment. Configuration files for the experiment executions in this work are in Appendix A: Simulation Configuration Files.

The controller code is the set of instructions for executing the simulation. This controls the execution of equipment, introduces malfunctions, and defines the actions that take place in and around the simulation modules. The controller is generally different for each configuration of biosim.

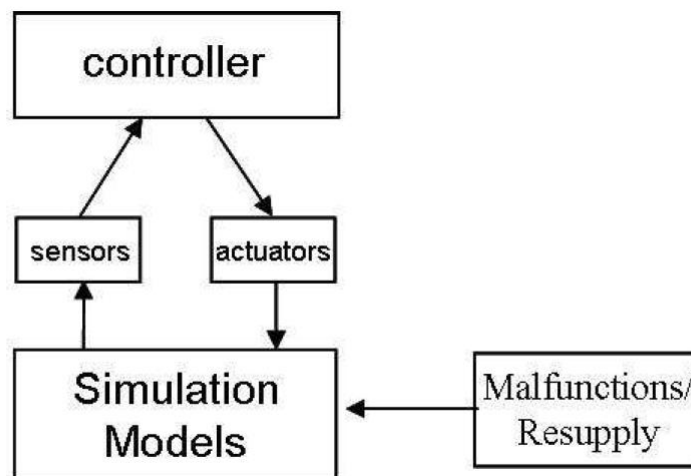

Figure 43 BioSim Execution Flow Control (Traclabs, 2018)

BioSim Modifications

Summary of modification to the BioSim base Java code to configure and monitor variables for stability calculations.

Crew Monitoring

Some modifications were required to the crew specific code to aggregate O₂ consumption, CO₂ production, water consumption/production and waste produced. Sensors were created to record these values to the log file or in the Simulation GUI. Created a group level O₂, CO₂, Water Consumed, Water Produced, and Waste sensors that can be initialized as part of the simulation configuration to roll up crew values in a single place without having to individually parse and add up individual crew members usage from the log file. Modification were also made to better track crew member activities and functions during the simulation. Additional modifications were required to correct some observed conditions where values were incorrectly set when attempting to schedule crewmember arrival and departures during the simulation.

Plant Monitoring.

Currently the plant implementation allows for detailed logging of O₂ production, CO₂ consumption, Water consumption, and Water production by the plants in the Biomass Production modules. Like the crew monitoring values, sensors were created that could be initialized as part of the simulation configuration to rollup values in a single place. For single crop runs, no additional changes were required other than enabling of 'debug' mode on plant implementations. Multiple Crops required modification of the plant implementation specific code to aggregate multiple crops into a single value for ease of analysis.

Specific module source code changes

The following java source code modules were modified to implement the crew and plant monitoring. For specific changes please see the code repository and history at <https://github.com/ciholmer/UND> .

Medications to Source Client Code Modules

Util (com.traclabs.biosim.client.util)

BioHolder.java and BioHolderInitalizer.Java

- Added support for CrewGroupO2ConsumerSensor, CrewGroupCO2ProducerSensor, CrewGroupWaterConsumerSensor, CrewGroupWaterProducerSensor, CrewGroupWasteProducerSensor, CrewGroupFoodConsumedSensor, BiomassTotalCO2ConsumedSensor, BiomassTotalO2ProducedSensor, BiomassTotalWaterConsumedSensor, BiomassTotalWaterProducedSensor to allow for implementation of the sensors

Medications to Framework Code Modules

None

Modifications to Source Interface Definition Language code

`com.tracklabs.biosim.idl`

`biosim.idl`

- Added interface definitions for the CrewPerson section for `getO2Consumed`, `getCO2Produced`, `getWaterConsumed`, `getWaterProduced`, `getWasteProduced`, `getFoodConsumed`
- Added interface definitions for the CrewGroup section for functions for `getO2Consumed`, `getCO2Produced`, `getWaterConsumed`, `getWaterProduced`, `getWasteProduced`, `getFoodConsumed`
- Added interface definitions for the Food section for `BiomassTotalO2ProducedSensor`, `BiomassTotalCO2ConsumedSensor`, `BiomassTotalWaterConsumedSensor`, and `BiomassTotalWaterProducedSensor`.

Modifications to Server Source Code

Crew Sensor (`com.tracklabs.biosim.server.sensor.crew`)

`CrewGroupO2ConsumedSensorImpl.java`

- Created sensor implementation to allow for the gathering of O2 consumed at the crew group level, code based on `CrewGroupProductivitySensorImpl`

`CrewGroupCO2ProducedSensorImpl.java`

- Created sensor implementation to allow for the gathering of CO2 produced at the crew group level, code based on `CrewGroupO2ConsumedSensorImpl`

`CrewGroupWaterProducedSensorImpl.java`

- Created sensor implementation to allow for the gathering of Water produced at the crew group level, code based on `CrewGroupO2ConsumedSensorImpl`

`CrewGroupWasteProducedSensorImpl.java`

- Created sensor implementation to allow for the gathering of the waste produced at the crew group level, code based on `CrewGroupO2ConsumedSensorImpl`

`CrewGroupWaterConsumedSensorImpl.java`

- Created sensor implementation to allow for the gathering of Water consumed at the crew group level, code based on `CrewGroupO2ConsumedSensorImpl`

`CrewGroupFoodConsumedSensorImpl.java`

- Created sensor implementation to allow for the gathering of the Food consumed at the crew group level, code based on `CrewGroupO2ConsumedSensorImpl`

Food Sensor (com.traclabs.biosim.server.sensor.food)

BiomassTotalCO2ConsumedSensorImpl.java

- Created sensor implementation to allow for the gathering of CO2 consumed at the overall biomass level, code based on CrewGroupO2ConsumerSensorImpl

BiomassTotalO2ProducedSensorImpl.java

- Created sensor implementation to allow for the gathering of O2 produced at the overall biomass level, code based on BiomassTotalCO2ConsumedSensorImpl

BiomassTotalWaterConsumedSensorImpl.java

- Created sensor implementation to allow for the gathering of Water consumed at the overall biomass level, code based on BiomassTotalCO2ConsumedSensorImpl

BiomassTotalWaterProducedSensorImpl.java

- Created sensor implementation to allow for the gathering of water produced at the overall biomass level, code based on BiomassTotalCO2ConsumedSensorImpl

Framework (com.traclabs.biosim.server.sensor.framework)

SensorInitializer.java

- Add sensor initialization for Crew Group Sensors:
 - O2Consumed
 - CO2Produced
 - FoodConsumed
 - WaterConsumed
 - WaterProduced
 - Waste Produced
- Add sensor initialization for Biomass Sensors:
 - TotalCO2Consumed
 - TotalO2Consumed
 - TotalWaterProduced
 - TotalWaterConsumed

Air (com.traclabs.biosim.server.simulation.air)

VCCRLinearImpl.java

- Provide more detailed logging for the carbon dioxide produced.

Crew (com.traclabs.biosim.server.simulation.crew)

BaseCrewPersonImpl.java

- Added `getCurrentActivityName()` function to return the current activity as a string for use in logging
- Modified `arriveOrDepart()` function to correct a logic error when determining if a crew member had arrived or departed the simulation. Created the new activities of 'Absent' and 'Onboard' to allow for a crew member to be listed in the configuration but not in the simulation.
- Added `isOnBoard()` function to easily check to see if a crew member is in the simulation or not.
- Added `getO2Consumed()`, `getCO2Produced()`, `getWaterConsumed()`, `getDirtyWaterProduced()`, `getGreyWaterProduced`, `getFoodConsumed`, `getDryWasteProduced()` functions for aggregate logging.

CrewPersonImpl.java

- Added variables for crew aggregate logging.
- Added activity to the logging routine to track the current crew members activity change during simulation execution.
- Added `getO2Consumed()`, `getCO2Produced`, `getWaterConsumed()`, `getDirtyWaterProduced()`, `getGreyWaterProduced`, `getFoodConsumed`, `getDryWasteProduced()` functions for aggregate logging.

Schedule.java

- Modified `createDefaultActivites()` to add 'absent' and 'Onboard' activity to assist with the proper scheduling of crewmembers in and out of the simulation

CrewGroupImpl.java

- `getO2Consumed()`
- `getCO2Produced()`
- `getGreyWaterProduced()`
- `getDirtyWaterProduced()`
- `getPotableWaterConsumed()`
- `getFoodConsumed()`
- `getDryWasteProdcued()`

Food (com.traclabs.biosim.server.simulation.food)

BiomassPSImpl.java

- Added `getTotalO2Produced()`, `getTotalCO2Consumed()`, `getTotalWaterConsumed()`, `getTotalWaterProduced()` functions to aggregate resources by all the plants on the shelves.

PlantImpl.java

- Modified `growBiomass()` to enable better logging of carbon dioxide and oxygen produced.
- Added variables for plant/crop aggregate logging.
- Added `getMolesOfCO2Consumed`, `getMolesofO2Produced`, `getLtrWaterConsumed`, `getLtrWaterProduced`, `getMolesWaterProduced` functions for aggregate logging.

BiomassImpl.java

- Added `getCO2Consumed`, `getO2Produced`, `getWaterConsumed`, `getWaterProduced` functions for aggregate logging.

Food Sensor (com.traclabs.server.sensor.food)

Added:

- `BiomassTotalO2ProducedSensorImpl`
- `BiomassTotalCO2ConsumedSensorImpl`
- `BiomassTotalWaterConsumedSensorImpl`
- `BiomassTotalWaterProducedSensorImpl`

Food Interface (com.traclabs.biosim.idl.simulation.food)

`_ShelfStub.java`, `ShelfOperations.java`, `ShelfPOA.java`, and `ShelfPOATie.java`

Added:

- `getCropO2Produced`
- `getCropCO2Consumed`
- `getCropWaterConsumed`
- `getCropWaterProduced`

Waste (com.traclabs.biosim.server.simulation.waste)

`IncineratorImpl.java`

- Modified `log()` to enable better logging of all values tracked including carbon dioxide produced.

Modifications to Server Code Stubs

Com.traclabs.biosim.idl.sensor.crew

Added:

- `_CrewGroupO2ConsumedSensorStub.java`
- `CrewGroupO2ConsumedSensor.java`
- `CrewGroupO2ConsumedSensorHelper.java`
- `CrewGroupO2ConsumedSensorHolder.java`
- `CrewGroupO2ConsumedSensorOperations.java`

- CrewGroupO2SensorPOA.java
- CrewGroupO2SensorPOATie.java
- _CrewGroupCO2ProducedSensorStub.java
- CrewGroupCO2ProducedSensor.java
- CrewGroupCO2ProducedSensorHelper.java
- CrewGroupCO2ProducedSensorHolder.java
- CrewGroupCO2ProducedSensorOperations.java
- CrewGroupCO2ProducedPOA.java
- CrewGroupCO2ProducedPOATie.java
- _CrewGroupWaterConsumedSensorStub.java
- CrewGroupWaterConsumedSensor.java
- CrewGroupWaterConsumedSensorHelper.java
- CrewGroupWaterConsumedSensorHolder.java
- CrewGroupWaterConsumedSensorOperations.java
- CrewGroupWaterSensorPOA.java
- CrewGroupWaterSensorPOATie.java
- _CrewGroupFoodConsumedSensorStub.java
- CrewGroupFoodConsumedSensor.java
- CrewGroupFoodConsumedSensorHelper.java
- CrewGroupFoodConsumedSensorHolder.java
- CrewGroupFoodConsumedSensorOperations.java
- CrewGroupFoodSensorPOA.java
- CrewGroupFoodSensorPOATie.java
- _CrewGroupWaterProducedSensorStub.java
- CrewGroupWaterProducedSensor.java
- CrewGroupWaterProducedSensorHelper.java
- CrewGroupWaterProducedSensorHolder.java
- CrewGroupWaterProducedSensorOperations.java
- CrewGroupWaterProducedSensorPOA.java
- CrewGroupWaterProducedSensorPOATie.java
- _CrewGroupWasteProducedSensorStub.java
- CrewGroupWasteProducedSensor.java
- CrewGroupWasteProducedSensorHelper.java
- CrewGroupWasteProducedSensorHolder.java
- CrewGroupWasteProducedSensorOperations.java
- CrewGroupWasteProducedSensorPOA.java
- CrewGroupWasteProducedSensorPOATie.java

Com.traclabs.biosim.idl.sensor.food

Added:

- _BiomassTotalCO2ConsumedSensorStub.java
- BiomassTotalCO2ConsumedSensor.java
- BiomassTotalCO2ConsumedSensorHelper.java

- BiomassTotalCO2ConsumedSensorHolder.java
- BiomassTotalCO2ConsumedSensorOperations.java
- BiomassTotalCO2ConsumedSensorPOA.java
- BiomassTotalCO2ConsumedSensorPOATie.java
- _BiomassTotalO2ProducedSensorStub.java
- BiomassTotalO2ProducedSensor.java
- BiomassTotalO2ProducedSensorHelper.java
- BiomassTotalO2ProducedSensorHolder.java
- BiomassTotalO2ProducedSensorOperations.java
- BiomassTotalO2ProducedSensorPOA.java
- BiomassTotalO2ProducedSensorPOATie.java
- _BiomassTotalWaterProducedSensorStub.java
- BiomassTotalWaterProducedSensor.java
- BiomassTotalWaterProducedSensorHelper.java
- BiomassTotalWaterProducedSensorHolder.java
- BiomassTotalWaterProducedSensorOperations.java
- BiomassTotalWaterProducedSensorPOA.java
- BiomassTotalWaterProducedSensorPOATie.java
- _BiomassTotalWaterConsumedSensorStub.java
- BiomassTotalWaterConsumedSensor.java
- BiomassTotalWaterConsumedSensorHelper.java
- BiomassTotalWaterConsumedSensorHolder.java
- BiomassTotalWaterConsumedSensorOperations.java
- BiomassTotalWaterConsumedSensorPOA.java
- BiomassTotalWaterConsumedSensorPOATie.java

Modifications to Server Resource Framework Configurations

Com.traclabs.biosim.server.framework.schema.sensor

Added to crew.xsd:

- CrewGroupO2ConsumedSensorType
- CrewGroupCO2ProducedSensorType
- CrewGroupWaterConsumedSensorType
- CrewGroupWaterProducedSensorType
- CrewGroupWasteProducedSensorType
- CrewGroupFoodConsumedSensorType

Modified the CrewSensorsType to include new sensor types.

Added to food.xsd:

- BiomassTotalCO2ConsumedSensorType
- BiomassTotalO2ProducedSensorType

- BiomassTotalWaterConsumedSensorType
- BiomassTotalWaterProducedSensorType

Modified the FoodSensorsType to include new sensor types.

Results and Analysis

Methods of Analysis

To examine the hypothesis that ‘stability overall is correlated with scale, depth, and efficiency of material processing’ and that it ‘can be linked through closure degree and tropic network complexity’ we first look at the CLESS senario and facility to determine the theoretical stability and closure indexes for the experiment as explained in section “Correlation between Closure Degree, Tropic Network Complexity, and Stability Level” on page 58. A converter map similar to Figure 33 is created based on the scenario to assist with calculations and visualization of the data. Then Equation 15 - Equation 20 is applied to arrive at the Theoretical Closure and Stability Indexes. To endure the proper level of efficiency is used for the converters, an examination of the real world results of that converter are examined.

A general model for the converters is then created for the scenario using the methods in section “Methods for detecting critical transitions” on page 68. Once this model is created, the simulation scenario is translated into a configuration file to run in BioSim. The measurements for the converters values for the simulation execution are recorded in the simulation log file. The log file is then parsed and imported into a spreadsheet to apply the stability calculations and look for critical transition early warning signals to support the stability conclusions.

To ensure statistically valid samples, multiple runs of the configuration will be made to ensure a consistent outcome.

Since this model can be applied to existing experiments, two progressively closed experiments were chosen to both validate the BioSim accuracy and examine the proposed calculated theoretical closure index with the observed actual values from the experiment. This also demonstrated that methods described can handle an increasingly complex system. The Lunar-Mars Life Support Test Project (LMLSTP) was chosen for this proof of concept and validation comparison.

Simulation Executions and Resulting Analysis

BioSim Validation

Proof of Concept – LMLSTP Phase I

Phase I of the LMLSTP was conducted in July 1995 and was the first in a series of tests at JSC utilizing crops to revitalize atmospheric conditions in a habitat with human test subjects. (Barta, Dominick, & Kallberg, 1995; Barta D. J., 2016; Barta D. , et al., 2006; Edeen & Barta, 1996; Lane, Sauer, & Feeback, 2002) The overall goal was to conduct a continuous test with a single person to verify performance of using higher plants (Wheat, Yecora Rojo) for atmospheric regeneration with physiochemical systems for complement and backup. Food and potable water were stored in chamber, hygiene water and solid

waste were not recycled. The test lasted 15 days, with the wheat crop grown in the Variable Pressure Growth Chamber (see Figure 12 and Figure 14). The test subject would be in the chamber for 15 days during the anticipated peak oxygen generating capability between day 15 and 45. Gas levels will be continued to be monitored after the crew departure until day 65. (Edeen & Barta, 1996, p. 13; Lane, Sauer, & Feedback, 2002, p. 38)

The objectives of the simulation for this validation test:

- Create a stable stimulation with all of the components from the LMLSTP Phase I experiment
- Verify the growth model of the simulated wheat produces a similar result that was observed in the LMLSTP Phase I experiment
- Verify that the gas exchange model of the crew member is consistent with the results observed in LMLSTP Phase I experiment
- Verify that the gas exchange between the simulated wheat and crew member is consistent with the results observed in the LMLSTP Phase I experiment
- Verify that the controller model can adequately inject gasses from storage into the simulated environment and keep the gas levels within levels observed in the LMLSTP Phase I experiment

The secondary objectives for this simulation will be to examine the gas exchange levels for possible signs of critical transformation signals as described in the section 'Methods for detecting critical transitions' on page 68. Given the short duration of this experiment and the fact that only the fast gas exchange cycle will be monitored, it is not expected that any signals will be observed.

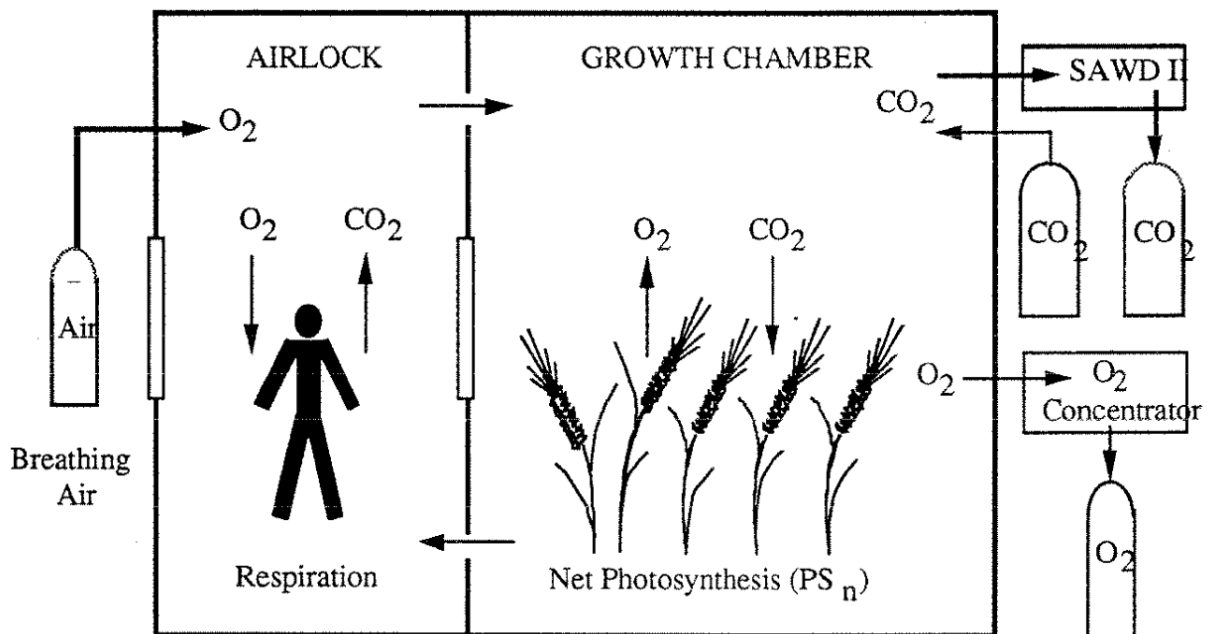

Figure 44 LMLSTP Phase I Gas Exchange Diagram (Barta D. J., 2016)

Stability and Closure Index

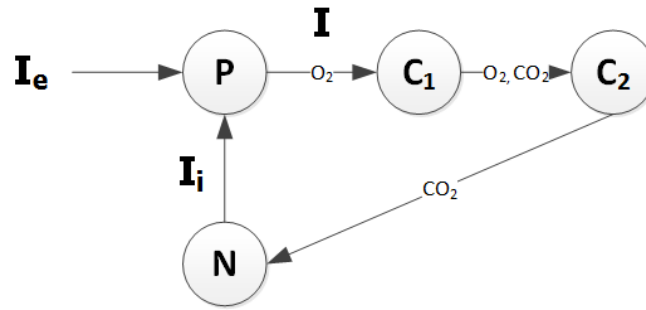

Figure 45 LMLSTP Phase I Material Cycling Diagram

Two converters are present in this scenario. C1 is the crew member in the air lock. C2 is the Solid Amine Water Desorbed (SWAD II) molecular sieve. The N Stores include both Oxygen and Carbon Dioxide for injection if needed. Carbon Dioxide was injected, and Oxygen removed during non-human occupation that would mimic a human in the system. (Lane, Sauer, & Feedback, 2002, p. 38; Edeen & Barta, 1996, p. 13) Since Oxygen is injected as needed into the system from the stores, the Oxygen removed by SWAD II is not treated as deadlocked for calculations.

The reported CO₂ conversion by the Plants in Phase I actual test was almost 100%. The wheat crop removed a total of 79.5 kg of CO₂ from the chamber during the 68-day test. Respiration by Bob Roberts was calculated to be 20.6 kg during the 15-day human test and 58.9 kg were injected into the system over the other days. Similarly, the O₂ production was equally efficient between the human test subject and the SWAD II molecular sieve. (Edeen & Barta, 1996, pp. 17-19) Given this description q for the CI calculation will be set at 99%.

$$q = \frac{0.999 + 0.999}{2}$$

$$q = 0.999$$

Figure 46 Determining q for the Gas Converter portion of LMLSTP Phase I

Applying Equation 16:

$$CI = \frac{I_i}{I} = 1 - (1 - q)^N$$

$$CI = 1 - (1 - .99)^2$$

$$CI = .9999$$

Figure 47 LMLSTP Phase I Gas Converter Closure/Stability Index Calculation

This results in a Closure/Stability Index of .9999, however, this is only for the gas exchange portion of the overall habitat. This level of stability is expected for this experiment since we are only looking at a single cycle of the slowest cycle in the system, the growth of the wheat crop. The cycle time for the wheat crop is 65 days and the full length of the experiment was 68 days. Given this, we should not see any critical transition warning signs until close to the end of the experiment if at all.

If we assume that the food, water, and waste portions of the system are essentially deadlocked or not cycled for the full system, this will increase the number of converter cycles for N to 5. This will allow for the CI index to be directly compared to that of Phase 3. The value for q would drop to 39.96% (the average conversion efficiency across all 5 converters) with 0% applied for the other 3 cycles. This results in overall closure/stability index of 0.9219.

$$q = \frac{0.999 + 0.999 + 0 + 0 + 0}{5}$$

$$q = 0.3996$$

$$CI = 1 - (1 - .3996)^5$$

$$CI = 1 - (.6004)^5$$

$$CI = .9219$$

Figure 48 LMLSTP Phase I System Closure/Stability Index Calculation

Parameters and Assumptions

One of the primary objectives of the actual LMLSTP Phase I was to examine different control modes for controlling the level of photosynthesis by the crop plants during the human occupied portion. These were not attempted to be reproduced during test runs of the simulation.

Initial Atmospheric conditions were set to the mean value for the ranges documented for Phase IIa in section 2.1 of ISOLATION: NASA Experiments in Closed-Environment Living, pg 42.

Atmospheric Element	Percent Composition
Water Vapor	1%
Nitrogen	65.9%
Carbon Dioxide	0.33%
Oxygen	21%
Other Elements	0.1%

Table 4 Initial LMLSTP Phase I BioSim Atmospheric Composition

Modules

Two modules were used the actual Experiment. The Airlock chamber and the VPCG. Airflow between the two chambers was reported to be free flowing (Barta, Dominick, & Kallberg, 1995), therefore, to simplify the simulation, these were combined into a single 'Sim Environment' module that contained both the crew and the plants. The volume used for the Sim Environment was 44.8 m³ due to the simulated wheat plants under-performing in CO₂/O₂ comparisons with actual test results.

Crew and Activities

The crew member for the Actual Phase I was Bob Roberts. For privacy reasons, Mr. Roberts's actual bio-stats were not published, but he was described as a 43-year-old male weighing 77kg in the sample BioSim configuration file. (Traclabs Inc, 2017) These values were used for the simulation.

Figure 49 shows the anticipated daily metabolic profile for the actual test event. BioSim's smallest time slice is 1 hour (1 'Tick'). The exercise period was combined to be a single period lasting an hour. BioSim

also uses an intensity rating for respiration and metabolic expenditure depending on the activity to be scheduled. The BioSim schedule and intensity was set to values shown in Table 5.

Activity	Length (in Ticks)	Intensity
Sleep	8	1
Hygiene	1	2
Exercise	1	5
Eating	1	2
Mission	9	3
Health	1	2
Maintenance	1	2
Leisure	2	2

Table 5 LMLSTP Phase I BioSim Crew Activity Schedule

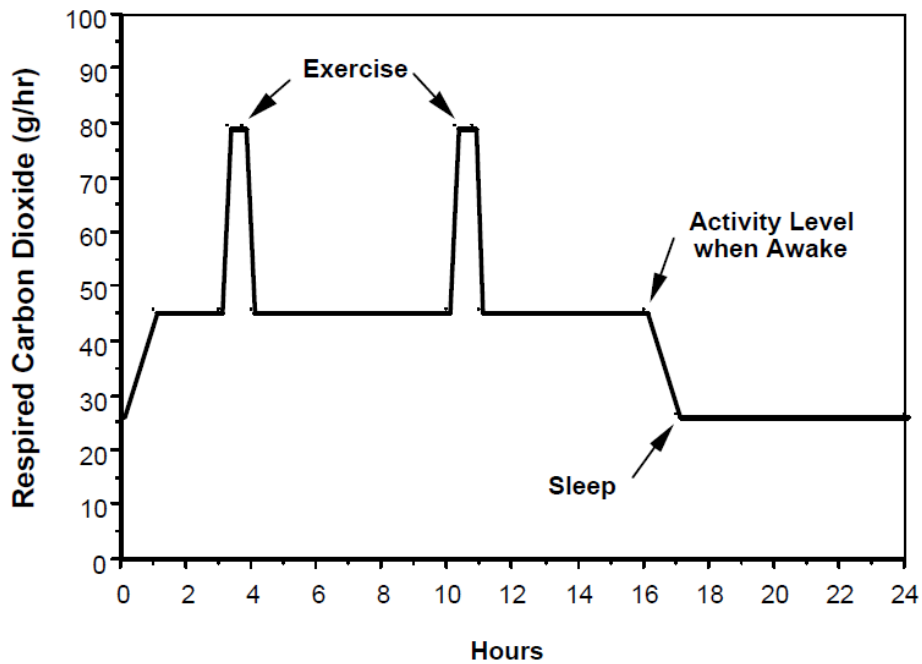

Figure 49 LMLSTP Phase I Baseline daily metabolic profile (expected) (Edeen & Barta, 1996; Barta D. J., 2016)

Duration

The actual Phase I test was conducted in July and August of 1996 and ran for 68 days with the human entering on day 17 for a 15 day stay. (Edeen & Barta, 1996) The simulation was programmed to run for 1680 ‘ticks’ or 70 days. The crew member ‘Bob Roberts’ was scheduled to enter on ‘tick’ 408 and depart on ‘tick’ 768.

Outcome Analysis

The BioSim recreation of LMLSTP Phase I was completed using the configuration in Appendix A1 – Lunar-Mars Life Support Test Project Phase I. The simulation completed with the simulated crewmember exiting the chamber in good virtual health.

The growth of the virtual wheat crop did perform as expected as can be seen in the Carbon Dioxide absorption rate by comparing Figure 50 LMLSTP Phase I Actual Carbon Dioxide Absorption and Figure 51 LMLSTP Phase I Sim Carbon Dioxide Sources. While this was achieved, an anomaly was observed in earlier tests. The growth area reported for the wheat in LMLSTP Phase I was 11.2 m². (Barta D. J., The Lunar Mars Life Support Test Project, 2016; Eckart, 1994; Edeen & Barta, 1996) Testing with this area with BioSim resulted in an underperformance of the simulated wheat by almost exactly 75%. Increasing the growth area to 44.8m² allowed for the duplication of the actual LMLSTP gas exchange data as seen in Figure 51 and Figure 53.

The simulated crew member did consume the expected levels of Oxygen and produced the expected levels of Carbon Dioxide. These levels fluctuated as expected due to the crew members activities as prescribed in Table 5 LMLSTP Phase I BioSim Crew Activity Schedule and were within the observed ranges from the LMLSTP Phase I experiment.

While the early respiration profile was matched in the simulation during the simulated crew member occupation (Figure 50 LMLSTP Phase I Actual Carbon Dioxide Absorption and Figure 51 LMLSTP Phase I Sim Carbon Dioxide Sources) were not exactly duplicated, due to two different factors. First, the simulations injection of CO₂ did not trail off in the later part of the simulation due to an acknowledged limitation in the plant model (Traclabs Inc, 2017) where CO₂ conversion does not slow as the plant reaches maturity as was see in the real world results. Additionally, the LMLSTP Phase I experiment did further experiments with adjusting the lighting in the growth chamber for the second half of the human occupation to examine lighting effects on CO2 absorption rates of the plants and match the respiration of the human occupant. (Barta D. J., The Lunar Mars Life Support Test Project, 2016; Eckart, 1994; Edeen & Barta, 1996) This was not attempted in the simulation. Given that the expected levels were seen and maintained, it is concluded that this did validate the internal models of BioSim for human and plant respiration.

The simulation controller did inject Carbon Dioxide from stores during the execution keeping the CO² levels in the simulation between the target values of 1251 +/- 448 PPM of CO₂ as was seen in the LMLSTP Experiment. (Edeen & Barta, 1996). While O² was not injected, the simulation did active the oxygen concentrator to remove excess oxygen from the environment and add it back to the O² storage to keep the oxygen concentration levels below 22.6% documented by LMLSTP Phase I (Edeen & Barta, 1996).

Examination of the eigenvalues for critical transitions in the gas exchange model (Figure 58 BioSim eigenvalues for oxygen LMLSTP) was, as expected, inconclusive due to the short duration of the test. It appears that no instabilities had time to develop. Examination of the eigenvalues on an hour by hour basis proved to be too noisy for any meaningful analysis. Using the daily average values to look for possible transitions was clearer, but still inconclusive. The system appeared to destabilize when the human enters the simulation but returns to stable quickly after they depart. Given the lack of evidence for critical transitions, they cannot be used to verify/validate the predicted stability index calculations for this particular validation run.

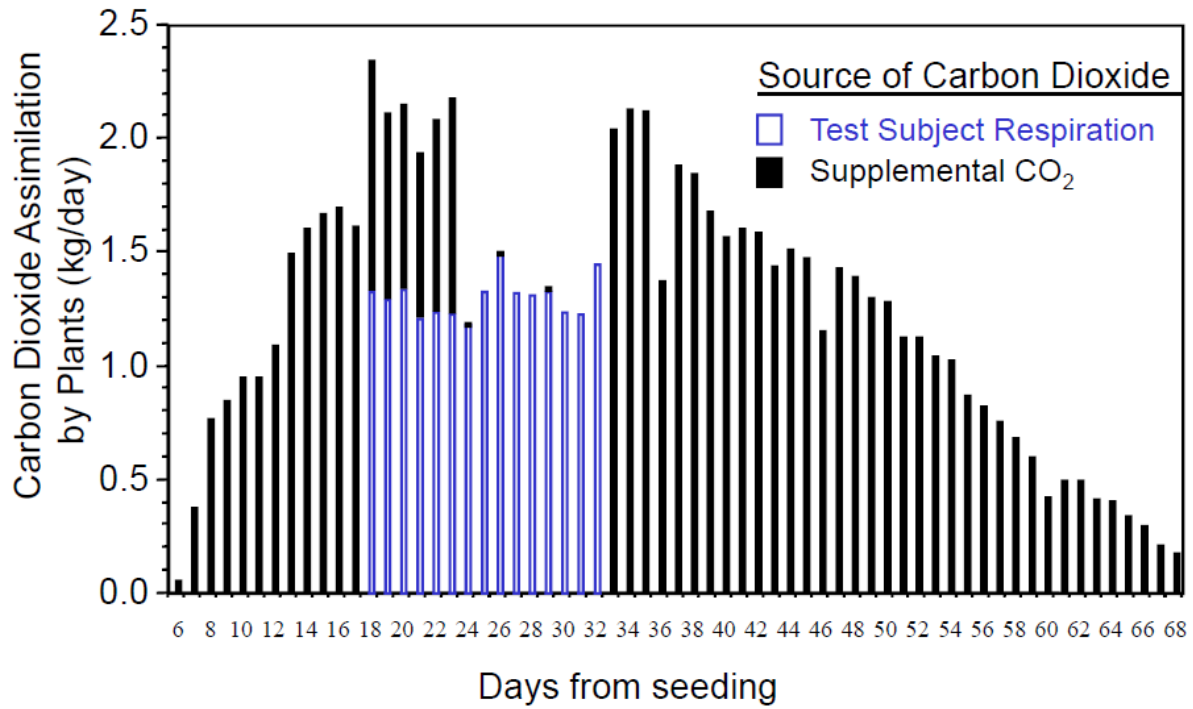

Figure 50 LMLSTP Phase I Actual Carbon Dioxide Absorption (Barta D. J., 2016)

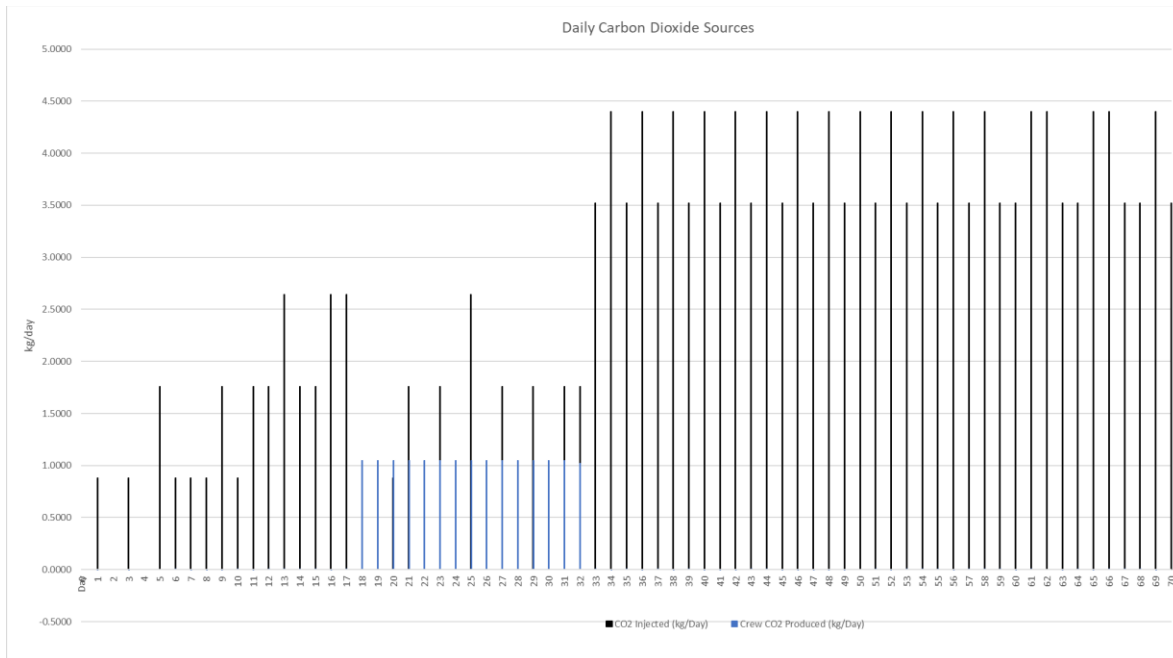

Figure 51 LMLSTP Phase I Sim Carbon Dioxide Sources

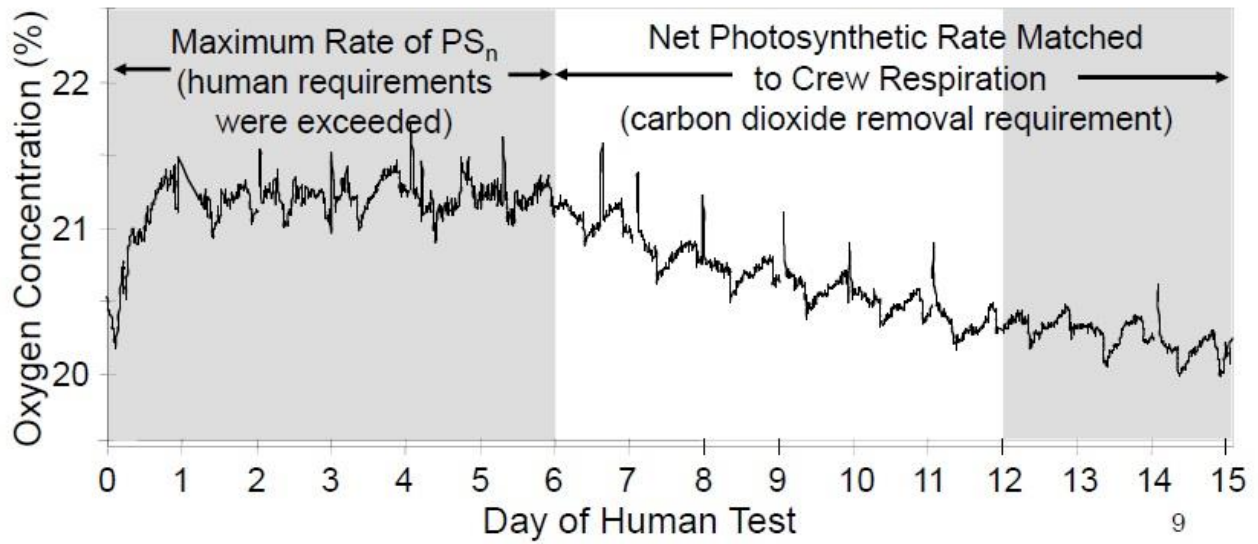

Figure 52 Oxygen Concentration in LMLSTP Phase I during human occupation (Barta D. , et al., 2006; Barta D. J., The Lunar Mars Life Support Test Project, 2016)

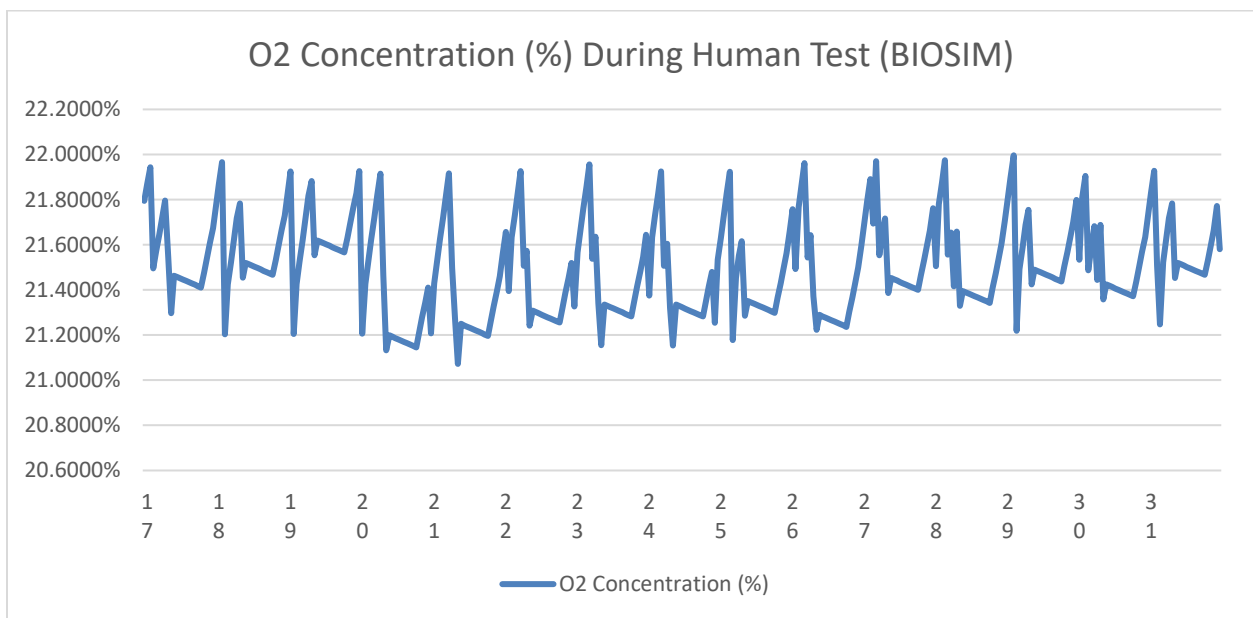

Figure 53 Oxygen Concentrations in Sim LMLSTP Phase I during simulated crew occupation

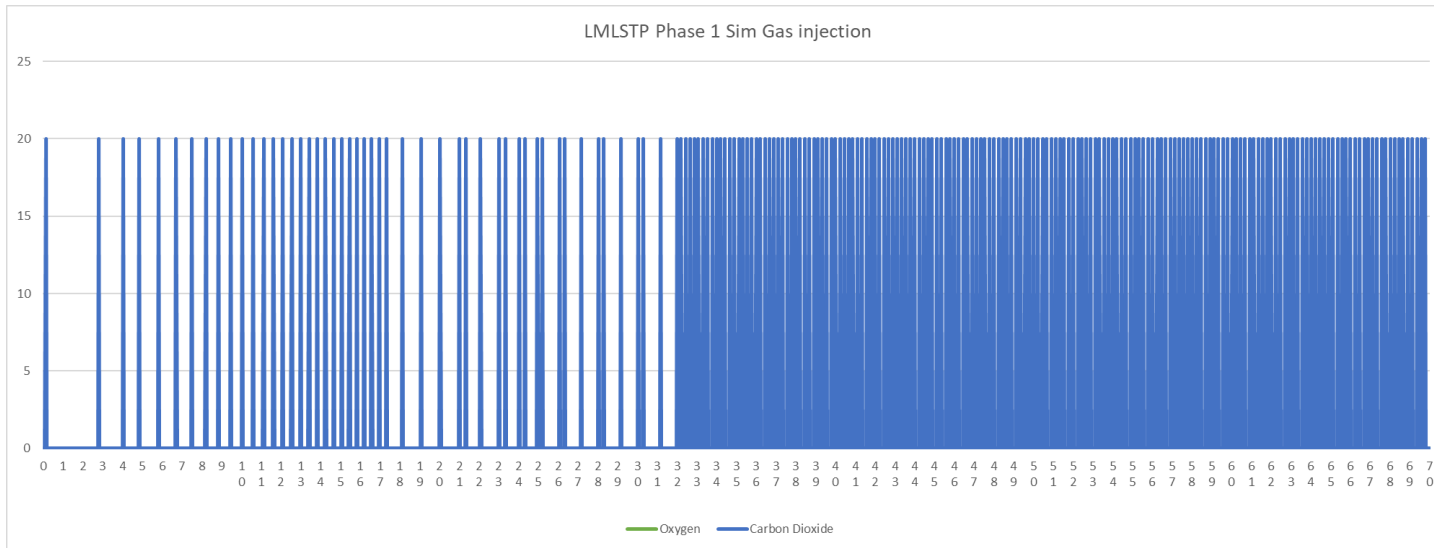

Figure 54 BioSim Gas injection LMLSTP Phase I (moles)

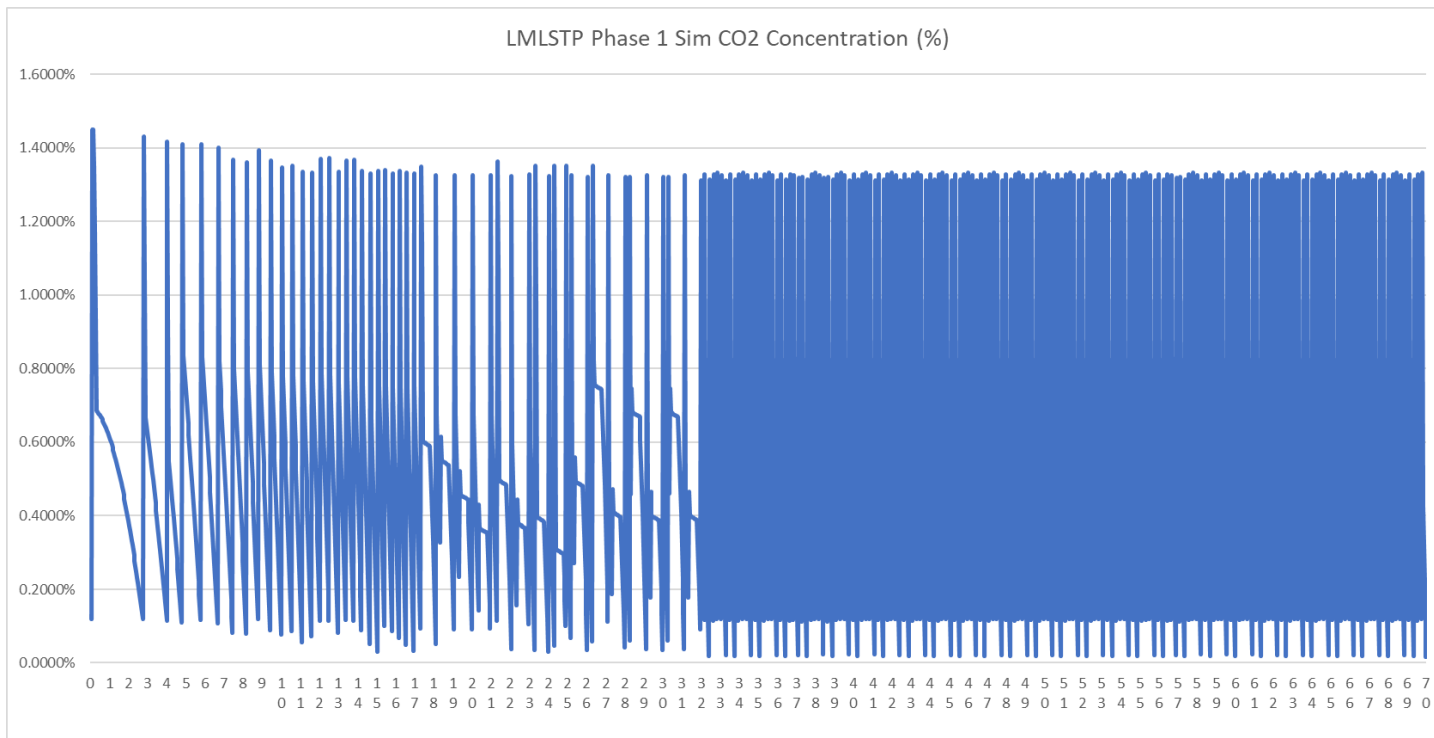

Figure 55 BioSim CO2 Concentration LMLSTP Phase I

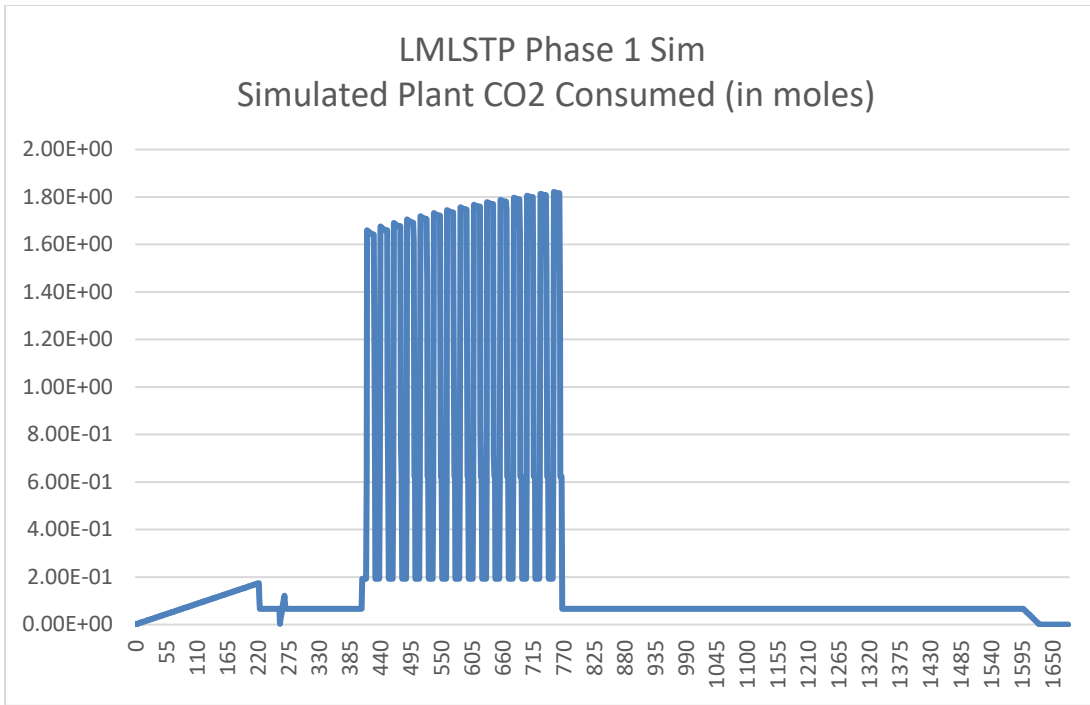

Figure 56 BioSim Plant Carbon Dioxide Absorption LMLSTP Phase I

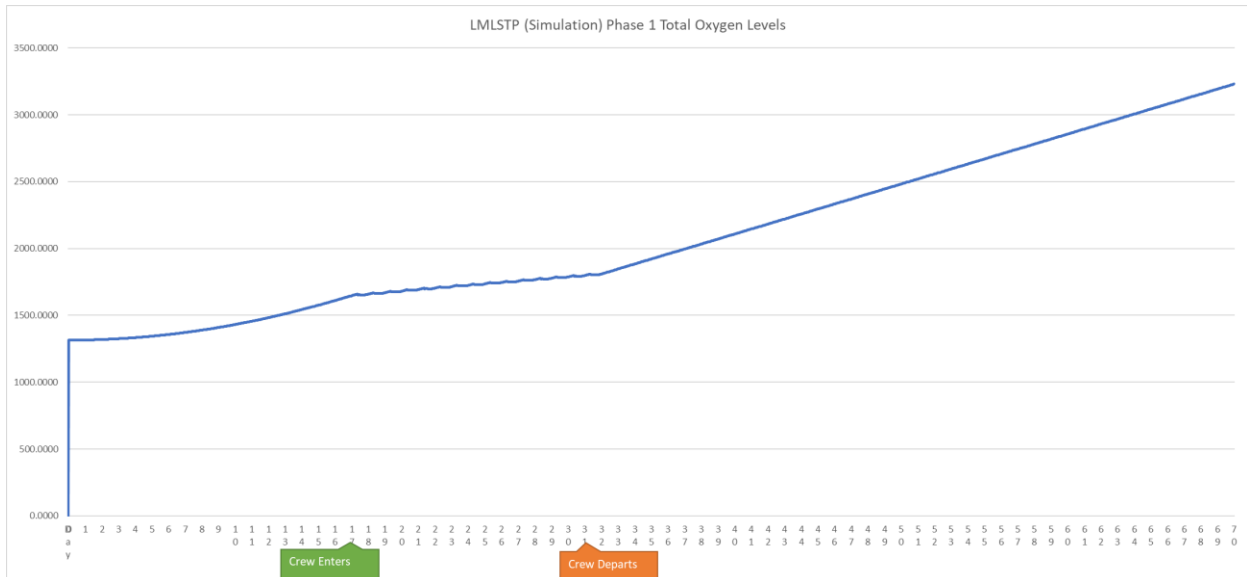

Figure 57 BioSim Environment Oxygen levels LMLSTP Phase I

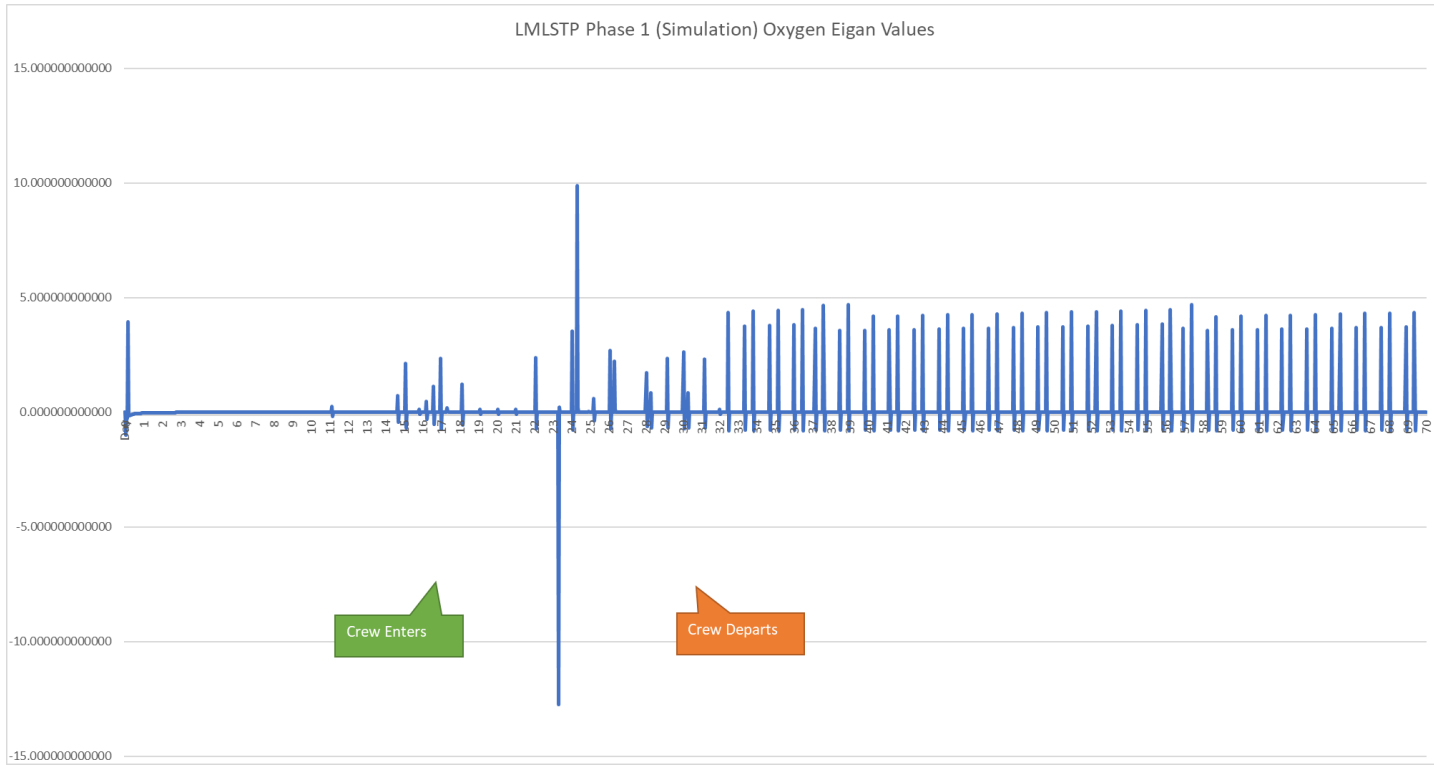

Figure 58 BioSim eigenvalues for oxygen LMLSTP Phase I

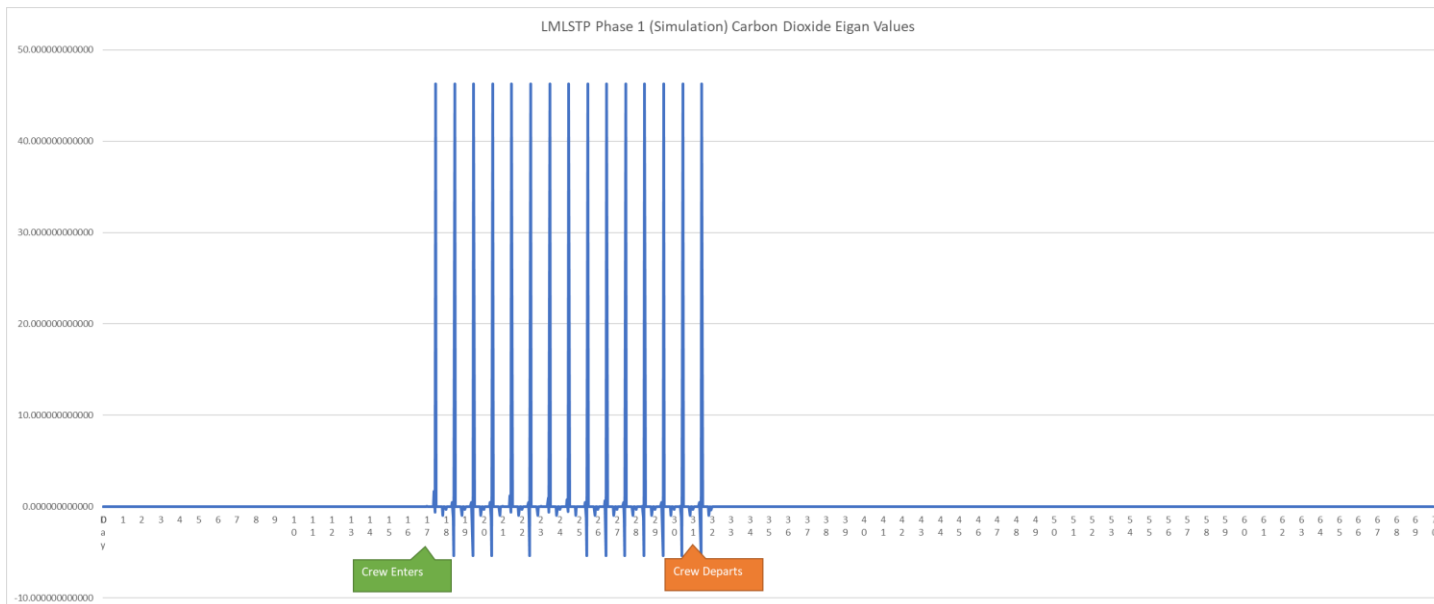

Figure 59 BioSim eigenvalues for carbon dioxide in LMLSTP Phase I

Proof of Concept – LMLSTP Phase III

The LMLSTP phase III test, was the final of four closure tests conducted at JSC. Unlike phase I, this test was a full hybrid of physicochemical and biological life support technologies and cycled air, water, and part of the solid waste cycle. This connected the large Life Support Systems Integrated Test Facility (LISSF) at JSC with the Variable Pressure Growth Chamber at KSC. A crew of 4 was enclosed for 91 days. Lettuce was grown in the main habitat and the wheat produced in the VPGC was dried, transferred to the habitat, and use for baking bread. The VPGC maintained the same size as Phase I and was only depended on for revitalizing a single crew member's atmosphere, capacity for the other 3 crew members was covered by physiochemical means and stored reserves (NASA, 2000).

The objectives of the simulation for this validation test:

- Create a stable simulation with all the components from the original LMSTP Phase III experiment
- Verify that the gas exchange model of the crew members is consistent with the results observed, without the system malfunctions, in LMLSTP Phase III experiment
- Verify the water cycle of the simulation model is consistent with the results observed in the LMLSTP Phase III experiment
- Verify that the controller model can adequately manage all the physio-chemical models and keep the simulation gas, water, and waste levels within levels observed in the LMLSTP Phase III experiment

As with the Phase I simulation, the secondary objectives for this simulation will be to examine the gas, water and waste exchange levels for possible signs of critical transformation signals as described in the section ' Methods for detecting critical transitions' on page 68. Given the longer duration of this experiment and that several slow cycles will be executed with different systems (wheat, water, waste) it is possible that some signals will be observed. However, this experiment was designed for stability (Edeen & Barta, 1996), and no instabilities were reported observed in the actual experiment.

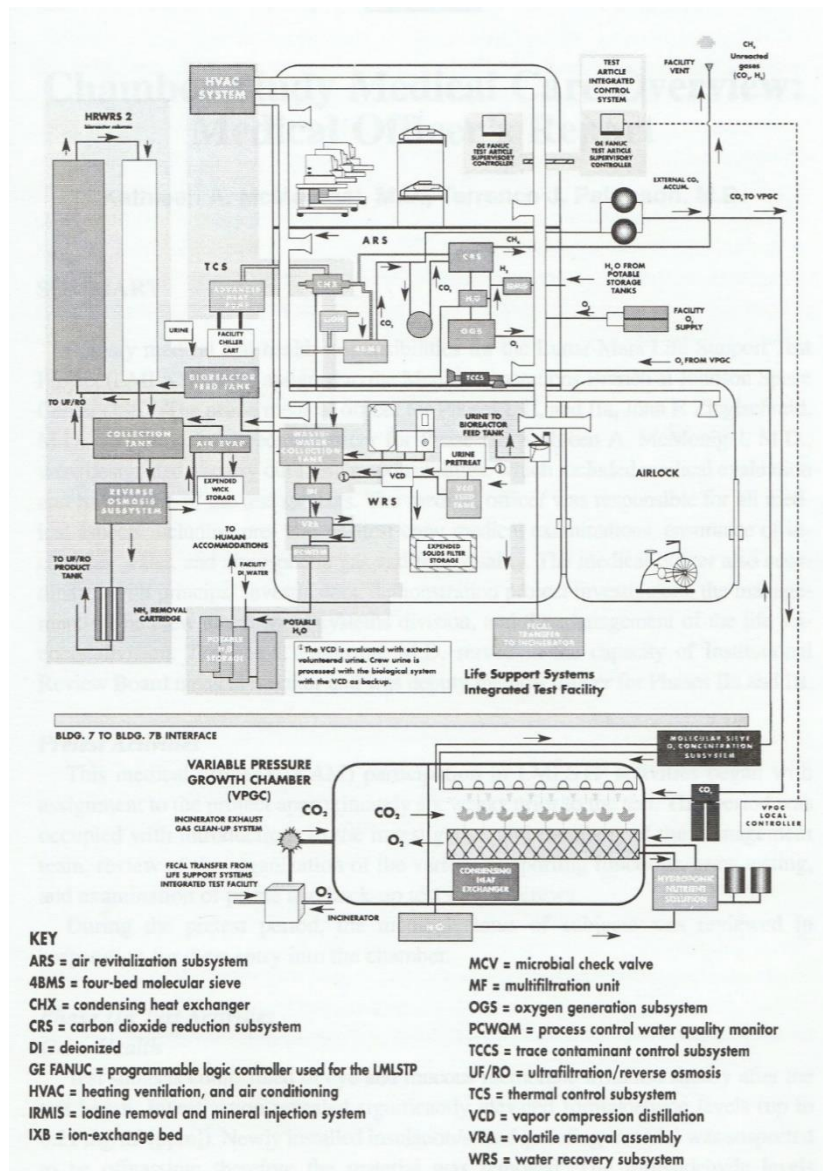

Figure 60 LMLSTP Phase III, 91 day test functional schematic (Lane, Sauer, & Feedback, 2002, p. 49)

Stability and Closure Index

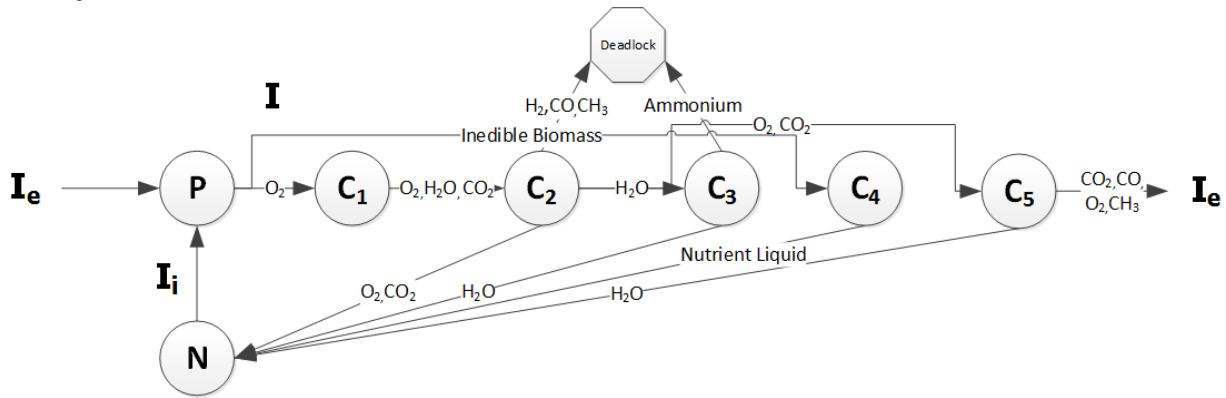

Figure 61 LMLSTP Phase III Material Cycling Diagram

Five converters are present in this scenario. C1 is the crew members. C2 is the plants and the Air Revitalization Subsystem (ARS) which consists of Oxygen Generation Subsystem (OGS), Carbon Dioxide Reduction Subsystem (CRS), and the 4 Bed Molecular Sieve (4BMS). C3 is the Water Recovery Subsystem (WRS). C4 is the Dry Waste Converter where inedible biomass was liquified using a bioreactor and nutrients recovered to create a recycled nutrient liquid. (Edeen & Pickering, 2000, pp. 11, 72) C5 is the Waste Incineration Subsystem (WIS), where both dry waste and fecal matter is incinerated using a fluidized bed incinerator (NASA, 2000, p. 87). Ash from the incinerator was dissolved using acid to recover salts (Edeen & Pickering, 2000, p. 91) and is not treated as deadlocked. The N Stores include Primary Food Supplies, Water, Oxygen and Carbon Dioxide. Other gasses such as un-reacted Methane, Carbon Monoxide and Hydrogen were vented to the outside in the actual experiment (Lane, Sauer, & Feedback, 2002, pp. 47-50) and will be treated at deadlock for the quality and mass portions of the calculation.

To determine the efficiency for C2, we need to examine each of the components; plants, OGS, CRS, and 4BMS. The reported CO₂ conversion by the Plants in Phase 3 actual test, like in Phase I, was almost 100%. The wheat crop removed on average 1.05kg/day over the 170-day period and 1.1kg/day during the 91 day crew test. Unfortunately, due to size limitations, this was only enough for a single crew member. (Edeen & Pickering, 2000, pp. 64-65) This puts its efficiency to 25%. The rest of the ARS sub systems (OGS, CRS, 4BMS) operated closer to 98% when accounting for deadlocked materials and reported leaks. (Edeen & Pickering, 2000, pp. 95-96) Using an average of each of these subsystems, the overall gas converter efficiency is set at a 79.5% for C2.

The Water Recovery System initially began at an 85% efficiency rating, but due to hardware installation issues, declined to 65% over the course of the test. (Edeen & Pickering, 2000, p. 98) The median value of 75% is used for the CI/SI calculation for C3.

The dry waste recovery process and nutrient recycler was reported to have achieved a 67% recovery rate. 395L of recycled plant nutrient liquid were produced. (Edeen & Pickering, 2000, p. 72)

The waste incinerator reportedly obtained an overall efficiency of 95% between incineration and gasses, water recovery, and dissolving the ash with acid. However, only 25% of the solid waste produced by the crew was processed. (Edeen & Pickering, 2000, p. 87) The overall rate for the incinerator node is set to 25%

$$q = \frac{0.999 + 0.795 + 0.750 + 0.670 + 0.250}{5}$$

$$q = 0.6928$$

Figure 62 LMLSTP Phase 3 System Closure/Stability Index Calculation for the value of q

The value for q is 69.28% (the average conversion efficiency across all 5 cycles)

$$CI = 1 - (1 - .6928)^5$$

$$CI = 1 - (.3072)^5$$

$$CI = .9972$$

Figure 63 LMLSTP Phase 3 System Closure/Stability Index Calculation

Parameters and Assumptions

As with Phase I, the initial Atmospheric conditions were set to the mean value for the ranges documented for Phase IIa in section 2.1 of ISOLATION: NASA Experiments in Closed-Environment Living, pg 42, see Table 4.

Modules

Two modules were used for the Phase III simulation. First, the Crew Habitat modeled the LISSF where the crew was housed and did their activities, modeling the individual floors and chambers in the habitat was evaluated to not have any overall effect on stability and would only complicate the simulation. The VPCG was original modeled separately as its own module, however limitations in the injector programming made maintaining this separation untenable. The connection between the modules as with the actual test, was accomplished using transfers to/from the Oxygen and Carbon Dioxide stores to mimic respiration.

Crew and Activities

Crew daily activities were modeled based on the Phase I daily activity (see Table 5), except that the 'exercise' and 'maintenance' periods for two crew members were switched since the exercise facilities could only accommodate two crewmembers at a time.

Duration

The overall crop growth period was 170 days with a staggered growth pattern for the crops. The crew began operations on day 58 and occupied the habitat for 91 days.

Plant components

The same VPGC was used for Phase 3 as was used in Phase I. In the real experiment, 5.6 m2 of wheat was planted to provide 25% of the atmospheric regeneration for the crew of 4. The full crop was

planted on day 0. The simulation, like Phase I, used 44.8 m² of simulated wheat due to the discovered issue of the plant respiration model. In both cases, 25% of the wheat was harvested at 20 day intervals to keep peak gas exchange available. The harvested wheat was threshed, and the usable grain sent to JSC for the crew to use in baking. The dry waste was kept at KSC and burned in an incinerator that was exhausted into the chamber. (NASA, 2000) In the simulation the calculated useable biomass is moved to the biomass storage for use by the crew and the dry waste moved to the dry waste storage for later use in the incinerator.

Physiochemical Systems

Primary gas cycling in Phase III was conducted using physiochemical systems in addition to the 25% processing provided by the wheat crop. (NASA, 2000; Barta D. J., 2016; Eckart, 1994) The Air Revitalization System (ARS) consists of the four Bed Molecular Sieve (4BMS), a Water-Save CO₂ Removal system (WSCR), the Carbon Reduction System (CRS), the Oxygen Generation System (OGS), and the Trace gas Contaminant Control System (TCCS). (NASA, 2000). This system was described as having achieved a 95-99% efficiency for processing and revitalizing the atmosphere in the facility (NASA, 2000).

In BioSim, each of the ARS components are modeled after their JSC counter parts (Metrica Inc.; S&K Technologies, 2005) with the exception of the TCCS. The TCCS is not modeled in BioSim. The role for trace gas control was simulated using a pyrolyzer to remove contaminants. The role of the 4BMS in BioSim is done by the Variable Configuration Carbon dioxide Removal system (VCCR) configured as a four bed molecular sieve.

Water and Waste Components

The Water Recovery System in the JSC LMLSTP facility consisted of Bioreactors, Urine Processor and a Water Processor Assembly. The Water Recovery System model in BioSim is based on the JSC Water Recovery System and includes the bioreactors, reverse osmosis urine processor, and an evaporation system for final processing in a single model. (Metrica Inc.; S&K Technologies, 2005, p. 6)

The dry waste recovery process and nutrient recycler in LMLSTP Phase III was reported to have achieved a 67% recovery rate. 395L of recycled plant nutrient liquid were produced. (Edeen & Pickering, 2000, p. 72). This process was not modeled separately in BioSim and is assumed to be covered by the Biomass Processor System and Water Recovery Systems.

The waste incinerator reportedly obtained an overall efficiency of 95% between incineration and gasses, water recovery, and dissolving the ash with acid (NASA, 2000; Barta D. J., 2016). However, only 25% of the solid waste produced by the crew was processed. (Edeen & Pickering, 2000, p. 87) The overall rate for the incinerator node is set to 25% given the processing limitation of the system for stability calculations. In the simulation, the waste incinerator system is modeled after the JSC Incinerator used for the phase III Test (Metrica Inc.; S&K Technologies, 2005, p. 7)

Outcome Analysis

The BioSim recreation of LMLSTP Phase III was completed using the configuration in Appendix A2 – Lunar Mars Life Support Test Project Phase III. The simulation completed with all the simulated crewmember exiting the chamber in good virtual health at the end of their 91 virtual day stay.

The gas exchange as examined by the concentration of oxygen and carbon dioxide in the crew chamber can be seen in Figure 64 and Figure 65. These are consistent with the reported range of values for LMLSTP. (NASA, 2000, pp. 93-94, 101-102). The Carbon Dioxide levels in the crew chamber do show excessive fluctuations during the startup of the experiment before crew entry and may be an indication of too stringent of a range of values.

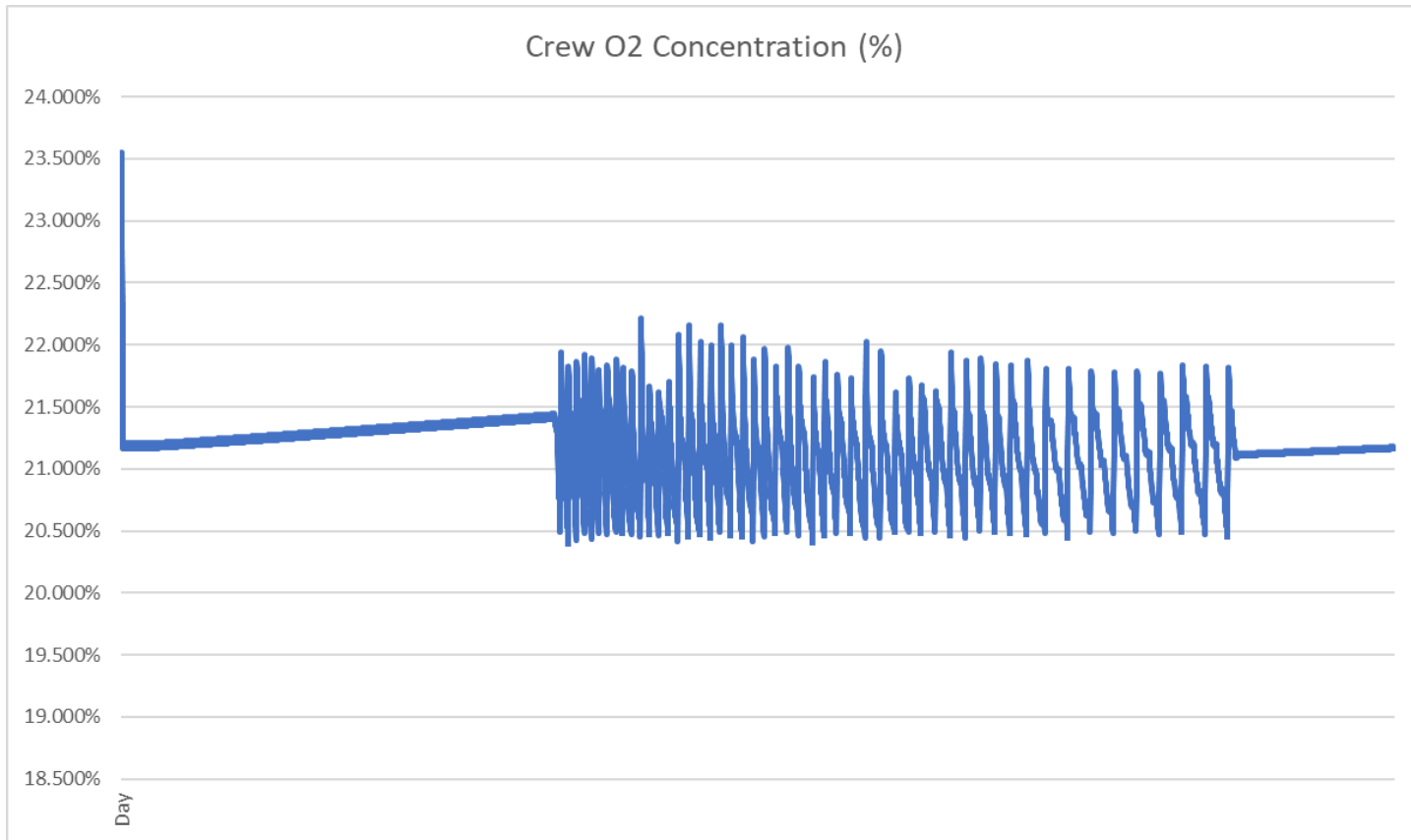

Figure 64 BioSim Crew Environment Oxygen Levels LMLSTP Phase III

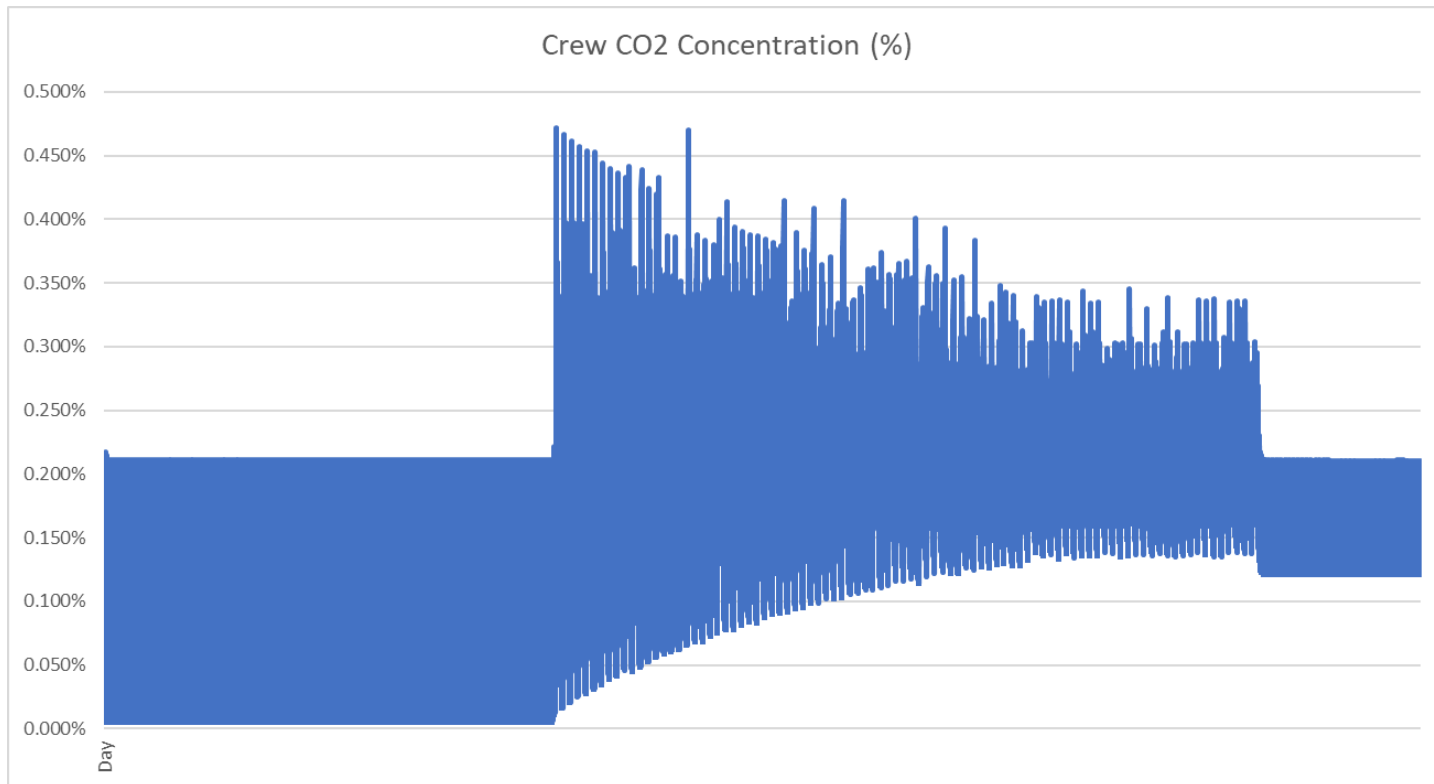

Figure 65 BioSim Crew Carbon Dioxide Levels LMLSTP Phase III

The water cycle unfortunately could not be fully verified and validated. The JSC LMLSTP Phase III water system reportedly cycled the water in the chamber ten times through the entire experiment (approximately every eight days) and did not use their backup systems or use facility water. (NASA, 2000, pp. 47, 157) The medium fidelity of system tracking in BioSim did not allow for the monitoring of water cycles to confirm the number of times that water may have cycled fully through the system or on what timelines. The BioSim documentation does state that the Water Recovery System was based on the system and subsystems under development at JSC during the time of Phase III (Metrica Inc.; S&K Technologies, 2005, p. 6), however some anomalies seen during the run show that there are some issues with the model or with logging/monitoring of water use by the model. Overall, the simulation did not require additional water supplies from outside stores to successfully complete the experiment. Unfortunately, the LMLSTP Phase III experiment did not reference the size of the stores used for the experiment. This makes it unclear if the sizing of the simulation stores at 10,000 kg was proper for validation. Total water in the system (as measured across the Dirty, Gray, and Potable stores) throughout the experiment can be seen in Figure 66.

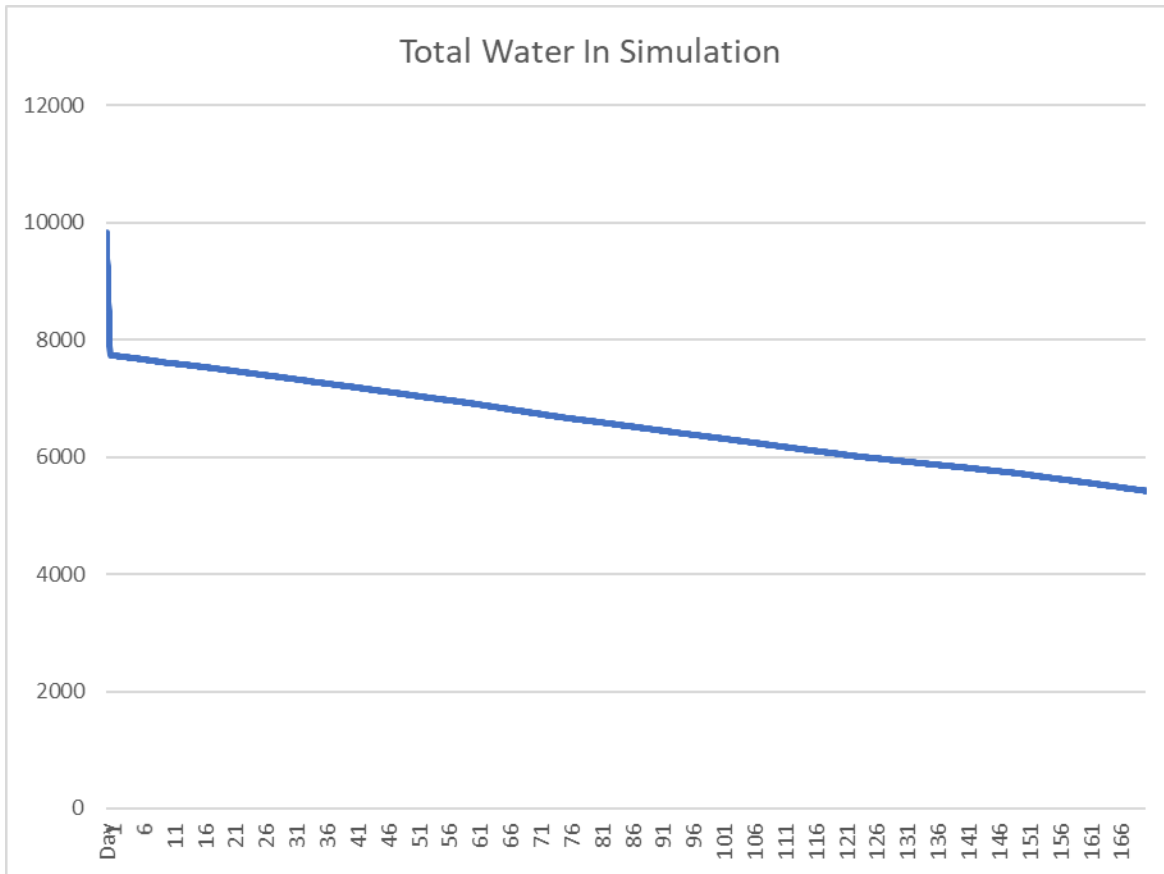

Figure 66 BioSim Total Water in Simulation LMLSTP Phase III

Examination of the logs shows several issues with the water cycle during the simulation. The first and most concerning is the drop at system startup. The second is a steady loss of water during the execution of the simulation.

The system startup is most concerning since it shows that approximately 2500 kg of water across all stores were used in the first 6 ticks (Hours) of the simulation start. Examination of the logs show that this is primarily from the Potable water store but cannot be accounted for by any potable water consumer component. The steady loss during the simulation execution is probably the continual running of the OGS to supply oxygen to the crew chamber, however this should have been recovered by the VCCR or CRS during the cycle and indicates a possible issue with the underlying model. Both items remain under investigation with TracLabs.

Additionally, the Biomass Processing element of BioSim did not allow for instrumentation of water returned to the cycle from the processing of harvested Biomass into usable material for the food stores. In the actual JSC LMLSTP this processing was done outside the environment by support personnel and was not a major factor in the water or food cycle.

Control of the physiochemical systems by the controller can be seen in Figure 67, Figure 68, and Figure 69. We can clearly see the throttling back of the OGS after day 10 and the adjustments made to the

VCCR and CRS as the crew comes on board at day 58 and adjusts levels as needed. The high volume of on/of cycles for the VCCR and the CRS indicate that there may be conflict in the referenced ranges and values used.

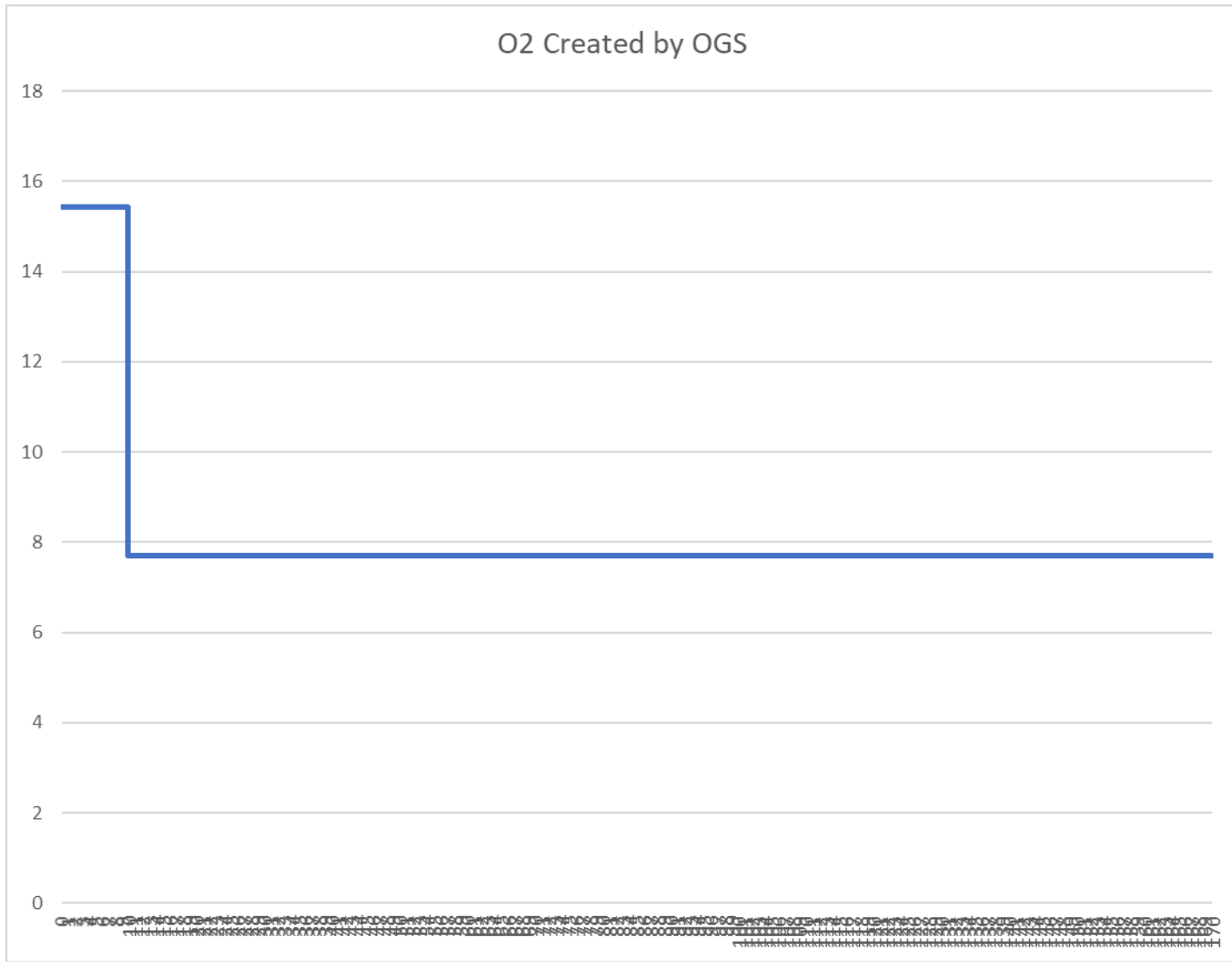

Figure 67 BioSim Crew OGS Production LMLSTP Phase III

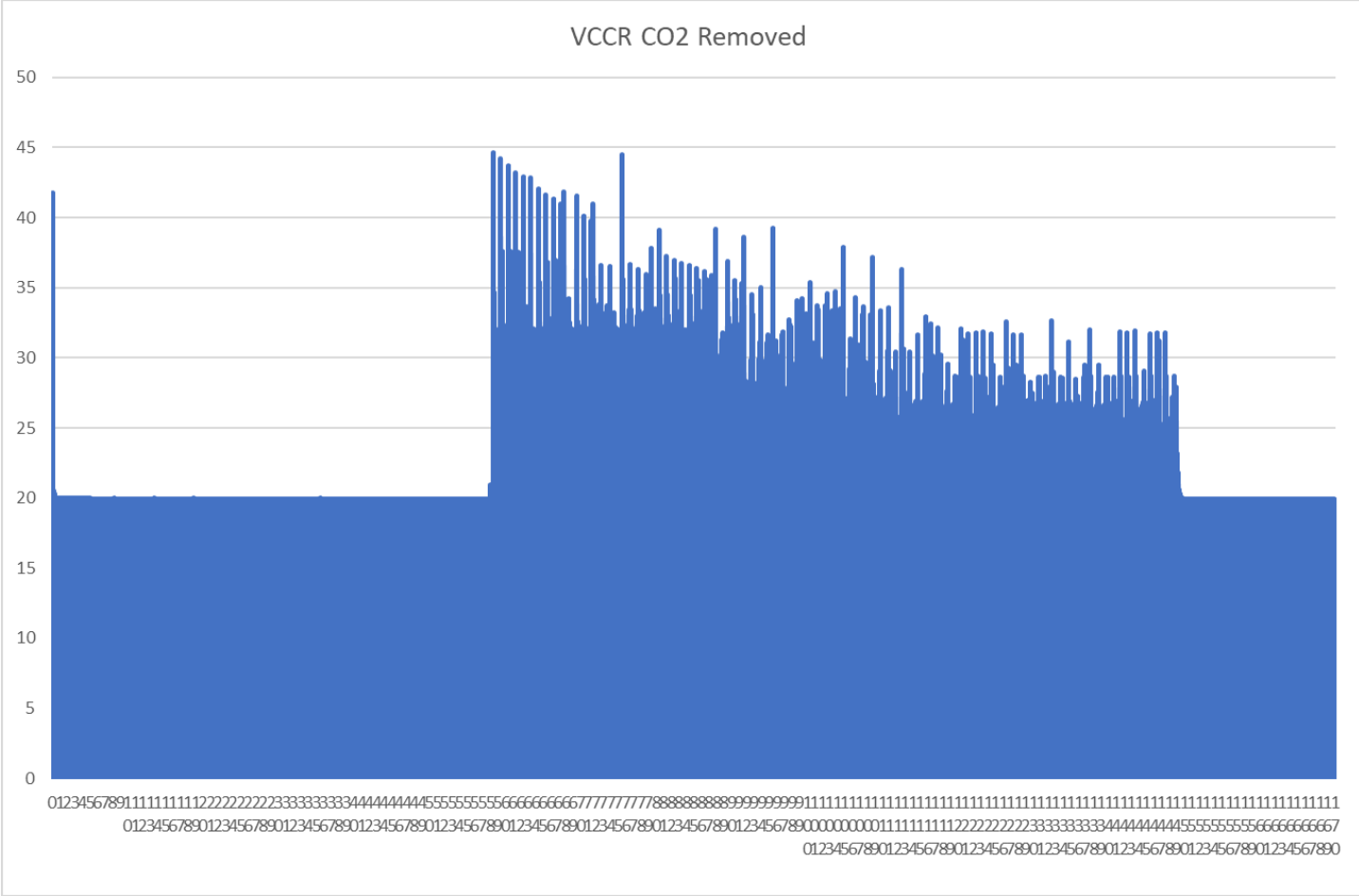

Figure 68 BioSim Crew VCCR Carbon Dioxide Removed LMLSTP Phase III

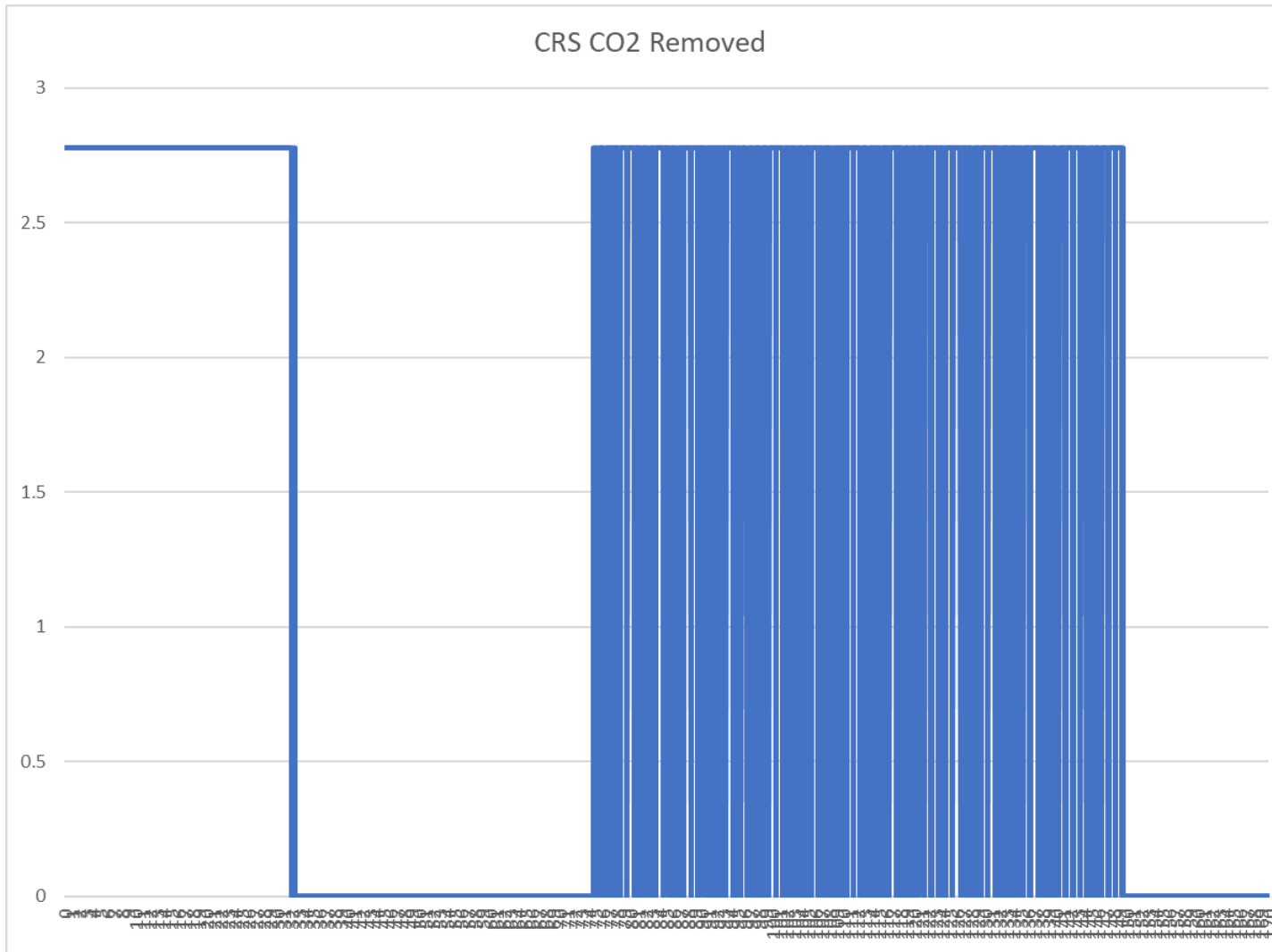

Figure 69 BioSim Crew CRS Carbon Dioxide Removed LMLSTP Phase III

In addition to the gas exchange subsystems, the controller also controlled the incinerator and the harvesting of the Wheat on a schedule that would keep at least the crop on one shelf at peak gas conversion. The incinerator was scheduled to run if the dry waste store became more than 50% full and every 1000 hours regardless of the amount of waste in dry waste storage. The harvest control was set to prematurely harvest 25% of the wheat starting 20 days into the simulation and trigger harvesting the next shelf after 20 days. This would setup a harvest schedule similar to what was implemented in the actual LMLSTP Phase III experiment. (NASA, 2000, p. 56; Barta D. J., 2016, pp. 15-16)

Examining the eigen values for both the gas cycle as well as the water cycles, we see some promising indications of patterns. With both the carbon dioxide and the water eigenvalues, we see a steady rise in the positive values that may indicate a growing instability in both systems. However, the large outliers and large negative values need further investigation.

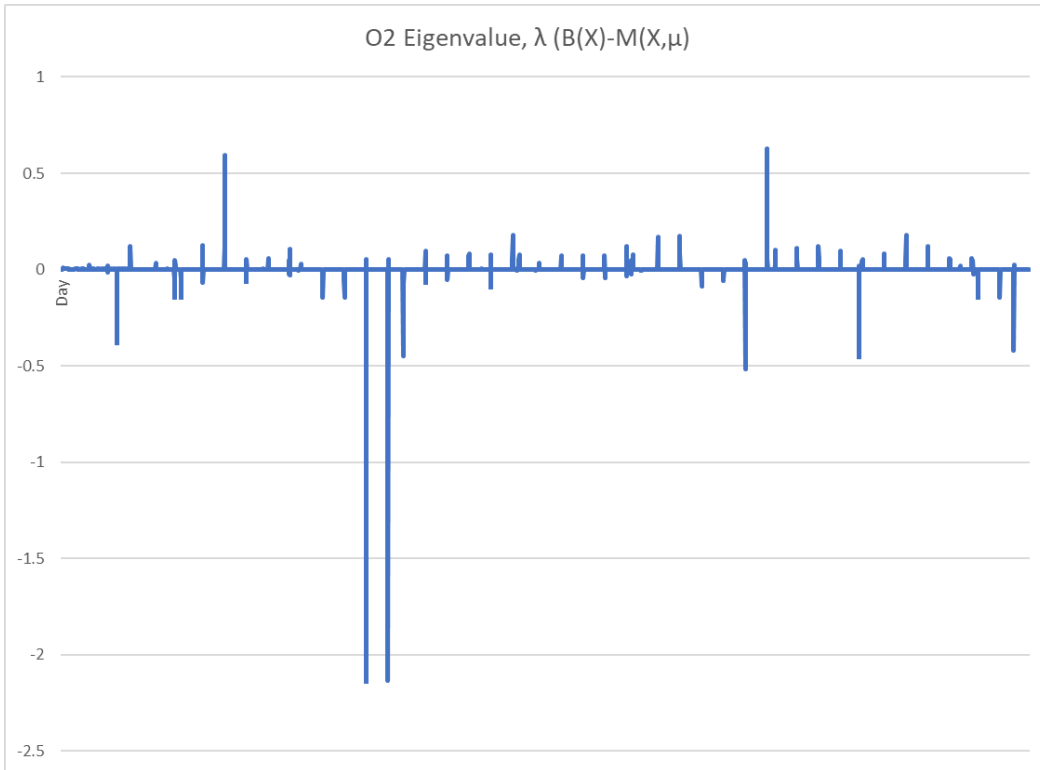

Figure 70 BioSim Oxygen Eigenvalues LMLSTP Phase III

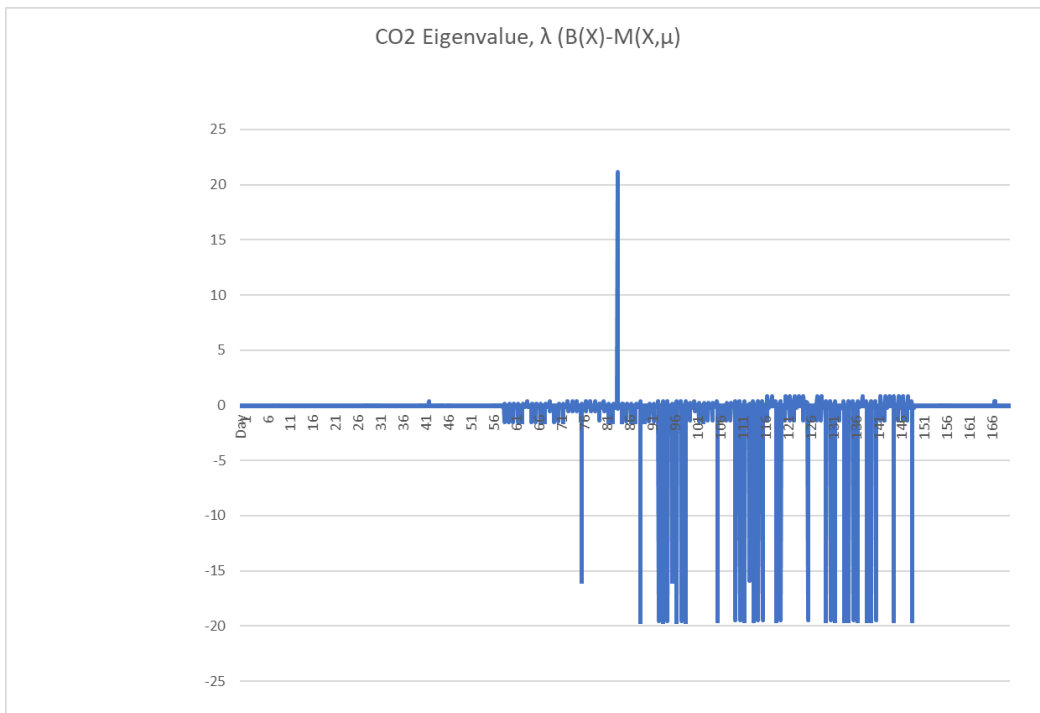

Figure 71 BioSim Carbon Dioxide Eigenvalues LMLSTP Phase III

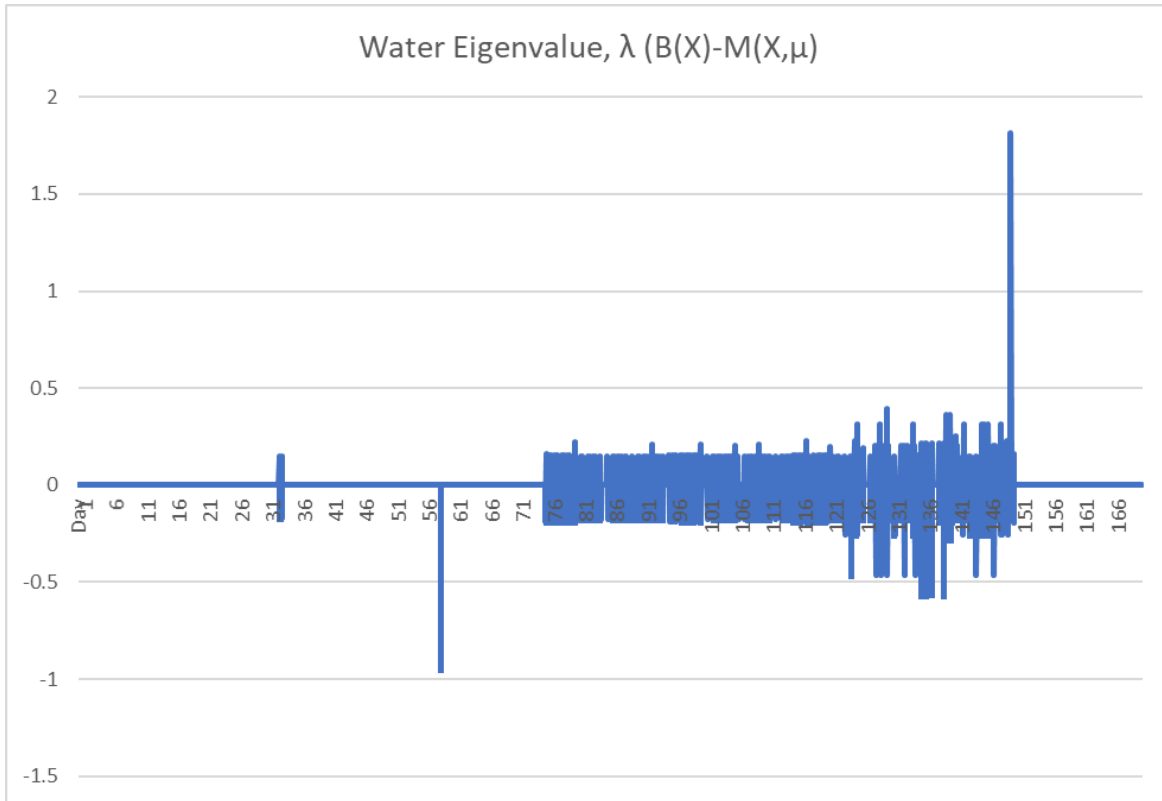

Figure 72 BioSim Total System Water Eigenvalue LMLSTP Phase III

Validation Conclusions

While both BioSim LMLSTP Phase I and Phase III simulations had anomalies, the outcomes did duplicate the results of the real-world experiments in the end. All issues encountered are under investigation by TracLabs. The validation did successfully prove the gas exchange models of human, simulated wheat, and physiochemical systems. The water cycle issues, while concerning, can be overcome with sufficient buffering capacity. Although this will prevent using the water cycle to search for indications of critical transitions until the issues are resolved. It does not appear that the observed anomalies would have any effect in examining the overall stability of long-term systems if sufficient buffers are used.

Stability Simulation Execution

Given the successful nature of the validation runs in creating similar outcomes to the overall results of the real world experiments, these configurations will be used to examine the hypothesis that long term stability of the systems as measured by the stability and closure index are indeed different. Specifically examining the comparison of the calculated stability index of .9219 for phase I (Figure 48 LMLSTP Phase I System Closure/Stability Index Calculation) will be less stable than the index of .9972 for phase III (Figure 63 LMLSTP Phase 3 System Closure/Stability Index Calculation) . This will be demonstrated by running each configuration to failure or a significantly longer period beyond the original time frame. The configurations will be modified to allow those systems that were not closed during the initial tests to have stufiest supply to not be as source of failure for the extended test. The timeline will be extended to 30,000 hours (1250 days). Ten runs with each configuration will ensure that runs and outcomes are consistent and not a one-off result.

Additionally, as with the validation runs for these configurations, the converters will be examined for early warning signs of instability as described in the section 'Calculation of early warning signals' on page 69.

Continuous LMLSTP Phase I Configuration

In this configuration, as with the original experiment, one human will enter the chamber on day 17 and will stay for the duration of the simulation. The carbon dioxide, oxygen, and water stores will be increased to 8,000, 1,000, and 10,000kg. The four-bed molecular sieve will be activated for this simulation to concentrate oxygen if needed. As with the original experiment, O₂ will be injected as needed and CO₂ will be pulsed into the environment as needed to maintain the 11.2m² virtual wheat crop. The wheat crop will be harvested and replanted on an 80-day cycle. Resulting harvest will not be transferred to food storage. Environment volume and gas composition will remain the same from the original simulation.

Execution Results

All ten runs of the simulated LMLSTP Phase 1 configuration ended after an average of 89.95 days +/- 0.5 days with the death of the simulated crew member from a lack of oxygen.

Run #	Phase 1 Sim End(in Ticks)	In Days
1	2166	90.25
2	2164	90.17
3	2165	90.21
4	2145	89.38
5	2146	89.42
6	2144	89.33
7	2164	90.17
8	2164	90.17
9	2166	90.25
10	2165	90.21
Average	2158.9	89.95

Table 6 Continuous Simulation LMLSTP Phase 1 Results

Each simulation end with a similar oxygen crash in the environment (Figure 73 Oxygen Concentrations Simulated LMLSTP Phase 1 Run 5). Examination of the eigenvalues shows an increase in instability in the oxygen levels starting to build at approximately two thirds of the way though (tick 1450 in run 5) but is not a strong signal (See Figure 74 Oxygen Eigenvalues Simulated LMLSTP Phase 1 Run 5).

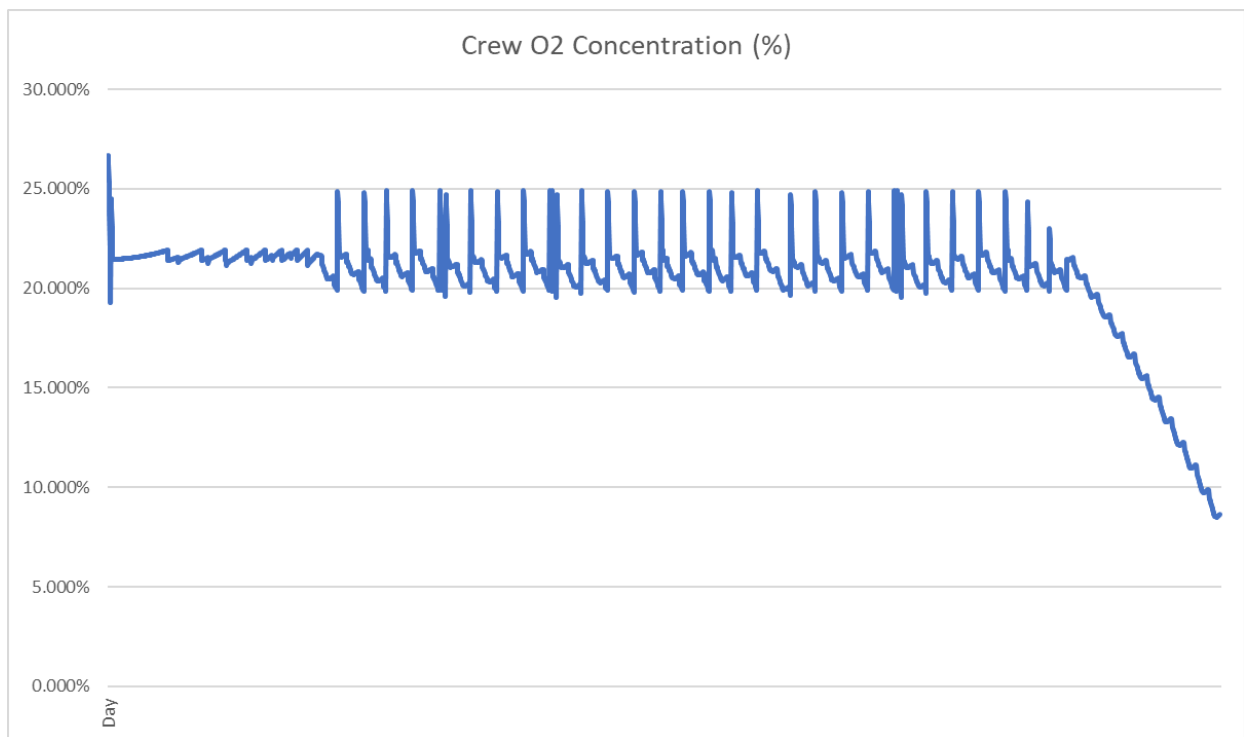

Figure 73 Oxygen Concentrations Simulated LMLSTP Phase 1 Run 5

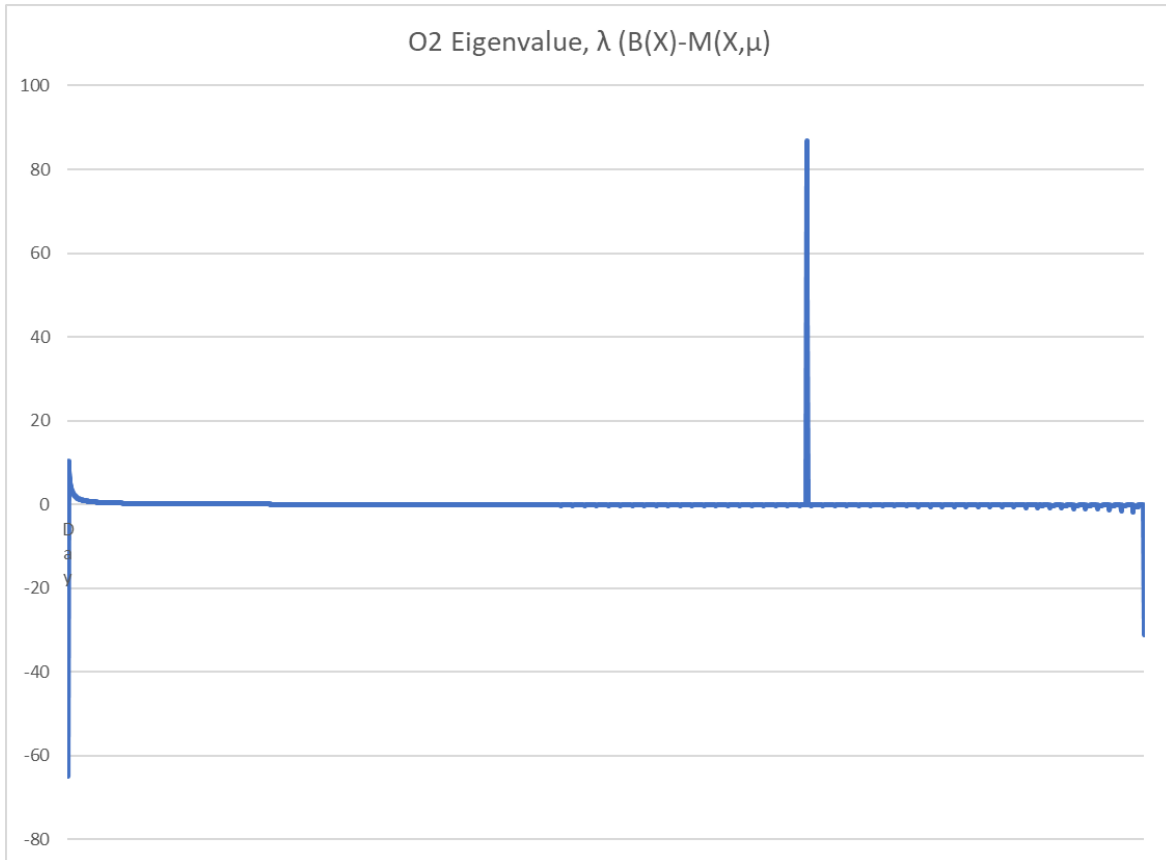

Figure 74 Oxygen Eigenvalues Simulated LMLSTP Phase 1 Run 5

Carbon dioxide levels appear to be steady (Figure 75 Carbon Dioxide Concentrations Simulated LMLSTP Phase 1 Run 5) with the eigenvalues showing little indication of instability (Figure 76 Carbon Dioxide Eigenvalues Simulated LMLSTP Phase 1 Run 5) once the outliers are discounted.

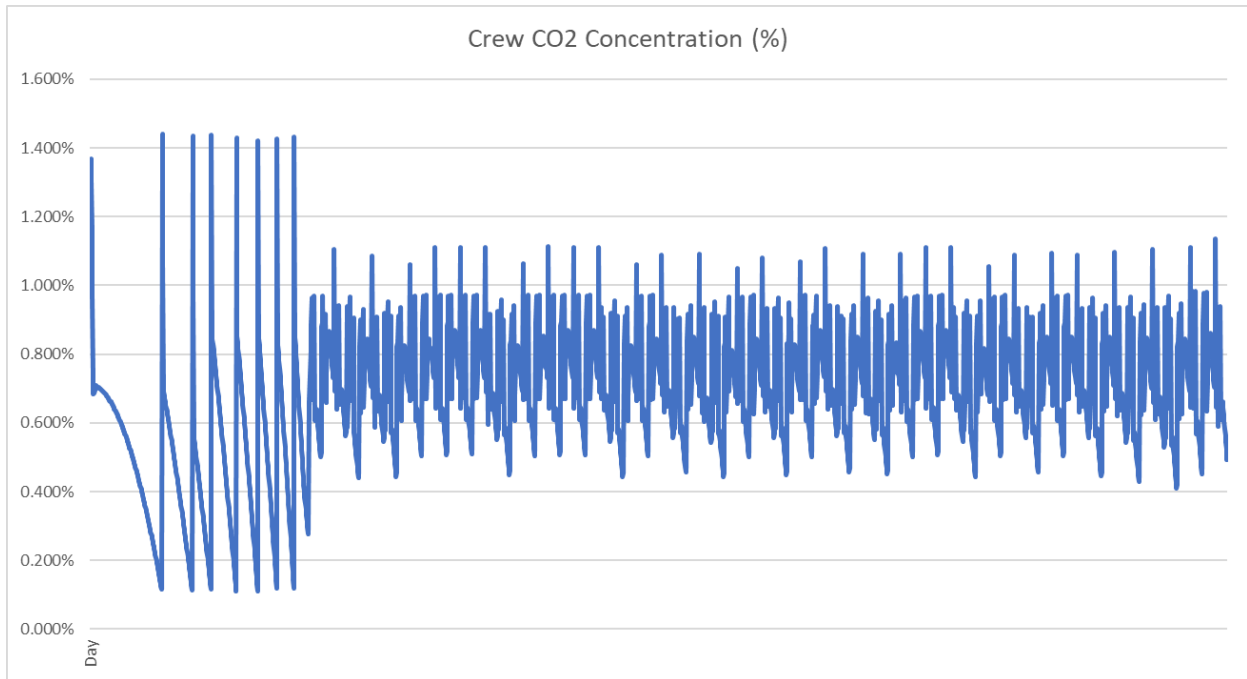

Figure 75 Carbon Dioxide Concentrations Simulated LMLSTP Phase 1 Run 5

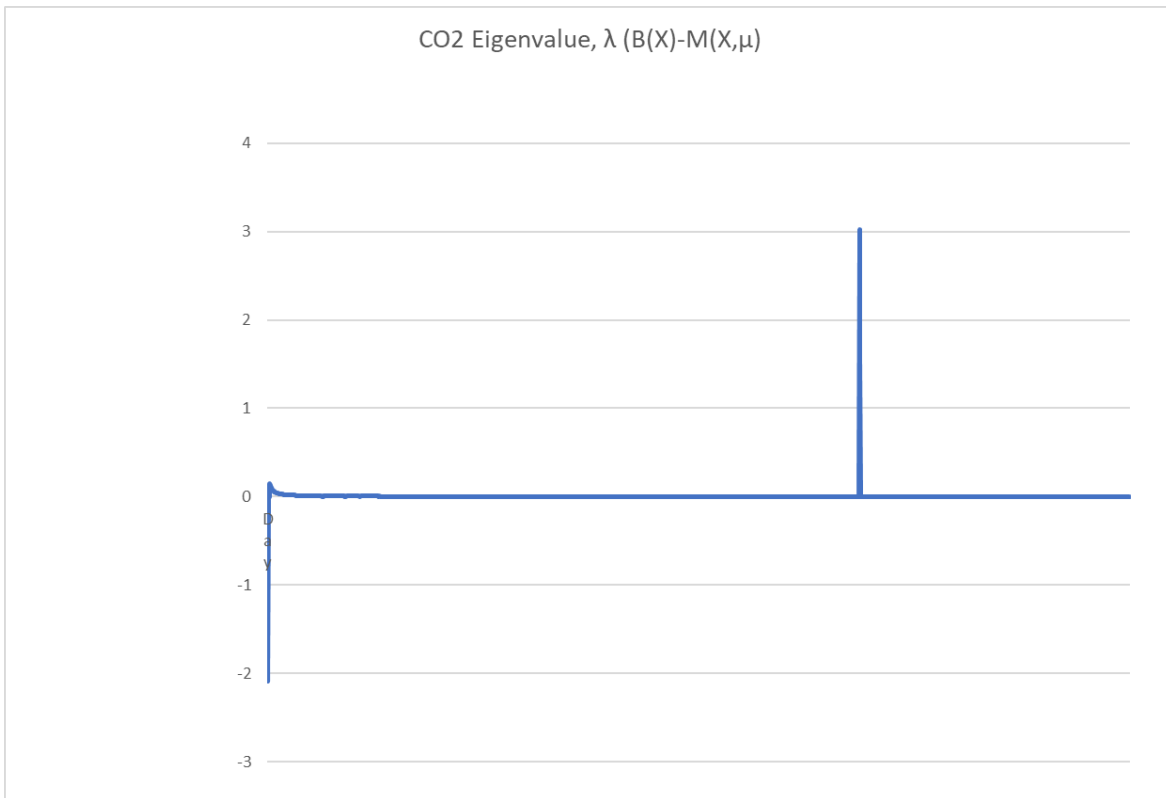

Figure 76 Carbon Dioxide Eigenvalues Simulated LMLSTP Phase 1 Run 5

Continuous LMLSTP Phase III

Configuration

In this configuration, as with the original experiment, four crew members will enter the chamber on day 58 and will stay for the duration of the simulation. The carbon dioxide and oxygen stores will be increased by a factor of four to 32,000 and 4,000 kg over the Phase I stores. Water stores were doubled to 20,000kg. The simulated physiochemical systems remain the same with the same operating parameters as with the Phase III Checkout. Air revitalization will utilize a combination of the Oxygen Generation System (OGS), Variable Configuration Carbon dioxide Removal system (VCCR) configured as a four bed molecular sieve, and the Carbon Reduction System (CRS). The Water Recovery System (WRS) includes the bioreactors, reverse osmosis urine processor, and an evaporation system for final processing in a single model. Waste will be eliminated using the incinerator on a scheduled basis. As with the original experiment, O₂ will be injected as needed and CO₂ will be pulsed into the environment as needed to maintain the 11.2m² virtual wheat crop. The wheat crop will be harvested and replanted on the same 25% schedule every 80-days. Resulting harvest will be processed in included into the food store. Environment volume and gas composition will remain the same from the original simulation.

Execution Results

<p>Nine runs of the simulated LMLSTP Phase 3 configuration ran to the end of the 30,000 hour (1250 day) simulation period with all four virtual crew members exiting in good virtual health. The only failure occurred with run seven at 2372 hours (98.83 days). This failure was with the wheat crop which died due to a low level of carbon dioxide. Run #</p>	<p>Phase 3 Sim End(in Ticks)</p>	<p>In Days</p>
1	30000	1250.00
2	30000	1250.00
3	30000	1250.00
4	30000	1250.00
5	30000	1250.00
6	30000	1250.00
7	2372	98.83
8	30000	1250.00
9	30000	1250.00
10	30000	1250.00
Average	27237.2	1134.88

Figure 77 Continuous Simulation LMLSTP Phase 3 Results

Examination of the growth chamber carbon dioxide concentration levels, do not show a crash or other abnormal readings (Figure 78 Carbon Dioxide Levels Simulated VPGC LMLSTP PHase 3 Run 7). Examination of the log showed that the gas levels in the VPGC were in expected limits as well with oxygen at 21.31%, carbon dioxide at 1.21% and water vapor at 0.84%. The final log check was with the plant model which revealed that the plants had died just after planting due to low carbon dioxide having fallen on the wrong side of the stochastic risk of death at less than 0.00001%.

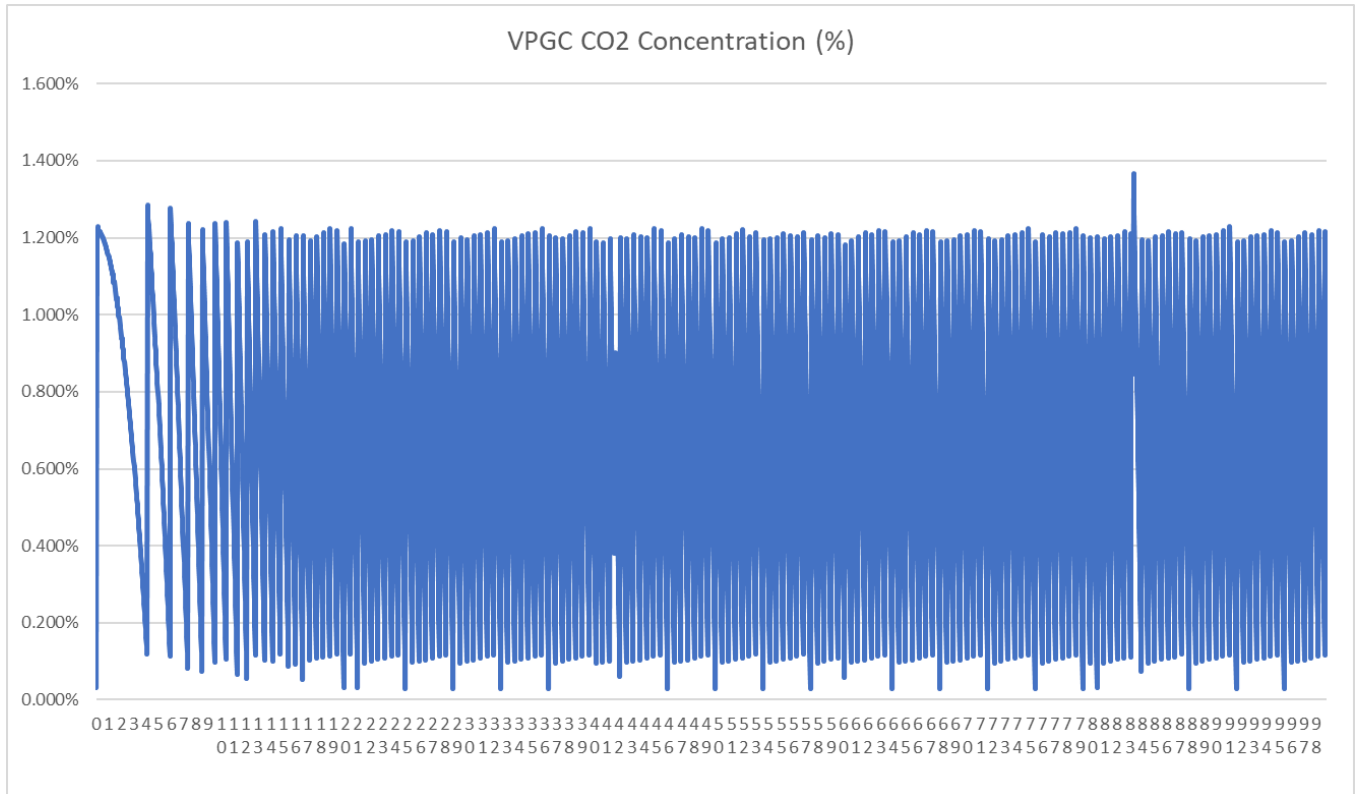

Figure 78 Carbon Dioxide Levels Simulated VPGC LMLSTP PHase 3 Run 7

Examination of the eigenvalues for carbon dioxide of run number seven did show a pattern consistent with increasing instability in the carbon dioxide cycle.

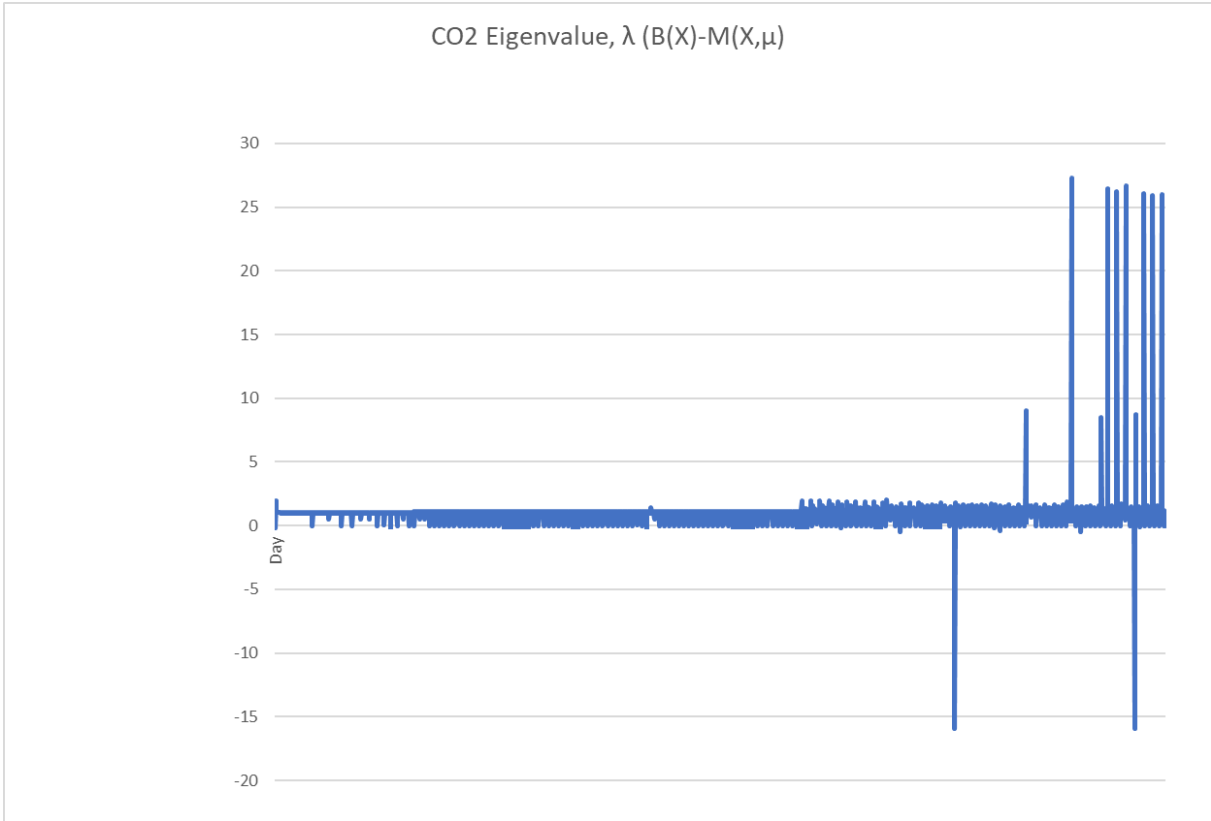

Figure 79 Carbon Dioxide Eigenvalues Simulated LMLSTP Phase 3 Run 7

Examination of oxygen and carbon dioxide level for the successful runs shows similar steady patterns across all nine successful runs. Figures

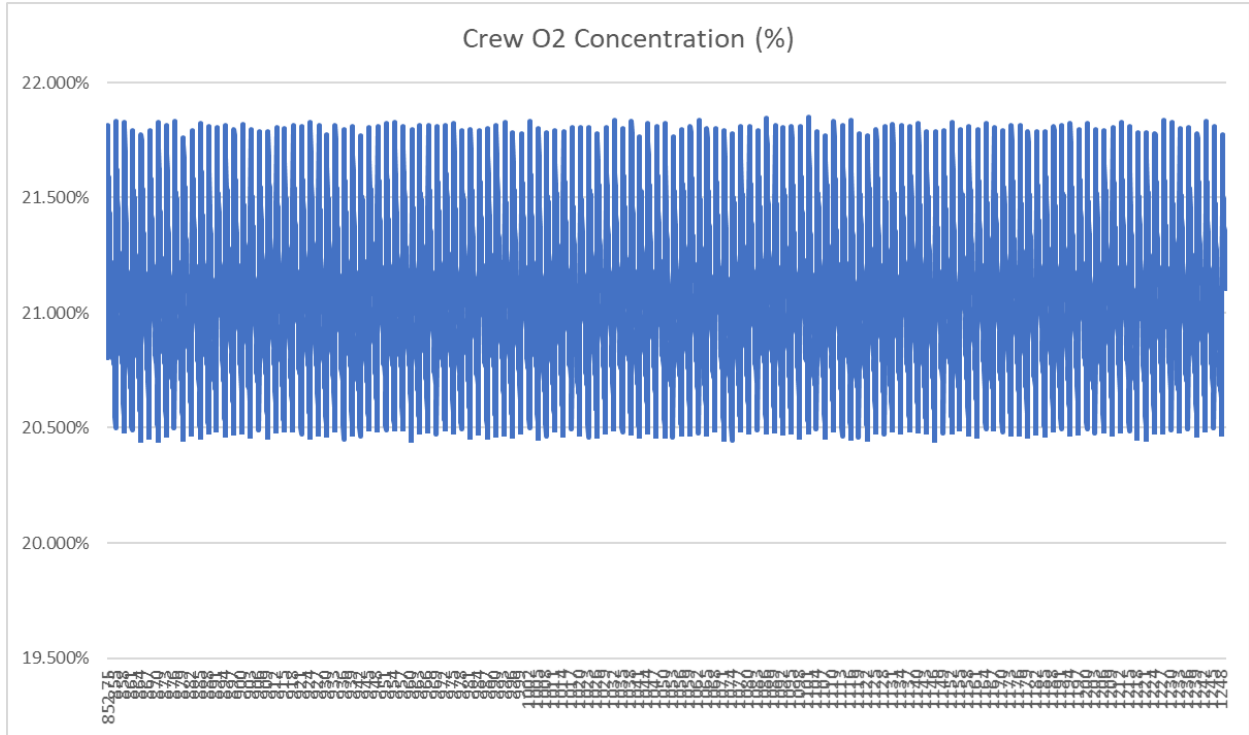

Figure 80 Oxygen Levels days 852-1250 Simulated LMLSTP Phase 3 Run 3

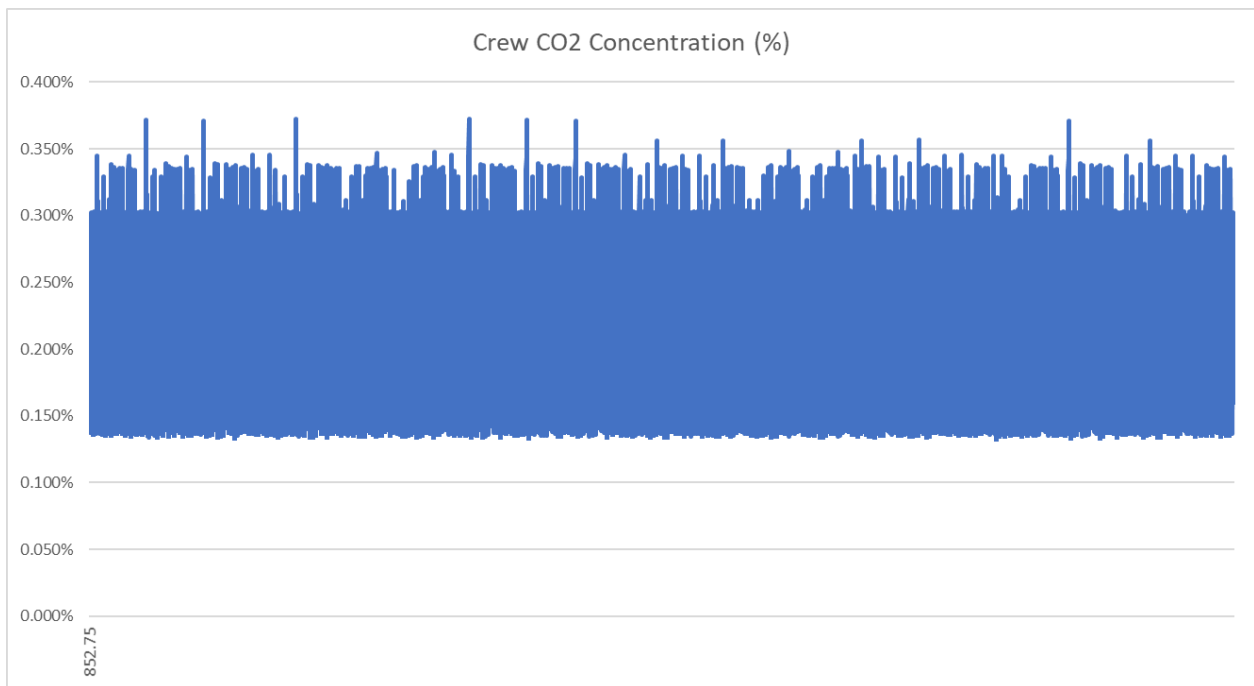

Figure 81 Carbon Dioxide Levels days 852-1250 Simulated LMLSTP Phase 3 Run 3

Similarity, eigenvalues during the same period for oxygen and carbon dioxide also show a steady pattern with a couple of outliers but do not show a pattern indicating increasing instability.

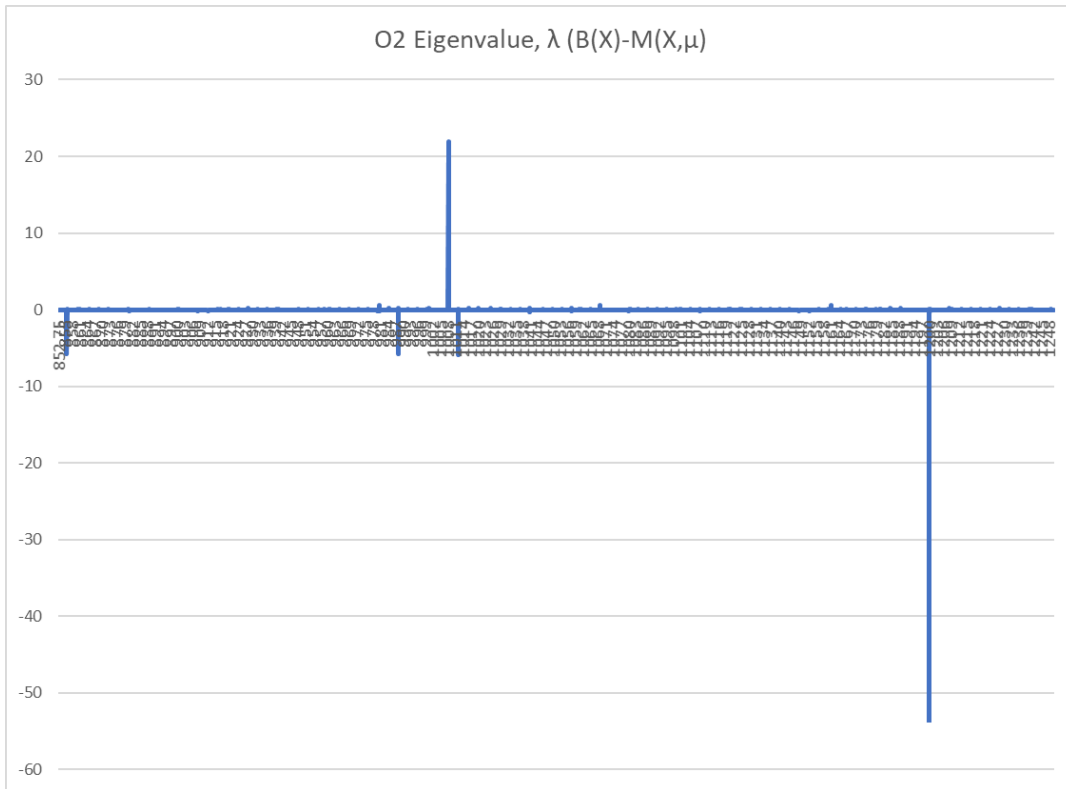

Figure 82 Oxygen Eigenvalues days 852-1250 Simulated LMLSTP Phase 3 Run 3

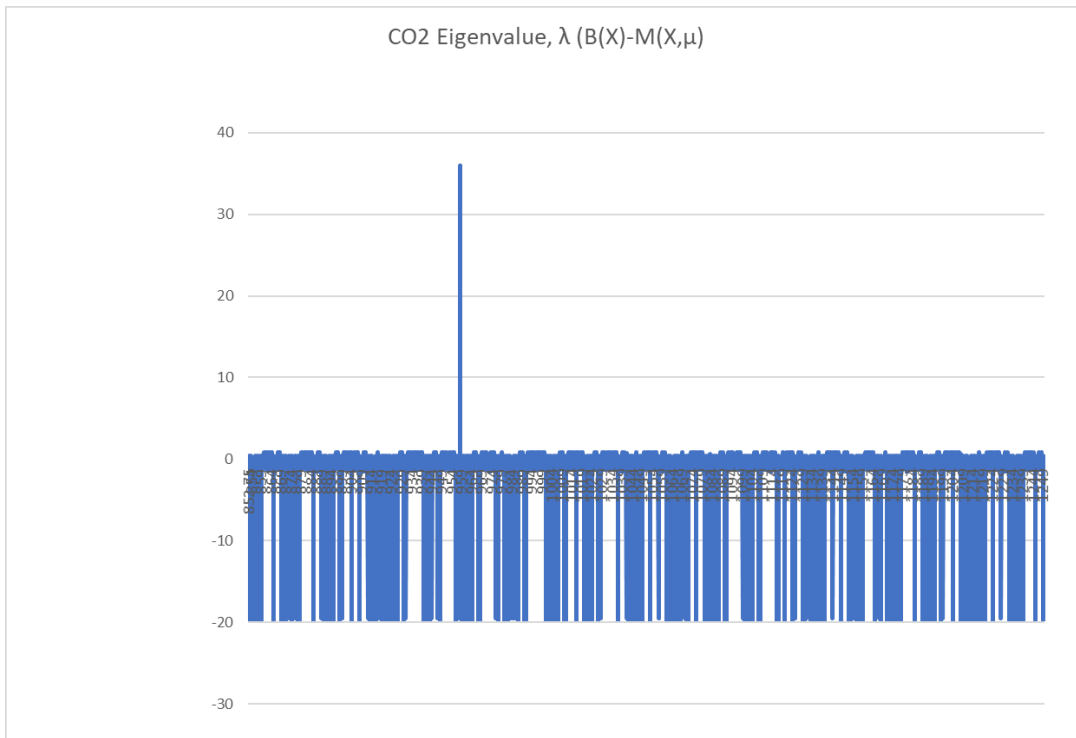

Figure 83 Carbon Dioxide Eigenvalues days 852-1250 Simulated LMLSTP Phase 3 Run 3

The total water in the simulation, while showing a continual decline does not show indications of instability.

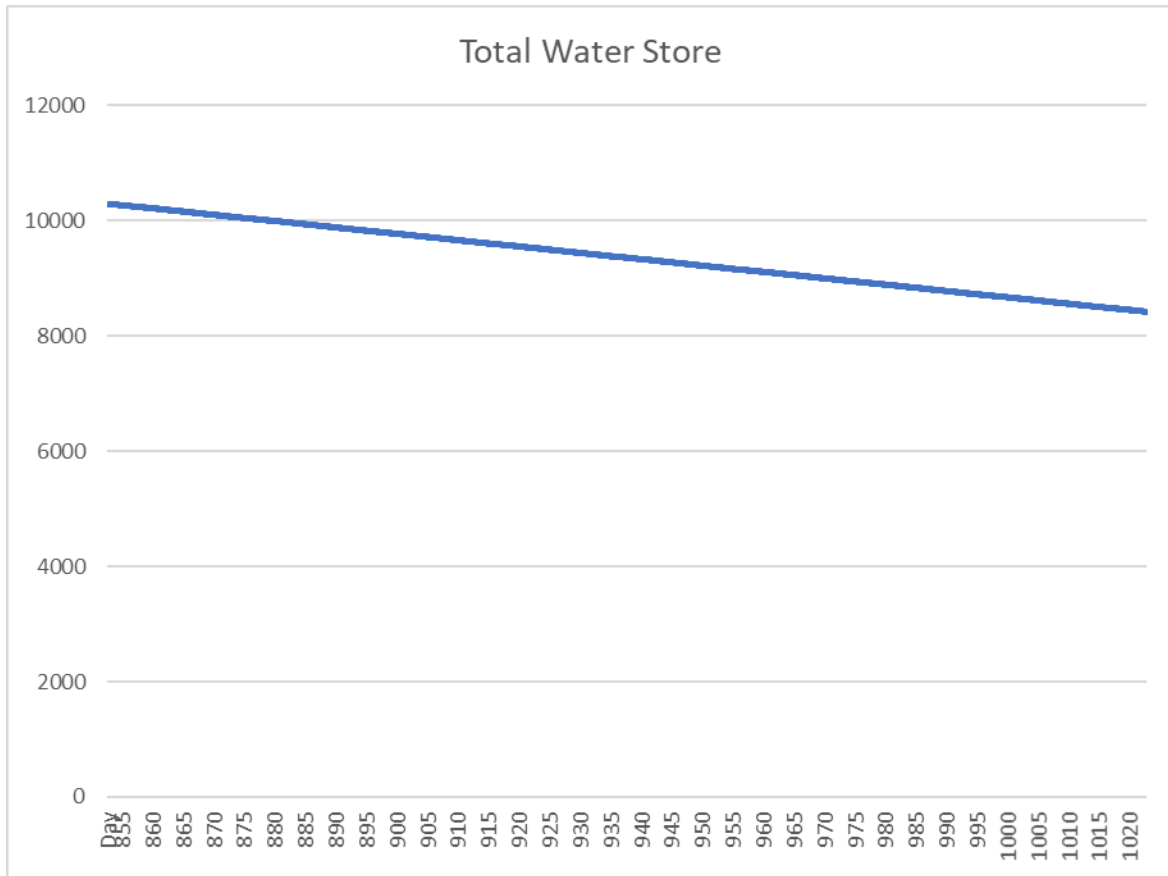

Figure 84 Total Sim Water days 852-1250 Simulated LMLSTP Phase 3 Run 3

The eigenvalues for the same period for the water in the simulation, while noisy do not appear to show a pattern indicating instability.

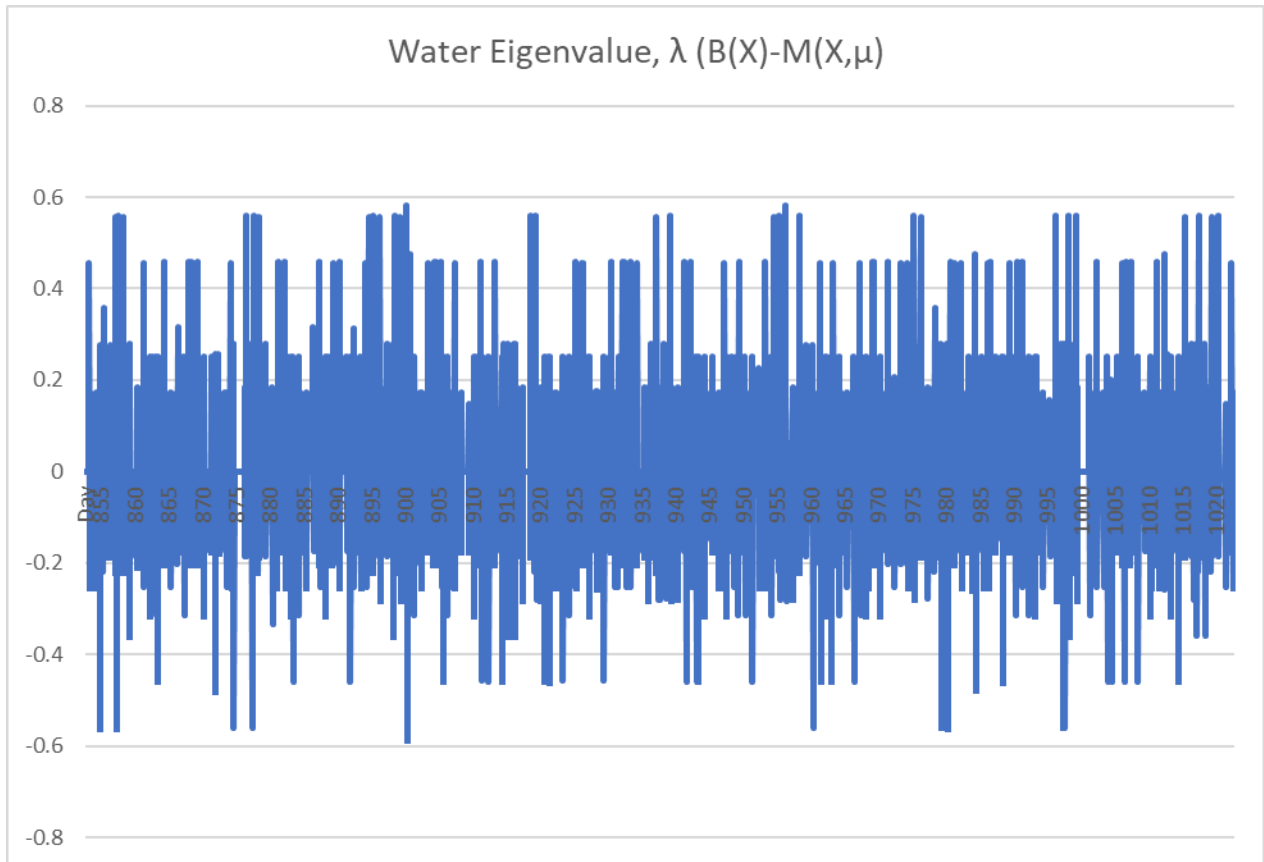

Figure 85 Water Eigenvalues days 852-1250 Simulated LMLSTP Phase 3 Run 3

Conclusions

The relationship between closure index and stability, while established is hard to measure and quantify. Application of a uniform definition allows for disparate system to be compared qualitatively and quantitatively using a Closure/Stability Index. This allows systems regardless of scale to be directly compared.

Current computer simulations are now capable of modeling real world experiments while duplicating actual results. This allows for systems to be created, investigated, and evaluated without the restrictions of long timelines or funding issues associated with large scale projects. BioSim does have some issues with some of the underlying models that need to be investigated. Continued refinement of these simulations and models is key to allowing for iteration and innovation of systems in this space.

The complex nature along with probable long timelines of ECLSS and hybrid life support systems makes finding possible instabilities difficult. Past experiments with large scale, real world systems such as BIOS, Biosphere 2, and LMLSTP have shown that even when many variables are accounted for, calculating the stability of systems can be difficult. General modeling can assist with the development of stability monitoring strategies and simplify analysis. These models can be used to create a high-level view of

systems of interaction and allow for systems to be documented while understanding the relationships of the subsystems.

There are several different ways to examine overall stability and determine if a system is headed for critical transition. Using eigenvalues for examining possible leading indicators of critical transitions shows promise but needs additional work to determine how to separate signal from noise and how to apply it at the overall converter/subsystem level in addition to the individual cycle level. Work needs to be continued to find a cycle that has both high reliability and a lower signal to noise ratio to use for stability.

Future Directions and Research

Given the inconclusive results with the use of eigenvalues as an indicator of critical transitions, additional detailed and focused work needs to be conducted to determine the viability of this indicator, including :

- Use of eigenvalues as an early warning indicator needs further study to refine signal detection
- Need to refine filtering to reduce outlier and one-off signals
- Explore and expand failure signatures
- Further exploration of methods to combine signals from multiple subsystems to address overall stability

Examine newly release simulation packages that may yield higher fidelity results and tracking of system cycling.

Further refinement and modernization of the BioSim code base including:

- Update BioSim code for modern cloud/container architecture to allow for multiple simulations to be run in parallel (large effort)
- Integrate Database for logging and data analysis
- Further validation of underlying BioSim Models and examination of observed simulation anomalies including:
 - Wheat growth and CO2
 - Water anomaly at startup and operation
 - Waste tracking and logging

Appendix A: Simulation Configuration Files

Configuration files used to define operational parameters for the simulation including starting gas levels, gas storage, habitual volume(s), water storage, waste storage, energy sources, food stores, crop types, crew members, crew activities, and air handling/circulating fans and pumps.

A1 - Lunar-Mars Life Support Test Project Phase I

```
<?xml version="1.0" encoding="UTF-8"?>
<?xml-stylesheet type="text/xsl" href="../../style/table.xsl"?>
<biosim xmlns="http://www.traclabs.com/biosim"
        xmlns:xsi="http://www.w3.org/2001/XMLSchema-instance"
        xsi:schemaLocation="http://www.traclabs.com/biosim
        ../../schema/BiosimInitSchema.xsd">

    <!-- Duplication of Lunar-Mars Life Support Test Project (LMLSTP) Phase
    I Test performed in August of 1995
        at Johnson Space Center (JSC)
        test runs for 70 days (1680 ticks)
        1 human subject enter on day 17 (tick 408) and leave on day 32
    (tick 768) (LMLSTP I Final)
        11.2 m of wheat used for Atmospheric regeneration growth begins on
    day 0
        VPGC (Variable Pressure Growth Chamber)
        {phase 1 parameters) 19.5 m3 crew space + 27 m3 plant growth space
    = 36.5 m3 of environment volume
        (Phase 1 Sim parameters) - 36.5 m3 of environment volume, VPGC set
    to 44.8 m3 of plan growth space due to wheat under-performing in CO2/O2
    comparisons with actual test results
        Initial Starting parameters (From LMLSTP Phase 1 Final Report, pg
    15, Average Environmental Conditions over the 68-Day Test)
        Relative Humidity (%) - 70.9 +/- 0.9
        Carbon Dioxide (ppm) - 1251 +/- 448 (in plant chamber)
        Oxygen (%) - 21.9 +/- 0.7
        SWAD - 4BMS - 4 Bed Molecular Sieve used for O2 concentration
        CO2 pulsed to maintain a constant level for plants
    -->
    <Globals
    runTillCrewDeath="true"
    runTillPlantDeath="true"
    runTillN="1680"
    crewsToWatch="Crew_Group"
    plantsToWatch="VPGC"
    startPaused="true">

    </Globals>
    <SimBioModules>
        <environment>
    <!--          <SimEnvironment moduleName="SimEnvironment"
    initialVolume="36500" > -->
        <SimEnvironment moduleName="Crew_Quarters"
    initialVolume="36500" >
            <percentageInitialization waterPercentage="0.01"
            nitrogenPercentage="0.75975"
    otherPercentage="0.001"
```

```

                                o2Percentage="0.219" totalPressure="101.325"
co2Percentage="0.001253"/>
    </SimEnvironment>
    <Dehumidifier moduleName="Main_Dehumidifier">
        <airConsumer inputs="Crew_Quarters"
            desiredFlowRates="1000" maxFlowRates="1000" />
        <dirtyWaterProducer desiredFlowRates="1000"
            outputs="DirtyWaterStore" maxFlowRates="1000"
        />
    />
        </Dehumidifier>
    </environment>
    <food>
        <BiomassPS moduleName="VPGC" autoHarvestAndReplant="false"
logLevel="INFO">
            <shelf cropArea="44.8" cropType="WHEAT"/>
            <powerConsumer maxFlowRates="20000"
desiredFlowRates="20000" inputs="PowerStore"/>
            <potableWaterConsumer maxFlowRates="250"
desiredFlowRates="250" inputs="PotableWaterStore"/>
            <greyWaterConsumer maxFlowRates="250"
desiredFlowRates="250" inputs="GreyWaterStore"/>
            <airConsumer maxFlowRates="1000"
desiredFlowRates="1000" inputs="Crew_Quarters"/>
            <dirtyWaterProducer maxFlowRates="1000"
desiredFlowRates="150" outputs="DirtyWaterStore"/>
            <biomassProducer maxFlowRates="1000"
desiredFlowRates="100" outputs="BiomassStore"/>
            <airProducer maxFlowRates="1000"
desiredFlowRates="1000" outputs="Crew_Quarters"/>
        </BiomassPS>
        <BiomassStore moduleName="BiomassStore" capacity="500"
level="300"/>
        <FoodStore moduleName="FoodStore" capacity="100000"
level="100000"/>
    </food>
    <power>
        <PowerStore moduleName="PowerStore" capacity="100000000000"
level="100000000000"/>
    </power>
    <water>
        <PotableWaterStore moduleName="PotableWaterStore"
capacity="500000" level="500000"/>
        <GreyWaterStore moduleName="GreyWaterStore" capacity="500"
level="0"/>
        <DirtyWaterStore moduleName="DirtyWaterStore"
capacity="500" level="0"/>
    </water>
    <air>
        <MethaneStore capacity="10000" moduleName="MethaneStore"
level="0"/>
        <NitrogenStore capacity="10000" moduleName="NitrogenStore"
level="0"/>
        <CO2Store capacity="10000" moduleName="CO2_Store"
level="8000"/>
        <H2Store capacity="10000" moduleName="H2_Store"
level="1000"/>

```



```

    <O2Store capacity="10000" moduleName="O2_Store"
level="1000"/>
    <VCCR moduleName="SWAD" logLevel="DEBUG" >
      <!-- Flow and power set to 0 since SWAD was not
activated during actual test -->
      <powerConsumer inputs="PowerStore"
        desiredFlowRates="0" maxFlowRates="2000"
></powerConsumer>
      <airConsumer inputs="Crew_Quarters"
        desiredFlowRates="0"
maxFlowRates="10000"></airConsumer>
      <airProducer desiredFlowRates="0"
        outputs="Crew_Quarters" maxFlowRates="10000" />
      <CO2Producer desiredFlowRates="10000"
        outputs="CO2_Store"
          maxFlowRates="10000"></CO2Producer>
    </VCCR>
    </air>
    <waste>
      <DryWasteStore moduleName="DryWasteStore" capacity="500"
level="0"/>
    </waste>
    <crew>
      <CrewGroup moduleName="Crew_Group">
        <potableWaterConsumer maxFlowRates="100"
desiredFlowRates="100" inputs="PotableWaterStore"/>
        <airConsumer maxFlowRates="0" desiredFlowRates="0"
inputs="Crew_Quarters"/>
        <foodConsumer maxFlowRates="100"
desiredFlowRates="100" inputs="FoodStore"/>
        <dirtyWaterProducer maxFlowRates="100"
desiredFlowRates="100" outputs="DirtyWaterStore"/>
        <greyWaterProducer maxFlowRates="100"
desiredFlowRates="100" outputs="GreyWaterStore"/>
        <airProducer maxFlowRates="0" desiredFlowRates="0"
outputs="Crew_Quarters"/>
        <dryWasteProducer maxFlowRates="100"
desiredFlowRates="100" outputs="DryWasteStore"/>
        <crewPerson name="Bob Roberts" age="43" weight="77"
sex="MALE" arrivalDate="408" departureDate="768" logLevel="INFO">
          <schedule>
            <activity name="sleep" length="8"
intensity="1"/>
            <activity name="hygiene" length="1"
intensity="2"/>
            <activity name="exercise" length="1"
intensity="5"/>
            <activity name="eating" length="1"
intensity="2"/>
            <activity name="mission" length="9"
intensity="3"/>
            <activity name="health" length="1"
intensity="2"/>
            <activity name="maintenance" length="1"
intensity="2"/>
            <activity name="leisure" length="2"
intensity="2"/>
          </schedule>
        </crewPerson>
      </CrewGroup>
    </crew>
  </VCCR>
</VCCR>

```

```

        </schedule>
    </crewPerson>
</CrewGroup>
</crew>
<framework>
    <Injector moduleName="CO2_Injector">
        <CO2Consumer inputs="CO2_Store" desiredFlowRates="0"
maxFlowRates="2000" />
        <CO2Producer desiredFlowRates="0"
outputs="Crew_Quarters" maxFlowRates="2000" />
    </Injector>
    <Injector moduleName="O2_Injector">
        <O2Consumer inputs="O2_Store" desiredFlowRates="0"
maxFlowRates="2000" />
        <O2Producer desiredFlowRates="0"
outputs="Crew_Quarters" maxFlowRates="2000" />
    </Injector>
    <Accumulator moduleName="O2_Concentrator">
        <O2Consumer inputs="Crew_Quarters"
desiredFlowRates="15" maxFlowRates="100"/>
        <O2Producer desiredFlowRates="0" outputs="O2_Store"
maxFlowRates="100"/>
    </Accumulator>
</framework>
</SimBioModules>
<Sensors>
    <crew>
        <CrewGroupO2ConsumedSensor input="Crew_Group"
moduleName="Crew_O2_Consumed" logLevel="DEBUG" />
    </crew>
    <framework>
        <StoreLevelSensor input="O2_Store" moduleName="O2_Store_Level"
logLevel="DEBUG"/>
        <StoreLevelSensor input="CO2_Store"
moduleName="CO2_Store_Level" logLevel="DEBUG"/>
        <StoreLevelSensor input="DirtyWaterStore"
moduleName="Dirty_Water_Store_Level" logLevel="DEBUG"/>
        <StoreLevelSensor input="GreyWaterStore"
moduleName="Grey_Water_Store_Level" logLevel="DEBUG"/>
        <StoreLevelSensor input="PotableWaterStore"
moduleName="Potable_Water_store_Level" logLevel="DEBUG"/>
    </framework>
    <air>
        <CO2OutFlowRateSensor input="SWAD"
moduleName="SWAD_Co2_Out_Sensor" index="0" logLevel="DEBUG"/>
        <O2InFlowRateSensor input="O2_Injector"
moduleName="O2_Injector_Sensor" index="0" logLevel="DEBUG"/>
        <CO2InFlowRateSensor input="CO2_Injector"
moduleName="CO2_Injector_Sensor" index="0" logLevel="DEBUG"/>
        <O2OutFlowRateSensor input="O2_Concentrator"
moduleName="O2_Concentrator_Sensor" index="0" logLevel="DEBUG"/>
    </air>
    <environment>
        <AirInFlowRateSensor input="SWAD"
moduleName="SWAD_Air_Influent_Sensor" index="0" logLevel="DEBUG" />
        <AirOutFlowRateSensor input="SWAD"
moduleName="SWAD_Air_Effluent_Sensor" index="0" logLevel="DEBUG"/>
    </environment>
</Sensors>
</framework>
</SimBioModules>
</crew>
</CrewGroup>
</crewPerson>
</crew>
</framework>
</SimBioModules>

```

```

        <GasConcentrationSensor input="Crew_Quarters"
moduleName="O2_Concentrator_Sensor" gasType="O2" logLevel="DEBUG"/>
        <GasConcentrationSensor input="Crew_Quarters"
moduleName="CO2_Concentrator_Sensor" gasType="CO2" logLevel="DEBUG"/>
        <GasConcentrationSensor input="Crew_Quarters"
moduleName="N_Concentrator_Sensor" gasType="NITROGEN" logLevel="DEBUG"/>
        <GasConcentrationSensor input="Crew_Quarters"
moduleName="Other_Concentrator_Sensor" gasType="OTHER" logLevel="DEBUG"/>
        <GasMoleSensor input="Crew_Quarters"
moduleName="Crew_Quarters_O2_Mole" gasType="O2" logLevel="DEBUG"/>
        <GasMoleSensor input="Crew_Quarters"
moduleName="Crew_Quarters_CO2_Mole" gasType="CO2" logLevel="DEBUG"/>
    </environment>
</Sensors>

    <Actuators>
        <air>
            <CO2OutFlowRateActuator output="CO2_Injector"
moduleName="CO2_Storage_Actuator" index="0" />
            <CO2InFlowRateActuator output="CO2_Injector"
moduleName="CO2_Injector_Actuator" index="0"/>
            <O2InFlowRateActuator output="O2_Injector"
moduleName="O2_Injector_Actuator" index="0"/>
            <O2OutFlowRateActuator output="O2_Injector"
moduleName="O2_Storage_Actuator" index="0"/>
            <O2InFlowRateActuator output="O2_Concentrator"
moduleName="O2_ConcentratorStore_Actuator" index="0"/>
            <O2OutFlowRateActuator output="O2_Concentrator"
moduleName="O2_Concentrator_Actuator" index="0"/>
        </air>
    </environment>
</Actuators>
</biosim>

```

A2 - Lunar Mars Life Support Test Project Phase III

```
<?xml version="1.0" encoding="UTF-8"?>
<?xml-stylesheet type="text/xsl" href="../../style/table.xsl"?>
<biosim xmlns="http://www.traclabs.com/biosim"
  xmlns:xsi="http://www.w3.org/2001/XMLSchema-instance"
  xsi:schemaLocation="http://www.traclabs.com/biosim
  ../../schema/BiosimInitSchema.xsd">

  <!-- Duplication of Lunar-Mars Life Support Test Project (LMLSTP) Phase
  III Test performed in 1997
    at Johnson Space Center (JSC)
    Sources:
      - Lunar-Mars Life Support Test Project: Phase III Final Report,
  NASA JSC CTSD-ADV-341 Engineering Directorate, Feb 23, 2000 (Report JSC-
  49144)
      - Isolation, NASA Experiments in closed living, H. Lane; R.
  Sauser; D. Feedback (eds),2002, American Astronautical Society
      - The Lunar Mars Life Support Test Project, Daniel J. Barta 2016
  (Presentation)
      Simulation/Experiment Parameters
      - 170 Days - 4080 'ticks'
      - 4 human subjects, enter on day 58 (tick 1392) and leave on day
  149 (tick 3576) (LMLSTP III Final, pg 58)
      - Air - regenerative biological and physicochemical
      75% Physicochemical Atmosphericic Regeneration (OGS / VCCR(4BMS)
  / CRS) (section 2.1.4 users manual)
      GARDEN experiment in Crew Quarters
      .22 m2 growing area (Barta 2016, pg 20, Isolation pg 264,
  LMLSTP III Final, pg 14 )
      * set to 1 m of growth space, based on Phase I experience
      harvested every 20 days (Barta 2016, pg 14, Isolation, pg
  264, LMLSTP III Final, pg 79)
      Atmospheric parameter for Crew Quarters
      CO2 0.2% to 0.65% with an average of 0.43% LMLSTP III
  Final, pg 93-94
      O2 20.5% to 21.6% LMLSTP III Final, pg 101-102
      40% humidity, Isolation, pg 282,
      4BMS ran day 0-47 and day 57 - 91 LMLSTP III Final, pg 94
      WSCR ran day 39-40 and day 47-57 LMLSTP III Final, pg 94
      CRS ran 75 days out of 91 LMLSTP III Final, pg 99
      OGS ran the entire 91 day test, LMLSTP III Final, pg 102
      25% VPGC (Variable Pressure Growth Chamber) (Barta 2016) 95% of
  O2 cycled back to Crew Compartment (LMLSTP III Final, pg 47)
      11.2 m of wheat used for Atmospheric regeneration and crew
  consumption (5% of calories)
      * set to 44.8 m of growth space per Phase 1 experience
      25% harvest rotation starting on day 20 (LMLSTP III Final, pg
  58)
      100420 - harvest control function set in controller routine
      Atmospheric parameters for VPGC
      CO2 1200 PPM
      O2 21.5 to 21.6%
      70% Humidity assumed
      VPGC Volume - 27.2 m3 growth area + 19.2m3 (total 46.4 m3) airlock
  - 2% leak rate (LMLSTP III Final, pg 3)
```

ILSSTF Crew chamber - 229 m3 + 23.4 m3 outer lock + 21.52 m2 inner lock (total 273.92 m3) - 4% leak rate (LMLSTP III Final, [pg 3](#))

Water Recovery System
8 days of water were cycled 10 times through crew chamber LMLSTP III Final, [pg 47](#))

Waste Management System - Incineration and Biodegradation
Fecal process was done every 4 days starting on day 4 (overall day 54 of test) LMLSTP III Final, [pg 87](#)
- Average processing time (Burn) was 4 hours - LMLSTP III Final, [pg 87](#)

Product Gas Transfer (PGT) not operational during first 3 weeks of test (LMLSTP III Final, [pg 90](#))

```
-->
<Globals
runTillCrewDeath="true"
runTillPlantDeath="true"
runTillN="4080"
crewsToWatch="Crew_Group"
plantsToWatch="Biomass"
startPaused="true">

</Globals>
<SimBioModules>
  <environment>
    <SimEnvironment moduleName="Crew_Quarters"
initialVolume="273920">
      <percentageInitialization waterPercentage="0.10"
nitrogenPercentage="0.659"
otherPercentage="0.001"
o2Percentage="0.21" totalPressure="101.325"
co2Percentage="0.0043" />
    </SimEnvironment>
    <SimEnvironment moduleName="VPGC" initialVolume="46400" >
      <percentageInitialization waterPercentage="0.50"
nitrogenPercentage="0.659"
otherPercentage="0.001"
o2Percentage="0.215" totalPressure="101.325"
co2Percentage="0.0003"/>
    </SimEnvironment>
    <Dehumidifier moduleName="Crew_Dehumidifier">
      <airConsumer inputs="Crew_Quarters"
desiredFlowRates="1000"
maxFlowRates="1000"></airConsumer>
      <dirtyWaterProducer desiredFlowRates="1000"
outputs="Dirty_Water_Store" maxFlowRates="1000"
/>
    </Dehumidifier>
    <Dehumidifier moduleName="VPGC_Dehumidifier">
      <airConsumer inputs="VPGC"
desiredFlowRates="1000"
maxFlowRates="1000"></airConsumer>
      <dirtyWaterProducer desiredFlowRates="1000"
outputs="Dirty_Water_Store" maxFlowRates="1000"
/>
    </Dehumidifier>
  </environment>
  <air>
```

```

level="1000"/>
<MethaneStore capacity="10000" moduleName="Methane_Store"
level="1000"/>
<NitrogenStore capacity="10000" moduleName="Nitrogen_Store"
level="1000"/>
<CO2Store capacity="10000" moduleName="CO2_Store"
level="8000"/>
<H2Store capacity="10000" moduleName="H2_Store"
level="1000"/>
<O2Store capacity="10000" moduleName="O2_Store"
level="1000"/>

<VCCR moduleName="Main_VCCR" >
  <powerConsumer inputs="Power_Store"
    desiredFlowRates="2000" maxFlowRates="2000"
></powerConsumer>
  <airConsumer inputs="Crew_Quarters"
    desiredFlowRates="10000"
maxFlowRates="10000"></airConsumer>
  <airProducer desiredFlowRates="10000"
    outputs="Crew_Quarters" maxFlowRates="10000" />
  <CO2Producer desiredFlowRates="10000"
outputs="CO2_Store"
    maxFlowRates="10000"></CO2Producer>
</VCCR>
<!-- Oxygen Generator System -->
<OGS moduleName="OGS" >
  <powerConsumer inputs="Power_Store"
desiredFlowRates="1000" maxFlowRates="1000"/>
  <potableWaterConsumer inputs="Potable_Water_Store"
desiredFlowRates="10" maxFlowRates="10"/>
  <O2Producer desiredFlowRates="1000"
outputs="O2_Store" maxFlowRates="1000"/>
  <H2Producer desiredFlowRates="1000"
outputs="H2_Store" maxFlowRates="1000"/>
</OGS>

<!-- Carbon Reduction System produced Water and Methane
(vented in actual exp) -->
<CRS moduleName="CRS" >
  <powerConsumer inputs="Power_Store"
    desiredFlowRates="100" maxFlowRates="100" />
  <CO2Consumer inputs="CO2_Store"
desiredFlowRates="100"
    maxFlowRates="100" />
  <H2Consumer inputs="H2_Store" desiredFlowRates="100"
    maxFlowRates="100" />
  <potableWaterProducer desiredFlowRates="100"
    outputs="Potable_Water_Store"
maxFlowRates="100" />
  <methaneProducer desiredFlowRates="100"
    outputs="Methane_Store"
maxFlowRates="100"></methaneProducer>
</CRS>
<Pyrolizer moduleName="Pyrolizer">
  <powerConsumer inputs="Power_Store"
    desiredFlowRates="100" maxFlowRates="100" />
  <methaneConsumer inputs="Methane_Store"

```

```

        desiredFlowRates="100" maxFlowRates="100" />
    <H2Producer desiredFlowRates="100" outputs="H2_Store"
        maxFlowRates="100" />
    <dryWasteProducer desiredFlowRates="100"
        outputs="Dry_Waste_Store" maxFlowRates="100" />
</Pyrolizer>
</air>
<food>
    <BiomassPS moduleName="Biomass"
autoHarvestAndReplant="false">
    <!-- Harvesting/replanting handled in the LMLSTP3
controller routine -->
        <!-- <shelf cropArea="5.6" cropType="WHEAT"/> changed crop
area to get expected levels of CO2 recycling -->
        <!-- ISOLATION book pg 48 LMLSTP Phase III, only wheat in VPGC,
lettuce was done in the GARDEN experiment -->
            <shelf cropArea="11.2" cropType="WHEAT"/>
            <shelf cropArea="11.2" cropType="WHEAT"/>
            <shelf cropArea="11.2" cropType="WHEAT"/>
            <shelf cropArea="11.2" cropType="WHEAT"/>
            <powerConsumer maxFlowRates="20000"
desiredFlowRates="18000" inputs="Power_Store"/>
            <potableWaterConsumer maxFlowRates="250"
desiredFlowRates="150" inputs="Potable_Water_Store"/>
            <greyWaterConsumer maxFlowRates="250"
desiredFlowRates="150" inputs="Grey_Water_Store"/>
            <airConsumer maxFlowRates="1000"
desiredFlowRates="500" inputs="VPGC"/>
            <dirtyWaterProducer maxFlowRates="1000"
desiredFlowRates="150" outputs="Dirty_Water_Store"/>
            <biomassProducer maxFlowRates="1000"
desiredFlowRates="100" outputs="Biomass_Store"/>
            <airProducer maxFlowRates="1000"
desiredFlowRates="500" outputs="VPGC"/>
        </BiomassPS>
        <BiomassPS moduleName="GARDEN"
autoHarvestAndReplant="true">
            <shelf cropArea="1" cropType="LETTUCE"/>
            <powerConsumer maxFlowRates="1000"
desiredFlowRates="1000" inputs="Power_Store"/>
            <potableWaterConsumer maxFlowRates="50"
desiredFlowRates="50" inputs="Potable_Water_Store"/>
            <greyWaterConsumer maxFlowRates="50"
desiredFlowRates="50" inputs="Grey_Water_Store"/>
            <airConsumer maxFlowRates="0" desiredFlowRates="0"
inputs="Crew_Quarters"/>
            <dirtyWaterProducer maxFlowRates="50"
desiredFlowRates="50" outputs="Dirty_Water_Store"/>
            <biomassProducer maxFlowRates="100"
desiredFlowRates="100" outputs="Biomass_Store"/>
            <airProducer maxFlowRates="0" desiredFlowRates="0"
outputs="Crew_Quarters"/>
        </BiomassPS>
        <BiomassStore moduleName="Biomass_Store" capacity="100"
level="25"/>

```

```

level="5000"/>
    <FoodStore moduleName="FoodStore" capacity="10000"
    <FoodProcessor moduleName="Grain_Mill">
        <powerConsumer maxFlowRates="1000"
desiredFlowRates="1000" inputs="Power_Store"/>
        <biomassConsumer desiredFlowRates="100"
maxFlowRates="100" inputs="Biomass_Store"/>
        <foodProducer desiredFlowRates="50"
outputs="FoodStore" maxFlowRates="100"/>
        <dryWasteProducer desiredFlowRates="100"
outputs="Dry_Waste_Store" maxFlowRates="100"/>
        <waterProducer maxFlowRates="10"
desiredFlowRates="10" outputs="Grey_Water_Store"/>
    </FoodProcessor>
</food>
</framework>

    <Injector moduleName="Crew_O2_Injector">
        <O2Consumer inputs="O2_Store" desiredFlowRates="10"
maxFlowRates="100"/>
        <O2Producer desiredFlowRates="10"
outputs="Crew_Quarters" maxFlowRates="100" />
    </Injector>
    <Injector moduleName="Crew_CO2_Injector">
        <CO2Consumer inputs="CO2_Store"
desiredFlowRates="1.2" maxFlowRates="100" />
        <CO2Producer desiredFlowRates="1.2"
outputs="Crew_Quarters" maxFlowRates="100"/>
    </Injector>
    <Accumulator moduleName="Crew_O2_Concentrator">
        <O2Consumer inputs="Crew_Quarters"
desiredFlowRates="15" maxFlowRates="100"/>
        <O2Producer desiredFlowRates="0" outputs="O2_Store"
maxFlowRates="100"/>
    </Accumulator>
    <Injector moduleName="VPGC_CO2_Injector">
        <CO2Consumer inputs="CO2_Store"
desiredFlowRates="0" maxFlowRates="100" />
        <CO2Producer desiredFlowRates="0" outputs="VPGC"
maxFlowRates="100"/>
    </Injector>
    <Injector moduleName="VPGC_O2_Injector">
        <O2Consumer inputs="O2_Store" desiredFlowRates="0"
maxFlowRates="100"/>
        <O2Producer desiredFlowRates="0" outputs="VPGC"
maxFlowRates="100" />
    </Injector>
    <Accumulator moduleName="VPGC_O2_Concentrator">
        <O2Consumer inputs="VPGC" desiredFlowRates="0"
maxFlowRates="100"/>
        <O2Producer desiredFlowRates="0" outputs="O2_Store"
maxFlowRates="100"/>
    </Accumulator>

</framework>
</power>

```



```

        <PowerStore moduleName="Power_Store"
capacity="100000000000" level="100000000000"/>
        </power>

        <water>
            <WaterRS moduleName="Water_Distiller"
implementation="LINEAR">
                <powerConsumer inputs="Power_Store"
desiredFlowRates="1000" maxFlowRates="1000" />
                <dirtyWaterConsumer inputs="Dirty_Water_Store"
desiredFlowRates="10" maxFlowRates="1000"/>
                <greyWaterConsumer inputs="Grey_Water_Store"
desiredFlowRates="10" maxFlowRates="1000" />
                <potableWaterProducer desiredFlowRates="1000"
outputs="Potable_Water_Store" maxFlowRates="1000" />
            </WaterRS>
            <PotableWaterStore moduleName="Potable_Water_Store"
capacity="10000" level="3000"/>
            <GreyWaterStore moduleName="Grey_Water_Store"
capacity="5000" level="1000"/>
            <DirtyWaterStore moduleName="Dirty_Water_Store"
capacity="5000" level="1000"/>

        </water>
        <waste>
            <DryWasteStore moduleName="Dry_Waste_Store" capacity="100"
level="0"/>
            <Incinerator moduleName="Waste_Incinerator"
logLevel="WARN">
                <powerConsumer inputs="Power_Store"
desiredFlowRates="0" maxFlowRates="1000"/>
                <O2Consumer inputs="VPGC" desiredFlowRates="100"
maxFlowRates="1000"/>
                <dryWasteConsumer maxFlowRates="1000"
desiredFlowRates="1000" inputs="Dry_Waste_Store"/>
                <CO2Producer desiredFlowRates="100" outputs="VPGC"
maxFlowRates="10000"/>
            </Incinerator>
        </waste>
        <crew>

            <CrewGroup moduleName="Crew_Group">
                <potableWaterConsumer maxFlowRates="100"
desiredFlowRates="100" inputs="Potable_Water_Store"/>
                <airConsumer maxFlowRates="0" desiredFlowRates="0"
inputs="Crew_Quarters"/>
                <foodConsumer maxFlowRates="100"
desiredFlowRates="100" inputs="FoodStore"/>
                <dirtyWaterProducer maxFlowRates="100"
desiredFlowRates="100" outputs="Dirty_Water_Store"/>
                <greyWaterProducer maxFlowRates="100"
desiredFlowRates="100" outputs="Grey_Water_Store"/>
                <airProducer maxFlowRates="0" desiredFlowRates="0"
outputs="Crew_Quarters"/>
                <dryWasteProducer maxFlowRates="100"
desiredFlowRates="100" outputs="Dry_Waste_Store"/>

```

```

        <crewPerson name="Nigel Packham" age="47" weight="77"
sex="MALE" arrivalDate="1392" departureDate="3576" >
        <schedule>
            <activity name="sleep" length="8"
intensity="1"/>
            <activity name="hygiene" length="1"
intensity="2"/>
            <activity name="exercise" length="1"
intensity="5"/>
            <activity name="eating" length="1"
intensity="2"/>
            <activity name="mission" length="9"
intensity="3"/>
            <activity name="health" length="1"
intensity="2"/>
            <activity name="maintenance" length="1"
intensity="2"/>
            <activity name="leisure" length="2"
intensity="2"/>
        </schedule>
    </crewPerson>
    <crewPerson name="John Lewis" age="35" weight="75"
sex="MALE" arrivalDate="1392" departureDate="3576">
    <schedule>
        <activity name="sleep" length="8"
intensity="1"/>
        <activity name="hygiene" length="1"
intensity="2"/>
        <activity name="exercise" length="1"
intensity="5"/>
        <activity name="eating" length="1"
intensity="2"/>
        <activity name="mission" length="9"
intensity="3"/>
        <activity name="health" length="1"
intensity="2"/>
        <activity name="maintenance" length="1"
intensity="2"/>
        <activity name="leisure" length="2"
intensity="2"/>
    </schedule>
    </crewPerson>
    <crewPerson name="Laura Supra" age="30" weight="60"
sex="FEMALE" arrivalDate="1392" departureDate="3576">
    <schedule>
        <activity name="sleep" length="8"
intensity="1"/>
        <activity name="exercise" length="1"
intensity="5"/>
        <activity name="hygiene" length="1"
intensity="2"/>
        <activity name="eating" length="1"
intensity="2"/>
        <activity name="mission" length="9"
intensity="3"/>
        <activity name="health" length="1"
intensity="2"/>
    </schedule>

```

```

intensity="2"/>         <activity name="maintenance" length="1"
intensity="2"/>         <activity name="leisure" length="2"
                          </schedule>
                          </crewPerson>
                          <crewPerson name="Vickie Kloenis" age="35"
weight="60" sex="FEMALE" arrivalDate="1392" departureDate="3576">
                          <schedule>
intensity="1"/>         <activity name="sleep" length="8"
intensity="5"/>         <activity name="exercise" length="1"
intensity="2"/>         <activity name="hygiene" length="1"
intensity="2"/>         <activity name="eating" length="1"
intensity="2"/>         <activity name="mission" length="9"
intensity="3"/>         <activity name="health" length="1"
intensity="2"/>         <activity name="maintenance" length="1"
intensity="2"/>         <activity name="leisure" length="2"
                          </schedule>
                          </crewPerson>
                          </CrewGroup>
                          </crew>
                          </SimBioModules>
                          <Sensors>
                            <crew>
                              <CrewGroupO2ConsumedSensor input="Crew_Group"
moduleName="Crew_O2Consumed" logLevel="DEBUG" />
                              <CrewGroupCO2ProducedSensor input="Crew_Group"
moduleName="Crew_CO2Produced" logLevel="DEBUG" />
                              <CrewGroupWaterConsumedSensor input="Crew_Group"
moduleName="Crew_WaterConsumed" logLevel="DEBUG" />
                              <CrewGroupWaterProducedSensor input="Crew_Group"
moduleName="Crew_WaterProduced" logLevel="DEBUG" />
                              <CrewGroupWasteProducedSensor input="Crew_Group"
moduleName="Crew_WasteProduced" logLevel="DEBUG" />
                            </crew>
                            <food>
                              <BiomassTotalCO2ConsumedSensor input="Biomass"
moduleName="Biomass_CO2Consumed" logLevel="DEBUG"
></BiomassTotalCO2ConsumedSensor>
                              <BiomassTotalO2ProducedSensor input="Biomass"
moduleName="Biomass_O2Produced" logLevel="DEBUG" />
                              <BiomassTotalWaterConsumedSensor input="Biomass"
moduleName="Biomass_WaterConsumed" logLevel="DEBUG" />
                              <BiomassTotalWaterProducedSensor input="Biomass"
moduleName="Biomass_WaterProduced" logLevel="DEBUG" />
                              <BiomassTotalCO2ConsumedSensor input="GARDEN"
moduleName="Garden_CO2Consumed" logLevel="DEBUG"
></BiomassTotalCO2ConsumedSensor>

```

```

        <BiomassTotalO2ProducedSensor input="GARDEN"
moduleName="Garden_O2Produced" logLevel="DEBUG" />
        <BiomassTotalWaterConsumedSensor input="GARDEN"
moduleName="Garden_WaterConsumed" logLevel="DEBUG" />
        <BiomassTotalWaterProducedSensor input="GARDEN"
moduleName="Garden_WaterProduced" logLevel="DEBUG" />
    </food>
    <framework>
        <StoreLevelSensor input="O2_Store" moduleName="O2_Store_Level"
logLevel="DEBUG"/>
        <StoreLevelSensor input="CO2_Store"
moduleName="CO2_Store_Level" logLevel="DEBUG"/>
        <!-- H2 and Methane store monitored for CRS running -->
        <StoreLevelSensor input="H2_Store" moduleName="H2_Store_Level"
logLevel="DEBUG"/>
        <StoreLevelSensor input="Methane_Store"
moduleName="Methane_Store_Level" logLevel="DEBUG"/>
        <StoreLevelSensor input="Nitrogen_Store"
moduleName="Nitrogen_Store_Level" logLevel="WARN"/>
        <StoreLevelSensor input="Dirty_Water_Store"
moduleName="Dirty_Water_Store_Level" logLevel="DEBUG"/>
        <StoreLevelSensor input="Grey_Water_Store"
moduleName="Grey_Water_Store_Level" logLevel="DEBUG"/>
        <StoreLevelSensor input="Potable_Water_Store"
moduleName="Potable_Water_store_Level" logLevel="DEBUG"/>
        <StoreLevelSensor input="Biomass_Store"
moduleName="Biomass_Store_Level" logLevel="DEBUG"/>
        <StoreLevelSensor input="Dry_Waste_Store"
moduleName="Dry_Waste_Store_Level" logLevel="DEBUG"/>
    </framework>
    <air>
        <CO2OutFlowRateSensor input="Main_VCCR"
moduleName="Main_Vccr_Co2_Out_Sensor" index="0" logLevel="DEBUG"/>
        <O2OutFlowRateSensor input="OGS"
moduleName="Main_OGS_O2_Out_Sensor" index="0" logLevel="DEBUG" />
        <O2InFlowRateSensor input="Crew_O2_Injector"
moduleName="Crew_O2_Injector_Sensor" index="0" logLevel="DEBUG"/>
        <CO2InFlowRateSensor input="Crew_CO2_Injector"
moduleName="Crew_CO2_Injector_Sensor" index="0" logLevel="DEBUG"/>
        <O2OutFlowRateSensor input="Crew_O2_Concentrator"
moduleName="Crew_O2_Concentrator_Sensor" index="0" logLevel="WARN"/>
        <O2InFlowRateSensor input="VPGC_O2_Injector"
moduleName="VPGC_O2_Injector_Sensor" index="0" logLevel="DEBUG"/>
        <CO2InFlowRateSensor input="VPGC_CO2_Injector"
moduleName="VPGC_CO2_Injector_Sensor" index="0" logLevel="DEBUG"/>
        <O2OutFlowRateSensor input="VPGC_O2_Concentrator"
moduleName="VPGC_O2_Concentrator_Sensor" index="0" logLevel="WARN"/>
        <O2InFlowRateSensor input="Waste_Incinerator"
moduleName="Waste_Incinerator_O2_in_Sensor" index="0" logLevel="DEBUG"/>
        <CO2OutFlowRateSensor input="Waste_Incinerator"
moduleName="Waste_Incinerator_CO2_out_Sensor" index="0" logLevel="DEBUG"/>
        <CO2InFlowRateSensor input="CRS"
moduleName="CRS_CO2_In_Sensor" index="0" logLevel="DEBUG" />
    </air>
    <environment>
        <GasMoleSensor input="Crew_Quarters"
moduleName="Crew_Quarters_O2_Moles" gasType="O2" logLevel="DEBUG"/>

```

```

        <GasMoleSensor input="Crew_Quarters"
moduleName="Crew_Quarters_CO2_Moles" gasType="CO2" logLevel="DEBUG"/>
        <GasMoleSensor input="VPGC" moduleName="VPGC_O2_Mole"
gasType="O2" logLevel="DEBUG"/>
        <GasMoleSensor input="VPGC" moduleName="VPGC_CO2_Mole"
gasType="CO2" logLevel="DEBUG"/>

        <GasConcentrationSensor input="Crew_Quarters"
moduleName="Crew_O2_Concentrator_Sensor" gasType="O2" logLevel="ALL"/>
        <GasConcentrationSensor input="Crew_Quarters"
moduleName="Crew_CO2_Concentrator_Sensor" gasType="CO2" logLevel="ALL"/>
        <GasConcentrationSensor input="Crew_Quarters"
moduleName="Crew_N_Concentrator_Sensor" gasType="NITROGEN" logLevel="WARN"/>
        <GasConcentrationSensor input="Crew_Quarters"
moduleName="Crew_Other_Concentrator_Sensor" gasType="OTHER" logLevel="WARN"/>

        <GasConcentrationSensor input="VPGC"
moduleName="VPGC_O2_Concentrator_Sensor" gasType="O2" logLevel="DEBUG"/>
        <GasConcentrationSensor input="VPGC"
moduleName="VPGC_CO2_Concentrator_Sensor" gasType="CO2" logLevel="DEBUG"/>
        <GasConcentrationSensor input="VPGC"
moduleName="VPGC_N_Concentrator_Sensor" gasType="NITROGEN" logLevel="WARN"/>
        <GasConcentrationSensor input="VPGC"
moduleName="VPGC_Other_Concentrator_Sensor" gasType="OTHER" logLevel="WARN"/>

        <AirInFlowRateSensor input="Main_VCCR"
moduleName="MainVccrAirInSensor" index="0"
isBionetEnabled="false"></AirInFlowRateSensor>
        <AirOutFlowRateSensor input="Main_VCCR"
moduleName="MainVccrAirOutSensor" index="0"
isBionetEnabled="false"></AirOutFlowRateSensor>

        <GasConcentrationSensor input="Crew_Quarters"
moduleName="Crew_Humidity_Concentrator_Sensor"
gasType="VAPOR"></GasConcentrationSensor>
        <GasConcentrationSensor input="VPGC"
moduleName="VPGC_Humidity_Concentration_Sensor"
gasType="VAPOR"></GasConcentrationSensor>

    </environment>
    <water>
        <PotableWaterOutFlowRateSensor input="CRS"
moduleName="CRS_Potable_Water_Produced" index="0" logLevel="DEBUG"/>
        <PotableWaterInFlowRateSensor input="OGS"
moduleName="OGS_Potable_Water_Consumed" index="0" logLevel="DEBUG"/>
        <DirtyWaterOutFlowRateSensor input="Crew_Dehumidifier"
moduleName="Crew_Dehumidifier_Dirtywater_Recovery" index="0"
logLevel="DEBUG"/>
        <DirtyWaterOutFlowRateSensor input="VPGC_Dehumidifier"
moduleName="VPGC_Dehumidifier_Dirtywater_Recovery" index="0"
logLevel="DEBUG"/>
        <!-- <DirtyWaterOutFlowRateSensor input="Grain_Mill"
moduleName="Grain_Mill_Dirty_Water_Produced" index="0" logLevel="DEBUG"/>
        CIH 201025 Does not like attaching to the FoodProducer
    water flow-->
    </water>
</power>

```

```

        <PowerInFlowRateSensor input="Main_VCCR"
moduleName="MainVccrPowerSensor" index="0" isBionetEnabled="false"/>
    </power>
</Sensors>
<Actuators>
    <power>
        <PowerInFlowRateActuator output="Main_VCCR"
            moduleName="MainVccrPower" index="0"
            isBionetEnabled="false">
        </PowerInFlowRateActuator>
    </power>
    <air>
        <CO2OutFlowRateActuator output="Crew_CO2_Injector"
moduleName="Crew_CO2_Storage_Actuator" index="0" />
        <CO2InFlowRateActuator output="Crew_CO2_Injector"
moduleName="Crew_CO2_Injector_Actuator" index="0"/>
        <O2InFlowRateActuator output="Crew_O2_Injector"
moduleName="Crew_O2_Injector_Actuator" index="0"/>
        <O2OutFlowRateActuator output="Crew_O2_Injector"
moduleName="Crew_O2_Storage_Actuator" index="0"/>
        <O2InFlowRateActuator output="Crew_O2_Concentrator"
moduleName="Crew_O2_ConcentratorStore_Actuator" index="0"/>
        <O2OutFlowRateActuator output="Crew_O2_Concentrator"
moduleName="Crew_O2_Concentrator_Actuator" index="0"/>

        <CO2OutFlowRateActuator output="VPGC_CO2_Injector"
moduleName="VPGC_CO2_Storage_Actuator" index="0" />
        <CO2InFlowRateActuator output="VPGC_CO2_Injector"
moduleName="VPGC_CO2_Injector_Actuator" index="0"/>
        <O2InFlowRateActuator output="VPGC_O2_Injector"
moduleName="VPGC_O2_Injector_Actuator" index="0"/>
        <O2OutFlowRateActuator output="VPGC_O2_Injector"
moduleName="VPGC_O2_Storage_Actuator" index="0"/>
        <O2InFlowRateActuator output="VPGC_O2_Concentrator"
moduleName="VPGC_O2_ConcentratorStore_Actuator" index="0"/>
        <O2OutFlowRateActuator output="VPGC_O2_Concentrator"
moduleName="VPGC_O2_Concentrator_Actuator" index="0"/>

    </air>

</Actuators>
</biosim>

```

A3 - Continuous LMLSPT Phase I

```
<?xml version="1.0" encoding="UTF-8"?>
<?xml-stylesheet type="text/xsl" href="../../style/table.xsl"?>
<biosim xmlns="http://www.traclabs.com/biosim"
        xmlns:xsi="http://www.w3.org/2001/XMLSchema-instance"
        xsi:schemaLocation="http://www.traclabs.com/biosim
../../schema/BiosimInitSchema.xsd">

    <!-- Modification of Lunar-Mars Life Support Test Project (LMLSPT)
Phase I Test performed in August of 1995
        at Johnson Space Center (JSC). This uses the basic configuration
of the LMLSPT Phase 1 and extends the experiment until system failure
        Goals for this configuration:
        - Determine length of stability of this configuration
        - Examine failure modes for possible early warning signs of
impending fold events

        1 human subject enter on day 17 (tick 408) and stays for the
duration
        11.2 m (double from original 5.6m to get proper CO2 processing) of
wheat used for Atmospheric regeneration growth begins on day 0, plants are
set to auto harvest and
        replant, harvest is not used for food stores in keeping with the
initial experiment where all food stores were provided
        VPGC (Variable Pressure Growth Chamber)
        {phase 1 parameters} 19.5 m3 crew space + 27 m3 plant growth space
= 36.5 m3 of environment volume
        (Phase 1 Sim parameters) - 36.5 m3 of environment volume, VPGC set
to 44.8 m3 of plan growth space due to wheat under-performing in CO2/O2
comparisons with actual test results
        Initial Starting parameters (From LMLSPT Phase 1 Final Report, pg
15, Average Environmental Conditions over the 68-Day Test)
        Relative Humidity (%) - 70.9 +/- 0.9
        Carbon Dioxide (ppm) - 1251 +/- 448 (in plant chamber) - reserve
set at 5000
        Oxygen (%) - 21.9 +/- 0.7 - reserve set at 1000
        SWAD - 4BMS - 4 Bed Molecular Sieve used for O2 concentration
        CO2 pulsed to maintain a constant level for plants,
        Water reserve set at 10000
    -->
    <Globals
runTillCrewDeath="true"
runTillPlantDeath="true"
runTillN="10000"
crewsToWatch="Crew_Group"
plantsToWatch="VPGC"
startPaused="true">

    </Globals>
    <SimBioModules>
        <environment>
    <!--          <SimEnvironment moduleName="SimEnvironment"
initialVolume="36500" > -->
        <SimEnvironment moduleName="Crew_Quarters"
initialVolume="36500" >
                <percentageInitialization waterPercentage="0.01"

```

```

nitrogenPercentage="0.75975"
otherPercentage="0.001"
co2Percentage="0.001253"/>
  </SimEnvironment>
  <Dehumidifier moduleName="Main_Dehumidifier">
    <airConsumer inputs="Crew_Quarters"
      desiredFlowRates="1000" maxFlowRates="1000" />
    <dirtyWaterProducer desiredFlowRates="1000"
      outputs="DirtyWaterStore" maxFlowRates="1000"
    />
  </Dehumidifier>
</environment>
<food>
  <BiomassPS moduleName="VPGC" autoHarvestAndReplant="true">
    <shelf cropArea="11.2" cropType="WHEAT"/>
    <powerConsumer maxFlowRates="20000"
desiredFlowRates="20000" inputs="PowerStore"/>
    <potableWaterConsumer maxFlowRates="250"
desiredFlowRates="250" inputs="PotableWaterStore"/>
    <greyWaterConsumer maxFlowRates="250"
desiredFlowRates="250" inputs="GreyWaterStore"/>
    <airConsumer maxFlowRates="1000"
desiredFlowRates="1000" inputs="Crew_Quarters"/>
    <dirtyWaterProducer maxFlowRates="1000"
desiredFlowRates="150" outputs="DirtyWaterStore"/>
    <biomassProducer maxFlowRates="1000"
desiredFlowRates="100" outputs="BiomassStore"/>
    <airProducer maxFlowRates="1000"
desiredFlowRates="1000" outputs="Crew_Quarters"/>
  </BiomassPS>
  <BiomassStore moduleName="BiomassStore" capacity="500"
level="300"/>
  <FoodStore moduleName="FoodStore" capacity="100000"
level="100000"/>
</food>
<power>
  <PowerStore moduleName="PowerStore" capacity="100000000000"
level="100000000000"/>
</power>
<water>
  <PotableWaterStore moduleName="PotableWaterStore"
capacity="50000" level="10000"/>
  <GreyWaterStore moduleName="GreyWaterStore"
capacity="50000" level="0"/>
  <DirtyWaterStore moduleName="DirtyWaterStore"
capacity="50000" level="0"/>
</water>
<air>
  <MethaneStore capacity="10000" moduleName="MethaneStore"
level="0"/>
  <NitrogenStore capacity="10000" moduleName="NitrogenStore"
level="0"/>
  <CO2Store capacity="10000" moduleName="CO2_Store"
level="8000"/>
  <H2Store capacity="10000" moduleName="H2_Store"
level="1000"/>

```



```

    <O2Store capacity="10000" moduleName="O2_Store"
level="1000"/>
    <VCCR moduleName="SWAD" logLevel="DEBUG" >
      <!-- Flow and power set to 0 since SWAD was not
activated during actual test -->
      <powerConsumer inputs="PowerStore"
        desiredFlowRates="0" maxFlowRates="2000"
></powerConsumer>
      <airConsumer inputs="Crew_Quarters"
        desiredFlowRates="0"
maxFlowRates="10000"></airConsumer>
      <airProducer desiredFlowRates="0"
        outputs="Crew_Quarters" maxFlowRates="10000" />
      <CO2Producer desiredFlowRates="10000"
        outputs="CO2_Store"
          maxFlowRates="10000"></CO2Producer>
    </VCCR>
    </air>
    <waste>
      <DryWasteStore moduleName="DryWasteStore" capacity="500"
level="0"/>
    </waste>
    <crew>
      <CrewGroup moduleName="Crew_Group">
        <potableWaterConsumer maxFlowRates="100"
desiredFlowRates="100" inputs="PotableWaterStore"/>
        <airConsumer maxFlowRates="0" desiredFlowRates="0"
inputs="Crew_Quarters"/>
        <foodConsumer maxFlowRates="100"
desiredFlowRates="100" inputs="FoodStore"/>
        <dirtyWaterProducer maxFlowRates="100"
desiredFlowRates="100" outputs="DirtyWaterStore"/>
        <greyWaterProducer maxFlowRates="100"
desiredFlowRates="100" outputs="GreyWaterStore"/>
        <airProducer maxFlowRates="0" desiredFlowRates="0"
outputs="Crew_Quarters"/>
        <dryWasteProducer maxFlowRates="100"
desiredFlowRates="100" outputs="DryWasteStore"/>
        <crewPerson name="Bob Roberts" age="43" weight="77"
sex="MALE" arrivalDate="408" logLevel="INFO">
          <schedule>
            <activity name="sleep" length="8"
intensity="1"/>
            <activity name="hygiene" length="1"
intensity="2"/>
            <activity name="exercise" length="1"
intensity="5"/>
            <activity name="eating" length="1"
intensity="2"/>
            <activity name="mission" length="9"
intensity="3"/>
            <activity name="health" length="1"
intensity="2"/>
            <activity name="maintenance" length="1"
intensity="2"/>
            <activity name="leisure" length="2"
intensity="2"/>
          </schedule>
        </crewPerson>
      </CrewGroup>
    </crew>
  </VCCR>
</VCCR>

```

```

        </schedule>
    </crewPerson>
</CrewGroup>
</crew>
<framework>
    <Injector moduleName="CO2_Injector">
        <CO2Consumer inputs="CO2_Store" desiredFlowRates="0"
maxFlowRates="2000" />
        <CO2Producer desiredFlowRates="0"
outputs="Crew_Quarters" maxFlowRates="2000" />
    </Injector>
    <Injector moduleName="O2_Injector">
        <O2Consumer inputs="O2_Store" desiredFlowRates="0"
maxFlowRates="2000" />
        <O2Producer desiredFlowRates="0"
outputs="Crew_Quarters" maxFlowRates="2000" />
    </Injector>
    <Accumulator moduleName="O2_Concentrator">
        <O2Consumer inputs="Crew_Quarters"
desiredFlowRates="15" maxFlowRates="100"/>
        <O2Producer desiredFlowRates="0" outputs="O2_Store"
maxFlowRates="100"/>
    </Accumulator>
</framework>
</SimBioModules>
<Sensors>
    <crew>
        <CrewGroupO2ConsumedSensor input="Crew_Group"
moduleName="Crew_O2_Consumed" logLevel="DEBUG" />
        <CrewGroupCO2ProducedSensor input="Crew_Group"
moduleName="Crew_CO2Produced" logLevel="DEBUG" />
        <CrewGroupWaterConsumedSensor input="Crew_Group"
moduleName="Crew_WaterConsumed" logLevel="DEBUG" />
        <CrewGroupWaterProducedSensor input="Crew_Group"
moduleName="Crew_WaterProduced" logLevel="DEBUG" />
        <CrewGroupWasteProducedSensor input="Crew_Group"
moduleName="Crew_WasteProduced" logLevel="DEBUG" />
    </crew>
    <framework>
        <StoreLevelSensor input="O2_Store" moduleName="O2_Store_Level"
logLevel="DEBUG"/>
        <StoreLevelSensor input="CO2_Store"
moduleName="CO2_Store_Level" logLevel="DEBUG"/>
        <StoreLevelSensor input="DirtyWaterStore"
moduleName="Dirty_Water_Store_Level" logLevel="DEBUG"/>
        <StoreLevelSensor input="GreyWaterStore"
moduleName="Grey_Water_Store_Level" logLevel="DEBUG"/>
        <StoreLevelSensor input="PotableWaterStore"
moduleName="Potable_Water_store_Level" logLevel="DEBUG"/>
    </framework>
    <food>
        <BiomassTotalCO2ConsumedSensor input="VPGC"
moduleName="Biomass_CO2Consumed" logLevel="DEBUG"
></BiomassTotalCO2ConsumedSensor>
        <BiomassTotalO2ProducedSensor input="VPGC"
moduleName="Biomass_O2Produced" logLevel="DEBUG" />
    </food>
</Sensors>

```

```

        <BiomassTotalWaterConsumedSensor input="VPGC"
moduleName="Biomass_WaterConsumed" logLevel="DEBUG" />
        <BiomassTotalWaterProducedSensor input="VPGC"
moduleName="Biomass_WaterProduced" logLevel="DEBUG" />
    </food>
    <air>
        <CO2OutFlowRateSensor input="SWAD"
moduleName="SWAD_Co2_Out_Sensor" index="0" logLevel="DEBUG"/>
        <O2InFlowRateSensor input="O2_Injector"
moduleName="O2_Injector_Sensor" index="0" logLevel="DEBUG"/>
        <CO2InFlowRateSensor input="CO2_Injector"
moduleName="CO2_Injector_Sensor" index="0" logLevel="DEBUG"/>
        <O2OutFlowRateSensor input="O2_Concentrator"
moduleName="O2_Concentrator_Sensor" index="0" logLevel="DEBUG"/>
    </air>
    <environment>
        <AirInFlowRateSensor input="SWAD"
moduleName="SWAD_Air_Influent_Sensor" index="0" logLevel="DEBUG" />
        <AirOutFlowRateSensor input="SWAD"
moduleName="SWAD_Air_Effluent_Sensor" index="0" logLevel="DEBUG"/>
        <GasConcentrationSensor input="Crew_Quarters"
moduleName="O2_Concentrator_Sensor" gasType="O2" logLevel="DEBUG"/>
        <GasConcentrationSensor input="Crew_Quarters"
moduleName="CO2_Concentrator_Sensor" gasType="CO2" logLevel="DEBUG"/>
        <GasConcentrationSensor input="Crew_Quarters"
moduleName="N_Concentrator_Sensor" gasType="NITROGEN" logLevel="DEBUG"/>
        <GasConcentrationSensor input="Crew_Quarters"
moduleName="Other_Concentrator_Sensor" gasType="OTHER" logLevel="DEBUG"/>
        <GasMoleSensor input="Crew_Quarters"
moduleName="Crew_Quarters_O2_Mole" gasType="O2" logLevel="DEBUG"/>
        <GasMoleSensor input="Crew_Quarters"
moduleName="Crew_Quarters_CO2_Mole" gasType="CO2" logLevel="DEBUG"/>
    </environment>
</Sensors>

    <Actuators>
    <air>
        <CO2OutFlowRateActuator output="CO2_Injector"
moduleName="CO2_Storage_Actuator" index="0" />
        <CO2InFlowRateActuator output="CO2_Injector"
moduleName="CO2_Injector_Actuator" index="0"/>
        <O2InFlowRateActuator output="O2_Injector"
moduleName="O2_Injector_Actuator" index="0"/>
        <O2OutFlowRateActuator output="O2_Injector"
moduleName="O2_Storage_Actuator" index="0"/>
        <O2InFlowRateActuator output="O2_Concentrator"
moduleName="O2_ConcentratorStore_Actuator" index="0"/>
        <O2OutFlowRateActuator output="O2_Concentrator"
moduleName="O2_Concentrator_Actuator" index="0"/>
    </air>
    <environment>
    </environment>
</Actuators>
</biosim>

```

A4 – Continuous LMLSTP Phase III

```
<?xml version="1.0" encoding="UTF-8"?>
<?xml-stylesheet type="text/xsl" href="../../style/table.xsl"?>
<biosim xmlns="http://www.traclabs.com/biosim"
        xmlns:xsi="http://www.w3.org/2001/XMLSchema-instance"
        xsi:schemaLocation="http://www.traclabs.com/biosim
../../schema/BiosimInitSchema.xsd">

    <!-- Modification of Lunar-Mars Life Support Test Project (LMLSTP)
Phase III Test performed in 1997
        at Johnson Space Center (JSC). This uses the basic configuration
of the LMLSTP Phase III and extends the experiment until system failure
        Sources:
            - Lunar-Mars Life Support Test Project: Phase III Final Report,
NASA JSC CTSD-ADV-341 Engineering Directorate, Feb 23, 2000 (Report JSC-
49144)
            - Isolation, NASA Experiments in closed living, H. Lane; R.
Sauser; D. Feedback (eds),2002, American Astronautical Society
            - The Lunar Mars Life Support Test Project, Daniel J. Barta 2016
(Presentation)
                Goals for this configuration:
                - Determine length of stability of this configuration
                - Examine failure modes for possible early warning signs of
impending fold events

                Simulation/Experiment Parameters
                - 1250 Days - 30,000 'ticks'
                - 4 human subjects, enter on day 58 (tick 1392) and stay for the
duration
                - Air - regenerative biological and physicochemical
                75% Physicochemical Atmospheric Regeneration (OGS / VCCR(4BMS)
/ CRS) (section 2.1.4 users manual)
                GARDEN experiment in Crew Quarters
                11.2 m2 growing area (Barta 2016, pg 20, Isolation pg 264,
LMLSTP III Final, pg 14 )
                * set to 44.8 m of growth space, based on Phase I experience
                One shelf harvested every 20 days (Barta 2016, pg 14,
Isolation, pg 264, LMLSTP III Final, pg 79)
                Atmospheric parameter for Crew Quarters
                CO2 0.2% to 0.65% with an average of 0.43% LMLSTP III
Final, pg 93-94
                O2 20.5% to 21.6% LMLSTP III Final, pg 101-102
                40% humidity, Isolation, pg 282,
                4BMS ran day 0-47 and day 57 - 91 LMLSTP III Final, pg 94
                WSCR ran day 39-40 and day 47-57 LMLSTP III Final, pg 94
                CRS ran 75 days out of 91 LMLSTP III Final, pg 99
                OGS ran the entire 91 day test, LMLSTP III Final, pg 102
                25% VPGC (Variable Pressure Growth Chamber) (Barta 2016) 95% of
O2 cycled back to Crew Compartment (LMLSTP III Final, pg 47)
                11.2 m of wheat used for Atmospheric regeneration and crew
consumption (5% of calories)
                * set to 44.8 m of growth space per Phase 1 experience
                25% harvest rotation starting on day 20 (LMLSTP III Final, pg
58)

                100420 - harvest control function set in controller routine
                Atmospheric parameters for VPGC
```

CO2 1200 PPM
O2 21.5 to 21.6%
70% Humidity assumed
CO2 store increased from 10000 to 40000
O2 store increased from 1000 to 4000 (4x Phase 1 Continuous setting)
Potable Water set at 20000 (2x Phase 1 Continuous setting)
VPGC Volume - 27.2 m3 growth area + 19.2m3 (total 46.4 m3) airlock
- 2% leak rate (LMLSTP III Final, pg 3)
ILSSTF Crew chamber - 229 m3 + 23.4 m3 outer lock + 21.52 m2 inner
lock (total 273.92 m3) - 4% leak rate (LMLSTP III Final, pg 3)
Water Recovery System
8 days of water were cycled 10 times through crew chamber LMLSTP
III Final, pg 47)
Waste Management System - Incineration and Biodegradation
Fecal process was done every 4 days starting on day 4 (overall
day 54 of test) LMLSTP III Final, pg 87
- Average processing time (Burn) was 4 hours - LMLSTP III
Final, pg 87
Product Gas Transfer (PGT) not operational during first 3 weeks
of test (LMLSTP III Final, pg 90)
-->
<Globals
runTillCrewDeath="true"
runTillPlantDeath="true"
runTillN="30000"
crewsToWatch="Crew_Group"
plantsToWatch="Biomass"
startPaused="true">

</Globals>
<SimBioModules>
<environment>
<SimEnvironment moduleName="Crew_Quarters"
initialVolume="273920">
<percentageInitialization waterPercentage="0.10"
nitrogenPercentage="0.659"
otherPercentage="0.001"
o2Percentage="0.21" totalPressure="101.325"
co2Percentage="0.0043" />
</SimEnvironment>
<SimEnvironment moduleName="VPGC" initialVolume="46400" >
<percentageInitialization waterPercentage="0.50"
nitrogenPercentage="0.659"
otherPercentage="0.001"
o2Percentage="0.215" totalPressure="101.325"
co2Percentage="0.0003"/>
</SimEnvironment>
<Dehumidifier moduleName="Crew_Dehumidifier">
<airConsumer inputs="Crew_Quarters"
desiredFlowRates="1000"
maxFlowRates="1000"></airConsumer>
<dirtyWaterProducer desiredFlowRates="1000"
outputs="Dirty_Water_Store" maxFlowRates="1000"
/>

</Dehumidifier>
<Dehumidifier moduleName="VPGC_Dehumidifier">
<airConsumer inputs="VPGC"

```

                                desiredFlowRates="1000"
maxFlowRates="1000"></airConsumer>
                                <dirtyWaterProducer desiredFlowRates="1000"
                                outputs="Dirty_Water_Store" maxFlowRates="1000"
/>
                                </Dehumidifier>
                                </environment>
                                <air>
                                <MethaneStore capacity="10000" moduleName="Methane_Store"
level="1000"/>
                                <NitrogenStore capacity="10000" moduleName="Nitrogen_Store"
level="1000"/>
                                <CO2Store capacity="40000" moduleName="CO2_Store"
level="32000"/>
                                <H2Store capacity="10000" moduleName="H2_Store"
level="1000"/>
                                <O2Store capacity="10000" moduleName="O2_Store"
level="4000"/>

                                <VCCR moduleName="Main_VCCR" >
                                <powerConsumer inputs="Power_Store"
                                desiredFlowRates="2000" maxFlowRates="2000"
></powerConsumer>
                                <airConsumer inputs="Crew_Quarters"
                                desiredFlowRates="10000"
maxFlowRates="10000"></airConsumer>
                                <airProducer desiredFlowRates="10000"
                                outputs="Crew_Quarters" maxFlowRates="10000" />
                                <CO2Producer desiredFlowRates="10000"
                                outputs="CO2_Store"
                                maxFlowRates="10000"></CO2Producer>
                                </VCCR>
                                <!-- Oxygen Generator System -->
                                <OGS moduleName="OGS" >
                                <powerConsumer inputs="Power_Store"
desiredFlowRates="1000" maxFlowRates="1000"/>
                                <potableWaterConsumer inputs="Potable_Water_Store"
desiredFlowRates="10" maxFlowRates="10"/>
                                <O2Producer desiredFlowRates="1000"
                                outputs="O2_Store" maxFlowRates="1000"/>
                                <H2Producer desiredFlowRates="1000"
                                outputs="H2_Store" maxFlowRates="1000"/>
                                </OGS>

                                <!-- Carbon Reduction System produced Water and Methane
(vented in actual exp) -->
                                <CRS moduleName="CRS" >
                                <powerConsumer inputs="Power_Store"
                                desiredFlowRates="100" maxFlowRates="100" />
                                <CO2Consumer inputs="CO2_Store"
                                desiredFlowRates="100"
                                maxFlowRates="100" />
                                <H2Consumer inputs="H2_Store" desiredFlowRates="100"
                                maxFlowRates="100" />
                                <potableWaterProducer desiredFlowRates="100"
                                outputs="Potable_Water_Store"
                                maxFlowRates="100" />

```

```

        <methaneProducer desiredFlowRates="100"
            outputs="Methane_Store"
maxFlowRates="100"></methaneProducer>
    </CRS>
    <Pyrolizer moduleName="Pyrolizer">
        <powerConsumer inputs="Power_Store"
            desiredFlowRates="100" maxFlowRates="100" />
        <methaneConsumer inputs="Methane_Store"
            desiredFlowRates="100" maxFlowRates="100" />
        <H2Producer desiredFlowRates="100" outputs="H2_Store"
            maxFlowRates="100" />
        <dryWasteProducer desiredFlowRates="100"
            outputs="Dry_Waste_Store" maxFlowRates="100" />
    </Pyrolizer>
</air>
<food>
    <BiomassPS moduleName="Biomass"
autoHarvestAndReplant="false">
    <!-- Harvesting/replanting handled in the LMLSTP3
controller routine -->
    <!-- <shelf cropArea="5.6" cropType="WHEAT"/> changed crop
area to get expected levels of CO2 recycling -->
    <!-- ISOLATION book pg 48 LMLSTP Phase III, only wheat in VPGC,
lettuce was done in the GARDEN experiment -->

        <shelf cropArea="11.2" cropType="WHEAT"/>
        <shelf cropArea="11.2" cropType="WHEAT"/>
        <shelf cropArea="11.2" cropType="WHEAT"/>
        <shelf cropArea="11.2" cropType="WHEAT"/>
        <powerConsumer maxFlowRates="20000"
desiredFlowRates="18000" inputs="Power_Store"/>
        <potableWaterConsumer maxFlowRates="250"
desiredFlowRates="150" inputs="Potable_Water_Store"/>
        <greyWaterConsumer maxFlowRates="250"
desiredFlowRates="150" inputs="Grey_Water_Store"/>
        <airConsumer maxFlowRates="1000"
desiredFlowRates="500" inputs="VPGC"/>
        <dirtyWaterProducer maxFlowRates="1000"
desiredFlowRates="150" outputs="Dirty_Water_Store"/>
        <biomassProducer maxFlowRates="1000"
desiredFlowRates="100" outputs="Biomass_Store"/>
        <airProducer maxFlowRates="1000"
desiredFlowRates="500" outputs="VPGC"/>
    </BiomassPS>
    <BiomassPS moduleName="GARDEN"
autoHarvestAndReplant="true">
        <shelf cropArea="1" cropType="LETTUCE"/>
        <powerConsumer maxFlowRates="1000"
desiredFlowRates="1000" inputs="Power_Store"/>
        <potableWaterConsumer maxFlowRates="50"
desiredFlowRates="50" inputs="Potable_Water_Store"/>
        <greyWaterConsumer maxFlowRates="50"
desiredFlowRates="50" inputs="Grey_Water_Store"/>
        <airConsumer maxFlowRates="0" desiredFlowRates="0"
inputs="Crew_Quarters"/>
        <dirtyWaterProducer maxFlowRates="50"
desiredFlowRates="50" outputs="Dirty_Water_Store"/>

```

```

        <biomassProducer maxFlowRates="100"
desiredFlowRates="100" outputs="Biomass_Store"/>
        <airProducer maxFlowRates="0" desiredFlowRates="0"
outputs="Crew_Quarters"/>
    </BiomassPS>
    <BiomassStore moduleName="Biomass_Store" capacity="100"
level="25"/>
    <FoodStore moduleName="FoodStore" capacity="10000"
level="10000"/>
    <FoodProcessor moduleName="Grain_Mill">
        <powerConsumer maxFlowRates="1000"
desiredFlowRates="1000" inputs="Power_Store"/>
        <biomassConsumer desiredFlowRates="100"
maxFlowRates="100" inputs="Biomass_Store"/>
        <foodProducer desiredFlowRates="50"
outputs="FoodStore" maxFlowRates="100"/>
        <dryWasteProducer desiredFlowRates="100"
outputs="Dry_Waste_Store" maxFlowRates="100"/>
        <waterProducer maxFlowRates="10"
desiredFlowRates="10" outputs="Grey_Water_Store"/>
    </FoodProcessor>
</food>
<framework>

    <Injector moduleName="Crew_O2_Injector">
        <O2Consumer inputs="O2_Store" desiredFlowRates="10"
maxFlowRates="100"/>
        <O2Producer desiredFlowRates="10"
outputs="Crew_Quarters" maxFlowRates="100" />
    </Injector>
    <Injector moduleName="Crew_CO2_Injector">
        <CO2Consumer inputs="CO2_Store"
desiredFlowRates="1.2" maxFlowRates="100" />
        <CO2Producer desiredFlowRates="1.2"
outputs="Crew_Quarters" maxFlowRates="100"/>
    </Injector>
    <Accumulator moduleName="Crew_O2_Concentrator">
        <O2Consumer inputs="Crew_Quarters"
desiredFlowRates="15" maxFlowRates="100"/>
        <O2Producer desiredFlowRates="0" outputs="O2_Store"
maxFlowRates="100"/>
    </Accumulator>
    <Injector moduleName="VPGC_CO2_Injector">
        <CO2Consumer inputs="CO2_Store"
desiredFlowRates="0" maxFlowRates="100" />
        <CO2Producer desiredFlowRates="0" outputs="VPGC"
maxFlowRates="100"/>
    </Injector>
    <Injector moduleName="VPGC_O2_Injector">
        <O2Consumer inputs="O2_Store" desiredFlowRates="0"
maxFlowRates="100"/>
        <O2Producer desiredFlowRates="0" outputs="VPGC"
maxFlowRates="100" />
    </Injector>
    <Accumulator moduleName="VPGC_O2_Concentrator">
        <O2Consumer inputs="VPGC" desiredFlowRates="0"
maxFlowRates="100"/>

```



```

                                <O2Producer desiredFlowRates="0" outputs="O2_Store"
maxFlowRates="100"/>
                                </Accumulator>

                                </framework>
                                <power>
                                    <PowerStore moduleName="Power_Store"
capacity="100000000000" level="100000000000"/>
                                </power>

                                <water>
                                    <WaterRS moduleName="Water_Distiller"
implementation="LINEAR">
                                        <powerConsumer inputs="Power_Store"
desiredFlowRates="1000" maxFlowRates="1000" />
                                        <dirtyWaterConsumer inputs="Dirty_Water_Store"
desiredFlowRates="10" maxFlowRates="1000"/>
                                        <greyWaterConsumer inputs="Grey_Water_Store"
desiredFlowRates="10" maxFlowRates="1000" />
                                        <potableWaterProducer desiredFlowRates="1000"
outputs="Potable_Water_Store" maxFlowRates="1000" />
                                    </WaterRS>
                                    <PotableWaterStore moduleName="Potable_Water_Store"
capacity="50000" level="20000"/>
                                    <GreyWaterStore moduleName="Grey_Water_Store"
capacity="5000" level="1000"/>
                                    <DirtyWaterStore moduleName="Dirty_Water_Store"
capacity="5000" level="1000"/>

                                </water>
                                <waste>
                                    <DryWasteStore moduleName="Dry_Waste_Store" capacity="100"
level="0"/>
                                    <Incinerator moduleName="Waste_Incinerator"
logLevel="WARN">
                                        <powerConsumer inputs="Power_Store"
desiredFlowRates="0" maxFlowRates="1000"/>
                                        <O2Consumer inputs="VPGC" desiredFlowRates="100"
maxFlowRates="1000"/>
                                        <dryWasteConsumer maxFlowRates="1000"
desiredFlowRates="1000" inputs="Dry_Waste_Store"/>
                                        <CO2Producer desiredFlowRates="100" outputs="VPGC"
maxFlowRates="10000"/>
                                    </Incinerator>

                                </waste>
                                <crew>
                                    <CrewGroup moduleName="Crew_Group">
                                        <potableWaterConsumer maxFlowRates="100"
desiredFlowRates="100" inputs="Potable_Water_Store"/>
                                        <airConsumer maxFlowRates="0" desiredFlowRates="0"
inputs="Crew_Quarters"/>
                                        <foodConsumer maxFlowRates="100"
desiredFlowRates="100" inputs="FoodStore"/>
                                        <dirtyWaterProducer maxFlowRates="100"
desiredFlowRates="100" outputs="Dirty_Water_Store"/>

```

```

        <greyWaterProducer maxFlowRates="100"
desiredFlowRates="100" outputs="Grey_Water_Store"/>
        <airProducer maxFlowRates="0" desiredFlowRates="0"
outputs="Crew_Quarters"/>
        <dryWasteProducer maxFlowRates="100"
desiredFlowRates="100" outputs="Dry_Waste_Store"/>
        <crewPerson name="Nigel Packham" age="47" weight="77"
sex="MALE" arrivalDate="1392" >
            <schedule>
                <activity name="sleep" length="8"
intensity="1"/>
                <activity name="hygiene" length="1"
intensity="2"/>
                <activity name="exercise" length="1"
intensity="5"/>
                <activity name="eating" length="1"
intensity="2"/>
                <activity name="mission" length="9"
intensity="3"/>
                <activity name="health" length="1"
intensity="2"/>
                <activity name="maintenance" length="1"
intensity="2"/>
                <activity name="leisure" length="2"
intensity="2"/>
            </schedule>
        </crewPerson>
        <crewPerson name="John Lewis" age="35" weight="75"
sex="MALE" arrivalDate="1392" >
            <schedule>
                <activity name="sleep" length="8"
intensity="1"/>
                <activity name="hygiene" length="1"
intensity="2"/>
                <activity name="exercise" length="1"
intensity="5"/>
                <activity name="eating" length="1"
intensity="2"/>
                <activity name="mission" length="9"
intensity="3"/>
                <activity name="health" length="1"
intensity="2"/>
                <activity name="maintenance" length="1"
intensity="2"/>
                <activity name="leisure" length="2"
intensity="2"/>
            </schedule>
        </crewPerson>
        <crewPerson name="Laura Supra" age="30" weight="60"
sex="FEMALE" arrivalDate="1392" >
            <schedule>
                <activity name="sleep" length="8"
intensity="1"/>
                <activity name="exercise" length="1"
intensity="5"/>
                <activity name="hygiene" length="1"
intensity="2"/>
            </schedule>
        </crewPerson>

```

```

intensity="2"/>
intensity="3"/>
intensity="2"/>
intensity="2"/>
intensity="2"/>
</schedule>
</crewPerson>
<crewPerson name="Vickie Kloenis" age="35"
weight="60" sex="FEMALE" arrivalDate="1392" >
  <schedule>
    <activity name="sleep" length="8"
intensity="1"/>
    <activity name="exercise" length="1"
intensity="5"/>
    <activity name="hygiene" length="1"
intensity="2"/>
    <activity name="eating" length="1"
intensity="2"/>
    <activity name="mission" length="9"
intensity="3"/>
    <activity name="health" length="1"
intensity="2"/>
    <activity name="maintenance" length="1"
intensity="2"/>
    <activity name="leisure" length="2"
intensity="2"/>
  </schedule>
</crewPerson>
</CrewGroup>
</crew>
</SimBioModules>
<Sensors>
  <crew>
    <CrewGroupO2ConsumedSensor input="Crew_Group"
moduleName="Crew_O2Consumed" logLevel="DEBUG" />
    <CrewGroupCO2ProducedSensor input="Crew_Group"
moduleName="Crew_CO2Produced" logLevel="DEBUG" />
    <CrewGroupWaterConsumedSensor input="Crew_Group"
moduleName="Crew_WaterConsumed" logLevel="DEBUG" />
    <CrewGroupWaterProducedSensor input="Crew_Group"
moduleName="Crew_WaterProduced" logLevel="DEBUG" />
    <CrewGroupWasteProducedSensor input="Crew_Group"
moduleName="Crew_WasteProduced" logLevel="DEBUG" />
  </crew>
  <food>
    <BiomassTotalCO2ConsumedSensor input="Biomass"
moduleName="Biomass_CO2Consumed" logLevel="DEBUG"
>>/BiomassTotalCO2ConsumedSensor>
    <BiomassTotalO2ProducedSensor input="Biomass"
moduleName="Biomass_O2Produced" logLevel="DEBUG" />
    <BiomassTotalWaterConsumedSensor input="Biomass"
moduleName="Biomass_WaterConsumed" logLevel="DEBUG" />

```

```

        <BiomassTotalWaterProducedSensor input="Biomass"
moduleName="Biomass_WaterProduced" logLevel="DEBUG" />
        <BiomassTotalCO2ConsumedSensor input="GARDEN"
moduleName="Garden_CO2Consumed" logLevel="DEBUG"
></BiomassTotalCO2ConsumedSensor>
        <BiomassTotalO2ProducedSensor input="GARDEN"
moduleName="Garden_O2Produced" logLevel="DEBUG" />
        <BiomassTotalWaterConsumedSensor input="GARDEN"
moduleName="Garden_WaterConsumed" logLevel="DEBUG" />
        <BiomassTotalWaterProducedSensor input="GARDEN"
moduleName="Garden_WaterProduced" logLevel="DEBUG" />
    </food>
    <framework>
        <StoreLevelSensor input="O2_Store" moduleName="O2_Store_Level"
logLevel="DEBUG"/>
        <StoreLevelSensor input="CO2_Store"
moduleName="CO2_Store_Level" logLevel="DEBUG"/>
        <!-- H2 and Methane store monitored for CRS running -->
        <StoreLevelSensor input="H2_Store" moduleName="H2_Store_Level"
logLevel="DEBUG"/>
        <StoreLevelSensor input="Methane_Store"
moduleName="Methane_Store_Level" logLevel="DEBUG"/>
        <StoreLevelSensor input="Nitrogen_Store"
moduleName="Nitrogen_Store_Level" logLevel="WARN"/>
        <StoreLevelSensor input="Dirty_Water_Store"
moduleName="Dirty_Water_Store_Level" logLevel="DEBUG"/>
        <StoreLevelSensor input="Grey_Water_Store"
moduleName="Grey_Water_Store_Level" logLevel="DEBUG"/>
        <StoreLevelSensor input="Potable_Water_Store"
moduleName="Potable_Water_store_Level" logLevel="DEBUG"/>
        <StoreLevelSensor input="Biomass_Store"
moduleName="Biomass_Store_Level" logLevel="DEBUG"/>
        <StoreLevelSensor input="Dry_Waste_Store"
moduleName="Dry_Waste_Store_Level" logLevel="DEBUG"/>
    </framework>
    <air>
        <CO2OutFlowRateSensor input="Main_VCCR"
moduleName="Main_Vccr_Co2_Out_Sensor" index="0" logLevel="DEBUG"/>
        <O2OutFlowRateSensor input="OGS"
moduleName="Main_OGS_O2_Out_Sensor" index="0" logLevel="DEBUG" />
        <O2InFlowRateSensor input="Crew_O2_Injector"
moduleName="Crew_O2_Injector_Sensor" index="0" logLevel="DEBUG"/>
        <CO2InFlowRateSensor input="Crew_CO2_Injector"
moduleName="Crew_CO2_Injector_Sensor" index="0" logLevel="DEBUG"/>
        <O2OutFlowRateSensor input="Crew_O2_Concentrator"
moduleName="Crew_O2_Concentrator_Sensor" index="0" logLevel="WARN"/>
        <O2InFlowRateSensor input="VPGC_O2_Injector"
moduleName="VPGC_O2_Injector_Sensor" index="0" logLevel="DEBUG"/>
        <CO2InFlowRateSensor input="VPGC_CO2_Injector"
moduleName="VPGC_CO2_Injector_Sensor" index="0" logLevel="DEBUG"/>
        <O2OutFlowRateSensor input="VPGC_O2_Concentrator"
moduleName="VPGC_O2_Concentrator_Sensor" index="0" logLevel="WARN"/>
        <O2InFlowRateSensor input="Waste_Incinerator"
moduleName="Waste_Incinerator_O2_in_Sensor" index="0" logLevel="DEBUG"/>
        <CO2OutFlowRateSensor input="Waste_Incinerator"
moduleName="Waste_Incinerator_CO2_out_Sensor" index="0" logLevel="DEBUG"/>

```

```

        <CO2InFlowRateSensor input="CRS"
moduleName="CRS_CO2_In_Sensor" index="0" logLevel="DEBUG" />
    </air>
    <environment>
        <GasMoleSensor input="Crew_Quarters"
moduleName="Crew_Quarters_O2_Moles" gasType="O2" logLevel="DEBUG"/>
        <GasMoleSensor input="Crew_Quarters"
moduleName="Crew_Quarters_CO2_Moles" gasType="CO2" logLevel="DEBUG"/>
        <GasMoleSensor input="VPGC" moduleName="VPGC_O2_Mole"
gasType="O2" logLevel="DEBUG"/>
        <GasMoleSensor input="VPGC" moduleName="VPGC_CO2_Mole"
gasType="CO2" logLevel="DEBUG"/>

        <GasConcentrationSensor input="Crew_Quarters"
moduleName="Crew_O2_Concentrator_Sensor" gasType="O2" logLevel="ALL"/>
        <GasConcentrationSensor input="Crew_Quarters"
moduleName="Crew_CO2_Concentrator_Sensor" gasType="CO2" logLevel="ALL"/>
        <GasConcentrationSensor input="Crew_Quarters"
moduleName="Crew_N_Concentrator_Sensor" gasType="NITROGEN" logLevel="WARN"/>
        <GasConcentrationSensor input="Crew_Quarters"
moduleName="Crew_Other_Concentrator_Sensor" gasType="OTHER" logLevel="WARN"/>

        <GasConcentrationSensor input="VPGC"
moduleName="VPGC_O2_Concentrator_Sensor" gasType="O2" logLevel="DEBUG"/>
        <GasConcentrationSensor input="VPGC"
moduleName="VPGC_CO2_Concentrator_Sensor" gasType="CO2" logLevel="DEBUG"/>
        <GasConcentrationSensor input="VPGC"
moduleName="VPGC_N_Concentrator_Sensor" gasType="NITROGEN" logLevel="WARN"/>
        <GasConcentrationSensor input="VPGC"
moduleName="VPGC_Other_Concentrator_Sensor" gasType="OTHER" logLevel="WARN"/>

        <AirInFlowRateSensor input="Main_VCCR"
moduleName="MainVCCRAirInSensor" index="0"
isBionetEnabled="false"></AirInFlowRateSensor>
        <AirOutFlowRateSensor input="Main_VCCR"
moduleName="MainVCCRAirOutSensor" index="0"
isBionetEnabled="false"></AirOutFlowRateSensor>

        <GasConcentrationSensor input="Crew_Quarters"
moduleName="Crew_Humidity_Concentrator_Sensor"
gasType="VAPOR"></GasConcentrationSensor>
        <GasConcentrationSensor input="VPGC"
moduleName="VPGC_Humidity_Concentration_Sensor"
gasType="VAPOR"></GasConcentrationSensor>

    </environment>
    <water>
        <PotableWaterOutFlowRateSensor input="CRS"
moduleName="CRS_Potable_Water_Produced" index="0" logLevel="DEBUG"/>
        <PotableWaterInFlowRateSensor input="OGS"
moduleName="OGS_Potable_Water_Consumed" index="0" logLevel="DEBUG"/>
        <DirtyWaterOutFlowRateSensor input="Crew_Dehumidifier"
moduleName="Crew_Dehumidifier_Dirtywater_Recovery" index="0"
logLevel="DEBUG"/>
        <DirtyWaterOutFlowRateSensor input="VPGC_Dehumidifier"
moduleName="VPGC_Dehumidifier_Dirtywater_Recovery" index="0"
logLevel="DEBUG"/>

```

```

        <!-- <DirtyWaterOutFlowRateSensor input="Grain_Mill"
moduleName="Grain_Mill_Dirty_Water_Produced" index="0" logLevel="DEBUG"/>
        CIH 201025 Does not like attaching to the FoodProducer
water flow-->
        </water>
        <power>
            <PowerInFlowRateSensor input="Main_VCCR"
moduleName="MainVccrPowerSensor" index="0" isBionetEnabled="false"/>
        </power>
    </Sensors>
    <Actuators>
        <power>
            <PowerInFlowRateActuator output="Main_VCCR"
                moduleName="MainVccrPower" index="0"
                isBionetEnabled="false">
            </PowerInFlowRateActuator>
        </power>
        <air>
            <CO2OutFlowRateActuator output="Crew_CO2_Injector"
moduleName="Crew_CO2_Storage_Actuator" index="0" />
            <CO2InFlowRateActuator output="Crew_CO2_Injector"
moduleName="Crew_CO2_Injector_Actuator" index="0"/>
            <O2InFlowRateActuator output="Crew_O2_Injector"
moduleName="Crew_O2_Injector_Actuator" index="0"/>
            <O2OutFlowRateActuator output="Crew_O2_Injector"
moduleName="Crew_O2_Storage_Actuator" index="0"/>
            <O2InFlowRateActuator output="Crew_O2_Concentrator"
moduleName="Crew_O2_ConcentratorStore_Actuator" index="0"/>
            <O2OutFlowRateActuator output="Crew_O2_Concentrator"
moduleName="Crew_O2_Concentrator_Actuator" index="0"/>

            <CO2OutFlowRateActuator output="VPGC_CO2_Injector"
moduleName="VPGC_CO2_Storage_Actuator" index="0" />
            <CO2InFlowRateActuator output="VPGC_CO2_Injector"
moduleName="VPGC_CO2_Injector_Actuator" index="0"/>
            <O2InFlowRateActuator output="VPGC_O2_Injector"
moduleName="VPGC_O2_Injector_Actuator" index="0"/>
            <O2OutFlowRateActuator output="VPGC_O2_Injector"
moduleName="VPGC_O2_Storage_Actuator" index="0"/>
            <O2InFlowRateActuator output="VPGC_O2_Concentrator"
moduleName="VPGC_O2_ConcentratorStore_Actuator" index="0"/>
            <O2OutFlowRateActuator output="VPGC_O2_Concentrator"
moduleName="VPGC_O2_Concentrator_Actuator" index="0"/>

        </air>

    </Actuators>
</biosim>

```

Appendix B: Simulation Analysis Results

Formatted simulation run logs used for detailed analysis and graphics.

B1 – Validation LMLSTP Phase I Results

See LMLSPT P1 Validation Test V200320-1.xlsx

B2 – Validation LMLSTP Phase III Results

See LMLSTP P3 Validation Test V201026-1.xlsx

B3 – Continuous LMLSTP Phase I Results

Full data in Stability calculations Phase 1.xlsx

Summary Results Run 1

Log Date Time	MS	Thread	Level	Component	Message
10/27/2020 20:45	748	main	INFO	class com.traclabs.biosim.server.simulation.crew.CrewPersonImpl.Bob Roberts	Bob Roberts has died from lack of oxygen on tick 2165 (risk was 50.0%)
10/27/2020 20:45	748	main	INFO	com.traclabs.biosim.server.framework.BioDriverImpl	BioDriverImpl0: simulation ended due to crew death at 10000
10/27/2020 20:45	748	main	INFO	com.traclabs.biosim.server.framework.BioDriverImpl	BioDriverImpl0: simulation ended on tick 2165
10/27/2020 20:45	748	main	INFO	com.traclabs.biosim.framework.BiosimStandaloneLMLSTPController	Controller ended on tick 2165

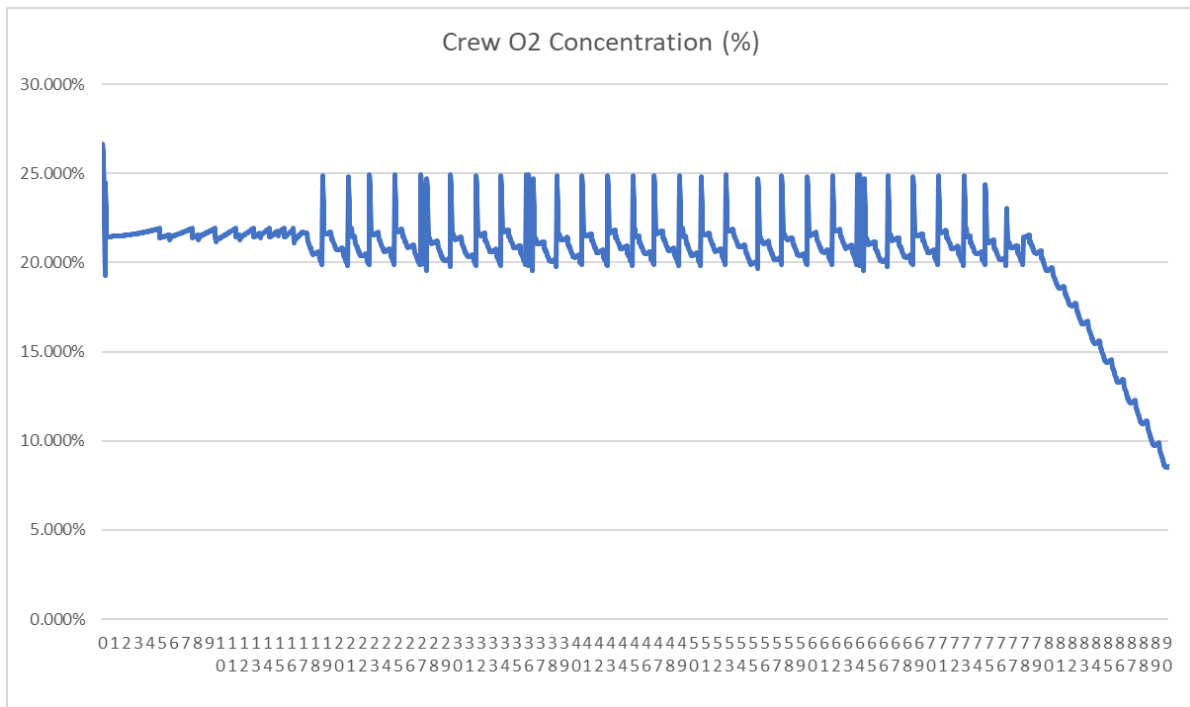

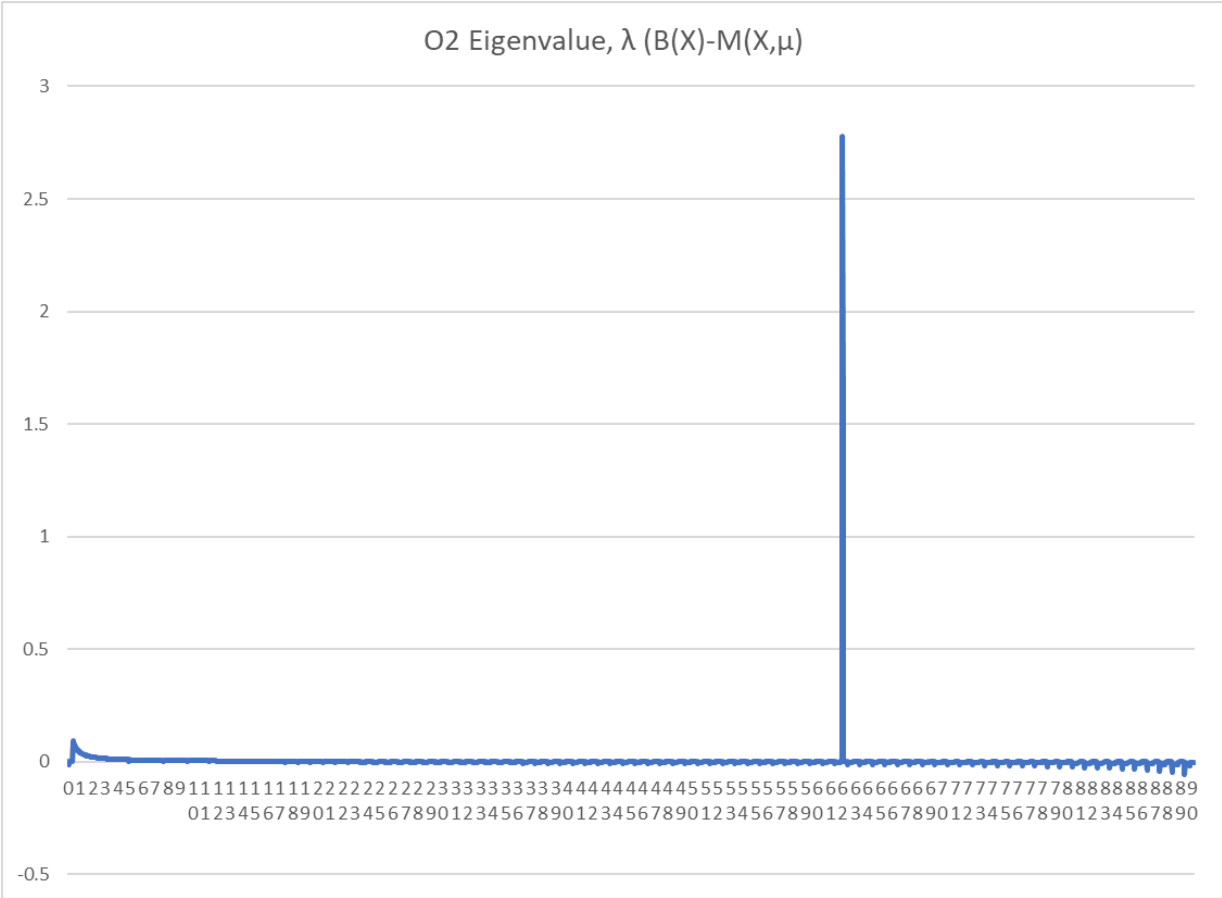
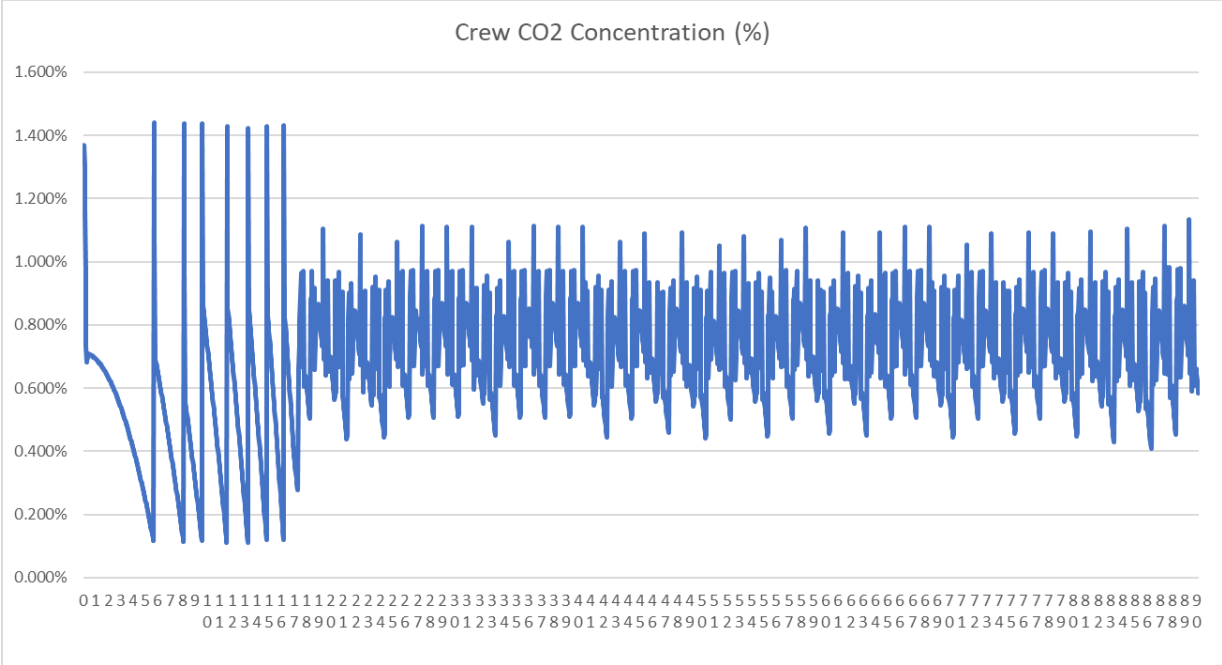

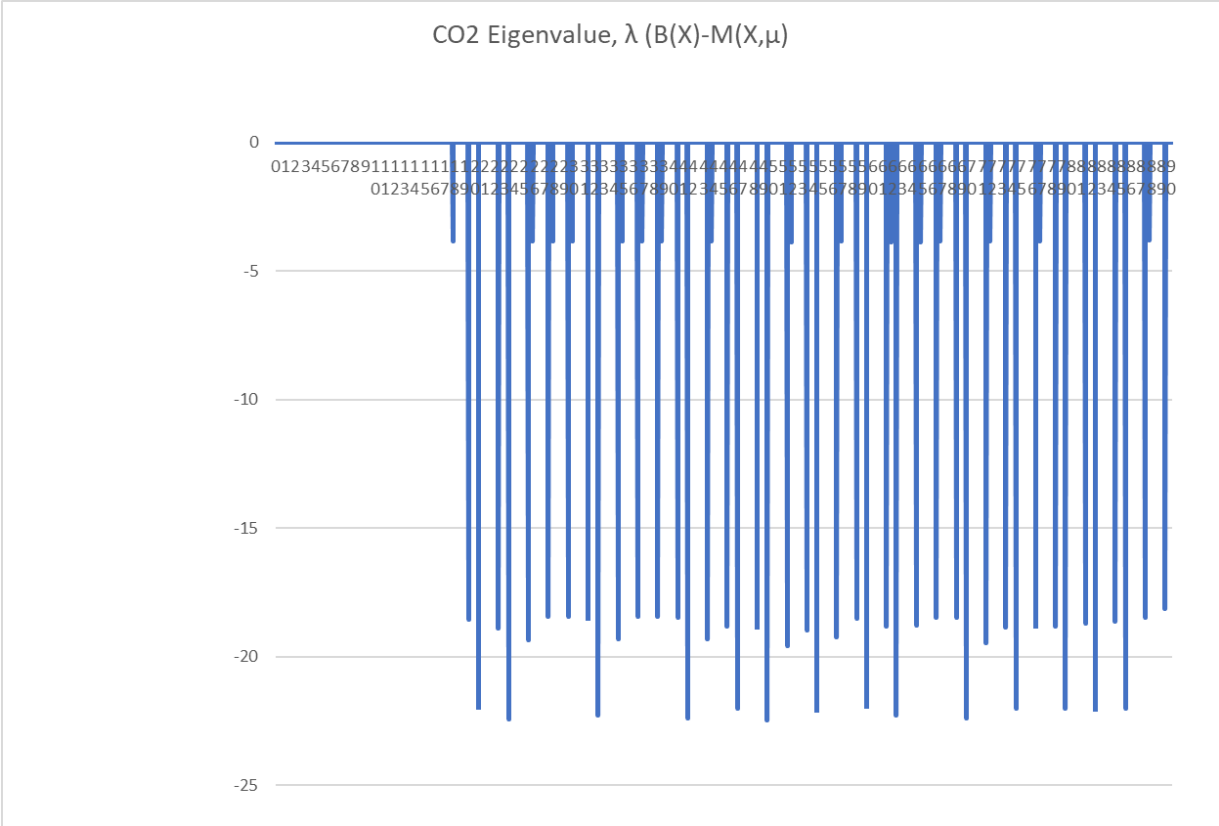

Summary Results Run 2

Log Date Time	MS	Thre ad	Level	Component	Message
10/27/20 20 20:46	440	main	INFO	class com.traclabs.biosim.server.simulation.crew.CrewPer sonImpl.Bob Roberts	Bob Roberts has died from lack of oxygen on tick 2163 (risk was 20.56822%)
10/27/20 20 20:46	444	Biosi m Tick Threa d	INFO	com.traclabs.biosim.server.framework.BioDriverImpl	BioDriverIm pl0: simulation ended due to crew death at 10000
10/27/20 20 20:46	444	Biosi m Tick	INFO	com.traclabs.biosim.server.framework.BioDriverImpl	BioDriverIm pl0: Simulation is

		Thread			done
10/27/20 20 20:46	444	Biosim Tick Thread	INFO	com.traclabs.biosim.server.framework.BioDriverImpl	BioDriverImpl0: simulation ended on tick 2164

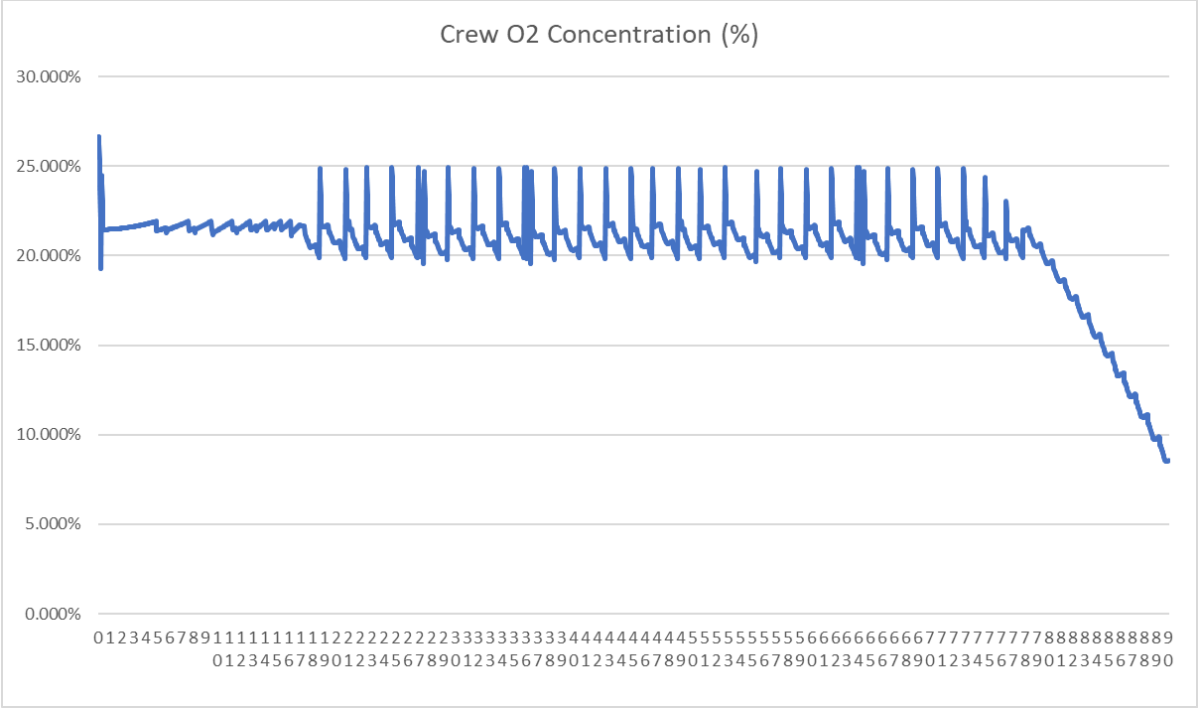

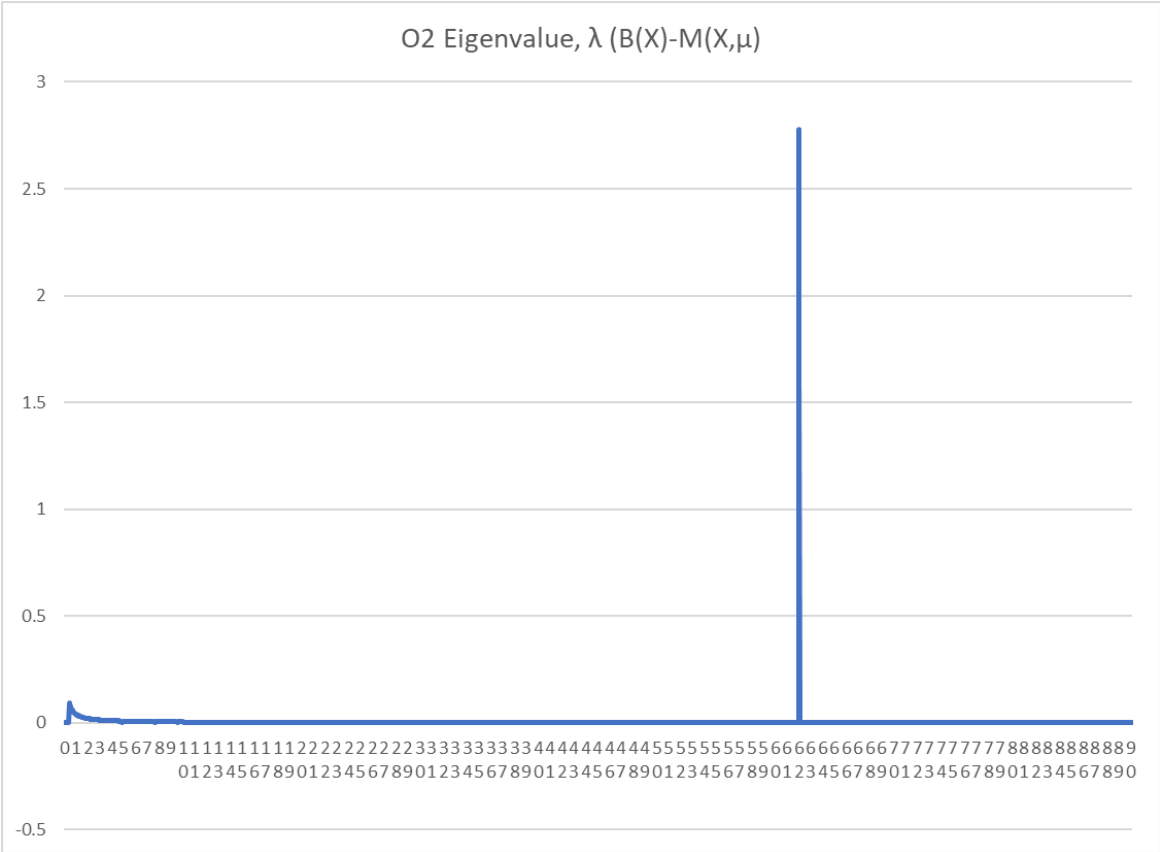
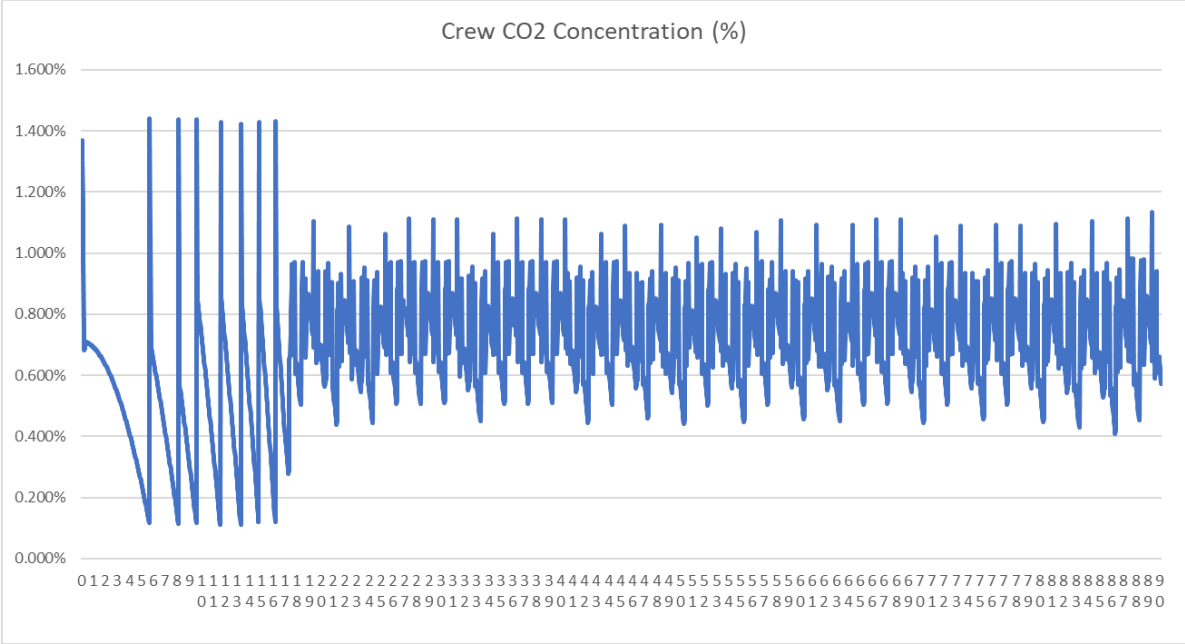

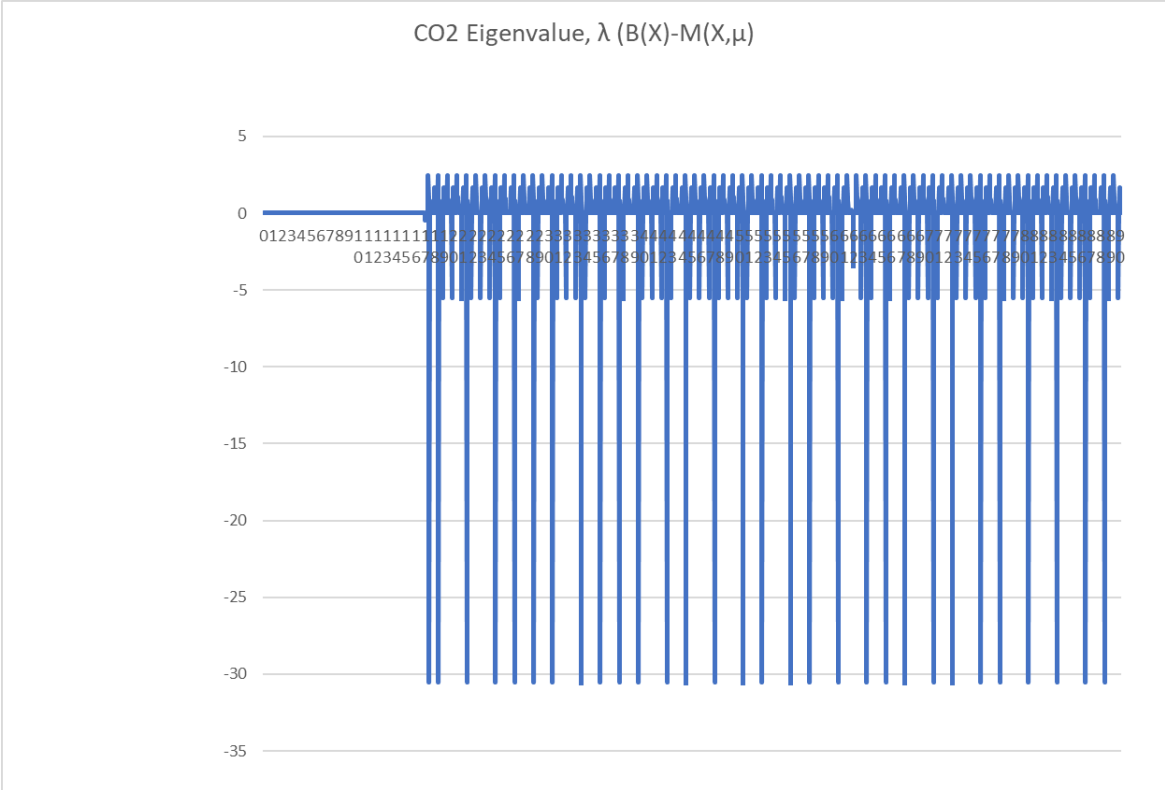

Summary Results Run 3

Log Date Time	MS	Thre ad	Leve l	Component	Message
10/27/20 20 20:47	785	main	INFO	class com.traclabs.biosim.server.simulation.crew.CrewPers onImpl.Bob Roberts	Bob Roberts has died from lack of oxygen on tick 2164 (risk was 37.729496%)
10/27/20 20 20:47	791	main	INFO	com.traclabs.biosim.server.framework.BioDriverImpl	BioDriverIm pl0: simulation ended due to crew death at 10000
10/27/20 20 20:47	791	main	INFO	com.traclabs.biosim.server.framework.BioDriverImpl	BioDriverIm pl0: simulation ended on

10/27/20

20 20:47

791

main

INFO

com.traclabs.biosim.framework.BiosimStandaloneLM

LSTPController

tick 2164

Controller

ended on

tick 2164

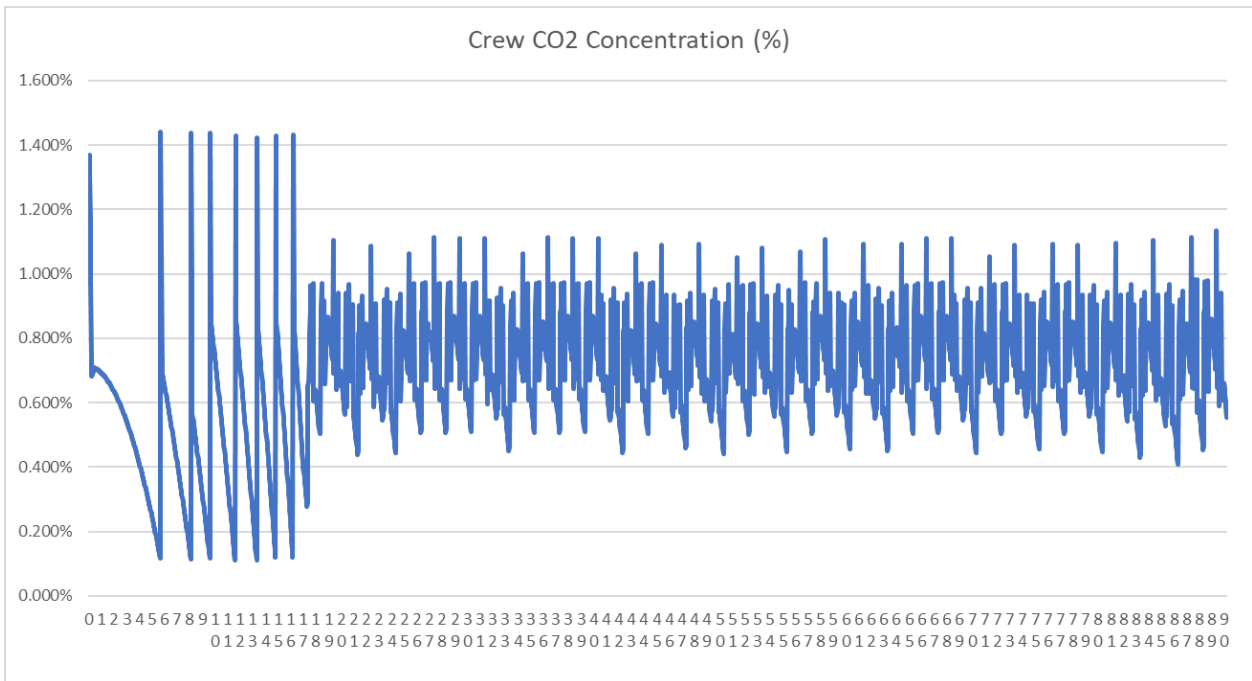
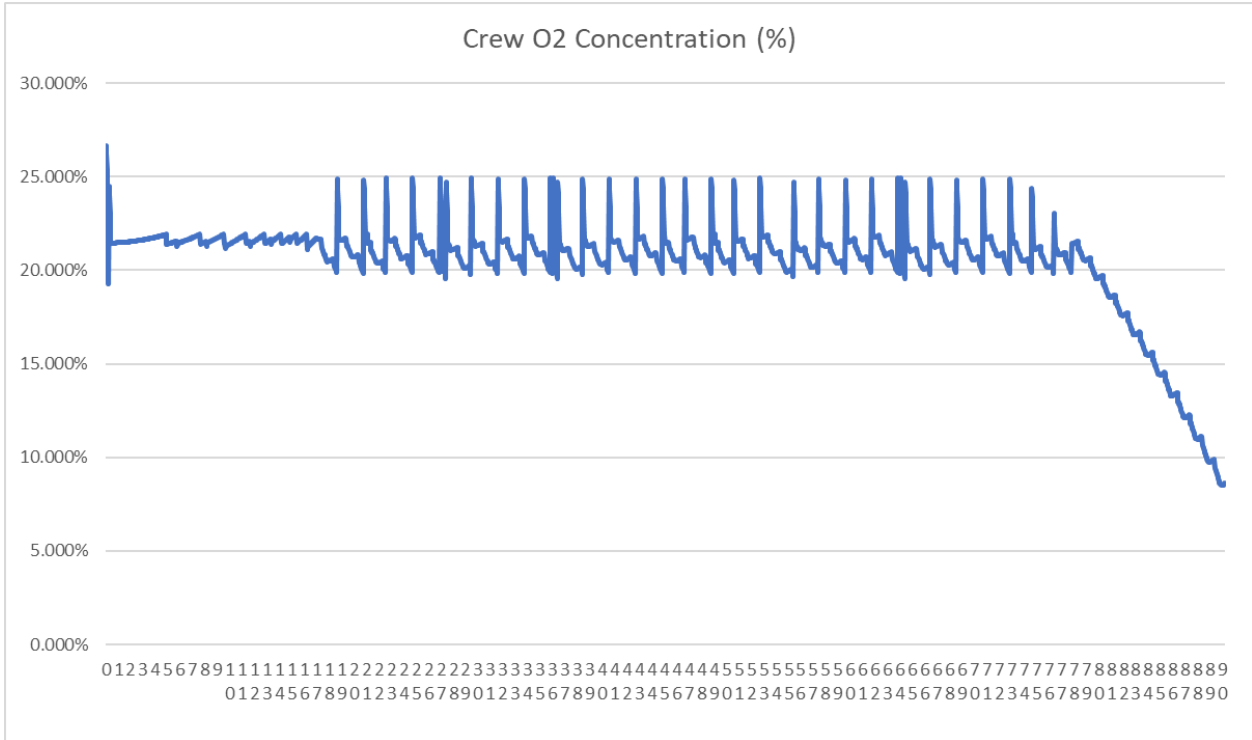

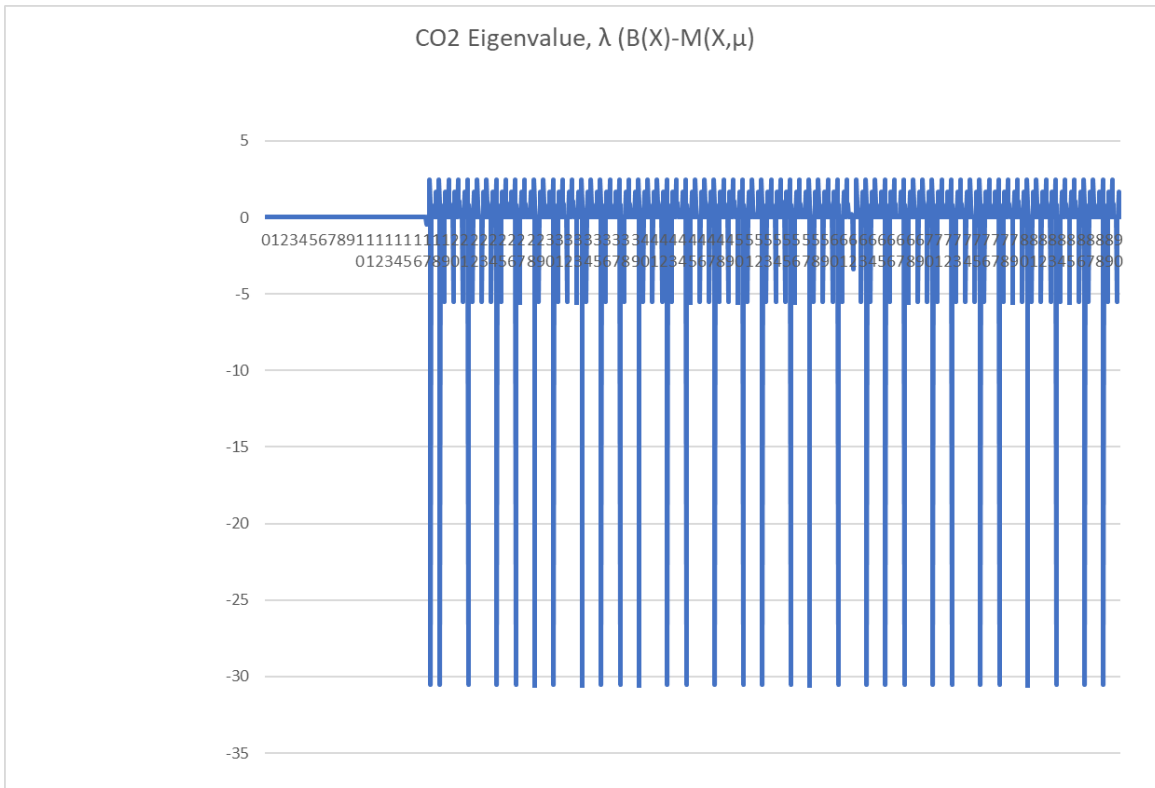
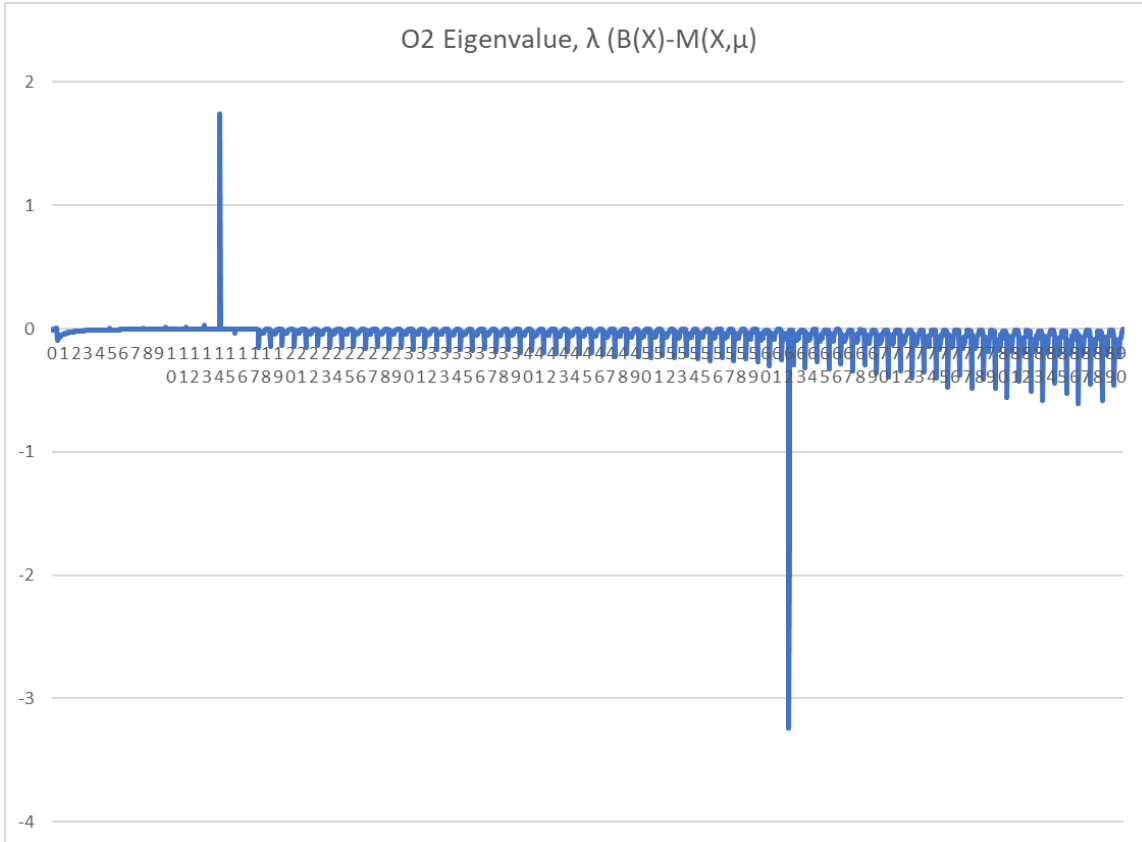

Summary Results Run 4

Log Date Time	MS	Thre ad	Leve l	Component	Message
10/27/20 20 20:47	571	main	INFO	class com.traclabs.biosim.server.simulation.crew.CrewPers onImpl.Bob Roberts	Bob Roberts has died from lack of oxygen on tick 2144 (risk was 31.333578%)
10/27/20 20 20:47	571	main	INFO	com.traclabs.biosim.server.framework.BioDriverImpl	BioDriverIm pl0: simulation ended due to crew death at 10000
10/27/20 20 20:47	571	main	INFO	com.traclabs.biosim.server.framework.BioDriverImpl	BioDriverIm pl0: simulation ended on tick 2144 Controller
10/27/20 20 20:47	572	main	INFO	com.traclabs.biosim.framework.BiosimStandaloneLM LSTPController	ended on tick 2144

Crew O2 Concentration (%)

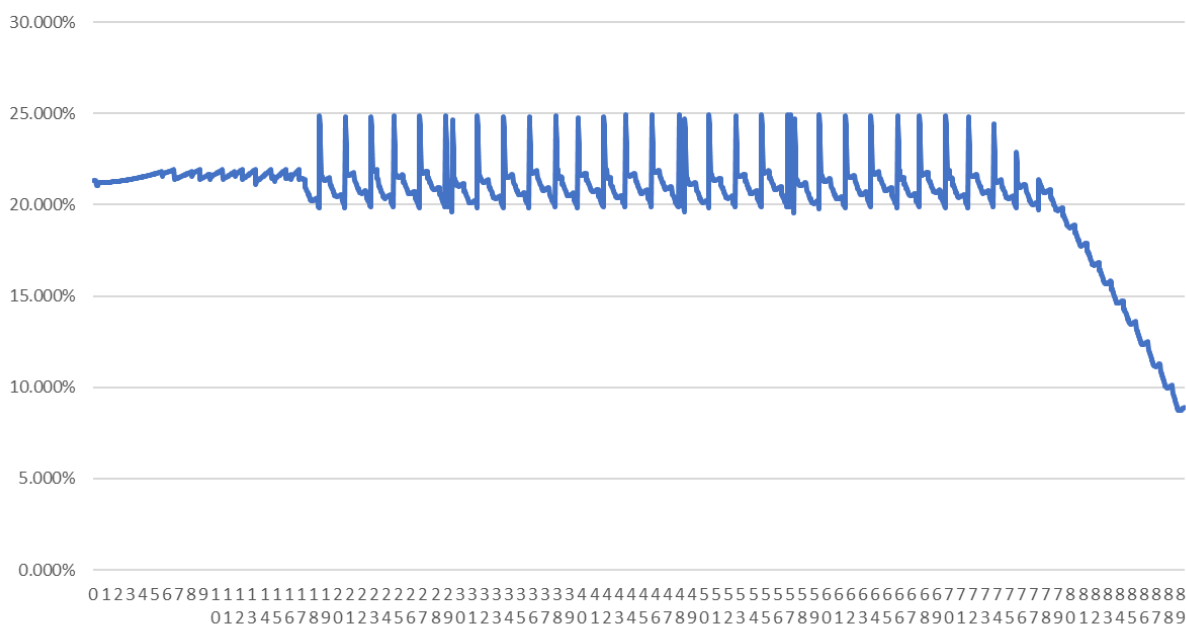

Crew CO2 Concentration (%)

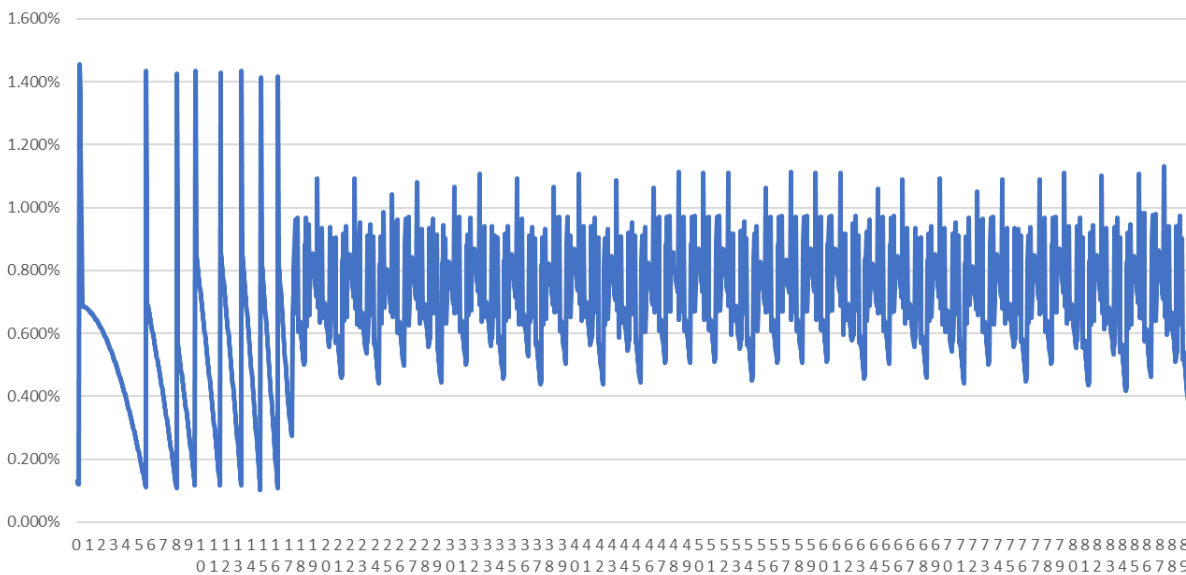

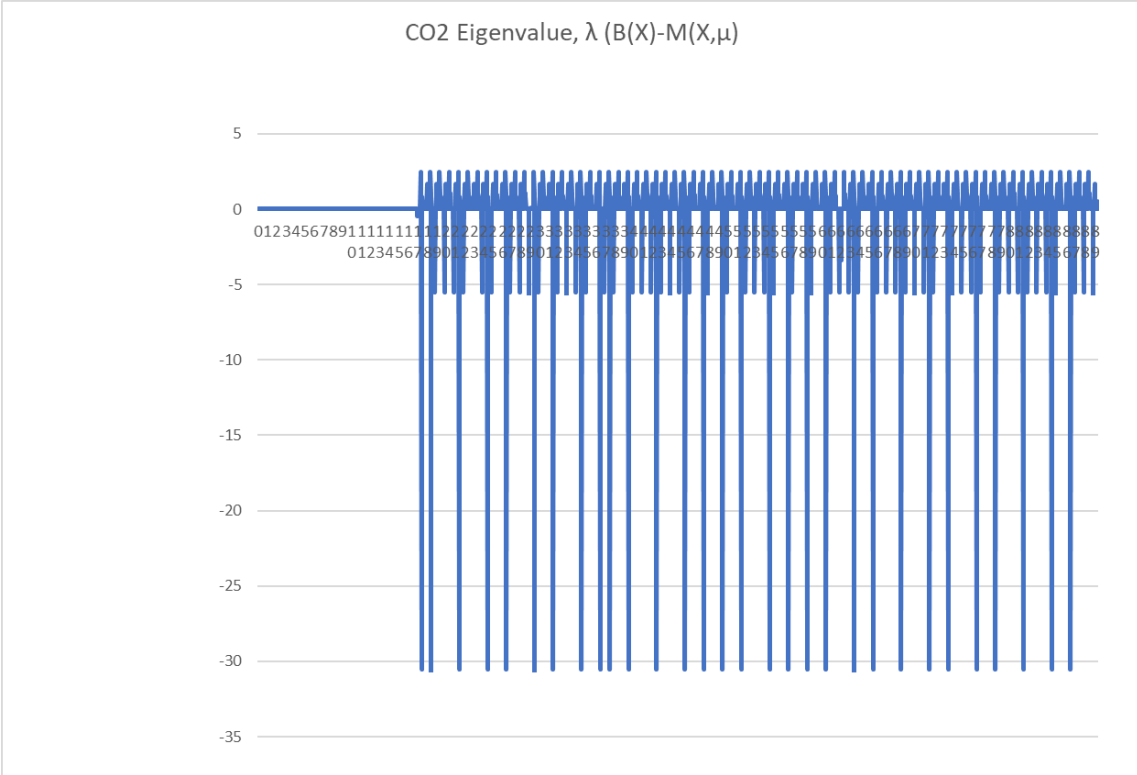
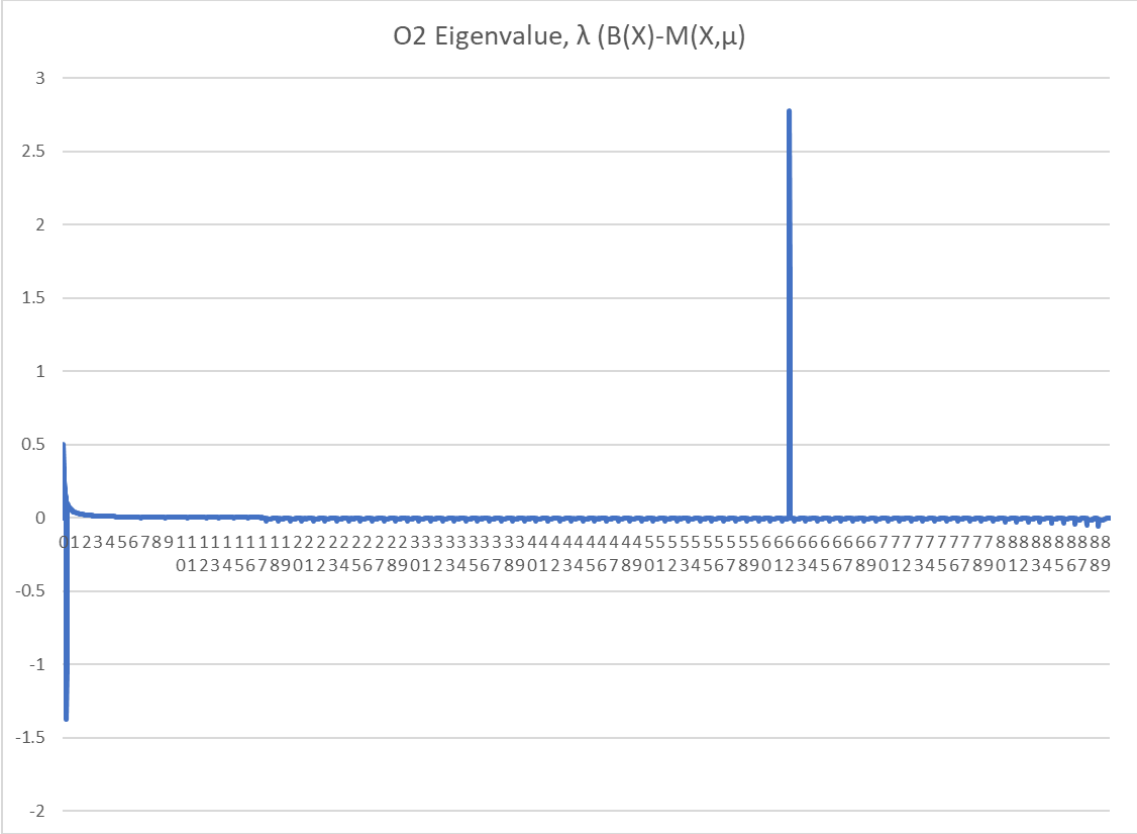

Summary Results Run 5

Log Date Time	MS	Thre ad	Leve l	Component	Message
10/27/20 20 20:48	468	main	INFO	class com.traclabs.biosim.server.simulation.crew.CrewPers onImpl.Bob Roberts	Bob Roberts has died from lack of oxygen on tick 2145 (risk was 46.714676%)
10/27/20 20 20:48	469	main	INFO	com.traclabs.biosim.server.framework.BioDriverImpl	BioDriverIm pl0: simulation ended due to crew death at 10000
10/27/20 20 20:48	469	main	INFO	com.traclabs.biosim.server.framework.BioDriverImpl	BioDriverIm pl0: simulation ended on tick 2145
10/27/20 20 20:48	469	main	INFO	com.traclabs.biosim.framework.BiosimStandaloneLM LSTPController	Controller ended on tick 2145

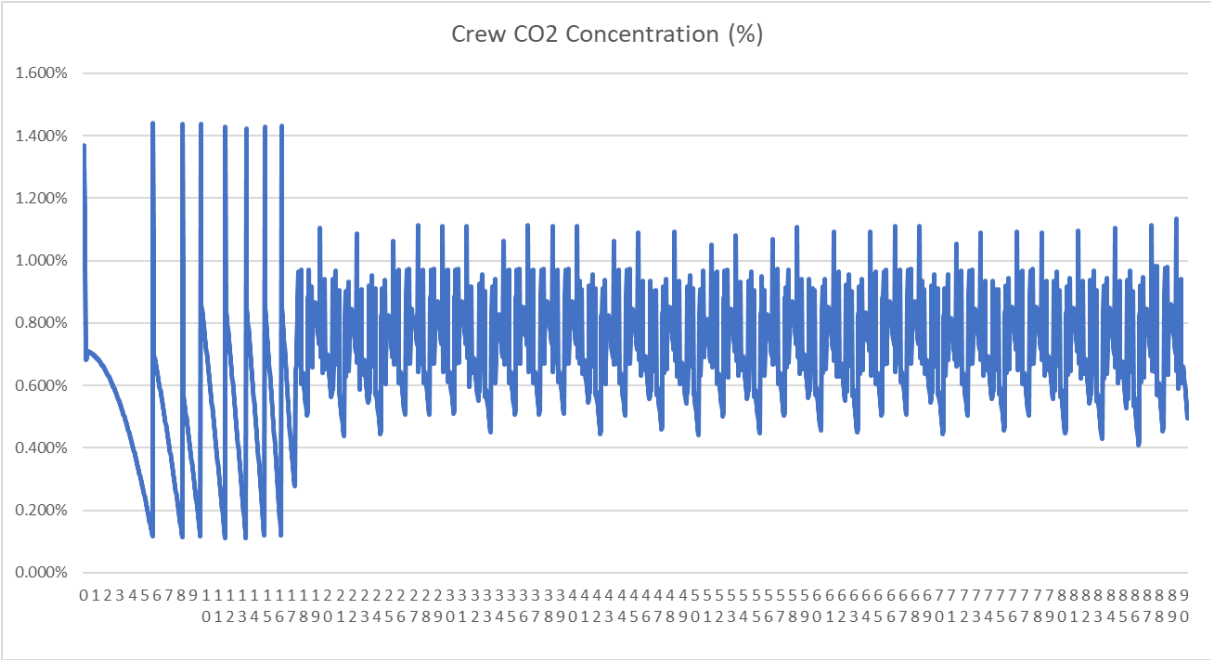
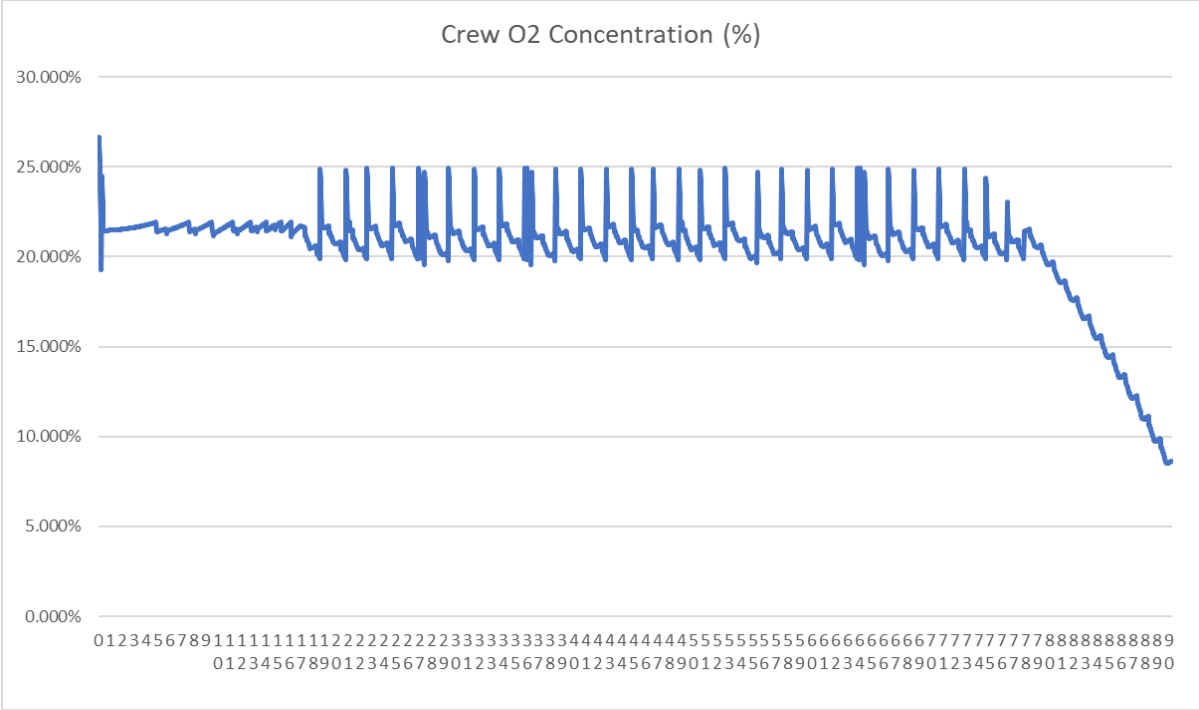

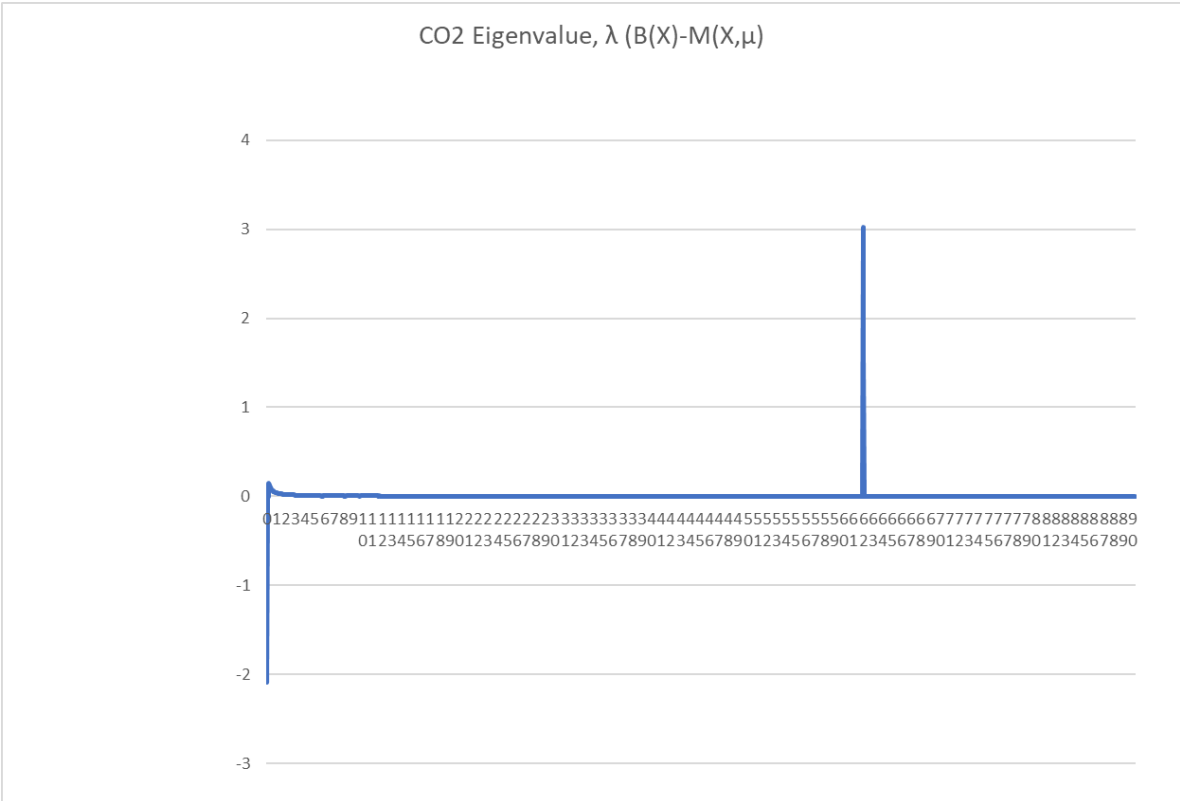
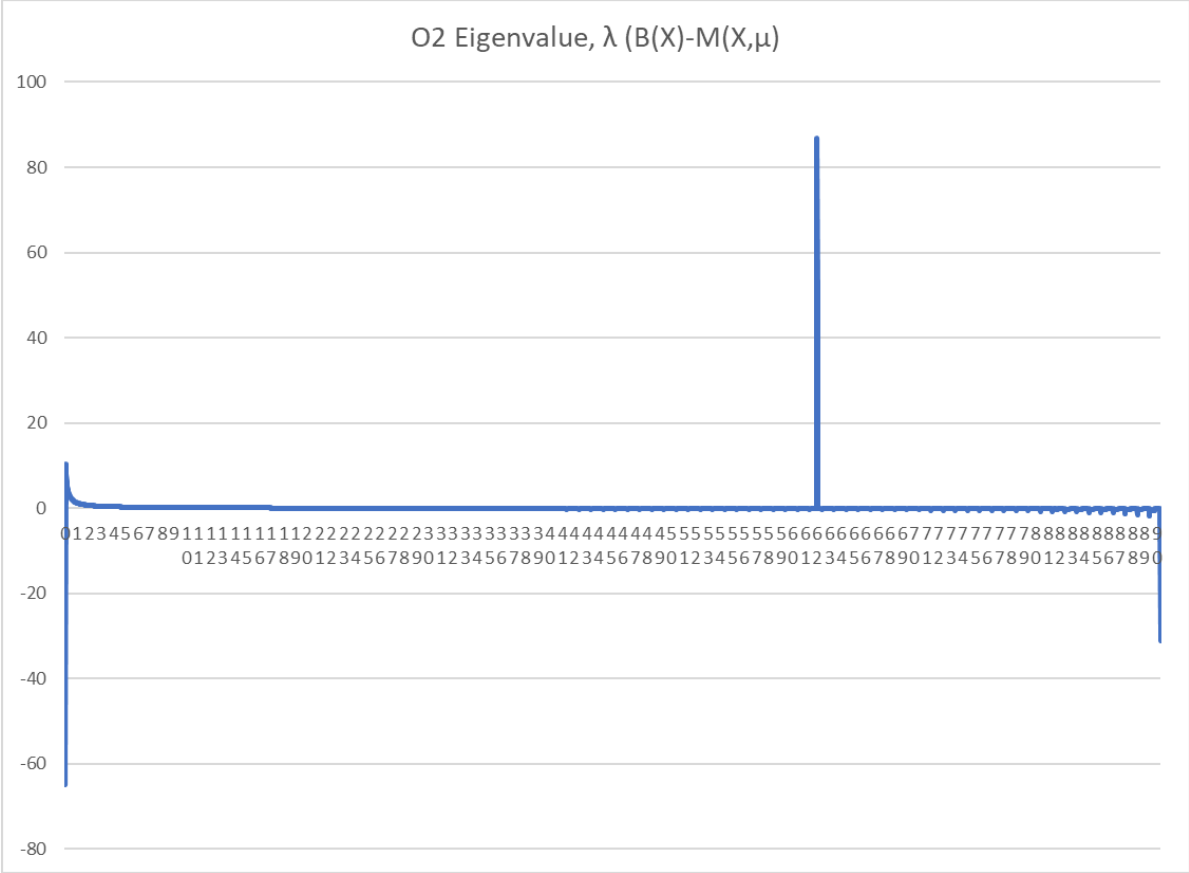

Summary Results Run 6

Log Date Time	MS	Thre ad	Leve l	Component	Message
10/27/20 20 20:49	241	main	INFO	class com.traclabs.biosim.server.simulation.crew.CrewPers onImpl.Bob Roberts	Bob Roberts has died from lack of oxygen on tick 2143 (risk was 19.385431%)
10/27/20 20 20:49	241	main	INFO	com.traclabs.biosim.server.framework.BioDriverImpl	BioDriverIm pl0: simulation ended due to crew death at 10000
10/27/20 20 20:49	241	main	INFO	com.traclabs.biosim.server.framework.BioDriverImpl	BioDriverIm pl0: simulation ended on tick 2143 Controller
10/27/20 20 20:49	241	main	INFO	com.traclabs.biosim.framework.BiosimStandaloneLM LSTPController	ended on tick 2143

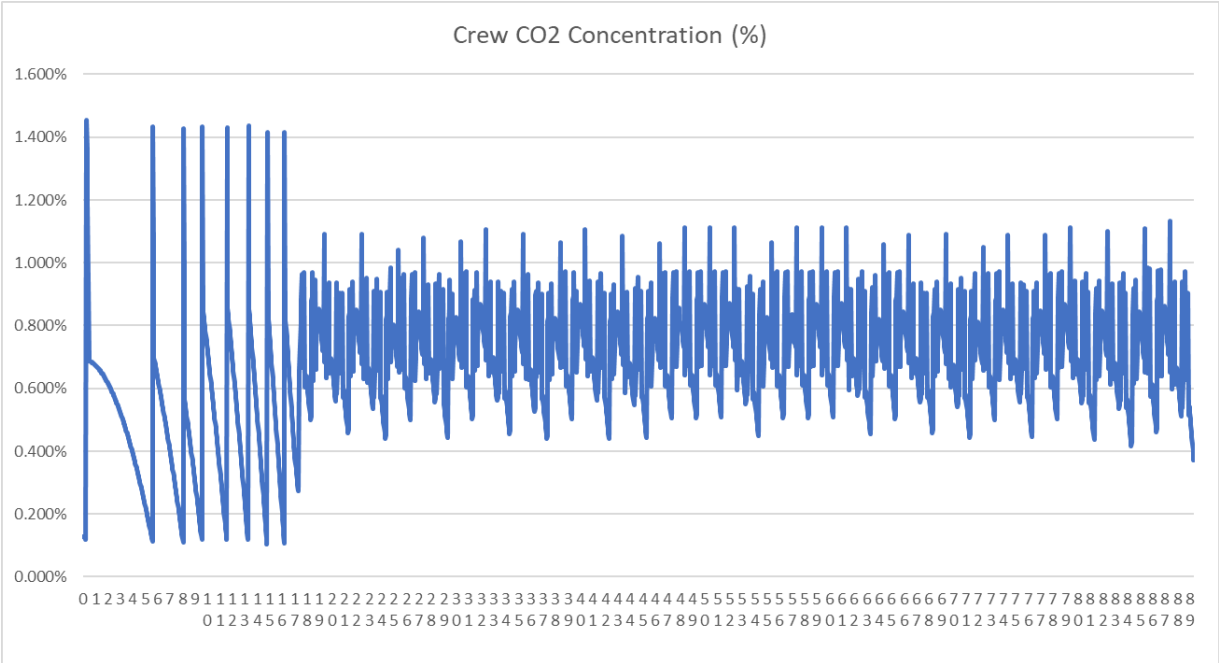
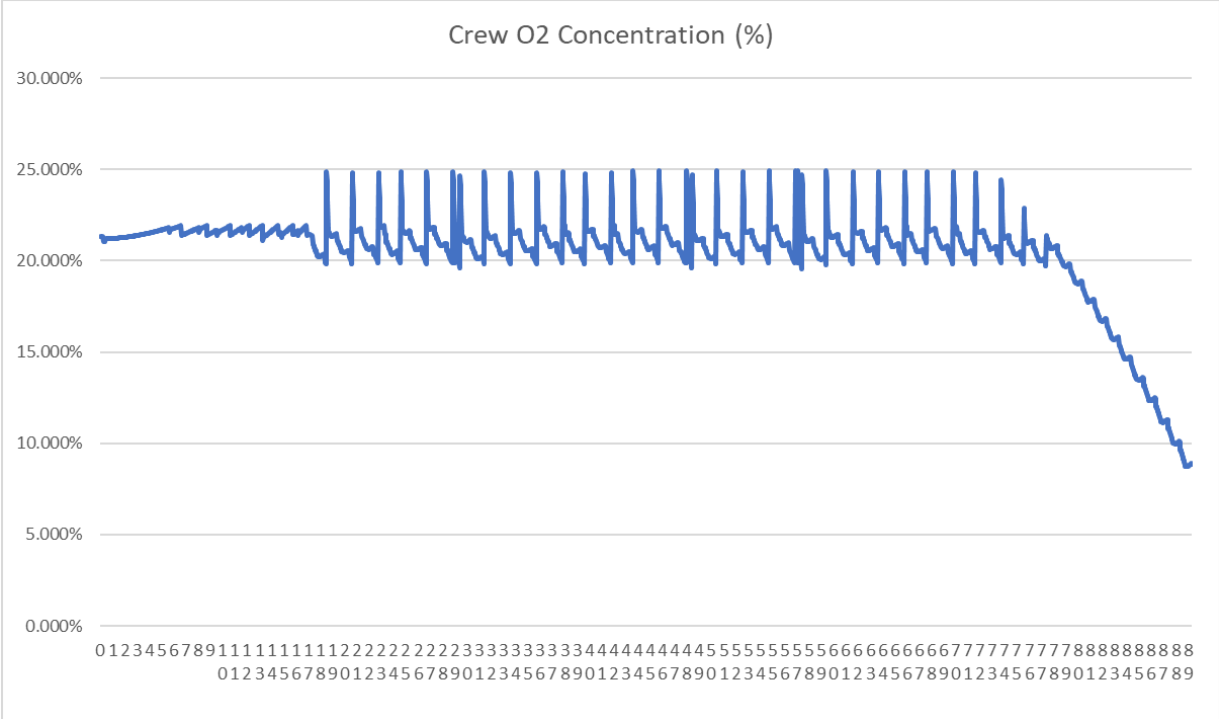

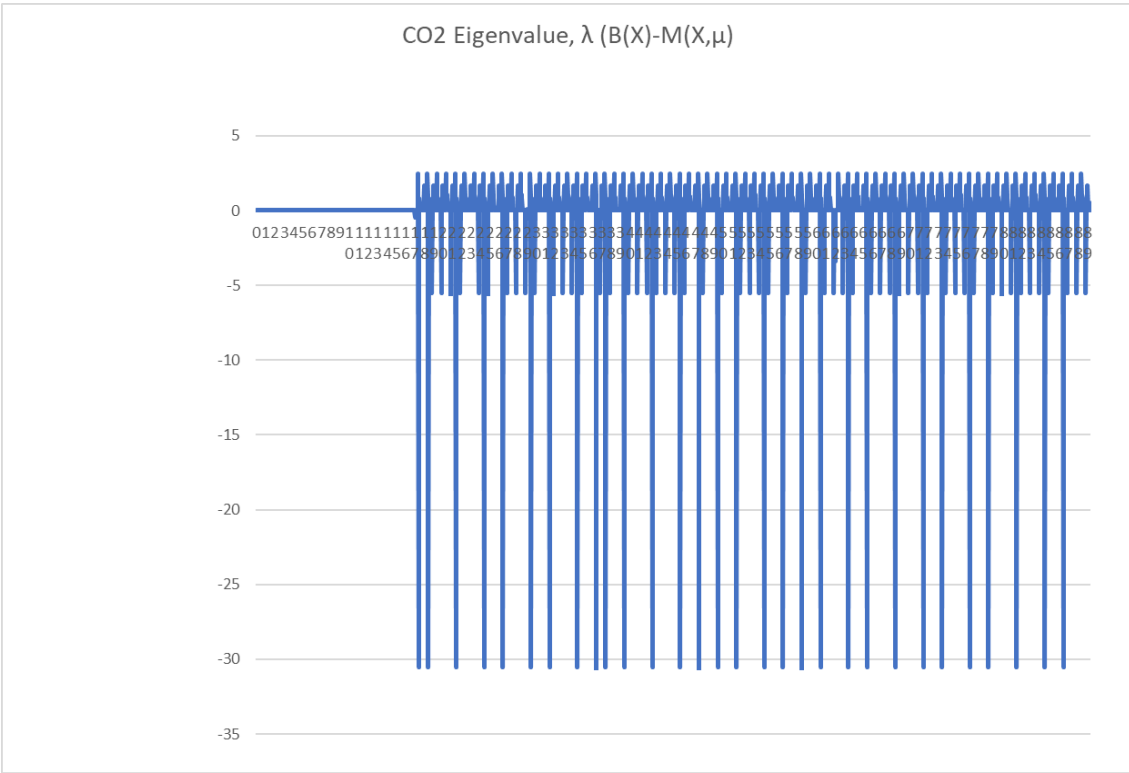
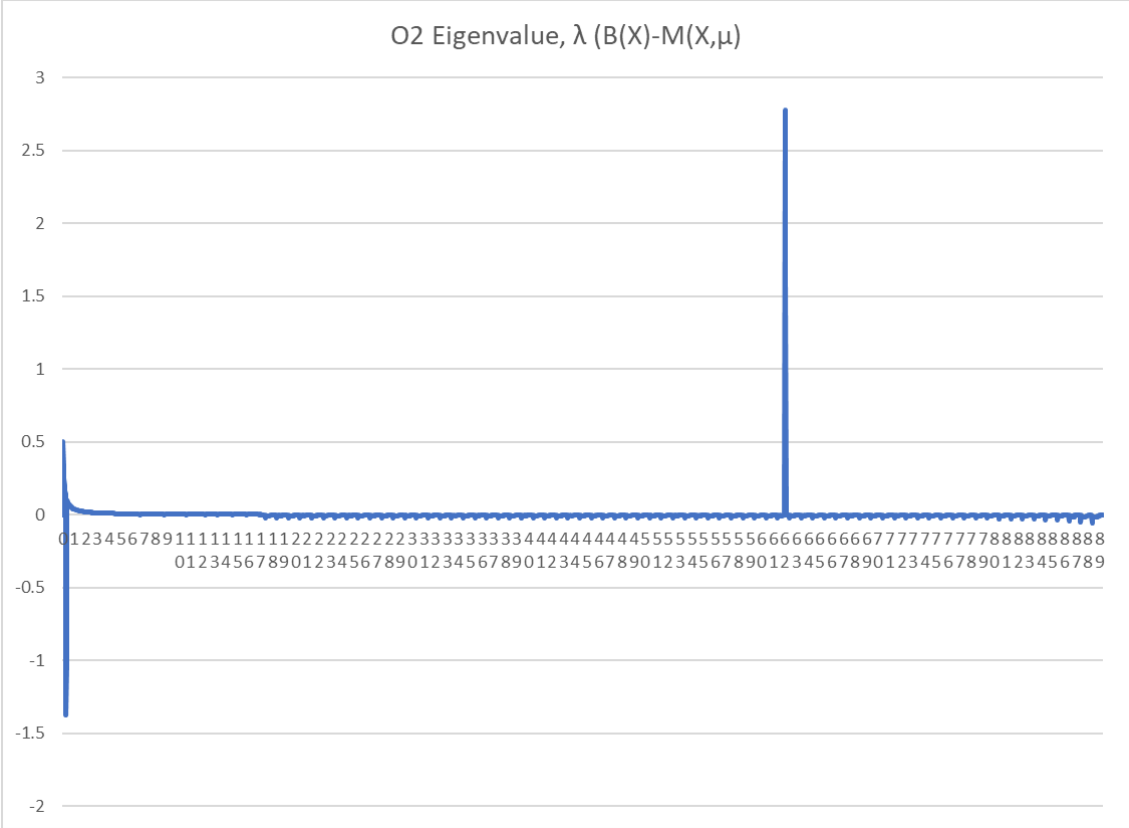

Summary Results Run 7

Log Date Time	MS	Thre ad	Leve l	Component	Message
10/27/20 20 20:49	963	main	INFO	class com.traclabs.biosim.server.simulation.crew.CrewPer sonImpl.Bob Roberts	Bob Roberts has died from lack of oxygen on tick 2163 (risk was 20.56822%)
10/27/20 20 20:49	964	main	INFO	com.traclabs.biosim.server.framework.BioDriverImpl	BioDriverIm pl0: simulation ended due to crew death at 10000
10/27/20 20 20:49	964	main	INFO	com.traclabs.biosim.server.framework.BioDriverImpl	BioDriverIm pl0: simulation ended on tick 2163
10/27/20 20 20:49	964	main	INFO	com.traclabs.biosim.framework.BiosimStandaloneLM LSTPController	Controller ended on tick 2163

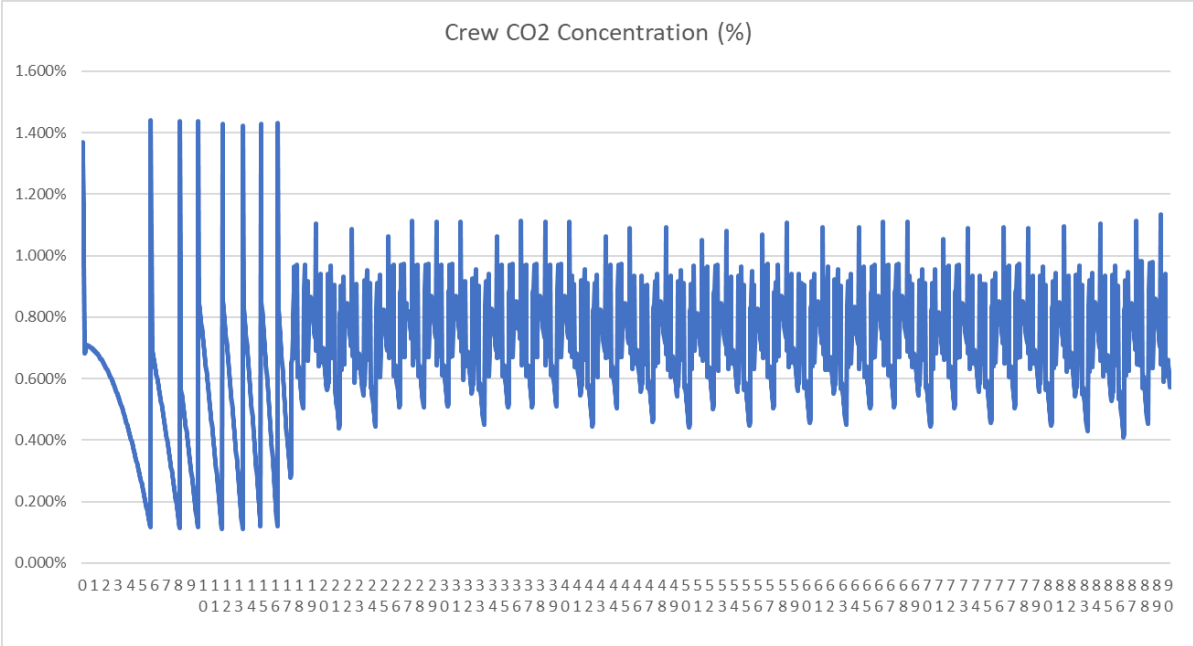
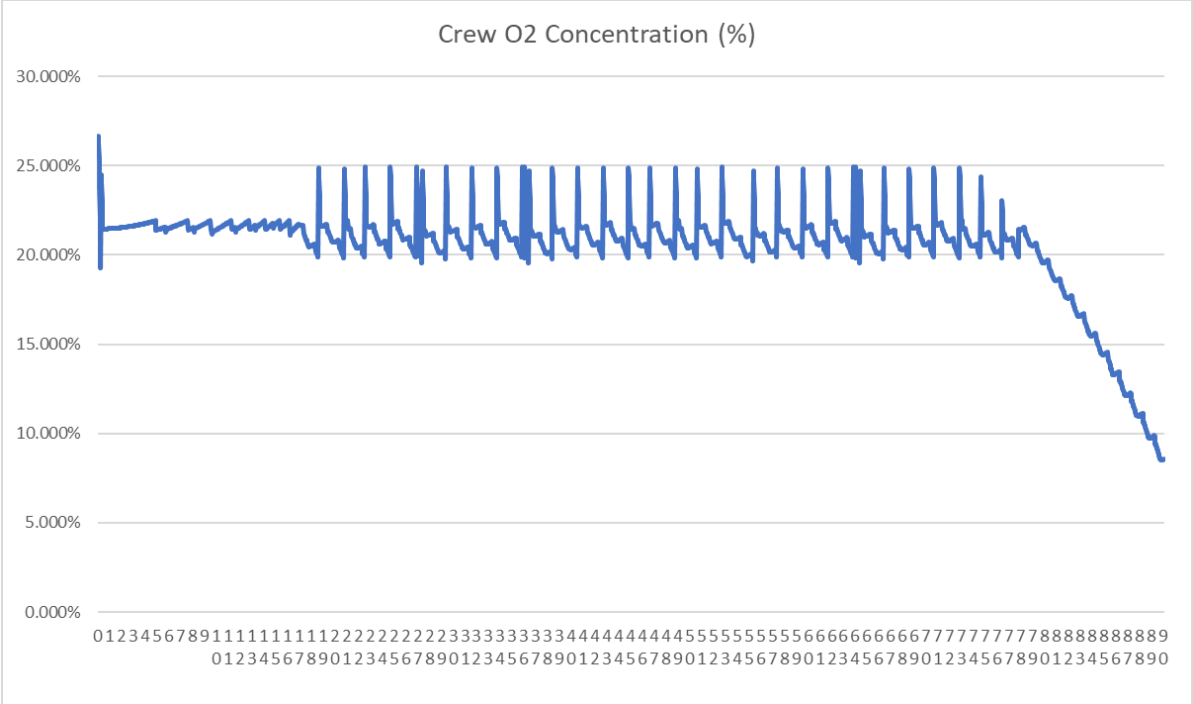

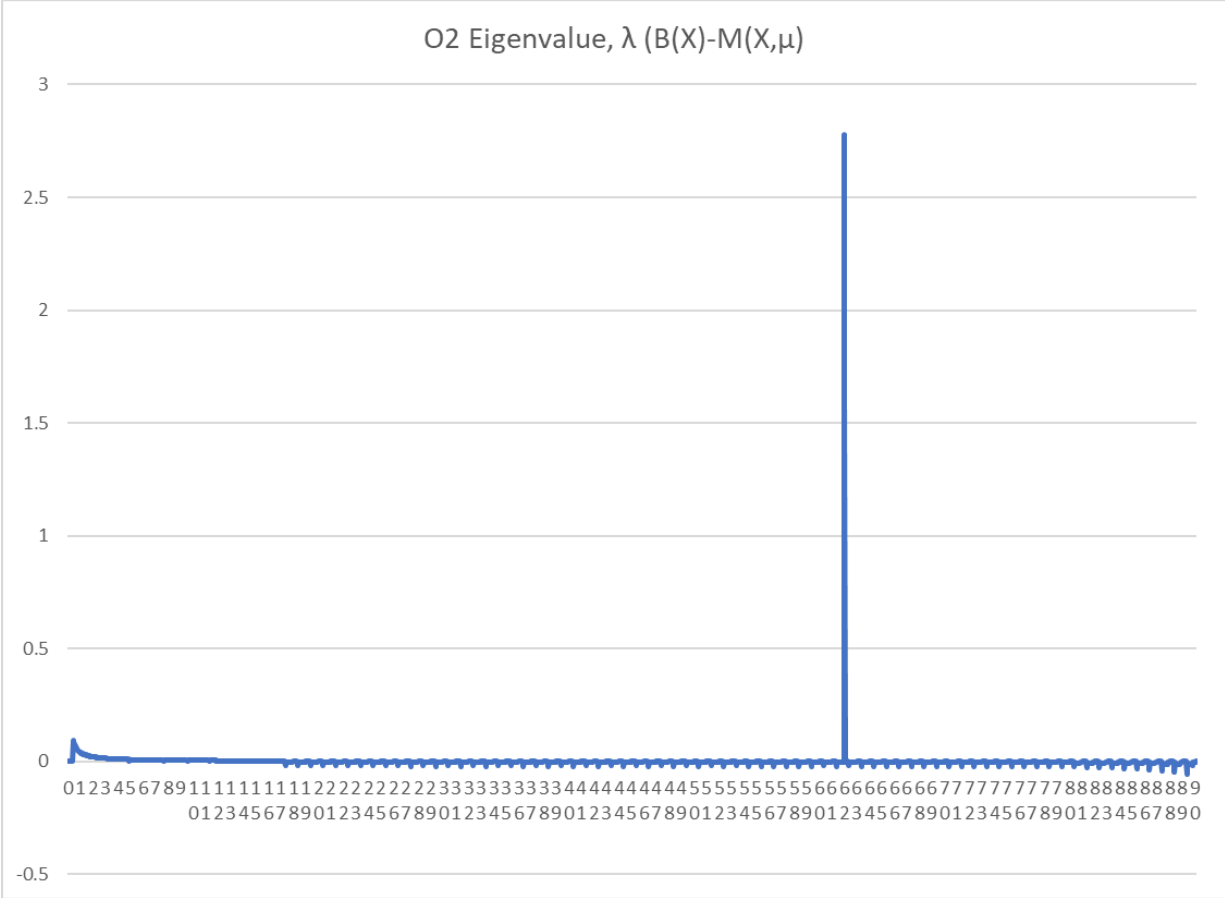

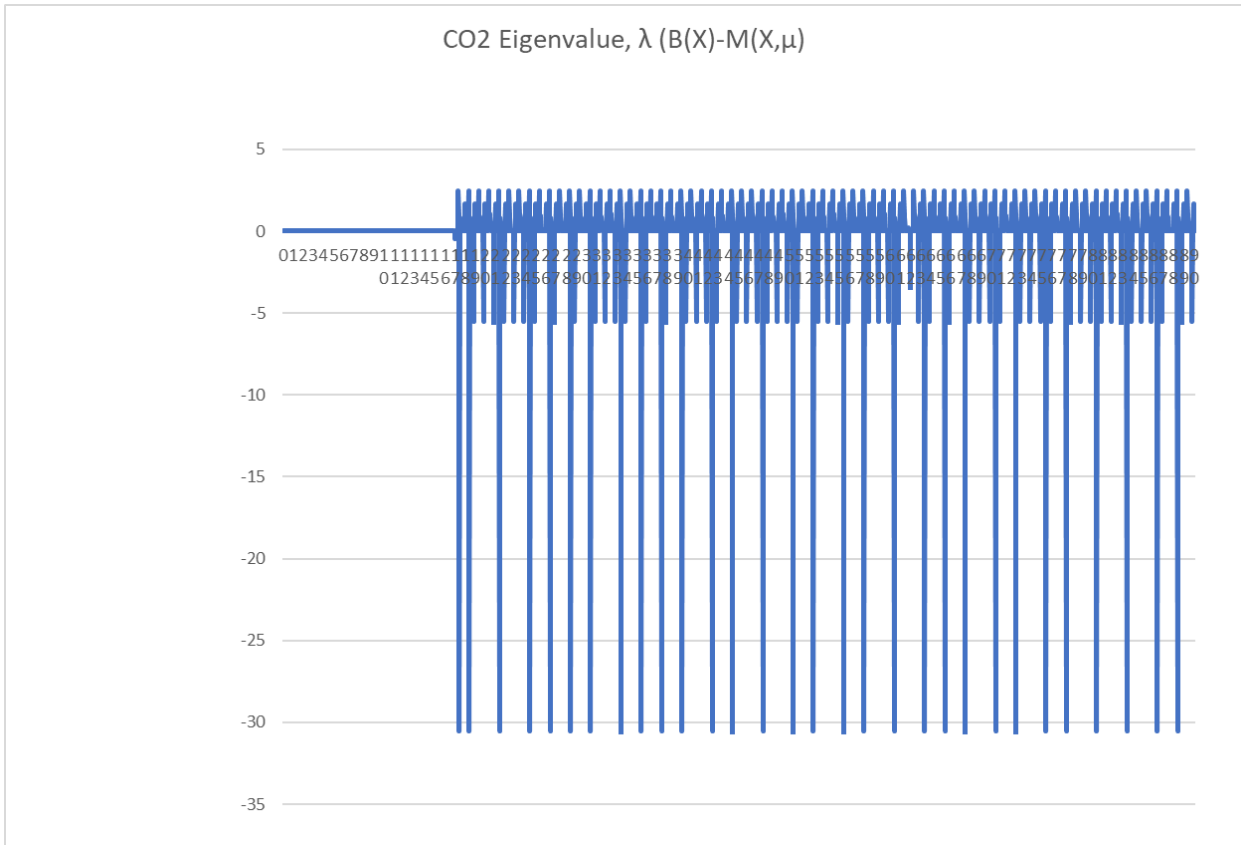

Summary Results Run 8

Log Date Time	MS	Threa d	Level	Component	Message
10/27/2020 20:50	523	main	INFO	com.traclabs.biosim.server.framework.BioDriverImpl	BioDriverImpl 0: simulation ended on tick 2163
10/27/2020 20:50	530	Biosim Tick Thread	INFO	com.traclabs.biosim.server.framework.BioDriverImpl	BioDriverImpl 0: simulation ended due to crew death at 10000
10/27/2020 20:50	530	Biosim Tick Thread	INFO	com.traclabs.biosim.server.framework.BioDriverImpl	BioDriverImpl 0: Simulation is done
10/27/2020 20:50	530	Biosim	INFO	com.traclabs.biosim.server.framework.BioDriverImpl	BioDriverImpl 0: simulation

Tick
Thread

ended on tick
2164

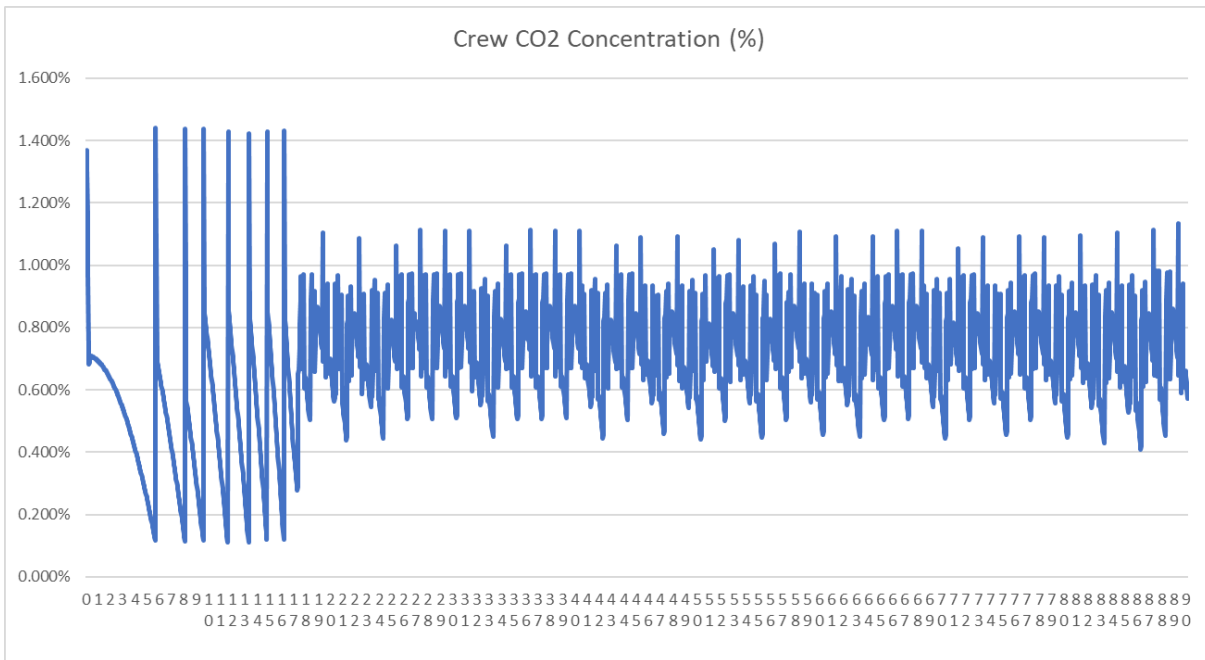
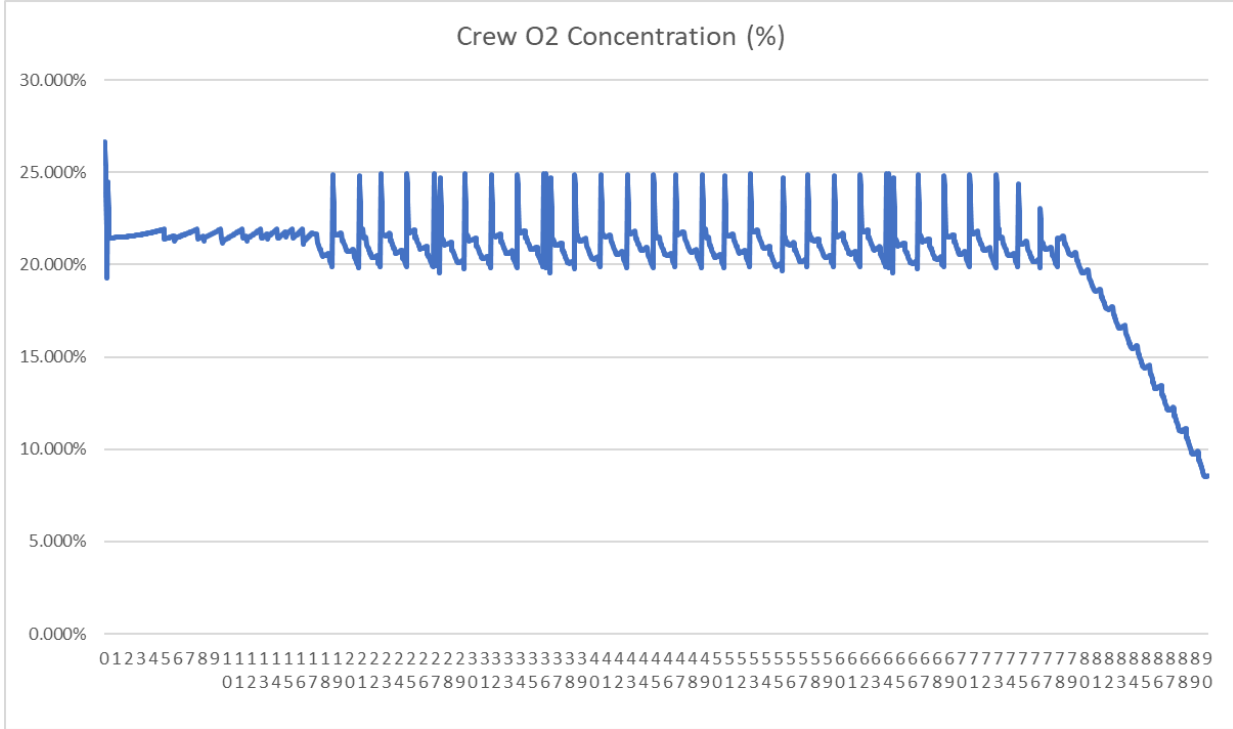

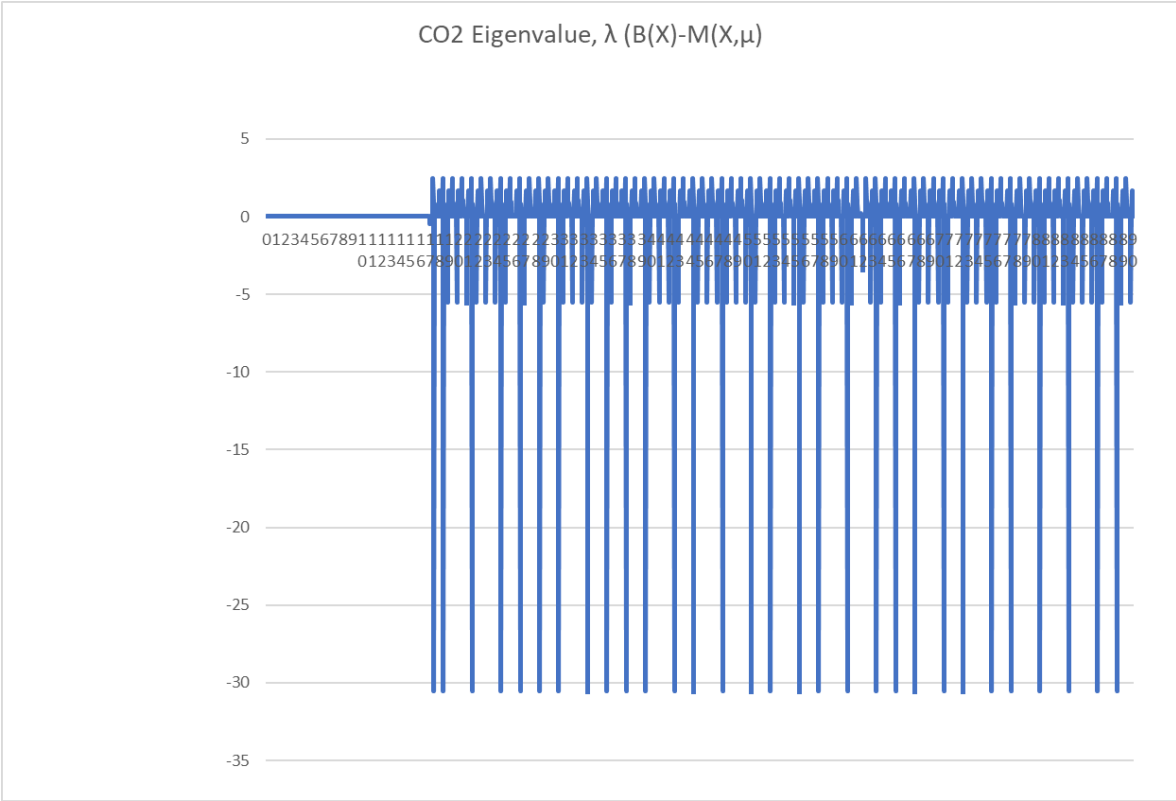
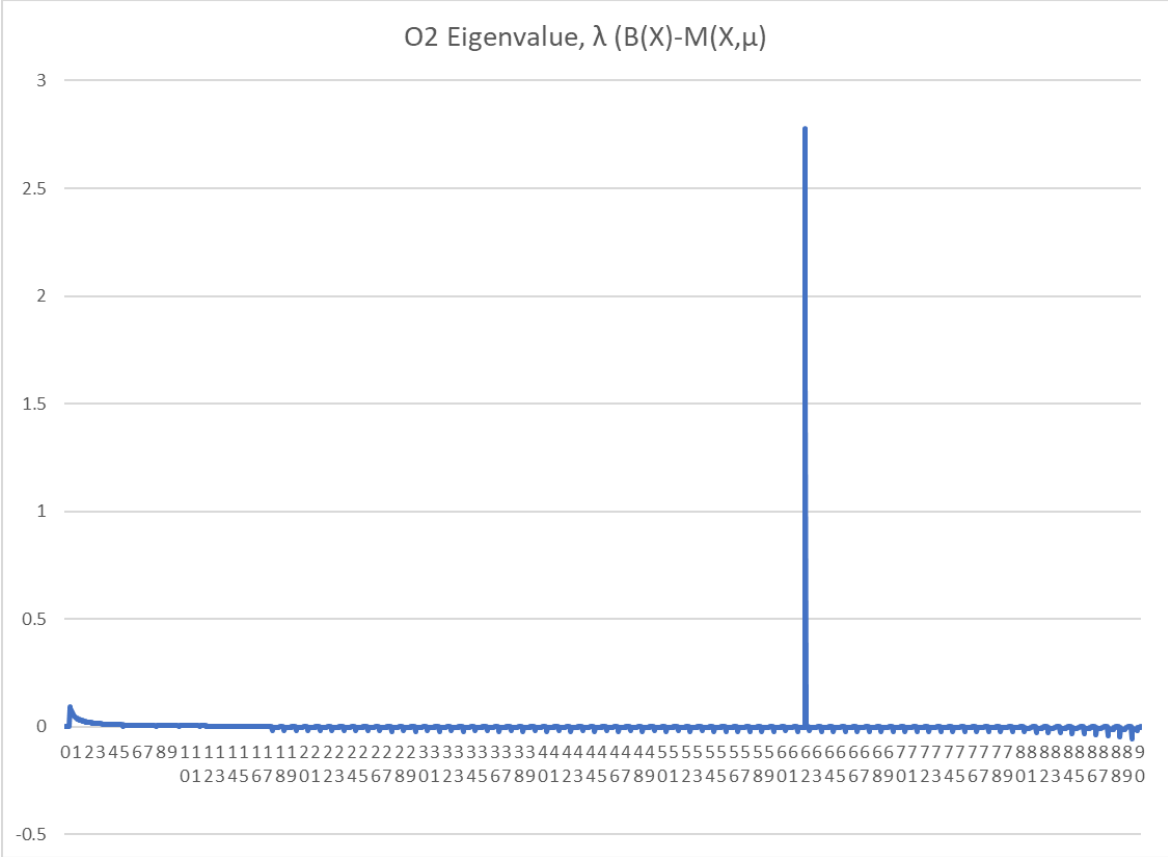

Summary Results Run 9

Log Date Time	MS	Thre ad	Leve l	Component	Message
10/27/20 20 20:50	42	main	INFO	class com.traclabs.biosim.server.simulation.crew.CrewPer sonImpl.Bob Roberts	Bob Roberts has died from lack of oxygen on tick 2165 (risk was 50.0%)
10/27/20 20 20:50	42	main	INFO	com.traclabs.biosim.server.framework.BioDriverImpl	BioDriverIm p0: simulation ended due to crew death at 10000
10/27/20 20 20:50	42	main	INFO	com.traclabs.biosim.server.framework.BioDriverImpl	BioDriverIm p0: simulation ended on tick 2165
10/27/20 20 20:50	43	main	INFO	com.traclabs.biosim.framework.BiosimStandaloneL MLSTPController	Controller ended on tick 2165

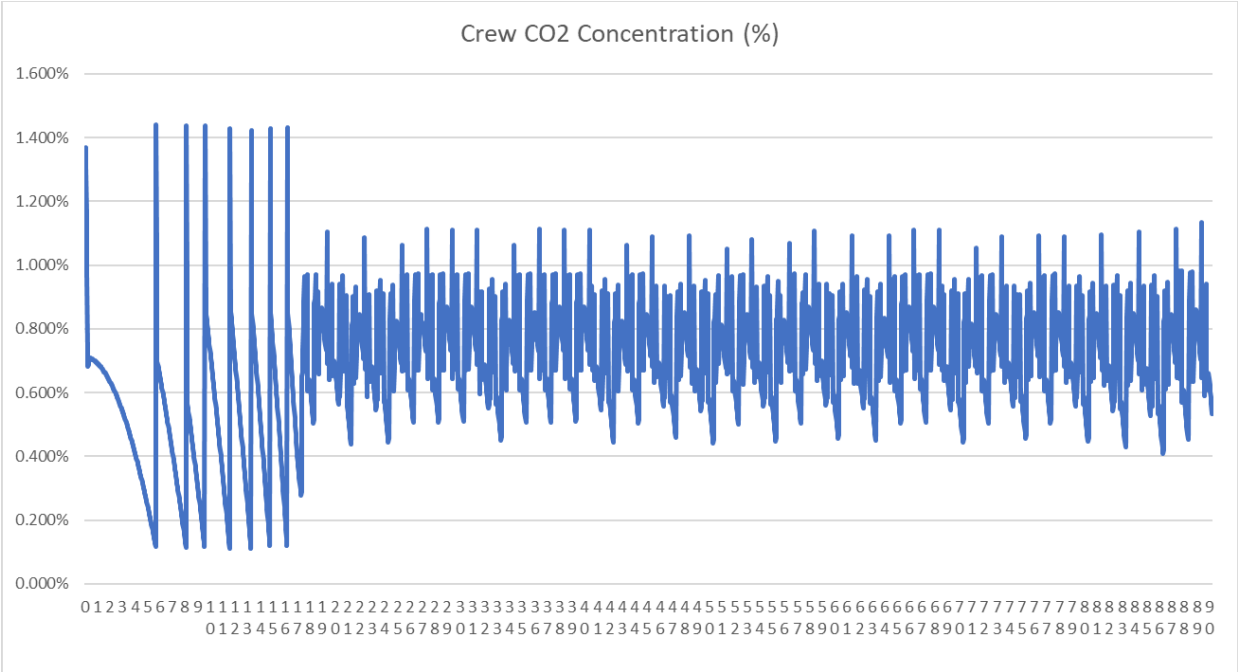
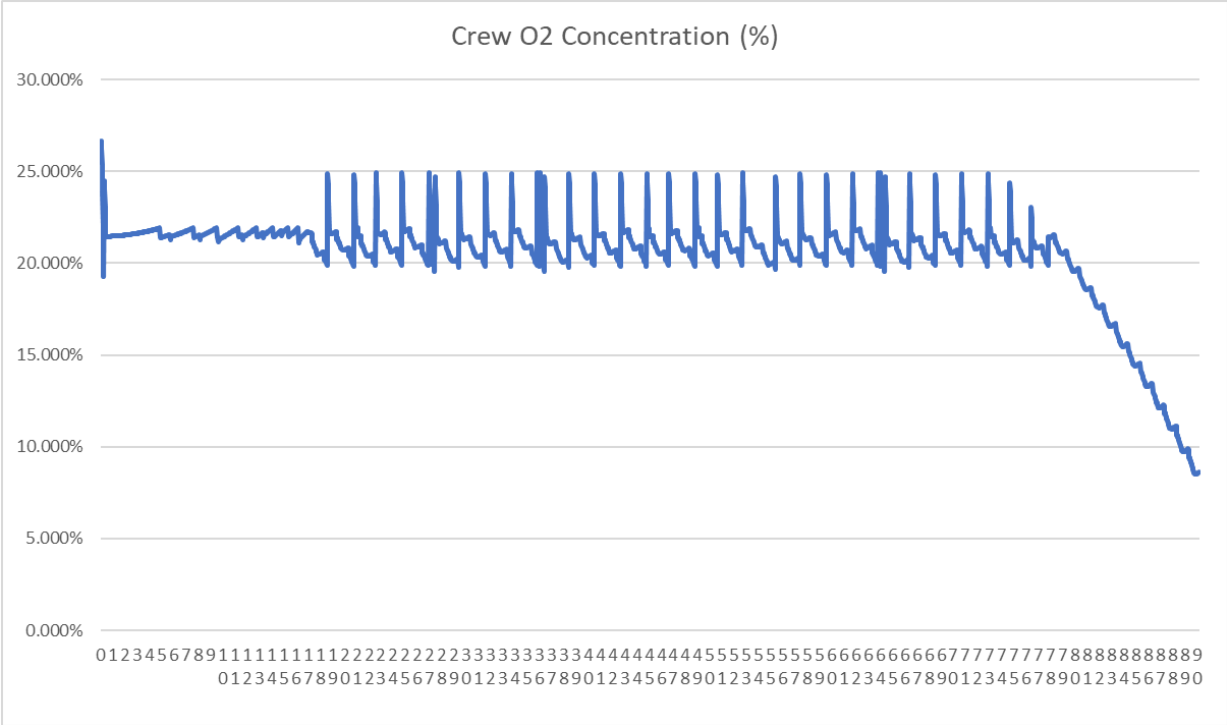

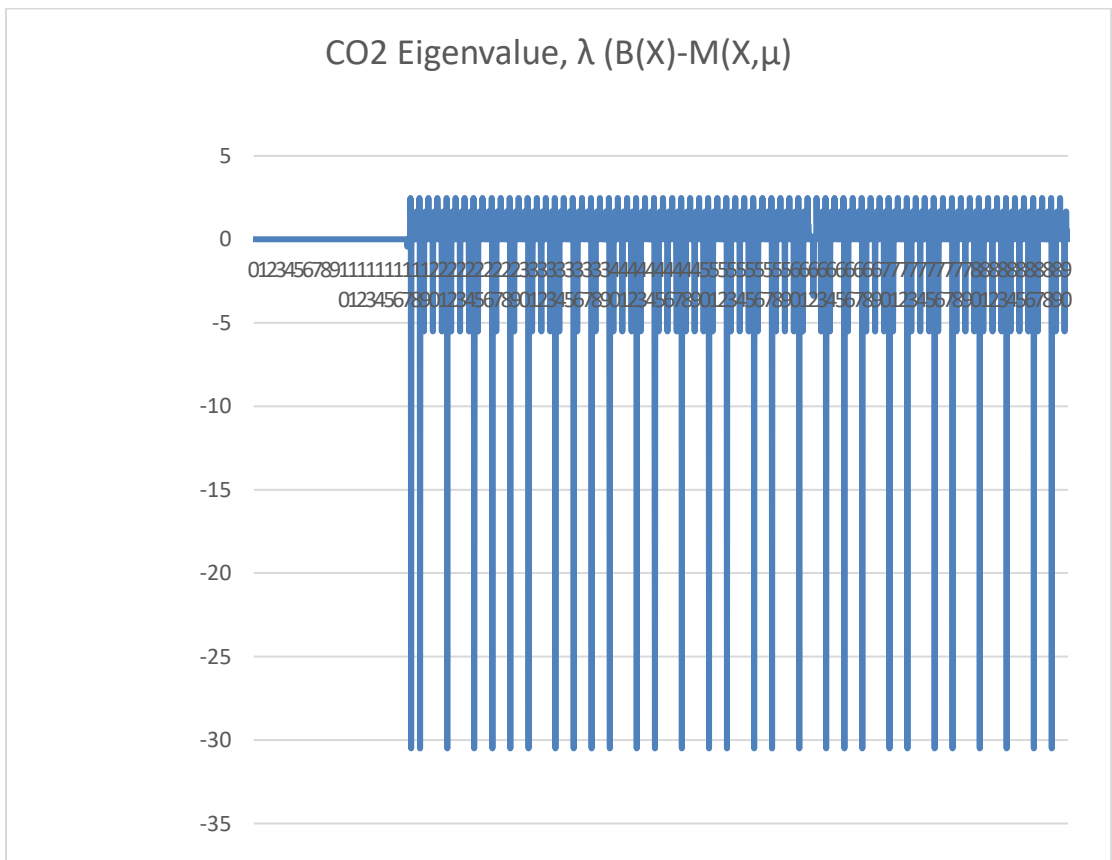
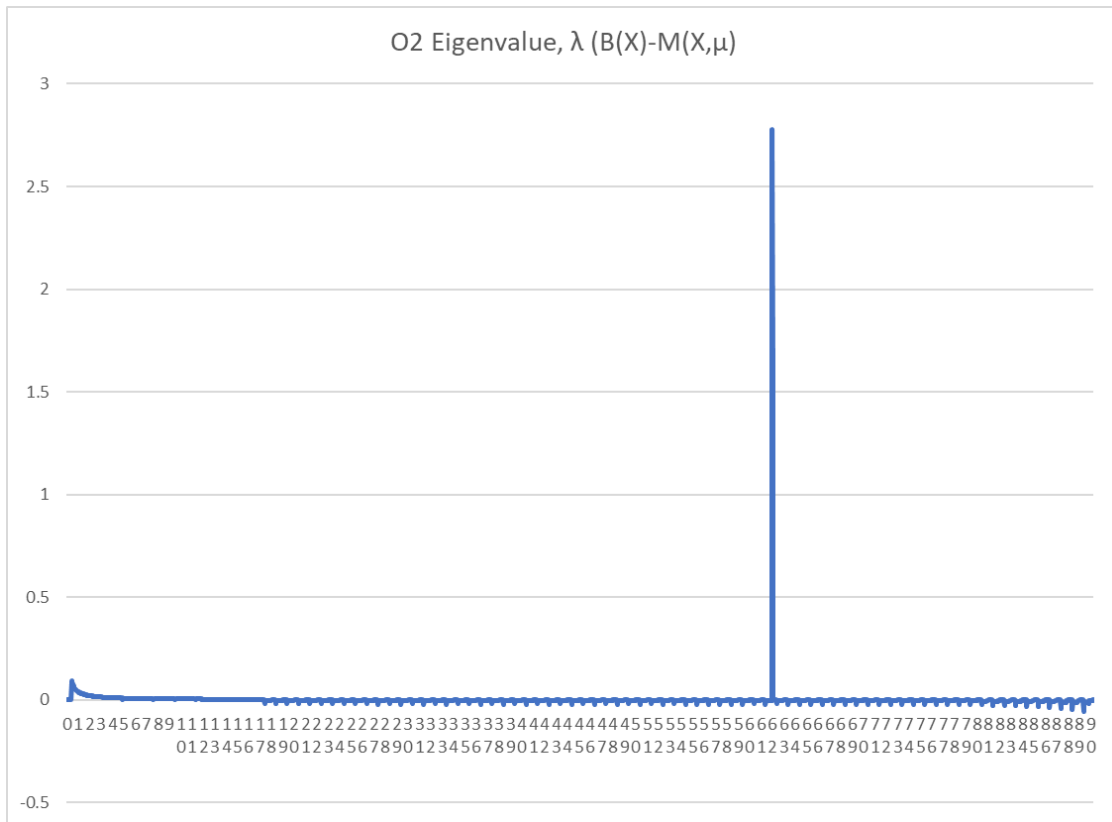

Summary Results Run 10

Log Date Time	MS	Thre ad	Leve l	Component	Message
10/27/20 20 20:51	281	main	INFO	class com.traclabs.biosim.server.simulation.crew.CrewPers onImpl.Bob Roberts	Bob Roberts has died from lack of oxygen on tick 2164 (risk was 37.729496%)
10/27/20 20 20:51	282	main	INFO	com.traclabs.biosim.server.framework.BioDriverImpl	BioDriverIm pl0: simulation ended due to crew death at 10000
10/27/20 20 20:51	282	main	INFO	com.traclabs.biosim.server.framework.BioDriverImpl	BioDriverIm pl0: simulation ended on tick 2164
10/27/20 20 20:51	282	main	INFO	com.traclabs.biosim.framework.BiosimStandaloneLM LSTPController	Controller ended on tick 2164

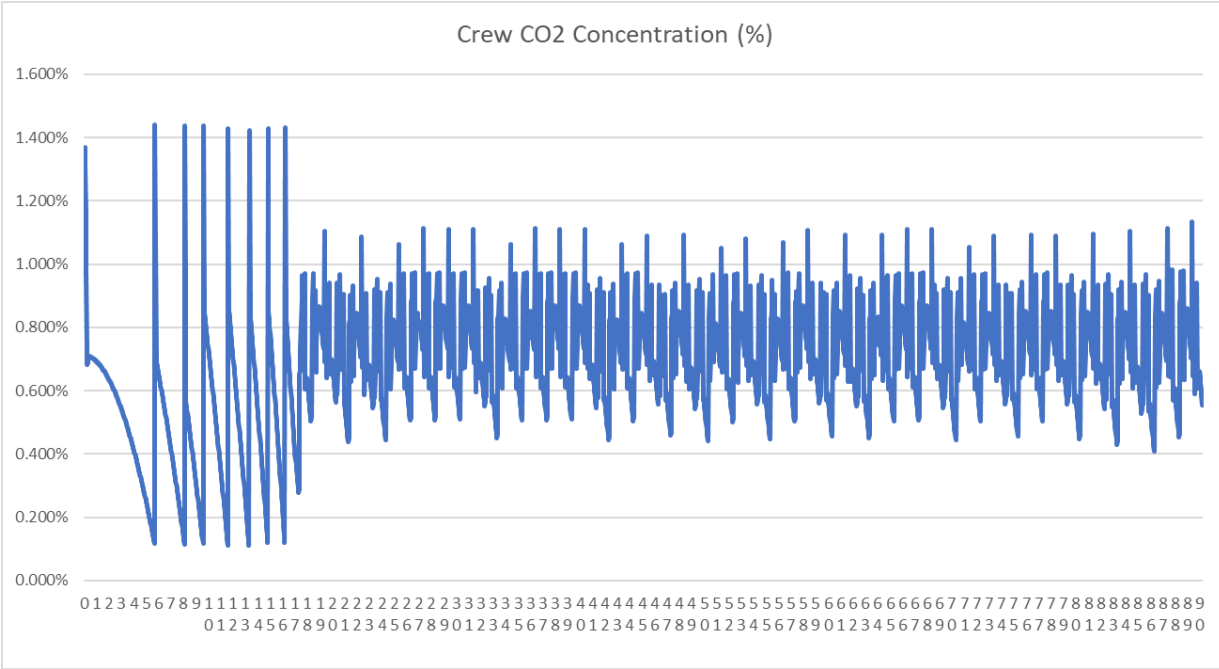
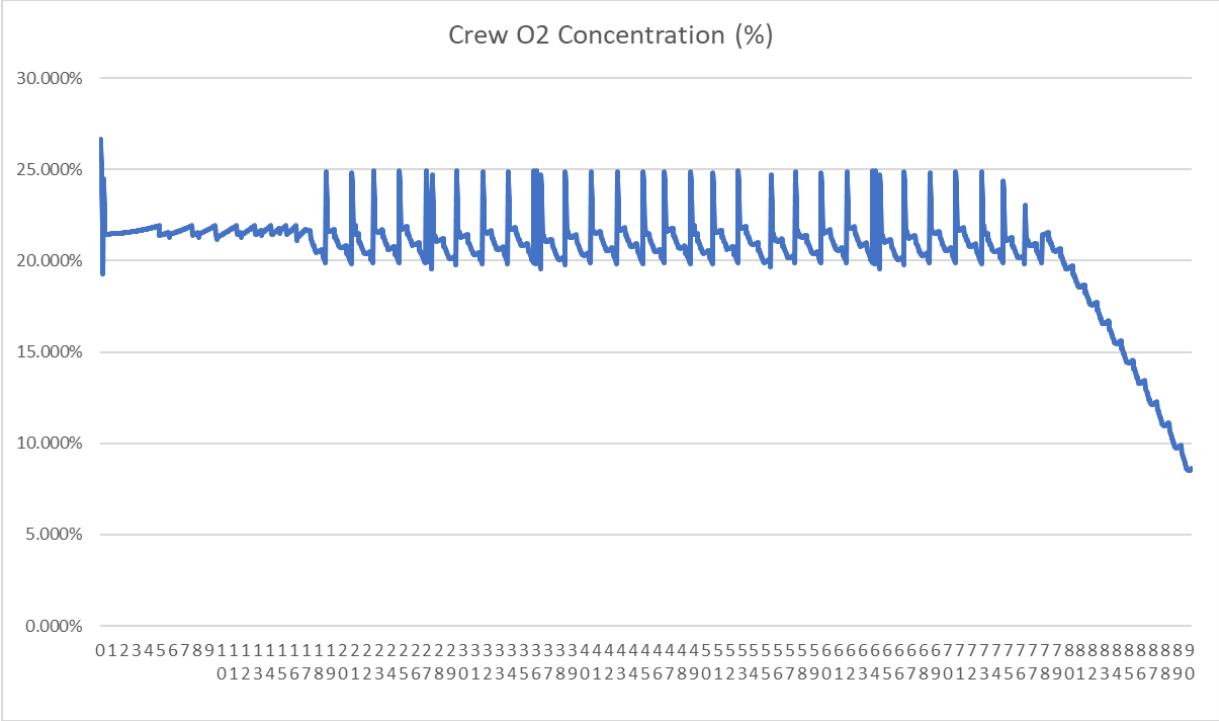

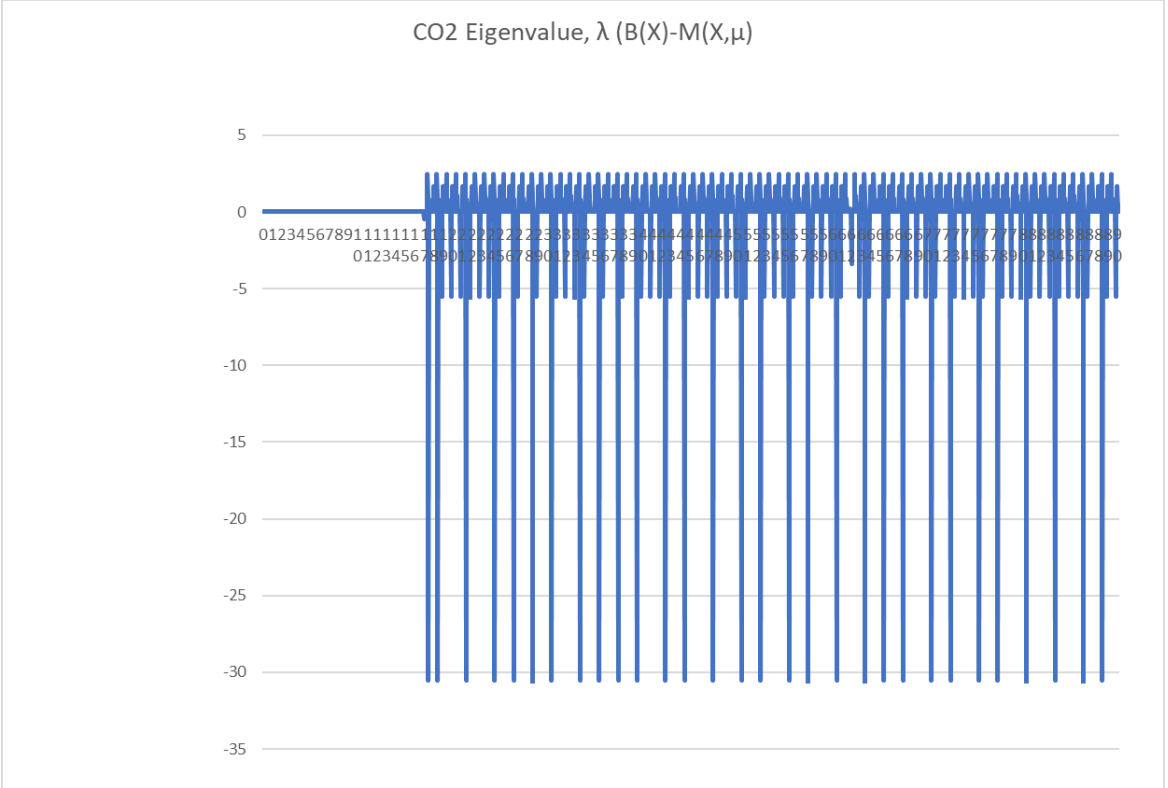
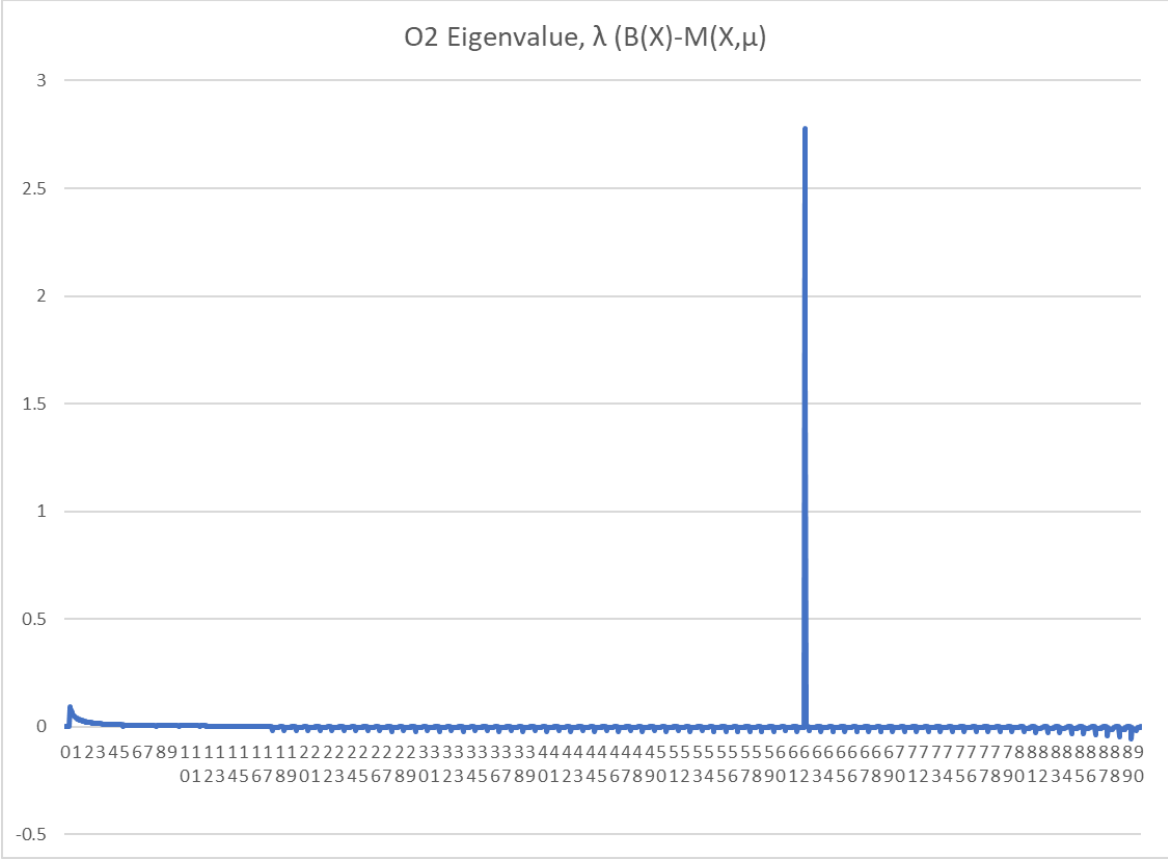

B4 – Continuous LMLSTP Phase III Results

Summary Results Run 1

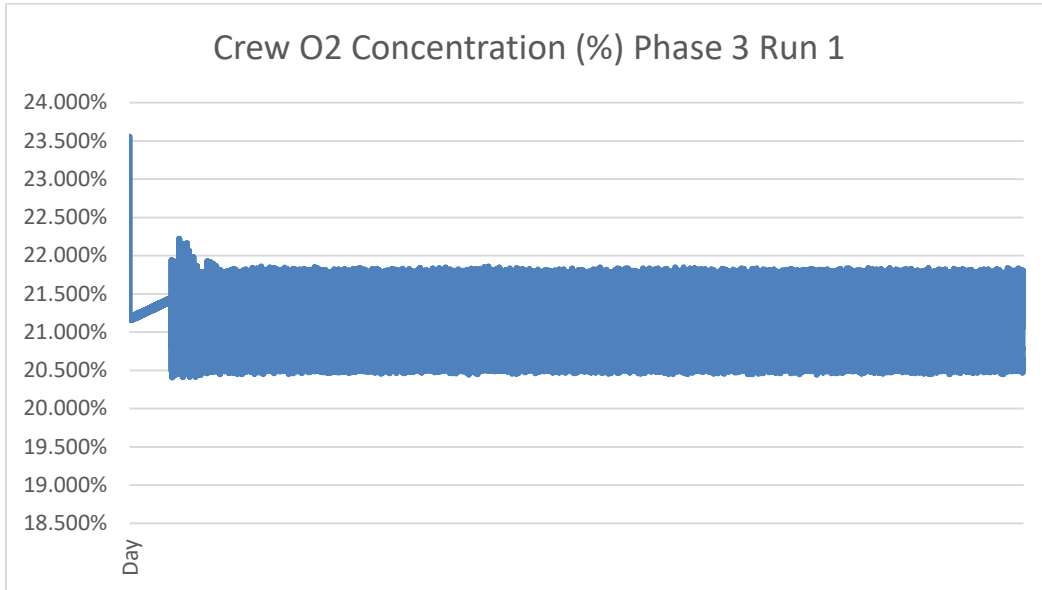

Figure 86 Phase 3 Run 1 Crew O2 entire period

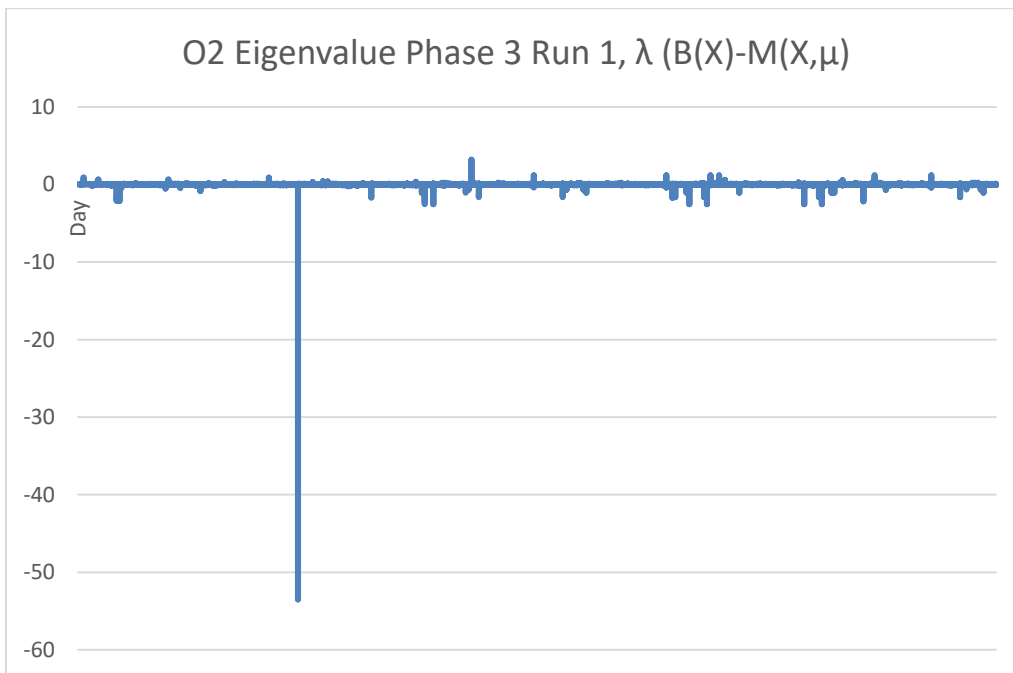

Figure 87 Phase 3 Run 1 O2 Eigenvalues entire period

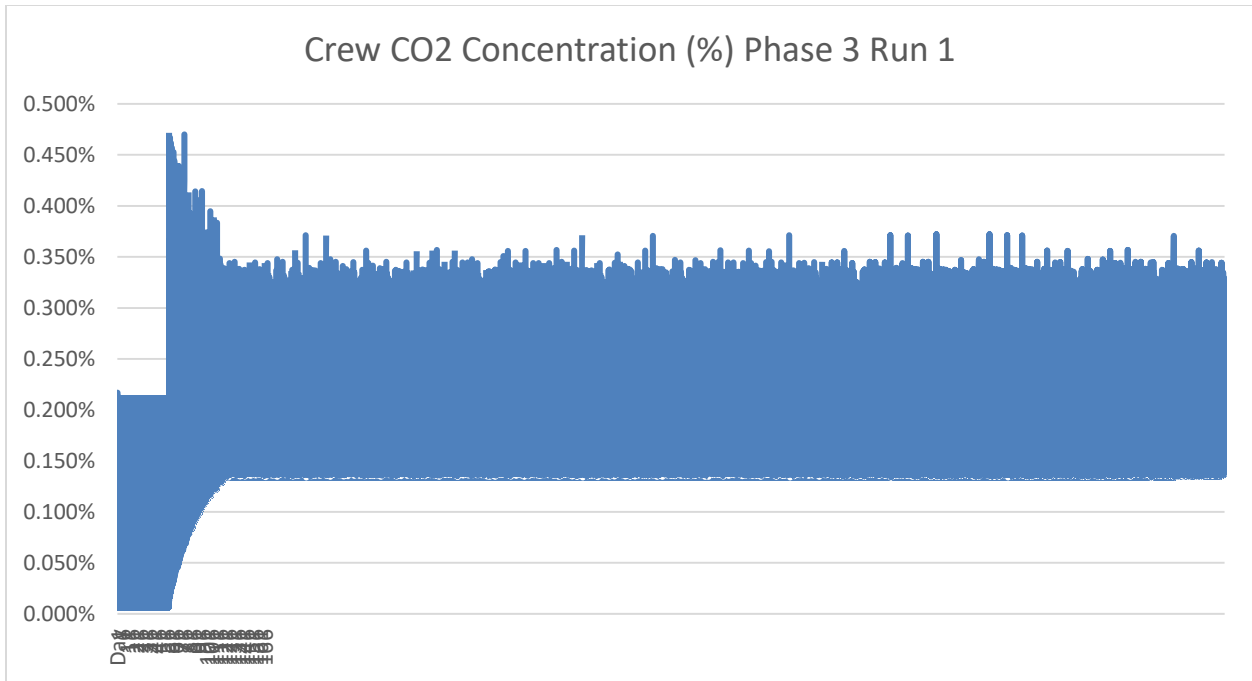

Figure 88 Phase 3 Run 1 Crew CO2 entire period

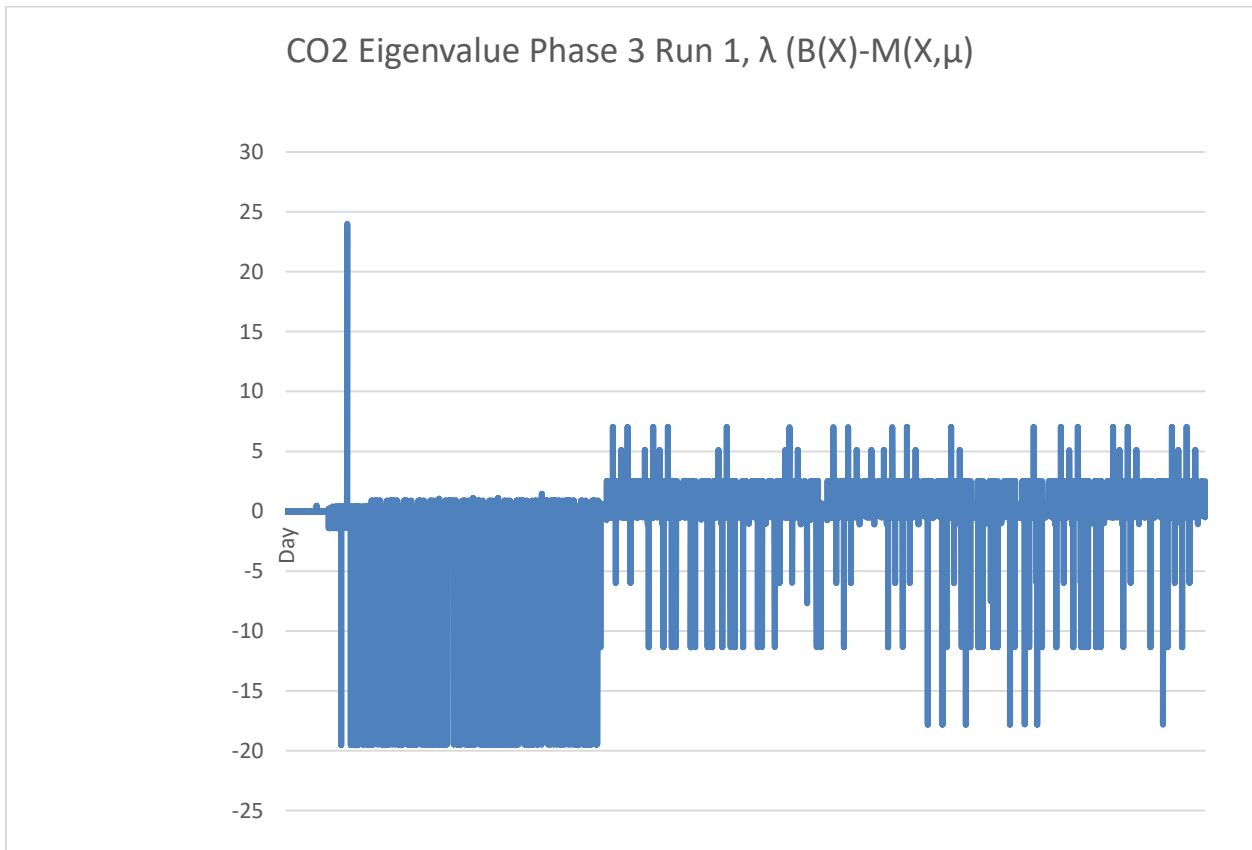

Figure 89 Phase 3 Run 1 CO2 Eigenvalues entire period

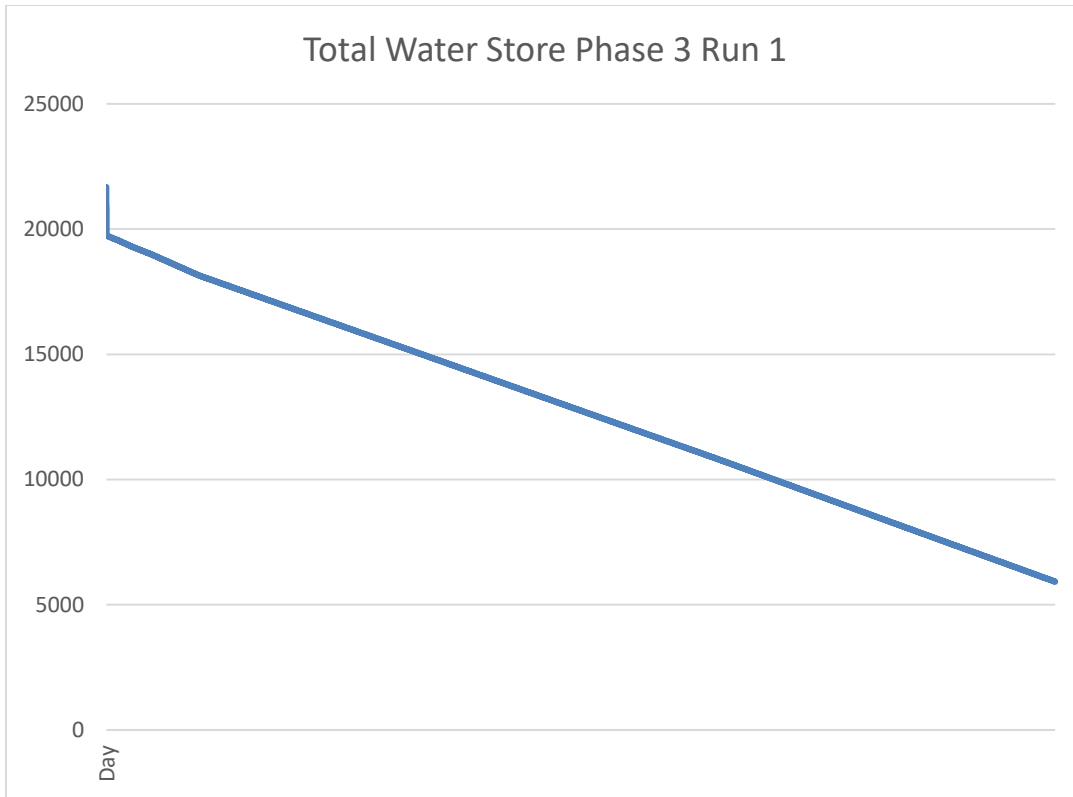

Figure 90 Phase 3 Run 1 Total Water entire period

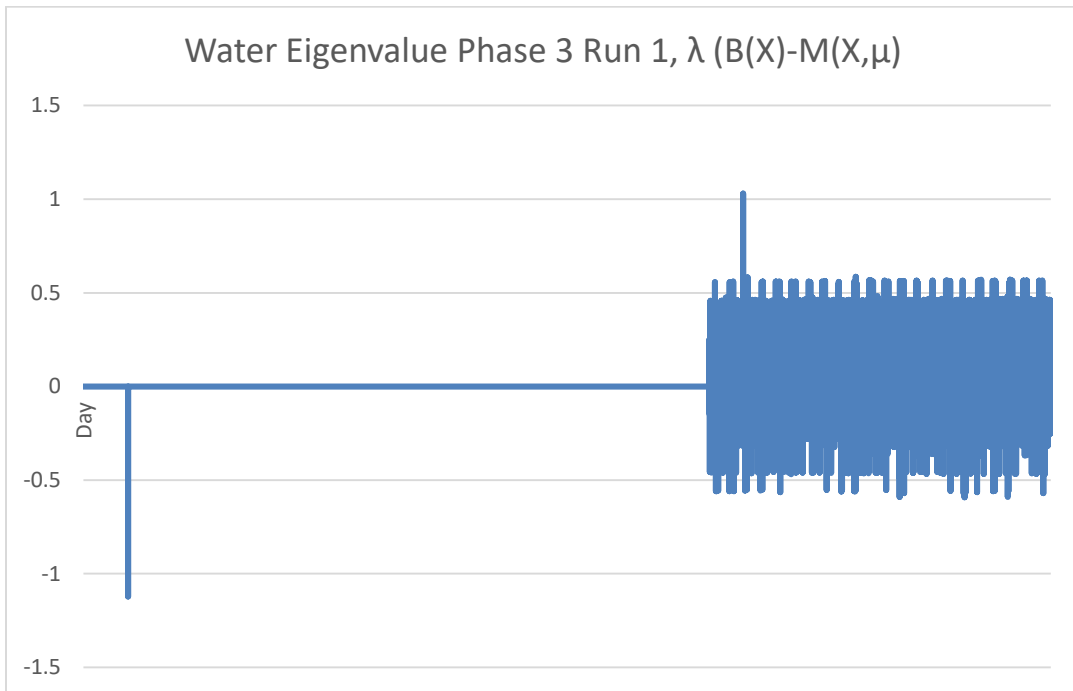

Figure 91 Phase 3 Run 1 Water Eigenvalues entire period

Summary Results Run 2

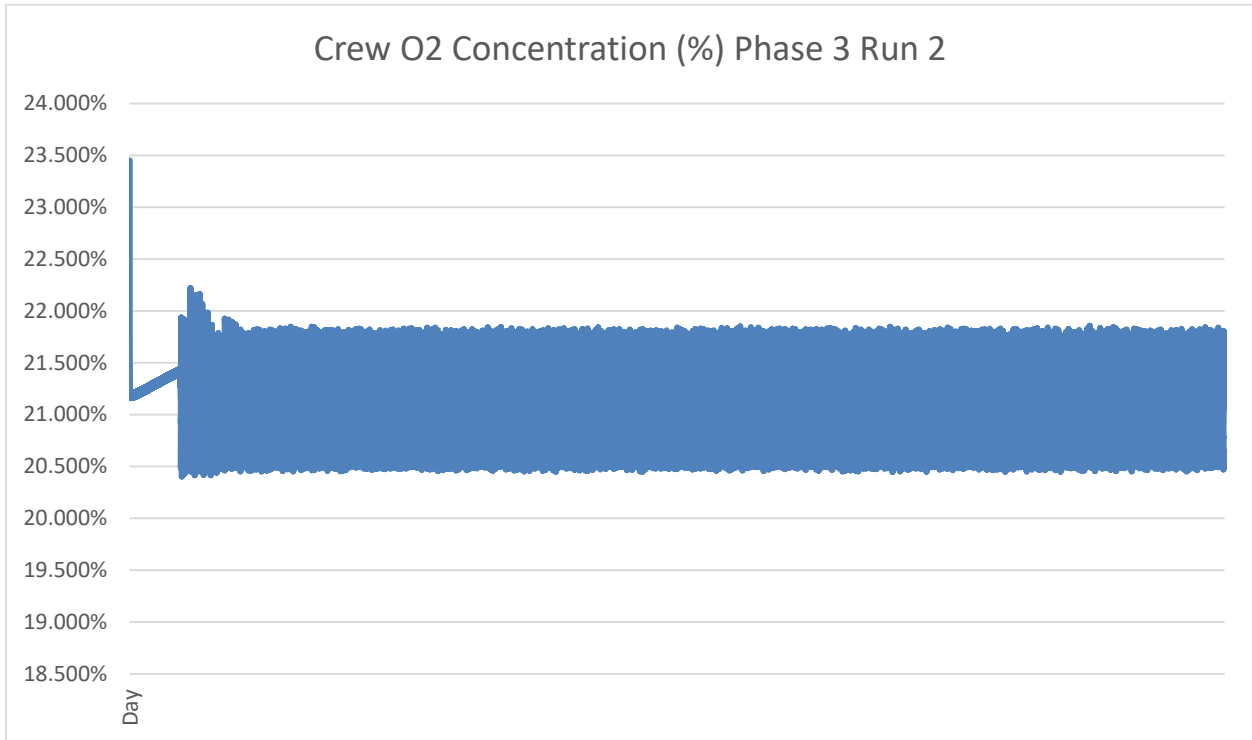

Figure 92 Phase 3 Run 2 Crew O2 entire period

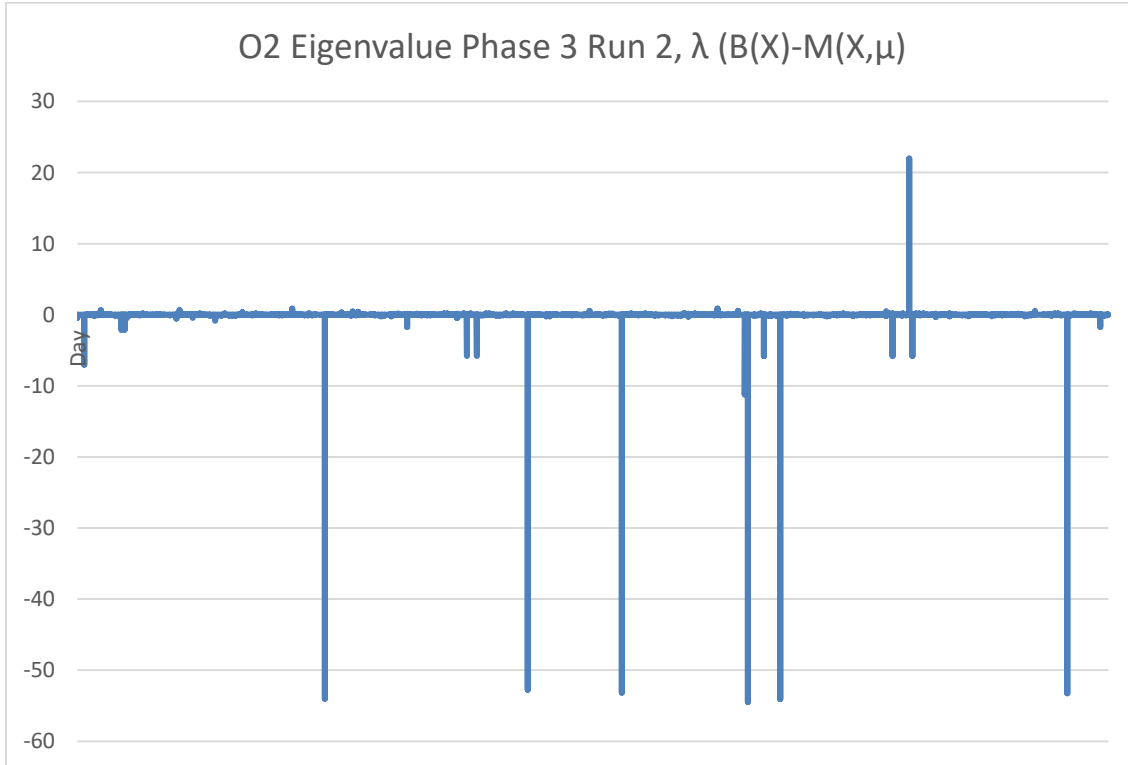

Figure 93 Phase 3 Run 2 O2 Eigenvalues entire period

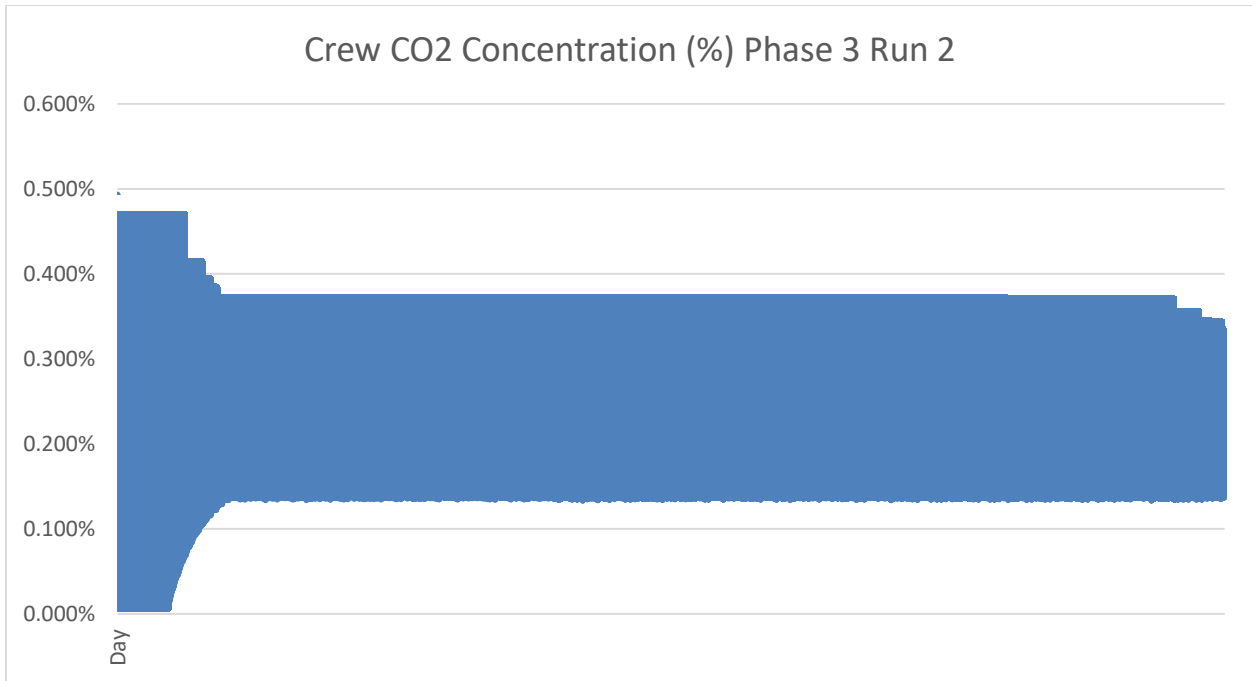

Figure 94 Phase 3 Run 2 Crew CO2 entire period

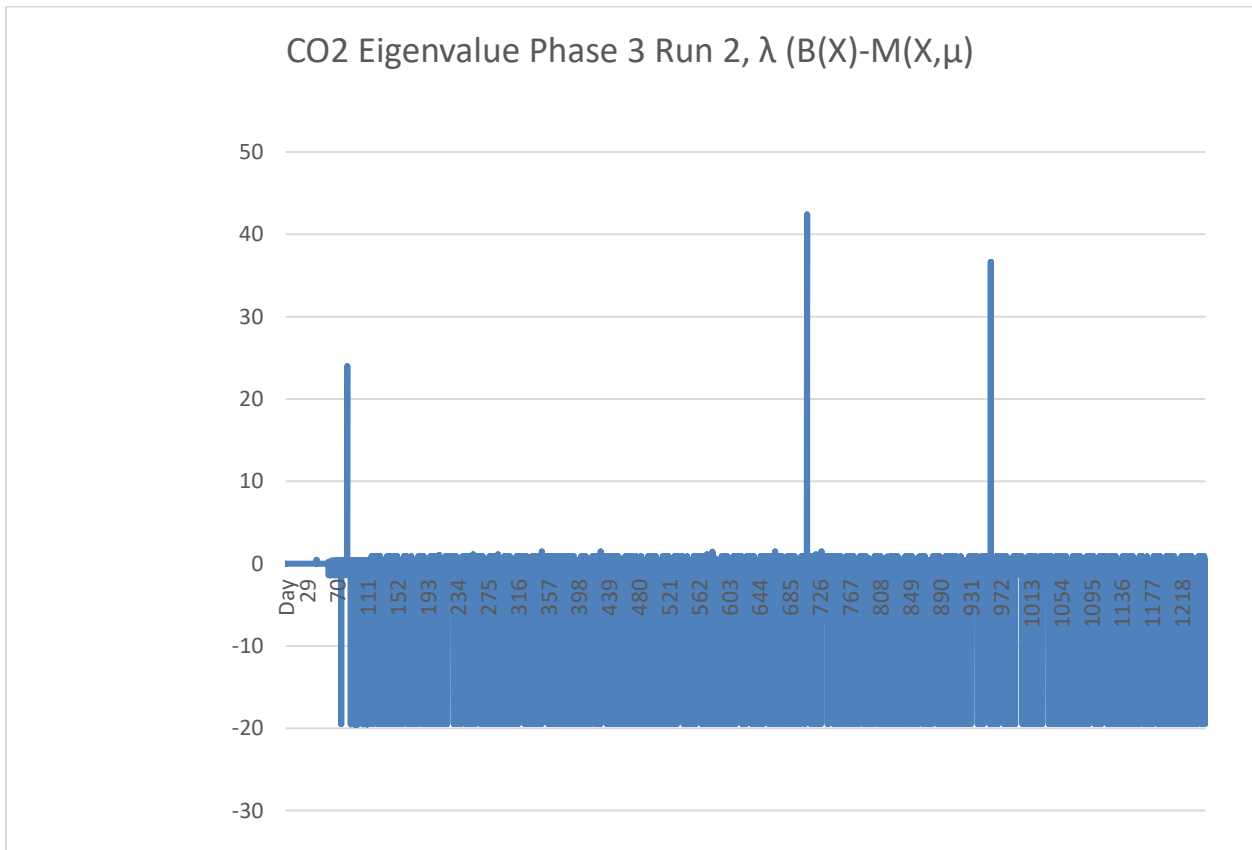

Figure 95 Phase 3 Run 2 CO2 Eigenvalues entire period

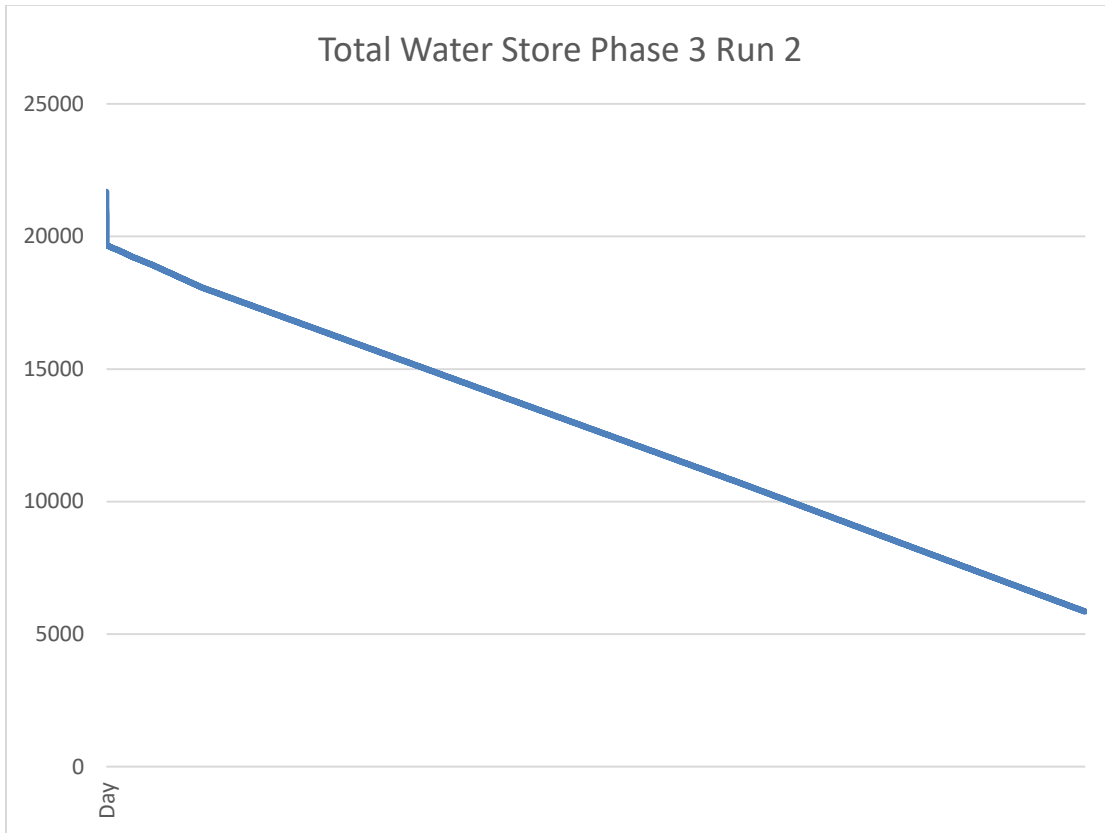

Figure 96 Phase 3 Run 2 Total Water entire period

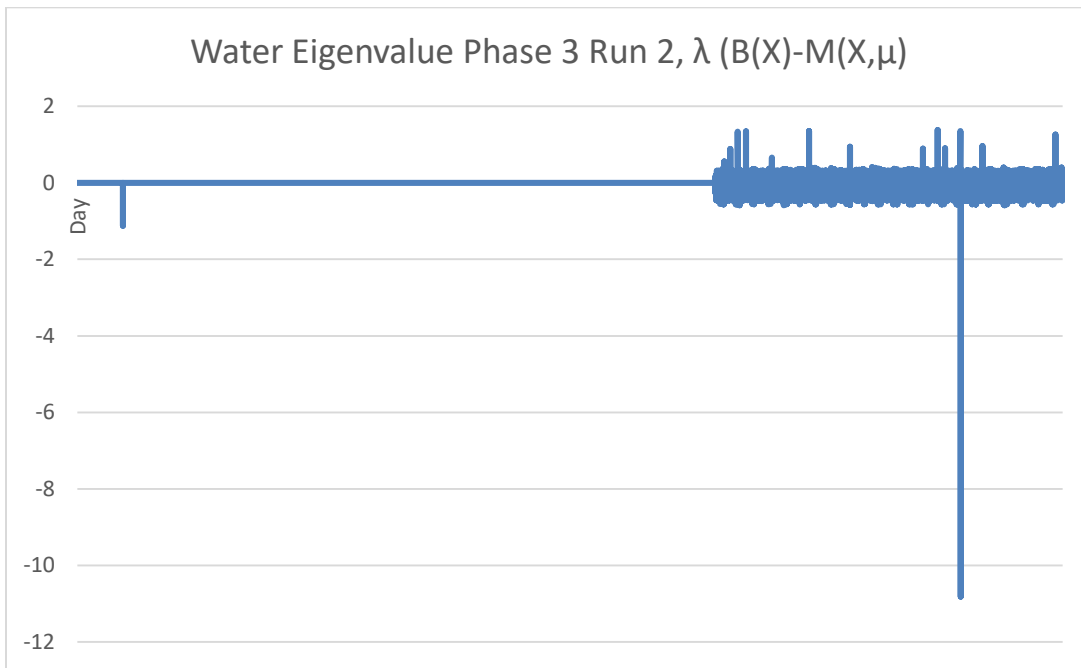

Figure 97 Phase 3 Run 2 Water Eigenvalues entire period

Summary Results Run 3

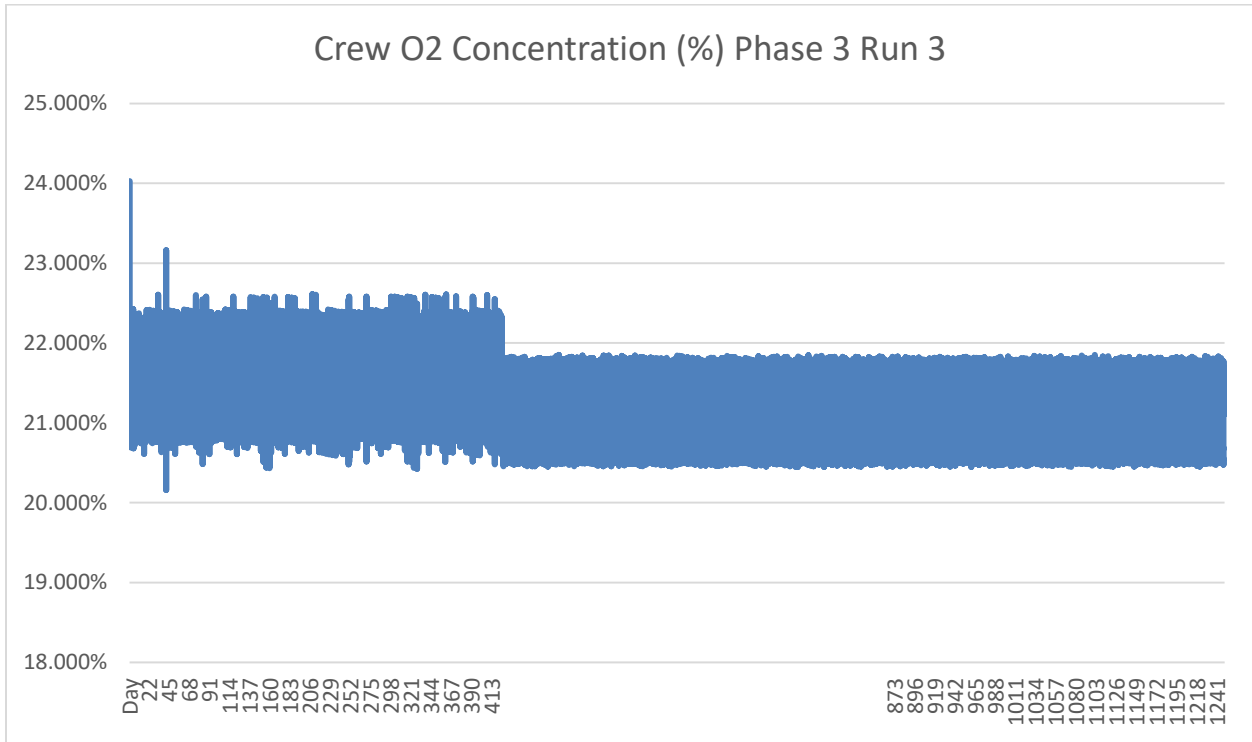

Figure 98 Phase 3 Run 3 Crew O2 entire period

Figure 99 Phase 3 Run 3 Crew O2 last 398 days

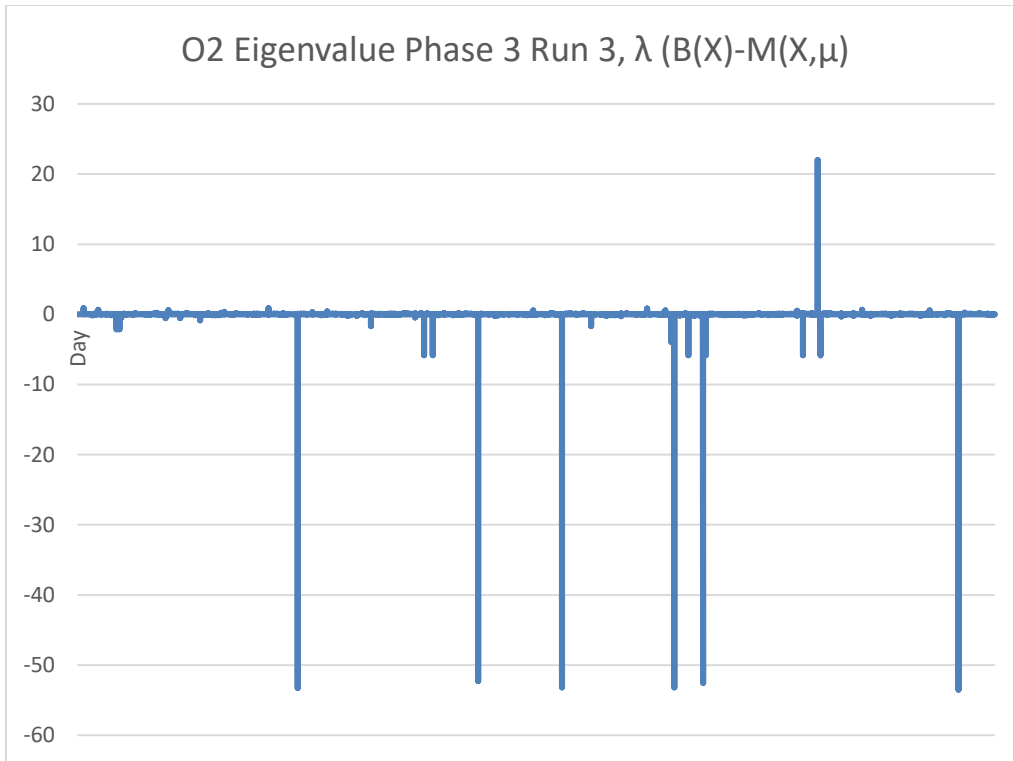

Figure 100 Phase 3 Run 3 O2 Eigenvalues full period

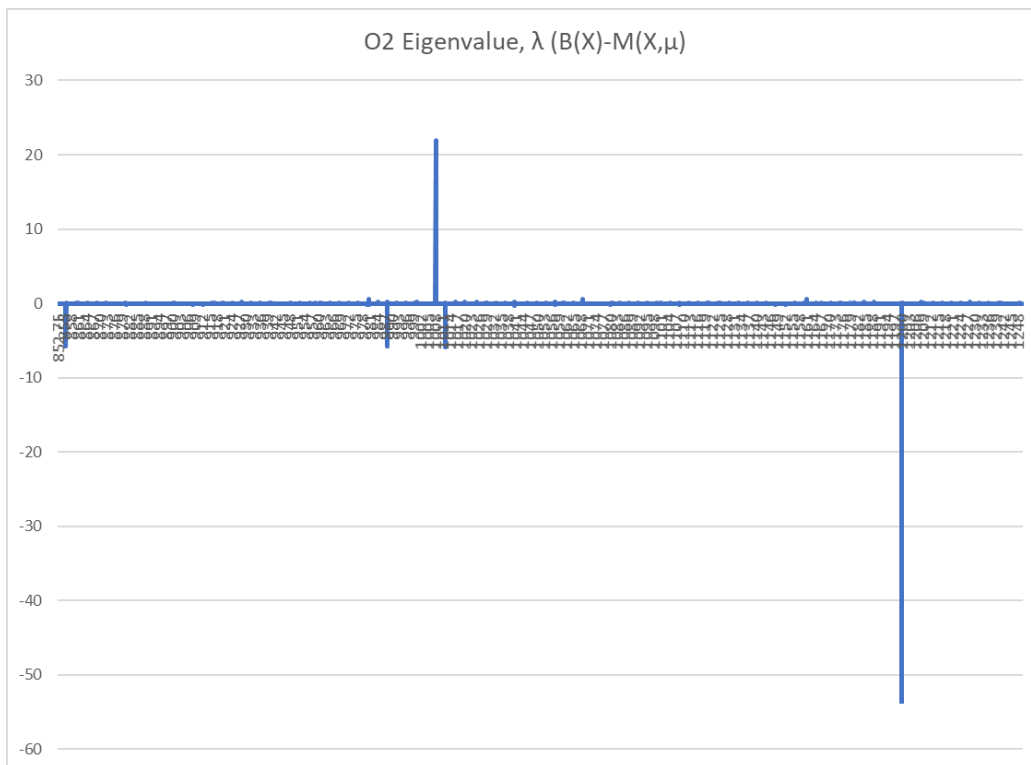

Figure 101 Phase 3 Run 3 O2 Eigenvalues last 398 days

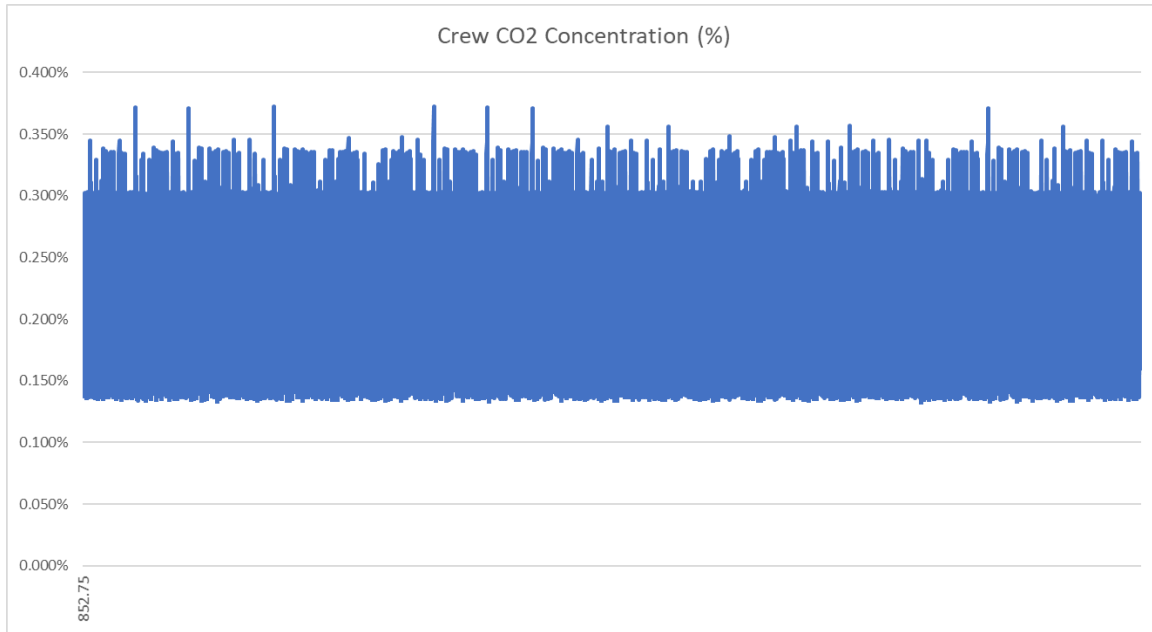

Figure 102 Phase 3 Run 3 Crew CO2 last 398 days

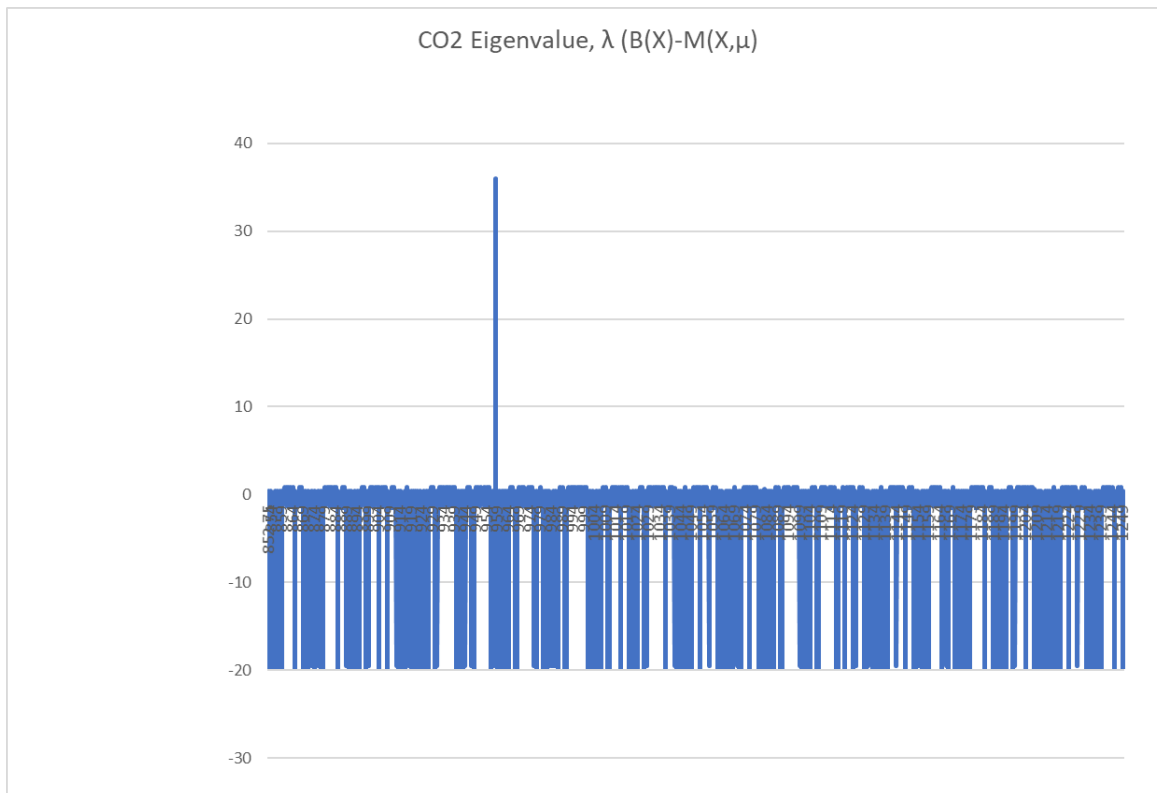

Figure 103 Phase 3 Run 3 CO2 Eigenvalues last 398 days

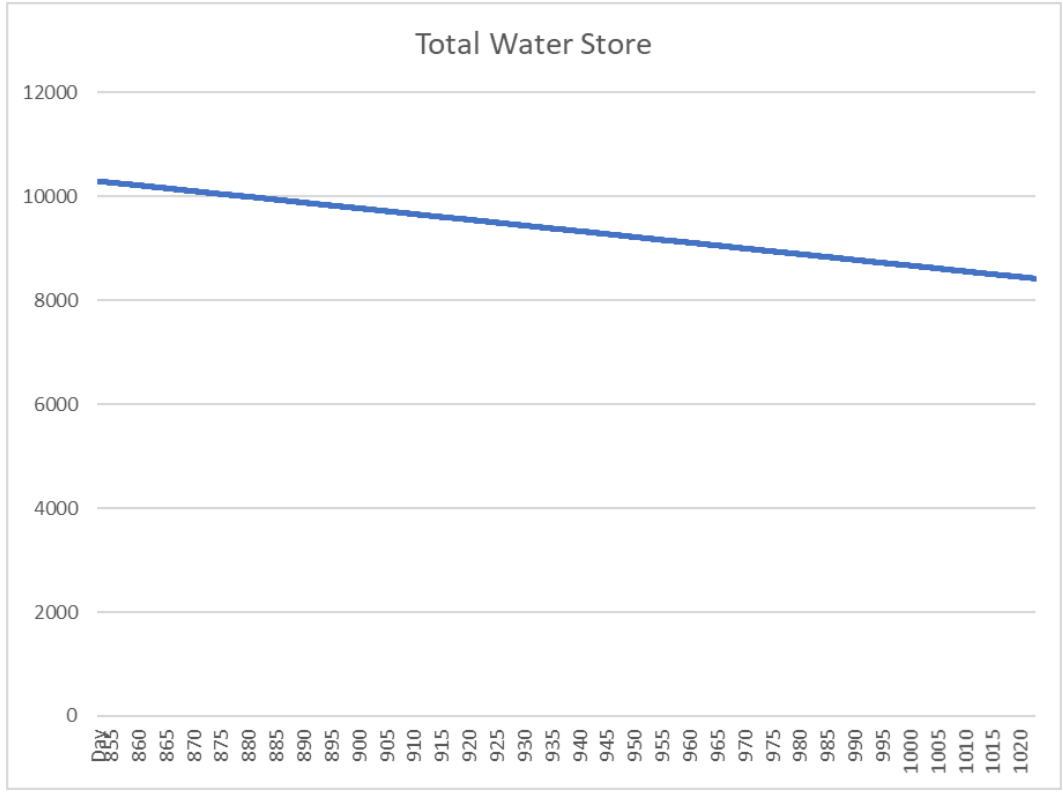

Figure 104 Phase 3 Run 3 Total Water last 398 days

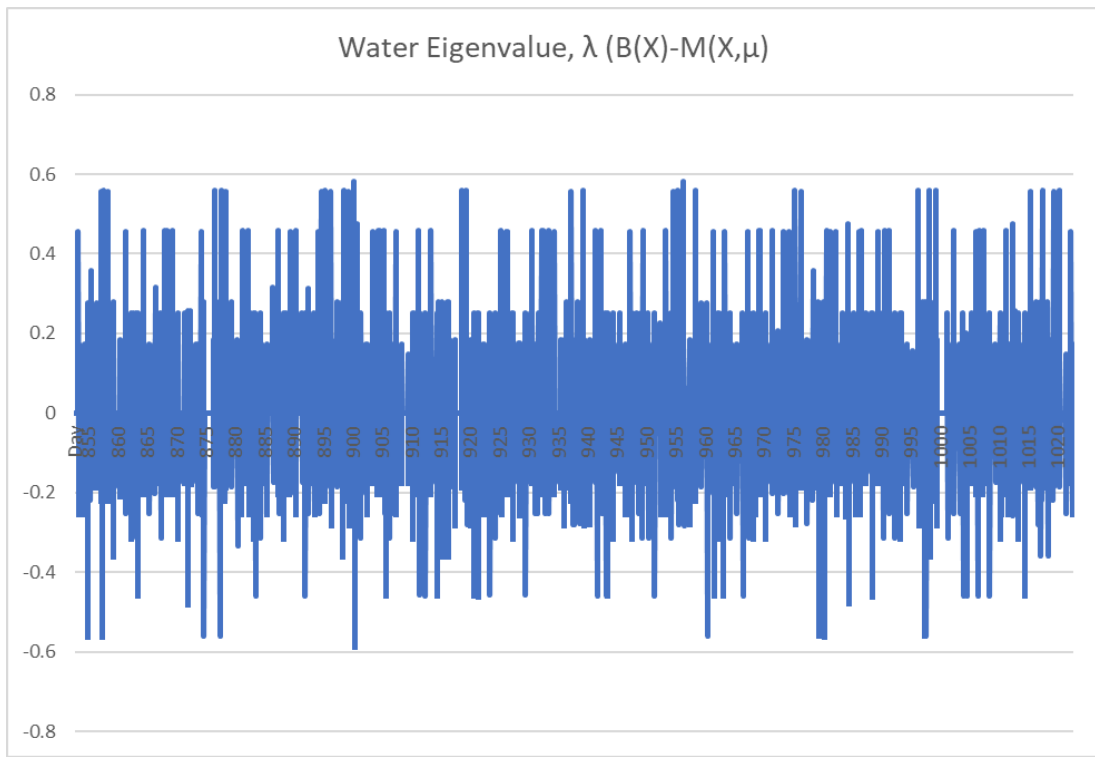

Figure 105 Phase 3 Run 3 Water Eigenvalues last 398 days

Summary Results Run 4

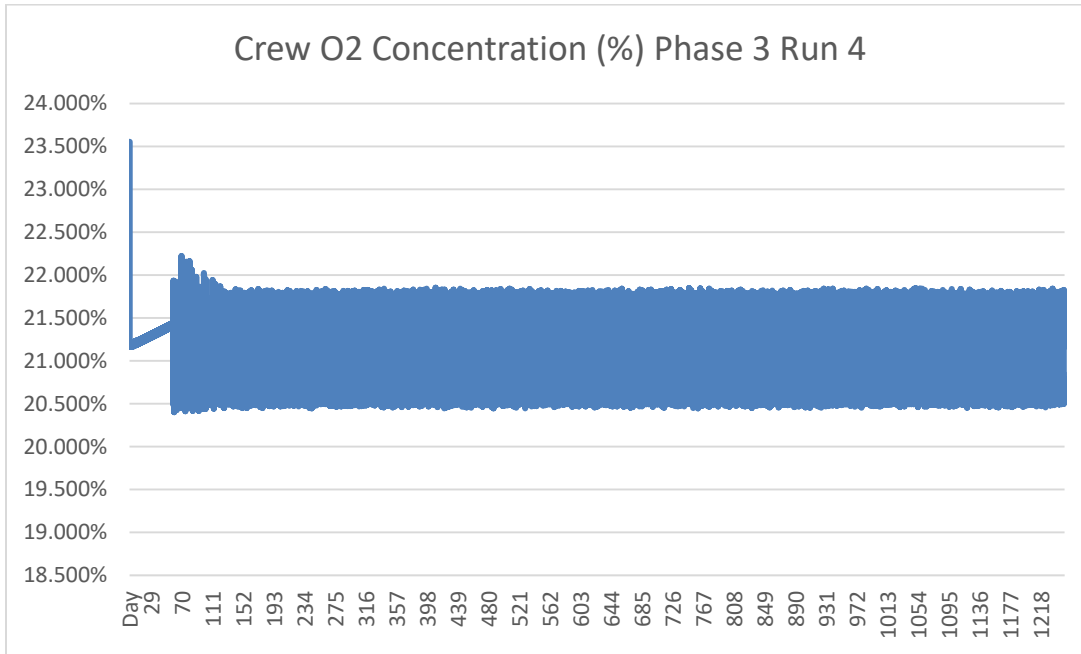

Figure 106 Phase 3 Run 4 Crew Oxygen Concentration

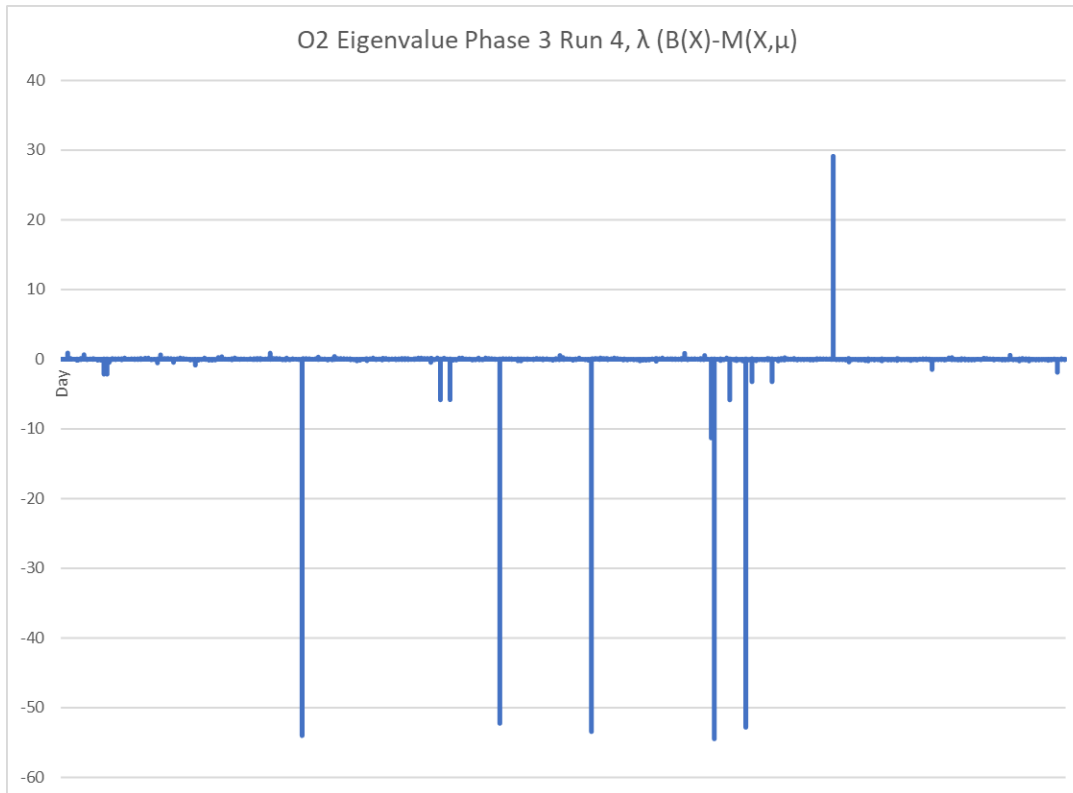

Figure 107 Phase 3 Run 4 Oxygen Eigenvalues

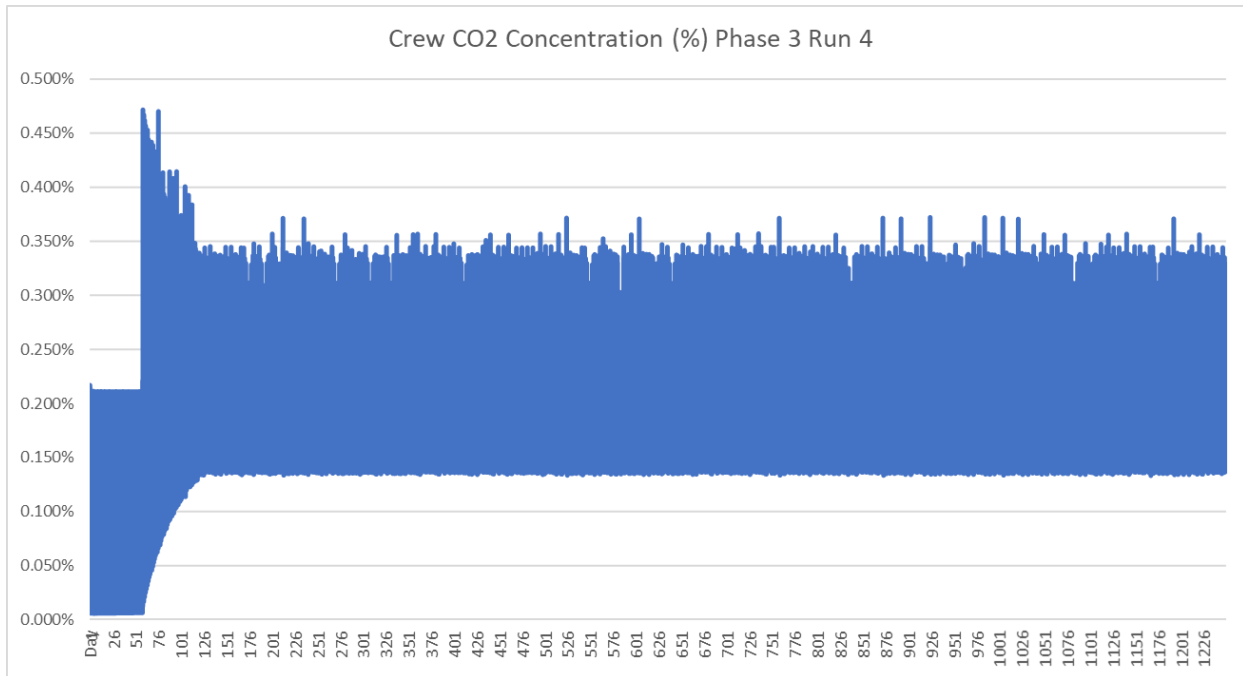

Figure 108 Phase 3 Run 4 Crew Carbon Dioxide Concentration

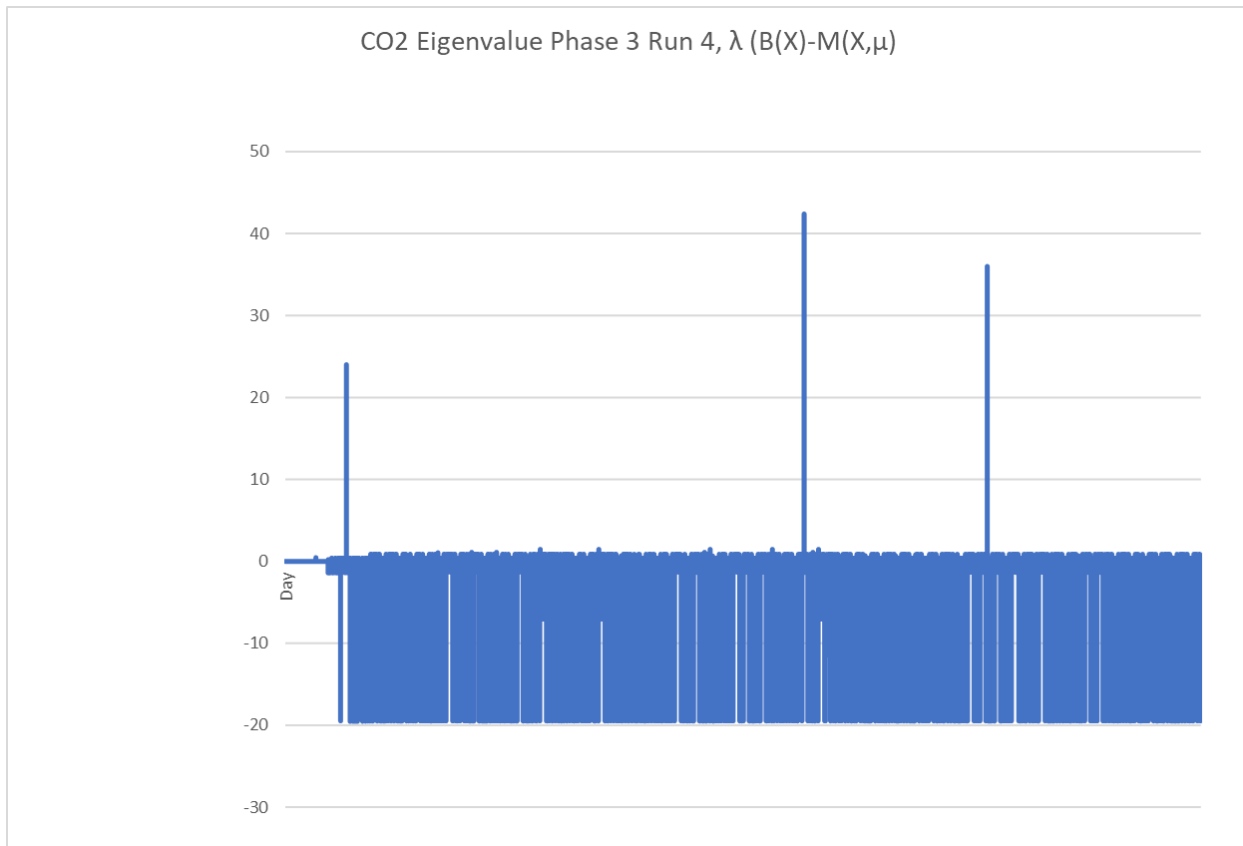

Figure 109 Phase 3 Run 4 Carbon Dioxide Eigenvalues

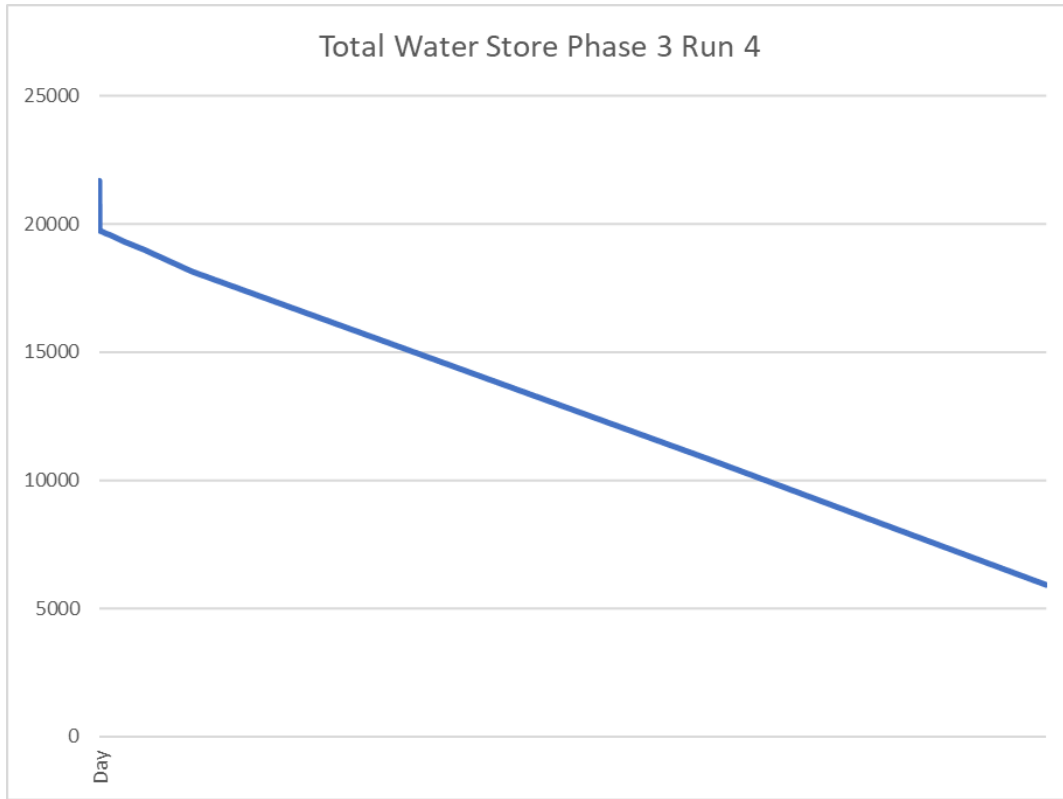

Figure 110 Phase 3 Run 4 Total Simulation Water

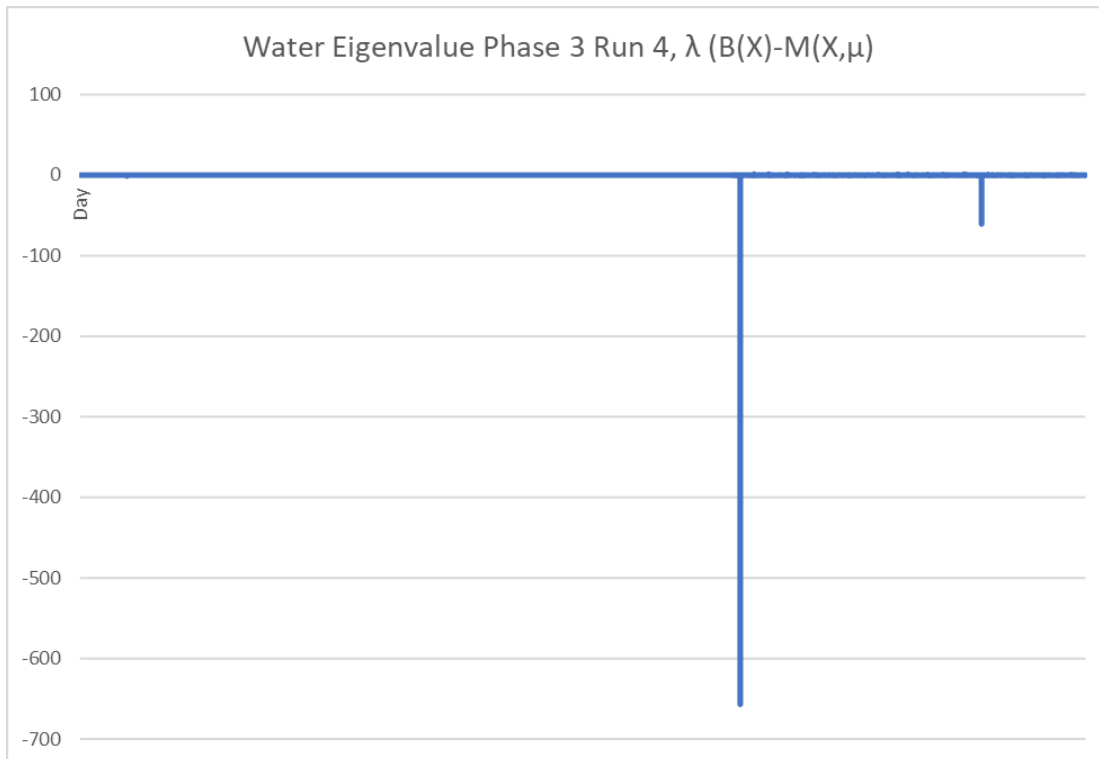

Figure 111 Phase 3 Run 4 Water Eigenvalues

Summary Results Run 5

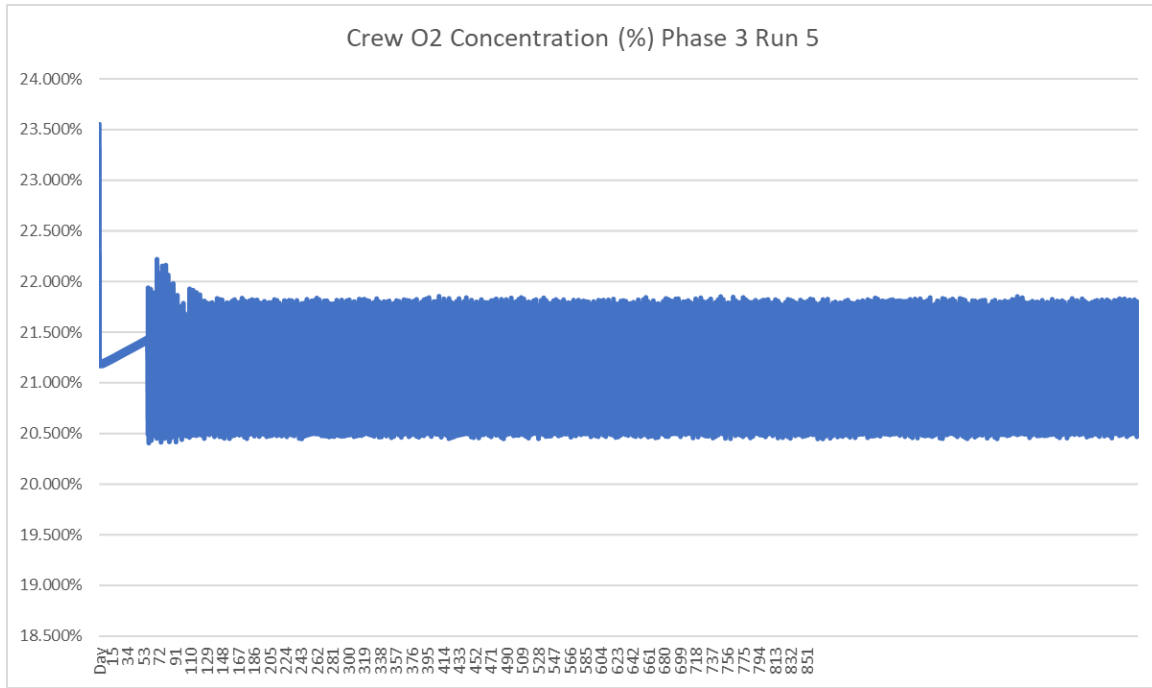

Figure 112 Phase 3 Run 5 Crew Oxygen Concentration

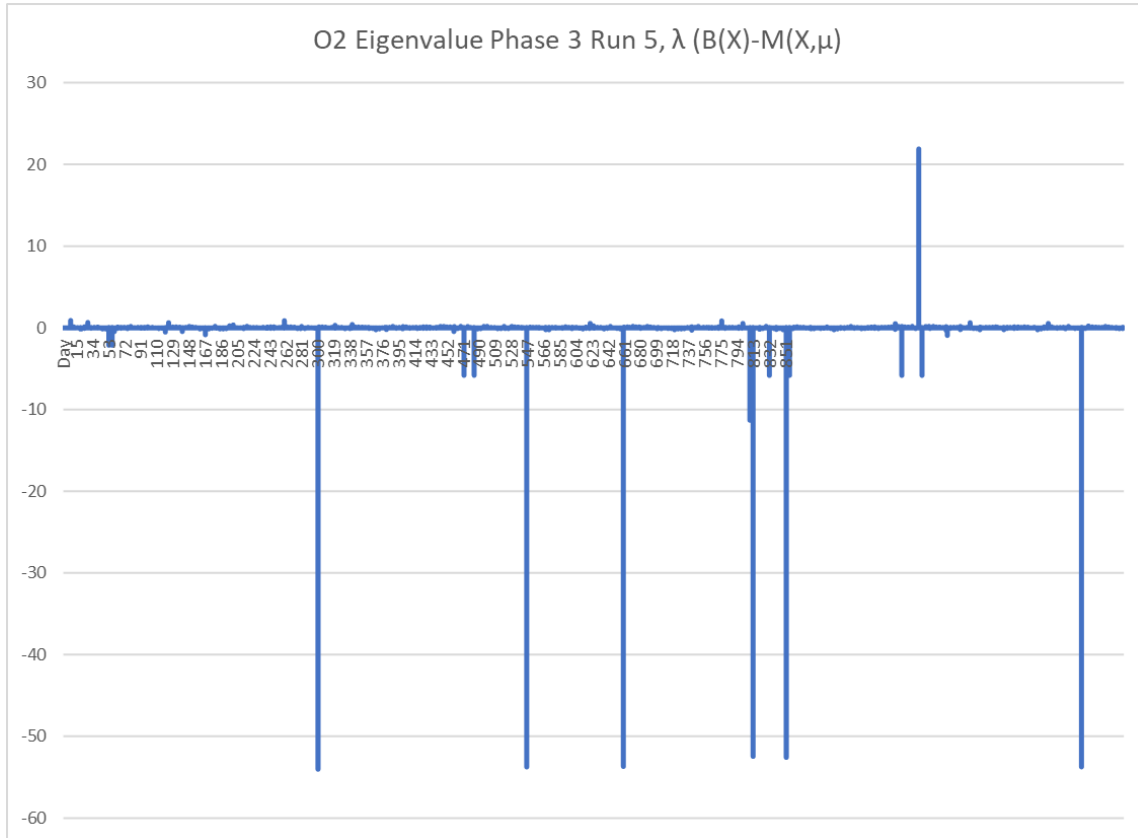

Figure 113 Phase 3 Run 5 Oxygen Eigenvalues

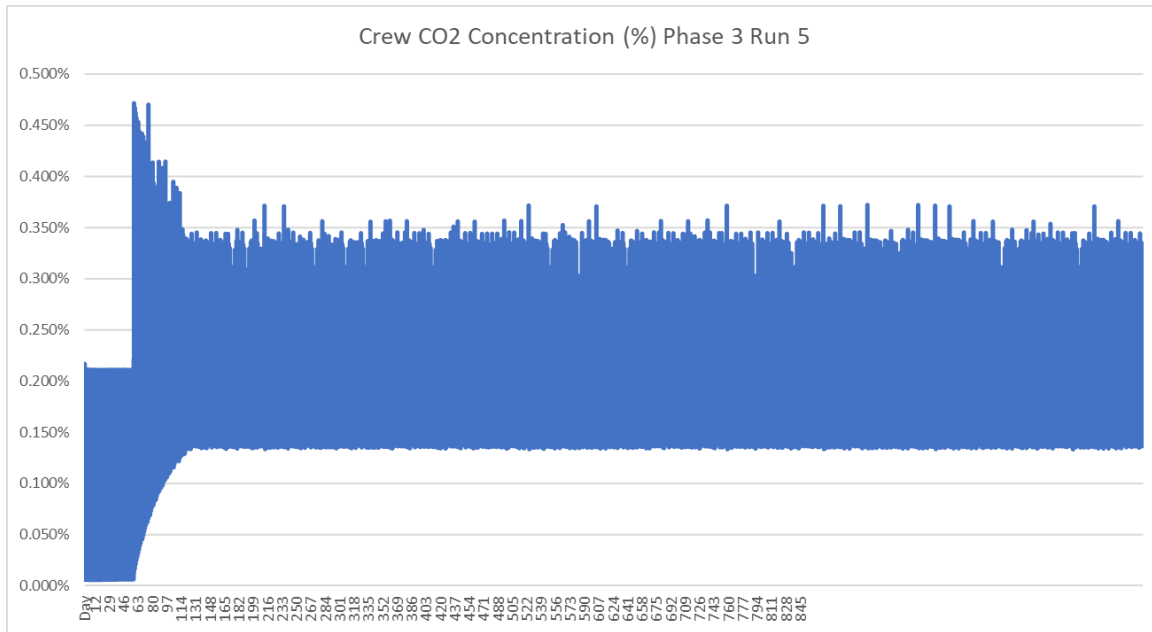

Figure 114 Phase 3 Run 5 Crew Carbon Dioxide Concentration

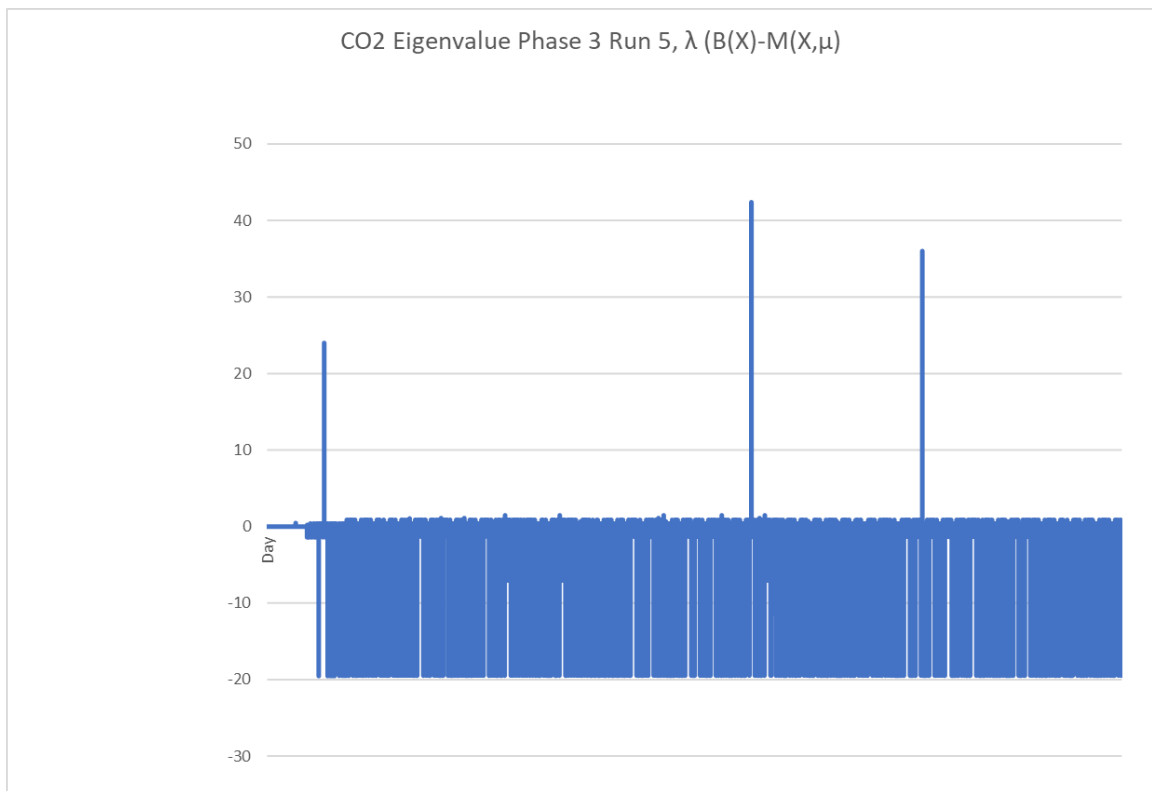

Figure 115 Phase 3 Run 5 Carbon Dioxide Eigenvalues

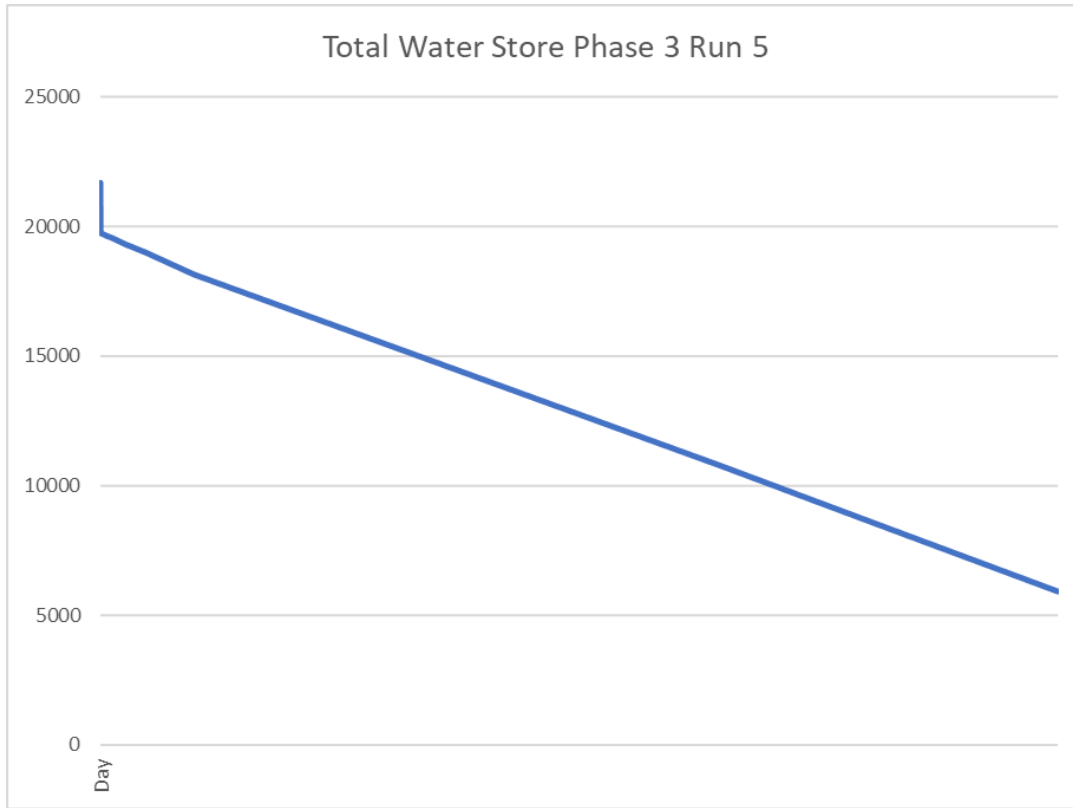

Figure 116 Phase 3 Run 5 Total Simulation Water

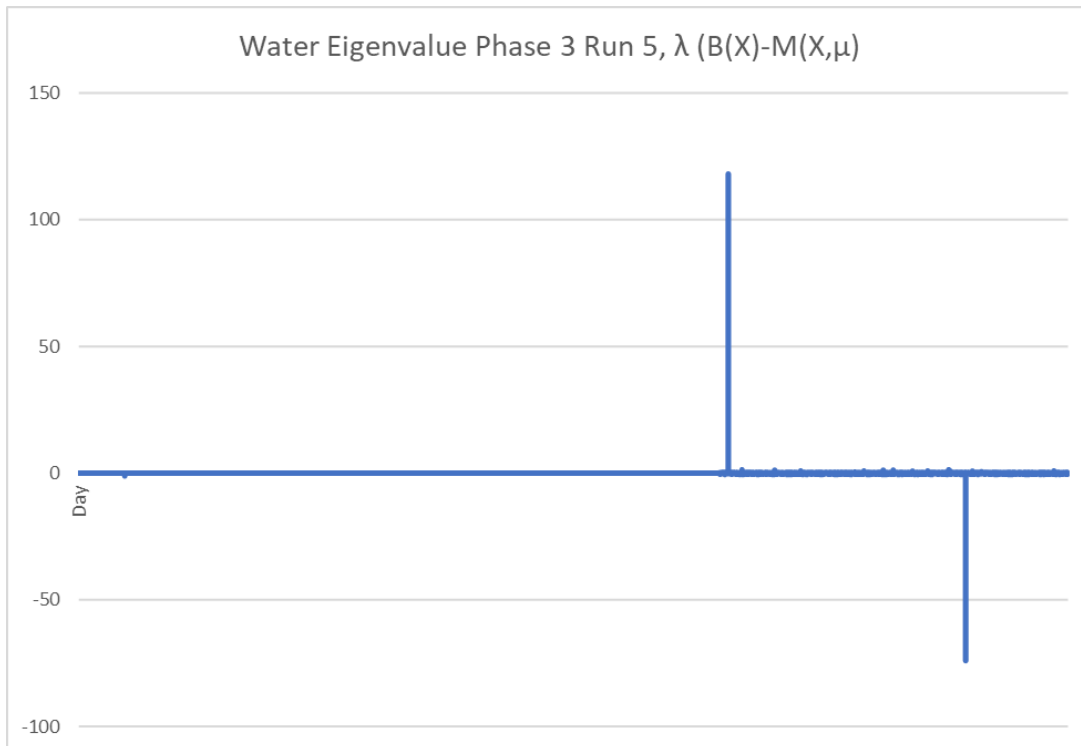

Figure 117 Phase 3 Run 5 Water Eigenvalues

Summary Results Run 6

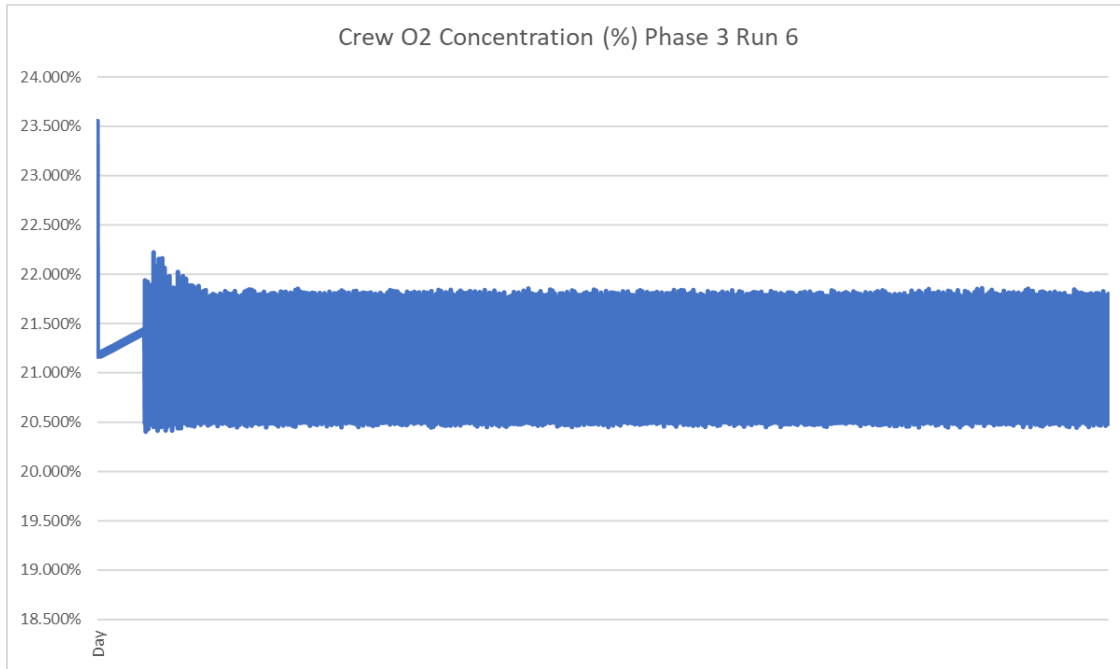

Figure 118 Phase 3 Run 6 Crew Oxygen Concentration

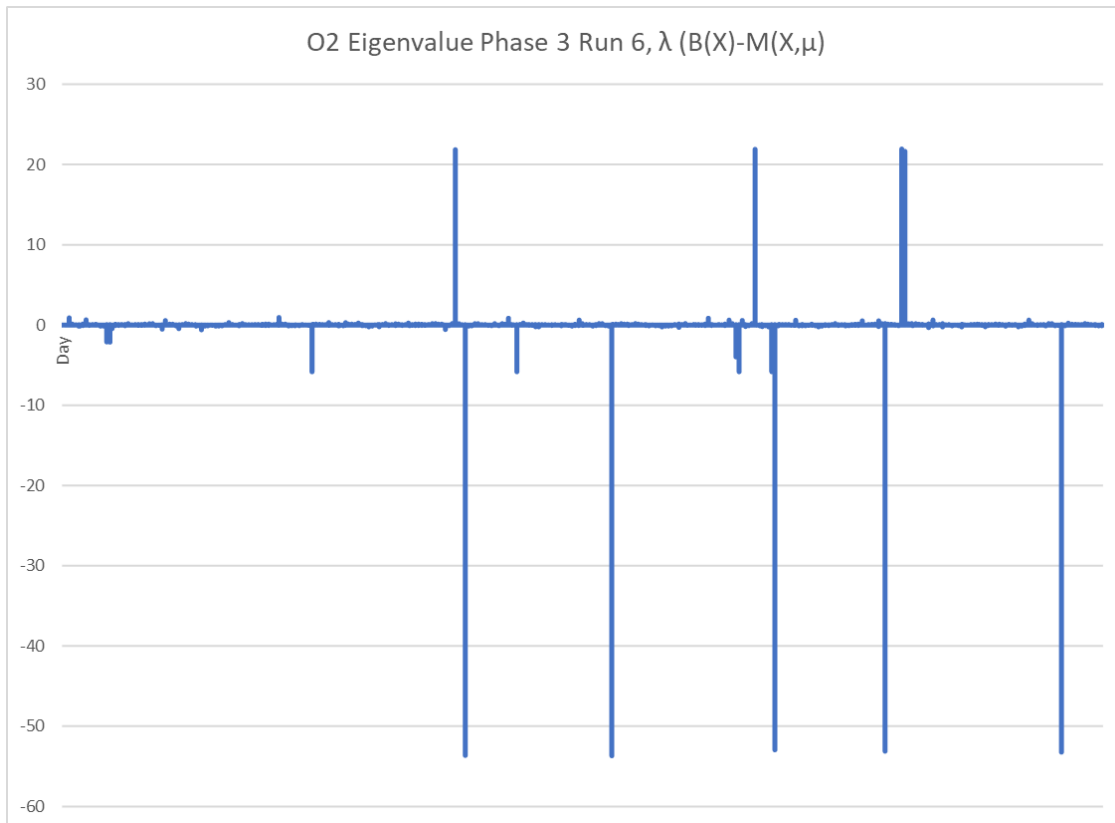

Figure 119 Phase 3 Run 6 Oxygen Eigenvalues

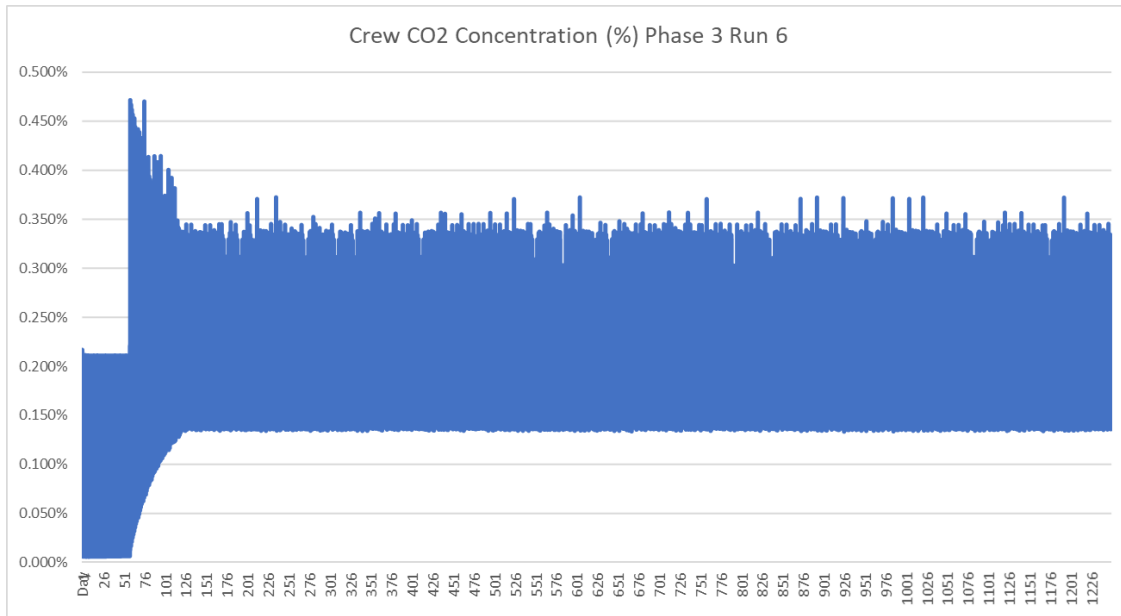

Figure 120 Phase 3 Run 6 Crew Carbon Dioxide Concentration

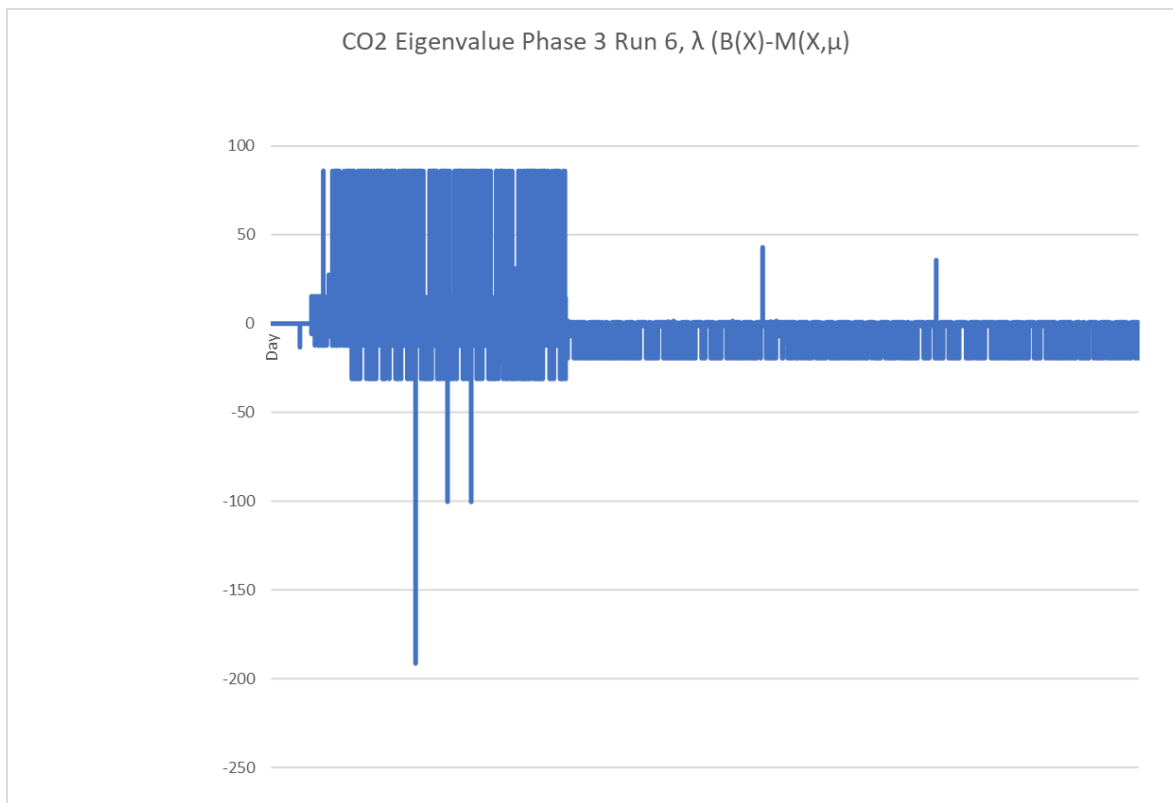

Figure 121 Phase 3 Run 6 Carbon Dioxide Eigenvalues

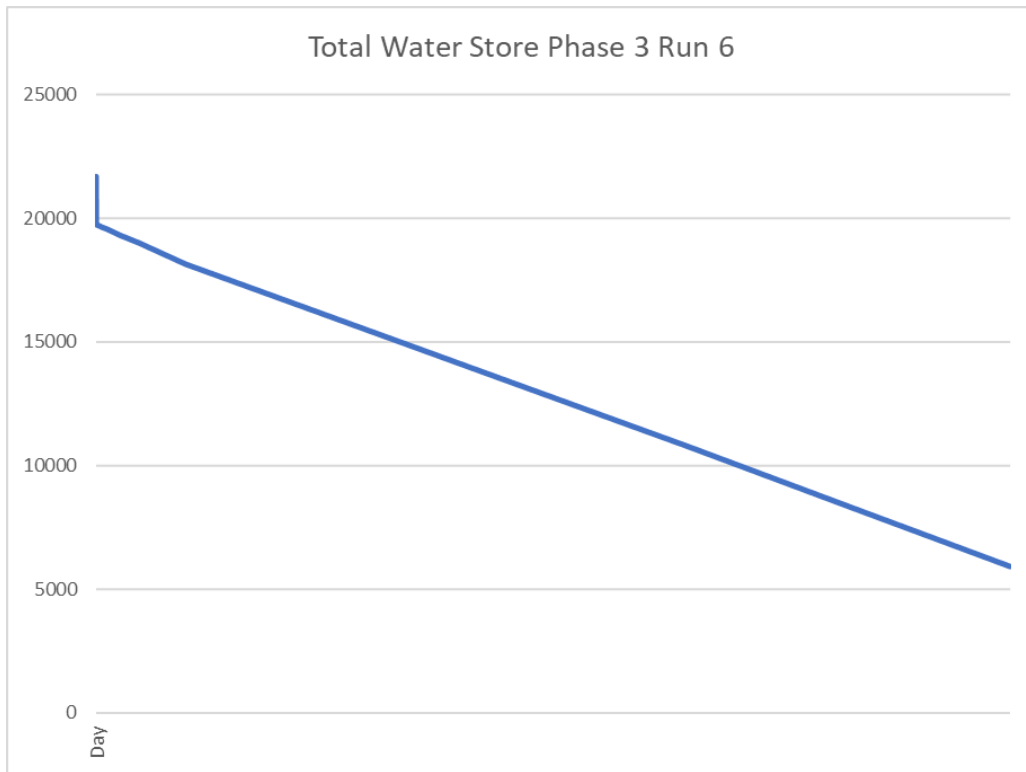

Figure 122 Phase 3 Run 6 Total Simulation Water

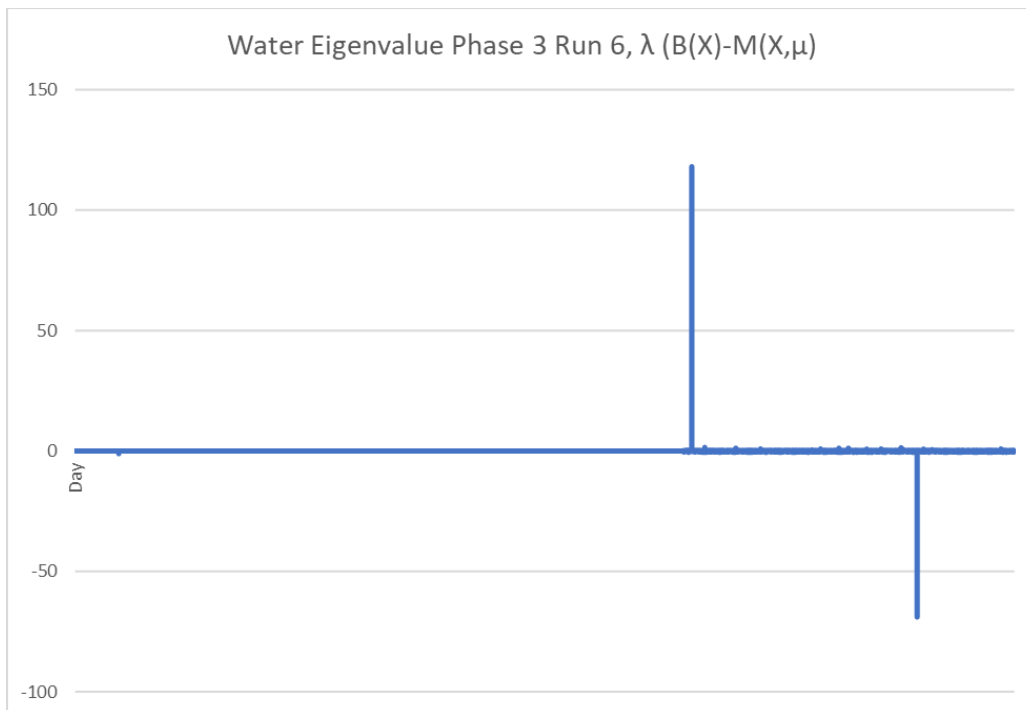

Figure 123 Phase 3 Run 6 Water Eigenvalues

Summary Results Run 7

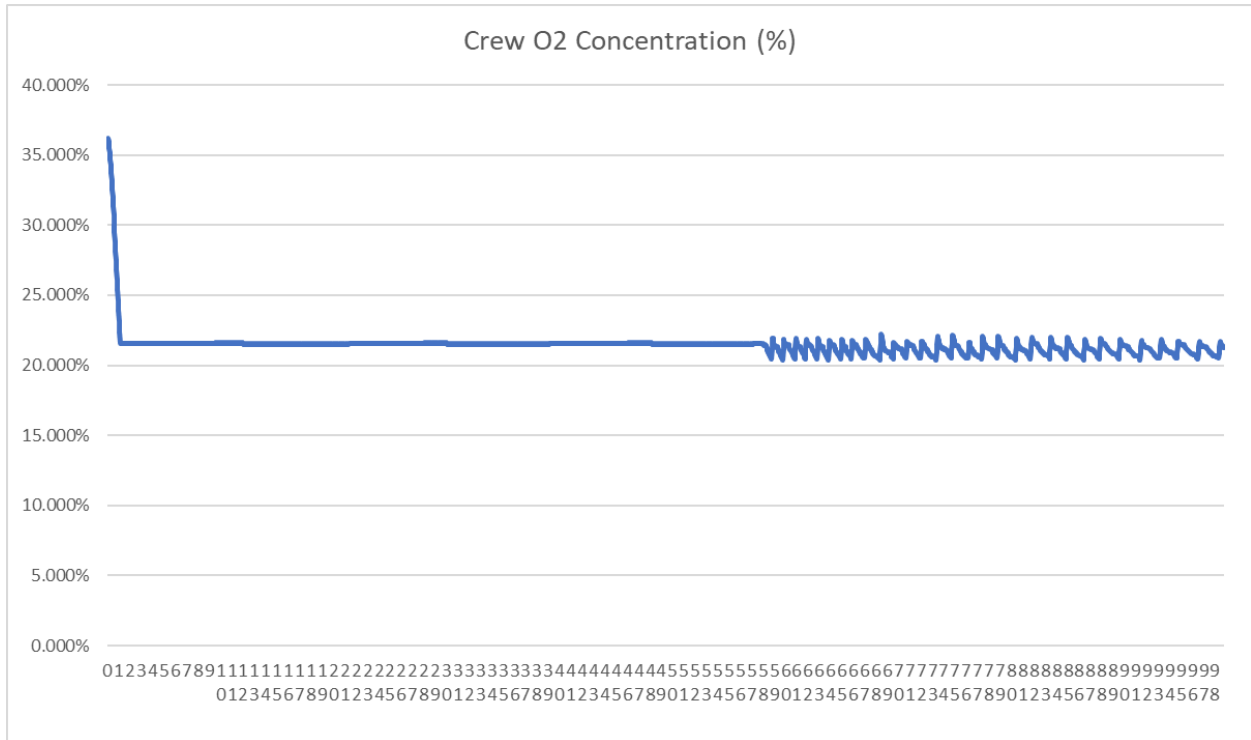

Figure 124 Phase 3 Run 7 Crew Oxygen entire period

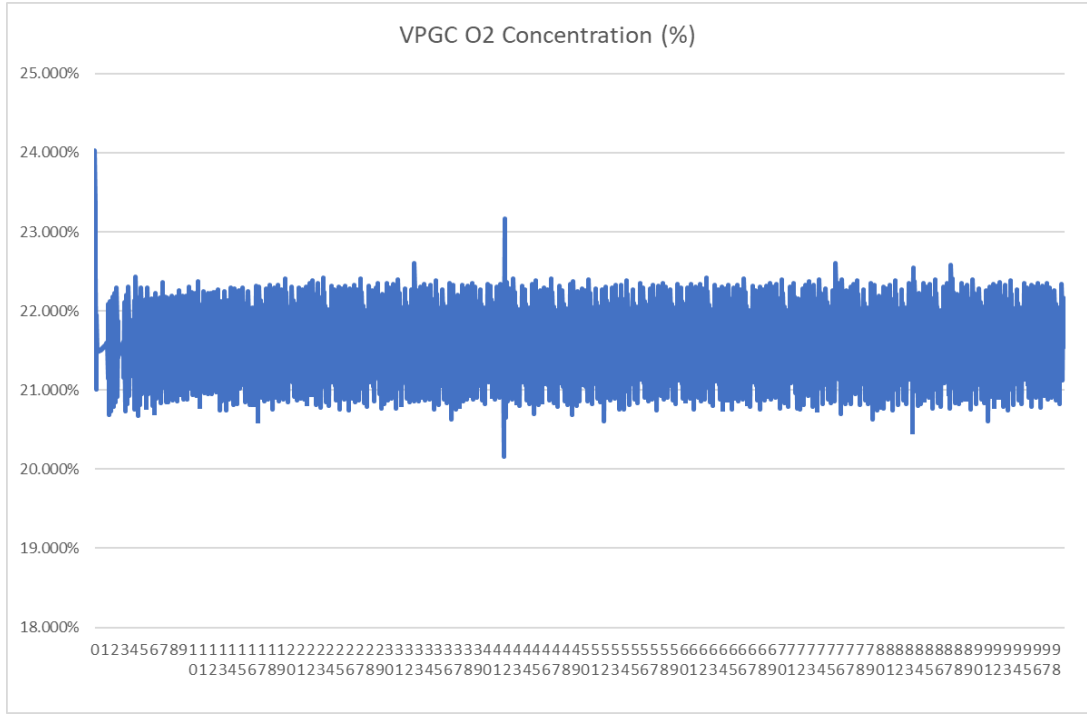

Figure 125 Phase 3 Run 7 VPGC Carbon Dioxide entire period

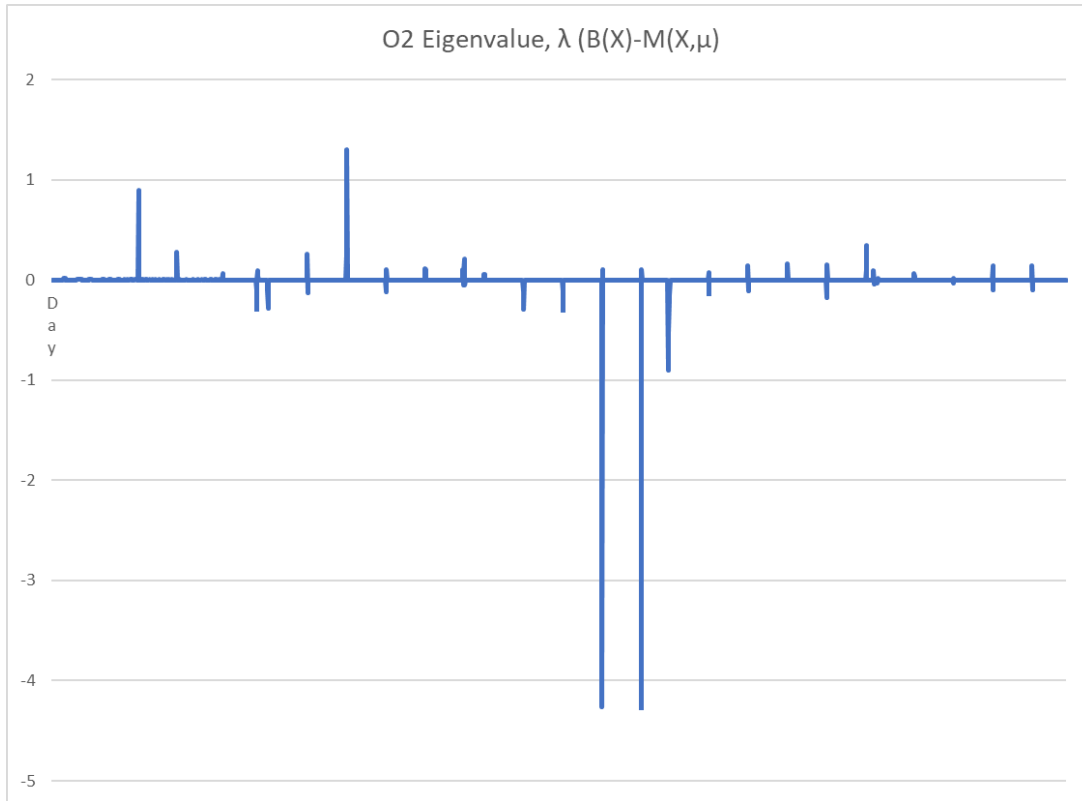

Figure 126 Phase 3 Run 1 Oxygen Eigenvalues entire period

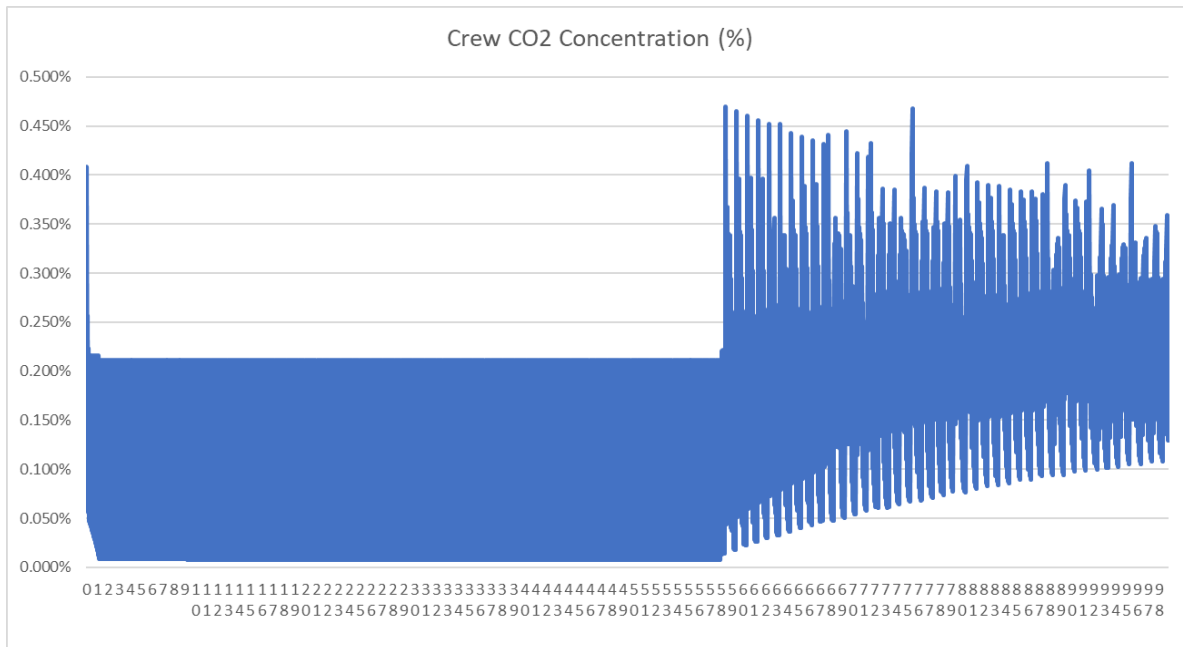

Figure 127 Phase 3 Run 7 Crew Carbon Dioxide entire period

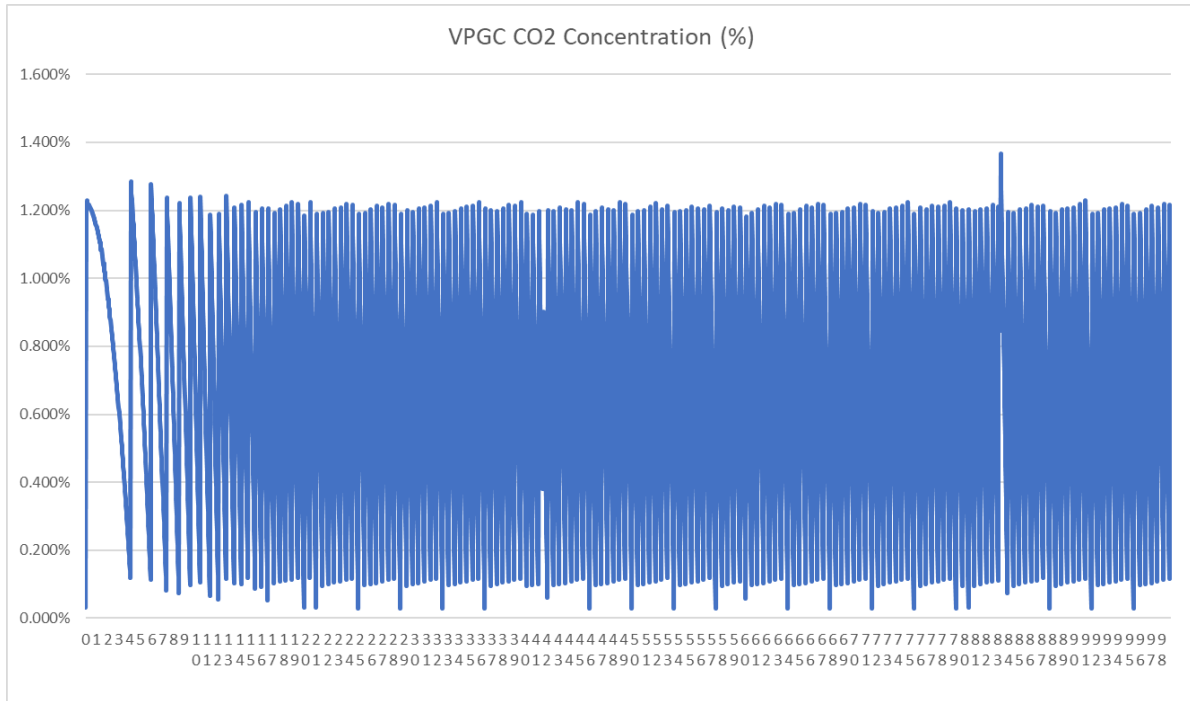

Figure 128 Phase 3 Run 7 VPGC Carbon Dioxide Concentration entire period

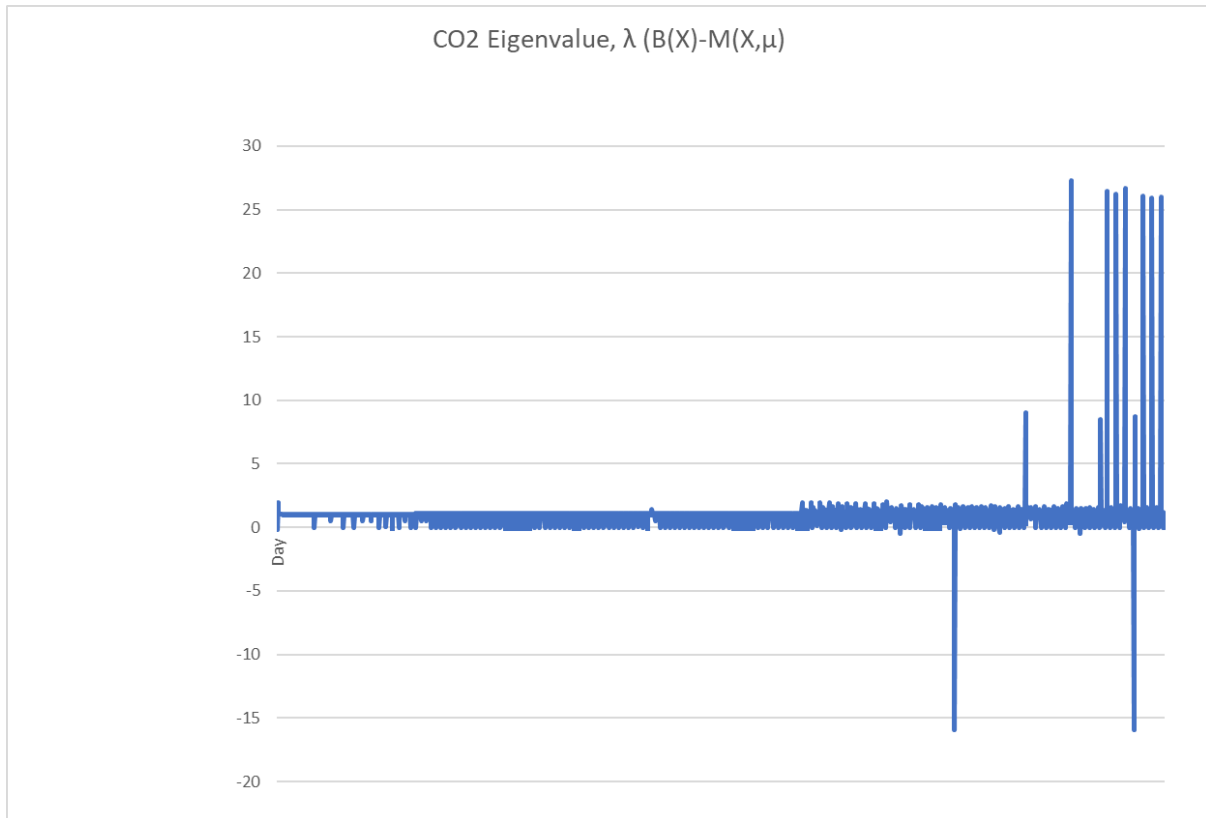

Figure 129 Phase 3 Run 7 Carbon Dioxide Eigenvalues entire period

Summary Results Run 8

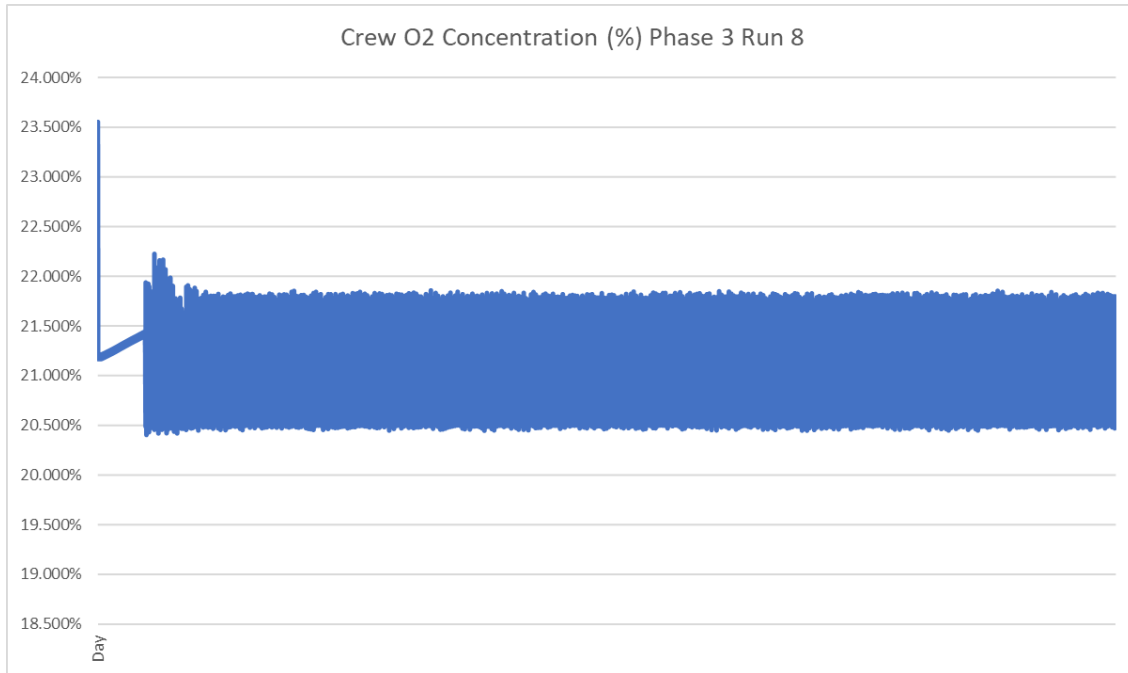

Figure 130 Phase 3 Run 8 Oxygen Concentration

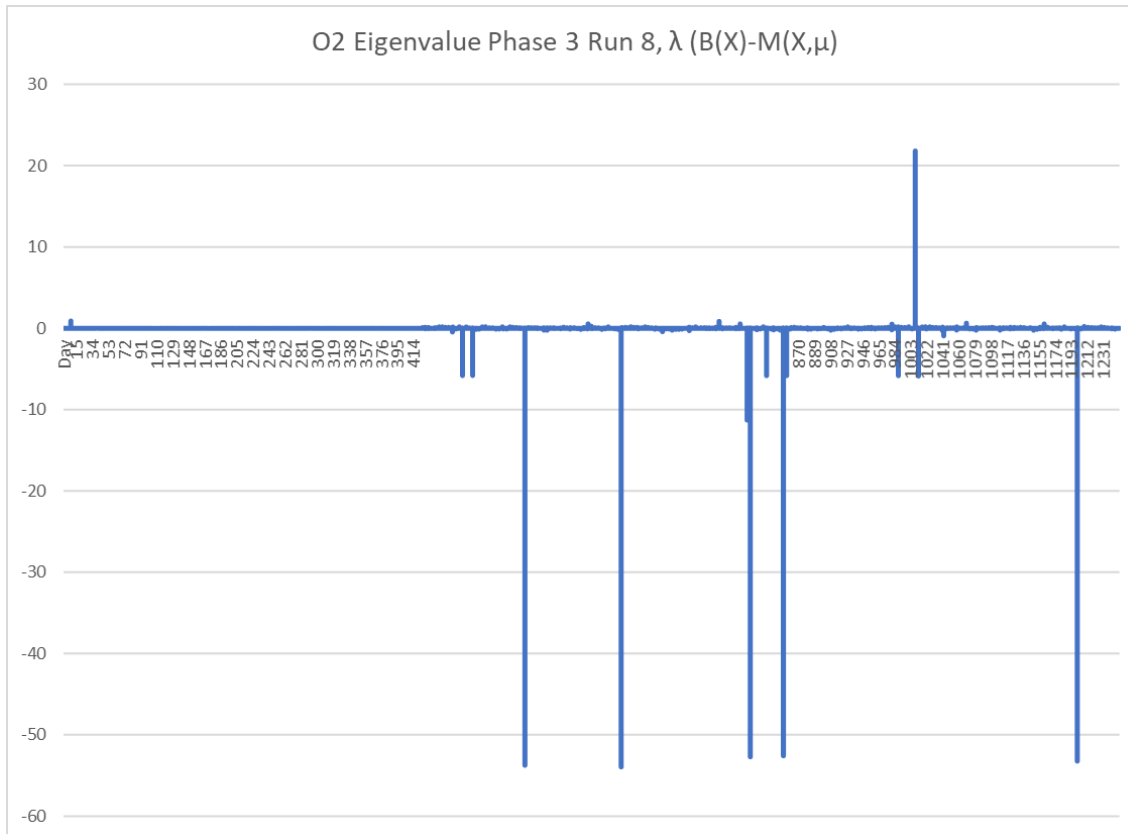

Figure 131 Phase 3 Run 8 Oxygen Eigenvalues

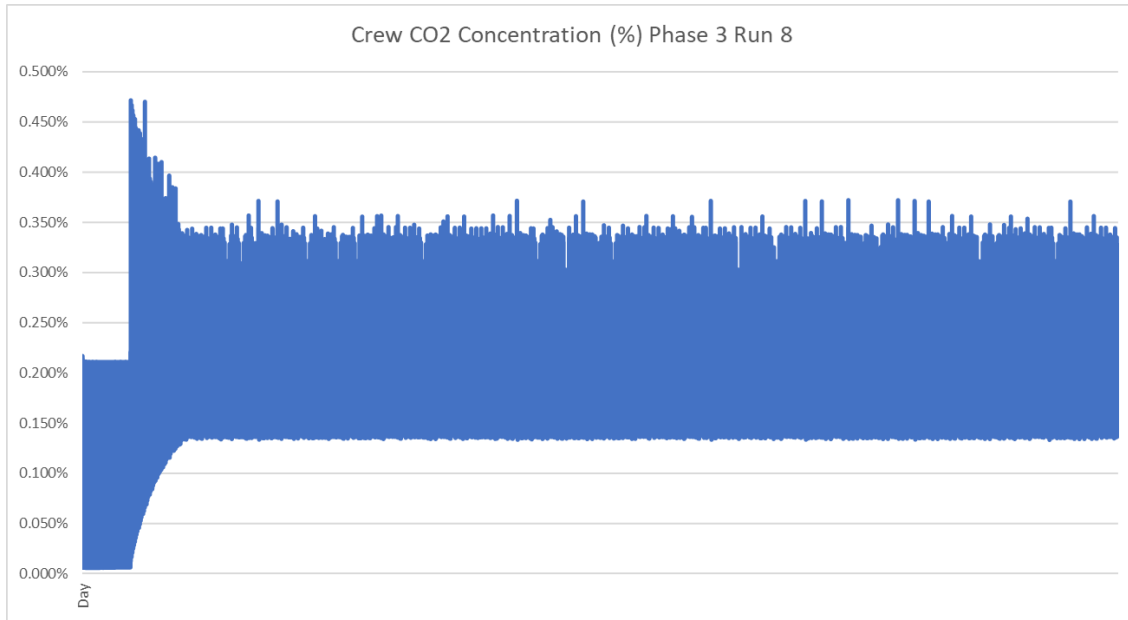

Figure 132 Phase 3 Run 8 Crew Carbon Dioxide Concentration

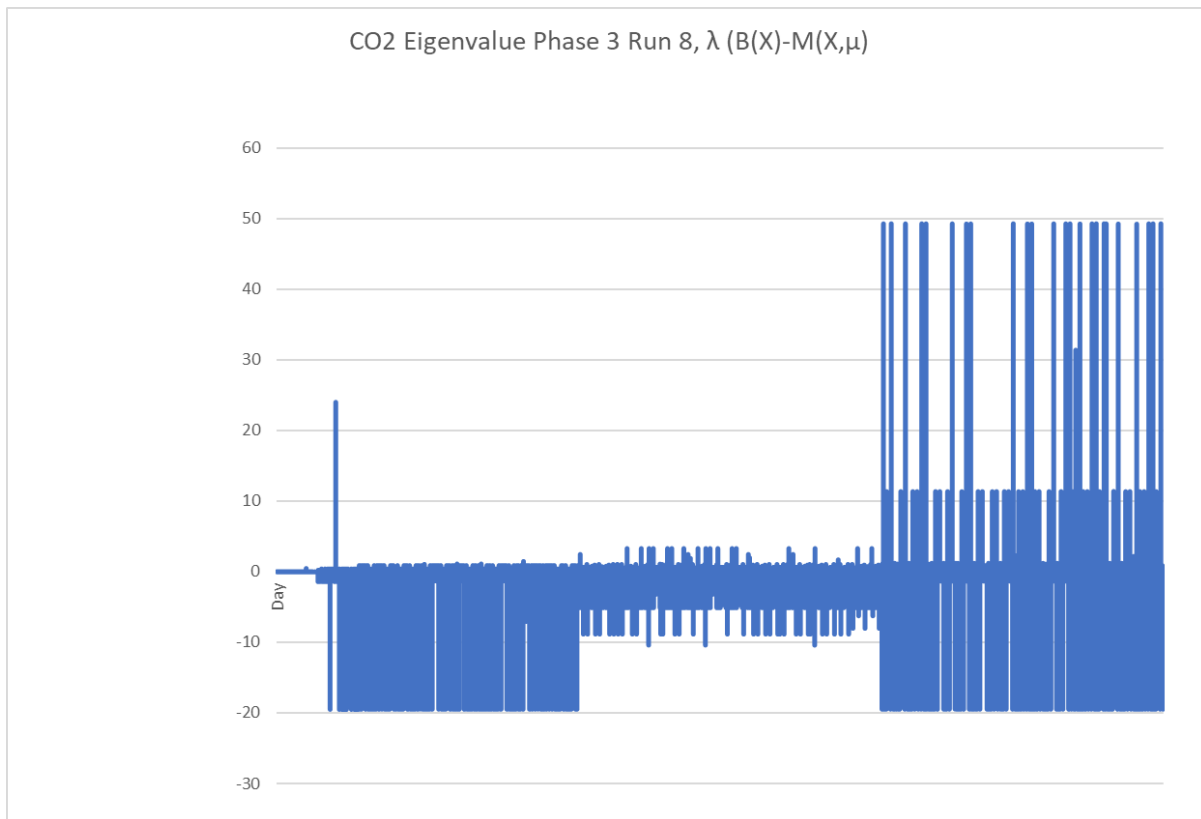

Figure 133 Phase 3 Run 8 Carbon Dioxide Eigenvalues

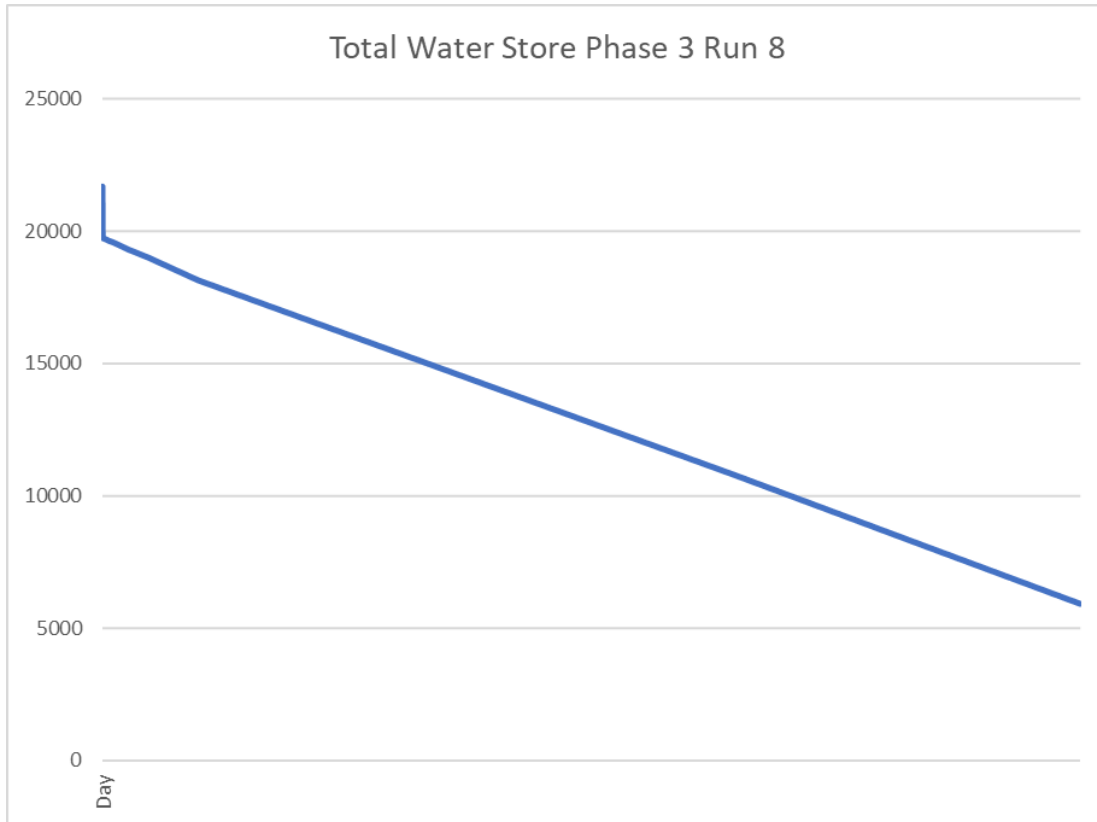

Figure 134 Phase 3 Run 8 Total Simulation Water

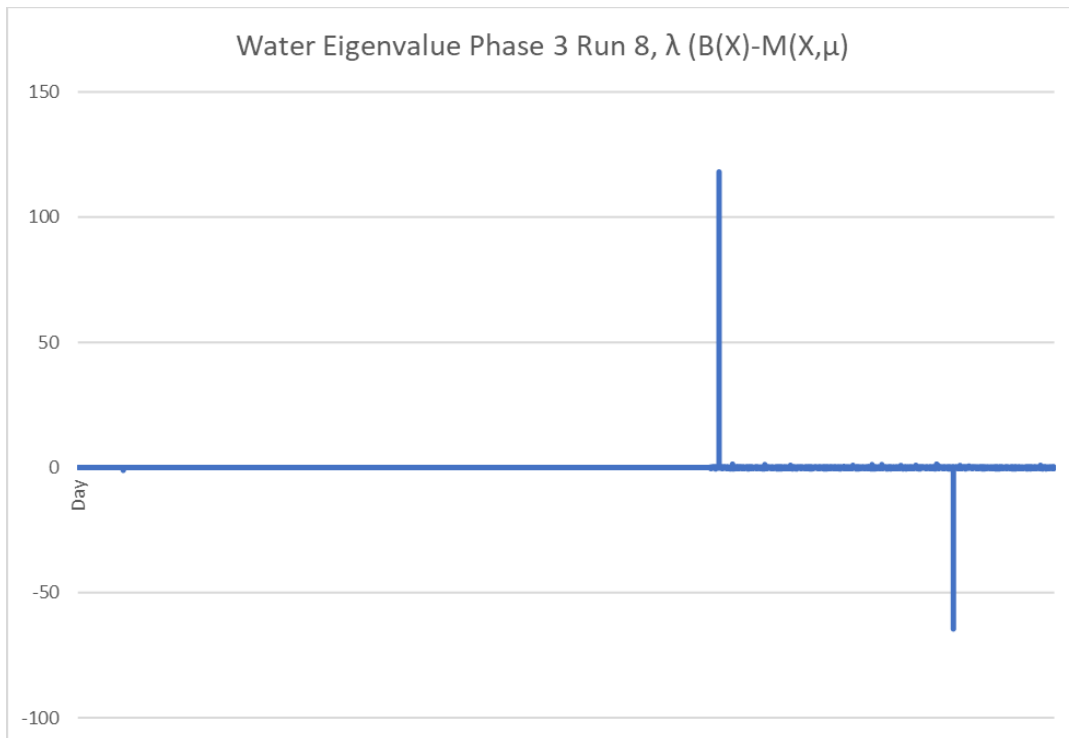

Figure 135 Phase 3 Run 8 Water Eigenvalues

Summary Results Run 9



Figure 136 Phase 3 Run 9 Crew Oxygen Concentration

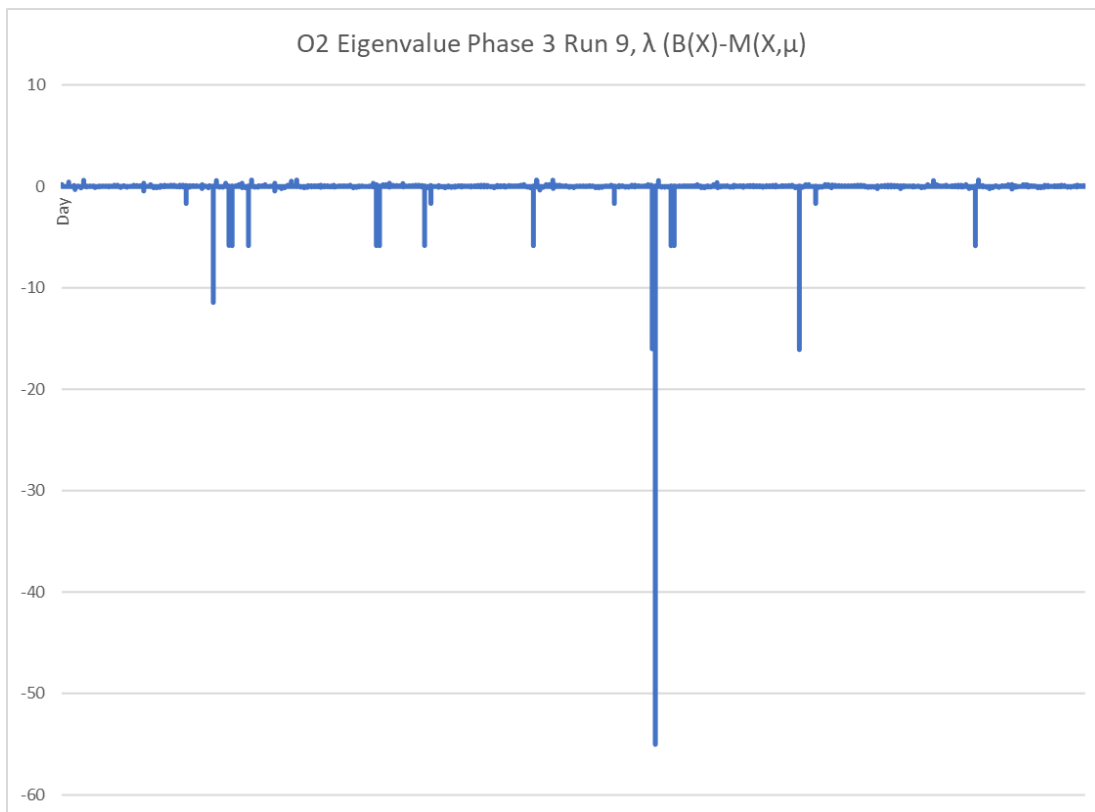

Figure 137 Phase 3 Run 9 Oxygen Eigenvalues

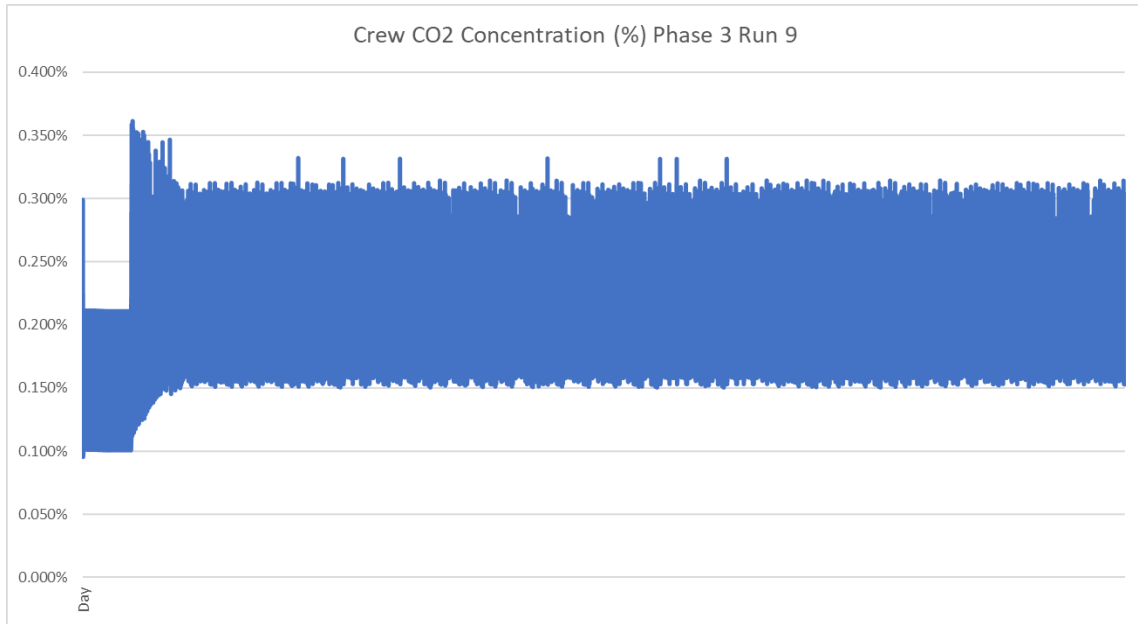

Figure 138 Phase 3 Run 9 Crew Carbon Dioxide Concentration

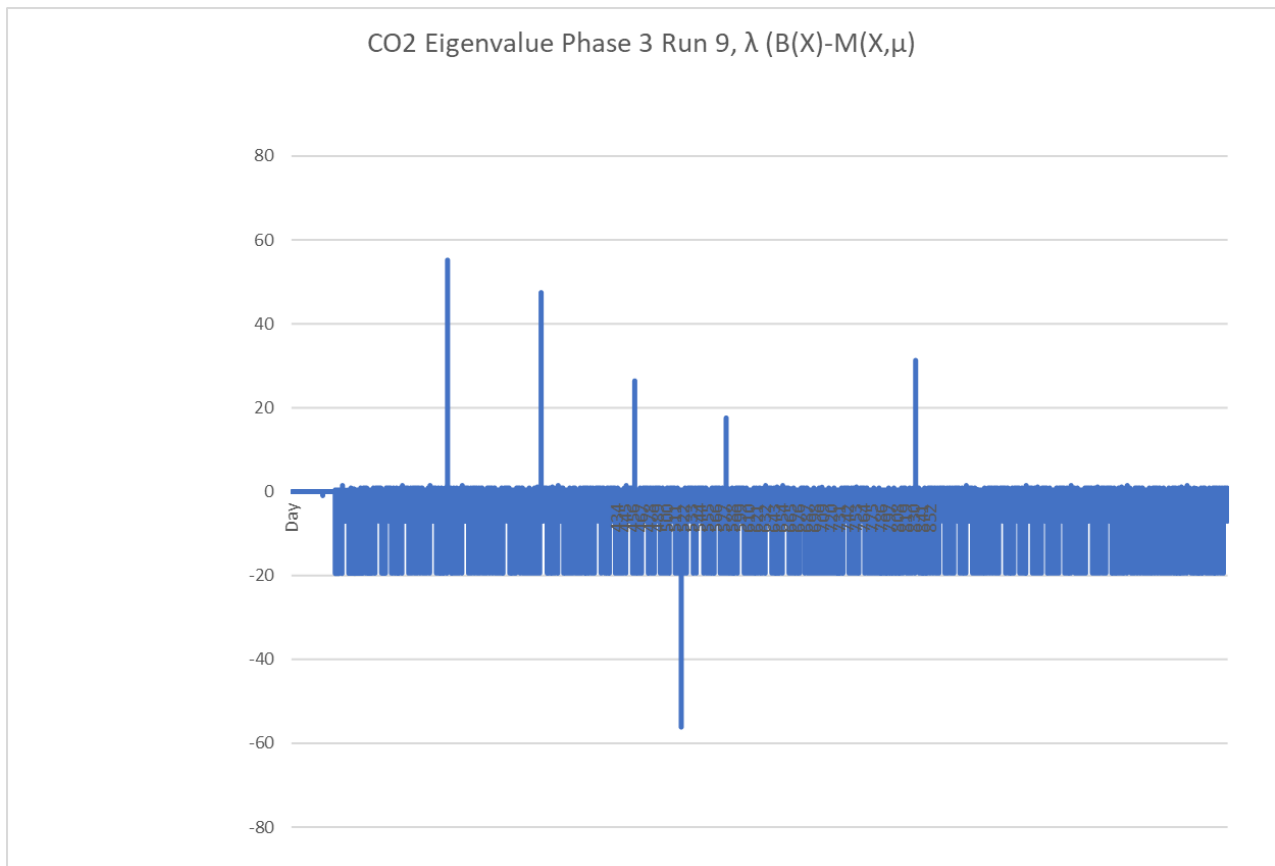

Figure 139 Phase 3 Run 8 Carbon Dioxide Eigenvalues

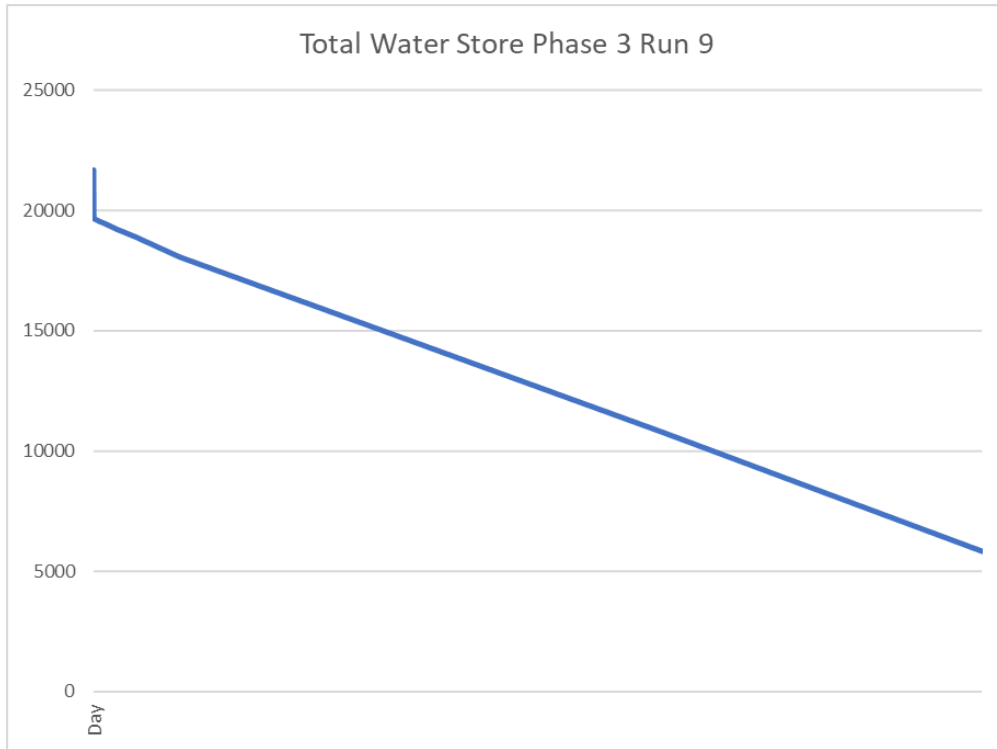

Figure 140 Phase 3 Run 9 Total Simulation Water

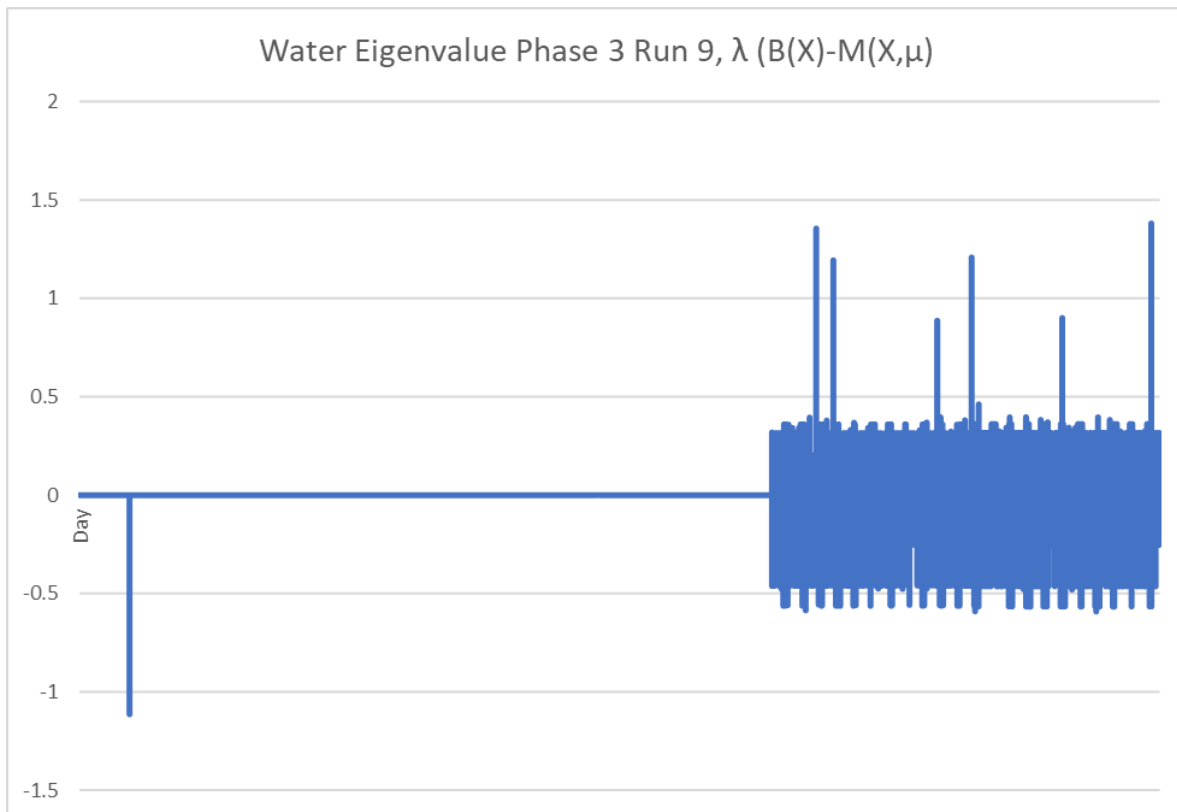

Figure 141 Phase 3 Run 9 Water Eigenvalues

Summary Results Run 10

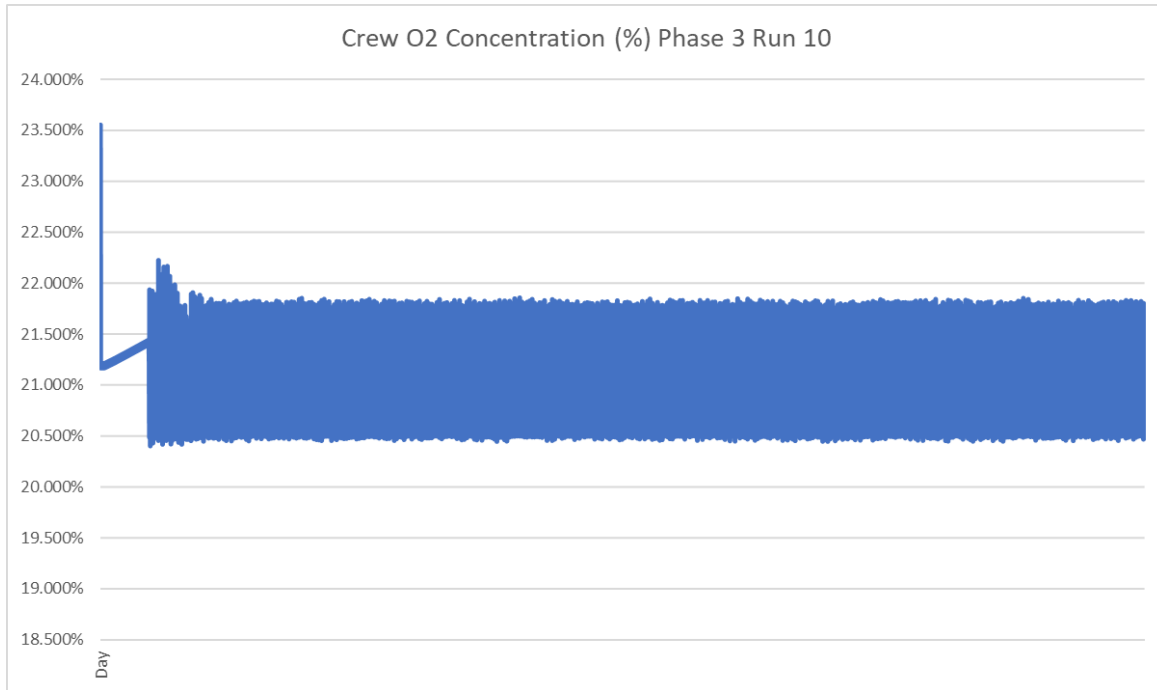

Figure 142 Phase 3 Run 10 Crew Oxygen Concentration

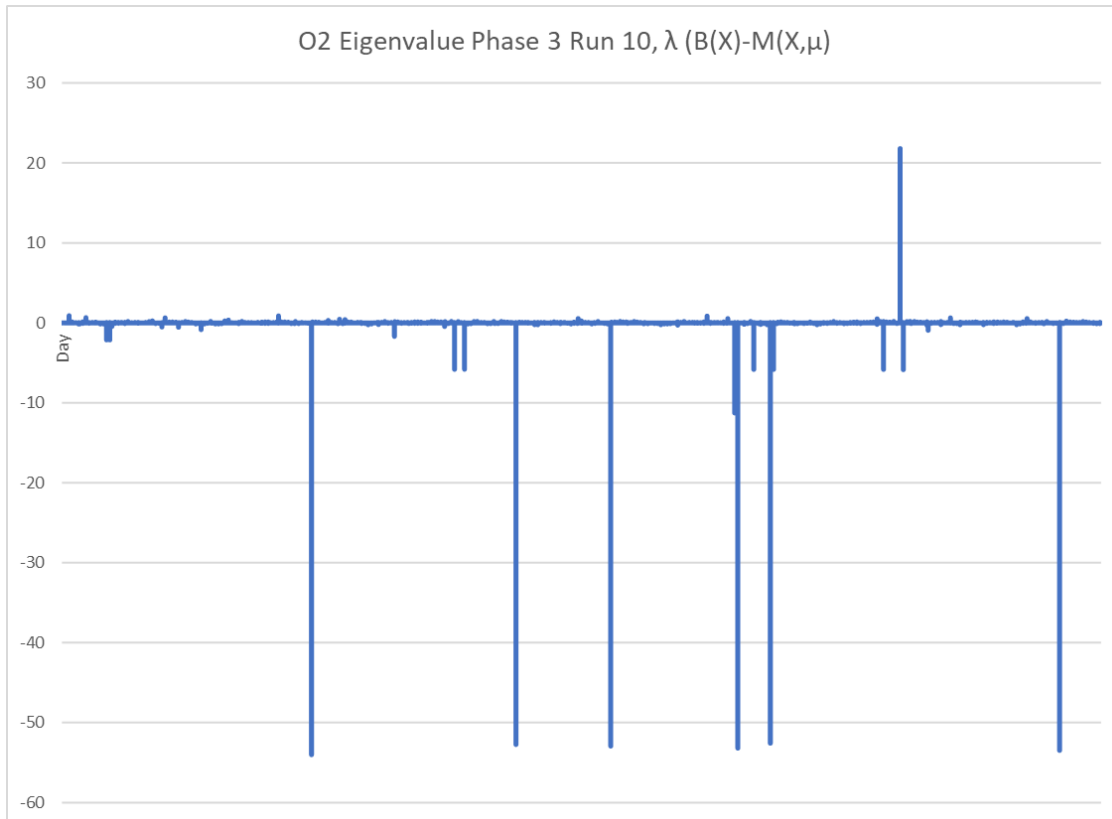

Figure 143 Phase 3 run 10 Oxygen Eigenvalues

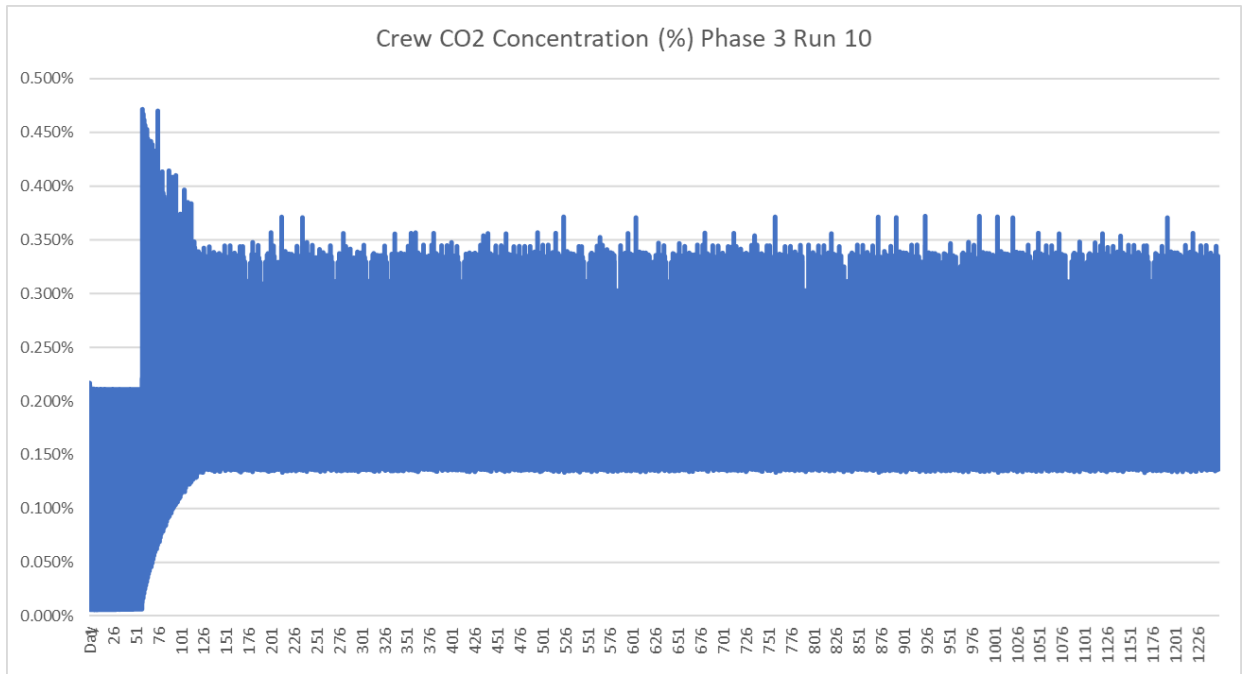

Figure 144 Phase 3 Run 10 Crew Carbon Dioxide Concentration

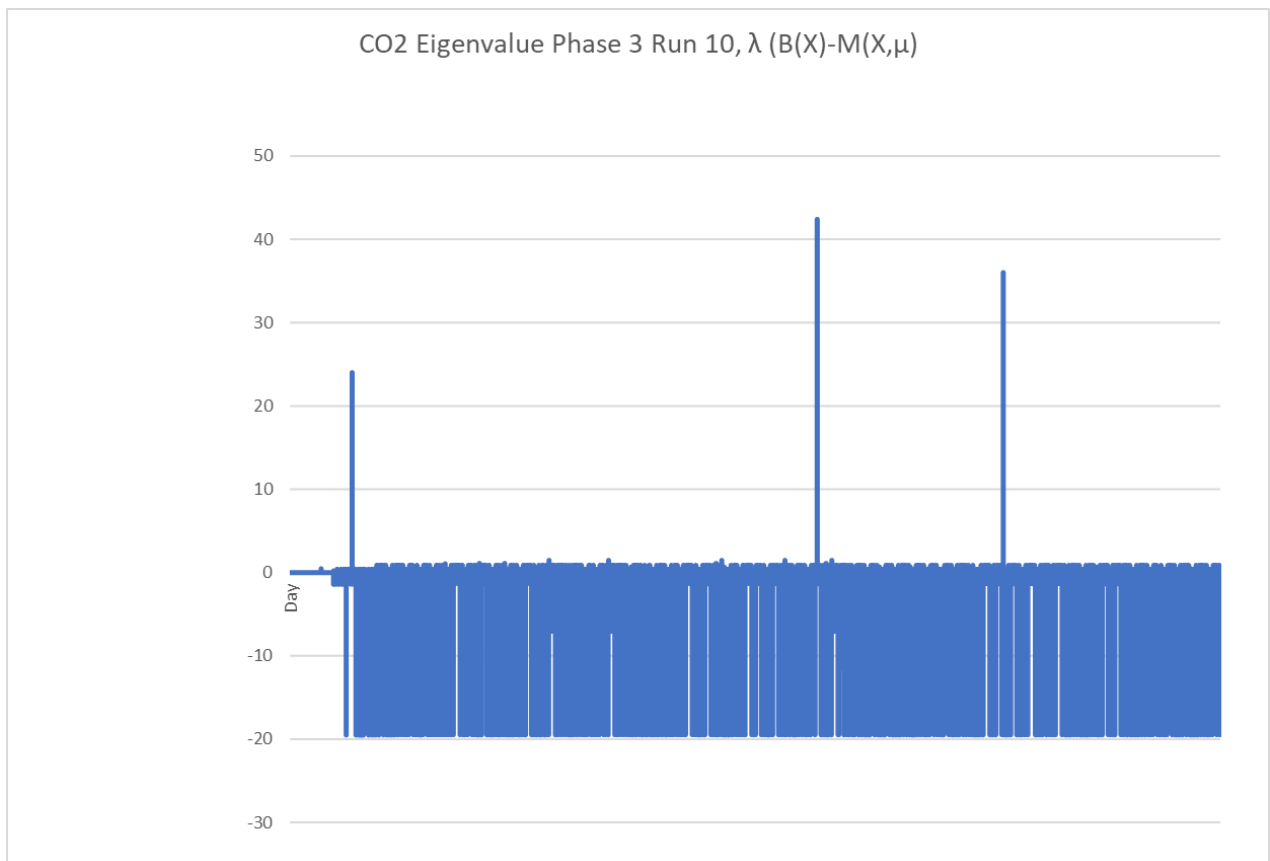

Figure 145 Phase 3 Run 10 Carbon Dioxide Eigenvalues



Figure 146 Phase 3 Run 10 Total Simulation Water

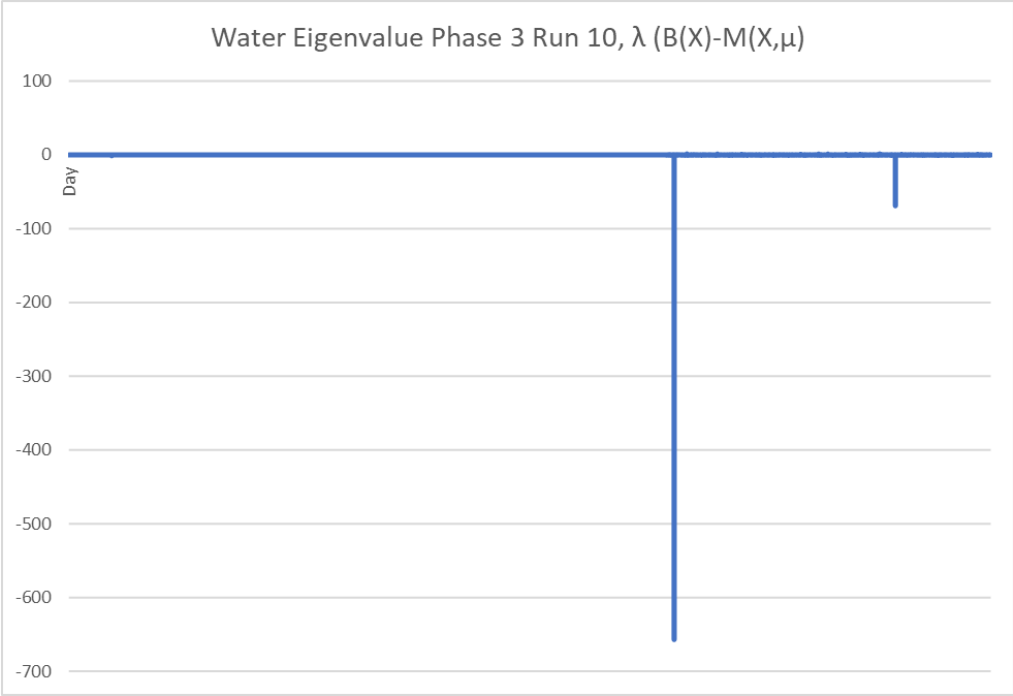

Figure 147 Phase 3 Run 10 Water Eigenvalues

Appendix C: Simulation Procedures

This appendix contains the process and procedure to Run the modified BioSim software to produce output for analysis. The first process is how to identify the configuration file to be used by the software and execute the simulation. The 2nd process is how to extract and format the log information into useable data.

C1 – Simulation Run Process

Run Configuration Parameters

Validation LMLSTP Phase I

Main Class:

```
com.traclabs.biosim.framework.BiosimStandaloneLMLSTPController
```

Arguments:

```
-xml=test/CIH_LMLSTP_Phase1.xml
```

VM Arguments:

```
-DORBInitRef.NameService=corbaloc::localhost:16315/NameService
```

```
-Dorg.omg.CORBA.ORBClass=org.jacorb.orb.ORB
```

```
-Dorg.omg.CORBA.ORBSingletonClass=org.jacorb.orb.ORBSingleton
```

Validation LMLSTP Phase III

Main Class:

```
com.traclabs.biosim.framework.BiosimStandaloneLMLSTP3Controller
```

Arguments:

```
-xml=test/CIH_LMLSTP_Phase3.xml
```

VM Arguments:

```
-DORBInitRef.NameService=corbaloc::localhost:16315/NameService
```

```
-Dorg.omg.CORBA.ORBClass=org.jacorb.orb.ORB
```

```
-Dorg.omg.CORBA.ORBSingletonClass=org.jacorb.orb.ORBSingleton
```

Continuous LMLSTP Phase I

Main Class:

```
com.traclabs.biosim.framework.BiosimStandaloneLMLSTPController
```

Arguments:

```
-xml=stability/CIHThesis_LMLSTP_Phase1.xml
```

VM Arguments:

-DORBInitRef.NameService=corbaloc::localhost:16315/NameService

-Dorg.omg.CORBA.ORBClass=org.jacorb.orb.ORB

-Dorg.omg.CORBA.ORBSingletonClass=org.jacorb.orb.ORBSingleton

Continuous LMLSPT Phase III

Main Class:

com.traclabs.biosim.framework.BiosimStandaloneLMLSPT3Controller

Arguments:

-xml=stability/CIHThesis_LMLSPT_Phase3.xml

VM Arguments:

-DORBInitRef.NameService=corbaloc::localhost:16315/NameService

-Dorg.omg.CORBA.ORBClass=org.jacorb.orb.ORB

-Dorg.omg.CORBA.ORBSingletonClass=org.jacorb.orb.ORBSingleton

C2 – Simulation Log Format and Analysis Process

Basic process for organizing data to perform stability calculations. Detailed instructions for O2 calculations. Steps will need to be repeated for each group of variables to be analyzed (O2, Water, Waste, etc). See Appendix C2 – BioSim Components Used for Analysis for specific components to be analyzed for each type of simulation run. This procedure is for the Gas portion of Phase 1 the analysis. Water and other subsystems are similar but will have different search and column header values. See Analysis spreadsheets for examples

- 1) Locate log file 'envLog.log' in Biosim home log folder (..\biosim\log\)
- 2) Move and rename 'envLog.log' to a descriptive name and replace the .log extension with .csv. This prevents additional simulation runs from adding extraneous data to the file that is not needed for analysis.
- 3) Open .csv log file using Microsoft Excel and Save the file as an excel Spreadsheet
- 4) Add the header row. On the log file tab, insert a row above row 1. Add the following column values starting with column 'A' as column headers
 - a) Log Date Time
 - b) MS
 - c) Thread
 - d) Level
 - e) Component
 - f) Message

- 5) Turn on the filter. Highlight row 1 (the newly created column headers), select the 'Data' menu option and turn on the auto filter option.

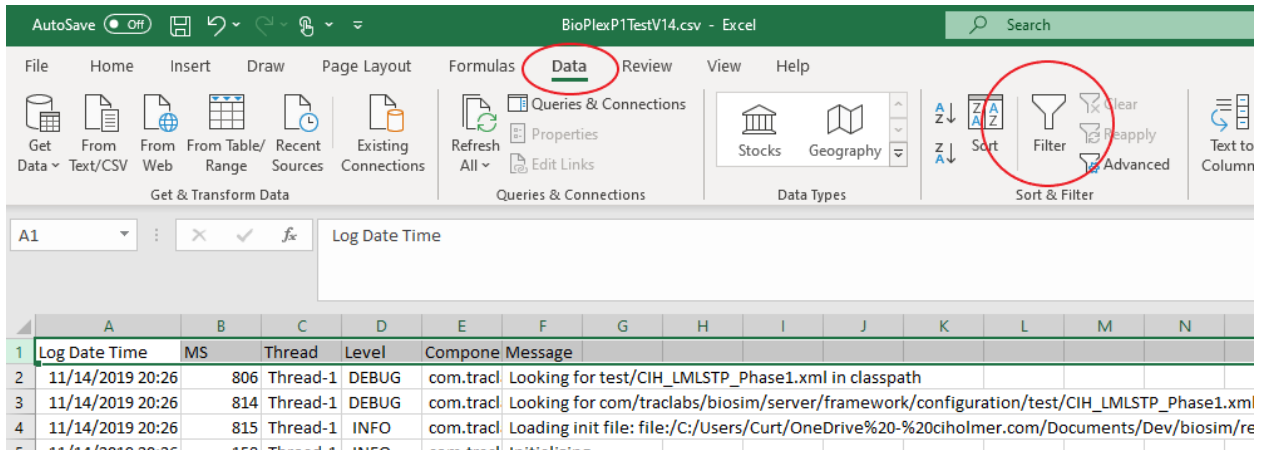

- 6) Add a new sheet for the data analysis. Select the plus symbol next to the existing tab to insert a new sheet. Rename 'Sheet1' to a descriptive name for the analysis (e.g. 'Phase 1 Jacobian')

- 7) Add the following columns starting in Column 'A'

- a) Log Date Time
- b) MS
- c) Tick
- d) Day
- e) Crew O2 Consumed
- f) Incinerator O2 Consumed
- g) Crew Env O2
- h) VPGC Env O2
- i) O2 Store
- j) O2 Store (Moles)
- k) Total Sim O2
- l) O2 Created by OGS
- m) Plant O2 Produced
- n) GARDEN O2 Produced
- o) Total O2 Produced
- p) Crew O2 Concentration (%)
- q) VPGC O2 Concentration (%)
- r) B(X) - Change in Creation of O2/Change in Total O2
- s) O2 B(X) Daily Average
- t) $M(X, \mu)$ - O2 Consumed or Removed/Total O2
- u) O2 $M(X, \mu)$ Daily Average
- v) O2 Eigenvalue, λ
- w) O2 Eigenvalue, λ of Daily Average
- x) Filter for Daily value
- y) CO2 Store
- z) CO2 Store - Moles

- aa) Crew CO2 Injected
- bb) VPGC CO2 Injected
- cc) VPGC CO2 Injected (Kg/Day)
- dd) Total CO2 Injected
- ee) Crew CO2 Produced
- ff) Incinerator CO2 Produced
- gg) VCCR CO2 Removed
- hh) CRS CO2 Removed
- ii) VPGC Plant CO2 Consumed
- jj) GARDEN CO2 Consumed
- kk) Total Plant CO2 Consumed
- ll) Plant CO2 Consumed (kg/day)
- mm) Physiochemical Removed (kg/day)
- nn) Air Revitalization (kg/CO2 Per Day)
- oo) Total CO2 Produced
- pp) Total CO2 Removed
- qq) Crew Env CO2
- rr) VPGC Env CO2
- ss) Total Sim CO2 (moles)
- tt) Crew CO2 Concentration (%)
- uu) VPGC CO2 Concentration (%)
- vv) B(X) - Change in Creation of CO2/Change in Total O2
- ww) CO2 B(X) Daily Average
- xx) $M(X,\mu)$ - CO2 Consumed or Removed/Total O2
- yy) CO2 $M(X,\mu)$ Daily Average
- zz) CO2 Eigenvalue, λ
- aaa) CO2 Eigenvalue, λ of Daily Average

- 8) Add the tick numbers to the analysis sheet. Switch back to the log tab (the first tab) and select the dropdown list for 'Component' and remove the checkmark for next to 'Select All' and select

'com.tracelabs.biosim.server.framework.BioDriverImpl'

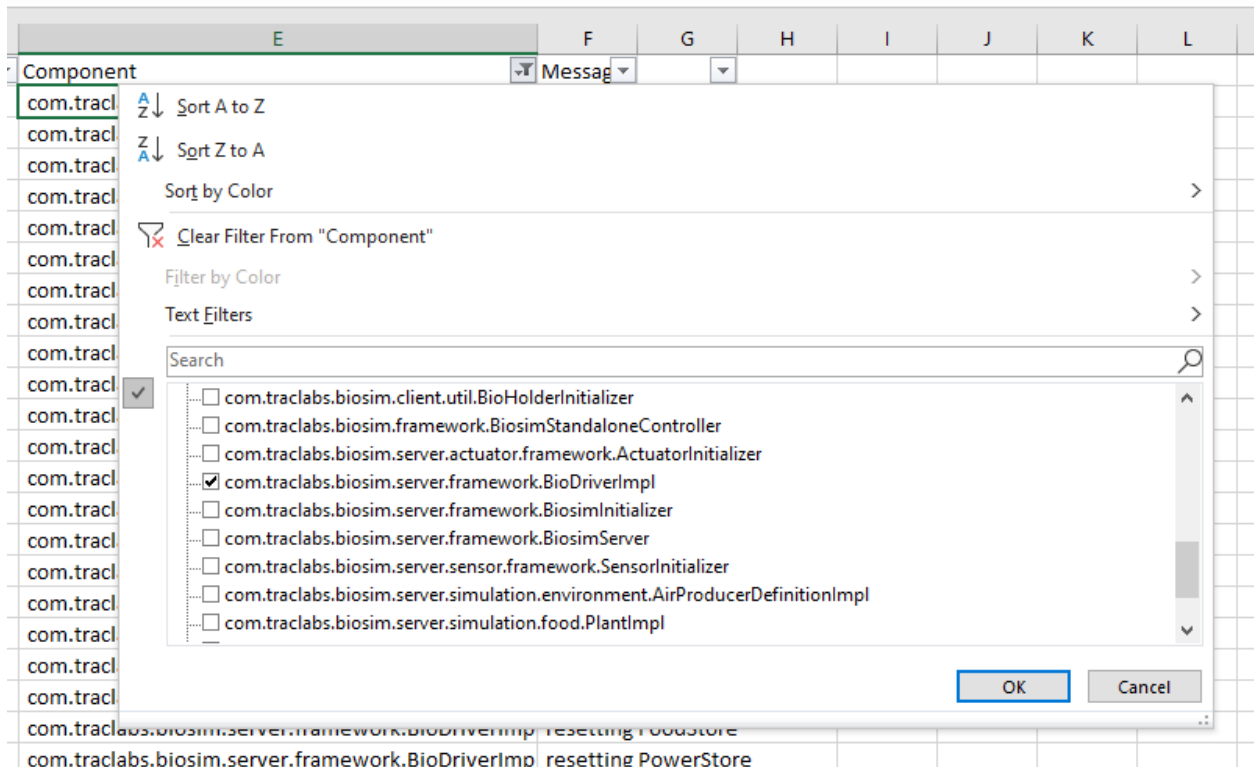

- 9) Select and delete any row that the 'Message' Column does not begin with 'BioDriverImpl: begin tick'
- 10) Having only a single cell selected, bring up the find and replace box with the key combination ctrl+h. Put 'BioDriverImpl: begin tick' in the 'Find What' box and leave the replace box empty, Press the 'Replace All' button. The number of replacements should be equal to the number of 'ticks' the simulation ran (see the last row for number or the configuration file). Close the Find and Replace box.
- 11) Hide columns C – E (Thread, Level, and Component). Hold down the ctrl key and select each column, right click and select 'hide'.
- 12) Select all of the rows with data (do not select the header row) and copy with ctrl+c, switch to the analysis tab and select the first cell under the 'Log Date Time' header and paste using ctrl+v.
- 13) Add in the day # formula. Select Cell D3 (should be tick '0') and enter the formula '=c3/24' (use the cell address for 'tick 0'). Press Enter.
- 14) Select the cell with the day number formula and holding down the shift key and go to the cell in the Day Column (Column D) next to tick 23' and select column D. This will highlight all the cells in the range. Hold down the control key and move the cursor to the lower right corner of the selection until it becomes a double plus '+' symbol. Then drag down column D until you reach the last row of tick data and release. This should copy the formula in the first cell of column D down the list and skip the intervening 23 rows. Only whole numbers should be in the day column.
- 15) Replace data in the last row of the 'tick' column with a number if the data still reads 'BioDriverImpl0: Reached user defined tick limit of xxxx'
- 16) Switch tabs back to the log data and return to the top of the spread sheet. Unhide columns C – E. Right click on column C, then hold the shift key down and left click on column F, release the shift key

and right click on column F, select 'Unhide'. Remove the filter on the 'Component' column by selecting 'Select All' and then de selecting 'Select All'

- 17) Get the O2 Consumed. Select the option for
`'com.traclabs.biosim.server.sensor.crew.CrewGroupO2ConsumedSensorImpl.Crew_O2_Consumed'`
- 18) Select the first value in the cell under 'Messages', bring up the find and replace box with the key combination ctrl+h. Put 'Value=' in the 'Find What' box and leave the replace box empty, Press the 'Replace All' button (there should be the same number of replacements as number of 'ticks' in the simulation). Close the Find and Replace box.
- 19) Keeping the first cell under 'Messages' selected, scroll to the bottom of the data. Holding down the shift key, select the last cell of data under 'Messages'. This will highlight the entire column of data values (minus the header). Press ctrl+c, switch to the analysis tab and select the first cell under 'O2 Consumed' and press ctrl+v.
- 20) Get the O2 Consumed by the incinerator (if used, phase 3 only). Select the option for 'class
`com.traclabs.biosim.server.sensor.air.O2InFlowRateSensorImpl.Waste_Incinerator_O2_in_Sensor'`
- 21) Select the first value in the cell under 'Messages', bring up the find and replace box with the key combination ctrl+h. Put 'Value=' in the 'Find What' box and leave the replace box empty, Press the 'Replace All' button (there should be the same number of replacements as number of 'ticks' in the simulation). Close the Find and Replace box.
- 22) Keeping the first cell under 'Messages' selected, scroll to the bottom of the data. Holding down the shift key, select the last cell of data under 'Messages'. This will highlight the entire column of data values (minus the header). Press ctrl+c, switch to the analysis tab and select the first cell under 'Incinerator O2 Consumed' and press ctrl+v.
- 23) Get the amount of O2 in the Crew Environment. Return to the log tab. Clear the previous selection in the 'Component' filter and select 'class
`com.traclabs.biosim.server.sensor.environment.GasMoleSensorImpl.Crew_Quarters_O2_Mole'`.
- 24) Select the first value in the cell under 'Messages', bring up the find and replace box with the key combination ctrl+h. Put Value= in the 'Find What' box and leave the replace box empty, Press the 'Replace All' button (there should be the same number of replacements as number of 'ticks' in the simulation). Close the Find and Replace box.
- 25) Keeping the first cell under 'Messages' selected, scroll to the bottom of the data. Holding down the shift key, select the last cell of data under 'Messages'. This will highlight the entire column of data values (minus the header). Press ctrl+c, switch to the analysis tab and select the first cell under 'Crew Env O2' and press ctrl+v.
- 26) Get the amount of O2 in the VPGC Environment (if used, phase 3 only). Return to the log tab. Clear the previous selection in the 'Component' filter and select 'class
`com.traclabs.biosim.server.sensor.environment.GasMoleSensorImpl.VPGC_O2_Mole'`.
- 27) Select the first value in the cell under 'Messages', bring up the find and replace box with the key combination ctrl+h. Put Value= in the 'Find What' box and leave the replace box empty, Press the 'Replace All' button (there should be the same number of replacements as number of 'ticks' in the simulation). Close the Find and Replace box.
- 28) Keeping the first cell under 'Messages' selected, scroll to the bottom of the data. Holding down the shift key, select the last cell of data under 'Messages'. This will highlight the entire column of data

values (minus the header). Press ctrl+c, switch to the analysis tab and select the first cell under 'VPGC Env O2' and press ctrl+v.

- 29)
- 30) Get the amount of O2 in the Storage Tanks. Return to the log tab. Clear the previous selection in the 'Component' filter and select 'class com.traclabs.biosim.server.sensor.framework.StoreLevelSensorImpl.O2_Store_Level'.
- 31) Select the first value in the cell under 'Messages', bring up the find and replace box with the key combination ctrl+h. Put Value= in the 'Find What' box and leave the replace box empty, Press the 'Replace All' button (there should be the same number of replacements as number of 'ticks' in the simulation). Close the Find and Replace box.
- 32) Keeping the first cell under 'Messages' selected, scroll to the bottom of the data. Holding down the shift key, select the last cell of data under 'Messages'. This will highlight the entire column of data values (minus the header). Press ctrl+c, switch to the analysis tab and select the first cell under 'O2 Store' and press ctrl+v.
- 33) Calculate the moles of O2 in the stores. In the O2 Store(moles) column, insert a formula to multiply the value in the O2 Store column by 0.32. (i.e. =I3*0.032). Copy this formula down to the end of the data in the spreadsheet.
- 34) Calculate the total amount of in the simulation for this tick. Add a formula that adds the Crew Env O2, the VPGC Env O2 and O2 Store (moles). (i.e. =SUM(G3:H3)+J3). Copy this formula down to the end of the data in the spreadsheet.
- 35) Get the amount of O2 generated by the OGS (if used, phase 3 only). Return to the log tab. Clear the previous selection in the 'Component' filter and select 'class com.traclabs.biosim.server.sensor.air.O2OutFlowRateSensorImpl.Main_OGS_O2_Out_Sensor'.
- 36) Select the first value in the cell under 'Messages', bring up the find and replace box with the key combination ctrl+h. Put Value= in the 'Find What' box and leave the replace box empty, Press the 'Replace All' button (there should be the same number of replacements as number of 'ticks' in the simulation). Close the Find and Replace box.
- 37) Keeping the first cell under 'Messages' selected, scroll to the bottom of the data. Holding down the shift key, select the last cell of data under 'Messages'. This will highlight the entire column of data values (minus the header). Press ctrl+c, switch to the analysis tab and select the first cell under 'O2 Created by OGS' and press ctrl+v.
- 38) Get the amount of O2 produced by the plants. Return to the log tab. Clear the previous selection in the 'Component' filter and select 'class com.traclabs.biosim.server.sensor.food.BiomassTotalO2ProducedSensorImpl.Biomass_O2Produced'.
- 39) Select the first value in the cell under 'Messages', bring up the find and replace box with the key combination ctrl+h. Put Value= in the 'Find What' box and leave the replace box empty, Press the 'Replace All' button (there should be the same number of replacements as number of 'ticks' in the simulation). Close the Find and Replace box.
- 40) Keeping the first cell under 'Messages' selected, scroll to the bottom of the data. Holding down the shift key, select the last cell of data under 'Messages'. This will highlight the entire column of data

values (minus the header). Press ctrl+c, switch to the analysis tab and select the first cell under 'VPGC Plant O2 Produced' and press ctrl+v.

- 41) Get the amount of O2 produced by the Garden Experiment. Return to the log tab (if used, phase 3 only). Clear the previous selection in the 'Component' filter and select 'class class com.traclabs.biosim.server.sensor.food.BiomassTotalCO2ConsumedSensorImpl.Garden_CO2Consumed'.
- 42) Select the first value in the cell under 'Messages', bring up the find and replace box with the key combination ctrl+h. Put Value= in the 'Find What' box and leave the replace box empty, Press the 'Replace All' button (there should be the same number of replacements as number of 'ticks' in the simulation). Close the Find and Replace box.
- 43) Keeping the first cell under 'Messages' selected, scroll to the bottom of the data. Holding down the shift key, select the last cell of data under 'Messages'. This will highlight the entire column of data values (minus the header). Press ctrl+c, switch to the analysis tab and select the first cell under 'Crew GARDEN O2 Produced' and press ctrl+v.
- 44) Get the total amount of O2 Created in the environment. Put a formula under Total O2 Produced to add together the O2 Created by OGS, VPGC Plants, and Garden experiment. i.e. =SUM(L3:N3). Copy the formula to the end of the data in the sheet.
- 45) Get the amount of O2 Concentration in the crew's environment. Return to the log tab. Clear the previous selection in the 'Component' filter and select 'class com.traclabs.biosim.server.sensor.environment.GasConcentrationSensorImpl.O2_Concentration_Sensor' and click 'OK'.
- 46) Select the first value in the cell under 'Messages', bring up the find and replace box with the key combination ctrl+h. Put 'value=:' in the 'Find What' box and leave the replace box empty, Press the 'Replace All' button (there should be the same number of replacements as number of 'ticks' in the simulation). Close the Find and Replace box.
- 47) Keeping the first cell under 'Messages' selected, scroll to the bottom of the data. Holding down the shift key, select the last cell of data under 'Messages'. This will highlight the entire column of data values (minus the header). Press ctrl+c, switch to the analysis tab and select the first cell under 'O2 Concentration (%)' and press ctrl+v.
- 48) Select the values passed and change the formatting to % and adjust to show two decimal places.
- 49) Get the amount of O2 Concentration in the VPGC environment (if used, phase 3 only). Return to the log tab. Clear the previous selection in the 'Component' filter and select class com.traclabs.biosim.server.sensor.environment.GasConcentrationSensorImpl.VPGC_O2_Concentration_Sensor' and click 'OK'.
- 50) Select the first value in the cell under 'Messages', bring up the find and replace box with the key combination ctrl+h. Put 'value=:' in the 'Find What' box and leave the replace box empty, Press the 'Replace All' button (there should be the same number of replacements as number of 'ticks' in the simulation). Close the Find and Replace box.
- 51) Keeping the first cell under 'Messages' selected, scroll to the bottom of the data. Holding down the shift key, select the last cell of data under 'Messages'. This will highlight the entire column of data values (minus the header). Press ctrl+c, switch to the analysis tab and select the first cell under 'VPGC Concentration (%)' and press ctrl+v.

- 52) Select the values passed and change the formatting to % and adjust to show two decimal places.
- 53) Add Calculations for Eigen values for each tick and each day. In the first row of data (row 3). Place 0's in the following columns:
- * B(X) - Change in Creation of O2/Change in Total O2
 - * M(X,μ) - O2 Consumed or Removed/Total O2
 - * Eigenvalue, λ
 - * Eigenvalue, λ of Daily Average
- Place '#N/A' in the following columns for the first days' worth of values (rows 3-23)
- * B(X) Daily Average
 - * M(X,μ)Daily Average
 - * Eigenvalue, λ of Daily Average (Start in row 4, leave the 0 put in previous edit)
- 54) Calculate B(X); the Change in Creation of O2 divided by the Change in Total O2. In the row below the 0 in the 'B(X) - Change in Creation of O2/Change in Total O2' (column (K)) create a formula that will calculate the total amount of O2 produced by the plants this past tick (subtract the current tick plant produced O2 value from the previous tick O2 value) and divide by the change in total simulation O2 value (subtract the current tick Total Sim O2 from the previous tick's Total Sim O2). i.e. $= (O4 - O3) / (K4 - K3)$. Copy the formula down to the end of the data.
- 55) Calculate M(X,μ); the O2 Consumed or Removed divided by the Total O2. In the row below the 0 in the 'M(X,μ) - O2 Consumed or Removed/Total O2' column (column (M)) create a formula that will calculate the total amount of O2 Consumed (E4) or Removed (F4) and divide by the total O2 in the summation for the current tick (I4). (i.e. $= (E4 + F4) / I4$). Copy the formula down to the end of the data.
- 56) Calculate the Eigenvalue, λ. Subtract M(X,μ) (column (N)) from B (X) (Column (L)). i.e. $= (SUM(E4:F4) / K4)$, Copy the formula down to the end of the data.
- 57) Create the formula to easily filter on the daily values. Select the first cell under 'Filter for Daily Value' (Q3) enter the formula $'=MOD((C3),24)=0'$. Copy the formula to the end of the data.
- 58) Calculate the daily average for the 'B(X)' value. In the first empty cell of the column 'B(X) Daily Average' (Column (L), row 27). Enter a formula to calculate the average value from the previous 24 ticks of 'B(X)'. i.e. $=AVERAGE(K4:K27)$, Copy the formula down to the end of the data.
- 59) Calculate the daily average for the 'M(X,μ)' value. In the first empty cell of the column 'B(X) Daily Average' (Column (N), row 27). Enter a formula to calculate the average value from the previous 24 ticks of 'M(X,μ)' i.e. $=AVERAGE(M4:M27)$, Copy the formula down to the end of the data.
- 60) Calculate the daily average for the 'Eigenvalue, λ'. In the first empty cell of the column 'Eigenvalue, λ of Daily Average' (Column (P), row 27). Enter a formula to calculate the Eigenvalue value previous 24 tick (hour) period by subtracting the average value of B from the average value of M. i.e. $=L27 - N27$, Copy the formula down to the end of the data.

C2 – BioSim Components Used for Analysis

LMLSTP Phase I

For Simulation Tracking

- `com.traclabs.biosim.server.framework.BioDriverImpl`

For Oxygen Stability

- com.traclabs.biosim.server.sensor.crew.CrewGroupO2ConsumedSensorImpl.Crew_O2_Consumed
- com.traclabs.biosim.server.sensor.environment.GasMoleSensorImpl.Crew_Quarters_O2_Mole
- com.traclabs.biosim.server.sensor.framework.StoreLevelSensorImpl.O2_Store_Level
- com.traclabs.biosim.server.simulation.food.PlantImpl (O2 Consumed)
- com.traclabs.biosim.server.sensor.environment.GasConcentrationSensorImpl.O2_Concentration_Sensor

For Carbon Dioxide Stability

- Crew CO2 produced is 'backed into' by subtracting previous tick total sim CO2 from current tick total sim CO2 and adding the CO2 consumed by the plants
- com.traclabs.biosim.server.sensor.environment.GasMoleSensorImpl.Crew_Quarters_CO2_Mole
- com.traclabs.biosim.server.sensor.framework.StoreLevelSensorImpl.CO2_Store_Level
- com.traclabs.biosim.server.simulation.food.PlantImpl (CO2 Consumed)
- com.traclabs.biosim.server.sensor.environment.GasConcentrationSensorImpl.CO2_Concentration_Sensor

LMLSTP Phase 3

For Simulation Tracking

- com.traclabs.biosim.server.framework.BioDriverImpl

For Oxygen Stability (Crew Quarters and VPGC)

- com.traclabs.biosim.server.sensor.crew.CrewGroupO2ConsumedSensorImpl.Crew_O2_Consumed
- com.traclabs.biosim.server.sensor.environment.GasMoleSensorImpl.Crew_Quarters_O2_Mole
- com.traclabs.biosim.server.sensor.environment.GasMoleSensorImpl.VPGC_Quarters_O2_Mole
- com.traclabs.biosim.server.sensor.framework.StoreLevelSensorImpl.O2_Store_Level
- com.traclabs.biosim.server.sensor.food.BiomassTotalO2ProducedSensorImpl.Garden_O2Produced
- com.traclabs.biosim.server.sensor.food.BiomassTotalO2ProducedSensorImpl.Biomass_O2Produced
- com.traclabs.biosim.server.sensor.environment.GasConcentrationSensorImpl.Crew_O2_Concentration_Sensor
- com.traclabs.biosim.server.sensor.environment.GasConcentrationSensorImpl.VPGC_O2_Concentration_Sensor

For Carbon Dioxide Stability (Crew Quarters and VPGC)

- com.traclabs.biosim.server.sensor.crew.CrewGroupCO2ProducedSensorImpl.Crew_CO2Produced
- com.traclabs.biosim.server.sensor.environment.GasMoleSensorImpl.Crew_Quarters_CO2_Mole
- com.traclabs.biosim.server.sensor.environment.GasMoleSensorImpl.VPGC_CO2_Mole
- com.traclabs.biosim.server.sensor.framework.StoreLevelSensorImpl.CO2_Store_Level
- com.traclabs.biosim.server.sensor.food.BiomassTotalCO2ConsumedSensorImpl.Garden_CO2Consumed
- com.traclabs.biosim.server.sensor.food.BiomassTotalCO2ConsumedSensorImpl.Biomass_CO2Consumed
- com.traclabs.biosim.server.sensor.environment.GasConcentrationSensorImpl.Crew_CO2_Concentration_Sensor
- com.traclabs.biosim.server.sensor.environment.GasConcentrationSensorImpl.VPGC_CO2_Concentration_Sensor

For Water Stability

- com.traclabs.biosim.server.sensor.framework.StoreLevelSensorImpl.Potable_Water_Store_Level
- com.traclabs.biosim.server.sensor.framework.StoreLevelSensorImpl.Gray_Water_Store_Level
- com.traclabs.biosim.server.sensor.framework.StoreLevelSensorImpl.Dirty_Water_Store_Level
- com.traclabs.biosim.server.sensor.crew.CrewGroupWaterConsumedSensorImpl.Crew_WaterConsumed
- com.traclabs.biosim.server.sensor.crew.CrewGroupWaterProducedSensorImpl.Crew_WaterProduced
- com.traclabs.biosim.server.sensor.food.BiomassTotalWaterConsumedSensorImpl.Garden_WaterConsumed
- com.traclabs.biosim.server.sensor.food.BiomassTotalWaterProducedSensorImpl.Garden_WaterProduced
- com.traclabs.biosim.server.sensor.food.BiomassTotalWaterConsumedSensorImpl.Biomass_WaterConsumed
- com.traclabs.biosim.server.sensor.food.BiomassTotalWaterProducedSensorImpl.Biomass_WaterProduced

References

- AFP. (2017, May 11). *China tests 'Lunar Palace' as it eyes moon mission*. Retrieved June 1, 2017, from phys.org: <https://phys.org/news/2017-05-china-lunar-palace-eyes-moon.html>
- Allan, J., Nelson, M., & Alling, A. (2003). The Legacy of Biosphere 2 for the Study of Biospherics and Closed Ecological Systems. *Advances in Space Research*, 31(7), 1629-1639.
- Allen, J. (2009). *Me and The Biospheres*. Santa Fe: Synergetic Press.
- Allen, J. P. (1989). Historical Overview of the Biosphere 2 Project. *Proceeding of the Workshop on Biological Life Support Technologies* (pp. 12-22). Oracle, Az: Synergetic Press.
- Allen, J., & Nelson, M. (1986). *Space Biospheres*. Oracle, AZ: SP Synergetic Press, Inc.
- Allen, J., & Nelson, M. (1999, June). Overview and Design Biospherics and Biosphere 2, mission one (1991 – 1993). *Ecological Engineering*, 13, pp. 15-29.
- Alling, A., & Nelson, M. (1993). *Life Under Glass*. Tuscon: Biosphere Press.
- Alling, A., Leigh, L. S., MacCallum, T., & Alvarez-Romo, N. (1989). Biosphere 2 Test Module Experimentation Program. *Proceeding of the Workshop on Biological Life Support Technologies* (pp. 23-32). Oracle: Synergetic Press.
- Averner, M. M. (1981). *An approach to the mathematical modelling of a controlled ecological life support system*. University of New Hampshire, Complex Systems Research Center. Durham: NASA.
- Babcock, P., Auslander, D., & Spear, R. (1984). Dynamic considerations for control of closed life support systems. *Advanced Space Resarch*(12), 4.
- Bagowski, C. P., & Jr., J. E. (2001). Bistability in the JNK cascade. *Current Biology*, 1176–1182.
- Ballard, R. W., & MacElroy, R. D. (1971). Phosphoenolpyruvate, a new inhibitor of phosphoribulokinase in *Pseudomonas facilis*. *Biochemical and biophysical research communications*, 44.3, 614-618.
- Barta, D. (2020, 11 10). E-mail Corespondance.

- Barta, D. J. (2016). The Lunar Mars Life Support Test Project. *7th International AgroSpace Workshop*.
Sperlonga: NASA. Retrieved June 30, 2016, from
<https://ntrs.nasa.gov/archive/nasa/casi.ntrs.nasa.gov/20160006345.pdf>
- Barta, D. J., & McQuillan, J. (2011). Life Support and Habitation Systems: Crew Support, and Protection
for Human Exploration Missions Beyond Low-Earth Orbit. *41st International Conference on
Environmental Systems*. Portland: NASA.
- Barta, D., & Henderson, K. (1998). *Performance of Wheat for Air Revitalization and Food Production
During the Lunar-Mars Life Support Test Project Phase III Test*. SAE International.
- Barta, D., & Henninger, D. (1999). Johnson Space Center's Regenerative Life Support Systems Test Bed.
Advances in Space Research, 18(1), 211-221.
- Barta, D., Dominick, J., & Kallberg, M. (1995). *Early Human Testing of Advanced Life Support Systems,
Phase I*. SAE International.
- Barta, D., Henninger, D., Edeen, M., Lewis, J., Smth, F., & Verostko, C. (2006). Closure of Regenerative
Life Support Systems: Results of the Lunar-Mars Life Support Test Project. *36th COSPAR
Scientific Assembly meeting*. Beijing: Committee on Space Research.
- Bartsev, S., Mezhevikind, ..., & Okhonin, a. V. (2003). Systematic approach to life support system analyses
and integration. *Advances in Space Research*, 7(31), 1823-1832.
- Beyers, R. J., & Odum, H. T. (1993). *Ecological Microcosms*. New York, New York: Springer-Verlag New
York Inc.
- Beyers, R. J., & Odum, H. T. (2012). Chapter 19: Human Microcosms and Space. In *Ecological Microcosms*
(p. 404). New York: Springer-Verlag.
- Biggs, R., Carpenter, S., & Brock, W. (2009). Turning back from the brink: Detecting an impending regime
shift in time to avert it. *Proceedings of the National Academy of Sciences*, 826-831.
- Biosphereics. (2016, August 25). *15. Results: Mission Two*. Retrieved from Biosphereics:
<http://www.biospherics.org/biosphere2/results/15-results-mission-two/>
- Biosphereics. (2016, August 26). *Chronology*. Retrieved from Biospherics:
<http://www.biospherics.org/biosphere2/chronology/>

- Blüm, V. (2001). Aquatic Modules for Bioregenerative Life Support Systems: Developmental Aspects Based on the Space Flight Results of the C.E.B.A.S. Mini-Module. *Acta Astronautica*, 287–297.
- Blum, V. (2003). Aquatic Modules for Bioregenerative Life Support Systems: Developmental Aspects based on the Space Flight results of the C.E.B.A.S. Mini-module. *Advances in Space Research*, 31(7), 1683-1691.
- Blum, V., Andriske, M., Eichhorn, H., Kreuzberg, K., & Schreibman, M. P. (1995). A Controlled Aquatic Ecological Life Support System (CAELSS) for Combined Production of Fish and Higher Plant Biomass Suitable for Integration into a Lunar or Planetary Base. *Acta Astronautica*, 361-371.
- Blüm, V., Andriske, M., Kreuzberg, K., & Schreibman, M. (1995). Animal Protein Production Modules in Biological Life Support Systems: Novel Combined Aquaculture Techniques Based on The Closed Equilibrated Biological Aquatic System (C.E.B.A.S.). *Acta Astronautica*, 615-623.
- Blüm, V., Andriske, M., Kreuzberg, K., Paassen, U., Schreibman, M., & Voeste, D. (1998). Novel laboratory approaches to multi-purpose aquatic bioregenerative closed-loop food production systems. *Acta Astronaut*, 25-35.
- Blum, V., Andriske, M., Ludwig, C., Paßen, U., & Voeste, D. (2003). The "C.E.B.A.S. Mini-Module": A Self Sustaining Closed Aquatic Ecosystem for Spaceflight Experimentation. *Advances in space research*, 201-210.
- Blum, V., Hollander-Czytko, H., & Voeste, D. (1997). The closed equilibrated biological aquatic system: general concept and aspects of botanical research. *Planta*, 201-208.
- Botella, C., Baños, R. M., Etchemendy, E., García-Palacios, A., & Alcañiz, M. (2016, February). Psychological countermeasures in manned space missions: "EARTH" system for the Mars-500 project. *Computers in Human Behavior*, 55, 898-908.
- Brock, W. (2006). Tipping points, abrupt opinion changes, and punctuated policy change. In R. R. (Ed), *Punctuated Equilibrium and the Dynamics of U.S. Environmental Policy* (pp. 47-77). New Haven: Yale University Press.
- Brunner, B. (2011). *The Ocean at Home: An Illustrated History of the Aquarium*. (A. M. Slapp, Trans.) London: Reaktion Books. Retrieved June 2016, from https://books.google.com/books?id=8NQDDS_enYoC

- Bubenheim, D. (1989). CELSS Research and Development Program. *Proceeding of the Workshop on Biological Life Support Technologies* (pp. 53-59). Oracle, Az: Synergetic Press.
- Burrows, W. E. (1999). *This New Ocean: the Story of the first Space Age*. Modern Library Paperbacks.
- Calloway, D., & Margen, S. (1968). *Investigation of the Nutritional Properties of Hydrogenomonas eutropha*. Berkeley: NASA. Retrieved from <https://ntrs.nasa.gov/search.jsp?R=19710002851>
- Carpenter, S., & Brock, W. (2006). Rising variance: a leading indicator of ecological transition. *Ecology Letters*, 311–318.
- Chernigovsky, V. (1975). Experimental Ecological Systems with a Man. *Problems of Space Biology*, 312.
- China Daily. (2017, May 10). *Volunteers begin year-long life support experiment*. Retrieved June 15, 2017, from China Daily.com: http://wap.chinadaily.com.cn/2017-05/10/content_29291491.htm
- Chisholm, R. A., & Filotas, E. (2009). Critical slowing down as an indicator of transitions in two-species models. *Journal of Theoretical Biology*, 142-149.
- Churchill (ed.), S. E. (1997). *Fundamentals of space life sciences*. Vol. 2. Krieger Publishing Company.
- Columbia Disaster. (2003, April). *Competition Science Vision*, 6(62), 150.
- Committee on the Engineering Challenges to the Long-Term Operation of the International Space Station. (2000). Operation, Maintenance and Reliability. In A. a. Committee on the Engineering Challenges to the Long-Term Operation of the International Space Station, *Engineering Challenges to the Long-Term Operation of the International Space Station* (pp. 13-14). National Academies Press.
- Contemporary Educational Programmes. (2003). *State Research Centre of the Russian Federation Institute For Biomedical Problems*. Retrieved December 15, 2016, from Contemporary Education Programs - Education in Russia: <http://www.cep.ru/imbp.shtml>
- Czapalla, M., Horneck, G., & Blome, H. (2009). The conceptual design of a hybrid life support system based on the evaluation and comparison of terrestrial testbeds. *Advances in Space Research*, 1609-1620.

- Dakos, V., Nes, E. H., Donangelo, R., Fort, H., & Scheffer, M. (2010). Spatial correlation as leading indicator of catastrophic shifts. *Theoretical Ecology*, 163-174.
- Dakos, V., Scheffer, M., Nes, E. H., Brovkin, V., Petoukhov, V., & Held, H. (2008). Slowing down as an early warning signal for abrupt climate change. *Proceedings of the National Academy of Sciences of the United States of America*, 14308-14312 .
- David, L. (2014, June 16). *China's 'Lunar Palace' for Space Research Tested on Earth*. Retrieved July 24, 2014, from Space.com: <https://www.space.com/26267-china-lunar-palace-space-research-mission.html>
- DeLong, S. (2011, November 30). *Biosphere 2 Landscape Evolution Observatory*. Retrieved December 15, 2016, from Water Resources Research Center: <https://wrrc.arizona.edu/sites/wrrc.arizona.edu/files/DeLongtalk11302011.pdf>
- Dictionary.com. (2016, June 1). *biosphere*. Retrieved from Dictionary.com Unabridged: <http://www.dictionary.com/browse/biosphere>
- Drake, G., King, C., Johnson, W., & Zuraw, E. (1966). Study of Lifesupport systems for Space Missions Exceeding One Year in Duration. In A. R. Center, *The Closed Life-Support System* (pp. 5 - 74). Moffit Field: NASA.
- Echosphere Associates Inc. (2016, 1 May). *About the EcoSphere Closed Ecosystem*. Retrieved from EcoSphere: <http://eco-sphere.com/about-the-ecosphere-closed-ecosystem/>
- Eckart, P. (1994). *SpaceFlight Life Support and Biospherics*. Munich: Herbert Utz.
- Edeen, M., & Barta, D. (1996). *Early Human Testing Initiative Phase 1 Final Report*. Houston: NASA.
- Edeen, M., & Pickering, k. (2000). *Lunar-Mars life support test project: Phase III final report*. Houston: Crew and Thermal Systems Division, Johnson Space Center.
- Eley, J., & Myers, J. (1964). Study of a photosynthetic gas exchanger, a quantitative repetition of the priestley experiment. *Texas Journal of Science*, 16.
- European Space Agency. (2013, October 26). *MELiSSA: The European project of Closed Life Support System EMC 13, October 26th*. Retrieved June 15, 2017, from Association Planete Mars: <http://www.planete-mars.com/wp-content/uploads/2013/11/MELiSSA.pdf>

- European Space Agency. (2015, December 2). *ESA wastewater Recovery*. Retrieved February 15, 2017, from ESA Space Science and Technology:
http://www.esa.int/Our_Activities/Space_Engineering_Technology/ESA_wastewater_recovery_picked_as_key_climate_technology
- European Space Agency. (2015, June 9). *MELISSA*. Retrieved January 15, 2017, from European Space Agency: http://www.esa.int/Our_Activities/Space_Engineering_Technology/Melissa
- European Space Agency. (2015, August 18). *MELISSA Closed Loop Compartement*. Retrieved January 15, 2017, from European Space Agency:
http://www.esa.int/Our_Activities/Space_Engineering_Technology/Melissa/Closed_Loop_Compartments
- European Space Agency. (2015, May 22). *MELISSA Organization*. Retrieved January 15, 2017, from European Space Agency:
http://www.esa.int/Our_Activities/Space_Engineering_Technology/Melissa/Organisation
- Finn, M., Kangas, P., & Adey, W. H. (1999). Mangrove Ecosystem Development in Biosphere II. *Ecological Engineering*, 13, 173-178.
- Folsom, C., & Hanson, J. (1986). The emergence of materially closed system ecology. In N. P. (Ed.), *Ecosystem Theory and Application* (pp. 269-288). John Wiley & Sons, Ltd.
- Garland, J. L. (1989). *A Simple, Mass Balance Model of Carbon Flow in A Controlled Ecological Life Support System*. University of Virginia, Department of Environmental Sciences. Kennedy Space Center, FL: NASA.
- Gitelson, I., Lisovsky, G., & MacElroy, R. (2003). *Manmade Closed Ecological Systems*. London: Taylor & Francis Inc.
- Gitelson, I., Terskov, I., Kovrov, B., Lisovskii, G., Okladnikov, Y., Sid'ko, F., . . . Tirranen, L. (1989). Long-term experiments on man's stay in biological life-support system. *Advances in Space Research*, 9(8), 65-71.
- Gitelson, I., Terskov, I., Kovrov, B., Sidko, F., Lisovsky, G., Okladnikov, Y., . . . Rerberg, M. (1976, Sep.-Oct.). Life support system with autonomous control employing plant photosynthesis. *Acta Astronaut*, 3(9-10), 633-50.

- Gitelson, J. (1992). Biological life-support systems for Mars mission. *Advances in Space Research*, 12(5), 167-192.
- Gitelson, J. I., & Okladnikov, G. M. (1997). *Human Functions in a Biological Life Support System*. SAE. Retrieved December 23, 2016, from <http://papers.sae.org/972513/>
- Gladwell, M. (2000). *The Tipping Point: How Little Things Can Make a Big Difference* (1st ed.). New York: Little, Brown and Company.
- Glister, P. (2016, May 20). *Towards Producing Food in Space: ESA's MELiSSA and NASA's VEGGIE*. Retrieved from Centauri Dreams: <https://www.centauri-dreams.org/2016/05/20/towards-producing-food-in-space-esas-melissa-and-nasas-veggie/>
- Grinevald, J. (1998). The invisibility of the Vernadskian Revolution. In V. I. Vernadsky, *The Biosphere* (p. 29). New York: Nevraumont Publishing Company.
- Groffman, P., Baron, J., Blett, T., Gold, A., Goodman, I., Gunderson, L., . . . Wiens, J. (2006). Ecological Thresholds: The key to Successful Environmental Management or an Important Concept with No Practical Application? *Ecosystems*, 3-13.
- Gross, T., Rudolf, L., Levin, S. A., & Dieckmann, U. (2009). Generalized Models Reveal Stabilizing Factors in Food Webs. *Science*, 747-750.
- Haken, H. (1978). Non-Equilibrium Phase Transitions and Self-Organizations in Physics, Chemistry and Biology. In H. Haken, *Synergetics* (e-book edition ed., p. 404). Berlin-Heidelberg-New-York: Springer-Verlag. Retrieved December 2016
- Hempel, E., Winther, U., & Hambrey, J. (2003). *Shrimp Farming and the Environment*. Washington DC: World Bank.
- Hendrickx, L., Wever, H. D., Hermans, V., Mastroleo, F., Morin, N., Wilmotte, A., . . . Mergeay, M. (2006). Microbial ecology of the closed artificial ecosystem MELiSSA (Micro-Ecological Life Support System Alternative): Reinventing and compartmentalizing the Earth's food and oxygen regeneration system for long-haul space exploration missions. *Research in Microbiology*, 77-86.
- Henninger, D., Tri, T., & Packham, N. (1996). NASA's Advanced Life Support Systems Human-Rated Test Facility. *Advances in Space research*, 18(1), 223-232.

- Highfield, R. (2004, Jan 14). Big trouble in the bio bubble. *The Telegraph*. Retrieved August 18, 2016, from <http://www.telegraph.co.uk/news/science/science-news/3317688/Big-trouble-in-the-bio-bubble....html>
- Holubnyak, Y., & Rygalov, V. (2009). Theoretical Analysis for Long-Term Space Life Support Reliability. *Proceedings of 39th International Conference on Environmental Systems*, (pp. 2009-01-2494). Savannah, Ga, USA.
- Hooke, L. R., Donaldson, P. L., Teeter, R. e., Garshnek, V. e., & Rowe, J. e. (1988). *USSR Space Life Sciences Digest*. Washington Dc: NASA. Retrieved December 23, 2016, from <https://ntrs.nasa.gov/archive/nasa/casi.ntrs.nasa.gov/19890006135.pdf>
- Hutchinson, G. E. (1970). The Biosphere. *Scientific American*, 223(3). Retrieved January 15, 2016, from <https://www.scientificamerican.com/article/the-biosphere-1970-09/>
- Ijiri, K. (2003). Life-Cycle Experiments of Medaka Fish Aboard the International Space Station. In H. J. Marthy (Ed.), *Developmental Biology Research in Space (Advances in Space Biology and Medicine)* (Vol. 9, pp. 201-216). Amsterdam: ELSEVIER.
- Institute of Biophysics. (2019, September 1). *Closed Life Support System*. Retrieved from Institute of Biophysics: <http://www.ibp.ru/labs/mc.php>
- Ives, A. R. (1995). Measuring Resilience in Stochastic Systems. *Ecological Monographs*, 217-233.
- Jang, H., Rodriguez, L. F., Bell, S., & D. Kortenkamp. (2008). Reconfigurable Control System Design for Future Life Support Systems. *38th International Conference on Environmental Systems* (pp. 1-11). San Francisco,: SAE International.
- Joel E. Cohen, D. T. (1996, Nov 15). Biosphere 2 and Biodiversity--The Lessons So Far. *Science*, 274(5290), 1150-1151. doi:10.1126
- Jones, H. (2008). Ultra Reliable Space Life Support Systems. *38th International Conference on Environmental Systems* (p. 28). San Francisco: Society of Automotive Engineers.
- Jones, H. (2017). Would Current International Space Station Recycling Life Support Sytems Save Mass on A Mars Transit? *47th International Conference on Environmental Systems*. Charlston: NASA.

- Kelly, K. (1995). Chapter 8: Closed Systems. In K. Kelly, *Out of Control* (p. 136). Perseus Publishing.
Retrieved March 15, 2016, from <http://kk.org/mt-files/outofcontrol/ch8-c.html>
- Kennedy, K. J. (2006). Advanced Habitation Efforts at JSC-CTSD . *AIAA Space 2006*. San Jose: AIAA.
- Kleinen, T., Held, H., & Petschel-Held, G. (2003). The potential role of spectral properties in detecting thresholds in the Earth system: application to the thermohaline circulation. *Ocean Dynamics*, 53-63.
- Kortenkamp, D., & Bell, S. (2003). BioSim: An Integrated Simulation of an Advanced Life Support System for Intelligent Control Research. *i-SAIARAS Proceedings*. Nara, Japan: International Symposium on Artificial Intelligence, Robotics and Automation in Space.
- Kovrov, B. (1992). Manmade microecosystems with closed material cycle as models of the biosphere. *Biofizika kletochnykh populatsii i nadorganizmennykh sistem*. Novosibirsk: Nauka, 62-70.
- Krauss, R. W. (1962). Mass Culture of Algae for Food and Other Organic Compounds. *American Journal of Botany*, 425-435.
- Kuehn, C. (2011). A mathematical framework for critical transitions: Bifurcations, fast-slow systems and stochastic dynamics. *Physica D*, 1020-1035.
- Kuznetsov, Y. (2004). *Elements of Applied Bifurcation Theory; 3rd edition* . New York: Springer.
- Lade, S. J., & Gross, T. (2012). Early Warning Signals for Critical Transitions: A Generalized Modeling Approach. *PLoS Computational Biology*, 8(2).
- Lane, H. W., Sauer, R. L., & Feeback, D. L. (2002). *Isolation: NASA Experiments in Closed-environment Living: Advanced Human Life Support Enclosed System Final Report*. San-Diego, CA: Amer Astronautical Society.
- Lenton, T. M., Held, H., Kriegler, E., Hall, J. W., Lucht, W., Rahmstorf, S., & Schellnhuber, H. J. (2008). Tipping elements in the Earth's climate system. *Proceedings of the National Academy of Sciences of the United States of America*, 1786-1793.
- Lenton, T. M., Myerscough, R. J., Marsh, R., Livina, V. N., Price, A. R., Cox, S. J., & Team, T. G. (2009). Using GENIE to Study a Tipping Point in the Climate System. *Philosophical Transactions: Mathematical, Physical and Engineering Sciences*, 871-884.

- Lenton, T., Held, H., Kriegler, E., Hall, J., Lucht, W., & al., e. (2008). Tipping elements in the Earth's climate system. *Proceeding of the National Academy of Science 105*, (pp. 1786-1793).
- Leung, H. (2000). Bifurcation of synchronization as a nonequilibrium phase transition. *Physica A*, 311-317.
- Leveque, C. (2003). *Ecology: From Ecosystem to Biosphere*. Paris: Science Publishers.
- Lighty, J. S., Burton, B., Sirdeshpande, A., Inkley, D., Pershing, D., Brouwer, J., . . . Pisharody, S. (1997). *Waste Incineration for Resource Recovery in a Bioregenerative Life Support System*. SAE International.
- Liscovsky, G., Kovrov, B., Terskov, I., & Gitelson, I. (1969). Methods and technique of wheat continuous culture as a link of life support system. *Proceedings of Eighth International Symposium on Space Technology and Science*, (p. 1189). Tokyo.
- Lisovsky, G. (1979). *Closed system: man-higher plants*. Novosibirsk, Russia: Nuka Press.
- Lisovsky, G. M. (1979). Man – Higher Plants (4-months tests). *Novosibirsk*, 160.
- Lisovsky, G. M., & Rygalov, V. (1992). Micro-CES as a tool for closed ecosystem stability research. *private communication*. Krasnoyarsk, Russian Federation: Institute of Biophysics SB RAS.
- Liu, H., & et al. (2014). CES research in China, Beihang University of Beijing, China. *Private Communication V. Rygalov*. Russian Federation: 40th COSPAR Assembly.
- Livina, V. N., & Lenton, T. M. (2007). A modified method for detecting incipient bifurcations in a dynamical system. *Geophysical Research Letters* .
- Lok-yee, W., & Fei, Y. (2014, June 24). *Chinese scientists prepare for lunar base life support system*. Retrieved March 15, 2017, from [icrosschina.com](http://www.icrosschina.com):
<http://www.icrosschina.com/indepth/2014/0624/749.shtml>
- MacElroy, R., & Averner, M. (1978). *Space Ecosynthesis: An Approach to the Design of Closed Ecosystems for Use in Space*. Ames Research Center. Moffett Field: NASA.
- MacElroy, R., Tremor, J., Bubenheim, D., & Gale, J. (1989). The CELSS research program - A brief review of recent activities. *Lunar Base Agriculture: Soils for plant Growth* (pp. 165-172). Madison,

Wisconsin: American Society of Agronomy, Crop Science of America, Soil Science Society of America.

MacElroy, R., Tremor, J., Smernoff, D., Knott, W., & Prince, R. (1987). A Review of Recent Activities in the NASA CELSS Program. *Controlled Ecological Life Support System - Topical session of the 26th COSPAR Meeting held in Toulouse, France, Jul. 1986* (pp. 51-55). Moffett Field, California: NASA.

Malin, J. T. (1999, September). Using Hybrid Modeling for Testing Intelligent Software for Lunar-Mars Closed Life Support. *Journal of the Minerals, Metals, and Materials Society*, 51(9). Retrieved August 2016, from <http://www.tms.org/pubs/journals/JOM/9909/Malin/Malin-9909.html>

May, R. M. (1977). Thresholds and breakpoints in ecosystems with a multiplicity of stable states. *Nature*, 471 - 477.

McGraw-Hill. (2007). *Biosphere 2: Creating Another Earth*. McGraw-Hill Companies. Retrieved August 20, 2016, from http://www.mhhe.com/Enviro-Sci/CaseStudyLibrary/Topic-Based/CaseStudy_Biosphere2CreatingAnot.pdf

MEDES- Institut de Médecine et de Physiologie Spatiales. (2013, July 4). *BIOSMHARS*. Retrieved December 22, 2016, from BIOSMHARS: <http://www.biosmhars.eu>

Merriam-Webster. (2020, 11 01). *Efficiency - Definition*. Retrieved from Merriam-Webster: <https://www.merriam-webster.com/dictionary/efficiency>

Merriam-Webster. (2020, 11 01). *Efficient - Definition*. Retrieved from Merriam-Webster: <https://www.merriam-webster.com/dictionary/efficient>

Merriam-Webster. (2020, 11 01). *Stability | Definition*. Retrieved from Merriam-Webster: <https://www.merriam-webster.com/dictionary/stability>

Metrica Inc.; S&K Technologies. (2005, February 7). *BioSim: An Integrated Simulation of an Advanced Life Support System for Intelligent Control Research Users Manual*. Houston, TX, US: NASA.

Micco, V. D., Buonomo, R., Paradiso, R., Pascale, S. D., & Aronne, G. (2012). Soybean cultivar selection for Bioregenerative Life Support Systems (BLSS) - Theoretical selection. *Advances in Space Research*, 1415-1421.

- Milledge, J. J. (2011, March). Commercial application of microalgae other than as biofuels: a brief review. *Reviews in Environmental Science and Bio/Technology*, 10(1), 31–41.
- Millenium Ecosystem Assessment Board. (2005). *Ecosystems and Human Well-Being: Synthesis*. Washington DC: Island Press.
- Mohanty, S., Fairburn, S., Imhof, B., Ransom, S., & Vogler, A. (2008). *Survey of Past, Present and Planned Human Space Mission Simulators*. SAE International.
- Myers, J. (1954). Basic remarks on the use of plants as biological gas exchangers in a closed system. *Journal of Aviation Medicine*, 24.
- N., C. V. (1975). Experimental Ecological Systems with a Man. *Problems of Space Biology*, 28.
- NASA. (1966). *The Closed Loop Life-Support System (SP-134)*. Moffitt Field: Scientific and Technical Information Division, Ames Research Center.
- NASA. (1979). *Controlled Ecological Life Support Systems, Use of Higher Plants*. Moffitt Field: Scientific and Technical Information Branch.
- NASA. (2000). *Lunar-Mars Life Support Test Project: Page III Final Report*. Houston, TX: Engineering Directorate, Crew and Thermal Systems Division.
- NASA. (2014). *Human Integration Design Handbook (HIDH)*. Washington, DC: Government Printing Office.
- NASA. (2018). *Life Support: Baseline Values and Assumptions Document Rev 1*. Houston: CTSD, Lyndon B. Johnson Space Center. Retrieved June 15, 2018, from <https://ntrs.nasa.gov/archive/nasa/casi.ntrs.nasa.gov/20180001338.pdf>
- NASA Johnson Space Center. (2002). *Advanced Life Support Project Plan*. Houston: Advanced Life Support Project Plan.
- Nelson, M. (1993). BIOREGENERATIVE LIFE SUPPORT FOR SPACE HABITATION AND EXTENDED PLANETARY MISSIONS. In S. Churchill (Ed.), *Sace Life Sciences* (p. 9). Malabar, Florida: Orbit Books. Retrieved July 2019, from <https://marknelsonbiospherian.com/wp-content/uploads/2018/11/ISU-textbook-chapter.pdf>

- Nelson, M. (1997). Bioregenerative Life Support for Space Habitation and Extended Planetary Missions. In S. Churchill, *Fundamentals of Space Life Sciences* (pp. 314-337). Malabar: Krieger Publishing Company.
- Nelson, M., & Soffen, G. (1989). Forward. *Proceedings of the Workshop on Biological Life Support Technologies 1989* (p. vii). Oracle: Synergetic Press.
- Nelson, M., & Soffen, G. (1990). *Biological Life Support Systems*. Synergetic Pr.
- Nelson, M., Gray, K., & Allen, J. P. (2015). Group dynamics challenges: Insights from Biosphere 2 Experiment. *Life Sciences in Space Research*, 6, 79-86.
- Nelson, M., Pechurkin, N. S., Allen, J. P., Somova, L. A., & Gitelson, J. I. (2010). Closed Ecological Systems, Space Life Support and Biospherics. In L. K. Wang, V. Ivanov, J.-H. Tay, & Y.-T. Hung, *Handbook of Environmental Engineering, Vol. 10: Environmental Biotechnology* (pp. 517 - 565). New York: Springer.
- Nes, E. v., & Scheffer, M. (2007). Slow recovery from perturbations as a generic indicator of a nearby catastrophic shift. *The American naturalist*, 738-747.
- Nitta, k., Otsubo, K., & Ashida, A. (2000). Integration test project of CEEF — A test bed for closed ecological life support systems. *Advances in Space Research*, 335-338.
- Odum, H. (1996). Scales of ecological engineering. *Ecological Engineering*, 6, 7-19.
- Okladnikov, Y., & Kasaeva, G. (1969). Algal culture as an utilizer of carbon oxide and ammonia in a biological life support system. *Materials of the 2nd All-Union Conference on Controlled Biosynthesis and Biophysics of Populations*, (pp. 137-138). Krasnoyarsk.
- Oracle Corp. (2018, April 15). *Java IDL Code Samples*. Retrieved from Oracle Technology Network - Java: <http://www.oracle.com/technetwork/java/idl-139708.html#>
- Oswald, W. (1965). *Sanitation Engineering Division Proceedings of Society of Civil Engineers*. 90(4), p. 23. American Society of Civil Engineers. Sanitary Engineering Division.
- Paine, T. O. (1989). Biospheres and Solar System Exploration. *Proceedings of the Workshop on Biological Life Support Technologies 1989* (pp. 10-11). Oracle: Synergetic Press.

- Palinkas, L. (2001, June). Psychosocial issues in long-term space flight: overview. *Gravitational and space biology bulletin*, 14(2), 25-33.
- Pearson, A. O., & Jackson, J. K. (1971). Summary of a 90-Day Manned Test of a Regenerative Life Support System. In L. G. Napolitano, P. Contensou, & W. Hilton (Ed.), *Astronautical Research 1971: Proceedings of the 22nd Congress of the International Astronautical Federation* (pp. 151 - 162). Brussels: Ridel Publishing Company.
- Porterfield, M. (2015, May 18). NASA Bioregenerative Life Support: Past, Present & Future. *ISLSWG Bioregenerative Life Support Workshop*. Turino, Italy. Retrieved June 15, 2016, from http://www.asi.it/it/download_file?itd=sites/default/files/attach/notizia/1.6_portelfield.pptx&u sg=AFQjCNE9UfO3_jdFHAIQz5H0FIYBfGXJeg&bvm=bv.139782543,d.eWE
- Posadskaya, M. (1976). Peculiarities of biochemical oxidation of wheat straw by active sludge biocenosis. *Proceedings of the All-Union Workshop on Material cycling in closed ecosystems - Materialy bsesoyuznogo rabochego soveshchaniya po voprosu krugovorota veshchestv v zamknutykh ekosistemakh*, (pp. 117-119). Kiev.
- Poughon, L., Farges, B., Dussap, C., Godia, F., & Lasseur, C. (2009). Simulation of the MELISSA closed loop system as a tool to define its integration strategy. *Advances in Space Research*, 1392-1403.
- Powell, R., Nevels, E., & McDowell, M. (1961). Algae Feeding in Humans. *Journal of Nutrition*, 7.
- Poynter, J. (2009). *The Human Experiment, Two years and twenty minutes inside Biosphere 2*. New York: Basic Books.
- Prince, R. P., & Knott, W. M. (1989). CELSS Breadboard Project at the Kennedy Space Center. In D. Ming, & D. Henninger, *Lunar base agriculture, soils for plant growth* (pp. 155-163). Madison: Agronomy Society of America.
- Priyadarshani, I., & Rath, B. (2012). Commercial and industrial applications of micro algae - A Review. *Journal of Algal Biomass Utilization*, 89-100.
- Rodriguez, L. F., Kang, S., & Ting, K. C. (2003). Top-Level Modeling of an ALS System Utilizing Object-Oriented Techniques. *Advances in Space Research*, 31(7), 1811-1822.

- Rummel, J. D., & Volk, T. (1987). A modular BLSS simulation model. *Controlled Ecological Life Support System: Regenerative Life Support Systems in Space* (pp. 57-65). Toulouse: COSPAR.
- Rygalov, V. (2016). Theoretical Analysis for Long-Term Space Life Support Reliability. *Unpublished*.
- Rygalov, V. Y. (1996). Cultivation of Plants in Space: Their Contribution to Stabilizing Atmospheric Composition in Closed Ecological Systems. *Advances Space Research*, 18(4/5), 165-176.
- Rygalov, V., & Degermendji, A. G. (1991). Acting Member of RAS, Stability of CES for life Support; Institut of Biophysics SB RAS, . *private communication*. Krasnoyarsk, Russian Federation.
- Rygalov, V., & Holmer, C. (2014). Correlation between Closure Degree, Trophic Network Complexity, and Stability Level for Closed Ecological Systems Designed for Autonomous Functioning in Space. *65th International Astronautical Congress*. Toronto: International Astronautical Congress.
Retrieved from <http://iafastro.directory/iac/browse/IAC-14/A1/6/>
- Rygalov, Y. (2015, November). Discussions on Bios-3 and deadloc considerations. *Private Correspondance*.
- Sagan, D. (2013). Chapter 14: What Narcissus Saw: The Oceanic "Eye". In L. Margulis, & D. Sagan, *Santed Truths: Essays on Gaia, Symbiosis and Evolution* (pp. 185-200). New York: Springer.
- Salsbury, F. B., Gitelson, J. I., & Lisovsky, G. M. (1997, October). Bios-3: Siberian Experiments in Bioregenerative Lfe Support. *BioScience*, 47(9), 575 - 585. Retrieved June 15, 2016, from <http://bioscience.oxfordjournals.org/content/47/9/575.full.pdf>
- Scheffer, M., Bascompte, J., Brock, W. A., Brovkin, V., Carpenter, S. R., Dakos, V., . . . Sugihara, G. (2009, September 3). Early -Warning Signals for Critical Transitions. *Nature*, 461, 53-59.
- Scheffer, M., Carpenter, S., Foley, J. A., Foke, C., & Walker, B. (2001). Catastrophic shifts in ecosystems. *Nature*, 591-596.
- Schroeder, M. (2009). *Fractals, Chaos, Power Laws: Minutes from an Infinite Paradise* . Mineola: Dover Books.
- Silverstone, S. (1993). *Eating In; From the field to the Kitchen in Biosphere 2*. Oracle, Az: The Biosphere Press.

- Silverstone, S., & Nelson, M. (1996). Food production and nutrition in Biosphere 2: Results from the first mission September 1991 to September 1993. *Advances in Space Research*, 49-61.
- Smith, J. F. (2010, December 20). Life Under the Bubble. *Discover Magazine*. Retrieved from <http://discovermagazine.com/2010/oct/20-life-under-the-bubble>
- Smith, J. F. (2010, October 20). Life Under the Bubble. *Discover*. Retrieved October 22, 2016, from <http://discovermagazine.com/2010/oct/20-life-under-the-bubble>
- Sohail. (2015, November 4). *Soviet Martian*. Retrieved from Hybrid the Car: <http://hybridtechcar.com/soviet-martian/>
- Spolare, P., Joannis-Cassin, C., Duran, E., & Isambert, A. (2006). Commercial Applications of Microalgae. *Journal of Bioscience and Bioengineering*, 87-96.
- Stahr, J., Auslander, D., Spear, R., & Young, G. (1982). *An approach to the preliminary evaluation of Closed Ecological Life Support System (CLESS) scenarios and control Strategies*. NASA.
- State Space Agency of Ukraine. (2005). *Ukrainian research in Microgravity*. State Space Agency of Ukraine. Retrieved June 22, 2016, from http://www.nkau.gov.ua/pdf/booklet_research_all.pdf
- Sterman, J., & Sterman, J. D. (2000). *Business Dynamics: Systems Thinking and Modeling for a Complex World with CD-ROM*. McGraw-Hill/Irwin.
- Strogatz, S. H. (1994). *Nonlinear Dynamics and Chaos: With Applications to Physics, Biology, Chemistry and Engineering*. Cambridge: Westview Press.
- Svirezhev, Y. M., & Logophet, D. O. (1978). *The Stability of Biological Conglomerates*. Moscow: Nauka.
- Svirezhev, Y. M., & Logophet, D. O. (1978). *The Stability of Biological Conglomerates*. Moscow: Nauka Publishing Company.
- Tako, Y., Arai, R., Tsuga, S.-i., Komatsubara, O., Masuda, T., Nozoe, S., & Nitta, K. (2010). CEEF: CLOSED ECOLOGY EXPERIMENT FACILITIES. *Gravitational and Space Biology*, 13-16.
- Tako, Y., Shinohara, M., Komatusbara, O., & Nitta, K. (2001). Advanced Technologies of Environment Control and Life Support. *Proceedings of the International Meeting for Advanced Technology of Environment Control and Life Support*, (p. 340). Rokkasho, Aomori, Japan.

- Tako, Y., Tsuga, S., Tani, T., Arai, R., Komatsubara, O., & Shinohara, M. (2008). One-week habitation of two humans in an airtight facility with two goats and 23 crops-Analysis of carbon, oxygen, and water circulation. *Advances in Space Research*, 41, 714-724. Retrieved from <https://doi.org/10.1016/j.asr.2007.09.023>
- Tamponnet, C., Binot, R., Lasseur, C., & Savage, C. (1991). Man in Space - A European Challenge in Biological Support. *ESA Bulletin*, 67, pp. 38-49.
- the Melissa Foundation. (2017, Jan 15). *The MELiSSA Program*. Retrieved from MELiSSA Foundation: <http://www.melissafoundation.org/>
- Thynne, A., & Goose, P. (1859). On the Increase of Madrepores. *The Annals and Magazine of Natural History: Zoology, Botany, and Geology*, 3(3), 449-460. Retrieved October 31, 2016, from <https://books.google.com/books?id=CrBMAAAAYAAJ&printsec=frontcover#v=onepage&q&f=false>
- Tikhomirov, A., Ushakova, S., Kovaleva, N., Lamaze, B., Lobo, M., & Lasseur, C. (2007). Biological life support systems for a Mars mission planetary base: Problems and prospects. *Advances in Space Research*, 1741-1745.
- Tikhomirov, A., Ushakova, S., Manukovsky, N., Lisovsky, G., Kudenko, Y., Kovalev, V., . . . Lasseur, C. (2003). Mass exchange in an experimental new-generation life support system model based on biological regeneration of environment. *Advances in Space Research*, 31(7), 1711-1720.
- Tikhomirov, A., Ushakova, S., Velichko, V., Tikhomirova, N., Kudenko, Y., Gribovskaya, I., . . . Lasseur, C. (2011). Assessment of the possibility of establishing material cycling in an experimental model of the bio-technical life support system with plant and human wastes included in mass exchange. *Acta Astronautica*, 1548-1554.
- Ting, K., Chao, K., & Giacomelli, G. (1997). Systems Studies of NJ-NSCORT for BLSS: An Overview. *27th International Conference on Environmental Systems, Lake Tahoe, Nevada, July 14-17, 1997*. SAE International.
- Traclabs. (2018, 06 20). *BIOSim - TRACLabs*. Retrieved from TRACLabs: <https://traclabs.com/projects/biosim/>

- Traclabs Inc. (2017, January 15). *BIOSIM*. Retrieved from TRACLABS.COM:
<https://traclabs.com/projects/biosim/>
- TraClabs Inc. (2017, Jan 30). BioSim ReadMe. *BioSim ReadMe.md*. Houston, TX, US.
- Tremor, J. W., & MacElroy, R. D. (1986). *CLESS Program Meeting*. NASA.
- Ulanowicz, R. E. (1972, February). Mass and energy flow in closed ecosystems. *Journal of Theoretical Biology*, 34(2), 239-253.
- United States Department of Agriculture. (2017, September). *Welcome to the USDA Food Composition Database*. Retrieved from United States Department of Agriculture:
<https://ndb.nal.usda.gov/ndb>
- University of Arizona. (2016, August 26). *Biosphere 2 - History*. Retrieved from Biosphere 2:
<http://biosphere2.org/visit/about-biosphere2/history>
- University of Arizona. (2016, August 15). *Fast Facts | Biosphere 2*. Retrieved from Biosphere 2:
<http://biosphere2.org/visit/about-biosphere2/fast-facts>
- University of Arizona. (2016b, December 15). *Projects - Landscape Evolution Observatory*. Retrieved from Biosphere 2 Research: <http://biosphere2.org/research/projects/landscape-evolution-observatory>
- V Guttal, C. J. (2008). Changing skewness: an early warning signal of regime shifts in ecosystems. *Ecology Letters*, 450-460.
- Veggeberg, S. (1996, Winter). *Biosphere's image: rise, fall, and rehabilitation*. Retrieved June 22, 2016, from The World of Research at Columbia University: <http://www.columbia.edu/cu/21stC/issue-1.3/metaspere.html>
- Veradesky, V. I. (1986). *The Biosphere*. Oracle, Az: Synergetic Press.
- Vernadsky, V. I. (1998). *The Biosphere*. New York: Nevraumont Publishing Co.
- Verne, J. (1865). *From the Earth to the Moon* (March 30, 2011, Kindle ed.). Amazon. Retrieved from <https://www.amazon.com/Earth-Moon-Round-ebook/dp/B004UJTUKI>

- Vodovotz, Y., Bourland, C. T., & Rappole, C. L. (1997). Advanced Life Support Food Development: A New Challenge. *International Conference on Environmental Systems*. Lake Tahoe: SAE International. doi:10.4271/972363
- Volk, T., & Rummel, J. D. (1987). Mass Balances for a Biological Life Support System Simulation Model. *Advances in Space Research*, 7(4), 141-148.
- Volk, T., & Rummel, J. D. (1987). Mass balances for a biological life support system simulation model. *Advances in Space Research*, 7(4), 141-148. doi:10.1016/0273-1177(87)90045-7
- WA Brock, S. C. (2010). Interacting regime shifts in ecosystems: implication for early warnings. *Ecological Monographs*, 353–367.
- Walford, R., Mock, D., MacCallum, T., & Laseter, J. (1999). Physiologic Changes in Humans Subjected to Severe, Selective Calorie Restriction for Two Years in Biosphere 2: Health, Aging, and Toxicological Perspectives. *Toxicological Sciences*, 61-65.
- Walstad, D. L. (2003). *Ecology of the Planted Aquarium: A Practical Manual and Scientific Treatise for the Home Aquarist, Second Edition*. Echinodorus Pub.
- Warington, R. (1851). Notice of observations on the adjustment of the relations between the animal and vegetable kingdoms, by which the vital functions of both are permanently maintained. *Chemical Society, London*, 52-54. doi:10.1039/QJ8510300052
- Wheeler, R. (2006). Potato and human exploration of space. . *Potato Research*, 67-90.
- Wheeler, R. M. (2014). NASA's Controlled Environment Agriculture Testing for Space Habitats. *International Commission of Agricultural and Biosystems Engineering (CIGR)*. Kyoto, Japan. Retrieved June 2016, from <https://ntrs.nasa.gov/search.jsp?R=20140017323&hterms=20140017323&q=N%3D0%26Ntk%3DAll%26Ntt%3D20140017323%26Ntx%3Dmode%2520matchallpartial%26Nm%3D123%7CCollection%7CNASA%2520STI%7C%7C17%7CCollection%7CNACA>
- Wheeler, R. M. (2016). The Role of Plants in Space Exporation: Some Hisotry and Bacground. *International Controlled Environment Conference / AusPheno 2016; 5th; 18-23 Sep. 2016*. Canberra: NASA.

- Wheeler, R. M. (2016). The Role of Plants in Space Exploration: Some History and Background. *International Controlled Environment Conference / AusPheno 2016; 5th; 18-23 Sep. 2016*. Canberra: NASA.
- Wheeler, R. M., Berry, W. L., Mackowiak, C., Corey, K. A., Sager, J. C., Heeb, M. M., & Knott, W. M. (1993). A data base of crop nutrient use, water use, and carbon dioxide exchange in a 20 square meter growth chamber: I. wheat as a case study. *Journal of Plant Nutrition*, *16*(10), 1881-1915.
- Wheeler, R. M., Corey, K. A., Sager, J. C., & Knott, W. M. (1993). Gas Exchange Characteristics of Wheat Stands Grown in a Closed, Controlled Environment. *Crop Science*, *33*(1), 162-268.
- Wheeler, R. M., Drese, J. H., & Sager, J. C. (1991). *Atmospheric leakage and condensate production in NASA's biomass production chamber. Effect of diurnal temperature cycles*. Coco Beach: NASA Biomedical Operations and Research Office.
- Wheeler, R. M., Tibbitts, T. W., & Fitzpatrick, A. H. (1991). Carbon Dioxide Effects on Potato Growth under Different Photoperiods and Irradiance. *Crop Science*, *31*(5), 1209-1213.
- Wheeler, R., Mackowiak, C., Stutte, G., Sager, J., Yorio, N., Ruffe, L., . . . Corey, K. (1996). NASA's biomass production chamber: A testbed for bioregenerative life support studies. *Advances in Space Research*, *18*, 215-224.
- Wilkenson, E. A. (1980, March 23). Purdue Scientist Studies Ways To Farm In Space. *The Indianapolis Star*, p. 57. Retrieved November 28, 2016, from <https://www.newspapers.com/newspage/107595077/>
- Wissel, C. (1984). A Universal Law of the Characteristic Return Time near Thresholds. *Oecologia*, 101-107.
- Woodwell, J. (1970). *Energy cycling in the biosphere*. Moscow: Mir.
- Zanwa, P., Johnson, R., Ham, C., Qu, Z., Ballmann, G., & Eom, K. (2001). Development of the ALSARM-EE for Bio-Production Chamber. *ASTED, Robotics and Applications Conference*. Clearwater, Florida.
- Zhang, C. (2016, November 21). *Getting ready for a real-life "The Martian"*. Retrieved February 15, 2017, from Science Line: <http://scienceline.org/2016/11/getting-ready-for-a-real-life-the-martian/>

