

# **THE STRUCTURE OF THE BANGLA DP**

**Tanmoy Bhattacharya**

**Dissertation submitted in partial fulfilment of the  
requirements for the degree of PhD**

**University College London**

**February 1999**

ProQuest Number: 10609343

All rights reserved

INFORMATION TO ALL USERS

The quality of this reproduction is dependent upon the quality of the copy submitted.

In the unlikely event that the author did not send a complete manuscript and there are missing pages, these will be noted. Also, if material had to be removed, a note will indicate the deletion.



ProQuest 10609343

Published by ProQuest LLC (2017). Copyright of the Dissertation is held by the Author.

All rights reserved.

This work is protected against unauthorized copying under Title 17, United States Code  
Microform Edition © ProQuest LLC.

ProQuest LLC.  
789 East Eisenhower Parkway  
P.O. Box 1346  
Ann Arbor, MI 48106 – 1346

## Abstract

The thesis offers a description and analysis of the DP in the Eastern Indo-Aryan language Bangla (Bengali). In particular, it re-establishes the dominant theme in the DP literature of showing the syntactic equivalence between the structure of the clause and that of the DP. This is done on the one hand by investigating various clause-like syntactic phenomena like specificity, deixis and aspect inside the DP and on the other by working out NP movement inside the DP -- the common theme across chapters 2-4.

Chapter 1 provides an outline of the thesis and introduces relevant parts of the minimalist and the antisymmetry framework adopted for this study. In addition, it suggests a trigger for Merge and proposes that a condition governing XP movements to multiple specifiers in clauses is operative in DPs as well.

The second chapter discusses a three layered structure of the DP structure for Bangla where the layer intermediate between DP and NP is the Quantifier Phrase. The proposed structure accounts for the DP-internal specificity in Bangla and suggests that specific NPs move out of the deepest NP-shell by LF. This is identified as the DP-internal 'Object' Shift and constitutes the first instance of DP-internal NP movement.

In the following chapter, the three-layered DP structure is re-examined on the basis of data from kinship terms. Specifically, it is shown that the possessive is generated in the nP shell of the DP but moves up to its derived position of [Spec,DP] for reasons of feature checking. It is proposed that the demonstrative is an XP and is the specifier of a 'focus-related' head F, located between the D and the Q heads. NP movement proposed in this chapter is identified as Kinship Inversion and is shown to be triggered by the same feature of specificity explored in chapter 2. The analysis exploits two different types of NP movement within the DP which accounts for DP-internal deixis.

The last chapter discusses the structure of the gerund phrase and proposes that it too has the structure of a DP. Both the external and the internal distribution of the gerund is investigated which show that they exhibit both nominal and verbal properties. This is reflected in the proposed derivation of gerunds which involve leftward NP movement out of a VP embedded inside an Aspect Phrase. The presence of aspectual features like [ $\pm$ PERFECT] and [ $\pm$ DELIMITED] drive this movement. This final evidence for DP-internal NP movement leads us towards the conclusion that NP movement inside the DP is a pervasive phenomenon in Bangla.

## Acknowledgements

The most serious education that I received from Rita Manzini, my principal supervisor, is the conviction that any syntax writing must be useful for the reader. She has imparted this training, directly and indirectly (and not in so many words), at the risk of criticism from those who see 'usable' as a dirty word and an excuse for reinstating a dominant canon of writing conventions in generative syntax. Thanks to her, I have learned to grow out of this criticism and participate in the conventions of writing in a way that is hopefully understandable for fellow linguists everywhere.

Neil Smith is the person responsible for making the majority of decisions where decisions needed to be made -- starting with the organisation of the thesis and ending with the final draft -- he has seen through it all. He is the one person besides me who has read through every word of this dissertation. I am truly grateful for this. He has practically taken up the role of the first supervisor during most of the past 18 months when Rita was away in Florence. Learning how to use certain words carefully (which *therefore explains* the cautiousness in using certain everyday words in this work) in particular and a controlled use of language in general has been one of the most valuable lesson that Neil has imparted.

Ad Neeleman's entry into the department has been a bonus for me. Although I wish he had come earlier I am lucky to have been able to meet him regularly over the past 18 months at least. He has provided some very practical suggestions both regarding the thesis and my career. I am grateful for his advice to send abstracts to conferences which has helped me to make my CV a little respectable. As for the dissertation, he has specifically helped me in bringing clarity in the organisation and presentation of Chapters 1-3.

Misi Brody, whenever he was in London, was very generous with his time and the discussions I had with him forced me to look at syntax from a different perspective. If more of his thoughts are not visible in this dissertation it is a result of my lack of courage as well as my unwillingness to imprison those ideas in a dissertation framework. I am also thankful to him for suggestions on chapters 1 and 4.

I am thankful to the following scholars who have helped me with papers and comments: Josef Bayer, Elabbas Benmamoun, Guglielmo Cinque, Probal Dasgupta, Alice Davison, Giuliana Giusti, Anders Holmberg, K.A. Jayaseelan, Richard Kayne, Ayesha Kidwai, Hans van de Koot, Shalom Lappin, Pino Longobardi, Gillian Ramchand, Andrew Simpson, Juan Uriagareka and Roberto Zamparelli.

Audiences at conferences at New Delhi, Manchester, York, Bergamo and Bergen have helped sharpen some of the ideas included in this work.

My study at UCL was sponsored by the Commonwealth Commission. Teresa Anderson of the ACU, in particular, has been a most efficient awards administrator and has shown a generous and mature understanding of the relatively tricky problems of overseas students. I am thankful for her understanding and support. My contact officers at the British council, William Samuel and Steve Dunnett, have been very helpful especially in terms of providing supporting letters and documents for our annual trips to Croyden!

A special mention to Charles Wallace India Trust for granting a maintenance allowance award towards the end of the writing up period based on a generous recommendation from Neil. The Graduate School at UCL has been very kind in awarding two small grants

enabling me to attend conferences in Milan, Bergamo and Bergen. My department generously topped up one of these grants which partially covered the air-fare to Italy.

Neil is foremost among those who made my stay in London easier, starting from the first day in October 1995 when he showed me around till the very the last days of unexpected crisis. Among friends, Anne Teng introduced me to various institutions within the University and to other students of the department. I am thankful to her for deciding to leave her hard disk with me. Among other friends in the department who shared similar worries and concerns are: Maya Arad, Dirk Bury, Brian Chan, Karen Froud, Hye Keung Kang, Young Kook Kim, Fuyo Osawa, Jonathan White and Kriszta Szendroi. Molly Bennett and Stefanie Anyadi of the department offices made paper work smoother and unnoticeable. Among non-departmental friends, Sue Griffith, Giovanna Hendel, Madhuchhanda Sen and Stefano Villani have helped to make my stay in London pleasurable. Probal Dasgupta, Ayesha Kidwai, Indrani Roy and Udaya Narayana Singh did the same long distance.

My parents, while bravely and silently coping with the harshness of a tough city back in India, have, as always, provided the most undemanding encouragement and succour whenever needed. No words are adequate or even appropriate, they know how I feel.

In spite of the best efforts of various opposing forces the dissertation got done. This miracle would not have been possible if we hadn't had the overdose of support from parents and friends during those difficult months, partially anaesthetising the suffering. The one who endured all that and much more has as always been the personalised model in Life & Letters, without whom neither would have made much sense.

## List of Abbreviation

Transcription Key:

T D R = Retroflex $\text{t d r}$
S = Palato-alveolar $\text{ʃ}$
N = Velar $\text{ŋ}$
E O = mid vowels $\text{æ ɔ}$
M = Nasalisation.

A-P = Articulatory-Perceptual

ACC = Accusative

CAUS = Causative

CEN = Complex event Noun

C-I = Conceptual-Intentional

Cla/ CLA = Classifier

CONJ = Conjunctive

DAT = Dative

DECL = Declarative

DEF = Definite

Dem/ DEM = Demonstrative

DM = Distributed Morphology

DN = Derived Nominals

DPOS = DP Object Shift

EA = External Argument

ERG = Ergative

EXP = Expression

FEM = Feminine

FI = Full Interpretation

FL = Faculty of Language

FQ = Floated Quantifier

GEN = Genitive

GER = Gerundial

GN = Gerundive Nominal

INST = Instrumental

KI = Kinship Inversion

LA = Lexical Array

LCA = Linear Correspondence Axiom

LEX = Lexicon

LI = Lexical Item

MAS = Masculine

MLC = Minimal Link Condition

MP = Minimalist Programme

MSO = Multiple Spell Out

NAQ = Non-*all* Quantifiers

NML = Nominaliser

NOM = Nominative

Num = Numeral

OBJ = Objective

OBL = Oblique

PASS = Passive

PART = Partitive

PL = Plural

PPL = Participle

PROG = Progressive

PRS = Present

Poss/POSS = Possessive

PST = Past

RN = Result Nominal

RS = Rightward Scrambling

SEN = Simple Event Noun

S-H-C = Spec-Head-Complement

SA = South Asian

SG = Singular

TOP = Topic

WCO = Weak Crossover

## TABLE OF CONTENTS

<b>Chapter 1: Introduction To The Thesis And Discussion Of The Framework .....</b>	<b>9</b>
1.0 Outline of the Thesis .....	9
2.0 The Framework .....	14
2.1 Minimalism of Chomsky (1995).....	14
2.1.1 Levels of Representation.....	15
2.1.2 Checking Theory .....	16
2.1.3 Economy of Derivation/ Representation.....	16
2.2 Kayne's LCA .....	17
2.2.1 Adjunction in LCA .....	19
2.3 An Example of LCA in the Bangla DP .....	20
2.4 Further Evidence of LCA for South Asian Languages.....	23
2.4.1 Oblique Case Agreement in Hindi PPs.....	24
2.4.1.1 Prepositional Agreement in Welsh.....	28
2.4.2 WCO Violation in Hindi/ Bangla .....	30
3.0 The Place of LCA in MP.....	32
3.1 Some differences between Bare Phrase Structure and Antisymmetry .....	33
4.0 Merge.....	35
4.1 Problems with Merge .....	36
4.2 Integration .....	37
4.3 Merge in Chomsky (1998) .....	39
4.4 Lexical Integration.....	40
5.0 Deriving LCA .....	42
5.1 Multiple Spell-Out.....	43
5.2 Successive Spell-Out in Chomsky (1998) .....	46
5.2.1 Reduction of Complexity .....	46
5.2.2 Reduction of Derivational Space .....	47
6.0 Richards (1997).....	49
<b>Chapter 2: Specificity and DP-Internal NP Movement.....</b>	<b>54</b>
1.0 The Layered DP.....	54
1.1 Word Order inside the Bangla DP .....	58
1.2 Middle layer as Predicative .....	60
2.0 The Quantifier Phrase .....	62
3.0 Q/Num-Cla Sequence as a Quantifier .....	65
3.1 Headedness of the Q .....	68
3.2 Quantifier Float.....	71
4.0 The Adjective-Noun Order .....	76
4.1 Adjectives as Specifiers .....	77
4.2 APs as Adjunction .....	80
4.3 Adjectives as Heads .....	82
4.4 Adj-N in Bangla .....	84
5.0 DP-internal NP Movement in H-Final Languages .....	86
6.0 Specificity Related NP Movement .....	90
6.1 Presuppositionality as a Semantic source for Specificity .....	92

6.2 Leftward NP-movement in Bangla DP.....	95
6.3 The nature of the [SPECIFICITY] feature .....	97
<b>Chapter 3: Kinship Inversion and NP Movement.....</b>	<b>103</b>
1.0 Introduction .....	103
2.0 Derived Position of the Possessives .....	103
2.1 A Counterexample to [Spec,DP] as the derived position for Poss .....	106
2.2 Base Position of the Poss .....	108
2.2.1 NP (and not N) Moves in Bangla .....	110
2.2.2 Poss is not at [Spec,QP].....	111
2.2.3 Poss in the nP-shell.....	112
3.0 Demonstrative as an XP .....	114
3.1 Demonstrative Reinforcers .....	116
3.2 Deixis and the Generalised Licensing Condition.....	120
3.2.1 Focus inside the DP .....	122
3.2.2 Contrastive and Non-locative Deixis .....	124
3.2.3 Deixis and Focus .....	126
3.3 A trigger for KI .....	128
3.4 FP in Bangla.....	131
3.5 Further evidence for FP.....	135
4.0 DP-internal NP Movement .....	141
4.1 nP Movement .....	143
4.2 NP movement .....	147
4.2.1 Specificity and KI.....	148
5.0 Conclusions .....	151
Appendix: Dem in the nP-shell .....	152
<b>Chapter 4: The Gerund and NP Movement.....</b>	<b>155</b>
1.0 Introduction .....	155
1.1 The Importance of Nominalisation .....	156
1.2 Gerunds as Complex Event Nominals.....	158
1.3 Structure of the Gerund.....	160
1.3.1 T in DP .....	161
2.0 The Data: The Gerund Suffix in Bangla .....	164
2.1 Other uses of the gerund suffixes.....	168
3.0 The Data: Distribution of Gerunds .....	169
3.1 ACC-ing.....	170
3.2 External Distribution of POSS-ing .....	171
3.2.1 Object of a P .....	173
3.2.2 Subject of an embedded clause .....	174
3.2.3 With S-initial adverbs .....	174
3.2.4 Topic position.....	176
3.2.5 Subject of NP .....	177
3.3 Internal Structure.....	178
3.3.1 Case of the Gerund Phrase .....	182
3.3.2 Case of the Gerund Subject.....	184
3.3.3 Case as a property of argument structure .....	186
3.4 Verbal Properties of the Gerund .....	189



3.5 The Data: Gerund and Participle .....	192
3.5.1 Gerunds as a Superset.....	196
3.5.2 Predicate types of the verbal source of gerunds and participles.....	198
3.5.3 Conclusion .....	201
4.0 Nominal Aspect .....	204
4.1 Predicate Aspect and NP Interpretation .....	204
4.2 Nature of the Nominal Aspect .....	206
4.2.1 Debounding/ Grinding.....	207
4.2.2 Bounding/ Packaging .....	210
4.3 Syntactic account of Aspect .....	211
4.4 Asp in Participles.....	214
5.0 Analysis.....	218
5.1 Derivation of the Gerund.....	219
5.2 Derivation of the Participle .....	220
5.3 Unergatives .....	221
5.4 Unaccusatives.....	225
5.5 Affectedness of the Object.....	228
6.0 Gerundives .....	231
6.1 Gerundives are not APs.....	232
6.3 Gerundives are Nominal.....	233
6.4 Derivation of Gerundives .....	235
7.0 Result Nominals .....	238
8.0 Conclusion.....	240
Appendix: A Critique of a Non-Lexicalist Account.....	241
<b>Appendix: Are Q and Cla two separate Heads? .....</b>	<b>245</b>
1.0 Some Relevant Data on <i>All</i> and Non- <i>All</i> Quantifiers (NAQ) .....	246
2.0 Q and Cla as separate heads.....	248
2.1 The right order is the [ClaP-QP] order.....	249
2.2 Feature of Q .....	251
2.3 Difference between <i>All</i> and Non- <i>All</i> Qs .....	252
2.4 <i>All</i> is internal to the DP in Bangla .....	254
2.5 Revisiting the relevant data: Back to Q and Cla as a fused head.....	256
<b>References .....</b>	<b>260</b>

## **Chapter 1**

### **Introduction To The Thesis And Discussion Of The Framework**

The main finding of this thesis corroborates the assumption that noun phrases may reflect certain clausal properties. The similarity between the structures of the two was most clearly demonstrated in Abney's (1987) thesis. The theme that unites most of the present work is that there are instances of clause-like NP movement within the DP. I demonstrate this in terms of the feature-checking mechanism of Chomsky (1995). In particular, I investigate the DP structure of the Indo-Aryan language Bangla (Bengali) and show that there are clear instances of such DP-internal NP movement. As I discuss in detail in section 5.0 of Chapter 2, this independent finding of the thesis, in addition, is derivable from the antisymmetry framework of Kayne (1994).

#### **1.0 Outline of the Thesis**

In this section, I present summaries of the main discussions and findings in various chapters of the thesis. The rest of this chapter reviews the theoretical assumptions: Minimalism (section 2.1), the Antisymmetry of Kayne (1994) (section 2.2), some evidence for the Linear Correspondence Axiom (LCA) in South Asian languages, especially, Bangla (sections 2.3 and 2.4); its place in the minimalist program of Chomsky (1995) (section 3.0); a discussion of Merge (section 4.0), with special reference to a problem for Merge (section 4.1) and a possible solution for its trigger (section 4.2). Next, I discuss the derivation of LCA from the Minimalist Program (MP) in section 5.0 and point out some similarities between the multiple

spell-out of Uriagareka (1996-1999) and the successive cyclic spell-out of Chomsky (1998). Lastly (in section 6.0) based on Richards (1997), I propose a principle restricting movement to multiple specifiers which predicts the correct word order in cases requiring such movement.

In Chapter 2, I discuss the structure of the Bangla DP and explore the possibility of considering nominal phrases as projecting a three-layered DP structure as follows:

(1)

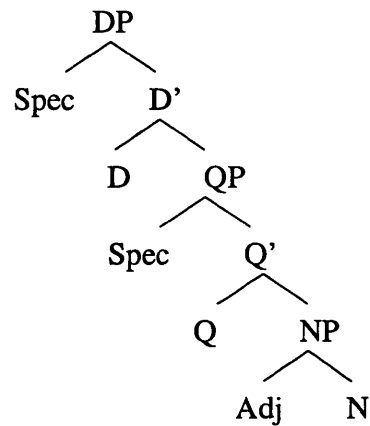

That is, I propose that there is an intermediate functional category, QP, between DP and NP. Since Bangla shows no agreement, I propose that this intermediate projection is different from an AgrP and must instead be viewed as a predicational layer, in the sense of Zamparelli (1996). In section 4.0, I discuss the position of adjectives in Bangla and suggest that they should be considered as NP specifiers as shown in (1).

Using studies on specificity at the clausal level, especially those of Mahajan (1990) and of Diesing (1992), I show that specificity inside the DP drives clause-like leftward NP movement (section 6.0) which constitutes the first case of DP-internal NP movement mentioned earlier. That is, I explore the internal effects of DP-specificity in terms of NP movement inside the DP as shown in (2a) and (2b). I

call this movement DP-internal phrasal ‘object’ shift (DPOS) purely as a descriptive name, which comes about as a result of a feature of [SPECIFICITY] of the Q head in accordance with the principle of feature driven movement in Minimalism. I adduce evidence for the main conclusion from certain nominal phrases such as (3a) containing numerical expressions, which lack the classifier (a part of the complex head Q in (1) as shown in (3c)), otherwise obligatory with numerical words:

(2)a. du-To chele

two-CLA boy

‘two boys’

b. chele du-To

‘the two boys’

(3)a. tin(\*-Te) caka-r gaRi

three(\*-CLA) wheel’s car

‘three-wheeled car’

b.\* caka-r tin gaRi

c.

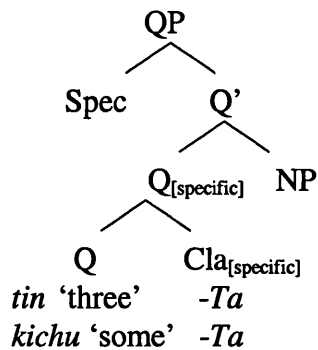

Specifically, I claim that the lack of the classifier and the absence of NP movement can be connected if we locate the [SPECIFICITY] feature at the Q head.

Also, connected with the DP structure in (1), I examine the intermediate

layer of QP in greater detail in a General Appendix at the end of the thesis and show that Qs and Classifiers (Cla) do not project separate heads inside the DP. In particular, I show that the difference in the behaviour of *all* and non-*all* quantifiers may suggest a separation initially, but finds a natural explanation in terms of the structure in (1). In this thesis, therefore, Q is considered to be a complex head containing the Cla as shown in (3c).

However the minimal structure in (1) is brought under scrutiny in Chapter 3. Based on an analysis of Kinship Inversion (KI) this chapter is devoted to further refinements in the structure of the Bangla DP with regard to the position of the possessive (Poss) and the demonstrative (Dem). I modify the three-layered structure of the DP proposed in the earlier chapter based on new evidence from kinship nouns and suggest that to derive contrastive deixis a Focus-like head F projects to hold the demonstrative in its specifier and to make available a head position for the lower head Q to move into. Having decided on the position of the Dem, I propose that the Poss be generated in the nP shell, which later moves up to [Spec,DP] to check genitive Case. This movement is shown to be covert in the case of *Kinship Inversion*. But the main contribution of this chapter resides in the discovery that kinship nouns move to the left of the Q head. This then provides further evidence for DP-internal NP movement in Bangla. The structure of the Bangla DP proposed is as follows:

(4)

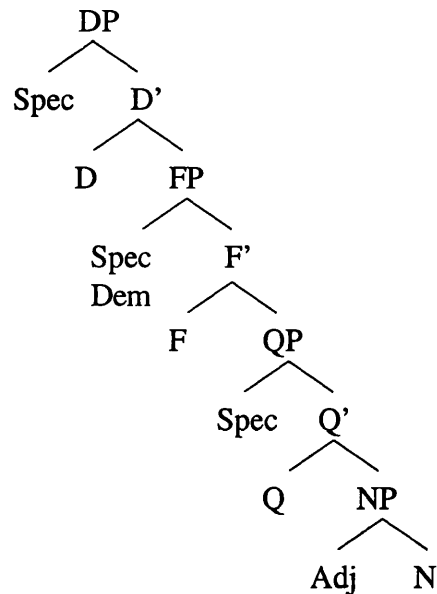

Chapter 4 is concerned with the structure and distribution of gerundials in Bangla. I look at four constructions, namely, gerunds, participles, result nominals and gerundives all of which share the suffix *-(w)a/-no*. I discuss in detail the external and internal distribution of the gerund and show that they show both nominal and verbal properties. This is reflected in their proposed derivation which crucially takes into account a nominal aspectual head, *Asp*, inside the DP. The structure of the Bangla gerund is as follows:

(5)

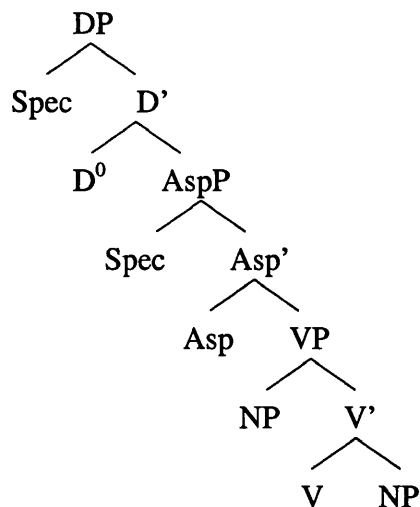

In particular, I suggest that gerunds are derived by leftward NP movement from the base structure due to the presence of an aspectual feature. This movement is

motivated on the basis of the predicate-based theories of aspect of Tenny (1987) and Borer (1993). This account provides further and the final evidence for DP-internal NP movement.

## **2.0 The Framework**

The sentential property of NP movement that DPs in Bangla exhibit can be argued to be a result of the Linear Correspondence Axiom (LCA) of Kayne (1994) for a strictly head-final language. I will show that embedding LCA within a modified form of MP will lead us to express DP-internal NP movement clearly. Adopting LCA makes leftward NP movement necessary. Minimalism with a version of LCA incorporated provides a better account than one without such a version as far as the nominal syntax of Bangla is concerned. In addition, I will show that the LCA independently predicts certain internal properties of the DP in Bangla. First, I will briefly review Minimalism of Chomsky (1995) and Kayne's (1994) formulation of the LCA.

### **2.1 Minimalism of Chomsky (1995)<sup>1</sup>**

I will present three features of the Minimalist Program (MP) which show how it differs from previous models of generative grammar. The reader is referred to Chomsky (1995) for a detailed presentation of the concepts discussed below.

---

<sup>1</sup> A modified version of the minimalist programme is now available in ms form as Chomsky (1998). I will review part of it in sections 4.3 and 5.2 of this chapter, but will not adopt the technical/ conceptual modifications for the purpose of this dissertation.

### 2.1.1 Levels of Representation

The only levels of representation in MP are the Interface levels: LF or the conceptual-intentional (C-I) and PF or the articulatory-perceptual (A-P). A language L is understood as a system that generates pairs  $(\pi, \lambda)$  to be interpreted at these two interface levels<sup>2</sup>. Crucially, the Deep and Surface structure levels of the earlier GB model are eliminated.

A language consists of a lexicon and a computation which maps an array of lexical choices to the pair  $(\pi, \lambda)$ . This array is at least a numeration N defined as a set of pairs  $(LI, i)$  where LI is a lexical item and i its index, understood to be the number of times LI is selected. The operation *Select* takes items out of N and introduces them into the derivation. An operation *Merge* (see section 4.0 for further discussion of *Merge*) takes a pair of syntactic objects and creates a new combined syntactic object. Another operation that forms larger units and which is driven by economy considerations (see 2.1.3) is called *Move*.

A derivation *converges* if it yields interpretable representations at the two interface levels, satisfying economy considerations; otherwise it *crashes*. At some point in the computation to LF the operation *Spell-Out* applies to a structure already formed to strip away elements relevant for the PF leaving the structure with elements relevant for the LF.

The lexical entry of an LI consists of formal features (apart from phonological features and semantic features relevant for PF and LF respectively) which must be eliminated by *Spell-Out*. A distinction is made between intrinsic and

---

<sup>2</sup> See Brody (1995) for a different approach which recognises LF as the only level of representation. Also, a derivational approach, in spirit, might consist of more than two levels.



optional features and between +Interpretable and –Interpretable features<sup>3</sup>.

### 2.1.2 Checking Theory

MP tries to restrict the set of possible relations by (a) removing the notion of government and (b) introducing checking theory. As a consequence of (a) no direct relation obtains between a head and the specifier of another head. As a result of (b) syntactic movement take place only when forced to check certain features of the head and the specifier in a ‘checking configuration’.

Functional categories in MP are specified for categorial features both nominal and verbal. These can be  $\pm$ strong. Strong features must be eliminated by either merge or Move before the derivation can proceed. These features on functional heads therefore trigger either movement or merging of XP and X to spec and head of the functional projection respectively which define the checking domain. Movement involves *attraction* of formal features only, overt movement of categories is a result of pied piping necessary for PF convergence.

### 2.1.3 Economy of Derivation/ Representation

Movement in MP is driven by certain economy principles<sup>4</sup> which specify diverse conditions: derivations must be as short as possible, steps in derivations must involve the smallest possible link, movement takes place only if forced by some checking requirement (*Last Resort*), and as late as possible (*Procrastinate*). This

---

<sup>3</sup> See Brody (1995), Roberts and Roussou (1997) and Manzini and Roussou (1998) for alternative proposals treating all features in the grammar as interpretable features.

<sup>4</sup> See Collins (1997) and Yang (1997) for a criticism of the global nature of these principles.

last principle derives the difference between covert and overt operations.

Economy of Representation is ensured by the principle of *Full Interpretation* (FI) which applies at the interface: every symbol must receive an external interpretation by language independent rules. By FI, LF/PF contain only those elements that are legitimate at their respective levels where legitimacy derives from their ability to receive an appropriate interpretation provided by grammar-external systems.

## 2.2 Kayne's LCA

By looking at what we do not find cross-linguistically, Kayne (1994) presents evidence that movement in the functional domain is invariably leftward. Thus the apparent absence of *wh*-movement to the right, or the absence of word order alternation from VO to OV, or the absence of extraction of P-complement to the right, or the fact that subjects always precede objects (Greenberg's Universal 1) suggest that specifiers are to the left and that there is a general ban against rightward movement. Although counterexamples to each of these apparent universals have been reported and although many problems remain with the original formulation of the LCA, the empirical range that LCA covers in terms of giving a principled account of many left/ right asymmetries in natural languages<sup>5</sup>, demands

---

<sup>5</sup> For example, a well-know anomaly pointed out in Cinque (1996) of syntactic theories till now has been the observation that in a right-branching language while movement to the left could apply over an unbounded domain, the apparent movement to the right was 'upward bounded'. Surprisingly, no mirror-image unbounded movement to the right was attested in left-branching languages of the OV type. LCA derives this as consequence since no adjunction to a c-commanding position to the right is possible. OV languages in this theory are not mirror-images but are derived by leftward movement of the object. Kayne shows that in most cases, rightward movement analyses of various phenomena (like right node raising, HNPS, Subject Inversion, Right Dislocation and Relative Clause Extraposition) are independently ruled out.

serious consideration of the axiom.

Kayne derives the universal order of Specifier-Head-Complement (S-H-C) through the Linear Correspondence Axiom (LCA) according to which, if  $\alpha$  asymmetrically c-commands  $\beta$ , then  $\alpha$  must linearly precede  $\beta$ . That is, linear precedence mimics asymmetric c-command (as defined in (6) below).

- (6) X asymmetrically c-commands Y iff X c-commands Y and Y does not c-commands X. (Kayne 1994, p.4)

His main proposal is as follows. In a phrase marker P, the following holds:

- (7) Linear Correspondence Axiom  
 $d(A)$  is a linear ordering of T

In (7)  $d$  is the non-terminal to terminal relation and  $A$  the set of all non-terminals such that the first element asymmetrically c-commands the second, i.e.  $A$  is the maximal set of ordered pairs and  $T$  the set of terminals.

Let us see how the LCA works by taking the simple phrase markers in (8).

Italicised small letters indicate terminal elements, and capital letters non-terminal elements.

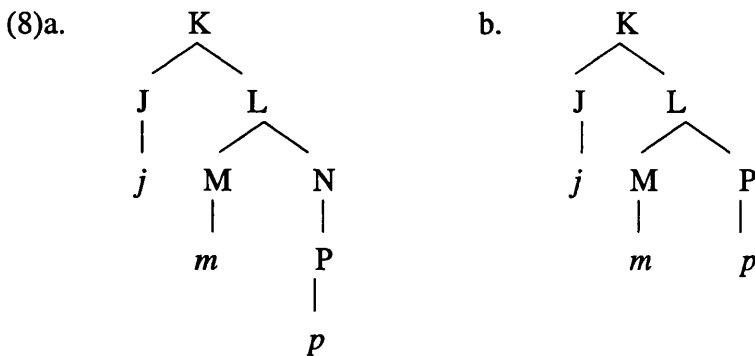

The pairs for which asymmetric c-commands holds for (8a) are  $\langle J, M \rangle$ ,  $\langle J, N \rangle$ ,  $\langle J, P \rangle$ ,  $\langle M, P \rangle$  which results in linear ordering  $\langle j, m, p \rangle$ . Hence the LCA holds. In (8b) the relevant pairs are  $\langle J, M \rangle$  and  $\langle J, P \rangle$ , hence the  $d(A)$  is  $\langle j, m \rangle$  and  $\langle j, p \rangle$

where the order between the terminals  $m$  and  $p$  is unspecified. Hence the structure fails LCA. This derives at least two important consequences: (i) LCA prohibits the complement of a head to be a head itself (ii) the X'-theoretic stipulation that a phrase can only have one head derives from LCA by the exclusion of a configuration like (8b). Notice that a phrase with two heads will look like  $[_L M P]$  or (8b) in other words.

### 2.2.1 Adjunction in LCA

To allow for specifiers and adjuncts, Kayne introduces the category versus segment distinction (May 1985, Chomsky 1986) into the definition of asymmetric c-command in (6) above as follows:

- (9) X c-commands Y iff X and Y are categories and X excludes Y and every category that dominates X also dominates Y

With this redefinition, the structure (10a) below which is inadmissible since  $d(A)$  contains both  $\langle q,r \rangle$  and  $\langle r,q \rangle$  (by virtue of P asymmetrically c-commanding Q) is fine when L is replaced by another P as in (10b):

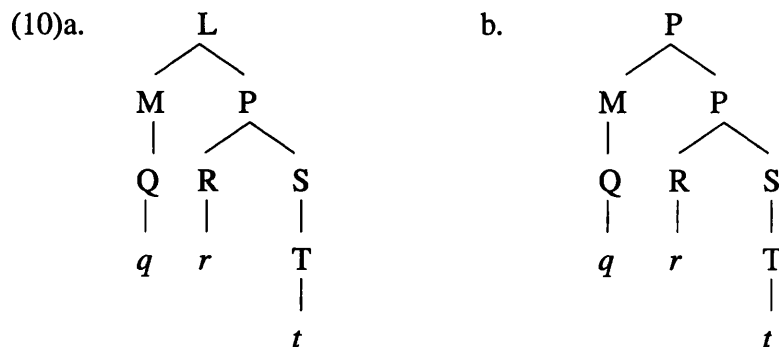

The result for (10a) is correct for M and P as maximal projections. By the redefinition of (9), L and P are segments of the same category (shown in (10b) by replacing L by P to indicate adjunction) with the result that  $\langle P,Q \rangle$  is no longer

obtained as the lower P is a segment. Specifiers are therefore taken to be a case of adjunction.

The antisymmetry requirement of the LCA bans adjunction of more than one non-head to another non-head. Crucially, it also bans right adjunction. This will become relevant in section 2.4.2 where we present cases of Weak Cross Over (WCO) violation in Hindi as an argument against rightward adjunction. Consider the following tree:

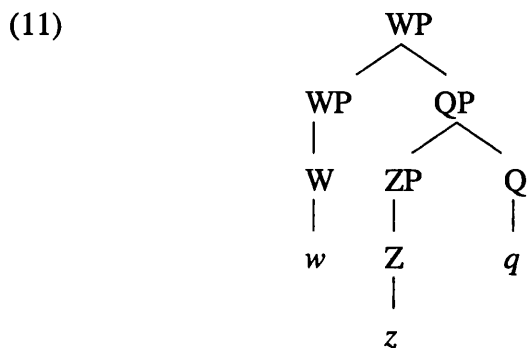

In this tree, the non-terminal QP has right adjoined to WP. The  $d(A)$  for this structure is  $\langle q,w \rangle$ ,  $\langle q,z \rangle$ ,  $\langle w,z \rangle$ . Kayne points out that orders in  $\langle w,z \rangle$  and  $\langle q,w \rangle$  cannot express any relation. The former would express 'w precedes z' and the latter 'q is followed by w'. However, if  $\langle x,y \rangle$  reads as 'x precedes y' then the structure above is ruled out since  $\langle q,w \rangle$  and  $\langle q,z \rangle$  are not ordered.

### 2.3 An Example of LCA in the Bangla DP

Before proceeding further, in this subsection, I provide a direct but brief demonstration of the advantage of adopting LCA for the analysis of Bangla DPs. It may be noted here that I offer additional advantages of adopting the LCA in Chapter 3 where I have proposed that specificity and deixis inside the DP can be accounted for in an analysis based on the LCA. Here I will present a brief preview

of specificity effect in DPs in Bangla.

Consider, first, the possibility of starting the computation with the Complement-Head order, contrary to LCA. Consider the simplified, three-layered DP structure as in (12) below and the DPs in (13).

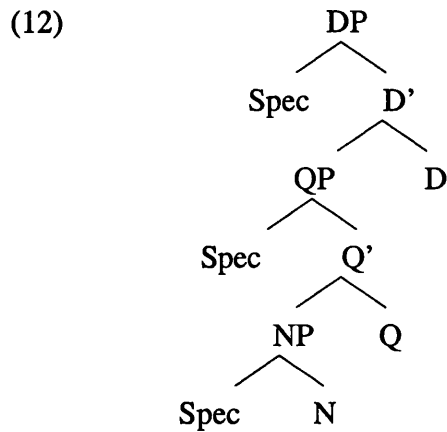

(13)a. chele du-To (Specific)

boy two-CLA

'the two boys'

b. du-To chele (non-specific)

'two boys'

These DPs exhibit a robust property of Bangla DPs: namely, that specificity is a function of word order, making this construction a fertile ground to test a theory of word order such as Kayne's Antisymmetry. Since the DPs in (13) are related, I assume that this relation is captured by deriving one from another<sup>6</sup>. Using the DP structure in (12) above, the specific DP in (13a) has the base-generated order of [NP Q] where 'two-CLA' is the Q head. The non-specific DP in (13b) can then be derived from (13a). This is undesirable for at least two reasons. First, such a

<sup>6</sup> Although there is no reason, a priori, for this to be the case, the surface similarity between the two strings prompts the connection intended.

derivation would mean deriving the unmarked construction in (13b) from the marked one (the specific DP in (13a))<sup>7</sup>. Secondly, the derivation would necessarily involve moving a head (*du-To* ‘two’ as the Q head) to the left of the NP *chele* ‘boy’. No matter how this is done (that is, by substitution or adjunction), it will involve movement of an X<sup>0</sup> category into an XP category. Given the principle of structure preservation, this is clearly undesirable. The other alternative of moving the NP<sup>8</sup> to the right is unwanted given that most constructions requiring rightward movement are shown to be independently (i.e. irrespective of LCA) undesirable in Kayne<sup>9</sup>. Note that if we allow rightward movement then the burden of deriving the right/ left asymmetry noted in note 5 without a stipulation lies with us. In section 2.4.2, I report Mahajan’s (1997) observation that a rightward movement analysis of the so-called ‘rightward scrambling’ in Hindi derives the wrong predictions for WCO cases. Given this range of empirical evidence, it is undesirable to derive (13b) by a rightward movement of the NP. Therefore, I conclude that a complement-head order cannot derive the unmarked order in (13b) under the assumptions of the present study.

---

<sup>7</sup> Again, nothing in the theory precludes generating the non-specific order from the specific one, in terms of suggestions made here, the unmarked order from the marked one. Consider, in this connection the two sentences in (i); although (ia) is derived by movement where (ib) involves *there*-insertion and no movement, the former ‘looks’ like the unmarked order:

- (i)a. John arrived  
 b. There arrived John

As for the Bangla examples in (13), I will assume that since the specific order at least involves selecting a feature of [SPECIFICITY] in the numeration, its computation is more costly (and therefore marked) than the non-specific version which does not require checking of this feature. Notice that such a re-interpretation assumes a syntactic definition of the notion of markedness invoked here.

<sup>8</sup> I show in Chapter 2 that in Bangla the whole NP (of which Adjective is the part) moves. That is, in Bangla there is no instance of N to D movement as in Romance, Semitic and Germanic (Longobardi 1994, Siloni 1997, Bernstein 1993a, Ritter 1988, Duffield 1996, Mallén 1997, etc)

<sup>9</sup> See for example, Kayne (1994: 67f., 71ff., 77ff., 78ff., 117 ff, 126 ff.) for evidence against rightward movement. Note also that the proper binding condition of Fiengo (1977) rules out a rightward lowering approach to any of these analyses.

Now, consider the following basic structure of the DP in (1) (repeated here as (14)) in line with the spec-head-complement (S-H-C) predicted by the LCA:

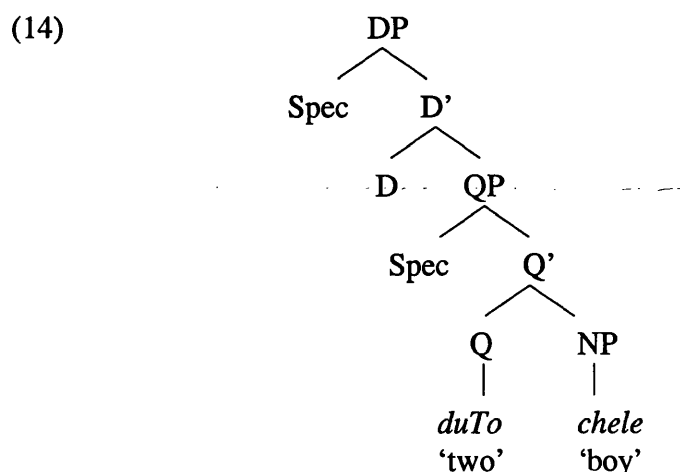

In this structure, the marked word order of NP QP (as in (13b) above) is obtained by moving the NP leftwards. This movement, as I show in greater detail in Chapter 2, is well motivated since it is driven by the need to check the feature of [SPECIFICITY]. As is clear from the example above, the [NP QP] order obtains a specific meaning of the noun phrase. LCA, therefore, provides a natural explanation to the specificity of Bangla DPs.

#### 2.4 Further Evidence of LCA for South Asian Languages

We have just concluded that the starting configuration for the XP assumed in this work is X-Complement, in line with the S-H-C order that LCA derives. In this section I will present further evidence for adopting the universal underlying word order of Specifier-Head-Complement for South Asian (SA) languages including Bangla. The following arguments are based on data from Hindi. I will assume with Kayne's (1997) introductory remarks that a micro-linguistic trend of comparing closely related languages is a meaningful one. That is, I will take the position



(obvious but not apparent in the UG view of language) that comparing Bangla with geographically closely related Indo Aryan languages will lead to more interesting results than comparing it with genetically more distantly related Romance/Germanic languages.

- (15)a. The agreement pattern obtained in Hindi PPs predicts that the complement of the adposition (the postposition, in this case) moves to the left of the head, i.e., the adposition itself.
- b. Instances of so-called ‘Rightward Scrambling’ in Hindi (and by extension, Bangla), when re-interpreted in terms of leftward movement of all materials preceding the scrambled NP gives us the right results for Weak Cross Over effects.

#### 2.4.1 Oblique Case Agreement in Hindi PPs

Case in Hindi is construed in terms of Case particles like *ne*, *ko*, and *kii* for Ergative, Dative and Genitive respectively and a null Case particle for Nominative and Accusative.

These Case particles trigger oblique morphology on the noun and its modifiers. Obliqueness, in Hindi, “spreads”. Consider the following contrast where the spreading is shown in bold:

- (16)a. ye      accha      laRkaa  
           this    good.FEM    boy
- b.    is            acche      laRke      kii  
           this.OBL    good.OBL    boy.OBL    GEN  
           ‘of this good boy’

Dasgupta (1997) re-interprets Obliqueness as a feature on the Case particle (here *kii*) which is checked by all the material to its left which bear obliqueness. He assumes that the oblique agreement on a DP is the result of leftward movement of the DP *ye acchaa laRkaa* across an Agr-like head. I will depart from his proposal and suggest the simplified structure in (17) where the Case particle heads a PP (=PP1) of its own which can be embedded inside another PP (=PP2):

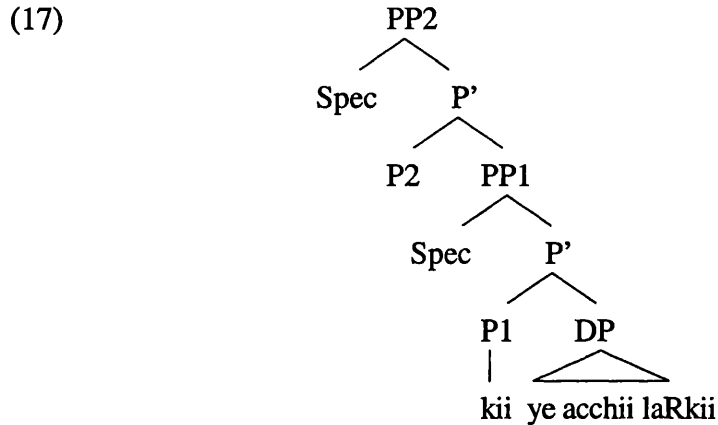

In (17) P1 is a functional particle which requires overt movement of the DP to [Spec,PP1] for checking Oblique Case and results in the oblique marking inside the DP to give (16b). The following example shows that the presence of a P2 is quite common. In (18) *saath* occupies the P2 slot of (17).

- (18)a. us                    ke                    saath  
           he.OBL            GEN.MAS            with (MAS)  
           ‘with him’
- b.    ghar    ke                    saamne  
           house GEN.MAS            front (MAS)  
           ‘in front of the house’

Notice that the Genitive Case is the typical morphology of P1 in these languages. In the structure proposed in (17), the derivation for (18b) would proceed as in

(19).

(19)

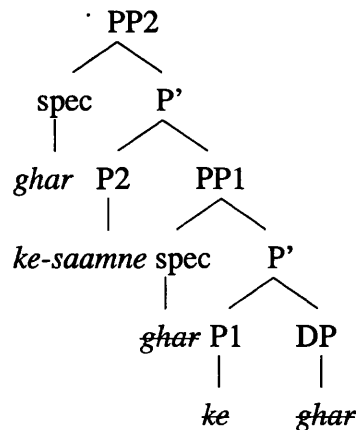

All movements are driven by feature checking needs. The argument DP *ghar* ‘house’ checks for Oblique Case at [Spec,PP1] and then moves up to check the features on the P2 head. The Case particle *ke* ‘of’ on the other hand checks for this matching feature on P2 by adjoining to the P2 head. Agreement between *ke* and *saamne* is thus established<sup>10</sup>.

What do we gain from this? If we look at (19) we see that the direction of movement for the purpose of head-adjunction (P1 to P2) and substitution (DP to [Spec,PP1/PP2]) is identical in that both are leftward. If we had started with a head-final, or S-C-H order then we would be forced to move rightward for the purpose of head-adjunction and leftward for the purpose of substitution. With a S-H-C structure we achieve uniformity of movement.

However, we do not need to look specifically into the structure of PPs to

<sup>10</sup> Notice that I have avoided the added complication of analysing the locative marker *-e* which is an inseparable part of some of these Ps (“heavy” Ps or P2s). Historically these Ps were derived from a nominal base but synchronically they behave as Ps (by taking NPs or other PPs as complements). This is evident from the fact that no cognate noun *\*saamn-* or *\*piich* for *piiche* ‘behind’ exist in the language. Additionally, the observation that sequence of two real Ps are found in the language as well (as in (i) below) justifies the analysis in (19):

(i) chat par se gir gayaa  
 roof on from fell go.PST.MAS.SG  
 ‘(He) fell off from (top of) of the roof’

understand this. The importance of this examination of the Case properties lies somewhere else. Notice that for the S-H-C order to work for PPs in postpositional languages, we must posit obligatory movement of the complement of the adposition leftward to get the surface order of DP-P. In other words, we should have the following:

(20) [DP<sub>i</sub> P t<sub>i</sub>]

Kayne (1994) (based on pc with Hale) reports that there are postpositional languages which show agreement between the adposition (postposition) and their complement, although prepositional phrases never show such agreement (but see 2.4.1.1 below for Welsh). Marácz (1989) (in Kayne) reports that P-DP order is possible in Hungarian only when the adposition is of the class that never shows agreement. If we compare this with the analysis of Hindi Oblique Case as a case of DP-P agreement then we get the expected result. The following examples bring out the agreement pattern more clearly:

- (21)a. [makaan<sub>i</sub> ke t<sub>i</sub>]<sub>j</sub> paas t<sub>j</sub>  
           house GEN.MAS.OBL near(MAS)
- b. [makaan<sub>i</sub> kii t<sub>i</sub>]<sub>j</sub> or t<sub>j</sub>  
       house GEN.FEM.OBL towards(FEM)

The agreement facts are explained in terms of feature-checking by overt pied-piping of the argument DP from a post-adposition position to a pre-adposition position. For us, this lends further support for taking Specifier-Head-Complement as the universal underlying order.

### 2.4.1.1 Prepositional Agreement in Welsh

One corollary to Kayne's position on PP derivation in head-final languages is that Ps in prepositional languages do not agree with their complements. The case of Prepositional agreement in a language like Welsh, therefore, will count against this derivation. I will show that, rather than being an argument against LCA, prepositional agreement in Welsh falls out as a consequence of LCA.

In Welsh, like other Celtic languages, inflected prepositions agree with their pronominal (overt/ covert) objects (Borsley and Roberts 1996: 41-42). Non-pronominal DP objects of Ps do not show agreement:

(22)a. i 'r dynion

to the men

'to the men'

b. iddyn (nhw)

to.3PL they

'to them'

c.\* iddyn y dynion

to.3PL the men

Rouveret (1991) makes an interesting observation in this connection. He shows that in the majority of cases there is a third element appearing between the inflected stem and the inflection. He observes two cases. One in which the third element appears only in the 3<sup>rd</sup> person (23) and the other in which a connective appears in all persons (24):

(23) P P-dd-Agr

a. yn yn-dd-o

- ‘in’ ‘in him’
- b. gan gan-dd-o  
‘with’ ‘with him’
- c. heb heb-dd-o  
‘without’ ‘without him’
- (24)
- |    |                     |                        |
|----|---------------------|------------------------|
|    | Sg                  | Pl                     |
| 1. | o-hon-of            | o-hon-om               |
|    | ‘of me’             | ‘of us’                |
| 2. | o-hon-ot            | o-hon-och              |
|    | ‘of thou’           | ‘of you’               |
| 3. | o-hon-o/<br>o-hon-i | o-hon-ynt<br>‘of them’ |
|    | ‘of him/ of her’    |                        |

Rouveret claims that this connective is a functional head and proposes (25):

(25) Agreement morphology can only be affixed to a functional head

With this background, I will show that P agreement can be seen as predicted by the LCA. In fact, Kayne mentions (1994: 50) that agreement between a Preposition and its complement is possible only in V...S... languages. This prediction seems to hold for Celtic languages (which Kayne does not mention).

I suggest the derivation proceeds as follows. The PP starts out as P-DP<sup>11</sup>.

---

<sup>11</sup> The fact that prepositional agreement obtains only when the DP is a pronominal complement, remains unexplained in the derivation advanced here. One difference between DPs and pronominals in Celtic in general that is relevant to the present argument is the fact noted by McCloskey (1996:250, 263) that in “salient unaccusative” verbs in Irish, the complement oblique DP cannot raise out of its internal position in the structure V [<sub>PP</sub> P DP], whereas pronouns freely postpose to right-peripheral positions. I am not sure how such an analysis would fare in terms of LCA but this fact of Irish hints at the possible freedom of movement of pronominal DPs as opposed to non-pronominal DPs.

The DP complement then moves to the specifier of the PP which establishes the agreement with the head. This is followed by head movement of P to a higher head. This is where Rouveret's observation in (25) of a F head comes in handy as it provides a landing site for the P head.

However, in such a derivation the specifier of FP is unoccupied. This, I suggest is the correct interpretation of Kayne's prediction noted above – a V-initial word order at the clausal level in these languages is derived by a head moving to the head of the higher functional projection whose specifier is lexically empty. The derivation above is a reflection of the derivation of the VSO from an underlying SVO order. This accounts for the similar pattern obtained in case of finite verb agreement in these languages as noted in Borsley and Roberts (1996: 40).

#### 2.4.2 WCO Violation in Hindi/ Bangla<sup>12</sup>

Mahajan (1997: 187) uses the term rightward scrambling (RS) for the construction type in (26) below where a nominal argument (in this case a quantified DP shown in italics) appears to the right of the verb instead of in its canonical preverbal position:

- (26) raam-ne            mohan-ko        dii                *har ek kitaab*  
 Ram-ERG        Mohan-DAT    gave.FEM        every book.FEM

'Ram has given every book to Mohan'

It has been noted in the literature on scrambling (Mahajan1989, Saito 1992) that leftward clause internal scrambling of a quantifier overrides WCO effects:

<sup>12</sup> Example used in this section are from Hindi as they are taken from Mahajan (1997) but the analysis applies equally to Bangla.

(27)a.\* uske<sub>i</sub> bhaai-ne har ek aadmii-ko<sub>i</sub> maaraa

his brother-ERG every man-OBJ hit

\* 'His<sub>i</sub> brother hit everyone<sub>i</sub>'

b. har ek aadmii-ko<sub>i</sub> uske<sub>i</sub> bhaai-ne maaraa

every man-OBJ his brother-ERG hit

??<sup>13</sup> 'Everyone<sub>i</sub>, his<sub>i</sub> brother hit'

However RS does not override WCO even though under a rightward movement analysis of RS, the postverbal NP is in a position to c-command the pronoun that needs to be construed as a variable to overcome WCO. Under the assumption that object agreement in Hindi is mediated through Spec-Head agreement, a rightward movement analysis of RS would give us the following derivation (this labelled diagram is constructed here on the basis of a slightly different example in Mahajan), VP-internal traces are not shown:

(28)\* [<sub>IP</sub> [<sub>IP</sub> uske<sub>i</sub> bhaai-ne [<sub>AgroP</sub> t<sub>SUBJ</sub> [<sub>AgroP</sub> t<sub>IO</sub> [<sub>VP</sub> maaraa] Agro] Agro] I] har ek aadmii-ko<sub>i</sub>]

In this derivation the IO *har ek aadmii-ko* moves to the right from [Spec,AgroP] to right adjoin to IP from where it can c-command the co-indexed pronoun *uske* but still does not override WCO. Consequently the ungrammaticality of the sentence (shown in 29) is unexpected in a rightward movement analysis:

(29)\* uske<sub>i</sub> bhaai-ne maaraa har ek aadmii-ko<sub>i</sub>

his brother-ERG hit every man-OBJ

\* 'His<sub>i</sub> brother hit everyone<sub>i</sub>'

An alternative to the rightward movement (shown in (28)) would be to

<sup>13</sup> This notation is meant to indicate that the English example is marginally acceptable.



have the verb move leftward leaving the IO stranded (as in (30) below). In such a structure the quantifier will no longer c-command the pronoun thereby giving a simple account for the missing variable reading of the pronoun under the assumption that variable binding requires c-command.

However, notice that this leftward movement of the V is possible only if we have a S-H-C structure predicted to be the universal order by LCA:

(30) SUB V [<sub>VP</sub> t<sub>SUB</sub> t<sub>V</sub> IO]

### 3.0 The Place of LCA in MP

In discussing some differences between phrase structure in MP and LCA it will transpire that the notion of Merge, whereby complements are merged to the right of the head, suggests that LCA is operative in computing PF sequences in Bangla. Although LCA can be derived from basic minimalist concepts (e.g., along the lines of the *Multiple Spell-Out* model of Uriagareka (1996-99) discussed in section 5.1), I will suggest that LCA can itself act as a trigger for Merge in the first place (section 4.0). I will briefly review the notion of *Integration* in Collins (1995 and 1997) and Chomsky (1998) in this connection (see section 4.0). In this section, I will offer a general discussion of the place of LCA in the MP.

The Inclusiveness Condition<sup>14</sup> proposed in Chomsky (1995) bars addition of any new objects after the array of LIs (Numeration) has been selected. In particular, no new phrasal category or bar level can be introduced. This implies that there cannot be X-Bar theory. As we have seen in section 2.2 that basic tenets of X-

---

<sup>14</sup> “...any structure formed by the computation is constituted of elements already present in the lexical items selected for N, no new objects are added in the course of computation apart from rearrangement of lexical properties.” (Chomsky 1995: 228)

Bar theory are derivable in LCA, we could in principle, therefore, adopt a version of LCA which respects this notion of strict Inclusiveness.

However, although the MP adopts the basic claim of LCA in a Bare Theory (Chomsky 1994), at some points they differ radically. I will briefly discuss some of these differences in the next subsection.

### 3.1 Some differences between Bare Phrase Structure and Antisymmetry

I Chomsky (1995) disagrees with the conceptual arguments of Kayne (1994).

Consider the following two configurations in this connection:

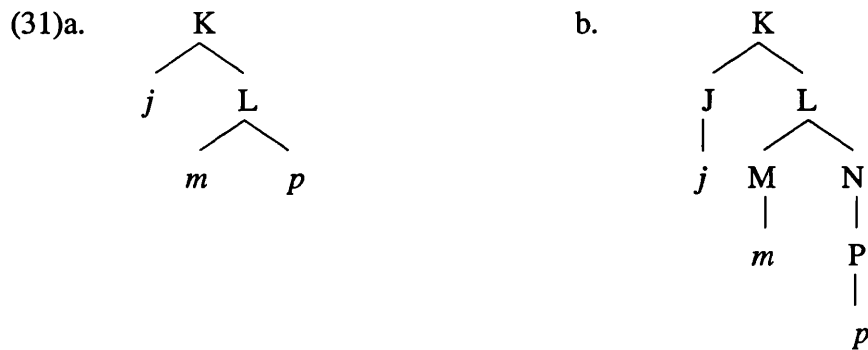

(31a) is the Bare Phrase equivalent of the Kaynian structure (31b). The heads in (31a) are the terminal items themselves, there are no head projections (since there are no bar levels). In (31a) *j* asymmetrically c-commands *m* and *p*. *L* is a head and an  $X^{\max}$  as well. By this c-command relation  $\langle j, m \rangle$ ,  $\langle j, p \rangle$  are valid pairs which implies that *j* precedes both *m* and *p*. Nothing more. This structure will not go through LCA since there is no ordering between *m* and *p*. LCA would repair this structure as in (31b) with the addition of a non-branching projection. Bare Phrase Theory does not allow non-branching projections (Chomsky 1994: 398) since

Merge, the basic tree building operation, is a binary operation<sup>15</sup>.

II Another difference between the two theories concerns the level of application of the LCA. Chomsky (1995) claims that linear order plays a role only at PF. For Kayne, however, LCA is respected at all levels including LF. Chomsky re-interprets LCA as applying after the component of Morphology which is a module which operates after the Spell-Out point:

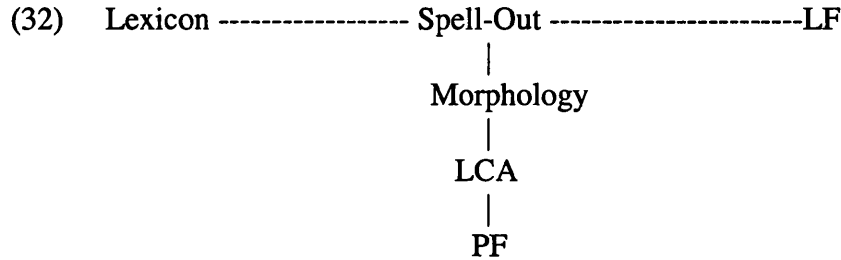

from the discussion in the next section, it will be clear that in the present study LCA is considered to be applicable *before* Spell-Out as well since it will be shown to be a trigger for Merge.

III Contrary to the LCA, MP retains the distinction between specifiers and adjuncts since they have distinct properties corresponding to the A/ A' distinction. This distinction is relevant only for maximal projections.

However, the A/A' distinction does not straightforwardly translate into the Specifier/ Adjunct distinction. For example, [Spec,CP], a position for specifiers, is clearly an A' position. The result of adjunction cannot be distinguished from a specifier after the process of adjunction has taken place in MP. Therefore, *j* in

<sup>15</sup> Thus, (i) is ruled out in favour of (ii) since the former contains 3 non-branching projections: D as a projection of *the*, N' is a projection of *man* and thirdly, NP as a projection of N':

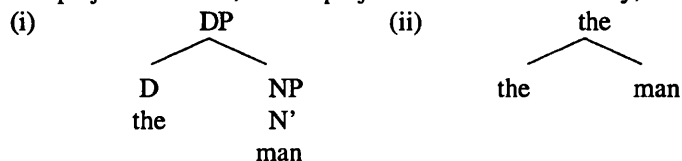

(31a) can be a specifier in an A position or an adjunct in an A' position.

IV Bare Theory allows for multiple specifiers, excluded by LCA. However, note that some syntactic constructions, like the V2 phenomenon in German, seem to be best accounted for in a restricted specifiers structure. In an unrestricted specifier approach the following should be possible as adjunction to a maximal projection is not blocked:

(33)\* Gestern Peter tanzte

'Yesterday Peter danced'

LCA would rule this out as only one adjunction per maximal projection is allowed<sup>16</sup>:

(34)

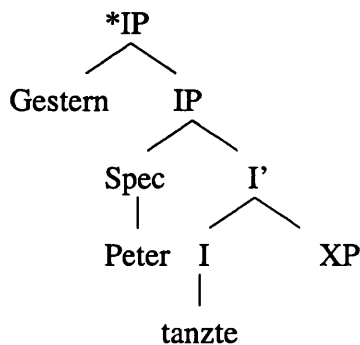

Given this, it is perhaps not difficult to see that LCA acts as a filtering device at PF. Crucially however, I will show in the next section that it has a more basic function of acting as the trigger for Merge, thereby making LCA a core principle in accordance with the strict Inclusiveness condition mentioned earlier in section 3.0.

#### 4.0 Merge

Since Merge is a syntactic operation, I assume that Merge must be triggered. In

<sup>16</sup> However, see Donati and Tomaselli (1997) for an argument against an LCA account of V2.

this section I will discuss the problem of finding a trigger for Merge. I will discuss, in 4.2, the notion of Integration (of Collins (1995, 1997)) as a possible motivation for Merge. However, I will adopt the view that Integration follows from LCA – in effect, making LCA the trigger for Merge. Thus the model of (31) is rejected insofar as the position of application of LCA is concerned. This modification makes LCA a pre-Spell-Out operation.

In MP, Merge is a basic operation (shown in (35)) in MP whereby phrase structures are built up piece by piece as the computation proceeds.

$$(35) \quad \text{Merge}(\alpha, \beta) = \{\alpha, \beta\}$$

Given a pair of syntactic objects  $(\alpha, \beta)$  which are selected from the Numeration, the operation ‘Merge’ constructs a new syntactic object out of the pair  $(\alpha, \beta)$  creating a single syntactic object  $(K)$ . The operation Merge  $(\alpha, \beta)$  is asymmetric, projecting either  $\alpha$  or  $\beta$ . The element which projects becomes the label of the complex. In general, the syntactic object  $K$  must be of the form  $\{\gamma, \{\alpha, \beta\}\}$ , where  $\gamma$  identifies the type to which  $K$  belongs.  $\gamma$  is called the label of  $K$  (not shown in (35) above).

#### 4.1 Problems with Merge

Notice crucially that the order of the merged elements is irrelevant in this proposal. The notation  $\{\alpha, \beta\}$  in (35) states precisely that. Collins (1997: 64) points out that this may not be sufficient as the operation fails to identify the head of the derived constituent. Collins also observes that the operation in (35) does not distinguish between segments and categories. The headedness problem is discussed below.

Although finding the head is not an operation, Collins assumes that it is

calculated automatically at the time the constituent is formed by Merge – one simply finds the head of one of the daughters. Consider the following derivation from Collins (1997: 64) to see this more clearly:

- (36)a. Select V
- b. Select N
- c. Merge (N,V) = {N,V}  
 Head ({N,V}) = V
- d. Select Agr<sub>o</sub>
- e. Merge (Agr<sub>o</sub>, {N,V}) = {Agr<sub>o</sub>, {N,V}}  
 Head ({Agr<sub>o</sub>, {N,V}}) = Agr<sub>o</sub>

If instead, at (36c), N was chosen as the head, at LF we would have an NP with a V complement. Collins concludes that it is reasonable to assume that the V will be uninterpretable at this position. I will simply note here that such an assumption rests on a grammar model with a look-ahead facility which is presumed to inflate the complexity of the computational component of the grammar<sup>17</sup>. However, Collins proposes a principle of “integration” which responds to this.

## 4.2 Integration

Consider the following partial derivation of *John left*:

- (37)a. Select *John*
- b. Select *left*
- c. Merge (*John, left*) = {*John, left*}

The question that we have been trying to answer is what motivates the Merge in

---

<sup>17</sup> See Chomsky (1998) for some relevant discussion on this point.

(37c). It is unlikely that a feature of either *John* or *left* is being checked through Merge. One possibility is that in selecting either of the two LIs, a property of the LI concerned is being satisfied, namely, the property of being taken out of the Numeration (and consequently its associated integer reduced by one). This is rejected by Collins on the grounds that if two phrases (and not LIs) are merged, no appeal to the Numeration is made.

He assumes the alternative that Merge of  $\alpha$  and  $\beta$ , whether lexical or not, is driven on the basis of the fact that both must be integrated into the clause. He calls this trigger for Merge which involves no feature checking, Integration, and defines it as follows:

(38) Every category (except the root) must be contained in another category<sup>18</sup>.

(Collins, 1997: 66)

Collins further points out that Integration is conceptually related to the LCA since if a phrase is not integrated into a clause, its terminals will not be ordered with respect to other terminals of the clause. One possible way of looking at this relation is that Integration follows from LCA (Collins 1995: 69)<sup>19</sup>. I will adopt this view for the present study and consider LCA as the trigger for Merge<sup>20</sup>.

---

<sup>18</sup> The problem with the definition of root (a category not contained within any other category) is not addressed in Collins. Without such a definition, Integration as stated above is not meaningful. One possible line of approach in defining the root could be in terms of look-ahead. If we say that the grammar needs look-ahead of some variety, contrary to the attempt in Chomsky (1998) of eliminating it, root could be the point where there is no more look-ahead. The asymmetry pointed out in section 5.2.2 (see note 24) in Chomsky (1998) regarding the reduction of complexity, indicates the possibility of incorporating a certain amount of look-ahead in the grammar.

<sup>19</sup> In Collins (1997) he rejects this possibility based on the status and position of LCA discussed in Chomsky (1994). However, since the conceptual relation between Integration and LCA remains and because Collins (1997: 137) himself suggests the possibility of reducing Integration to LCA, perhaps it is likely that some form of LCA is responsible for Integration and therefore, Merge.

<sup>20</sup> See, however, section 5.0, where I briefly discuss an approach (Uriagareka 1996-99) which derives LCA from basic minimalist assumptions.

This modification has the effect of applying LCA not just at the PF component as in (32), but all over the computation, now including the branch before Spell-Out (LA denotes Lexical Array (see 5.2.1)):

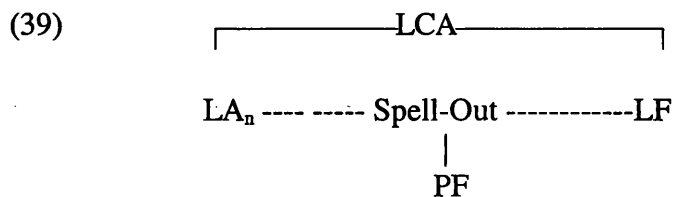

It is obvious from the discussion in this section that the alternative of eliminating LCA altogether will leave us with no mechanism to ensure that Merge respects the S-H-C order.

### 4.3 Merge in Chomsky (1998)

In this subsection I will briefly discuss the status of Merge (and its trigger) as presented in Chomsky (1998: 49-51). As will be clear from the discussion, the notion of Merge advanced in this refinement to MP is a feature-based, selectional view which has been independently shown By Collins (1997) to be inadequate.

As we have seen, one of the conditions for Merge is that it must perform the operation of constructing a new object. However, as in (35) above, there is no information available about the label of this new construct. Chomsky considers the possibility of predicting the label of a merger as follows.

First, he distinguishes between *set-Merge* for merger by substitution and *pair-Merge* for merger by adjunction. Adjunction is inherently asymmetric (X is adjoined to Y) and leaves the category adjoined to, unchanged. It is easy to see that pair-Merge of  $\alpha$  to  $\beta$  will project the target  $\beta$ . Set-Merge as an operation is symmetric, so either label may project. The result is either interpretable at LF or



not. Notice, however, that such a formulation implies look-ahead as part of the language design since Merge proceeds in the manner dictated by the success of the derivation at LF. In discussing problems with Merge, we have rejected this approach as increasing the complexity of the computation. Chomsky sees a way out of this.

Set-Merge also has an inherent asymmetry since  $\alpha$ ,  $\beta$  merge in order to satisfy selectional requirements of one of them (the *selector*) but not both. Chomsky observes that the selector is *uniquely* determined (emphasis mine). In particular he opts for a featural account for Merge triggers. A feature F of one of the merged elements in  $\{\alpha, \beta\}$  must be satisfied for the operation to take place. F is in the label of the selector and the label of the selector projects.

In conclusion, in case of the asymmetric operation pair-Merge there is no selector whereas set-Merge has a unique and obligatory selector which determines the label of the construction. I will point out, based on Collins (1997) that this selectional view is inadequate, in the next section.

#### 4.4 Lexical Integration

Note that the Integration approach presented in section 4.2 offers a non-featural trigger for Merge in contrast to the approach in section 4.3 which crucially takes into account an F feature of the selector.

Watanabe (1995) presented a version of Integration which pre-empts a selectional views as follows:

(40) *Lexical Integration*

Every constituent must either

- (i) be dominated by another constituent, satisfying the lexical selectional property of the head of the dominating projection or
- (ii) dominate every other constituent (the root)

In (40) selectional properties drive Merge.

Collins (1997: 74) clearly demonstrates that a selectional view cannot explain what selectional properties, if any, are satisfied either by the DP or the V' in the following configuration (42) which is an intermediate representation of the VP in (41):

(41) John threw the ball to Mary

(42)

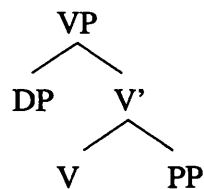

If theta-role assignment is purely an interpretive process (i.e., operating at LF) we cannot accept the view that theta-roles drive the operation Merge. Similarly, if Case feature checking is also a property of the LF interface, then Case features of the DP cannot drive Merge either. Collins points out that the Integration condition as defined in (38) above can take care of this.

However, I would like to point out that a selectional view of Merge appeals to an interpretable F feature, and thus cannot rid the system of the problem of look-ahead, since the theta-criterion, which appeals to lexically encoded semantic features of a head, is an LF interface principle. This a deep rooted problem of MP<sup>21</sup> which can be overcome by a feature-based theta-theory in line with Manzini and Roussou (1997).

---

<sup>21</sup> See the discussion on this issue in Johnson and Lappin (1997)

In conclusion, I will adopt the Integration view of Merge with the assumption that LCA derives the condition that the complement is merged to the right of the head at Merge.

## 5.0 Deriving LCA

Lastly, I will discuss an alternative approach (Uriagareka (1997, 1999)) which derives LCA from minimalist bases insofar as it bears on the current modifications to the MP suggested in Chomsky (1998). However, I will not adopt the conclusion reached in such a derivation as it crucially relies on a re-interpretation of Merge (see 43) which, given the discussion in 4.0, is not necessary.

(43) All other things being equal, choose the (optimal) ordering which can be reduced to standard Merge notation

Bypassing various details, in (43) Merge is re-interpreted as an optimisation function which provides the optimal mapping between sequences of terms and their respective PF slots. Thus (43) obviates the need to appeal to any other external principle (like LCA) to derive the PF order. The LCA, in this view, would thus seem to follow from the derivational history of Merge.

I find (43), which implies that Merge by definition encodes the PF order of Head-Complement, unconvincing for two reasons. First, it increases look-ahead in the grammar which goes against recent attempts to do just the opposite. Secondly, standard Merge notation implied in (43) derives, according to Uriagareka, from the notion of *Calculus of Variation*, i.e, given various derivational paths that may be invoked when going from a point  $\emptyset$  to a final point  $f$ , the path the derivation takes is determined in terms of it being the one involving least action. It is not clear, from

this explanation, what action means. Moreover, it is far from clear at this stage if a principle based on the notion of least action, is applicable to Merge.

Nevertheless, Uriagareka's proposal of Multiple Spell-Out (MSO) bears a striking resemblance to cyclic spell-out and interpretation outlined in Chomsky (1998). I will therefore discuss this in relation to the importance of the present study of DPs.

### 5.1 Multiple Spell-Out

The justification for presenting this piece of research lies first in its similarity to the current trend that the MP seems to be taking, which is discussed in the next section (5.2). Secondly, the notion of MSO or successive cyclic Spell-Out supports incremental computation<sup>22</sup> which perhaps includes studying local behaviour of DP fragments.

MSO appeals to a *Dynamically Split Model* in which a derivation spells out different chunks of structure in steps. Once a particular unit is spelled out to an intermediate PF (and LF) sequence, it is no longer possible to access its internal constituent structure. It can nonetheless be part of a phrase marker, that is, it can participate in further Merge but only as an inaccessible whole unit.

Uriagareka claims that MSO predicts the following paradigm which exhibits the classical restriction on extraction domain. The derivation in (45) accounts for the ungrammaticality of (44b):

(44)a. [who did you see [a critic of t]]

---

<sup>22</sup> The use of the term incremental here is intended to mean a PHASE-wise (see section 5.2.2) computation or derivation. No implication for a processing/ parsing connotation is intended.

b.\* [who did [[ a critic of t] see you]]

The derivation for (44b) proceeds as follows:

(45)a. Copy part of one of two separate command units<sup>23</sup>:

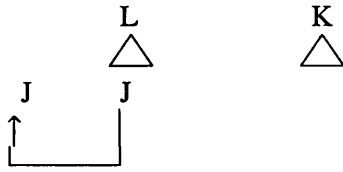

b. Spell-out as trace the lower copy:

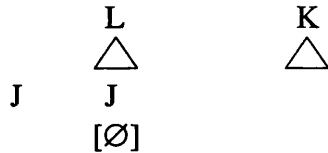

c. Merge the command unit containing the trace:

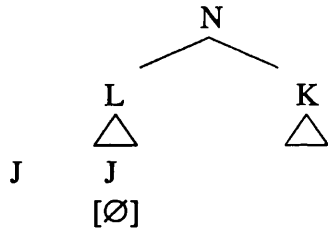

d. Merge the higher copy

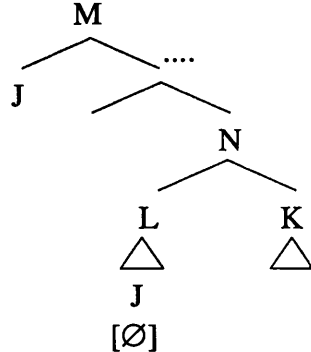

The structure in (45d) is in effect the sentence in (44b), we must therefore stop the derivation in (45). This is done in MSO without adding any machinery. According to MSO, after linearising L in (45c) with respect to K, its internal structure becomes inaccessible to the syntactic system. We cannot now proceed to (45d) as

<sup>23</sup> Command Units are basic units of operation and are obtained by merging elements to already merged PMs in Uriagareka (1997, 1999).

the chain (J,J) is undetermined since the lower copy is lost in the spelled out L.

The grammatical (44a) on the other hand involves L itself forming a chain with its upper copy. The internal structure of L is lost but not L itself, as desired. Forming a chain between upper and lower L is as simple as, Uriagareka points out, it would be to form a chain between a moved word and its silent copy. The derivation of (44a) proceeds as follows:

(46)a. Copy one of the two independently merged command units:

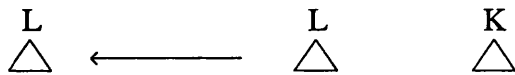

b. Spell-out as trace the lower copy:

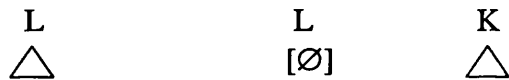

c. Merge the trace:

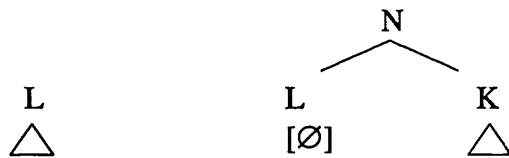

d. Merge the higher copy

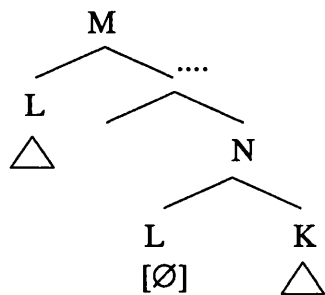

## 5.2 Successive Spell-Out in Chomsky (1998)

The demonstration in the previous section is strikingly similar to the notion of successive cyclic spell out and interpretation that is proposed in a modified MP. In this section I will briefly point out the similarities between these two approaches and conclude by suggesting that studying fragments of clauses (like nominal phrases) is in keeping with this trend of incremental derivation.

### 5.2.1 Reduction of Complexity

Chomsky (1998) is a sophistication of the programme towards making the Faculty of language FL a device designed optimally as a reflection of the bare output conditions or the legibility conditions. The architecture of the model is designed to reduce complexity. Thus language L maps a subset of features [F] constructed out of the universal feature set F to a set of expression EXP by *one time selection*. Complexity is further reduced if L involves a one-time operation that “assembles” elements of [F] into a lexicon LEX. A language L therefore maps ([F], LEX) to EXP. Chomsky then proceeds to further reduce access to this domain by suggesting that [F] is not accessed at all in the computation to LF, only LEX is accessed. Furthermore, he assumes that derivations make one-time selection of lexical arrays LA from LEX.

In sum, a language L then follows the procedures (47a,b) to specify the language and (47c,d) to derive a particular expression EXP:

- (47)a. Select [F] from the universal set F
- b. Select LEX, assembling features from [F]
- c. Select LA from LEX

- d. Map LA to EXP, with no recourse to [F] for narrow syntax (i.e. computation of LF)

(Chomsky 1998: 14)

Chomsky attempts one final reduction (p19-20) and suggests that in terms of access to the LEX, at each stage of the derivation a subset  $LA_i$  is extracted out of LA and is placed in active memory (or the “work space” of the derivation). When  $LA_i$  is exhausted the computation may proceed if possible or it may return to LA and extract  $LA_j$  to continue<sup>24</sup>.

### 5.2.2 Reduction of Derivational Space

The functional LIs that participate in computation processes as a whole are the Core Functional Categories (CFS) like C, T and  $v$  which have different s-selectional properties and allow an extra SPEC beyond their s-selection: for C, a raised *wh*-phrase, for T, the surface subject and a phrase raised by object shift for  $v$ . The basic configuration of a CFC is the following where EA is the optional external argument:

$$(48) \quad \alpha = [XP [ (EA) H YP]]$$

Next Chomsky considers the notion of a natural syntactic object. The syntactic equivalent of a proposition in the “meaning side” is either a full clause or a verb phrase with all theta-roles assigned, i.e., a CP or a  $vP$ . Selection of an  $LA_i$  must therefore involve selection of a C or a  $v$ . Chomsky calls this unit a PHASE and

---

<sup>24</sup> Note that this is different from the reduction observed above in the sense that it alone involves multiple access to the LA. Chomsky notes that (p20) “operative complexity *in some natural sense* is reduced” (emphasis mine). Although Chomsky does not mention it, this asymmetry reasonably implies that the language faculty must incorporate a version of look-ahead at some point to allow for the property of recursion in human language.



proposes the following cyclicity condition:

- (49) The head of a PHASE is “inert” after the PHASE is completed, triggering no further operations. (Chomsky 1998:20)

I would like to point out that the notion of a PHASE and the condition in (49) above suggest a system similar in essence to the one proposed in Uriagareka (1996-99). The condition (49) virtually ensures that fragments of syntactic objects (CPs and  $\nu$ Ps) are inaccessible once the computation is locally complete (see the derivation in (45)).

This similarity is made transparent in Chomsky’s discussion of deleted features. In MP the deleted features are invisible at LF but remain accessible to PF. So a particular (attractor) feature is checked but not erased until spell-out. This is a potential ambiguity in MP. However, this problem disappears if deleted features are considered erased only after they are sent to the PF along with the rest of the structure  $\Sigma$ . Chomsky concludes that “Spell-Out therefore applies cyclically in the course of the (narrow syntactic) derivation” (Chomsky 1998: 48).

Such an approach to spell-out implies strictly local/ incremental derivation. In Bhattacharya (1995a,b) it is shown that research on DPs is a testing ground for an incremental approach to computation (i.e. derivation) of bigger structures like clauses. The present study is an attempt to investigate the strictly local operations within the DP. Since the present work is a contribution to the hypothesis that DPs exhibit clausal properties, I will consider DP as constituting a PHASE. This is a justification for studying DP-internal syntactic operations like specificity, deixis and kinship inversion. However, whether or not the nP-shell, proposed in Chapter 3, is a PHASE in line with its supposed similarity with  $\nu$ P, is the next step in this

programme and I leave it for future research.

## 6.0 Richards (1997)

Lastly, I will briefly review one particular aspect of Richards (1997) which crucially bears upon the DP-internal NP movement of Chapters 2-4. In particular, since this study adopts a multiple specifier approach to phrase structure, a criterion such as Richards (1997) which dictates movement to multiple specifiers at the clausal level, is shown at various points in the dissertation to be applicable at the level of DP as well.

Richards looks at three types of multiple wh movement in the languages of the world: (i) Bulgarian-type languages where Wh movement is entirely overt (ii) Japanese-type languages where Wh movement takes place in the covert component entirely, and (iii) English-type languages which mixes up these two strategies, moving one Wh and keeping the rest *in situ*. Richards settles for the classic approach to the comparison of these systems and suggests that the difference and similarities<sup>25</sup> obtain by investigating the point of Wh-movement in these languages. In this connection, he looks at multiple Wh-movement and proposes that they must involve crossing rather than nesting paths in their movement to multiple specifiers of a single head. He shows that cyclicity as defined in Chomsky (1995) (see (50)) does not distinguish between crossing and nesting paths.

(50) A strong feature must be checked as soon as possible after being introduced into the derivation

---

<sup>25</sup> For example, Richards shows that Bulgarian and Japanese, as opposed to English, show similar syntactic behaviour since both involve movement within a single component – Bulgarian in overt syntax and Japanese in the covert syntax.

This principle together with the assumptions that Merge always expands the tree and that overt movement is due to the presence of a strong feature, derives the following sets of possibilities:

(51)a.

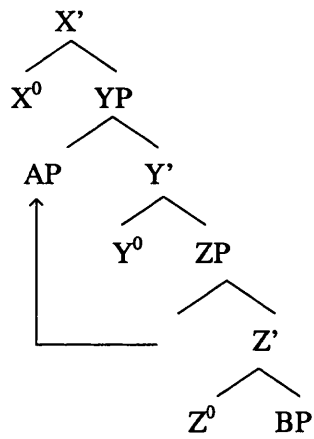

b.

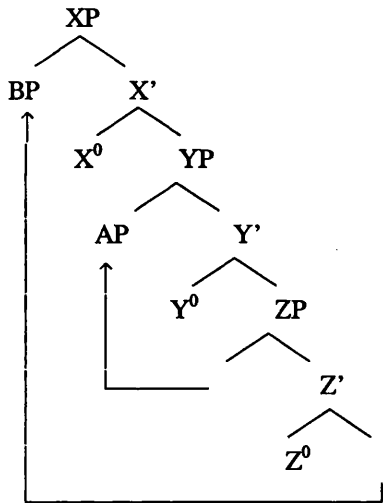

(52)a.

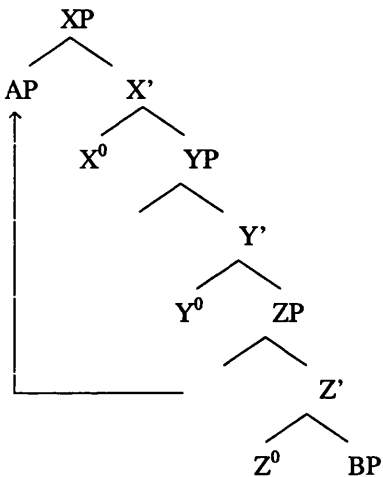

b.

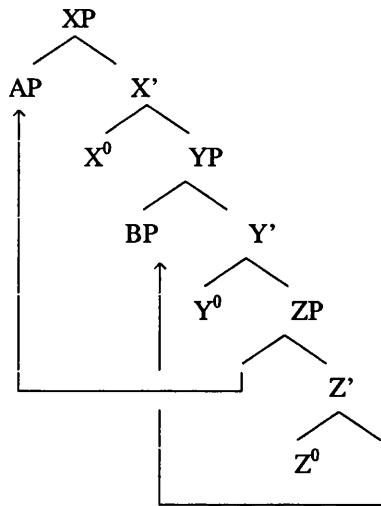

Both the derivations involve ZP with specs AP and BP to which heads X<sup>0</sup> and Y<sup>0</sup> with strong features are added. Notice that in (52) cyclicity is violated since BP moves to [Spec, YP] *after* XP has been projected. The condition in (50) therefore correctly rules out the configurations in (52).

However, movement to multiple specifiers of a single head may not be predicted in the same way by (50). Consider the following derivations:

(53)a.

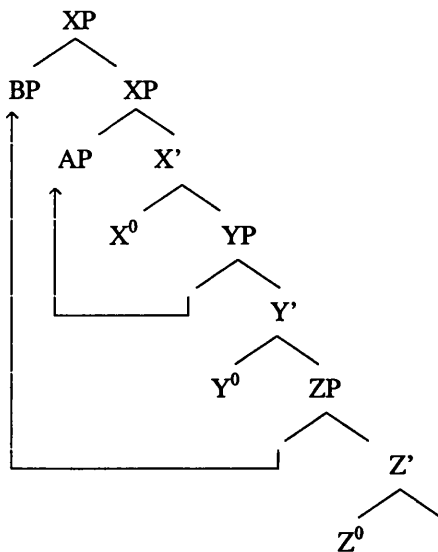

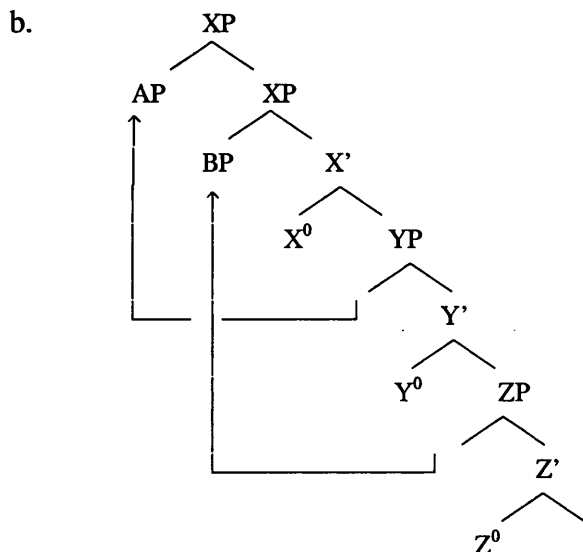

By the cyclicity principle of (50) as long as both XPs move to check a strong feature, either derivation is allowed. Richards claims that the specifier inside the one containing the AP is closer to the base position of BP (for (53b)) than the one outside AP and thus Shortest Move should require the derivation in (53b).

That this is the correct generalisation, is shown in Richards (1997: 63) by considering multiple Wh fronting in Bulgarian:

(54)a. koj kogo vizda

who whom sees

‘Who sees whom?’

b.\* kogo koj vizda

If we maintain that movement always expands the tree, we must conclude that a kind of “anti-superiority” effect is obtained in the derivation of (54), i.e., the lower Wh must move first. The other possibility is to move the lower Wh later to a lower specifier. Based on data from, among others, local and long-distance scrambling in Japanese, Richards shows that this is the correct generalisation. I refer the reader to Richards (1997) for details.

Based on this generalisation, I formulate the following principle:

(55) *Tuck-in*

If more than one XP checks feature(s) of a single head, then later XP movement targets inner specifiers.

I show that this principle is at work in deriving the right word order in DPs containing the quantifier *all* (see section 2.5 of the general Appendix) and in gerunds containing a negative element (see section 2.1 of Chapter 3 and various places in Chapter 4).

However, I depart crucially from Richards in the way (55) is derived. With respect to (53), it must be pointed out that by the formulations in MP the two specifiers are equidistant from a lower head position and movement to either count as legitimate movement. Richards is incorrect in deriving (53b) as preferable under MP. The derivations in Richards necessarily involve crossing rather than nesting paths. The point of similarity between Richards and *Tuck-in* is the mechanism by which an inner spec is “created” once the outer spec fills up, the manner in which the paths intersect is not crucial for the final configurations. This is evident in cases where (55) is applied to a Merge (to the outer spec) and a Move (to the inner spec) where the question of crossing does not arise. One example of this can be found in section 3.5 of Chapter 3.

Based on a modification in the definition of c-command suggested in Cinque (1996) (see Note 8 of the General Appendix) and Zwart (1993) which allows for multiple specifiers within an antisymmetric framework, I suggest that (55) above obtains a restriction on movement to these multiple specifiers in the essentially minimalist framework that this study adopts.

## Chapter 2

### Specificity and DP-Internal NP Movement

In this chapter, I offer a preliminary description of DP structure in Bangla in terms of specificity-related NP movement inside the DP. The chapter is organised as follows. In section 1.0, I discuss the layered structure of the DP in general and in Bangla in particular. In section 2.0, I justify the existence of a QP phrase as the layer intermediate between DP and NP. I propose the canonical DP structure of Bangla in this section with the caveat that I progressively unpack the DP structure further in the next chapter. The analysis of NP movement offered in this chapter however remains unaffected by refinements in the structure in the next chapter. Section 3.0 discusses the content of the Q-head of the QP that I propose in section 2.0. The next section (4.0) takes up for discussion the Adjective-Noun order and the status of the AP in the canonical Bangla DP and proposes that it should be seen as a specifier of NP. In section 5.0 I draw on Cinque (1996) and show that DP-internal NP movement follows from the Antisymmetry model. In the last section (6.0) I discuss the issue of specificity in Bangla and propose that specific NPs should move out of the NP-shell.

#### 1.0 The Layered DP

Most research on the syntax of DPs is concerned with the similarity between clausal and phrasal structure. A plausible hypothesis is that these approaches can be subsumed under a common structure like the following:

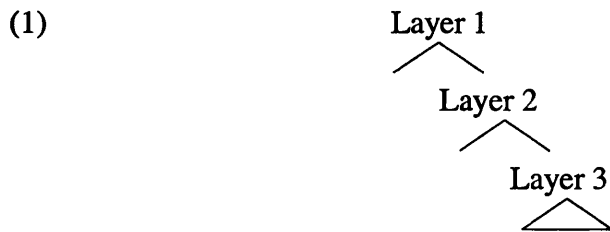

One major piece of research on noun phrases advanced the DP-hypothesis which made NPs look like the following (Abney 1987):

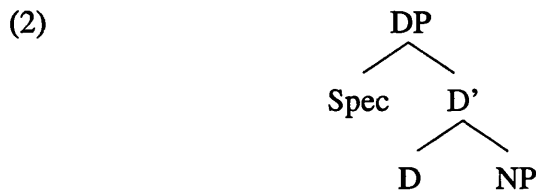

Abney argued that Noun Phrases are headed by the functional category of D(eterminer). D is in some way similar to INFL in accommodating an AGR feature. In the following sentence (3), for example, *John* gets Case in [Spec,DP] from the 's morpheme in D, similar to clausal subjects getting Case from INFL by specifier-head agreement<sup>1</sup>.

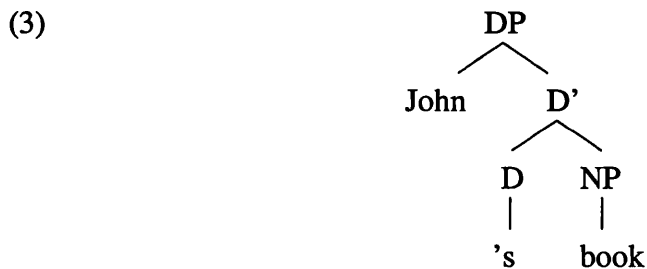

Szabolcsi (1983) had earlier argued in favour of an INFL head inside the Noun Phrase in her study of Hungarian possessor constructions. In (4a), the possessor

<sup>1</sup> See Kayne (1994: 85) for the DP structure (i) where the possessive 's is the N head of the NP selected by a [+DEF] D<sup>0</sup> and which selects a QP as a complement with an [-DEF] Q<sup>0</sup> head:

(i) [DP D<sup>0</sup> [NP [N 's [QP Q<sup>0</sup> NP]]]]

Such a structure is based on Szabolcsi's analysis (1981, 1983, 1994) of Hungarian possessives (see below) and accounts for *John's two pictures* where the D is phonetically empty. However, in the case of *Two pictures of John's* the QP *two pictures* has moved to [Spec,DP] and *of* inserted at D<sup>0</sup>.



which behaves like the subject in a clause receives its  $\theta$ -role in the [Spec,NP] position, and gets Case from an NP-internal INFL. The head Noun (*vendége*) in (4a) agrees in phi-features with its subject, just like the verb agreeing with the subject in a clause in (4b).

(4a) [DP a [NP Mari- $\emptyset$  INFL vendég-e- $\emptyset$ ]]  
       the Mary-NOM guest-POSS-3SG  
       ‘Mary’s guest’

b. Mari- $\emptyset$  alud-t- $\emptyset$   
       Mari-NOM sleep-PAST-3SG  
       ‘Mary slept’

She further argues that NPs in Hungarian also contain a pre-determiner, COMP-like, A’ position, thus making DPs similar to CPs. In (5) below, the possessor appears in front of the determiner and is marked for Dative Case.

(5) [DP Mari-nak a vendég-e- $\emptyset$ ]  
       Mary-DAT the guest-POSS-3SG  
       ‘Mary’s guest’

Her proposal regarding (5) is that the NP has moved to [Spec,DP] (or KOMP<sup>2</sup>) where it gets Dative Case. The Hungarian D<sup>0</sup> is capable of licensing Oblique Case (Dative, in this case) in its Spec. It is a movement from a thematic Case position to an A’-position.

This conclusion is based on crucial data such as the following:

<sup>2</sup> The Phrase Structure Rules proposed in this work were (i,a,b) where the INFL carried the [ $\pm$ Poss] as an AGR feature:

(i)a. NP’  $\rightarrow$  KOMP NP

b. NP  $\rightarrow$  *a*(z) NP’ INFL N’

In her (1987), the “hanging” definite article *a*(z) is given the status of D which is parallel to C at the clause level.

(6)a.\* a ki-Ø vendég-e-Ø  
 the who-NOM guest-POSS-3SG  
 ‘Whose guest’

b. ki-nak<sub>i</sub> a t<sub>i</sub> vendég-e-Ø  
 who-DAT the guest-POSS-3SG  
 ‘Whose guest’

(6b) shows that the WH-operator can only be a Dative possessor and it precedes the article. Since WH moves to [Spec,CP] typically in clauses, (6b) is assumed to undergo a similar movement to the nominal equivalent, [Spec,DP].

Subsequent research has concentrated attention on the region between the DP and the NP. These studies, more or less, propose the following structure for DPs:

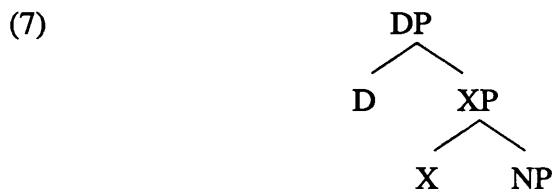

What is X? There has been no general consensus:

X = NumP (Ritter 1988 for Hebrew, Valois 1991 and Bernstein 1993a for French)

X = QP (Giusti 1991 for Romanian, Löbel 1989 for German)

X = KP (Sigúrdsson 1993 for Icelandic; Tang 1990 for Chinese for whom it is a “Klassifier” Phrase)

X = ArtP (Santelmann 1993 for Swedish)

X = BP (Dasgupta and Bhattacharya (1993), Bhattacharya (1995a,b), Bhattacharya and Dasgupta (1996) for Bangla where B stands for

“Badge”)

X= Agt<sub>GEN</sub>P (Siloni 1997 for Hebrew)

In fact, there has been a general proliferation (which means more than one XP between DP and NP) of functional projections within the DP structure.

Note, however, that in all these cases the DP structure has been modelled after the classical sentential structure as in (8).

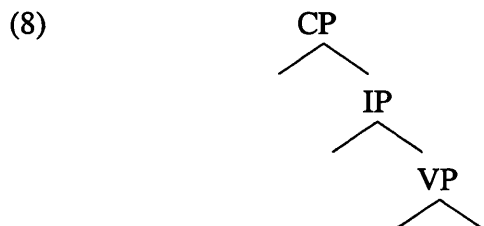

It is interesting to note, in this connection, that independent of the sentential structure above, research on nominals in general (that is, irrespective of the framework) has tended to report such tripartite partitioning in nominal phrases<sup>3</sup>.

### 1.1 Word Order inside the Bangla DP

Continuing with the assumption that (7), or the more general (1), is the null case, I will briefly look at Bangla.

Descriptively speaking, the Bangla DP consists of three distinct units as shown in (9). Notice particularly that numeral-classifier and adjective-noun are like independent units, although the word order is relatively free. To keep the account

<sup>3</sup>Rijkhoff (1990: 24), working within the Functional Grammar framework, suggests the following to be the canonical structure of the NP:

(i) [Ω1 .....[ Ω2 .....[ Ω3 .... ]]]

where Ω1, Ω2, Ω3 are operators that indicate “locality”, “quantity”, and “quality”, respectively, of the phrase and each of which has scope over a different part of the underlying structure. According to Rijkhoff, Ω3 indicates the “nominal aspect” of the phrase, expressed by primitive categories such as mass, count, collective etc. Quantifiers, cardinal numerals and number markers, on the other hand, being Ω2 operators, have scope over the qualified part, that is, the head, N, and its modifiers. Determiners are Ω1 operators and as such have scope over the quantified part of the phrase.

easy to follow, I will assume that all the phrases below have the same meaning.

- (9)a. [Dem] [Num-Cla] [Adj N]  
 ei tin-Te Sobuj boi<sup>4</sup>  
 this 3-CLA green books  
 ‘these three green books’
- b. [Dem] [Adj N] [Num-Cla]  
 ei Sobuj boi tin-Te
- c. [Num-Cla] [Adj N] [Dem]  
 tin-Te Sobuj boi ei
- d.? [Num-Cla] [Dem] [Adj N]  
 tin-Te ei Sobuj boi
- e.\* Num-*Dem*-Cla Adj N  
 tin-ei-Te Sobuj boi
- f.\* Num-Cla Adj *Dem* N  
 tin-Te Sobuj ei boi

There are more (im)possible orders but this is enough to show that there is enough freedom of movement as long as Dem, Num-Cla, Adj-N form three separate units. Thus in (9e,f), where the Num-Cla and the Adj-N units are interrupted by the Dem, clear cut unacceptability judgements obtain.

This piece of data leads to the descriptive conclusion that Bangla may also have a general three layered DP structure assuming that the tripartite linear structure reflects a tripartite hierarchical structure. In the next sub-section, I briefly discuss the nature of the middle layer, or the XP, in (7).

---

<sup>4</sup>For a key to the transcription see the list of abbreviation (p5).

## 1.2 Middle layer as Predicative

A proposal by Zamparelli (1996) instantiates the middle layer of (7) as a “Predicative Phrase” (PDP) as in the following structure:

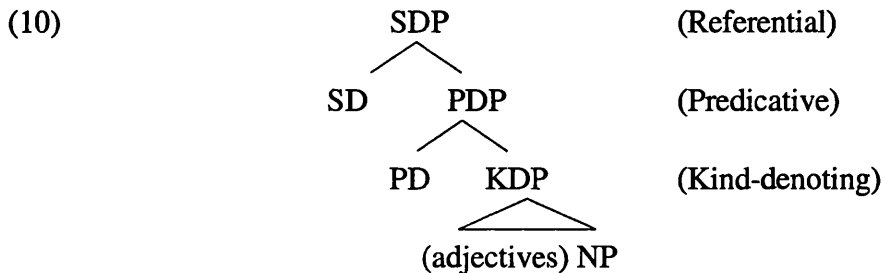

In (10) SD is the “Strong” Determiner head and PD is the “Weak” Determiner head<sup>5</sup>. SDP in this system is the only ‘referential’ part of the DP and is the locus of pronouns, demonstratives, proper names and strong determiners<sup>6</sup>. PDP denotes the predicative part of the DP. It is the locus of weak determiners: indefinites and numerals in their nonspecific reading. It denotes a property which forms the predicate of the DP or the restrictive clause part of a tri-partite structure (see note 27). KDP is the kind-denoting part of the DP, containing the NP proper.

<sup>5</sup> Strong and weak Dets are first discussed in Milsark (1974) who also gives a semantic distinction between the two types based on the notion of presuppositionality: strong Dets presuppose the existence of entities they are applied to whereas weak Dets are ambiguous and show an additional non-presuppositional reading where they assert the existence of the entity. By this criterion, strong Dets may include *the, every, all* and *most* and weak Dets may be *a, some, a few* and *many*.

<sup>6</sup> Zamparelli’s system includes numerals and (in)definites in their strong/ referential sense as part of this domain. However, according to Milsark (1974) weak terms can be ambiguous between a weak and a strong reading. This is shown in, e.g., *Two books* which can have a strong reading with the numeral/ quantifier indicating a partitive meaning, i.e. two out of a known set of books as in *Two (of these) books are on the table* or it could denote a weak reading with the subject NP in *There*-insertion context (classical test for weak Dets in Milsark’s system) *There are two books on the table*. Déprez (to appear) has demonstrated this difference among French N-words like *personne* in *Je n’ai vu personne* which may have a weak reading meaning *I didn’t see anyone* (the party was cancelled etc) and a strong reading with a covert partitive meaning with an assumed known set of people that I expected to see. Given that Bangla does not have an equivalent of the indefinite article, numerals typically follow the Dem (equivalent of the definite article in English) and therefore, I assume, have a weak reading. I will assume with Milsark and Déprez that weak terms may however display ambiguity and I further assume that this is played out at the PDP layer. This is pre-empted from the discussion of Bangla specifics to follow (section 6.0) which are shown to typically follow the Dem.

Given this partitioning<sup>7</sup>, it is reasonable to consider the unmarked “middle” unit in the Bangla examples to represent a predicative part of the DP. This is the Num-Cla cluster in (9a), the unmarked order.

Zamparelli’s arguments for noun phrases containing predicative material as in (10) carry over to indicate the predicative nature of the NP in Bangla as well.

- (11) (i) They can be negated (shown in (12))  
 (ii) They can be modalised. (shown in (13) and (15))

(12)a. A non-linguist

- b. Ek-jon n-astik  
 one-CLA non-believer

The example in (13) below can only have the (14a) interpretation where the modal has scope only over the noun phrase and not (14b).

(13) The doctor examined [a possible case of cholera]

(14)a. The doctors examined *something*, which possibly was a case of cholera

b. ≠ Possibly, the doctor examined a case of cholera (but maybe he didn’t examine anything at all)

(15) ukil ek-Ti SOMBhabito ghOTona peS korlen  
 lawyer one-CLA possible event present did

a. ‘the lawyer presented a possible event’

<sup>7</sup> It is interesting to note that Partee (1987) considers three basic NP-types, each a “bigger” set in some sense than the previous one: “referential” (denoted by <e>) as in *John, He, The man*, “predicative” (denoted by <e,t>) as in *a man, dogs*, and “quantificational” (denoted by <<e,t>,t>) as in *every man*. Since Bangla lacks either a definite/ indefinite article, the difference between the first two types is obtained, as the analysis in this chapter will show, configurationally and in terms of specificity. Moreover, the quantificational elements in Bangla are “weak” (e.g. they can appear with the predicate *consider* – the diagnostic for predicative NPs in Partee) and may therefore be considered part of the 2<sup>nd</sup> type. Therefore the NP-type divisioning may not be as neat as it seems. However, the reference here is intended to merely draw attention to the fact that a three-way divisioning perhaps has consequences beyond syntax.

b.≠ ‘possibly, the lawyer presented an event’

To conclude, I have shown in this subsection that there is predication between D and NP, that is, the “space” between DP and NP in a configuration like [DP.....NP] is predicative in nature. In proposing the DP structure, Abney (1987: 76) had similar intuitions to those implicit in (10) above:

the function of the Det is to specify the reference of the NP. The N provides a predicate, and the Det picks out a particular member of the predicate’s extension. The same function is performed in the verbal system by Tense, or Inflection. The VP provides a predicate, that is, a class of events, and Tense locates a particular event in time.

## 2.0 The Quantifier Phrase

The proposal outlined in this section suggests that this “space” denoted by the middle layer is uniquely occupied by a Quantifier Phrase QP. Löbel (1989) proposes a similar structure for German. She observes that the relation between the Q and the N is that of “countability” or rather the function of the category Q is to “ensure” the countability of the NP. For a [+Count] N, Q is morphologically realised as a plural suffix in English and German<sup>8</sup>:

- |        |                      |                       |        |       |
|--------|----------------------|-----------------------|--------|-------|
| (16)a. | drei                 | [ <sub>Q</sub> Ø]     | Bäum-e | COUNT |
|        | three                |                       | tree-s |       |
| b.     | drei                 | [ <sub>Q</sub> Stück] | Wild-Ø | MASS  |
|        | three                | head                  | game   |       |
|        | ‘three head of game’ |                       |        |       |

<sup>8</sup> Emonds (1987) expressed similar views in his Invisible Category Principle which states that *bright-er* expresses inflectionally what *more bright* expresses in terms of a separate word. The pair *\*(the) bad student* (count) versus *bad students* makes the same point that if a N is capable of expressing plurality, in the case of count Ns, it is expressed as an inherent syntactic feature which constitutes a functional projection.

In (16b) *Wild* is a non-discrete substance and the measure N *Stück* is inserted to quantify over the N whereas for *Bäum-e* the countability is marked by a suffix. Giving evidence from agreement inside the NP in German, she shows that quantifiers are heads. She also mentions that in numeral-classifier languages, the Q is lexically realised as Num+Cla.

The data in (9) shows that Bangla nominals consist of three units; additional data (see (17) below) show full noun phrases with the addition of the possessive (Poss). Taking (9) and (17) into consideration, I propose the initial structure of the DP as in (20).

- (17)a. tomar ei notun SaRi  
       your this new sari
- b. tomar ei SOb notun SaRi  
       your this all new sari
- c. tomar ei kOek-Ta notun SaRi  
       your this some-CLA new sari
- d. tomar ei tin-Te notun SaRi  
       your this three-CLA new sari

So a full noun phrase has the following order of constituents:

- (18) Poss D Num/Q-Cla Adj NP

Assuming that numerals and quantifiers are quantifying expressions, then their occurrence at the same position is not surprising. Moreover, these two different kinds of quantifying expressions can never co-occur<sup>9</sup>:

<sup>9</sup> See however, the General Appendix where I investigate the nature of the universal Q *SOB* 'all' in Bangla and suggest that they may be considered not as Q heads but as specifiers of QP. Consequently this will allow *all* to co-occur with some Q(+CLA) sequences – exactly the case in examples like *SOB kO-Ta boi* "all some-CLA book" 'All the books'. Notice that such a modification maintains the truth of the statement regarding (18) above, namely, that Q heads and



(19)\* tomar ei kichu tin-Te notun SaRi

your this some 3-TA new sari

Furthermore, if we assume that the possessive phrase *tomar* occupies the [Spec,DP] position at some stage of the derivation, as is assumed in standard DP literature (Abney (1987), Ritter (1988), Miyagawa (1993)) then we have a structure like the following:

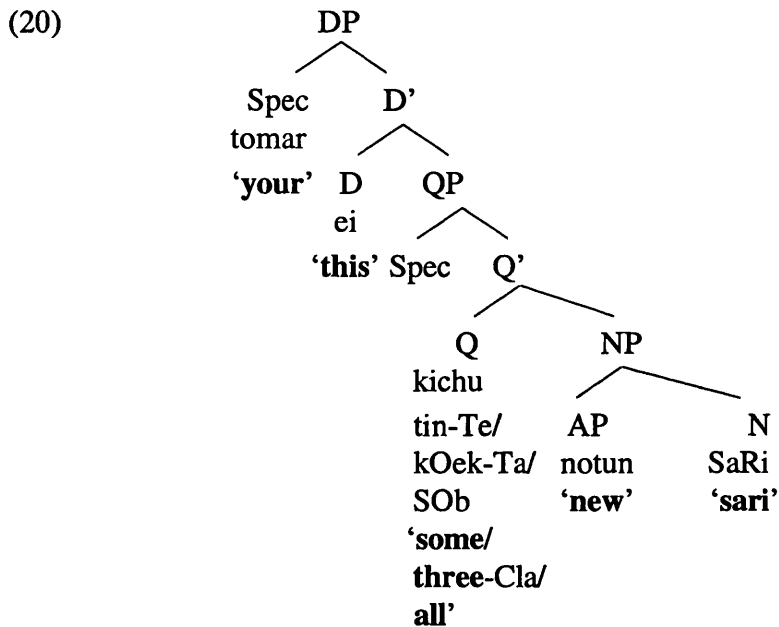

In this structure I have shown the Dem to be at the head of the DP. This will be the structure of the DP used in the rest of this chapter with the caution that I analyse Dem as *not* the D head in the next chapter based on data from DP-internal deixis and focus inside the DP. The arguments for analysing Dem as an XP can be found in section 3.0 of chapter 3. Consequently, no attempt is made here to provide evidence one way or the other for the position of the Dem in this chapter. The rest of the DP proposed here and the analysis of NP movement in section 6.0 are not contingent upon this simplification. However, it may be noted here that the D and

---

numerals never co-occur.

the specifier of the DP do not show any agreement in this structure. Note that this is similar to the lack of *wh* agreement in English.

The head-initial word order presumed in (20) is expected given that we have adopted the LCA for reasons outlined in Chapter 1 (see section 2.3 and 2.4). Furthermore, we observe the following with respect to the DP-structure above:

- The placement of classifier expressions (as in Num-Cla sequences) in the Q head (section 2.0 and 3.0)
- Status and the placement of the adjective in relation to the noun (section 4.0)
- Genitive subject of the DP in [Spec-DP]

In addition to the sections noted, I discuss the issue of specificity in Bangla DPs in section 6.0 and postpone a discussion of the genitive Case of the subject till the next chapter. I also show in section 5.0 that DP-internal NP movement in SOV languages is a natural consequence of adopting the LCA.

### 3.0 Q/Num-Cla Sequence as a Quantifier<sup>10</sup>

This section discusses the nature of the Q head and the claim that Num-Cla (and Q-Cla) in Bangla is part of the QP domain. In the following I show that a quantifier followed by a cliticised *Ta* appears to quantify over, in the sense of having scope over, whatever follows it in the maximal sequence noted in (18), namely, a N (as in (21)) or a zero N (as in (22)). Consider the following cases of Q-Cla sequences:

- (21)a. kichu-Ta      doi  
           some-CLA    curd

---

<sup>10</sup> In the general Appendix to this dissertation, I discuss the viability of splitting up the complex Q head into two separate heads Q and Cla based on evidence from behaviour of the Q *SOB* 'all'.

- b. SOb-Ta      doi  
       all-CLA     curd
- c.  khanik-Ta    doi  
       some-CLA   curd
- d.  Onek-Ta      doi  
       a-lot-CLA   curd
- e.  kOto-Ta            doi  
       how much-CLA    curd
- f.  Oto-Ta        doi  
       so much-CLA    curd

Let us now see how these combine with verbs:

- (22)a. kichu-Ta      dekhechi  
       some-CLA     seen.1  
       ‘I have seen some’
- b.  SOb-Ta        dekhechi  
       all-CLA      seen.1  
       ‘I have seen all’
- c.  khanik-Ta     dekhechi  
       some-CLA    seen.1  
       ‘I have seen some’
- d.  Onek-Ta        dekhechi  
       a lot-CLA    seen.1  
       ‘I have seen a lot’

e.? kOtok-Ta            dekhechi  
       how much-CLA    seen.1  
       ‘I have seen so much’

f.    Oto-Ta            dekhechi  
       so much-CLA    seen.1  
       ‘I have seen that much’

The examples in (22) above are similar to the set in (21) if we consider that the verb in (22) “governs” a zero N. More crucially, we see that in (21) the Q involved quantifies over Ns, whereas in case of (22) the Q quantifies over the “zero” N. Consider also the following set of data where the Q-Cla sequence seems to quantify over an adjective:

(23)a. dilli-er            cee    *kichu-Ta*    *bORo*  
       Delhi-GEN    than    somewhat-CLAbig  
       ‘Somewhat bigger than Delhi’

b. ag-er            cee    *khanik-Ta*    *bhalo*  
       before-GEN    than    a little-CLA    good  
       ‘A little better than before’

c. ekhan theke *Onek-Ta*    *dur*  
       here    from    a lot-CLA    far  
       ‘Quite far from here’

The data above shows that a Num/Q-Cla sequence is followed either by an N (21), a zero N (22), an Adj (23), or Adj-N (17c,d). In other words the maximal sequence noted in connection with (20) for DP can account for the data above. The data also show that the Num-Cla sequence acts as a Q.

### 3.1 Headedness of the Q

I discuss the five grammatical criteria for Head determination in Zwicky (1985). In view of the framework adopted for this study, these reduce to three in the context of the behaviour of the Num-Cla complex which I take to indicate both Num-Cla and Q-Cla sequences.

The five criteria discussed in Zwicky are as follows<sup>11</sup>:

- (i) Agreement
- (ii) Obligatory constituent
- (iii) Distributional Equivalence
- (iv) Subcategorizand
- (v) Governor

In the following discussion, it will become clear that (ii) and (iii) are variants of each other<sup>12</sup> and that (iv) and (v) reduce to one property when translated in terms of Merge. However, whether reducible or not, these criteria establish the headedness of Num-Cla.

(i) *Agreement*: Zwicky claims that the dependent triggers agreement with the head, as found in languages with object agreement. In the context of Bangla, which shows only person concord at the clause level, the shape of the classifier morpheme used in the DP is the only remnant of agreement. Thus, in (24) below, the classifier chosen is determined by some feature of the N; names of the classifiers are

---

<sup>11</sup> Zwicky also discusses Morphosyntactic locus as another criterion by which an element bearing the morphosyntactic markers which enable the constituent to link to a bigger constituent is identified as the head. However, in the context of DP-internal material in a language without agreement, it is difficult to see the usefulness of such a criterion and I will, therefore, keep it out of the discussion.

<sup>12</sup> See Hudson (1987) for a similar argument

indicated as below:

- (24)a. du-To chele/ boi [General Classifier<sup>13</sup>]  
 two-CLA boy/ book  
 ‘two boys/ books’
- b. du-jon chele/ \*boi [Human Classifier]  
 two-CLA boy/ book
- c. du-khana \*chele/ boi [Inanimate Count Classifier]  
 two-CLA boy/book

This data with the statement that the choice of the Q in Q-Cla is determined by whether the following N is mass/ count (see (16) above for German, and examples in (21, 22) for Bangla) shows that Num-Cla is a head.

(ii) *Obligatory constituent*: The Head should be the obligatory constituent in the unit. The data in (25) shows that only Num/Q and the Cla together can act as a head by this criterion:

- (25)a. \*du/ \*To/ du-To chele  
 two/ CLA/ two-CLA boy
- b. \*kO/ \*jon/ kO-jon chele  
 some/ CLA/some-CLA boy

(iii) *Distributional Equivalence*: A head is the constituent that belongs to a category with roughly the same distribution as the construct as a whole. This

<sup>13</sup> *Ta* is the default form of the common classifier which has various allomorphs governed by phonological conditions (see Dasgupta 1983 for details):

(i) *Te* occurs with ‘three’ and ‘four’ as in *tin-Te* ‘three-CLA’, *car-Te* ‘four-CLA’ – historically *car* is derived from /*cari*/ with the high vowel at the end which raised *Ta* to *Te*; in free variation with *Ta* in *ei/oi-Ta/Te*, ‘this/that-CLA’ where the exact transcription should be *ey/oy* for the Dem denoting a high glide

(ii) *To* occurs only with ‘two’, again, explained in terms of vowel harmony

(iii) *Ta* occurs with the rest of the numerals and with other Ns.

derives from (ii) above since if the head is the obligatory constituent it is obvious that it will have “roughly”<sup>14</sup> the same distribution as the construct, and certainly more than the dependent.

(iv) *Subcategorizand*: An element that requires a subcategorization frame is a head. For example, in V+NP construction, V requires a subcategorization frame and is therefore the head. This requirement is satisfied by the same examples under (i) above if we consider that the NPs are selected by the Num-Cla complex. I suggest that this requirement, together with the next criterion, falls out of the way Merge operates.

(v) *Governor*: Head is the constituent that governs the grammatical form of its sister constituent. Zwicky claims this to be different from (iv) as the form of the complement defined by government does not enter into semantic interpretation.

Given that in the Minimalist framework there is no scope for a rule of lexical insertion based on subcategorization frames, and because of the elimination of government, it is desirable to derive (iv) and (v) from some other source. If a numeration selected from the Lexicon to construct a DP is (26), then a derivation as in (27a) crashes as the animate Cla *jon* cannot be merged with a non-human N; the derivation in (27b) which selects a human complement goes through:

(26) N = {du-jon ‘two-CLA’, boi ‘book’, chele-er ‘boy’s’ }

(27)a. {du-jon, boi}

{chele-er, {du-jon, boi}}

\*<du-jon boi chele-er> or \*<chele-er du-jon boi><sup>15</sup>

<sup>14</sup> See Croft (1996: 37) for questioning the use of this term (and other criteria of Zwicky and for suggesting an alternative).

<sup>15</sup> Both orders may be produced depending on whether there is Move after the first Merge, I have ignored various details which are not relevant for the point being made.

b. {du-jon, chele-er }

{boi, {du-jon, chele-er}}

<du-jon chele-er boi> or <boi du-jon chele-er>

A matching of features between the Num-Cla and the following N must be established for the derivation to proceed. Although many questions remain unanswered, it is nevertheless possible to derive the criteria of subcategorization and governor from this feature matching requirement of Merge (see Merge as feature-checking discussed in Chapter 1, section 4.3).

### 3.2 Quantifier Float<sup>16</sup>

Consider the following data involving a Q/Num-Cla sequence (the data can be replicated for other Qs and Numerals):

(28)a. ami boi du-To t dekhechi

I book two-CLA seen

'I have seen the two books'

b. Se bhat kichu-Ta t kheyechi

S/he rice some-CLA eaten.3PPL

's/he has eaten some of the rice'

I will consider this as a case of movement of the NP *boi* 'book' and *bhat* 'rice' to the left of the Q inside the DP. The analysis offered in section 6.0 will crucially involve this leftward movement of the NP to account for the specificity effect that is obtained inside the DP.

For the present, notice that (28) above is syntactically related to the

<sup>16</sup> See Bobaljik (1998) for an over-view of the phenomenon.



following<sup>17</sup>:

(29)a. ami du-To boi dekhechi  
I two-CLA book seen-1P

‘I have seen two books’

b. Se kichu-Ta bhat kheyechi  
s/he some-CLA rice eaten-has-3P

‘S/he has eaten some rice’

Comparing (29) and (28), we see that (28) gives the effect of a “floating” quantifier. By “effect” I mean stranding of the quantifier. Consider in this regard an example of floating quantifier in French (Sportiche 1988: 426).

(30)a. *tous* les enfants ont vu ce film  
all the children have seen this movie

b. les enfants ont *tous* vu ce film  
the children have all seen this movie

In (30b) the quantifier *tous* appears dislocated (and therefore “floated”) from its position in (30a) where it modifies the DP [*the children*]. These sentences are identical at some level of representation since the universal force of the floated quantifier (FQ) *tous* is identical in both sentences. Therefore the relation between the two sentences must be captured. This is done in Sportiche (1988) through a transformational account (the so-called “stranding” analysis) which springs from the supposition that FQ and D must be a single constituent at the D-structure level.

Sportiche’s (1988) analysis of the structure of this construction shows that there is no actual “floating” of the quantifier involved, rather the following can

<sup>17</sup> See Notes 6 and 7 of Chapter 1 in this connection.

uniquely determine the occurrence of floating Qs:

(31) (Floating) Qs may appear in [D]P-initial position (Sportiche, 1988:427)

That is, Q-float results in stranding the Q in a position adjacent to the trace of DP.

This would independently follow from the VP-internal subject hypothesis. The sentence in (30b) would be represented by this criterion as in (32a), its D-structure as in (32b) falls out from the clause structure that Sportiche proposes ((32a) below.

(32)a les enfants<sub>i</sub> ont [tous t<sub>i</sub>] vu ce film

b.

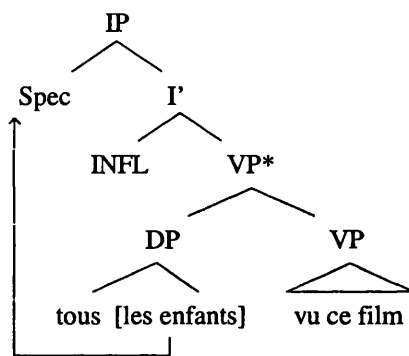

If the subject of a clause originates in the VP-internal position, then according to Sportiche's analysis, this subject NP moves out, stranding the Q. For this reason, FQs have been widely discussed to predict the D-structure position of the subject. I would like to suggest that it can be used equally well as a diagnostic for determining the Q-ness of a Q.

Now, let us look at (28) again which is reproduced below as (33) for convenience:

(33)a. ami boi du-To t dekhechi

I book two-CLA seen

'I have seen the two books'

- b. Se bhat kichu-Ta t kheyechē  
 S/he rice some-CLA eaten  
 's/he has eaten some of the rice'

As mentioned earlier, the 'object' NP in the above sentences shifts out from their base-generated position to a higher position. This would give us the pairs (*du-To,t*) and (*kichu-Ta,t*) which follow the pattern (FQ, t) as in (32). Based on Sportiche's analysis and incorporating Bobaljik's (1995: 131) claim that object-oriented FQs *are* possible in object-shift languages, I conclude that NP shift in (33) above leaves the Q stranded.

The fact that Q-float in DPs follow the same pattern is shown in Shlonsky's (1991) work on Q-DPs in Hebrew (one example is discussed in the General Appendix). Finally, Miyagawa's (1988) analysis of Japanese numeral quantifiers (NQs) draws a very similar conclusion which strengthens the claim made here regarding Num/Q-Cla. Miyagawa observed that an NQ occurring to the right of the DP it modifies could be dislocated from it if the DP is a subject of an unaccusative (34a) or a passive verb (34c) but that the DO may not intervene between the transitive subject and an NQ (34b)<sup>18</sup>:

- (34)a. Gakusei-ga kyoo san-nin kita  
 students-NOM today 3-CLA came  
 'Three students came today'
- b.\*? Gakusei-ga hon-o san-nin katta  
 students-NOM book-ACC 3-CLA bought  
 'Three students bought books'

<sup>18</sup> Miyagawa, however, argues against a single-constituent analysis of the NQ and the associated DP. See Kawashima (1994) for a single-constituent analysis.

- c. Yuube, kuruma-ga doroboo ni 2-dai nusum-are-ta  
 last night, cars-NOM thief by 2-CLA steal-PASS-PST  
 'Last night, two cars were stolen by a thief'

Miyagawa assumes that the Numeral-Quantifier must be in a relation of mutual c-command with the DP it quantifies over at D-structure. Since both unaccusative and passive subjects are derived from VP-internal positions, the NQ can c-command the DP-trace in both (34a) and (34c) but not in (34b). Notice that adopting an LCA type structure does not invalidate the conclusions reached by Miyagawa even though mutual c-command is not available as an option anymore. Instead, if we consider the ungrammaticality of (34b) due to the subject failing to c-command its trace then since the object is required by LCA to move up leftwards anyway, I assume it moves up one step further and lands between the subject and its trace.

These examples can be replicated for Bangla which proves that the Num-Cla constituents in Bangla are like FQs and are therefore by definition, Qs:

- (35)a. chatro<sub>i</sub> aj tin-Te t<sub>i</sub> eSechilo  
 studenttoday 3-CLA came  
 'three students came today'
- b.\* chatro boi tin-Te enechilo  
 studentbook 3-CLA brought  
 'three students brought books today'
- c. gaRi<sub>i</sub> cor dara car-Te t<sub>i</sub> curi gEche  
 car thief by 4-CLA theft gone-PASS  
 'four cars were stolen by the thief'

The conclusion that Q/Num-Cla sequences are, therefore, to be thought of as belonging to the domain of QP is evident from their behaviour as FQs.

#### 4.0 The Adjective-Noun Order

In this section, I will present a short review of the literature on the position of the adjective inside the DP and in the process elaborate on the position of adjectives in Bangla, shown earlier in the structure in (20).

There has been considerable research on the topic of the order of Adj with respect to the noun and on the topic of adjectival agreement (Abney (1987), Cinque (1992) (published as Cinque (1995)), Valois (1991), Bernstein (1991), (1993a,b), Guisti (1993), Delsing (1993), Kester (1993), Taraldsen (1990), Svenonius (1993), Holmberg (1993), Sigurdsson (1993), Bhattacharya (1995a,b), Corver (1997), etc). I will report some of the research below which is of relevance for the position I take in this work.

We will concentrate our attention on attributive adjectives. There are three major positions taken with regards to attributive Adjectives (see Delsing (1993) for a short review):

- (i) specifiers                    (Jackendoff (1977), Giorgi and Longobardi (1991), Cinque (1994) and Longobardi (1994))
- (ii) heads                        (Abney (1987), Kester (1993), also Bernstein (1993b))
- (iii) adjuncts
  - (a) adjoined to NP        (Valois(1991),Svenonius (1993), Bernstein (1993b))
  - (b) adjoined to N'        (Fukui (1986))

I will briefly discuss (i), (ii) and (iii) as the three major strands and evaluate each

in turn.

#### 4.1 Adjectives as Specifiers

This was the earliest position on the issue, although in Jackendoff's theory specs have no special status. But Giorgi & Longobardi (1991) concentrate on thematic APs and based on their analysis of these APs showing subject like behaviour, they assume them to be in specs. Later, Cinque (1994) advances our understanding of the order of various types of adjectives within the DP and proposes that thematic APs are generated as specs of N and other modifying adjectives as specs of various functional projections to the left of N. I will try to show in this subsection that this stand, uncomplicated and attractive though it may be, is unwarranted for Bangla given the reasons to be discussed shortly. However, the position of Adj that I adopt for this study is derivative of Cinque (1994).

He proposed that the base position of the AP in both Romance and Germanic is to the left of the N and their different surface position is to be attributed to the raising of the N in Romance (but not in Germanic) to a functional head intermediate between N and D, across some of the APs:

(36)a. [D...[AP Y [AP N]]] (Romance)



b. [D...[AP Y [AP N]]] (Germanic)

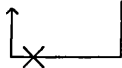

In favour of this proposal, Cinque argues that thematic APs (like *Italian* in the following example) which express the external  $\theta$ -role of a N and are thus supposed to occupy the canonical subject position, exhibit the distribution pattern as in (37)

which can arise most naturally if it is derived as in (38):

- (37)a.\* L'italiana      invasione      dell'Albania  
           the Italian      invasion      of Albania
- b.    L'invasione      italiana      dell'Albania
- c.\*    L'invasione      -dell'Albania-      -italiana---

- (38) [DP ... [NP l'italiana [N' invasione dell'Albania]]]<sup>19</sup>
- S                    N                    O
- 

This analysis is strengthened by the fact that N movement to higher functional heads inside DPs has been independently proposed in numerous studies: Semitic (Ritter (1988), (1991), Siloni (1991), Fassi Fehri (1993)), Scandinavian (Taraldsen (1990), Kester (1993), Santelmann (1993) etc), Celtic (Duffield (1995), (1996)) and Bantu languages (Carstens (1991)) – where clear cases of N to D movement have been proposed.

Cinque further shows that different types of APs are hierarchically structured and the N can occur between different APs (indicated by \* in the following example):

- (39) [XP AP<sub>SPEAKER-ORIENTED</sub> \* [YP AP<sub>SUBJ-OR</sub> \* [ZP AP<sub>MANNER/THEMATIC</sub> \* [NP N ...

This strict ordering coupled with the apparently universal ordering restriction shown by different classes of APs as in (40) is used by Cinque to argue strongly against the adjunction analysis since adjunction is normally intended to be free. He favours the spec-analysis of APs which does not need any stipulation for the observation that APs are to the left of the head.

<sup>19</sup> It is also possible to get this order by heavy NP-shifting the complement to the right of the AP. However, Cinque mentions (1994: 86) that given the obligatory nature of the movement, a head to head movement is more natural than re-ordering of XPs.

(40)a. Evaluating Size Colour N (AN ordering)

beautiful big red ball (English)

schoener grosseroter Ball (German)

b. Evaluating Size N Colour (ANA ordering)

un joli gros ballon rouge (French)

una bella grande palla rossa (Italian)

In particular, (40b) derives from the same basic ordering of APs with the additional N movement between two APs in the case of Romance.

The Bangla data in (41), however, does not show N movement across Adjs:

(41)a. Sombhoboto<sub>[SPK]</sub> tatkhonik<sub>[MANN]</sub> ghOTona

probable immediate event

a'.\* Sombhoboto<sub>[SPK]</sub> ghOTona<sub>i</sub> tatkhonik<sub>[MANN]</sub> t<sub>i</sub>

probable event immediate

b. Sundor bORo lal bOl

beautiful big red ball

b'.\* Sundor bOl<sub>i</sub> bORo lal t<sub>i</sub>

beautiful ball big red

b''.\* Sundor bORo bOl<sub>i</sub> lal t<sub>i</sub>

beautiful big ball red

Additionally, one objection to Cinque's analysis as pointed out by Delsing (1993: 107) regards the status of the empty functional head of the intermediate maximal



projections holding the APs in their specs. Cinque suggests that strong features of gender and number of the N in Romance derive the word order difference in terms of overt checking. However, as pointed out in Arnaudova (1996: 9), this does not explain the prenominal position of Bulgarian Adjs which nonetheless show strong features of gender and number on the N.

Given this objection and the Bangla facts in (41), I will assume that the attributive AP is generated as a spec of the NP<sup>20</sup> which retains the advantages of Cinque's model without generating extra heads. The position of the adjective in Bangla is therefore as noted in the DP structure proposed in (20), partially elaborated here as (42):

(42)

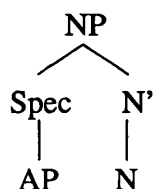

## 4.2 APs as Adjunction

Valois (1991) and, to some extent Bernstein (1993b), take up this approach. Valois proposes different adjunction sites depending on the type of the adjective in a DP structure such as (43) where *No* is a nominalising affix head. Adjectives are classified into three classes and depending on their class membership, adjectives are base-generated at different levels in the NP. Valois' analysis springs from his analysis of adjective classes (and their relative ordering) as similar to adverb classes. APs, therefore, are a case of adjunction since adverbs are. The different adjunction sites of different classes of adjectives that he proposes are as follows:

<sup>20</sup> One way of stacking APs, given the Antisymmetry framework, would be to progressively stack them as spec-of-specs. However, I do not explore the intricacies of the proposal here.

(43)

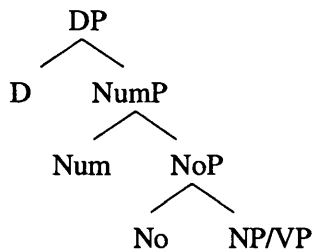

- (i) to NumP (probable class)
- (ii) to NumP/NoP (frequent class)
- (iii) to NoP/NP (complete class)

$N^0$  movement (to Num in Valois' case) derives the post-nominal appearance of adjectives in French. The prenominal position of adjectives on the other hand is a result of adjunction of the adjective to the H noun.

For Bernstein, adjectives, are base-generated in the prenominal position for Romance languages as in Valois. However, she uses the notion of a Word Marker Phrase which has the Word Marker (WM) as the head. This WM head, by overt movement, achieves adjectival agreement in these languages<sup>21</sup>. Bernstein too offers different sites of Adj adjunction depending on the type of adjective. Like Valois, Bernstein gives a head  $A^0$  analysis of certain adjectives (e.g. *mero* 'mere' in Spanish/ Italian which can appear only pre-nominally<sup>22</sup>. This is true of English as well).

Apart from the problems noted for the adjunction analysis in general in the

<sup>21</sup> The motivation for WM head is not very clear since movement of the N (e.g. *libro*) to Num as shown in (i) below does not have any obvious advantage over an analysis where the "Word Marker" is part of the Num head to which the N moves in the same way as in (i). I refer the reader to Bernstein (1993b) for details.

(i)  $[DP\ un_k\ [_{NumP}\ [QP\ t_k]\ [_{Num}\ libr_j\ -o_i]\ [_{WMP}\ t_i\ [_{NP}\ rojo\ [_{NP}\ t_j]]]]]$

<sup>22</sup> One property among the properties Bernstein lists for these prenominal adjectives is their inability to occur in predicative contexts (see (ia) of Spanish); in Bangla however, it is possible to use such adjectives predicatively ((ib)):

(i)a.\* el accidente es mere  
 b. ekTa durghOTona matro  
 one-CLA accident mere  
 'A mere accident'

previous section, Cinque (1994: 104) points out that some of these Adjs (e.g. *solo* ‘only’ in Italian) can be crossed over by proper Ns:

(44)a. \*Sola Maria si è presentata

b. Maria sola si è presentata

‘Only Maria showed up’

I have nothing more to add to the relevance of this criticism to Bangla here except the observation that if indeed APs occupy a position between D and N, ‘object’ movement noticed in section 3.0 (and discussed in detail in 6.0) would move the whole AP to a higher spec as in (45):

(45) [<sub>DP</sub> ei [<sub>QP</sub> [<sub>AP</sub> Sobuj [<sub>NP</sub> SaRi]]<sub>i</sub> du-To t<sub>i</sub>]]

this green sari two-CLA

‘these two green saris’

In such a case there would be no strong reason for the AP to move to a higher spec since Adjs in this language are neither distinguished in terms of  $\pm$ DEF/ SPECIFICITY (as in Scandinavian languages) nor do they participate in agreement with the head N.

### 4.3 Adjectives as Heads

We have already seen proposals of ADJs as heads in the previous section. One motivation for suggesting that adjectives are A<sup>0</sup> heads that take an NP complement is the phenomenon of adjectival inflection in Romance and adjectival agreement in other languages (shown in (46) for Spanish and Hindi). The other reason being the property of Adjs blocking D to N movement in Scandinavian (shown in (47) for Norwegian).

- (46)a. el/ las chico/ chicas alto/ altas  
 the boy/ girls tall.MAS.SG/ tall.FEM.PL (Kester 1993)
- b. lambii/ lambaa laRkii/ laRkaa  
 tall.FEM/ tall.MAS girl/ boy
- (47)a. et/ det (\*huset) stort/ store<sup>23</sup> hus/ huset (Kester 1993)  
 a/ the (\*house-the) big house/ house-the  
 'the big house'
- b. [DP det [AP store [DP hus<sub>i</sub> -et [NP t<sub>N</sub>]]]]

This analysis presumably predicts, for the same reason, why the lower D<sup>0</sup>, unlike the higher one, cannot select an AP complement. However, such a prediction would imply a difference between the two D<sup>0</sup>s in terms of their selectional properties -- an unwanted consequence for the X-Bar theory. Also, the agreement between the non-phi feature on the Adj is triggered by the definiteness feature of the complement DP which is not a checking domain in the current framework.

Anticipating somewhat the analysis of specificity in Bangla proposed in section 6.0, which takes specificity as a matter of the domain of QP, it is possible to give an account of the data in (47) above by considering APs as being in a Spec-NP configuration. If we consider Q as the position of the suffixal article *-et*<sup>24</sup>, then the following derivation accounts for the adjectival agreement as spec-head checking in terms of a definiteness feature of the Q head:

- (48) 
$$\begin{array}{c} \text{DP} \\ \wedge \end{array}$$

<sup>23</sup> The difference between the two forms of the adjective is due to the marker of definiteness *-t* present in one. Although this is typical of Scandinavian languages, the presence of such (non-phi) features is common in Dutch as well (see Kester 1993): *de lange jongen* 'the tall boy'.

<sup>24</sup> See Santelmann (1993: 161) for a similar positioning of the suffixal article in the head Art which is in between D and N. However, my suggestion based on the definiteness feature checking on the Adj by the Q head derives independent support from the analysis of Bangla specificity offered in this chapter.

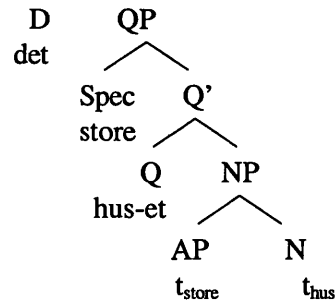

#### 4.4 Adj-N in Bangla

The proposal for spec of NP as the position for the adjective in Bangla takes care of the descriptive fact that the Adj-N unit may not be broken. The data from section 1.1 is repeated below:

- (49)a. ey      duTo      Sobuj SaRi  
           this    two-CLA    green sari  
           'these two green saris'
- b.      ey      Sobuj SaRi    duTo  
           this    green sari    two-CLA  
           'these two green saris'
- c.\*    ey      Sobuj duTo      SaRi  
           this    green two-CLA    sari

Bangla thus disallows any leftward movement of the adjective.

The phrase in (49b) is derived from (49a) as follows:

(50)

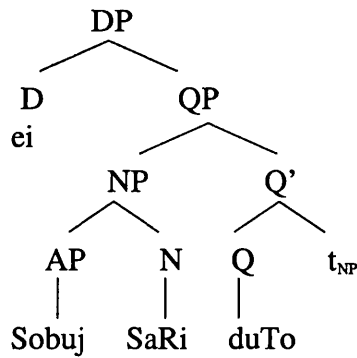

That is, the whole NP is moved to [Spec,QP] to derive the specific order. Notice that NP movement leaves the Q stranded as in cases of Q-float (section 3.2) which provides additional justification for treating Num-Cla structures as QPs. Two questions arise which I deal with in the next two sections:

- (i) Why does NP move instead of the N inside the DP in Bangla?
- (ii) What drives this leftward movement?

With regard to (i), I show that LCA derives the putative (DP-internal) universal that NP moves (and N does not) in H-final languages and I propose (51) below with regard to (ii) which I justify in the next section.

(51) A presuppositional/ specific feature of the Q head drives leftward movement.

I will show in the next section that (51) in Bangla is independently needed.

## 5.0 DP-internal NP Movement in H-Final Languages

Cinque (1996: 452) demonstrates that Greenberg's (1966) Universal 20 (as in (52) below) is accommodated naturally within the Antisymmetry framework of Kayne (1994).

(52) When any or all of the items (demonstrative, numeral and descriptive adjective) precede the noun they are always found in that order. If they follow,

the order is either the same or its exact opposite.

A clue to this asymmetry comes from Hawkins (1983) (reported in Cinque 1996).

Hawkins observes that in prepositional languages if the Dem follows the N then

Adj follows the N too and if the Num follows the N then Adj follows the N too.

These are interpreted as follows by Cinque:

- (53)a. N-Dem & N-A (Swahili, Fulani, Bahasa Indonesian, ...)
- b. Dem-N & N-A (Maori, Baure, Douala, Tunen, ...)
- c. Dem-N & A-N (Greek, Maya, Norwegian, ...)
- d\* N-Dem & A-N
- (54)a. N-Num & N-A (Swahili, Douala, Tunen, ...)
- b. Num-N & N-A (Maori, Baure, Bahasa Indonesian, ...)
- c. Num-N & A-N (Greek, Maya, Norwegian,...)
- d.\* N-Num & A-N (Cinque 1996: 453)

Cinque proceeds to show that this can be explained if we adopt the structure (55)

as the base structure and derive different orders by raising N to higher functional

heads.

(55)

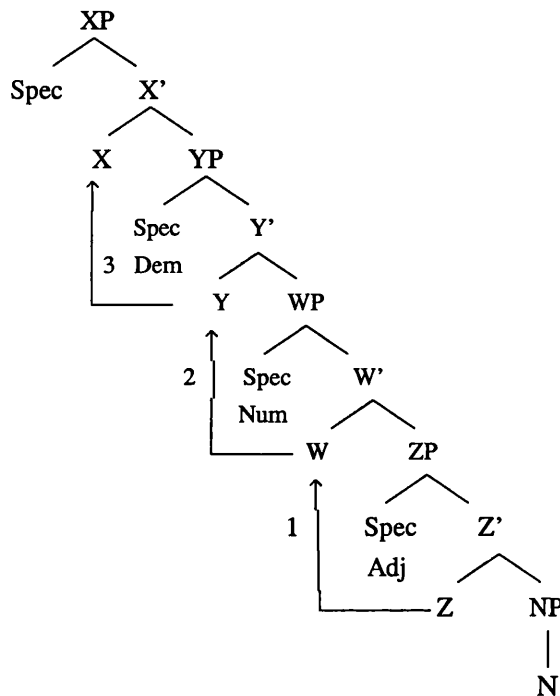

The head N either remains in-situ or moves to W as in 1 (in Maori for example) and derives the order in (53b) and (54b); Y as in 2 (in Douala e.g.) giving the orders (53b) and (54a); X as in 3 (in Swahili e.g.) giving the orders (53a) and (54a).

Hawkins' predictions for postpositional languages translate into the following patterns:

- (56)a. N-Dem & N-A (Selepet, Mojave, Digueño, ...)
- b. Dem-N & N-A (Burmese, Kabardian, Warao, ...)
- c. Dem-N & A-N (Burushaski, Hindi, Japanese, ...)
- d.\* N-Dem & A-N
- (57)a. N-Num & N-A (Selepet, Mojave, Kabardian, Warao, ...)
- b. Num-N & N-A (Burmese, Hixkaryana, Ubykh, ...)
- c. Num-N & A-N (Burushaski, Hindi, Japanese, ...)
- d.\* N-Num & A-N (Cinque 1996: 455)



This can be explained in terms of the same base structure as in (55), and then either nothing moves to derive the order Dem>Num>Adj>N as in Hindi, or there are a number of leftward movements of the complements of the functional Z, W, Y of (55) to spec positions on intermediate XPs<sup>25</sup>:

(58)

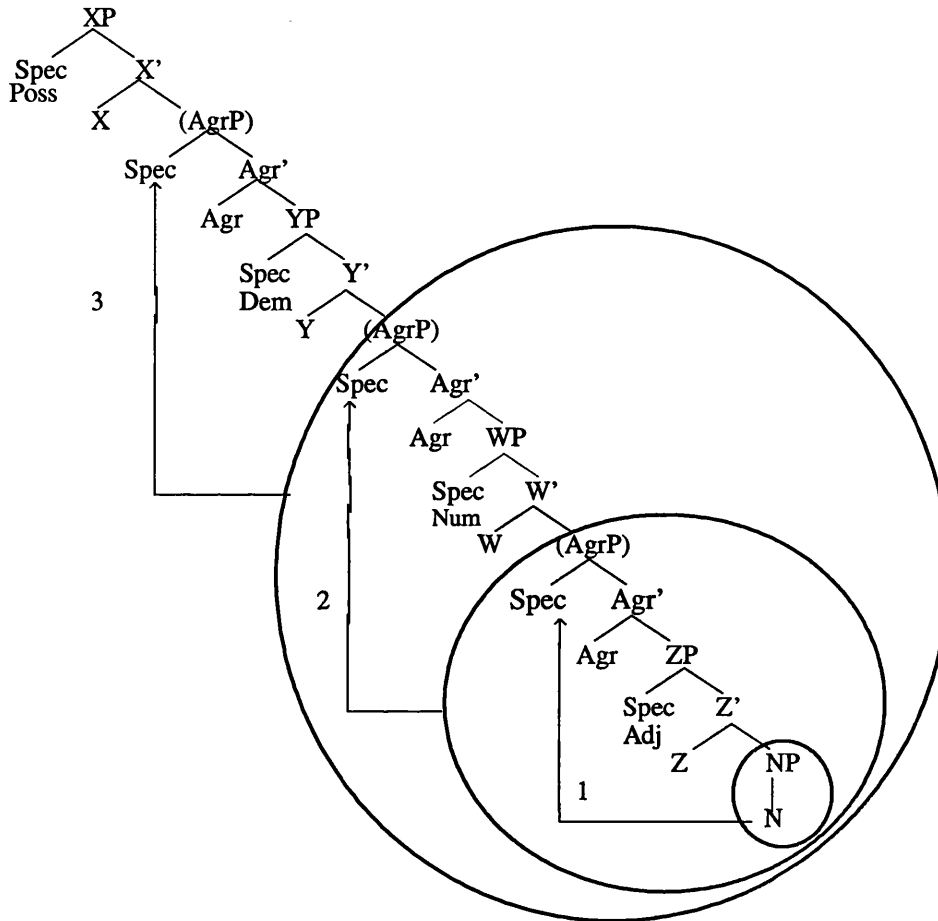

Given that successive leftward XP movement is typically found in head-final languages (see proposals in Kayne (1994: 52ff) for deriving final complementisers), these sets of movements are licit. The fact that intermediate steps in (58) are also attested supports the derivation. For example the orders Dem-N-Adj-Num is found

<sup>25</sup> If postpositional languages are considered to be left branching, with specs on the right and with rightward movement, as shown in (i), one would expect that DemN implied AN, thus ruling out the postpositional languages in (56b):

(i)  $[_{NP} N] Z [_{ZP} Adj ZP] W [_{WP} Num WP] Y [_{YP} Dem YP] X [_{XP} XP] \dots$

in postpositional languages like Kabardian and Warao and Dem-Num-N-Adj attested in Burmese, Kokama and Ubykh (see Hawkins (1983) for details).

Although many questions remain<sup>26</sup>, especially with regards to the status of the AgrPs in (58), it nevertheless establishes the independent finding of this thesis, namely, that in head-final languages XP movement (of which NP movement is a special case) instead of N movement inside the DP is the expected norm.

## 6.0 Specificity Related NP Movement

In this section, I discuss the second question raised at the end of section 4.0, i.e. what drives leftward NP movement in specific DPs in Bangla and suggest that a feature [SPECIFICITY], part of the featural make-up of the head Q, the head between D and N is responsible for this.

Let us first identify the nature of specificity involved in the language under consideration. For most authors (e.g. Heim (1982), Fodor and Sag (1982), Enç (1991), Ludlow and Neale (1991), among others), specificity essentially presumes an identified discourse referent. With regard to South Asian languages, Mahajan (1990) gives a purely syntactic definition of specificity in terms of Case marking by Agr<sub>o</sub>; Case-marked objects of all predicates, agreeing objects of perfective participles and psych-predicates are specific by definition. Kidwai (1995) shows that it is not the case that all DPs that trigger verb agreement or are Case-marked are necessarily and unambiguously definite in Hindi. Since Bangla does not show

---

<sup>26</sup> For example, unpredictable orders in Welsh, Berber, Hebrew, Basque among others, are discussed in Cinque (1996: 16, 20ff) and noted in the various typological studies like Hawkins (1983), Dryer (1988), and may be derived in terms of a different set of movements (e.g. skipping step 2 would derive the Num>N>Adj>Dem order found in Basque) or a lower origin of Dem, but they remain contentious nonetheless.

number/gender agreement, there is no obvious way of implementing Mahajan's proposals for Bangla. At least for Bangla I agree with Kidwai that Case and agreement facts alone cannot decide the specificity effect. It may be noted that the core of the specificity effect (movement of the object NP out of the VP) that Mahajan discusses can be imported into the type of theory that Diesing (1992) discusses which, in essence, forces all presuppositional material out of the VP in LF.

Note that in Bangla sentences like (59), the moved object (in a sense to be made precise below) gives a presuppositional/ specific reading (as in (59a)). If specificity is a matter of presuppositionality then (59a) below shows a specific use of *boi* 'book' since it must have a prior discourse reference.

(59)a. ami    boi    du-To        dekhechi

I        book two-CLA    seen.1

'I have seen the two books'

b.        ami    du-To        boi    dekhechi

I        two-CLA    book seen.1

'I have seen two books'

The phenomenon connected with the movement of the object, therefore, is specificity. However, as will become clear in the course of the discussion that follows, I consider this movement of the object as a purely DP-internal phenomenon. That is, I claim that clausal specificity in Bangla is readable from the DP-internal specificity which a consequence of the movement of the 'object' of the DP inside the DP. The movement of the clausal object outside VP has nothing to do with specificity as it is independently required by adopting LCA for a head-final

language.

### 6.1 Presuppositionality as a Semantic source for Specificity

In this subsection, I first discuss Diesing's (1992) notion of specificity which is equated with presuppositionality, and then propose that this notion can be imported for similar effects inside the DP since, as we have seen, the internal structure of the DPs involved have a crucial role to play in determining the specificity effect of the clause as a whole.

The typology of determiners (as in Milsark (1974)) is a force behind Diesing's (1992) formulation of the Mapping Hypothesis, a "tree-splitting" algorithm: material from the VP is mapped onto the nuclear scope and material from IP is mapped onto the restrictive clause at LF<sup>27</sup>. In particular, the ambiguity of the weak determiner *some* in (60) below between a cardinal (nonpresuppositional) and a quantificational (presuppositional) reading, as opposed to the non-ambiguity of a presuppositional/ quantificational reading of the strong determiners *every* and *most* in (61) cannot be captured in a unified QR analysis à la May (1985).

(60)a. There are some men in my house

(unstressed *some*, asserts the existence of men)

b. *Some* men are in the room, the others are in the attic

(presupposes the existence of men)

---

<sup>27</sup> The notion of semantic splitting of a sentence into quantifier, restrictive clause and a nuclear scope is taken from Kamp (1981) and Heim (1982). In a sentence like (i), the logical form in (ii) indicates the restrictive clause in square brackets and *banana* is in nuclear scope:

(i) Every llama ate a banana

(ii)  $\text{Every}_x [x \text{ is a llama}] (\exists_y) y \text{ is a banana} \wedge x \text{ ate } y$  (Diesing 1992: 7)

(61)a. Every boy roasted marshmallows

b. Most boys sleep late

Diesing suggests that QR may be amended to allow for the strong/weak distinction of the determiner system such that strongly quantified DPs raise to IP by QR as in May's system whereas weakly quantified DPs are ambiguous. On their cardinal reading (like (60a) above) they do not induce QR (in the sense of adjoining to IP). DPs with weak quantifiers may remain within the VP. On their presuppositional reading, weak quantifiers behave just like strong Qs as they are raised to IP by QR to form a tripartite quantificational structure (Diesing 1992: 61).

The theory thus provides a syntactic definition (at LF) of presupposition. By considering the essential semantic content of specificity to be presuppositionality, Diesing accounts for the specific interpretation of Indefinite subjects in Dutch and objects in Turkish, in certain syntactic contexts. Let us consider this proposal in terms of the following Bangla data which shows that it is possible to equate specificity with presuppositionality.

(62)a. ami du-To chele-ke dekhechi

I two-CLA boy-DAT seen.1

'I have seen two boys'

b. ami chele du-To-ke dekhechi

'I have seen the two boys'

The DO *chele* 'boy' in (62b) presupposes a prior discourse mention of its reference. The presuppositional nature of the DO in (62b) is clear if we consider the fact that (62b) cannot be an answer to a question like (63) since it does not presuppose the existence of two boys:

(63) tumi ki dekhecho?

you what seen

‘What have you seen?’

This constitutes the evidence that specificity effects in Bangla can be subsumed under a Diesing-type presuppositional analysis. The pair in (62) additionally shows that Case alone cannot decide the specificity of the DP since it is marked with the Dative in both cases although only (62b) is specific.

In the case of Turkish, Enç (1991) identifies the Acc Case marker *-(y)i* as a marker of specificity. The following discourse fragment from Enç shows that presuppositionality and specificity are closely related semantic notions, with very similar syntactic representations.

(64)a. odam-a birkaç çocuk girdi

my-room-DAT several child entered

‘Several children entered my room’

b. İki kız-ı tanıyordum

two girl-ACC I-knew

‘I knew two girls’

c. İki kız tanıyordum

two girl I-knew

‘I knew two girls’

(64b) can be only be felicitous in the context provided in (64a), the intended meaning, therefore, can only be partitive. That is, in (64b) the two girls must be from the set of children introduced in (64a) whereas (64c) can only be used to introduce two new girls into the discourse. Given that partitivity is a test for

presuppositionality, this is expected. Since presuppositionality is linked to the formation of the restrictive clause by the mapping hypothesis, Turkish objects must appear outside the VP by LF.

As declared at the end of section 6.0, I import this notion of NP movement from the base position into DP internal syntax and suggest that as specificity in Bangla is marked not via Case marking but by the relative position of the NP in question, this mapping takes place in the overt syntax *inside* the DP. Therefore, for our purpose, movement outside the NP within the DP counts as a reflection of the mapping hypothesis as applicable inside the DP. The implied claim is that clausal specificity is a property of the DP specificity in this language. The specificity effect in Bangla thus derives from NP movement inside the DP<sup>28</sup>. It may be mentioned that subject DPs are, for the purpose of specificity determination, identical in all respects to object DPs.

## 6.2 Leftward NP-movement in Bangla DP

Let us now look closely at instances of this movement noticed earlier:

(65)a. oi      duTo      Sobuj      SaRi

those two-CLA green      sari

'those two green saris'

b.      oi      Sobuj SaRi      duTo

those green sari two-CLA

'those two green saris'

(Lit. *those green saris two*)

<sup>28</sup> This is evident from the observation that the Q head is contained well inside the DP in Bangla (e.g. it is preceded by both the Dem and the Poss, see section 2.0 for details).

Note that the specificity of the DP in (65b) is not clear from the English translation. However, in (65b) where the (object) NP has moved out of its base position, the phrase is felicitous only if the object has a prior discourse reference.

I extend Diesing's analysis here to suggest that a specific NP moves out of its immediate NP to a higher position. Notice that (65b) indicates a specific reading of the NP *Sobuj SaRi* 'green sari'. The N is specific or presuppositional in (65) and therefore it must move up. This leftward movement of the NP is shown in (50) above.

The following example where a weak quantifier (*kO-Ta* 'some' in (66b)) makes the DP non-specific overriding the presence of the Dem, shows that the Dem is not a major site for specificity in Bangla.

- (66)a. *ritu ei boi-gulo kineche*  
 Ritu this book-CLA bought  
 'Ritu bought these books'
- b. *ritu ei kO-Ta boi kineche*  
 Ritu this some-CLA book bought  
 'Ritu has bought some books'<sup>29</sup>

Based on this observation, I propose that the landing site for the moved NP *Sobuj SaRi* 'green sari' in (65b) from its base-generated position is [Spec,QP]:

<sup>29</sup> This may be similar to the use of Dem in an English sentence like: *There was this man from Lancashire*. However, the Dem *this* in this use is indefinite but specific. Notice also that by the *there*-test of Milsark (1974), the determiner here must be considered weak. I have no explanation for this anomaly.



(67)

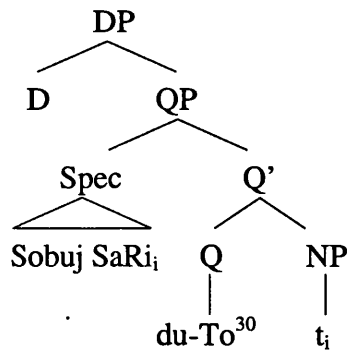

### 6.3 The nature of the [SPECIFICITY] feature

An important question to ask at this point is: What drives this movement? Since movement in the framework adopted for this work (Chomsky (1995)) is feature-

<sup>30</sup> Most of the examples so far have avoided the use of the numeral 'one'. Observe the following minimal pair in this connection:

- |                 |            |               |
|-----------------|------------|---------------|
| (i)a. Ek-Ta boi | b. boi-Ta  | c.* boi Ek-Ta |
| one-CLA book    | book-CLA   | book one-TA   |
| 'A/ one book'   | 'The book' |               |

The above data shows that (b) is the specific variant rather than the expected (in parity with (65b)) (ic). The existence of (ib) has led earlier researchers to posit TA as a marker of definiteness paralleling the English gloss. In terms of the theory proposed here, the specificity effect of (ib) is due to the overt object shift similar to the case in (66b). The Num of Num-Cla in case of (ib) is "understood" to be 'one' where the derivation of the specific (ib) can start with a 'silent' numeral understood to be 'one'. For the non-specific reading (ia), the understood numeral is actually instantiated for PF reasons (since the general classifier *Ta* must cliticise onto a Num/Q host). The type of Num selected for the derivation, quite possibly, has a role to play in the derivation. Note, in this connection, the following set of data:

- |                           |                    |
|---------------------------|--------------------|
| (ii)a. aRai-Te biskuT     | b.* biskuT aRai-Te |
| 2½-CLA biscuit            | biscuit 2½-CLA     |
| 'Two-and-a-half biscuits' |                    |
| c. Egaro-Ta boi           | d.* boi Egaro-Ta   |
| eleven-CLA book           | book eleven-Cla    |
| 'Eleven books'            |                    |

The examples in (ii) show that for the object shift to take place, the Q must contain a small, whole numeral like two, three or an understood one. *aRai* 'two-and-a-half' in (iib) is not a whole number and *Egaro* 'eleven' in (iid) is not small. This property of the numeral, first noticed in Dasgupta (1983), can be accommodated in a feature-based theory by suggesting that the [SPECIFICITY] feature must satisfy certain appropriate conditions. There is some indication that this may be the case. Historically, Qs/ Nums start out their lives as heads of their constructions, the modified Ns being in genitive subordinate phrases (see Croft (1996: 60) on this) but later on the N becomes the head and the Num a modifier. The reanalysis is [Num [N-gen]] > [Num N]. Greenberg's (1978) Universal 47 suggests that in synchronic state of languages, higher numerals act as independent heads. It is possible then to think of lower numerals in Bangla carrying an attractor feature (in the sense of Chomsky (1995)) missing in higher numerals. However, this reasoning must be modified to include the case of fractions like (iib) above. Needless to say, at this stage of the work this remains a speculation.

driven, the movement in (67) above must involve a feature. Let us look at (51) again carefully. In connection with (51), I mentioned the option of dealing with a feature of specificity or presuppositionality.

I propose that a feature of [SPECIFICITY] on the Q head (containing *du-To* as above) ATTRACTS the NP to its spec as shown in (67), giving rise to the specific reading. I assume that when the [SPECIFICITY] feature of Cla is not selected the DP is non-specific as in (65a), similar to Collins and Thráinsson's (1996) assumption regarding the optional character of the strong N feature of Agr<sub>o</sub> in Icelandic Object Shift at the clausal level.

Since movement is feature-driven, the default option would be to formulate a mechanism for the movement observed in (67) in terms of a feature. Let us assume that a filled Q comes with an optional feature of specificity in the numeration<sup>31</sup>. Following Chomsky (1995: 277) we will assume that optional features are added arbitrarily as the LI enters the numeration. In the present theory, this option is exercised by the Q in a specific DP in Bangla.

Again, essentially following Chomsky (1995: 281) since the features of the target which enter into checking relations are non-interpretable, I assume that the Q head bears a -Interpretable syntactic feature of specificity and therefore, must be checked at the latest by LF. Any difficulty in construing specificity as non-interpretable although the prevalent notion of specificity is of interpretability must be disbanded since it is a configurational property of the Bangla. In addition,

---

<sup>31</sup>An alternative possibility would be to suggest that specificity be represented by a constant +Intp feature and the marked word order for specific DPs be considered as a result of a strong +N feature on the same head. I would like to suggest that since the specificity effect obtained in Bangla is configurational/ syntactic, it is best represented as a -Intp feature which displays, to quote Chomsky (1995: 278) "the special role of the property of displacement of categories that is characteristic of human language". Also, it avoids invoking another feature like +N on the Cla head.

associating non-interpretability with a fundamentally interpretable notion is not uncommon in the framework, for example, the feature Q in MP. To ensure that the checking occurs in overt syntax, I assume further that this optional feature which is picked up by a Q as it enters the numeration is STRONG.

Optional features are standardly accepted in Chomsky (1995: 368), where the non-substantive categories T and  $\nu$  may optionally carry a strong [nominal] feature which, like the optional [SPECIFICITY] proposed here, is –Interpretable. In this system, optional features are chosen when needed for convergence in accordance with the economy principle which states that an item  $\alpha$  enters a numeration only if it has an effect on output. That is, optional features are added when the numeration is formed<sup>32</sup>.

Only when a Q is morphologically present, can a [SPECIFICITY] feature be optionally selected. That this is so is shown immediately below in (68) and (69).

So far we have observed that numeral expressions in Bangla always carry a cliticised Classifier *Ta*. There are, however, certain classifierless Num-N sequences in the language. The following examples are from Dasgupta (1983):

- (68)a. du      deS-er      moitri  
           two    country-GEN    friendship  
           ‘friendship between two countries’
- b.     tin      caka-r      gaRi  
           three    wheel-GEN    vehicle  
           ‘three-wheeled vehicle’
- c.     tin      bOchor

<sup>32</sup> Collins (1997: 93) who rejects the notion of numeration, suggests a couple of alternatives for incorporating optional features.

three year

'three years'

d. car paS

four sides

'Four sides'

e. tin dik

three direction

'three directions'

A similar classifier-less [Num N] sequence appears in the following measure expressions:

(69)a. du gOj

two yard

b. tin hat

three hand/arm

'three cubits'

c. car miTar

four metre

d. paMc peala ca

five cup tea

Note that, crucially, in none of these phrases can the NP move leftward to give a specific reading. The following, therefore, are not possible:

(70)a.\* deSer dui moitri<sup>33</sup>

b.\* cakar tin gaRi

<sup>33</sup> Note that we are concerned here with the 'subject' DP *dui deS-er* 'two country's' and not with the 'object' NP *moitri* 'friendship'. Similarly for the next example.

- c.\* bOchor tin<sup>34</sup>
- d\* paS car
- e.\* dik tin
- f.\* gOj dui<sup>35</sup>
- g.\* hat tin
- h.\* miTar car
- j.\* ca paMc peala<sup>36</sup>

I take this data to mean that the Q head in these cases, lacking a classifier, never exercises the option of picking up a specificity feature when it enters the numeration. Note two things about these examples: Q lacks a classifier element, and the NP cannot prepose across the Q. These two facts --- the absence of the classifier morpheme and the absence of leftward NP movement -- are correlated. The account that I propose explains this correlation by giving the option of choosing a non-interpretable formal feature of specificity for the computation only when Cla is morphologically present in the syntactic Q-head.

Now consider the nature of this feature. Since I presume this feature to be [-Interpretable], it must be checked in a Spec-Head configuration either in the covert or the overt component. In the immediately preceding discussion, I have shown the need to endow the Q head of QP with a specificity feature as a lexical option made available if Cla is morphologically present. Does this mean that the post-Cla NP must move leftward whenever Cla occurs morphologically? No, for in the nonspecific DP examples in (62a) and (65a), the post-Cla NP remains in-situ

---

<sup>34</sup> The order is acceptable for a 'vague' meaning like *three years or so*; however, a vague meaning is far from a specific meaning

<sup>35</sup> The order in (70f) gives a vague meaning as in (70c)

<sup>36</sup> That the order gives only a topicalised meaning (and not a specific meaning), is strengthened by the fact that there is a distinct pause after *ca* 'tea'.

despite the presence of Cla. Choosing among formal possibilities, I assume that in a given derivation, the option of assigning the strong specificity feature to the Cla may or may not be exercised. But once such feature assignment has taken place, there is no further choice. The complement NP must prepose overtly to check this strong feature. This account assumes a standard mechanism to drive the movement of NP to the Spec of QP. If, however, the numeration contains a nonspecific Cla, then there is no need for feature checking and hence no overt preposing in the case of nonspecific (62a) and (65a).

Now consider the cases in (68) and (69). These DPs are without a classifier. According to the analysis presented above, the Q head in these DPs cannot carry any feature of specificity. The impossibility of using classifiers with these expressions is a morphological reflection of this fact. Why? Because the absence of classifiers precludes the choice of the strong specificity feature for Q. The point that (68, 69) help establish is that, in the absence of classifiers, the Q bears no attractor feature that could trigger complement NP preposing.

This indicates that specific NPs cannot occur in Bangla, even though their features would be interpretable, unless they enter into a checking relation with a specific classifier. It may be interesting to note that in the next chapter I investigate the nature of DP-internal deixis and suggest that both specificity and deixis are syntactic effects that obey a Generalised Licensing Criterion which requires that *both* (and not either) the spec and the head of a functional projection must be filled to obtain certain DP-internal syntactic effects. The notion of specificity discussed in this section satisfies such a condition.

It may be of interest to point out that the Ns in these expressions seem to

form a class of their own. These are similar to the bare adverbs discussed in Larson (1985)<sup>37</sup>. Temporal NPs that Larson discusses include ‘calendrical’ Ns where particular intervals of calendar years function as proper Ns for temporal periods. This is true of our example in (68c). Larson also discusses these NPs functioning as location, direction and manner which can include our (68d,e). For the NPs in (68a,c), ‘relation’ is a possible function that may also be included into the special class of Ns<sup>38</sup>. As for (69), measure phrases form a class of their own<sup>39</sup>.

Larson’s specific proposal is to do with a [+F] feature of this special class of Ns which can assign OBLIQUE Case to its own NP. That is, these NPs get their Case assigned by their own heads. This proposal can be incorporated in the minimalist program where Case/ agreement is established through a mechanism of feature-checking.

To conclude, what I have suggested is the following: If there is no morphological Cla, there is no strong feature of specificity in the complex Q head. If there is a morphological Cla, then it has the option of picking up a strong non-interpretable feature of [SPECIFICITY] which then effects the leftward movement of the post-Cla NP.

---

<sup>37</sup> Larson discusses the following types of NP adverbs:

- (i) I saw John [that day]/ [someplace you’d never guess]
- (ii) John headed [that way]
- (iii) Mary pronounced my name [every way imaginable]

<sup>38</sup> Notice the use of the GEN Case marker with the relevant examples bearing this function.

<sup>39</sup> Whether Measure Phrases project a phrase of their own is not dealt with in this chapter. See in this connection Corver (1990) and Zamparelli (1996) and references contained therein.

## Chapter 3

### Kinship Inversion and NP Movement

#### 1.0 Introduction

This chapter introduces a fully worked out structure for the Bangla DP in the light of data from, among others, kinship terms. Specifically, I show that the possessive (Poss) is generated lower in the DP and ends up in its derived position of [Spec,DP] for reasons of feature checking. As a consequence, different types of NP movements within the DP are distinguished, in particular, a distinction is made between nP and NP movement. I show that while the DP-internal movement discussed in the previous chapter is nP movement followed by Poss-movement, Kinship Inversion (KI), the main focus of this chapter, involves NP movement alone. This distinction leads to a prediction regarding the nature of DP-internal deixis obtained. The chapter begins by resolving the derived and base position of the Poss and proceeds to propose that the demonstrative (Dem) is an XP occupying the specifier of a 'focus-related' head F located between the D and the Q head.

#### 2.0 Derived Position of the Possessives

I will begin the discussion by consider the position of the possessive (Poss) inside the DP in Bangla. The structure of the DP proposed in Chapter 2 is supported by (1). In particular, (1) would support a structure like (2) where the Poss *amar* 'mine' is in [Spec,DP] and the Dem *ei* 'this' is in D.



- (1) ama-r<sup>1</sup> ei tin-Te notun Sari  
 my-GEN this two-CLA new sari  
 'these three new saris of mine'

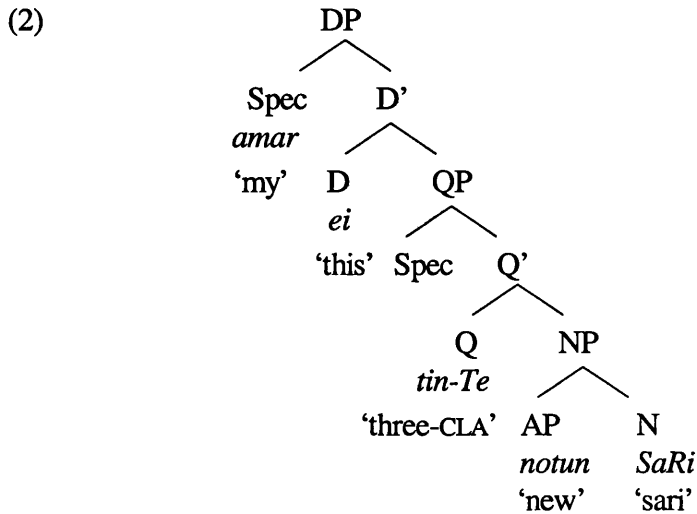

The following phrases also support the structure in (2):

- (3)a. ram-er gaRi  
 Ram-GEN car  
 'Ram's car'

<sup>1</sup> I will consider possessives, as understood in well-known languages like English (e.g. *John's*), and possessive pronouns as similar and not different in Bangla in terms of their status and Case marking. Notice, for example, that both *John's* and *my* get the same Genitive Case marker *-(e)r*:

- (i)a. jOn-er                      b. ama-r  
 'John's'                      'my'

This implies that the difference suggested in Longobardi (1994) between pronouns and names, based on an earlier suggestion in Postal (1969), is not maintained in this study. Longobardi concludes that pronouns occupy D underlyingly whereas nouns are generated at N and may raise, under certain circumstances, to D. Significantly, he shows that this movement takes place in Italian in the absence of articles, suggesting that the landing site of this movement is D:

- (ii)a. La sola Maria si e presentata                      (iii)a.\* La sola lei si e presentata  
 'Only Maria showed up'                      'Only she showed up'  
 b. Maria sola si e presentata                      b. Lei sola si e presentata

That is, while the (proper) noun can precede the Adj (in the absence of the article) as in (iib), the pronoun must (iii). Longobardi suggests that the derived position of both the (proper) noun and the pronoun is D. Since Bangla on the one hand lacks an article and on the other, does not show the asymmetry of (ii) and (iii) above, I will assume that the possessive pronoun versus possessive noun asymmetry does not obtain in the language.

b. toma-r            du-To            lal        boi  
       you-GEN        two-CLA        red        book  
       ‘your two red books’

c. rakhal-er        bORo    bhai  
       Rakhal-GEN    big        brother  
       ‘Rakhal’s elder brother’

In the structure (2) the ‘subject’<sup>2</sup> of the above DP *amar* ‘your’ is in the [Spec,DP] position. Note that the subject of the DP must get genitive Case. The proposal that genitive Case is checked at the [Spec,DP] position is fairly standard (Ritter 1988, Miyagawa 1993, among others). One indirect piece of evidence for the fact that genitive Case is checked in [Spec,DP] comes from the following contrast:

(4)a. ama-r            ei        gan  
       my-GEN        this     song  
       ‘this my song’

<sup>2</sup> The observation that genitives behave as subjects is apparent in Cinque (1994) who asserts that thematic APs are not DP ‘subjects’ (contrary to Kayne (1981) or Giorgi and Longobardi (1991)) based on the following observation that the N does not move across the thematic adjective *americana* but does across genitive subject *di Bush* in the following example (i). The respective derivations are shown in (ii):

(i)a.\* La reazione ostile americana alle critiche  
       the reaction hostile American to criticism

b. La reazione ostile di Bush alle critiche

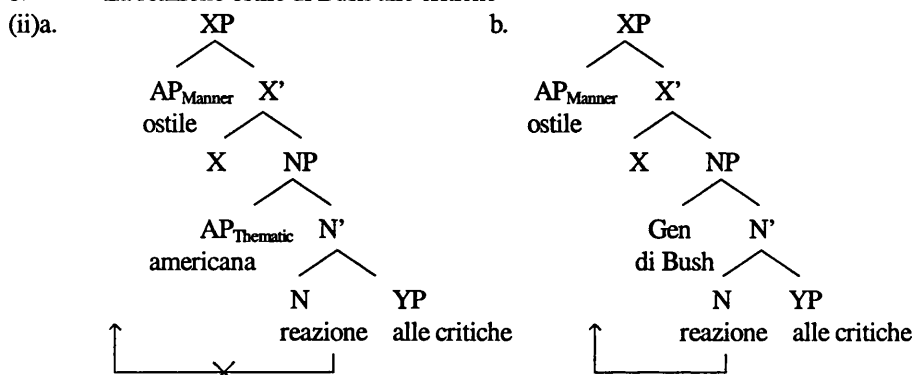

(iib) shows that genitives are better subjects.

b.\* ei ama-r gan<sup>3</sup>

The phrase in (4b) shows that a genitive case-marked subject in a Bangla DP may not stay between the D and the NP. Therefore, we conclude that the derived position of the the Poss in Bangla is the [Spec,DP] position where it checks for genitive Case.

## 2.1 A Counterexample to [Spec,DP] as the derived position for Poss

A counterexample to the fact that a 'subject' may not occur between the Det and the NP in Bangla is shown in the following contrast obtained in gerunds:

(5)a. ram-er ei na aS-a-Ta  
 Ram-GEN this not come-ing-CLA  
 'This failure of coming of Ram'

b. ei ram na aS-a-Ta  
 this Ram not come-ing-CLA

'Ram's this not coming' (De 1985, as cited in Dasgupta 1988)

In (4) above, it was implied that if there is a subject within the DP it must move up to the [Spec,DP] position and must check for genitive Case. However, (5b) shows that a subject may appear in a lower position and it need not check for genitive Case either. (5b) therefore constitutes a counterexample to the earlier claim. However, as De herself notes, this possibility of a non-genitive agent in a Bangla NP is possible only in cases of unaccusative verbs. In other words, verbs which do not allow for a "deep" subject position. In (5b), therefore, *ram* is really an object and thus may not get the genitive Case which is reserved for the subject of the DP.

In consonance with LCA, the object moves leftward but not high enough to

<sup>3</sup> Notice that an expression like (4b) in Bangla is excluded as a nominal projection though the string is okay as a verbless clause meaning 'This [is] my song'.

end up checking the genitive Case feature. The fact that the object moves out of the  $\nu$ P-shell (or the equivalent nP-shell) is evident from the surface order in (5b). If Neg is assumed to have its own projection just above VP, then the word order above is clear evidence for the object shift. However, This is not a convincing explanation since the subject NP *ramer* also moves up in the case of (5a). I offer the following possible analysis based on the structure of the gerund to be proposed in Chapter 4 (see in particular section 3.4). Anticipating the discussion there somewhat, since gerunds are complex events, they project an Asp head inside the DP. The non-finite *na* in Bangla is considered to be adverbial in nature (Bhattacharya 1998b) and is therefore assumed to occupy the [Spec,NegP] position as in Zanuttini (1997). The following derivation for the phrase in (5b) shows the head movement of V to Asp and the XP movement of the object for Case reasons and of the adverbial Neg phrase to an inner specifier of the Asp head to check some aspectual feature (details are to be found in Chapter 4):

(6)

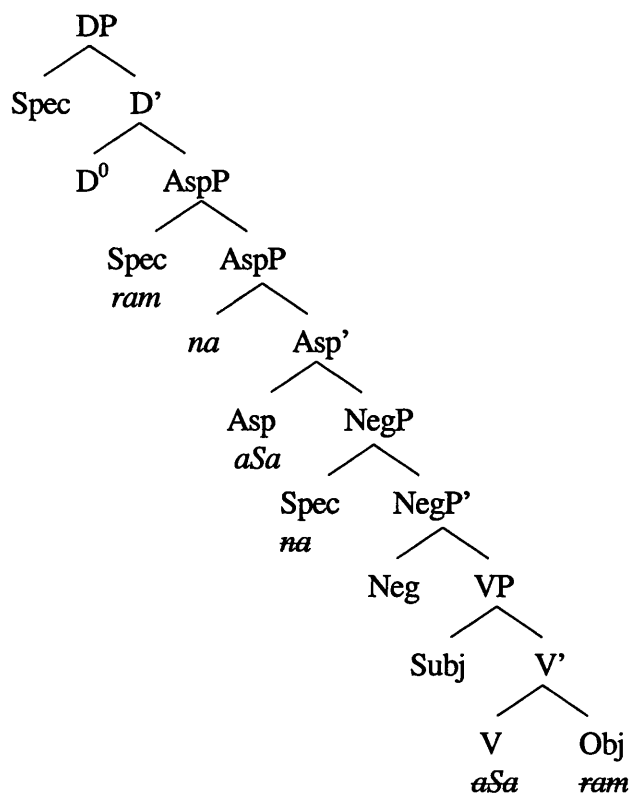

The derivation shows that after the NegP Merge, the Asp head is merged to the left and the gerundial aspectual feature attracts the V head to Asp. The Object raises to [Spec,AspP] to check Case. Finally *na* moves to the inner spec of AspP, as per the condition *Tuck-in* derivable from Richards (1997) who concludes that later XP movement target the inner spec. This also accounts for the ungrammatical (7) where the later movement of the Neg takes it to an outer spec of AspP:

(7)\* [DP D [AspP na [Asp' ram[Asp aSa] [NegP na Neg [VP aSa ram]]]]]

This analysis would allow an object to check for Case at [Spec,Asp] against the Asp head (in line with the predicate-based theories of Tenny (1987) and Borer (1993) where aspect can check for Case) but not the subject. In the case of (5a), therefore, the subject *ramer* can check genitive only at [Spec,DP] and due to the scopal nature of the MLC, does not interfere in the aspectual feature checking at [Spec,AspP].

In conclusion, the counterexample in (5) can be accommodated within the DP structure that we propose here (and in the next chapter) without altering the conclusion reached in the previous section that the derived position of the DP 'subject' is [Spec,DP].

## 2.2 Base Position of the Poss

In this section I will provide evidence to the effect that [Spec,DP] is only the derived position for the Poss since in certain contexts it may not occur highest in the DP tree. This would indicate that the Poss is generated lower in the tree and is sometimes left behind in its base position.

So far we have seen that the Poss phrase occurs highest in the tree. Additionally, (8) below shows that the Poss cannot be lower than the Dem in the

structure:

- (8)\*    ei        amar    tin-Te        notun   Sari  
           this     my        three-CLA    new    sari

However, consider the following:

- (9)a.    baba    amar    khub    gorib!<sup>4</sup>  
           father   mine    very    poor
- b.        chele    amar    khub    duSTu!  
           son     mine    very    naughty
- c.        ma        amar    SOt     manuS!  
           mother   mine    honest   human

The data above shows that the normal, unmarked order of Poss-NP (as in 1-4) is reversed with certain kinship expressions<sup>5</sup>. The data in (9) also shows that the Poss need not be the highest in the tree.

We have evidence from other languages that the restriction to kinship terms is not unexpected. For example, in a footnote in Longobardi (1994), it is reported that in Italian, kinship terms have a cluster of properties not shared by other common nouns. He suggests that kinship terms, in fact, behave like proper nouns. Proper nouns in Longobardi's theory obligatorily move to D. Thus we can simply say that kinship Ns in Bangla are like proper names (as in Italian) and therefore they move to D to give the order we notice above.

---

<sup>4</sup> A term of endearment may be added to the kinship term in these examples in a free gloss to convey the sense of affection intended (indicated by the exclamation mark) when such phrases are used; e.g. *dear father*, *darling son* etc. I will assume this to be the case and not use such free translation or be consistent with the use of the exclamation mark.

<sup>5</sup> See note 17 for a condition on this movement.

### 2.2.1 NP (and not N) Moves in Bangla

Bangla, however, differs from Italian in that in the former, it is the whole NP which moves up. Consider the following:

- (10)a. amar buRo baba khub bhalo (unmarked Poss-NP order)  
 my old father very good  
 'my old father is very good'
- b. [<sub>NP</sub> buRo baba] amar t<sub>NP</sub> khub bhalo (marked NP-Poss order)  
 (Lit.) 'Old father (of) mine is very good!'
- c. \*baba amar buRo khub bhalo

The example in (10b) above in contrast with (10c) clearly indicates that the N moves up along with its modifiers<sup>6</sup>. In Bangla, therefore, it is a case of NP movement and not N (to D) movement as noticed in Italian and other languages. I will call this phenomenon, Kinship Inversion (KI) for purely mnemonic reasons. Discussion of this phenomenon constitutes the core of this chapter. I will show specifically that KI involves DP-internal NP movement, similar to the leftward NP movement studied in Chapter 2. In this chapter, however, I reanalyse this latter movement as nP movement to [Spec,QP] followed by the movement of the Poss to [Spec,DP] (discussed in detail in section 4.1).

<sup>6</sup> I have provided evidence in Chapter 2 in support of the [Spec,NP] status of Adj in Bangla. However, even without such an assumption, the point about NP movement can be made by considering participial modifiers like the following:

- (i)a. ghOre bOSa baba amar  
 home-LOC sit-PPL father mine  
 (Lit.) 'the home-sitting father mine!'
- b.\* baba amar ghOre bOSa  
 father mine home-LOC sit-PPL

(ib) is ungrammatical in the relevant phrasal sense; since the copula in the present is not expressed in Bangla, it can have the clausal meaning 'Father mine is sitting at home'.

### 2.2.2 Poss is not at [Spec,QP]

The data above (9-10) involving KI indicates that Poss need not be the highest spec in the tree, since apparently there is a landing site for the movement of NP to the left of the Poss. The only other XP position available in (2) for the Poss is the [Spec,QP] position. Placing the Poss in [Spec,QP] would create more problems than it solves. Let us see, why.

In Chapter 2, I proposed that a [SPECIFICITY] feature of the Q head attracts the “object” leftward to [Spec,QP] which I labelled DP ‘Object’ Shift or DPOS:

- (11)  $boi_i$  du-To  $t_i$  (Specific)  
 book two-CLA  
 ‘the two books’

More importantly, the following, involving a Poss, is also possible:

- (12) amar  $boi_i$  du-To  $t_i$   
 my book two-CLA  
 ‘my two books’

That is, the Poss (like *amar* ‘my’) precedes the moved specific noun *boi* ‘book’. Now, if we claim that the Poss is generated (or even, ends up) at [Spec,QP] then the DPOS story is problematic unless we resort to multiple specs for QP. There is nothing in principle to avoid generating multiple specs for QP but crucially, a Poss argument has nothing to do with a Quantifier Phrase, i.e. it does not quantify. Although I will show in section 3.5 that the Poss may pass through [Spec,QP] checking the [SPECIFICITY] feature, there seems to be no reason to generate it at [Spec,QP].



### 2.2.3 Poss in the nP-shell

The only spec position left in the DP structure in (2) for the Poss to occupy is the NP. In conformity with the similarity between clausal structure and the DP structure, I will assume that similar to the  $\nu$ P shell at the sentence level, an nP shell is generated inside the DP. I will argue that the base position of the Poss is indeed the spec of this nP-shell.

Let us remind ourselves that we have indirectly proposed that the derived position for Poss is [Spec,DP]. We have seen in the previous section that it cannot be generated at [Spec,QP]. According to some authors (Giorgi & Longobardi (1991), Mallén (1997) and others) Poss elements are like adjectives (for some languages) and therefore must be generated within the NP. In Lehman (1974), it is reported that attributive genitives in Old Indo European behave like attributive adjectives but unlike the latter, are appositional in nature. Appositional relationship is obtained where no formal relationship occurs between the relevant elements, for example, in the case of two vocatives as in *Goddess, daughter of Zeus*; or, in the case of two or more Ns used to refer to one person as in titles<sup>7</sup>. Therefore, it is possible to consider Poss as loosely connected to the NP based on its appositional relation with the head noun.

Given these observations that Poss elements are like attributive adjectives but at the same time bear an appositional relation with the following N, I suggest generating the Poss in a pre-nominal position within the NP. In the current framework, this would be possible if we generated the Poss within an nP-shell as in (13b) in order to derive the phrase in (13a):

---

<sup>7</sup> Interestingly, titles are postposed in OV languages and preposed in VO languages. For example, *Tanaka-san* in Japanese or *Rajiv-ji* in Hindi but Mr Tanaka or Mr Rajiv as their English translations. Although *Shri Neelkant* for 'Mr Neelkant' seems to be patterned after English.

- (13)a. amar du-To lal boi  
 my two-CLA red book

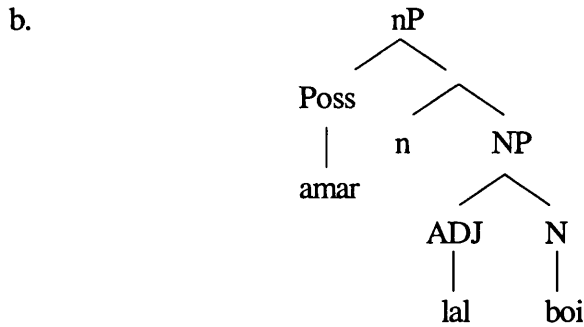

There is no immediate advantage of an *n* head in the *nP* shell for Bangla and as such it will be not be shown (but its presence will be implied) in the *nP*-shell structure for Bangla. However, for a closely related language like Hindi, which shows agreement between the Poss and the N, *n* may be considered as mediating this agreement<sup>8</sup>.

The subject-like character of the possessor is also attested for Hungarian in Szabolcsi (1994: 186). She observes that it triggers person-number agreement on the possessed noun, and can be dropped under the same condition when pronominal.

<sup>8</sup> One advantage of the *nP*-shell structure in (13b), I claim, is that it can account for the genitive Case marked possessed N in the following Hungarian example:

- (i)a. (a) Mari kapal-ja  
 the Mari hat-POSS  
 'Mari's hat'

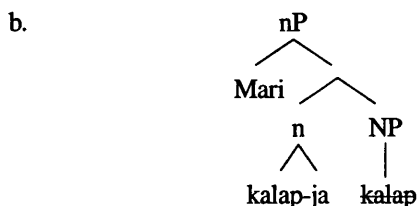

The fact that genitive is available lower in the DP is clear from the optional D in (i). The [Spec,DP] position in Hungarian is therefore for the Dative marked subjects as in the following where the possessor precedes (rather than follows) the definite article:

- (ii) Mari-nak a kapal-ja  
 Mari-DAT the hat-POSS  
 'Mari's hat'

Although the usefulness of a functional *n* head inside the NP in Hungarian (and other languages showing agreement of a similar sort) remains speculative at this stage, the availability of a genitive lower in the DP has been shown to account for certain cases of 'weak' possessives in South Asian languages in Shah and Bhattacharya (forthcoming). Since the existence of a functional head may not be proposed purely on the basis of the agreement, some semantic motivation in terms of 'weak' possessive may be desirable.

Crucially though, it does not share any of the properties of a syntactic modifier. Notice that the structure in (13b) reflects this property of the possessor whereby it is a part of the NP (as a generic cover term) and yet does not stand in a modifier relation with the N.

In order to derive a noun phrase like (13a) from the nP-shell structure in (13b) it is necessary for the Poss to move all the way up to [Spec,DP]<sup>9</sup>. This will become clear when we have discussed the position of the Dem in the next section. In the case of KI as in (9) and (10b), I will claim that the NP moves out of the nP-shell stranding the Poss. KI, therefore, constitutes another piece of evidence for DP-internal NP movement. Two questions arise at this point: *What triggers this movement?* and *What is the landing site for the NP in KI?*

I will answer these questions in section 3.3. First, let us discuss the position of the Dem in the Bangla DP, as it bears crucially upon the answers offered and the accompanying discussion.

### 3.0 Demonstrative as an XP

Having decided on the base position of the Poss, let us now look at the position of the Dem on which I have deliberately not taken a clear stand so far in this (and the previous) chapter. Consider the following data:

- (14)a. ei      du-To      boi  
           this    two-CLA    book  
           ‘these two books’

---

<sup>9</sup> Although nothing crucial in the present analysis depends on it, this movement is triggered by the presence of a relevant feature ([POSS]) in D. In the case of KI (as in 9 and 10) this movement does not take place in the overt syntax. I discuss this in detail in section 3.3.

b.\*  $boi_i$   $ei$   $du\text{-}To$   $t_i$

c.  $ei$   $boi_i$   $du\text{-}To$   $t_i$

'these two books' (specific)

The unacceptable order in (14b) shows that the 'object' NP *boi* 'book' may not move across the Dem *ei* 'this'. Let us look at the following example with an adjectival modifier:

(15)a.  $ei$   $du\text{-}To$   $lal$   $boi$

this two-CLA red book

'these two red books'

b.\*  $[lal\ boi]_i$   $ei$   $du\text{-}To$   $t_i$

c.  $ei$   $[lal\ boi]_i$   $du\text{-}To$   $t_i$

'these two red books' (specific)

The starred (b) phrases in both (14) and (15) show that leftward movement of the object NP across the Dem is barred. The crucial barrier here seems to be the Dem. If the Dem is a head, then it is difficult to see how it can act as a barrier to XP movement. If the Dem is not a head then it cannot occupy either D (as shown in the DP structure in (2)) or any other head between D and Q.

The proposal that the Dem may not be equated with  $D^0$  is well established in the literature (Giusti (1997), Bernstein (1997), Brugé (1996)). They argue that the definite article (at  $D^0$ ) and the Dem can co-occur in many languages:

(16)a.  $el$   $libro$   $este/ ese/ aquel$  (Spanish) Brugé (1996)

the book this/ that/ that

'this book'

- b.     **äiaat-ul acesta** (frumos)                   (Rumanian)     Giusti (1997)  
           boy-the this     nice  
           ‘this nice boy’
- c.     ika     n     anak (Javanese)     (Giusti 1995)  
           this     the     boy
- d.     ez     a     haz (Hungarian)     (Giusti 1995)  
           this     the     house

For (16b), Giusti suggests that N to D movement of *bäiat* ‘boy’ takes place across the Dem as well as the Adj, if present. This shows that the Dem is neither at D, which has the article *-ul*, nor in an intermediate head, otherwise the Head Movement Constraint (HMC) would be violated for this local-N movement. Additionally, (17) below shows that the Dem also blocks AP movement to [Spec,DP] which is otherwise allowed in Rumanian.

- (17) frumos-ul     (\*acesta)     bäiat  
        nice-the     this            boy

The intermediate head position at whose spec the Dem is located, is needed as an escape hatch for the N to D movement to proceed.

We have seen in (9) that in Bangla there is no N to D movement, rather in this language the whole NP moves. There is no compelling evidence, therefore, to posit a head  $X^0$  between  $D^0$  and  $Q^0$ , although the Dem behaves like an XP.

### 3.1 Demonstrative Reinforcers

The phenomenon of double definiteness in Scandinavian is well-know (see section 4.3 of Chapter 2). This extends to demonstrative expressions in the following, literally

meaning *the here, the there* for *this* and *that*:

(18)a. den här bil-en  
           the here car-the  
           ‘this car’

b. den där bil-en  
       the there car-the  
       ‘that car’

(Swedish from Santelmann 1993: 156)

Bernstein (1997) investigates this phenomenon further and identifies *here* and *there* in the example above as demonstrative reinforcement. Furthermore, she proposes these reinforcers to be heads of an FP and the spec of this FP hosts the Dem. She claims that apart from these colloquial Scandinavian varieties (as in Norwegian in (19)), the demonstrative reinforcer is available in some non-standard varieties of English (20):

(19)a. den herre klokka  
           the here watch-the  
           ‘this watch’

b. det derre huset  
       the there house-the  
       ‘that house’

(20)a. this here guy

b. that there car (Bernstein 1997: 90)

The same phenomenon is observed in French where the reinforcer is an enclitic *-ci* or *-la* following the noun:

(21)a. *cette femme-ci*

this woman-here

'this woman'

b. *ce livre-là*

that book-there

'that book'

The Dem in this system is generated in a configuration such as the following:

(22)a. [<sub>FP</sub> *ce* [<sub>F'</sub> *-ci*]]

b. [<sub>FP</sub> *this* [<sub>F'</sub> *here*]]

That is, the Dem is at the specifier of a functional projection FP. The French example in (21) is derived by moving the NP to [Spec,FP] and by moving the Dem to [Spec,DP].

One immediate problem with this analysis is as follows. Notice that although Bernstein's analysis cites crucial support from the Scandinavian examples, it forces her to treat determiner *den* in these languages as an XP<sup>10</sup>. This is problematic since most standard analyses of Scandinavian NPs treat it as the D<sup>0</sup> head (see e.g. Kester (1993), Delsing (1993), Santelmann (1993) among others). Furthermore, she derives the Swedish and nonstandard English facts by assuming that for a [+definite] Dem, the "demonstrative head" raises to the "DP projection" (Bernstein 1997:98). Further reading of this proposal reveals that Dem "head" here stands for the Dem word. That is, *den*, the Dem "head" in the [Spec,FP] position raises to D<sup>0</sup> to derive the Swedish facts. She is forced to take this position in order to get the right order in (18-20) above.

However, the basic insight of Bernstein's analysis of Dem reinforcers as heads can be imported into Bangla. I will suggest that the Dem in Bangla occupies a specifier

<sup>10</sup> Although Bernstein remains silent about the status or nature of *den*, her analysis clearly implies that *den* is the Dem and is at [spec,FP] in these languages.

position and the head of the projection of which it is a specifier is a focus-like head. I will give evidence for the presence of focus inside the DP in Bangla in section 3.2.1.

The particle *je* in the following comes closest to the reinforcers in Scandinavian<sup>11</sup>. This particle, I claim, has a strong deictic interpretation. Therefore, (23a), for example, can be used in the context where something is suddenly found at a particular place whereas (23b) can be used to locate/ point someone/ something in a nearby or distant place:

- (23)a. ei je!  
           this HERE!
- b. oi je!  
       that THERE!

The use of this particle to identify a location is also clear from the following examples:

- (24)a. ei je rakhal  
           this here Rakhal  
           ‘this guy here is Rakhal’
- b. oi je mandir  
       that there temple  
       ‘that one there is the temple’

It can also have a vocative function as follows<sup>12</sup>:

- (25)a. ei je!  
           this JE  
           ‘(you) THERE!’

<sup>11</sup> This particle is identified as a relative demonstrative in Shah and Bhattacharya (forthcoming) since it is homophonous with the relative pronoun used at the clause level.

<sup>12</sup> This use is locational as well as it is used to demand attention of someone by calling out or by placing the person at a particular space by the use of *je*.



- b.    ei     je     Sunchen  
       this    JE     listening.2.HON  
       ‘you there, are you listening?’

In all these cases the particle has a strong deictic interpretation and is typically accompanied by pointing. Generating this particle at the F head serves at least two clear cut purpose for the analysis offered here. It accounts for the *strong* deictic interpretation since the F head is a Focus-like head and it brings about deictic interpretation of the phrase by the interaction of the Dem at [Spec,FP] and a filled F head. The reinforcer, therefore, establishes the deixis of the phrase.

In the next section I will investigate DP-internal deixis in detail, in particular, I will propose that in the absence of an overt F head a lower head moves up to establish contrastive deixis. If such head movement does not take place, the resulting deixis is “non-locative” (see section 3.2.2 for details). Thus the proposal for a FP inside the DP and the proposal for the Dem at [Spec,FP] jointly predict the nature of deixis obtained inside the DP.

In conclusion, I have proposed that the Dem in Bangla, like in many other languages, is an XP, located at the spec of a functional projection FP. The head of this projection may be overtly filled by a reinforcer or may remain unoccupied.

### 3.2 Deixis and the Generalised Licensing Condition

Bernstein points out the difference between the pair in (26) by suggesting that in (26a), the deictic effect is obtained by moving the Dem to  $D^0$ , this movement does not take place in the syntax for (26b).

(26)a. this woman (right here) (Bernstein 1997: 95)

= this woman (deictic)

b. this woman (from Paris)

= a woman (indefinite specific)

That is, for Bernstein, deixis is obtained through movement of the Dem to  $D^0$  whereas in the case of the indefinite there is no movement of the Dem.

Bernstein's account of deixis is unsatisfactory on at least one ground. She proposes movement of an XP (Dem) to an X ( $D^0$ ), but she does not specify what feature triggers this process<sup>13</sup>. Based on empirical evidence, I will suggest that deixis is obtained not through movement to  $D^0$  but rather of a lower head into the head of which the Dem is a specifier, that is,  $F^0$ . Thus the deictic effect in a phrase like (32a) below is obtained through the Dem being merged at [Spec,FP] and some lower head moving to  $F^0$ . This obeys, I propose, I condition such as the following:

(27) *Generalised Licensing Condition (GLC)*

In order to obtain a particular syntactic effect inside the DP, both the head and the spec of a relevant functional projection must be occupied.

In (27) "generalised" is to be understood in the sense of a sentential principle being applicable to the DP as well. Although there have been proposals to the contrary at the clausal level, (27) may be seen as a putative DP universal dictated by economy

<sup>13</sup> She provides the following examples from Boulogne Picard as the only piece of evidence for this claim:

- |       |              |    |             |
|-------|--------------|----|-------------|
| (i)a. | chele école  | b. | che monde   |
|       | this school  |    | this world  |
|       | 'the school' |    | 'the world' |

I.e. in this dialect of French, the Dem is used as a definite article. However, this evidence is too marginal to support a strong anti-structure preserving analysis involving XP to  $X^0$  movement.

<sup>14</sup> Effectively such a condition is similar to the Focus Criterion of Brody (1990):

- |       |  |
|-------|--|
| (i)a. | A +F-operator must be in spec-head agreement with a +F $X^0$   |
| b.    | A +F $X^0$ must be in a spec-head agreement with a +F-operator |

requirements since by definition GLC constructs “smaller” trees.

### 3.2.1 Focus inside the DP

In order to demonstrate this principle, consider first the suggestion in Giusti (1996) regarding a DP-internal Focus position. She shows that Albanian, where adjectives normally follow the head noun (28a), can have prenominal adjectives only if the adjective is emphasised (28b):

(28)a. një grua e bukur

a woman the nice

‘a nice woman’

b. një e bukur grua

a the nice woman

‘a nice woman’

(Albanian; Giusti (1996: 112))

She provides further evidence from Russian where a marked order of adjectives is possible only if the adjective in question bears emphasis:

(29)a. eta staraja amerikanskaja knjiga o lingvistike

this old american book on linguistics

b.\* eta amerikanskaja staraja knjiga

c. eta *amerikanskaja* staraja knjiga

This is the case in English too. I will adopt this position of a Focus head inside the DP and additionally argue that the Focus position is associated with the Dem.

Consider in this connection, the possibility that Dems in Bangla may be thought of as derived from pronouns, given the following table:

- |        |                   |                 |                  |               |
|--------|-------------------|-----------------|------------------|---------------|
| (30)a. | e                 | o               | Se               | [+pronominal] |
| b.     | ei                | oi              | Sei              | [-pronominal] |
|        | 'this (proximal)' | 'that (distal)' | 'that (sequent)' |               |

Dasgupta (1992) notes that Dems are formed by the anti-pronominaliser augment *-i*. I claim that this augment is same as the homophonous emphatic particle *-i*:

- |        |  |        |         |
|--------|--|--------|---------|
| (31)a. | rajen-i                                  | baRi   | jabe    |
|        | Rajen-EMP                                | home   | go-will |
|        | 'Only Rajen/ Rajen himself will go home' |        |         |
| b.     | rajen                                    | baRi-i | jabe    |
|        | 'Rajen will go to the house itself'      |        |         |
| c.     | rajen                                    | baRi   | jabe-i  |
|        | 'Rajen will definitely go home'          |        |         |

This suggests that Dems in Bangla contain a focus particle which constitutes, in terms of the current theory, a focus feature<sup>15</sup>. Interestingly, in a historical/ diachronic study of the language, Chatterji (1926: 835) considers *ei*, *oi*, and *Sei* as clearly emphatic demonstrative forms.

There is some historical evidence that Indo-European (IE) had deictic particles attached to personal pronouns (Peterson 1930: 192). In fact, Shields (1994) believes that IE originally marked the distinction between emphatic and non-emphatic personal pronouns by affixing deictic particles of the 'here and now' variety. If this is correct, then it strengthens the argument presented here regarding the syntactic, pronominal origin of Dems as indicators of deixis with a marker of emphasis. Based on this

<sup>15</sup> It is reasonable to assume Dem-formation takes place in a pre-syntactic level like that of the Lexicon-syntax Interface of Cummins and Roberge (1994) but is merged in the Computational Component at [Spec,FP] where it checks for the focus feature. I will discuss this prospect further in the Appendix.

evidence, I claim that the so-called ‘anti-pronominaliser’ of Dasgupta (1992) is actually the emphatic particle *-i* that we have seen in (31) above.

### 3.2.2 Contrastive and Non-locative Deixis

In continuation of the discussion in the preceding section, I will argue in this section that whenever a Dem is used deictically (as in (32a)), it involves contrastive deixis.

First, consider the following simple case:

(32)a. *ei*      *du-To*      *boi*      (deictic)

*this*    *two-CLA*    *book*

‘these two books (here)’

b. *ei*      *boi<sub>i</sub>*    *du-To t<sub>i</sub>*      (specific)

‘these two books’

The data shows that in (32a) the deictic meaning is more important (shown in the translation by *here*), whereas in (32b) the specificity of the books is more important. In view of the proposal outlined in (27), GLC ensures that the syntactic reflex of deixis is obtained by the head moving Q to F. The absence of this head-movement in (32b) results in ‘non-locative’ deixis, i.e., the Dem is devoid of a deictic meaning.

An indirect evidence that (32b) does not involve deixis can be provided as follows. In a slight variation with the reasoning offered here (and based on studies on IE pronouns mentioned earlier), let us consider the augment *-i* in pronouns to signify deixis. If that is so then in a non-deictic DP, a Dem without the augment or a “bleached” Dem should be acceptable and conversely it should not be acceptable with a deictic DP. This seems to be the case:

(32)'a.?      e      duTo      boi-(t)e      hath      dio      na  
                   this      two-CLA      book-LOC      hand      give      NEG  
                   'Don't touch these two books'

b.              e      boi      duTo-te                      hath      dio      na

The pattern obtained in (32) is reflected in a larger set of data involving the Dem and the Poss:

(33)a.      ama-r              /              ei      du-To              chele              (contrastive)  
                   my-GEN              this      two-CLA              son  
                   'these two sons of mine'

b.              ama-r              ei      chele      du-To              (non-locative)  
                   my-GEN              this      son      two-CLA  
                   'these two sons of mine'<sup>16</sup>

In connection with (33), note that whenever Poss precedes the Dem, the nature of deixis obtained is contrastive (as in (33a)). That is, apart from performing its deictic function of 'pointing', the Dem seems to contribute a contrastive meaning to the phrase as well.

The contrastive meaning of (33a) is suggested by the full sentence (34) where the Dem clearly contrasts the set of two boys with another set consisting of *RomeS*.

The contrastive reading of (33a) is clear from the following expandable form:

(34)      ama-r      ei      du-To      chele      khub      bhalo,      rOmeS-Ta-i              boka  
                   my      this      two-clason      very      good      Romesh-CLA-EMP              foolish  
                   'these two sons of mine are very good, it's only Ramesh who's a fool'

<sup>16</sup> The similarity of the English gloss indicates the impossibility of the *boys two* order for specific two boys. However, the fact that the natural focus for this expression in English is carried by *these* confirms the contrastive nature of the deixis obtained for the Bangla DP in (33a). The fact that even in English if *these* is stressed then a contrastive meaning seems to obtain will be addressed in the next section in connection with Bangla examples of a similar sort.

That is, the set of two sons is contrasted with another consisting of *RomeS*. In (34) *ei duTo chele* is the constituent in focus which is set in contrast with the phrase appearing within the negative contrastive adjunct -- a necessary and sufficient diagnostic for focus in Rochemont (1998). Notice that the NP has not moved across the Q *duTo*, that is, there is no ‘object’ shift involved here.

Note in connection with (33b) that the Dem in (32a) is used deictically whereas in its specific counterpart (32b), the Dem loses its deictic effect, it is used “pleonastically”, an effect I have characterised as non-deictic. I conclude that specificity makes deixis non-locative. This is seen in (33b) as well. The implication is that whenever the Dem is used deictically it must be contrastive deixis as well, in all other cases (e.g. in case of specific DPs), the deixis is non-locative. This conclusion fits well with the claim in the last section that Dem is generated within FP – a focus projection. I will derive the non-locative deixis of (32b) and (33b) in section 4.1 as a consequence of the GLC proposed in (27). With regards to (33a), notice that contrasting is a reflection of focussing which implies that a feature of [FOCUS] is involved in this case. Let us look at this in greater detail.

### 3.2.3 Deixis and Focus

A closer comparison of (33a) and (33b) reveals that the natural stress of the phrase falls on the Dem to obtain the intended meaning in (33a). The Dem in (33b) remains distinctly unstressed. Note also that, crucially, in cases where specificity makes deixis non-locative, as in (32b) and (33b), we can force a deictic reading by focussing the Dem. Focussing the Dem, therefore, is the only way for these DPs to obtain a deictic meaning for the Dem.

(35)a. *ei* *boi<sub>i</sub>* *du-To t<sub>i</sub>* (specific/deictic)

‘THESE two books’

b. *ama-r* *ei* *chele du-To* (specific/deictic)

*my-GEN* *this* *son* *two-CLA*

‘THESE two sons of mine’

This leads to the conclusion that focussing the Dem is one way of obtaining deixis. However, these are cases of overt DPOS, which, going by what we have said regarding (33a) and (34), should make the deixis of the phrase non-locative. I will assume a theory of focus in the manner of Rochemont (1986) to sort out this anomaly. Translating his proposal into minimalist terms, I will assume that a Focus head is generated in the syntax for (35) but a rule like his Accent Placement Rule operates at the PF interface to assign focus to the Dem. In other words, the difference between a phrase in (33a) (where the natural stress falls on the Dem) and (35a) is in the domain where the focus assignment rule operates. Notice that the combination [specific, deictic] as in (35) above is possible only when the pair is [specific, deictic [+f]] where [+f] denotes the Focus feature.

Coming back to (33b), notice that a fuller expression (in (36)) is constructed in a manner similar to the way we constructed the marked NP-Poss, that is, the KI examples in (9-10)<sup>17</sup>. That is, (33b) in its non-locative use behaves as if it has

<sup>17</sup> Notice that the ‘manner of continuation’ is dictated by the nature of the predicate in KI cases:

- |       |                                  |             |              |              |                                 |
|-------|----------------------------------|-------------|--------------|--------------|---------------------------------|
| (i) # | <i>baba</i>                      | <i>amar</i> | <i>aSben</i> |              | (stage level)                   |
|       | father                           | mine        | come-will    |              |                                 |
|       | ‘father mine will come’          |             |              |              |                                 |
| (ii)  | <i>baba</i>                      | <i>amar</i> | <i>khub</i>  | <i>bhalo</i> | <i>manuS</i> (individual level) |
|       | father                           | mine        | very         | good         | man                             |
|       | ‘father mine is a very good man’ |             |              |              |                                 |

This contrast is clearer in Hindi:

- |        |             |             |                |               |                                |
|--------|-------------|-------------|----------------|---------------|--------------------------------|
| (iii)* | <i>baba</i> | <i>mere</i> | <i>aayenge</i> |               | (stage level)                  |
|        | father      | mine        | come-will      |               |                                |
| (iv)   | <i>baba</i> | <i>mere</i> | <i>acche</i>   | <i>aadmii</i> | <i>haiM</i> (individual level) |
|        |             |             |                |               |                                |



undergone a phenomenon similar to KI:

- (36) ama-r            ei        chele    du-To,            Ekdom            pagol !  
          my-GEN        this     son     two-CLA        absolutely        mad

‘these two sons of mine are absolutely mad!’

This is also true of (32b) where I have replaced *books* with *sons* to make the similarity with KI clearer:

- (37) ei chele du-To, Ekdom pagol !

‘these two boys are absolutely mad!’

This shows that DPOS (movement of the ‘object’ NP leftwards across the Q head as in (32b) and (33b)) and KI share some property so that they are licensed in exactly the same environment. The similarity between these two cases of NP movement suggests that in the case of real KI (to be discussed in detail shortly) the meaning obtained for the Dem is predicted to be non-locative as well. I investigate the nature KI in the next sub-section.

### 3.3 A trigger for KI

Now let us see the effect of deixis in DPs with real KI. KI, as we said before, involves shifting the kinship NP to the left of the Poss. Recall that at the end of section 2.2.3, I raised a couple of questions, one of them being: *What triggers KI?* I will now proceed to show that a feature of the Q head induces the inversion noticed with kinship terms. Towards the end of this section, I will answer the other question raised, viz, *What is the*

---

father    mine    good    man    is

It is well-known that the distinction between the predicate types translates into a difference between the base position of the subject (see Diesing (1992) for details) at the clausal level. The relevance of this distinction is reflected inside the DP somehow in terms of the inversion possibility in one case as opposed to the other. However, at present I have no clear theory of how this similarity can be formulated and I leave it for future research.

*landing site of this movement?*

First, the following pair shows that inversion is obligatory when an ‘affectionate’ Cla *-Ti* instead of the regular *-Ta* is used with kinship terms:

(38)a. bon-Ti            amar    khub    Sada-Sidhe  
        sister-CLA        my        very    plain-straight  
        ‘sister mine is very plain and simple’

b. \*    amar    bon-Ti    khub    Sada-Sidhe

This shows that *-Ti* induces KI, i.e. the use of this particular Cla and KI have matching requirements. More importantly, the Cla instantiates a feature of the Q head which is responsible for this inversion.

Secondly, the following contrast shows that kinship terms when associated with Proper Names (PN) do not undergo KI (shown in (39b)), but may only do so in the presence of a Cla (shown in (39c)).

(39)a. rakhal-er        bhai    khub    bhalo  
        Rakhal-GEN    brother very    good  
        ‘Rakhal’s brother is very good’

b.\*    bhai    rakhal-er        khub    bhalo  
        brother Rakhal-GEN    very    good

c.        bhai-Ti rakhal-er    khub    bhalo  
        ‘the brother of Rakhal is very good’

This example again show that a feature of the Q head (instantiated by the Cla) is responsible for KI in (39c).

Now let us look at the status of the Dems in the case of KI. Notice that KI, like DPOS, makes the deixis of the phrase non-locative:

- (40)a. ei      bhai-Ti      amar, ...      (non-locative)  
           this    brother-CLA    mine  
           ‘this brother of mine, ...’
- b.      ei      bhai    du-To amar      (non-locative)  
           this    brother two-CLA      mine  
           ‘these two brothers of mine, ....’

In both these cases the kinship NP *bhai* ‘brother’ has moved up across the Poss (in (40a)) and the Q (in (40b)), with the nature of the deixis obtained is as indicated. As with other kinship inversion examples, these too are appropriate in a particular set of contexts (expressing affectionate emotion, for example – see note 17)<sup>18</sup>. The pattern in the case of DPOS (in (32b) and (33b)) inducing non-locative deixis is repeated for the KI cases in (40) as predicted.

Based on the preceding discussion, I conclude that a feature of the Q head (instantiated by the Cla as part of the complex head) is responsible for KI. This is in effect similar to DPOS discussed in Chapter 2 (see section 6.3). I will assume that the same feature of [SPECIFICITY] that is responsible for DPOS drives the leftward NP movement in the case of KI too (see the text above (70) in section 4.2 for an independent justification for this claim). Independently of this assumption, I have pointed out that both DPOS and KI make the deixis of the phrase non-locative and that both movement target the same landing site, [Spec,QP]. Thus, we have answered both the questions raised at the end of section 2.2.3.

With the assumption that KI involves specificity as well, it is possible to conclude that specificity makes the deixis non-locative. Armed with this set of

<sup>18</sup> Although not apparent, (40a) involves ‘object’ shift to induce specificity.

conclusions, I will now show that proposing an FP inside the DP in Bangla derives these consequences.

### 3.4 FP in Bangla

Based on the conclusion reached in section 3.2 where I proposed the presence of a Focus head inside the DP, I will present a modified DP structure for Bangla in this section. Some analyses of focussing at the clausal level posit a pre-verbal FP projection where the head carries a feature of [focus] (Brody 1990, among others). If we believe in the strong similarity between clauses and phrases then we may want to posit a similar focus-like head in the pre-QP position in the DP, which would provide us with a spec position for the Dem.

Given the theoretical assumptions motivating a functional projection for the Dem and given what we have seen so far for Bangla (i.e. independent evidence of a [FOCUS] feature in the DP, see especially sections 3.2.1 and 3.2.3), let us propose an FP within the Bangla DP. The F head carries a [FOCUS] feature, which if selected, must be erased before the derivation reaches spell-out. The following is the new structure for the Bangla DP:

(41)

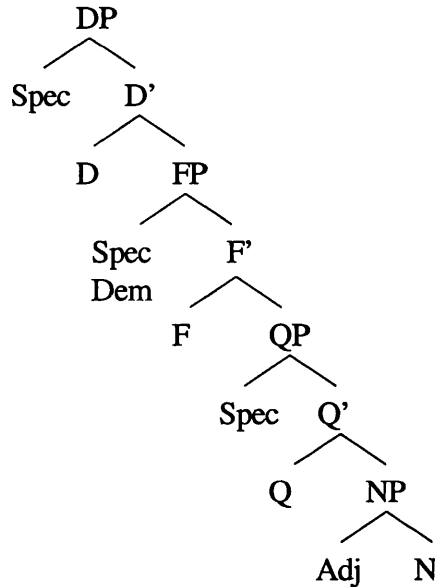

That is, we have generated the Dem as a specifier of the intermediate FP projection. I have argued that Dems in Bangla are derived from personal pronouns plus the particle - *i* (see section 3.2.1).

The new DP structure accommodates (15) repeated here as (42) which was the original motivation for treating Dems as XPs:

- (42)a. ei      du-To      lal      boi  
           this    two-Cla      red      book  
           ‘these two red books’
- b.\* [lal boi]<sub>i</sub>      ei      du-To t<sub>i</sub>
- c.    ei      [lal boi]<sub>i</sub>      du-To t<sub>i</sub>  
           ‘these two red books’                      (specific)

The structure in (41) above now explains the inability of the NP to move across Dem in terms of minimality. Let us now see how the above structure can derive the simple DP in (32a), repeated here as (43):

- (43) *ei du-To boi* (contrastive deixis)  
 this two-CLA book  
 ‘these two books (here)’

I suggest that a functional head *F* with a strong [FOCUS] feature is taken from the Numeration after merging of the *Q duTo* and the NP *boi* has taken place. This strong feature induces raising of the *Q* head to *F* and thus ‘Dem-hood’ is established. I am assuming that the Dem *ei* is merged at [Spec,FP]<sup>19</sup>.

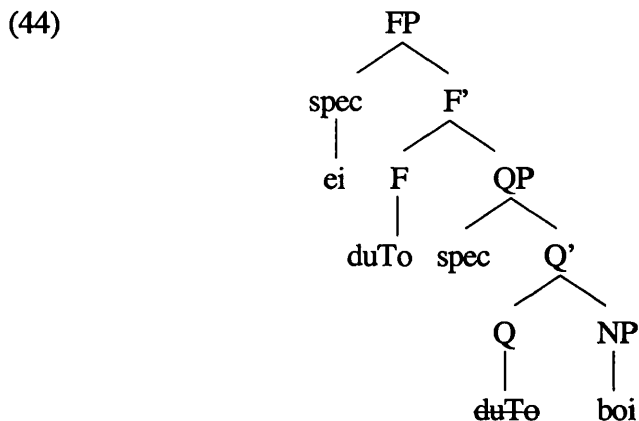

The supposition that the Dem itself does not carry a feature of deixis is based on research on aspectual deixis by Lamarche (1996) who treats deixis at the syntactic level and not at the lexical level. That is, deixis is not a lexical property of a lexical item but is rather dependent on syntactic contexts. Similarly, I suggest that deixis inside the DP in Bangla is obtained by means of a particular syntactic configuration and not by any lexical (or featural) property of the Dem.

Let us take stock of the developments so far. I started with a quest to chart out the movement of the Poss in examples like (1). I rejected the possibility of generating it at [Spec,QP] (section 2.2.2) and concluded that the Poss is generated in a lower nP-shell (section 2.2.3) and is moved to a Case position. Let us look at (1) again, repeated

<sup>19</sup> Note that this is similar to the observation in Kayne (1994: 152ff) that in Hungarian, focus and Interrogative phrases move to a pre-V position below C<sup>0</sup> (cf. Brody (1990)).

here as (45a). The DP structure as in (41) seems inadequate as the Dem (as an XP) would block the movement of the Poss XP across it. This is clearly not the case as shown by (45b,c):

(45)a. ama-r<sub>i</sub>            ei        tin-Te            t<sub>i</sub>        nOtun SaRi  
           my-GEN            this        three-CLA            new        sari  
           ‘these three new saris of mine’

b.        \*ei        tin-Te amar        nOtun SaRi

c.        \*ei        amar<sub>i</sub> tin-Te t<sub>i</sub>            nOtun SaRi

We have seen that the Dem cannot be a head and that it is generated as the spec of FP. There is no reason to assume that the Poss is a head since it is a full NP with genitive Case. We have also seen that the Dem blocks movement of other NPs across it (14) but not the Poss (as above). Is there a way out of this?

Given either the Minimal Link Condition (MLC) of Chomsky (1995) or the scopal MLC of Manzini (1998), shown in (46) below, movement of the Poss to [Spec,DP] (in case of (45a)) is not a problem since the Dem is not an attractor of the [POSS] feature.

(46) Given an attractor feature  $F$  and an attractee feature  $A_F$ ,  $F$  attracts  $A_F$  only down to the next attractor  $F'$  for  $A_F$ <sup>20</sup>

<sup>20</sup> The reason for proposing (46) is as follows. As Manzini (1996) pointed out, MLC fails to account for weak island violations:

(i)a. [do-Q] [you [not believe [that they fired him why]]]

b.\* Why don't you believe [they fired him t<sub>why</sub>]

Clearly, *not* blocks the movement of the *wh* which is possible only if *Neg* shares feature with *Q*, and as far as we know there is no such feature which is common to both. In Rizzi's (1990) notion of Minimality, both are  $A'$  specifiers. They share the property of being weak DPs, their *Ds* are empty and the *wh* or the *neg* realised lower in the DP. However, *a man* e.g. does not block *wh*-movement. Another solution to pursue could be that the attractors rather than the attractees interact

(ii) An attractor can attract an indefinite *D* only down to the next attractor

(iii)a. [Do-Q'] [you wonder [what *Q* [to repair t<sub>what</sub> how]]]

b. [do-Q] [you [not believe [that they fired him why]]]

In (iii)a) the indefinite *D* needs to be found down to the next attractor which is *Q* and in the case of (iiib) the relevant next attractor is *not*. In either case the lower *wh* is not included in the attractor scope of the

The Poss in our theory moves up to [Spec,DP] to check the [POSS] feature at D. This checking takes place overtly in the case of overt Poss movement to [Spec,DP] as in (45a), or after spell-out in the case of KI when the Poss is stranded in its base-generated position (as in (40)). This is similar in spirit to Kayne's (1994: 86) suggestion that in English the Poss NP (as in *John's*) raises past an empty  $D^0$  head at LF. Overt or covert movement for Case checking in Bangla Poss is reflected in the obligatory presence of Genitive Case on Poss in all cases. We will see at the end of the next section that the Poss may however stop by at intermediate specifiers due to the presence of some other feature in Poss itself.

I suggest that the blocking effect noticed with the Dem is therefore due to the absence of any relevant feature in the NP to check beyond the Dem. Even if it had [FOCUS], it must, by *Tuck-in*, check this feature at the inner spec of FP giving us the possible linear order *ei CHELE duTo ...* (see note 23 in this connection).

### 3.5 Further evidence for FP

In this section I will present three pieces of evidence in support of an FP projection inside the DP.

(I) The first of these consists of the use of the 'Focus Marker'<sup>21</sup> (FM) *-to* below:

---

higher operator.

<sup>21</sup> The Hindi cognate of *-to* has been identified by Kidwai (1995) as a topic marker since it is 'discourse anaphoric'. According to her *-to* in the following Hindi sentence can have a thematic meaning as indicated in b:

- (i) raam to aayegaa  
Ram FM come-will
- a. 'At least Ram will come'
- b. 'As for Ram he will come'

However, apart from the fact that (ia) shows a contrastive meaning (which indicates its focal character), the claim here that it behaves more like a focaliser is substantiated by examples like (ii) where *-to* along with the negation denies a presupposition:

- (ii) ami jabo na to  
I go-will not FM



(47) *ei to duTo chele*  
 this FM two-CLA boy

- a. 'these (HERE) two boys'  
 b.\* 'these are two boys (not three)'

That is, the FM gives a strong deictic meaning and does not contrast the material following it. This is accounted for if we consider *-to* similar to the Dem reinforcer *je* discussed in section 3.1, to be carrying a [FOCUS] feature and therefore merged at F. The FM thus establishes a spec-head relation with the Dem at [Spec,FP] and obtains the strong deictic meaning in accordance with the GLC as in (27) as follows:

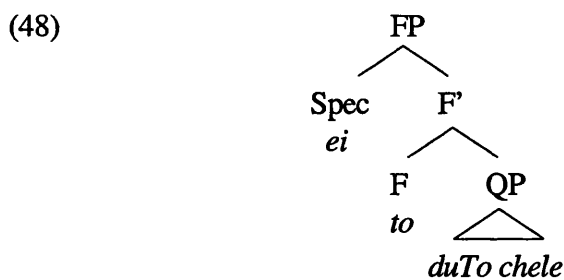

Now consider the following case:

(49) *ei duTo chele to ....*  
 this two-CLA boy FM

- a. 'these two boys (as opposed to those two) ....'  
 b.\* 'these two boys (not the girls) ....'

That is, the FM here contrasts the whole QP *duTo chele* but not just a part of it (e.g. *chele*). This is accounted for by considering the movement of the whole phrase QP to [Spec,FP] as follows:

---

'I am not going!'

As for the thematic meaning in (ib), it is possible to present it as new information in answer to a question: Who else will come? This would suggest that *-to* need not be uniquely discourse anaphoric.

(50)

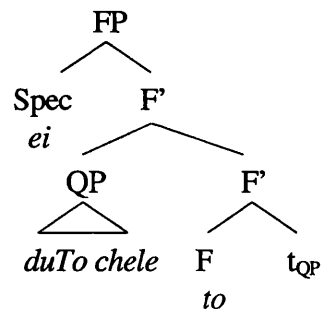

Notice that in accordance with the condition *Tuck-in* based on Richards (1997), mentioned in section 2.1, whereby later movements target inner specs, the QP in (50) moves to an inner spec of FP. In this case the QP as whole checks for the [FOCUS] against the F head containing the FM *-to*.

(II) In addition, I claim that an FP analysis provides an account of the double-definiteness pattern prevalent in (most) Scandinavian languages (see (51a,b)). In particular, I propose that the enclitic article of these languages be considered as an F head to which the N head moves.

(51)a. den gamla mann-en (Swedish)

the old man-the

‘the old man’

b. denna gammal mann-en

this old man-the

‘this old man’

(Spoken Swedish)

The claim that the enclitic article is an F head is based on the observation in Santelmann (1993: 156) that if both pre and post-nominal articles are present without an intervening adjective then the noun phrase has an emphatic meaning:

(52)a. den film-en var rolig (men den här film-en var tråkig)

the film-the was funny (but this here film-the was dull)

‘that film was funny but this film was dull’

b.\* den film var rolig

(52b) shows that the post-nominal enclitic must be present to get the emphatic meaning. Based on this observation, I assume the following to be the derivations of the DPs in (51):

(53)a.

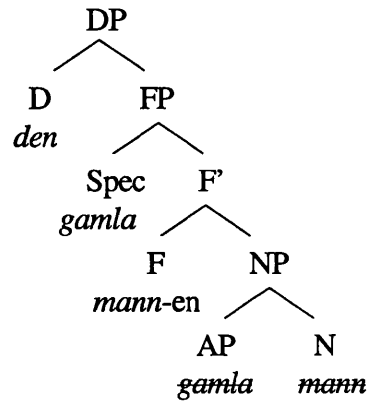

b.

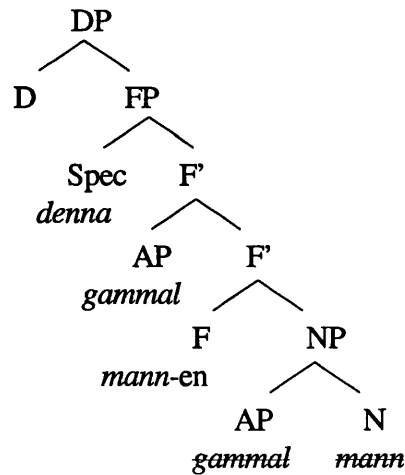

Notice that movement of the Adj to the inner spec in the case of (53b) follows the same criterion of *Tuck-in* mentioned in connection with the derivation in (50). Note that movement of either N or AP in (53) obeys GLC for FP.

(III) Finally, I will provide evidence from KI in Bangla in favour of an F head inside the DP.

In Chapter 2 and section 3.3., we have seen that only those NPs are attracted to the [Spec,QP] position which can check the [SPECIFICITY] feature of the Q head. In this section, I will show that the Poss always gives a specific reading. I will also produce

data from Persian, based on Ghomeshi (1997), which shows that the Poss must take a presupposed/ definite object in Persian. First, consider the following:

(54) amar chele khub bhalo

my son very good

a. 'my son is very good'

b. 'MY son is very good'

(55) robin-er gaRi-Ta gEche

Robin's car-CLA has gone

a. 'Robin's car is gone!'

b. 'ROBIN's car is gone!'

Although the b reading in each case can be forced upon any noun when emphasised phonologically, the Poss by its very function restricts the set of possible 'sons' or 'cars' in the above examples. That is, the Poss always picks out a specific member from a particular set of nouns. 'My son' or 'Robin's car' are identifiable, specific son or car.

Let us investigate this position further. In (54) above, *amar chele* 'my son' contrasts *chele* with other members in the set of relations/ things/ objects belonging to me. So the very use of *amar* reduces the set of objects that belong to everybody to objects that belong to me. Consider now the following sentence:

(56) amar CHELE khub bhalo, meye-Ta-i bOjjat

my son very good daughter-CLA-EMP nasty

'my SON is very good, it's only the daughter who's nasty!'

The focus on *chele* 'son' now picks out *chele* as opposed to other objects that may belong to the set already created by *amar*.<sup>22</sup> Let us now consider the following where

<sup>22</sup> In the theory of Rooth (1985), focussing creates several alternate sets one of which is then picked up by the denotation of the NP.

the Poss is focussed:

(57) AMAR chele khub bhalo, (tomar-Ta bOjjat)

my son very good your-CLA nasty

'MY son is very good, (it's yours who is nasty!)

Comparing (56) and (57), notice that in the unmarked Poss-NP order, both the possessed and the possessor can be focussed. Let us now see if this is the case for the other order we have been looking at, that is, the marked order of NP-Poss in KI.

(58)a. CHELE<sub>i</sub> amar t<sub>i</sub> khub bhalo, ...

son mine very good, ...

'SON mine is very good, ...'

b.\* chele<sub>i</sub> AMAR t<sub>i</sub> khub bhalo, ...

We conclude that in the marked order of NP-Poss, the Poss cannot be focussed. This empirical conclusion is imported into our analysis of KI (see section 4.2 for details) where NP movement leaves the Poss stranded. I assume that focus is obtained by raising the NP being focussed to the specifier of the FP in the canonical DP structure like (41). This would not be possible if the Poss is stranded in its base-generated position.<sup>23</sup>

Independent evidence from the Indo-Iranian language Persian shows that the

<sup>23</sup> The presence of a Dem makes matters more complicated but the following judgements support the theory as outlined above:

(i)a. amar ei CHELE  
my this son

b.\* AMAR ei chele

(ii)a. ei CHELE amar

b.\* ei chele AMAR

I assume that when the F head has a strong [FOCUS] feature it may be preceded by a focussed element, a requirement which rules out (iiia) as opposed to b or c (example (iii) is taken from Kidwai (1995:163)):

(iii)a.\* HE even met him

b. He even MET him

c. He even met HIM

However, the difference between null F head with a strong [FOCUS] feature and an inherently focussed item like *even* creates obvious problems for this analysis which needs some working out.

presence of a Poss makes the noun phrase definite/ presupposed. Object nouns in Persian may occur with the definite marker *-râ*, the indefinite enclitic *-i* or without any marker as shown in (59a). However, whenever a Poss is present, the object NP must appear with the definite marker (59b).

(59)a. ketab-o/ ketab-i/ ketab            xund-am

book-*râ*/ book-INDEF/ book    read-1s

'I read the book/ a book/ books'

b. ketab-e            jiân-o/ \*jiân-i/ \*jiân            xund-am

book-EZ<sup>24</sup>        Jian-*râ*/ Jian-INDEF/ Jian        read-1s

'I read Jian's book'

(Ghomeshi (1997))

What we have gained so far from this discussion is the following. There is reason to believe that Poss induces specificity effects and that perhaps it stops by an intermediate spec position, possibly either/ both [Spec,QP] (for specificity) and [Spec,FP] position (for Focus), on its way to [Spec,DP]. This prediction is supported syntactically, since the Poss can use an intermediate spec position as an escape hatch before moving out to [Spec,DP]. The final movement of the Poss to its derived -- that is, the [Spec,DP] position -- is due to a feature [POSS] in D which attracts a Poss to its spec.

#### 4.0 DP-internal NP Movement

In this section, I will consider cases of NP movement inside the DP based on the DP structure in (41) obtained as a result of investigation in sections 2.0 and 3.0 of the

<sup>24</sup> In (59b) EZ denotes EZAPE, a vowel inserted between different elements within a NP, PP or AP which is typical of Persian grammar and has well-identified syntactic consequences. Ghomeshi denotes the definite marker *-o* as *râ* in the gloss, I have followed the author retaining this notation.

relative positions of the Poss and the Dem in Bangla. I will also show that the grammar of the Bangla DP must distinguish between at least two types of NP movement. In other words, I will provide well-motivated reasons to move different “chunks” of the nP within the DP. This distinction will be shown on the one hand to necessitate generating the F head, and on the other will predict the nature of DP-internal deixis discussed in section 3.2.2.

To get a quick overview of the rest of the discussion, let us look at the following:

- (60)a. amar ei bhai duTo (DPOS; nP movement)  
 my this brother two-CLA  
 ‘these two brothers of mine’
- b. ei bhai duTo amar ... (KI; NP movement)  
 ‘these two brothers of mine ...’

That is, these two operations, DPOS and KI, in effect, result in different ‘chunks’ of NPs being moved. As expected, the deictic effect obtained in both (60a) and in (60b) is non-locative, since both DPOS and KI result in non-locative deixis (see section 3.2.2. and 3.2.3). However, in their non-specific counterparts, the order of things is different:

- (61)a. amar ei duTo bhai (nonspecific; Poss movement)  
 my this two-CLA brother  
 ‘these two brothers of mine’
- b. ei duTo bhai amar ... (nonspecific KI; NP movement)  
 ‘these two brothers of mine ...’<sup>25</sup>

The deixis obtained in both a and b of (61) is contrastive. Notice that in both cases

<sup>25</sup> Although the English translation fails to capture the differences between the two, the KI case in (61b) should literally translated as *These two brothers mine*.

nothing intervenes between the empty F head and *duTo*, the Q head. The Q, therefore, can head move to F in each case, in effect, deriving the contrastive deixis obtained. I claim this to be the theoretical justification for a head between D and Q.

#### 4.1 nP Movement

In this section I will propose that movement due to specificity is nP movement to [Spec,QP] followed by a movement of the Poss to [Spec,DP] if present. That is, I reinterpret leftward NP movement (descriptively identified as DPOS) of Chapter 2 as nP movement. The following pair shows specific vs non-specific order:

(62)a. *ei du-To bhai* (non-specific)

this two-CLA brother

'these two brothers (here)'

b. *ei bhai<sub>i</sub> du-To t<sub>i</sub>* (Specific)

'these two brothers'

In the case of (62a) the base generated order of the Q head *duTo* followed by the NP *bhai* is manifested. However, notice that (62a) is purely deictic (see (32a) above). Recall that in terms of the proposal made in this study deictic use of a Dem is always contrastive, which is obtained by merging the Dem at [Spec,FP] and by moving a lower head to F. In the case of (62a), therefore, I suggest that the *duTo* head moves to F as follows:



(63)

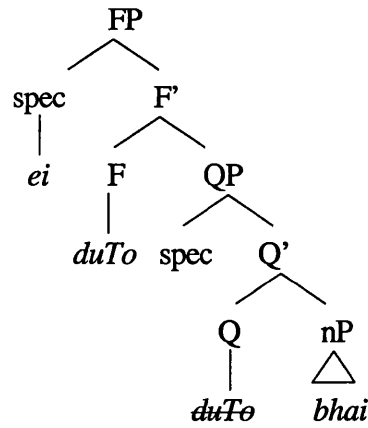

Recall further that FP is the domain of deixis, in the same way as QP is the domain of specificity. In accordance with GLC (in (27)), since both the head and the spec of FP are occupied in (63), the relevant syntactic effect, that is, contrastive deixis, is obtained. In (62b) the DP is specific and therefore NP must move up to [Spec,QP] to check the strong [SPECIFICITY] feature of the Q head. Thus by GLC the syntactic effect of specificity is obtained as both the head and the spec of the relevant domain QP are occupied. Since there is no [FOCUS] feature in the Numeration, the Q in this case must not head move and we obtain a non-locative deixis as desired.

Notice that the movement of *bhai* in this case does not obtain for us any difference that may exist between nP movement and NP movement. To decide on this, let us now consider the following where due to the presence of Poss a full nP is generated.

(64)a. amar ei duTo bhai (-specific, contrastive deixis)

my this two-CLA brother

'these two brothers of mine'

b. amar ei bhai duTo t<sub>i</sub> (+specific, non-locative deixis)

'these two brothers of mine'<sup>26</sup>

<sup>26</sup> Notice that the specificity effect remains uncaptured in the English translations. This is because specificity in English is solely a matter of Det or Dem and not of word order.

Similar to (62a), the order in (64a) is base-generated except for the movement of the Poss to [Spec,DP]. Although this movement can be motivated by the scopal-MLC of Manzini (1998), I will suggest that based on the reasoning offered in section 3.5 (see (III)) regarding the specificity of Poss, the movement of the Poss takes place via [Spec,QP] followed by its movement to [Spec,DP]. The contrastive reading is obtained by head movement of the Q to F. This is shown in(65).

(65)

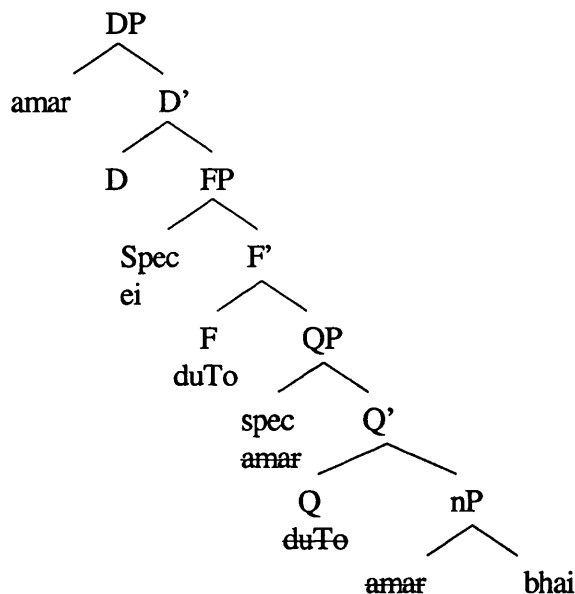

In both (63) and (65), Q→F results in contrastive deixis. I will repeat the earlier suggestion that contrastive deixis is obtained not only by moving the Q to F but additionally by merging the Dem at [Spec,FP]. Note that we are assuming that the F head selected in (65) carries a strong feature of Focus.

In the case of (64b), however, this head movement does not take place as the Focus feature is not strong. In effect, this means the NP gets a specific interpretation when the Q→F movement does not take place.

The set of movements that derive (64b) is suggested to comprise movement of the Poss to [Spec,DP] through [spec,QP] followed by the NP moving leftwards to [Spec,QP] to induce specificity. However, in effect, this is similar to moving the whole

nP to [Spec,QP] first and then moving the Poss out to the higher spec next. Since we have already established the need to have Poss and NP movement in the grammar, there is no need to introduce another kind of NP movement. On the other hand, the number of steps required for the derivation with nP movement is less than with Poss movement followed by NP movement. Furthermore, the distinction between NP and nP will be shown to capture the difference between contrastive and non-locative deixis. For this reasons, I will consider movement due to specificity in non-KI cases to be nP movement. This is shown below for (64b) but (65) now should be seen in terms of nP movement followed by movement of *amar*<sup>27</sup>.

(66)

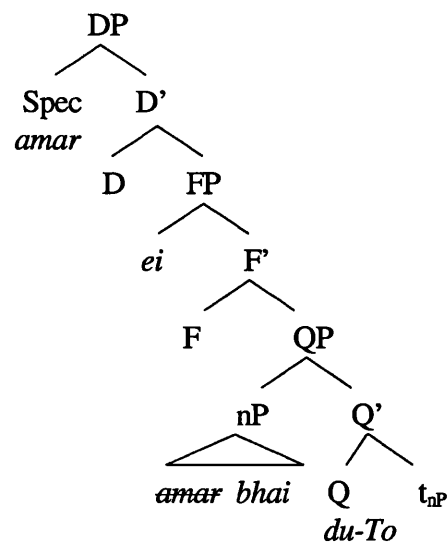

To reiterate, the specificity effect is obtained by the “joint” action of something moving into [Spec,QP] and the presence of some relevant head in Q, identical to the requirement that contrastive deixis is obtained by the joint action of merging the Dem in [Spec,FP] and movement of a lower head into F. This requirement of having both the Spec and the Head filled to obtain a particular syntactic effect is the property shared by

<sup>27</sup> Notice that I am assuming that the specificity effect obtained by the re-interpreted nP movement in (64a) is ‘overshadowed’ by the contrastive requirement. I am not sure as to the semantic implications of such a possibility. In terms of the syntactic derivation, it is conceivable that the [FOCUS] feature being a feature of a higher head, contrastivity is a ‘later’ requirement which ‘breaks up’ the specificity obtained by nP movement.

deixis and specificity.<sup>28</sup> Since (64b) is specific, both the spec and the head of QP must remain filled with the result that head movement of Q cannot take place. And since there is no Q→F movement, the requirement that both the spec and the head of FP must be filled is not met, with the result that the deixis obtained is non-locative.

## 4.2 NP movement

As mentioned in the preview in section 4.0, KI involves NP movement. Now that we have charted the movement of the Poss all the way up to the highest Spec in the DP, it is time for us to remind ourselves of the data in connection with kinship terms repeated from (9):

- (67)a. baba amar khub gorib!  
           father mine very poor
- b. chele amar khub duSTu!  
       son mine very naughty
- c. ma amar SOt manuS!  
       mother mine honest person

I had earlier suggested that the marked order of NP-Poss in these examples is the result of NP movement. Now, with the additional knowledge regarding the position of the Poss, I claim that the Poss in these cases does not move to [Spec,DP]. The Poss in KI is therefore stranded in its base position within the nP shell. The Poss in such cases, therefore, does not check the [POSS] feature at [Spec,DP] in the overt syntax.

Does this mean that the NP, then, raises all the way up to [Spec,DP] in these

---

<sup>28</sup> This requirement runs counter to the suggestion in Giusti (1997) that only one of either the spec or the head D needs to be occupied to obtain definiteness in DP. However, in many languages the requirement is just the opposite of what Giusti states (see section 3.0 for examples). That is, both the [Spec,DP] and the D must be filled to get a definite DP.

cases? If it did, then the following data would be problematic.

- (68)a. *ei bhai amar* (non-locative deixis)  
           *this brother mine*
- b.\* *bhai ei amar*

If the kinship noun *bhai* ‘brother’ raises to [Spec,DP] to check some feature on the D, the unacceptability of (68b) is strange. It is, therefore likely that the NP does not raise all the way up but only up to [Spec,QP]. Therefore, in (68a) the NP *bhai* moves to [Spec,QP]. This is one reason to analyse KI as NP movement. However, any movement to this position has been analysed so far as movement due to specificity. Let us look at a fuller data set to see if we also get a specificity effect in the case of kinship inversion.

#### 4.2.1 Specificity and KI

DPOS and KI share the property that they make the deixis of the phrase non-locative.

Let us look at the order in (69):

- (69) *bhai duTo amar, ...*  
           *brother two-CLA mine*  
           ‘two brothers of mine, ....’

KI in the case of (69) raises the NP *bhai* through [Spec,QP] therefore inducing a specificity effect as well. On the surface, there is no way to distinguish NP movement to [Spec,QP] or further up to [Spec,DP] if there is no other head present in between. In (69) the reading obtained is specific, i.e. something is being said about two specific brothers. One justification for choosing this feature is that a question which does not assume that the referent has prior discourse mention (like *Who will come tomorrow?*)

may not be felicitously answered with a kinship inverted NP. However, nothing in the theory rests on the nature of this feature. There is nothing prohibiting Q having both a feature of [SPECIFICITY] for DPOS and another feature (e.g. [KI]) responsible for KI. In keeping with the discussion in chapter 2, I will keep to the usage [SPECIFICITY] as the triggering feature for KI. This will become clear if we look at the following:

(70)a. ei      du-To              bhai    amar    ....      (-specific, contrastive deixis)

          this    two-CLA            brother mine

          ‘these two brothers of mine, ....’

b.      ei      bhai    du-To amar                              (+specific; non-locative deixis)

          ‘these two brothers of mine, ....’

For KI cases like (69), I have said that the NP moves up to [Spec,QP] stranding the Poss. Notice that the Poss in all cases so far carries the GEN Case marker. This would indicate that in all cases, including the ones of KI where the Poss is stranded, D is generated, since that is the domain of GEN Case checking. I will assume that the Poss satisfies the [POSS] feature of the D in KI cases covertly.

To see whether the NP in (69) moves all the way up to [Spec,DP] let us look at (70). From (70) we can see that whenever the Dem is used in KI order, it is either contrastive (as in (70a)) or non-locative (as in (70b)). The difference between the two versions is that of specificity, the b version, therefore, must involve movement to [Spec,QP] to induce the specificity effect when the Q head is filled:

(71)

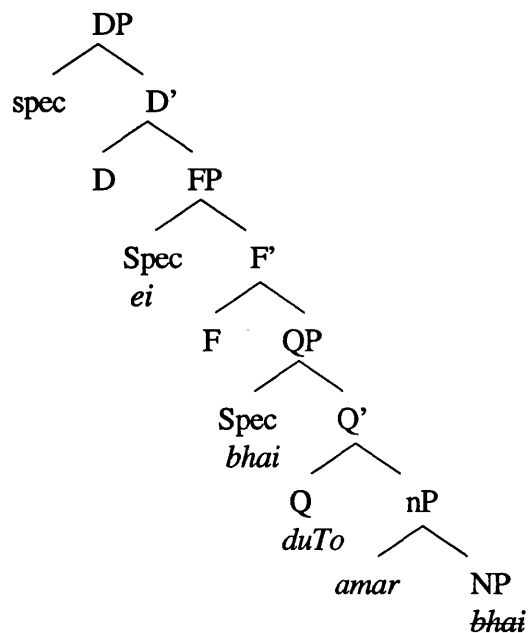

Notice that KI as NP movement to [Spec,QP] leaves the Poss behind in its base-generated position. KI takes place in the case of (70a) as well. KI is always obtained in this analysis by NP movement. Movement to [Spec,QP] on the other hand induces specificity if the Q head also remains filled by spell-out. Since the version in (70a) is not specific, I suggest the specificity is “overridden” (see note 27) by the presence of a strong [FOCUS] feature which head-moves Q to F which results in contrastive deixis:

(72)

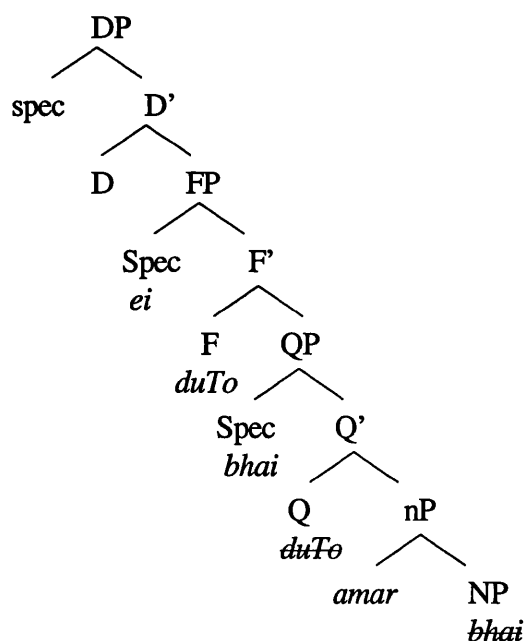

The deixis facts obtained in (70) fall out of the analysis that we have proposed based on a difference between nP and NP movement.

## 5.0 Conclusions

The main findings of this chapter are outlined below:

- The possessive is base-generated in a lower nP-shell and moves up later to check Case either in overt or covert syntax to [Spec,DP] (section 2.0)
- The demonstrative is an XP merged at the specifier of a focus-related functional projection FP (section 3.0)
- Both specificity and deixis require that both the spec and the head of QP and FP, domains of specificity and deixis respectively, must be filled at spell-out as part of a Generalised Licensing Condition (GLC) as stated in (27) (section 3.2)
- NP movement inside the DP involves movement of either NP or nP: Kinship Inversion is NP movement whereas DP-internal Object Shift is nP movement (section 4.0)
- When the nP moves to [Spec,QP] in the case of DPOS, the Poss moves out to [Spec,DP] to check [POSS] feature; in the case of KI this feature checking takes place at LF; this is economically less costly in comparison to movements of Poss and NP separately (sections 4.1 and 4.2)



### Appendix: Dem in the nP-shell

Given the proposal (for example in Brugè 1996) that Dems may be generated lower in the DP, in this appendix I will consider this possibility (and then reject it).

One evidence suggesting a lower origin of the Dem is the composition of the words in the following examples, previously unnoticed in the literature on Bangla syntax.

- (1)a. Emon/ Omon            ‘like this/ that’  
 b. egulo/ ogulo            ‘these/ those’

In Chapter 2, *gulo* has been identified as a well recognised count Cla word. For the purpose of this discussion, I will suggest that *mon* in (1a) is a frozen Cla<sup>29</sup>. The above data shows that, although not productive, Dems are closely linked with Cla<sup>30</sup>.

Notice however that the Dem in these examples is the unaugmented form, i.e. without the anti-pronominaliser *-i*. It is conceivable that the pronominal *e* originating in NP moves up to the nearest head to form the expressions in (1).

I will, however, distinguish between *mon* and *gulo* by suggesting that the former is a Cla-spec (as *jOna*, the human Cla, discussed in greater detail in the general appendix). The count Cla *gulo* is a standard Cla head like *-Ta* discussed in Chapter 2.

<sup>29</sup> Although Mod Bangla uses the derivative *mOto(n)* ‘like, similar to’ as a full word, its use in similar contexts to (1) is not attested at all; it is presumably derived from the Vedic root *-mant* implying likeness or size (Chatterjee 1926: 851).

<sup>30</sup> *ekhan/ okhan* ‘here/ there’ may also be considered in this connection where the pronominal *e* combines with the Cla *khan* (or “Cla-Spec” in the analysis offered in the general appendix). However, because of the irregularity associated with its use (e.g. the usage of *khana/ khan* in (i) and its combination with Dems in Asamiya (Assamese) as in (ii)), I will not consider it for this discussion:

- (i) tin khan boi                    (Standard East Bangla)  
     three CLA book  
     ‘three books’  
 b. tin khana/ \*khan boi        (Standard Bangla)  
     ‘three books’  
 (ii) ei-khon kitap                (Asamiya)  
     this-CLA book  
     ‘this book’

I thank Rajat Ghosh (p.c.) for the data in (ii).

This distinction is suggested by the following:

(2)a. E-mon-Ta

'like this'

b.\* e-gulo-Ta

That is, *mon* can take the standard Cla -*Ta* after it but *gulo* cannot. Consider the possibility that when *e* moves up to *mon*, it forms an adjunct structure as in (3a). Thus it cannot further move up which would require excorporation, though the whole of the adjoined structure can (see (4a) below). The possible derivations for both words in (1) are shown below::

(3)a.

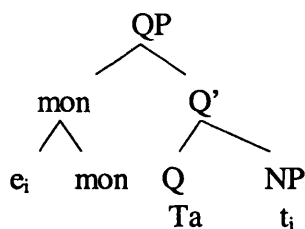

b.

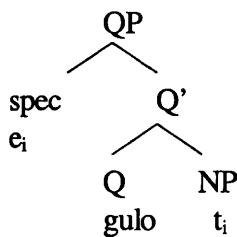

(4a) below shows that the complex in (3a) as a whole can move up:

(4)a.   emon            duTo            boi  
          this-like        two-CLA        book  
          'two books like this'

b.\*    egulo    duTo            boi  
          these    two-CLA        book  
          'these two books'

Furthermore compare the behaviour of *emon* and *egulo* in the following which shows that the latter can take up the augment *-i* to form a regular Dem *ei* while the former cannot:

- (5)a. *ei gulo*  
       this CLA  
       ‘these’
- b.\* *ei mon*

Given the derivation in (3) above, it is clear that (5b) is out because *e* cannot move out of the adjoined structure to the domain of Dem, i.e. to FP. However, I would like to suggest that the syntax of Dem-formation is unconcerned with the internal make-up of the Dem word as it is merged at [Spec,FP].<sup>31</sup>

To conclude, when a Dem is selected as part of a numeration to form a syntactic object, it is merged as a specifier of an F head, the internal structure of the Dem being invisible to the syntax<sup>32</sup>. This short discussion, has nevertheless, given us further synchronic evidence in favour of an F head associated with the syntax of Dems.

---

<sup>31</sup> The *non*-syntactic character of this process is visible in the case of adjunct complex *Emon* ‘like this’ as a whole taking up the augment *-i* to form *Emoni* meaning ‘similarly’ as also, *emni* meaning ‘simply’.

<sup>32</sup> It may be interesting to note that under a Distributed Morphology view, operations producing words are distributed among various systems. It may take place in phonology, morphology or in syntax (McGinnis 1995: 167).

## Chapter 4

### The Gerund and NP Movement

#### 1.0 Introduction

The central assumption of this thesis has been a continuation of the investigation begun by Abney more than ten years ago, namely, DPs exhibit similar or identical behaviour to clauses. The main finding of this dissertation so far has been the existence of NP movement inside the DP (see Chapters 2 and 3). This chapter is an attempt to investigate both the wider assumption and the particular finding in terms of the structure of gerunds in Bangla. Towards the former goal, I will show how certain sentential aspectual properties are reflected inside the DP consisting of gerund structures. Consequently, the gerund head is considered a nominal aspectual head. Towards the latter goal, I will show that the derivation of gerunds involves NP movement inside the DP.

In section 1.0, I discuss the relevance of nominalisation for grammar in general. Section 2.0 introduces the gerund suffix in Bangla. Postponing the discussion of gerundives and result nominals to sections 6.0 and 7.0, I discuss in detail the relation between gerunds and participles in Bangla in terms of the predicate type of the verbal source. In section 3.0, I discuss the external and the internal distribution of gerunds which show the ambiguity of Bangla gerunds similar to the English ones. In section 4.0, I introduce the notion of nominal aspect inside the gerund. Section 5.0 deals with the analysis of the data presented in earlier sections.

## 1.1 The Importance of Nominalisation

In this section I will discuss the place of nominalisation in the grammar, in particular, how it leads to the important distinction between lexicalist versus non-lexicalist accounts, in past and present models of grammar.

The place of nominalisation in grammar was given considerable significance by Chomsky (1970). The issue revolved around the enrichment of one component of the grammar via a possible simplification in another. For Chomsky (1970: 185) the proper balance between the various components is an empirical issue, which must be studied in order to establish the principles of UG and to choose the evaluation measure. Chomsky's study led to the generalisation that regular correspondences between linguistic forms should be captured in the syntax (through transformations) and the irregularities in the lexicon. This in turn led to the lexicalist versus non-lexicalist debate. Thus we may derive from the verb *give* the derived nominal (DN)<sup>1</sup> *gift* or the gerundive nominal (GN)<sup>2</sup> *giving*, whereas the former is traditionally viewed as part of derivational morphology, the latter as inflectional or as part of syntax. The literature on nominalisations in English includes numerous arguments to show the difference<sup>3</sup>

---

<sup>1</sup> In contrast to Gerundive Nominals, which will be discussed shortly, there is no controversy in naming these constructions in the literature. However, derived nominals can come in two varieties, namely, active (ia) and passive (ib) derived nominals:

- (i)a. The chairman's selection of the book pleased its author
- b. The book's selection (by the chairman) pleased its author

Snyder (1998: 133) makes a distinction between the two in terms of the latter indicating a "culmination" of the event while the former is ambiguous between both a development and culmination reading.

<sup>2</sup> There is no general consensus in using these terms in the generative tradition. For example, in the same volume as Chomsky's paper, Bruce Fraser uses the term Factive Nominals for Chomsky's gerundive nominals and Substantive Nominals for Chomsky's Derived Nominals (Fraser 1970: 84-85).

Further, gerundive nominals are often identified as verbal gerunds or imperfect gerunds (Vendler 1967) as opposed to nominal or perfect gerunds (as in *John's refusing of the offer*) which in turn is also identified as Action Nominal (Fraser 1970, Grimshaw 1990) or as mixed nominals (Chomsky 1970: 215). A distinction is also made in the literature between Action/ Event/ Process nouns versus Result nouns (see Grimshaw 1990, Siloni 1997 among others). I have discussed this terminological confusion further in note 16 and section 6.0.

<sup>3</sup> Corresponding to the sentence in (ia), there are GN in (ib) and DN in (ic) (from Chomsky (1970:

between these two different nominalisations: differences which indicate, according to Chomsky, a transformational derivation of GNs (i.e. underlyingly GNs are sentences in this theory)<sup>4</sup>. Due to these differences, Chomsky argued, it would be wrong to derive both from the same source by applying different transformations. He concluded that “derived” nominals are not derived at all but are rather listed in the lexicon.

However, it is the similarities between two types of nominals that led to X-Bar theory. In particular, Chomsky observed that both DNs and GNs have subjects like sentences (see (1)). This led to the X' rule schema in (2) which additionally captured the similarity of the complements of the three structures shown in (3).

- (1)a. John gave the book
- b. John's giving (of) the book [Gerundive Nominal]
- c. John's gift of the book [Derived Nominal]
- (2)a. X'' → Spec, X'
- b. X' → X (YP) (ZP)

---

187)):

- (i)a. John has refused the offer
- b. John's refusing the offer
- c. John's refusal of the offer

<sup>4</sup> Some of the differences pointed out in Chomsky (1970) concern their relative productivity, the generality of the relation between the nominal and the associated proposition and the internal structure of the nominal. The fact that GNs are quite productive, the relation of meaning between the nominal and the proposition is quite regular and they do not have the internal structure of NP since *John's of John's refusing the offer angered Mary* cannot be replaced by a determiner like *that* or *the* indicating, furthermore, that GNs are derived transformationally.

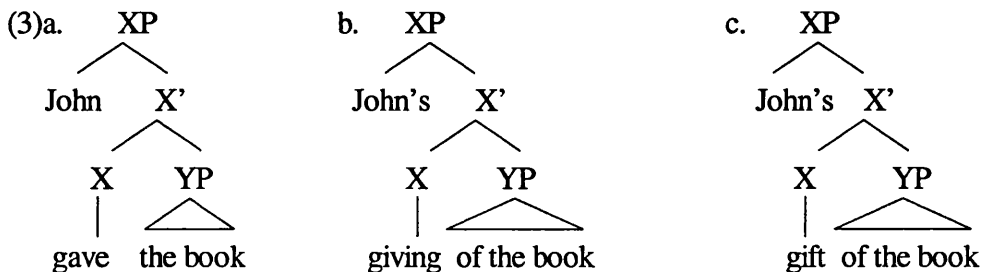

The pre-X' rule schema does not capture this similarity.<sup>5</sup>

## 1.2 Gerunds as Complex Event Nominals

The differences between the two types of nominals point to the non-transformational derivation of the DNs. Deriving DNs by specifying them in the lexicon constitutes the lexicalist position. Prior to frameworks with an explicit lexical component, the only way to derive deverbal nouns was through nominalisation transformations<sup>6</sup>. There was no other way to relate, for example, the verb *criticise* and the noun *criticism*. After the incorporation of syntactic features and the separation of the lexical component, a noun like *criticism* is entered in the lexicon with fixed subcategorisation and selectional properties which are independent of categorial features like [Noun] and [Verb]. Morphological rules determine the surface forms of DNs. The similarity of NPs formed out of DNs with NPs formed out of concrete Ns led Chomsky to take the lexicalist

<sup>5</sup> This is so because the following set of rules (in (i)) will lead to the structures in (ii):

- (i)  $S \rightarrow NP VP$   
 $VP \rightarrow V (NP) (PP)$   
 $NP \rightarrow (Det) N PP$   
 $Det \rightarrow NP$



<sup>6</sup> Thus, Lees (1960), for example, had deverbal nouns generated as clauses which were mapped onto noun phrases through a series of nominalisation transformations.

position arguing against a nominalisation transformation<sup>7</sup>.

Within variants of lexicalist theories of the eighties, attention shifted to the extent to which nouns are similar to or different from their related verbs. Studies like Higginbotham (1983) and Dowty (1989) argued that nouns take arguments only optionally. Grimshaw (1990) challenged this notion and proposed that nouns can take obligatory (internal) arguments<sup>8</sup>. She specifically distinguished between nouns referring to complex events and nouns referring to simple events. The difference between the two types of nominals identified in Chomsky (1970) does not automatically translate in this system since DNs are shown to be ambiguous between a complex and a simple event interpretation.

A distinction based on Grimshaw's (1990) event classification can capture the range of nominals appearing with the gerundial suffix that we take up for study in this chapter. This is due to the fact that these constructions (the ones formed with the gerundial suffix *-(w)a/no*, to be discussed in section 2.0) -- participles, gerunds, 'gerundives' (I explain the usage of this term in the context of Bangla in note 16 and section 6.0) and result nominals -- can be distinguished by virtue of their event (or aspectual) properties. I show that gerunds and participles are syntactically related to the verbal source whereas the other two constructions (discussed in sections 6.0 and 7.0) are fully nominal in character. In particular, I assume with Grimshaw that gerunds denote complex event nominals (CEN) whereas gerundives and result nominals are

---

<sup>7</sup> Williams (1991) adopts a similar strategy to show that semantically too DNs behave like NPs as opposed to Action nominals and gerunds which behave like sentences in terms of four variables that he studies: extent, event, fact and manner.

<sup>8</sup> The result nominal reading of (i) is out because the N is without its obligatory argument. In (ii) the CEN reading of the N licenses the modification:

- (i)\* The constant assignment is to be avoided
- (ii) The constant assignment of unsolvable problems is to be avoided
- (iii) The city's development \*(of housing) was applauded

These examples show that in certain cases the N takes an argument obligatorily.



simple event nominals (SEN)<sup>9</sup> in the sense of Grimshaw (1990) who proposes that CENs have an obligatory argument structure or a-structure<sup>10</sup>. This distinction translates in the current analysis as aspectual differences, i.e., gerunds in Bangla project an a-structure in the syntax with specific aspectual positions absent in other nominals. I will deal with this and related issues in sections 4-7.

In sum, based on Grimshaw (1990), I conclude that gerunds denote complex events and this is encoded in the aspect of the phrase. This suggests that gerunds contain a syntactic position for aspect. The structure of the Bangla gerund that I propose in the next section makes use of this conclusion. Furthermore, I suggest that the gerund suffix, to be discussed shortly, heads this aspect phrase.

### 1.3 Structure of the Gerund

Based on the discussion in the preceding section, I claim that gerunds in Bangla contain a fully projected VP containing the functional projections of AspP as follows:

<sup>9</sup> Snyder (1998) argues for a three way distinction: propositional, simple and complex reading for nominals. Specifically he disagrees with Grimshaw's classification of passive nominals (*John's selection (by the chairman) angered Mary*) as SEN and instead argues that they resist an "on-going process" reading available to action nominals.

<sup>10</sup> A non-lexical, syntactic approach to DNs would take the presence of a-structure (and an event reading) as verbal properties. It would, therefore, account for DNs as V incorporation into N as follows:

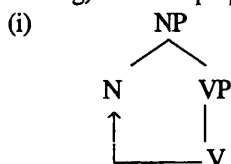

This is the approach taken by Hazout (1995) for Hebrew event nominals. However, as Siloni (1997: 75) observes, this incorporation differs from other cases of head to head incorporation that Baker (1988) discusses all of which involve incorporation of two semantically autonomous units whereas the incorporation in (i) involves a semantically empty noun which inherits the semantic content of the incorporated V. Moreover, since DNs are known not to be systematically productive, only some verbs will undergo such incorporation. I offer a critique of another non-lexical account of DNs in the Appendix.

(4)

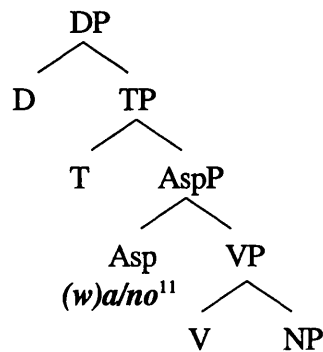

In section 3.0 I discuss the distribution of gerunds and show that they behave like a noun phrase justifying the DP structure in (4). The nominal character of the gerund is encoded in the  $D^0$  head which is nominal. Furthermore, in section 3.4 I discuss their ambiguous nature and their behaviour as VPs which justify the V head inside the gerund DP as in (4). Notice that the DP in (4) contains a TP besides an AspP. I present evidence in favour of the TP in the following section. I postpone the discussion of nominal aspect as represented by AspP in (4) till section 4.

### 1.3.1 T in DP

The presence of tense inside nominals was first pointed out in Hockett (1958: 238). In Potawatomi, the tense morpheme *-an* can appear on both event and common object nouns. It is the same morpheme which is affixed to verbs to express tense or aspect relations:

(5)a. nos

‘my father’

b. nosan

‘my deceased father’

<sup>11</sup> I will shortly discuss in section 2.0 that *-(w)a/no* is the gerund suffix in Bangla.

- c. nciman  
‘my canoe’
- d. ncimanpan  
‘my former canoe’

(6)a. nkasatas  
‘I am happy’

b. nkasataspan  
‘I was formerly happy’

As per Lecarme’s (1996: 162) interpretation the tense morphology in Somali is associated with nouns. The distinction between past/ non-past (see (7) below), parallels the identical distinction in the VP:

(7)a. sannad-ka dambe  
year-DET next  
‘next year’

b. sannad-kii/\*ka hore  
year-DET.PAST before  
‘last year’

Lecarme points out that nominal tenses in Somali can have an independent reading.

Additionally, I suggest that in the context of the analysis of adjectives in chapter 2 (namely, adjectives as specifiers of NPs), tense in adjectives in Japanese is another piece of evidence in favour of a TP inside the DP. Nakamura (1994: 375), in discussing the tense system in Japanese in general presents the following data which shows that the tensed adjectives in the non-past tense which end with *-i* contrast with those in the past which end with *-katta* (I ignore the possibility that (8) is sometimes considered to

exhibit relative clause properties):

- (8)a.    aka-i            kuruma  
           red-PRS        car  
           ‘a red car’
- b.        aka-katta        kuruma  
           red-PAST       car  
           ‘a car that was red’

This is visible in a sentence as follows:

- (9)a.    Taroo-wa        aka-i            kuruma-o        kat-ta  
           Taroo-TOP    red-PRS        car-ACC        buy-PAST  
           ‘Taro bought a red car’
- b.        Taroo-wa        aka-katta        kuruma-o        kat-ta  
           Taroo-TOP    red-PAST        car-ACC        buy-PAST  
           ‘Taro bought a car which had been red’

Furthermore, as Cinque (1994) points out, the presence of adjectives like *present*, *past* or *future* indicates the existence of a TP projection inside the DP<sup>12</sup>.

Most crucially, however, the presence of the TP, apart from the reasons given so far, solves the problem of some Bangla gerunds where the gerund subject bears Nominative Case. I will discuss this in section 3.3.3 as part of the introduction to the data that the structure in (4) covers.

Finally, in the analysis of van Hout and Roeper (1998) a TP in a nominalisation structure is needed in order to get the event entailment right (on a par with Kratzer’s

---

<sup>12</sup> Siloni (1997: 176) argues against the presence of T in Hebrew gerunds. However, we will stick to the present formulation of a T head inside the gerund with the caveat that although gerunds do not have an internally fixed time frame, the T head is needed for reasons given in the text and also it accounts for the data in Bangla.

(1994) proposal for event closure at the sentential level). Recall in this connection the conclusion reached in the previous section based on Grimshaw (1990: 26) that gerunds are complex event nominals. I discuss the nature of this event as expressed through aspect in section 4.0, and suggest that the event entailed by the gerund suffix is imperfect.

## 2.0 The Data: The Gerund Suffix in Bangla

In this section I introduce the range of data that the gerund structure in (4) is intended to cover. Specifically, I identify the gerund suffix in this language and return to a fuller description of the distribution of gerunds in section 3.0.

The title of this section implies that gerunds in Bangla are morphologically identifiable. Although the issue of what constitutes a gerund has been contentious, the study of gerunds in English within generative grammar, most thoroughly analysed in Abney (1987) subsuming the work of Emonds (1970), Schachter (1976), Chomsky (1981), Reuland (1983) and Baker (1988) among others, shows uniformity in the range of constructions considered to be gerunds, namely, *POSS-ing*, *ACC-ing* and *Ing-of*<sup>13</sup> shown in (10) below. This has also been the case for studies in non-generative frameworks like GPSG/ HPSG as in Pullum (1991), Lapointe (1993) and Yoon (1996) among others in English, and Dasgupta (1980), De (1984) and Bagchi (1993) in Bangla. I do not see any reason to question this conformity in identifying the construction. However, since out of the gerunds in (10), (10b) and (10c) do not obtain in Bangla, I will discuss the type (10a) as the only gerund type in Bangla in the rest of

---

<sup>13</sup> This is another name for the “mixed form” in Chomsky (1970: 215).

this chapter. For the purpose of this study I will, therefore, assume any deverbal nominal which can have a possible Genitive subject (to be made explicit below in section 3.3) and which denotes a complex event as per Grimshaw (1990), discussed in section 1.2, as a gerund in Bangla.

- (10)a. *His going* to the market .... [POSS-*ing*]
- b. We approve of *him going* to the market [ACC-*ing*]
- c. John's *fixing of* the car ... [Ing-*of*]

Gerunds are formed in Bangla by adding a gerund suffix. There are four gerund suffixes in Bangla:

- (11) -a: pOR-a 'reading'  
 -wa: ga-wa 'singing'  
 -no: pala-no 'escaping'  
 -ba: kha-ba 'eating'

I will treat the first three suffixes as one group, the *-(w)alno* group which contrasts with *-ba* in its distribution:

- (12)a. kha-
- i. khawa 'eating'
- ii. khaba<sup>14</sup> 'eating' (dialectal)
- iii.\* khaa
- iv.\* khano

<sup>14</sup> All the (ii) forms with *-ba* in (12) also act as a stem for the corresponding gerundive *khavar* 'of eating', *dEkhar* 'of seeing' *takar* 'of staring'.

- b. dEkh-
- i.\* dEkhwa
  - ii. dekhba 'seeing' (dialectal)
  - iii. dEkha 'seeing'
  - iv.\* dEkhno
- c. taka-
- i.\* takawa
  - ii. takaba 'staring' (dialectal)
  - iii.\* takaa
  - iv. takano 'staring'

Let us briefly discuss these two groups in turn.

### (w)a/ no

The suffixes *-a/-wa* occur after monosyllabic verb roots, *-a* occurs after consonant ending verb roots while *-wa* occurs elsewhere. Their distribution could therefore be accounted for by a phonological feature. This is implicit even in Chatterji (1926) since he considers that suffixes like *-aano* (earlier form of *-no*) etc. must attach to causative and denominative verb bases, these being longer than monosyllabic forms. Although *-wa* and *-no* are in complementary distribution, diachronically they are from different sources and are phonologically distinct from each other. These two therefore form a suppletive morpheme *-(w)a/no*.

### -ba

As shown in (12), this suffix contrasts with the other group in its distribution. This

suggests that a verb root forming a gerund with *-(w)alno* also has another form with *-ba*. This has two varieties among the speakers of the language -- *ba* and *-iba*.<sup>15</sup> An interesting observation which remains unexplained in De (1984) is that *-ba* gerunds, unlike *-(w)alno* gerunds, do not occur independently (i.e. they must have a Genitive marker), rather, they appear in the template (13a) as in (13b):

(13)a. V+*ba*+GEN

b. *ja-ba-r*

go-GER-GEN

'going'

The appearance of the Genitive marker is a consistent diagnostic for gerundives<sup>16</sup> in Bangla. Given the reasons in note 16, the term gerundive will be reserved for constructions where the *-ib* (or *-ba*)<sup>17</sup> morpheme is used to form the gerund and

<sup>15</sup>This is shown below:

(i)a. *lekh-ba/ Son-ba/ kor-ba* 'writing/ hearing/ seeing' (Standard)

b. *likh-ba/ Sun-ba/ kor-ba* 'writing/ hearing/ seeing' (Dialectal)

In case of (b) the high vowel of *-iba* raises the preceding vowel and deletes (see Dasgupta 1980 for details).

<sup>16</sup>Weir (1986) gives the following definition for English gerundives:

English gerundives are nominalisations containing a VP whose initial, non-adverbial element has an *-ing* morpheme associated with the progressive verb form suffixed to it. Often gerundives also contain a POSS NP and so they are sometimes referred to as POSS-ing

Thus, in English, both ACC-ing and POSS-ing (and mixed nominals of Chomsky (1970)) are 'gerundives'. Notice that the Bangla gerundive construction is closer to the traditional definition of gerundives (as in Crystal (1992: 290)) whereby a verb (like *crumble*) may be turned into an adjective (like *crumbling*).

Following the Orientalists who study Sanskrit in English, there has been an attempt (e.g. in De (1984) and Dasgupta (1994)) to distinguish the terms gerund and gerundive, identifying the latter with forms V+nominaliser+adjectivaliser/ Genitive marker. It is important to see that the term gerundive has been wrongly used as the simple adjective of gerund in Chomsky (1970) onwards. As Dasgupta (1986) points out, according to the *Webster's Third New International Dictionary* (although there is no reason to believe that this is an authority on linguistics terminology) the adjective corresponding to gerund is "gerundial", and the gerundive, as per the classical scholarship, is the future passive participle form of the verb. The matter is made worse by the fact that gerundives are often derived from gerunds. Since gerund to gerundive derivation happened in the New Indo Aryan stage of Bangla, that is, independent of the influence of Sanskrit, it need not be considered to be a deep seated pattern in Latin alone. However, given that there are various opinions on the gerundive in Vedic/ Sanskrit itself (see Peterson (1997) for a review), it is not clear whether gerundive is the right term for these constructions in Bangla. Until we reach a more satisfactory analysis of the "gerundive" in Bangla, I will maintain the classical usage for the purpose of this thesis.

<sup>17</sup>The *-ib/ba* form is sometimes reduced to *-a* making it similar to the *-walno* gerund structure.



furthermore is followed by the Genitive Case marker. Historically, the *-ib* morpheme was used in the verbal noun in Genitive to indicate the present or future relative participial (Chatterji 1926: 1017) as in *amar pOr-ba-r kapoR* “my wear-GER-GEN cloth” ‘cloth to be worn by me’. Similarly in Modern Bangla, the gerundive form has the *V-ba-GEN* structure and is used adjectively.

## 2.1 Other uses of the gerund suffixes

It is important to point out that the morphological identification of the gerund suffixes is not sufficient to identify a gerund phrase. The following example shows constructions sharing the gerund suffix.

- (14)a. *amar naTok lekha* (gerund)  
 my play writing  
 ‘my play writing’
- b. *amar lekha naTok* (adjectival participle)  
 my written play  
 ‘a play written by me’
- c. *khabar ghOr* (gerundive)  
 eating.GEN room  
 ‘dining room’
- d. *apnar duTo lekha dekhlam* (Result nominal)  
 your two write.GER saw  
 ‘(I) saw two of your articles’

Notice that the strings representing the gerund and the adjectival participle are quite

---

However, a gerundive always takes a Genitive marker after the affix.

similar to each other. For this reason, these two constructions have been traditionally discussed under the same heading and, further, quite often one has been treated as derived from the other<sup>18</sup>. I will discuss various aspects of the similarity between these two forms in section 3.5. In sections 6 and 7 I will show that Gerundives and Result Nominals in Bangla are pure nominals.

### 3.0 The Data: Distribution of Gerunds

The ambiguous nature of gerunds is most visible in connection with their distribution. It is generally accepted that in their external distribution they behave like a noun phrase whereas internally they exhibit verbal characteristics (Emonds (1976), Schachter (1976), Reuland (1983), Abney (1987)). I will show that both in their external distribution as well as in their internal structure the gerund in Bangla (like its POSS-ing counterpart in English) behaves as a noun phrase. However, in section 3.4 I show the ambiguous nature of gerunds in terms of their verbal behaviour which thus justifies the embedded VP in the gerund structure in (4).

In keeping with the ambiguous nature of the gerund in the syntactic literature in general, there have been proposals concerning the clausal and (noun) phrasal nature of gerunds in Bangla too (Dasgupta 1980<sup>19</sup>, De 1984 and Bagchi 1993<sup>20</sup>).

If the head is treated as a V under an NP then it results in an exocentric

---

<sup>18</sup> For example, Dasgupta (1980) derives participles from the gerund since the latter constitutes a "bigger" set (see section 3.5.1 for a discussion on gerunds as constituting a superset).

<sup>19</sup> In the phrasal hypothesis of Dasgupta (1980) gerunds are believed to be base-generated as [<sub>NP</sub> NP NP N] whereas the unacceptable clausal hypothesis would have to derive them from [<sub>NP</sub> [<sub>S</sub> NP NP<sub>i</sub> V] NP<sub>i</sub>] by an EQUI-NP rule.

<sup>20</sup> Bagchi (1993) includes a study of gerunds in the autolexical framework which when translated into the GB notation is similar to the earlier proposals of Schachter (1976) and Chomsky (1981), suffering as these earlier works, from the X'-theoretic problem of including a V head inside the NP. Apart from this, it treats the gerund affix as a lexical category and does not give a satisfactory account of Genitive on the gerund subject.

construction. De (1984), therefore, considers it as a transferred category like [V;N] -- a V ‘approaching’ an N. According to their verbal characteristics they take adverbs, objects, negative markers etc. and because of their nominal nature they respond to Case inflections and the classifier *-Ta* in Bangla. In English, there are a number of constructions which display, according to the “nouniness” scale of Ross (1973), a discernible affinity to one or the other end of this scale. The generally accepted cut, according to Abney (1987: 167), is between ACC-ing (the most NP like sentence) and POSS-ing (the most sentence like NP).

We have briefly seen in section 2.1 that in Bangla participles are quite similar to gerunds in their morphological make-up and syntactic configuration. Among the various gerundial V+ing constructions available in English, like ACC-ing, POSS-ing, etc. only POSS-ing has a gerund form in Bangla. I will look at ACC-ing (and PRO-ing) constructions first (Reuland (1983) being the major study in this realm<sup>21</sup>).

### 3.1 ACC-ing

The ACC-ing construction in English is shown by (15):

(15) We approve of [him studying Linguistics] (Abney 1987: 169)

Accusative Case for the subject is the crucial defining property of the ACC-ing construction. In the following Bangla gerund, the subject cannot be marked accusative (which is marked by zero if inanimate or by *-ke* if animate):

---

<sup>21</sup> Reuland (1983) considers ACC-ing constructions as CPs with an empty complementiser which select an IP headed by *-ing*.

- (16)\* amra o/ta-ke<sup>22</sup> biggan pORa anumodan korchi  
 we he-Ø/he-ACC science studying approve do  
 ‘we approve of him studying science’

Another property of ACC-ing constructions relevant for Bangla is their ability to take PRO subject as in (17).

- (17) We approve of studying linguistics

Again, this is also not possible in Bangla:

- (18) amra \*PRO biggan pORa onumodon kori<sup>23</sup>  
 ‘We approve of studying science’

We conclude from this short discussion that ACC-ing construction are not available in Bangla. We will, therefore, concentrate on the distribution of the POSS-ing gerund which does exist in Bangla.

### 3.2 External Distribution of POSS-ing

First, let us look at the claims made for the NP status of gerund phrases in English. Emonds (1976: 127) shows that non-gerund clauses appear only in extraposition and topicalised NP positions, while gerunds appear in all NP positions. Even in some crucial positions like cleft focus position where only NPs with lexical heads and PPs occur, gerund phrases do occur. In this particular position, VPs, APs and Ss which are clearly not NPs do not occur. In small clauses where only NPs are allowed, gerunds can occur but infinitives cannot:

<sup>22</sup> *o* is the distal pronoun: ‘he-there’ and *Se* (which becomes *ta* when followed by a Case like GEN, LOC or DAT) is the ‘sequent’ pronoun, i.e. one which has a prior discourse reference. See Dasgupta (1992) for some discussion on different forms of pronominals in Bangla.

<sup>23</sup> This sentence can have a PRO only if it is identified as a Poss, i.e. a PRO<sub>GEN</sub>, but it appears that such a PRO will not be recoverable from the context and therefore will not count as a PRO.

- (19)a. I kept the trees green  
 b. I consider sneezing loudly in public bad  
 c.\* I consider to sneeze loudly in public bad

Infinitives in Bangla end with *-te*. They are quite similar to gerunds but do not occur in

NP positions, e.g. the subject position:

- (20)a. *jawa* SOmbhob nOy (Gerund)  
 going possible is not  
 'Going is not possible'
- b. \**jete* SOmbhob nOy (Infinitive)  
 to go possible is not

The occurrence of infinitives in the complement position is either disallowed (21b) or restricted (22b):

- (21)a. *rakhal bichana kOra SeS koreche* (Gerund)  
 Rakhal bed making finish has-done  
 'Rakhal has finished making the bed'
- b.\* *rakhal bichana korte SeS koreche* (Infinitive)  
 Rakhal bed to-make finish has-done
- (22)a. *rakhal SaMtar Sekha Suru koreche* (gerund)  
 Rakhal swimming learning start has-done  
 'Rakhal has started learning to swim'
- b.? *rakhal SaMtar Sikhte Suru koreche* (Infinitive)  
 Rakhal swimming to-learnstart has-done  
 'Rakhal has started to learn to swim'

This is one more reason for claiming that Bangla gerund phrases are also NPs. There

are other positions from which sentences are excluded: (i) object of a preposition (ii) subject of an embedded sentence (iii) subject of a sentence following a sentence initial adverb (iv) topic position (v) subject of a NP. I will look at each of these in turn.

### 3.2.1 Object of a P

The following example from Abney (1987) shows that the preposition *about* takes a POSS-ing gerund as a complement but not a sentence:

(23)a. I learned about John's smoking stogies

b.\* I learned about that John smoke(s) stogies

Similarly Bangla prepositions<sup>24</sup> take gerund complements (and exclude sentential complements) but with some added complications which will become clear as we proceed.

(24)a. [robi-r khawa]            nie/ Sombondhe/ matro  
        Robi's eating            about/ regarding/ as soon as  
        'about/ regarding/ as soon as Robi's eating'

b. [robi-r khawa]-r            bEpare/ opore/ moddhe  
        Robi's eating-GEN        about/ upon/ in between  
        'about/ upon/ in between Robi's eating'

The complication is the Case of the gerund phrase as a whole. It appears that there are (at least) two classes of Ps in the language, one which marks its complement with the Genitive and the other with zero. We will discuss this, and the other alternation regarding the Case of the gerund subject, not visible here, in section 3.3.

<sup>24</sup> Given the discussion in Chapter 1 regarding the advantages of adopting Kayne's (1994) LCA, Bangla Ps are taken to be underlyingly prepositions.

### 3.2.2 Subject of an embedded clause

Acceptability of a gerund in this position in English is shown below:

(25)a. I believe that John's smoking stogies would bother you

b.\* I believe that John smokes stogies bothers you

The following Bangla example shows that similar results are obtained for Bangla:

(26)a. amar mone hOy [robi-r ekhane aSa-Ta] tomake cintito  
 my seem is Robi's here coming-CLA you-DAT worried  
 koreche  
 has made

'It seems to me that Robi's coming here has made you worried'

b.\* amar mone hOy [CP robi ekhane eSeche] tomake cintito  
 my seem is Robi here has come you-DAT worried  
 koreche  
 has made

Again this shows that gerunds pattern with NPs rather than with clauses.

### 3.2.3 With S-initial adverbs

The relevant examples in Abney for English are the following where the subject of the sentence following the sentence-initial adverb *perhaps* can be a gerund (27a) but cannot be a tensed clause (27b):

(27)a. Perhaps John's smoking stogies would bother you

b.?? Perhaps that John smokes stogies bothers you

The equivalent Bangla examples are as follows:

- (28)a. hOyto            rubir    baRi    aSaTa   rOma   pOchondo    kOre    na  
 perhaps            Ruby's home    coming Roma    like            do        not  
 'Perhaps Roma does not like Ruby's coming home'

- b.\* hOyto (je)        rubi    baRi    aSche   rOma   pOchondo    kOre    na  
 perhaps (that) Ruby    home    is coming Roma    like            do        not

However, including a clitic complementiser *je* 'that' inside the complement clause and a resumptive element (*Se-*)<sup>25</sup> in the matrix sentence improves the acceptability of (28b)<sup>26</sup>:

- (29) hOyto            rubi-je            baRi    aSche            rOma    SeTa  
 perhaps            Ruby-that        home    is coming        Roma    that  
 pOchondo        kOre    na  
 like                do        not  
 'perhaps (the fact) that Ruby is coming home, Roma does not like it'

In this connection, it is worth mentioning that the (27b) sentence of Abney is marked as marginal. It appears that the acceptability of the sentential complement in (29) above is due to its co-indexing with a pleonastic or dummy NP like *SeTa* in the matrix clause<sup>27</sup>.

<sup>25</sup> *Se* is a "pleonastic" element in Srivastav's (1991) treatment of the equivalent Hindi element, which is co-indexed with the extraposed complement clause in an adjunct position. Although (29) is different as the complement is not extraposed, it is nonetheless, co-indexed with the pleonastic/ dummy element inside the matrix clause.

<sup>26</sup> See Dasgupta (1999) for a description of the 'anchoring' properties of *je* which is homophonous with the regular s-initial complementiser in Bangla. The following example shows the clitic properties of *je* and the use of the corresponding resumptive *Se* 'that-resumptive/ sequent' in the matrix clause:

- (i)a. Radha je kOkhon aSbe SeTa tumi jante  
 Radha that when come-FUT that you knew  
 'you knew when Radha will come'  
 b. Radha kOkhon je aSbe SeTa tumi jante  
 Radha when that come-FUT that you knew  
 c. kOkhon je Radha asbe SeTa tumi jante  
 when that Radha come-will that you knew  
 d. kOkhon Radha je asbe SeTa tumi jante  
 when Radha that come-will that you knew

*SeTa* can also cliticise to any of the words in the complement clause.

<sup>27</sup> Bal (1990) (quoted in Shah (1995: 31)), in discussing the properties of *je* in Oriya, another eastern Indo-Aryan language like Bangla, considers the *je* relative pronoun (which has the same properties as



### 3.2.4 Topic position

The restriction of the topic to host an NP but not a sentence is shown below:

(30)a. John's smoking stogies I can't abide

b.\* That John smokes stogies I can't believe

This restriction, like the previous one about subjects following S-initial adverbs, is not clearly marked in Bangla for similar reasons. The fact that the sequent NP *SeTa* 'that-sequent' (or the trace of the topicalised clause) has a co-indexed clause improves the acceptability of the degraded sentence in (31b) which uses the homophonous s-initial COMP *je*.

(31)a. [tomar cole jawa] amra t dekhlam

your away going we saw

'we saw your going away'

b.\* [je tumi cole jabe] amra t dekhlam

that you away go.FUT we saw

c. [tumi-je cole jabe] (SeTa) amra dekhlam

you-that away go.FUT (that) we saw

'that you will go away, we saw'

However, Hindi does not allow the equivalent of either (29) with the s-initial adverb or

---

the COMP *je*) as generated in situ within the IP which moves to [Spec,CP] when the complement clause itself is moved (Bal adopts an extraposition analysis) from its canonical governed position:

(i)a. mun [raama je maache khaae] jaaNe

I Ram that fish eats know

'I know that Ram eats fish'

b. mun jaaNe [je raam maache khaae]

c.\* mun jaaNe [raama je maache khaae]

However, since the complement in (29) is not extraposed (i.e. moved to the right), this analysis fails to predict the position of the COMP.

(31c) above since the language does not have a clitic COMP like *je* in Bangla to bind a dummy NP or a trace lower down and admits only an s-initial COMP *ki* ‘that’ like English. Given this fact we will conclude from the data with the initial COMP ( in (28b) and (31b)) that both the subject position after s-initial adverb and the topicalised position are not available for a sentence.

### 3.2.5 Subject of NP

The subject of an NP is an NP position where, according to Abney (1987; 174), gerunds do not appear, as shown in the ungrammatical example in (32):

(32)\* Stagnating’s evils

Abney conjectures that this is due to the fact that *-ing* forms in general do not make good possessors, even when they are nouns as in the following:

(33)a.\* [The singing]’s effect on them was heartwarming

b.\* [The rioting]’s polarization of the country

However, the following data shows that gerunds in Bangla can easily occupy the subject of N position:

(34)a. [rothiner aSa]-r SObdo

Rothin’s coming-GEN noise

‘The noise of Rothin’s coming’

b. [rebar bideS jawa]-r kOtha

Reba’s foreign going-GEN talk

‘The talk of reba’s going abroad’

This is due to the fact that the gerund suffix in Bangla is a dedicated suffix, in a sense to be made precise in section 3.5, whereas *-ing* in English is not. This makes the Bangla

nominaliser nominal in a way that the English nominaliser is not. I discuss this issue as observed in Pullum (1991) and Yoon (1996) briefly in section 3.5. Notice that sentential complements are clearly out from this position (with or without their being marked Genitive by the N head):

(35)a\* [rothin aSlo]-r      SObdo

Rothin has come-GEN noise

b.\* [reba bideS gElo]-r      kOtha

Reba's foreign gone-GEN talk

Based on the results obtained from the above sections, we conclude that the Bangla gerund, not unlike its English counterpart, exhibits NP properties as far as its external distribution is concerned.

### 3.3 Internal Structure

In this sub-section we will look at the internal structure of the gerund as evidence for its NP character. The subject of the gerund, unlike the subject of a sentence, bears Genitive Case. To determine the subject of a gerund, let us consider the causative formation test. The underlying non-causal subjects of the gerund in (36b) and (37b) are demoted either to the status of indirect object (36a) or to prepositional object (37a):

(36)a. tomar<sub>obj</sub> amake<sub>obj</sub> khawano      (Causative)

your I-OBJ eat-CAUS-ing

'your feeding me'

b. amar<sub>subj</sub> khawa      (Gerund)

my eating

- (37)a. tomar [amake<sub>pobj</sub> die] ciThi lekhamo (Causative)  
 your to-me by letter write-CAUS-ing  
 'your getting the letter written by me'
- b. amar<sub>subj</sub> ciThi lekha (Gerund)  
 'my letter writing'

This test shows that *amar* is the gerund subject in both (36) and (37). The gerund subject, here and elsewhere, bears the Genitive. Chomsky (1981: 50, 165) considers the Genitive of the subject as being assigned structurally: the structure [<sub>NP</sub>NP N] itself assigns Genitive to the NP. The following example, however shows that the subject of the gerund may not bear Genitive:

- (38)a. [rod-Ø/\*er oTha] Sabhabik  
 sunshine-NOM/\*GEN rising normal  
 'shining of the sun is normal'
- b. [moTor-Ø/\*er cOla] bondho  
 car-NOM/\*GEN going prohibited  
 'Motoring is prohibited'

These cases have been noticed by Dasgupta (1980), Klaiman (1981) and De (1984) but none of these studies offers any explanation or solution (or advance only stipulative rules) for this apparent problem. De (1984) pointed out that these zero Case-marked NPs are objects and not subjects and are therefore non-recipients of Genitive Case -- reserved for the subjects of gerunds. Translating De's argument into the current framework, it appears that the fact that these NPs occur to the right of the Dem (39b) is evidence that these are objects since subject NPs always occur to the left of the Dem<sup>28</sup>:

<sup>28</sup> This is in line with the rule she proposes for the generation of the gerund: N' → (DET) [V;N]'

(39)a.\* SOBha        ei        Suru    howar        age  
                          meeting        this        start    happening.GEN before

b.        ei        SOBha        Suru    howar        age  
                          this    meeting        start    happening.GEN before

‘Before the starting of this meeting’

However, De’s argument does not go through since the Dem can modify the N *meeting* alone meaning *this meeting* or the gerund phrase as a whole meaning *this (event of) starting of the meeting* and in the former case *this meeting* as a whole acts as the subject. De also shows that gerund subjects marked Genitive always occur to the left of the Dem:

(40)a. moTor-er        ei        na        cOla  
                          motor’s        this        not        running

‘this not running of the motor’

b.\*        ei        moTor na        cOla  
                          this    motor not        running

There are some obvious problems with this argument. In some gerund constructions the subject can be either in Genitive or zero-marked as in (41). For De, this would mean that the argument of the gerund is a subject in one case and an object in another – there is no obvious reason why this should be.

(41) [rukun-(er)    phOl    khawa]        SOtteo  
                          Rukun-(GEN) fruit    eating        in spite of

‘in spite of Rukun(’s) eating fruits’

The observation that the Genitive subject of the gerund is always in the pre-Dem position is not true either, as in the following example (42a) where a Dem selects

a gerund DP (shown in (42b)):

- (42)a. ei        tomar/ rakhir/ baRiTar        hOThat        kore    bhenge pOra  
           this    your/ Rakhi's/ house's        sudden        done    break    falling  
           'this sudden breaking down of you/ Rakhi/ the house'

b.        [DP Dem [DP Gerund]]

Although the observation in De that the zero-marked NP cannot precede the Dem seems to hold, there is no obvious reason why they should not be considered as gerund subjects. For example, by the causative test noted earlier in this section (see (36-37)), the gerund argument in (41) can be demoted into a causative object (43). This shows that *Rukun* in (41) is a subject. The optional (zero) Case marking borne by it in (41) is therefore Nominative.

- (43)    tomar    rukun-ke        phOl    khawano  
           your    Rukun-OBJ    fruit    eat-CAUS-ing  
           'your feeding of fruits to Rukun'

However, given the theory of DP proposed in this thesis it is reasonable to expect the pattern we obtain in (40). In Chapter 3, it was shown that possessive subjects occur highest in the DP tree on the surface unless they have undergone Kinship Inversion. Given the structure for the Bangla DP assumed so far, we can see why the NPs lacking a Genitive do not cross over the Dem and reach the [Spec,DP] position -- the domain of Genitive Case checking. Thus, for the non-Genitive Case-marked NPs in a gerund, this movement to [Spec,DP] does not take place resulting in the non-assignment of the Genitive Case.

The question that arises out of this discussion is the following: How is the Nominative Case assigned to the subject in these gerund structures? In the next sub-

section I attempt to look at a larger set of data in order answer this question. In the process, I will provide another piece of evidence for a Tense head inside the gerund DP in Bangla.

### 3.3.1 Case of the Gerund Phrase

I will briefly review the case properties of the gerund in this and the next section. To begin with, let us look at the gerund phrase as a whole which can either carry the Genitive Case marker or be marked zero. That is, we obtain the following patterns:

(44)a. [PP [Gerund]-Ø P]

b. [PP [Gerund]-GEN P]

The head last order is obtained by leftward NP movement as per LCA which has been shown to be operative in Bangla grammar (see section 2.3 of Chapter 1). Some examples depicting the above pattern follow:

(45)a. [kha-wa] -Ø obdi

eating until

'Until eating'

b. [aS-a]-Ø babod

coming except

'on account of coming'

c. [dEkh-a]-Ø matro

seeing as soon as

'as soon as seeing'

- (46)a. [kha-wa]-r      dorun  
           eating-GEN      because  
           ‘because of eating’
- b.     [dEkh-a]-r      moto  
           seeing-GEN.      worth  
           ‘worth seeing’
- c.     [ja-wa]-r      phOle  
           going-GEN      because  
           ‘because of going’

The *wa* affix of the complement in all the above examples shows that it is a gerund. The Ps in these PPs form a distinct group as they are not derived from a cognate noun or a verb. I will consider these Ps as lexically different<sup>29</sup>. Furthermore, these Ps bear a Case feature which matches the Case borne by the complement: Ps marking their complements with zero morphological case<sup>30</sup> and those which mark their complements Genitive. I will have nothing more to say about the Case of the gerund phrase as a whole.<sup>31</sup> However, I will show that the Case properties of the gerund subject are

<sup>29</sup> Alternatively, these Ps may be considered as argument heads into which the argument noun incorporates.

<sup>30</sup> Both NOM and ACC can be zero in Bangla and such zero marked gerunds can occur at both subject or object position. The preceding discussion is independent of the actual abstract Case represented by zero, I will therefore continue to denote it as “zero”.

<sup>31</sup> Notice that the gerund phrase can bear several cases depending on the selecting predicate:

(a) Nominative:

- (i)       [rakhal-ke      khObor              dewa]-Ø              joruri  
           Rakhal-DAT      news              giving-NOM              necessary  
           ‘it is necesasry to give the news to Rakhal’

(b) Accusative/ Objective

- (ii)      rOma [amar    jore      gaRi      calano]-ke      bhOy    kore  
           Roma    my      fast      car      driving-OBJ      fear      does  
           ‘Roma is scared of my fast driving’

(c) Genitive

- (iii)     [robiner aSa]-r              khObor  
           Robin’s coming-GEN      news  
           ‘the news of Robin’s coming’



independent of the Case of the gerund as a whole.

### 3.3.2 Case of the Gerund Subject

The subject of the complement of both types of Ps can be either Nominative or Genitive. Thus the following examples show that the class of Ps which mark their complements zero, mark the gerund subject as a Nominative (i.e. zero) or Genitive:

- (47)a. [rukun-(er) baRi aS-a] matro  
 Rukun-(GEN) home come-GER as soon as  
 'by the time of Rukun('s) coming home'
- b. [robi-(r) baRi aS-a] obdi  
 Robi-(GEN) home come-GER till  
 'until Robi('s) coming home'
- c. [rOmen-(er) baRi aS-a] babod  
 Romen-(GEN) home come-GER except  
 'on account of Romen('s) coming home'
- d. [rukun-(er) phOl kha-wa] SOtteo  
 Rukun-(GEN) fruit eat-GER in spite of  
 'in spite of Rukun('s) eating the fruit'

The following examples show that the Ps which mark their complement Genitive, can also mark the gerund subject Genitive optionally:

- (48)a. [rakhal-(er) pOr-a]-r phOle  
 Rakhal-(GEN) read-GER-GEN as a result of  
 'As a result of Rakhal('s) reading it'

- b. [o-(r) taRataRi aS-a]-r dorun  
 his/her quickly come-GER-GEN because  
 'because of his/ her coming quickly'
- c. [robin-(er) aS-a]-r phOle  
 Robin-(GEN) come-GER-GEN because  
 'because of Robin('s) coming'
- d. [bhai-(er) kha-ba]-r pOr  
 brother-(GEN) eat-GER-GEN after  
 'after brother('s) eating'
- e. [ami/ amar gaRi ken-a]-r jonno  
 I/ my car buy-GER-GEN for  
 'Because of I/ my buying a car'
- f. [reba-(r) ja-wa]-r SOnge SOnge  
 Reba-(GEN) go-GER-GEN as soon as  
 'as soon as Reba('s) going'
- g. [radha-(er) aS-a]-r age/ opor  
 Radha-(GEN) come-GER-GEN before/ upon  
 'before/ upon Radha('s) coming'

These examples show that the subject can optionally appear without the Genitive in all cases. We can conclude that the optionality of the subject appearing in Genitive has nothing to do with the Case of the gerund phrase as a whole.

It is instructive to look at the Case properties of non-gerundial complements of these two class of Ps. Note that the class of Ps which mark their complements zero, cannot take a non-gerundial complement:

- (49)a.\* aSbe matro  
 come-will as soon as
- b.\* megh hocche SOTteo  
 cloud happening in spite of
- c.\* jete obdi  
 going-INF until

Based on this observation, I will call these gerundial Ps.<sup>32</sup>

### 3.3.3 Case as a property of argument structure

So far, in our discussion about subject Case variation inside the gerund when it is a P-complement, it has been implied that the Genitive gerundial subject and Nominative gerundial subject do not differ in terms of interpretation of the gerund phrase as a whole. This has been standardly assumed in the discussion of Bangla gerunds (see De (1984) and Dasgupta (1994)). Looking closely, however, we find that though in both cases the gerund itself denotes an event, the interpretation of the gerund with a Nominative subject entails a temporal event or at any rate a 'sequential' interpretation of events as the salient interpretation. With a Genitive subject the event highlights not a sequential interpretation but a causal or at any rate an agentive interpretation. This difference is most clearly visible in the case of temporal Ps like *pOr* 'after', *SONge*

<sup>32</sup> Among this set, I will also include Ps like *niye* 'about' and *diye* 'by means of' although they take non-gerundial complements. These are clearly derived from cognate verbs like *nawa* 'to take' and *dewa* 'to give' (a similar observation is made in Dasgupta (1997) although in a different context) and therefore can mark their non-gerundial complements in dative:

(i) ama-ke/ ram-ke niye/ diye  
 I-DAT/ Ram-DAT about/ by means of

However, they mark their gerundial complements with NOM and thus pattern with gerundial Ps:

(ii) [amar/ ami/ rukun-(er) aSa]-(\*r) niye/ diye  
 [my/ I/ Rukun-(GEN) coming]-(\*GEN)about/ by means of  
 'About/ by means of my/ I/ Rukun/ Rukun's coming'

*SONge* ‘immediately’, etc. on the one hand and causal Ps like *jonno* ‘because of’, *phOle* ‘as a result of’, *dorun* ‘because of’, etc. on the other. As a result, in the case of Nominative constructions a causal P behaves like a temporal/ sequential P and in the case of Genitive constructions a temporal P behaves like a causal P. In (50), the a and a’ examples are respectively Nom with temporal P and a causal P both resulting in a sequential meaning. In b and b’ a Gen subject is used, temporal P and causal P both giving causal meaning:

- (50)a. rOmen aSa-r            pOr    kaj    Suru    holo  
 Romen coming-GEN    after    work    start    happened  
 ‘After Romen coming, the work got started’
- a’.    rOmen aSa-r            phOle            kaj    Suru    holo  
 Romen coming-GEN    result-of            work    start    happened  
 ‘After the event of Romen coming, the work got started’<sup>33</sup>
- b.    rOmen-er    aSa-r            pOr    kaj    Suru    holo  
 Roman-GEN    coming-GEN    after    work    start    happened  
 ‘Because of Romen’s coming, the work started’
- b’.    rOmen-er    aSa-r            phOle            kaj    Suru    holo  
 Roman-GEN    coming-GEN    result-of            work    start    happened  
 ‘Because of Romen’s coming, the work started’

This distinction, can now be captured in the gerund structure that we have proposed in (4) (and discussed further in section 5.0 below) in terms of the aspectual properties of the gerund. Anticipating the discussion in section 4 and 5 somewhat, the difference

<sup>33</sup> A sequential reading of a causal P is harder to get than a causal reading of a temporal P (as in (50b)), but it improves with a temporal adverb. The point that this data establishes is that the agentive/ causal reading is stronger (more salient) with the Genitive.

between the two gerund phrases in (50a,b) above is based on the following argument structure of the gerund (repeated from (4) plus the external argument position shown):

(51)

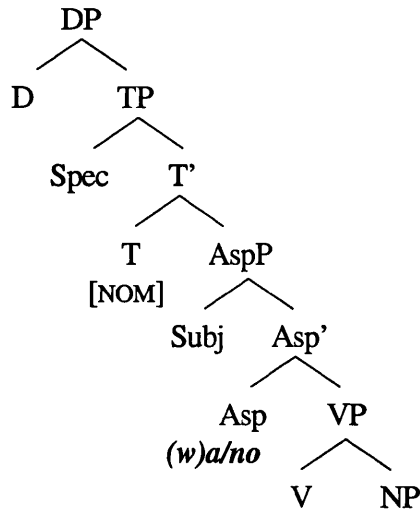

The temporal/ sequential interpretation is due to the T head which the V moves to (via the Asp head) in the case of (50a) since the gerund head contains an appropriate aspectual feature. This forces the internal argument to check NOM at [Spec,TP]. In the case of the (50b) interpretation, Genitive Case is checked at the [Spec,DP] domain which supplies the agent/ causer interpretation as well. Consider in this connection the observation that the light verb *v* in a *v*P-shell structure can have a limited inventory of meanings in Hale & Keyser (1993) and CAUSE is one of them. It is therefore possible for the NP to check for an appropriate aspect at the Spec of Asp at Merge before it moves to Spec of D. However, as we shall see in detail later, in the predicate-based theories of Tenny (1987) and Borer (1993) only objects can check for Case at [Spec,AspP]. The subject argument therefore moves up to [Spec,DP] and checks for Genitive.

The fact that the subject in (50a) does not go all the way up to [Spec, DP] is evident from the following contrast:

(52)a.\* rOmen ei baRi aSa-r pOr

Romen this home coming after

b. ei rOmen baRi aSa-r pOr

'After this act of Romen coming home'

c. rOmener ei baRi aSa-r pOr

Romen's this home coming after

That is, the Nom marked subject in (52a) cannot move across the Dem, which is lower than D (see Chapter 3), since [Spec,DP] is the domain of the Genitive case checking. However when there is a Genitive subject as in (52c) it must move up to this position<sup>34</sup>.

### 3.4 Verbal Properties of the Gerund

The gerund phrase in accordance with its verbal properties allows optional subjects (53a, c, d), an optional direct object (53b, c, d), an optional indirect object (53c), and a number of adverbs (53b, c) below.

(53)a. (rakhaler) deS cheRe jawa purono khObor

Rakhal's countryleave going old news

'Rakhal's leaving the country is old news'

b. (taRataRi) (phOl) khawa ucit nOy

quickly fruit eating right not

'Eating fruits quickly is not good'

<sup>34</sup> Notice that the interpretation distinguishes between an Act reading and a Fact reading. Abney (1987: 245) makes a similar distinction between mixed form gerunds ("Ing-of") and POSS-ing gerunds where only the former by virtue of the presence of an N<sup>0</sup> (as opposed to a V<sup>0</sup> in POSS-ing) does not involve any affix raising.

- c. (rinar) (tomake) (taRataRi) (khOborTa) dewa ucit  
 Rina's you-DAT quickly news giving proper

'Rina must give you the news quickly'

- d. (ami) (rakhaler) (chobi) aMka dekhechi  
 I Rakh'al's picture drawing seen

'I have seen Rakh'al drawing pictures'

Another verbal character of the Bangla gerund is exhibited by its ability to take a Neg. This by itself is not an argument in favour of a V head but assuming that the analysis of Bhattacharya (1998b) to be right in analysing the non-finite Neg in Bangla as adverbial, the position of the Neg in the pre-verbal position in (54) is evidence for an embedded VP inside the gerund.

- (54) rOnok-er phul na tola  
 Ranok's flower not plucking

'Ranok's not plucking the flower'

Since the non-finite *na* in Bangla is adverbial in nature it is therefore to be considered as occupying the [Spec,NegP] position as per Zanuttini (1997). The following derivation for the phrase in (54) shows head movement of V to Asp and XP movement of the object for Case reasons and of the adverbial Neg phrase to an inner specifier of the Asp head (see also section 2.1 of Chapter 3 for a similar derivation):

(55)

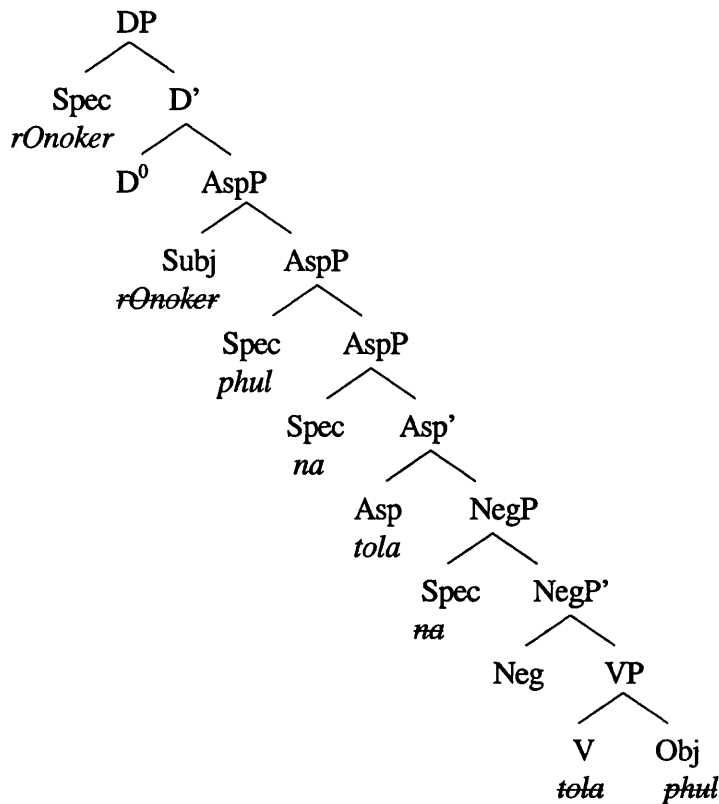

The derivation shows that an aspectual feature of the Asp head attracts the V head to Asp. The Object movement to [Spec,AspP] to check Case and final movement of *na* to the inner specifiers of AspP is according to the condition of *Tuck-in* (see section 6.0 of Chapter 1 for details on this criterion). Notice that in the context of the analysis presented here, Case checking is done through the aspect head. This amounts to a complex event like a gerund to satisfy its event properties.

This analysis would allow an object to check for Case at [Spec,Asp] against the Asp head (in line with the predicate-based theories of Tenny (1987) and Borer (1993) where aspect can check for Case). In the case of (54) the subject *rOnoker* can check Genitive only at [Spec,DP].

In addition to the adverbial Neg, the property of the gerund word to assign Case to its complement (e.g. *His discovering/\*discovery a city*) adds to its verbal character. Since we propose that the gerund affix is a nominal-aspectual head (to be



made precise in section 4.0), the Case of the complement is checked at the specifier of an aspect phrase inside the DP. The demonstration in this subsection, of the verbal properties of the gerund justifies the embedded VP in the gerund structure in (55) and earlier.

### 3.5 The Data: Gerund and Participle

In section 2.1 I had briefly mentioned the similarity between the gerund and the participle constructions. In this subsection, I will explore the relationship between these two constructions further. The participial construction under scrutiny here is an adjectival participle and shows nominal characters<sup>35</sup>. In continuation of the earlier usage, I will refer to these constructions simply as a participle most of the time.

The gerund and the participle have been treated as two sides of the same coin in Bangla grammar. The morphological identity of the gerundial and participial suffix (both being *-wa/no*) and the similarity of word order between the two forms cannot be accidental. In fact Dasgupta (1980) in his dissertation treats the participial as derived from the gerund. He proposes a gerund-participle rule (in a lexicalist framework) where

---

<sup>35</sup> In the following, the participle appears as the object of a P (ia), subject of a clause (ib), in the topic position (ic), after S-initial adverbs (id) and as subject of an embedded clause (ie):

- (i)a. [robin-er lekha kobita] nie alocona hobe  
 Robin-GEN written poem about discussion happen-will  
 'there will be discussion on poems written by Robin'
- b. [pORa boi] phele dao  
 read book throw give  
 'throw away the already read books'
- c. [tomar kena baRi] amar dekhechi  
 your bought house we seen-have  
 'we have seen the house bought by you'
- d. hOyto [rina-r kena baRi] tomake cintito koreche  
 probably Rina's bought house you.OBJ worried done  
 'Probably, the house bought by Rina has made you worried'
- e. amar mone hOy [robi-r kena baRi] tomar bhalo lage ni  
 to-me seem become Robi-GEN bought house your good seem NEG  
 'it seems to me that you didn't like the house bought by Robi'

the participle is derived by the addition of a null affix to the nominal head of the gerund.

Thus only gerunds are identified in the lexicon and not participles.

I argue for a syntactic derivation of gerunds from the same verbal source as the participle. That is, I will reject the zero-affixation analysis of gerunds (or participles) for reasons which will become apparent as we proceed. Firstly, note that the verbal basis of the gerund seems to be the core structure from which the gerund is generated in many languages (the present participle *-ing* in English and the infinitive in Romance languages<sup>36</sup>). In the case of Bangla, although the gerund (and participial) suffix does not show verbal properties (save for their VP-like distribution noted in 3.4.1), since gerunds and participles are deverbal forms, they are, by definition derived from a verbal stem. Notice that since the adjectival participle in Bangla appears in typical NP positions (see note 35) and have a genitively Case marked subject, following earlier authors, I consider it as nominal and denote it as a DP like the gerund

Some authors (Pullum (1991), Lapointe (1993), Yoon (1996) have argued at length against the nominal character of the nominalising suffix in English. I do not have anything to contribute in this respect but I will show that the Bangla gerundial affix is fully nominal. It is not a dedicated suffix in the sense that the corresponding suffix in Korean is (see examples in note 37), since it is also used to form the participle, it is not verbal either as it takes nominal inflections (like Case markers and classifiers as in (57)) and rejects verbal markers (like Tense, Mood etc. as in (56)).

(56)a. o-r kha-wa-(\*lam)

his eat-GER-(PRF)

---

<sup>36</sup> Although Romance has an independent gerund form in constructions such as *Going to school, I met Mary*. Here, I am using the term gerund for Romance as a purely descriptive label.

b. o-r kha-wa-(\*cchi)

his eat-GER-(PROG)

(57)a. or khawa-r/ ke/ te

his eating-GEN/ DAT/ LOC

b. or khawa-Ta

his eating-CLA

In Korean, similarly, in both phrasal nominalisation (like *your giving the book to Bill*) and lexical nominalisation (like *your giving (of the book) (to Bill)*), the nominalising affix takes the Nominative and the conjunctive affix<sup>37</sup>. The affix cannot take verbal inflections like tense/ mood markers but takes Cases such as Instrumental, Nominative and Genitive which are like postpositions<sup>38</sup>. The deverbal nominal in case of lexical nominalisation behaves similarly by rejecting verbal affixes<sup>39</sup>.

By Pullum's (1991) criteria, the gerund in Bangla seems to have a nominal head inside. Pullum argues that if there were a nominal head inside a gerund then there would be an N' as well which would in turn allow for constructions associated with N' like restrictive relatives, prenominal adjectives, *one* anaphora and Dets/Dems. None of

<sup>37</sup>The nominalising affix *-um* (glossed as NML) takes the Nominative and the conjunction affix (glossed as CONJ) in (ia) and (ib) respectively:

(i)a. [John-uy chayk-ul ikl-um-i] nolawu-n sasil-i-Ø-ta  
John-GEN book-ACC read-NML-NOM surprise fact-be-PRS-DECL  
'John's reading the book is a surprising thing'

b. Cwuk-um-kwa sal-m  
die-NML-CONJ live-NML  
'life and death'

<sup>38</sup>The affix *-m* does not take verbal inflections (as in ia) but takes Cases (ib-d):

(i)a.\* [mek-hi-m]-ess-ta?  
eat-PASS-NML-PST-DECL

b. [mek-hi-m]-ulo  
eat-PASS-NML-INST  
'through being eaten'

c. [mek-hi-m]-i  
eat-PASS-NML-NOM  
'being eaten (subject)'

d. [mek-hi-m]-uy  
eat-PASS-NML-GEN  
'being eaten (possessor)'

<sup>39</sup>As in the following:

(i)a.\* [cwuk-um]-ess-ta?  
die-NML-PAST-DECL

b. [cwuk-um]-ulo/ i/ uy  
die-NML-INST/ NOM/ GEN  
'through death/ death (subject)/ death's'

these are in fact allowed in English nominalised constructions:

- (58)a.\* [John's singing the song] that I like (restrictive relative)  
 b.\*? John's constant singing the song (prenominal Adj)  
 c.\* John's singing the song was worse than Bill's one (*One* anaphor)  
 d.\* The/ that singing the song was as bad as the recording (Det/ Dem)

He also argues that gerunds cannot occur in the prenominal GEN position since elements occurring before the possessive clitic 's must be NPs headed by a lexical N:

(59)\* [John's singing the song]'s effect on his audience

Most of these tests do not hold for the Bangla gerund construction<sup>40</sup>:

- (60)a. [jOner Sei gan gawa] ja amar bhalo lage<sup>41</sup>  
 John's that song singing that my good seem  
 'John's singing the song that I like'  
 b. joner gan gawa biler ceye bhalo  
 John's song singing Bill's than good  
 'John's singing is better than Bill's (singing)'  
 c. ei roj chobi aMka mon Santo rakhe  
 this daily picture drawing mind peaceful keeps  
 'this drawing of pictures daily keeps the mind at peace'

A Genitive gerund subject is also quite common (as we have seen in section 3.3.2):

- (61) [jOner gan gawa]-r probhab  
 John's song singing-GEN effect  
 'John's song singing's effect'

<sup>40</sup> Bangla gerunds are rarely modified by adjectives, in most cases, adverbial modification is more natural.

<sup>41</sup> See the notes in section 3.2.3 for some properties of the various elements inside the Bangla RC.

Therefore, in all likelihood, the Bangla gerund seems to have a nominal head inside which extends to a DP to which all the above can attach. The proposal for a nominal Asp head in this chapter satisfies this condition<sup>42</sup>. Notice that the adjectival participle can also appear in the same environment as the gerund in (60-61)<sup>43</sup>.

Furthermore, the zero-derivation approach is an unconstrained device that does not explain why the null affix changes a verbal form to a gerund in one case and to an adjectival participle in another in Bangla, nor does it explain why zero-affixation to participles fails to apply in the case of certain verbs – the topic we deal with immediately.

### 3.5.1 Gerunds as a Superset

To review the facts and conclusions so far, we have seen that Bangla gerunds and participles can freely convert from their verbal source (see some more example below) . The examples (62-64) below provide some more instances of the regularity of gerund and participle formation. Notice that all the three variants of the gerund suffix *-a/-wa/-no* can appear with the participle form as well. The members of the pairs below are not ambiguous.

---

<sup>42</sup> It must be pointed out that the analysis of Dem as F heads (rather than D heads as intended in Pullum) in the present work can be accommodated if, as per the proposal in Chapter 3, the presence of an empty D<sup>0</sup> head (with a [GEN/POSS] feature) is assumed.

<sup>43</sup> Notice the following two examples for participles (other gerund examples of the text can also be replicated):

- (i) joner gawa gan biler ceye bhalo  
John's sang song Bill's than good  
'The song sang by John is better than Bill's'
- (ii) [jOner gawa gan]-er probhab  
John's sang song-GEN effect  
'The effect of the song sang by John'

(62)a. amar kobita lekh-a

my poetry write-GER

'My poetry writing'

b. amar lekh-a kobita

my written poem

'poem written by me' (Lit: My written poem)

(63)a. amar gaRi cala-no

my car drive-GER

'my driving a car'

b. amar cala-no gaRi

my driven car

'a car driven by me' (Lit: My driven car)

(64)a. amar phOl kha-wa

my fruit eat-GER

'my fruit eating'

b. amar khawa phOl

my eaten fruit

'a fruit eaten by me' (Lit: My eaten fruit)

However, as pointed out in Dasgupta (1980: 139) there are cases of gerunds which do not have the corresponding participle:

(65)a. ramer baje                      kOtha bole                      bERa-no

Ram's nonsensical      saying say-and                      go around-GER

'Ram's going around talking nonsense'

b.\* ramer bole bERa-no bajе kOtha

'nonsense Ram has been talking'

(66)a. ramer Sastrio Songit ERa-no

Ram's classical music avoid-GER

'Ram's avoiding classical music'

b.\* ramer ERano Sastrio Songit

'classical music avoided by Ram'

Dasgupta uses this fact to argue that it is therefore natural to expect participles to be derived from gerunds, since all participles can also function as gerunds but the reverse is not true. Consequently, gerunds which undergo this rule are marked lexically as such.

I will show, first of all, that a few examples are not enough to argue one way or other, and that a much bigger set of predicates must be considered. This will lead to interesting consequences for the theory of Bangla nominalisation in general and of the exceptional cases in particular. Especially, the discussion of nominal aspect that we launch in section 4 may be seen in the context of the investigation of predicate types that we take up for study now.

### 3.5.2 Predicate types of the verbal source of gerunds and participles

If we consider a bigger set of predicates which fail to have a participial form corresponding to a gerund (as in (65-66)), it will become immediately clear that there is a pattern among them. Let us first consider some clear cut examples in this connection:

(67)a. cheler kaSa

boy's coughing

- b.     radha-r        douRono  
        Radha's        running
- c.     rebar         haMSa  
        Reba's         laughing
- (68)a.\* kaSa        chele        —  
        coughed        boy
- b.\*    douRono       radha  
        run            Radha
- c.\*    haMSa         reba  
        laughed        Reba

That is, none of the predicates of (67) can have a corresponding participial reading. A null-affixation approach cannot give an account of why this is so. Notice that these verbs belong to the unergative class of verbs<sup>44</sup>. Since unergatives' only apparent argument is an external one and they are marked by the apparent absence of an object, they are standardly assumed (e.g. Burzio 1986) to have a structure where the verb does not subcategorise for an object argument position<sup>45</sup>.

It is possible to conclude that unergative predicates do not form participles corresponding to the gerunds. However, the existence of data like (69-70) must be

<sup>44</sup> The agent of unergatives is seen as actively and volitionally involved in the action of the verb (Perlmutter 1978). In many languages, the difference is reflected in auxiliary selection, for example, in Italian and Danish, unergatives form their perfective with *to have* (as opposed to *to be*).

<sup>45</sup> The structure in (i) assumes a VP-internal subject position, the subject moves up to a canonical subject Case position later in the derivation ([Spec,TP] or [Spec,AgrsP] etc) overtly (in Accusative languages) or takes place at LF (in Ergative languages) (see Murasugi (1992), or the Obligatory Case Principle of Bobaljik (1993)):

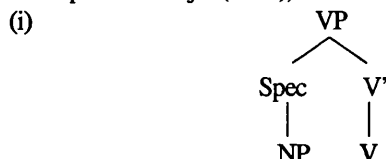

Alternatively, in accordance with the vP-shell structure of Chomsky (1995), the subject can be assumed to be merged at [Spec,vP] (see Arad (1998) for an approach on this line).



taken into consideration before such a conclusion can be drawn. In (69-70) both a gerund and a participle can be formed out of unergative predicates:

(69)a. rekha-r            gan    gawa            [gerund]

Rekha's            song    singing

'Rekha's singing the song'

b.    rekha-r            gawa    gan            [participle]

Rekha's            sang    song

(70)a. rekha-r            kOtha    kOwa            [gerund]

Rekha's            talk    talking

'Rekha's talking'

b.    rekha-r            kOwa    kOtha            [participle]

'Rekha's            talked    talk

However, this can be accounted for as follows. The behaviour of unergatives across the world's languages is not entirely predictable from the generalisation that unergative verbs do not subcategorise for an object position<sup>46</sup>. Postal (1986) noticed that unergatives in German and Dutch regularly passivise. Also, certain predicates like *sing*, *dance* etc<sup>47</sup> can have cognate objects. We can thus conclude that except for certain unergative predicates which can take cognate objects (like *sing*, *dance*, *talk*, etc.) unergatives in general cannot have corresponding participles.

Now let us look at another set of data:

<sup>46</sup> See also Laka (1993) in connection with Basque.

<sup>47</sup> Thus *John sang a song* is OK where the cognate object is marked accusative by the unergative predicate. In the aspectual theory of Tenny (1987: 154), a cognate object "delimits" (see section 4 for more on this notion) the event described by the unergative verb which otherwise describes non-delimited events. Note that in (i) below, the accusative marking is clearly visible (Jayaseelan 1996):

(i)a.    John laughed *him* out of the court

b.    John laughed *himself* silly

- (71)a. cheler            baRi    aSa  
           boy.GEN        home   coming  
           ‘The boy’s coming home’
- b.    cheler            pherot    jawa  
           boy.GEN        retrun    going  
           ‘The boy’s going back’
- c.    cheler            baRi    pouMchono  
           boy.GEN        home    arriving  
           ‘The boy’s arriving home’
- (72)a.? baRi    aSa    chele  
           ‘the come home boy’
- b.?    pherot    jawa    chele  
           ‘the returned boy’
- c.?    baRi    pouMchono    chele  
           ‘the arrived home boy’

That is, unlike the unergative set, here the intransitive predicates marginally allow the corresponding participles. The verbs in (71), belong to unaccusatives<sup>48</sup> whose only argument is the internal one (Borer (1996)), or in any event not the external one (Chomsky (1995)).

### 3.5.3 Conclusion

In concluding section 3.0, we can say that gerunds in Bangla behave as noun phrases in

---

<sup>48</sup> In Burzio (1986) unaccusatives are called *ergatives*, however we will adopt the more standard term for this class of verbs. Unaccusatives have a surface subject which does not take any active part in the action of the predicate. That is, the subject is non-volitional.

their distribution. This justifies their denotation as DPs. However, they also have some verbal properties which in turn justifies a V inside the gerund DPs. As pointed out earlier, the gerund construction in Bangla is quite similar to participles in its distribution and nominal properties. The nominal property of the nominaliser suffix in both constructions is due to the nominal aspect head Asp in the gerund (and the participle) DP. I will discuss this in detail in the next section.

In investigating the similarity between gerunds and participles, I claimed that only unergative intransitive predicates do not allow the participial forms corresponding to the verbal source. However, as will be clear from the discussion later (section 5.5), the absence or presence of an internal argument in the verbal source is not enough to decide whether or not a particular verbal source can have a participial form. In particular, I will argue that a distinction in terms of the aspectuality of the predicate as well as the aspectuality of the object argument is important in deciding the ungrammaticality of examples like (66b) of Dasgupta (1980) where even a transitive predicate fails to have a participle form. I will particularly argue that the lack of an aspectual feature like [DELIMITED] or [AFFECTED] in a predicate like *avoid* implies an in-situ NP complement which is uninterpretable due to FI (see section 5.5 for details).

The relevance of the discussion in 3.5 is as follows. I showed that a lexicalist theory of deriving participles from certain lexically marked gerunds by null-affixation is faulty. The discussion showed us that a special group of verbs fails to have participial forms. As it turns out these verbs belong to a well identified subtype of intransitives, namely, unergatives, which are marked in the lexicon anyway for either taking different complements or a different argument structure, depending on which theory one follows

(Lexical-entry driven or Predicate-based<sup>49</sup>). On the basis of what we have seen so far, it is possible to conclude that verbs which cannot have a participial form are independently identified in the lexicon as belonging to a group of intransitive predicates.

Given the similarity of the gerund/ participle marker suffix and the relative similarity in their construction, and given the discussion so far, I suggest that in the absence of zero affixation, gerunds and participles represent one and the same verbal form. Their semantic distinction is a matter of the type of aspectuality involved. That is, (73a) and (73b) are derived from the verb stem *likh-* ‘to write’:

(73)a. amar lekha kobita

my writng poetry

‘my written poetry’

b. amar kobita lekha

my poetry writing

‘my poetry writing’

Given that the first Merge is to the right (see discussion in Chapter 1), i.e., [Q NP], the gerund configuration in (73b) would indicate that it is derived by leftward movement of the NP. This move binds the present study of gerunds with the central theme of the thesis, which is about DP-internal NP movement. I will have more to say about this movement in the section on analysis (5.0). The difference in the gerundial and the participial aspect accounts for the word order differences between these two constructions.

---

<sup>49</sup> See Borer (1993) and Arad (1998) for an overview of both approaches.

## 4.0 Nominal Aspect

Since this thesis is meant to be a contribution to the continued research agenda of finding similarities between clauses and DP, it is reasonable to expect sentence like aspect inside nominals. In this section I will investigate the nature of the aspectual information obtained in nominals. In particular, I will propose that the gerund suffix in the case of true gerunds (i.e. in exclusion of gerundives and result nominals) carries aspectual features which must be checked in the overt syntax. However, within gerunds and participles, a further difference in terms of aspect type carried by each has to be made. In accordance with Grimshaw (1990), the difference between different nominals would seem to follow from their difference in aspectuality which in turn indicates their difference in event readings.

### 4.1 Predicate Aspect and NP Interpretation

The relation between the interpretation of NP and the aspectual properties of the predicate is well known. For example, de Hoop (1994) shows a correlation between the Case of the object and the type of interpretation it receives in Finnish. In (74a) the object receives Partitive Case resulting in an irresultative or atelic interpretation whereas Accusative Case in (74b) makes the predicate resultative or telic:

(74)a. Anne rakensi taloa

Anne built house-PART

'Anne was building a/the house'

b. Anne rakensi talon

Anne built house-ACC

'Anne built a/the house'

Verkuyl (1972) suggested that the properties of the DO influence the aspect of the predicate. In particular, he suggested that the aspect of the predicate is determined by the combinations of V+Object and Subject+V.

In other words both these approaches suggest that the aspectual property of the verb alone is not responsible for the determination of the full range of the aspectual information of the sentence. This is evidence in favour of object DP contributing towards aspect determination of the clause as a whole. I discuss some further evidence for this next.

In many languages, omissibility of the object depends on the aspect of the clause. Van Hout (1992) shows that in Hungarian, in an atelic VP the object is optional (75a) but is obligatory with a telic VP (75b):

(75)a. Ildiko evett (egy tortát)

Ildiko was eating a cake

b. Ildiko megevett \*(egy tortát)

Ildiko was eating up a cake

The perfective form of the verb in (75b) makes it telic. This can be seen to be operating in English<sup>50</sup> (de Hoop 1994) and Bangla to some extent:

(76)a. Carol was drinking (wine) [atelic]

b. Carol was drinking up \*(the wine) [telic]

(77)a. kobi (phul) tulchilo [atelic]

Kobi flower pick.PROG.PST

'Kobi was picking flowers'

<sup>50</sup> In atelic predicates the object is optional in English but when it is present its semantic type is that of a predicate modifier rather than a real argument. In English when the object is strong (i.e. delimited or affected in the sense of Anderson (1979), see section 4.3), a P is needed to turn it into a predicate modifier (e.g. *She is eating of the cake*). However, it must be pointed out that none of the native speakers that I consulted agreed with the judgement in (76b).

- b. kobi   ?(phul) tule                    nicchilo           [telic]  
       Kobi   flower pick.CONJ           take.PROG.PST

‘Kobi had been picking off the flowers’

In minimalism the difference between the a and the b cases would find a natural explanation. The aspect of the verb acts like an attractor feature which attracts a matching feature in the complement NP. In cases where the telic aspectual feature of the predicate is present, the object NP may not be deleted (as in the (b) cases above).

If we take the predicate-based aspectual theories of Tenny (1987) and Borer (1993), we may require the NP to check a matching aspectual feature with an Asp head. In a more mainstream Minimalist theory, covert checking of the telicity feature will require the obligatory presence of the object NP. Either way, we prove that a matching aspectual feature on the nominal is predicted<sup>51</sup>.

## 4.2 Nature of the Nominal Aspect

In this section I will look into the type of aspectual information instantiated by the *-ing* morpheme in English and the *-wa/no* gerund suffix in Bangla and show that both encode imperfective aspect in gerunds. By nominal aspect, I mean aspectual information available inside the DP similar to the aspectual information at the clausal level. In this section, I hope to show that a clear cut case for nominal aspect can be

---

<sup>51</sup> However, a point made in the lexical approach of van Hout (1992), militates against the conclusion reached in this section. As a consequence of her analysis, the ineffectiveness of the strength of the DO in changing the overriding telicity of the VP is predicted in the following where the atelic (imperfective) verb takes a strong (definite) DO in Hungarian:

- (i) Ildiko ette a tortat  
       Ildiko was eating of the cake  
       ‘Ildiko was eating of the cake (but didn’t quite finish it)’

However, the strong object here plays a predicate modifier role (by introducing the P -- discussed in the text) and not as a real argument. This affects the meaning of the sentence as a whole. Therefore, I will consider this as one more piece of evidence for nominal aspect.

made.

This demonstration rests on the theory that grammatical gerunds by their very function display event properties through morphological or abstract aspect. Such a putative “semantic universal”, I claim, is derivable from Grimshaw’s formulations mentioned earlier.

Furthermore, notwithstanding the pitfalls of finding historical motivation for any aspect of synchronic grammar, it may be noted that at least one historical interpretation of the connection between the current progressive in *-i(t)-* in Bangla and the older verbal noun in the locative exists in Chatterji (1926: 1025).

The well attested similarity between the clausal and the NP structures is reflected in the fact that event verbs pattern with count nouns and state/ activity verbs pattern with mass nouns. Thus, as Brinton (1995) points out, event verbs can be counted (as in (78a)) like count nouns which take number morphemes, and activities can be modified by mass adverbials (as in (78b)) just as mass nouns are modifiable with adverbials like *much, a little, etc.*

(78)a. John arrived three times/ \*a lot

b. John knew a lot/ \*three times<sup>52</sup>

#### 4.2.1 Debounding/ Grinding

The analogy between event verbs and count nouns and between stative/ activity verbs

---

<sup>52</sup> Although Brinton (1995) does not point it out this distinction does not seem to be as obvious as presented. For example, certain stative/ activity verbs like *resemble, play, swim* can act as count nouns (as in *John resembled Jack three times, John swam the full length thrice*) as well. Whereas certain event verbs (which include accomplishment, achievement and semelfactives) can act as measure nouns (as in *He grew up a lot in recent months, He coughed a lot during the performance* etc). However, the general trend of event verbs acting as count nouns (and thus *an/ \*much arrival*) and stative/ active verbs as measure nouns (and thus *A quantity off/ \*a living*) seem to hold.



and mass nouns is supported by English deverbalising suffixes. The *-ing* suffix, as opposed to other latinate suffixes, does not preserve the aktionsart of the verb<sup>53</sup>. It makes the situation atelic, durative and dynamic by converting the situation into an activity. This is a shift from count to mass interpretation<sup>54</sup>. That is, we have the following situation:

(79) Count + *ing* → Mass

This is called ‘debounding’ or the process of imperfectivising in the verbal domain (Jackendoff (1991)) by the progressive *-ing*. The process equivalent to debounding in the nominal domain has been identified as ‘grinding’ in Jackendoff (1991), shown by the NPs in italics below (examples are taken from Paparotte (1988) quoted in Brinton (1995, 1998)):

- (80)a. The room smells of *onion*  
 b. I taste *apple* in the salad  
 c. This puzzle piece has a *cat* on it  
 d. That’s a lot of *car* for the money

<sup>53</sup> Latinate suffixes like *-age*, *-al*, *-ance/-ence*, *-ation* etc preserve the aktionsart of the verb. Aktionsart denotes the inherent temporal nature of the situation denoted by the predicate. Thus stative vs dynamic, punctual vs durative, telic vs atelic, strictly speaking, denote aktionsart of the verb. Since state/ activity verbs create mass nominalisations (ia) and accomplishment/ achievement verbs create count nominalisation (ib), latinate suffixes retain the pattern (see Brinton (1998) for details):

- (i)a. the survival/ \*a survival, a lot of guidance/\*several guidances, much astonishment/ \*two astonishments  
 b. a refusal/ \*much refusal, a few conquests/ \*an amount of conquest etc

<sup>54</sup> This is supported by the fact that the activity denoted by the *-ing* suffix is generally mass (examples are taken from Brinton (1998)):

- (i) Some Coughing/ \*two coughings, much melting/ \*several meltings  
 Also, referring to the end point is impossible with this suffix (as in (iia)) but it allows a focus on the process leading to the end point (as in (iib)) (see Brinton (1998) for more examples):

- (ii)a. \*His dying/ escaping/ arriving occurred at 5:00  
 b. His dying/ escaping/ arriving took several minutes

The ungrammaticality of (iia) may be accounted for by Vendler’s (1967) diagnosis of identifying events. He suggested that NPs and clauses denoting a proposition cannot act as the subject of the verb *occur*:

- (iii)a. \*The chairman’s selecting the book occurred last year  
 b. The chairman’s selection of the book occurred last year

According to Parsons (1990), this is because only events by their nature ‘happen’, propositions do not.

The examples in (80) are therefore the nominal equivalent of the imperfectivising aspect at the sentential level which makes a mass expression out of a count one by the addition of the suffix *-ing* as represented in (79). This therefore constitutes evidence for nominal aspect<sup>55</sup>.

In the following example ((81a,b) similar to the English example in (80)) shows the count to mass conversion (or ‘grinding’) in (a,b) and the effect of the gerund suffix on the aktionsart of the verb in (c-g). The analysis of the *-ing* (and the *-i(t)-*) in the verbal domain with the *-ing* or the *-(w)a* in the gerund in the nominal domain is best expressed through different aktionsart effects like continuous activity (c), iterative (d), achievement (e), accomplishment (f), and state (g). The gerund focuses on the activity in (c,d) and on process in (e-f). In (g) the gerund gives an activity a temporary sense.

- (81)a. ghOre            roSuner            gOndho  
           in room            garlic’s            smell  
           ‘There is a smell of garlic in the room’
- b.    tOrkaRi-te        murgi            pelam  
           curry-LOC        chicken            found  
           ‘(I) found chicken in the curry’
- c.    probiner            kobita lekha    eggocche  
           Probin.GEN        poem write.GER    progress.PROG.3  
           ‘Probin’s poetry wrting is progressing’

<sup>55</sup> Vikner (1994: 156) suggests that this count to mass conversion in the nominal domain is due to a process of homogenisation which results from ‘contour-deletion’ or by looking inside the individual at the stuff which it is made up of, this process creates a stuff out of multiplication of individuals.

- d. bar bar ghOnTa beje oTha  
 again again bell sound.INF rise.GER  
 'ringing of the bell again and again'
- e. robiner mOraTa OSSabhabik  
 Robin.GEN die.GER.CLA abnormal  
 'Robin's dying was/is abnormal'
- f. baRi bhaNgaTa taRataRi holo  
 house break.GER.CLA quick happened  
 'the breaking of the house was quick'
- g. SaStrio SoNgit SonaTaSabhabik  
 classical music listen.GER.CLA normal  
 'listening to classical music is normal'

#### 4.2.2 Bounding/ Packaging

The following example exhibits the 'bounding' or perfectivising at the clausal level:

- (82)a. Fowler played yesterday (simple past tense)  
 b. Jane was sad for three months (Durative adverb)

In (82a) past tense demarcates (or bounds) a section of a durative situation. In (82b) adverb functions in the same way by denoting a specific quantity of time.

The nominal counterpart to perfectivising has the effect of turning a mass expression into a count one<sup>56</sup>. This process, analogous to the temporal bounding of

---

<sup>56</sup> This process is identified as 'packaging' in Jackendoff (1991) where a portion of the stuff is spatially demarcated by referring to a serving, a kind or a quantity of it. According to Vikner (1994), measure phrases are the nominal counterpart of adverb of duration in the VP, they denote a specific quantity of an unbounded substance.

verbal situation, is called ‘packaging’ and is shown by the following example (taken from Paparotte (1988) quoted in Brinton (1995, 1998)):

- (83)a. I’ll have *another beer*  
 b. Bavaria is world famous for its *many beers*  
 c. Please wipe up *the beer* on the counter

The following Bangla example show mass nouns as used in a count sense by using the Cla -*Ta*:

- (84)a. amake *mOd-Ta*      dao  
           to me drink-CLA      give  
           ‘give me the drink’  
 b.    *jOl-Ta*            poriSkar      kOro  
           water-CLA      clean            do  
           ‘clean up the (spilled) water’

In conclusion, ‘Packaging’ therefore constitutes the second instance of nominal aspect, i.e., the DP equivalent of the clausal aspect. As the preceding discussion shows, nominal aspect can be either in the form of ‘packagers’ or ‘grinders’. However, keeping the topic of discussion in focus, this proposal translates into minimalism as the gerund suffix selecting a [-PERFECT] feature for the numeration (or an unbounding device as in Bartsch (1981)) whereas the participle selects a [+PERFECT] feature.

### 4.3 Syntactic account of Aspect

We have earlier mentioned Grimshaw’s (1990) position in section 1.1 on Complex Event Nouns (CEN) and Simple Event Nouns (SEN). By this account only CENs have an internal aspectual structure and thus an argument structure (which by definition

denote thematic and aspectual properties of the predicate). She notes that event structure can be broken down into aspectual sub-parts (Grimshaw 1990: 26). Thus a Vendler/ Dowty 'accomplishment' event denotes a complex event consisting of an activity and a resulting state. Therefore *John breaks X* would involve an activity which is John's breaking X and a resulting state: X is broken.

Given such a position, I will consider event identification in terms of aspectual features. That is, I will adopt a feature checking approach to aspect in line with many predicate-based accounts of aspect (Tenny (1987) and Borer (1993) in particular). Such theories are based upon Verkuyl's (1972) suggestion that the semantic nature of the object determines the telicity of the entailed event. Telic and atelic predicates respectively require bounded and unbounded NP complements.

Syntactically, telicity of the verb is checked by an NP (which is an event measurer or delimiter) in the specifier of an aspectual head in the theory of Borer (1993). In other words, the NP carries a feature of [DELIMITER] or [EVENT MEASURER] or [BOUNDED] which is checked against the telicity feature of the Asp head like [ $\pm$ PERFECT]. This accounts for de Hoop's (1994) observation that Case properties of objects are crucially derived from or are determined by the aspectual property (i.e. telicity) of the predicate in Finnish (see section 4.1).

In Borer's account, Case and aspect are linked by postulating an Asp head over VP (replacing AgrO of Chomsky (1993)). Borrowing from Tenny (1987), Borer assumes that a feature [DELIMIT]<sup>57</sup> of the Asp head is responsible for checking the

---

<sup>57</sup> Tenny (1987: 112) replaces Anderson's (1979) notion of affectedness by the delimited/ non-delimited distinction which also subsumes other oppositions like telic/ atelic etc. She proposes the Aspectual Interface Hypothesis which determines the mapping of aspectual information into syntax in terms of argument structure and Case. In Borer (1993) the delimited feature may be distinct from Case (see 5.5 in this connection).

corresponding feature of delimited direct arguments which pass through its Spec in the process, checking an Accusative Case feature as well:

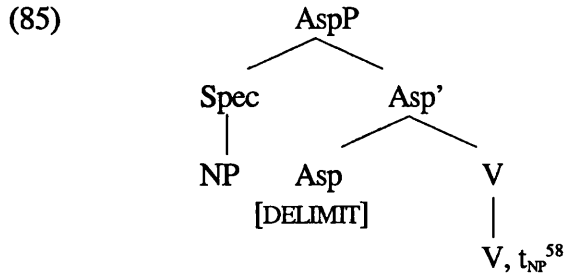

I have adopted a similar position for the gerund/ participle structure. In the case of nominalisation, as I have suggested, the nominaliser *-(w)a/no* projects an AspP which takes a VP as a complement. That is, I take the position that the Asp head is equivalent to the light verb as in Hale and Keyser (1993) and Chomsky (1995). The internal argument of the verb is merged to the right. The nominal character of the construction is reflected in the presence of a nominal D and Asp heads.

Based inter alia on de Hoop's (1992) treatment of resultatives in Finnish, I will assume that aspectual information encodes argument structure as Case. This would suggest that the Asp head checks both aspectual and Case features of the internal argument. Later, I make a distinction in terms of the trigger for the NP movement in gerunds and participles. I assume that the external argument of the gerund is generated at the [Spec,AspP] position. Note that Asp therefore shares the similarity with *v* in being both a functional head by checking the Case (aspect) of the internal argument and a lexical head by virtue of having an external argument merged at its specifier.

In sum, I have provided motivation for the presence of an aspectual head Asp

<sup>58</sup> In Borer (1993), arguments of the V are not hierarchically ordered, i.e., lexical phrases do not have an internal structure although they may have a head and a maximal projection. So the verbs *derive* and *wilt* have the following representations (Borer 1993):

(i)a.  $V^{\text{MAX}}$   
 |  
*derive*, NP, NP

b.  $V^{\text{MAX}}$   
 |  
*wilt*, NP

inside the gerund DP in this section. I have thus motivated the gerund structure proposed in (4) in section 1.2 fully. The structure is repeated here as 4':

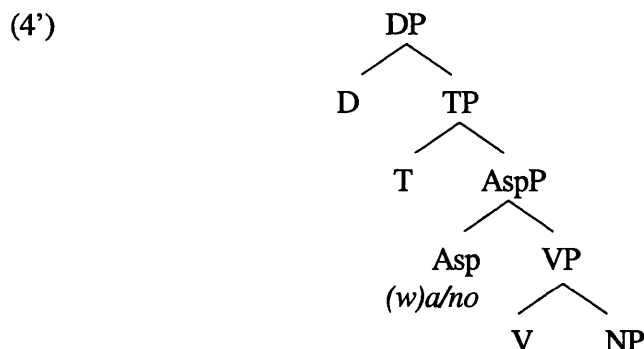

#### 4.4 Asp in Participles

The adjectival participles in Bangla that we have seen in section 2.1 and 3.5 seem to share the same aspectual property as the verbal source. Egerland (1996: 318) quotes Bosque (1990) who studies this property in connection with a group of adjectives in Spanish which are lexically derived from the corresponding verbal source and they share some fundamental aspectual property. Adjectives like *full* are morphologically and semantically related to the verbal source *fill*. However, the shared aspectuality here is perfectivity according to Egerland. Given this general property, I assume that participles too contain an Asp head which holds the participial aspect feature [+PERFECT].

Let us consider the presence of Asp in participles from another perspective. The fact that French on the one hand and Italian/ Spanish on the other are different in terms of participial agreement pattern as in (86) below prompts Egerland (1996: 157) to propose that Accusative in French is checked in AgrO and in Italian/ Spanish it is checked at Asp. The relevant structures are given in (87).

- (86)a. Les lettres que j'ai écrites ... (French)  
 the letters.FEM.PL that I have written.FEM.PL
- b. Le lettere che ho scritto ... (Italian)  
 the letters.FEM.PL that I have written [-Agr]

(87)a. Les lettres<sub>i</sub> que j'ai [<sub>AgrOP</sub> t<sub>i</sub> [<sub>AgrO'</sub> écrites t<sub>i</sub>]].

b. Le lettere<sub>i</sub> che ho [<sub>AspP</sub> t<sub>i</sub> [<sub>Asp'</sub> scritto t<sub>i</sub> ...]]

That is, non projection of AgrOP in the latter accounts for the lack of participial agreement. While there is no place for Agr phrases in the later version of MP, the essential insight of Eagerland's argument can be retained within the present version utilising instead multiple specs.

The point of similarity between the parametric division in (86) and (88) below shows that Bangla behaves like Italian/ Spanish in this respect as far as the participles are concerned whereas Hindi behaves like French:

- (88)a. likhii/ \*likhaa                      hui      cīTThii                      (Hindi)  
 written.FEM/ written.MASC      done      letter.FEM
- b. lekha                      cīThi                      (Bangla)  
 written-[-Agr] letter

This would suggest that in Bangla the Asp head is projected instead of AgrO or its current equivalent. Notice that in Hindi the verbal form used is a "verbal" participial but in Bangla the participial is adjectival and is homophonous with the gerund form. The data in (88) therefore is consistent with the requirement that (88b) in Bangla projects an aspectual head in the syntax.

So it is reasonable to assume that participials have some aspect feature to check. This would indicate that the NP the participial modifies acts as the delimiter



similar to the internal argument of gerunds. A similar conclusion is drawn in Josefsson (1998: 161) in discussing word formation in Swedish, who argues that the only  $\theta$ -role assigned by an adjectival past participle is an [EM] role<sup>59</sup> which stands for Event Measurer after Arad (1998).

In line with these studies I will assume that the [+PERFECT] aspect of the participle in the present formulation to be contingent upon the presence of an affected object NP. This requirement is also made appropriate on the basis of observation made by de Hoop (1994) (see section 4.1) that for a perfective verb in Hungarian (and to some extent Bangla, see (77)) the object is obligatory.

Additionally, following Abney's (1987: 257) argument about the difference between adjectival passives and verbal passives whereby the former cannot assign Case because of the Case-absorbing property of the *-en* morpheme in the former (see (89-90)), I will consider the participial aspect as non-Case assigning. Although nothing crucial hinges on this assumption since I have followed mainstream predicate-based theories in making the Asp head responsible for Case checking as well, unavailability of Case in participles derives the contrast obtained in (65-66) (see section 5.5 for details).

- (89)a.\* A book was [sent John]           (Adjectival passive)  
 b.     John was sent a book           (Verbal passive)

---

<sup>59</sup> It must be pointed out that the line of research that Josefsson's study is based on, namely, Tenny (1987), Borer (1993), Egerland (1996), among others, attempts to project arguments *independent* of  $\theta$ -theory.

(90)a. [AP [A [v send] -en] a book]

b. [AP -en [VP [v send] a book]]<sup>60</sup>

The assumption that the adjective participle is non-Case assigning is also supported given the observation that the Bangla participle in *-a* is a passive participle (Chatterji 1926: 660). Given this, I propose the following as the structure of the participle:

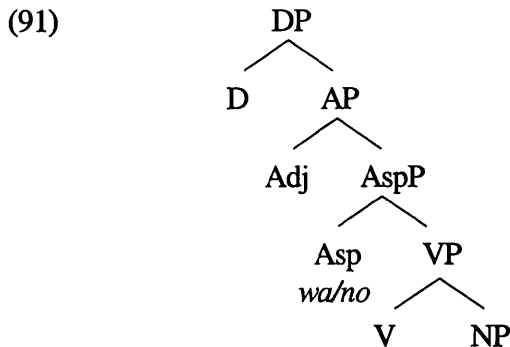

In this structure the V stem moves up first to Asp to check the [+PERFECT] aspectual feature and then to Adj presumably to check an adjectival/ participial feature following the preceding discussion that adjectives and participles have shared aspectual values in adjectival participles. The NP moves to [Spec,AspP] and checks the matching aspectual feature [DELIMIT] but no Case.

It is interesting to point out that the analysis proposed for Swedish participle formation in Josefsson (1998: 158) relies on V movement to A to form the participial word which is an AP. So a participle in (92a) is derived as in (92b):

<sup>60</sup> Abney (1987: 254) proposes that the difference between the two types of passives lie in the relative scope of *-en* as in the following structures:

(i) Verbal Passive:

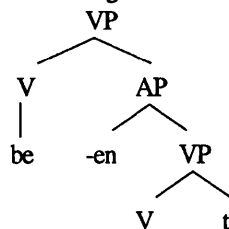

(ii) Adjectival Passive:

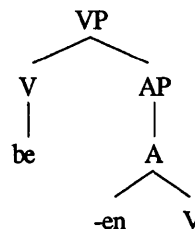

He also conjectures (but does not adopt) the possibility that participial *-ing* derives adjectival categories from verbal categories in the same way that gerundial *-ing* derives nominal categories from verbal ones. The analysis of participials adopted in this chapter is based on this suggestion.

- (92)a. av Jan målat staket  
 by Jan paint+ed fence  
 'a fence painted by Jan'

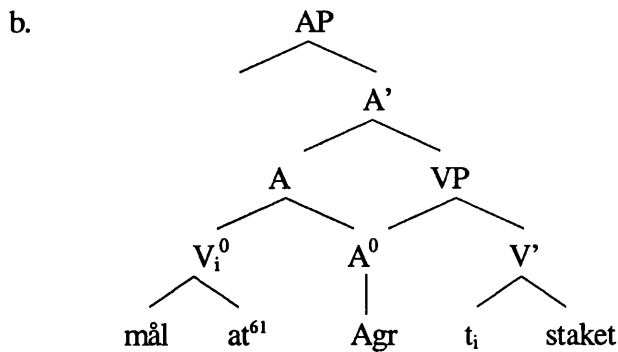

Based on the structures of the gerund and participle as proposed I will offer an analysis in the next section.

## 5.0 Analysis

Based on the conclusion arrived at in section 3.5 that gerunds and participles in Bangla are syntactically derived from the same verbal base, I will now consider the derivation of the following pair of gerund and participle from the VP structure as in (94):

- (93)a. kobita lekha  
 poetry writing  
 writing poetry
- b. lekha kobita  
 writing poetry  
 'written poetry'

<sup>61</sup> In Josefsson, the clitic-like particle *-t* is identified as another head ( $Ptc^0$ ) which moves to the Adj head as well. I have omitted the details in the representation in the text. For the Bangla analysis I assume that the participle head is our  $A^0$  head. Presumably Josefsson's system is preferable for a language with adjectival agreement. Since that is not the case with Bangla I will assume the simpler structure.

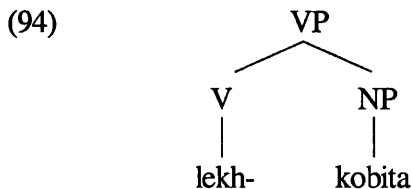

### 5.1 Derivation of the Gerund

Given the preceding discussion, the verbal stem *lekh-* in (94) above maps into a syntactic structure where the gerundial aspect feature of the gerund head and the aspectual and Case features of the complement NP are checked against an aspectual functional/ lexical head Asp as follows:

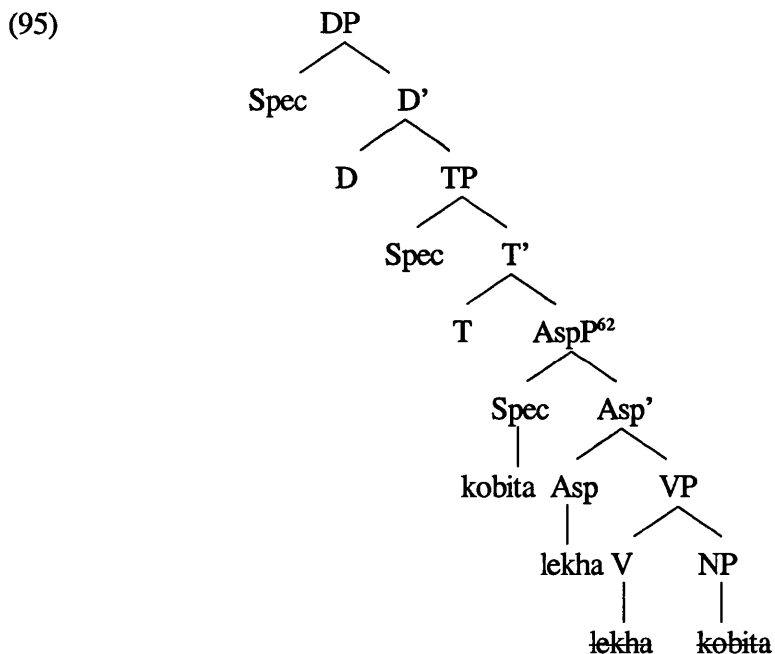

I will assume with van Hout and Roeper (1998) that event anchoring is established trivially through an empty T in cases where the verbal head does not carry a Nom Case feature, if it does then Nom Case is checked at [Spec,T] *along* with the event feature

<sup>62</sup> I will assume with Chomsky (1995) (and what we have adopted in preceding chapters) that there may be multiple specifiers of functional projections. The AspP shell structure above is essentially identical to the *v*P-shell structure in Chomsky (1995) which may therefore have the external argument generated at the outer spec of AspP which moves up to [Spec,DP] to check Genitive. Internal structure of the AspP is shown whenever required.

checking. I will show the TP projection only when it is needed.

In line with our account of argument generation<sup>63</sup>, the NP *kobita* checks Accusative of the Asp head at [Spec,AspP]. The head movement of the V to Asp involves an aspectual feature checking, this time [-PERFECT] for a gerund<sup>64</sup>. Thus, in this respect, the current theory departs from Borer's formulations and suggests that an atelic object can also check Case at [Spec,AspP].

## 5.2 Derivation of the Participle

Based on the structure of the participle in section 4.5, the participle in (93b) above is derived as follows:

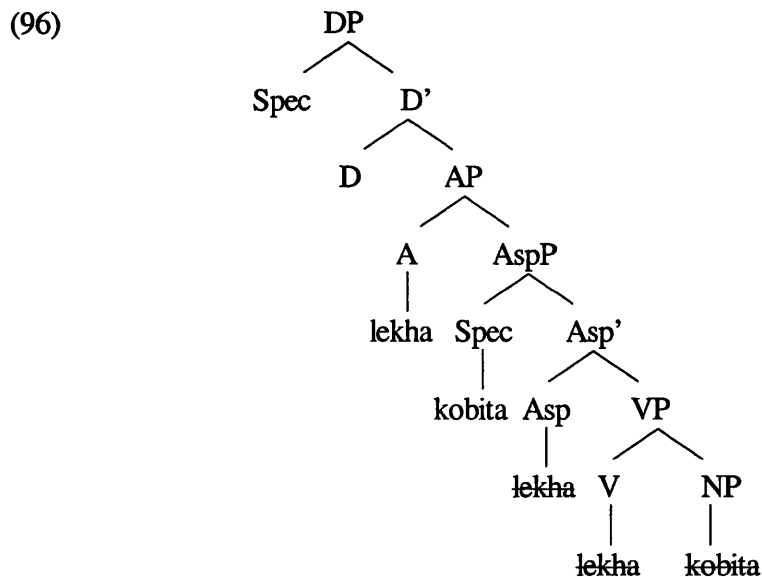

Notice that the NP movement to [Spec,AspP] takes place in the same way as in the case of gerunds head except that the relevant aspectual feature in this case is [+PERFECT], but the V head, along with the Asp moves up to an Adj head. This is in

<sup>63</sup> Note that the VP in our account is structured (and not hierarchically *unordered* as in Borer (1993)) and that syntactic structures are generated in accordance with a feature based theory such as Chomsky's (1995).

<sup>64</sup> Note that in case of participles the Asp head contains two aspectual features, one to attract the delimited/ affected NP and the other to head attract the V with gerundial imperfective aspect.

keeping with the observation in section 4.4 that adjectives in adjectival participles share the aspectual feature [PERFECT] with the verbal head.

Comparing the derivation for a gerund in (95) and the one for the participle in (96), we can see that both involve NP movement inside the DP with an extra head movement in the case of the participle. Thus, gerund and participle formation is a matter of the argument structure that the LIs are mapped onto in the syntax.

The difference between the two derivations lies in the fact that the participial *wa/no* is unable to check for Case<sup>65</sup>. Borer (1993) provides for this possibility in her theory. The delimited feature may be distinct from Case, as [Spec, AspP] may or may not be a Case position. Therefore, delimited arguments which do not carry accusative pass through a Spec which is specified as a place for checking [+DELIMIT] but [-ACC] (see Egerland (1996: 111) on this point). This is consonant with our conclusion in 4.4 that the participial *wa/no* absorbs Case.

### 5.3 Unergatives

In this subsection we discuss the derivation of the gerund from an unergative verb and the non-derivability of the participle from unergatives. Consider the following data repeated from section 3.5.2:

(97)a. *cheler kaSa* (Gerund)  
 boy's coughing

---

<sup>65</sup> I have no clear position to take on how Burzio's Generalisation can be maintained in this theory. There are some possibilities. It could be argued that the agent in participial constructions of the sort we are discussing (adjectival passive participles) bears a purely possessor relation and is merged higher than the AP – it can be thought of as linked to an abstract prepositional element as in the theory of Kayne (1993) and Mahajan (1994). Or, we can assume with Egerland (1996: 319) that the possessor in such constructions does not count as an external argument. Alternatively, if we do assume the possessor as the external argument, it could be argued that a version of Burzio's Generalisation for nominals is that affected/ delimited objects imply external arguments. We leave this for future research.

- (98)a.\* kaSa            chele                            (Participle)  
                          coughed            boy

Since unergatives project a structure with an external argument position (which is [Spec,AspP] for us), I will assume that the derivation starts off with the structure in (99a) and forms a gerund as in (99b):

(99)a.

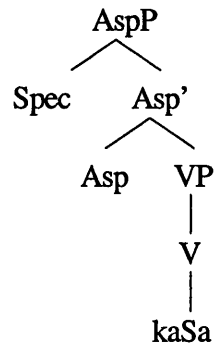

b.

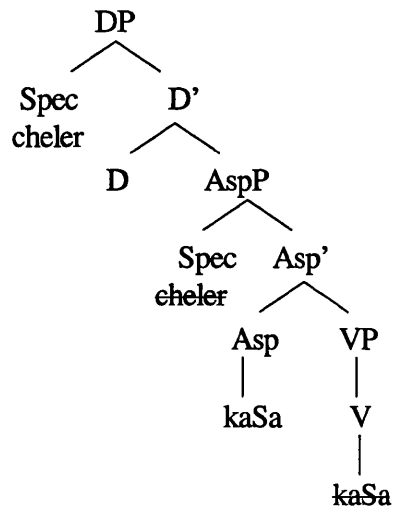

The V checks for its gerundial aspect feature [-PERFECT] by head movement to Asp. The subject moves to [Spec,DP] to check Genitive. The Asp does not select for a [DELIMIT] as unergatives do not select an inner argument.

For the derivation of the participle, as indicated in section 4.4, the perfective aspect of the participle is contingent upon the presence of a delimited/ affected object. If this is so then given the structure in (99a) above, the absence of an internal argument prevents participle formation since the nominal aspect feature of [DELIMIT] of the Asp

head remains unchecked and therefore the derivation crashes. The V may head move via Asp to A<sup>0</sup> checking [PERFECT] at Asp but the NP argument cannot check Case since participle *wa/no* absorbs Case. The difference between the two constructions therefore derive from the difference in their aspectual properties. All of this is visible in the structure below:

(100)\*

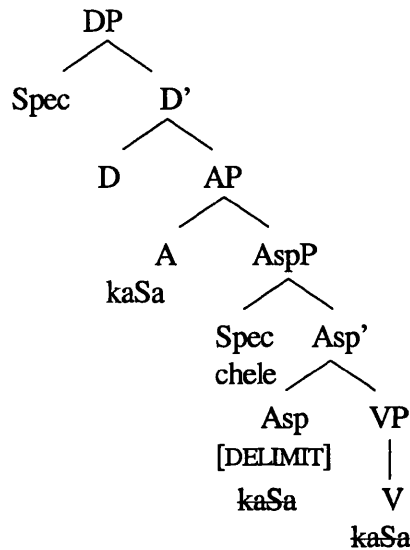

Consider now the derivation of unergatives with cognate objects as in (101).

(101)a. rekha-r      gan      gawa      (Gerund)

Rekha's      song      singing

'Rekha's singing the song'

b.      rekha-r      gawa      gan      (Participle)

Rekha's      sang      song

We saw in section 3.5.2 that unergatives with cognate objects behave like transitives.

They are therefore derived in the same way as regular gerunds and participles. This is shown below:



(102)a.

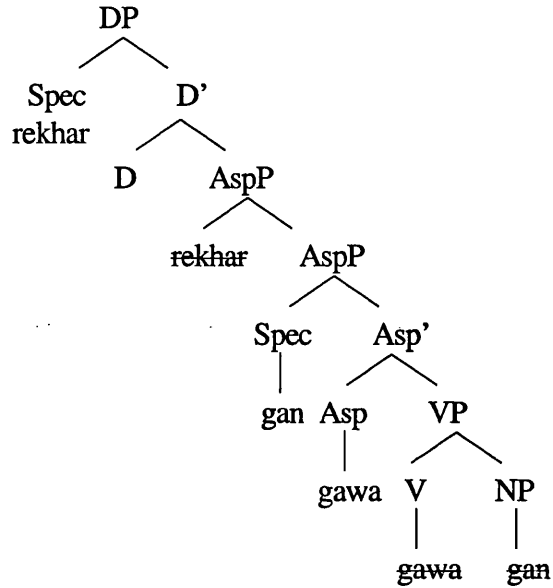

b.

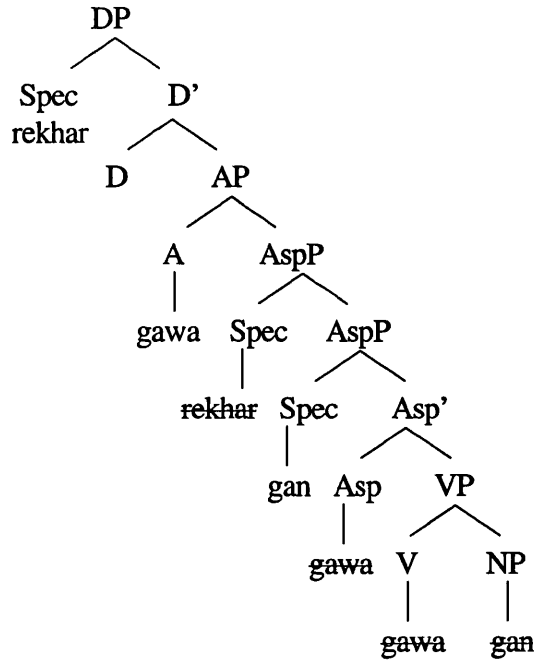

The internal argument NP *gan* in both cases moves up to the inner [Spec,AspP] in accordance with the *Tuck-in* condition for later XP movement of Richards (1997) discussed in section 6.0 of Chapter 1 to check the feature [DELIMIT] of the head in (102b) abs [ACC] in (102a) with the additional movement of the V+Asp to A<sup>0</sup> in case of participles in consonance with the observation in section 4.4 that adjectives in adjectival participles share the aspectual feature [PERFECT] with the verbal head.

Regarding the Case checking possibilities note that in section 3.5.2 we observed that cognate objects in unergatives check Accusative. This is predicted by the derivation in (102a) but not in (102b) since we have concluded in section 4.4 that the participial Asp head is non-Case assigning as it absorbs Case. In this connection recall that the theory proposed here assumes with Borer (1993) that NP movement to [Spec,AspP] in such cases checks the [DELIMIT] feature but not Case. I assume with Egerland (1996: 320) that in cases where the adjective and the verbal form seem to share perfective aspectuality (drawing on Bosque (1990); see section 4.4 for details), the adjective is responsible for Case assignment. Given the derivation in (102b) above, I assume that the internal argument checks Case at [Spec,AP] covertly.<sup>66</sup>

#### 5.4 Unaccusatives

Recall that unaccusatives do not project an external argument position. Given the discussion of unaccusatives in 3.5.2, the base structure from which a gerund (104a) and a participle (104b) are derived is as in (103) (data repeated from section 3.5.2 with the

<sup>66</sup> The proposal in Egerland (1996) accounts for the inversion possibility in 'Possessive Auxiliary+Participle' constructions in Italian as in (i).

- (i)a. Ho la cena pronta  
'I have the dinner ready'  
b. Ho pronta la cena  
'I have ready the dinner'

The proposed derivation is as follows where the DP gets Accusative from the A head in situ before moving to check the [+del] feature of Asp:

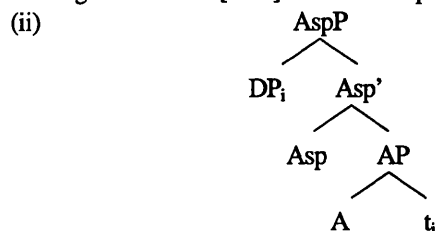

My proposal regarding the adjectival participles is similar in spirit to this proposal. Crucially, Egerland's analysis shows that Accusative may be available in conjunction with the A head. I adopt a more minimalist view of Case checking as a spec-head relation.

goal argument omitted):

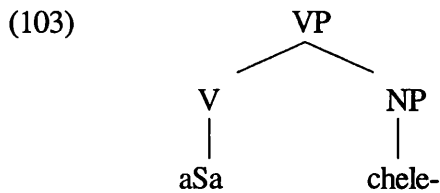

(104)a. cheler          aSa<sup>67</sup>          (Gerund)

boy's          coming

'The boy's coming'

b.? aSa    chele          (Participle)

'the come boy'

Accordingly the gerund and the participles are derived as follows:

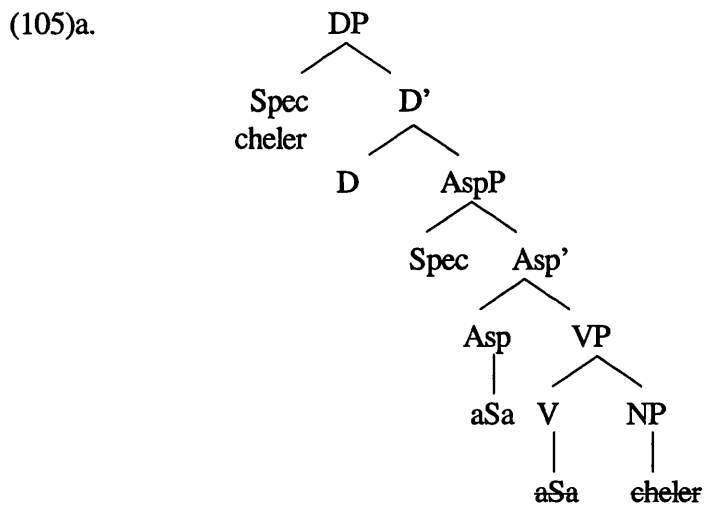

<sup>67</sup> I have not mentioned the Cla *-Ta* in this example to avoid generating the Q head as part of the DP. But a gerund/ participle with the Cla would be derived in the same way as here.

b.

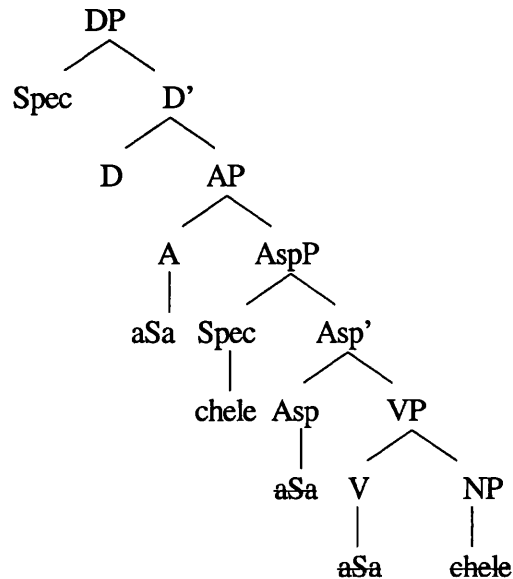

In the case of both (105a,b) above the complement NP moves from an internal position to an external position as per the nature of unaccusatives. In the present theory this is made possible by the presence of the [DELIMIT] feature on the Asp for the participle and [POSS] in D for the gerund and a matching feature on the argument *chele*. It is generally assumed<sup>68</sup> that unaccusatives express a ‘change of state’. They refer to either ‘change of location’ (*arrive, go, run, etc*) or a ‘change of condition’ (*improve, increase, diminish, etc*). This semantic distinction is assumed to be captured by the [DELIMIT] in the present proposal for the participle drawing on a similar proposal in Tenny (1987).

Additionally, since unaccusatives, by definition do not have an Accusative Case checking feature, *chele* moves up to [Spec,DP] to check Genitive in the case of (105a). The difference between the derived position of the noun in the case of (105b) obtains as a result of the fact that *chele* itself is a full DP in the case of the gerund and can therefore take a Dem modifying only the noun concerned, whereas, a Dem can only modify the whole phrase in the case of (104b)<sup>69</sup>. An alternative to consider in this

<sup>68</sup> See for example Moro (1997: 229) who distinguishes between the object of transitives as bearing the  $\theta$ -relation of <patient> and that of unaccusatives as bearing the <theme> relation.

<sup>69</sup> E.g. consider the following:

(i) ei cheler Ekhon aSa holo

respect is that in the absence of Case in Asp in the case of unaccusative participles, a Nominative Case feature may be selected when an unaccusative predicate is also selected for the numeration. The exceptionality of this arrangement for Case checking in the case of unaccusative participles, I presume, is responsible for the marginality of (104b).<sup>70</sup>

### 5.5 Affectedness of the Object

We have mentioned earlier in section 3.5.1 (see also conclusion in section 3.5.3) in connection with the gerund as constituting a superset that the mere presence of an object does not guarantee the formation of participles. Rather, given the aspectual account of gerunds proposed in this chapter, the object must be affected. I will now show that this condition accounts for the data in section 3.5.1 repeated below in (106).

- (106)a. *ramer Sastrio Songit ERa-no* (Gerund)  
 Ram's classical music avoid-GER  
 'Ram's avoiding classical music'
- b.\* *ramer ERano Sastrio Songit* (Participle)  
 'classical music avoided by Ram'

- 
- this boy's now coming happened  
 'At last this boys has arrived'
- (ii)\* *aSa ei chele*  
 come this boy
- (iii) ? *ei aSa chele*  
 this come boy  
 'this having come boy'

<sup>70</sup> Another alternative to consider is spelt out in Moro (1997: 243). He considers that to account for Burzio's generalisation UG must contain a principle of 'Case Economy', namely, that there is a hierarchy of Cases (Nom > Acc > Obl etc) and a principle requiring that an element should not pick up a given Case K unless all those Cases which can be assigned in a given structure and precede K in the hierarchy have already been assigned. This accounts for the observation that since the Acc Case feature is not available for participles in unaccusatives, Nom must be checked at the object position. However, this is merely a descriptive principle. The question of what forces the Asp in these cases to select [NOM] remains to be investigated.

I will suggest that the gerund is derived as in (107b) from the base structure as in (107a) below where the object NP is marked as an unaffected agent since the object of the activity of avoiding does not get affected in any way by the activity itself<sup>71</sup>:

(107a)

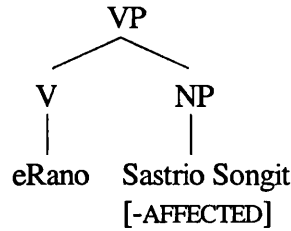

b.

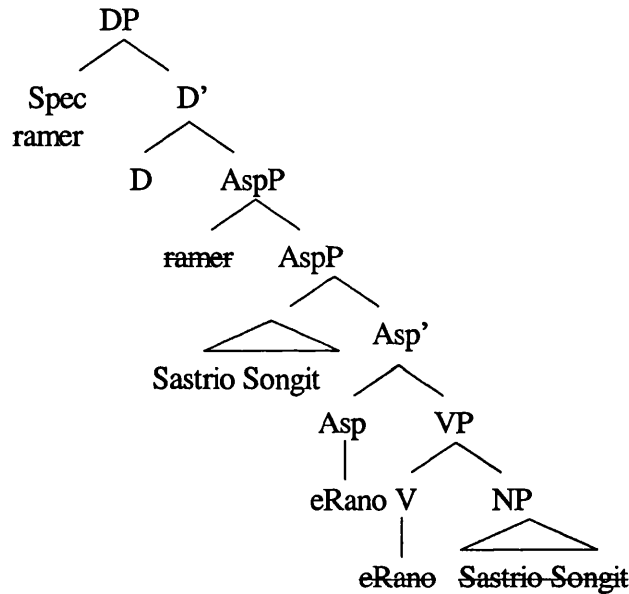

Although the object is marked non-affected, it still has to move up to [Spec,AspP] to check the Case feature. However, in the case of participles, as mentioned in section 4.4, since the participle selects a [+PERFECT] Asp, it also requires an affected object. Thus, the derivation crashes due to reasons of feature mismatch with the result that participle

<sup>71</sup> Anderson (1979:44) argues on similar lines for the following contrast:

- (i)a. The Mongols' destruction of the city
- b. The city's destruction by the Mongols
- (ii)a. John's avoidance of Bill
- b.\* Bill's avoidance by John

The difference in event types is responsible for the contrast above. In order to be affected an object must be changed or moved by the action of the head nominal. Tenny (1987) re-interprets this as the delimited/ non-delimited dichotomy that I have adopted for this study. However, I will continue to use affected/ delimited interchangeably in this and other sections.

formation does not take place<sup>72</sup>:

(108)\*

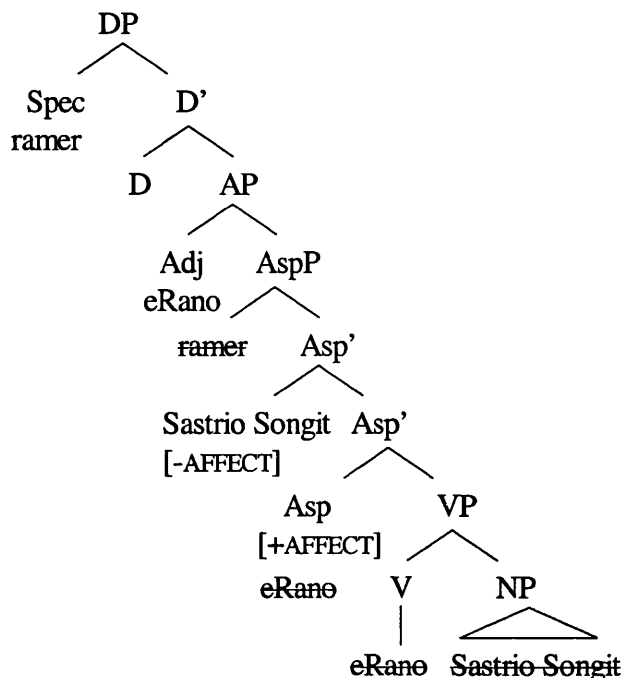

To conclude this section, I have shown that a feature theory utilising aspectual and Case properties of gerund and participle arguments can account for the data presented earlier. In particular, keeping the central theme of this dissertation in focus, I have shown that information about Case features in combination with the delimited/ non-delimited nature of the arguments drive NP movement inside the DP in the case of both gerunds and participles. The absence of this movement in the case of unergative participles as opposed to unaccusative participles is accounted for by the absence of either an aspectual or a Case feature in the former. The various possibilities of gerund and participle formation is summarised below:

<sup>72</sup> So far, I have ignored in this discussion the other type of counterexample of Dasgupta (1980) in section 3.5.1 – *bole bERano* ‘talk and going around’. At present, I have no clue as to the aspect of complex predicates. However, it can be argued that if the aspect of the complex is determined by the aspect of the head, then this particular complex predicate would pattern with unergatives explaining the absence of the participial form.

Predicate Type	Object	Gerund	Participle
Transitive	[+AFFECT]	✓	✓
Transitive	[-AFFECT]	✓	×
Unergative	nil	✓	×
Unaccusative	[+AFFECT]	✓	✓

## 6.0 Gerundives

I will now attend to some unfinished business with regard to the other two constructions sharing the gerund suffix (section 2.1). In this section and the next, I will discuss gerundives and result nominals, both of which according to the analysis offered in this chapter, show no verbal properties.

In section 2.1 we mentioned gerundives as sharing the gerund suffix *-wa/no*. I will consider this group of *-ing* forms in Bangla which appear to be pronominal adjectives. It was pointed out earlier that gerundives in Bangla have the form [V-*ba*-GEN N]. However there are a few gerundives which look like the *-wa/no* form as in (109) below. However, due to the Genitive marking on the gerund which is the most consistent diagnostic for gerundives, I will consider these as gerundives, albeit with a phonologically reduced *-ib/-ba* gerundive affix.

- (109)a. bOS-a-r      ghOr  
           sit-ing-GEN    room  
           ‘drawing room’



- b.     phOl   kaT-a-r       chuRi  
        fruit   cut-ing-GEN   knife  
        ‘fruit cutting knife’

To re-open the discussion on terminology in note 16, it is important to see that the term gerundive has been wrongly used as the simple adjective of gerund in Chomsky (1970) onwards. As was pointed out earlier (also in Bhattacharya (forthcoming b)), the adjective corresponding to gerund is gerundial. Gerundive, on the other hand, is the future passive participle form of the verb according to classical scholarship.

### 6.1 Gerundives are not APs

Bangla gerundives are similar to some *-ing* forms in English which act as adjectives. The fact that these apparently adjectival forms include *-ing* in their make up forced Emonds (1988) (as quoted in Borer (1990)) to conclude that they behave like verbs internally but are like adjectives externally. Borer (1990) also studied them and came to the same conclusion. She cites the following as examples of such gerundives in English:

(110)a. The *jumping* cow

b.     The *flying* spacecraft

c.     The *sleeping* beauty

Notwithstanding the initial evidence against their adjectival status in (111) by their inability to be modified by *very*, Borer concludes, on the basis of the data in (112), that they are adjectival:

(111)\* a very/ rather/ more/ less sleeping beauty

(112)a. a very/ rather high-jumping cow

b. a very/ rather soundly sleeping beauty

The compounds in (112) can be modified by *very* and given that the right-hand element of the compound is the head of the construction, it can be said that these forms do take *very-modification*<sup>73</sup>.

The gerundives in Bangla, as the following examples show, are not adjectival:

(113)a.\* EkTa khub bOSar ghOr  
one very sitting room

b.\* EkTa khub phOl kaTar chuRi  
one very fruit cutting knife

(114)a.\* EkTa khub rajoSik bOSar ghOr  
one very stately sitting room

b.\* EkTa khub SadharOnoto phOl kaTar chuRi  
one very ordinarily fruit cutting knife

The difference in the above set of data is shown clearly in the verbal flavour of the gerundive expressions in English, allowing, therefore compound formation with an adverbial (*soundly* in (112b)). The Bangla data in (113-114), in contrast, show that gerundives are neither adjectival nor verbal.

### 6.3 Gerundives are Nominal

The lack of verbal character of the Bangla gerundival forms is evident from the following. They cannot be negated (115a) or show a choice of tense (115b):

<sup>73</sup> Although William's (1981) Righthand Head Rule has been challenged over the years (see di Sciullo and Williams (1987) for a revised RHR) for affixes, it is sufficient to account for headedness of compounds where the linear preservation of the percolation conventions of the language is preserved (see Don (1993) for an overview).

- (115)a.\*      na      phOl    (na)    kaTar    chuRi  
                  NEG    fruit    (NEG) cutting knife
- b.\*            phOl    kaT-be-r      chuRi  
                  fruit    cut-FUT-GEN    knife

The lack of tense in gerundives indicates that they are purely nominal in Bangla. I would like to consider gerundives as being completely nominal at least in the syntax. In particular, I will consider gerundives not to project a TP or an AspP at any point during the course of the derivation.

That is, there are no event properties projected in gerundives. Van Hout and Roeper (1998), come to the same conclusion regarding compounds in English which do not entail an event structure. The similarity between nominal compounds and gerundives is obvious if we look at the meanings of these constructions: *sitting room*, *cutting knife*, etc. I will assume that gerundives are like compound nominals in terms of their event properties<sup>74</sup>.

Synthetic compounds in English may contain a head and a non-head which acts as the argument of the head (116a) or a head and a non-head which is an adjunct (116b), the head in this example is shown in bold face:

- (116)a. truck **driver**    < One who drives *a truck*
- b.      pan-**fried**          < Fried *in a pan*

I will consider *sitting room* (117a) and the Bangla gerundive (117b) on par with the English nominal compound to be similarly derived where the head is nominal:

- (117)a. sitting **room**    < A room *for sitting*

---

<sup>74</sup> Notice that the compound (ii) in English can be thought of as derived from the NP in (i):

- (i)      the room for sleeping  
 (ii)     the sleeping-room

Here the P-Comp (Kayne 1984) *for* is left behind and deleted. I will take up this suggestion shortly.

- b.    bOSar ghOr < *bOsar jonno* ghOr  
       sitting room sitting for room

I will come back to this derivation in detail soon. First, consider another nominal property of gerundives.

That the gerundive is the closest modifier of the head noun is clear from the following examples where an adjective (118a), Dem (118b), Poss (118c) or a Num-Cla complex (118d) cannot intervene between the gerundive and the N:

- (118)a.\*    bOSbar        bORo ghOr  
               sitting        big room

Intended meaning: 'big sitting room'

- b.\*        bOSbar        ei ghOr  
               sitting        this room

Intended meaning: 'this sitting room'

- c.\*        bOSbar        tomar ghOr  
               sitting        your room

Intended meaning: 'your sitting room'

- d.\*        bOSbar        duTo ghOr  
               sitting        two room

Intended meaning: 'two sitting rooms'

#### 6.4 Derivation of Gerundives

The nominal origin of the modern Bangla gerundive is indicated in the following where the NP in (119a) is related to – and I claim, is the source for – the gerundive in (119b):

- (119)a. *Sobar jonno ghOr*  
 sleeping-GEN for room  
 ‘a room for sleeping’
- b. *Sobar ghOr*  
 sleeping room

Consider the fact (from section 3.3.1 and 3.3.2) that *jonno* belongs to a class of Ps which obligatorily assigns Genitive to their complements<sup>75</sup>. Some examples follow:

- (120)a. *amar/ \*ami jonno*  
 my/ I for  
 ‘for me’
- b. *khawa-r/ \*khawa jonno*  
 eating-GEN/ eating for  
 ‘for eating’

I offer the following analysis of the gerundive where the PP complement of the N involves Genitive Case checking inside the PP which contains an empty P with properties like a P-Comp like *jonno*. I further claim that this Case checking counts as “agreement” between P and NP in a postpositional language in accordance with LCA. I will assume that *Sobar* starts off as an NP in syntax<sup>76</sup> and moves up to the [Spec, PP] to check Genitive leaving an empty P-Comp behind:

<sup>75</sup> It may be of interest to point out the German regularly shows this Case pattern:

- (i) *ZuGunsten seines Sohnes ...*  
 For his-GEN son ...
- b. *Zu [meines Freundes] Gunsten*  
 to my friend-GEN favour (Helmantel (1998))

Shah and Bhattacharya (forthcoming) provides theoretical analysis of the availability of Genitive lower down in the DP.

<sup>76</sup> There is much research available on syntactic structures below word level one of which is Hale and Keyser’s (1993) approach to a presyntactic level called I-syntax. It is possible that the Bangla gerundive has an I-syntax derivational history of being formed through a V→N incorporation. However, my present concern is the syntax of gerundives.

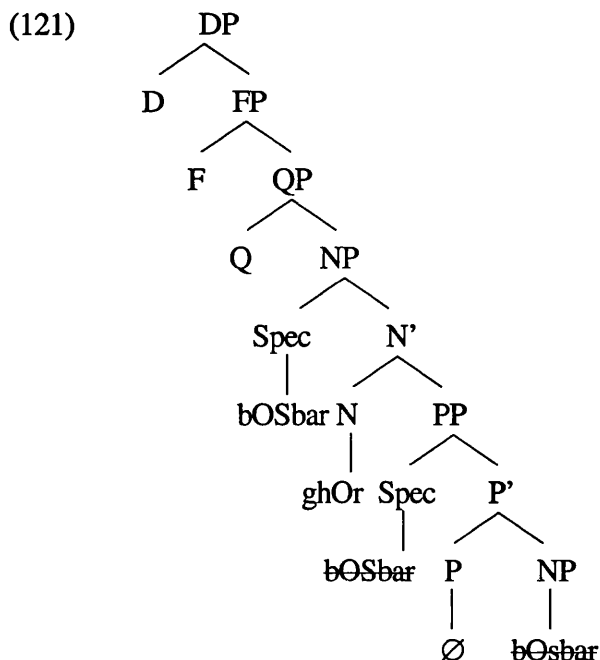

In this derivation, the movement of the NP to [Spec,NP], I assume, is triggered by the same feature which is also responsible for the sense of ‘future imperative’ that is generally obtained (though difficult to see in the above example) with gerundives (Chatterjee (1926: 967)). This feature is also therefore responsible for the compounding taking place. Comparing this derivation with the English example in (117a) *sitting room* from *room for sitting*, the lack of Genitive in English is result of the absence of NP movement where instead, I assume that, the whole PP (with the empty P-Comp) moves to the left.

The fact that a Dem (at [Spec,FP]) or a Num-Cla (at Q) occurring with a gerundive nominal can occupy their respective positions as per the DP structure in (121), shows that this analysis is on the right track:

(122) [DP<sub>[FP]</sub> ei [QP duTo [NP Sobar ghOr]]]

this two-CLA sleeping room

‘These two sleeping rooms’

## 7.0 Result Nominals

A distinction between Event Nominals (also known as Action or Process Nominals) and Result Nominals (RN) has been crucial in investigating the behaviour of nouns with respect to argument structure and theta-theory (Anderson (1983-84), Lebeaux (1986), Grimshaw (1990) etc.). As I pointed out in section 1.2 Grimshaw (1990) argues against the prevalent notion (Higginbotham (1983), Dowty (1989)) that nouns take arguments only optionally and showed that nouns can take arguments obligatorily. She makes the crucial distinction in terms of some clear cut diagnostics between the two types of nominals and proposes that only event nominals have an event structure and therefore an argument structure<sup>77</sup>. The lack of an event structure in RNs results in their inability to discharge a theta-role. This difference should be encodable in terms of the argument structures of the respective nominals and therefore in the lexicon, and eventually in the syntax.

In Bangla, RNs share the same suffix as the gerunds (see section 2.1 for an example). They have the *wa* suffix but never *-no*, instead some other (possibly) related affixes like *-on*, *-ni* are found:

- |       |                            |                          |
|-------|----------------------------|--------------------------|
| (123) | <i>colon</i> <sup>78</sup> | ‘the gait’ <sup>79</sup> |
|       | <i>nacon</i>               | ‘the dance’              |
|       | <i>calan</i>               | ‘the consignment’        |
|       | <i>uRan</i>                | ‘the flight’             |

<sup>77</sup> The distinction she makes is between Ns denoting complex events (like event/ action Ns) and Ns denoting simple events (like RNs).

<sup>78</sup> Notice that *cOlon* is related to the verbal base *cOla* ‘to walk’, *nacon* to *naca* ‘to dance’ and *uRan* to *oRa* ‘to fly’ but there is no recognisable cognate base form in modern Bangla for *calan* or *coban*. It is best, therefore, to consider them as unrelated in the syntax of modern Bangla (see also the next note).

<sup>79</sup> Notice that the nominals here have a definite reading (overlooked in any previous generative study). Chatterji (1926: 644) in his historical study of the Bangla language has held that the affix *-aan/ aaano* (precursor of the gerundial suffix) has acquired in New Bangla a definite, concrete meaning.

cobani 'the dousing'

There are four ways of forming result nominals in Bangla:

(i) simple forms with *-(w)a/no*

- (124) khEla 'play'  
 lekha 'written material'  
 khawa 'treat'

(ii) Reduplication

- (125) dhOra-dhori 'seeking favour'  
 haSa-haSi 'laughter'

(iii) Compounding

- (126) baMca-mOra 'survival'  
 dewa-newa 'give and take'  
 haMTa-cOla 'movement'

(iv) Echo words

- (127) khawa-dawa 'meal'

Traditionally gerunds and RNs are clubbed together as verbal nouns (Chatterjee (1926)). In De (1984) RNs are wrongly identified as action nominals. Although she reaches the conclusion that RNs are like concrete nouns, notice that, RNs although sharing the gerundial affix, show no other similarity with gerunds<sup>80</sup>. The RNs, therefore

<sup>80</sup> For example, RNs are not negatable (ib), cannot have a Nom subject (iib) or cannot take an object (iiib) or an adverb (ivb) as opposed to gerunds (the a examples):

- |   |  |
|---|--|
| (i)a. amar na jawa<br>my not going  | (iii)a. amar bhat khawa<br>my rice eating                                |
| b.* duTo na khEla<br>two NEG games  | b.* bhat khawa-dawa<br>rice meal   |
| (ii)a. goru-Ø cORa bOndho<br>cow-NOM grazing stopped<br>'Grazing of the cows has stopped' | (iv)a. amar taRataRi lekha<br>my swiftly writing<br>'My writing swiftly' |
| b.* Se lekha bhala<br>s/he writing good   | b.* amar taRataRi lekha duTo<br>my swiftly articles two                  |



do not show any ambiguity in terms of their behaviour (whether verbal or nominal). This would imply that RNs lack layers in their internal structure and are, in terms of Anderson (1982), not inflectional affixes.

In minimalism this can perhaps be translated as a nominal D head selecting an NP<sup>81</sup> with no internal argument or indeed any aspectual projection. (128) is the structure for an RN like *amar cOlon* 'my walk':

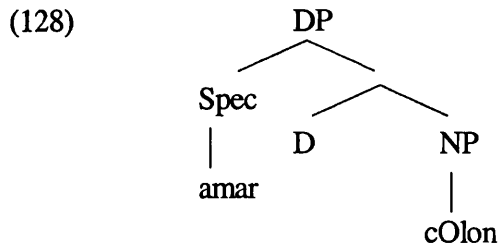

In the syntax, RNs in Bangla are thus assumed to be concrete Ns.

## 8.0 Conclusion

In conclusion, in this chapter I have shown that gerunds universally exhibit events through an Asp head either morphologically or abstractly. In continuation with the central theme of this thesis, I have also shown that either Case (for gerunds) or a [ $\pm$ DELIMIT] feature (for participles) of this Asp head drives NP movement inside gerundial and participial DPs in Bangla. The difference in the trigger on the other hand accounts for the unavailability of unergative participles in Bangla.

---

Intended reading: 'His articles are good'

<sup>81</sup> This accommodates the fact that there are some RNs derived from Ns such as *jutano* 'shoe-beating' (from the N *juta* 'shoe'), *lathano* 'kicking' (from the N *lathi* 'kick'), etc pointed out in Chatterji (1926: 665).

## Appendix: A Critique of a Non-Lexicalist Account

In sections 1.1 and 1.2 it was shown that in the generative grammar tradition derived nominals (DN) are marked lexically whereas gerunds are derived syntactically. I have looked at the latter constructions in Bangla and proposed a derivational analysis. In this appendix I will present a critique of the study on nominalisation of Harley and Noyer (1998: 126) (HN from now on) who suggest a non-lexicalist account of nominalisation in general based on the Distributed Morphology (DM) framework. The reason for discussing this in an appendix is because it is not about gerunds but DNs. Nevertheless, I will point out that HNs' is actually a lexicalist account.

First, in what follows, I provide a brief sketch of the general background of the framework. HN adopt a version of the DM theory as explicated in Halle and Marantz (1993, 1994) where phrase markers are constructed freely out of abstract categories defined by universal features. Phonological expressions are called Vocabulary Items (VI) which are inserted into syntactic structures at Spell-Out after syntactic operations. Therefore, by definition there is nothing like a lexicon anymore where morphophonological expressions can be related (e.g *grow* and *growth*). An account of nominalisation based on such a framework, will, by definition, be a non-lexical account.

Syntactic terminals in this theory fall into two classes: *f-nodes* and *l-nodes*, the former contains feature bundles for which the speaker has no choice, in the latter speaker's choice of VI is predetermined. In (1), the VIs *the*, *-ed*, *a* are determined by grammar for the speaker given a syntactic structure with f-nodes with features such as [definite], [past] and [indefinite]. Choice of the other VIs like *cat* and *mouse* are not so (*sic*) constrained:

- (1)a. The cat chased a mouse  
 b. The shark chased a fish

HN state that a separate component *Encyclopaedia*, relates VIs or structures of these with meaning.

The following VP structure illustrates the type of entity an l-node must be. For a transitive predicate, the *v* which selects the external argument must also select the feature [CAUSE] :

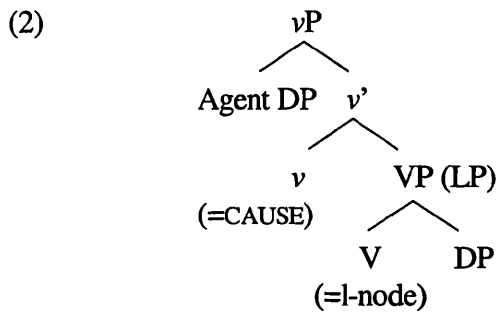

After a VI like *destroy* is inserted at the l-node which denotes a “resultant state” it combines with *v* to produce the transitive verbal form *destroyed*. The *v* can have a small inventory of meanings, namely, CAUSE (as above), BE, HAPPEN (for intransitives) and maybe some more. Crucially, this model uses the concept of subcategorisation frames to decide on the insertion point of the VIs.

In the domain of nominal structures, HN study whether this approach can capture the distinction between, e.g., *grow* and *destroy*, in terms of fact that the possessor of the nominalised *grow* cannot be interpreted as an agent<sup>82</sup> while the

<sup>82</sup> The so-called “mixed” form of Chomsky (1970) as in (ia) is derived from an intransitive verb and is ambiguous, whereas the corresponding DN in (ib) is not:

- (i)a. *the growing of tomatoes*  
 b. *the growth of tomatoes*

To explain this discrepancy, Chomsky suggest that a feature [+cause] is assigned to the intransitive *grow* as a lexical property which ‘becomes’ transitive and the subject becomes the object of the DN. However, an agent interpretation of the transitive DN is not possible:

- (ii)\* *John’s growth of the tomatoes*  
 This problem is not addressed in Chomsky.

possessor of nominalised *destroy* can be:

(3)a.# John's growth of tomatoes

b. The insect's destruction of the crop

Nominalisations in this theory are created by inserting VIs into a terminal node governed by D:

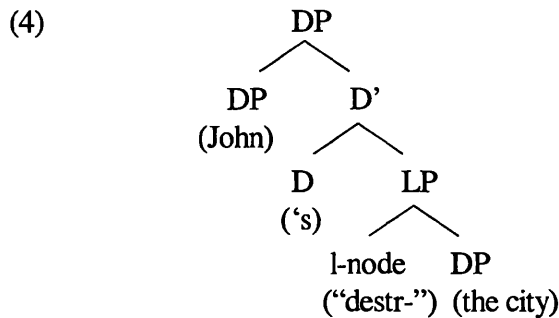

Furthermore, the nominalising affix *-ion* is added by a readjustment rule in a post-syntactic component.

As far as the DP at [Spec,DP] is concerned, they suggest that the interpretation of a possessor as agent or theme is determined not by subcategorisation information but by our real-world or encyclopaedic knowledge about the meaning of the roots in question. This is relevant in ruling out a DN like (3a). Based on Levin and Rappaport (1995) who point out that the type of causation involved in a predicate like the transitive *grow* is a result of internal activity, Marantz (1997, quoted in HN) suggests that for an internally caused event like GROW, the external causer interpretation is not available. This knowledge, according to HN, is part of our real-world knowledge. Thus, they claim, in accordance with the general strategy employed in DM, this account shifts the burden of interpretation from syntax to general conceptual/ semantic interface (HN 1998: 130). HN argue that this approach can even account for the speaker variation observed in cases of nominalisation with regards to the subject as the true

causer of the event as in (5) below. This, they claim, is predicted by the fact that licensing of the transitive nominalisation depends on Encyclopaedic or real-world knowledge. However, conveniently they do not attempt to formalise this age-old problem of speaker variation.

I suggest that if such encyclopaedic knowledge is used in a computation, it must constitute a part of the lexicon or at least a separate domain distinct from the conceptual/ interpretive interface<sup>83</sup>. If it is the case that real-world knowledge is learnt as a part of word meaning, then it must be present in the lexicon. According to this interpretation, the DM account of DNs therefore is a lexical account. In this connection, the assertion in Chomsky (1998:13) that the lexicon is a distinct component of memory, is relevant in conferring word-knowledge as part of the lexicon.

In the context of the discussion in this chapter, Bangla gerundial constructions were shown to be derived by NP movement triggered by a [ $\pm$ PERFECT] and [ $\pm$ DELIMIT] aspectual feature in the syntax. According to Chomsky (1995: 277) features in the minimalist theory can be either an inherent part of the lexical items or be introduced *at the time* of the selection of the LI. This requirement that the numeration must contain the full set of LIs with all the relevant features is necessary since in the minimalist theory of syntax nothing can be introduced during the course of the computation in accordance with the Inclusiveness principle (Chomsky 1995: 226)<sup>84</sup>.

---

<sup>83</sup> E.g. Domain-D (for Discourse) of Wiltschko (1995) and Kidwai (1996)

<sup>84</sup> Nash and Rouveret (1997) propose certain purely derivational heads (called *Proxy* categories) which are created in the course of computation and are not included in the initial numeration. I have not considered this modification to the minimalist program in this thesis.

## Appendix

### Are Q and Cla two separate Heads?

In this appendix, I will look in detail at some interesting facts about the nature of the Q head and consider the possibility of splitting up the complex Q head proposed in Chapter 2 and followed throughout this study, into two separate heads. Although such a possibility would perhaps enhance the supposed similarity with the clausal structure<sup>1</sup>, relegating the discussion to an appendix is driven by the fact that the range and the scope of the data and the analysis are interesting by themselves yet too limited to be promoted as well-carved formulations.

I would like to investigate classifiers other than the general *Cla Ta* here. To retain consistency with the proposal so far, let us suppose that non-clitic *Cla* is also a part of the complex head. By extension, these other *Cla* should also be morphological realisations of the [SPECIFICITY] feature. The complex headedness of Q, assumed in this study, can be represented as follows:

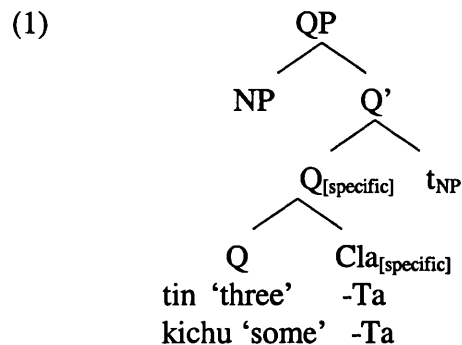

The following table is an attempt to look at the combinations of Qs and Cla more carefully:

---

<sup>1</sup>For example, splitting up of the INFL in Pollock (1989), Chomsky (1991), Mahajan (1989) and others.

(2)

Q	Classifiers			
	-Ta	gulo	khana/ khani	jOn
		[+count	[+count/mass	[+human
SOB 'all'	✓	✓	✓	✗
kOtok 'somewhat'	✓	✓	✗	✗
kichu 'some'	✓	✗	✗	✗
khanik 'a bit'	✓	✗	✗	✗
Olpek- 'a little'	✓	✗	✗	✗
prottek 'every other'	✓	✗	✗	✗
Onek 'a lot'	✓	✓	✓	✓
kOto 'how/so much'	✓	✓	✓	✓
Oto 'so much'	✓	✓	✓	✓
kOek 'a few'	✓	✗	✓	✓
numerals	✓	✗	✓	✓
num+Ek 'num or so'	✗	✗	✓	✓

In this table each column indicates combinatorial possibilities between the classifier mentioned at the head of the column and the various Qs listed under the first column.

### 1.0 Some Relevant Data on All and Non-All Quantifiers (NAQ)

Notice first the behaviour of the Q *SOB* 'all' in the following pair:

- (3)a. SOb gulo chele aSbe  
 all CLA boy come.FUT  
 ‘All the boys will come’
- b. SOb chele gulo aSbe  
 all boy CLA come.FUT  
 ‘all the boys will come’

The difference between the two is that in (3b) *SOB* ‘all’ quantifies over a particular set of boys, a set which has a prior discourse reference. (3a) on the other hand is a quantification over an exhaustive set of boys. Additionally, (3b) shows, for the first time, that an NP can appear between Q and Cla. This would suggest that these two ought to be split up into two heads and that unlike *-Ta*, the classifier *gulo* does not cliticise to the Num/Q. Before making any proposals, let us look at quantifiers other than *all*, which I identify, for purely mnemonic reasons, as non-*all* quantifiers (NAQs):

- (4)a. Onek gulo chele  
 a lot CLA boy  
 ‘a lot of boys’
- b.\* Onek chele gulo
- (5)a. kOtok gulo chele  
 some CLA boy  
 ‘some boys’
- b.\* kOtok chele gulo

Similar results obtain with other classifiers:



(6)a. Onek-jon chele  
 a lot-CLA boys  
 'a lot of boys'

b.\* Onek chele-jon

(7)a. Onek-khani rasta –  
 a lot-CLA road  
 'a lot of distance'

b.\* Onek rasta-khani

Changing the Q gives us the same results:

(8)a. kOek-jon chele  
 a few-CLA boy  
 'A few boys'

b.\* kOek chele-jon

(9)a. kOto-gulo lok  
 'Some people'

b.\* kOto lok-gulo  
 some people-CLA

(10)a. kOto-khani doi  
 so much-CLA yoghurt  
 'so much yoghurt'!

b.\* kOto doi-khani

## 2.0 Q and Cla as separate heads

One possibility of accommodating the above data is by splitting the Q/Num-Cla

into two separate heads Q and Cla:

(11)

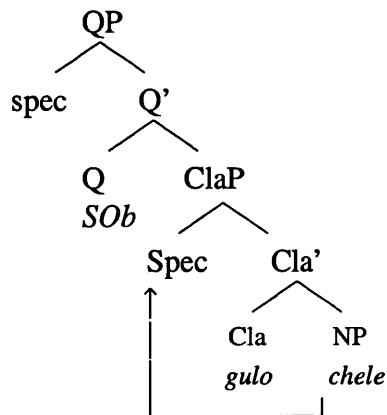

The movement of the NP to [Spec,ClaP] would derive the order in (3b) whereas no movement is necessary for (3a). I will suggest that the above derivation is incorrect for at least three reasons. I discuss these briefly in three separate subsections below.

### 2.1 The right order is the [ClaP-QP] order

Given the reasons for the headedness of the Num/Q-Cla complex Head in section 3.1 (Chapter 2) and given the data in (4a) to (10a) above, it is likely that a Num/Q-Cla sequence is formed through head adjunction of Q and Cla. If that is the case then the derivation in (11) would give us the wrong order of [Cla-Q]. This is based on the reasoning that adjunction is always to the left. Although there are proposals in the literature<sup>2</sup> in favour of a right adjunction at the word level, I will consider adjunction as always to the left for uniformity of analysis without committing myself one way or the other whether these (and other, especially in section 2.4) movements are part of morphology or syntax. In fact given that there is a

<sup>2</sup> See Barbosa (1996) who suggested right adjunction to be the case for getting the right order for French clitic placement and negative order, where the general claim is that head adjunction in Romance is right adjunction.

considerable literature on the treatment of various morphological processes as part of syntax or as obeying restrictions on movement similar to ones in syntax<sup>3</sup>, the question of making a distinction in terms of the status of adjunction does not arise.

So the revised structure is as follows:

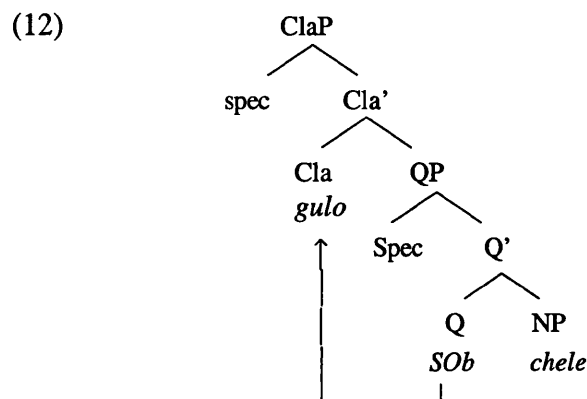

This is the derivation for (3a) achieved through head adjunction of Q to Cla, but what about (3b)?

One possibility is to derive (3b) via head movement of Q to a head higher than Cla and then moving the NP to [Spec,ClaP]. I reject this possibility since it unnecessarily increases the number of heads without any strong motivation for doing so, especially, since this extra head is needed only to derive this order.

The other possibility is to move the whole QP to [Spec,ClaP]. There are two problems with this. Firstly, this will not stop the derivation of the unwanted (b) versions of the other Qs in (4-10) by raising the NP as follows:

(13)\* [ClaP [QP Onek [NP chele]] gulo t<sub>QP</sub>]

Secondly, this would imply that a feature of the Cla is responsible for the movement of the QP to its spec. This is against the evidence given in (4-10). I deal

<sup>3</sup> See for example Di Sciullo (1996: 84) who considers derivational morphology as syntactic. In particular, she rejects the notions of lexical subcategorisation and theta-grids and suggests that selectional restrictions are encoded in terms of X' positions.

with this in the next section. Based on the above observations, I reject the head analysis of *SOB*. I discuss its status further in section 4.4.

## 2.2 Feature of Q

The structure in (11) cannot explain why the NP does not move in the case of NAQs. A closer inspection of the makeup of the Qs in the NAQ group reveals that all of them contain some indivisible version of the word for *Ek* 'one', at times morphologically unrecognisable:<sup>4</sup>

- (14) a. Onek 'a lot'  
 b. kOek 'a few'  
 c. khanik 'a bit'  
 d. Olpek 'a little'  
 e. prottek 'each one'  
 f. kOtok<sup>5</sup> 'a few'

In addition (15) below shows another curious use of the *Ek* morpheme/ word. This use of the numeral is restricted to its use with another numeral<sup>6</sup>:

<sup>4</sup> Notice the English glosses suggest a similar presence of 'one'

<sup>5</sup> In others without a visible *-ek* morpheme, we get either a reduced Wh-word (K -word) as in (ia,b) or a demonstrative particle (ic):

(i)a. kichu 'some' b. kOto 'how/so many' c. Oto 'so many'

It is possible that all these indivisible particles contribute to the featural makeup of the Q head contributing towards a general notion of counting or enumeration. However, I have no idea if this connection between the *-ek* set and (i) is a robust one or whether it can be stated formally.

<sup>6</sup> It is interesting to note that this use of the *-Ek* numeral is restricted to the number two:

(i) \* tin/ car-Ek-Ta chele (ii) \* tin/car-Ek khana ruTi  
 three/ four-one-CLA boy three-one CLA bread

Misi Brody (p.c.) suggested that the use with the number two could be idiomatic. My guess is that it is still a syntactic problem because of possibilities like the following:

(ii)a. jona du-Ek/ tin-ek/ car-ek (cf \* jona du/ tin/ car)  
 CLA two-one/ three-one/ four-one  
 'Two/ three/ four or so'  
 b. khan du-Ek/ tin-ek/ car-ek (cf \* khan du/ tin/ car)  
 'Two/ three/ four or so'  
 c. goTa du-Ek/ tin-ek/ car-ek (cf \* goTa dui/ tin/ car)

(15)a. du-Ek-Ta chele

two-one-CLA boy

'One or two boys'

b. du-Ek khana ruTi

two-one CLA bread

'One or two loaves'

In this connection, note that like NAQs, NP cannot intervene between the Q and the Cla in these cases:

(16)a.\* du-Ek chele jon

two-one son CLA

b.\* du-Ek ruTi khana

two-one bread CLA

I call this morpheme '*Vague-one*' since it gives a vague meaning to the numeral. The presence of this morpheme in some form bars the possibility of moving an NP between the Q/Num and the Cla. The discussion so far has shown that some feature of the Q decides on the NP movement noticed in (3b) and the lack of it in (4-10).

### 2.3 Difference between *All* and *Non-All* Qs

The most serious problem with the derivation in (11) is its inability to distinguish

---

'Two/ three/ four or so'

Regarding this problematic data, I have suggested in Bhattacharya (forthcoming a) that the classifiers in these examples are different from classifier heads and are Cla-Specs. Thus *jOna* is an XP whereas *jon* is a head. However, more comparative work with dialectal Bangla and with other Eastern Indo-Aryan languages like Oriya and Assamese are needed to come to any definitive conclusion regarding this problem. I leave it for future research.



(19) [QP [ha-praxim]<sub>i</sub> kul-am [DP t<sub>i</sub> ]

The categorial status of the Q *kol* 'all' is that of a head selecting a full DP. Similarly for (18a) *tutti* is a Q head selecting the DP [*i ragazzi*]. For (18b), Giusti (1997) proposes that these are Adjs and are located inside the DP as a specifier of an AgrP between D and N. In the next section I will argue that there is no evidence in Bangla to consider Qs being external to the DP.

#### 2.4 All is internal to the DP in Bangla

The Dem or the Poss which have been shown to be inside the DP always precede *SOB*:

(20)a. ei SOB gulo chele

this all CLA boy

'all these boys'

b.\* SOB ei gulo chele

(21)a. amar SOB gulo chele

my all CLA son

'all my sons'

b.\* SOB amar gulo chele

The Bangla *all* therefore does not select a DP. On the other hand, there is evidence to show that *SOB* regularly combines with a [Q+Cla] sequence (22a-c) while NAQs do not (22d,e):

(22)a. SOB-kO-jon

all-some-CLA

'all (of them)'

- c. SOb-kO-Ta  
all-some-CLA  
'all (of those)'
- d.\* Onek-kO-Ta/ jon  
a lot-some-CLA/ CLA
- e.\* kichu-prottek-Ta  
some-every one- CLA

The data suggests that *SOB* results in [*SOB*-Q-Cla] sequences but NAQs do not, so that \*[NAQ-Q-Cla]. One plausible hypothesis – given that we have rejected the head analysis of *SOB* earlier in section 2.1 on theoretical grounds – is that this sequence is the result of a structure such as the following:

(23)

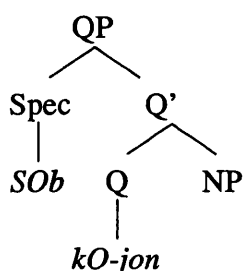

That is, *all* in Bangla is a phrasal category merged at [Spec, QP]. However, notice that the order [*SOB*-Q-Cla] can be derived with a head to head analysis as well by considering *SOB* as a Q head. I offer the following evidence to argue against such a possibility. This is based on the proposal made in Chapter 3 that Dems are XPs.

(24)\* ei-kichu/ ei-Olpek/ ei-khanik etc

this-some/ this-a little/ this-a bit

That is, the NAQs cannot combine with the Dem *ei*. By the principle of structure preservation, only an XP can adjoin to another XP, like the Dem *ei*, and not to a head Q like *kichu* 'some' and *Olpek* 'a little' etc.



Based on the discussion in this section, I conclude that *SOB* is an XP at [Spec,QP].

## 2.5 Revisiting the relevant data: Back to Q and Cla as a fused head

Armed with the conclusion from the preceding section let us look at the relevant data presented in section 1.0 again.

(25)a. *SOB gulo chele aSbe*  
 all CLA boy come.FUT

'All the boys will come'

b. *SOB chele gulo aSbe*  
 all boy CLA come.FUT

'all the boys will come'

(26)a. *Onek gulo chele*  
 a lot CLA boy

'a lot of boys'

b.\* *Onek chele gulo*

It is clear from this data (and the bigger set from (3) to (10)) that *SOB* is different from NAQs in allowing the NP to appear between it and the Cla. Now with the conclusion that *SOB* is indeed different, I claim that the structure of the Bangla DP proposed in Chapter 2 has a natural way of accommodating the data related to *SOB*. That is, the Q and Cla should *not* be split into two separate heads. The headedness of the Num/Q-Cla offered in section 3.1 of Chapter 2, therefore, stands. The derivation for (25) (= (3)) is shown below:

(27)a.

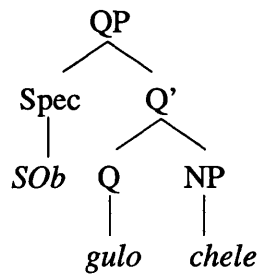

(Represents (25a))

b.

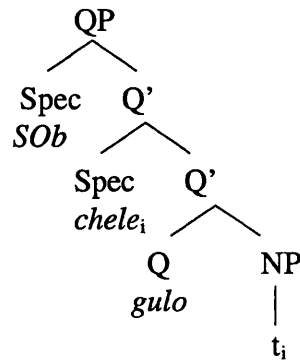

(Represents (25b))

Apart from the fact that we do not require another head for the Cla, mentioned in the preceding paragraph, this analysis is desirable on three counts:

(i) Note that the derivation in (27b) exhibits leftward NP movement inside the DP. This has been claimed to be the major thread of discovery running throughout this dissertation. The analysis of *SOb* therefore provides additional evidence towards this demonstration.

(ii) Notice that the derivation in (27b) crucially depends on the availability of multiple specifiers. I claim that this is expected (a) given the minimalist framework adopted for this study<sup>8</sup> and (b) confirms a crucial principle proposed in Richards

<sup>8</sup> Crucially though, LCA does not permit it (see section 3.1 of Chapter 1 on the differences between the two). However, Cinque observes that a prohibition against more than one specifier is by no means a logically necessary property of X'-theory and that a definition of c-command (as in (ii) below) slightly different (denoted in italics) from the one adopted in Kayne (1994) (as in (i)) could allow multiple specifiers while retaining most other features of antisymmetry:

(i) *X* c-command *Y* iff *X* and *Y* are categories and *X* excludes *Y* and every *category* that dominates *X* dominates *Y*

(1997). Based on multiple WH construction in some Balkan languages, Richard shows that the principle predicts that later XP movements land in inner specifiers.

(iii) The analysis in (27b) provides an elegant solution to the puzzle of NAQs. Note that in (26b) (and in (4b) to (10b) for other NAQs) the NAQ *Onek* does not allow the leftward NP movement noticed with *SOB*. Recall one of the differences between the two types of Qs elaborated in section 2.2. NAQs were shown to embed a special morpheme *-Ek* 'one' which was missing in *SOB*. The analysis in (27b) has a natural way of incorporating the connection between this morphological observation and the lack of NP movement in NAQs as follows.

In Chapter 2, I have shown that DP-internal NP movement is due to the presence of a feature of [SPECIFICITY] on the Q head. Similarly, the NP movement shown in (27b) above is also due to such a feature of the Q. I propose that in case of NAQs, the *-Ek* morpheme makes the Q head non-specific. This is not unlikely, given that (at least) the Vague-one morpheme makes the meaning vague or non-specific. The derivation for NAQs, therefore proceeds as follows:

---

(ii) X c-commands Y iff X and Y are categories and X excludes Y and every *segment* that dominates X dominates Y

This ensures that the higher adjunct/ specifier asymmetrically c-commands the lower one since every segment that dominates X in (iii) dominates Y but not vice-versa:

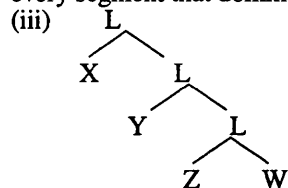

However this loses the property that adjunct/ specifiers c-command out of the adjoinee. See Zwart (1993) for a similar modification in the framework allowing for multiple specifiers. The analysis of *SOB* offered in the text supports a structure with multiple specifiers. As nothing definitive can yet be said against such a structure I have assumed the existence of multiple specs for the purpose of this study.

(28)

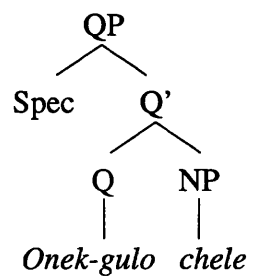

(Represents (26a))

The NP cannot move up because there is no attractor feature in Q.

## References

- Abney, S.1987. The English NP in its Sentential Aspect. Cambridge, MA: MIT dissertation.
- Anderson, M. 1979. Noun Phrase Structure. Storrs, CT: University of Connecticut dissertation.
- Anderson, M. 1983-84. Prenominal Genitive Noun Phrases. *Linguistic Review* 3 1-24.
- Anderson, S.R. 1982. Where's Morphology? *Linguistic Inquiry* 13.4 571-611.
- Arad, M. 1998. VP Structure and the Syntax-Lexicon Interface. London: University College London dissertation.
- Arnaudova, O. 1996. The Bulgarian Noun (Adjective) Movement to D. *Formal Approaches to Slavic Linguistics 3*. University of Trondheim Working Papers in Linguistics, ed. by M. Dimitrova-Vulchanova and L. Hellan, 1-28.
- Bagchi, T. 1993. Clausal Subordination in Bangla: A Cross-Modular Approach. Chicago, IL: University of Chicago dissertation.
- Baker, M. 1988. Incorporation: A Theory of Grammatical Function Changing. Chicago, IL: University of Chicago Press.
- Bal, B.K. 1990. COMP and Complementizers in Oriya and English. Hyderabad: Central Institute of English and Foreign Languages dissertation.
- Barbosa, P. 1996. In defence of right adjunction for head movement. *Configurations: Essays on Structure and Interpretation*, ed. by Anna-Maria Di Sciullo, 161-184. Somerville, MA: Cascadilla Press.
- Bartsch, R. 1981. Semantics and Syntax of Nominalization. *Formal Methods on the Study of Language*, ed. by J. Groenendijk, T. Janssen, and M. Stokhof, 1-28. Amsterdam: Amsterdam Mathematical Centre Tracts 135.

- Bernstein, J. 1991. DPs in French and Walloon: evidence for parametric variation in nominal head movement. *Probus* 3.1 1-26.
- Bernstein, J. 1993a. The Syntactic Role of Word Markers in Null Nominal Constructions. *Probus* 5(1-2) 5-38
- Bernstein, J. 1993b. Topics in the Nominal Structure across Romance. New York, NY: CUNY dissertation.
- Bernstein, J. 1997. Demonstratives and Reinforcers in Romance and Germanic Languages. *Lingua* 102 87-113.
- Bhattacharya, T. 1995a. DPs in Bangla. *Journal of the MS University of Baroda* 43.1
- Bhattacharya, T. 1995b. A Computational Study of Transitivity. Hyderabad: University of Hyderabad dissertation.
- Bhattacharya, T. 1998a. Kinship Inversion in Bangla. *PLUM Series* 7.
- Bhattacharya, T. 1998b. The Subjunctive in Bangla. Paper presented at the Conference on Tense and Mood Selection, Bergamo.
- Bhattacharya, T. 1998c. The nP-Shell in Bangla. Paper presented at the 19<sup>th</sup> Roundtable meeting of the South Asian Linguistics Association, York.
- Bhattacharya, T. 1998d. DP-Internal NP Movement. *UCL Working Papers in Linguistics* 10 225-252.
- Bhattacharya, T. 1999. Specificity in the Bangla DP. *Yearbook of South Asian Language and Linguistics* 2, ed. by R. Singh, 71-99. New Delhi/ London: Sage Publications.
- Bhattacharya, T. (forthcoming a). In Search of the Vague 'One'. *Proceedings of ConSOLE 7, Leiden*.
- Bhattacharya, T. (forthcoming b). Gerundial Aspect and NP Movement. *Yearbook of*

- South Asian Language and Linguistics 3, ed. by R. Singh, New Delhi/ London: Sage Publications.
- Bhattacharya, T. and P. Dasgupta 1996. Classifiers, Word Order and Definiteness. Word Order in Indian Languages, ed. by V.S. Lakshmi and A. Mukherjee, 73-94. Hyderabad: Booklinks.
- Bobaljik, J. 1993. Ergativity and Ergative Unergatives. Papers on Case and Agreement II. MIT Working Papers in Linguistics 19, ed. by C. Collins and J.D. Bobaljik, 45-88. Cambridge, MA: MIT.
- Bobaljik, J. 1995. Morphosyntax: The Syntax of Verbal Inflection. Cambridge, MA: MIT dissertation.
- Bobaljik, J. 1998. Floating Quantifiers: Handle With Care. Glot International 3.6 3-10.
- Borer, H. 1990. *V+ing*: It Walks like an adjective, It Talks like an Adjective. Linguistics Inquiry 21.1 95-103.
- Borer, H. 1993. The Projection of Arguments. Functional Projections. University of Massachusetts Occasional Papers 17, ed. by E. Benedicto and J. Runner, 19-47. Amherst, MA: University of Massachusetts.
- Borer, H. 1996. Passives without theta grids. Morphological Interfaces, ed. by S. Lapointe. Stanford: CSLI.
- Borsley, R. and I. Roberts. (ed.) 1996. The Syntax of Celtic Languages: A comparative Perspective. Cambridge: Cambridge University Press.
- Bosque, I. 1990. Sobre el aspecto en los adjetivos y en los participios. Tiempo y aspecto en español, ed. by I. Bosque. Madrid: Catedra
- Brinton, L. 1995. The aksionsart of deverbal noun in english. Temporal Reference, Aspect and Actionality 1. Semantic and Syntactic Perspectives, ed. by P.M.

- Bertinetto, V. Bianchi, J. Higginbotham and M. Squartini, 27-42. Turin: Rosenberg and Sellier.
- Brinton, L. 1998. Aspectuality and Countability: A cross cultural analogy. *English Language and Linguistics* 2(1) 37-63.
- Brody, M. 1990. Some Remarks on the Focus Field in Hungarian. *UCL Working Papers* 2 201-225
- Brody, M. 1995. *Lexico-Logical Form. A Radically Minimalist Theory*. Cambridge, MA: MIT Press.
- Brugé, L. 1996. Demonstrative Movement in Spanish. A Comparative Approach. *University of Venice Working Papers in Linguistics* 6.1 1-53
- Burzio, L. 1986. *Italian Syntax: A Government-Binding Approach*. Dordrecht: Reidel.
- Carstens, V.M. 1991. *The Morphology and Syntax of Determiner Phrases in Kiswahili*. Los Angeles, CA: UCLA dissertation.
- Chatterji, S.K. 1926. *The Origin and Development of the Bengali Language, Part II*. Calcutta: Calcutta University Press.
- Chomsky, N. 1970. Remarks on Nominalization. *Reading in English Transformational Grammar*, ed. by R. Jacobs and P. Rosenbaum, 184-221. Waltham, MA: Ginn and Co.
- Chomsky, N. 1981. *Lectures on Government and Binding*. Dordrecht: Foris Publication.
- Chomsky, N. 1986. *Knowledge of Language*. New York: Prager.
- Chomsky, N. 1991. Some Notes on Economy of Derivation and Representation. *Principles and Parameters in Comparative Grammar*, ed. by R. Friedin, 417-454. Cambridge, MA: MIT.



- Chomsky, N. 1993. A Minimalist Program for Linguistic Theory. The View from Building 20, ed. by K. Hale and S. J. Keyser, 1-52. Cambridge, MA: MIT Press.
- Chomsky, N. 1994. Bare Phrase Structure. Government and Binding Theory and the Minimalist Program, ed. by G. Webelhuth, 383-439. Oxford: Blackwell.
- Chomsky, N. 1995. The Minimalist Program. Cambridge, MA: MIT Press.
- Chomsky, N. 1998. Minimalist Inquiries: The Framework. Cambridge, MA: MIT, ms.
- Cinque, G. 1992. Functional Projections and N movement within the DP. Paper presented at XIV GLOW Colloquium, Lisbon. (Published as Cinque, G. (1995)).
- Cinque, G. 1994. On the evidence for partial N-movement in the Romance DP. Paths towards universal grammar, ed. by G. Cinque, J. Koster, J-Y. Pollock, L. Rizzi and R. Zanuttini, 85-110, Georgetown University press.
- Cinque, G. 1995. Italian Syntax and Universal Grammar. Oxford: Oxford University press.
- Cinque, G. 1996. The 'antisymmetric' programme: theoretical and typological implications. *Journal of Linguistics* 32 447-464.
- Collins, C. 1995. Toward a theory of optimal derivations. *Papers on Minimalist Syntax*. MIT Working Papers in Linguistics 27, ed. by R. Pensalfini and H. Ura. 65-103. Cambridge, MA: MIT
- Collins, C. 1997. *Local Economy*. Cambridge, MA: MIT Press.
- Collins, C. and H. Thráinsson 1996. VP internal structure and object shift in Icelandic. *Linguistic Inquiry* 27.3 391-444.
- Corver, N. 1990. The syntax of left branch extractions. Brabant: Katholieke Universiteit dissertation.
- Corver, N. 1997. The internal syntax of the Dutch extended adjectival projection.

Natural Language and Linguistics Theory 15 289-368.

Croft, W. 1996. What's a Head? Phrase structure and the lexicon, ed. by J. Rooryck and L. Zaring, 35-76. Dordrecht: Kluwer.

Crystal, D. 1992. An Encyclopaedic Dictionary of Language and Languages. Oxford: Blackwell.

Cummins, S. and Y. Roberge. 1994. Romance Inflectional Morphology in and out of Syntax. The Morphology-Syntax Connection: MIT Working Papers in Linguistics 22, ed. by Heidi Harley and Colin Phillips, 53-70. Cambridge, MA: MIT

Dasgupta, P. 1980. Question and relative and complement clauses in Bangla grammar. New York: New York University dissertation.

Dasgupta, P. 1983. The Bangla Classifier /Ta/, its Penumbra, and Definiteness. Indian Linguistics 44 11-26.

Dasgupta, P. 1986. Gerunds, participles and the meaning of categories. Bulletin of the Deccan College Postgraduate and Research Institute 45 7-18.

Dasgupta, P. 1988. Bangla Quantifier Extraction, Unaccusatives in situ, and the ECP. Linguistic Inquiry 19.4 691-698.

Dasgupta, P. 1992. Pronominality and Deixis in Bangla. Linguistic Analysis 22 61-77.

Dasgupta, P. 1994. Verbless and nonfinite clauses. PILC Journal of Dravidic Studies 4.2 57-68.

Dasgupta, P. 1997. Prepositions, Postpositions, Parameters. ms, University of Hyderabad, Hyderabad

Dasgupta, P. 1999. The ubiquitous complementiser. Paper presented at the II International Conference on South Asian Languages. Patiala: Punjabi University.

- Dasgupta, P. and T. Bhattacharya. 1993. Classifiers and the Bangla DP. Papers from the 15<sup>th</sup> SALA Round Table Conference, ed. by A. Davison and F.M. Smith, 59-69. University of Iowa.
- De, M. 1984. Bangla Gerunds. Hyderabad: Osmania University M.Phil dissertation.
- De, M. 1985. Subjects of unaccusative gerunds. Paper presented at the Advanced Transformational Grammar Workshop, Delhi.
- de Hoop, H. 1992. Case Configuration and Noun Phrase Interpretation. Groningen: University of Groningen dissertation.
- de Hoop, H. 1994. Nominal and aspectual factors in NP interpretation. *Lingua e Stile* 29.3 437-456.
- Delsing, L-O. 1993. On the attributive adjectives in Scandinavian and other languages. *Studia Linguistica* 47.2 105-125.
- Depréz, V. (to appear). The roots of negative concord in French and French-based Creoles. *Parametric Approaches to Creole Syntax*, ed. by M DeGraff, Cambridge, MA: MIT Press.
- Diesing, M. 1992. *Indefinites*. Cambridge, MA: MIT Press.
- Di Sciullo, A.M. 1996. X' Selection. *Phrase structure and the lexicon*, ed. by J. Rooryck and L. Zaring, 77-108. Dordrecht: Kluwer.
- Di Sciullo, A.M. and E. Williams. 1987. *On the definition of word*. Cambridge, MA: MIT Press.
- Don, J. 1993. *Morphological Conversion*. Utrecht: OTS dissertation series.
- Donati, C. and A. Tomaselli. 1997. Language types and generative grammar: a review of some consequences of the universal VO hypothesis. *Rightward Movement*, ed. by D Beerman, D. Leblanc, H. van Riemsdijk, 331-354. Amsterdam: John

Benjamins.

Dowty, D. 1989. On the semantic content of the notion "thematic role". Property Theory, Type Theory and Natural Language, Volume II: Semantic Issues, ed. by G. Chierchia, B. H. Partee and R. Turner, 69-129. Dordrecht: Kluwer.

Dryer, M. S. 1988. Object-verb order and adjective-noun order: dispelling a myth. *Lingua* 74 185-217.

Duffield, N. 1995. *Particles and Projections in Irish Syntax*. Dordrecht: Kluwer.

Duffield, N. 1996. On structural invariance and lexical diversity in VSO languages: arguments from Irish noun phrases. *The Syntax of Celtic Languages: A comparative Perspective*, ed. by R. Borsley and I. Roberts, 314-340. Cambridge: Cambridge University Press.

Egerland, V. 1996. *The Syntax of Past Participles: A Generative Study of Nonfinite Constructions in Ancient and Modern Italian*. Lund: Lund University Press.

Emonds, J. 1970. *Root and structure preserving transformation*. Cambridge, MA: MIT dissertation.

Emonds, J. 1976. *A transformational approach to English syntax*. New York: Academic Press.

Emonds, J. 1987. Invisible category principle. *Linguistic Inquiry* 18.4 613-632.

Emonds, J. 1988. The autonomy of the (syntactic) lexicon and syntax: insertion condition for derivational and inflectional morpheme. University of Provence, ms.

Enç, M. 1991. The Semantics of Specificity. *Linguistic Inquiry* 22.1 1-25.

Fiengo, R. 1977. On trace theory. *Linguistic Inquiry* 8 35-61.

Fassi Fehri, A. 1993. *Issues in the structure of Arabic clauses and words*. Dordrecht: Kluwer.

- Fodor, J.D. and I. Sag. 1982. Referential and quantificational indefinites. *Linguistics and Philosophy* 5 355-398.
- Fraser, B. 1970. Some remarks on the action nominalization in English. *Readings in English Transformational Grammar*, ed. by R. Jacobs and P. Rosenbaum, 83-98. Waltham, MA: Ginn and Co.
- Fukui, N. 1986. SPEC, Agreement and the Comparative Syntax of English and Japanese. Cambridge, MA: MIT dissertation.
- Ghomeshi, J. 1997. Non-projecting Nouns in Persian. *Natural Language and Linguistic Theory* 15 729-788.
- Giorgi, A. and G. Longobardi. 1991. *The Syntax of Noun Phrases*. Cambridge: Cambridge University Press.
- Giusti, G. 1991. The categorial status of quantified nominals. *Linguistische Berichte* 136 438-452.
- Giusti, G. 1993. Enclitic articles and double definiteness: a comparative analysis of nominal structure in Romance and Germanic. *University of Venice Working Papers in Linguistics* 3 83-94.
- Giusti, G. 1995. Heads and modifiers among determiners: evidence from Rumanian. *Advances in Roumanian Linguistics*, ed. by G. Cinque and G. Giusti, 103-125. Amsterdam: John Benjamins.
- Giusti, G. 1996. Is there a FocusP and TopicP in the Noun Phrase Structure? *University of Venice Working Papers* 6.2 105-128.
- Giusti, G. 1997. *The Categorial Status Of Determiners. The New Comparative Syntax*, ed. by L. Haegeman, 94-113. Cambridge: Cambridge University Press.
- Greenberg, J. 1966. Some universals of grammar with particular reference to the order

- of meaningful elements. *Universals of Languages* (2<sup>nd</sup> edition), ed. by J. Greenberg, 73-113. Cambridge, MA: MIT Press.
- Greenberg, J. 1978. Generalizations about numeral systems. *Universals of Human Language, Volume 3: Word Structure*, ed. by J. Greenberg, C. Ferguson and E. Moravcsik, 249-295. Stanford: Stanford University Press.
- Grimshaw, J. 1990. *Argument Structure*. Cambridge, MA: MIT Press.
- Hale, K and S.J. Keyser. 1993. On argument structure and the lexical expression of syntactic relations. *The View from Building 20*, ed. by K. Hale and S. J. Keyser, 1-52. Cambridge, MA: MIT Press.
- Halle, M. and A. Marantz. 1993. Distributed morphology and the pieces of inflection. *The View from Building 20*, ed. by K. Hale and S. J. Keyser, 1-52. Cambridge, MA: MIT Press.
- Halle, M. and A. Marantz. 1994. Some key features of distributed morphology. *Papers on Phonology and Morphology. MIT Working Papers in Linguistics 21*, ed. by A. Carnie, H. Harley with T. Bures, 275-288. Cambridge, MA: MIT
- Harley, H. and R. Noyer .1998. Licensing in the non-lexicalist lexicon: Nominalization, Vocabulary Items and Encyclopaedia. *MIT Working Papers in Linguistics 32, Papers from MIT/UPenn Roundtable on Argument Structure and Aspect*, ed. by H. Harley, 119-137.
- Hawkins, J. 1983. *Word Order Universals*. New York: Academic Press.
- Hazout, I. 1995. Action Nominalizations and the Lexicalist Hypothesis. *Natural Language and Linguistic Theory* 13 355-404.
- Heim, I. 1982. *The semantics of definite and indefinite NP*. Amherst: University of Massachussets dissertation.

- Helmantel, M. 1998. On the relation between structural position and morphological Case: adposition in German. Paper presented at ConSOLE 7 meeting, Bergen.
- Higginbotham, J. 1983. Logical Form, Binding and Nominals. *Linguistics Inquiry* 14 395-420.
- Hockett, C. F. 1958. *A Course in Modern Linguistics*. New York: MacMillan.
- Holmberg, A. 1993. On the Structure of Predicate NP. *Studia Linguistica*. 47.2 126-138.
- Hudson, R. 1987. Zwicky on Heads. *Journal of Linguistics* 23 109-132.
- Jackendoff, R. 1977. *X-Bar Syntax*. Cambridge, MA: MIT Press.
- Jackendoff, R. 1991. Parts and Boundaries. *Cognition* 41 9-45.
- Jayaseelan, K.A. 1996. Question-word movement to focus and scrambling in Malayalam. *Linguistics Analysis* 26.1-2 63-83.
- Johnson, D. and S. Lappin. 1997. A critique of the minimalist program. *Linguistics and Philosophy* 20 272-333.
- Josefsson, G. 1998. *Minimal Words in Minimal Syntax: Word-Formation in Swedish*. Amsterdam: John Benjamins.
- Kamp, H. 1981. A theory of truth and semantic representation. *Formal Methods on the Study of Language*, ed. by J. Groenendijk, T. Janssen, and M. Stokhof, 277-322. Amsterdam: Amsterdam Mathematical Centre Tracts 135.
- Kawashima, R. 1994. *The structure of noun phrases and the interpretation of quantification NPs in Japanese*. Ithaca, NY: Cornell University dissertation.
- Kayne, R. 1981. ECP extensions. *Linguistic Inquiry* 12 93-133
- Kayne, R. 1984. *Connectedness and Binary Branching*. Dordrecht: Foris.
- Kayne, R. 1993. Toward a modular theory of auxiliary selection. *Studia Linguistica*

47.1 3-31.

- Kayne, R. 1994. *The Antisymmetry of Syntax*. Cambridge, MA: MIT Press.
- Kayne, R. 1996. *Microparametric syntax: some introductory remarks*. *Microparametric Syntax and Dialectic Variation*, ed. by J. R. Black and V. Motopanyane, ix-xviii. Amsterdam/ Philadelphia: John Benjamins.
- Kester, E. 1993. *The Inflectional Properties of Scandinavian Adjectives*. *Studia Linguistica* 47.2 139-153
- Kidwai, A. 1995. *Binding and Free Word Order Phenomenon in Hindi and Urdu*. Delhi: Jawaharlal Nehru University dissertation. Forthcoming from Oxford University press.
- Kidwai, A. 1996. *Word Order and Focus Position in Universal Grammar*. Talk presented at the Department of Phonetics and Linguistics, University College London.
- Klaiman, M. 1981. *Volitionality and Subject in Bengali: A study in semantic parameters in grammatical processes*. Bloomington: Indiana University Linguistics Club.
- Kratzer, A. 1994. *The event argument and the semantics of voice*. Cambridge, MA: MIT, ms.
- Laka, I. 1993. *Unergatives that Assign Ergative*. *Papers on Case and Agreement I*. MIT Working Papers in Linguistics 18, ed. by J.D. Bobaljik and C. Phillips, 149-172. Cambridge, MA: MIT.
- Lamarque, J. 1996. *Aspectual deicticity*. *Chicago Linguistic Society* 32. The Main Session, ed. by L.M. Dobrin, K. Singer and L. McNair, 207-224.
- Lapointe, S. 1993. *Dual lexical categories and the syntax of mixed category phrases*. *Proceedings of the Eastern State Conference on Linguistics*. Cornell Working



Papers in Linguistics, 199-210. Ithaca: Cornell University.

- Larson, R. 1985. Bare-NP Adverbs, *Linguistic Inquiry* 16 595-621.
- Lebeaux, D. 1986. On the interpretation of derived nominals. *Proceeding of Chicago Linguistic Society Meeting 22*, ed. by A.M. Farley, P. Farley, and K-E. McCullough, 231-247.
- Lecarme, J. 1996. Tense in the nominal system: the Somali DP. *Studies in Afroasiatic Syntax*, ed. by J. Lecarme, J. Lowenstamm and U. Shlonsky, 159-178. The Hague: Holland Academic Graphics.
- Lees, R. 1960. *The Grammar of English Nominalizations*. The Hague: Mouton.
- Lehman, P. 1974. *Proto-Indo-European Syntax*. Austin and London: U of Texas Press
- Levin, B. and M. Rappaport. 1995. *Unaccusativity at the Syntax-Lexical Semantics Interface*. Cambridge, MA: MIT Press.
- Löbel, E. 1989. Q as a functional category. *Syntactic Phrase Structure Phenomena in noun phrases and sentences*, ed. by C. Bhatt, E. Löbel and C. Schmidt, 133-157. Amsterdam: John Benjamins.
- Longobardi, G. 1994. Reference and Proper Names: A Theory of N-movement in *Syntax and Logical Form*. *Linguistic Inquiry* 25.4 609-665.
- Ludlow, P. and S. Neale 1991. Indefinite descriptions: in defence of Russell. *Linguistics and Philosophy* 14 171-202.
- Mahajan, A. 1989. Agreement and agreement phrases. *MIT Working Papers in Linguistics* 10, ed. by A. Mahajan and I. Laka, 217-252. Cambridge, MA: MIT.
- Mahajan, A. 1990. *The A/A-bar Distinction and Movement Theory*. Cambridge, MA: MIT dissertation.
- Mahajan, A. 1994. The ergativity parameter: *have-be* alternation, word order and split

- ergativity. Proceedings of NELS 24, ed. by M. Gonzalez. Amherst, MA: GLSA, University of Massachusetts.
- Mahajan, A. 1997. Rightward scrambling. Rightward Movement, ed. by D Beerman, D. Leblanc, H. van Riemsdijk, 185-213. Amsterdam: John Benjamins.
- Mallén, H. 1997. A Minimalist Approach to Concord in Noun Phrases. *Theoretical Linguistics* 23.1-2 49-77
- Manzini, R. 1996. Syntactic dependencies and their properties. *Studies on Universal Grammar and Typological Variation*, ed. by A. Alexiadou and T. Alan Hall. Berlin: De Gruyter.
- Manzini, R. 1998. A Minimalist Theory of Weak Islands. *Syntax and Semantics: The Limits of Syntax* 29, ed. by Peter W. Culicover and Louise McNally, 185-207. San Diego, CA: Academic Press
- Manzini, R. and A. Roussou. 1997. A minimalist theory of A-movement and control. London and Bangor: University College London and University of Wales, ms.
- Marácz, L. 1989. Asymmetries in Hungarian. Groningen: University of Groningen dissertation.
- Marantz, A. 1997. No escape from syntax: don't try morphological analysis in the privacy of your own lexicon. *UPenn Working Papers in Linguistics* 4.2. Proceedings of the 21<sup>st</sup> annual Penn linguistics colloquium, ed. by A. Dimitriadis, L. Siegal et al., 201-225.
- May, R. 1985. *Logical Form*. Cambridge, MA: MIT Press.
- McCloskey, J. 1996. Subjects and subject positions in Irish. *The Syntax of Celtic Languages: A comparative Perspective*, ed. by R. Borsley and I. Roberts, 241-283. Cambridge: Cambridge University Press.

- McGinnis, M. 1995. Fission as feature-movement. *Papers on Minimalist Syntax*. MIT Working Papers in Linguistics 27, ed. by R. Pensalfini and H. Ura. 165-188. Cambridge, MA: MIT.
- Milsark, G. 1974. *Existential Sentences in English*. Cambridge, MA: MIT dissertation.
- Miyagawa, S. 1988. Numeral quantifiers and thematic relations. *Structure and Case Marking in Japanese*. *Syntax and Semantics* 22, ed. by S. Miyagawa, 19-84. New York: Academic Press.
- Miyagawa, S. 1993. Case Checking and Minimal Link Condition. *Papers on Case and Agreement II*. MIT Working Papers in Linguistics 19, ed. by C. Phillips and J.D. Bobaljik, 213-254. Cambridge, MA: MIT.
- Moro, A. 1997. *The raising of predicates*. Cambridge: Cambridge University Press.
- Murasugi, K. 1992. *Crossing and Nesting Paths: NP Movement in Accusative and Ergative Languages*. Cambridge, MA: MIT dissertation.
- Nakamura, A. 1994. On the tense system in Japanese. *Japanese Korean Linguistics*, ed. by N. Akatsuka, 363-378. Stanford, CA: CSLI.
- Nash, L. and A. Rouveret. 1997. Proxy Categories in Phrase Structure Theory. *NELS* 27, ed. by K. Kusumoto, 287-304. Montreal: McGill University.
- Paparotte, W. 1988. A discourse perspective on tense and aspect in standard Modern Greek and English. *Topics in Cognitive Linguistics (Current Issues in Linguistic Theory 50)*, ed. by B. Rudzka-Ostyn, 447-505. Amsterdam and Philadelphia: John Benjamins.
- Parsons, T. 1990. *Events in the Semantics of English*. Cambridge, MA: MIT Press.
- Partee, B.H. 1987. Noun phrase interpretations and type shifting principles. *Studies in Discourse Representation Theory and the theory of Generalized Quantifiers*, ed.

- by J. Groenendijk, D. De Jongh, and M. Stokhof, 115-143. Dordrecht: Foris.
- Perlmutter, D. 1978. Impersonal Passives and the Unaccusative Hypothesis. Berkely Linguistic Society 4. 157-189.
- Peterson, W. 1930. The inflection of Indo-European person nouns. Language 6 164-193.
- Peterson, J. M. 1997. Grammatical relations in Pali and the Emergence of Ergativity in Indo-Aryan. München: Lincom Europa.
- Pollock, J-Y. 1989. Verb movement, universal grammar and the structure of IP. Linguistic Inquiry 20 365-424.
- Postal, P. 1969. On so called 'pronouns' in English. Modern Studies in English, ed. by D. Reibel and S. Schane, 201-224. Englewood Cliffs, NJ: Prentice-Hall.
- Postal, P. 1986. Studies of Passive Clauses. Albany, NY: State University of New York Press.
- Pullum, G. 1991. English nominal gerund phrases as noun phrases with verb phrase heads. Linguistics 29 763-799.
- Reuland, R. 1983. Governing *-ing*. Linguistic Inquiry 14.1 101-136.
- Richards, N. 1997. What Moves Where When in Which Language? Cambridge, MA: MIT dissertation.
- Rijkhoff, K. 1990. Explaining Word Order in the Noun Phrase. Linguistics 28 5-42.
- Ritter, E. 1988. A Head movement Approach to Construct-State Noun Phrases. Linguistics 26 909-929.
- Ritter, E. 1991. Two functional categories in noun phrases: evidence from modern Hebrew. Perspectives on Phrase Structure: Heads and Licensing. Syntax and Semantics 25, ed. by S. Rothstein, 37-62. San Diego, CA: Academic Press.

- Rizzi, L. 1990. *Relativized Minimality*. Cambridge, MA: MIT Press.
- Roberts, I and A. Roussou. 1997. *Interface interpretation*. University of Stuttgart and University of Wales, ms.
- Rochemont, M.S. 1986. *Focus in Generative Grammar*. Amsterdam: John Benjamins.
- Rochemont, M.S. 1998. Phonological focus and structural focus. *The Limits of Syntax. Syntax and Semantics 29*, ed. by P. W. Culicover and L. McNally, 337-364. San Diego: Academic Press
- Rooth, M. 1985. *Association with Focus*. Amherst: University of Massachusetts dissertation.
- Ross, J. 1973. Nouniness. *Three dimensions of linguistic theory*, ed. by O. Fujimura, 137-257. Tokyo: TEC Company.
- Rouveret, A. 1991. Functional categories and agreement. *The Linguistic Review* 8 353-387.
- Saito, M. 1992. Long distance scrambling in Japanese. *Journal of East Asian Linguistics* 1 69-118.
- Santelmann, L. 1993. The distribution of double-determiners in Swedish: Den support in D<sup>0</sup>. *Studia Linguistica* 47.2 154-176.
- Schachter, P. 1976. A non-transformational account of gerundive nominals in English. *Linguistic Inquiry* 7.2 205-241.
- Shah, A. 1995. *Complement Clauses in Hindi and Gujarati*. Hyderabad: University of Hyderabad dissertation.
- Shah, A. and T. Bhattacharya. (forthcoming). Weak deixis and possessive inside the DP. Leiden: *Proceedings of ConSOLE 7*.
- Sheilds, K. 1994. The role of deictic particles in the IE personal pronoun system. *Word*

- Shlonsky, U. 1991. Quantifiers as functional heads: A study of quantifier float in Hebrew. *Lingua* 84 159-180.
- Sigurdsson, H.A. 1993. The Structure of Icelandic Noun Phrases. *Studia Linguistics* 47.2 177-197.
- Siloni, T. 1991. Noun raising and the structure of noun phrases. MIT Working Papers in Linguistics 14, ed. by J.D. Bobaljik and T. Bures, 255-270. Cambridge, MA: MIT.
- Siloni, T. 1997. Noun Phrases and Nominalizations. *The Syntax of DPs*. Dordrecht: Kluwer.
- Snyder, W. 1998. On the aspectual properties of english derived nominals. *The Interpretive Tract*. MIT working Papers in Linguistics 25, ed. by U. Sauerland and O. Percus, 125-139. Cambridge, MA: MIT.
- Sportiche, D. 1988. A Theory of Floating Quantifiers and its Corollaries for Constituent Structure. *Linguistic Inquiry* 19 425-449.
- Srivastav, V. 1991. Wh dependencies in Hindi and the theory of grammar. Ithaca, NY: Cornell University dissertation.
- Svenonius, P. 1993. Selection, adjunction, and concord in the DP. *Studia Linguistics* 47.2 199-220.
- Szabolcsi, A. 1981. The possessive construction in Hungarian: A configurational category in a non-configurational language. *Acta Linguistica Academiae Scientiarum Hungaricae* 31 261-289.
- Szabolcsi, A. 1983. The possessor that ran away from home. *The Linguistic Review* 3 89-102.

- Szabolcsi, A. 1987. Functional categories in the noun phrase. *Approaches to Hungarian* 2, ed. by I. Kenesei, 167-190. Szeged: JATE.
- Szabolcsi, A. 1994. The Noun Phrase. *The Syntactic Structure of Hungarian. Syntax and Semantics* 29, ed. by F. Keifer and K.E. Kiss, 179-274. San Diego: Academic Press.
- Tang, C.-C. J. 1990. A Note on the DP Analysis of the Chinese NP. *Linguistics* 28 337-354.
- Taraldsen, T. 1990. D-projections and N-projections in Norwegian. *Grammar in progress: Glow essays for Henk van Reimsdijk*, ed. by J. Mascaro and M. Nespors, 419-431. Dordrecht: Foris.
- Tenny, C. 1987. *Grammaticalizing Aspect and Affectedness*. Cambridge, MA: MIT dissertation.
- Uriagareka, J. 1996. Warps: Some Thoughts on Categorization. *ZAS Papers in Linguistics* 5, ed. by A. Alexiadou, N. Fuhrhop, P. Law and S. Dohken, 119-158.
- Uriagareka, J. 1997. Formal and Substantive Elegance in the Minimalist Program (On the Emergence of Some Linguistic Forms). *The Role of Economy Principles in Linguistic Theory*, ed. by M. Bierwisch, H. M. Gaertner and C. Wilder, 170-204. Berlin: Akademie Verlag.
- Uriagareka, J. 1998. *Rhyme and Reason. A Minimalist Dialogue on Human Language*. Cambridge, MA: MIT Press.
- Uriagareka, J. 1999. Multiple Spell-Out. *Working Minimalism*, ed. by N. Hornstein and S. Epstein, Cambridge, MA: MIT Press.
- Valois, D. 1991. *The Internal Syntax of DP*. Los Angeles, CA: University of California dissertation.

- van Hout, A. 1992. On the role of aspect in the lexicon (Linking activity verbs).  
Proceedings of the 2nd Computational Lexical Semantics Seminar, Toulouse.
- van Hout, A. and T. Roeper. 1998. Events and aspectual structure in derivational morphology. Papers from the UPenn/MIT Roundtable on Argument Structure and Aspect. MIT Working Papers in Linguistics 32, ed. by H. Harley, 175-200.  
Cambridge, MA: MIT.
- Vendler, Z. 1967. *Linguistics in Philosophy*. Ithaca, NY: Cornell University Press.
- Verkuyl, H. 1972. *On the Compositional Nature of the Aspects*. Dordrecht: Reidel.
- Vikner, C. 1994. Change in homogeneity in verbal and nominal reference. Tense, aspect and action: empirical and theoretical contributions to language typology (Empirical Approaches to Language 12), ed. by C. Bache, H. Basbøll and C-E. Lindberg. 139-164. Berlin and New York: Mouton de Gruyter.
- Watanabe, A. 1995. The conceptual basis of cyclicity. *Papers on Minimalist Syntax*. MIT Working Papers in Linguistics 27, ed. by R. Pensalfini and H. Ura. 269-291.  
Cambridge, MA: MIT.
- Weir, C.E. 1986. *English Gerundive Constructions*. Austin, TX: University of Texas dissertation.
- Williams, E. 1981. On the notions 'lexically related' and 'head of a word'. *Linguistic Inquiry* 12 245-274.
- Williams, E. 1991. Meaning categories of NPs and sentences. *Linguistic Inquiry* 22.3 584-587.
- Wiltschko, M. 1995. *IDs in Syntax and Discourse. An Analysis of Extraposition in German*. University of Wein dissertation.
- Yang, C. 1997. *Minimal computation: derivations of syntactic structures*. Cambridge,



MA: MIT, Artificial Intelligence Laboratory, MSc thesis.

Yoon, J. 1996. Nominal gerund phrases in English as phrasal zero derivations.

Linguistics 34 329-356.

Zamparelli, R. 1996. Syntactic Layers and Semantic Interpretations in the Noun Phrase.

Paper presented at the Inside NP conference in DIPSCO, Milan.

Zanuttini, R. 1997. Negation and Clause structure. Oxford: Oxford University Press.

Zwart, J-W. 1993. Dutch Syntax. Groningen: University of Groningen dissertation.

Zwicky, A. 1985. Heads. Journal of Linguistics 21 1-29.