

Jack Migwambo

Wireless Patient Monitoring Over The 4G Network

Helsinki Metropolia University of Applied Sciences

Bachelor of Engineering

Information Technology

Thesis

27/04/2016

Author(s) Title	Jack Migwambo Wireless Patient Monitoring Over the 4G Network
Number of Pages Date	55 pages 27 th March 2016
Degree	Bachelor of Engineering
Degree Programme	Information Technology
Specialisation option	Telecommunications
Instructor(s)	Dr. Tero Nurminen, Supervisor
<p>The purpose of this thesis is to explain how remote patient monitoring systems work over the 4G network using wearable sensors and corresponding interface devices. Gathered data from the sensing devices are carried over the Monitoring Wireless Sensor Network to the more elaborate 4G Network where the data is then relayed to the interface devices for reading, storage, interpretation and effective utilization.</p> <p>This thesis describes the underlying technologies and principles of sensors and sensor networks, the concept of the 4G Network and how it integrates with the sensor network.</p> <p>The goal of Wireless Patient Monitoring over the 4G Network is link the spatial gap that exist between Healthcare and ICT, this will in turn enhance patients care efficiency while Cutting costs, maximising profits and increase security while monitoring patients.</p> <p>This thesis is important in that it gives the reader an overview and basic idea of how Wireless patient monitoring system works over the 4G Network. Increasing number of ICT firms, Healthcare and medical institutions are investing heavily on remote patient monitoring systems technologies and this thesis provides the reader the insight of how such systems work and how they can be implemented.</p>	

Keywords	4G , LTE, WiMAX, ZigBee

Contents

1	Introduction	1
2	The 4G Network	4
2.1	Evolution of Wireless Mobile Communications	5
2.2	4G Enabling Technologies	6
2.2.1	Multicarrier Modulation and Multiple Access	6
2.2.2	Multuser Diversity and Scheduling	7
2.2.3	Adaptive Coding and Modulation	7
2.2.4	Frequency Reuse	8
2.2.5	Wideband Transmissions	8
2.2.6	Multiple Antenna Techniques	8
2.2.7	Relaying	8
2.2.8	Femtocells	9
2.2.9	Coordinated Multipoint Transmissions	9
2.2.10	Power Management	10
2.2.11	Inter-Technology Handovers	10
2.3	System and Network Architecture	11
2.3.1	WiMAX	12
2.3.2	LTE and LTE-Advanced	13
3	Sensors and Underlying Technologies	16
3.1	Sensor Characteristics	18
3.1.1	Transfer Function	18
3.1.2	Sensitivity	19
3.1.3	Linearity	19
3.1.4	Span	20
3.1.5	Accuracy	20
3.1.6	Hysteresis	20
3.1.7	Bandwidth	20
3.1.8	Resolution	21
3.1.9	Noise	21

3.2	Sensing Principles	21
3.3	Sensor Electronics	23
3.4	Microelectromechanical Systems	25
3.5	Radio Frequency Sensing	27
4	Wearable Health Technology	29
4.1	Attributes of Health Wearable	30
4.2	Types of Healthcare Wearable	31
4.2.1	Heart rate sensors	32
4.2.2	ECG sensors	33
4.2.3	Inertial Sensors	33
4.2.4	Smart Vests	33
4.2.5	PPG Sensors	34
4.2.6	GSR Sensors	35
4.2.7	Implantable Health Wearable	35
4.3	Future of Wearable Health Technology	36
5	Monitoring Sensor Network	37
5.1	Wireless Sensor Networks	38
5.2	Components of Monitoring Sensor Networks	38
5.2.1	Sensor Nodes	39
5.2.2	Networking Infrastructure	40
5.2.3	Base Station Sink	40
5.2.4	Computing Resources	40
5.3	Features and Requirements of Health MSN	41
5.4	Health MSN Operating Principles	43
5.5	4G Gateway Integration Principles	44
5.6	Typical monitoring using Ring Sensor	46
6	Conclusion	48
	References	49

1 Introduction

Wireless Patient Monitoring over the 4G is an elaborate system in which a number of sensing apparatus are deployed onto the human body to monitor electrophysiological signals. The signals collected by are sent to collection sensor nodes which in turn relay the data to the larger 4G network through a gateway. The sensors, sensor nodes make up a small network of wireless sensors called a wireless sensor network. The 4G network assists in quick transmission of data. This system enables medical staff who are the primary care givers to be aware of patients Health conditions and wellbeing without physical interaction. The ability to monitor patients wirelessly without physical interaction is referred to as remote monitoring.

Medical and Healthcare Institutions have made concerted efforts to be at the forefront of technology. A lot of financial resources and time have been exhausted in medical research in the hope of developing new pharmaceuticals, hospital equipment and apparatus. These avenues have led better qualities of life but the cost of such undertakings has been exorbitant. For several years, the medical and healthcare sector has been reluctant in embracing Information Technology and this has been to the detriment of the whole sector. The health sector is the biggest sector in any particular country and several governments allocate a lot of money for its operation. Studies and research show that Remote Patient monitoring helps save cost and time. A study taken by an economist Robert Litan for Brookings Institution deduced that wireless monitoring technologies had the potential to cut costs to the tune of 197 billion dollars in the next two decades in the United States alone. Cost and time saving is of essence especially when dealing with chronic diseases. The old traditional way of having routine check-ups at the hospital are expensive, time consuming and somewhat inconvenient for the parties involved. Remote monitoring devices speed up the treatment of patients requiring medical intervention due to the 24 hour electronic data transition monitoring. Rather than getting to wait for patients to find out there is a complication, the wearable detect and identify deteriorating health conditions in real-time and alert the medical personnel through the network. [9]

The advancement in technology over the past two decades has made it possible for the sophistication of Healthcare applications, apparatus and equipment. Interest in wireless medical application systems has been rapidly increasing majorly because of the advantages it has over the wired systems, such as low cost of care delivery, enhanced mobility, ease of use, reduce patient discomfort, reduced risk of infection and failure. Remote patient monitoring systems opens possibilities and new avenues for modern applications and paraphernalia in the Healthcare and medical market [7].

The Healthcare and medical industry and market is by far the largest in any particular country and always characterised by a lot of congestion due to vast number of patients that need medical attention and care. Monitoring over the 4G Network helps alleviate this problem by using a combination of sensors elements placed on the body, sensor nodes that communicate with the body sensors and then relays the gathered data to a base station (BS) sink which is a part of a wireless monitoring sensor network. The BS sink is integrated to the 4G Network which communicates the data over longer distances. User Interface devices such as mobile phones, computers or monitors are used to display, read, analyses, interpret and utilize the data appropriately. Sensing apparatus and devices worn on the body as wearable include heart rate sensors, pulse oximeters, inertial sensors, blood pressure and enzyme monitoring devices are all attached to the body wirelessly thereby liberating the old wire systems that made patients bed bound. Patients can therefore easily moved when need be without necessarily interfering with the monitoring process. [6]

Wireless patient monitoring is significant and a gateway for elevated Healthcare monitoring systems. The system permits the augmented freedom for patients to move around, reduce demand for hospital stays and contact care services. In addition it also enhances the ability to manage and control situations despite the spatial gap for example it is possible to avoid, detect and manage accidents or emergencies. [21,562].

Wireless patient monitoring over the elaborate 4G network is even more essential especially when it comes to continuous monitoring scenarios. A particular set of patients need more medical attention and monitoring. Wireless Monitoring over the 4G is therefore necessary in such cases.

The patients that suffer from the following set of diseases require continuous monitoring [28, 5]:

- **Chronic diseases:** Real-time management is important especially for cardiovascular diseases (CVDs). Diabetic patients need to monitor their blood glucose levels and adjust their insulin intake to proper levels. With the help of remote monitoring devices, patients can record their glucose levels away from the hospital and electronically transmit the data to their healthcare providers.
- **High risk pregnancy care:** During the later stages of a pregnancy, the health condition of a mother and the unborn child should be monitored at regular intervals. Vitals like maternal and foetal heart rate, uterine movements need to be continuously monitored without necessarily having frequent hospital visits.
- **Elderly care:** Most European countries such as Finland have a high demographic of ageing and elderly people. As such, they stand a greater chance of benefiting and cutting costs with implementation of remote monitoring systems for the elderly. This will help reduce the number of people and running cost at the elderly homes and hospitals as the service can be administered from the comfort of their homes.
- **Neurological Diseases:** Diseases such as stroke, Parkinson's disease are amongst the major causes of disability. Neurological rehabilitation offers therapeutic exercises that help in restoring motor functions. MEMS inertial sensors such as accelerometers (ACCs) and gyroscopes are remotely adopted in monitoring and enhancing motor activities. [18]
- **Post-operative care:** Patients can leave the medical facilities early while still their health parameters being remotely monitored by the medical staff.

2 The 4G Network

In order to understand how Wireless Patient Monitoring is done over the 4G Network, a basic understanding of the 4G Network itself is necessary. The monitoring system is primarily made up of the Sensor Network and the 4G Network. The Sensor Network consists of sensors, sensor nodes and a BS sink. Sensors and sensor nodes are in constant communication with each other. The Sensor Network is discussed in later chapters. The 4G network is the future of mobile communication and as such it is important in the implementation of the wireless patient monitoring for long-term benefits.

In most terms, 4G is the label given to the fourth generation of wireless technology developed and standardized by the 3rd Generation Partnership Project (3GPP). 4G was introduced to provide wide area network for internet access. It is an evolution and successor to the 1G, 2G and 3G mobile networks. It offers relatively; high data rates, internet speeds of up to 100 Mbps download speeds, 50 Mbps upload speeds for LTE and 128 Mbps and 56 Mbps for WiMAX are realised respectively. Due to low latency the network is able to exhibit faster reaction times and stable connections even in low coverage areas.

Mobile communication has become an integral part of communication in today's world and just over a four billion mobile devices currently in use in 2016. Mobile communication technologies have evolved from expensive technologies for selected few individuals to the now ubiquitous system utilised by majority of the human population. The 3GPP is the global standards developing organization charged with the responsibility of developing mobile technologies.

4G is any wireless mobile communication technology that adheres to the International Mobile Telecommunications Advanced (IMT-Advanced) set of requirements that was developed and published in early 2008 by The International Telecommunication Union Radiocommunication Sector (ITU-R).

The ITU-R requirements for IMT-Advanced were to enable [11, 9-10]:

- Peak data rate support of 100 Mbps for high mobility and up to 1 Gbps peak data rate for low mobility case
- Inter-working and Compatibility with other radio systems

- High quality cellular services
- Universal roaming capability
- Flexibility for cost efficient support of wide range of service and applications
- Cell spectral efficiency, 3 bits/Hz/cell in indoor downlink to 0.7 bits/Hz/cell in high speed uplink scenarios
- Peak spectral efficiency, up to 15 bits/s/Hz
- Bandwidth scalability, 40 MHz up to 100MHz
- Mobility support, up to 350 kmph
- Latency requirements for control plane to achieve 100 ms transition time between idle and active state, and 10 ms user plane latency
- VoIP capacity, 30-50 users per sector/MHz
- Handover interruptions of 27.5 ms for intra-frequency case, and 40 and 60 ms for inter-frequency within the band and between bands

2.1 Evolution of Wireless Mobile Communications

Mobile communication technologies are classified into generations, that is, 1G, 2G, 3G and 4G. 1G was the analog mobile radio communication system that was used in the 1980s. Though seen as a breakthrough, it had disadvantages such as poor voice quality, poor battery life, poor handoff reliability leading to call drops, and enormous phone size. 2G or otherwise commonly referred to as Global System for Mobile (GSM) was the first digital mobile system. Its use came in the early 1990s in Europe, provided voice and limited data services. The primary data services offered were text messaging (Short message services, SMS) and circuit-switched data services at a peak of 9.6kbits/s. 2G limitations were poor transmission quality, inability to support complex data such as videos, abrupt dropped calls, low system capacity and limited coverage area by cell towers. 3G is the first mobile system handling broadband data. Some of the 3G shortcomings include high bandwidth requirement and high spectrum licensing fees. [19, 1-2]

Table 1 below shows the various technologies that lead to the evolution of the different generations of mobile technology.

Table 1. Evolution of Cellular Technologies [31, 3]

Generation	Year	Network	Technology	Data
1G	Early 1980s	Circuit switched	TACS, AMPS	Analog Voice
2G	Early 1990s	D-AMPS, GSM, CDMA (IS-95)	D-AMPS, GSM, CDMA	Digital Voice
2.5G	1996	Circuit switched or Packet switched	GPRS, EDGE, EVDO, EVDV	Digital Voice + Data
3G	2000	Non-IP Packet switched/Circuit switched	WCDMA, CDMA2000	Digital Voice + High speed Data + video
4G	2012	IP based, Packet switched core network	Not finalized	Digital Voice, High speed Data, Multimedia, Security

From Table 1 we see that 4G offers more when it comes to data communications thereby making it suitable for wireless continuous monitoring systems due to high speed data communications. The various limitations in the 1G, 2G and 3G generations of Mobile communication technologies and the need to overcome them lead to the development of the 4G technology. 4G is still a developing technology with various update recommendations being submitted to IMT-Advanced by standards developing bodies.

2.2 4G Network Enabling Technologies

The 4G enabling technologies are basically the ITU-R requirements for IMT-Advanced networks. These technologies aim to take advantage of advances at the core network and access levels.

2.2.1 Multicarrier Modulation and Multiple Access

IMT-Advanced requirements mandate that the utilized multiple access technologies to have backwards compatibility with IMT-2000 systems. Contention and contention-free multiple access are also supported to allow for different services. For interference control, FR is supported. For heterogeneity accommodation in various regions of the world,

Time Division Duplex (TDD) and Frequency Division Duplex (FDD) duplexing schemes are supported alongside half and full duplex FDD. [38, 20]

LTE-Advanced and WiMAX use multicarrier techniques such as Orthogonal Frequency Division Multiplexing (OFDM), Single-Carrier FDMA (SC-FDMA) and Orthogonal Frequency Division Multiplexing Access (OFDMA). WiMAX uses OFDMA in both uplink and downlink while LTE-Advanced uses OFDMA for downlink and SC-FDMA for uplink.

Multicarrier access techniques are important because of their robust communication and stable interference management. They also facilitate fractional FR and exploitation of multiuser diversity at smaller fragments compared to CDMA- based networks. System throughput is enhanced by alleviating frequency selective randomness (frequency selective fading). [31, 20]

2.2.2 Multiuser Diversity and Scheduling

Wireless channels are susceptible to random fluctuations resulting from diffraction, underlying scattering and reflection phenomena. To negate these effects, exploitation of these phenomena is done to enhance system communication. This is done by allocating resources to users with good channel quality. Continued and uninterrupted acquisition of Channel State Information (CSI) for all users is also required. [31, 23]

Exploitation of multiuser diversity by carefully scheduling the user is a system of achieving efficient resource allocation. Scheduling method that solely depends on CSI is an unfair strategy since a section of users may experience bad channel conditions for extended periods of time. Ignoring CSI of users and allocating them equal access to shared resources is a fair strategy that only allows fairness in resource allocation but not in quality of delivered services.

2.2.3 Adaptive coding and Modulation

Adaptive coding and modulation (ACM) is a dimension in which CSI variations are used. Instead of allocating or depriving access to the resources based on CSI, ACM fine tunes the transmission parameters based on the CSI. Benefits of ACM and multi-

user diversity does not need full or even instantaneous CSI in order to attain the full potentials of the channel. [31, 23]

2.2.4 Frequency Reuse

Mobile networks tackle interference capacity trade-off. Permitting every cell to use all the available spectrum bands raises the overall system capacity and simultaneously Interference experience is raised by the cell-edge users to intolerable levels. As a result, QoS (Quality of Service) requirements of users will not be guaranteed thereby compromising the overall system fairness. Frequency reuse (FR) is therefore used to strike a balance between these different setups. The set of available bands in FR is equally divided between a few neighbouring cells (cluster) and consequently the system capacity is kept at acceptable levels while the inter-cell interference is significantly reduced. [31, 24]

2.2.5 Wideband Transmissions

Enabling Wideband transmissions exploits the flexible spectrum allocations of OFDMA and SC-FDMA systems. Carrier aggregation also enables compatibility with 3G networks. [31, 25]

2.2.6 Multiple Antenna Techniques

The uses of multiple transmit and multiple receive antennas which are commonly referred to as Multiple Input and Multiple Output (MIMO) techniques. MIMO techniques are prominent capacity and reliability enhancement technology for most wireless communication standards such as LTE and WiMAX. [31, 27]

2.2.7 Relaying

MIMO techniques can be utilized at the Base Station side while the Mobile Station options are limited. Cooperative diversity, a cooperative communication technique is used to bring MIMO virtues to MSs especially at cell-edge. With these techniques, single-

antenna MS can enjoy MIMO benefits through mutually relaying their signals to the BS. The co-operation overcomplicates the processing at the Base Station as well as causing significant reduction in the MSs Battery lives. Relay stations (RSs) are proposed as the ultimate solutions to replace the user cooperation. RSs have low processing power thereby making them cheaper than the BSs and as a result they are used to; increase coverage area, reduce transmission range from and to the MSs thereby increasing their achievable throughputs by increasing their signal to noise ratio (SNRs). RSs access the network backbone through the BSs therefore careful resource allocation methods are needed. RSs therefore provide lower operational expenditure (OPEX) and Capital expenditure (CAPEX) option that allows faster roll-out and flexible configuration. [31, 29]

2.2.8 Femtocells

With RSs, the mobile network enhances the communication experience of its users by shortening their transmission distances. The upside to this is that the overall traffic system remains the same since RSs communicate directly with the BSs. Femtocells can therefore be used to reduce this traffic while reducing the transmission range to and from the MSs. [31, 30]

A femtocell is literally a small home BS operating in the conventional licensed cellular bands but with; short range, a low cost and a low transmit power specifications.

2.2.9 Coordinated Multipoint Transmissions

Coordinated multipoint transmission (CoMP) refers to a family of techniques through which the Uplink and/or the Downlink transmissions can be simultaneously managed by multiple neighbouring BSs. The interface-limited performance of cell-edge users is an unavoidable occurrence for the previous generations of cellular networks due to inherent per-cell processing. CoMP offers radical shift in cell-centric processing. [31, 33]

CoMP exploits inter-cell interference thereby establishing a distributed multiple antenna system. It is possible for MSs to take advantage of consistent performance and QoS when they access and share high-bandwidth services regardless of their remoteness

from the BS by coordinating and combining signals from multiple BSs. CoMP techniques improve the cell coverage; enhance the cell-edge throughput, and overall system efficiency. [31, 34]

Some of the common features of CoMP include [31, 34-35]:

- Interference Cancellation
- Single Point Feedback and Single point Reception
- Multichannel Feedback and Single Point Reception
- Multichannel Feedback and Multipoint Reception
- Inter-cell MIMO

2.2.10 Power Management

A lot of emphases are put on power management in the IMT-advanced requirements in an attempt to minimise the MS power demands. Replacement of OFDMA by SC-OFDMA in LTE-Advanced UL was made to improve the efficiency of the MS power amplifier. Coverage enhancement technologies such as RSs, femtocells and CoMP tend to minimise the UL power consumption. [31, 36]

2.2.11 Inter-Technology Handovers

Convergence to an all-IP wireless infrastructure coupled with advances in supporting IP mobility have all made possible the interworking of various access technologies. Possibility of multimodal devices to maintain session while traversing various access technologies is a key benefit. Both standardization bodies along with 3GPP2 have defined extensive signalling mechanisms to support both interworking and inter-technology handovers at both radio interface and core level. The IEEE 802.21 working group defines extensible media access mechanisms to facilitate handovers between IEEE 802 based networks and mobile networks and to maximise handovers between heterogeneous media. [31, 36]

2.3 System and Network Architecture

4G technology has two main standards for mobile communication that is WiMAX and LTE. The evolved 4G system consist of radio and core network. By standard the core side of the network is called Evolved Packed Core (EPC) and is also used to be called System architecture Evolution (SAE) in the beginning of standardization. EPC is an all IP architecture that supports inter-communication between 3GPP and non-3GPP based systems.

The eNodeB serves as the radio access system providing the management of the air-link to the user equipment (UE). The eNodeB uses S1-MME control plane interface to communicate with mobility management entity (MME). The eNodeB connects to one or more MME for control plane management. The eNodeB uses the S1-u interface as the user plane interface to transport both the voice and data to the serving gateway (S-GW), the X2 interface on the other hand is used between the eNodeB systems. Figure 1 Shows the network architecture of the LTE/EPC.

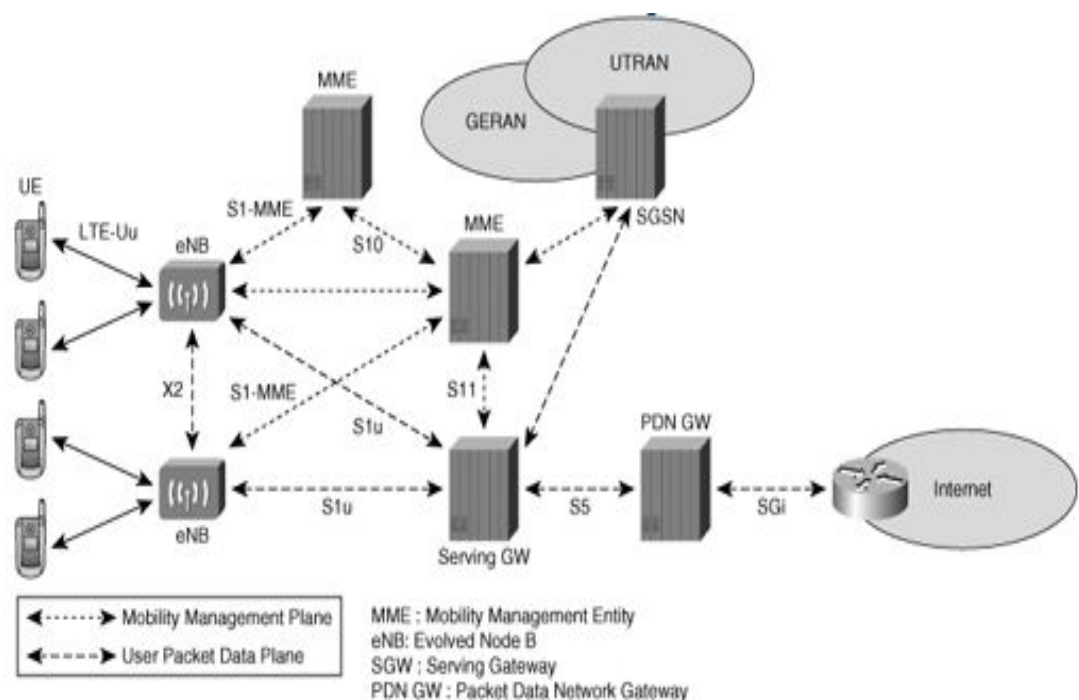

Figure 1. LTE/EPC Architecture [30]

The architecture provides native IP interfaces for transport of the control plane and user plane between all three entities. This all IP network infrastructure provides a flattened infrastructure in the Radio Access Network (RAN). The control plane is decoupled from the user plane by separating the functions in the MME and S-GW respectively. The eNodeB, MME and S-GW provide more flexibility in managing mobility of the UE while maintain user plane connectivity. [30]

2.3.1 WiMAX

Worldwide Interoperability for Mobile Access (WiMAX) is an access technique that inherently uses IP networking technologies to deliver both fixed and mobile radio access services. WiMAX is an end-to-end all-IP wireless system designed to provide wide area mobile access to broadband IP services. 4G WiMAX network and functionalities are defined using the IEEE 802.16-2009 standard. IEEE response to IMT-Advanced requirements are detailed in IEEE 806.16m which is an upgrade from the 802.16-2009 standard. 806.16 standard describes various modes of operation with each befitting a specific use. On the other hand the 802.16-2009 standard only describes two modes of operation, that is, a mandatory point to point (PMP) and an optional multihop (MR). [31, 41]

Network entry capabilities allow Subscriber station (SS) and Mobile station (MS) to associate with other IEEE 802.16 access networks. Legacy systems also allow for handover and backward compatibility with other IEEE 802.16 systems such as ZigBee. This is the concept of Integration of 4G network to Wireless Sensor Networks and thus the basis of this literature. [31]

From figure 2; the subscriber station, the BS and the access service node gateway (ASN-GW) are the components of the WiMAX access system.

Figure 2 shows the WiMAX access system architecture

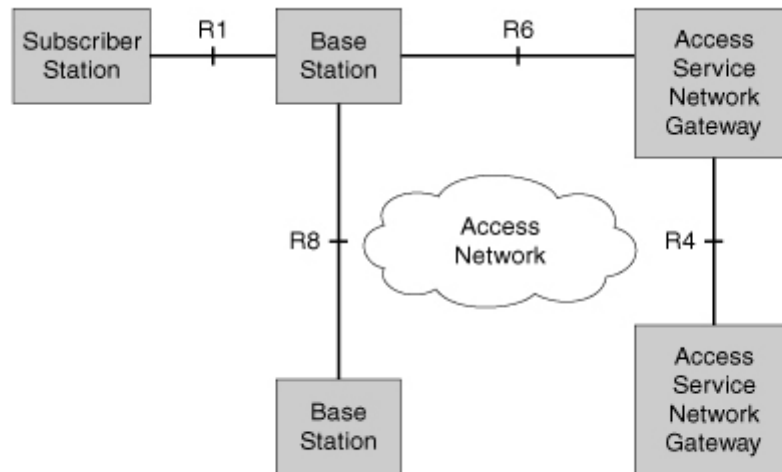

Figure 2. WiMAX Access system Architecture [30]

- R1 interface: corresponds to the IEEE 802.16-2005 specifications
- R8 interface: supports inter-BS communications in order to support fast and seamless handovers
- R6 interface: provides control and bearer plane connectivity between BS and ASN-GW. Control plane provides tunnel management with ability to modify, establish and release Generic routing encapsulation (GRE) tunnels between the BS and the ASN-GW
- R4 interface: supports mobility between different ASN-GW

2.3.2 LTE and LTE-Advanced

LTE is a system of mobile Data transmission entirely based on IP access system. It is the Evolved UMTS Terrestrial Radio Access Network (EUTRAN) and is part of 3GPP Release 8 completed in 2009. LTE supports S1-flex functionality for network redundancy, a single EUTRAN access system can therefore be parented to multiple EPC networks.

LTE's main objective is to provide high data rate, low latency and packet optimized radio access technology with flexible bandwidth deployments.

The following are some of the benefits of LTE [10]:

- High throughput: High data rates achieved by both downlink and uplink results in high throughput.
- Superior end-user experience: There is superior end-user experience due to optimized signalling for connection establishment and other air interface and mobility management procedures.
- Seamless Connection: LTE supports seamless connection to existing networks such as GSM, CDMA and WCDMA.
- Plug and Play: no manual installation of drivers is needed for the device. The system automatically detects the device and then loads new drivers for the hardware when need be and resumes functions with the newly connected device.
- FDD and TDD on the same platform: both schemes can be used on the same platform.
- Simple architecture: allows for low operating expenditure (OPEX)

LTE-Advanced on the other hand is the proposed upgrade of the EUTRAN under International Mobile Telecommunications Advanced (IMT-Advanced) standards. The process started in early 2008 when The International Telecommunication Union Radio-communication Sector (ITU-R) distributed circular calling for proposals for radio technologies that would meet requirements sets for a versatile radio technology that would pass for IMT-advanced technology. The 3GPP group responded to the circular with the release 10 LTE-Advanced and evaluation results of the achievable performance with LTE-Advanced.

LTE-Advanced requirements defined by 3GPP include [30]:

- Reduced control plane latency: this allows for transition from dormant power saving state in less than 10 ms.
- Increased peak rates: downlink peak rates of 1 Gbps and up-link rate of 500 Mbps are expected.
- Increased average spectrum efficiencies: this will include 2.4 bps/Hz in the downlink with 2x2 MIMO configurations and 3.7 bps/Hz with 4x4 MIMO configurations.
- Increased peak spectral efficiencies: these will support peak efficiencies of up to 30 bps/Hz in the downlink and 15 bps/Hz in the uplink.

The 3GPP has its own requirements for LTE-Advanced which are relatively tighter and strict than those of the IMT-Advanced.

4G networks are ideal in the implementation of wireless patient monitoring system in that the capability to provide seamless connection enables uninterrupted data connection due to backward compatibility to the previous generations of mobile networks such as 3G. As such, movements do not affect connections. In addition 4G provides high bandwidths of upto 100 Mbps thereby making data transfer quick.

3 Sensors and Underlying Technologies

A sensor is basically a device that converts a physical phenomenon into an electrical signal. A sensor receives stimuli from the surrounding and then gives out an electrical signal as a response. A sensor therefore is some kind of an energy converter. The principle of sensing itself is a particular case of information transfer in which energy is required in the transmission process. A sensor therefore represents the interface between the physical world and the world of electronic devices [1].

Sensors conform to two types; Direct and Complex sensors. Direct sensors convert stimuli into an electrical signal by use of a physical effect such as photo effect while Complex sensors needs additional transducers before an electrical signal can be generated. Sensors do not function in isolation; they are always part of larger systems that may include many other detectors, signal conditioners, signal processors, memory devices, data recorders, and actuators. Sensors are part of some particular kind of data acquisition system and are either intrinsic or extrinsic to the system it is assigned. Figure 3 shows a typical sensor architecture

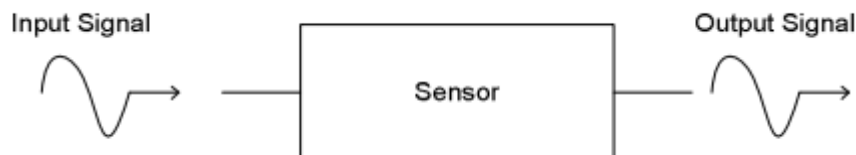

Figure 3. Basic sensor architecture [29]

By the response being an electrical signal, it means that the signal can be channelled, amplified, and modified by electrical devices. The output signal can therefore be in the form of voltage, current or charge. These can further be extrapolated in terms of amplitude, polarity, frequency, phase, or a digital code. Because of these output signals format, a sensor therefore comprises of input properties and electrical output properties. [8]

The sensor technology is a rapidly growing field that has a significant potential to improve the utility, serviceability, reliability, efficiency and operation of the Healthcare Industry in general [18]. Wearable sensors are advancements in sensors technology and as a result have had a huge impact on the Healthcare field. The human body is a constantly functioning system with numerous processes occurring constantly. The food and water we consume is used to run the immense body systems such as the digestive system, endocrine system, Immune system, nervous system, muscular system, reproductive system, respiratory system, skeletal system, urinary system, integumentary system and the lymphatic system. A single body system such as the respiratory system carries out numerous processes that require different foods, minerals and water. The body system is made up of basic living units called cells, several specialised cells make up body tissues and several specialised body tissues make up the organs, organs may link up together with tissues to make organ systems such as the blood vessels, veins and arteries. The organ systems make up the body systems such as the respiratory system which entails the heart, lungs, blood vessels, veins and arteries.

The human health is dependent on these body systems functioning smoothly and in harmony with each other. If or when any of these body systems, organ systems, organs, tissues functions are impaired, then the human health is at risk and urgent counter measures are needed for life to be sustained. The human body is constantly radiating data; for example, the heart pumps blood to the blood vessels that run throughout the entire body at an average rate of seventy-two times per minute, the average body temperature is 37°C , with years of research the chemical compositions of different body fluids are known. All these information and data can be constantly monitored and analysed so that informed decisions and adjustments can be made on human health. Wearable sensors and Biosensors can play an even advanced role in collection of these data and information.

Wearable sensors expand our abilities to be human; the sensors can be worn on the body like stick-patches or wrist-bands, or the sensor can be placed inside the body-like in the cases of pacemakers, heart pumps (Left Ventricular Assist Device), cochlea implants and several others.

3.1 Sensor Characteristics

In wearable sensors, the stimuli are not electrical in nature. The human body's physiological signals such as heartbeats, body temperatures, and galvanic skin response are parameters being measured as stimuli. The proceeding sections explain the various properties of sensors as well as their significance in the measuring of physiological signals of interest.

3.1.1 Transfer Function

The transfer function of a sensor basically shows the functional relationship between physical input signal and electrical output signal [1].

Figure 4 shows the transfer function of bitalino wireless ECG sensors.

TRANSFER FUNCTION

[-1.5mV, 1.5mV]

$$ECG(V) = \frac{\left(\frac{ADC}{2^n} - \frac{1}{2}\right) \cdot VCC}{G_{ECG}}$$

$$ECG(mV) = ECG(V) \cdot 1000$$

$VCC = 3.3V$ (operating voltage)

$G_{ECG} = 1100$ (sensor gain)

$ECG(V)$ – ECG value in Volt (V)

$ECG(mV)$ – ECG value in millivolt (mV)

ADC – Value sampled from the channel

n – Number of bits of the channel¹

Figure 4. Information from the Electrocardiography Sensor Datasheet [22]

A transfer function represent the relationship between stimulus \mathbf{s} and response electrical signal \mathbf{S} produced by the sensor. This relationship can be expressed as $\mathbf{S} = f(\mathbf{s})$. The stimulus \mathbf{s} is unknown while the output signal \mathbf{S} is known during measurement and it is basically a number representing the value of the stimulus \mathbf{s} . Sensors are attached

to measuring systems that unveils the value \mathbf{S} and unmask the value of \mathbf{s} from the measured value \mathbf{S} . The measurement system basically uses the inverse transfer function $F(\mathbf{S})$ to obtain the value of the stimulus \mathbf{s} . Every sensor has an ideal or theoretical input (stimulus)-output (response) relationship. A sensor ideally designed and fabricated with ideal materials by ideal designers working in an ideal environment using ideal tools and equipment, the output would represent true value of the stimulus [8].

3.1.2 Sensitivity

A sensor's sensitivity is classified in terms of the relationship that exist between input physical signal and the output electrical signal. It is essentially a ratio between small change in physical signal and may be expressed as the derivative of the transfer function with respect to physical signal. [1, 2]

Sensitivity expresses how much the sensor's output changes when the measured quantity changes. As such, Sensors that measure very small changes such as the human body's electrophysiological signals have high sensitivities. The introduction of MEMS technology allow for the manufacture of new advanced sensors in microscopic scale thereby enhancing their efficiency due to their high sensitivity capabilities. [33]

The sensitivity of the TEMD50000 photodiode used in the pulse oximetry ring sensor is 0.8 A/W at 950 nm according to the datasheet of the photodiode.

3.1.3 Linearity

Linearity of a sensor refers to the maximum deviation from a linear transfer function over the specified dynamic range. Linearity is a mathematical application with several measures. The common measure compares the actual transfer function to the "best straight line" which exist halfway between two parallel lines that surrounds the whole transfer function over the specified dynamic range of the sensor device. Consistency of use of a particular measure is recommended. Sensors with linear transfer function are convenient for use. [1, 3]

3.1.4 Span

Span refers to the extent of input physical signals that may be converted to electrical signal by the sensor. Signals that exist outside the span are expected to result in large inaccuracies that are unacceptable. The span is specified by the sensor supplier and performance characteristics detailed in the data sheets are expected to apply [1, 2]

3.1.5 Accuracy

Accuracy is the largest expected error between actual and ideal output signals. In other instances this can be expressed as a fraction of the full-scale output or a fraction of the reading [1, 3]

This is a very important characteristic of a sensor. It is measured as a highest deviation of a value represented by the sensor from the ideal value of a stimulus at its input [8, 49]

3.1.6 Hysteresis

Hysteresis refers to the width of the expected error in terms of the measured quantity. This feature applies to certain sensors that do not return to the same output value when the input stimuli are cycled up or down [1, 3]

3.1.7 Bandwidth

Bandwidth of a sensor refers to a sensor's frequency range of the upper and lower cut-off frequencies. Sensors have a finite response times to an instantaneous change in physical signal. Most sensors in addition have decay times whose reciprocal correspond to the upper and lower cut-off frequencies respectively [1, 4]

In the pulse oximetry sensors, Light Emitting Diodes (LED) operational amplifiers (Op-amps) are required to have good slew-rate and gain-bandwidth properties. [34]

3.1.8 Resolution

Resolution of a sensor is the minimum detectable signal fluctuation. Sensor data sheets give minimum detectable signals for a specific measurement because some sensors are limited by noise with white spectral attributes [1, 4]

3.1.9 Noise

Sensors produce noise in addition to the output signal. When the noise of the sensor is less compared to the next element in the electronics, the noise can be ignored since it is not important. In others cases sensor noise may limit the performance of a system (electronics). [1, 3]

Noise and distortions pose the most difficult challenge in sensors design especially in creating the amplifier circuit with acceptable noise levels.

3.2 Sensing Principles

Sensing principles detail the processes involved in obtaining the desired output signal in a sensor device. Sensors are converters of stimuli, which are nonelectrical, into electrical signals. Before the electrical output signal is obtained, a number of transformation steps are required. The steps involve transformation and transmission of energy to produce the desired output. In most sensors like in complex sensors, the stimuli cannot be directly converted into an electrical signal and intermediary steps are required. The steps are physical effects that are used in the conversion of stimuli into electrical signal.

The physical effects are based on fundamental principles of physics and which include:

- Electrical Charges, Fields, and Potentials
- Capacitance: This refers to the ability of an electrostatic system to store electrical charge (energy).

- Magnetism: This is the physical attribute of an object of possessing magnetic properties. Magnets are objects that possess magnetic fields and therefore attract other objects that contain magnetic properties.
- Induction: Refers to the ability of an electrostatic system to transfer electric charges (energy) from a fully charged body to a neutral without contact
- Resistance: Refers to the hindrance to the flow of electrical energy (charge).
- Piezoelectric Effect: Functions on the principle that a charge is displaced across a crystal when it is strained. Piezoelectric accelerometer sensors measure charge polarization across piezoelectric crystal subject to distortions due to inertia of mass.
- Pyroelectric Effect: Functions on the basis that crystals become polarized when their temperature changes.
- Hall Effect: works on the principle that voltage is generated perpendicular to current flow in a magnetic field. Proximity sensors detect when magnetic fields change due to the presence of metallic objects.
- Thermoelectric Effects: Refers to the principle of conversion of Heat or electricity to electricity or heat. Energy form is converted to another and vice-versa.
- Sound Waves: These are longitudinal and mechanical waves that travel through all mediums with exception of a vacuum.
- Temperature and Thermal Properties of Materials
- Heat Transfer: Refers to the transfer of energy from a higher temperature matter to a lower temperature matter. The transfer continues until the matter objects are at an equilibrium temperature.
- Light: This is an electromagnetic radiation, with variable wavelengths, some that is detected by the human eye and special diodes.
- Dynamic Models of Sensor Elements

The physical Effects results from signals being fed through sensor electronics such as transducers, amplifiers, filters, signal conditioners and associated circuits. Passive sensors such as thermocouples and photodiodes generate physical effects of thermoelectric voltages and photocurrents respectively. Sensor electronics dictate the type of physical effects produced in a sensor. [1, 16]

3.3 Sensor Electronics

Sensor electronics are sensor interface electronics that complement the physical sensor element. They are an integral part of the sensor device. Sensors produce an electrical signal that may be weak, too noisy or contain undesirable components. The interface electronics such as amplifiers, filters and signal conditioners help in making the signal stronger, cutting out the noise, and converting the signal into forms that are suitable for feeding into external systems respectively. The architecture of interface electronics help alleviate the effects of distorted signals and allow for maximum extraction of data. [1]

Figure 4 below shows the various sensor interface electronics of an ECG sensor which include an amplifier, a microcontroller, an antenna and a radio chip.

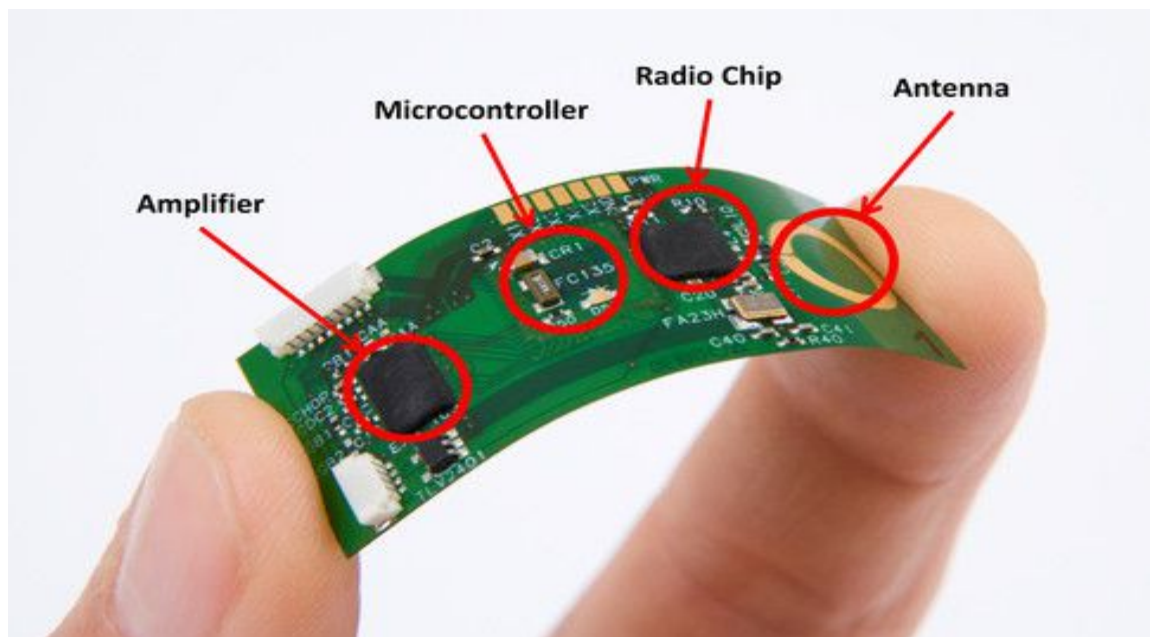

Figure 5. ECG sensor electronics [29]

Sensor electronics helps in harmonizing signals from the sensor element up to the format that is compatible with electronic load device which is mostly an external system. For example, most sensors do not produce voltages directly so an interface circuit is added to produce voltages suited for input microprocessors and Analog-to-Digital (A/D) converters.

Physiological Signals gathered from the human body are raw and include high noise levels coming from out and within the body. Unlike contact Sensors that make direct contact with bare skin through conductive electrodes, Non-contact sensors such as Electric Potential Integrated Circuit (EPIC) sensors can collect physiological data without necessarily making contact with the body through contact electrodes. As such, most of the noise in EPIC sensor signal arises from 50-60 Hz power line noise capacitively-coupled to the body from the surrounding circuit. Effective functioning of the sensor depends on the sensor being able to extract small electrophysiological signals from signals characterised by larger noise levels. Electrophysiological signals from ECG sensors therefore have to be accurately and reliably extracted to reduce the power line noise. EPIC sensors used in ECG measurements use the Driven right leg (DRL) system to reduce power line noise by feeding back an inverted average of signal from sensors on to the patient's body. The DRL circuit improves the sensor's signal to noise ratio (S/N) immensely. [36]

Figure 6 illustrates a typical circuit configuration of ECG EPIC sensors.

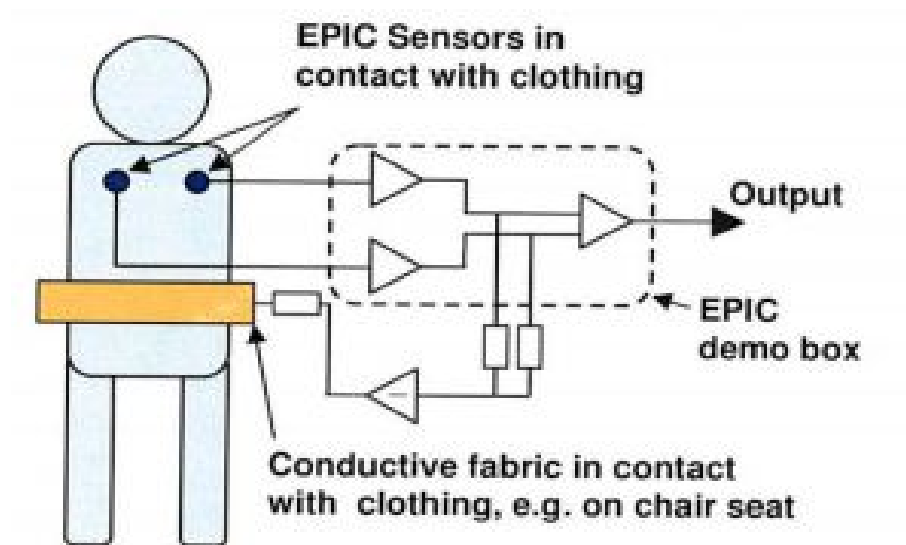
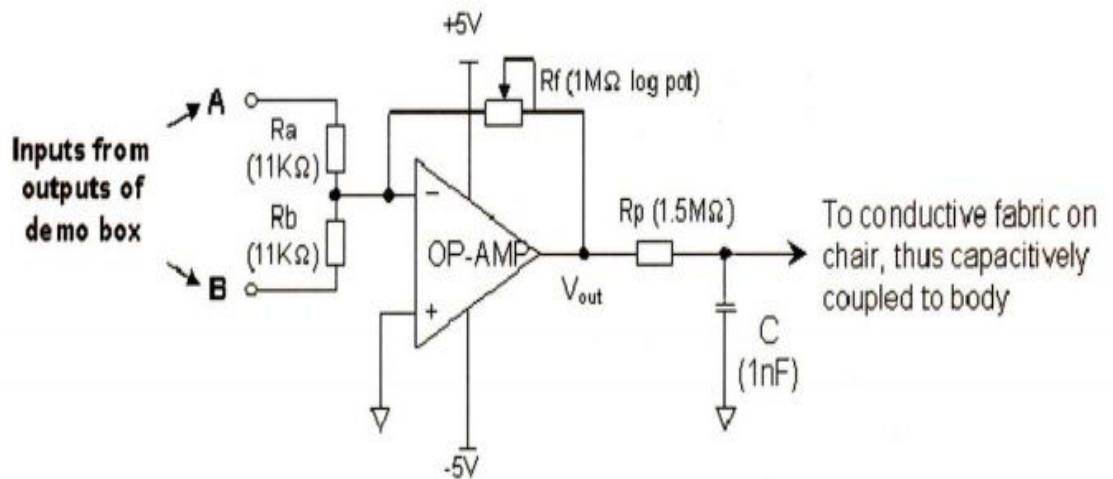

Figure 6. Basic configuration of non-contact ECG sensor [36]

EPIC sensors ability to gather physiological data without having direct contact to bare skin makes them ideal in continuous patient monitoring systems. The EPIC sensors can therefore be embedded on patient's beds, chairs or just worn on the body as a

wearable. The sensors are set in a way such that the electrodes touch on the patient's clothing when deployed.

Figure 7 outlines the DRL circuit design in non-contact ECG measurement using EPIC sensors.



$$\text{Operational amplifier output } V_{out} = - (V_A + V_B) * \frac{R_f}{11K}$$

Figure 7. Design of DRL circuit [36]

R_p is the protector resistor that restricts current feedback to the body and R_f sets voltage gain. The optimum value of R_f is dependent on the type of sensor being deployed, type of clothing worn, and the background of noise levels. The R_f value is set to achieve maximum noise reduction while simultaneously maintaining circuit stability.

3.4 Microelectromechanical Systems

The Microelectromechanical Systems (MEMS) is an area of technology that entails miniaturized mechanical and electro-mechanical elements that are made using techniques of micro-fabrication. The technology has proven to be potent especially in the design and making of advanced sensors and actuators. [24]

Nanoelectromechanical Systems (NEMS) and MEMS are seen as the future of next generation type of sensors, actuators, smart chips, extensive circuits and processors. NEMS and MEMS sensors are elaborate apparatus that contain; sensor elements that inputs information from the environment into the system, an electronic circuit that conditions the sensor signal and an actuator that responds to the electrical signals generated within the circuit. MEMS in general have enhanced the development medical equipment in a manner that makes them safer, easier and effective to use. The development of Very large Scale Integration (VLSI) systems has enabled MEMS technology to come up with miniature but highly effective and reliable circuits with high processing power. [20]

MEMS and NEMS have enabled the design of complex sensors that are sensitive, reactive, responsive and adaptive to a particular environment of interest. These qualities of MEMS sensors have played an even greater role in Healthcare industry especially in the setting up of Patient monitoring systems. Bio-MEMS which are used as a lab-on-a-chip for DNA analysis and Radio Frequency (RF) MEMS are just but a few of MEMS devices of interest to mention. Special types of MEMS are inserted inside the body through an opening called catheter for diagnosis, treatment and curing of cerebral thrombosis and aneurysm [5].

MEMS technology encompasses four distinct components which include:

- Microsensors
- Microstructures
- Microelectronics
- Microactuators

MEMS technology is very significant in Health and medical sensors because they allow for intelligence that advanced ICs enable [24]

The physical properties of MEMS sensors have to be carefully monitored as stress or strains transmitted to the electronics above acceptable limits may impair its immediate performance and long term stability even if compensation techniques are used. Need to sustain external strain is complicated in that MEMS are designed for their physical sensing applications to interact with its environment in order to function. [25]

In the creation and design of sensors, MEMS device selection is of utmost importance. In wet climatic areas and environments, hermetically sealed devices are used. Thus, design of sensors and wearables change depending on areas of use. Sensor nodes and sensors used outdoors are properly sealed with special types of overmold and epoxy. Device selection should also depend on environmental exposure temperatures and not necessarily operating temperatures. Devices are required to operate in range that conforms to their material capabilities.

Figure 4 shows an example of a MEMS sensor with complementary interface electronics.

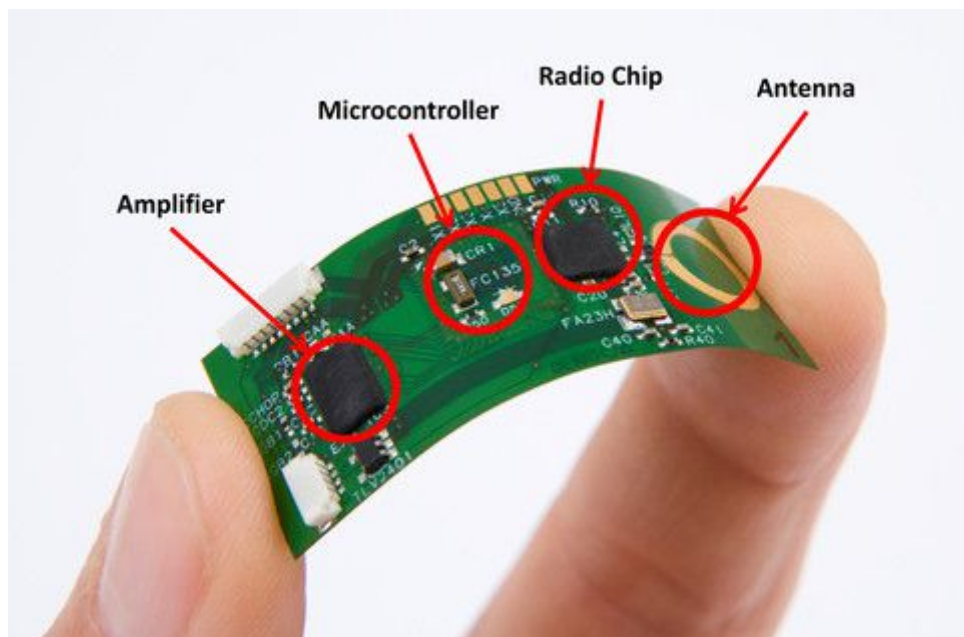

Figure 8. Wireless ECG Sensor with a functional Microcontroller [35]

High vibration and shock application sensors such as inertial sensors, smart vests and other health wearables, a lot of emphasis is taken in the design. Armature spring compressors and pressure springs are used to maintain contact closure in most commercial sensor applications to avoid clustering and premature contact failure under high vibration levels. [1, 538-539]

3.5 Radio Frequency Sensing

Radio Frequency (RF) sensing uses radio waves which are electromagnetic radiations. RF sensors are non-contact and therefore extensively used in measuring velocity and

distance, detection of motion, pressure as well as indicating the direction of motion and detecting the presence of foreign objects. RF sensing techniques include Surface acoustic wave (SAW) sensors, Doppler radar, sonar, ultrasonic and microwave sensors. [2]

4 Wearable Health Technology

Wearable are mostly electronic devices, some miniature in nature, that are worn on the body for the sole purpose of monitoring human body's physiological signals such as electrocardiogram (ECG), body temperature, blood pressure, motor activity, Photo-plethysmography, galvanic skin response (GSR) and heart rate. The signals being monitored are extremely essential for advancement of both diagnosis and treatment of diseases. Health Wearable therefore, have sensing capabilities. The most common and popular wearable devices are in the form of bandages, patches, wrist/ankle bands or other items that can be worn. These devices allow care givers, doctors and qualified medical personnel, to use technology to monitor patients over an extended period of time without the patients necessarily being in the presence of a medical staff or medical institutions. Healthcare Wearable for remote patient monitoring are made up of the sensor elements and complementing electronic hardware. The complementing hardware comprises of communication hardware that transmits data to the remote data collection centre through special sensor nodes. At the remote collection centres which are basically base station sinks, data storage, analysis and interpretation is done [33].

Figure 9 shows a system of wireless health wearable used in patient monitoring

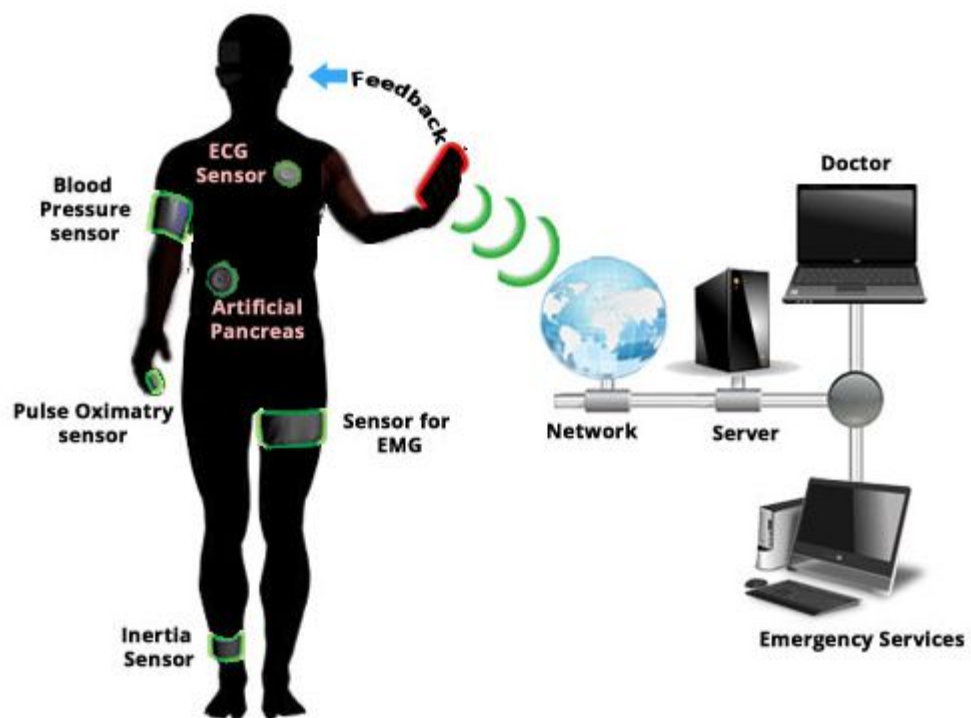

Figure 9. Monitoring Health Wearable on the body [35]

Wireless patient monitoring systems are continuously benefitting a great deal due to the advances in MEMS, VLSI, RFID, and sensor technologies. These technologies have led to the development of more advanced and efficient wearable. In addition, the LTE 4G network is viewed as the ultimate integration network that will bring all services together through the Internet of Things (IoT) platform.

4.1 Attributes of Health Wearable

The health wearable should meet certain specifications in order to be suitable for use. The wearable should be appealing and almost inviting while still able to execute their duties effectively. The human population will not gravitate to heavy and ambiguously conspicuous wearable. That will also limit their ability to be worn all the time and patients would rather just visit the hospitals for check-ups.

Figure 10 shows the various attributes of Health wearable

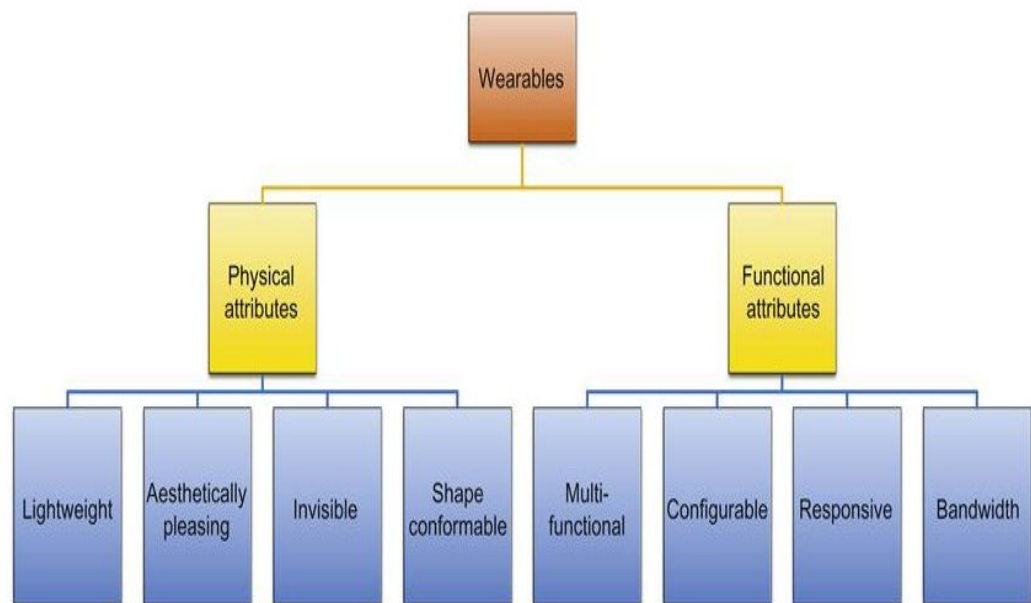

Figure 10. Attributes of Health Wearable [18]

Health Wearable has physical and functional attributes that have to be acceptable. Since patients will not find it comfortable to fill their bodies with wearable, the wearable

devices should be lightweight, miniature, pleasing to the eye, and shape-conformable from a physical standpoint. On the functional standpoint the devices should be; easily configurable for end-use applications, highly responsive because data gathering and transmission should occur in real-time, multi-functionality in that the body should not have several different kind wearable for monitoring different physiological vitals, high bandwidth for quick relay of information to and fro the device. [18]

4.2 Types of Healthcare Wearable

Remote patient monitoring systems use different kinds of wearable to constantly measure physiological body vitals. Figure 11 shows examples of the most recent Health wearable used in monitoring body's physiological signals.



Figure 11. Examples of emerging sets of Health Wearable [18]

The Nike Fuelband measures the calories that the body expend during routine activities. The Fitbit, Jawbone UP and Sony SmartWatch are activity trackers. The information collected from these devices are synced with smart phones which displays the parameters being measured.

The common types of wireless health of wearable currently in use in remote monitoring are described in the sub-chapters below.

4.2.1 Heart Rate Sensors

Heart rate sensor wearables are used for monitoring heart rates and oxygen saturation. The pulse oximetry Ring sensor is a good example of a wireless heart rate sensor. The ring sensor is a ring-like shaped wearable that is worn on the finger. Other models of pulse oximetry sensors are worn on the ear-lobe. The ring sensor is controlled by a single processor that is embedded with the transmitter which sends waves wirelessly through digital communication to the nearby node. The pulse oximetry technology is built into the nodes and data is instantaneously sent to the base station and interpretation done almost in real-time. Figure 12 shows the architecture of Ring Sensor.

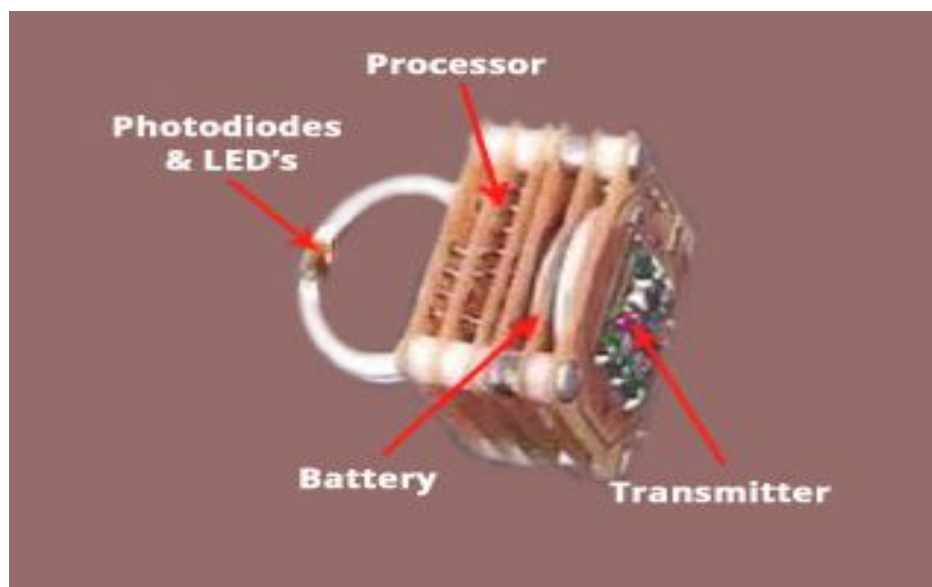

Figure 12. Pulse oximetry ring sensor [35]

Pulse oximeters function under the fundamental principles of variation of light absorption across human tissues. The blood components oxyhaemoglobin (HbO_2) and deoxyhaemoglobin (HbR) absorb a specific light wavelength, the red and near infra-red light wavelengths. HbO_2 has more affinity for the infra-red wavelengths while HbR have more affinity for the red wavelengths. The variation in absorption of the two light wavelengths by the blood components correlate with the change in relative concentrations of oxyhaemoglobin and deoxyhaemoglobin as well as heart diastole and systole due to variations in blood volume. The ring shape of the Ring Sensor allows for optimal light collection. [20]

4.2.2 ECG sensors

ECG sensors are used in monitoring heart activities. Wireless monitoring of heart activities is made possible using non-contact electrodes. Capacitive electrodes can register electrophysiological signals without the necessity of bare skin contact. This is a very important aspect because of the ability to function in spite of insulation such as clothing and also to avert discomfort and allergies that are associated with metals. This is referred to as ballisto-cardiography and has been made possible by the introduction of Electric potential Integrated Circuits (EPIC) sensors [4]. By fine tuning the digital signal processor and adjusting the amplification circuitry, the sensors can be tuned for detection in spite of spatial gap. [36]

4.2.3 Inertial Sensors

Inertial Sensors are used in Neurological Rehabilitation and Motor activity monitoring of patients suffering from Neurological Diseases such as stroke and Parkinson's disease in home settings where attention of medical personnel is limited. In addition, Gyroscopes are used to measure changes in orientation such as rotational displacement, velocity and acceleration. Accelerometer sensors on the other hand are used to measure changes in velocity and displacement. The two sensors are extensively used for automatic and continuous monitoring of movement disorders and functional activities. [18]

4.2.4 Smart vests

Smart vests are special apparel that is made up of sensing apparatus that measure electrophysiological body signals. Developments in smart technologies have brought about more emphasis on possible uses of smart vests. The technology was conceived as a military application. Specifications have been made for use in Healthcare especially in wireless health monitoring of patients. Smart vests maybe textile apparels or special types of clothing that have built-in sensing platform for monitoring and measuring a range of electrophysiological signals. The sensors located in the vest are in direct contact with the body. Physiological signals monitored include ECG, PPG, GSR, blood pressure, muscle activities, body temperature, and heart rate. [4]

Figure 13 below shows a smart vest with various integrated parameters for monitoring electrophysiological signals.

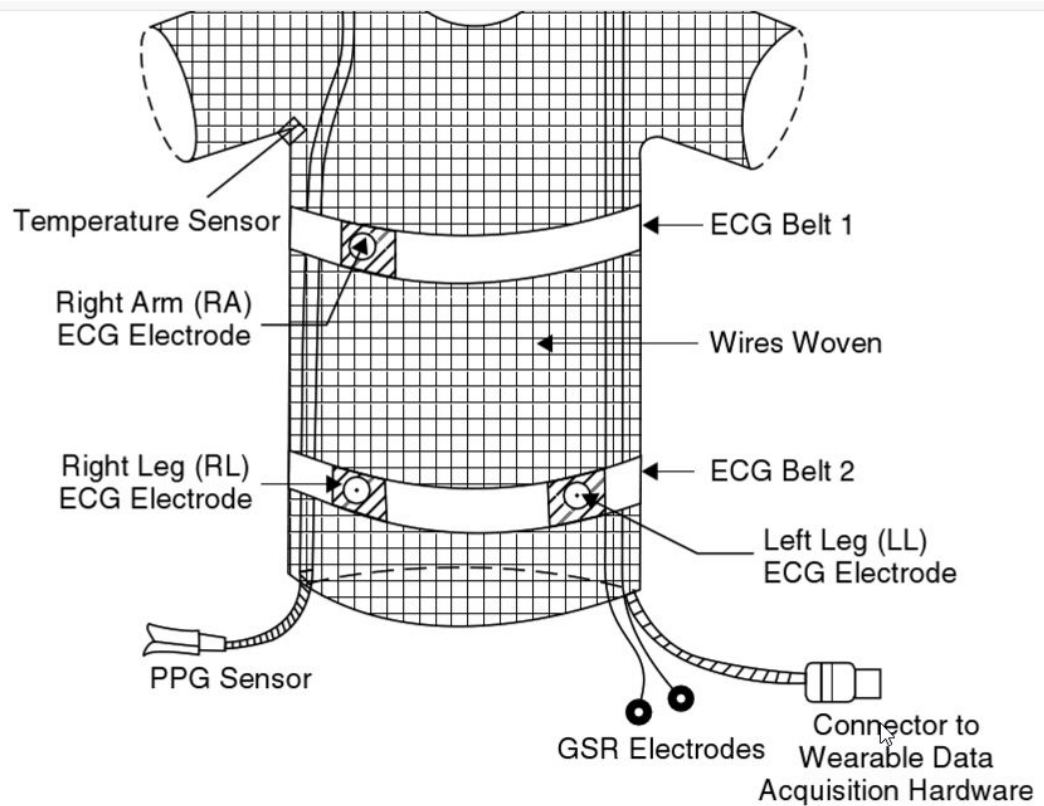

Figure 13. Diagram of a smart vest [4]

The electrophysiological signals collected from the various elements of the vest feed an electronic module that attached to the vest. The electronic module is a small kit that contains sensor nodes, transmitters and inertial sensors that detects movement of the patient. The signals are sampled at 250 samples/s, digitalised at 12-bit resolution and wirelessly transmitted by electronic module to the base station. [4]

4.2.5 PPG Sensors

Photoplethysmograph (PPG) sensors are specialized types of sensors with wide ranging applications such as monitoring cardiac cycle, heart rate and respiratory patterns.

The pulse oximetry ring sensor described earlier under heart rate sensors (4.2.1), doubles up as a heart rate sensor and a PPG sensor.

Photo-plethysmograph basically refers variations in blood volume due the varying signals due to the heart's diastolic and systolic activities which inherently result from variations in light absorption by HbO₂ and HbR. The signals acquired are used to estimate and calibrate arterial oxygen saturation. [20]

4.2.6 GSR Sensors

The galvanic skin response sensors measures electrical conductance of the skin. The electrical conductance of the skin varies with moisture levels. The human body's sympathetic nervous system controls the sweat glands and on occasions of strong emotions, the electrical resistance of the skin varies. The sensor therefore takes note of these changes which are then communicated to the node and the base station and the response sent back to the phone almost in real-time. This is important in rehabilitative treatments especially in anger management patients.

4.2.7 Implantable Health Wearable

Implantable Health wearables are electronic devices that are inserted into the body to assist in mitigating the effects of health complications. The Implantable devices are placed into the body through some surgical procedures and their operations are wirelessly managed from outside the body. The common Implantable Health wearables used in wireless health monitoring include the pacemaker, cochlear implants and Micromachined Endovascular-Implantable wireless aneurysm pressure sensors. Size, power consumption, communication frequency, and power efficient communication plays a big role in the design of Implantable health wearable. [12,41]

Pacemakers are electronic devices that are placed in the chest cavity on the heart. Pacemakers help regulate heartbeats in patients with heart complications such as arrhythmias. The pacemaker works on the fundamental principle that the human heart has its own electrical system that controls the heart rate and rhythm of the heartbeat. Electrical signal triggered by sinoatrial node cells of the heart, travel up and down the heart causing the heart to contract thereby pumping blood to the body. The heart is a very vital organ and any disruption in its activity maybe fatal to human life. In cases

where there are irregular electrical signals, the pacemaker recreates the appropriate low energy electrical signals. Pacemakers can be temporary or permanent solutions and specialised designs can also monitor and record blood temperatures, breathing rate and synchronised the patient's heart rate to changes in their activities. Pacemakers are made up of electrodes, an energy source, programming unit that mainly consist of a generator and a transmitter that communicates with the node outside the body, and tiny connecting wires that link up the programming unit to the various chambers of the heart. Electrodes are specialised sensors that detect the electrical activities of the heart and relay the data to the programming unit. The pacemaker can therefore be wirelessly managed over the 4G network depending on the patient's condition and physical activity being undertaken.

Micromachined endovascular-implantable wireless aneurysm pressure sensor is another example of an Implantable health wearable. It is used in the treatment of abdominal aortic aneurysms (AAAs). AAA is a weakening of the aortal wall close to the junction of aorta and iliac arteries. AAA is common and the leading cause of death in persons over 60 years of age. The Aneurysm Pressure sensor monitors the intra-sac pressures and communicates with an external RF receiver on the sensor nodes. The RF transmitter is built in the aneurysm pressure sensors and it interactively communicates with the receiver. [4,157-158]

4.3 Future of Wearable Health Technology

The continued advancement of MEMS and RF sensing is looking into the development of devices that can be swallowed and will work from within the body. The device will be some kind of an "electronic pill" and will be harmless to the body when ingested. The electronic pill will be an emergency measure to try and detect illnesses and diseases that are not yet known to the medical world. The information collected by the pill will be wirelessly sent to remote medical centres where they will be analysed and appropriate counter measures will be devised.

Studies are underway in the upgrade of smart vests. Technicians are looking into the use of textile conformable sensing clothing in which piezo-resistive materials are integrated in the form of fibres and yarns, bringing forth fabric sensors, electrodes, and connections. [4]

5 Monitoring Sensor Network

The remote patient monitoring system is an elaborate network that comprises of a large number of inter-communicating wireless sensors and sensor nodes, a gateway node that links the Sensor Network to the 4G network and the interface electronics such as monitors and computers that displays the information into forms that can be understood by the patients and care givers. Figure 14 shows a schematic of a typical wireless health monitoring system

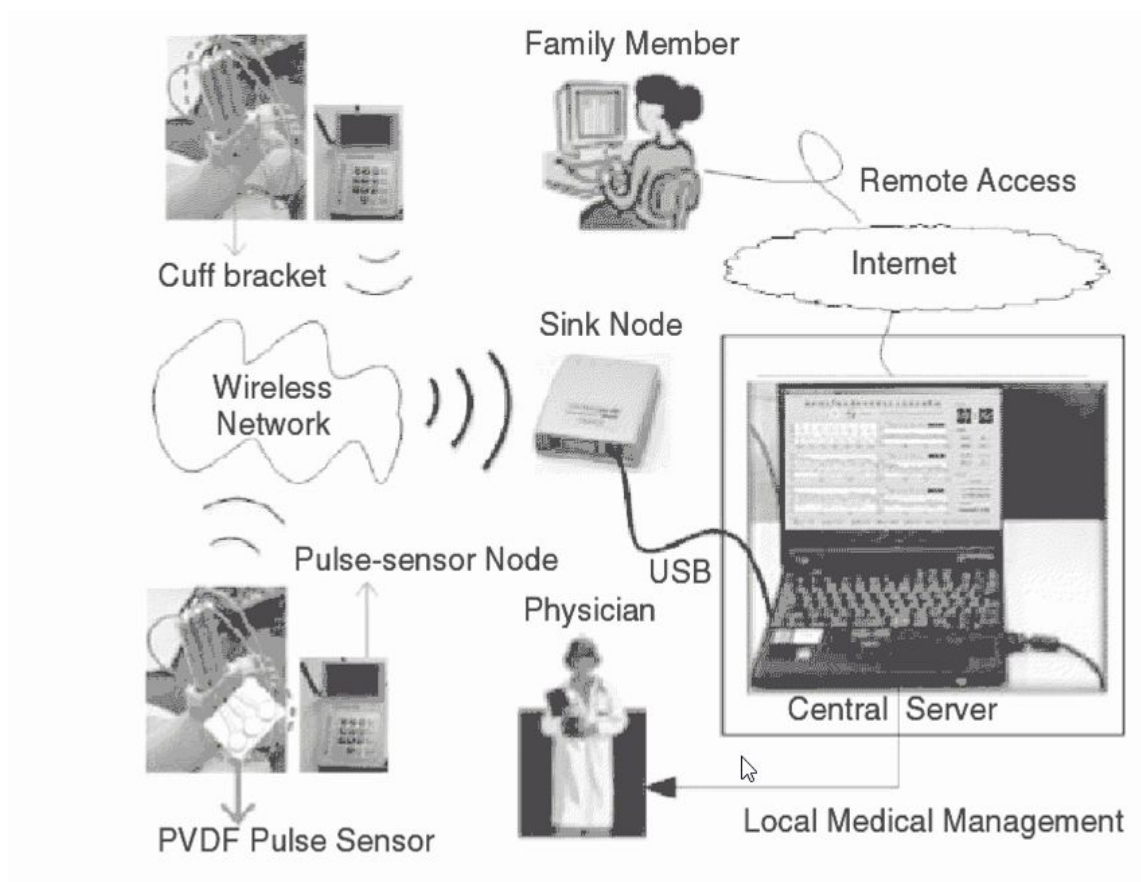

Figure 14. Schematic of Health monitoring system [4]

The monitoring sensor network (MSN) is basically a specialised wireless sensor network with a gateway coordinator to the cellular 4G network. The various features of the health monitoring network are discussed below.

5.1 Wireless Sensor Networks

Wireless Sensor Networks (WSNs) are the common data gathering networks for monitoring systems. As such their use has been extended to include wireless monitoring of patients over the 4G Network. Due to their monitoring capabilities, WSNs are taking a popular centre stage in Healthcare and the medical field as a whole. The recent advancements in technologies such as sensors, MEMS, VLSI and low-power radio frequency designs have made WSNs even more viable. Health monitoring sensor networks are specialised WSNs. [25, 1-2]

The MSNs are viewed as components of distributed sensor systems, and gateway to pervasive technology. The wireless patient monitoring system over the 4G network is seen as the ultimate goal in advancement of Health technology and a step forward in the realisation of internet of things (IoT) in general. WSNs used in remote applications use ZigBee module which is a WSN platform based on the IEEE 802.15.5. ZigBee is a wireless sensor standard that addresses the special needs of many remote applications. WSNs used for monitoring are basically ZigBee Sensor Networks. ZigBee is suitable for RF appliances in that it is; low cost, ultra-low power consumption for devices that require long battery life, use of unlicensed radio bands, cheap and easy installation, flexible and extendable and can therefore be integrated into larger networks such as the 4G network. The ability of ZigBee compliant devices to operate in unlicensed RF bands makes it highly flexible and extendable network. The ZigBee MSN comprises of distributed sensing apparatus (Sensors), a collection of Nodes or motes which are strategically positioned in an area of interest to execute a task through coordination and communication with the objective of enabling the appropriate reaction to an occurrence of events in the environment. [33]

5.2 Components of Monitoring Sensor Networks

The Integral and significant features of Health Monitoring Sensor Networks are explained in the following chapters.

5.2.1 Sensor Nodes

Sensor Nodes are made up of the sensing apparatus whose sole purpose measuring physical phenomena. They are low-power with memory capacity in the order of kilobytes and low computational power. They play a greater role of helping the network to monitor and react to physiological events of interest. The nodes form a self-organized network and therefore are tasked with responsibility of communicating and coordinating in data gathering. Sensor data is converted to digital streams using Analog-to-Digital converter (ADC). [24; 13]

Figure 15 shows the functional block diagram of a sensor node

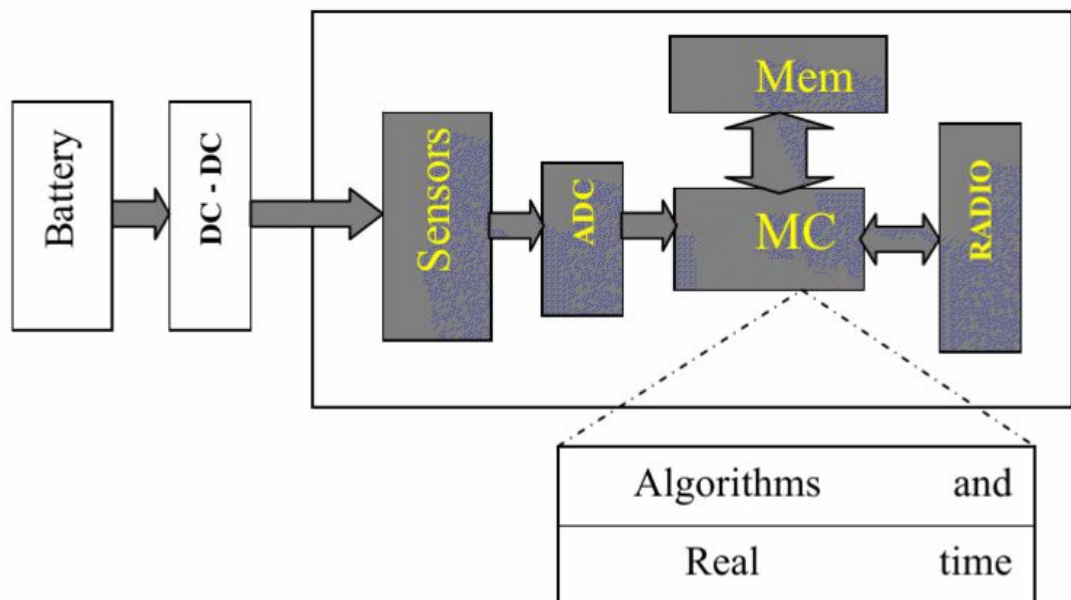

Figure 15. Architecture of a Sensor Node [25]

The microcontroller unit (MCU) contains a protocol stack for efficient data routing over the area covered by the network. MCU is also charged with the responsibilities of managing data collection from sensing apparatus, executing power management functions, interfacing sensor information to the physical radio layer as well as managing the radio network protocol. The radio unit is embedded with both RF transmitters and receivers for sending and receiving information respectively. The MCU also processes data by executing algorithms and then the processed data is communicated over the network by the radio unit. The memory unit allows for remote nodes to acquire data on com-

mand from the base station or an event sensed. Sensor nodes in patient monitoring systems entirely work under a real-time operating system (OS) that are embedded within the node and can be upgraded wirelessly from the master nodes at the base stations (BSs). [1, 576]

5.2.2 Networking Infrastructure

Networking Infrastructure refers to the platform on which data is relayed, in this case it is wireless over the ZigBee network to the 4G Network. The network is composed of several to unlimited programmed sensor nodes depending on the physiological phenomenon being monitored for example when monitoring Neurological diseases such as Parkinson's disease movements are taken into account and more nodes are used. The positioning of the sensor nodes also depends on phenomenon being monitored. The networking infrastructure is the communication unit of a Health MSN and comprises of a radio devices, inbuilt communication stack and modules for communicating data to the nearby sensor nodes. [24]

5.2.3 Base Station Sink

Base station sink is the smart unit of the health monitoring system. The sensed information from the nodes is sent to the sink for processing. Unlike the Nodes, they are equipped with greater computational power and high data storage capacity. The sink plays an important role of initiating the transfer of data from and to the sensor nodes. The sensor nodes can be configured and updated from the sink. The sink is basically the computational unit of the MSN and contains a powerful microcontroller for data processing. The sink links the Health MSN to the 4G network and comprises of a master node that communicates with gateway that is in-built in the node.

5.2.4 Computing Resources

Computing resources refer to interface devices such as computers and monitors that are available to the end-users of the MSN for displaying collected data and sending commands at the sink. Computing resources are also useful in data analysis, interpretation, comparison and storage. The interface devices exist to operators of and users of MSN.

NB: Since monitoring is a constant event, the power consumption is considerably high. Of the various domains described above, sensor nodes expend maximum energy in data communication, data transmission and reception by radio unit.

The exponential growth and success of MSN is attributed to a number of factors, thus:

- Semiconductor and Micro-fabrication technologies: According to Moore's law, the number of transistors on a cost-effective chip doubles every year or two. As a result, a computing unit exponentially becomes smaller physically and cheaper with each passing year at least for 10-20 years until it eventually reaches a fundamental technical and economic limit. Micro-fabrication and semiconductor technologies have enabled the miniaturization and manufacture of extremely small radios in addition to mechanical structures that are able to sense fields and forces in the physical world.
- Miniaturization of energy capacity: The past two decades has seen the increase of double-A nickel alkaline battery capacity from 0.4 to 1.2 Ah with fast recharging capabilities. Furthermore, a circuit's power consumption is strongly related to its performance capacity. A circuit can therefore be designed to require less energy if given more time to complete the task.
- System-on-a-Chip Integration technology (SoC): This has allowed for integration of Microsensors, on-board processing, and wireless interfacing at relatively small scale and at low power. [26; 2]

5.3 Features and Requirements of Health MSN

The subsequent preceding sections explain the characteristics and Requirements of Health Monitoring Sensor Networks.

Size constraints: For the purposes of unobtrusiveness, the sensor nodes need to be small for aesthetic value. Advancement in nanotechnology, VLSI and MEMS has aided

in the development of smaller sensor nodes. Current setbacks being faced are in the power supply. Batteries lead to larger sensor nodes. Renewable energy sources within the nodes will help in achieving smaller sensor nodes. [25]

Duty cycle: The sensor nodes are designed to stay in sleep mode most of the time. The duty cycle is low and typically around 1 % for sleep and wake mode, the node is kept on when its sensor is sensing data or communicating data from/to other nodes. This is aimed at reducing energy consumption. [25]

Bit rates: Health MSNs have low bit rates due to low varying rates of sensor parameter. For example, the Affectiva Q sensor used to measure human emotions has ADC resolution of 16 bit [35].

Cost: Because several sensor nodes are required in monitoring systems, the nodes should be relatively cheap.

Energy Constraints: Energy constraints influence the design of sensor nodes and choice of algorithms for MSNs. The algorithms need to be energy-efficient and ultra-low power circuitry is highly recommended. The lifespan of a MSN is highly dependent on the energy that can be stored and harvested by a sensor device. [26]

Localization: Localization is the association of data from sensor node with the position of the sensor node. Data from the node needs to be sent along with the coordinates of the sensor node.

Scalability: Due to the large number of sensor nodes in Health MSN, attention should be given in the design of algorithms. Automatic configuration, maintenance and upgrade of device is an urgent requirement. The network has to be adaptable and scalable to changes in network size, node density and topology.

Multi hop: Multi-hop assists in conveying signals from sensor nodes that may not reach the base station sink directly.

Data-centric: Health MSN emphasises on data being routed and therefore data-centric and gathering by nature.

Dynamic Networks: Health MSNs systems exhibit a highly dynamic network topology in order to overcome obstacles and restricted resources.

Redundancy in data: Redundancy in data arises in sensor readings. Spatial redundancy results from sensor nodes giving similar value of measured quantity due to sensor nodes being placed too close to each other. Temporal redundancy arises from the fact that in spatial redundancy, the measured physical quantity does not change abruptly in a short span of time, thus, data measured over a short time span is unlikely to change. In this regard, MSN must have in place an efficient data processing and management algorithms.

Distributed Network and Processing: The network consists of a large number of nodes that are distributed over an area of interest. Every node should be able to process local data, using filtering, and data fusion and aggregation algorithms to gather data from the environment and aggregate the data and transform it into information.

MSNs are application specific in nature and the ones deployed in Patient monitoring systems have different requirements than the ones in the jungle for monitoring wild animals' lifestyle patterns. [25]

5.4 Health MSN Operating Principles

Figure 16 shows unit operations in a typical wireless health monitoring system

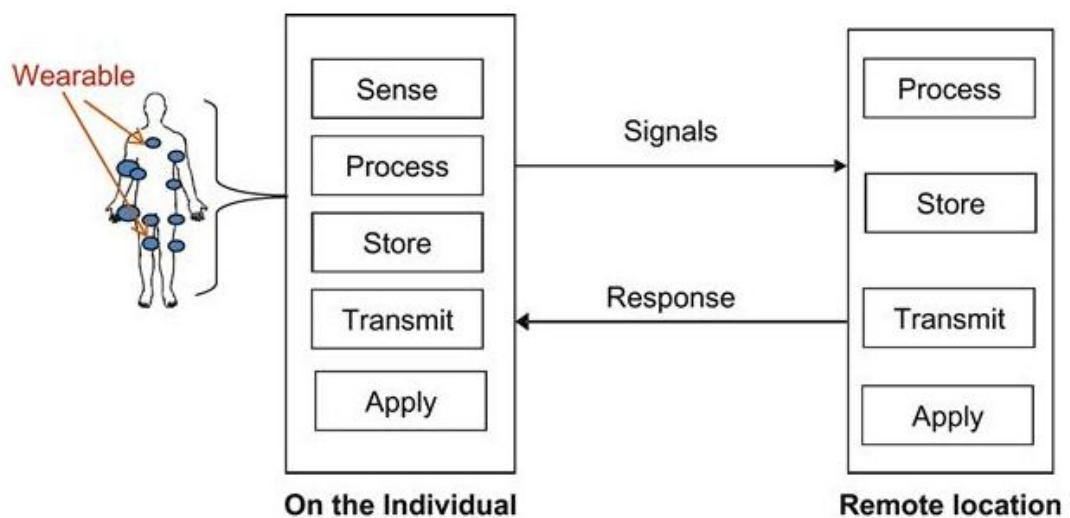

Figure 16. Schematic representations of MSN unit operations [18]

Health MSN is made up of sensor nodes that are strategically positioned in the area of interest. A single sensor node is connected to several sensor elements or wearable in patient monitoring system. The wearable is worn on the body to be constantly monitored, the wearable on the body maybe under a single sensor node or several sensor nodes that constantly communicate with each other. The sensor nodes are property of the care givers who manage the monitoring system. The nodes can be placed at different geographic locations such as the shopping malls, along the roads and public places of interest such as schools or stadiums so that when a patient moves from one place to another, the monitoring process is not tampered with. The sensor nodes can be placed in residential areas, offices or at a patient's home.

The sensor nodes communicate with each other and the base stations (BS). They send the gathered information to the base stations that are usually far away since it is not economically viable to have a lot of base stations. The sensing equipment and wearable on the body communicate with the Nodes through their RF transmitters which in turn communicate with the base station.

Health Monitoring sensing apparatus and wearable communicate with the sensor nodes using ZigBee protocol which is suitable for embedded applications. ZigBee is a wireless low power, radio communication technology. The technology is highly recommended for transmission of non-voice data to and from sensors and sensor nodes. The monitoring sensor network implemented by ZigBee basically makes up a ZigBee sensor network. ZigBee is the ultimate wireless sensor standard based technology that addresses requirement of remote applications as well as enabling interoperability between products from varied manufacturers. ZigBee enables installation of reliable, cost effective monitoring and control of devices. ZigBee's simple design and efficient power consumption allowing monitoring devices to function on ordinarily available batteries for extended period of time (years) thereby making its use indispensable. [32, 57]

5.5 4G Gateway Integration Principles

The ZigBee wireless sensor network coordinator hardware and software is embedded in the gateway router or node. ZigBee networks provide security using 128 bit symmet-

ric encryption keys. Due to ZigBee's unlicensed bands; the data rates is 250 kbps at 2.4 GHz which is suitable for periodic signal transmission especially from sensors, 40 kbps at 915 MHz and 20 kbps at 868 MHz. ZigBee uses Direct sequence Spread spectrum (DSSP) that helps mitigate the effects of frequency selective multipath fading in radio transmissions [27]. ZigBee also uses AT and API commands for communication. AT module is used for point to point communications and applications where user commands is required. API module is suitable for machine-to-machine applications and applications where changing configurations of remote modules is required. ZigBee MSN uses API module.

The system is integrated into the WiMAX 4G network using ZigBee tree routing protocol. Tree routing is used to find the next hop knob for a specific destination address without routing tables. WiMAX is an all IP network 4G technology used to transmit wireless data over longer distances. Both WiMAX and ZigBee are developed by IEEE and are relatively open standards and interoperability between the two standards is defined in the IEEE 802.16e specification. The ZigBee sensor nodes of MSN are integrated with mobile WiMAX technology for secure data transmission. The ZigBee Nodes are made up of 802.16e conformant radio transceiver. The ZigBee MSN comprises of routers, end devices and a coordinator which are all connected by a tree topology. For smart vest applications, a mobile node whose movement is sensed and captured by the controlling unit, is configured to cover the area of MSN. Traffic on every node is configured as random destination except for mobile node that is configured to send traffic to its parent node. ZigBee coordinators are interfaced through a processing controller unit connected to a WiMAX BS through a Wireless Access Gateway (WAG) which acts as a transmitter. The receiver part also consist of WiMAX BS along with WAG where corresponding application server is present. This will transmit signals directly to WiMAX BS and using wireless link it receives the signal at another BS. ZigBee MSN sends collected physiological data with the help of the coordinator through end users who are either patients who make health inquiry through phones or care givers who send the already interpreted data. The coordinator communicates with the 4G BS and transmits the physiological data to the receiving WiMAX BS. The application servers receive the physiological data which are sent by ZigBee sensor nodes using tree routing. The mobile node transmits stored data through the 4G Network. [33, 393-395]

5.6 Typical monitoring using Ring Sensor

Pulse oximeters function under the fundamental principles of variation of light absorption across human tissues. The blood components oxyhaemoglobin (HbO_2) and deoxyhaemoglobin (HbR) absorb specific light wavelengths, the red and near infra-red light wavelengths. HbO_2 has more affinity for the infra-red wavelengths while HbR have more affinity for the red wavelengths. The variation in absorption of the two light wavelengths by the blood components correlate with the change in relative concentrations of Oxyhaemoglobin and deoxyhaemoglobin as well as heart diastole and systole due to variations in blood volume. [20]

The ring sensor comprises of sensor unit, transmission unit (transmitter) and MCU (CC430, Texas instruments, USA). Sensing unit consists of the LED's and photodiodes. The MCU consist of the processor and is interfaced with ZigBee stack. The processor controls the operations of the sensor. The ZigBee module is used for the communication of data to the nodes. LED's are infra-red (IR) LED and Red LED. The LED's have emission wavelengths of 940nm for IR and 660nm for Red .The MCU controls the LED driving circuit. The photodiodes are used to detect and record the reflected IR and RED wavelengths. The photodiodes convert light wavelengths into electrical signal, output current. [34, 24]

Figure 17 shows a typical pulse oximeter ring sensor

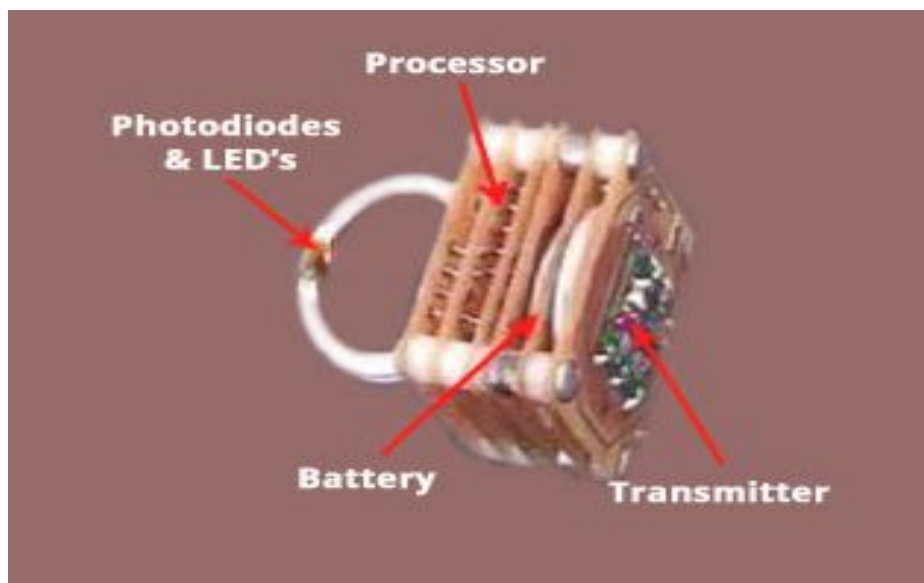

Figure 17. Architecture for Pulse Oximetry Ring.Reprinted [35]

When the heart pumps, there is a sharp rise in blood pressure forcing blood to flow through the blood vessels in pulses. The levels of IR and Red light wavelengths reflected from the LED's emitters also sharply varies with the pulses due to absorption levels. Blood components HbO₂ and HbR reflect more IR and Red light wavelengths respectively when the heart pumps. Photodiodes converts IR and Red lights to current and the more the reflected lights detected the more current conversion in the circuit. The ring sensor circuit is set up such that an increase in current results into a voltage drop across the entire circuit. The onset of every pulse results in current creation by the photodiodes and a signal.

The Photodiode amplifier circuits comprises of 20 M trans-resistance amplifiers that converts output current into voltage signal. The voltage signal is then passed through two Op-amps all contained in an IC. The Op-amps are used to establish a steady baseline for the signal, emphasize the peaks and filter out the noise. The first Op-amp amplifies the signals and passes it to the second Op-amp which outputs a clean but weak signal. The signal is further amplified by transistors before being fed to the processor where the signal is digitalized by 12-bit ADC with a sampling rate of 25 Hz. The digitalized signal is sent to the transmission unit that consist of ZigBee module. The signal is the transmitted to the node. [20]

6 Conclusion

Wireless patient monitoring over 4G Networks is a new undertaking that is still in developmental stages. Significant acceptability of health wearable will be realised with heavy integration of MEMS, NEMS and Smart Sensor Technologies. Health Wearable that are miniature in size, lightweight and size conformable while maintaining plenty of usability functions are more likely garner more likes and acceptability from the public. The Health Wearable has to be “cool” for patients to opt to wear and be seen wearing them.

The main goal of this literature was to explain how patient monitoring can be done wirelessly over the 4G network using sensors. To achieve this feat, sensor principles and characteristics were explained. In addition, the ZigBee health monitoring sensor network as well as the 4G network and technologies are also covered.

References

1. Sensor Technology Handbook

URL:<http://site.ebrary.com.ezproxy.metropolia.fi/lib/metropolia/reader.action?docID=10128138&ppg=12> [ONLINE]

Accessed: 22 January 2016

2. Understanding Smart Sensors

URL:<http://site.ebrary.com.ezproxy.metropolia.fi/lib/metropolia/reader.action?docID=10857829> [ONLINE]

Accessed: 24 January 2016

3. Various Informative Healthcare sensors links

URL:<http://www.sciencedirect.com/science/journal/09565663> [ONLINE]

Accessed: 27 January 2016

4. Distributed Sensor Systems

URL:<http://site.ebrary.com.ezproxy.metropolia.fi/lib/metropolia/reader.action?docID=10538743&ppg=3> [ONLINE]

Accessed: 21 January 2016

5. Smart MEMS and Sensor Systems

URL:<http://site.ebrary.com.ezproxy.metropolia.fi/lib/metropolia/reader.action?docID=10201291&ppg=120> [ONLINE]

Accessed: 12 February 2016

6. Prof. Raj. Medical Applications of Wireless Networks

URL: <http://www.cse.wustl.edu/~jain/cse574-08/ftp/medical.pdf> [ONLINE]

Accessed: 29 January 2016

7. Rajasekaran.S,Kumaran.P,Premnath.G,Karthik.M

Human Health Monitoring Using Wireless Sensors Network

URL: <http://www.ijaiem.org/volume2issue12/IJAEM-2013-12-31-093.pdf> [ONLINE]

Accessed: 26 January 2016

8. Jacob Fraden. Handbook of Modern Sensors

Handbook of Modern Sensors: Physics, Designs and Applications, Fourth Edition. Springer Science + Business Media, LLC, 233 Spring Street, New York, NY 10013, USA.

Accessed: 30 January 2016

9. Darrell M. West. Issues in Technology Innovation: How Mobile Devices are Transforming Healthcare

URL: <http://www.brookings.edu/~media/research/files/papers/2012/5/22-mobile-health-west/22-mobile-health-west.pdf> [ONLINE]

Accessed 25 February 2016

10. Jean-Gabriel Remy, Charlotte Letamendia. LTE Services, Second Edition. John Wiley & Sons, Inc.111 River Street, Hoboken, NJ 07030, USA

URL:<http://site.ebrary.com.ezproxy.metropolia.fi/lib/metropolia/reader.action?docID=10944983&ppg=217> [ONLINE]

Accessed: 5 March 2016

11. Harri Holma, Antti Toskala. LTE-Advanced: 3GPP Solution for IMT-Advanced

URL:<http://site.ebrary.com.ezproxy.metropolia.fi/lib/metropolia/detail.action?docID=10593178> [ONLINE]

Accessed: 7 March 2016

12. Val Jones, Nadav Shashar, Oded Ben Shaphrut. M-Health: Remote Monitoring for Healthcare and for Safety in Extreme Environments

URL:http://link.springer.com.ezproxy.metropolia.fi/chapter/10.1007/0-387-26559-7_43

[ONLINE]

Accessed: 12 March 2016

13. Hande Ozgur Alemdar, Cem Ersoy. XII Mediterranean Conference on Medical and Biological Engineering and Computing 2010, IFMBE Proceedings Volume 29.

URL:http://link.springer.com.ezproxy.metropolia.fi/chapter/10.1007/978-3-642-13039-7_216#page-2 [ONLINE]

Accessed: 10 March 2016

14. Safdar Nawaz Khan Marwat, Thomas Potsch, Yasir Zaki. Advances in Communication Networking

URL:http://link.springer.com.ezproxy.metropolia.fi/chapter/10.1007/978-3-642-40552-5_9 [ONLINE]

Accessed: 11 January 2016

15. Edward Mutafungwa, Zhong Zheng, Jyri Hämäläinen. Wireless Mobile Communications and Healthcare

URL: http://link.springer.com.ezproxy.metropolia.fi/chapter/10.1007/978-3-642-29734-2_24 [ONLINE]

Accessed: 28 January 2016

16. Mark Grayson, Kevin Shatzkamer, Scott Wainner. IP Design for Mobile Networks

URL:<http://proquestcombo.safaribooksonline.com.ezproxy.metropolia.fi/book/networkin/network-management/9781587059377> [ONLINE]

Accessed: 29 January 2016

17. Robert Faludi. Building Wireless Sensor Networks

URL: <http://proquestcombo.safaribooksonline.com.ezproxy.metropolia.fi/book/networking/wireless/780596807757> [ONLINE]

Accessed: 30 January 2016

18. Michael R Neuman, Edward Sazonov. Wearable Sensors

URL: <http://proquestcombo.safaribooksonline.com.ezproxy.metropolia.fi/book/hardware/9780124186620> [ONLINE]

Accessed: 3 February 2016

19. Erik Dahlman, Stefan Parkvall, Johan Sköld. 4G LTE/LTE-Advanced for Mobile Broadband. The Boulevard, Langford Lane, Kidlington, Oxford, OX 1GB, UK

Accessed: 11 March 2016

20. Novel wearable and wireless ring-type pulse oximeter with multiple detectors

URL: <http://www.ncbi.nlm.nih.gov/pmc/articles/PMC4208240/> [ONLINE]

Accessed: 9 March 2016

21. Healthcare Information Systems: A look at the past, present, and future

URL: <https://www.healthcatalyst.com/healthcare-information-systems-past-present-future> [ONLINE]

Accessed: 23 February 2016

22. ECG Sensor Datasheet

URL: http://bitalino.com/datasheets/ECG_Sensor_Datasheet.pdf [ONLINE]

Accessed: 7 February 2016

23. Pervasive computing and Networking

URL:<http://site.ebrary.com.ezproxy.metropolia.fi/lib/metropolia/reader.action?docID=10484670> [ONLINE]

Accessed: 28 February 2016

24. Wireless Sensor Networks

URL:<http://site.ebrary.com.ezproxy.metropolia.fi/lib/metropolia/reader.action?docID=10675034> [ONLINE]

Accessed: 19 March 2016

25. Wireless sensor Network Systems

URL:<http://site.ebrary.com.ezproxy.metropolia.fi/lib/metropolia/reader.action?docID=10091340&ppg=17> [ONLINE]

Accessed: 6 March 2016

26. MEMS Mechanical Sensors

URL:<http://site.ebrary.com.ezproxy.metropolia.fi/lib/metropolia/reader.action?docID=10081990&ppg=67> [ONLINE]

Accessed: 11 February 2016

27. Wearable biosensing: signal processing and communication architectures issues

URL: <http://www.nit.eu/czasopisma/JTIT/2005/4/90.pdf> [ONLINE]

Accessed: 14 March 2016

28. mHealth Solutions Empower Masses with Affordability ,Accessibility and Quality Healthcare

URL:<http://www.wipro.com/documents/mhealth-solutions-empower-masses-with-affordability-accessibility-and-quality-healthcare.pdf> [ONLINE]

Accessed: 29 February 2016

29. A review of wearable sensors and systems with application in rehabilitation

[URL:https://jneuroengrehab.biomedcentral.com/articles/10.1186/1743-0003-9-21](https://jneuroengrehab.biomedcentral.com/articles/10.1186/1743-0003-9-21)

[ONLINE]

Accessed: 8 February 2016

30. IP Design for Mobile Networks

[URL:http://proquestcombo.safaribooksonline.com.ezproxy.metropolia.fi/book/networking/network-management/9781587059377/connectivity-and-transport/ch05lev1sec7#X2ludGVybmFsX0h0bWxWaWV3P3htbGikPTk3ODE1ODcwNTkzNzclMkZjaDAzbGV2MXNIYzMmcXVlcnk9](http://proquestcombo.safaribooksonline.com.ezproxy.metropolia.fi/book/networking/network-management/9781587059377/connectivity-and-transport/ch05lev1sec7#X2ludGVybmFsX0h0bWxWaWV3P3htbGikPTk3ODE1ODcwNTkzNzclMkZjaDAzbGV2MXNIYzMmcXVlcnk9) [ONLINE]

Accessed: 15 March 2016

31. LTE, LTE-Advanced and WiMAX: Towards IMT-Advanced Networks

[URL:http://site.ebrary.com.ezproxy.metropolia.fi/lib/metropolia/reader.action?docID=10510673&ppg=69](http://site.ebrary.com.ezproxy.metropolia.fi/lib/metropolia/reader.action?docID=10510673&ppg=69) [ONLINE]

Accessed: 29 March 2016

32. Building the Internet of Things with IPv6 and MIPv6 : The Evolving World of M2M Communications

[URL:http://site.ebrary.com.ezproxy.metropolia.fi/lib/metropolia/reader.action?docID=10722526&ppg=157](http://site.ebrary.com.ezproxy.metropolia.fi/lib/metropolia/reader.action?docID=10722526&ppg=157) [ONLINE]

Accessed: 3 April 2016

33. ZigBee sensor network integrated with 4G for IoT

[URL:http://www.academia.edu/7911880/ZIGBEE_SENSOR_NETWORK_INTEGRATED_WITH_4G_FOR_IOT](http://www.academia.edu/7911880/ZIGBEE_SENSOR_NETWORK_INTEGRATED_WITH_4G_FOR_IOT) [ONLINE]

Accessed: 6 April 2016

34. Wireless Pulse Oximeter

[URL:https://www.wpi.edu/Pubs/E-project/Available/E-project-042408-101301/unrestricted/WPO_MQP-Final_04242008.pdf](https://www.wpi.edu/Pubs/E-project/Available/E-project-042408-101301/unrestricted/WPO_MQP-Final_04242008.pdf) [ONLINE]

Accessed: 4 April 2016

35. Review of Future and Applications of Wearable Biosensors

[URL:http://www.techionix.com/articles/review-of-future-and-application-of-wearable-biosensors/](http://www.techionix.com/articles/review-of-future-and-application-of-wearable-biosensors/) [ONLINE]

Accessed: 4 April 2016

36. Non-contact ECG Measurement Using EPIC Sensors

[URL:http://www.saelig.com/supplier/plessey/Non-contact%20ECG%20measurement%20using%20EPIC-article0911312P.pdf](http://www.saelig.com/supplier/plessey/Non-contact%20ECG%20measurement%20using%20EPIC-article0911312P.pdf) [ONLINE]

Accessed: 6 April 2016

