



Title	An efficient method of computing impact degrees for multiple reactions in metabolic networks with cycles
Author(s)	Tamura, T; Cong, Y; Akutsu, T; Ching, WK
Citation	IEICE Transactions On Information And Systems, 2011, v. E94-D n. 12, p. 2393-2399
Issued Date	2011
URL	http://hdl.handle.net/10722/146395
Rights	IEICE Transactions on Information and Systems. Copyright © Institute of Electronics, Information and Communication Engineers.

PAPER

An Efficient Method of Computing Impact Degrees for Multiple Reactions in Metabolic Networks with Cycles*

Takeyuki TAMURA^{†a)}, Member, Yang CONG^{††}, Nonmember, Tatsuya AKUTSU[†], Member, and Wai-Ki CHING^{††}, Nonmember

University of Hong Kong Libraries

© The copy is for purposes of private study or scholarly research only.

You should delete the file as soon as a single paper copy has been printed out satisfactorily.

SUMMARY The impact degree is a measure of the robustness of a metabolic network against deletion of single or multiple reaction(s). Although such a measure is useful for mining important enzymes/genes, it was defined only for networks without cycles. In this paper, we extend the impact degree for metabolic networks containing cycles and develop a simple algorithm to calculate the impact degree. Furthermore we improve this algorithm to reduce computation time for the impact degree by deletions of multiple reactions. We applied our method to the metabolic network of *E. coli*, that includes reference pathways, consisting of 3281 reaction nodes and 2444 compound nodes, downloaded from KEGG database, and calculate the distribution of the impact degree. The results of our computational experiments show that the improved algorithm is 18.4 times faster than the simple algorithm for deletion of reaction-pairs and 11.4 times faster for deletion of reaction-triplets. We also enumerate genes with high impact degrees for single and multiple reaction deletions.

key words: metabolic networks, Boolean networks, impact degree, robustness

1. Introduction

Analyzing biological networks with various quantitative measures is one of the efficient methods for understanding biosystems. Among such measures, robustness is a paramount property for living organisms since vital functions must be sustained even when some genes are mutated. Since many and rather accurate network data are available from such databases as KEGG [13] and EcoCyc [14], we focus on the robustness of metabolic networks in this paper. It is known that knockout of a single gene does not necessarily cause the death of a cell. In many cases, there exist alternative pathways which compensate for inactivated pathways. In particular, it is suggested in [17] that cancer cells are very robust and thus identifying the origin of robustness of cancer cells may lead to new treatment methods for cancers and other difficult diseases.

For analyzing the robustness of metabolic networks, the *flux balance analysis* (FBA) methods [4], [8] have been extensively studied. Among various approaches based on

FBA, *elementary flux modes* (EFMs) play a key role, where an EFM is a minimal set of reactions that can operate at steady state [19], [20]. Based on FBA and/or EFM, several works have been done on finding a minimum set of enzymes/reactions deletion of which leads to prevention of the production of a specified set of compounds, which is called a *minimum reaction cut* [1], [5], [10], [16]. Recently, Behre et al. proposed a measure of structural robustness based on the number of remaining EFMs after knockout vs. the number of EFMs in the unperturbed situation [3]. Deutscher et al. proposed another measure using the Shaply value from the game theory [7]. However, applications of most of the above mentioned methods were limited to the middle-scale metabolic networks. One of the reasons is that EFM based methods are not efficient. Indeed, Klamt and Stelling showed that the number of EFMs grows exponentially with the network size [15], and Acuña et al. showed that finding a minimum reaction cut is NP-hard [1]. Furthermore, stoichiometry parameters, which are required for applying FBA-based methods, are not always easy to obtain. Therefore, other approaches should also be studied.

On the other hand, extensive studies have recently been done on structural analysis of metabolic networks [2], [11], [23], [24] based on such properties/concepts as *small world*, *scale-freeness* and *network motifs*. However, robustness and/or specific structural features of metabolic networks were not taken into account in these studies.

In order to study larger scale metabolic network data, Boolean models of metabolic networks have recently been studied [9], [12], [21], [22]. In particular, Jiang et al. introduced the concept of *impact degree* [12]. The impact degree is defined as the number of reactions inactivated by deleting a specified reaction (or a set of specified reactions). Although *damage* [18] is a similar notion of impact degree, damage considers only effects of successors of each reaction while impact degree takes the effects of predecessors into account. Impact degrees are useful both for analyzing the robustness of metabolic networks and for mining influential enzymes/genes (e.g., drug targets) from metabolic networks data. However, cycles are not taken into account in their method. Since cycles are important components of metabolic networks, it would be desirable to take the effects of cycles into account.

In this paper, we extend the impact degree so that it can be defined in metabolic networks with cycles by modifying the concept of the *maximal valid assignment* and its com-

Manuscript received May 23, 2011.

Manuscript revised September 9, 2011.

[†]The authors are with Bioinformatics Center, Institute for Chemical Research, Kyoto University, Uji-shi, 611-0011 Japan.

^{††}The authors are with Advanced Modeling and Applied Computing Laboratory, Department of Mathematics, The University of Hong Kong, Pokfulam Road, Hong Kong, China.

*A preliminary version has appeared in Proc. ACM Third International Workshop on Data and Text Mining in Bioinformatics (DTMBIO 2009), pp.67-70, 2009 as a short paper.

a) E-mail: tamura@kuicr.kyoto-u.ac.jp

DOI: 10.1587/transinf.E94.D.2393

putation method proposed in [22]. Maximal valid assignment is a notion based on the assumption that all compounds and reactions are initially active unless manually deleted. Without the notion of maximal valid assignment, we cannot uniquely calculate the impact degree in many cases due to the effect of cycles. Then, as a preliminary experiment, we calculate distributions of impact degree of a central part of the metabolic network of *E. coli* consisting of 253 reactions and 261 compounds downloaded from KEGG. The average impact degrees for deleting one reaction and two reactions are 1.9331 and 3.8461 respectively. Since the simple algorithm takes about 1 hour to obtain the distribution of impact degree by reaction-pair deletions, we develop a more efficient algorithm which can handle multiple reaction deletions for larger networks and confirm that the improved algorithm is 38.5 times faster than the simple algorithm in the preliminary experiment. Next, we apply the proposed method to the whole map of the metabolic network of *E. coli*, that includes reference pathways, of KEGG consisting of 3281 reactions and 2444 compounds. We calculate distributions of the impact degree for single-reaction, reaction-pair and reaction-triplet deletions and enumerate genes with high impact degrees. The average impact degrees are 2.651, 5.299 and 7.944 respectively. From theoretical analysis used by the improved algorithm and the result of computational experiment, it is seen that multiple reaction deletion causes cascade of failure in metabolism under a certain condition. However, in many cases, such difference is not observed when impact degrees by reaction-pair deletions are compared with the sums of impact degrees of two corresponding single-reaction deletions.

2. Impact of Single Deletion

We extend the definition of *impact degree* introduced in [12] so that cycles can be treated. Analysis of metabolic networks including cycles usually becomes harder because there may exist multiple stable global states. In order to uniquely determine the stable global state, the concept of the *maximal valid assignment* was introduced in [22] using a Boolean model of metabolic networks. Here, we give a new definition of the impact degree by combining these two concepts. This definition also provides an algorithm for computing the impact degree, which we call SIMPLE ALGORITHM.

Let $V_c = \{C_1, \dots, C_m\}$ and $V_r = \{R_1, \dots, R_n\}$ be a set of *compound nodes* and a set of *reaction nodes* respectively, where $V_c \cap V_r = \{\}$. Let $V = V_c \cup V_r$. It is to be noted that most reactions are catalyzed by enzymes and thus each reaction can be disabled in most cases by disruption of a gene corresponding to the enzyme catalyzing the reaction.

A *metabolic network* is defined as a directed graph $G(V, E)$ satisfying the following conditions: For each edge $(u, v) \in E$, either $(u \in V_c) \wedge (v \in V_r)$ or $(u \in V_r) \wedge (v \in V_c)$ holds. This means that $G(V, E)$ can be treated as a bipartite graph, where one part consists of reactions and the other consists of compounds. The state of each reaction (or com-

pound) is quantized to two levels: non-disabled (or activated) represented by 1 and disabled (or inactivated) represented by 0.

To calculate the impact degree of reaction R_i , we first only delete reaction R_i ($R_i = 0$, and $R_j = 1$ for all $j \neq i$) and activate all the compounds ($C_k = 1$). Then we deduce the states of reactions and compounds according to the following rules.

1. For each reaction, there are three different compounds: consumed compounds (i.e., substrates), produced compounds (i.e., products), and directly unrelated compounds.
2. Reaction should be inactivated if any consumed compound or produced compound is inactivated.
3. For each compound, there are three different reactions: consuming reactions, producing reactions, and directly unrelated reaction.
4. Compound should be inactivated if all its consuming reactions or all its producing reactions are inactivated.

We repeat the above procedure until the states are stable. The impact degree of the reaction is the number of inactivated reactions (represented by 0).

The above rules for reaction and compound can be represented by Boolean Functions. In Fig. 1, the state of reaction R is determined by $R = (C_1 \wedge C_2) \wedge (C_3 \wedge C_4)$, and the state for compound C is determined by $C = (R_{12} \vee R_2) \wedge (R_{11} \vee R_3 \vee R_4) = (R_1 \vee R_2) \wedge (R_1 \vee R_3 \vee R_4)$. There are two kinds of reactions, reversible reactions and irreversible reactions. We divide a reversible reaction into two irreversible reactions with opposite directions. In Fig. 1, reversible reaction R_1 is divided into two irreversible reactions R_{11} and R_{12} .

We can prove that the number of inactivated reactions and compounds increases monotonically and thus converges within $m + n$ repetitions, where m and n are the numbers of compounds and reactions respectively. We can also prove that the impact degree calculated by SIMPLE ALGORITHM is the same as the number of reactions assigned to 0 in the maximal valid assignment [22], where both production pathways and degradation pathways are taken into account here.

We use Fig. 2 to illustrate how to calculate the impact degree. To calculate the impact degree of reaction R_1 , we first set $R_1(0) = 0$, $R_2(0) = R_3(0) = 1$, $A(0) = B(0) = C(0) = D(0) = 1$. For compounds, we let $A(t+1) = R_1(t)$, $B(t+1) = (R_1(t) \vee R_2(t)) \wedge R_3(t)$, $C(t+1) = R_2(t)$ and $D(t+1) = R_3(t)$,

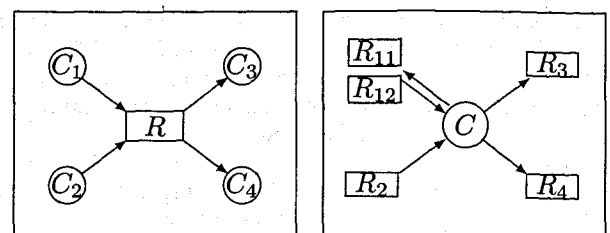

Fig. 1 Examples of reactions and compounds.

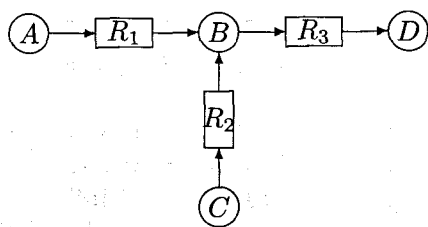

Fig. 2 An example of metabolic network.

then we have $A(1) = 0$, $B(1) = 1$, $C(1) = 1$, $D(1) = 1$, and $R_i(1) = R_i(0)$ for $i = 1, 2, 3$. For reactions, we let $R_1(t+1) = A(t) \wedge B(t)$, $R_2(t+1) = B(t) \wedge C(t)$, and $R_3(t+1) = B(t) \wedge D(t)$, then we have $R_1(2) = 0$, $R_2(2) = R_3(2) = 1$ and $A(2) = A(1)$, \dots , $D(2) = D(1)$. Note that we let $R_1(t) = 0$ for all t since R_1 is deleted. Then, the states become stable and thus the impact degree for reaction R_1 is 1. In the same way, we know that the impact degrees for deletion of R_2 and deletion of R_3 are one and three, respectively.

3. Impact of Multiple Deletion

SIMPLE ALGORITHM given in Sect. 2 can be trivially applied to the computation of impact degree for multiple reactions. Suppose that R_g and R_h are deleted. Then, we start with $R_g(0) = R_h(0) = 0$ and $R_i(0) = 1$ for all $i \neq g, h$ and $C_i(0) = 1$ for all i . However, it would take long CPU time if the impact degrees for all pairs of reactions should be computed. Therefore, we develop an efficient algorithm (called IMPROVED ALGORITHM) for computing the impact degrees for all pairs of reactions, where it can be generalized for triplets, quadruplets, \dots of reactions.

In order to explain the IMPROVED ALGORITHM, we begin with a simple example. In the metabolic network shown by Fig. 3, deletion of reaction R_1 impacts reactions R_1 , R_2 and compounds B , C . Deletion of reaction R_3 impacts only reaction R_3 . The deletion of reaction pair (R_1, R_3) impacts reactions R_1 , R_2 , R_3 and compounds B , C . In the aspect of reaction and compound, the impact of reaction pair (R_1, R_3) is the sum of impacts of deleting reaction R_1 and reaction R_3 separately. We call this case as *simplified case*.

For reaction R_i , *related reactions* are defined as the reactions disabled by deletion of R_i . We define *inactivated compounds* as all the compounds inactivated. *Related compounds* are defined as all the consumed and produced compounds for all the related reactions. *Remained compounds* of reaction R_i are defined as the compounds related but cannot be inactivated by reaction R_i . Table 1 lists the relationship among reactions and compounds in the metabolic network shown in Fig. 3.

Overlapped compounds are defined as the compounds that are remained for both reaction R_g and reaction R_h . For reaction pair (R_1, R_3) in Fig. 3, the overlapped compound is compound A . Since $A = R_1 \vee R_3 \vee R_6$, compound A cannot be inactivated by reaction pair (R_1, R_3) . The impact of R_1 and R_3 cannot be extended to any other compound except those inactivated by single deletion of R_1 or R_3 . Thus the

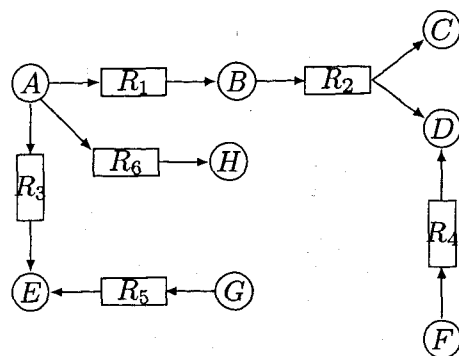

Fig. 3 An example for deletion of multiple reactions.

Table 1 Relationship among reactions and compounds.

R	R_{relate}	$C_{inactivate}$	C_{relate}	C_{remain}
R_1	R_1, R_2	B, C	A, B, C, D	A, D
R_2	R_1, R_2	B, C	A, B, C, D	A, D
R_3	R_3	-	A, E	A, E
R_4	R_4	F	D, F	D
R_5	R_5	G	E, G	E
R_6	R_6	H	A, H	A

impact of the reaction pair cannot extend to any reaction not related to R_1 and R_3 . This is why the reaction pair (R_1, R_3) is a simplified case. For reaction pair (R_1, R_5) , there is no overlapped compound. Obviously, the impact of the reaction pair only stays among the reactions related to R_1 and R_5 .

For reaction pair (R_g, R_h) , if any of the following two conditions is satisfied, then we have the simplified case. One condition is that there is no overlapped compound, e.g. reaction pair (R_1, R_5) . The other is, after setting all the related reactions to R_g and R_h disabled, no overlapped compound can be inactivated, e.g. reaction pair (R_1, R_3) or (R_1, R_2) . Then, the impact of the reaction pair is computed from the bitwise AND of the impact vectors for R_g and R_h .

On the other hand, if there exists at least one overlapped compound that can be inactivated, then we need to check the impact for the reaction pair, e.g. reaction pair (R_2, R_4) .

Based on the above ideas, we develop IMPROVED ALGORITHM as follows. We utilize the impact vector of single deletion, where we assume that a single impact vector \mathbf{v}_g (i.e., 0-1 vector representing reactions and compounds impacted by deletion of R_g) is already computed for every reaction R_g .

IMPROVED ALGORITHM(R_g, R_h)

```

for  $i = 1$  to  $n$  do  $R_i := \mathbf{v}_g(i) \wedge \mathbf{v}_h(i)$ .
for  $j = 1$  to  $m$  do  $C_j := \mathbf{v}_g(n+j) \wedge \mathbf{v}_h(n+j)$ .
 $t := 0$ ,  $M(t) := [R_1, R_2, \dots, R_n, C_1, C_2, \dots, C_m]$ .
if there exist overlapped compounds  $(C_{1'}, \dots, C_{s'})$  then

  flag := 0.
  for  $k = 1$  to  $s$  do

     $C_{k'} := (R_{pro}^1 \vee \dots \vee R_{pro}^{pk'}) \wedge (R_{con}^1 \vee \dots \vee R_{con}^{qk'})$ .
    if  $C_{k'} = 0$  then flag := 1.

```

if $s = 0$ or $flag = 0$ then return $\sum_{i=1}^n (1 - R_i)$.
 /* simplified case */

if $flag = 1$ then

while $M(t) \neq M(t-1)$ do

for $j = 1$ to m do

if $C_j \neq 0$ then

$C_j := (R_{pro}^1 \vee \dots \vee R_{pro}^{p_j}) \wedge (R_{con}^1 \vee \dots \vee R_{con}^{q_j})$.

if $C_j = 0$ then $R_{pro}^1 = \dots = R_{pro}^{p_j} := 0$, $R_{con}^1 = \dots = R_{con}^{q_j} := 0$.

$t := t + 1$, $M(t) := [R_1, \dots, R_n, C_1, \dots, C_m]$.

return $\sum_{i=1}^n (1 - R_i)$.

In the above, $R_{pro}^1, \dots, R_{pro}^{p_j}$ and $R_{con}^1, \dots, R_{con}^{q_j}$ denote producing reactions and consuming reactions for C_j respectively, and $v_k(i)$ denotes the value of the i -th position in vector v_k .

4. Computational Experiments

In Sect. 4.1, we conduct a preliminary experiment using a medium-scale network (514 nodes) with reaction-pair deletions to compare the efficiency of IMPROVED ALGORITHM with SIMPLE ALGORITHM. Then a large-scale network (5725 nodes) with deletion of reaction-triplets is analyzed in Sect. 4.2.

4.1 Preliminary Experiment with a Medium-Scale Network

We extract 253 reactions and 261 compounds of the metabolic network of *E. coli* from the KEGG database [13], among which 150 reactions are reversible. This extracted subnetwork is obtained by combining eco00010.xml, eco00020.xml, eco00030.xml, eco00040.xml, eco00051.xml, eco00052.xml, eco00053.xml, eco00061.xml, eco00062.xml, eco00071.xml, eco00100.xml, eco00120.xml, eco00130.xml of KEGG. Preliminary experiments are conducted on this extracted subnetwork.

Figure 4 (a) shows the distribution of impact degree by single deletion. The average impact degree among all the 253 reactions is 1.9331. In [12], the average impact among all the 3377 reactions in KEGG database was 1.98. Although our network is a subnetwork of [12], similar results are obtained. In Fig. 4 (a), we can observe a peak at the impact degree 7. This is because there are two groups of 7 reactions joining together in a chain shape. In each chain, the only producing compound of one reaction is the only consuming compound of the other reaction. The genes with high impact degrees are listed in Table 2, where GO (Gene Ontology) ID numbers are also shown if they are available, and we could not identify genes for some reactions.

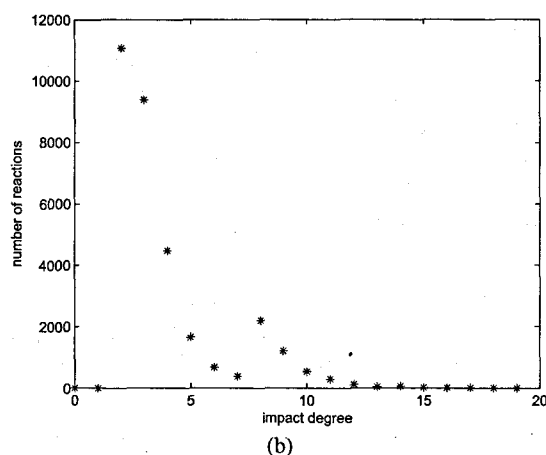
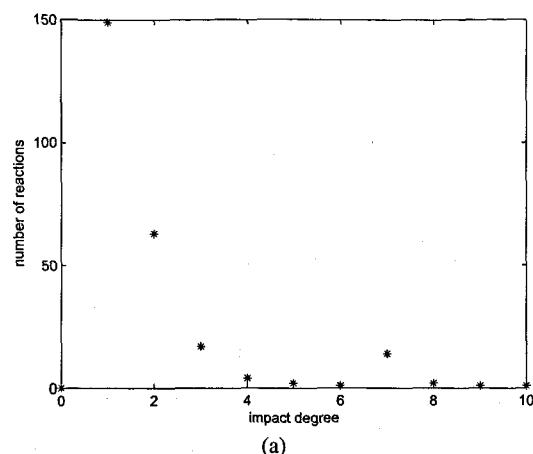

Fig. 4 Distribution of impact degree for (a) single-reaction deletion (b) reaction-pair deletion for a sub-network of the metabolic network of *E. coli*.

Table 2 Genes with high impact degrees.

impact	genes
9	fabD(GO:0004314)
8	ubiG, ubiC (0008813)
7	ispD, ispE, ispF, ispG, ispH dxr (GO:0008661), dxs, ubiB

Figure 4 (b) provides the distribution of the impact degrees of all the 32131 two-reaction pairs. The average impact degree is 3.8461. It is interesting that a peak is found at the impact degree 8. The existence of seven-reaction chains is a possible explanation (e.g., seven + one from a deleted pair).

For the metabolic network in the preliminary experiment, there are 32045 simplified cases (99.73%) against 32131 reaction pairs in total. For computation of the impact degrees for all pairs of two-reaction, SIMPLE ALGORITHM took 3427.7 seconds, whereas IMPROVED ALGORITHM took 88.9 seconds. This shows that IMPROVED ALGORITHM is 38.5 times faster than SIMPLE ALGORITHM (in this case). Preliminary experiments were performed via MATLAB 7.0 in Windows XP using an Intel 1.86 GHz processor with 512 MB RAM.

4.2 Experiment with a Large-Scale Network

Since efficiency of IMPROVED ALGORITHM can be seen in the preliminary experiment with reaction-pair deletion, we then apply IMPROVED ALGORITHM to the whole map of *E. coli* of KEGG database and reaction-triplet deletion. To conduct the experiment in tolerable computation time, the experiments are performed via GNU compiler for C on Xeon 5470 3.33 GHz CPU and 10 GB RAM running under the LINUX (version 2.6.16) operating system.

Figure 5 shows the distribution of impact degree by single deletion. The average impact degree among all the 3281 reactions is 2.651, which is larger than the result of [12], which is 1.98. The reason why a larger value is obtained is because cycles are taken into account in our model. Enzymes and genes with high impact degrees are listed in Table 3, where GO ID numbers are also shown if they are available. Deleting R00829 causes the highest impact de-

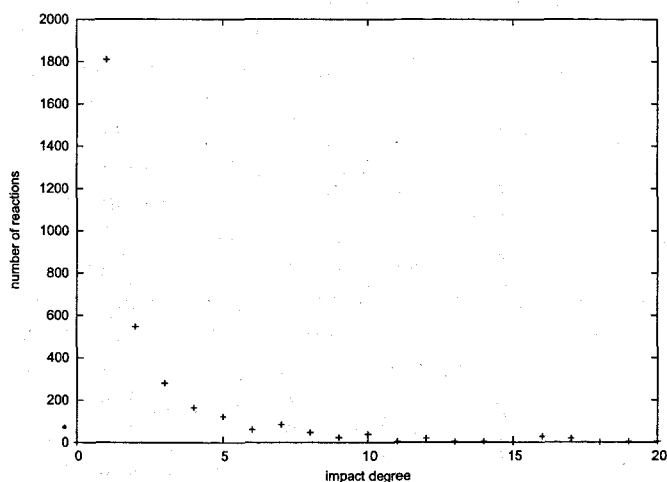

Fig. 5 Distribution of impact degree for single-reaction deletion. The average impact degree is 2.651. The maximum impact degree is 55. The average elapsed time is 0.41 sec.

gree, 55. Associated enzymes and genes are acetyl-CoA C-acyltransferase and (fadI, fadD) respectively. The second highest impact degree is 50 by R02990. Deleting R02988 causes the third highest impact degree, 48, and the associated enzymes and genes are maleylacetate reductase and tcbF respectively.

Figure 6 shows the distribution of impact degree by reaction-pair deletion for all the $_{3281}C_2$ cases. The average elapsed times by IMPROVED ALGORITHM and SIMPLE ALGORITHM were 4.766 sec. and 87.71 sec. respectively as shown in Table 4. This shows that IMPROVED ALGORITHM is 18.4 times faster than SIMPLE ALGORITHM in this case. The average impact degree is 5.299, which is slightly less than $5.302 (= 2.651 \times 2)$. Reaction-pairs with the highest impact degrees are shown in Table 5. Deleting (R00829, R00416) causes the highest impact degree, 100. Associated enzymes and genes are omitted since they appear also in Table 3. It is seen that most reactions appeared

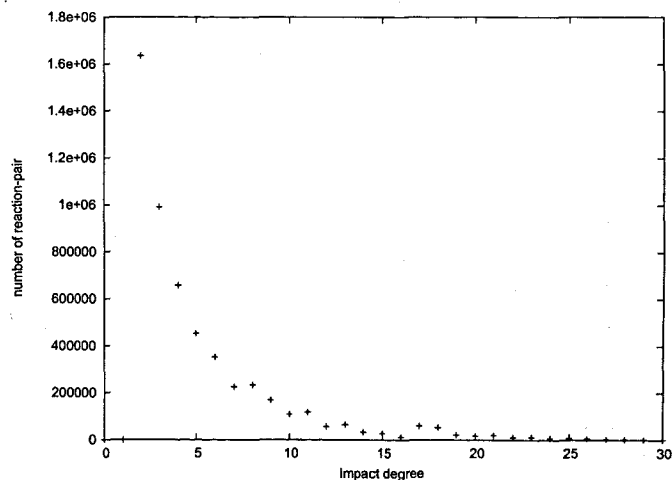

Fig. 6 Distribution of impact degree for reaction-pair deletion. The average impact degree is 5.299. The maximum impact degree is 100. The average elapsed time by SIMPLE ALGORITHM and IMPROVED ALGORITHM are 87.718 and 4.766 sec. respectively.

Table 3 Reaction, enzyme and gene with high impact degree by single-reaction deletion.

impact	reaction	enzyme	gene
55	R00829	acetyl-CoA C-acyltransferase	fadI, fadA
50	R02990	acetyl-CoA C-acyltransferase	fadI, fadA
48	R02988	maleylacetate reductase	tcbF
45	R00416	UDP-N-acetylglucosamine diphosphorylase	glmU(GO:0003977)
27	R03197	uroporphyrinogen decarboxylase	hemE(GO:0020037)

Table 4 Summary of experiment for large-scale network.

#reaction deletion	1	2	3
SIMPLE ALGORITHM	0.41 sec.	87.71 sec.	105923.37 sec. (29h25m23s)
IMPROVED ALGORITHM	-	4.766 sec.	9260.26 sec. (2h34m)
avg. impact degree	2.651	5.299	7.944
#reaction		3281	
#compound		2444	

Table 5 Reaction, enzyme and gene with high impact degree by reaction-pair deletion. Associated enzymes and genes are omitted if they appear in Table 3.

impact	reaction-pair	enzyme	gene
100	R00829, R00416		
95	R02990, R00416		
93	R02988, R00416		
82	R00829, R03197		
80	R00829		
	R03222	protoporphyrinogen oxidase	hemG(GO:0070818)

Table 6 Reaction, enzyme and gene with high impact degree by reaction-triplet deletion. Associated enzymes and genes are omitted if they appear in Table 3.

impact	reaction-pair	enzyme	gene
127	R00829, R00416, R03197		
125	R00829, R00416, R03222		
124	R00829, R00416		
	R04089	catechol 2,3-dioxygenase	GO:0018577
124	R00829, R00416		
	R05138	Hydrolases	

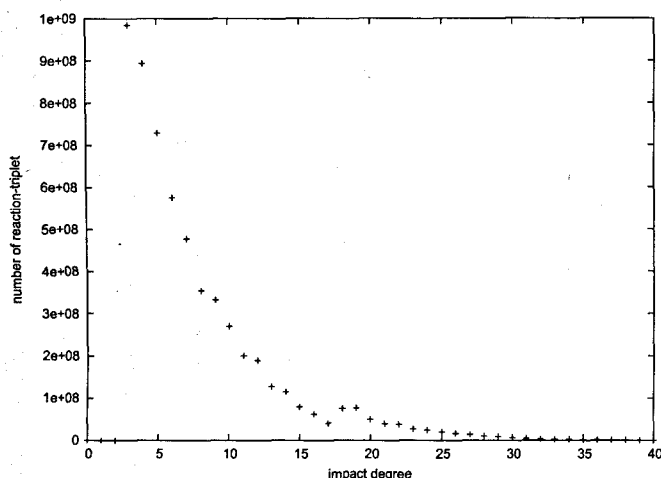
**Fig. 7** Distribution of impact degree for reaction-triplet deletion. The average impact degree is 7.944. The maximum impact degree is 127. The elapsed time by IMPROVED ALGORITHM and SIMPLE ALGORITHM are 9260.26 sec. (2h34m) and 105923.37 sec. (29h25m23s) respectively.

in Table 5 also appear in Table 3. The impact degree by deleting R00829 and R00416 (100) is the same as the sum of impact degrees of each deletion (55 + 45) since they distantly locate in the metabolic network. On the other hand, deleting (R00829, R02990), each of which causes the highest and second highest impact degree in single deletion respectively, impacts only 55 since R02990 is impacted by deleting R00829.

Finally, Fig. 7 shows the distribution of impact degree by reaction-triplet deletion for all the ${}_{3281}C_3$ cases. The elapsed times by IMPROVED ALGORITHM and SIMPLE ALGORITHM were 2h34m and 29h25m23s respectively as shown in Table 4. This shows that IMPROVED ALGORITHM is 11.44 times faster than SIMPLE ALGORITHM in this case. The average impact degree is 7.944, which is slightly less than $7.953 (= 2.651 \times 3)$. Reaction-triplets with the highest impact degrees are shown in Table 6. Deleting (R00829, R00416, R03197) causes the highest impact degree, 127.

5. Conclusions

In this paper, we have proposed algorithms for computing the impact degrees of deletions of single or multiple reaction(s) in a metabolic network including cycles. The results of our computational experiments suggest that the improved version of the algorithm is 10~20 times faster than the simple algorithm. We also calculated distributions of the impact degree of the metabolic network of *E. coli*, that includes reference pathways, downloaded from KEGG database. Furthermore, we enumerated reactions with high impact degree together with associated enzymes and genes.

Although we examined the cases of deletions of single reaction, two reactions and three reactions, our algorithms can be extended for deletions of more than three reactions. However, developing more efficient algorithm for checking whether overlapped compounds exist may be necessary when deleting more than three reactions. Although we focused on computational efficiencies of the proposed algorithms in this paper, analyzing the results of computational experiments from a biological viewpoint is left as future work. In particular, the relation between genes with high impact degree and essential genes should be examined.

Acknowledgment

The work was partially supported by JSPS KAKENHI 23700017.

References

- [1] V. Acuña, F. Chierichetti, V. Lacroix, A. Marchetti-Spaccamela, M.F. Sagot, and L. Stougie, "Modes and cuts in metabolic networks: Complexity and algorithms," *Biosystems*, vol.95, no.1, pp.51-60, 2009.
- [2] M. Arita, "The metabolic world of *Escherichia coli* is not small," *Proc. Natl. Acad. Sci. USA*, vol.101, no.6, pp.1543-1547, 2004.
- [3] J. Behre, T. Wilhelm, A. von Kamp, E. Rupp, and S. Schuster,

- "Structural robustness of metabolic networks with respect to multiple knockouts," *J. Theoretical Biology*, vol.252, no.3, pp.433–441, 2008.
- [4] H.P.J. Bonarius, G. Schmid, and J. Tramper, "Flux analysis of underdetermined metabolic networks: The quest for the missing constraints," *Trends in Biotechnology*, vol.15, no.8, pp.308–314, 1997.
- [5] A.P. Burgard, P. Pharkya, and D. Maranas, "OptKnock, A bilevel programming framework for identifying gene knockout strategies for microbial strain optimization," *Biotechnology and Bioengineering*, vol.84, no.6, pp.647–657, 2003.
- [6] Y. Cong, T. Tamura, T. Akutsu, and W.K. Ching, "Efficient computation of impact degrees for multiple reactions in metabolic networks with cycles," (short paper) *Proc. ACM Third International Workshop on Data and Text Mining in Bioinformatics (DTMBIO 2009)*, pp.67–70, 2009.
- [7] D. Deutscher, I. Meilijson, S. Schuster, and E. Rupp, "Can single knockouts accurately single out gene functions?," *BMC Systems Biology*, vol.2, no.50, 2008.
- [8] J. Edwards and B.O. Palsson, "Metabolic flux balance analysis and the in silico analysis of *Escherichia coli* K-12 gene deletions," *BMC Bioinformatics*, vol.1, no.1, 2000.
- [9] T. Handorf, N. Christian, O. Ebenhöf, and D. Kahn, "An environmental perspective on metabolism," *J. Theoretical Biology*, vol.252, no.3, pp.530–537, 2008.
- [10] U.U. Haus, S. Klamt, and T. Stephen, "Computing knock-out strategies in metabolic networks," *J. Computational Biology*, vol.15, no.3, pp.259–268, 2008.
- [11] H. Jeong, B. Tombor, R. Albert, Z.N. Oltval, and A.L. Barabási, "The large-scale organization of metabolic networks," *Nature*, vol.407, pp.651–654, 2000.
- [12] D. Jiang, S. Zhou, and T.-P.P. Chen, "Compensatory ability to null mutation in metabolic networks," *Biotechnology and Bioengineering*, vol.103, no.2, pp.361–369, 2009.
- [13] M. Kanehisa, M. Araki, S. Goto, M. Hattori, M. Hirakawa, M. Itoh, T. Katayama, S. Kawashima, S. Okuda, T. Tokimatsu, and Y. Yamanishi, "KEGG for linking genomes to life and the environment," *Nucleic Acids Research*, vol.36, pp.D480–D484, 2008.
- [14] P.D. Karp, I.M. Keseler, A. Shearer, M. Latendresse, M. Krummenacker, S.M. Paley, I. Paulsen, J. Collado-Vides, S. Gama-Castro, M. Peralta-Gil, A. Santos-Zavaleta, M.I. Penaloza-Spinola, C. Bonavides-Martinez, and J. Ingraham, "Multi-dimensional annotation of the *Escherichia coli* K-12 genome," *Nucleic Acids Research*, vol.35, pp.7577–7590, 2007.
- [15] S. Klamt and J. Stelling, "Combinatorial complexity of pathway analysis in metabolic networks," *Molecular Biology Reports*, vol.29, pp.233–236, 2002.
- [16] S. Klamt and E.D. Gilles, "Minimal cut sets in biochemical reaction networks," *Bioinformatics*, vol.20, no.2, pp.226–234, 2004.
- [17] H. Kitano, "Cancer as a robust system: Implications for anticancer therapy," *Nature Reviews Cancer*, vol.4, pp.227–235, 2004.
- [18] N. Lemke, F. Heredia, and C.K. Barcellos, A.N. dos Reis, and J.C.M. Mombach, "Essentiality and damage in metabolic networks," *Bioinformatics*, vol.20, no.1, pp.115–119, 2004.
- [19] J.A. Papin, J. Stelling, N.D. Price, S. Klamt, S. Schuster, and B.O. Palsson, "Comparison of network-based pathway analysis methods," *Trends in Biotechnology*, vol.22, no.8, pp.400–405, 2004.
- [20] S. Schuster and C. Hlgetag, "On elementary flux modes in biochemical reaction systems at steady state," *J. Biological Systems*, vol.2, no.2, pp.165–182, 1994.
- [21] P. Sridhar, B. Song, T. Kahveci, and S. Ranka, "Mining metabolic networks for optimal drug targets," *Proc. Pacific Symposium on Biocomputing 2008*, pp.291–302, 2008.
- [22] T. Tamura, K. Takemoto, and T. Akutsu, "Finding minimum reaction cuts of metabolic networks under a Boolean model using integer programming and feedback vertex sets," *International Journal of Knowledge Discovery in Bioinformatics*, vol.1, pp.14–31, 2010.
- [23] A. Wagner and D. Fell, "The small world inside large metabolic net-

works," *Proc. Royal Society of London B*, vol.268, pp.1803–1810, 2011.

- [24] D. Zhu and A.S. Qin, "Structural comparison of metabolic networks in selected single cell organisms," *BMC Bioinformatics*, vol.6, no.8, 2005.

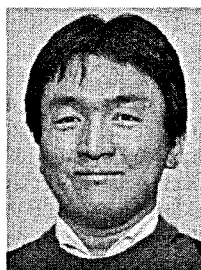

Takeyuki Tamura received B.E., M.E. and Ph.D. degrees in informatics from Kyoto University, Japan, in 2001, 2003, and 2006, respectively. He joined Bioinformatics Center, Institute for Chemical Research, Kyoto University as a postdoctoral fellow in April, 2006. He works as an assistant professor from December, 2007. His research interests are bioinformatics and the theory of combinatorial optimization.



Yang Cong received her B.S. degree in Computation Mathematics from Dalian University of Technology in China in 2007. She is a Ph.D. candidate majored in Mathematical and Computational Biology at The Department of Mathematics, The University of Hong Kong. Her research interests are multi-scale tumor modeling, system biology, metabolic networks, and application of Markov Chain in genetic regulatory networks.



Tatsuya Akutsu received his M.Eng. degree in Aeronautics in 1986 and a Dr.Eng. degree in Information Engineering in 1989 both from University of Tokyo, Japan. From 1989 to 1994, he was with Mechanical Engineering Laboratory, Japan. He was an associate professor in Gumma University from 1994 to 1996 and in Human Genome Center, University of Tokyo from 1996 to 2001 respectively. He joined Bioinformatics Center, Institute for Chemical Research, Kyoto University, Japan as a professor in Oct. 2001.

His research interests include bioinformatics and discrete algorithms.



Wai-Ki Ching is an associate professor in the Department of Mathematics at the University of Hong Kong. He was awarded the Best Student Paper Prize (2nd Prize) in the Copper Mountain Conference, the Outstanding Ph.D. Thesis Prize in the Engineering Faculty, the Chinese University of Hong Kong, Hong Kong (1998) and the Croucher Foundation Fellowship, Hong Kong (1999). His research interests are mathematical modeling, applied computing and Bioinformatics.