



<b>Title</b>	<b>A virtual dual-level reconfigurable additive manufacturing system for digital object fabrication</b>
<b>Author(s)</b>	<b>Choi, SH; Cai, Y</b>
<b>Citation</b>	<b>The 21st Annual International Solid Freeform Fabrication (SFF) Symposium: An Additive Manufacturing Conference, Austin, TX., 9-11 August 2010. In Proceedings of the 21st International SFF Symposium, 2010, p. 266-277</b>
<b>Issued Date</b>	<b>2010</b>
<b>URL</b>	<b><a href="http://hdl.handle.net/10722/134519">http://hdl.handle.net/10722/134519</a></b>
<b>Rights</b>	<b>Creative Commons: Attribution 3.0 Hong Kong License</b>

# **A virtual dual-level reconfigurable additive manufacturing system for digital object fabrication**

S.H. Choi, Y. Cai

*Department of Industrial and Manufacturing Systems Engineering,  
The University of Hong Kong, Hong Kong*

Reviewed, accepted September 23, 2010

## **Abstract**

This paper proposes a virtual dual-level reconfigurable additive manufacturing system (DRAMS) for simulation and verification of deposition strategies in digital fabrication of product prototypes. The DRAMS is aimed to improve additive manufacturing (AM) processes with the concept of system reconfiguration. It consists of adaptable support and manipulation modules for deposition of fabrication materials. Topologies are investigated to determine the structures of these modules, and methods are developed to evaluate and optimize the system configuration. Simulations show that the DRAMS can not only handle prototypes of different sizes and fabrication materials, but also increase the process speed. The DRAMS offers an effective tool for simulation, verification and optimization of deposition strategies under different system configurations to improve process performance.

## **1. Introduction**

Although there have been great developments in additive manufacturing (AM) technologies in recent years, some common drawbacks and process-specific deficiencies have yet to be addressed (Chua et al., 2003). A major limitation is that most AM processes are not rapid enough (Wohlers, 2008), particularly for fabricating large complex objects. Some processes are inherently slow because of the point-processing characteristics, while others may need tedious post-process operations. Another drawback is that most AM machines to date can only build objects of a single material or of a limited number of materials (Qiu et al., 2001;Zhu and Yu, 2002), despite there are huge demands for prototypes of heterogeneous materials (Choi and Cheung, 2007) for advanced manufacturing and biomedical applications. Although some processes may be capable of multi-material deposition, few have taken full advantage of their potential, because of the limitations of the hardware mechanism and the control software (Bourell et al., 2009). A further issue seems that most AM machines can only build relatively small objects in comparison with subtractive manufacturing processes.

A possible approach to mitigating the above problems would be to combine the concept of reconfigurable manufacturing system (RMS) with AM technologies. An RMS (Mehrabi et al., 2000) is often characterised by modular component machine design and open-architecture controllers, and is designed for rapid adjustment of production capacity and functionality in response to sudden market changes or new circumstances. The word “reconfigurable” indicates that both basic hardware and software process modules can be quickly and reliably replaced or rearranged in order to fulfil variable requirements (Mehrabi et al., 2002). The integration with RMS will change an AM machine from the current fixed structure to a relatively responsive one, and will bring about benefits in many ways. Build time reduction in AM could be achieved with concurrent deposition by multiple modules and advanced process planning. Material diversity of prototypes could be handled by adding new modules, while size variation could be settled by changing parameters of modules or by adjusting the layout of modules. Different geometrical accuracy requirements could be met by employing corresponding modules with required precision. Moreover, by adding non-AM modules, hybrid process can be realized with relative

ease for electronic component embedment and contour milling, etc. Thus, the capability of AM machines can be greatly enhanced.

In this paper, a virtual dual-level reconfigurable additive manufacturing system (DRAMS) is proposed to improve additive manufacturing (AM) processes with the concept of system reconfiguration. The DRAMS is aimed to simulate vector-based AM processes, which are relatively flexible for fabricating multi-material objects; it consists of adaptable support and manipulation modules for deposition of fabrication materials. A virtual AM machine built with these modules can easily change its configuration to suit its performance and user requirements, while different material deposition strategies can be explored, verified and compared. As such, build time can be reduced, geometrical accuracy improved, and product size and materials varied easily. The DRAMS adopts virtual manufacturing technology to alleviate the risks and shorten the cycle of building a physical AM system. Moreover, it provides flexibility for studying possible integration of RMS with AM technologies.

The rest of the paper is organised as follows. The elements and workflow of the DRAMS will be described in detail in Section 2, while selection and modelling of manipulation and support modules in the DRAMS will be discussed in Section 3. Evaluation and optimization methods of different deposition strategies will be discussed in Section 4, and implementation and simulations with the DRAMS will be presented in Section 5. Finally, conclusions and future works will be given in Section 6.

## **2. The dual-level reconfigurable additive manufacturing system (DRAMS)**

The proposed DRAMS is a software system consisting of a suite of adaptable support and manipulation modules, from which a virtual vector-based AM machine can be easily built and reconfigured to suit different requirements for digital fabrication of multi-material objects. As such, simulation and analysis of deposition strategies of fabrication materials can be carried out conveniently.

Material deposition strategy is mainly concerned with three aspects of an AM process. The first aspect is the choice of process control parameters, such as build orientation, layer thickness and hatch space, which affect the surface quality and build time of the prototype (Choi and Chan, 2004). The second aspect is planning toolpaths for internal contour filling and for controlling the sequence of tool motions. While contour filling concerns mainly with what pattern a contour in a specific layer is filled, tool sequencing aims to coordinate the motions of a number of tools (nozzles) to build a multi-material product safely and efficiently. The last aspect, which is an original concept in RMS and seldom applied in AM, is about the configuration of an AM system under which a prototype can be best fabricated. Indeed, by making some changes in the system configuration of a reconfigurable AM machine, for example, changing the structural parameters of a mechanical module, adding more nozzles or transferring the layout of modules within the system, the fabrication performance, such as build time and work envelope, can possibly be improved. We attempt to address this aspect by taking advantage of the concept of reconfiguration to help further develop AM.

Fig. 1 shows the main elements and the workflow of the proposed DRAMS. It mainly consists of three sections, namely building section, simulation section and result section. Detailed NC control codes are not included in the DRAMS, for we focus on simulation and verification of different deposition strategies, instead of on detailed NC command realization.

There are two levels of reconfigurability in the DRAMS. The first level is module-based that provides reconfigurability of mechanical hardware modules of a virtual AM machine. The user can select from the module library a range of support and manipulation modules and change their structural parameters accordingly. Moreover, the layout of these modules in the virtual machine can be adjusted to suit specific requirements of the fabrication process. The second level is control software-based that provides reconfigurability in toolpath planning. From the toolpath library, the user can select zigzag-style or spiral-style contour filling strategy, sequential or concurrent tool sequencing strategy. The user can also develop specific hardware module or toolpath planning strategies and incorporate them into the DRAMS, if necessary. These two levels of reconfigurability make the DRAMS greatly suitable for simulation and verification of different deposition strategies.

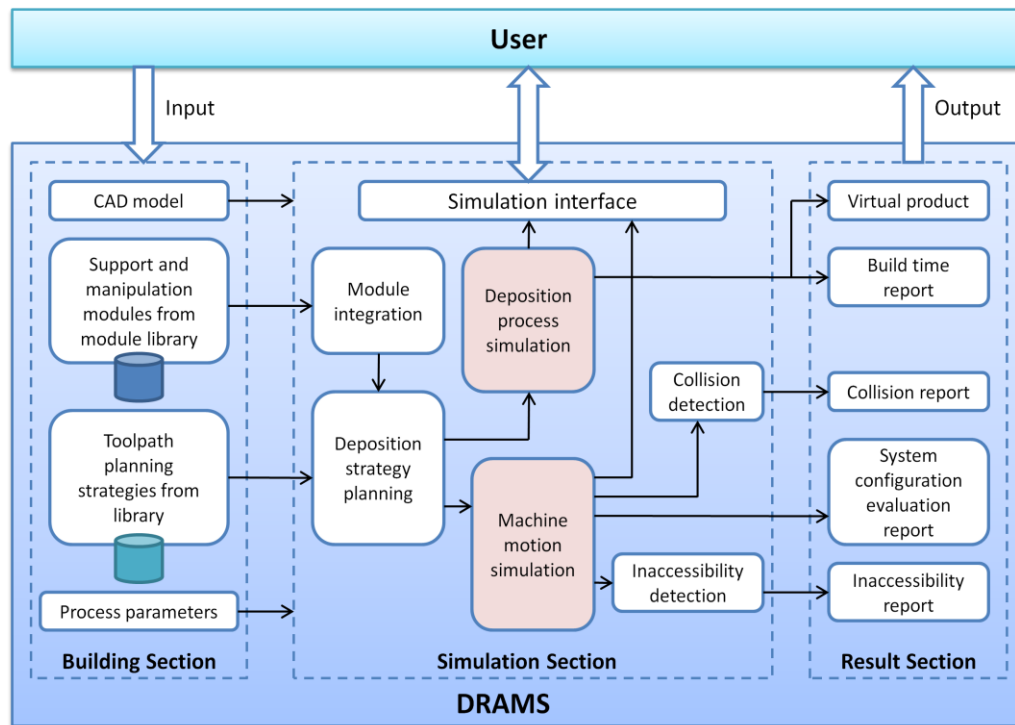

Fig. 1. Main elements and flow of the DRAMS

The operation of the DRAMS to build a virtual AM machine for digital fabrication of a prototype is as follows:

In the building section, the user can input and preview a colour STL model of an object in the DRAMS. Geometric information like volume and number of materials can be extracted accordingly for selection of a number of support and manipulation modules in the module library. These modules can be parameterized and placed at proper locations to build a virtual AM machine capable of fabricating the prototype of the required size and number of materials. Details of support and manipulation modules will be described in Section 3.

With the virtual AM machine, the user can now perform digital fabrication of a prototype following the three main steps shown in Fig. 2, namely pre-simulation, fabrication simulation and post-simulation. This process can be iterated conveniently until a desirable digital prototype is fabricated.

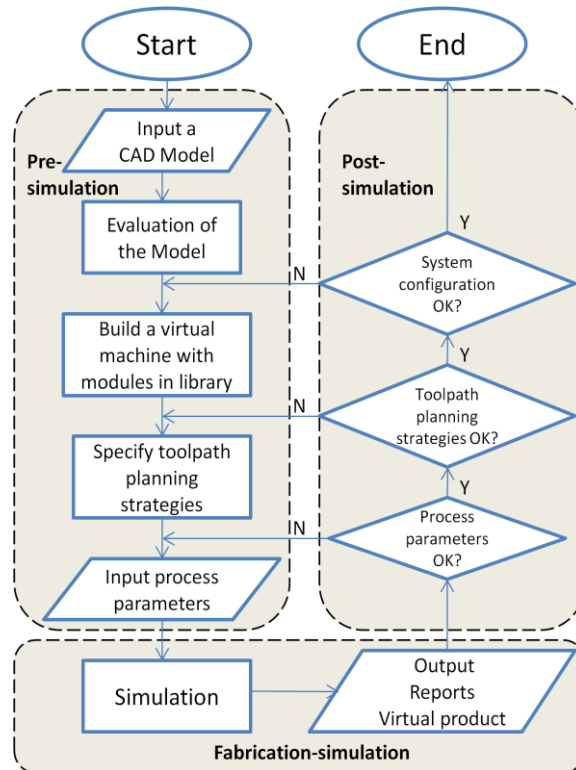

Fig. 2. Operation processes with the DRAMS

In the pre-simulation step, the user can specify the contour filling strategy and tool sequencing strategy from the toolpath planning library, for example, either sequential or concurrent deposition. Process parameters, like the build orientation, the layer thickness and the hatch space can also be specified accordingly. All these input data will be used for simulation of material deposition and tool motions in the simulation section.

In fabrication simulation step, deposition of materials highlights the building process of a prototype, which is simulated by adding rectangular strips one by one (Choi and Chan, 2002) as in real operations. Machine motion simulation shows the locations of tool modules and their motion sequences according to the toolpath planning strategies. Collision detection and inaccessibility detection are carried out and reported accordingly. The simulation results can be graphically visualized on the PC screen.

In the post-simulation step, the resulting digital prototype together with quality information and reports of collisions, inaccessibility and build time during the fabrication process is generated. The user can thus evaluate and improve the deposition strategy accordingly. Evaluation and optimization methods of different deposition strategies will be discussed in Section 4.

### 3. Module Design of the DRAMS

According to the characteristic of 2.5-axis deposition process in AM, a variety of kinematic structures are investigated, and some are selected as support modules or manipulation modules in the DRAMS after considering both kinematic requirements and realization possibilities. With these modules, a virtual AM machine can be built with ease and its configuration can be changed

to meet different requirements. As shown in Fig. 3, a virtual reconfigurable AM machine built in the DRAMS typically includes a module platform, one or more support modules, and one or more manipulation modules.

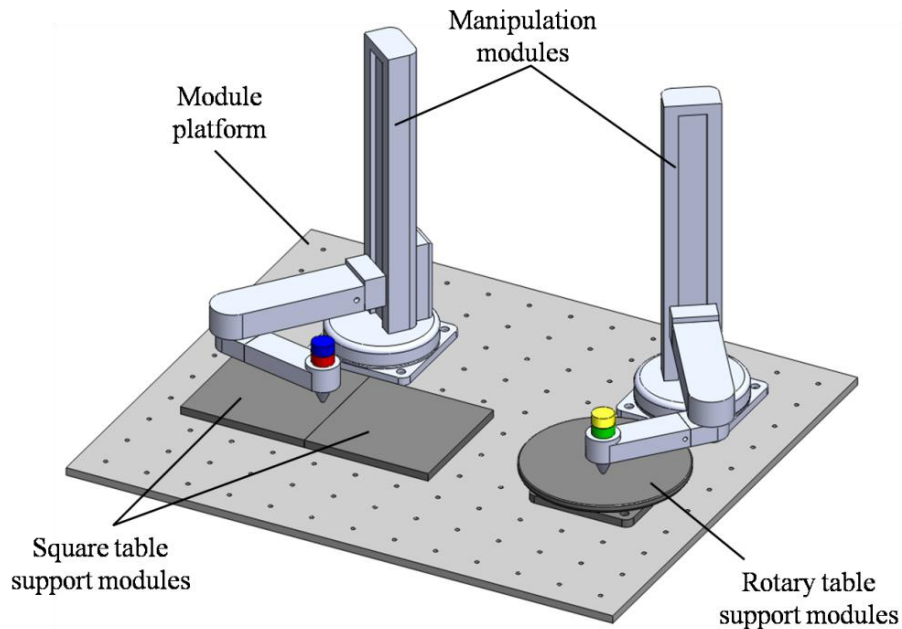

Fig. 3. A typical virtual reconfigurable AM machine in the DRAMS

### 3.1 Module Platform

The module platform in the DRAMS is a workbench on which support and manipulation modules can be located. Positioning holes with constant inter-distance are distributed on the module platform. In real practice, they not only help to determine the relative locations among the modules, but also provide easy fixation of these modules by using common interfaces like bolt-bowel pin system.

### 3.2 Support Modules

Product prototypes are built on support modules. In general, industrial FDM machines adopt a gantry configuration with three translational axes. While the X- and Y-axes position a tool, the Z axis is usually associated with a support table that descends incrementally one layer thickness after the previous layer is built. Such a configuration of 2.5-axis tool motion is virtually inextendable (Djuric and Urbanic, 2009), especially for large prototypes and more sophisticated deposition strategies. Another drawback is that it may be difficult to assure all the deposition nozzles are coplanar in the X-Y plane for multi-material deposition. Therefore, a support module in the DRAMS is designed as a square table without Z-motion, which can be mounted at appropriate positioning holes on the module platform. A few support modules can form a larger table for large prototypes if necessary. The lost Z-motion is instead compensated by that of a manipulation module, which is 2.5-axis-motion capable.

To facilitate more sophisticated deposition strategies to enhance the fabrication process, a rotary support table is also designed in the DRAMS. Although this rotary motion may seem to be redundant, it can bring about more flexibility in the deposition process. For example, by rotating the prototype being built by a certain angle, collisions between manipulation modules can be avoided during concurrent deposition. Thus, the build time can be reduced.

### 3.3 Manipulation Modules and End Effector

A manipulation module transports nozzles to fabricate a prototype on support modules. Fig. 4 shows three types of manipulation modules with common topologies of 3-Degrees-Of-Freedoms (3-DOFs). The motion of the manipulation modules is 2.5-axis, with simultaneous motion in the X-Y plane only.

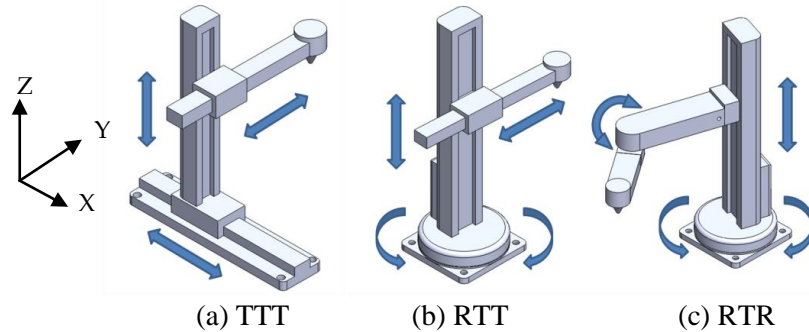

Fig. 4. Manipulation modules with common 3-DOF topologies

The TTT topology in Fig. 4(a) has three translational DOFs; it is commonly used and relatively easy to implement. The kinematic equations for this topology are simple, and good motion accuracy can be realized with precise ball-screw driving stages. However, modules with this topology may suffer relative small work-envelop/module-size ratio because the work envelop is strictly constrained by the motion range of the three axes. This drawback also makes it inconvenient for multiple modules to work together. The RTT topology in Fig. 4(b) has instead two translational and one rotary DOF, which employs cylindrical coordinate system.

The kinematic equations for this topology are also simple, because the relative direction and distance between certain positions are easy to calculate. Though RTT topology has a larger work-envelop/module-size ratio than the previous one, yet its maximal work envelop remains limited by the length of the horizontal arm. However, increasing the length of the arm may hamper concurrent operation of multiple modules because of increased potential collision. The RTR topology in Fig. 4(c), on the other hand, has one translational and two rotary DOFs, and its variants have been widely used in Selective Compliance Assembly Robot Arm (SCARA). Despite the fact that its kinematic equations are relatively more complicated, RTR has the largest work-envelop/module-size ratio among the three topologies. A comparison of the work envelopes of these three topologies with similar module sizes is shown in Fig. 5, in which the theoretical work envelopes and the equivalent square work envelopes are shown in solid lines and dashed lines, respectively. In this RTR topology, additional work envelop can be obtained without significant increase in module size by adjusting the lengths of the links through stretchable links and dowel pins. As AM application is mostly of low load-bearing, a structure with high rigidity may not be needed for the module structure. Moreover, good motion accuracy has been reported in commercial SCARA machines of this topology variance (EPSON, 2010). These characteristics make RTR a suitable topology for manipulation modules in the DRAMS.

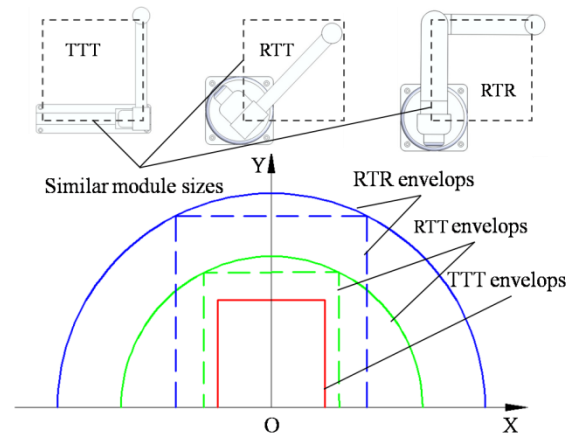

Fig. 5. Comparison of the work envelopes



The end effector of a manipulation module is an extrusion head carrying one or more nozzles from which deposition materials are extruded. An extrusion head of a standard industrial FDM system usually has two nozzles, one for deposition of build material, and the other for support material. For some biomedical applications, more nozzles may be attached on the extrusion head (Khalil and Sun, 2007). Theoretically, a number of nozzles can be attached on an extrusion head, but this will make the machine quite cumbersome. In the DRAMS, it is assumed that a single extrusion head holds no more than four nozzles. The colour cylinders on top of an extrusion head indicate the materials to be deposited, as is shown in Fig. 3.

#### 4. Methods for Deposition Strategy Evaluation and Optimization

Among the three aspects in AM deposition strategy, this paper focuses on the toolpath planning and the system configuration of the virtual AM machine, since the other aspect – process control parameters, has been widely studied. Three criteria, namely build time, dexterity, and safety, are adopted to evaluate and optimize deposition strategies and to improve process performance.

##### 4.1 Build time criterion

Build time reduction is achieved mainly by concurrent deposition of nozzles, but a single value of build time does not reveal much about the level of concurrent multi-material deposition, as well as the suitability of the system configuration. We therefore propose a *concurrency index (CI)* to evaluate the system configuration and efficiency, in addition to build time. The *CI* is defined as follows:

$$CI = (n, C)$$

where  $n$  is the number of manipulation modules, and  $C$  is the concurrence level of the deposition strategy. It is given by:

$$C = \frac{(T_s - T)}{(T_s - T_c)} \quad (1)$$

where  $T$  is the real build time in the current deposition strategy, and  $T_s$  is the build time in sequential deposition strategy; and  $T_c$  is the ideal build time if all manipulation modules can deposit concurrently. It is given by:

$$T_c = \frac{T_s}{n} \quad (2)$$

With the definition of *CI*, we can evaluate and compare different deposition strategies, based on the system configuration and the concurrency level. For example, for the same prototype built with identical process control parameters, a virtual AM machine with a *CI* of (2, 0.6) builds faster than one with a *CI* of (2, 0.3), and a virtual AM machine with a *CI* of (4, 0.6) also builds faster than one with a *CI* of (2, 0.6). System configuration, deposition concurrency level, and efficiency can all be reflected in *CI*.

##### 4.2 Dexterity criterion

In order to express how a relative error in the joint variables gets amplified and brings in a relative error in the end effector, an error amplification factor, defined as the *condition number  $\kappa$*  (Merlet, 2006), is adopted.  $\kappa$  has been generally accepted for measuring local performance and evaluating velocity and accuracy mapping between

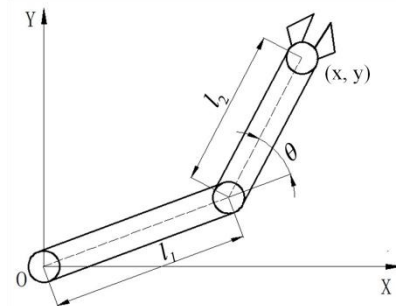

Fig. 6. A typical 2-DOF planar structure



the joint variables and the end effector, as well as robot dexterity (Huang et al., 2004;Kircanski, 1994) .

For a 2-DOF planar structure shown in Fig. 6, which is the same as the two rotary DOFs in manipulation modules in the DRAMS, the condition number  $\kappa$  can be calculated by (Kircanski, 1994):

$$1 \leq \kappa = \sqrt{\frac{l_1^2 + 2l_2^2 + 2l_1l_2 \cos \theta + \sqrt{(l_1^2 + 2l_2^2 + 2l_1l_2 \cos \theta)^2 - 4l_1^2l_2^2 \sin^2 \theta}}{l_1^2 + 2l_2^2 + 2l_1l_2 \cos \theta - \sqrt{(l_1^2 + 2l_2^2 + 2l_1l_2 \cos \theta)^2 - 4l_1^2l_2^2 \sin^2 \theta}}} \leq \infty \quad (3)$$

where  $l_1$  and  $l_2$  are the lengths of the two links respectively, and  $\theta$  is the angle between the two links. The cosine and sine of  $\theta$  are given by:

$$\cos \theta = \frac{x^2 + y^2 - l_1^2 - l_2^2}{2l_1l_2} \quad (4)$$

$$\sin \theta = \sqrt{1 - \cos^2 \theta} \quad (5)$$

For a kinematic structure, the closer  $\kappa$  is to 1, the better the accuracy and dexterity of the structure will be (Merlet, 2006). The maximum value of  $\kappa$ ,  $\kappa_{\max}$ , should be recorded to evaluate the worst situation. However, since  $\kappa$  may vary with different kinematic poses due to changes in  $\theta$ , a global performance index is also used as the dexterity measure in the DRAMS:

$$1 \leq \bar{\eta} = \frac{1}{N} \sum_{n=1}^N \kappa_n \leq \infty \quad (6)$$

where  $\kappa_n$  is the local value of  $\kappa$  evaluated at the  $n^{\text{th}}$  grid of the total  $N$  grids meshed equally in the contours on each layer. Though its acceptable upper boundary may differ in different application scenarios (usually no more than 5), the value of the global performance index,  $\bar{\eta}$ , should be as close to 1 as possible to ensure satisfactory performance of an AM machine (Huang et al., 2004;Wu et al., 2007). This is because a large value of  $\bar{\eta}$  implies that even a slight error in the joint angle may bring about obvious motion deviations in the end effector, hampering the accuracy of the prototype.

### 4.3 Safety criterion

Manipulation modules are likely to collide when they deposit multiple materials concurrently. Collision detection is therefore essential to ensure the safety and effectiveness of a deposition process. The DRAMS detects potential collisions of the extrusion head and the joints of a manipulation module with the similar parts of other manipulation modules. Because of the characteristic of 2.5-axis motion in AM, collision detections can be executed in 2D X-Y plane. To further increase the detection efficiency, the extrusion head and joints in a manipulation module are simplified as a circle in the collision detection, while the links are rectangles.

## 5. Implementation of the DRAMS

The design and criteria presented above are incorporated in Microsoft Visual C++ to develop a prototype of the proposed DRAMS for digital fabrication of multi-material objects. OpenGL is adopted for graphics rendering of the machine support and manipulation modules. Case studies are carried out to validate the effectiveness of the DRAMS for building virtual AM machines to help reduce build time and handle prototypes of different sizes and materials.

### 5.1 Build time reduction

To illustrate the effects of different deposition strategies on build time, a discrete multi-material sample part, as shown in Fig. 7, is fabricated using a virtual AM machine built in the DRAMS with different configurations. The size of the part is  $388\text{mm} \times 233\text{mm} \times 50\text{mm}$ . A dashed envelope around a contour represents the work area in which the related extrusion head can deposit the contour safely, while overlapping envelopes indicate that potential collisions of extrusion heads may occur if they deposit concurrently.

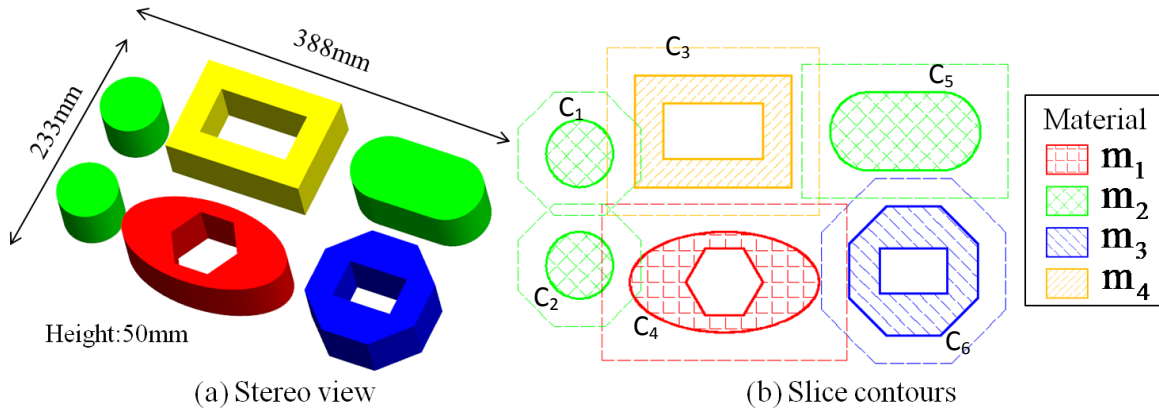

Fig. 7. A discrete multi-material sample part

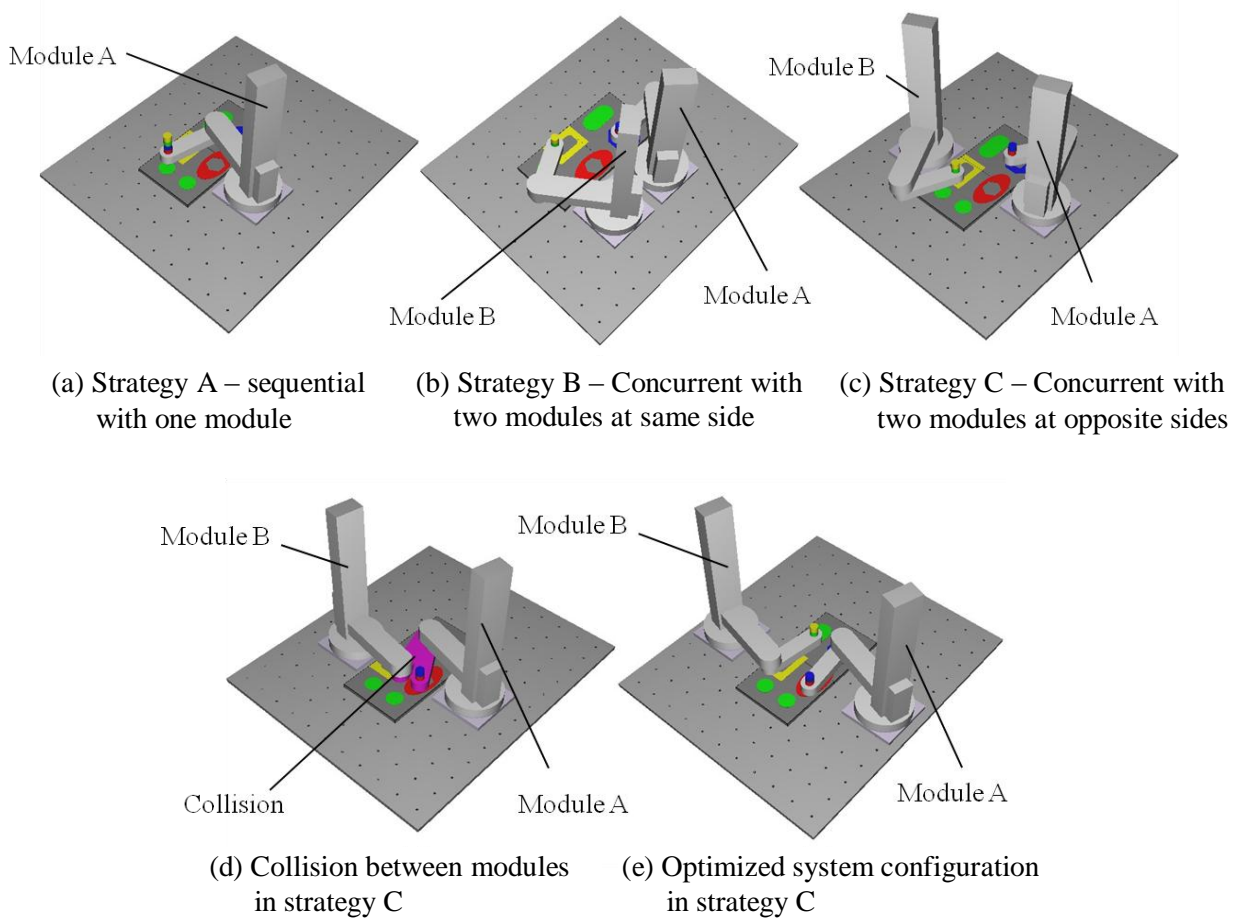

Fig. 8. Deposition strategies for the fabrication of the sample part

At present, most extrusion-based multi-material AM systems deposit materials one after another in a sequential manner. A virtual AM machine with a single manipulation module, as shown in Fig. 8(a), is built for sequential deposition. The manipulation module has four nozzles on its extrusion head, each for one material of the part. The deposition sequence of the contours is  $C_1 \rightarrow C_2 \rightarrow C_5 \rightarrow C_3 \rightarrow C_4 \rightarrow C_6$ . While such sequential toolpath is relatively easy to plan, it is slow for large prototypes.

As such, another manipulation module is added at the same side, as shown in Fig. 8(b), to deposit materials concurrently. The deposition is approximately equally shared between the two modules, i.e., Module A deposits materials  $m_1$  and  $m_3$  on contours  $C_4$  and  $C_6$ , while Module B deposits materials  $m_2$  and  $m_4$  on contours  $C_1$ ,  $C_2$ ,  $C_3$ , and  $C_5$ , respectively. Theoretically, Module B, which is at the left of Module A while facing the prototype, can deposit the contours at the left of the extrusion head of Module A without collision. Thus, for contours  $C_3$  and  $C_6$ , since  $C_3$  is at the left of  $C_6$ , and their safety envelopes do not overlap, these two contours can be deposited by Modules A and B concurrently. However,  $C_1$ ,  $C_2$ ,  $C_4$ , and  $C_5$  have to be deposited sequentially because of their relative locations and overlaps of envelopes. The resultant deposition sequence is  $C_1 \rightarrow C_2 \rightarrow C_5 \rightarrow C_4 \rightarrow \{C_3, C_6\}$ , where concurrent deposition is partly realized.

To further reduce the build time, the virtual AM machine is further reconfigured by putting Modules A and B at the opposite sides of the support modules, as shown in Fig. 8(c). In this new configuration, Module B can access the contours both at the left and above the extrusion head of Module A without collision. Thus, in addition to concurrent deposition of  $C_3$  and  $C_6$ , contours  $C_4$  and  $C_5$  can be deposited simultaneously, because  $C_5$  is above  $C_4$  and their envelopes do not overlap. The resultant deposition sequence is further shortened as  $C_1 \rightarrow C_2 \rightarrow \{C_5, C_4\} \rightarrow \{C_3, C_6\}$ . However, due to the short distance between these two manipulation modules, collision between the links is detected, as is shown in Fig. 8(d). Therefore, the configuration in this deposition strategy is optimized by moving each manipulation module one positioning hole backwards to avoid collisions, as is shown in Fig. 8(e).

**Table 1** Comparison of the three deposition strategies

	Deposition strategy A	Deposition strategy B	Deposition strategy C
Process parameters	Layer thickness: 0.5mm. Layer number: 100. Hatch distance: 1.0mm. Deposition velocity: 100mm·s <sup>-1</sup> .		
Toolpath planning	Zigzag-style contour filling, sequential nozzle deposition.	Zigzag-style contour filling, semi-concurrent nozzle deposition.	Zigzag-style contour filling, semi-concurrent nozzle deposition.
System configuration	One manipulation module with four nozzles.	Two manipulation modules on the same side of the support modules. Each has two nozzles.	Two manipulation modules on opposite sides of the support modules. Each has two nozzles.
Build time	693.75mins	545.25mins	405.58mins
<i>CI</i>	(1, 0)	(2, 0.43)	(2, 0.83)

The simulation options and results of build time and *CI* of these three deposition strategies are listed in Table 1. As indicated in Table 1, strategy B and strategy C shorten the build time by 21.0% and 42.0%, respectively, in comparison with the sequential deposition in strategy A. With only one manipulation module and sequential deposition, the *CI* of strategy A is (1, 0),

which indicates that module resource is saved at a cost of relatively long build time. For strategy B and strategy C, the  $CI$ s are (2, 0.43) and (2, 0.83), respectively, indicating that two manipulation modules can work together in these two strategies to improve the level of concurrence. In this case study, simulation, verification and optimization of deposition strategies with different system configurations have been conducted with the DRAMS to improve process performance.

## 5.2 Prototype size adaption

To fabricate large product prototypes, a number of square support modules can together form a larger table, and manipulation modules can be reconfigured to expand the work envelop by adjusting the link lengths through stretchable links and dowel pins, as shown in Fig. 9(a). However, the increase in these lengths may reduce structural rigidity and lead to a large global performance index  $\bar{\eta}$ . Thus, the motion accuracy may be affected. Another method is to add more manipulation modules in the virtual AM machine while the link lengths are controlled within a proper range, as in Fig. 9(b). This method not only avoids hampering the accuracy, but also increases process speed with concurrent deposition, though complex process planning may be needed. In another scenario, a number of support modules can be placed around a manipulation module in a C style, thus a large prototype can be fabricated with only one manipulation module, as is shown in Fig. 9(c). Moreover, multiple manipulation modules can work together around support modules to reduce the build time, as is shown in Fig. 9(d). Overall, the DRAMS offers great flexibility for simulation and verification of different deposition strategies for fabrication of large prototypes.

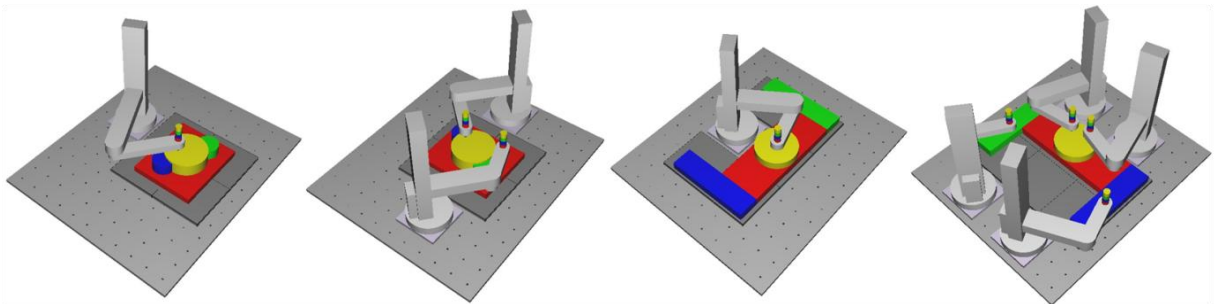

(a) Adjusting link lengths; (b) Dual modules operation; (c) C-style layout; (d) Multiple modules operation.

Fig. 9. Fabrication of large prototypes in the DRAMS

## 6. Conclusions and Future Work

This paper presents a virtual dual-level reconfigurable additive manufacturing system (DRAMS) for simulation and verification of deposition strategies in digital fabrication of product prototypes. The DRAMS integrates the concept of system reconfiguration with additive manufacturing (AM). Topologies are studied to determine appropriate support structures and manipulation modules in the DRAMS by considering the kinematic requirements and realization possibilities. Using the DRAMS, a virtual AM machine can easily be built for digital fabrication of multi-material objects. Methods are developed to evaluate and optimize system configuration based on build time reduction, dexterity and safety requirements. Although the DRAMS is currently incorporated with only a few simple modules, simulations show that it can not only handle prototypes of different sizes and fabrication materials, but can also increase the process speed. The DRAMS offers an effective tool for simulation, verification and optimization of deposition strategies under different system configurations.

Future development of the DRAMS may be focused on several aspects. First, easy and reliable calibration methods should be developed for the modules after system reconfiguration in order to enhance practical operation. Second, since there are only a few simple modules in the DRAMS, more viable modules should be developed together with the associated system configurations and deposition strategies. Third, prototype quality information should be processed for evaluation of the associated deposition strategies.

## References

- Bourell, D.L., Leu, M.C. and Rosen, D.W. (eds.) 2009. *Roadmap for Additive Manufacturing-- Identifying the Future of Freeform Processing*. Austin, Texas: The University of Texas at Austin, Laboratory for Freeform Fabrication, Advanced Manufacturing Center.
- Choi, S.H. and Chan, A.M.M. 2002. A dextral-based virtual prototyping system for product development. *Rapid Prototyping Journal*, 8(5): 300-314.
- Choi, S.H. and Chan, A.M.M. 2004. A virtual prototyping system for rapid product development. *Computer-Aided Design*, 36(5): 401-412.
- Choi, S.H. and Cheung, H.H. 2007. Multi-material virtual prototyping for product development and biomedical engineering. *Computers in Industry*, 58(5): 438-452.
- Chua, C., Leong, K. and Lim, C. 2003. *Rapid prototyping: principles and applications*. World Scientific Publishing Company.
- Djuric, A. and Urbanic, J. 2009. Design and evaluation of reconfigurable robotic systems for 2 1/2 axis based material deposition strategies. *Integrated Computer-Aided Engineering*, 16(4): 315-338.
- EPSON. 2010. <http://www.robots.epson.com/products/e2rbts.htm>
- Huang, T., Li, Z., Li, M., Chetwynd, D. and Gosselin, C. 2004. Conceptual design and dimensional synthesis of a novel 2-DOF translational parallel robot for pick-and-place operations. *Journal of mechanical Design*, 126(3): 449-455.
- Khalil, S. and Sun, W. 2007. Biopolymer deposition for freeform fabrication of hydrogel tissue constructs. *Materials Science and Engineering: C*, 27(3): 469-478.
- Kircanski, M.V. 1994. Robotic isotropy and optimal robot design of planar manipulators. In: IEEE International Conference on Robotics and Automation. p.1100-1105
- Mehrabi, M.G., Ulsoy, A.G. and Koren, Y. 2000. Reconfigurable manufacturing systems: Key to future manufacturing. *Journal of Intelligent Manufacturing*, 11(4): 403-419.
- Mehrabi, M.G., Ulsoy, A.G., Koren, Y. and Heytler, P. 2002. Trends and perspectives in flexible and reconfigurable manufacturing systems. *Journal of Intelligent Manufacturing*, 13(2): 135-146.
- Merlet, J.P. 2006. Jacobian, Manipulability, Condition Number, and Accuracy of Parallel Robots. *Journal of mechanical Design*, 128(1): 199-206.
- Qiu, D., Langrana, N., Danforth, S., Safari, A. and Jafari, M. 2001. Intelligent toolpath for extrusion-based LM process. *Rapid Prototyping Journal*, 7(1): 18-24.
- Wohlers, T.T. 2008. Wohlers Report 2008. Fort Collins, Colorado: Wohlers Associates Inc.
- Wu, J., Li, T., Liu, X. and Wang, L. 2007. Optimal Kinematic Design of a 2-DOF Planar Parallel Manipulator. *Tsinghua Science & Technology*, 12(3): 269-275.
- Zhu, W. and Yu, K. 2002. Tool path generation of multi-material assembly for rapid manufacture. *Rapid Prototyping Journal*, 8(5): 277-283.