

3-2000

## A Primer on GIS-T Databases

J. Allison Butler

Kenneth Dueker  
*Portland State University*

Let us know how access to this document benefits you.

Follow this and additional works at: [http://pdxscholar.library.pdx.edu/cus\\_pubs](http://pdxscholar.library.pdx.edu/cus_pubs)



Part of the [Transportation Commons](#), and the [Urban Studies and Planning Commons](#)

---

### Citation Details

Butler, J. Allison and Dueker, Kenneth, "A Primer on GIS-T Databases" (2000). *Center for Urban Studies Publications and Reports*. 9.  
[http://pdxscholar.library.pdx.edu/cus\\_pubs/9](http://pdxscholar.library.pdx.edu/cus_pubs/9)

This Working Paper is brought to you for free and open access. It has been accepted for inclusion in Center for Urban Studies Publications and Reports by an authorized administrator of PDXScholar. For more information, please contact [pdxscholar@pdx.edu](mailto:pdxscholar@pdx.edu).

# **A Primer on GIS-T Databases**

**J. Allison Butler  
Hamilton County  
Tennessee**

**Kenneth J. Dueker  
Portland State University**

**March 2000**

**Center for Urban Studies  
Portland State University  
Portland OR 97207-0751**

**[www.upa.pdx.edu/cus/](http://www.upa.pdx.edu/cus/)**

## **Abstract**

This paper describes the primary database design approaches that have been and are being used in geographic information system applications for transportation (GIS-T). While not intending to be exhaustive, the paper covers the primary approaches used in federal, state, and local transportation agencies.

# Introduction

Geographic information systems (GIS) have been used by transportation agencies for many years. And, yet, significant progress has rarely been achieved toward realizing the promise of GIS as an integrator of data and operations in these agencies. A primary cause for this shortcoming is a lack of common definitions for transportation features and different representations of the transportation system. Legitimate differences in requirements frequently lead to application-specific definitions and representations of transportation features and their geometry.

Each major division of a transportation organization has a different perspectives of the transportation system that result in different networks to support various applications—vehicle navigation systems, overweight truck routing, facility location, address geocoding, and emergency management—or to supply a reference layer of roads for resource management applications. These applications define roads differently. Some include trails, private streets, alleys, and resource roads, while some do not. In addition, the level of detail and spatial accuracy differs. A state department of transportation may need to look at a large geographic area for long-range planning, or a very small area for a traffic operations project.

Geographic Information Systems in Transportation (GIS-T) applications have three quite different views of the transportation system. An inventory of the system focuses on the attributes of transportation features. Others may see transportation features as a framework for geocoding street addresses to coordinates or to various systems of small areas. And others may see the transportation system as a network for routing and navigation applications.

The challenge is to establish a means of data exchange among representations of the transportation system to support diverse applications. Also, the means of data exchange should lead to overall improvements in accuracy, consistency, and completeness *as the users of each system perceive these qualities*. And, more importantly in the long run, to share updates to maintain currency in representing the transportation system. At the same time, it is important to recognize the legitimacy of specialized representations needed to support specific applications.

We contend that the solution is to embrace this diversity within a unifying enterprise data model for GIS-T that allows each application group to meet their needs and enables the enterprise to integrate and share data. The primary objective of this model is to allow frequent transaction-based data exchanges and updates, the type that cooperating organizations are likely to need. As transportation agencies move towards a more integrated way of doing business, such as involving design units earlier in the project planning cycle, the need for data to cross former institutional or jurisdictional barriers will become greater.

The authors have proposed such a model (Dueker and Butler, 1998), but its implementation has been hampered by a lack of discussion of data models used in transportation. Consequently, the purpose of this paper is to provide a primer on data models used in transportation in order to understand strengths and weaknesses of different approaches to structuring transportation data.

Many GIS applications in transportation rely on GIS software that bundle all types of information about a transportation feature within a single object. It's an all or nothing affair for the user: to get the attributes for a roadway, the user must also accept the cartography and probably its relationships to other objects (topology). Such a tightly integrated GIS design hampers data exchange because it ignores the legitimate differences between GIS applications for cartography, networks and attributes.

Our approach is to replace the bundled or integrated transportation object with an unbundled approach for data integration that will support the development of application-specific databases that are interoperable within domains. This approach moves data sharing to a lower level, or intermediate level, database than the application databases themselves.

Interoperability is not possible between databases that do not share the same entity structure, i.e., have different definitions of links. We call for agreement on a broader set of transportation features.

Currently, the sharing of GIS data in transportation consists of matching one user's objects to another's, a process called conflation. Conflation attempts to match cartographic objects in two map databases. One of our primary objectives is to propose a means of avoiding cartographic conflation as a prerequisite for data exchange. This is our motive for recommending that GIS-T databases utilize an unbundled data model. Even if an agency does not want to share or exchange data with others, an unbundled approach provides a number of internal advantages, such as the ability to migrate to stay with changing technology and facilitation of distributed processing. Dueker and Butler (2000) develop this approach to data sharing.

## **Approach**

This paper reviews today's GIS data structures to foster a more systematic discussion of a comprehensive GIS-T data model. Each existing data structure is presented as a data model and a set of implementation choices that can support or work against data exchange. The paper uses a data model approach to guard against ambiguities and provide a basis for the development of the operating framework and principles for sharing transportation data.

We will utilize the entity-relationship diagram (ERD) to graphically express each of these data models. An ERD consists of entities, the things in which we are interested, and relationships, how those things interact with each other. Our ERDs will use the symbols shown in Figure 1.

**Figure 1.** *Entity-relationship diagram symbols.*

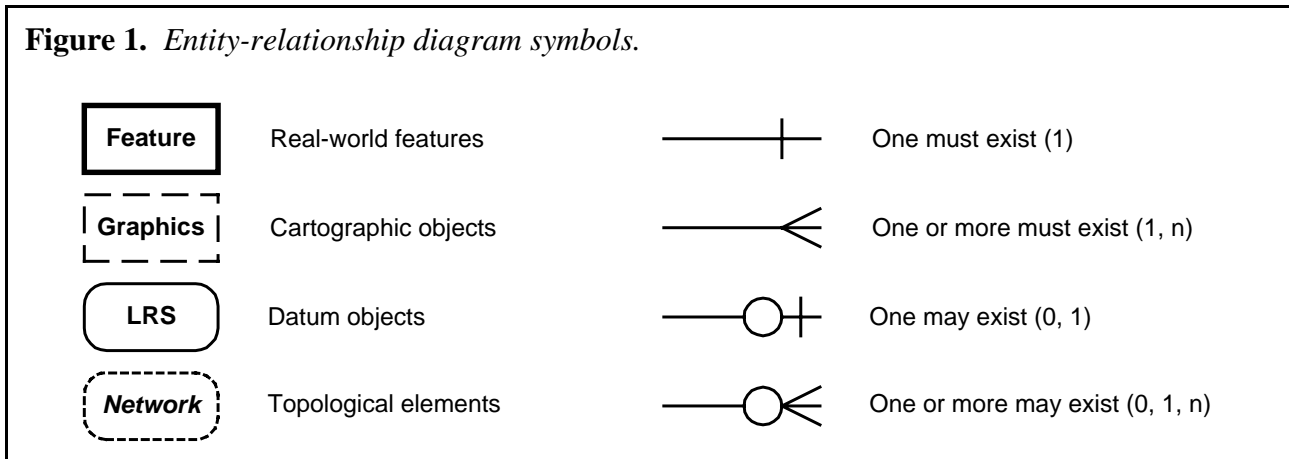

Entities are shown on the left side of Figure 1, while relationships are shown on the right side. Entities, expressed as ERD nouns, are real and conceptual. In general, real-world features are represented on maps using cartographic objects. The location of real-world features is usually stated in terms of a geographic datum, while a cartographic datum is used to define the location of cartographic objects. Topological elements provide a means of showing connectivity of network entities. Some cartographic objects are also topological element; they will be shown as cartographic elements since that is their primary function.

Relationships, expressed as ERD verbs, include the number of such entity instances that may exist, which can be zero, one, or more than one. A typical relationship might be, “One adult has zero, one, or more child,” with ‘adult’ and ‘child’ being nouns (entities), ‘has’ being the relationship verb, and ‘zero, one, or more’ being the scalar quantity. Such a relationship is generally referred to as a one-to-many relationship. Such statements form a universe of discourse (Becker, 1998). If we changed the first noun from ‘adult’ to ‘parent’, then the statement of relationship would be, “One parent has one or more child.” The difference—that an adult doesn’t have to have a child while a parent must have at least one—is in the definitions of adult and parent, and such distinctions are equally present in GIS-T applications. Is a road defined as a paved surface maintained by a public agency for travel by motorized vehicles, or as any traveled way that could be used for motorized vehicles, bicycles, and pedestrians? Does the term ‘bridge’ include all facilities covered by the National Bridge Inventory, which can include tunnels and larger culverts, or as a structure with a deck for conveyance of motorized vehicles?

Why should you care? It is because entities define attribute columns in data tables while relationships say which columns (foreign keys) can be used to link tables together. Everyone “knows” what a road and a bridge are, right? Or do they? Does it matter? Fortunately, for us the answer to the last question is, “No, it doesn’t matter.” This is because a data model that meets the criteria we have set deals only with transportation features; it doesn’t care what kind they are. Nor does it care whether your agency treats bridges and intersections as elements of a roadway, or transportation features in their own right. It is sufficient for producing a data model to know that Road and Bridge are entities about which you must keep certain information, and that there is a relationship between roads and bridges.

We have opted to use ERD rather than the more modern convention of object-oriented diagrams and terminology of the Unified Modeling Language. There are two primary reasons for our choice. First, we believe the ERD approach to be more readily understood due to its simpler diagrams. Second, most implementations will employ the relational model of database design.

## Existing Transportation Data Structures

Data used in transportation agencies may fall into one or more of several general classifications:

- Environmental and social
- Traffic flow models
- Facility inventories
- Site surveys
- Design plans

In general, environmental and social databases and transportation data applications have the lowest level of positional accuracy, while site surveys and design plans require a high level of positional accuracy. Facility inventories fall somewhere between these two extremes. Another difference is the degree to which GIS- or CAD-centric data models have been used as a foundation for these application-specific databases. Environmental and social data models are GIS centric, while site surveys and design plans are CAD centric. Facility inventories originated in a non-graphical environment and have the most data. They represent the most likely source of data used by the other systems.

All of these systems must address the issue of abstraction. Maps are an abstraction of reality. A lower level of positional accuracy is generally reflected in a higher level of abstraction. For example, a city map may show all the ramps at a highway interchange, while a state map shows only an interchange symbol without ramp details. Whether GIS or CAD based, the data models used in GIS-T applications assume that features are discrete, well defined, and analogous to either a point, line, or area (polygon). None of these assumptions are universally true. The use of point symbols to represent intersections and bus stops, or lines to represent roads are common conventions of abstraction. But in the real world, both are areas and are often ill defined. So, is an intersection a point or an area? The answer depends on your perspective. A planner looking at an entire district map would see it as a point, while a project engineer designing a new traffic signal would see it as a polygon. The GIS-T professional designing a system to be used by both the planner and the engineer would have to accommodate both views. The requirement to meet the needs of multiple users with different abstraction conventions is general to GIS-T and is referred to as the need for multiple representations. It is sufficient for our purposes to recognize this need. For more information on the phenomenon of features with indeterminate boundaries, see Timpf, et al. (1994) and Burrough & Frank (1995).

# GIS-Centric Data Models in Transportation

GIS-centric data models include those used for environmental and social data, traffic flow models, and facility inventories. These are judged to be GIS centric because they are graphically expressed in a GIS form, which is *not* the same as saying they were first implemented on a GIS platform. All of them originally had a non-graphical basis and frequently went through a graphical expression phase that was based on CAD software. However, their present expression is in a GIS form, so that is the structure that will be used to explain them here.

Although grouped under the GIS banner, they utilize different elements of the GIS toolkit. Environmental and social data typically apply to areas of the Earth and are therefore polygonal in nature in a GIS. Traffic flow models are linear and topological. Facility inventories, at least for GIS-T, are also linear but usually not topological. Some GIS-T implementations use all of these characteristics. For example, topology may be added to a facility inventory to support pathfinding.

## Environmental and Social Data Structures

In the multi-disciplinary GIS world, environmental and social data still dominate. They consist principally of polygonal objects defining areas with a given characteristic value, such as the area with a specific soil type. The boundaries of such environmental features are generally fuzzy; i.e., the precise edge of the feature cannot be determined. In addition, the use of a discrete set of domain values for an environmental characteristic typically flies in the face of the ambiguities of feature definition. A soil must be of this type or that other one, not some amalgam of the two. A sharp line does not exist in the soil to say that it changes from one type to another *here*. However, the edges of soil type polygons are defined by narrow lines that form polygon borders in a GIS database.

Such a database structure is called a classification schema. Classification values may be displayed on a map using color, fill pattern, line style, labels, graduated symbols and proportional symbols (Zeiler, 1999). Most users deal with the indeterminate nature of feature boundaries by using the data at only smaller scales where the width of the boundary might approximate the degree of uncertainty.

Point data structures may be used alone or to derive polygonal data. For example, soil testing is done through a set of sample points that are then generalized to form classified polygonal areas in a map layer. To simplify their use, polygons may be treated as point features through the use of a centroid, a logical equivalent to the entire area that requires only a single coordinate pair or triplet, rather than a long series of coordinates defining a boundary.

Social data structures are almost exclusively polygonal in nature, and are frequently applied to census tracts and blocks derived from census TIGER files. These files consist of transportation, water, and other dominant features forming census unit polygon boundaries in a fully topological structure. Generally derived from 1:100,000 maps, like environmental data sets, social data sets

less concerned with precise positional accuracy as with broader perspectives of geographic patterns. Transportation planning quality maps, where the focus is also on geographic scope rather than a few features, are frequently derived from TIGER files.

Environmental and social data are normally stored in a GIS database in a fully integrated cartography/topology form (the 'TI' in TIGER stands for topologically integrated). This means that the cartographic objects also store the relationships between objects and, by implication, between the real-world features they represent. This form, called topological vector, is described in Figure 2 as an ERD.

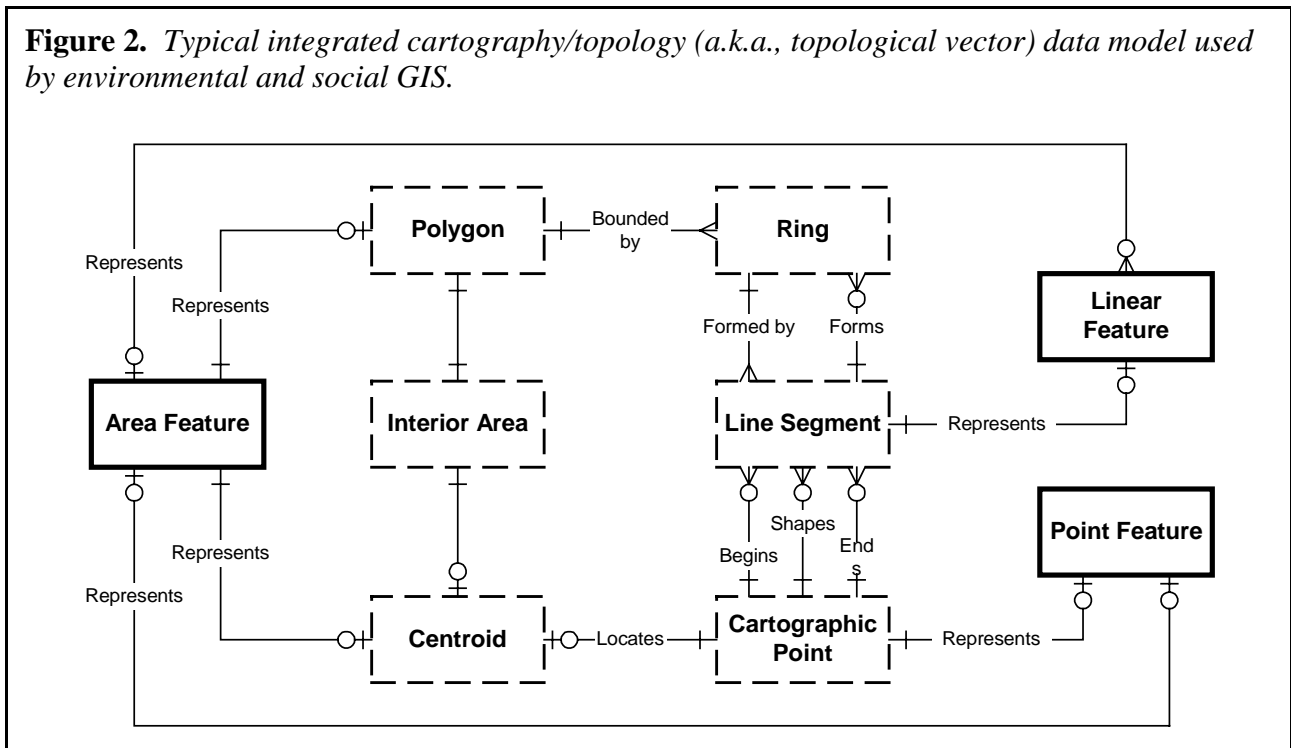

Not all of the entities shown in Figure 2 need to exist for a given data theme. For example, a point theme ERD would include only the Point Feature and Cartographic Point entities. The basic relationships are:

- One cartographic point may represent one point feature.
- One line segment may represent one linear feature.
- One area feature may be represented by one or more linear features.
- One area feature may be represented by one point feature.
- One area feature may be represented by one polygon *or* one centroid.
- One line segment must begin at one cartographic point.
- One line segment must end at one cartographic point.
- One line segment may be shaped by one or more cartographic points
- One or more line segments may go through or terminate at one cartographic point.



- One polygon consists of one or more boundary rings and an interior area. (One ring must define the outer perimeter of the polygon; additional rings, if any, will define holes in the polygon.)
- One interior area may be represented by one centroid *and/or* one polygon.
- One ring may be formed one or more line segments; one line segment may form the boundary of one or more rings.

Of these relationships, the one that may take a little explaining is the use of point and linear features to represent area features. One example is the use of lines to represent transportation features, such as roads. One linear feature could be the section of a road inside a city. The city itself could be represented as an area feature, or the area feature could be used to generate a linear feature, with the area feature not being present in the database at all.

The absence of a connection between Interior Area and Area Feature, when it is really the former that illustrates the latter, illustrates the use of point features to represent area features. From an implementation perspective, it is really the centroid that usually carries the attribute data for the area feature, although some systems apply the attributes to the polygon. The polygon is defined by its boundary in a topological vector database, not its interior area. In addition, a common practice is to convert area features with indeterminate boundaries to point features, as in the case of unincorporated communities. Although some may view this practice as an implementation detail rather than a data model characteristic, we have elected to make it part of the illustrative data model to better reflect the way these systems are constructed.

The chief advantage of the integrated cartography/topology data model is its ability to utilize relationships as a way to reduce total data storage requirements. The long series of coordinate pairs (or triplets) defining the path of a line are the most space-consuming elements of a GIS database. A topological data model also offers operational benefits, such as when boundaries have to be modified. With a topological structure, moving the boundary of one polygon will alter all affected adjacent polygons. Without a topological structure (or software that simulates one), each neighboring polygon will have to be separately adjusted.

From a practical perspective, attributes of the real-world features are treated as attributes of the cartographic objects used to represent them. So, in addition to integrating cartography and topology, this data model also integrates feature attributes. As a result of the planar graph approach and attribute integration, the data model requires linear feature attributes to be segmented in the same manner as the cartography has been. In the case of a roadway network, for example, lines representing roads cross, and are therefore subdivided, at intersections. In this case, an intersection is formed even where one does not exist in the real world, such as at an overpass. With a planar graph approach, there is no such thing as an overpass.

Although providing great economy of disk space, the integrated data model probably represents the largest single obstacle to data sharing in GIS-T. This is the result of the need to fully define cartography and topology before attribute data can be exchanged, and the subdivision of the attributes at the segment level. At its most basic level, an integrated data structure would allow only one value for, say, the number of lanes for a roadway segment between two intersections

when there may be several values. This is clearly undesirable since it is fairly common for roadway attributes to change at mid-block locations.

Eventually, every implementation of the topological vector data model must provide a way to relate one attribute record with one cartographic object. This can mean creating a topological node<sup>1</sup> at every point where a needed attribute value changes at locations other than the intersection of two roadways. The problem with this approach is the need to change the basic network every time an attribute value change point moves.

## Traffic Flow Data Models

Planners and traffic engineers frequently construct theoretical models of the transportation network to evaluate the reaction of the network to changes, such as new development or capacity. Traffic flow data models are topological in nature, simplify the transportation network, and generally do not attempt to represent the real world at any particular scale. As such, traffic flow data models are schematic diagrams rather than true maps and represent the highest level of abstraction normally found in a GIS-T application. They consist of major linear transportation features, represented by links, and their intersections or termini, represented as nodes, to form the topological structure defining both paths through the network and the boundaries of polygonal traffic analysis zones. The interior area of the traffic analysis zone is generally reduced to a centroid connected to a network node. Travel demand is tied to the centroids.

Figure 3 presents the generic traffic flow data model. It is the topological subset of the integrated model discussed in the preceding section. In other words, unlike the topological vector data model, the traffic flow data model does not include a requirement to have any cartographic information. However, some implementations include point symbols to reflect the position of nodes and line segments to illustrate links. If a particular implementation does include cartography, then it becomes a topological vector data structure with nodes being point features and links being linear features. The relevant relationships in Figure 3 are:

- One link represents one transportation segment. (In practice, a single transportation segment may represent the combination of several transportation features, such as both legs of a one-way street pair.)
- One link must begin at one node.
- One link must end at one node.
- One node must terminate (begin or end) one or more links.
- One node may represent one traffic analysis zone centroid or one intersection. (Due to the composite nature of some links, related nodes may actual represent multiple intersections. But, as far as the model is concerned, it is logically one intersection.)

---

<sup>1</sup> Topological networks are composed of links and nodes. A node represents the end of a link and a link represents the path between two nodes. A node is generally created at every line intersection and endpoint.

**Figure 3.** *Traffic flow data model.*

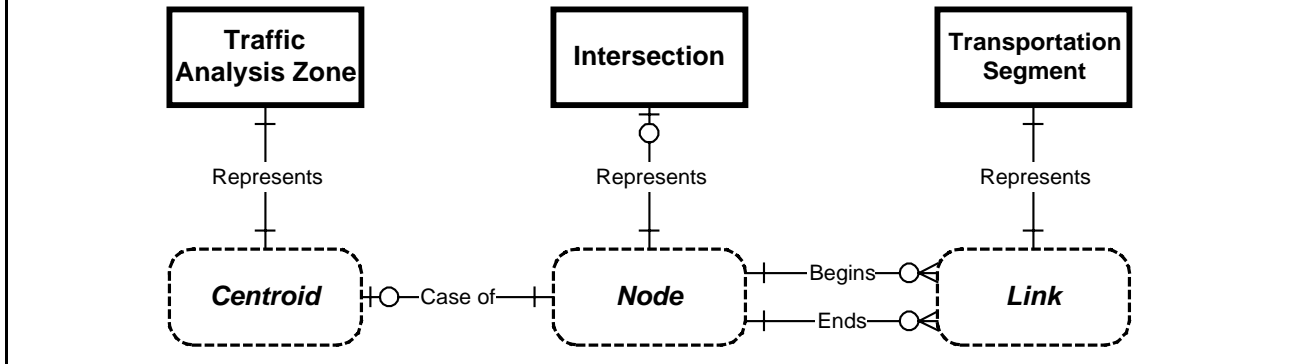

Nodes and links in the traffic flow data model are both geometric and topological when expressed as a diagram. The level of network simplification typically found in these data models and the use of one link to represent multiple linear transportation features makes it very difficult to use them as transport mechanisms for data sharing.

## Facility Inventories

Every state DOT and most transportation organizations have an inventory of transportation facilities that utilize a linear location referencing method (linear LRM). Such an LRM is referred to as a one-dimension (1D) method in that the position of an attribute or object is defined in terms of distance from the beginning of the transportation feature. Facility inventories are typically regarded as being maintained at the planning (small-scale) level of accuracy and are not suitable for use in detailed project design work. This shortcoming is the result of how the data are collected and stored, not the data model itself. The ultimate limit of position accuracy is determined by the field methods used and the event point resolution. Field measures are typically recorded in units of 0.01 mile (52.8 feet or 16.1 m) or 0.001 mile (5.3 feet or 1.6 m) in the United States and in meters elsewhere. Such linear LRMs are called route/milelog methods.

Field measure data are typically collected using a vehicle-mounted distance measuring instrument (DMI), which is an accurate odometer, using a two-person team (driver and data recorder). More advanced DMIs allow the user to press a button and enter a code to represent the observed feature or attribute at that point. Data are typically acquired for both sides of the road at one time as the vehicle moves in the direction of increasing linear LRM measures. Errors in measurement are cumulative; the longer the measured roadway, the greater the error becomes as the team moves down the road unless some sort of recalibration occurs along the route. Such recalibration may be as simple as setting the DMI to a previously recorded “standard” value at relatively immovable objects, like bridge abutments. The linear LRM, combined with the rules for acquiring data and checking its quality, are referred to as a linear location referencing system (linear LRS).

**Figure 4.** *Facility inventory data model.*

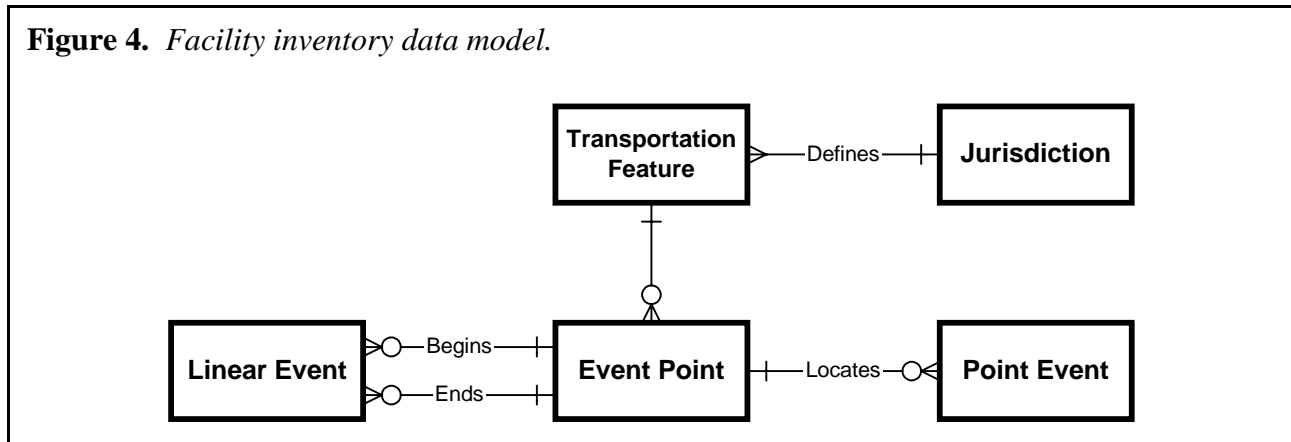
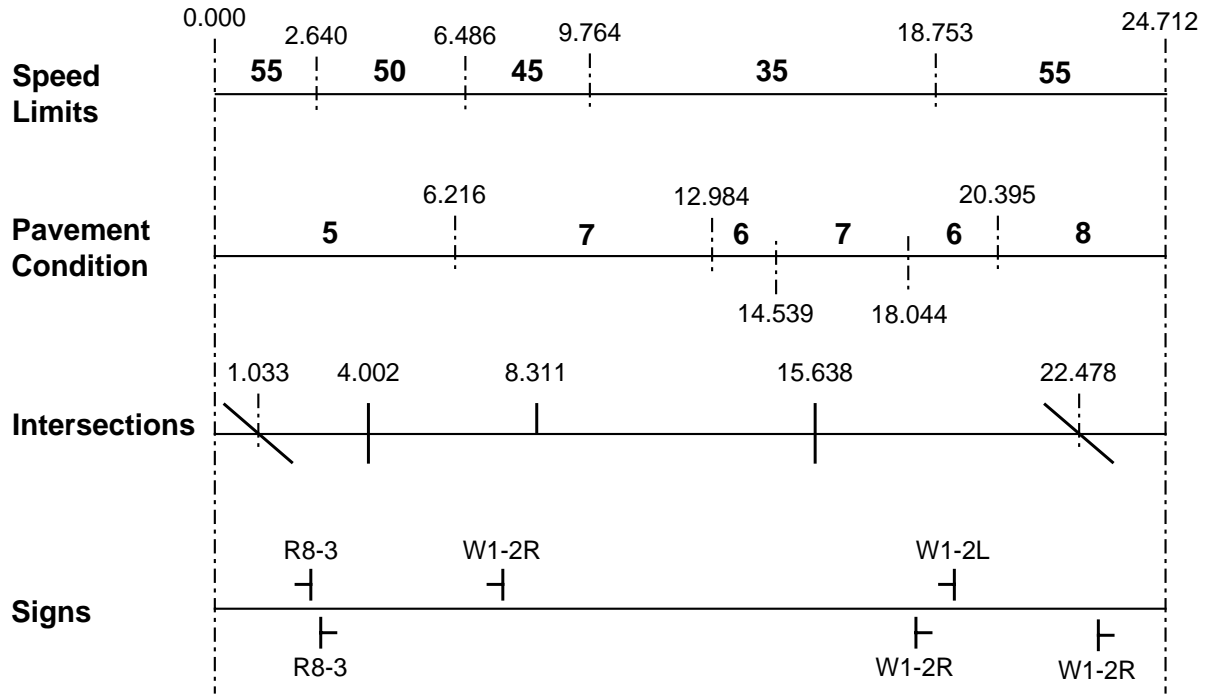

Figure 4 illustrates the basic facility inventory data model. It shows that the extent of transportation features is defined on a jurisdiction basis, whether it is a city pavement management system that stops at the city limits or a state DOT inventory that subdivides roads at county lines. Event points represent linear LRM measures along the length of a transportation feature. Some event points locate a point event, such as an intersection or a sign, while others define the beginning and/or ending of a linear event, such as a speed zone or guardrail. At least the beginning and ending measures of a linear feature are assumed to exist, but a point or area feature will have no event points. The formal relationship statements are:

- One jurisdiction defines the extent of one or more transportation features.
- One transportation feature must be defined within the context of one jurisdiction.
- One transportation feature may have two or more event points.
- One event point must be related to one transportation feature.
- One event point may locate the position of one or more point events.
- One point event must be located by one event point.
- One event point may begin one or more linear events.
- One event point may end one or more linear events.
- One linear event must be located by two event points.

It is rather straightforward to match the entities in the integrated data model and that of facility inventories. An agency that has kept an enterprise perspective for facility inventories has a good start for an enterprise GIS-T. Unfortunately, most state DOTs have more than one linear LRM used for various functional applications, or have developed different field methods for specific applications. In addition, some state DOTs have taken the view that their facility inventory is for federal reporting purposes alone and has no bearing on internal operations. In such cases, data quality is likely to be low.

**Figure 5.** How existing transportation databases are presently displayed using a straight-line diagram (SLD).



Given the breadth of data available, roadways will comprise the primary component of most transportation feature databases. As noted earlier, most facility inventory systems originally operated in a non-graphical environment, with CAD-based illustration mechanisms arriving later. Many transportation agencies use the straight-line diagram (SLD) with annotations derived from attribute databases to graphically describe roadways. In many respects, transportation agencies look at GIS as an evolutionary step that puts true shape into these diagrams and allows connections (topology) between what were previously separate SLDs. Any useful transportation GIS must support the existing data structure and its linear LRS.

Figure 5 is an example of what an SLD might look like. A straight-line diagram will use tic marks, text annotation, and line styles to display attributes from a transportation database. Speed limits, pavement conditions, intersections, and roadside signs are all displayed on the SLD using offset distances. Those distances are shown on the SLD of Figure 5 for the points where speed limit and pavement condition values change, and where intersections are located. Let's assume this route has been given the identifying number 33S058, the data item storing the route identifier is called `roadway_ID`, the beginning milelog measure is called `begin_ML`, and the ending milelog measure is called `end_ML`:

### ***Speed Limit Table***

<u>roadway ID</u>	<u>begin ML</u>	<u>end ML</u>	<u>speed limit</u>
33S058	0.000	2.640	55
33S058	2.640	6.486	50
33S058	6.486	9.764	45
33S058	9.764	18.753	35
33S058	18.753	24.712	55

### ***Pavement Condition Table***

<u>roadway ID</u>	<u>begin ML</u>	<u>end ML</u>	<u>condition</u>
33S058	0.000	6.216	5
33S058	6.216	12.984	7
33S058	12.984	14.539	6
33S058	14.539	18.044	7
33S058	18.044	20.395	6
33S058	20.395	24.712	8

### ***Intersection Table***

<u>roadway ID</u>	<u>begin ML</u>	<u>int_angle</u>	<u>int_type</u>
33S058	1.033	45	cross
33S058	4.022	90	cross
33S058	8.311	90	left tee
33S058	15.638	90	cross
33S058	22.478	45	cross

### ***Sign Table***

<u>roadway ID</u>	<u>begin ML</u>	<u>side</u>	<u>facing</u>	<u>offset</u>	<u>type</u>
33S058	2.245	left	westbound	24	R8-3
33S058	2.755	right	eastbound	18	R8-3
33S058	7.744	left	westbound	32	W1-2R
33S058	18.248	right	eastbound	17	W1-2R
33S058	19.210	left	westbound	20	W1-2L
33S058	23.004	right	eastbound	21	W1-2R

SLDs may show these attributes and objects on separate lines, as depicted here, or all on one line using various graphical methods, such as line width and pattern, or by placing tic marks across the road and labeling both sides of the mark to show what value changes at that point.

Additional attributes could be provided for the entities shown; e.g., intersecting street name.

Latitude/longitude, state plane, and other real-world coordinate systems are often utilized for data exchange. The Global Positioning System (GPS) is a good data collection tool for these two- and three-dimension coordinate systems. However, these systems are of limited value to express where transportation feature attributes are located *on the transportation network*. Data collection methodologies, such as GPS, are often not appropriate for roadway attributes because one must deal with both field measurement and map errors when trying to display the data.

Knowing precisely where an object is located on the earth's surface is not useful if the map is not equally precise—and very few are. The national map accuracy standard is 1:40; e.g., a map compiled at a scale of 1:24,000 (1" = 2,000') and prepared to national map accuracy standards

has a precision of plus or minus 50 feet for at least 90% of all objects. A roadway inventory using a 0.01 mile unit of measure will have a precision no better than plus or minus 26.4 feet (one-half the unit of measure), which converts to a maximum display scale of about 1" = 1,000'. Uncorrected GPS data has an accuracy of plus or minus 100 m. Real-time differential correction can get this down to about plus or minus 10 feet (3 m) in an urban setting.

Roadway data must be displayed in the relatively correct location on the road map; e.g., a bridge point symbol should be placed in alignment with the roadway centerline. This is a very important criterion for the GIS base map and the software used to display roadway attributes and is the reason the route-milelog linear LRS was developed. It is extremely difficult to design and construct a GIS-T base map that can reliably and consistently accommodate GPS survey methods, particularly for map maintenance activities.

## **CAD-Centric Data Models in Transportation**

CAD-centric data models differ from GIS-centric models in subtle but significant ways. For example, they typically have difficulty dealing with large graphics files and raster data because CAD systems were developed for the construction industry, where straight lines prevail and polygons are not generally used. CAD was developed as an automated drawing mechanism that can reproduce human actions. Most people start out using GIS the same way, then progress to more complicated applications. So, in many ways, CAD and GIS look the same when doing the same work. How they are working behind the scenes, though, is often very different.

One significant difference is the data file structure they use. A single CAD file contains an entire drawing, with objects organized within it using a level log. A GIS file, on the other hand, has a separate file for each map layer, what would be a level in a CAD file, and often has several files for each layer.

CAD systems are generally used for projects that cover only a small part of the world, like a single building, parcel, or construction project. This difference allows GIS users to provide their information to CAD users in small chunks that don't suffer as often from file size constraints. It also means that CAD users are working at larger scales than the GIS users, so CAD is often a superior source of data for GIS map updates.

The difference between GIS and CAD platforms is fading. Intergraph's MicroStation Development Language and AutoDesk's AutoLISP provide many of the same functional tools as VisualBasic and Avenue. AutoDesk, Bentley Systems, Visio, and Intergraph all sell mapping products built on a CAD platform. But while the functions are similar, the file structures are not. Data exchange between CAD and GIS platforms remains a serious problem.

### **Site Surveys**

When a public works agency really cares about the location of a feature or attribute, it dispatches a survey crew. Surveyors usually collect data before a project is designed, as right of way is being acquired, during construction, and after construction. Site surveys are good for providing better quality data to facility inventories; however, their being limited to the extent of a project means that they are unable to fully resolve field measure problems along the entire length of a transportation feature.

At least one state has contemplated development of a survey-quality facility inventory by doing a site survey along the entire length of the state highway system. Such an approach is destined to fail for three primary reasons. First is the huge cost of doing such a survey for thousands of miles of state roads. Second is the need to maintain the database, which will require doing the survey over and over again. Indeed, the temporal requirements for such a detailed database are enormous. The time between updates must go down as positional accuracy goes up since accuracy requires knowing not only where a feature or attribute is located, but whether it is still there. Third is the need to integrate the state roads into a total transportation network. As other



features will not be located with the same level of precision and accuracy, it will be a large task to “rubber sheet” other data sources to align with the state road network.

**Figure 6.** *Site survey data model.*

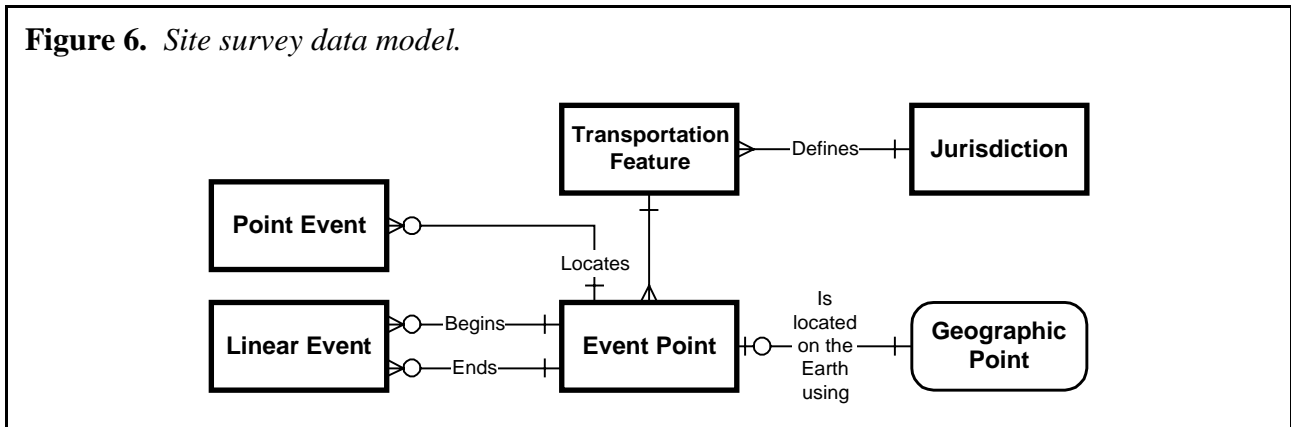

Figure 6 shows that the site survey data model is the same as the facility inventory data model with the addition of a geographic point entity. This entity stores the Earth location of the event point, which can supplement or replace the linear LRM measures stored in the event point. The new relationships for this model are:

- One geographic point may locate one event point. (Some geographic points may be used during the course of surveying but not reflect the position of a transportation feature or attribute.)
- One event point must be located on the Earth using one geographic point.

In addition to representing site surveys conducted using typical surveying processes, the data model of Figure 6 also represents facility inventories taken by use of the Global Positioning System (GPS) receivers. Most such linear surveys are conducted in the same manner as DMI-conducted field surveys, with the addition of shape points for the path of the feature being acquired through a fixed-time-increment position record. Accordingly, site surveys and facility inventories collected by using Earth position approaches (e.g., site surveys or GPS) represent another version of the integrated data model. This is because the attribute data are collected at the same time as the geometry that will be used to create related cartographic objects. Unlike site surveys, GPS surveys used for facility inventory data collection suffer from position errors that make them irreproducible. This makes future updates more difficult to conduct given the need to replace the geometry, not just revise the attributes.

## Design Plans

Design plans are almost exclusively developed today using CAD systems, which have the least complicated data model of all the alternatives discussed here. As Figure 7 shows, there are only four entities. The model represents a subset of the integrated data model presented earlier, so it

is not necessary to restate the entity relationships. Attributes are attached to the cartographic entities. Only cartographic relationships are possible to discern.

**Figure 7.** *Design plans (CAD) data model.*

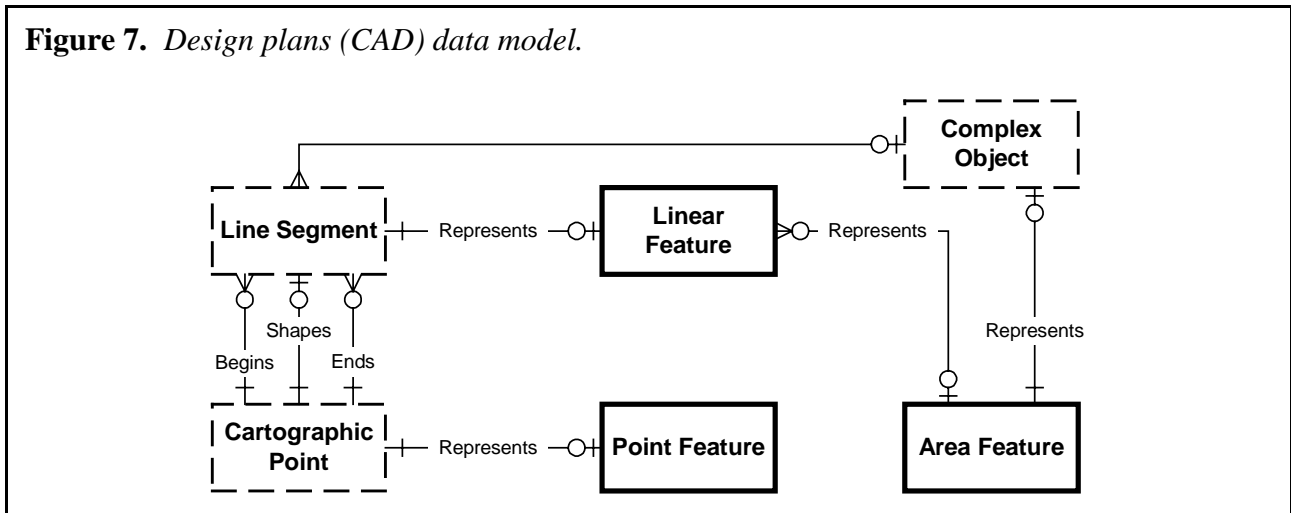

One difference between CAD and GIS is not in the data model but in the cartography. Where a GIS-T database might include, say, the logical and physical roadway centerlines for a highway, the design plans will include a survey stationing (project) centerline, curb faces, gutters, paved shoulders, and numerous other linear features—none of which are the ones the GIS database needs.

Figure 7 shows the basic CAD data model. We have elected to omit annotation, which is generally handled as a point feature, and show a Complex Object entity although not all CAD products support this design element. It is an alternative to a purely line and point object structure provided by the basic CAD design. In the basic version, area features are represented only as a set of boundary lines there is no area object to directly represent area features. The complex object extension offers a direct way to group line segments to form an explicit polygon boundary and to treat the group as a single object.

However, in a CAD database this is replicated again and again, with different data types in separate layers and without relationships among the layers. Knowing relationships among layers requires geometric processing.

## Concluding Remarks

This discussion of data models used is presented to foster more discussion of different proposals, such as the NCHRP 20-27 data model (Opiela, 1997) and the GIS-T Enterprise data model (Dueker and Butler, 1998). This discussion is particularly timely given the introduction of new GIS software and database tools in ArcInfo 8 (Zeiler, 1999) and spatial operators in Oracle and other DBMS.

The data models presented here represent those currently used in transportation applications.

## References

- Becker, S. (1998). "Building a Better Data Model." *The Data Administrator Newsletter*, Issue 7. Upper St. Clair, PA: [www.tdan.com](http://www.tdan.com).
- Burrough, P.A., & A.U. Frank (1995). "Concepts and Paradigms in Spatial Information: Are current geographical information systems truly generic?" *International Journal of GIS*, Vol. 9, No. 2, pp. 101-116.
- Butler, J.A., & K. Dueker (1998). *A Proposed Method of Transportation Feature Identification*. Portland, OR: Center for Urban Studies, Portland State University.  
<http://www.upa.pdx.edu/CUS/PUBS/contents.html>
- Date, C.J., & H. Darwen (1998). *Foundation for Object/Relational Databases: The Third Manifesto*. Reading, MA: Addison Wesley.
- Dueker, K., & J.A. Butler, 1998. "GIS-T Enterprise Data Model with Suggested Implementation Choices." *Journal of the Urban and Regional Information Systems Association*. 10, 1, pp. 12-36.
- Dueker, K., & J.A. Butler (forthcoming), "A Framework for GIS-T Data Sharing". *Transportation Research Part C: Emerging Technologies*.
- Opiela, K.S. (1997). *Research Results Digest No. 218: A generic data model for linear referencing systems*. Washington, DC: Transportation Research Board.
- Timpf, S., P. Burrough, & A. Frank (1994). *Concepts and Paradigms for Spatial Data: Geographical objects with indeterminate boundaries*. Strasbourg, Austria: European Science Foundation. (Specialist meeting report, Baden, Germany, June 8-12, 1994.)
- Zeiler, M. (1999). *Modeling Our World: The ESRI guide to geodatabase design*. Redlands, CA: Environmental Systems Research Institute.