

**AN IN-VITRO ASSESSMENT OF MYOCARDIAL ISCHAEMIA**

**A thesis submitted in partial fulfilment of  
the requirements for the degree of  
DOCTOR OF PHILOSOPHY  
University of London**

**MARIE COOPER**

**Department of Physiology  
University College London  
London**

**In collaboration with  
Department of Cardiology  
The Rayne Institute  
St. Thomas's Hospital  
London**

ProQuest Number: 10609346

All rights reserved

INFORMATION TO ALL USERS

The quality of this reproduction is dependent upon the quality of the copy submitted.

In the unlikely event that the author did not send a complete manuscript and there are missing pages, these will be noted. Also, if material had to be removed, a note will indicate the deletion.



ProQuest 10609346

Published by ProQuest LLC (2017). Copyright of the Dissertation is held by the Author.

All rights reserved.

This work is protected against unauthorized copying under Title 17, United States Code  
Microform Edition © ProQuest LLC.

ProQuest LLC.  
789 East Eisenhower Parkway  
P.O. Box 1346  
Ann Arbor, MI 48106 – 1346

There have been more tears shed over  
prayers that were answered than ever  
were over those that went unheard.

Saint Theresa

## ABSTRACT

Ischaemic heart disease is the most common causes of death in the United Kingdom. In addition to the mortality associated with this disease there are the human and economic costs associated with chronic illness. Many strategies for the treatment and prevention of heart disease are in use and under investigation. The consequences of myocardial infarction have been well described but the causes and mechanisms underlying the disease and its sequeli remain largely unknown. In order to investigate the mechanisms of ischaemic injury and the interventions that might lead to new or improved therapeutic strategies a number of model systems have been devised.

The work described in this thesis concerns the construction and validation of a new model system.

In order to investigate the mechanisms of ischaemic injury at the cellular level a model has been constructed based on the adult cardiac myocyte in culture.

In the first series of experiments described in this thesis the characteristics of adult cardiomyocytes in culture were investigated and a model of ischaemia / reperfusion injury was devised.

The model was tested to determine the effects of the individual components of the ischaemic milieu, in living tissues, on cells in culture. Combinations of these components that would cause reproducible lethal and sub-lethal stimuli analogous to those observed in other models and in living tissues were also investigated. It was also determined that cells in culture retained the responses to injury found in the in-vivo heart and that these responses could be modified by similar interventions.

The second series of experiments described in this study dealt with the potential for gene-transfer to myocardial cells as a strategy for modifying the response of these cells to ischaemic injury. This work was divided into three parts. The first was concerned with finding the optimal gene delivery vehicle for use in cells in culture that would also have utility in other model systems such as the in-vitro or in-vivo heart. In this section of the work, both viral and non-viral gene delivery systems were investigated. The second part of the work involved an assessment of the modification of response to injury of gene transfer techniques *per se*. The final part of the work was to have looked at the action of the transfer of specific genes on the response to ischaemic injury in the in-vitro model.

## TABLE OF CONTENTS

<b>Title Page</b>	<b>1</b>
<b>Abstract</b>	<b>3</b>
<b>Table of contents</b>	<b>4</b>
<b>Acknowledgements</b>	<b>8</b>
<b>List of Abbreviations</b>	<b>9</b>
<b>List of Figures</b>	<b>10</b>
<b>List of Tables</b>	<b>12</b>
<b>Key to all Graphs</b>	<b>14</b>

## SECTION ONE

### CHAPTER 1: GENERAL INTRODUCTION

<b>1.1</b>	<b>Ischaemic heart disease</b>	<b>17</b>
<b>1.2</b>	<b>Preconditioning</b>	
	<b>a. Discovery and description of preconditioning</b>	<b>20</b>
	<b>b. Classical preconditioning</b>	<b>22</b>
	<b>c. Mechanisms of classical preconditioning</b>	<b>23</b>
	<b>d. Delayed preconditioning</b>	<b>36</b>
	<b>e. Mechanisms of delayed preconditioning</b>	<b>38</b>
<b>1.3</b>	<b>Models of ischaemic heart disease</b>	
	<b>a. Whole animal models</b>	<b>44</b>
	<b>b. Ex-vivo whole heart and isolated muscle</b>	<b>45</b>
	<b>c. Models based in humans and human tissues</b>	<b>47</b>
	<b>d. Cellular models</b>	<b>49</b>
	<b>e. Existing cell based models</b>	<b>51</b>
	<b>f. A definition of ischaemia at the cellular level</b>	<b>52</b>

## **CHAPTER 2: GENERAL METHODS**

<b>2.1</b>	<b>Animals</b>	<b>60</b>
<b>2.2</b>	<b>Anaesthesia</b>	<b>60</b>
<b>2.3</b>	<b>Dissection</b>	<b>62</b>
<b>2.4</b>	<b>Microbiological screening</b>	<b>63</b>
<b>2.5</b>	<b>Western blot analysis</b>	<b>64</b>
<b>2.6</b>	<b>Cell viability assays</b>	<b>66</b>
<b>2.7</b>	<b>Statistical methods</b>	<b>71</b>

## **SECTION TWO**

### **CHAPTER 3: DEVELOPMENT OF THE ISOLATION TECHNIQUE**

<b>3.1</b>	<b>Introduction</b>	<b>84</b>
<b>3.2</b>	<b>Perfusion</b>	<b>86</b>
<b>3.3</b>	<b>Isolation</b>	<b>93</b>
<b>3.4</b>	<b>Results</b>	<b>96</b>
<b>3.5</b>	<b>Discussion</b>	<b>102</b>

### **CHAPTER 4: DEVELOPMENT OF CELL CULTURE TECHNIQUE**

<b>4.1</b>	<b>Introduction</b>	<b>104</b>
<b>4.2</b>	<b>Plating</b>	<b>105</b>
<b>4.3</b>	<b>Cell survival in culture</b>	<b>110</b>
<b>4.4</b>	<b>Results</b>	<b>117</b>
<b>4.5</b>	<b>Discussion</b>	<b>125</b>

## **CHAPTER 5: SIMULATED ISCHAEMIA**

<b>5.1</b>	<b>Introduction</b>	<b>128</b>
<b>5.2</b>	<b>Materials and methods</b>	<b>130</b>
<b>5.3</b>	<b>Results</b>	<b>135</b>
<b>5.4</b>	<b>Summary</b>	<b>145</b>
<b>5.5</b>	<b>Discussion</b>	<b>146</b>

## **CHAPTER 6: PRECONDITIONING IN CULTURE**

<b>6.1</b>	<b>Introduction</b>	<b>148</b>
<b>6.2</b>	<b>Materials and methods</b>	<b>149</b>
<b>6.3</b>	<b>Results</b>	<b>151</b>
<b>6.4</b>	<b>Summary</b>	<b>170</b>
<b>6.5</b>	<b>Discussion</b>	<b>171</b>

## **CHAPTER 7: GENE TRANSFER TO ADULT CARDIOCYTES IN CULTURE**

<b>7.1</b>	<b>Introduction</b>	<b>174</b>
<b>7.2</b>	<b>Materials and methods</b>	<b>180</b>
<b>7.3</b>	<b>Results</b>	<b>194</b>
<b>7.4</b>	<b>Discussion</b>	<b>204</b>

## **SECTION THREE**

### **CONCLUSION**

#### **CHAPTER 8: General discussion and conclusions.**

**8.1** Summary of the work and its implications.

**8.2** Limitations of the work and scope for further investigations

### **REFERENCES**

### **PUBLICATIONS ARISING FROM THIS WORK**



## ACKNOWLEDGEMENTS

I am pleased to be able to take this opportunity to offer my thanks to the people who have helped and advised me during this research. Firstly, I would like to thank Dr M S Marber and Professor D M Yellon for providing me with the opportunity to undertake this project. Dr Marber, as my supervisor has also been an invaluable source of encouragement and support.

To all of those with whom I worked at the Hatter Institute where this work began I wish to extend my sincere appreciation for their tolerance and kindness. I wish to extend thanks, also, to Dr M Duchen and the staff at the department of Physiology, University College London for much helpful advice.

I acknowledge the financial support of the Graduate School of University College, without whose generosity I would have been unable to complete this work.

I wish to thank my husband for his unflagging support, encouragement and endless patience.

Lastly a word for Veronique, I expect the shoulder will dry out eventually.

I dedicate this work to my husband, Frederick Leeson.

## LIST OF ABBREVIATIONS

The following abbreviations are used in this thesis:

Adv	adenovirus
ATP	adenosine triphosphate
BDM	2,3-Butanedione Monoxime
BSA	bovine serum albumin
CCPA	2-Cloro-N <sup>6</sup> -cyclopentyladenosine
C-H	collagenase - hyaluronidase solution
DAG	diacyl glycerol
DPCPX	8-cyclopentyl-1,3-dipropylxanthine
EDTA	ethylene diamine tetra acetic acid
EGTA	ethyleneglycol-bis( $\beta$ -aminoethyl ether)N,N,N',N' tetraacetic acid
FCS	foetal calf serum
HEPES	N-2-hydrxyethylpiperazine-N'-2-ethane-sulphonic acid
HSP	heat shock protein
IP <sub>3</sub>	inositol-1,4,5,-triphosphate
KBp	kilo base pairs
LDH	lactate dehydrogenase
MTT	2,3-[4,5-Dimethylthiazol-2-yl]-2,5-diphenyltetrazolium bromide
NAD	nicotinamide adenine dinucleotide
PBS	phosphate buffered saline
PC	preconditioning
PIP	phosphoinositolphosphate
PKC	protein kinase C
PLA	phospholipase A
SDS	sodium dodecyl sulphate
SEM	standard error of the mean
SI	simulated ischæmia
SWOP	second window of protection
TB	trypan blue
TBS	tris buffered saline
TRIS	tris(hydroxymethyl)aminomethane

## LIST OF FIGURES

<b>Figure</b>	<b>Page</b>
<b>Chapter One.</b>	
1.1 Diagram: Outline of steps in signalling pathway to preconditioning	26
1.2 Diagram: Later stages in pathways to preconditioning.	32
1.3 Diagram: Putative signaling pathway to delayed preconditioning	42
<b>Chapter Two.</b>	
2.1 Scanned image of a protein loading electrophoresis gel.	70
2.2 Structure and reduction reaction of methyltetrazolium	77
<b>Chapter Three.</b>	
3.1 Diagram: Perfusion apparatus used for the isolation of adult rabbit cardiac myocytes	87
3.2 Graph: Standard curve for Ca <sup>2+</sup> using an ion specific electrode	97
3.3 Graph: Yields of adult myocytes per month over three years	99
3.4 Photograph: Freshly plated adult rabbit cardiac myocytes	101
<b>Chapter Four</b>	
4.1 Graph: Effect on plating density of different attachment substrata	118
4.2 Graph: Cell survival in culture	121
4.3 Photograph: Long – term cultured adult myocytes	123
4.4 Photograph: Agar embedded adult myocytes	124
<b>Chapter Five</b>	
5.1a Photograph: Hypoxia chamber	132
5.1b Schematic diagram of the hypoxia chamber	133
5.2 Graph: Rate of O <sub>2</sub> depletion in the hypoxia chamber	135
5.3 Graph: Effect of pH on the response to simulated ischaemia (SI)	137
5.4 Graph: Effect of glucose and lactate on the response to SI	140
5.5 Graph: Time course to the lethal stimulus	141
5.6 Graph: Effect of four hour lethal stimulus	143
5.7 Graph: Effect of six hour lethal stimulus	144

## Chapter Six

6.1	Graph: Preconditioning pilot study, simulated ischaemia	153
6.2	Graph: Preconditioning pilot study, glucose deprivation	155
6.3	Graph: Preconditioning pilot study, hypoxia	157
6.4	Graph: Effect of CCPA on hypoxic preconditioning: Time course	159
6.5	Graph: Effect of CCPA on the response to hypoxic preconditioning	160
6.6	Graph: Concentration response curve for DPCPX	163
6.7	Graph: Concentration response curve for chelerythrine	165
6.8	Graph: Effect of chelerythrine on the response to hypoxic preconditioning	166
6.9	Graph: Second window of protection, pilot study	168
6.10	Scanned image of Western blot for heat stress protein	169

## Chapter Seven

7.1	Diagram: Mitochondrial F <sub>1</sub> -F <sub>0</sub> ATPase complex	177
7.2	Photographs: Electrophoresis gels from DNA separations	187
7.3a	Diagram: Line diagram of a region on adenovirus genome	189
7.3b	Diagram: Line diagram of a region of herpes virus genome	189
7.4	Graph: Adv and herpes virus transfections using suspended cells	195
7.5	Graph: Preliminary transfection data for Adv transfections of cultured adult rabbit cardiac myocytes.	198
7.6	Graph: Data from Adv transfections of myocytes using $\beta$ -galactosidase as the indicator gene.	199
7.7a	Photograph: Transfected adult myocytes	200
7.7b	Photograph: Transfected neonatal myocytes	201
7.8	Photograph: Adult myocytes transfected with green fluorescent protein	203

## LIST OF TABLES

<b>Table</b>	<b>Page</b>
<b>Chapter Two</b>	
2.1 Image density data from scanned protein loading gel.	70
<b>Chapter Three</b>	
3.1 a Data obtained for calcium ion concentrations in cell isolation buffers using an ion specific electrode.	98
3.1 b Calcium ion concentrations measured in cell isolation buffers.	98
<b>Chapter Four</b>	
4.1 Cell attachment to three substrates.	119
4.2 Cell survival cultured on laminin coated plates.	120
<b>Chapter Five</b>	
5.1 Effect of varying pH on the response of cultured adult myocytes to simulated ischaemia.	137
5.2 Effect on cultured adult myocytes of components of the simulated ischaemia.	139
5.3 Time course of the lethal stimulus	141
5.4 Four hour lethal stimulus.	143
5.5 Six hour lethal stimulus.	144
<b>Chapter Six</b>	
6.1 Preconditioning with ischaemia.	153
6.2 Preconditioning with substrate withdrawal.	155
6.3 Preconditioning with hypoxia.	157
6.4 Concentration-response data for the adenosine receptor agonist CCPA.	159
6.5 Effect of the adenosine receptor agonist, CCPA, on the response of cultured adult myocytes to lethal simulated ischaemia.	160
6.6 Concentration response data for the adenosine receptor antagonist DPCPX	162

<b>6.7</b> Concentration response data for PKC inhibitor chelerythrine	165
<b>6.8</b> Effect of chelerythrine on the response of cultured adult myocytes to hypoxic preconditioning.	166
<b>6.9</b> Second window of protection in cultured adult myocytes. Preliminary data.	168

## **Chapter Seven**

<b>7.1</b> Typical dilution table for liposomal and conjugate transfection protocols.	191
<b>7.2</b> Comparison of Adenovirus and Herpes virus transfection efficiencies when applied to cells in suspension.	195
<b>7.3</b> Preliminary data for adenovirus transfection efficiencies.	198
<b>7.4</b> Comparison of Generation one and two adenovirus vectors.	199

## KEY TO ALL GRAPHS

### Label

### Treatment

**UTC:**

Untreated control

**IH:**

Ischaemia/hypoxia – The lethal stimulus

**PC:**

Preconditioned

**CH:**

Treated with hypoxia alone

**IN:**

Treated with simulated ischaemia,  
but without hypoxia

**PCG:**

Pre-treatment with glucose-free tissue culture media

**PCI:**

Pre-treatment with simulated ischaemia,  
but without hypoxia

## **SECTION ONE**

**CHAPTER 1: GENERAL INTRODUCTION**

**CHAPTER 2: GENERAL METHODS**



# CHAPTER ONE

## GENERAL INTRODUCTION

---

### 1.1 ISCHAEMIC HEART DISEASE

#### 1.2 PRECONDITIONING

- a. The discovery and description of ischaemic preconditioning
- b. Classical preconditioning
- c. Proposed mechanisms for classical preconditioning
- d. Delayed preconditioning
- e. Proposed mechanisms for delayed preconditioning

### 1.3 MODELS OF ISCHAEMIC HEART DISEASE

- a. Whole animal models
- b. Ex-vivo whole heart and isolated muscle
- c. Models based in humans and human tissues
- d. Cellular models
- e. Existing cell based models
- f. A definition of ischaemia at the cellular level

### 1.4 GENE TRANSFER

- a. Scope of gene transfer techniques
- b. Quantification and qualifications

## **AIMS OF THE PROJECT**

1. to construct a cell culture based model of ischaemia /reperfusion injury using cells derived from the ventricular muscle of adult rabbit hearts.
2. To demonstrate that the mechanism of endogenous cytoprotection known as classical preconditioning existed in isolated cultured cardiac myocytes.
3. To characterise the preconditioning response in this model.
4. To identify an efficient gene transfer vector for use with myocytes in culture
5. To use the vector for the transfer of genes to the cultured cells to explore the potential for transfected gene products to mimic the protection seen with preconditioning.

### **1.1: ISCHAEMIC HEART DISEASE**

Ischaemic heart disease is a major cause of death in the United Kingdom [1] and is increasing in incidence throughout the world [2]. The term ischaemic heart disease refers to the situation and symptoms pertaining when the blood flow to the heart is reduced. When circulation is restricted the supply of oxygen and nutrients to the muscle of the heart is insufficient to meet normal demand.

The commonest cause of circulatory insufficiency to the heart is a reduction in the diameter of the vessels supplying the tissue caused by atherosclerotic deposits in the walls of these vessels. These deposits are termed atherosclerotic plaques. The precise aetiology of atherosclerotic plaque formation is not known and a variety of inherited and life-style factors have been cited as causal or contributory in the development of the disease.

The mortality associated with ischaemic heart disease is a consequence of myocardial infarction [3], a loss of living muscle tissue in the heart muscle due to a period during which a major coronary artery is completely occluded. Occlusion is usually a consequence of a complicated atherosclerotic plaque. This involves the formation of an occlusive thrombus as a result of the damage to the vascular endothelium overlying the atherosclerotic plaque. Alternatively occlusion may result from the rupture of the plaque itself. A number of therapeutic strategies have been developed for treating the different phases of ischaemic heart disease, both before the development of complicated atherosclerosis and to salvage heart tissue during an acute myocardial infarction. In addition there are a number of approaches to altering the remodelling of the heart muscle that takes place after acute myocardial infarction.

The current clinical approaches to the treatment of heart disease broadly divide into two categories, thrombolysis and revascularisation. Revascularisation can be achieved by either relieving occlusion with mechanical means such as balloon angioplasty or effectively replacing occluded vessels using coronary artery bypass surgery.

The prognosis for patients who have undergone an infarct will vary depending on the severity of the incident and the degree of irreversible tissue injury that has been sustained. The speed with which adequate perfusion is re-established using thrombolytic therapies is also a critical factor in recovery from infarct [4]. In the longer term it is the nature of the cells comprising cardiac muscle that determines that the inevitable outcome is some loss of contractile tissue and hence of cardiac function.

The cells of the myocardial muscle have been widely accepted to be terminally differentiated i.e. these are cells that do not divide during adult life. Recent work by Kajstura et al [5,6] has suggested that this may not be the case in both normal and injured myocardium. In general, however and certainly in culture the cells of cardiac muscle have not been widely observed to re-enter the cell cycle and divide in significant numbers. The last cell division, which results in the complete complement of cardiac muscle cells, takes place 2-4 days after birth in the rat [7]. Once the process of cell division has ceased the heart can increase in size, both by the accumulation of non-myocyte cells and the increase in size of individual muscle cells.

It follows that contractile tissue that is irreversibly injured during the course of an infarct is lost. Necrotic tissue is replaced by the formation of scar tissue at the site of injury. The scar, which is generated by the synthesis of connective tissue is neither as elastic as the original muscle nor can it effectively transmit the

electrical signals controlling the regular co-ordinated contraction of normal heart muscle. The process of scar formation and the associated changes in the shape and size of the heart are termed remodelling.

Often scar tissue formed in the muscular wall of the left ventricle stretches over time, this results in further loss of contractile function and can lead to what is commonly described as heart failure. The wall of the left ventricle has become irregular in shape and may be distended. In this condition the filling and emptying of the ventricle is abnormal. Cardiac output is affected and normal oxygenation and blood pressure cannot be maintained. As a result peripheral tissues are not adequately perfused. Often the failure to maintain normal blood pressure without excess venous pressure results in the accumulation of water, especially in the lungs and in peripheral tissues.

The long-term prognosis for this condition is poor because the changes in scar tissue in the left ventricle are progressive.

Deaths from heart failure contribute to the overall mortality of ischaemic heart disease.

While large numbers of people live for many years while receiving treatment for ischaemic heart disease the consequences in terms of reduced quality of life and life expectancy are severe. In addition the cost to any society of widespread chronic disease is large, in terms of both the social and economic factors involved.

A greater understanding of the processes leading to and underlying the clinical symptoms of ischaemic heart disease is required. Investigation of the molecular biology of the heart and coronary blood vessels will help towards furthering the accurate diagnosis and effective treatment of the genetic diseases of the cardiovascular system.

At the same time this approach could lead to a greater understanding of the changes that occur in the cells of injured cardiac muscle. The molecular biological approach has shown potential in a number of strategies to the treatment of heart disease. These include the development of genetically modified donor animals for xenografting [8], targeted drug delivery systems, the use of recombinant proteins and gene therapy approaches. A deeper understanding of the effects of ischaemic injury on the heart will make it possible to devise novel therapeutic strategies.

## **1.2. PRECONDITIONING**

### **1.2a. The discovery and description of ischaemic preconditioning**

In 1986 Murry, Jennings and Reimer [9] published the findings of a study conducted in *in-vivo* dog hearts. They described a series of experiments in which short periods of ischaemia followed by reperfusion conferred protection on the heart against the lethal consequences of a subsequent period of sustained ischaemia. They called this phenomenon preconditioning myocardium with ischaemia.

The experiments conducted by Murry et al were designed to test the hypothesis that intermittent periods of brief ischaemia followed by reperfusion might reduce the extent of ischaemic injury sustained during a longer ischaemic episode.

They had previously observed that several short periods of ischaemia followed by reperfusion did not result in necrosis. In addition they had observed that several episodes of brief ischaemia and reperfusion slowed the rate of ATP depletion in tissue subjected to a subsequent episode of prolonged ischaemia [10].

In their discussion Murry et al address the possible mechanisms for the observed protection and conclude that these were, at the time, completely unknown.

The myocardium rapidly becomes ATP depleted during episodes of ischaemia [11]. As a result of the change from aerobic to anaerobic glycolysis and the failure of perfusion to remove metabolites the concentrations of lactate and H<sup>+</sup> in the extracellular space rise. Similarly the extracellular K<sup>+</sup> concentrations increase. Based on these observations the protective effect of preconditioning in terms of limiting infarct size might then involve the conservation of ATP. Equally the removal of accumulated metabolites during the brief reperfusion could contribute to protecting against osmotic injury.

In addition to the biochemical changes noted in preconditioned heart tissue effects were observed in terms of the functional responses of hearts subsequently exposed to prolonged ischaemia. Following an ischaemic episode there are changes in the contractile properties of the heart. These changes are observed both in the *in-situ* heart and can be measured in the *ex-vivo* model, the isolated perfused heart.

One consequence of a period of ischaemia is the development of cardiac arrhythmias upon reperfusion, a potentially life threatening development *in-vivo*. Other observed alterations in function include a reduction in force of contraction, elevation of the ST segment of the electrocardiogram; changes in end diastolic pressure and shortening of the cardiac action potential.

In a review of preconditioning edited by Marber and Yellon [12] it is pointed out by Parratt et al that as early as 1950 a reduction in post ischaemic arrhythmias had been described in an experimental model using a sequential coronary ligation technique. It is also noted here that partial coronary occlusion prior to

total occlusion had also been observed to reduce both post ischaemic ventricular fibrillation and elevation of ST segment [13].

Later it was demonstrated that the preconditioning regimen demonstrated by Murry et al to reduce infarct size could also prevent or reduce the development of post ischaemic arrhythmias [14].

It seemed possible that the mediators of ischaemic preconditioning that lead to conservation of tissue might also lead to conservation of function.

As a consequence of the observed benefits of preconditioning the fundamental molecular mechanisms for the protective effect have been the subject of much investigative effort. As yet no definitive model of the processes leading to protection exists.

### **1.2b. Classical preconditioning**

Murry et al also noted the transitory nature of the protection they had observed. After 180 minutes in the anaesthetised dog model used by this group the protection, measured as reduction in infarct size within a defined risk area, disappeared. This led them to state that preconditioning delayed rather than prevented cell death in tissue subjected to sustained ischaemia.

This brief, transitory protection has come to be known as early or classical preconditioning.

It was noted by Murry et al that such a powerful protective response, reducing the infarct size in the dog heart by 40% [6] might have therapeutic potential.

Within a decade of the original report of ischaemic preconditioning the phenomenon had been observed and described in the rabbit [15,16], pig [17,18,19] and rat[14,20,21,22] and possibly in humans [23] and human tissues [24].

In addition the protective effects of preconditioning had been demonstrated in a number of different tissues including rat brain [25], liver [26] and porcine skeletal muscle [27].

The discovery of this effect stimulated a great deal of interest. A search of the literature between the publication of Murry, Jennings and Reimers paper in 1986 and the time of writing produced an extensive list (> 1000) of publications citing preconditioning in either title or text.

This large body of literature represents the reports of studies involving every aspect of ischaemic preconditioning, prevalence, distribution, duration, mechanism and therapeutic implications [28 Review].

The sheer size of the literature is an indication of the interest aroused by the phenomenon of preconditioning.

### **1.2c Proposed mechanisms of classical preconditioning**

The mechanism of a cellular response to a change in the external environment can be broadly divided into three components, trigger, mediators and the end effector or effectors.

The primary trigger for ischaemic preconditioning is one or more brief periods of ischaemia and reperfusion.

#### **Adenosine**

Downey's group [15] proposed that substances released during the preconditioning ischaemia were responsible for the protection observed during the subsequent long ischaemia. An increase in the rate of ATP hydrolysis was observed during the short ischaemic episode leading to preconditioning. This in turn was responsible for a large, local increase in levels of adenosine and



adenine nucleotides. As a result of this observation the possible role of adenosine in the preconditioning effect was investigated. Downey's group then proposed the hypothesis that adenosine was the natural trigger for preconditioning in the rabbit heart. If this was the case then giving exogenous adenosine or adenosine receptor blockers would respectively mimic or block the protection seen in preconditioning.

Studies by a number of groups have confirmed the role of adenosine in preconditioning in the rabbit [15] pig [19] and dog [6] but the role of adenosine in preconditioning in the rat remains controversial [29,30].

To begin the process of elucidating the mediators between the preconditioning stimulus and the protective effect it was necessary to identify the cell surface receptor involved. Fu et al [31] and Thornton et al [32] independently demonstrated that preconditioning could be blocked with the use of pertussis toxin. These results suggested that the adenosine receptor subclass involved were coupled to a  $G_{i}/G_{o}$  protein. It was also shown that a number of agonists that function via receptors coupled to this class of membrane protein could also mimic preconditioning.

Triggers acting via the G-protein coupled receptor family that have been shown to mimic preconditioning include bradykinin [33], catecholamines [34] and opioids [35,36,37].

### **Protein kinase C**

Identifying the nature of the receptor mediating the response meant that it was now possible to begin the process of elucidating the cellular pathways leading to preconditioning. The signalling pathway downstream of G-protein coupled

receptors involves the activation of protein kinase C (PKC) via diacylglycerol (DAG).

An outline diagram of the proposed early steps in the signalling pathway is shown in figure 1.1.

Although the arrows in the diagram represent possible steps in the signalling pathway the relationship between these steps remains largely unconfirmed. It is not clear whether or not additional intermediaries are present between these stages in the events leading to preconditioning.

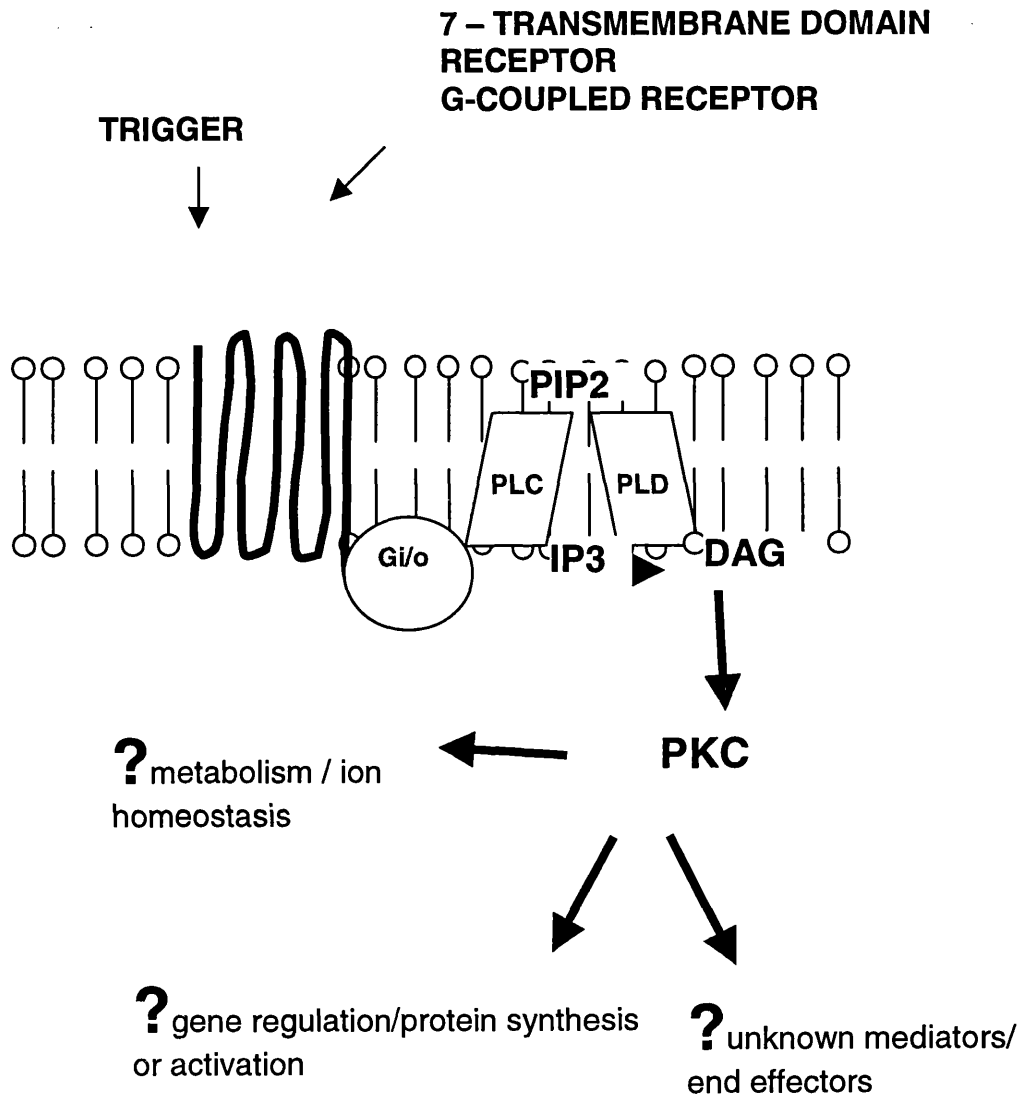

**Figure 1.1.** First steps in elucidating the signalling pathway leading to ischaemic preconditioning.

The term protein kinase C (PKC) refers to a family of threonine/serine kinases. These enzymes phosphorylate protein substrates at sites containing threonine or serine amino acid residues. The PKC family consists, at the time of writing, of 12 isoenzymes, divided into three groups.

Conventional PKC (cPKC) isoforms are activated only in the presence of  $\text{Ca}^{2+}$  and DAG. Novel isoforms (nPKC) are  $\text{Ca}^{2+}$  independent and the atypical isoforms (aPKC) are independent of both  $\text{Ca}^{2+}$  and DAG for activation. In each case the classification is based on the regulator molecules known to activate the isoform concerned. The members of the PKC family of isotypes identified so far are as follows:

Conventional PKCs:  $\alpha$ ,  $\beta_1$ ,  $\beta_2$ , and  $\gamma$

Novel PKCs:  $\delta$ ,  $\epsilon$ ,  $\zeta$ ,  $\eta$  and  $\theta$

Atypical PKCs:  $\iota$ ,  $\lambda$  and  $\mu$

The precise role of each isotype is not yet known. There appears to be considerable overlap of function between the different isotypes with more than one isotype involved in preconditioning [38,39].

Expression of the different isotypes of PKC has been demonstrated to differ between tissues and this variation may hold some clue as to the roles of the various molecules in different signalling pathways.

The PKC isoform profile expressed in whole rat and rabbit heart [40,41]. heart has been determined by using immunoblot and western blot analyses. With the exception of nPKC  $\theta$  all of the conventional and novel isotypes were identified in the rabbit heart. The atypical isotypes were not measured as Ping et al [41] were not able to obtain specific probes for these molecules. The measurements obtained indicate that the cPKCs  $\alpha$  and  $\gamma$  and the nPKC  $\epsilon$  are the quantitatively predominant isotypes present in rabbit heart.

At the time of writing it remains to be determined which are the predominant PKC isotypes in each different cell population in the heart.

The activation of PKC was confirmed as one of the mediators of the preconditioning response when substances known to block the action of PKC were seen to also block the protection conferred by preconditioning. Preconditioning has been shown to be abolished by staurosporine and polymyxin in the rabbit heart [40], and chelerythrine in the rabbit [43] and rat [44]. It must be noted that the selectivity and specificity of some PKC antagonist compounds is not yet fully characterised.

In addition the use of phorbol esters that enhance the activation of PKC were shown to mimic preconditioning in the rabbit [45] and in the rat [44].

Events in the signalling pathway downstream of the activation of PKC are far from clear. Investigations into the mode of action and possible targets for PKC in the preconditioning response have led to differences of opinion.

It has been proposed that the translocation of PKC to specific sites in the cell is necessary for its activation [46,47]. Others have produced experimental evidence disputing this view [48,49].

The questions pertaining to the mode of action of PKC in preconditioning remain open. Whether the apparently contradictory results obtained by different studies are due to differences in the models and methods used also remains to be resolved.

It is clear, however, that the activation of PKC forms a nexus point feeding into a number of signalling pathways.

## **Metabolism and metabolic intermediaries in preconditioning**

It has been proposed and demonstrated in several studies that PKC can activate the enzyme ecto-5'-nucleotidase in the canine model of ischaemic preconditioning [50]. This enzyme represents an important step in the generation of adenine nucleotides. The enzyme dephosphorylates adenosine monophosphate (AMP) to adenosine and guanosine monophosphate (GMP) to guanosine. Its role in the generation of adenosine may suggest that it also plays a part in the initiation of the preconditioning response.

The protection due to brief ischaemic episodes and called classical preconditioning appears over a short time course and there has been much speculation about the possible end effectors for this response.

Some events that modify the behaviour of the cell can take place very rapidly. Examples are the activation of an existing protein pool by phosphorylation or other forms of post-translational modification such as glycosylation, the translocation of an effector substance from one cellular compartment to another or the rapid upregulation of protein synthesis.

A candidate for the end effector in early preconditioning that has been proposed by a number of investigators [51,52,53,54], is an ion channel present in the membrane of cardiac myocytes that appears to be involved in the stress response.

### **ATP-sensitive potassium channel**

Several studies have reported that blocking the opening of the ATP-sensitive K<sup>+</sup> (K<sub>ATP</sub>) channel abolishes ischaemic preconditioning.

The  $K_{ATP}$  channel, an outward potassium channel that is both voltage gated and gated by the levels of ATP was first identified in cardiac myocytes by Noma in 1983 [55].

When the levels of ATP present in the cell fall, as they do in ischaemia, the reduction results in opening of the  $K_{ATP}$  channel and an outflow of  $K^+$ .

The other metabolic intermediaries that have been shown to open this channel include adenosine and low pH,[56] ADP has also been shown to block  $K_{ATP}$  opening and to compete for the inhibitory binding site on the channel protein with ATP.

It is difficult to discern what the beneficial effect of an efflux of  $K^+$  might be for the cell. The result of an outflow of  $K^+$  is a reduction in membrane potential and consequently a shortening of the action potential. This is associated with the early repolarisation of the membrane leading to the elevated ST segment seen in the ECG during ischaemia. On this basis the effect of enhanced  $K_{ATP}$  opening would appear to be to exacerbate injury.

One common observation in tissues that have received an ischaemic insult is the increase in extracellular levels of  $K^+$ .

The picture with respect to the role of the channel in preconditioning has been further complicated by the discovery of  $K_{ATP}$  channels in the inner membrane of the mitochondria [57]. These mitochondrial channels also appear to be involved in the protection due to preconditioning as evidenced by the opening of these channels mimicking preconditioning.

Pharmacological characterisation of the mitochondrial channel has shown that it can be manipulated using some of the same substances that have been demonstrated to act on  $K_{ATP}$  in the cell membrane [58]. Using 5 – hydroxydecanoate (5HD) at the appropriate concentrations to block the

mitochondrial channel has been demonstrated to abolish protection [59]. This blocker has been shown to abolish protection in a whole animal model of ischaemia [60].

It is unclear why the opening of this channel and the resultant swelling of the mitochondria exerts a protective effect on the response of the cell to ischaemia.

It is possible to speculate that the changes resulting from opening of the mitochondrial  $K_{ATP}$  channel are in some way involved in the conservation of ATP associated with preconditioning.

$K_{ATP}$  channel blockers glyburide and 5 HD have been shown to block the protection due to ischaemic preconditioning in rat [61] rabbit [53] dog [51,53,62] and in human tissue [24].

Also bimakalim a substance that is known to activate  $K_{ATP}$  has been shown to mimic preconditioning in the dog [63]. Furthermore PKC has been shown to activate  $K_{ATP}$  channels when applied in near physiological concentrations [64]. The involvement of PKC and the  $K_{ATP}$  channel permit a redrawing of the signalling map leading to early preconditioning.

Figure 1.2 illustrates one putative pathway to early protection



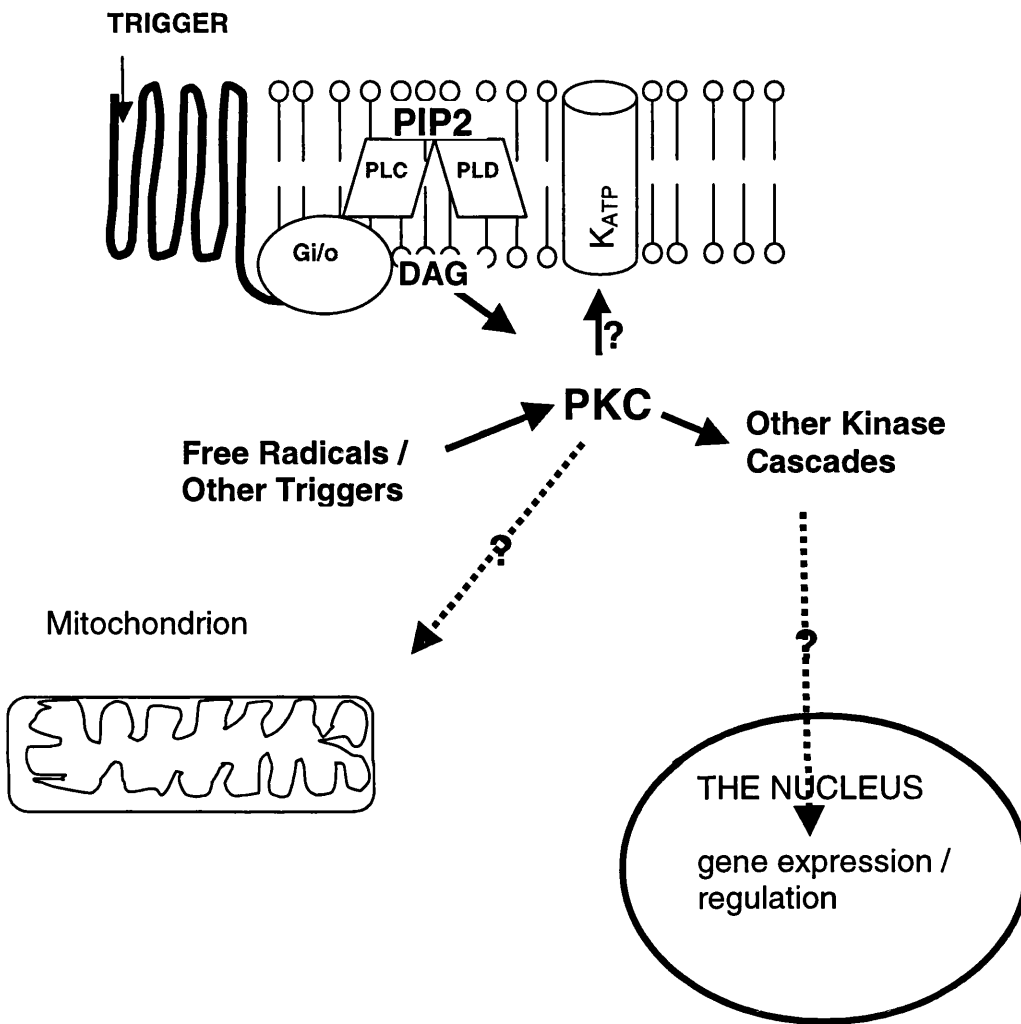

**Figure 1.2.** Further steps in the possible signalling pathway for early preconditioning.

Studies performed using isolated, human atrial trabeculae as a model system, by Speechly-Dick et al [24], demonstrated that glyburide, a K<sub>ATP</sub> channel blocker not only abolished the protection due to preconditioning, but also blocked protection due to PKC activators. These results are highly suggestive of the scheme shown above in figure 1.2, but there remains little or no evidence regarding

possible intermediaries in the path between PKC and  $K_{ATP}$ . In addition there remains no confirmation of whether the  $K_{ATP}$  channel in classical preconditioning is an end effector or a step in an as yet unidentified pathway.

The interactions of PKC with other kinases in signalling pathways leading to either modification of cellular processes or the up or down regulation of gene expression are being elucidated. It is considered likely that the alterations in gene expression brought about by the activation of transcription factors by kinase cascades are of more significance in delayed preconditioning. This view is in part supported by experiments performed using inhibitors of protein synthesis such as cycloheximide to try to block the onset of early preconditioning. It was found by Thornton et al that the prior administration of protein synthesis inhibitors did not block classical preconditioning in the rabbit [65].

The possible role of PKC in regulating gene expression will be discussed in the section of this introduction dealing with proposed mechanisms for delayed preconditioning.

Living organisms burn fuel in the form of carbohydrates and fats to generate energy. The energy generated is used to maintain the structures and function of the organism. The utilisation of fuel in the form of food takes place under two sets of conditions:

1. Aerobic metabolism in which oxygen acts as the final electron acceptor in the respiratory chain. The final breakdown products of aerobic metabolism are  $CO_2$  and  $H_2O$  accompanied by the rapid generation of large amounts of the high energy phosphate compound ATP.

2. Anaerobic metabolism in which, in mammalian cells, the breakdown of fuels to  $\text{CO}_2$  and  $\text{H}_2\text{O}$  does not go to completion and instead the metabolic intermediary lactate is formed. This type of metabolism is far less efficient at generating ATP.

Heart muscle preferentially metabolises free fatty acids derived from the breakdown of triglycerides to generate ATP under conditions of adequate oxygenation. Where demand is high, oxygenation is poor or the supply of fuel is inadequate the heart muscle is able to utilise increasing amounts of other metabolic substrates to meet demand. The approximately 30% of normal cardiac demand fulfilled by glucose can increase and stored glucose in the form of glycogen is released and metabolised.

Levels of lactate in the tissue are diagnostic of the type of metabolism occurring in the heart. Under normal oxygenation lactate can be oxidised during the course of the glycolytic pathway leading to the TCA cycle, where oxygen supply is inadequate the route stops at lactate which then accumulates in the muscle. The accumulation of lactate denotes low oxygen levels and is termed anaerobic glycolysis.

The reduced rate of synthesis of ATP and the accumulation of lactate are both observed in the ischaemic heart.

It has been demonstrated that the brief periods of ischaemia / reperfusion that form part of the preconditioning stimulus reduce the accumulation of catabolites in the extracellular space during the long ischaemia, it is not clear whether this is part of the mechanisms of protection Van Wylen [66].

It has also been shown that during preconditioning ischaemia the glycogen stores in the heart become depleted and that the rate of regeneration of these stores is reduced during the early phase of protection [67]. The reduction of

catabolite accumulation, particularly lactate and  $H^+$  associated with glycogen depletion may be protective in themselves. The role of glycogen in the response to the preconditioning stimulus and the subsequent protection is far from clear. It has been shown that functional recovery after the long ischaemia is virtually independent of the state of glycogen stores prior to ischaemia and that glycogen depletion *per se* does not mimic the protection afforded by preconditioning [68,69].

The metabolic status of the myocardial muscle cell under conditions of ischaemia and reperfusion and particularly the role of cellular acidosis and the regulation of cytosolic  $H^+$  have been implicated in the mechanisms of endogenous cytoprotection. The intracellular pH is regulated to a large extent by the  $Na^+ / H^+$  antiporter. This electrically silent membrane bound ion channel responds to changes in cellular pH by exchanging intracellular  $H^+$  with extracellular  $Na^+$ . The driving force for the antiporter is the sodium ion gradient across the membrane. The rise in intracellular  $Na^+$  is accompanied by an influx of water by osmosis and this is in turn dealt with by the  $Na^+ / Ca^{2+}$  and  $Na^+ / K^+$  ion exchangers. The assumption might be that both the potential for osmotic stress generated by the influx of sodium ion and the resulting increase in calcium influx would both contribute to the injurious effects of ischaemia. Inhibition of the  $Na^+ / H^+$  antiporter and the resulting cellular acidosis during ischaemia have been shown to have protective effects against the injury seen on reperfusion. In isolated adult rat cardiac myocytes subjected to anoxia and reoxygenation the presence of an inhibitor of the  $Na^+ / H^+$  was seen to delay the time to irreversible hypercontracture, the end point of cell viability used in the study [70] and similarly to delay or prevent the analogous response in the whole heart [71]. However the relationship of the protection observed on inhibition of

the antiporter, the role of glycogen depletion and residual glucose availability in cellular acidosis and what, if any, part these mechanisms may play in the phenomenon of preconditioning remains unclear [72]. Some investigators have demonstrated that the protection seen with blockade of the  $\text{Na}^+/\text{H}^+$  is at least partially additive to that seen with preconditioning [73], a result suggestive that these are parallel, but separate mechanisms. It is interesting to note that investigations into the role of the  $\text{Na}^+/\text{H}^+$  antiporter in the secretory functions of specific cells it has been suggested that the channel may be activated by DAG activation of PKC. This, if it is generally the case, offers a mechanism for the activation of the channel that is linked with the known early steps in signalling leading to preconditioning [74].

It would appear from the current state of knowledge that the metabolic consequences of brief preconditioning ischaemia and reperfusion may be part of the process, but do not seem to represent possible end points for the observed protection.

#### **1.2 d Delayed preconditioning**

It had been observed some years before the description of ischaemic precondition that *Drosophilla melanogaster* exposed to higher than optimal temperatures for short periods could survive for longer when re-exposed to the same adverse conditions [75]. Thermotolerance, as this phenomenon was called, was subsequently demonstrated to be conferred by the increased synthesis of a family of proteins, the heat shock proteins (Hsps), belonging to class of proteins called chaperones [76]. The chaperone proteins play an important role in the correct post-translational folding of newly synthesised proteins [77].

As a result of the role of the chaperones in thermotolerance it was proposed that these proteins also played an important part in the salvage and refolding of proteins damaged or partially denatured during physiological stress. In 1993 Dillmann and co-workers [78] described a rise in heat shock protein in isolated neonatal cardiocytes following prolonged hypoxia.

Subsequently this group and other workers continued examining the role of Hsps in myocardial protection discovered that heat stress conferred protection against ischaemic injury and that this protection was associated with a rise in Hsp expression [79]. The rise in protein expression due to heat stress occurred 24 hours after the initial stimulus and this phenomenon was termed delayed protection.

Two groups investigating the role of Hsps in myocardial protection observed this delayed period of protection from ischaemic injury. In the rabbit [79] Marber et al observed that both ischaemia and heat stress generated an elevation in Hsps associated with delayed protection against ischaemic injury, measured as infarct size. In the dog Kuzuya et al described a reduction in infarct size measured 24 hours after a sub-lethal ischaemia [80] having previously described elevation of endogenous antioxidant activity 24 hours after sub-lethal ischaemia in the same model [81]. This delayed resistance to infarction was termed the second window of protection (SWOP).

Some confusion in respect of terminology attaches to the phenomenon of preconditioning. Many reports (too numerous to mention) dealing with the characteristics of the second window of protection continued for some time to use the term preconditioning. Others immediately adopted SWOP or delayed preconditioning and a little later the term adaptive cytoprotection appeared. Throughout this thesis the term preconditioning is used when referring to early /

immediate protection and the term SWOP will be used when referring to delayed protection.

### **1.2e Proposed mechanisms of delayed preconditioning**

The immediate or classical preconditioning response may be mediated by activation of, rather than synthesis of subcellular components. The longer time course of delayed preconditioning implied that the cells have a 'memory' of the preconditioning stimulus persisting over a time course of days.

#### **The heat stress proteins**

The synthesis of new proteins is a possible mechanism for this 'memory'. Alterations in the regulation of gene expression have been regarded as a candidate mechanism for the second window of protection [82, 83]. Demonstrating that this is the case would require the measurement of increased amounts of active protein and that this increase was the result of new protein synthesis. It has been shown that mRNA for Hsps 27,70 and 89 was upregulated in response to preconditioning with ischaemia, but did not result in expression of significantly increased amounts of protein [84]. Conversely several groups have shown that heat stress proteins produced in response to hyperthermic stress protect against ischaemic injury, in cultured neonatal myocytes [85,81], and in adult rabbit, Marber et al. [79,86,87]. In favour of the role of Hsps in delayed preconditioning is the evidence that the overexpression of exogenous genes for these proteins in transgenic mice [88] and in transfected primary cardiac myocytes and myogenic cells [89,90] confers protection against ischaemic injury. The possible role of heat stress proteins as end effectors in the pathways of late preconditioning has been supported by much of the

experimental [91,92,93,94] evidence although it is clear that these are not the only mediators of protection, the upregulation of these genes in early preconditioning has not been demonstrated and not all investigators have found protection associated with increased Hsp expression [95].

The phenomenon of delayed preconditioning has an unusual property. This appears to be an adaptive response to a stimulus that has ceased to be applied some time before the response appears. It seems possible, therefore that the initiating signals for the delayed response are the same as those for the early response. It is the events taking place downstream of the primary cellular responses that are responsible for the distinction between early and late protections.

The more sustained protection observed in SWOP led several groups to begin investigating the underlying molecular mechanism of this effect. The longer time course of protection and the implied involvement of a relatively stable end effector or effectors increased the possibilities for finding a way of mimicking this protection using exogenous substances and thereby exploiting the protection in a controlled way for therapeutic applications.

To a considerable extent the steps in the pathways leading to the preconditioning responses, both classical and delayed are unknown. Several signal transduction pathways involving PKC have been at least partly elucidated, however there is much cross talk between pathways and the down-stream steps beyond the activation of PKC are by no means clear [96] (see figure 1.3).

In addition there is evidence that various pathways interact at points along the cascade making interpretation of the sequence of events flowing from the primary stimulus ever more difficult. It may be that subsequent to the activation of PKC a variety of transcription factors may be activated and the effect of these



is to upregulate (or possibly downregulate) the expression of a gene or genes involved in the cytoprotective response. However while this may well account for the second window response and explain its duration it remains to be demonstrated whether the time-scale of the response at the level of the genome is too great to explain the rapid onset and transitory nature of the response seen in classical preconditioning.

It has been shown that more than one signal will initiate the preconditioning response.

To summarise, it is widely accepted that the binding of an extracellular ligand to a G-coupled receptor initiates the process leading to the activation of PKC. The endogenous extracellular ligand may be adenosine [97], which freely diffuses across the cell membrane and is produced by the rapid degradation of ATP during an ischaemic episode. Other ligands demonstrated to initiate the protection due to preconditioning are bradykinin, angiotensin and exogenous triggers such as morphine. Adenosine analogues such as CCPA have been shown to mimic preconditioning in a number of models, rabbit heart [98], isolated rabbit cardiac myocytes [99,100,101], but only when applied prior to the long ischaemia suggesting that early activation of the pathway is required for protection [102].

Ligand binding to this class of receptors in turn activates membrane bound phospholipase enzymes that convert the membrane phospholipid phosphatidylinositol bisphosphate ( $PIP_2$ ) to inositol triphosphate ( $IP_3$ ) and subsequently to diacylglycerol (DAG), [103].

At the end of this chain of events lies the possible translocation and activation of PKC.  $IP_3$  stimulates the release of  $Ca^{2+}$  from intracellular stores and the rise in intracellular calcium is thought to be the stimulus for the translocation of cPKC $\delta$

to the membrane where DAG activates it. (The accuracy of this scenario will largely depend on which isoforms of PKC turn out to be involved in the preconditioning response as isotypes within the atypical subclass of this kinase are not activated by either calcium or DAG).

As discussed in the earlier section on classical preconditioning the events downstream from the activation of PKC may include ion channel activation, metabolic regulation or pathways of kinase cascades leading to activation of transcription factors and gene regulation.

Many of the triggers for the protection observed in classical and delayed preconditioning have been identified.

The evidence suggests that, with the possible exception of models based in the rat, the primary endogenous trigger is extracellular adenosine. The signalling pathways mediating protection are being elucidated, with each step identified the route becomes more complex (see figure 1.3). As far as identifying the end effector or effectors of the protection conferred by preconditioning is concerned the field remains open.

The possible roles in early and late protection of metabolic intermediaries, membrane ion channels, phosphorylation cascades and gene regulation are as yet undetermined. That all of these different parts of the cellular machinery are involved is supported by some of the experimental evidence.

Differences in observations between models, between species and between protocols have yet to be resolved. Preconditioning and adaptive cytoprotection represent important mechanisms in the control of injury in ischaemic heart disease.

Full elucidation of and thereby developing means of exploitation of these mechanisms have yet to be achieved.

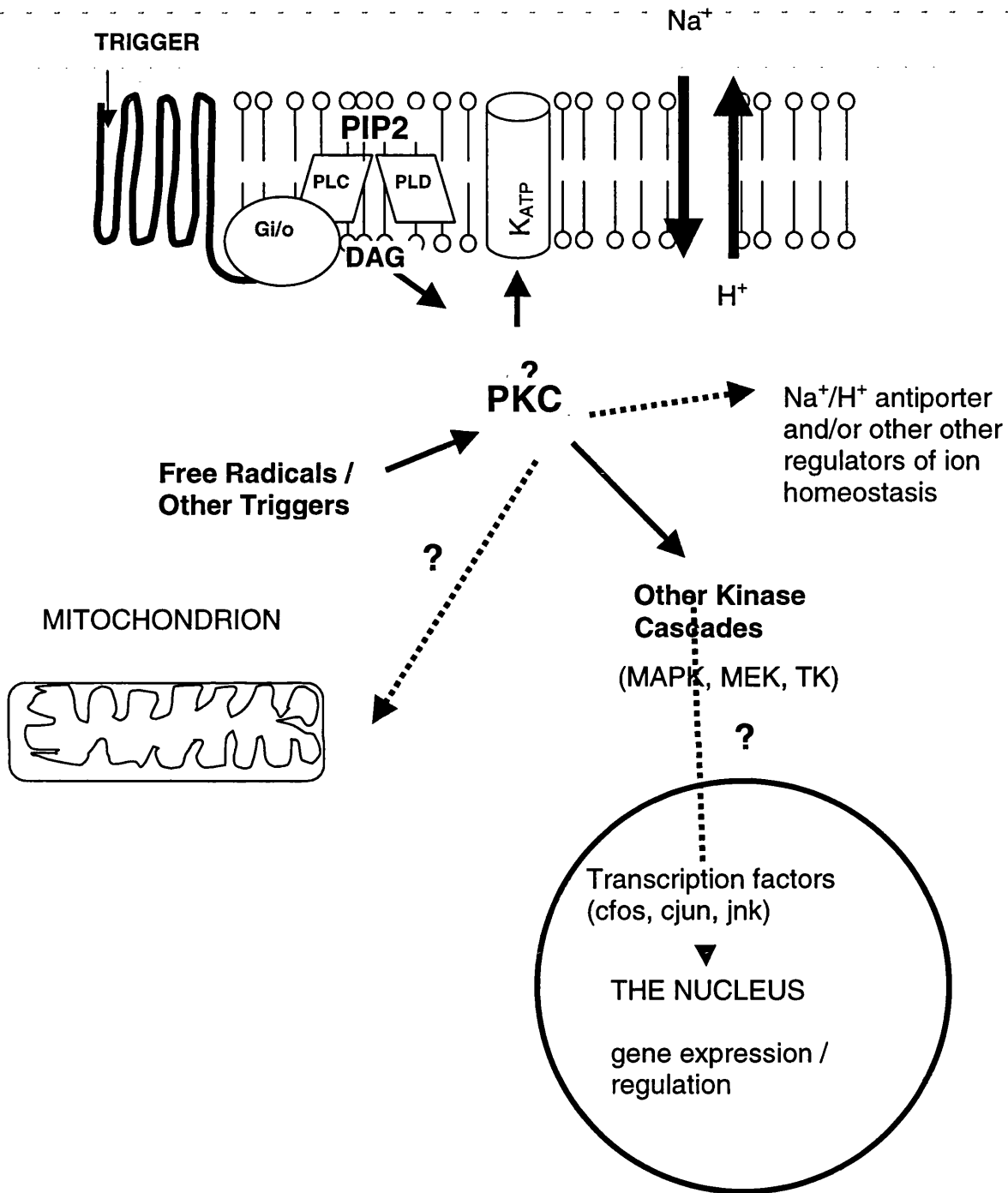

**FIGURE 1.3:** Putative signal transduction pathways and sites of action of the preconditioning response in cardiac myocytes.

### 1.3 MODELS OF ISCHAEMIC HEART DISEASE

There have been differences reported in the behaviour of rat and other animal models of ischaemic injury and preconditioning. The hypothesis that adenosine is the primary endogenous trigger eliciting an activation of PKC and leading to the protective response is widely accepted and has been demonstrated in a number of models yet in the rat the position of adenosine in the chain of events is unclear [104] although it is clear that the rat heart can be preconditioned and protection observed [20].

In addition to creating confusion species differences are a matter worthy of serious consideration. Variation between models may arise from differences between levels of complexity i.e. whole heart, isolated muscle or isolated cells. They may arise from differences in the age [105] and stage of development of the subject animal i.e. foetal, neonatal, immature adult or mature adult. They may arise from experimental procedures, which, if any anaesthetics are used, or may be due to real differences in the physiologies of the animals concerned.

Because of the utility of the laboratory rat as a source of experimental modelling systems a great deal of work in the field of ischaemic preconditioning has been done in this species. It is clear that the mechanisms of preconditioning persist throughout the animal kingdom from very early forms of life [106] and appear to have been conserved through the process of evolution to humans. It would be unreasonable to suggest that the mechanisms involved are unique to each class of organism, but they may not be identical. These are arguments that should be considered whenever interpreting results obtained from a model. As well as pointing out the difficulties always involved in the extrapolation of data derived from the laboratory [107] they are powerful arguments in favour of working in the most relevant species whenever possible.

The spontaneous development of atherosclerosis and ischaemic heart disease in the rodent has not been reported. This may be a function of shorter life-span, nutrition or factors not yet identified. Conversely the type of experimental protocols available in animal models e.g. brief periods of ischaemia prior to the sustained, injurious ischaemia are not available in the clinical setting.

Although it is possible that animals closely related to human beings such as the primates may have the capacity to develop ischaemic heart disease spontaneously [108,109] there is no indication that the disease and its associated disorders form any part of the normal life processes of these animals[110]. On the basis that primates are the closest living relatives to humans these animals represent an excellent candidate species for a laboratory model. With a long life expectancy, for chimpanzees in excess of thirty years, the time scale is too great.

Representatives of the more usual animal model systems such as rats, guinea pigs and mice have been specifically bred or genetically engineered to exhibit signs and symptoms similar to those characterising various aspects of cardiovascular disease as described in humans [111], examples are the hypertensive rat [112] and genetically obese rats and mice [113].

Such models are generally designed to investigate one aspect of heart disease or a known risk factor such as obesity.

### **1.3a Whole animal models.**

Using models of ischaemic injury and infarction based on anaesthetised or conscious whole animals such as the pig [114], dog [9], rat [115] and open-chest rabbit [116] has led to a number of important discoveries. The effects of

ischaemia on the heart, vasculature, haemodynamic parameters and survival have all been studied extensively in whole animal models.

The characterisation of ischaemic injury in these models has enabled studies to be conducted exploring the efficacy of a range of interventions. The roles of early reperfusion and thrombolytic therapy in post infarct survival have been tested in animal models [117,118], but the overwhelming body of data collected in respect of this type of intervention has been based in clinical practice [Nee 1977 review][119].

Both methods of investigation have led to advances in therapeutic approaches to the early treatment of heart disease.

Living organisms are complex interactive systems in which individual mechanisms are difficult to identify. While the influence of interactions on the outcome of any modification or perturbation of a system is a vital component to fully understanding the system it, at least initially, makes interpretation of experimental results difficult.

To dissect out mechanisms the use of simpler systems is often preferable, although an acknowledgement that the simplification is itself a negative as well as a positive characteristic of such systems is necessary.

For the modelling of biochemical and molecular biological parameters within the tissues of the heart and within specific cell populations in those tissues the whole animal model becomes too cumbersome.

### **1.3 b Ex-vivo whole heart and isolated muscle preparations**

The isolated whole heart as a model has been an invaluable investigative tool since the very first report of its successful sustained use in an experimental setting by Langendorff. The use of *in-vivo* models has advantages in terms of

avoiding oversimplification and retaining many of the levels of interaction present in life. The disadvantage of the *in-vivo* heart, as with all *in-vivo* models, are the difficulties incurred in controlling for the large number of variables present in a complex system.

The isolated, perfused heart is a useful modelling system for measuring the effects of inadequate perfusion. Mimicking myocardial ischaemia by restricting the flow of perfusate to the isolated heart and the measurement of infarct size, arrhythmia, diminished contractility and enzyme release have all been used as endpoints on injury.

Additional isolated tissue models have been developed, these include the isolated papillary muscle preparation. The isolated superfused or perfused papillary muscle preparation has been used to investigate electrophysiological [120], mechanical [121], physiochemical [122] and pharmacological [123] sequelae to simulated ischaemia and protective interventions in both crystalloid [120] and blood perfused [121] models. Tissues for this preparation have been derived from both laboratory animals including ferret, guinea-pig and rabbit and from humans.

Most isolated tissue preparations are perfused with carefully formulated crystalloid buffer solutions that are saturated with oxygen by directly gassing the solution. The stability of these preparations is short, in part due to crystalloid perfusion. Superfused tissue preparations may become under perfused a short distance from the surface of the tissue.

Perfusing isolated tissues with blood is one way to ameliorate these difficulties and is a technique that has been used to extend the life of such preparations during investigations of the mechanisms of ischaemic injury [124]. The life of isolated tissue preparations remains one of several hours, where investigations

involve determinations of changes in gene expression this time scale is much too short.

### **1.3c Experimental models based in humans and human tissues.**

In one sense all of the clinical procedures undertaken in the prevention and treatment of ischaemic heart disease represent experimental models. The precise aetiology and fundamental mechanisms of heart disease remain uncertain. However the objective of clinical intervention is to improve the situation for the patient, no procedure can be carried out in this arena simply to obtain information. It has been suggested that preconditioning exists in humans. The procedure known as coronary angioplasty where the obstructed coronary vessel is dilated mechanically by inflating a balloon catheter in the affected artery has provided one human modelling system for preconditioning. During this procedure the artery will be partially or completely obstructed as a consequence of the balloon inflation. Several studies of the effects of short sequential occlusions during angioplasty have been conducted since the introduction of the technique to clinical practice. Determination of whether the human myocardium displays adaptation to the ischaemic episodes during angioplasty has created controversy. The end points for measurement of adaptation such as less patient reported pain, reduction in ST segment shift of the ECG [23] and reductions in the release of lactate or adenosine nucleotide [125] have all been used. However the situation in humans is complex, the many studies conducted on patients undergoing angioplasty have failed to generate a consensus as to whether preconditioning has been observed. Improvements in blood flow due to the recruitment of collateral vessels [126] could account for the increased tolerance to subsequent balloon inflations after the initial occlusion, objective



measurements of such as left ventricular contractile function, ECG changes and the presence of metabolic indices of injury [127] have not generated agreement. The presence in all of the patients recruited to these trials and studies of symptomatic cardiovascular disease means that the heart and vasculature may already have undergone processes of adaptation to ischaemia and there is no possibility of conducting such studies in normal healthy human subjects.

It is also a common procedure to induce a brief period of global ischaemia during open-heart surgery using a technique called aortic cross clamping. During this brief occlusion the process of cardioplegia, or induced cardiac arrest is initiated. Temperature is reduced and / or high potassium ion concentrations or specially formulated crystalloid solutions that maintain the myocardium, but stop beating are introduced to allow the surgical procedure to be conducted. It has been reported [128] that cross clamping acts as a preconditioning stimulus in the human heart and that postischaemic recovery is improved by serial brief periods of cross-clamping.

The end point measured in studies involving humans has on occasion been the conservation of ATP. In other, laboratory based, studies it has been suggested that ATP conservation is not a good index of functional recovery after ischaemia [129,130]. The development of infarcted tissue does not normally occur in the context of the clinical applications of preconditioning. The comparison therefore of this situation with the endpoint of preconditioning frequently used experimentally i.e. infarct size is a difficult one to make.

As with the situation during angioplasty it is not entirely clear whether preconditioning is responsible for protection observed during cardiac surgery.

### **1.3d The role of cellular models of ischaemia**

E.B. Wilson wrote, in his work on the biology of the cell: *The Cell in Development and Inheritance* that “ The key to every biological problem must be sought in the cell ”. This observation remains valid over six decades after it was written.

The individual cell can be viewed as the smallest representative functional unit of the living tissue of which it is part. For this reason the use of cell culture as a means of constructing model systems for the investigation of biological phenomena is an approach that has been growing in both range and size.

In cultured, terminally differentiated cells the multitude of interactions between cells of the same and different types and the array of signals from local and remote sources are frequently absent. As a consequence tissue culture represents a highly reductionist model of otherwise bewilderingly complex and interactive systems.

To develop a model of a disease specific to a living tissue such as ischaemic heart disease at a cellular level calls for a cautious approach. Nonetheless it is at the level of the cell that the potential for creating experimental models of ischaemic heart disease in humans exists.

A number of investigations have been conducted into the electrophysiological, metabolic and mechanical properties of cells derived from adult human heart tissue using acutely isolated adult cardiac myocytes [131,132,133]. Acutely isolated cells persist for only short periods and this has limited the nature of the investigations that could be conducted.

Several researchers have tried to develop long-term culture systems for human derived cardiac myocytes, these have either involved attempts to transform the cells to derive a stable cell line [134,135] or the use of immature cells derived from embryonic or neonatal tissues [136].

The successful isolation of adult human cardiac muscle cells [137] from material obtained from biopsy and transplantation procedures has opened the possibility of modelling in adult human tissues. The culture of cells obtained from these sources has not been reported.

Several difficulties exist in developing the techniques for culturing adult human myocytes. The material can be difficult to obtain, the atrial appendage is often removed during coronary artery bypass surgery and this material has provided tissue for isolated muscle and cell preparations. Speechly-Dick et al 1995 [24] reported a model of ischaemia and preconditioning using the human papillary muscle derived from atrial tissue made available during bypass surgery.

Ventricular biopsies are carried out, although this procedure will generally result in the procurement of small amounts of tissue that are from regions of the ventricular wall affected by disease. Similarly transplant heart tissue from the recipient is unlikely to consist of entirely normal and healthy tissue. Healthy human ventricular tissue is not a readily available resource.

Cell culture offers the opportunity to do a great deal with very little material, but to develop a model of ischaemic injury and preconditioning in cultured adult cardiac myocytes that can have application in human tissues it is necessary to first build the model using a more readily available resource. This is part of the aim of the study presented in this thesis.

The level of simplification represented by working in cell and tissue culture represents both the major advantages and disadvantages of these modelling systems.

The absence of intercellular interaction permits the direct observation of the effects of any stimulus on the functioning of the individual cell and provides the opportunity to dissect out responses at the sub-cellular level. The ability to

investigate the mechanisms of interaction between the external environment and the living organism down to the level of the genome is unique to cellular modelling systems. The examination of cellular responses to specific stimuli under controlled conditions is the objective that the model described here has been developed to permit.

A modelling system fully developed for use with adult cells could create the opportunity to work with material derived from humans.

### **1.3d Existing cell based models**

Armstrong et al 1994 [44] , Cave et al [138]and Ikonimides et al 1997 [136] have described models of ischaemia and reperfusion injury in isolated cells.

In the Armstrong and Ganote pellet model adult rabbit cells were isolated and treated acutely and in the studies conducted by Ikonimides et al the cells used were derived from foetal human hearts and continuously cultured.

Ischaemic heart disease is amongst the most common causes of death in the United Kingdom, it is largely a disease of adults and as such a model that is based on the adult heart is the more appropriate method of investigation.

Some of the consequences of ischaemic injury such as the changes in gene expression in cardiac myocytes [139] may occur over periods of days rather than hours. It is clear that whatever mechanism represents the memory of the initial stimulus that leads to delayed preconditioning persists or acts over at least 24 hours.

In order to address the mechanisms of injury and to investigate possible interventions to reduce or prevent injury a modelling system that is stable for this period of time is needed.

### **1.3f A definition of ischaemia at the cellular level**

In 1994 an editorial entitled 'Myocardial ischaemia: can we agree on a definition for the 21<sup>st</sup> century?' appeared in Cardiovascular Research [140]. The author, Professor DJ Hearse had sent a request for a definition of myocardial ischaemia to 33 eminent cardiologists. The article provides abstracts of the replies returned by 31 respondents. No two replies are the same although several are at least similar. Given the difficulty encountered in trying to define ischaemia in its 'natural habitat' there is an element of impossibility about trying to do so in captivity.

The term ischaemia can be taken to mean the failure, total or partial, long or short-term of perfusion to an organ or part of that organ.

Even this simple definition cannot accurately be applied to the cell on a tissue culture plate, which is not perfused, but maintained in a static and largely invariant environment.

One definition of ischaemia is that used by Opie [141] which describes ischaemia as the situation resulting from metabolic demand exceeding supply. Others such as that provided by John Ross and Joanne Ingwall emphasis inadequate perfusion and cite the conditions existing in the tissue during ischaemia.

The conditions listed include the accumulation of extracellular lactate, reduction in pH, energy depletion and decreased oxygen tension. Using these definitions a simulation could be devised and applied to cells in culture to generate an acceptable analogy to ischaemia.

## 1.4 GENE TRANSFER

### 1.4a. The scope of gene transfer techniques

---

Selection of a gene transfer method or vector is dependent on the ability of the vehicle to enter the target cell, the amount of space available in the vector for the gene of interest with its necessary regulatory sequences of DNA. In prokaryotic genomes the expression of groups of genes, or operons are regulated in tandem by sequences of DNA known as promoter/inhibitor sites that switch the processes of transcription on and off in response to cellular signals.

In eukaryotic cells the regulation of gene expression is more complex and less well understood. It is clear that in eukaryotes a single promoter sequence and a number of regulatory sequences regulate the process of transcription of any single gene. Regulatory sequences that respond to transcription factors and modulate gene expression may be adjacent to the protein coding sequence or at some physical distance from it [142].

The presence of apparently non-coding DNA or introns in eukaryotic DNA can often result in protein coding sequences existing in widely spaced segments. The net result of all of these characteristics of eukaryotic genetic material is that gene sequences can be large relative to the size of a gene transfer vector.

The available space in a vector is limited by the size of the vector, The amount of vector DNA required to permit penetration of the target cell and the size of regulatory sequences needed for transcription and translation of the imported genetic material.

A variety of vectors exist ranging from small circular sequences of bacterial extrachromosomal DNA termed plasmids, through virus particles to yeast artificial chromosomes (YAC's).

The sizes of available vectors vary and the choice of which is used will depend on a number of factors. Virus based vectors have the advantage of exploiting viral mechanisms for cell penetration, but because some of the virus characteristics are conserved may be immunogenic and able to take inserts of only limited size [143]. Other vector types may not interact effectively with the target cell resulting in very low transfection efficiencies [144] this is sometimes the case with liposome mediated gene transfer. Yet others, such as plasmid vectors may require modifications of the condition of the target cell membrane to gain access. In this instance the conditions required such as increased temperature or salt concentrations may be too severe to be well tolerated by the target cell. Where *in-vivo* gene transfer is the aim some of the available techniques for the transfer of DNA to target cell populations have no application at all.

Size limitation of some of the available vectors can result in the regulatory sequences normally present with the gene being omitted from the construct. This is particularly likely to occur where the open reading frame for the gene product is some distance from promoter or enhancer sequences in the original genome.

As a result of this and the frequent requirement for continuous expression, genes inserted into transfection vectors for gene transfer are often placed under the regulation of a powerful alternative promoters able to switch them on although not necessarily able to tightly regulate the expression of the gene. Unless specific regulatory sequences, termed response elements are incorporated alternative promoters cannot regulate the expression of a gene as would be the case in cells where it is normally expressed. The synthesis of mammalian DNA that contains only coding sequences for the desired protein, cDNA, has reduced

space requirements for the insertion of mammalian genes into gene delivery vectors.

The general aims of gene transfer for gene therapy are to:

1. Express a protein in a cell in which it is not normally expressed, but considered beneficial.
2. To augment the expression of a protein that would normally be expressed, but either because of inherited or acquired insufficiency is functioning below optimal efficiency.

Supplementary to these general aims, but not unrelated are the application of genetic approaches to cancer treatment and targeted drug delivery.

Viral gene transfer vectors will often only efficiently transfer genes to cells that are actively replicating. Terminally differentiated cells are not a 'desirable' target for virus infection. The virus lifecycle exploits the replicative apparatus of the host cell and only few naturally occurring viruses will primarily infect non-replicating cells.

Two of these, the herpes simplex virus and the adenovirus have both been identified as able to infect non-dividing cells and transfection vectors also able to enter non-dividing cells have been derived from both. The development of a transfection vector requires primarily circumventing the viruses own agenda which is to infect the cell, modify the host cell genome and synthetic apparatus to the production of virus particles [145]. To achieve this sections of the virus genome are removed. These sections frequently include what are termed early genes. Deletion of these sequences deprives the virus of the ability to reproduce and thus render it non-infective in the classical sense[143]. The vector is able to enter a target cell but not to reproduce in it, such modified viruses are termed



replication deficient. The deletion of viral early genes also provides space in the viral genome for the insertion of selected DNA.

In some instances additional viral DNA can be and has been deleted simply to make more room for the desired insert. It is fair to note that some level of mystery exists as to which sections of the viral genome are those vital to the process of entering the cell and which actually play an important role in the life cycle of the virus once it has infiltrated the cell.

Clearly the less viral genome that needs to be included in a vector the more additional material can be transferred to the cell. In addition the fewer viral proteins synthesised within the host cell the lower the risk of any subsequent immune response to either infected cells or repeated doses.

For the purposes of using the virus as a mechanism of gene transfer it is desirable to retain as little as possible of the original viral genome. Replication deficient viral particles that do not integrate into the host cell genome will persist in the cell for only a limited time conferring transient gene expression. Genetic material present in the cell that is not chromosomal in nature is termed episomal.

### **Quantification and qualifications**

Levels of gene expression will be governed both by the nature of the promoter controlling the gene and the capacity of the host cell to tolerate the excess of gene product. It follows that individual cells in culture will express the gene product to different degrees. In addition the viral genome may however modified, continue to produce viral protein [143]. If any of the viral proteins synthesised by the vector are able to act as cell surface antigens the possibilities for repeated use of the vector are low. A second exposure to virus where cell

surface antigens are present will elicit an immune response even though the virus has not caused symptomatic disease [146].

In a therapeutic setting the potential for transformed cells to become targets for the immune response represents a considerable difficulty. The use of an immunologically neutral gene delivery vehicle would overcome this problem.

An alternative strategy for avoiding the need for repeated exposure to a viral based vector would be to use one based on a virus that can integrate into the host cell genome. Retrovirus based gene transfer vectors with high tissue type specificity have been considered for use in human tissues [147] despite considerable advances in vector design it is not currently possible to precisely pre-determine the point at which a virus would incorporate into the mammalian genome. If the virus were to integrate within a protooncogene there is the very real risk that gene transfer using retrovirus based vectors could initiate tumorigenesis. Site directed integration is an area where research remains to be conducted.

Several non-viral gene delivery systems have been developed partly to avoid the problems associated with the introduction of virus and partly because some cell populations are refractory to viral vectors [148].

The experience of microbiologists and biotechnologists suggested it might be possible to transfer genes using naked DNA. This can be done in E Coli using heat shock or high concentrations of calcium phosphate to cause temporary permeabilisation of the cell wall and membrane. The techniques used for gene transfer to microorganisms however are often too aggressive for mammalian cells, which do not have a cell wall. Even in cells able to withstand the assault only low efficiencies of gene transfer by these methods have been reported. In bacteria, which reproduce rapidly low initial transfection rates are sufficient. As

early as 1979 [149] the interaction between phospholipid monolayers, DNA and living membranes had been reported. The techniques for combining DNA with lipoproteins to form complexes that would attach to the cell membrane and stimulate absorption by endocytosis [148] were rapidly characterised and applied to a variety of cell types. The lipoproteins are termed liposomes although the term is also widely used to describe the lipoprotein-DNA complexes formed. The ability of liposomes to enter the target cell is dependent on the precise composition of the lipoprotein and its compatibility with the target cell membrane [149,150] The size of the complex will also have an influence on the ability of the target cell to absorb it.

Liposomal transfection has been successfully utilised for gene transfer to mammalian cells both *in-vivo* [151] and in mammalian cells [152] and cultured cell lines *in-vitro* [153]. Although some workers have reported problems with the use of this gene delivery vehicle *in-vitro* [154].

Other forms of non-viral transfection have been developed these include direct microinjection, virus and plasmid co-transfection, viral-plasmid conjugates and fairly recently synthetic integrin binding peptides. These peptides mimic the ability of viruses to bind to specific sites on the cell surface and stimulate endocytosis[155]. The clear advantage of this technique is that it makes exploiting the well developed viral techniques for gene transfer available without introducing any viral DNA into the cell at all. The peptides are mixed with plasmid expression vector containing the appropriate inserts and then simply added to the target cells.

## **CHAPTER 2**

---

### **GENERAL METHODS**

#### **2.1. ANIMALS**

- a. Animal housing and feeding
- b. Animal handling

#### **2.2 ANAESTHESIA and PREPARATION FOR DISSECTION**

#### **2.3. DISSECTION**

#### **2.4. MICROBIOLOGICAL SCREENING**

#### **2.5. ENZYME EVALUATION AND BATCH TESTING**

#### **2.6. WESTERN BLOTTING**

- a. Principle
- b. Method

#### **2.7 CELL VIABILITY ASSAYS**

- a. Trypan blue exclusion
- b. LDH release
- c. MTT conversion

#### **2.7. STATISTICAL METHODS**

## **2.1 ANIMALS**

### **2.1a Animals, housing and feeding**

For this work, male New Zealand White rabbits were used. Animals originated at Froxfield farm, Lincolnshire. Although the project relocated from University College to St Thomas's hospital after one year all animals were supplied from the same breeding colony. Animals were ordered to arrive weighing 2.2Kg and were housed in the institutional animal house overnight or for a maximum of three days.

The animals were fed on standard rabbit / guinea pig diet supplied by B.K. Universal supplemented with fresh vegetables or a 'chew'. All rabbits were housed individually in standard cages and supplied with food and water *ad lib*. No specific light-dark cycle was applied.

Room temperature was maintained between 18 - 20 °C and critical humidity at 55% +/- 10%. These conditions were continuously monitored. Animals were not fasted prior to procedures. All of the procedures carried out on these animals complied with Home Office guidelines.

### **2.1b. Animal handling**

All animals were transferred between housing and operating areas by means of a carrying box. Rabbits were lifted by firmly gripping the scruff and supporting the spine. These procedures were followed to avoid stress that could introduce experimental variability.

## **2.2 ANÆSTHESIA and PREPARATION FOR DISSECTION**

The ultimate aim of the isolation procedure was to generate sterile cells for tissue culture. Although the use of antibiotics can permit cells that were not

sterile at the time of plating to survive in culture it was clearly preferable to generate sterile cells. As a consequence the removal of the heart was carried out under aseptic conditions.

Prior to full anaesthesia, the animal was sedated with the veterinary sedative Hypnorm (Fentanyl citrate 0.315 mg/ml + Fluanisone 10mg/ml). To a rabbit weighing 2.2 - 2.5 Kg a dose of 0.8mls of this combination (0.25 mg Fentanyl citrate + 0.8 mg Fluanisone) was administered intramuscularly.

This combination of neuroleptic and narcotic produced effective sedation within 10 - 15 minutes of administration. Once the animal was judged to be sedated it was lifted onto a clean operating area covered in two layers of surgical drapes. The top layer of drapes was used to wrap the animal and a butterfly cannula was introduced into the left ear vein. The cannula was attached to a 10ml syringe containing 5mls of 60mg/ml pentobarbitone sodium (Sagatal) and 0.1mls of 100IU/ml lithium Heparin; 1.0 - 1.5 mls of Sagatal / Heparin mixture was administered via the cannula and the condition of the animal monitored.

When there was no response to pressure to the hind limb the drapes were unwrapped, but left under the animal which was then turned onto its back. Under this level of anaesthesia there was complete loss of the righting reflex. The chest and abdominal area were then shaved using clippers and the fur removed from the preparation area with a vacuum cleaner.

Once the area was free of hair the chest and abdomen were sprayed with chlorhexidine in 70% absolute alcohol and the top layer of drapes was removed and discarded. The animal and operating area were now ready for the dissection to proceed.

Immediately prior to opening the chest the animal was re-

covered with sterile drapes, sterile instruments were unpacked and the person performing the dissection applied sterile surgical gloves.

The remainder of the pentobarbital was then administered slowly via the ear vein cannula to kill the rabbit. The dissection proceeded immediately.

## **2.3 DISSECTION**

The thorax was opened via an anterior mid - line incision. The rib cage was opened by cutting with scissors held parallel to the sternum. The ribs were then separated using a pair of retractors and the heart freed from the pericardium by gently snipping with scissors. The heart was then lifted forwards and downwards using the fingers so that the aorta could be clearly visualised and the aorta was cut as far from the heart as possible.

The heart was then freed from remaining blood vessels as quickly as possible and transferred to ice - cold, calcium free Krebs - Heinseleit solution containing 120mM NaCl, 5.4 mM KCl, 5mM MgSO<sub>4</sub>. 7H<sub>2</sub>O, 5mM Pyruvate (sodium salt), 20mM Glucose, 9.15mM HEPES (sodium salt) 20mM Taurine, pH adjusted to 7.2 at room temperature.

The heart was then rapidly transferred on ice, to a perfusion rig. The perfusion was initially conducted in the buffer as detailed above, all enzyme solutions were also made in this buffer.

The pH was adjusted at the appropriate temperature and the effect of dissolved enzymes on the pH was tested. No significant change in pH was observed in enzyme solutions.

## 2.4 ENZYME EVALUATION AND BATCH TESTING

Collagenase to be used in the digestion of adult rabbit hearts was supplied by Lorne Diagnostics. Worthington Biochemicals manufactured the reagent in the United States. The enzyme was extracted from the bacterium *Clostridium histolyticum*. A written report was provided with each batch of enzyme. Activity was reported as units per mg dry weight in terms of three main constituents of the lyophilised preparation. Units of activity were quoted as one unit being the amount of activity that liberated 1 $\mu$  mole of L-leucine equivalents from collagen in 5 hours at 37°C and pH 7.5.

Each batch varied slightly in the activity reported. The manufacturer was able to supply an aliquot of each batch for testing and would normally provide three test samples from batches with similar characteristics. An activity report as provided by the manufacturer is attached as an appendix to this thesis.

No correlation was ever observed between the stated activities of the enzyme components and the suitability of the batch for use. The information provided gave no discernible clue as to the effectiveness of any particular batch of enzyme. It was therefore necessary to perform isolations with a number of test samples of enzyme and select a batch on the basis of performance.

Once selected for use a particular batch could be bulk purchased or held by the manufacturer on reserve for up to one year. This procedure was followed several times throughout the course of this work.

Preparations of protease (Type XXIV, bovine) supplied by Sigma Chemicals were not batch tested and no variation in the performance of this enzyme was observed.



## 2.5 MICROBIOLOGICAL SCREENING

The various protocols described above were conducted on different sites through both each individual experiment and during the conduct of the project. Initially the dissection was conducted in an ordinary laboratory in which a variety of animals were used and experimental procedures conducted. Although all cell preparation was conducted in a sterile field using a laminar flow cabinet contamination occurred and the organisms involved had to be excluded. In order to achieve this strictly aseptic techniques were applied and practised at all times. All glassware, solutions and suitable plastics were autoclaved, filtered or supplied sterile respectively, however problems continued and the option of using antibiotics was considered.

It was therefore necessary to identify the contaminating organisms and conduct an antibiotic resistance screen.

Blood agar plates kindly provided by the Medical Microbiology Department of University College Hospital were distributed around the bench surfaces in all areas in which this work was conducted.

The covers of the nutrient-coated plates were removed for a period of 60 minutes then re-covered and collected. These were then placed in an incubator at 37°C, normal air, for 24 hours. In addition swabs were taken from surfaces inside the laminar flow cabinet and all surfaces that were utilised during the dissection, perfusion and isolation procedures and these swabs were applied to blood agar plates which were also incubated under the conditions described for 24 hours. Finally an aliquot of visibly contaminated cell suspension was streaked onto a blood agar plate and sent to the medical microbiology department of University College hospital for an antibiotic resistance screening procedure.

At the end of the incubation period the plates exposed to air and swab samples were examined for the development of visible bacterial or fungal colonies. On plates that had been exposed to air in the laboratory there were few if any colonies and those present were readily identifiable as colonies of *Pseudomonas sp.* Which appear as discrete, off-white, circular colonies.

The same organisms were identified on swabbed plates and by the microbiology department on the plate raised from the contaminated cell suspension. The medical microbiology department subsequently identified these as non-pathogenic organisms resistant to penicillin and streptomycin, but susceptible to gentamicin.

In consequence gentamicin at a concentrations of 10-25µg/ml [156] was added to all media used for cell isolation and culture. No further problems with bacterial contamination were encountered.

Later, after transferring to another site, the heart was removed, as described, in an operating theatre in the animal facility, the perfusion took place on a prepared bench area in a nearby laboratory and the cell isolation in a tissue culture laboratory adjacent to this. The same screening procedure was undertaken. No bacterial colonies were observed and the use of antibiotics was suspended.

In addition at intervals throughout the conduct of the research 0.5 ml samples of all stock solutions and the FCS provided by Gibco RL were added to 5ml aliquots of fresh tissue culture medium and incubated for 24 hours in a tissue culture incubator to check for contamination at source. After incubation the tissue culture plates used for this sterility check were examined under the light microscope.

Bacterial cells are generally too small for easy identification under the low magnifications available using light microscopy. The presence of large numbers

of motile bacteria is readily apparent at x 100 magnification and the appearance of early fungal infection is also clearly visible. At this level of magnification single yeast cells appear as bright, flattened discs in the field of view.

## **2.6 WESTERN BLOTTING**

### **2.6a General Principle:**

This technique, first described by Burnette 1981[157], is used for the identification of proteins derived either from homogenates of whole tissue or lysates of cells in culture.

Protein separation is achieved by electrophoresis, the movement of charged molecules through an electric field. The commonest support media for electrophoretic separation are polyacrylamide gels, which are chemically inert and readily produced by the polymerisation of acrylamide. The pore size of the gel can be varied and acts as a molecular sieve to enhance separation.

Once separation is achieved the electrophoresed protein bands are transferred by electroblotting onto a nitro-cellulose membrane. Protein has a high affinity for nitro-cellulose.

The bound proteins can then identified by applying a specific probe. Antibodies are used as probes to identify proteins that have been transferred to a support membrane such as nitro-cellulose. In practice two antibodies are used in a "sandwich" with the primary, highly specific monoclonal antibody attached first followed by a second, polyclonal antibody that is labelled with a fluorescent marker.

The primary antibody both identifies and locates the protein while the secondary antibody provides a means of visualisation and amplification. Secondary antibodies are raised against the animal in which the primary antibody was

derived for example if the primary antibody to the target protein was raised in mice the secondary antibody would be rabbit or rat antimouse. The secondary antibody can therefore be used to probe for any primary antibody raised in mice. In addition more than one secondary antibody molecule will bind to the primary as the secondary antibody is polyclonal, this polyvalent binding acts to amplify the signal from the activation of the fluorescent marker.

The labelled nitro-cellulose membrane is treated with a visualisation reagent and exposed to X-ray grade photographic film and a dark band appears where the protein was located. The use of control samples and standards of known molecular weight run on the same gels aid in confirming the identity of the visualised bands.

### **2.6b Western Blotting method:**

Gels were poured vertically using plate forming apparatus (Bio Rad mini protean). Stacking gels for use in the mini-gel apparatus were made up as 3% w/v with respect to acrylamide. The purpose of the stacking gel is to focus the samples to facilitate separation. The running or separation gel was made at a concentration of 12.5% w/v with respect to acrylamide. Immediately prior to pouring the gel between the glass plates of the gel former apparatus the polymerisation reagent was added to the diluted, buffered acrylamide solution.

Prepared samples that had been denatured with  $\beta$ -mercaptoethanol and stained with bromophenol blue dye were applied to the electrophoresis gel in volumes determined by protein content ( see section on protein estimation). Gels were run at 65 V for two hours or until the bromophenol blue marker had reached the bottom of the gel. Electroblotting onto nitrocellulose gel was performed and bands were visualised by use of ECL reagent, (Amersham) the reagents in this

system emits light via the interaction with the horse radish peroxidase bound to the secondary antibody.

### **Sample Preparation**

Cells were treated for sample collection by using a lysis buffer containing 20% glycerol and 5% sodium dodecyl sulphate (SDS) in 0.12 M N-[2-Hydroxy-1,1-bis(hydroxymethyl)-ethyl] glycine (Tris) buffer at pH 6.8., 0.5mls of lysis buffer was applied to each well of cells to be collected for Western blot analysis and left in contact with the cells for 10 minutes. At the end of 10 minutes the resulting viscous solution was loosened from the well using a cell scraper. Finally an additional 0.5 mls of the lysis buffer was added and the suspension was pipetted into micro-centrifuge tube for storage. As the viscosity of the solution was high the pipette tip used for sample collection was trimmed with scissors a few centimetres from the tip and repeated pipetting was required to collect the entire sample. Samples were stored frozen until use.

For application to the electrophoresis gel samples were treated with  $\beta$ -mercaptoethanol at 20% v/v and heated at 100°C for 5 minutes to denature the proteins present. The treatment with mercaptoethanol reduces the viscosity of the sample and permits accurate pipetting.

Once cooled a small volume of the dye bromophenol blue was added so that the migration of protein down the electrophoresis gel could be followed by eye.

### **Protein determination**

In order to compare the samples quantitatively it was necessary to ensure that the same overall amount of protein was applied to each well of the electrophoresis gel at the outset. A variety of simple protein estimations such as

the Lowry or Bradfords colourimetric methods exist. However the detergent content of the lysis buffer would interfere with the commoner protein assays [158]. Estimates of the protein content were performed by running a protein loading gel and comparing the density of bands resulting from the same volume of each sample by using a scanned image of the loading gel and image analysis software (name). This method is approximate, but as gross changes in the expression of the proteins of interest would be visualised it was deemed adequate.

For the protein loading determination 10 $\mu$ l of each sample was added to each well of the electrophoresis gel and electrophoresed at a constant 85V until the bromophenol blue stain had visibly reached the bottom of the gel. This had usually taken place in 2.5 hours when using a mini-gel apparatus.

The gel was then placed into a small tray containing coumassie blue stain that binds to protein and the gel was left to stain overnight.

After overnight exposure to the coumassie stain the entire gel was blue. Sequential washing of the gel with a de-staining solution containing 10% acetic acid, 50% methanol and 40% distilled water (v/v) removed all of the coumassie stain not bound to protein.

This procedure left a colourless gel in which blue-stained bands of separated protein could be clearly seen.

In Fig. 2.1 an example of the scanned image (NIH image software) of a protein loading gel and a table of the data yielded by the quantification technique are illustrated. To standardise the protein loading of each sample the value obtained from one sample on the protein loading gel was selected as the source of comparison. Each of the other bands was then compared with this one and the volume of sample to be applied calculated as follows: density of the selected

sample (N), divided by density of the sample to be compared (X) and multiply by the volume of sample N to give the volume of sample X that would contain an equivalent amount of protein.

band no:     1     2     3     4     5     mwm     6     7

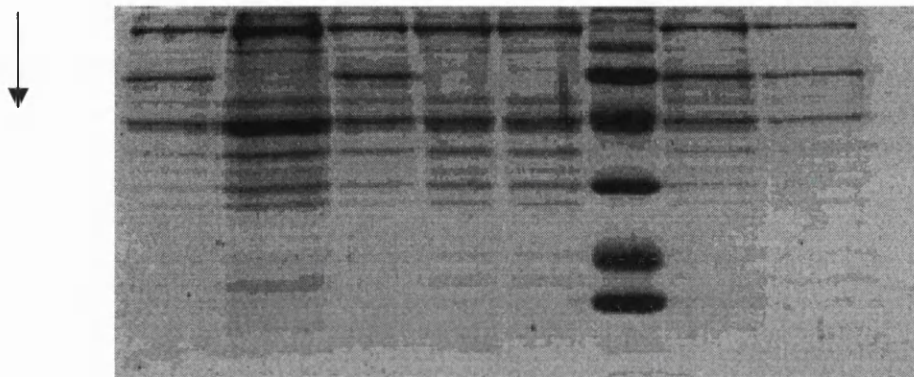

type:     IB     Vm     C<sub>24</sub>     PC     PC<sub>24</sub>     mwm     C     IH

**Figure 2.1** Scanned image of a protein loading gel performed in preparation for a Western blot analysis.

BAND NUMBER	MAPPED AREA/cm <sup>2</sup>	Sample Type	Measured band density/arbitrary units
1	0.02	IB	138.64
2	0.02	Vm- freshly isolated cells	210.88
3	0.02	C – experimental control	150.29
4	0.02	PC- Preconditioned	164.54
5	0.02	PC <sub>24</sub> -Peconditioned 24hs after PC	156.8
6	0.02	C <sub>24</sub> - Control 24hrs post PC	139.88
7	0.02	IH	102.93

**Table 2.1** : The results generated by the image analysis software for band density. The molecular weight marker covered the range 14.3–200 Kilodaltons

(Kd). standardisation was by comparing the uppermost band as viewed in the image, corresponding to a protein of approximately 150 -200Kd, myosin heavy chain.

## **2.7 CELL VIABILITY ASSAYS**

### **1.5 Cell death and end points of viability.**

Whilst it is simple enough to identify the loss of viable tissue in an injured organ by loss of function or the development of scar tissue, the apparently simple matter of defining when an individual cell is dead is fraught with difficulties.

The membrane surrounding the single mammalian cell is a fluid and complex structure that has evolved to maintain the internal environment of the cell in a different state from the outside world. When this primary barrier defining the internal from the external is breached is the cell dead?

Small breaches may be repairable and large ones fatal. What is large and what is small in this context? Even where the membrane is breached so that the cell can no longer maintain the internal environment if there are any energy reserves in the cell some of the processes of metabolism may continue for a brief period. What then is an appropriate and convincing measure of cell death and how can an 'end-point' be determined?

In the experiments detailed in this thesis the measurement of cell viability was conducted by measuring big and little holes in the membrane, using enzyme leakage and dye exclusion respectively. As for any remaining ability of the cell to conduct metabolic processes a substrate for dehydrogenase enzymes of the electron transport chain that is converted to a readily measurable coloured product by reduction has been used.



Much disagreement is exhibited at meetings and in the literature in regard to end point selection and measurement and the only conclusion is that measurement of a single endpoint is insufficient.

A decision regarding what, for the purposes of an individual study, will be the endpoint must be made and adhered to.

In the very earliest experiments reported here during the development of a model of lethal ischaemia for cultured cells measurements of cell viability were undertaken immediately after, 30minutes and 1 hour after the protocols were applied. In these instances, although trends were observed no significant loss of cell viability was measured in treated cells when compared to controls. The model therefore is one of ischaemia / reperfusion injury.

The effect of culture conditions on the time-course of events has transpired to be considerable.

## **2.7a Trypan blue exclusion**

### **Principle:**

Trypan blue is a relatively low molecular weight histological dye, 960.83d (Merck index reference 9701), that is soluble in water to form a deep blue solution. Trypan blue has been widely used as a stain for determining the integrity of biological membranes [159]. It is commonly assumed that the stain remains in the extracellular space if the cell membranes are undamaged. The stain does not passively diffuse across cell membranes and no known transport mechanism for transfer of the substance across undamaged cell membranes has been identified.

**Method:**

Trypan blue was dissolved in an isotonic solution such as phosphate buffered saline at normal physiological pH for application to cells in culture or in suspension to a concentration of 0.4% weight to volume.

Cells that had taken up the dye appeared deep blue under light microscopy and were readily distinguished from unstained cells that remained completely colourless.

Quantification of trypan blue staining was achieved by manual counting of cells. As with all manual methods of counting cells this is open to error, labour intensive and time consuming. Imposing random field selection and counting large numbers of cells are strategies that both improve the accuracy and objectivity of the method.

Ideally an operator blinded to the treatments the cells have received during experimental procedures should count cells.

The technique adopted for ensuring whole plate coverage and unbiased selection of fields for counting was as follows:

The plate for counting was placed on the microscope stage and a marker pen was used to place a dot roughly in the centre. The first field was counted adjacent to this mark and then by moving up, down, left and right further fields were selected.

Between each field selection the plate was returned to the point at which the dot was roughly in the centre of the microscope stage. The operator did not continue to look down the microscope while fields were selected. This procedure was followed, moving the plate to a different position each time until a minimum of 400 and maximum of 1000 cells had been counted using a hand-held click counter.

## 2.7b Lactate dehydrogenase ( LDH ) release

### Principle:

In addition to Trypan blue exclusion, cell viability after experimental procedures was determined by measuring the release of the intracellular enzyme lactate dehydrogenase (LDH), a tetramer of Mwt 140 Kd, into the medium. The assay was performed using a kit designed for diagnostic use (Sigma).

The diagnostics division of the Sigma chemical company also supply a quality control standard for use with diagnostic enzyme analysis kits, this standard called acutrol by the company was used to confirm that the kit was being utilised within the limits of accuracy and sensitivity defined for it.

NADH absorbs light of wavelength 340nm; it is the reduction in absorbance following the reduction in NADH concentration that is measured as the reaction proceeds.

The method employs the change in absorbance observed in a spectrophotometer at 340nm due to decrease in concentration of NADH according to the reaction:

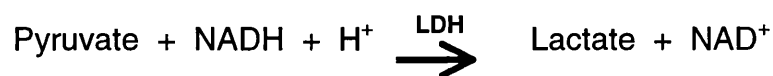

Lactate dehydrogenase is an intracellular enzyme that is not found in the extracellular space in the presence of undamaged cells.

The enzyme exists as five isoenzymes known as LD-1 to LD-5. Heart tissues express a high proportion of LD-1 and 2 and although when measurements are taken for the purpose of clinical diagnosis it is sometimes necessary to determine which isoform predominates, in samples taken from pure cultures where only cardiac myocytes were present this was unnecessary.

The reaction follows normal first order Michaelis-Menten kinetics and in the presence of an excess of substrate the rate of disappearance of NADH is directly proportional to the activity of the enzyme present in the sample.

The kit is widely used to support the diagnosis of myocardial infarction in clinical practice.

The recommended procedure for the interpretation of results involves a formula supplied by the manufacturer for the conversion of assay values to units of enzyme activity per litre of blood.

As in the context of this study the results were interpreted in terms of percentage release compared to the total amount of LDH in cells on an individual tissue culture plate this conversion was not used.

All estimations were made in the same volume of sample, being the total volume of medium available on the tissue culture plate and results are therefore expressed as percentages.

### **Method:**

Samples for the LDH estimation were collected from all plates at two time points. In experiments using the hypoxia chamber samples from all treatments were taken 30 minutes after the treated cells were removed from the chamber. All wells then received 0.5 mls of fresh medium and were returned to the incubator overnight.

In early experiments both trypan blue and LDH estimations revealed that little cell injury could be measured in the period immediately after treatment with the lethal stimulus. It was proposed that although cells were injured there was a time course of cell death associated with the treatment they had been subjected to.

In all later experiments measurements of cell viability were made after overnight “reperfusion” of 15-16 hours. After overnight in a tissue culture incubator the supernatant was collected and the remaining cells were lysed using 0.5 mls of 2% (v/v) SDS in water and gentle trituration. In the final estimation 100µl of SDS/protein solution was added to 2.5mls of the reaction mixture. When tested at this dilution of SDS did not have an absorbance above the reagent blank for the assay.

All three fractions were checked for volume and adjusted to ensure that they were 0.5mls. Overnight incubation at 37° C sometimes resulted in a small loss of volume due to evaporation.

### **2.7c Methyl thiazol tetrazolium (MTT) conversion assay**

#### **Principle:**

Methyltetrazolium assays are widely used both for assessing cell growth, and for determination of cell viability [160,161].

Tetrazolium salts are converted by mild reduction to formazan compounds. The five membered ring of the tetrazolium molecule is opened on reduction (see figure 2.2) and the resulting compound is highly coloured.

The tetrazolium salts used in these assay systems were very water soluble and readily taken up by cells in culture. After reduction under mild conditions the formazans formed are highly coloured and in the case of MTT, a crystalline product completely insoluble in water.

The electron donating systems within cells present in the mitochondrial respiratory chain will reduce the yellow tetrazolium salts to blue or blue/purple formazans.

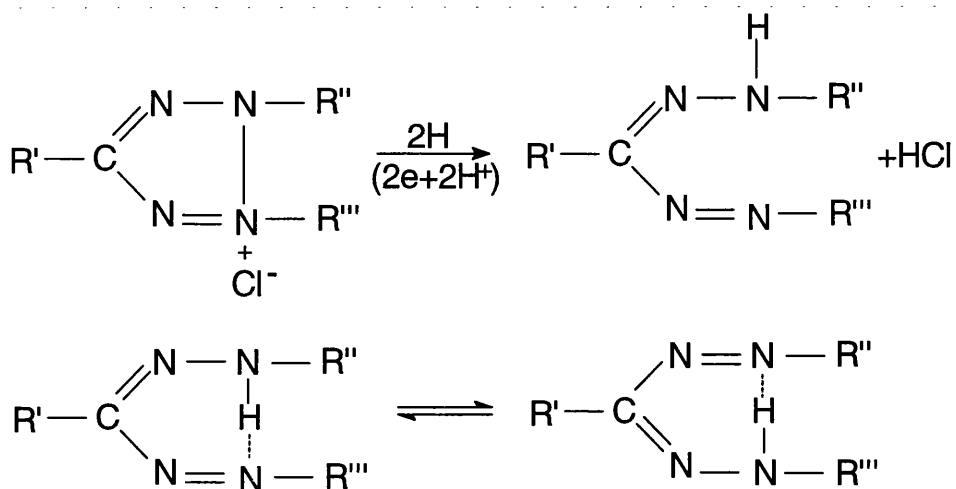

**Figure 2.2.** The general structure of a tetrazolium salt and its reduction to a coloured formazan. Upon reduction the tetrazolium ring is opened and the quaternary amine is converted to a tertiary amine. The structural formula of MTT is shown below.

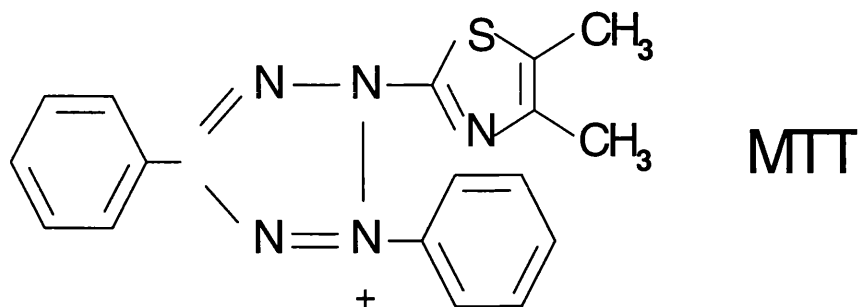

The methyltetrazoliums act as artificial electron acceptors [162]. In this way the conversion of MTT to its coloured formazan derivative provides an index of the metabolic activity of cells and hence their viability.

The coloured formazan product derived from the reduction of MTT exhibits maximal absorbance of light of wavelength 570nm.

There are problems with this as with all techniques of assessing cell viability.

The number of cells present will influence the quantity of the substrate converted as will the absolute capacity of any individual cell to convert the substrate.

Where large numbers of cells are present the latter influence should be minimal, however the former requires careful consideration.

Adult cardiac myocytes do not divide in culture, as a result a plate of cells will never be confluent and the number of cells per plate and per area of a plate will vary. In most cases the variation will be small. If the same numbers of cells are plated on each well, similar proportions of the applied cells in suspension attach and all handling is standardised the result should be uniform plating throughout any individual preparation.

This appears to be the case with the variation in total numbers of cells per plate being acceptable. However the presence of 30% more cells on a plate will influence the result of the MTT assay substantially more than the LDH assay which is normalised to the number of cells on the plate by the measurement of the total amount of LDH present in cells on each plate. It would have been preferable to normalise the MTT measurement to the total protein on the plate as an index of cell numbers.

Due to the intense colour of the formazan derivative and the need to lyse the cells to collect and solubilise the product such an assay cannot be conducted on the same individual well as the MTT assay. Only between well comparisons

could be made, e.g. average protein per well in a selection of wells, this measure would only go part of the way to solving the problem and is no closer to a truly reliable method of normalisation.

From the trypan blue exclusion assay it would be possible to determine a mean number of cells per well for most experiments, again however this does not quantify the number of cells present on the wells that are actually used for measuring MTT.

Methyl tetrazolium assays have become available that utilise analogues of MTT such as 5-(3 Carboxymethoxyphenyl)-2(4-5-dimethylthiazolyl)-3-(4-sulfophenyl) tetrazolium, inner salt (MTS) which generate a water soluble, purple coloured formazan on reduction [163].

In any future project involving the culture of adult cardiocytes the use of a water soluble formazan product in this type of assay would be worthy of consideration.

#### **Method:**

A stock solution of MTT at 10% w/v in Phosphate buffered saline (PBS) at pH 7.4 was prepared and stored (protected from light) at 4°C. Continuous exposure to light resulted in the spontaneous formation of small quantities of the coloured product.

This solution was applied to cells such that the final concentration obtained on the tissue culture plate was 1.0 % MTT w/v in PBS.

The solution was warmed in a 37° C water bath. Tissue culture media were removed immediately prior to the addition of the MTT solution as the presence in the media of phenol red indicator was known to interfere with the spectrophotometric assay for the coloured product (Sigma chemicals technical information).



Cells were then returned to the tissue culture incubator for 4 hours. At the end of 4 hours incubation cells were briefly inspected under the microscope to check that a reaction had occurred.

Cells were lysed and the coloured formazan dissolved by the addition 1ml of acidified isopropanol (1.0% hydrochloric acid in isopropanol). Lysis and dissolution could be observed to be complete after 20 - 30 minutes' exposure to acidified isopropanol at room temperature. More rapid lysis and elution could be achieved by adding 0.1% Triton X100, a non-ionic surfactant, to the acidified isopropanol.

The resulting blue solution was carefully collected using a pipette, the volumes checked to ensure conformity and the samples either stored overnight or read using a spectrophotometer immediately.

The absorbance was read at 570nm and duplicate samples were taken. Values obtained varied between 0.1 and 1 in absorbance units (meter reading as given by the spectrophotometer), these values were within the reported linear range for the coloured formazan [160].

## **2.8 STATISTICAL METHODS**

Results from cell counts were expressed in most experiments as a percentage of the untreated controls for each experiment.

Enzyme release was normalised to measurement of the total enzyme present. In each experiment six replicates of each treatment were performed to provide two replicates for each of the three analyses used.

All data were used in final statistical analysis so that all experimental variation both within and between experiments could be dealt with in the analysis. Where values of n for any series of experiments are quoted these refer to the number of

individual experiments e.g.  $n = 5$  refers to the results obtained from five separate preparations. In most experiments treatments were performed on 6 or 24 well tissue culture plates with two wells each set aside for each end-point determination. Therefore values given are derived from two replicate measurements from each preparation.

Where two groups are compared the unpaired t-test was used, where more than two groups were compared a one way analysis of variance was used. Calculations were performed using the Statview statistical programme written for the apple Macintosh computer. *Post hoc* test applied for significance using analysis of variance was the Fischer PLSD.

## **SECTION TWO**

---

### **CHARACTERISATION OF THE MODEL**

---

**CHAPTER 3 : DEVELOPMENT OF THE TECHNIQUE FOR  
DISSOCIATING CELLS FROM THE IN-TACT HEART**

**CHAPTER 4 : DEVELOPMENT OF OPTIMAL TISSUE  
CULTURE CONDITIONS**

**CHAPTER 5 : SIMULATED ISCHAEMIA**

**CHAPTER 6 : PRECONDITIONING IN CULTURE**

**CHAPTER 7: GENE TRANSFER TO ADULT CARDIOCYTES  
IN CULTURE**

---

## **CHAPTER 3**

---

### **DEVELOPMENT OF THE TECHNIQUE FOR DISSOCIATING CELLS FROM THE INTACT HEART**

#### **3.1 INTRODUCTION**

#### **3.2 PERFUSION**

- a. Apparatus
- b. Methods

#### **3.3 ISOLATION**

- a. Procedure

#### **3.4 RESULTS**

- a. Calcium determinations
- b. Cell yields
- c. Appearance of isolated myocytes

#### **3.5 DISCUSSION**

### 3.1. INTRODUCTION

The first published report of the successful isolation of adult mammalian ventricular myocytes appeared in 1974 [164], followed by the report of Powell and Twist detailing a method for the rapid isolation of large numbers of calcium tolerant cells from adult rat heart [165]

In this publication reference is made to previous attempts using a variety of tissue disruption techniques that had produced low yields of single cells unable to tolerate the reintroduction of calcium to the support medium.

The earliest reported successful culture of adult myocardial cells was of cells derived from amphibian hearts [166] and in 1981 Claycomb et al [167] reported the culture of adult mammalian cells.

Subsequently Schwarzfeld et al [168] Bihler et al [169] Pipers group in Germany, Jacobson et al [170] and Deckers group [156] in the USA were among a number of groups to report the successful isolation and culture of calcium tolerant adult, mammalian cardiac myocytes.

Although all of the methods reported in the literature had elements in common each group of investigators had developed a technique that provided myocytes in sufficient numbers and in good enough condition to satisfy the requirements of their own experimental protocols.

Bihler et al [169] quoted cell yields in excess of  $10^7$  rod shaped myocytes from a single rat heart and distinguished viable from non-viable cells by means of cell shape i.e. rod-shaped cells were counted as viable and rounded cells as non-viable. In this same paper the reported yields of viable cells were in excess of 90% of the total number of isolated cells. This proportion declined to 60% within 2 hours of exposure to normal physiological calcium ion concentrations in standard tissue culture medium.

A number of reports detailing the characteristics of these isolated myocytes rapidly followed.

The investigations into the electrophysiology [171,172], morphology [173, 174,175,176], culture conditions and the metabolism of adult myocytes in culture were examined by these and other investigators [177,178,179,180,181]

A review of the techniques then available published by Jacobson and Piper in 1986 [170] lists 132 references.

In this review the authors list the isolation methods, plating techniques, culture type and conditions used in the laboratories of nine groups that were working with cultured cardiac myocytes. No two methods are the same.

The situation regarding these techniques and their application has changed little in the last twelve years. As recently as April 1998 [182] a review published by Mitcheson et al rehearsed the same questions as those addressed in the 1986 review, namely the isolation and culture techniques available and suitability of experimental models based on adult cardiac myocytes.

The Mitcheson review places emphasis on the utility of such models for the exploration of the molecular biology of cardiac muscle. Molecular biology techniques offer the opportunity for both interrogating and modifying cellular processes.

Gene transfer techniques can potentially place the role of an individual gene product by offering the opportunity to either switch production on, the introduction of an exogenous gene, or off, the introduction of an antisense RNA.

The elimination of the intimate cell to cell contact and communication that exists in intact tissues allows, particularly in the heart, for the consequences of this type of manipulation to be determined for the individual cell. Although as a first step in

understanding the consequences of genetic or pharmacological manipulation of the cellular apparatus the isolated cell offers unique opportunities.

For a model of ischaemic injury large numbers of robust, calcium tolerant cells were required.

In order to achieve this a close study was made of many of the published techniques and from a modification of several published methods a reproducible technique for the isolation of large numbers of cells was developed. The final technique is described here.

The majority of the reported successful techniques for the isolation of adult myocardial cells adopted variations of the method reported by Powell et al [165]. The method involved the perfusion of the isolated heart with crystalloid calcium free buffers followed by solutions based on physiological buffers containing small concentrations of calcium and a variety of proteolytic enzymes.

## **3.2 PERFUSION**

### **3.2a Apparatus**

The perfusion rig consisted of a combined glass warming coil and bubble trap connected via silicon tubing to a Watson - Marlow peristaltic pump. A 50 ml, double walled, glass reservoir was included in the circuit via a length of tubing connected to a plastic three-way tap inserted just prior to the pump.

Figure 3.1 is a diagram of the 'mini' perfusion rig routinely used in the experiments described in this work.

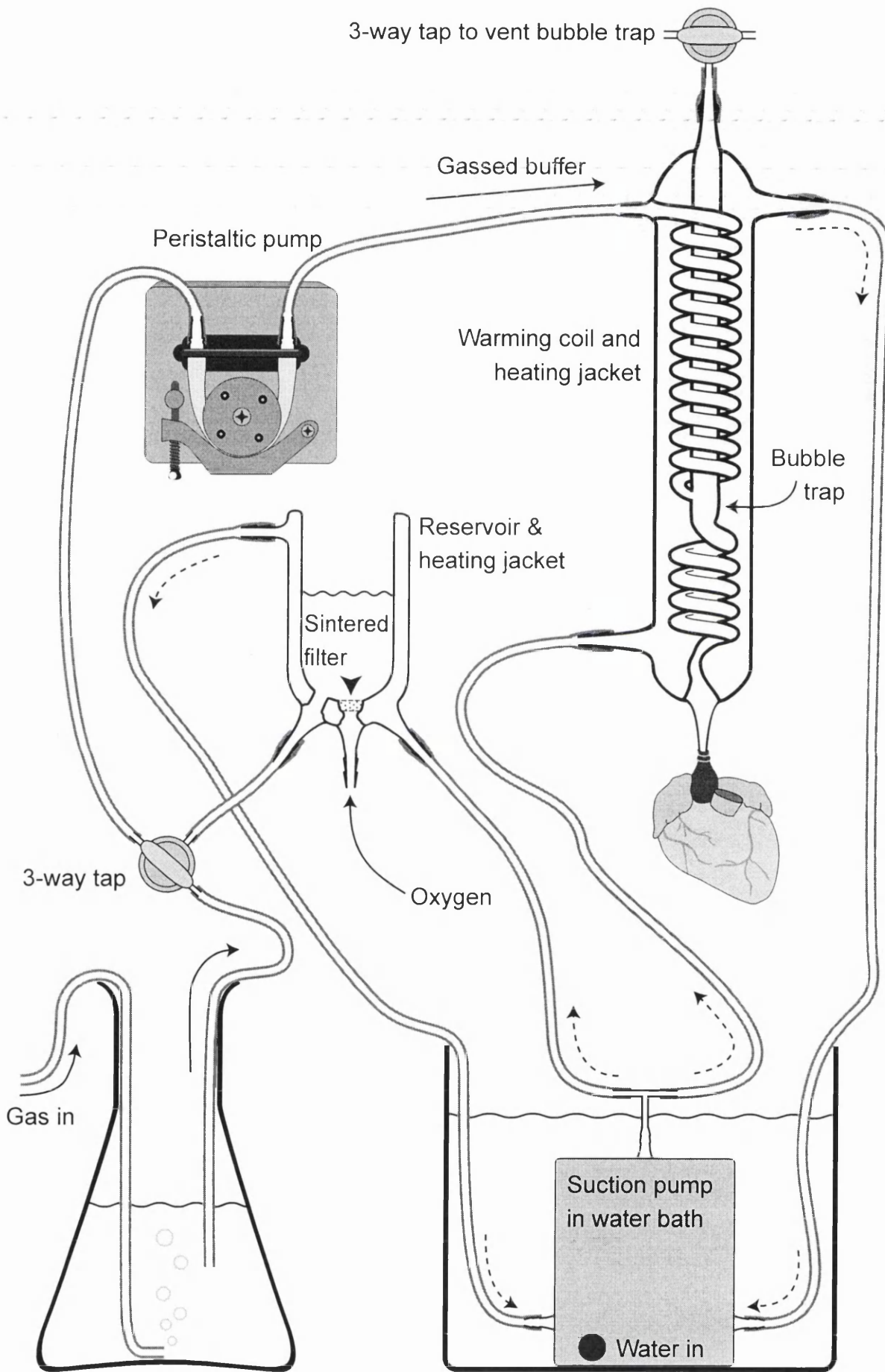

**Figure 3.1:** Schematic diagram of the 'mini rig' and apparatus used for the isolation of sterile cardiac myocytes from the adult rabbit heart. *(Not drawn to scale)*



The reduction in size of the apparatus by combining the warming coil, bubble trap and cannula assembly permitted the whole to be used in a specially constructed box so that asepsis could be maintained throughout the perfusion period.

The water jackets of the reservoir and warming coil were supplied with water at 37° C from a circulating water bath.

The perfusate entered the apparatus via a length of sterile silicon tubing running from a reservoir of Krebs - Heinseleit solution: 120mM NaCl, 5.4 mM KCl, 5mM MgSO<sub>4</sub>. 7H<sub>2</sub>O, 5mM Pyruvate (sodium salt), 20mM Glucose, 9.15mM HEPES (sodium salt) and 20mM Taurine or with a Krebs- Heinseleit solution of the formulation: 119mM NaCl, 4.7mM KCl, 0.94 mM MgSO<sub>4</sub>.7H<sub>2</sub> O, 1.22mM KH<sub>2</sub>PO<sub>4</sub>, 25mM NaHCO<sub>3</sub>, 10mM HEPES, 11.5 Mm Glucose and 1mM CaCl<sub>2</sub>.

The calcium free buffer was adjusted to pH 7.0 at 37° C and was continuously gassed with 100 % O<sub>2</sub>, the "normal" calcium buffer, when used, was gassed with 95% O<sub>2</sub> / 5% CO<sub>2</sub>.

It should be noted here that the normal circulating concentration of calcium ions in the rabbit is 2.5mmol/l [183,184].

The quoted values of [Ca<sup>2+</sup>] suitable for crystalloid perfusates for isolating myocytes vary from 0.25μM [165],through 25μM [169], to anything less than 50μM [185]

The reservoirs contained the two enzyme solutions, 0.3 mg/ ml protease followed by 0.5 mg /ml collagenase with 0.6 mg/ml hyaluronidase for the recirculation period. The enzyme solutions were gassed with 100 % O<sub>2</sub> independently. All of the components of the rig were sterile until unwrapped and re-assembled for use with each heart. Aseptic handling procedures were observed.

(The glassware used for this apparatus was kindly donated by Dr David Anderson of Glaxo – Wellcome ).

### **3.2b Method**

The heart was rapidly removed from the ice - cold Krebs - Heiseleit solution and mounted via the aorta on the cannula attached to the warming coil / bubble trap assembly (see fig 3.1). The pump speed throughout each perfusion was maintained at 40 mls / min, hence perfusion was at constant flow rather than at constant pressure.

As mentioned above some of the published isolation methods recommended initial perfusion with a low calcium Krebs-Heinseleit solution and the re-addition of calcium after the period of calcium free perfusion.

In the earliest attempts to isolate cells the so called “normal” calcium buffer was used to warm the heart and wash clear of anaesthetic. It was assumed that the heart was recovered from cold and anaesthesia once observed to be beating.

When perfused with the buffer containing 1mM  $\text{Ca}^{2+}$  the rabbit heart beat on the perfusion apparatus at between 60 - 80 beats/min.

This is far slower than the in-vivo heart rate of around 220 beats/min. The slow heart rate observed during the early wash out period of the perfusion may have been due, in part, to the residual effects of anaesthesia and cooling, but was most likely due to the low calcium ion concentration. Normal blood levels in the rabbit are 2.5 times greater than the concentration present in the buffer [183].

Following a washout period in the normal calcium buffer the heart was then perfused with oxygenated, calcium free Krebs-Heinseleit solution for 5minutes.

The gap junctions between cardiac myocytes are in part maintained by the intracellular calcium ion concentration.

Perfusion with calcium free buffer represents the first step in the isolation procedure.

Gap junctions have been shown to be present between cells that are coupled electrically [186]. These structures exist at points of intimate contact between adjacent cells and permit the flow of ions between cells. The structure of gap junctions has been proposed to consist of hexagonal arrangements of six units of a trans membrane protein called connexin.

The opening and closing of gap junctions is regulated by the binding of calcium to the connexin subunits which brings about a conformational change in the proteins comprising the gap junction and alters their alignment relative to each other. Perfusion with calcium free buffer and the resultant drop in intracellular calcium begins to disrupt the gap junctions and reduce the intimate attachment between adjacent cells.

The next stage in the isolation was the introduction into the perfusate of proteolytic enzymes. The function of these enzymes was to break down the extracellular matrix and liberate individual cells from the tissue. Many enzymes with proteolytic activity against matrix components are available.

Almost all reported myocyte isolation techniques have utilised collagenase as a crude lyophilised preparation. Various combinations of enzymes applied serially or concurrently have been reported, all methods use collagenase while others variously used in addition to collagenase, trypsin [187] protease [165,188], DNAase [177] and hyaluronidase [156].

Bihler et al recommended that a low concentration of calcium should be added back to the perfusate with the addition of enzymes. This was in part to ensure that the isolated cells were 'calcium tolerant' and in part because collagenase activity is improved in the presence of calcium.

However each time the perfused rabbit heart was exposed to enzyme solutions containing added calcium the heart went pale and rigid. There was evidence that the reapplication of calcium, even at levels as low as 20 $\mu$ M was causing a situation with the appearance of calcium paradox [189].

A series of isolations were performed, in each a different step of the procedure was modified in an attempt to determine which step was responsible for the damage to the perfused heart.

Ethyleneglycol-bis( $\beta$ -aminoethyl ether)N,N,N',N' tetraacetic acid (EGTA) at a concentration of 300 $\mu$ M was added to the buffer and calcium then added back to the perfusion solutions in the amounts required by the protocol. The calcium was added in the form of an aliquot of a volumetric standard solution of 1M CaCl<sub>2</sub> (BDH Chemicals). Once again the heart went pale and rigid upon the reintroduction of calcium when the heart was perfused with the enzyme solution.

One experiment each was performed using fresh supplies of protease, collagenase and hyaluronidase. In these experiments EGTA was used as described above and the calcium concentrations used continued to be added back as dilutions of a volumetric solution to give known concentrations. These changes did not prevent the damage to the heart.

2,3-Butanedione Monoxime (BDM) was added to the perfusion buffer in two isolations. The cytoprotective properties of this compound were not found to amend the situation.

Finally it was decided not to add exogenous calcium back with the enzyme solutions. In the absence of EGTA and BDM, but without adding calcium back to the perfusion solution the heart continued to remain dark and soft throughout the perfusion period.

Subsequently all enzyme solutions were made up in the nominally calcium free buffer.

The calcium ion concentrations of all of the solutions used was checked using a calcium specific ion selective electrode, a cumulative plot of several calcium standard curves is shown in Fig 3.2.

In addition the wash out period utilising a Krebs-Henseleit buffer containing 1mM  $\text{Ca}^{2+}$  was replaced with a 5 minute wash out period in calcium free, taurine and pyruvate supplemented buffer as used for the remainder of the perfusion. The low heart rate beating of the 1mM calcium perfused rabbit heart was not a useful indicator of the condition of the heart and contributed nothing to the efficiency of the isolation procedure. Increasing the calcium concentration during the washout period to more physiological levels would simply have extended the time required to create a low calcium milieu.

Providing the water used for the buffer solutions was of the highest purity and the reagents selected contained minimal trace element contamination (BDH Analar grade) the calcium levels measured in the buffer were 10 - 12 $\mu$  M. Once this modification was applied no further heart preparations exhibited the symptoms of calcium paradox. Hearts remained soft and dark in colour throughout the perfusion.

#### **Modified perfusion method:**

The heart was removed directly into ice-cold calcium free Krebs-Henseleit solution and mounted as described. The preparation was then perfused for 5 minutes with fresh, sterile, oxygenated, calcium-free Krebs-Henseleit solution to wash the heart free of blood. At the end of this period the tap connecting the reservoir to the main perfusion tubing was opened and 50mls of filter sterilised

protease solution (Sigma type XXIV, bacterial) 0.3mg/ml was allowed to perfuse the heart. After the protease solution had passed through the heart, approximately 1.25 minutes, the reservoir was filled with 50mls of filter sterilised 0.5 mg/ml Type II Collagenase (Worthington biosciences) and 0.6 mg/ml Hyaluronidase (Sigma, type I-S, bovine). Once the apparatus has filled with the Collagenase - Hyaluronidase (C-H) solution the reservoir was arranged so that the remaining solution could re-circulate through the heart and apparatus.

All enzyme solutions were gassed continuously with 100% O<sub>2</sub> that had been passed through a 0.22µm filter.

The C-H solution was re-circulated for 15mins in all experiments. At the end of the re-circulation period the heart was removed from the apparatus by cutting the ventricles free from the atria using a pair of sterile scissors.

The ventricles were placed in a petri dish containing 20mls of fresh, sterile C-H solution and the whole then transferred to a laminar flow cabinet. All subsequent manipulations of tissue and/or cells took place in a laminar flow cabinet.

### **3.3 ISOLATION OF ADULT RABBIT CARDIAC MYOCYTES**

#### **3.3a Isolation procedure**

Once transferred to the laminar flow cabinet the petri dish containing the rabbit heart ventricles was opened and the C-H solution was divided evenly between the two halves of the dish.

The right ventricle and any visible fatty tissue were dissected free of the left ventricle and septum and discarded. The remaining portion of the heart was opened out flat by dividing the septum with scissors and cut into to approximately equal portions. One portion was placed into each of the two

halves of the petri dish containing C-H solution and chopped into pieces roughly equivalent to 1mm cubes. The chopped tissue and C-H solution were then transferred to two sterile 50ml centrifuge tube (Falcon).

One 23G and one 28G sterile needles were inserted through the lids of each tube and they were then transferred to a water bath kept at 37° C. A sterile 3-way tap closed to the atmosphere was attached to each of the larger two needles and via the taps the 50ml containers were gassed with 100% O<sub>2</sub> which had been passed through a 0.22µ filter.

The tissue was then incubated at 37° C for 15mins.

At the end of the incubation period the 50ml tubes containing the tissue were returned to the laminar flow cabinet and the supernatant collected by gentle aspiration with a 10ml sterile pipette. A further 10 - 15mls of C-H solution was added to the tissue and the 50ml tubes were returned to the water bath for a further incubation.

The supernatant was collected into two 15ml capacity sterile centrifuge tubes (Falcon) and spun at 600rpm in a bench top centrifuge for 1 minute. At the end of centrifugation the tubes are returned to the laminar flow cabinet and the supernatant discarded. The resulting cell pellet was then re-suspended in 5 - 10mls of washing buffer consisting of the taurine and pyruvate supplemented K-H solution as used for the perfusion with 10% foetal calf serum (FCS) and 0.5mM calcium added.

The cell suspension was added to a 25ml tissue culture flask and transferred to an incubator at 37° C gassed with 95% air / 5% CO<sub>2</sub>.

The digestion described was repeated a total of three or four times and the cells harvested pooled into the tissue culture flask in a final volume of 20mls of washing buffer.

At the end of the final digestion the remaining tissue and the pooled cells were filtered through a piece of 100µm nylon gauze that had been sterilised by washing in 70% absolute ethanol and air dried in the laminar flow cabinet. The tissue residue remaining on the filter was washed several times with small volumes of washing buffer and the entire pooled cell suspension was then divided into 4 - 6 15ml sterile centrifuge tubes and spun at 600rpm for 1 minute. The supernatant was discarded and the cell pellet was re-suspended in fresh washing buffer to a final volume of 10mls. The cell suspension was then layered onto a 4% solution of essential fatty acid free Bovine Serum Albumin (BSA, Sigma chemicals) to which 0.5mM calcium has been added and spun at 600 rpm for 1 minute.

The resulting cell pellet was then washed once in fresh washing buffer and finally re-suspended in 10mls of tissue culture medium M199 with Earles salts, containing 5% FCS to assist attachment (plating medium). A 20µl aliquot was taken for counting using an improved Neubauer haemocytometer.

The suspension was applied to the counting chamber and the cells were allowed to settle under gravity for 2 minutes. This was necessary as the cells are large (>100µ) and as the grid is 100µ deep could be readily displaced by adding the coverslip.

Using the counting chamber in the normal way, by applying cell suspension to the edge of a firmly seated cover slip resulted in no visible cells in the grid.

Each square counted of the haemocytometer grid had a volume of  $1/40000 \text{ cm}^3$ .

Therefore counting the four corner sections permitted the following calculation:

$$\frac{\text{Total cells in four grid sections}}{4} \times 40000 = \text{cells/ml}$$

4



This provided an estimate of the number of cells present in 10mls of suspension which was then further diluted to contain approximately  $5 \times 10^5$  or  $10^6$  cells/ml. Plating densities were calculated based on this final cell suspension.

### **3.4. RESULTS**

#### **Calcium measurement**

Many ordinary laboratory reagents contain calcium at varying levels as a contaminant.

It is vital for the success of myocyte isolation techniques that the reagents to which cells are exposed are free from contamination with calcium. To ensure that the solutions used are free from calcium the highest purity of water and reagents must be used.

Figure 3.2. Illustrates the data gathered from using an ion-specific electrode for the measurement of calcium in buffer solutions used during the dissociation procedure.

The standard curve data shown were derived from twelve separate standard curves measured using serial dilutions of a volumetric stock 1M calcium chloride solution (BDH chemicals).

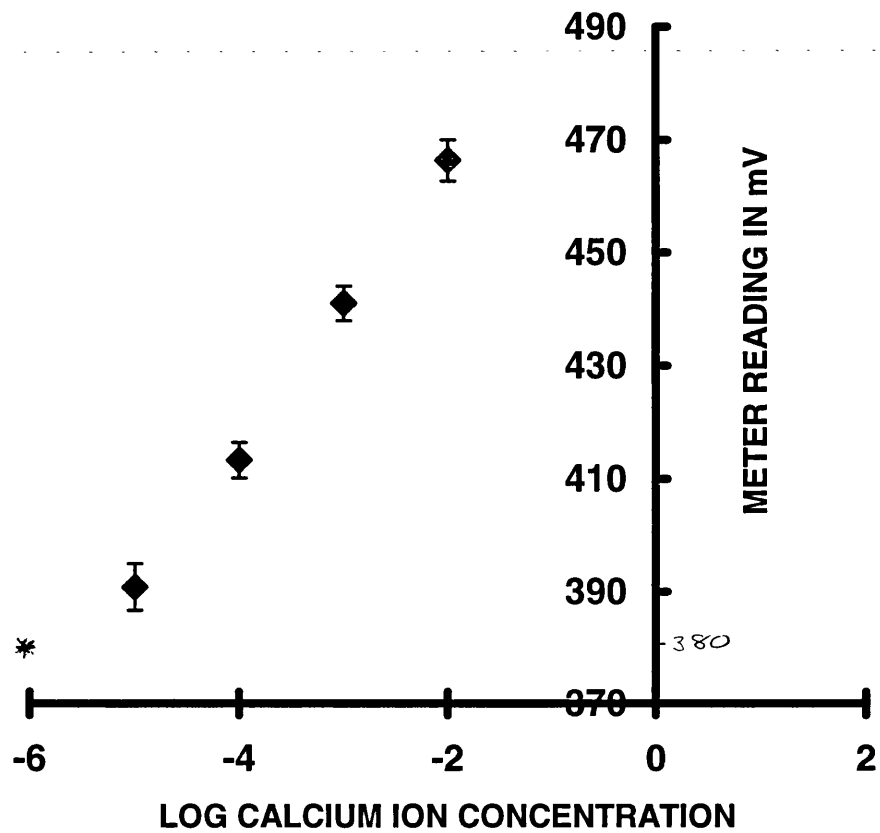

**Figure. 3.2: A graph of the means +/- sem of twelve calcium standard curves.**

The plot shows the meter reading obtained in mV versus the log of the calcium ion concentration. A fresh series of standards was prepared from the stock solution daily for each standard curve.

		<b>[Ca<sup>2+</sup>] M</b>				
		<b>10<sup>-6</sup></b>	<b>10<sup>-5</sup></b>	<b>10<sup>-4</sup></b>	<b>10<sup>-3</sup></b>	<b>10<sup>-2</sup></b>
<b>Meter Reading mV</b>		386	396	410	450	467
		385	386	412	440	469
		391	391	418	446	476
		385	380	416	424	473
		407	364	423	409	475
		352	403	410	450	461
		358	395	420	442	477
		378	395	411	444	470
		388	398	417	451	472
		378	398	406	449	446
		380	400	387	450	436
		375	384	430	436	474
<b>MEAN</b>	<b>380.3</b>	<b>390.8</b>	<b>413.3</b>	<b>440.9</b>	<b>466.3</b>	
<b>SEM</b>	<b>4.2</b>	<b>3.1</b>	<b>3.1</b>	<b>3.7</b>	<b>3.7</b>	

**Table 3.1a:** Values obtained for twelve standard curves used to estimate the concentration of calcium ion in buffer solutions used for the isolation of adult rabbit cardiac myocytes.

<b>[Ca<sup>2+</sup>] μ mol/l in nominally calcium free buffer</b>
10.0
7.5
10.0
12.0
6.5
9.0
14.0
10.0
7.5
10.0
10.0
12.5
Mean 10.0
SEM 2.2

**Table 3.1 b** Variation in calcium ion concentrations measured on nominally calcium free cell isolation buffer using an ion specific electrode.

## Cell Yields

The data shown in Figure 3.3 below were derived from 142 separate myocyte isolation procedures for which total cell yields were determined. Although the values for total cell yield were variable, ranging, as shown, from  $>0.5$  -  $>10 \times 10^7$  cells per heart there appears to be a gross seasonal variation. The source of any such variation would be difficult to account for given that all animals were maintained under standard conditions at all times. (The source of the variation could lie with the person isolating the cells).

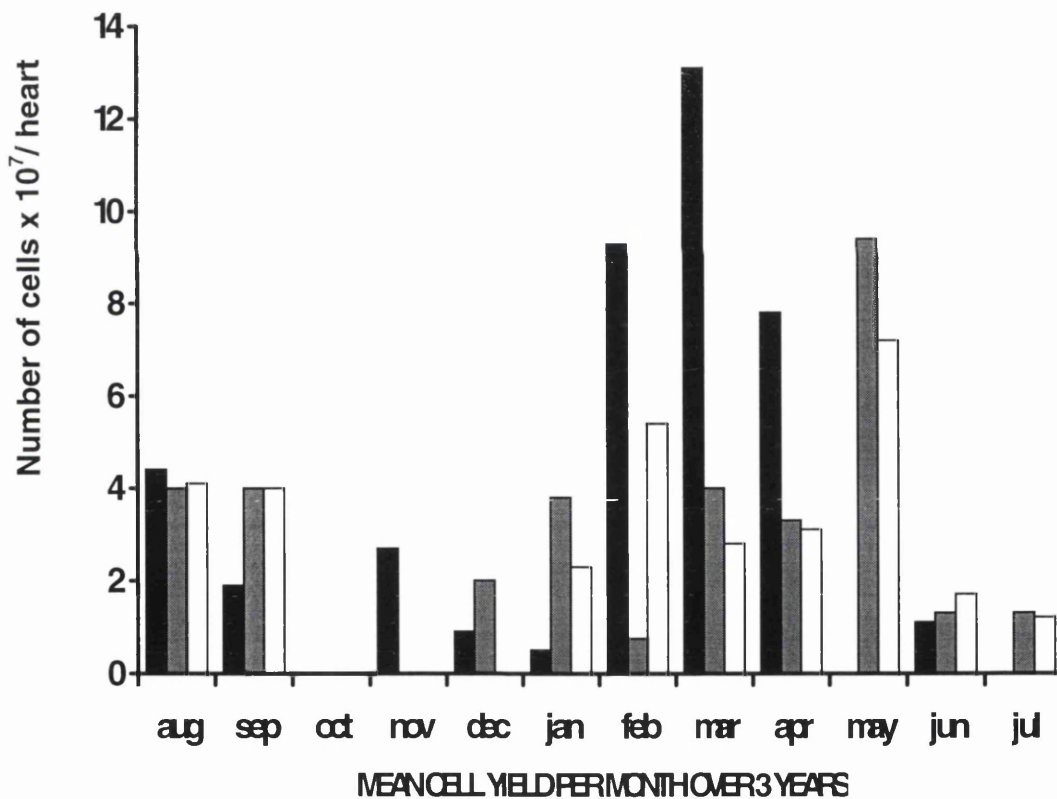

**Figure 3.3** Mean cell yields for each month over the 3 years of the project.

Black bars : year one  
Grey bars : year two  
White bars : year three

The standard errors are not shown on the graph in figure 3.3 as the variations in cell yield between preparations were large. This average cell yield became less variable with experience of the technique, but was still subject to sudden large and often inexplicable variations.

In general preparations yielding less than  $10^7$  cells per heart also produced cells of poor quality which were discarded as unsuitable for experimental procedures.

In addition any preparation contaminated with microorganisms was discarded.

The overall failure rate of the isolation over three years was 35%.

Whilst this seems high most of the losses occurred early in the project while isolation and culture methods were under development and do not appear in the figures quoted for successful isolations.

## Appearance of isolated myocytes

Figure 3.4 is a photograph taken under light microscopy of freshly isolated and attached adult cardiac myocytes.

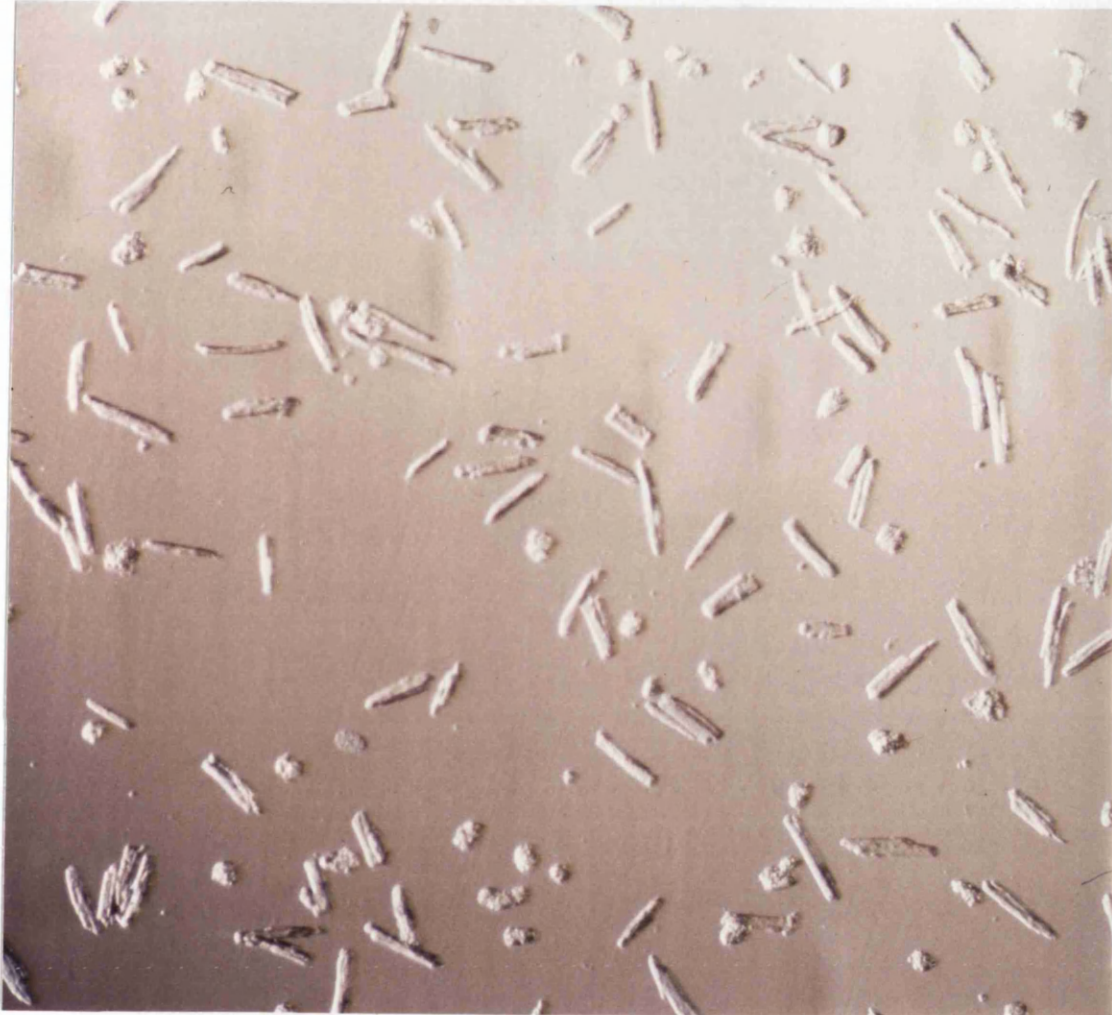

**Figure 3.4** Freshly plated adult rabbit cardiac myocytes. Cells were allowed to attach to gelatine / laminin coated six well tissue culture dishes for two hours in the presence of 5% FCS. After two hours the medium was removed and replaced with fresh medium 199 containing 1% FCS.

The photograph was taken at x 40 magnification and has subsequently been photographically enlarged.

The background colour present in the photograph is due to the colouration caused by phenol red indicator present in the tissue culture medium. The majority of attached cells are rod-shaped and striated in appearance.

### **3.5 DISCUSSION**

Despite the relatively small ,but detailed literature available on the isolation of adult cardiac myocytes adherence to techniques as described did not immediately result in the reproducible preparation of large numbers of calcium tolerant isolated cardiac myocytes. The major problems were experienced when trying to obtain sterile preparations.

Small numbers of cells could be obtained, but until the modified procedure described here was adopted as routine large numbers of sterile cells in good condition were not obtained.

The selection of enzymes, the duration of perfusion, composition of buffers and general state of cleanliness of all of the materials used are all factors that appear to be critical to the success of this technique. Similar observations were made by Trevor Powell in *The Biology of isolated myocytes* [190].

It is difficult to pinpoint specific reasons for the varying degrees of success experienced by each operator with each element of the technique.

In conclusion: The isolation and culture of adult cardiac myocytes remains a technically demanding technique which continues to evolve [182].

## **CHAPTER 4**

---

### **DEVELOPING OPTIMAL TISSUE CULTURE CONDITIONS**

#### **4.1 INTRODUCTION**

#### **4.2 PLATING**

- a. Attachment substrates
- b. Media
- c. Supplementary media and growth factors

#### **4.3 CELL SURVIVAL IN CULTURE**

- a. Cell viability
- b. Long term culture
- c. Embedding

#### **4.4 RESULTS**

- a. Attachment
- b. Survival
- c. Embedding
- d. Long term culture

#### **4.5. DISCUSSION**



## 4.1 INTRODUCTION

At the time of starting this project a small body of literature regarding the culture of adult cardiac myocytes was available. A search of the literature between 1966 and 1996 produced 483 references of which over half concerned the isolation and culture of cells from non-mammalian species or non-adult mammals.

The culture of adult cardiac myocytes has been reported for rat [168,173,174,176,177], guinea pig [191] and rabbit [177]. Also culture techniques for adult feline cardiac myocytes have been published[192,193].

Many reported techniques used different plating substrates, extended the culture period for different times and reported varying rates and degrees of dedifferentiation in culture. None of the techniques used were able to slow the rate of dedifferentiation observed and the described remodelling of the cells in culture [194,195] appeared, from the literature to be independent of either plating substrate or the support media selected.

Lundgren et al [175] observed that the presence of high concentrations of foetal calf serum (FCS) appeared to facilitate the process of dedifferentiation, but that the withdrawal of this growth medium resulted in the death of the cells or a rapid decline in the number of cells remaining adherent to tissue culture plates.

It was clear from this body of literature that in order to maintain adult cardiac myocytes in culture for sufficient time to perform studies on the effects of ischaemia or the potential for preconditioning the techniques required to be optimised for the cells derived from the rabbit heart.

The following describes the process of optimisation undertaken.

## 4.2 PLATING

### 4.2a Attachment substrates

Initially a number of different plating substrates were tested for efficacy in the attachment of adult rabbit cardiac myocytes.

Early attempts to plate and culture adult myocytes were conducted using collagen [196,197], fibronectin [175,197], foetal calf serum [170] and laminin [156,173,175].

Gelatine had proved very successful for plating and attachment of foetal rat cardiac myocytes [85], but was of only limited use for maintaining the attachment of adult myocytes to tissue culture plates. Growing cells secrete protein components of intercellular matrix onto the growing surface, a process that facilitates the maintenance of attachment once achieved.

In isolated adult cardiac muscle cells this process appeared to take place at a far lower rate, these cells were observed to be and had been reported to be virtually impossible to attach to unprimed tissue culture plastics [156,196,170].

It appeared that the attachment substrate must be one with which the cells actively interact to form long term attachment. Lundgren et al [198] using fluorescent antibody staining demonstrated the presence of cell surface receptors for laminin on the surface of adult rat cardiac myocytes. This is an important component of the extracellular matrix in the heart.

However it is clear from the literature that the affinity of myocytes from different species for each putative attachment substrate is different and mouse myocytes have been reported as initially failing to attach to this substrate (M. Eppenberger private communication).

In order to establish the most effective attachment substrate for adult rabbit myocytes the number of cells remaining attached overnight was investigated for gelatine, FCS, collagen and laminin.

The results for three out of four of these are shown in Fig 4.1

Collagen is not shown as the rabbit myocytes failed to attach at all to two types of collagen ( Type IV and a crude preparation of rat tail collagen).

The most effective attachment substrate was found to be laminin derived from the basement membrane of Engelbreth-Holm-Swarm mouse sarcoma (Sigma).

Laminin was applied to 35mm petri dishes and 6 well plates at a concentration of 10µg/well, 3µg to each well of a 24 well plate and 1µg to each well of a 96 well plate.

Although a proportion of the plated rabbit myocytes initially attached well using this regime the number of attached cells declined rapidly with each subsequent change of medium.

It was observed that the rate at which the cells became detached was different using different types of tissue culture plate. It appeared that the problem was composed of two elements;

1. The ability of the cells to attach to the substrate and
2. The capacity of the attachment substrate to remain on the plate.

The rapid removal of substrate and cells by the repeated media changes during initial plating, maintenance and experimental procedures was effectively prevented by first coating with 1% gelatine, a method that had been reported as effective for attaching human atrial myocytes (Kerry Davia, private communication).

The gelatine was applied for 45mins to 1 hour and the excess removed by aspiration. This was then followed by the laminin solution, which was left in contact with the gelatine-coated surface for 4 - 5 hours prior to use.

The excess laminin solution was removed completely by aspiration and the plate washed with fresh, unsupplemented tissue culture medium immediately before the aliquot of cell suspension was added to the tissue culture plates. Although this technique did not modify the rate of decline in cell viability (see figure 4.2) the proportion of plated cells that attached improved (see figures 3.4 and 4.2) and the absolute number of cells remaining attached also improved. In figure 4.1 the results of early experiments investigating the efficacy of plating substrates are shown. In each experiment a minimum of  $5 \times 10^5$  cells was applied to each well. As the figures indicate less than 5% of the applied cells attached successfully. The rate of attachment was substantially improved when the plates were primed with gelatine prior to coating with laminin. Attached cells were counted prior to viral transfection protocols and data from these counts gives an attachment rate of 19.1 %  $\pm$  1.6 sem in sixteen preparations for transfection experiments. Whilst this remains a relatively small proportion of the total cells applied it is nonetheless a substantial improvement on the single coating technique.

#### **4.2b. Media**

The precise nutrient requirements of many micro-organisms are known and fully characterised media, termed defined media, are available for such cultures.

The selection of support media for mammalian cells in culture is hampered by there being few if any fully defined media available.

Cells in culture require the addition of growth factors to facilitate attachment to tissue culture plates, support growth and to maintain them. Which factors and in what quantities remains largely unknown.

In order to provide a broad spectrum of trace chemicals and growth factors supplements such as foetal calf serum are used. Sera are used as supplements for mammalian cell culture on the assumption that the capacity of animal sera to support cells in the animal implies that all necessary elements for sustaining cells are present. Increasingly the precise composition of commonly used mammalian cell culture supplements is being elucidated. This may lead to precisely defined media for a variety of cell types.

As a consequence of the current rather *ad hoc* approach the selection of medium is a 'hit and miss' affair involving drawing on the experience of others and trying a variety of commercially formulated media to test the 'preference' of the cells in culture.

In deference to the efforts of large numbers of people in the field of mammalian cell culture it has to be noted that various forms of serum supplement have proved successful in sustaining cells *in-vitro*.

Comparing Dulbeccos minimal essential medium (DMEM) and standard Gibco minimal essential medium (MEM) with some complete media, Medium 199 (M199) supplemented with Earle's salts, M199 supplemented with Hanks salts produced no obvious, quantifiable evidence of superiority.

On inspection of individual wells on six well test plates after cells had been plated and maintained overnight using each of these media the cells appeared present in similar numbers and condition.

The published, detailed formulations of each of these media are provided by the manufacturers.

A wholly subjective impression that the cells attached more quickly and spread slightly less rapidly in M199 with Earles was the sole reason for the selection of this medium for all subsequent cultures.

#### **4.2c. Supplementary media and growth factors**

Foetal calf serum facilitates the attachment of primary cells to tissue culture substrates [161] for this reason the medium in which the cells were originally plated down contained 5% FCS, concentrations of this supplement as high as 25% [180] and as low as 1% [178] had been used for the plating and maintenance of adult rat and guinea pig cells in culture, for rabbit cells Haddad et al reported the use of 5% FCS for seven day cultures [156].

In an attempt to slow the processes of rounding, spreading and dedifferentiation that occur when adult cardiac myocytes are placed in two dimensional tissue culture the media used for maintaining cells was adjusted to contain 1% FCS.

When FCS had been substituted with horse serum the cells also failed to thrive. In three preparations, on some plates, plating medium containing 5% FCS was replaced with maintenance medium containing 5% horse serum at the end of the attachment period. All of the cells treated in this way died overnight. In consequence cells were plated in medium M199 with Earles salts supplemented with 5% FCS -termed plating medium (PM) then transferred to an incubator at 37° C gassed with 95% air / 5% CO<sub>2</sub> for two hours to attach.

At the end of the attachment period the plating medium was removed by aspiration, gentle agitation of the plates before the plating medium was removed helped to ensure that any unattached cells were removed with the medium. Fresh medium M199 with Earles Salts containing 1% FCS (maintenance medium) was then added and the cells were returned to the incubator.

A variety of supplements for tissue culture media have been recommended by people working with adult cardiocytes isolated from several species. Piper et al have suggested adding amino acids not commonly used in tissue culture media and the effect of insulin on glucose uptake and rates of oxygen consumption of adult cells in culture have also been investigated [199].

Neither of these strategies seemed to improve the tolerance of adult rabbit myocytes for culture conditions in my hands.

In addition the role of insulin and glycogen loading in the response of myocardium to ischaemia remains uncertain with some groups reporting beneficial effects of pretreatment with insulin [200] and others reporting exacerbation of ischaemic injury [201].

Given that no major observable benefit was gained by following any of these protocols the decision in regards to which medium to use was ultimately determined by time and cost considerations.

The spreading and dedifferentiation of cells in culture reported by all groups working with adult cardiac myocytes presented a different problem. The series of events that occurred following the taking of adult cardiocytes into culture, particularly in the presence of serum, had been previously described by several workers in the field [180,195,202,203].

Briefly attached cells exhibited two types of pattern of change. Cells that had successfully attached and were therefore viable at the time of plating would round up, but remain attached and rapidly spread, flatten and develop pseudopoda. Other cells remained rod shaped for periods of several days, rounding and flattening slightly at either end. After extended periods in culture the second group cells were also observed to spread and develop extensive psuedopoda.

### **4.3 CELL SURVIVAL IN CULTURE**

Attached adult rabbit cardiac myocytes would normally be left in the incubator in maintenance medium overnight. All experimental procedures were conducted in serum free medium.

In twelve preparations an assessment of the number of viable attached cells was made. The results of the Trypan blue exclusion tests performed are shown in figure. 4.2. In each of these preparations the number of viable cells remaining attached to the tissue culture plates was followed for three days after the day of isolation.

The value for each day is a mean of two replicates.

#### **4.3a. Cell viability**

As described above the initial yield of cells from any isolation was estimated by counting the total cell harvest suspended in 10mls of plating medium using the improved Neubauer haemocytometer. In all experiments described in this thesis  $10^6$  cells were plated onto either 35mm petri dishes or each well of a 6 well tissue culture plate. Where 24 well tissue culture were used  $5 \times 10^5$  cells were added to each well.

After the 2hour attachment period and change to maintenance medium the number of attached cells was estimated using a 1cm square eye-piece graticule divided into 10 x 10 mm squares (Southern Scientific Supplies).

The dimensions of the graticule were confirmed using a microscope stage micrometer.



The mean of counts from several fields equal to 1 x graticule area taken at x100 magnification was deemed to be the number of cells present on the plate per mm<sup>2</sup>.

Multiplying this result by the surface area of the plate in mm<sup>2</sup> produced an estimate of the total number of cells remaining on the plate after attachment to the gelatine / laminin coating. Similarly cells stained with Trypan blue were counted using the eyepiece graticule.

Determination of cell viability was initially made using the Trypan blue (3,3'- [3,3'-Dimethyl [1,1'-biphenyl] -4,4'-diyl) bis (azo) ] bis [5-amino-4-hydroxy-2,7-naphthalenedisulphonic acid] tetrasodium salt ) exclusion technique and LDH release.

#### **4.3b. Long - term culture of adult myocytes**

As stated the overall aim of creating this model was to have available a situation in which the circumstances prevailing in the in-vitro heart during ischaemia could be reproducibly simulated and modified.

In order for the model to parallel the situation in living tissue as closely as possible it was considered desirable to try and retain the characteristics of the freshly isolated myocyte for as long as possible.

As already reported the cells adapted to culture by spreading and developing extensive membrane processes.

A photograph of adult myocytes cultured in 1% FCS supplemented tissue culture medium for 22 days is reproduced in figure 4.3.

The cells have been stained with Coumassie blue, a general histological stain that binds avidly to protein.

The extensive processes seen in the photograph, taken at x100 magnification, were not clearly visible under light microscopy prior to staining. Several rounded cells are clearly visible in the photograph. Rounded myocytes have often been assumed to be non-viable cells, however close inspection of the picture reveals that several are developing extensions onto the culture plate. In addition the cells have been washed, stained, repeatedly washed and fixed prior to being photographed. Non-viable cells would normally come off of the tissue culture plate when handled to this extent.

It is not entirely clear from the photograph as to whether processes from different cells have joined together at a distance from the main body of the cultured cell, but it appears to be the case.

On several occasions cells that had maintained in culture for extended periods were seen to resume beating spontaneously. The rate of beating was irregular and the distribution of beating activity across an individual cell was not uniform.

These cells had undergone dramatic phenotypic alteration . Freshly isolated adult rabbit myocytes were quiescent once successfully attached to a tissue culture plate.

In order to construct a simulation of ischaemic injury and to examine the potential for intervention to alter the response to this injury time was required.

Using the techniques described thus far it was decided that a window of opportunity in which to conduct experiments of 3 days duration had been obtained. This decision was based on the observations of the proportion of plated cells remaining attached, the number remaining viable and the observable phenotypic changes during the culture period. Although the experimental procedures planned for this thesis could be conducted in the available, selected time efforts to improve cell survival in culture continued.

### **4.3c. Embedding – three dimensional tissue culture**

In order to successfully transfer an exogenous gene, allow for and measure gene expression and determine whether the presence of a novel gene product in any way modified the responses of myocytes in culture a longer period of stability in culture would be preferable. In order to try to extend the time over which experiments could be conducted on quiescent, morphologically unmodified cells a technique called embedding was investigated.

Embedding as a cell culture method was developed for use in industrial biotechnology where large cultures of bacteria or yeast were grown in bioreactor vessels up to 1000 litres capacity to generate by-products of microbial metabolism that were of high value, such as antibiotics.

In all of these industrial processes the product must be separated from the biomass generated by microbial growth, purified and processed for use.

To facilitate separation and purification the technique of embedding the cells in an inert, highly permeable, solid support material was developed [204,205]. Like the solid substrates use for laboratory based microbial culture these materials were largely polymerised complex carbohydrates.

The most commonly used embedding medium for microbial and plant cell culture has been sodium alginate, the sodium salt of a complex carbohydrate derived from seaweed and polymerised by exposure to high concentrations of calcium ion (1M).

The usual procedure for embedding using this medium is to mix cells and unpolymerised alginate in isotonic solution and to then add this mixture, dropwise using a small syringe or micropipette , to a solution of one Molar calcium chloride.

The drops of cell suspension and alginate mixture harden on contact with the calcium chloride solution to form fairly uniformly sized beads. The beads are then removed from the polymerisation medium by filtration, washed and rapidly transferred to the appropriate medium for culture.

This technique was tested by Decker et al [194] for use with feline cardiac myocytes that were to be used individually in electrophysiological studies.

The cells were removed from the embedding medium in the Decker study by adding the beads to a solution of EDTA that sequestered the calcium ion and depolymerised the carbohydrate embedding medium.

In these studies the cells were found to have retained their rod – like morphology for a longer period than cells from the same preparations maintained for the same period in two dimensional culture on standard tissue culture plates.

This technique was unsuitable for the type of experiment where cells were to be studied in large numbers and had to be attached to a fixed support medium such as tissue culture plates.

In an attempt to adapt the technique for the requirements of these studies a method was sought for applying a thin top layer of polymerised alginate to plated adult myocytes. The polymerised alginate proved too fragile for use as a thin layer. Although the calcium was bound rapidly by the alginate solution the addition of 1M CaCl<sub>2</sub> to the alginate layer damaged the underlying cells. Instead of using alginate a low concentration of tissue culture grade agar was tested as a potential substitute.

Solution of 0.5 or 1% agar in PBS were melted by placing in a microwave oven at full power for 1 minute. This solution was then placed in a 37°C water bath and allowed to equilibrate to this temperature. Cooling slowly by this method maintained the agar solution in a liquid state.

The warm agar was then applied as a thin layer by careful pipetting over the top of attached cardiac myocytes on tissue culture plates. To pipette the agar 1ml plastic pipette tips were trimmed with scissors to approximately double the diameter of the opening and placed in warm sterile PBS. Warming the pipette tips prevented the agar solidifying on contact with the plastic. The process of adding the warm agar displaced some cells which then floated into the agar phase.

Calculation of the volume of agar to be added to a well of known surface area gave an estimate of the depth of embedding medium that had been applied.

It was not possible to obtain a depth of less than 1mm and successfully cover the well before the agar solidified by applying the agar by hand.

In addition the bottom of the well of a multiwell tissue culture plate is not completely flat. The slight camber towards the outside edge resulted in there always being a greater depth of embedding medium at the edges than in the centre. Gentle agitation to prevent this only resulted in displacing the cells into the warm agar as it cooled and set.

Embedding cells that had been allowed to attach to substrate coated glass cover slips was also attempted. The cells attached well to coated glass cover slips that had been thoroughly acid washed and de-greased prior to coating.

However due to surface tension the embedding medium formed a dome-shaped layer across the cover slip making visualisation of the entrapped cells difficult.

## 4.4 RESULTS

### 4.4a Attachment

In each case the wells were coated with the attachment substrate under sterile conditions in a laminar flow cabinet and left at 37° C in a tissue culture incubator under 95% air / 5% CO<sub>2</sub> overnight

Cells were isolated from a single heart and plated onto a six well culture dish. On each tissue culture plate two wells had been treated with each attachment substrate. One point on the graph represents the mean of two replicate values and there are two independent experiments shown on the same axes for each graph.

In the preliminary experiments illustrated here cells were left to attach to the plating substrate for 2 hours. In earlier attempts at attaching isolated myocytes to a variety of surfaces, both treated and untreated it had become clear that the time allowed was largely irrelevant. In short cells that do not attach within 2 – 3 hours of plating will not attach at all. This observation was also made by Jacobson and Piper and become the basis of the 'rapid attachment method' [161] for culturing adult rat myocytes.

At the end of two hours 2mls of plating medium containing 5% foetal calf serum was removed and replaced with 2.5 mls of maintenance medium containing 1% foetal calf serum (FCS).

In addition to the need to reduce the FCS concentration to a minimum this change of medium, accompanied by gentle agitation, also removed unattached cells. The majority of the cells remaining after the medium change were rod-shaped and excluded trypan blue (85.5%± 5.5 sem n= 10). No further medium changes were made until after the 3 days of serial counting was completed.

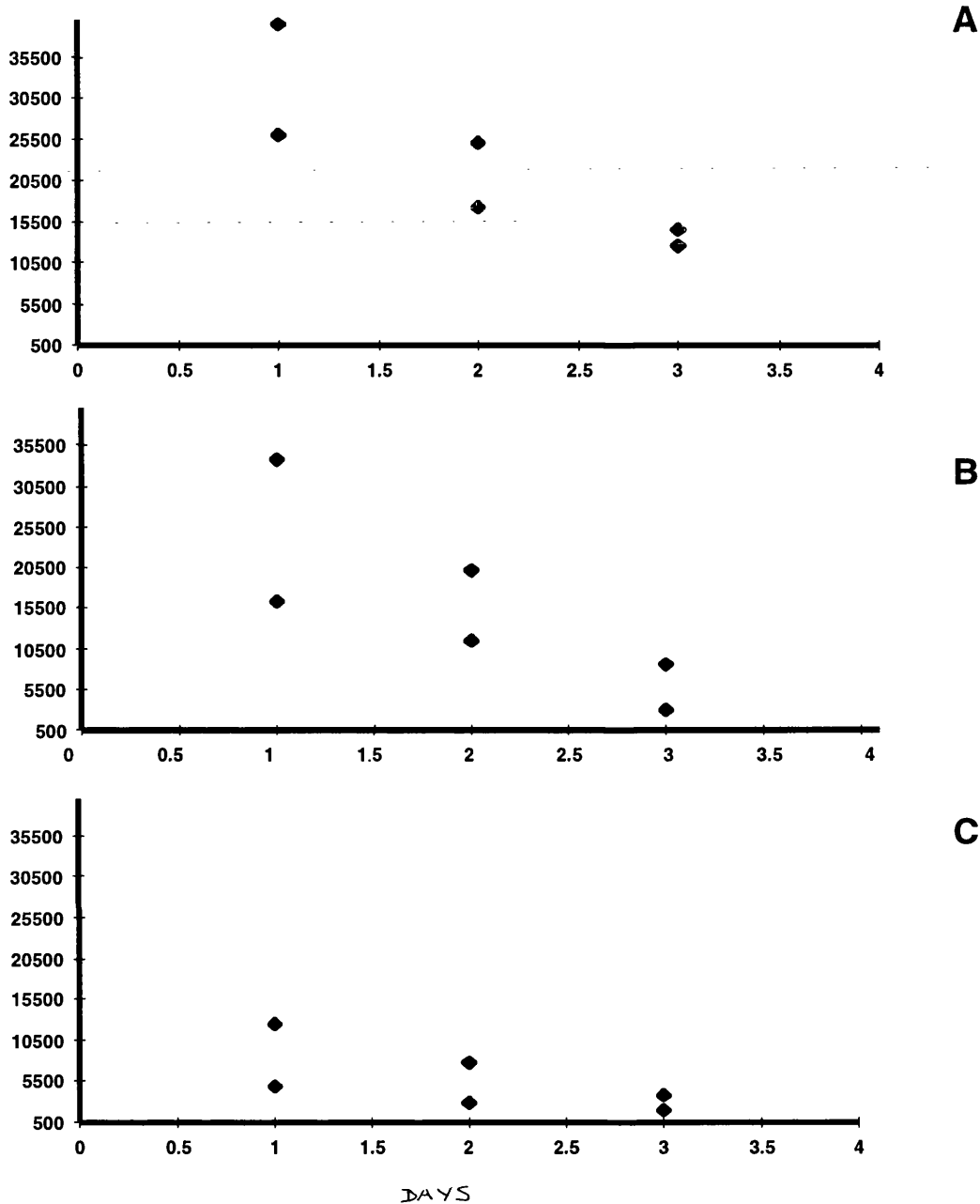

**Figure 4.1:** The effect of different cell attachment substrates on the number of cells remaining attached to 6 well tissue culture plates.

**A.** The attachment substrate used was 10 $\mu$ g / well laminin coated directly onto tissue culture plastic.

**B.** The attachment substrate was 1ml / well of 1% gelatine

**C.** The attachment substrate was 1ml / well Gibco RL (Australian) foetal calf serum.

SUBSTRATE		LAMININ	GELATINE	CALF SERUM
Number of days	1	39942	16354	12506
	1	25974	33670	4810
	2	17316	11544	7696
	2	25012	20202	2886
	3	12506	8658	1924
	3	11068	1759	988

**Table 4.1** Numbers of cells remaining attached over 3 days for 3 different plating substrates. Each value is the mean of two replicates, the results of two tests are shown.

#### 4.4b Survival

Cells were plated onto gelatine / laminin double coated six well plates at a density of  $10^5$  or  $10^6$  cells per well.

The number of viable cells counted as cells excluding trypan blue stain had declined by approximately 50% by the third day in culture.

As a consequence of the steady background rate of decline in viable cell numbers all experiments were conducted in the presence of concurrent untreated controls. Hence the effect of any treatments applied to the cells in culture could be observed in comparison to the behaviour of the cells undergoing no treatments, but being maintained in culture.

Although plating adult cardiac myocytes onto laminin coated tissue culture plastics is a successful method of obtaining large numbers of attached cells the cultures remain relatively fragile. Cell lines or actively dividing cells can attach very firmly to coated and uncoated tissue culture surfaces and rarely detach unless they have lost viability.

Adult myocytes are large, rectangular and non-dividing cells. Frequently as a result of the shape, size and condition of the isolated cells they can become detached if handled with anything less than the utmost care.



In order to facilitate comparison all control wells of cultured cells underwent the same number of changes of media as experimental wells.

<b>DAY</b>	<b>% LIVE</b>	<b>SEM</b>
0	82.5	5.5
1	81.6	4.0
2	60.5	4.6
3	35.5	7.8

**Table 4.2:** Cell survival over 3 days in culture. Means of ten values +/- sem. Graph of these values is shown in figure 4.2 overleaf.

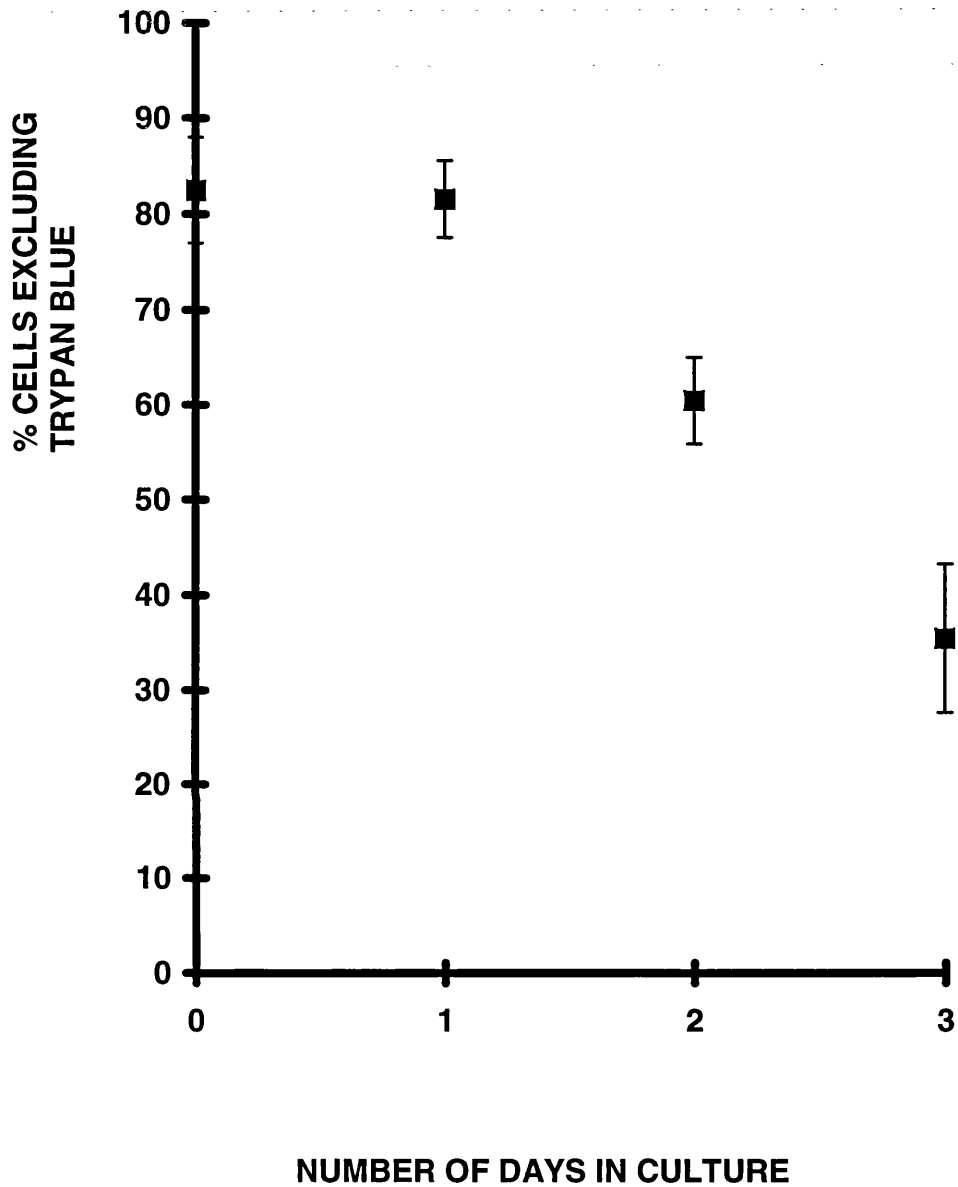

**FIGURE 4.2:** Graph of the data from 12 preparations in which one 6 well plate was taken for cell survival estimation by trypan blue exclusion assay. The values are shown as means  $\pm$  SEM

#### **4.4c Embedding**

The embedding procedure used made quantification of the cells very difficult. A selection of photographs of embedded cells is shown in Fig. 4.4. The additional depth of the embedding medium and the tendency of the cells to form several layers within the medium has impeded the ability to focus on the cells under the microscope.

In 4.4c cells that had been exposed to adenovirus serotype V carrying a gene for the enzyme  $\beta$ -galactosidase had been exposed to the substrate X-gal, which is cleaved by the enzyme to generate a dark blue product.

Blue stained cells were visible through the embedding medium. The very dilute agar used as an embedding medium in these experiments permitted free access to the cells by the virus. As both components of the medium and molecules of gasses are far smaller than virus particles this result confirmed that free movement of the substances required by the cells in culture was possible through the embedding medium.

The photographs illustrate that at three days post plating there was no discernible improvement in cell survival.

The technique, having proved unsuccessful in extending the life of myocytes in culture was abandoned.

#### **4.4d Long term culture**

The long term culture of adult rabbit cardiac myocytes was possible using the attachment substrate and culture conditions described here. The essential component of the successful long term culture of these cells was obtaining a contaminant free isolate at the outset. Bacterial and fungal cells overgrow the non-replicative myocytes in a matter of 24 – 48 hours. The use of antibiotics will

prevent the former providing the appropriate substance is applied and the contaminating bacteria are not resistant. However the use of antimycotics for myocyte cell culture is not advisable. The myocytes themselves may be killed by the presence in medium of an antimycotic agent [169]. Figure 4.3 shows a photomicrograph of adult cardiac myocytes that had been cultured for 22 days. Prior to the photograph the cells had been fixed using formol saline and stained with Coumassie blue.

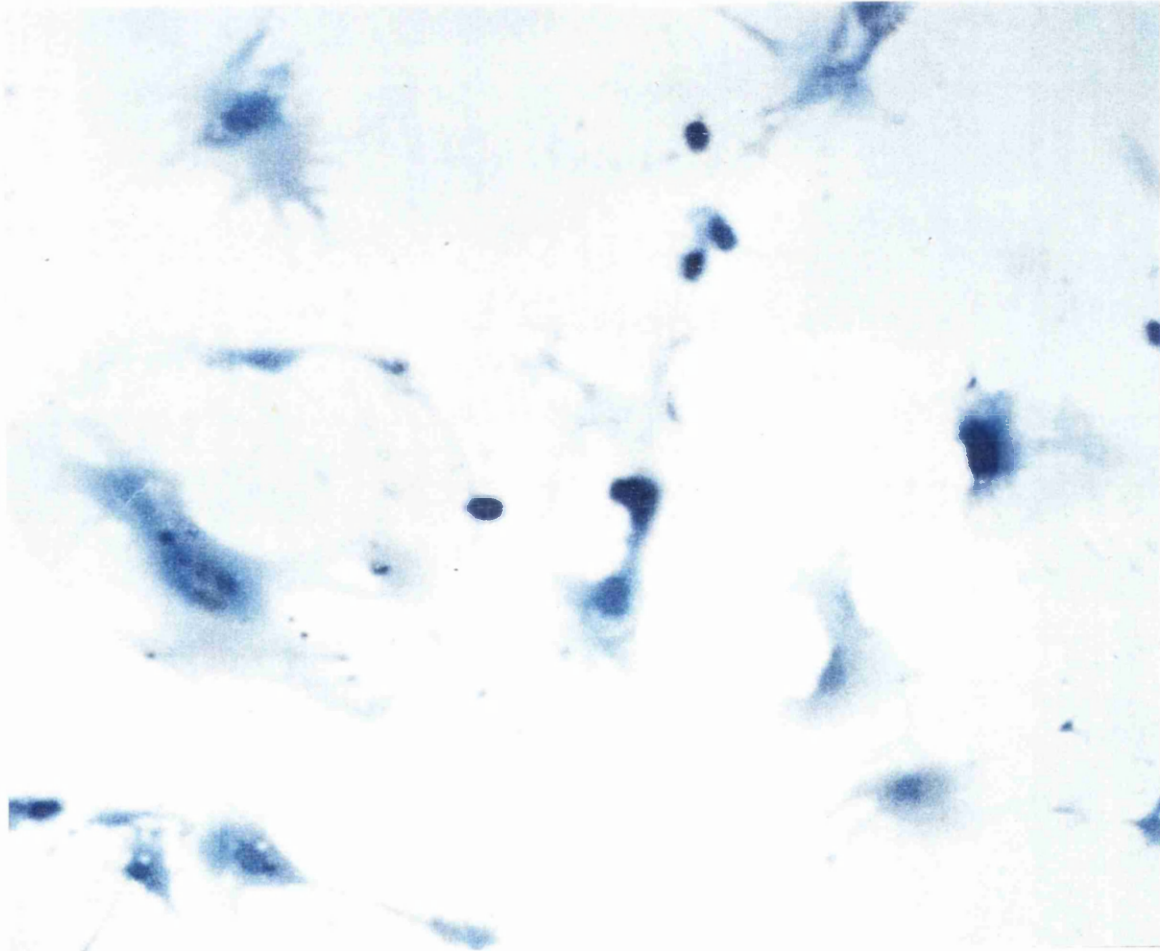

**Figure 4.3** Photomicrograph of adult cardiac myocytes cultured for 22 days. The cells have been stained with coumassie blue, a histological stain that has a high affinity for protein.

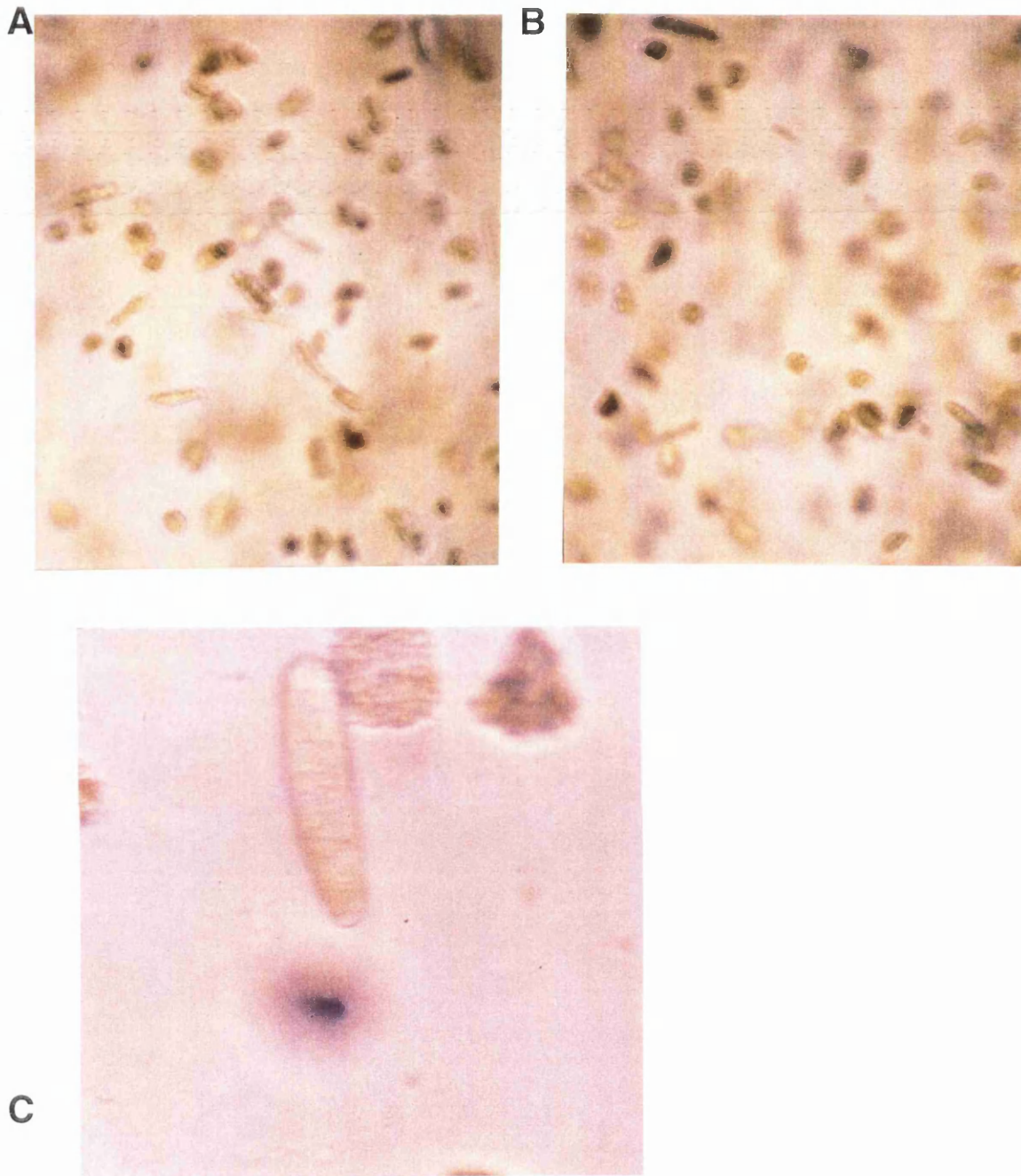

**Figure 4.4.** Adult myocytes plated onto laminin coated tissue culture plates and embedded in a 1% agar overlay.

A: Cells are shown 24 hours after embedding

B: Three days in culture.

C: Adv transfected cell, positive for  $\beta$ -galactosidase.

## 4.5 DISCUSSION

The isolation and culture of adult cardiac myocytes are techniques that have been under development for over two decades. Many groups use freshly isolated myocytes from adult and immature mammals to perform investigations into the physiology and electrophysiology of cardiac muscle cells.

In the light of the many published data derived from both acutely isolated and cultured cardiac myocytes the usefulness of the techniques as tools cannot be ignored. However the culture of adult cardiac myocytes is a difficult and intrinsically variable technique.

Extensive development and characterisation of primary cell cultures will continue.

The isolation, plating and culture conditions tested for this study produced large numbers of calcium tolerant, quiescent myocytes that attached well to gelatine primed laminin coated tissue culture plates.

These cells retained their native morphology for periods of several days, but the cell numbers began to decline rapidly after 3 days. Myocytes in two dimensional culture are sensitive to the turbulence and shear forces created by the removal and replacement of media and begin to lose their attachment to culture substrata when their viability declines.

For these reasons the decision was taken to perform all experiments within 3 – 5 days of isolation while the numbers of cells in culture remained relatively stable. For the measurements used to determine cell viability endpoints large numbers of cells were required. Obtaining and retaining such large numbers of attached cells was the deciding factor in the selected time course for experimental procedures.

The attempts to create a three dimensional culture environment for these cells were not successful, however the use of an attachment substrate throughout the embedding medium and more uniform distribution of the overlay are strategies that might well have improved the outcome. The technique reduced the visibility of the cells under the microscope and limited access for the determination of cell viability using techniques such as dye exclusion. Nonetheless three dimensional culture for delicate cell populations is a potentially useful technique.

## **CHAPTER 5**

### **SIMULATED ISCHAEMIA**

#### **5.1 INTRODUCTION**

#### **5.2 MATERIALS AND METHODS**

- a.** Extracellular milieu
- b.** Oxygen limitation
- c.** Use of the hypoxia chamber

#### **5.3 RESULTS**

- a.** Characteristics of the hypoxia chamber
- b** Components of the simulation
- b.** Effects of pH +/- hypoxia
- d.** Lactose and glucose deprivation
- e.** Time course
- f.** Defining the lethal stimulus

#### **5.4 SUMMARY**

#### **5.5 DISCUSSION**



## 5.1 INTRODUCTION

Ischaemia in living tissue generates a complex series of changes to the environment surrounding the cells comprising that tissue. These changes in turn influence the internal environment of the individual cells. Many of these changes are uncharacterised although measurements of the consequences of ischaemia in terms of the concentrations of ions, oxygen and the accumulation of metabolites in the extracellular fluid have been undertaken both in-vivo and in-vitro.

One of the consequences of any extended period of inadequate perfusion will inevitably be the loss of viability of some of the cells comprising the compromised tissue. Dying cells will release into the immediate surroundings a range of materials not encountered by living cells under normal conditions. One of the commonly used endpoints for the measurement of loss of viable cells is the release into the extracellular space of intracellular enzymes such as creatine kinase and lactate dehydrogenase. Although there is not total agreement as to whether enzyme release adequately reflects cell viability [206].

Other substances released into the extracellular milieu could include lysosomal enzymes, in-tact and partially digested structural proteins, metabolic by products, lipids, lipoproteins and phospholipids, indeed all or any of the components of the intracellular environment may be released during the breakdown of non-viable cells.

As blood is excluded the scavengers in the circulation, the phagocytic cells will also be largely excluded. The environment created by extended ischaemic insult will be substantively different from normal physiological conditions and both complex and dynamic.

Either measuring or simulating such a set of circumstances would present a series of virtually insurmountable logistical problems. As a consequence any simulation of the conditions that exist in ischaemia would be a gross simplification of the conditions in life.

An early report by Acosta et al [207] describes a simulation of ischaemia in cultures of neonatal rat cardiocytes. In this simulation the oxygen and glucose levels applied to the cells were reduced for periods of 4 – 24 hours and the leakage of intracellular enzymes into the supernatant medium was measured as an endpoint for cell injury.

Esumi et al [208] describe a simulated ischaemia based on the extracellular milieu of reversible myocardial ischaemia. The method involved the use of modified Krebs-Heinseleit buffers which contained metabolic inhibitors, increased lactate, proton and potassium ion concentrations. The method was developed for use with a single cell model of ischaemic injury in freshly isolated rat myocytes.

In 1995 Webster et al [209] published a model of ischaemic preconditioning in cultured neonatal rat cardiocytes using an environmental chamber to exclude oxygen, but not modifying either the extracellular pH or availability of substrate. A modification of this method utilising a custom built chamber to exclude oxygen from the extracellular environment had been in use by Dr DV Cumming in the Department of Molecular Pathology UCL for application to cultured neonatal rat cardiac myocytes. This method used both a modified extracellular milieu and an environmental chamber to create a simulation of ischaemia.

Armstrong and Ganote [45,52,99] in the pellet model of ischaemia that they have developed, based on acutely isolated adult myocytes used packing of the cells by gentle centrifugation to control extracellular volume, exclusion of oxygen by

applying a layer of oil over the pellet and withdrawal of metabolic substrate, in the form of glucose to create a simulation of ischaemia.

Ikonomidis et al published a simulated ischaemia protocol for use with cultured human paediatric ventricular myocytes. This simulation consisted of a specially constructed chamber in which conditions of anoxia and reduced extracellular volumes could be created.

This section describes the investigation of and adaptation of existing simulations for use with cultured adult rabbit cardiac myocytes.

## **5.2 Materials and Methods**

In all of the experiments described here cells were plated onto 6 well tissue culture plates or 35mm petri dishes at an initial plating density of  $10^6$  cells per well or per dish.

Cells used in these initial studies had been maintained overnight in maintenance medium containing 1% FCS in a standard incubator gassed with air enriched with 5% CO<sub>2</sub>. Prior to use all tissue culture wells were examined under an inverted light microscope for visible signs of microbial contamination.

Contaminated cultures were always discarded.

### **5.2a. Extracellular Milieu:**

Simulated ischaemia consisted of a Krebs - Heinseleit buffer containing NaCl 119mM, KCl 4.7mM, MgSO<sub>4</sub>. 7H<sub>2</sub>O 0.94mM, KH<sub>2</sub>PO<sub>4</sub> 1.22 mM, HEPES 10mM and CaCl<sub>2</sub> 1mM to which was added 12mM KCl and 20mM lactate.

The pH of this buffer was adjusted as required for the various experiments. No glucose was added and all controls were maintained in normal tissue culture medium.

This buffer was based on the rabbit Krebs-Heinseleit solution originally used for the 'normal calcium' step in the cell isolation procedure. The calcium ion concentration in this formulation is close to that present in M199 tissue culture medium and this Krebs solution would therefore not introduce any difficulties that might be associated with alterations in extracellular calcium.

Metabolic inhibitors were not added to the final buffer composition as in this simulation hypoxia could be obtained using a specially designed and purpose built apparatus.

### **5.2b. Oxygen limitation:**

Figure 5.1a is a simplified schematic diagram of the hypoxia chamber. In figure 5.1b a photograph of the hypoxia chamber is presented.

The unit was originally designed and constructed by the engineers of the mechanical workshops at University College London for use with neonatal cardiac myocytes in the course of research conducted by Dr D Cummings in the department of Molecular Pathology.

A copy of the device was later constructed by the bioengineering department at St Thomas's Hospital. The base, body and lid of the chamber were made from perspex and the body of the unit was insulated with expanded polystyrene.

Inside the unit a series of heating elements and temperature sensors were installed connected to a separate control device via a plug-in connection at the rear.

Two one-way valves were installed, one in the inwards direction in the base and one in the outwards direction in the lid to permit the flow of pressurised gas whilst excluding atmospheric air.

A perspex baseplate was installed in the bottom of the body of the unit to support tissue culture plates and enhance gas and heat circulation and a simple oxygen electrode was inserted via the lid and sealed into position. The electrode was connected to a meter external to the chamber as is illustrated in the photograph of the apparatus shown below.

The whole chamber was sealed by closing the lid with wing nut screw fittings, a rubber O-ring was rebated into the top surface of the base section to ensure a gas tight seal.

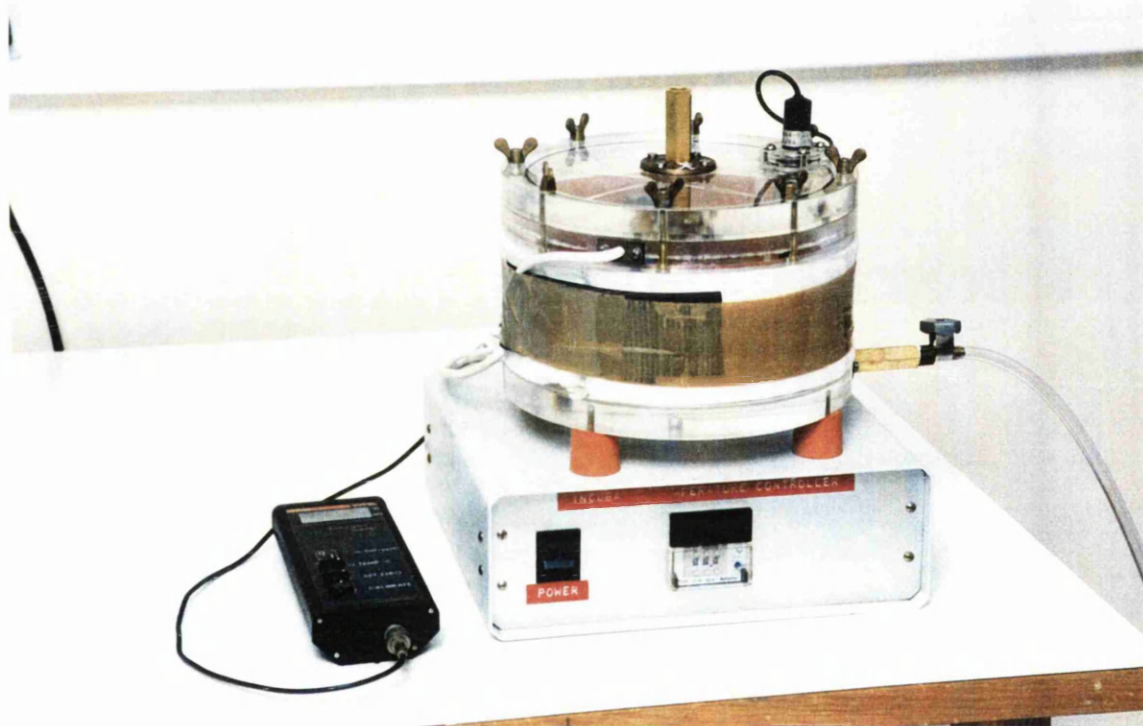

**Figure 5.1a** Photograph of the hypoxia chamber used in the experiments described in this thesis.

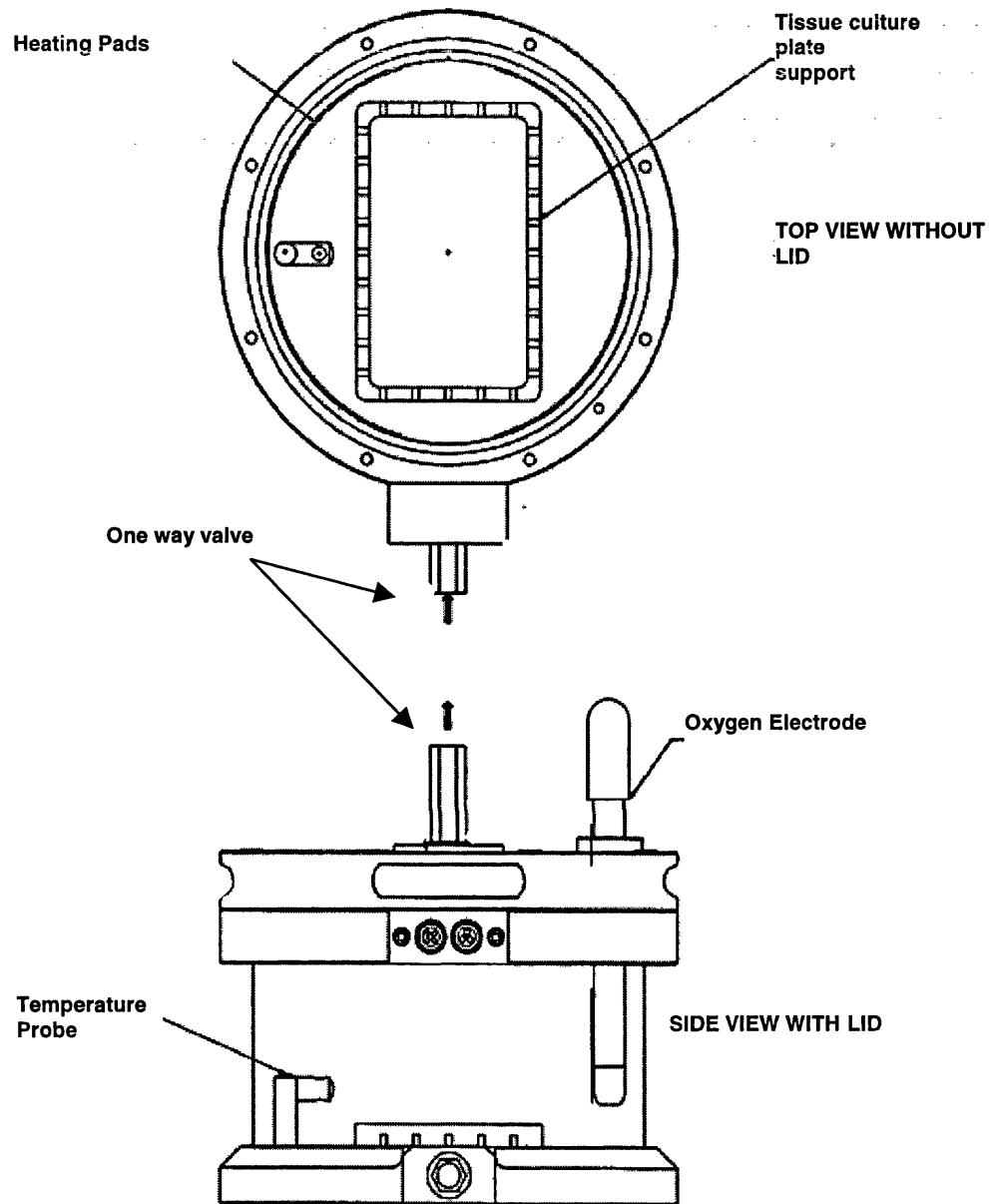

**Figure 5. 1b** Schematic diagram of the main components of the hypoxia chamber. Diagram kindly provided by the bioengineering department, Rayne Institute, St Thomas's Hospital

### 5.2c. Use of the hypoxia chamber

In use the chamber was flooded with a mixture of 95% Argon / 5% CO<sub>2</sub>. This heavier than air gas mixture was selected with the intention of creating an environment within the chamber that would permit the removal and addition of tissue culture plates without introducing atmospheric air.

Although this was the intention it did not prove possible to manipulate the contents of the chamber without causing significant reintroduction of atmospheric air as measured using the in situ oxygen electrode.

All media and buffers for use in the hypoxia chamber were pre-gassed with the Argon / CO<sub>2</sub> mixture for one hour prior to use. All solutions were sterile at the time of use.

While solutions were gassed the heating unit of the hypoxia chamber apparatus was activated and left to equilibrate to the pre-set temperature of 37°C. Despite normal rabbit core temperature being quoted as 38 – 40° C [184] all experimental procedures and incubations were conducted at the slightly lower temperature as facilities such as water baths, incubators and the hypoxia chamber were used by other workers.

It was specifically not possible to run a tissue culture incubator at the higher temperature.

Cells were removed from the incubator and transferred to the laminar flow cabinet. The maintenance medium was carefully removed by aspiration with a pipette and each well washed once with either buffer or medium as appropriate to the subsequent treatment.

All wells of the tissue culture plates were exposed to the same number of medium changes during an experiment. This procedure was followed to ensure

that loss of or damage to cells due to handling was as uniform across the culture as possible.

### 5.3 RESULTS

#### 5.3a The characteristics of the hypoxia chamber.

Figure 5.2: Graph showing the rate of decline of oxygen saturation in the hypoxia chamber as measured using in-situ oxygen electrode.

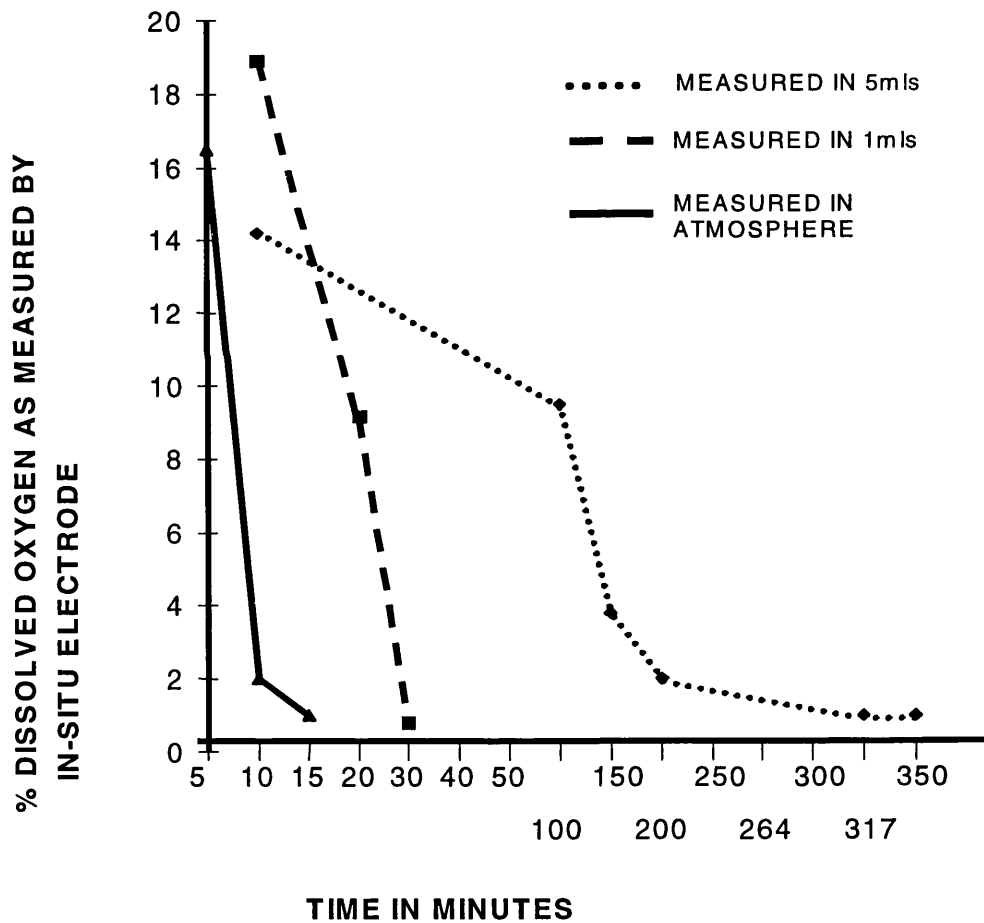



The electrode configuration precluded measurement in less than 1ml of solution. Measurements in solution were taken in 5mls and 1ml of pre-gassed simulated ischaemia buffer in tissue culture plates of the appropriate size. Solutions were unstirred. The volume normally applied to one well of a six well plate or a 35mm petri dish for use in the chamber was 0.5mls. All experimental protocols included a 30 minute equilibration period before the timing of the experiment commenced.

### **5.3b Components of the simulated ischaemia buffer.**

The data illustrated in Figs 5.3 – 5.5 were from preliminary experiments performed on cultured adult rabbit cardiac myocytes to determine the effects of individual components of the simulated ischaemia.

The graphs of the results obtained when the putative ischaemia buffer (IB) was modified by altering one component at a time. Cell viability was estimated by trypan blue exclusion only or by trypan blue exclusion and the MTT conversion assay in this series of experiments.

The aim was to adjust the simulated ischaemia protocol to reliably and reproducibly cause a 50% loss in cell viability and for the purposes of all subsequent experiments to define this as the 'lethal' stimulus.

With a smaller loss in cell viability it might prove difficult to see a significant effect above the background decline in cell numbers already described.

Also if any of the strategies to be tested for modification of the response of cells in culture to this stimulus were to cause an increase in cell death then a lethal stimulus causing a larger than 50% decline in cell numbers could mask any detrimental effects.

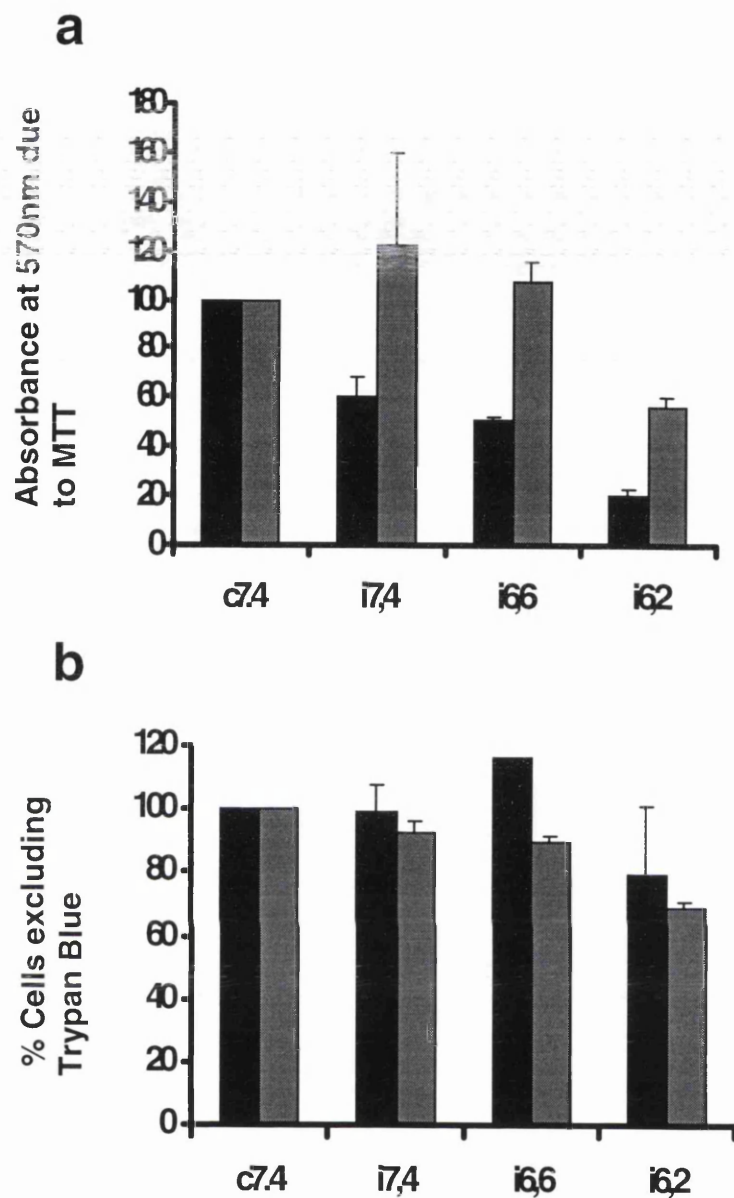

**Figures 5.3 a and b:**

Graphs of the trypan blue and MTT results from 4 experiments to determine the effect of pH on the efficacy of the simulated ischaemia buffer. In two experiments plates were placed in the Hypoxia chamber for four hours plus 30mins equilibration and in two experiments the plates were kept in a tissue culture incubator for 4.5 hours.

c = untreated control

i = ischaemia buffer

Without Hypoxia

With Hypoxia

**Table 5.1: Effect of pH on response to simulated ischaemia**

pH +Hypox.	%ex tb	SEM	MTT	SEM	pH no Hypox	%ex tb	SEM	MTT+	SEM
c7.4	100	0	100	0.0	c7.4	100	0	100	0
i7.4	99.2	8.5	60.5	8.0	i7.4	93	2.9	122	38
i6.6	116.3	0.3	51.7	0.4	i6.6	90	2	108	7
i6.2	79.0	21.8	19.8	2.7	i6.2	68.7	2	56	5

### **5.3c pH ± Hypoxia.**

The effect of reducing the pH of the simulated ischaemia buffer is shown in figures 5.3a and 5.3b. The reduction in pH of the ischaemia buffer does not begin to have clearly deleterious effects as measured by trypan blue exclusion until the level is below 6.5, both with and without hypoxia. The effects seen using MTT conversion as the endpoint are more pronounced at higher pH. In addition the effect of adding hypoxia is clearer in the metabolic endpoint.

All subsequent experiments were performed using simulated ischaemia were performed using the buffers adjusted to pH 6.2.

### **5.3d Lactate and Glucose deprivation:**

Figures 5.4 a and b show results obtained for trypan blue exclusion and MTT assays from two experiments to examine the effect of glucose deprivation and the addition of lactate to the simulated ischaemia buffer.

In these preliminary experiments the buffer was made up as a glucose free Krebs – Heinsleit solution containing : 119mM NaCl, 4.7mM KCl, 0.94 mM MgSO<sub>4</sub>.7H<sub>2</sub> O, 1.22mM KH<sub>2</sub>PO<sub>4</sub>, 25mM NaHCO<sub>3</sub>, 10mM HEPES and 1mM CaCl<sub>2</sub> , pH adjusted to 7.4.

The aim was to determine the effect of the addition of each individual component of the simulated ischaemia on the proportion of viable cells surviving exposure. These experiments were performed with the basic buffer adjusted to normal physiological pH prior to the addition of the simulation components.

The results from these experiments were not normalised to control values . It is clear that at this early stage in the development of the techniques for handling and deriving measurements from cultured adult myocytes neither the numbers of cells obtained nor the condition of the cells in culture was optimal.

By comparing these early sets of data with the overall picture obtained for cell yield, and survival in culture it can be seen that the situation steadily improved as experience was gained.

Controls were untreated controls. All control wells underwent the same number of medium changes as test wells.

Both the trypan blue and MTT results suggest that the addition of lactate to the buffer may actually have been beneficial, possibly due to the capacity of myocytes to utilise lactate as a metabolic substrate. It has been reported that mild acidosis can confer protection on isolated cells exposed to ischaemic conditions. It seems that of the conditions tested the removal of glucose in combination with a low pH is the most injurious set of conditions.

**Table 5.2** Effect on cell viability of 4 hours exposure to components of the simulated ischaemia.

<b>Treatment</b>	<b>% Cells excluding trypan blue</b>	<b>MTT Abs.</b>
<b>UTC</b>	<b>59.2</b>	<b>13.6</b>
<b>LAC+</b>	<b>59.6</b>	<b>22.8</b>
<b>GLUC -</b>	<b>36.5 *</b>	<b>15.2</b>
<b>Combined</b>	<b>37.5 *</b>	<b>16.0</b>

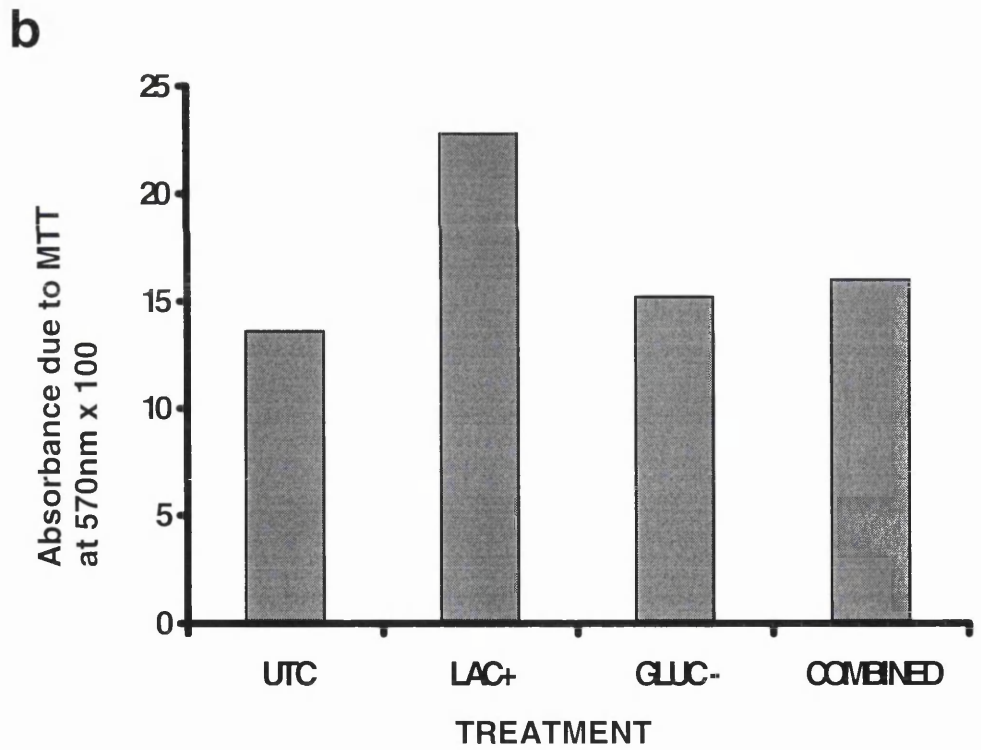
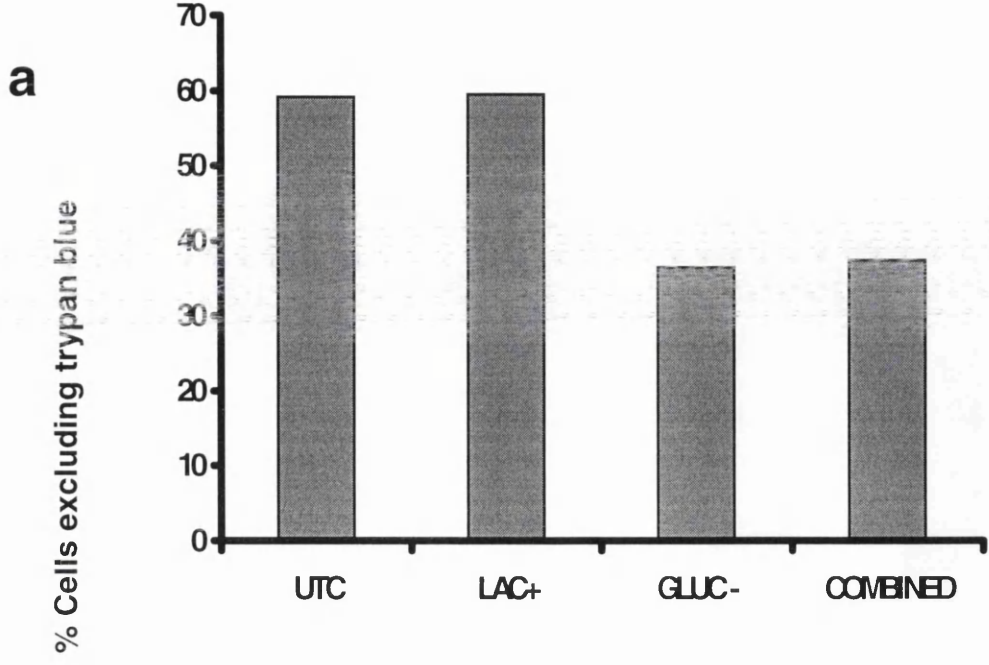

**Figure 5.4 a and b:**

Graphs of the results of trypan blue exclusion test and MTT assay in experiments to determine the effects of the addition of lactate (lac+) and removal of glucose (gluc-) from the simulated ischaemia protocol. Note that the addition of lactate in the absence of hypoxia either has no effect or possibly even a beneficial effect. The withdrawal of glucose clearly reduces cell viability. n=2 experiments for each variation of buffer composition.

### 5.3e Time course:

In the reported simulations of ischaemia the time courses for which the particular protocol was applied to simulate lethal ischaemia varied from 2 minutes [208], through 25 minutes [209], 90 minutes [138], 3 hours [99] to 4 – 24 hours [207]

To determine the time course needed to attain the desired “lethal stimulus” for adult rabbit cardiocytes in culture a series of experiments was performed.

The results of these experiments are shown in figure 5.5.

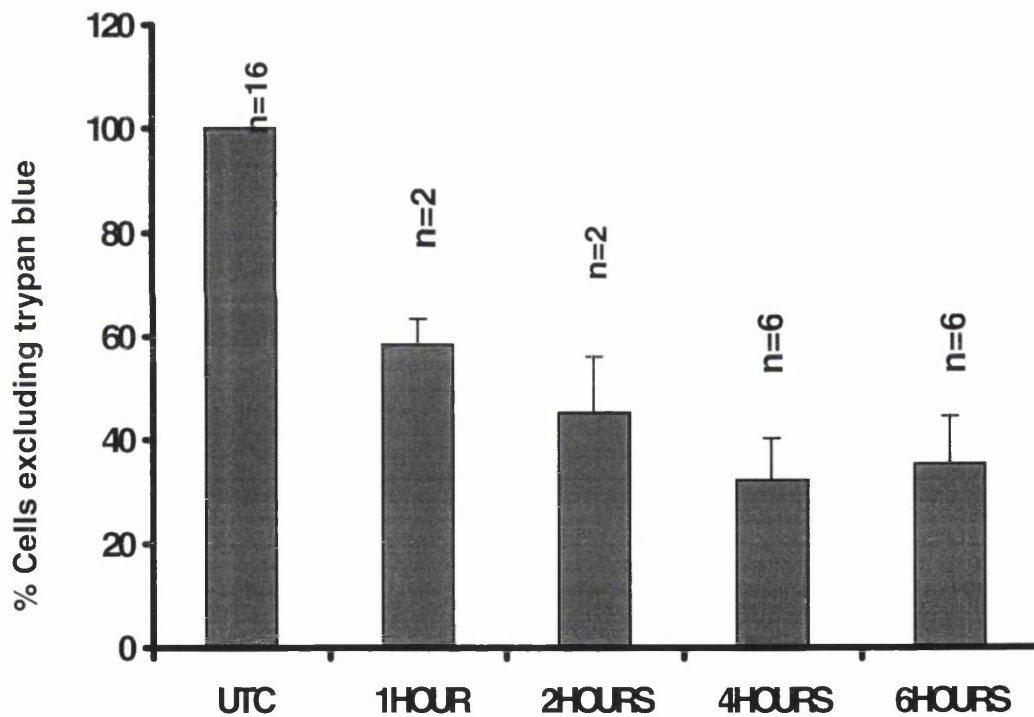

Figure 5.5 Time course of the lethal stimulus.

TIME	%Cells excluding Trypan blue	SEM
UTC	100	0
1Hr	58.4	4.6
2Hrs	45.2	11.1
4Hrs	32.3	8
6Hrs	35.5	9

Table 5.3: Time course data, means and standard errors, n as indicated in figure 5.5

From examination of these results it was decided that 4 hours exposure to the stimulus consisting of the hypoxia chamber and the ischaemia buffer, pH 6.2, + 20mM lactate and an additional 12mM K<sup>+</sup> would count as the lethal simulated ischaemia for adult rabbit cardiocytes in culture. As a consequence a number of the early experiments conducted in this model to identify a preconditioning stimulus and demonstrate protection were conducted using a four hour protocol.

Shortly after developing this simulation for adult rabbit cardiocytes a colleague began the process for use with neonatal rat cardiocytes. The simulated ischaemia buffer had been successfully used by Dr. R Heads in this model in our laboratory, however the combination of buffer and chamber was untried for neonatal rat cardiocytes. The results of the protocol in the rat model indicated that a six hour incubation was called for.

As the results obtained from the rabbit cells indicated that there was little difference between four and six hours exposure the six hour protocol was adopted in order to standardise the technique for all models in use in the laboratory.

### **5.3f The lethal stimulus, effect on adult cardiocytes in culture of the simulated ischaemia.**

Presented in the tables and figures below are the results from a number of experiments in which the simulated “lethal stimulus” was applied to adult cardiac myocytes in culture and for which three end points of cell viability were measured. The method that was finally chosen for measuring LDH release in this model is described in the general methods section of this thesis.

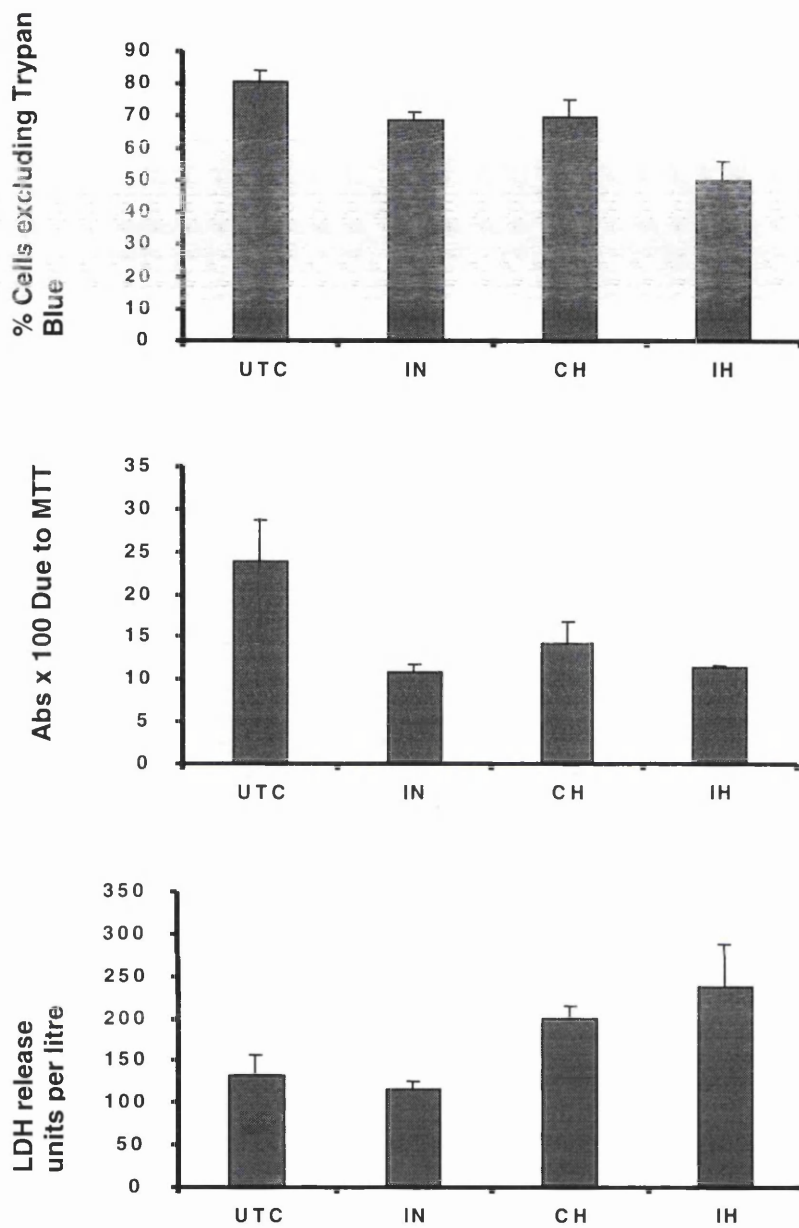

**Figure 5.6**  
 Response of cultured adult myocytes to simulated ischaemia  
 n= 4  
 UTC = Untreated controls  
 IN = Ischaemia buffer  
 CH = medium + hypoxia  
 IH = Ischaemia buffer + hypoxia  
 Duration = 4hrs.

**Table 5.4** Data from 4 hour preliminary experiment, all three endpoints. Non-normalised values.

TREATMENT	% Cells excluding Trypan blue	SEM	MTT Abs. x 100	SEM	LDH U/l	SEM
UTC	80.5	3.4	23.9*	4.7	132.5	24.8
IN	68.8	2.3	10.8*	1.0	115.0	8.9
CH	69.8	5.5*	14.2*	2.5	199.5*	14.6
IH	49.8	5.9	11.3	0.2	237.3	48.5

\*p < 0.05 With respect to Controls.



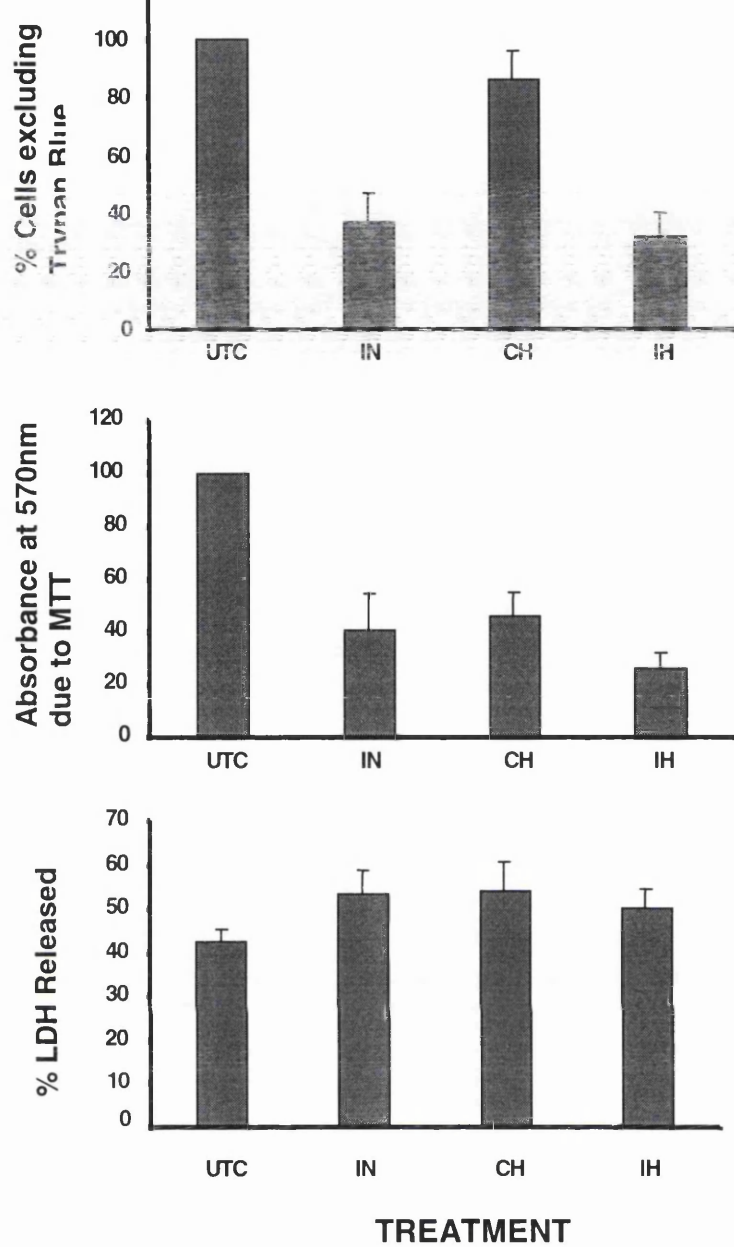

**Figure 5.7**

Response of cultured adult myocytes to simulated ischaemia

n= 6

UTC = Untreated controls

IB = Ischaemia buffer

CH = medium + hypoxia

IH = Ischaemia buffer + hypoxia

Duration = 6hrs.

Duration = 6hrs.

**Table 5.5** Data from preliminary six hour experiments. Means of 6 values +/- sem. Normalised data.

Treatment	% Cells excluding Trypan Blue	SEM	% LDH Released	SEM	MTT Abs.	SEM
UTC	100.0	0.0	42.30	3.2	100.0	0.0
IN	37.1*	10.2	53.28	6.4	40.80*	13.7
CH	86.00	9.8	54.20	6.3	46.20*	8.9
IH	32.3*	8.1	50.12	4.3	26.20*	6.1

\*p < 0.05 With respect to controls

## 5.4 Summary

It is apparent that each individual component of the protocol has some detrimental effect on cell survival over the 4 hour exposure used in the preliminary investigations. However it is not until the full range of changes in the extracellular milieu are applied that 50% loss of cell viability was consistently observed.

The additional effect of adding hypoxia to the simulated ischaemia protocol appears from the trypan blue data to be small, but the measurement of metabolic activity, the conversion of methyltetrazolium, shows a much larger effect. It seems from these results that metabolic processes are affected at a different rate during the simulation to the effects on the cell membrane. The decline in the metabolic activity appears not to be coupled directly to the loss of membrane integrity. A similar effect is seen with pH. It should be noted that the pH of the applied solution will not necessarily reflect the pH in the immediate environment of the cell in culture and will not be an accurate reflection of either cytosolic or mitochondrial matrix pH. The cell in culture, as with all particles in a liquid will generate what is known as a microenvironment [210] this consists of a small region at the solid/liquid interface where charge distribution is unlike that throughout the body of the solution. Microenvironments are more resistant to perturbation than the body of a solution and it may be that there is a lag phase between change in solution and change in the immediate environs of the individual cell.

The six hour experimental duration was selected for all subsequent experiments. As results reported in the following chapters will show the level of injury was not always consistent for reasons that are often not clear. It may in part be

dependant on the condition of cells derived from a particular isolation, which as has already been discussed can be variable.

The results of the LDH estimations shown demonstrate that the normalisation technique undertaken produced greater consistency of results, but because of the persistently high background levels [206] measured statistical significance was not reached. The high background did not correlate directly with the viability estimations obtained using trypan blue exclusion or MTT conversion and although the trends shown in the LDH estimations often followed the results of the other end-point measurements the results were rarely statistically significant.

## **5.5 DISCUSSION**

Based on the methods described by Esumi et al [208] a simulated ischaemia developed. The simulation was comprised of an extracellular environment of known composition. The composition was designed to reflect conditions in the extracellular milieu as known to exist in inadequately perfused tissues. Unlike the method of Esumi et al however, chemical inhibition of oxidative phosphorylation and blockers of glycolysis were not used.

Using a custom built apparatus filled with a heavy gas mixture hypoxia was added to this simulation. Components of the simulation were tested for their effects on cultured adult rabbit cardiac myocytes and a protocol that reproducibly resulted in a 50% loss of viable cells was constructed.

This protocol was termed the lethal stimulus and used as such in all subsequent experiments described in this thesis.

## **CHAPTER 6**

### **PRECONDITIONING**

#### **6.1. INTRODUCTION**

#### **6.2. MATERIALS AND METHODS**

- a. Classical preconditioning
- b. Glucose deprivation
- c. Culture handling protocols

#### **6.3. RESULTS**

- a. Preconditioning with brief ischaemia
- b. Preconditioning with metabolic inhibition/ hypoxia
- c. Pharmacological preconditioning with adenosine and the adenosine analogue CCPA
- d. Effects of the adenosine antagonist DPCPX
- e. Effects of the PKC inhibitor chelerythrine
- f. The second window of protection
- g. 70kd Heat stress protein expression

#### **6.4. SUMMARY**

#### **6.5. DISSCUSSION**

## 6.1 INTRODUCTION

Ischaemic preconditioning was first described in the heart of the dog by Murry et al 1981. In their report they describe how repeated or single, short, exposure to ischaemia followed by reperfusion conferred protection against the injury caused by a subsequent longer period of ischaemia.

The mechanisms of ischaemic preconditioning have been investigated in several models including the in-vivo dog heart [9,211], the in-vivo and in-vitro rabbit heart [212,213,214,215] the in-vitro rat heart [216,217,218,219] and in foetal human[220], and neonatal rat [85,209] cells in culture. In addition the phenomenon has been explored in acutely isolated and dedifferentiated adult myocytes [45,221,222,223].

The advantage of a cellular model is the relative simplicity of the system, devoid of interactions between cells and between different cell types it is possible in this type of model to dissect mechanism at the level of the individual cell and begin to gain some understanding of the pathways of response involved.

A large body of work using the adult rabbit model has been done in-vivo and in the in-vitro whole heart to determine the possible mediators of preconditioning. It was with these investigations in mind and the fact that ischaemic heart disease is a disease largely of the mature organ that the model based on adult rabbit cells was tested to determine whether the preconditioning response could be observed at the level of isolated cells.

Armstrong and Ganote had reported measuring protection conferred by a preconditioning stimulus in acutely isolated adult cardiac myocytes. The model as described did not provide the opportunity to examine the changes in cells over periods of longer than several hours. The adult rabbit cardiac myocyte

culture model could provide these opportunities. It had to be tested whether the protective effects of preconditioning could be observed in this model.

If intercellular communication or the presence of other cell populations were essential to the response then the model as constructed could not be used to test the possible benefits of interventions based on the proposed mediators of the endogenous cytoprotective response.

## **6.2 MATERIALS AND METHODS**

### **6.2a. Classical preconditioning**

The simulated ischaemia protocol described in the previous chapter was defined as and used as the 'lethal' stimulus in all of the experiments detailed here.

A variety of preconditioning stimuli have been reported in both in-vivo and in-vitro models of preconditioning. In the experiments described here the following stimuli were tested .

1. Glucose deprivation: this form of metabolic inhibition was reported by Armstrong et al [45] to demonstrate preconditioning in freshly isolated cells.
2. Simulated ischaemia for a brief time prior to the lethal stimulus a technique designed to mimic the protocol used in in-vivo and whole heart models of preconditioning.
3. Individual components of the simulated ischaemia other than glucose withdrawal.

### **6.2b. Glucose deprivation.**

Glucose deprivation was applied to cells using a custom-made tissue culture medium M199 with Earles salts from which glucose had been excluded. In all

other respects the formulation was identical to that used for culture of adult cardiac myocytes.

### **6.2c. Culture handling protocols:**

For each preconditioning stimulus involving a change in the medium applied to the cells the wells were emptied of normal medium by gentle aspiration and washed once with the new medium. The new medium, either fresh M199, the glucose free M199 or the simulated ischaemia buffer was then applied to the cells.

At the end of the preconditioning stimulus the medium or stimulus was removed and the medium replaced with normal tissue culture medium and the cells returned to the tissue culture incubator for a period that was designated the reperfusion or recovery period.

After the reperfusion/recovery period the cells were then exposed to the lethal stimulus. In all experiments the control wells were exposed to the same number of medium changes and washes as the experimental plates.

### **6.2d. Agonists and Antagonists:**

2-Chloro-N<sup>6</sup>-cyclopentyladenosine (CCPA), a potent adenosine A<sub>1</sub> receptor agonist [224] was applied to the cells diluted in normal tissue culture medium over a range of concentrations for either 30 minutes or 1 hour. CCPA was then removed by washing and replaced with normal tissue culture medium for 30 minutes prior to exposure to the lethal stimulus. In experiments where CCPA was applied during the long ischaemia the dose was added to the tissue culture medium / buffer immediately before transferring the cells to the hypoxia chamber. Similarly 8-cyclopentyl-1,3-dipropylxanthine (DPCPX) and

chelerythrine were added to the cells at a range of concentrations either during or before the preconditioning protocol.

Both of these compounds were then removed by washing prior to the long ischaemia. In experiments where antagonists were applied during the long ischaemia the drugs were added immediately prior to placing the tissue culture plates into the hypoxia chamber for the period of the lethal stimulus.

All tissue culture media and buffers used during experimental procedures were serum free all solutions were sterile at the time of use.

When cells were removed from either the incubator or the hypoxia chamber at the end of the 6 hour incubation period samples were taken for the LDH estimation as described and all wells received fresh maintenance medium containing 1% FCS. Cells were then returned to the incubator overnight.

#### **Heat stress proteins:**

Samples for Western blotting were taken and processed as described in the general methods section of this thesis.

### **6.3 RESULTS**

#### **6.3a Preconditioning: With brief ischaemia.**

The preconditioning protocol described by Murry et al [9] consisted of a brief ischaemia followed by a period of reperfusion. To simulate this protocol the cells in culture were exposed to a brief period of simulated ischaemia with hypoxia. The logistics of changing the media on a number of tissue culture plates and moving the plates physically from one location to another imposed limitations on the timing protocol.



Figure 6.1 and table 6.1 show the results of two experiments in which cells were exposed to the simulated ischaemia for 1 hour followed by 30 minutes recovery in normal medium and in the incubator and then returned to ischaemia buffer and the hypoxia chamber for the 6 hour lethal stimulus.

<b>ONE HOUR PRETREATMENT</b>	<b>30 MINUTES RECOVERY</b>	<b>SIX HOURS LETHAL STIMULUS</b>
----------------------------------	--------------------------------	----------------------------------

**PRECONDITIONING PROTOCOL**

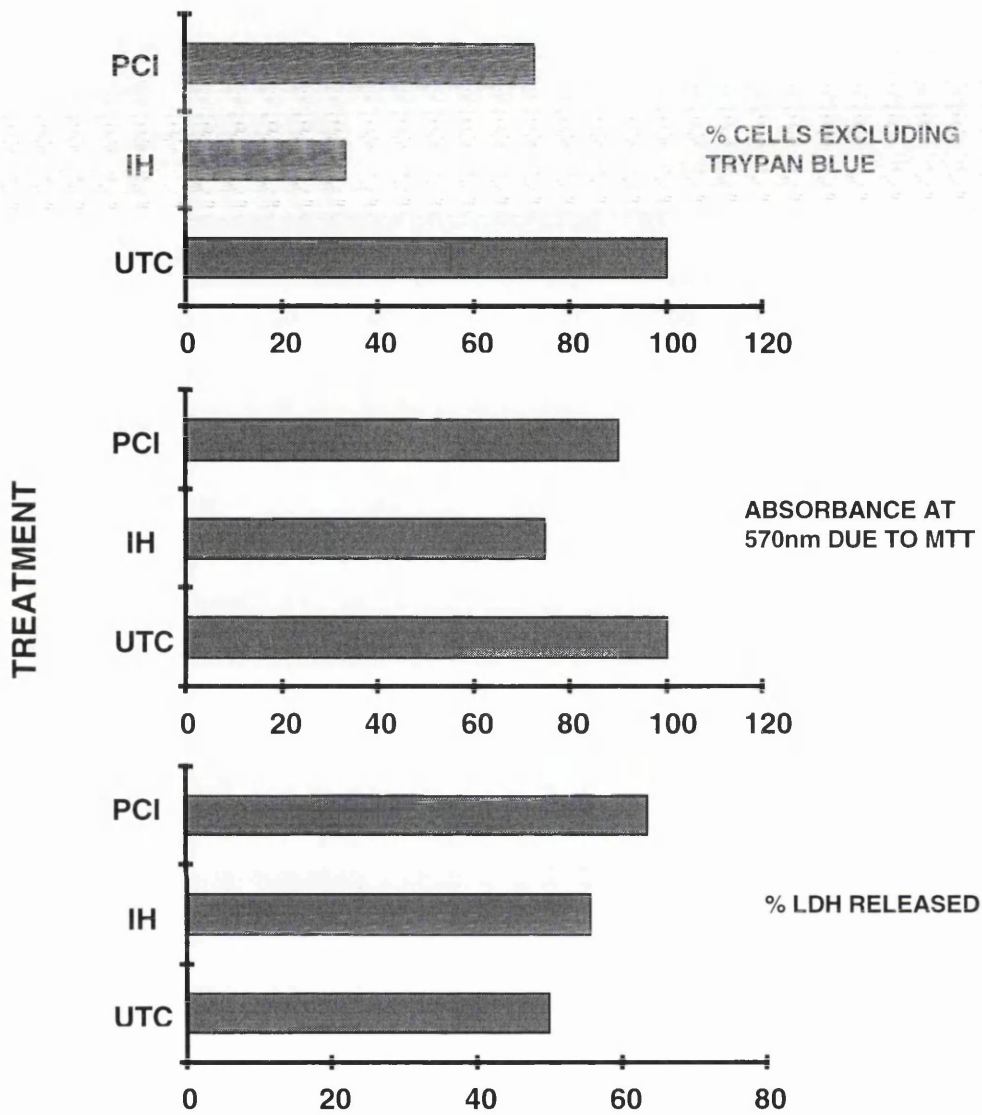

**Figure 6.1:**

Preconditioning pilot experiments. Cells were exposed to 1hr pre-treatment, 30mins recovery and 6hrs lethal ischaemia.

UTC= untreated control, IH= lethal ischaemia, PCI= preconditioning with ischaemia  
n = 2 experiments,

**Table 6.1:** Data from pilot preconditioning experiments

Treatment	%Cells excluding Trypan blue	MTT Abs.	% LDH Released
UTC	100	100	50
IH	33.3	70.8	55.7
PCI	72.9	85.4	63.7

From table 6.1 it can be seen that the lethal stimulus reduced the number of viable cells, by trypan blue, to 33.3 % +/- 4.5 of controls and preconditioning the cells with a brief exposure to the stimulus resulted in an increase in the number of viable cells present after the lethal stimulus to 72.9% +/- 4.1 of controls by the same measure. The amount of MTT converted is reduced to 70.5 % +/- 7.4 of the control value by the simulated ischaemia and restored to 85.4% +/- 2.5 by the preconditioning protocol. The changes in LDH released reflect the same general trend, but do not attain significance and the background level of release is high.

### **6.3b Preconditioning with metabolic inhibition/hypoxia**

Armstrong and Ganote had reported preconditioning acutely isolated adult rabbit cardiocytes in suspension by brief periods of glucose deprivation [99]. In my own laboratory Dr. R. Heads had successfully preconditioned cultured neonatal rat cardiocytes using metabolic inhibitors and Ikonomidis[136] had reported preconditioning cultured foetal human myocytes using hypoxia and reduced extracellular volume.

The results shown in figure 6.1 involved an experimental procedure during which a large number of medium changes had to be undertaken. Although the protocol appeared to have been successful it was decided to try to find a preconditioning stimulus that involved less handling and therefore less damage to the cultures.

The results of these experiments are shown in figures 6.2 – 6.5 and accompanying tables below.

**Glucose deprivation:** For the reasons already outlined in this chapter the 15 minute protocol as used by Armstrong et al to precondition with glucose

withdrawal was not available for use with cultured adult cardiac myocytes. In fig

6.3 the results of 2 experiments

are shown. It is clear that the withdrawal of glucose has not decreased the injury.

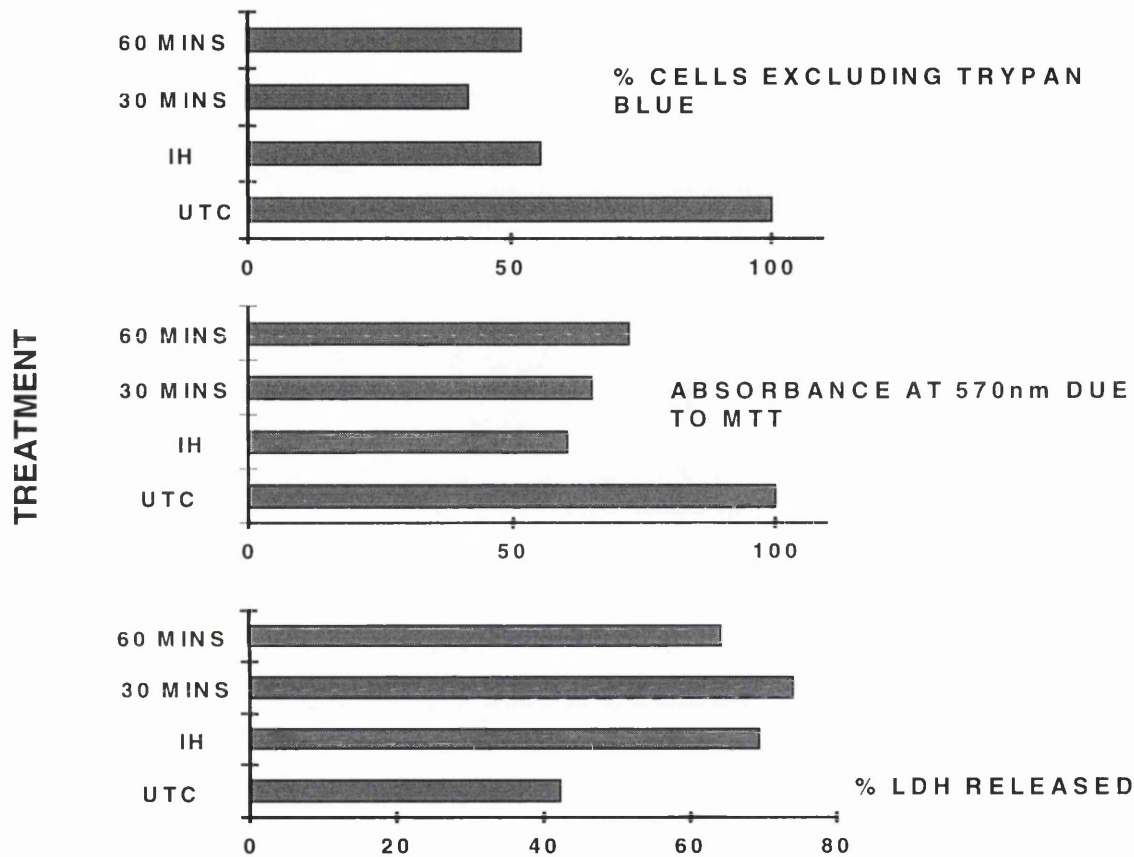

**Figure 6.2:**

Preconditioning pilot experiments. Cells were exposed to 30mins or 1hr pre-treatment with glucose free medium, 30mins recovery and 6hrs lethal ischaemia.

UTC= untreated controls, IH= lethal ischaemia

n = 2 experiments,

**Table 6.2:** Results from glucose withdrawal experiments

Treatment	%Cells excluding Trypan blue	MTT	LDH
UTC	100	100	42.2
IH	55.9	60.5	69.4
30 MINS	42.2	65.1	74.0
60 MINS	52.0	72.1	64.3

Two time- courses were investigated, 30minutes and 60 minutes of glucose deprivation, either of these pre-treatments was then followed by 30 minutes of recovery in normal tissue culture medium and then pre-treated cells were transferred to the hypoxia chamber for the lethal stimulus.

The results obtained from these experiments suggest that glucose withdrawal is not an effective preconditioning stimulus in this model.

### **Reduced extracellular volume and hypoxia:**

A series of experiments was performed in which two elements of the lethal stimulus were applied to the cells in culture to determine if this form of attenuated stimulus would result in protection. The cells were placed in the hypoxia chamber under 0.5mls of normal tissue culture medium for 30minutes or 1 hour. At the end of this pre-treatment period the tissue culture plates were returned to an incubator under fresh medium for 30 minutes recovery. After the recovery period the cells were placed in the hypoxia chamber for the six hour lethal stimulus.

The two experiments in which this stimulus was applied for 30 minutes showed no protection, however the experiments in which the stimulus was applied for 1 hour showed excellent protection.

This was chosen as the preconditioning stimulus for all subsequent experiments. Because this stimulus was used as a control for other variables in many subsequent experiments a large body of data was gathered.

In figure 6.3 and the accompanying table the data from 10 experiments are shown.

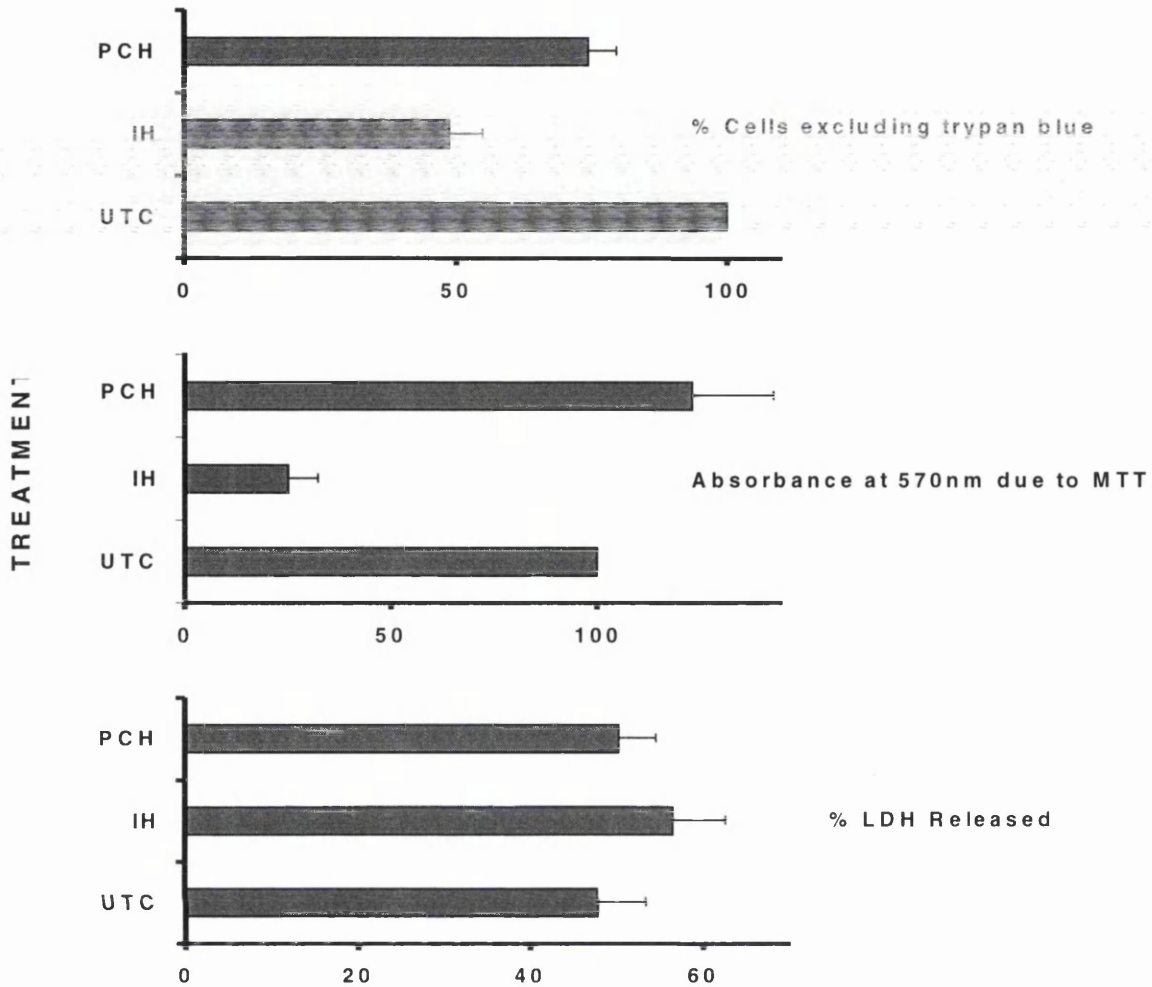

**Figure 6.3:**

Preconditioning pilot experiments. Cells were exposed to 1hr pre-treatment with hypoxia in a reduced volume of normal medium, 30mins recovery and 6hrs lethal ischaemia.

UTC= untreated controls, IH= lethal ischaemia, PCH= hypoxic preconditioning

n =10 experiments, 20 replicates

**Table 6.3:** Data from hypoxic preconditioning experiments

TREATMENT	%Cells excluding Trypan blue	SEM	MTT	SEM	LDH	SEM
UTC	100	0	100	0	47.7	53.52
IH	48.7	6.16	25.17	7.22	56.44	6.1
PCH	74.43*	5.27	122.8*	20.2	50.26	4.2

\* p< 0.05 with respect to lethal stimulus

### **6.3c Mimicking preconditioning with adenosine and the adenosine receptor agonist CCPA:**

It has been proposed that adenosine is one of the primary endogenous triggers for preconditioning. Adenosine and adenosine receptor agonists have been shown to mimic the protection due to preconditioning in the in-vitro rabbit heart [224]. There remains some controversy as to the role of adenosine in the rat heart.

To demonstrate that the protection observed in the cultured adult rabbit cardiac myocyte model is analogous to the preconditioning seen in other rabbit based models both adenosine and the adenosine receptor agonist CCPA were tested.

From preliminary results obtained there was some suggestion that the application of adenosine did protect the cells against the lethal stimulus, however the effect was both small and equivocal.

CCPA has been described as a selective and potent adenosine A<sub>1</sub> receptor agonist, approximately 100 times more potent than adenosine itself. One pilot experiment was performed using a dose of 1.0 μM CCPA over two time courses. In addition in this experiment the drug was given in medium to cells not exposed to the lethal stimulus to determine whether it was toxic to the cells in culture. Drugs given systemically do not reach the active site at large or often predictable doses, in a whole heart in-vitro other cell types are present also. In culture the target cell population is exposed directly to any agent added to the medium and an albeit crude test of cytotoxicity was deemed necessary. However testing a range of variables meant that only enough cells were available to perform the trypan blue exclusion assay and not all three end-point estimations.

The results from this experiment are shown in figure 6.4 and the accompanying table.

To determine the optimal dosage of this compound experiments were performed using the doses 0.1 and 1.0  $\mu\text{M}$  and pre-treating for 1 hour.

The results of six experiments performed to determine the optimal dose are shown in fig 6.5 and the accompanying table.

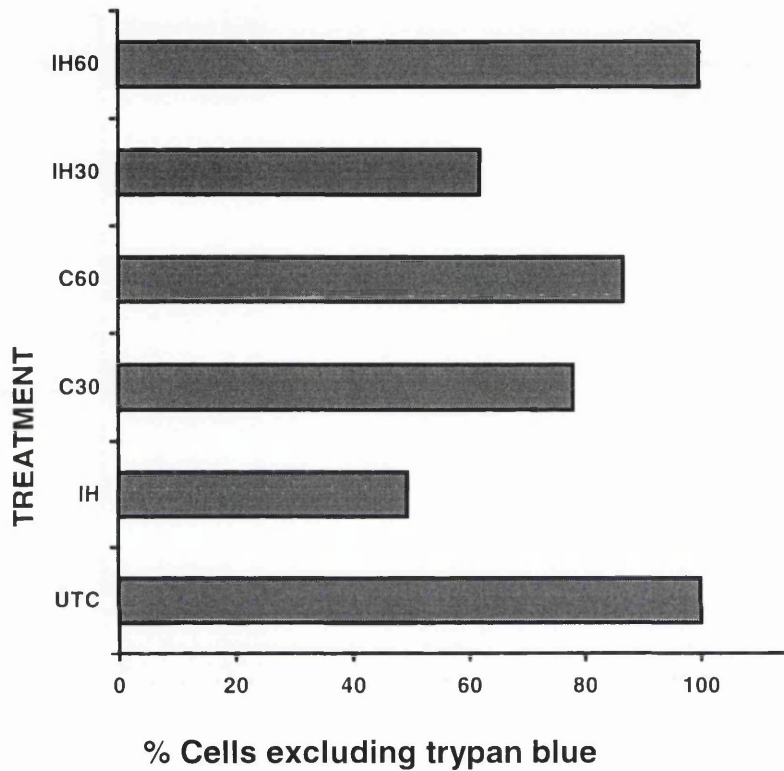

**Figure 6.4**

Pharmacological protection pilot experiment. Cells were exposed to 30 minutes (C30) or 1hr (C60) pre-treatment with CCPA +/- subsequent exposure to the lethal stimulus. The drug was removed at the end of the pre-treatment period and replaced with fresh medium. UTC= untreated controls  
IH= lethal ischaemia  
PCH= hypoxic preconditioning  
n =1

**N.B** The statistical analysis for these results could not be very meaningful, the sample =2 replicates from 1 experiment.

**Table 6.4** Data from CCPA pilot experiment

Treatment	% Cells excluding Trypan blue
UTC	100
IH	49.4
C30	78.0
C60	86.7
IH30	61.9
IH60	99.7

Means are of two replicates from one experiment.



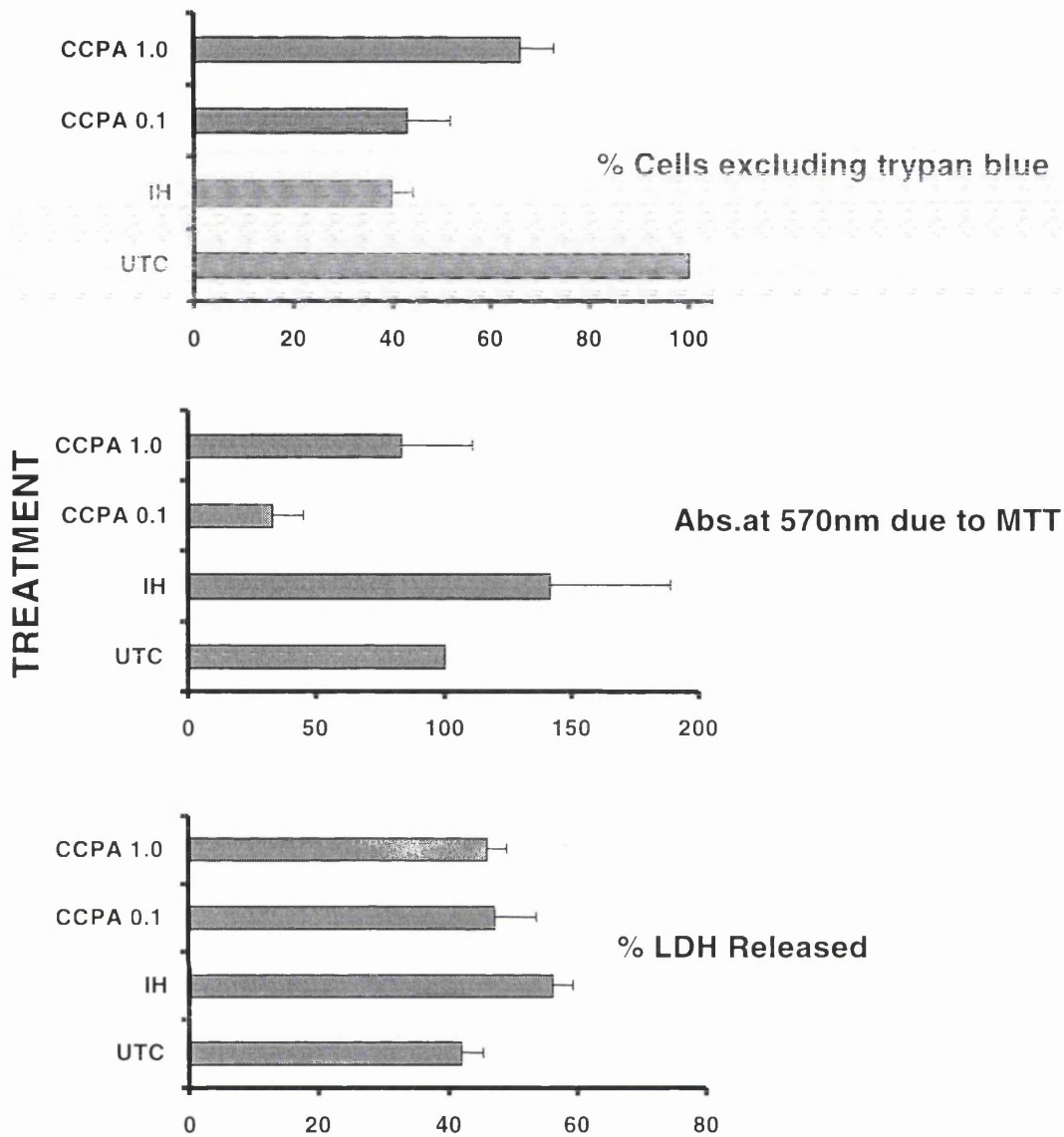

**Figure 6.5**

Pharmacological protection pilot experiment. Cells were exposed to 30 minutes or 1hr pre-treatment with 0.1 $\mu$  M or 1.0 $\mu$  M CCPA for one hour prior to exposure to the lethal stimulus. The drug was removed at the end of the pre-treatment period and replaced with fresh medium. UTC= untreated controls, IH= lethal ischaemia  
 n=6 12 replicates

**p < 0.05 with respect to lethal stimulus.**

**Table 6.5** Results of experiments to test the effects of CCPA, an adenosine A<sub>1</sub> agonist on cells in culture.

Treatment	% Cells excluding Trypan blue	SEM	% LDH Released	SEM	MTT Abs.	SEM
UTC	100	0	42.1	3.3	100	0
IH	39.7	4.6	56.1	3.3	141.9	47.0
CCPA 0.1 $\mu$ M	42.9	8.76	47.3	6.56	32.6	12.64
CCPA 1.0 $\mu$ M	65.7*	7.0	46.2	3.0	83.1	28.0

A clear protective effect was seen at 1.0 $\mu$ M. From the data shown the number of viable cells was reduced, by trypan blue exclusion, to 37.96%  $\pm$  4.6 of the control value by the lethal stimulus. After treatment with CCPA at the maximal dose applied the percentage of viable cells remaining after the lethal stimulus was increased to 87.1%  $\pm$  5.2 of the control. Cells were pre-treated for 1 hour with CCPA, washed and rested for 30 minutes and then exposed to the lethal stimulus. It was clear from these experiments that there is a reduction in cell death as a result of pre-treatment with the adenosine A<sub>1</sub> agonist CCPA.

CCPA applied in one experiment during the long ischaemia showed no protection.

### **6.3d Effect of the adenosine A<sub>1</sub> antagonist DPCPX**

In the preceding experiments it had been shown that the degree of injury, as loss of viable cells, caused by the lethal stimulus could be reduced using pre-treatment protocols analogous to preconditioning.

Preconditioning with a brief exposure to the full simulated ischaemia with hypoxia had been shown to confer protection as had preconditioning with hypoxia alone. It had also been demonstrated that this protection could be mimicked by applying the adenosine A<sub>1</sub> agonist CCPA to the cells prior to the long ischaemia. It remained to demonstrate that the protection due to hypoxic preconditioning was mediated by adenosine.

Cells were exposed to the adenosine A<sub>1</sub> receptor antagonist DPCPX prior to hypoxic preconditioning to test if the protection observed was mediated via the action of adenosine as has been proposed in both the in vitro and in vivo rabbit heart Downey et al. A range of effective doses for this antagonist are cited for different model systems, 1 or 10 $\mu$ M in rabbit cells [100] in the pellet model of

Armstrong and Ganote. As the pellet model is also based on isolated cells the experiments to determine the effectiveness of DPCPX at blocking the observed protection in this model were constructed around this dose range, but a wider range was covered.

The dose range 0.1-100  $\mu$ M DPCPX was tested, these doses were also screened for cytotoxic effects. Cells treated with DPCPX alone in one test showed no signs of toxicity.

The results of the preconditioning experiments show DPCPX abolished the protection due to hypoxic preconditioning. However at the lower end of the dose range the injury appears to be exacerbated and the higher doses exhibited the rather odd effect of apparently augmenting the protection.

Subsequent experiments performed using 10 $\mu$ M DPCPX, as reported by Armstrong and Ganote consistently show that the protection due to hypoxic preconditioning was blocked, interpreting the effects of doses on either side of this amount is rather difficult. (See discussion section).

**Table 6.6.** Results of experiments to test the effect of adenosine receptor blocker DPCPX on the response of cells in culture to hypoxic preconditioning.

Treatment	% Cells excluding Trypan blue	SEM	MTT Abs.	SEM	% LDH Released	SEM
UTC	100	0	100	0	50.5	1.2
IH	73.95	3.8	59.1	8.8	72.9	7.4
PCH	86.9*	2.4	85.5	30.3	54.2	5.5
$\mu$ M DPCPX						
0.1	10.1*	0.9	10	10	85.9	5.2
1	30.95*	0.5	0	0	86.1	2.6
10	71.75	4.25	100	8.43	58.25	2.15
100	85.03	13	94.3	5.6	51.2	3.7

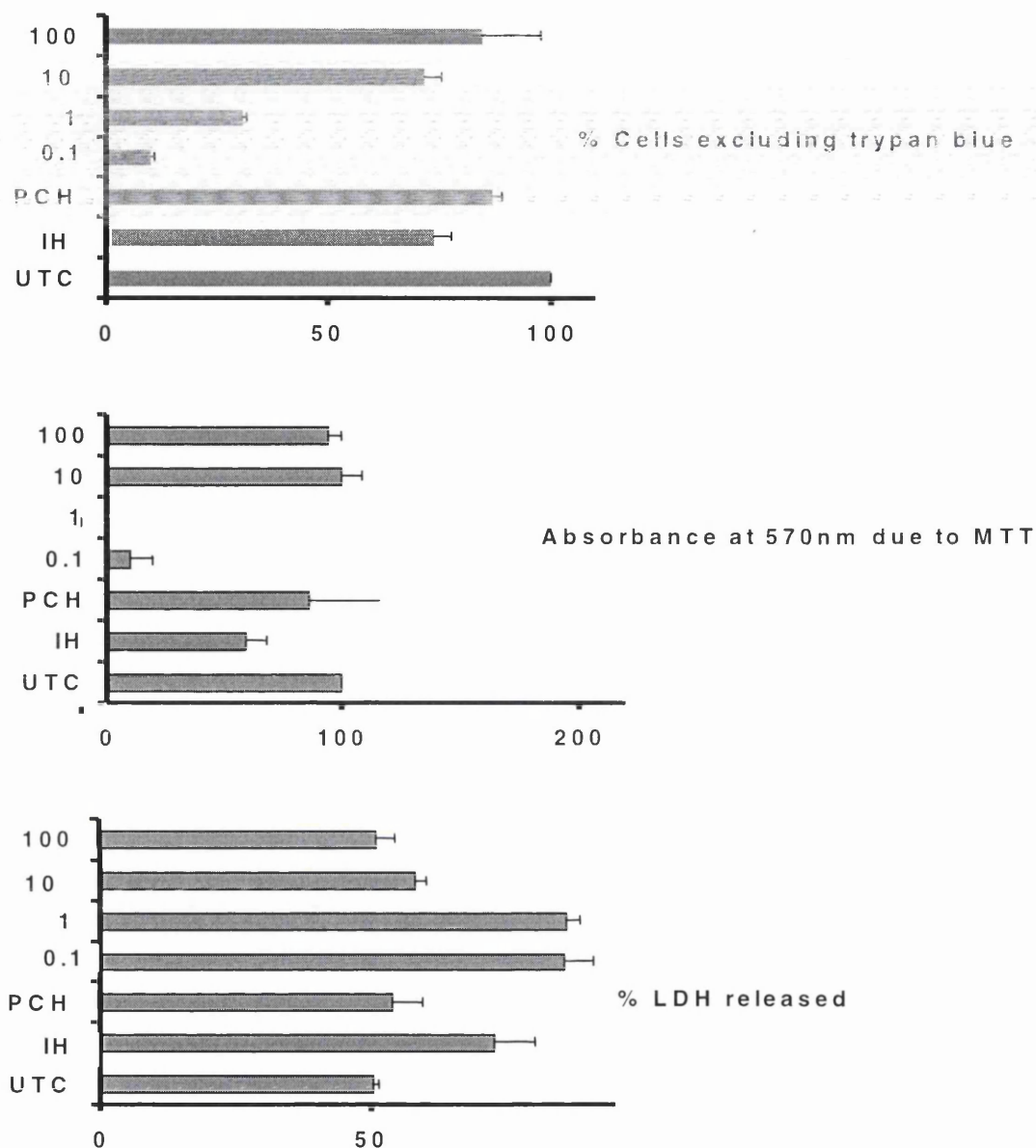

**Figure 6.6**

Plot of concentration – response curve for DPCPX vs hypoxic preconditioning. The graph illustrates the results for several series of experiments. Due to the size limitation of the hypoxia chamber and the restriction based on the number of plates available by the cell yield for each preparation it was not possible to test all of the doses in one experiment.

UTC= controls, n = 12 ,IH= lethal ischaemia, n = 12, PCH = hypoxic precon.n = 12

1.0 μM DPCPX n = 4

10.0μM DPCPX n = 4

100.0μM DPCPX n= 2

**p < 0.05 with respect to lethal stimulus.**

### **6.3e Effect on hypoxic preconditioning of cultured adult cardiac of the PKC inhibitor Chelerythrine.**

The next event after activation of adenosine receptors in the signalling pathway to preconditioning in rabbit has been identified as the activation and/or translocation of protein kinase C (PKC). To test if the activation of PKC is involved in the cultured adult cardiac myocyte model of preconditioning the PKC inhibitor chelerythrine was administered to cells in culture during the preconditioning hypoxia.

A range of doses of the inhibitor between 1 $\mu$ M and 10 $\mu$ M was tested. The results of these experiments are shown in figures 6.7 – 6.8 and the accompanying tables below.

In one experiment cells were exposed to the entire dose range of chelerythrine for one hour whilst maintained in a normal tissue culture environment. This was intended to determine if chelerythrine was lethal to the cells when administered alone. The lower dose seen to block preconditioning appeared to have no effect on cell viability whilst the higher dose, 10 $\mu$ M, resulted in the loss of most of the viable cells when compared to the untreated cells. The PKC family of protein kinases are involved in a number of signalling pathways within cells some of which are likely to be essential to maintaining normal function. Chelerythrine is not an isoform specific inhibitor and is reported to inhibit by interaction with the catalytic domain. At the high dose it seems likely therefore that chelerythrine was causing a level of non-specific blockade.

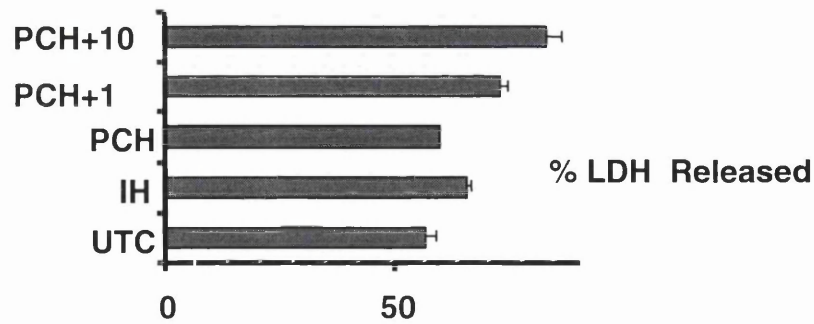
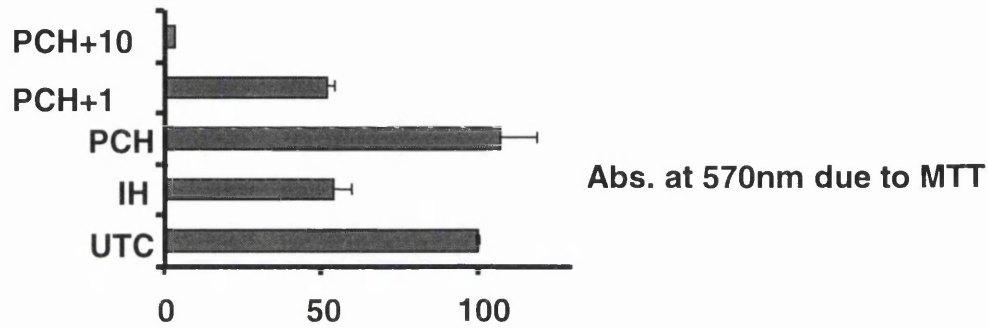
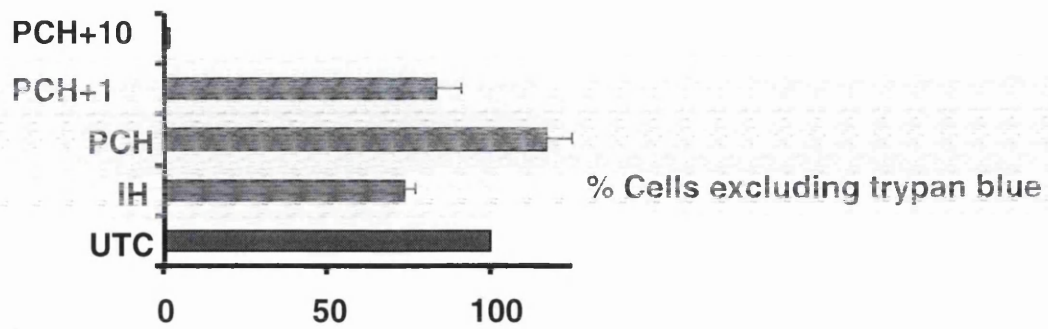

**Figure 6.7**

Cells were exposed to chelerythrine during preconditioning. The drug was removed prior to exposure to the lethal stimulus. UTC= untreated controls, IH= lethal ischaemia, PCH = hypoxic preconditioning, + = with chelerythrine. doses are in  $\mu\text{M/l}$ . n =2-4 rep.

**Table 6.7: Effects of chelerythrine**

Treatment	% Cells excluding Trypan blue	SEM	MTT Abs.	SEM	% LDH Released	SEM
UTC	100	0	100	0	56.7	2.1
IH	73.9*	3.6	54.1	6.25	65.35	1.15
PCH	117.4	7.4	107.35*	11.75	59.55*	0.15
PCH+ 1	83.9	7.3	52.2	2.2	72.65*	1.75
PCH+10	1.75	0.15	3.3	0.4	82.9	3.2

\*p < 0.05 with respect to lethal stimulus.

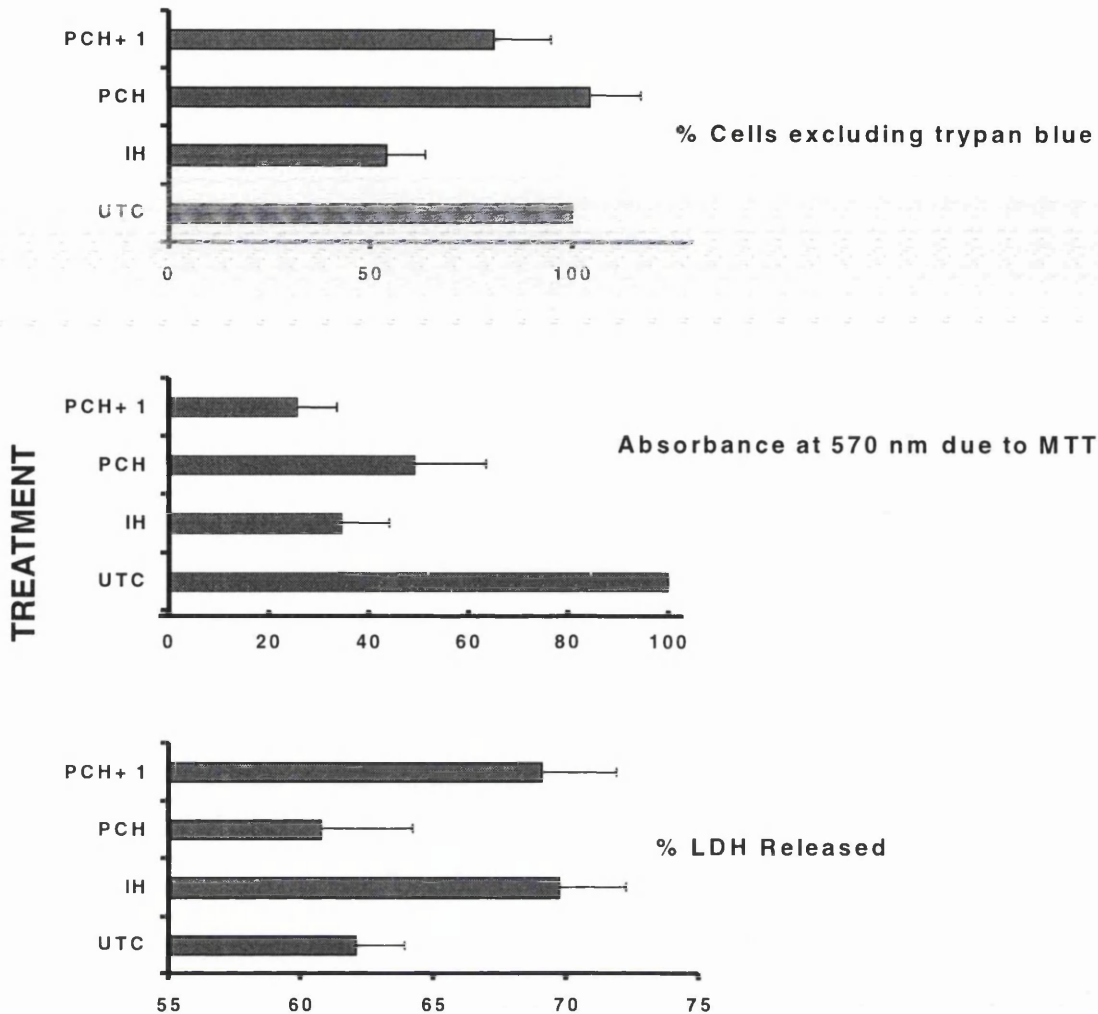

**Figure 6.8**

Cells were exposed to chelerythrine during the preconditioning hypoxia. The drug was removed prior to exposure to the lethal stimulus.

UTC= untreated controls, IH= lethal ischaemia, PCH = hypoxic preconditioning + = with chelerythrine, doses are in  $\mu\text{M/l}$ .

n =5 10 replicates

**Table 6.8.** Results of experiments to investigate the effect of chelerythrine on hypoxic preconditioning in cultured adult cardiac myocytes.

Treatment	% Cells excluding Trypan blue	SEM	MTT Abs.	SEM	% LDH Released	SEM
UTC	100	0	100	0	62.06	1.88
IH	53.79	10.19	34.63	9.52	70.8	2.48
PCH	104.55*	12.29	49.28	14.44	60.79	3.47
PCH+ 1	80.63	14.5	25.7	7.87	69.14	2.79

\*p < 0.05 with respect to lethal stimulus

Figures 6.7 and 6.8 show that in the cultured adult cardiac myocyte model of simulated ischaemia and hypoxic preconditioning the PKC inhibitor chelerythrine blocks the protection due to preconditioning at a dose of 1 $\mu$ Molar. The higher dose of blocker, 10 $\mu$ Molar was toxic to the cultured cells.

### **6.3f The second window in this model.**

Two experiments were conducted to see if the second window of protection could be observed using similar protocols to those used for the experiments detailed above. These experiments were performed on single cell culture plates from isolations that had produced particularly high yields of cells and on which other experiments were conducted. Only trypan blue data are available. The protocol was identical to that used for hypoxic preconditioning except that the cells were not placed into the chamber for the lethal stimulus until 24 hours after preconditioning.

At this point the cells have been in culture for 3 days and at the end of the experiment for 4 days. The protocol, used in this form, was pushing the limits of the time window available and the quality of the data reflects this. Nonetheless the data are suggestive that the SWOP is present and quantifiable in this model. It would be necessary to redesign the preconditioning protocol to improve these results. Preconditioning on the day of isolation and applying the lethal stimulus 24 hours later would have saved an entire day and possibly produced better results. As myocytes are a precious resource and other experiments and analyses were planned on a different time scale for each preparation this has not yet been possible.



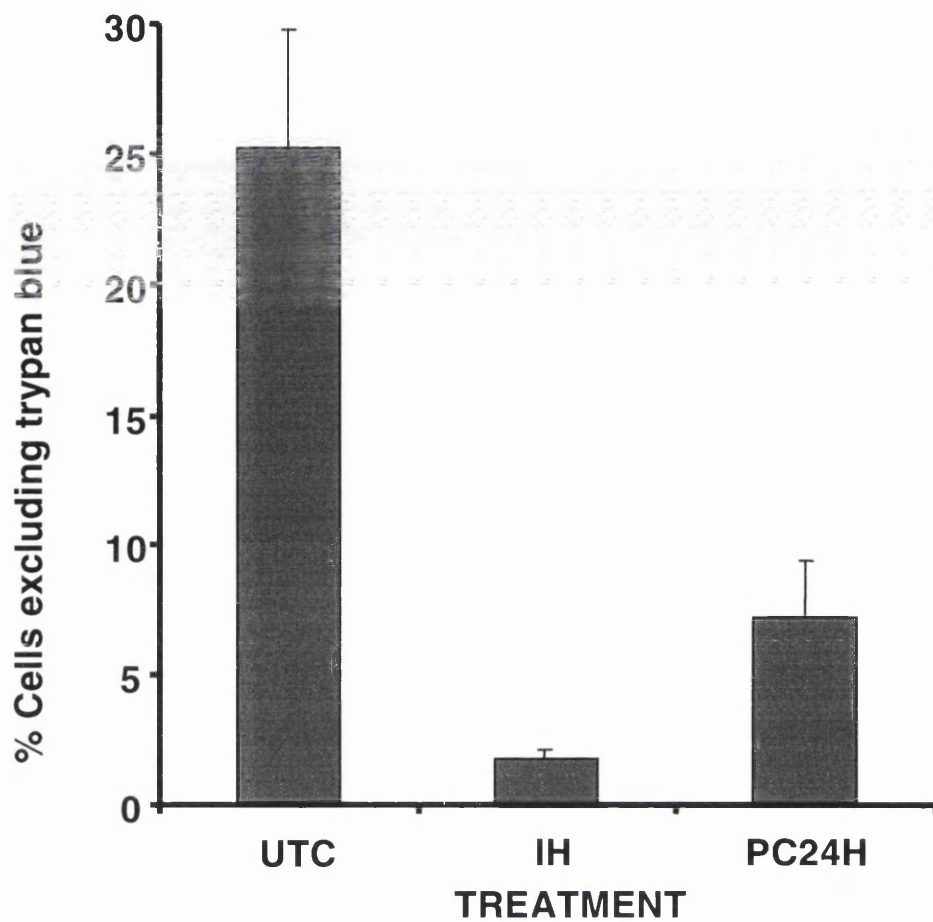

**Figure 6.9**

Graph of preliminary data from SWOP experiments in cultured adult rabbit myocytes

**Table 6.9.** Non – normalised data from two pilot SWOP experiments.

Treatment	% Cells Excluding Trypan blue	SEM
UTC	25.2	4.6
IH	1.8	0.3
PC24Hrs	7.18	2.2

### 6.3g 72Kd Heat stress protein expression in hypoxic preconditioning of adult cardiac myocytes in culture.

Samples for Western blot analysis of 72Kd heat stress protein were taken through the course on several experiments looking at preconditioning in adult cardiac myocytes in culture. Samples from freshly isolated cells (VM), cells maintained overnight in culture (UTC), preconditioned (PC1), 24 hours after preconditioning (PC2) and after exposure to the lethal simulated ischaemia (LS) were collected and stored. The positive control for Hsp72 was a sample taken from heat stressed neonatal rat cardiocytes (+ve). MWM = molecular weight marker.

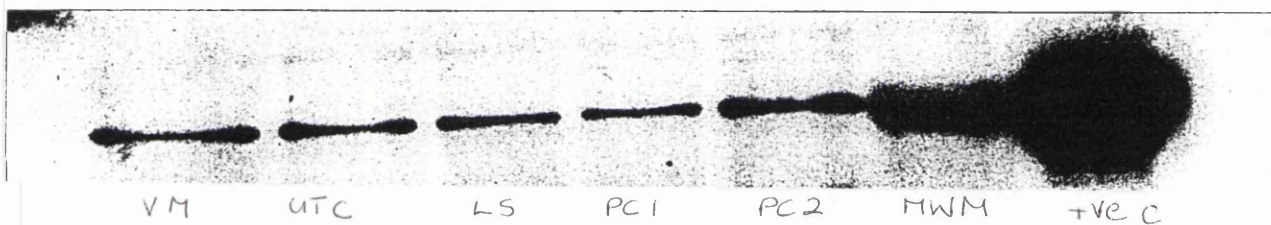

**Figure 6.10** Image of Western blot for Hsp 70 on samples of adult cardiac myocytes. Primary antibody: Mouse monoclonal N27 to HSP 72/73 (Bioquote) Secondary antibody. Poly clonal goat anti mouse conjugated to horse radish peroxidase (Bioquote)

Sample	Area mm <sup>2</sup>	Volume OD/ mm <sup>2</sup>	Adjusted Vs Background Volume OD/mm <sup>2</sup>
VM	21.0	3.8	1.4
UTC	18.1	3.2	1.1
LS	15.3	2.5	0.8
PC1	15.6	2.4	0.6
PC2	15.6	4.5	2.6
Background	80.6	9.4	0.0

Image and Optical Density data from image analysis program: Bio-Rad Multi-Analyst<sup>tm</sup>/PC Version 1.1

## 6.4 SUMMARY

In several series of experiments designed to compare the behaviour of adult myocytes in culture with the observations made in other models protection against the lethal stimulus was seen to be conferred by an adenosine A<sub>1</sub> agonist, CCPA, as described for in-vitro whole heart in the same species. Glucose deprivation, which has been described as a preconditioning stimulus in the rat myocyte model did not act as a preconditioning stimulus in cultured adult rabbit cardiac myocytes. Both brief exposure to the full simulated ischaemia protocol and hypoxia alone were seen to reduce the loss of viable cells on exposure to the lethal stimulus. The protection observed could be blocked by the adenosine A<sub>1</sub> receptor antagonist DCPCX and by the PKC inhibitor Chelerythrine applied at doses similar to those used in other models in the same species. However the effects on the response to the lethal stimulus seen using DCPCX are not straightforward. In their investigations into the protection conferred by CCPA in their model Rice, Armstrong and Ganote [100] observed a biphasic response to CCPA only one component of which was blocked by DCPCX at doses similar to those used in this study. They proposed that the agonist was acting at two sites, either subtypes of one class of receptor or two distinct receptor sub-populations. In the experiments described here it is the antagonist that appears to have a concentration dependant biphasic mode of action. Lower doses of DCPCX show substantial augmentation of the injury due to the lethal stimulus while the higher doses appear to confer protection. None of the doses tested had toxic effects when applied to cells in culture for several hours. It seems likely from these results that the antagonist may be exhibiting two modes of action with only one mediated via adenosine A<sub>1</sub> receptors and that the effect is dose dependent.

## 6.5 DISCUSSION

The results obtained during this section of the study indicate that the adult rabbit cardiac myocytes in culture can provide a model of classical preconditioning in which the nature of the phenomenon parallels that observed in other models. It is clear that the classical preconditioning is similar in character to that observed in the whole animal and in the isolated, perfused heart.

It is interesting to note that the second window of protection may also be present and observable in the cultured myocyte model.

Upregulation of Hsp72 could be observed to occur in samples collected from cells that had been maintained in culture for 24 hours after the preconditioning stimulus was applied. No increase in Hsp 72 expression was seen in freshly isolated myocytes or in those maintained in culture as untreated controls. This implies that the isolation and culture procedures do not elicit a stress response in terms of this particular stress protein.

The upregulation of the inducible Hsp 70i in heat stressed and ischaemically preconditioned rabbits has been demonstrated [79] to be associated with the second window of protection. The over expression of Hsp 70i in a heart derived cell line HS9c cells has been shown to confer protection against a simulated ischaemia [226] and similarly in cultured neonatal rat cardiocytes [89] and blockade of Hsp 70 expression with an antisense RNA [93] was shown to increase the injury caused by hypoxia and re-oxygenation. Although there is a significant body of literature in a range of models in which an increase in Hsp expression is associated with the second window of protection there have been dissenting voices. Yang et al 1996 [212] reported a modest rise in Hsp 70i in ischaemically preconditioned conscious rabbits that developed the SWOP and

Tanaka et al [84] reported a rise in Hsp 70i 24 hours after a preconditioning protocol that did not result in protection.

The measurement of Hsp 72 in the isolated cultured adult myocyte model serves to suggest that the cells going into the preconditioning protocol have not been stressed by the isolation procedure. The upregulation observed 24 hours after the preconditioning stimulus provides additional confirmation that the cultured adult rabbit cardiac myocyte model has similar characteristics to other models in the same species and that increased heat stress protein expression is a feature of delayed protection.

## **CHAPTER 7**

# **GENE TRANSFER TO ADULT RABBIT CARDIAC MYOCYTES IN CULTURE**

### **7.1 INTRODUCTION**

### **7.2 MATERIALS AND METHODS**

- a. Herpes simplex virus
- b. Construction of viral vectors
- c. Virus growth and purification
- d. Preparation of the IF1 plasmid
- e. Adenovirus transfection
- f. Confirmation of gene transfer
- g. Structure and mode of action of liposomes
- h. Liposomal transfection
- i. Preparation of viral conjugates
- j. Transfection with conjugates

### **7.3 RESULTS**

- a. Non-viral vectors of gene transfer
- b. Adenovirus serotype V as a gene transfer vector
- c. Herpes simplex derived vector
- d. Conjugated gene transfer systems

### **7.5 DISCUSSION**

## 7.1 INTRODUCTION

Somatic cell gene transfer offers the potential for a powerful tool to investigate cellular processes in health and disease. In inherited and acquired heart disease there is also the possibility for using gene transfer as a therapeutic strategy in both treatment and prevention of disease [227].

The aim of this section of the project was to identify a suitable and efficient method of introducing a selected gene into the target cell, the adult cardiac myocyte.

The vehicle used to transport an exogenous gene into a cell is termed a vector. A number of transfection vectors and gene transfer techniques have been developed. Those used include direct microinjection, electroporation, diethylaminoethyl dextran, liposomes and viruses [228].

Viruses are natural gene transfer vectors. In viral infections the virus particle penetrates the host cell and switches the genetic and enzymatic processes of the cell to the manufacture of viral proteins and DNA.

As millions of years of evolution have precisely equipped the virus for the tasks of penetrating the host cell and modifying the host cell genome it seems in many ways the ideal vector. Sufficient is known about the infectivity and life cycle of several viruses to enable manipulation of the viral genome to both reduce or eliminate infectivity and to permit the import of a specific gene sequence for transfer to a target cell [229].

Adenoviruses have been isolated from humans and a number of mammalian species. Structurally the adenoviruses are naked, linear double stranded DNA viruses of 36 kilobase pairs (Kbp) contained within an icosahedral protein coat.

Adenovirus causes upper respiratory tract infection in humans. Several of the variants, or serotypes of this virus have been well characterised and have been shown to have considerable utility as mammalian gene transfer vectors [230].

The viral particle is relatively stable and can be stored and handled without loss of structural integrity. In addition the genome is stable and does not undergo frequent spontaneous rearrangement, this allows foreign genes to be retained through several rounds of viral replication.

The adenovirus genome has also proved relatively easy to manipulate using existing recombinant DNA technology and can be grown in permissive cell lines to high titres. These characteristics added to the tropism of adenovirus for non-replicating cells has led to considerable interest in the use of adenovirus as an expression vector for mammalian cells including those of myocardium.

Herpes simplex virus (HSV) type 1 is also a candidate for use as a gene transfer vector to adult myocardial muscle cells. This virus is also an icosahedral double stranded DNA virus, but unlike Adv is enveloped and hence contains a more complex mixture of molecules than the naked Adv.

HSV has been reported to successfully transfer an indicator gene to neonatal cardiac myocytes and vascular smooth muscle cells [231]. HSV has a high tropism for neuronal cells and a biphasic life-cycle which includes long periods of latency. In this respect the HSV vector offers the potential for long-term expression of foreign genes in a target cell population.

Although viral vectors have the potential for rapid and efficient transfer of genes resulting in the augmentation of protein concentrations or expression of a novel protein in a target cell there are also drawbacks to the use of viruses.

Episomal gene expression is transient. The cells of multicellular organisms and particularly mammalian cells rarely contain episomal, non-chromosomal, DNA.



Such material will be eliminated from the cell by enzymes that digest the DNA as a normal part of the genomic maintenance and repair processes and degradation will also take place in the cytoplasm.

The alternative of using vectors that can incorporate permanently and randomly into the host cell genome can give rise to insertional mutations in the host cell genome.

The absence of immunological consequences from the use of non-viral vectors makes their use attractive.

The chemical and mechanical means of gene transfer have been effective in microbial cells. Calcium chloride, heat shock, direct microinjection and electroporation techniques are all used in transforming such cells, however the transfection efficiencies are low and the conditions frequently too aggressive for more fragile mammalian cells, although gene transfer to tumour cells using a combination of intraarterial injection of vector and the electroporation of cells in the target tissue has been reported [232].

Liposomes are cationic phospholipid complexes that associate with DNA by electrostatic interaction and have been shown to carry the genetic material into the cell [150]. In this chapter a comparison of some of the various gene transfer vectors available is described.

Once an appropriate and efficient gene transfer vector had been identified the next stage was to introduce a gene into the cultured adult cardiac myocytes that would generate a product able to modify the response to the lethal stimulus. Several candidate genes were proposed. The cDNA sequences for the heat stress proteins, sequences coding for various isoforms of the PKC family of kinases and the gene coding for the endogenous inhibitor of the mitochondrial  $F_1-F_0$  reversible ATPase.

At the end of the electron transport chain leading to the synthesis of ATP in the mitochondria a large multiple sub-unit complex termed the  $F_1$ - $F_0$  mitochondrial ATPase/synthase performs the transfer of an electron to the final electron acceptor, oxygen, in oxidative phosphorylation.

The complex contains at least 11 sub-units many of which appear to have catalytic properties regulated either allosterically by adjacent subunits or independently by the prevailing conditions in the mitochondria[233]. The complex is situated on the inner membrane with active components located in both the membrane and matrix spaces of the mitochondrion. See figure 7.1

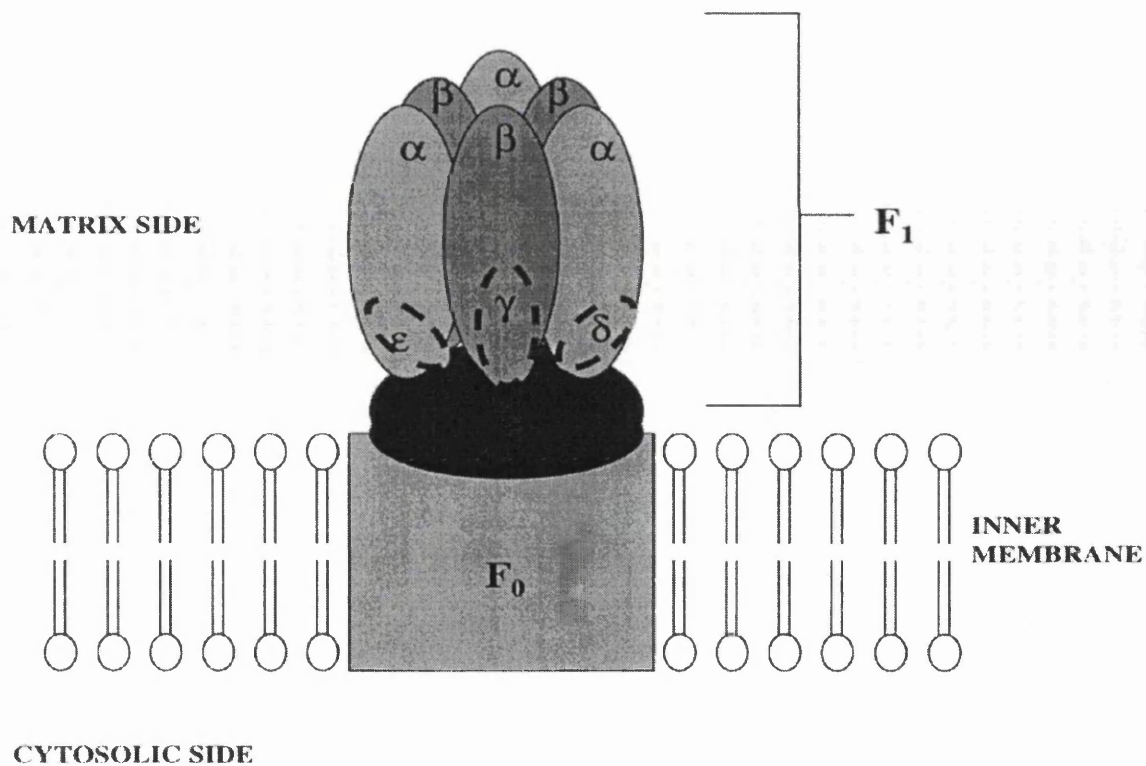

**Figure 7.1.** Diagram of the mitochondrial ATP synthase / hydrolase complex

Under conditions of normal oxygenation this complex is responsible for the majority of ATP synthesis, however under ischaemic conditions the reverse reaction predominates and the complex is responsible for significant ATP hydrolysis.

In some species an active endogenous inhibitor (IF1) of the reverse reaction has been identified and characterised, initially the inhibitor protein was isolated from bovine heart muscle[234]. The inhibitor is regulated by the pH in the mitochondrial inner matrix space [235]and cytosolic concentrations of inorganic phosphate from the breakdown of phosphocreatine [236] and high energy phosphate compounds. Conditions that exist in the ischaemic heart have been identified as regulators of the inhibitor of the hydrolysis reaction of the  $F_1-F_0$  complex.

The possible role of the reversible mitochondrial ATPase in the response to ischaemia and the phenomenon of preconditioning is unclear. Murry et al original observations [9] in the dog and experiments performed by Vuorinen et al [237] in the isolated rat heart showed that preconditioning was associated with conservation of ATP or at least slowed the rate of ATP depletion during subsequent prolonged ischaemia. This observation led them to suggest that inhibition of the reversible ATPase may play a role in preconditioning.

However experiments performed by Vander-Heide et al in the dog [238] and Grover et al in the rat [238] did not support the hypothesis that ATP conservation has a causal relationship with preconditioning. Determination of the role, if any of ATP conservation in preconditioning has been complicated by contradictory observations in different models, a lack of specific agonists or inhibitors of the synthase and hydrolase activities of the ATPase and difficulties in conserving the precise status of samples taken for assay[239].

Oligomycin has been used to block the hydrolysis of ATP by the  $F_1$ - $F_0$  complex, the protein subunit that confers sensitivity to oligomycin has been identified, but this substance may block the reaction in both directions making interpretation of the results obtained difficult. In addition the nature of  $F_1$ - $F_0$  regulation has been shown to be variable between species. Rouslin and Broge showed, using isolated mitochondria and sub-mitochondrial particles that two types of endogenous inhibitor could be identified. In fast heart rate species such as birds and small rodents[240,241], the inhibitor binds with low affinity whilst in slow heart rate species the inhibitor binds with high affinity to the hydrolysing sub-unit of the complex. In addition it was first demonstrated that in avian and reptilian species the low affinity inhibitor bound more effectively in the presence of two endogenous facilitatory proteins, the 9K and 15K binding proteins, subsequently it has been suggested that these binding proteins may be present in all species[233].

Sequencing of IF1 has shown that the inhibitor protein is a basic protein of 84 amino acids that binds to the  $\beta$ -subunit of the  $F_1$ - $F_0$  complex, the minimal inhibitory sequence was found to be a polypeptide 33 amino acids in length from residue 14 – 47 of the native structure. This short, a highly conserved binding sequence blocks the hydrolysis reaction [242,243]. This sequence, derived from the human, was obtained from the Human Genome Mapping Project and the process of building a plasmid construct was undertaken.

Two approaches to the use of this construct were considered. In the first to introduce the exogenous gene with a mitochondrial locator sequence into cells derived from the rabbit to determine if the continuous expression of active IF1 would protect against ischaemic injury. In the second approach to introduce the

gene into rat derived cardiac myocytes to see if the high affinity IF1 would confer protection in a species in which it was not normally present.

## **7.2 MATERIALS AND METHODS**

### **7.2a. Herpes Simplex Virus**

Herpes simplex virus type 1 derived vector was kindly supplied by the Department of Molecular Pathology at University College London.

Stocks of virus for use in *in-vitro* transfections were grown at The Rayne Institute by M. Wright. Purification of herpes virus stocks by CsCl gradient centrifugation resulted in virus suspensions containing between  $10^8$  -  $10^{10}$  plaque forming units (pfu) or virions per ml.

Titres are quoted herein as virions per ml.

### **7.2b. Construction of Adenovirus transfection vectors:**

Bacterial cells from certain species contain small circular segments of non-chromosomal DNA. In the bacteria these plasmids often contain the genes conferring antibiotic resistance or for enzymes that enable the organism to metabolise unusual substrates. One such group of species are the *E-coli*, these organisms are derived from the gut flora of many species of animal, have a rapid growth rate and some *E-coli* sp. are capable of spontaneous transfer of genetic material. These microorganisms are extremely tolerant of culture conditions and genetic manipulation, some of the reasons why these are amongst the most commonly cultured and transformed organisms in molecular biology and genetics.

A range of bacterial plasmids have been developed which consist of circular forms of adenovirus serotype V [244]. These plasmids used in conjunction with

an appropriate shuttle vector simplify the construction of recombinant adenovirus vectors.

The shuttle vector consists of a small circular plasmid containing numerous restriction sites. The restriction sites are points at which specific enzymes will cleave the plasmid.

Each restriction enzyme recognises a short, unique sequence of bases and cleaves the DNA in a specific way leaving either a blunt end or sticky end at the cleavage site.

Sticky ends are comprised of unequally cleaved double stranded DNA so that one strand is one or more bases longer after cleavage than its sister strand. The sticky end will anneal, under the appropriate conditions, to any similarly free complimentary sequence. This results in rapid ligation when two complimentary sequences are present.

Blunt end cleavage results in DNA segments where both strands are of equal length. Ligation of blunt end sequences resulting from restriction enzyme cleavage is achieved using ligation enzymes under conditions that promote the reaction.

The system of plasmid shuttle vectors permits the insertion of cDNA sequences into the viral genome. cDNA is the term used to refer to genomic material that has been obtained free from any non-coding sequences.

In addition to the facility to insert selected coding sequences the shuttle vector contains a region permissive of recombination with the plasmid containing the remainder of the viral genome. In essence viral replication will only occur if the recombination event takes place. In the case of the vectors used for the work presented in this thesis the plasmid pJM17 was used for the construction of adenovirus. This plasmid contains an insert that makes the viral genome too

large to package and hence the viral DNA generated by single transfection of host cells with this plasmid will remain within the host cells.

Plasmid pJM17 must be cotransfected into host cells with a shuttle vector designed to generate infectious virions of packagable size.

The result of recombination with an appropriately designed shuttle plasmid is infectious virus containing the desired gene for transfer.

This virus will enter target cells, but due to a deletion in one or more of the early viral genes of the virus will be unable to replicate.

In order to generate quantities of infectious, but non-virulent virus for use as a gene transfer vector a permissive cell line, human kidney derived 293 cells, has been raised [245]. This adenovirus host cell line has been transformed so that the essential early viral genes deleted from the viral genome carried on the plasmids used for vector construction.

Linear maps of the adenovirus variants and herpes simplex derived vector are shown in figure 7.3.

### **7.2c. Growth and purification of viral stocks**

Commercial suppliers of plasmids for adenovirus construction supplied circularised forms of adenovirus serotype V and a range of shuttle vectors suitable for the insertion of target genes into the viral genome by recombination (Microbix Biosystems Inc.). Suggested protocols for the cloning and amplification of virus stocks were also provided.

In brief the plasmid DNA was pelleted from the solution in which it is supplied and resuspended to transform *E-coli* by calcium phosphate mediated transfection techniques. The plasmid contains a gene conferring resistance to the antibiotic ampicillin. The bacteria were plated onto solid support medium

containing ampicillin on which only successfully transformed *E-coli* which have taken up the antibiotic resistance gene will grow.

Well defined colonies were selected for further amplification in liquid media (LB broth). After amplification of plasmid bearing microbial colonies in liquid medium the bacterial cells were pelleted by centrifugation and lysed.

Plasmid DNA was harvested by CsCl gradient centrifugation and the composition of the amplified plasmid was confirmed by restriction and agarose gel electrophoresis.

Once the vector containing the adenovirus backbone and a shuttle vector containing the desired gene plus a homologous adenovirus sequence permissive of recombination had been raised in sufficient quantity they were used to cotransfect cultures of 293 cells.

Only if a recombination event occurs between the adenovirus plasmid and shuttle vector will all of the components necessary for the replication of adenovirus particles be in place.

Dividing the adenoviral genome in this way achieves both control of the infectivity of the virus and a marker for the desired recombinant.

Cultures of low passage 293 cells were cotransfected with shuttle vector containing a marker gene coding for either  $\beta$ -galactosidase or green fluorescent protein and the circularised adenovirus backbone.

Cells were then maintained in culture under a 0.5% tissue culture grade agarose overlay. Cultures were then regularly monitored for the formation of plaques, areas of clumped and detached cells which appear as holes in a layer of confluent cells.

The presence of virus was confirmed by transferring supernatant from plates of 293 cells that have undergone cotransfection onto fresh cultures of 293 cells.



The appearance of plaques in these cultures confirmed the presence of virus in the supernatant from the transformed cultures.

To harvest and amplify recombinant virus the plaques were collected by picking out agarose plugs using a sterile pasteur pipette. The plugs were suspended in PBS supplemented with calcium and magnesium.

The agarose "suspension" was used to inoculate dishes of 80-90% confluent, low passage 293 cells which were then maintained in culture until the cells were observed to be rounded and detached from the culture dish due to the presence of virus.

The "bunch of grapes" appearance of heavily infected virus host cells, also known as the viral "cytopathic effect" indicated that virus was ready to harvest.

Virus stocks were harvested by lysis of the host cells and centrifugation and virus suspensions were aliquotted and stored in the presence of 10% glycerol at -70°C.

Virus titres were determined by Dr. L. Wightman.

#### **7.2d. Preparation of the IF<sub>1</sub> plasmid.**

The conserved sequence for the endogenous inhibitor of the F1-F0 ATP hydrolysis reaction from bovine heart was requested from Human Genome Mapping Project. The sequence was 360 base pairs in length. The plasmid map and the restriction sites on either side of the desired coding sequence were supplied by the Human Genome Mapping Project. Cells containing the plasmid were supplied on an agar slope and to obtain the plasmid DNA in quantity a maxiprep was performed. A petri dish was prepared with nutrient agar and ampicillin, the plasmid containing the required sequence for IF1 also carried the gene for resistance to this antibiotic and is termed amp<sup>+</sup>, under these culture

conditions only transformed cells will form visible colonies. The inoculated plate was incubated overnight at 37°C and inspected for visible colonies. One colony was picked from the plate which was then stored at 4°C. The selected colony was inoculated into 10mls of nutrient broth and incubated in a shaking incubator overnight at 37 °C. The resulting cell suspension was inoculated into a further 500mls of culture broth and grown overnight at 37 °C in a shaking incubator. The culture was centrifuged at 5000rpm for 10minutes at 4 °C. The pellet was resuspended in 20mls of 50mM glucose, 10mM EDTA, 25mM Tris buffer at pH 8.0. All subsequent operations were performed on ice. The resuspended pellet was mixed with NaOH/SDS 0.2M/1% and incubated for 10mins. To this was added 30ml of acidic Kacetate acidified with formic acid and this was incubated for a further 10 minutes. The resulting solution was mixed with ice cold isopropanol and spun at 9000rpm for 15mins at 4 °C. The supernatant was discarded and the tube carefully drained. The pellet was then resuspended in 0.72mls of Tris/EDTA buffer, 1.4ml of 1.75g/ml CsCl and 120µl of ethidium bromide. This final solution was left at 4 °C and in the dark overnight. The supernatant, containing DNA, was collected and spun under a solution of 65% CsCl at 100,000rpm for 2.5 hours at 16°C. The band of partially purified DNA was collected by needle aspiration and washed in water and absolute ethanol, spun at 3,000rpm at room temperature. The resulting pellet was incubated with 5M NaCl and 20mg/ml RNase for 15 minutes. The solution is phenol/chloroform extracted and finally the DNA precipitated with ethanol. The precipitate was harvested and resuspended in ultrapure water. This final solution could be stored frozen.

To determine whether the maxiprep DNA contained the insert for IF1 an aliquot of the harvested DNA was cut by incubation with the appropriate restriction

enzymes for the sites specified by the suppliers. Despite repeated attempts to cut out the IF1 sequence and further consultation with the Human Genome Mapping Project who supplied the sequence the electrophoretic separation of DNA fragments after restriction of the DNA did not generate a fragment of the appropriate size.

The gels resulting from several different restriction protocols are reproduced on page 174. Although the reproduction is poor due to the condition of the original photographs it is clear that multiple bands have been obtained with each restriction enzyme combination. None of the bands obtained corresponded to a fragment of the appropriate size.

### **7.2e. Transfection using adenovirus**

Adult myocytes were plated onto gelatine/laminin coated 24 well tissue culture plates at densities of  $10^3$  -  $10^5$  cells per well. Once attached cells were counted and an estimate of attached cells per well was used to calculate the virus dilution required to achieve the desired ratio of virions per cell.

To each well for transfection 0.5 mls of the appropriate dilution of virus suspension was added. All virus suspensions were handled and dilutions performed on ice in a laminar flow cabinet. Cells exposed to virus and controls were returned to the incubator for 2 hours to allow virus to adsorb.

At the end of the two hour incubation the virus suspension was gently removed and replaced with normal maintenance medium. Cells were returned to the incubator for 24 hours to allow for expression of the transfected gene.

Two polaroid photographs of ethidium bromide labelled DNA bands on electrophoresis gels. In **1** Not 1 and ECoR1 restriction enzymes have been used on **A** the construct reportedly containing the IF1 conserved sequence and **B** the pEGFP-N1 shuttle vector plasmid. The IF1 sequence was to be inserted into this shuttle vector for virus construction at a later date.

In photograph 2 three combinations of restriction enzymes have been used.

**A** Sal 1 and ECoR1, **B** HindIII and ECoR1 and **C** Pac1 and ECoR1. All of the alternative sites to Not 1 tried were reported present as unique sites on the plasmid supplied.

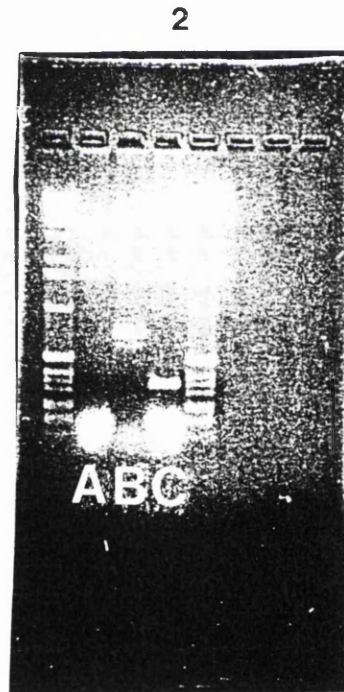
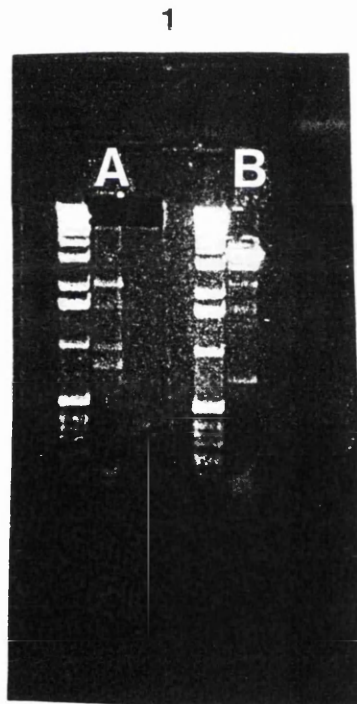

## 7.2f. Confirmation of gene transfer.

Where  $\beta$ -galactosidase was used as the indicator gene for transfection cells were fixed using 500 $\mu$ l 25% glutaraldehyde in 50 mls of phosphate buffered saline (PBS) supplemented with 1mM MgCl<sub>2</sub>.

Fixative was applied to the cells for 30 minutes and removed by aspiration and washing once with fresh PBS.

Once fixed cells were tested for enzyme activity by applying developer solution 3mM C<sub>6</sub>FeK<sub>4</sub>N<sub>6</sub>, 3mM C<sub>6</sub>FeK<sub>3</sub>N<sub>6</sub>, 1mM MgCl and 100  $\mu$ M 5-Bromo-4-chloro-3-indonyl  $\beta$ -D-galactopyranoside (X-gal) this latter being a chromophore cleaved by  $\beta$ -galactosidase to generate a strongly blue coloured product.

The developer solution was incubated with the fixed cells for 2-4 hours at 37°C in an incubator.

Developed cells were examined under light microscopy.

Quantification was achieved by cell counting using an eyepiece graticule, counting procedures were similar to those used when conducting trypan blue exclusion assays.

In figure 7.7 enlarged photographs of cells that have been transfected with either of two variants of adenovirus vector carrying the  $\beta$ -galactosidase gene are shown.

Cells transfected with green fluorescent protein (GFP) as a marker of gene transfer were viewed under the fluorescent microscope and photographed. A field of GFP transfected cells photographed under fluorescent and non-fluorescent illumination is shown in figure 7.8.

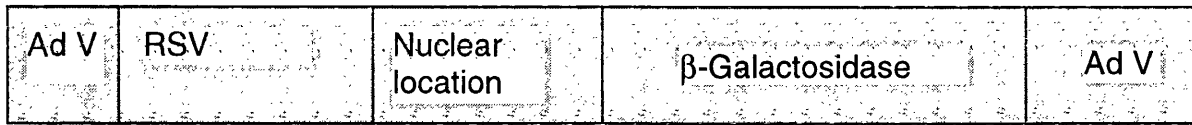

**GEN 1**

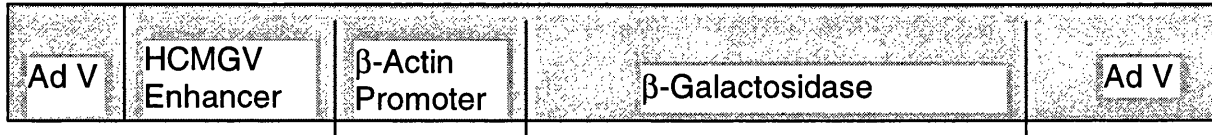

**GEN 2** | THIS SEGMENT USED FOR LIPOSOMAL TRANSFECTION

**Figure 7.3a** Line diagram of adenovirus serotype V vectors used for gene transfer to adult cardiac myocytes in culture.

RSV : Rous sarcoma virus

HCMGV: Human cytomegalovirus

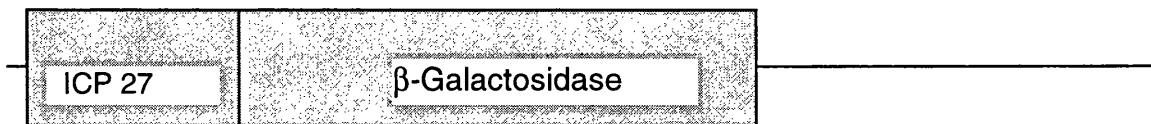

**Figure 7.3 b** Line diagram of the indicator gene region of the Herpes derived vector.

## 7.2g. Structure and mode of action of liposomes

Cationic liposomes were synthesised from 3 $\beta$ [N',N' - dimethylaminonethane) carbamoyl] cholesterol (DC-Chol and dioleoyl L- $\alpha$ -phosphatidylethanolamine (DOPE) mixed in a ratio of 3:2.[246]. The lipid molecules contain a charged, hydrophilic head, usually an amine which interacts with DNA, a short spacer group and a hydrophobic anchor region of cholesterol derived lipid. The liposome forms a bilayer structure which when complexed with DNA by electrostatic attraction form tubular structures of varying size consisting of supercoiled DNA and a single lipid bilayer.

It is postulated by Gao et al [246] that three steps are involved in the transfer of DNA to the recipient cell using DOPE rich liposomes as transfection vectors.

1. Binding to the cell membrane
2. Endocytosis of the liposome
3. Cytoplasmic release of the DNA

Efficiency of liposome transfection methods was dependant on the size of the liposome DNA complexes, the ratio of liposome to DNA, the composition of the liposome and the cell type to be transfected.

## 7.2h.Liposome transfection methods

A plasmid containing a gene coding for  $\beta$ -galactosidase under the control of a heterologous promoter (chicken  $\beta$ -actin promoter with the cytomegalovirus immediate early enhancer) was mixed with DOPE- DC-Chol liposome complex in a range of DNA to liposome ratios.

A typical dilution table for transfection ratios used is shown in Table 7.1.

Liposome and DNA were mixed gently and left to stand for 20mins at room temperature. The mixture was then added to 0.5mls of serum free tissue culture

medium and applied to culture wells plated with adult cardiac myocytes. Cells were returned to a tissue culture incubator at 37°C for 30 minutes.

At the end of this incubation/adsorption period the cells were returned to the laminar flow cabinet and a further 0.5 mls of serum free medium was added to each well. Cells were returned to the incubator and left for 24 hours to permit expression of transfected gene.

Well No.	10mg/ml DNA $\mu$ l	Liposome $\mu$ l	Virus $10^{11}$ /ml	$\mu$ l	Ratio
1&2	5	25	10		1:5:2
3&4	10	25	10		2:5:2
5&6	20	25	10		4:5:2
7&8	5	50	10		1:10:2
9&10	10	50	10		2:10:2
11&12	20	50	10		4:10:2
13&14	5	25	20		1:5:4
15&16	10	25	20		2:5:4
17&18	20	25	25		4:5:5
19&20	5	---	---		DNA control
21&22	---	---	20		Positive
23&24	---	25	---		Blank

**Table 7.1** Typical dilution table for a series of liposome / Virus cotransfections.

The DNA solution contains 10mg / ml plasmid DNA. Once the DNA and liposome had been mixed and incubated for 15minutes in 1.5 mls tubes 0.5mls of serum free medium was added and the mixture applied to the cells. The ratios shown here are an example of the range tested in a number of experiments. The plasmid DNA carried the gene for  $\beta$ -galactosidase activity and the adenovirus carried GFP.



## 7.2i. Preparation of viral conjugates

The construction of plasmids containing genes of interest is now a well developed technology. Insertion of genes of interest and the appropriate regulatory sequences can present technical difficulties. On occasion the desired DNA sequence may be too large for the vector to accommodate, although adenovirus can be engineered so that 7.5Kbp of foreign DNA can be introduced [247]. Even where the desired foreign gene sequence is not too large the recombination events required for the production of a vector are rare and random events and act as a rate limiting step in the production of novel vectors. Furthermore if the gene product is in some way injurious to the permissive host cell line in which vector is grown and amplified the production of quantities of transformed vector may be prevented.

Taking these problems into consideration a means of transferring plasmid with the efficiency of virus would be a very useful technique.

Several techniques have been developed for cotransfecting [248] and conjugating DNA molecules to virus bodies [249,250]. Essentially cotransfection involves the introduction of virus and plasmid DNA to the cells in culture simultaneously. The virus carries the DNA into the cell as a bystander molecule which is cointernalised in the endosome formed when the virus interacts with cell surface receptors [251].

Other techniques involve actively attaching the passenger DNA to the surface of the virus particle using linker molecule.

Polylysine ( mwt 34 -48 Kd) used as a linker molecule was effectively linked to passenger DNA and virus by mixing and incubating together for 30mins at room temperature. After incubation the plasmid DNA was added and a further 30

minute incubation was allowed. In order to ensure that only conjugated virus particles were used in the transfection solutions the mixture was purified by CsCl gradient centrifugation. The size of the polylysine molecules was not uniform and two bands of conjugate appeared in the gradient after centrifugation. Both were collected by needle aspiration and used separately in the transfection protocols.

### **Polyethylenimine - plasmid - virus conjugate**

Similarly to the technique used for polylysine the cationic polymer polyethylenimine (PEI) could be used as a linker molecule [252,253]. The advantage of using PEI was the uniformity of size of the resulting complex. A solution of 9mg of 50% PEI in water giving a final concentration of 10mM was prepared and adjusted to pH 7. This solution was sterilised by passage through a 0.22 $\mu$ M syringe end filter and then mixed drop-wise with plasmid DNA in HEPES buffered saline (HBS). The mixture was left to stand at room temperature for 10 minutes and finally a suspension of adenovirus in HBS was added and allowed to incubate for a further 10 minutes.

The critical factor in successful complex formation and penetration of cells was the ratio of DNA : linker : virus and in addition to the recommended proportions for each linker a number of ratios were tested.

### **7.2j. Transfection with conjugates**

Cells were isolated and plated either onto laminin and gelatine coated plates as has been described for other experiments or, in the preliminary experiments with viral gene transfer, plated onto laminin coated plates and embedded in 1% agar solution.

Cells were washed and exposed to virus mixed with normal serum free tissue culture medium for 2 hours. At the end of the exposure the medium containing virus was removed and replaced with fresh maintenance medium. Cells were then returned to a tissue culture incubator at 37° C, gassed with 95% air / 5% CO<sub>2</sub> overnight to allow transfected cells to express the viral protein.

## **7.3 RESULTS**

### **7.3a Herpes Simplex virus derived vector**

More than ten attempts to demonstrate gene transfer using herpes simplex virus derived vector with  $\beta$ -galactosidase as a marker gene generated no visibly positive cells. On several occasions the plates that had been exposed to high titres of this vector demonstrated clear evidence of cytotoxic effects with disrupted cells and debris clearly observable under the light microscope.

Three transfections were tried using suspended rather than plated cells. This strategy was suggested to us by R.Coffin from the department of Molecular Pathology UCL, who has worked extensively with herpes virus derived vectors in neuronal cells. A fresh preparation of vector was subjected to further purification by centrifugation and washing. Suspensions of 10<sup>3</sup> adult myocytes were used. The exposure time was two hours.

The proportion of cells successfully modified by exposure to herpes simplex derived vector was very small. an example of the type of transfection rates observed when exposing cells in suspension to both adenovirus and herpes virus is shown in the graph and table below. The vector was deemed unsuitable for use.

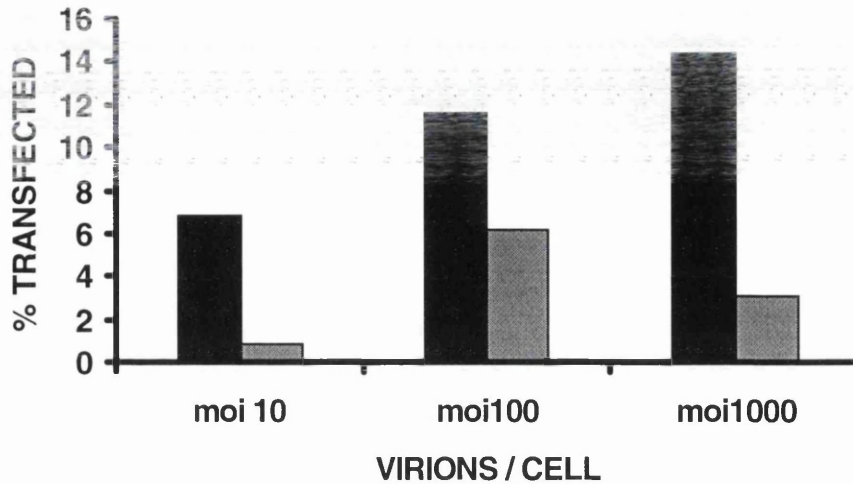

**Table 7.2**  
**Comparison of transfection efficiencies for Adv and HSV for cells in suspension**

Virions per cell	Adenovirus gen 1	Herpes Simplex
moi 10	6.8	0.8
moi100	11.6	6.2
moi1000	14.4	3.1

**Figure 7.4**

Transfection rates obtained by exposing cells in suspension to viral vectors.

The black bars show the results obtained using adenovirus first generation vector and the grey bars show the efficiency for herpes virus. The cells in suspension were transfected at a lower efficiency with adenovirus than when plated. The transfection efficiencies for herpes virus remained very low.

### **7.3b Liposomal gene transfer**

Numerous attempts to transfer  $\beta$ -galactosidase using various ratios of liposome to DNA, naked DNA and different formulations of liposome failed to generate any visibly positive cells.

It was concluded that adult cardiac myocytes were refractory to gene transfer by the techniques applied. It is possible that a formulation of liposome and a ratio of liposome to DNA that will penetrate adult cardiac myocytes exists, it was not found in the course of these experiments.

### **7.3c Virus/plasmid conjugate gene transfer**

None of the conjugate systems used resulted in the detection of significant numbers of cells positive for either  $\beta$ -galactosidase or GFP carried on the plasmid component of the conjugate although viral gene transfer was successful. On two occasions where the virus/ plasmid conjugate was applied at high titres to plates plated at  $10^5$  cells per well one or two  $\beta$ -galactosidase positive cells were observed on inspection of the entire plate surface. This represented a transfection efficiency  $< 1: 10000$ .

### **7.3d Adenovirus serotype V mediated gene transfer vector**

Figure 7.1a and b and 7.2 a and b show graphs of the observed transfection rates achieved with adenovirus gene transfer vectors in two series of transfections.

Each vector is described above. Quantification was by manual counting of cells showing  $\beta$ -galactosidase activity as visualised by the use of the X-gal stain developer solution.

From the results shown there appears to be a difference in the transfection efficiencies of the two adenovirus derived vectors.

This discrepancy between the two virus containing the nuclear locator sequence attached to the gene product and the one without may be largely artefact. A low level of cytoplasmic expression spread around the cell would be difficult to detect visually, while a similar level of expression concentrated in the smaller area of the nucleus would probably be easier to see.

However different sets of experiments gave differing results. In the series of five transfections shown in figure 7.3 the second generation appears more effective, while the reverse appears to be the case in the series of four experiments shown in figure 7.2. The virus stocks used for these early transfection experiments had been grown and stored in the Department of Molecular Pathology, UCL. The reported titres were  $10^{11}$  virions/ml for generation 1 and  $10^9$  virions/ml for generation two. The transfections were performed on 24 tissue culture plates, attached cell density was approximately  $10^4$  cells per well or  $10^3$  cells per well.

A number of factors influence virus titre. Repeated freezing and thawing can reduce the number virus particles present and virus distribution through a suspension may not be homogenous. In figure 7.4 showing the use of adenovirus with  $\beta$ -galactosidase as the marker gene the transfections were performed with a fresh virus preparation that was divided into 10 $\mu$ l aliquots prior to freezing.

The results of using a fresh aliquot each time are far more consistent. The reported titres of the virus preparations were  $2 \times 10^{11}$  virions/ml for adenovirus generation 2 and  $10^{10}$  virions/ml for the generation 1 adenovirus.

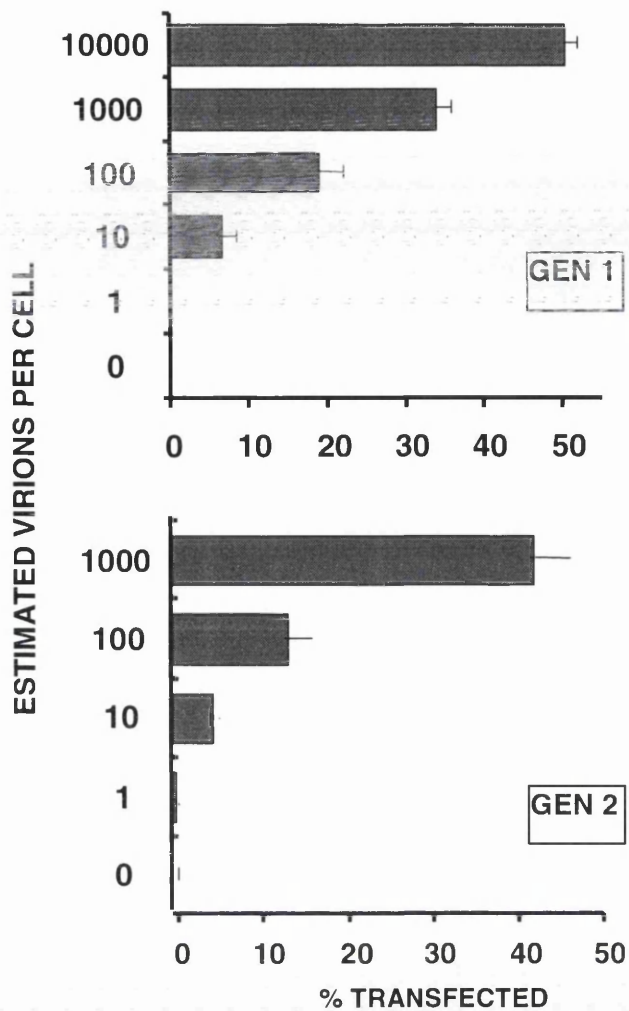

**Figure 7.5** Graphs of transfection efficiencies for Adv 1 and 2. Results are shown in the table as means +/- sem.

**Table 7.3**

VIRIONS/CELL	% TRANSFECTED	SEM
<b>GENERATION 1</b>		
MOI0	0	0
MOI1	0	0
MOI10	6.5	2.0
MOI100	18.9	3.1
MOI1000	33.7	2.0
MOI10000	50.3	1.8
<b>GENERATION 2</b>		
MOI0	0	0
MOI1	0.5	0.1
MOI10	4.8	0.1
MOI100	13.7	3.1
MOI1000	42.6	4.6

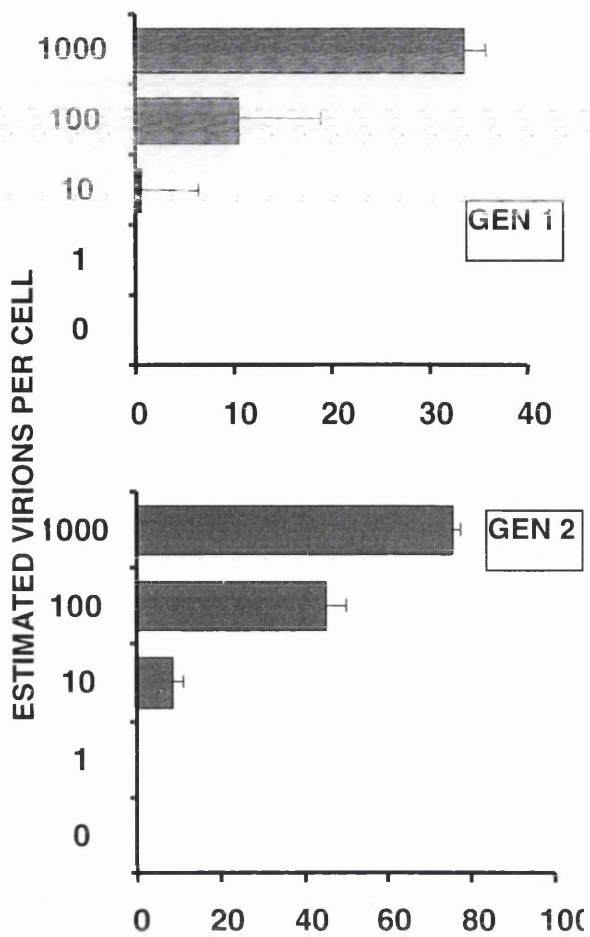

**Figure 7.6** Graphs of transfection efficiencies for Adv 1 and 2. Results are shown in the table as means +/- sem.

In this series of transfections gen 2 appears more effective than gen 1.

**Table 7.4** Comparison of generations 1 and 2 adenovirus vectors.

VIRIONS/CELL	% TRANSFECTED	SEM
<b>GENERATION 1</b>		
MOI0	0	0
MOI1	0	0
MOI10	0.5	0
MOI100	10.4	1.0
MOI1000	33.4	3.2
MOI10000		
<b>GENERATION 2</b>		
MOI0	0	0
MOI1	0.1	0.1
MOI10	8.3	0.7
MOI100	45.2	3.4
MOI1000	75.6	0.8



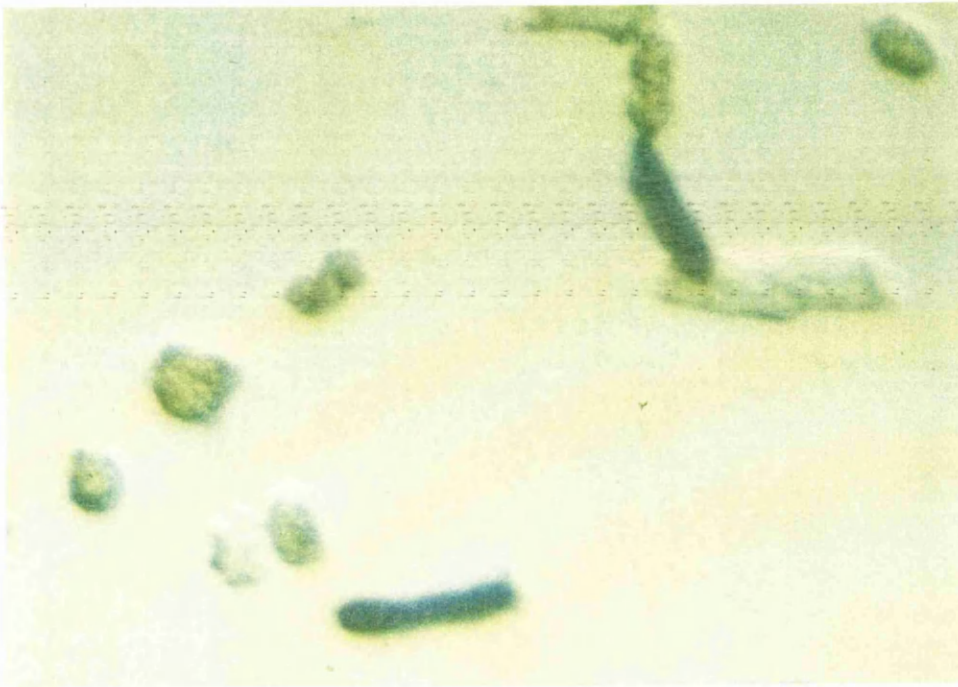

**Figure 7.7 a.** Photomicrographs of fixed and stained adult rabbit myocytes transfected with generation 1 or generation 2 Adv. vector. The generation 1 vector contains the nuclear locator sequence and the  $\beta$ -galactosidase stain is clearly restricted to the nuclei of the transfected cell. The generation 2 vector has no nuclear locator sequence and the stain is visible throughout the cytoplasm.

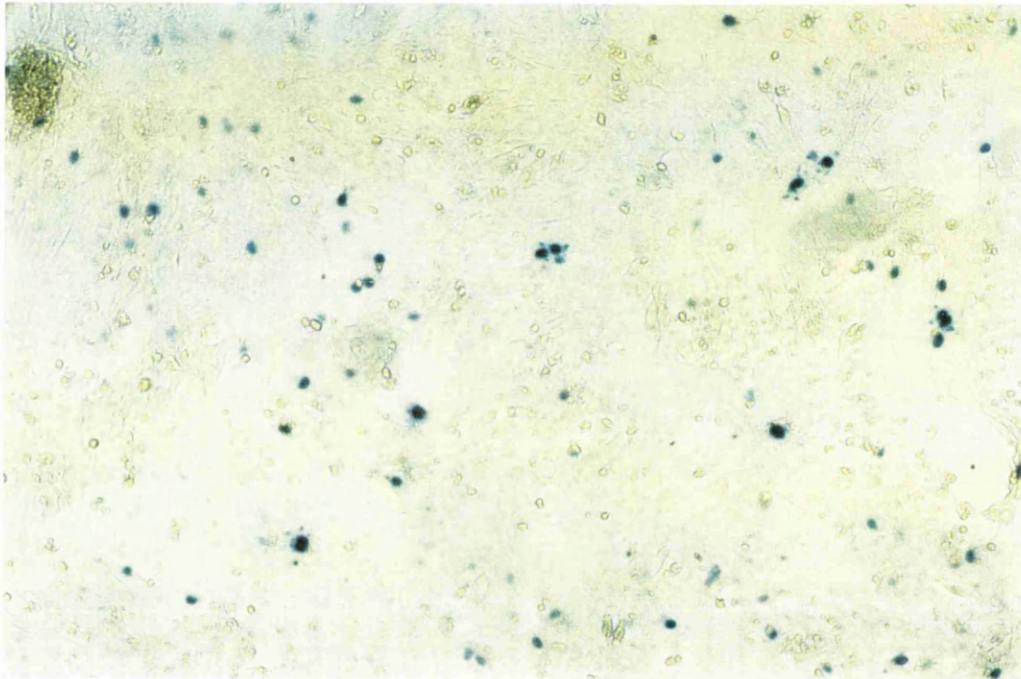

**Figure 7.7 b.** Shown in this figure are some photomicrographs of neonatal rat cardiac myocytes from an isolation I had performed three days prior to the photographs. Although the neonatal cardiocyte preparation was not used in the study reported in this thesis it was in use in the group working in the laboratory and I was asked to run some neonatal transfections with some of those for the adult cells to look at the efficiency of Adv vectors in these cell.

## **Adenovirus with green fluorescent protein as marker**

In figure 7.8 two photographs of adult cardiac myocytes that have been transfected using adenovirus vector carrying the gene for green fluorescent protein as a marker of transfection.

The cells were viewed under a fluorescent microscope using the appropriate excitation and emission filters. The two photographs show the same field of cells under fluorescent and normal illumination. On inspection virtually all of the cells appear to display some fluorescence.

As discussed in the discussion section of this chapter quantification of transfection efficiencies depends on the ability of the technique selected to detect the gene product. The coloured product generated when  $\beta$ -galactosidase is used as a marker could easily be present in very low quantities indistinguishable to the eye.

Elution of gene product and spectrophotometric determination of X-gal chromophore is an available technique, but as with other measurements some means of normalisation would have to be developed. The major advantage of GFP as a marker gene was that it could be used to confirm transfection in live cells.

The sensitivity of photographic film is far greater and even low levels of fluorescence can be detected. Improved detection and the availability of quantification in live rather than in fixed cells makes GFP a marker of greater utility than  $\beta$ -galactosidase.

Untransfected myocytes examined under the excitation /emission wavelengths used to visualise GFP positive cells displayed no auto fluorescence and were all but invisible.

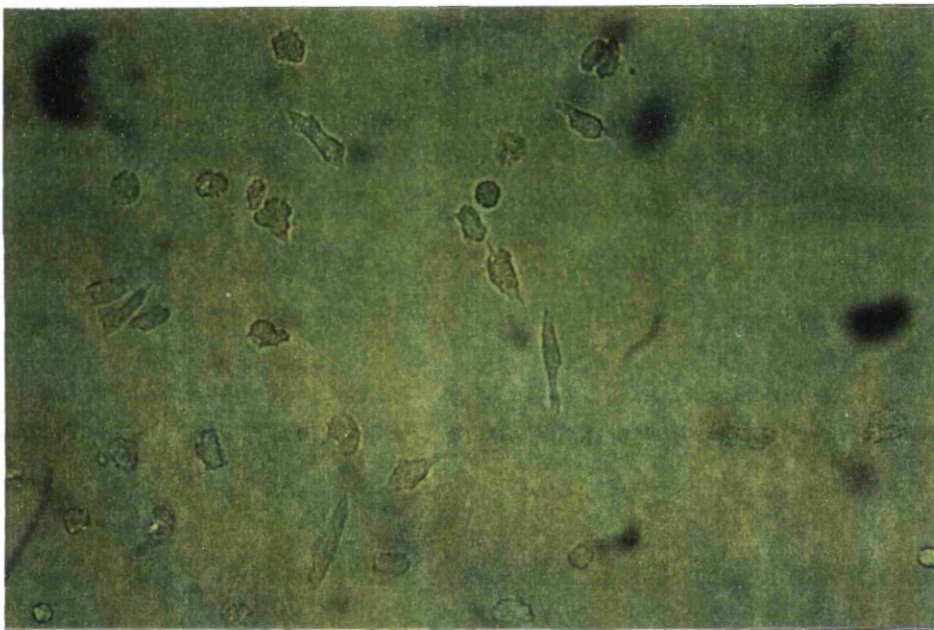
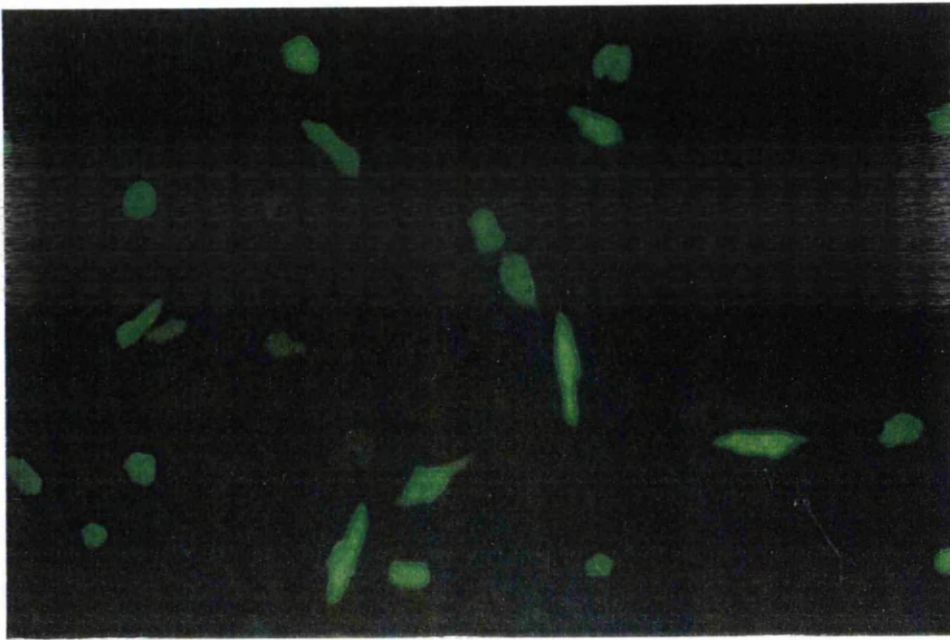

**Figure 7.8** Photomicrographs of adult myocytes transfected with adenovirus generation 2 vector carrying green fluorescent protein (GFP) as a marker. The cells were photographed under fluorescent light and with the activation wavelength switched off. On close examination it is possible to see that all of the cells in the field of view are showing some GFP activity under fluorescent light.

## 7.4 DISCUSSION

Most viral life cycles fit into one of two categories. Either the virus begins reproduction immediately on infection of the host cell and is liberated by lysis of the cell in what is called the lytic life cycle or the virus is incorporated into the host cell genome by non-site specific recombination. The latter life cycle is common to so called retroviruses and generally applies to target cell populations that are growing. The infected cells reproduce both their own and the virus genome with each cell division. At some point the virus may well return to the lytic life cycle and destroy the host cell. Indeed herpes simplex derived gene transfer vectors have been reported as reverting to the lytic phase in brain tissue [254]. The signal for this is not known with any certainty. Some retroviruses stably integrate into the host genome. Potentially a retrovirus that integrates with the host genome and remains in the non-lytic phase would be an ideal gene transfer vector leading to the long term expression of the transferred gene. The scenario is not as simple as it appears. Virus integration with the host genome does not occur at specific sites and the viral DNA can be inserted into protooncogenes leading to the development of unregulated cell growth and tumorigenesis.

The solution to the problem lies in targeting the integration site for a retrovirus, this technology is not yet available. Whilst retrovirus vectors offer a valuable tool for use in cell culture they cannot currently be used for systems that are intended to transfer from cell culture models to in-vivo models. The virus vectors whose preparation and use are described here are non-integrating DNA viruses. They have been modified by removal of portions of the viral genome to both provide space for the insertion of the gene to be transferred and to delete genes involved in regulation of the lytic viral life cycle.

Essentially genes are deleted from the viral genome whose absence prevents the replication of viral DNA and/or the assembly and packaging of mature virus bodies. As the viral genome does not integrate with the host chromosomal DNA it remains outside the nucleus and is termed episomal DNA. The life expectancy of extrachromosomal DNA in mammalian cells is relatively short ranging from days to weeks. The eventual removal of episomal DNA means that the expression of the introduced gene will be transitory. As a therapeutic strategy such episomal DNA would require repeated doses. Thus far such viral transfer vectors have not been demonstrated to be without immunogenic activity. An immune response to repeated doses of viral vector or to the infected cells would render the vector useless.

It is clear from the results shown and problems described in this chapter that while virus mediated gene transfer is an efficient method of importing foreign DNA into a target cell population, both targetting and quantification of gene transfer are imprecise techniques. Transfer of genes to cells in culture guarantees that where the virus has some tropism for the target cell population a measure of success will result. However specificity is obtained by only one cell type being present. Virus species with little host cell specificity infect several of the cell types present in whole tissues. Using or designing vectors that have cell type specificity is a technology that is in the early stages of development. Targetting the expression of the foreign gene to specific tissues is also a possibility and may be achieved by the incorporation of specific regulatory sequences or response elements with the foreign gene to be transferred.

Finally quantification of the success rate of gene transfer presents a variety of problems. In cell culture the counting of cells displaying a characteristic endowed by the new gene is one option. Manual cell counting techniques are

imprecise and time consuming. Where a fluorescent gene product is used quantification by fluorescence assisted cell sorting (facs) would be the technique of choice for isolated cells, but is not applicable to whole tissues or adult myocytes which are too large and the wrong shape to be interpreted by the detection device as individual cells. In the event of transfer of a target gene the amount of gene product could be measured directly, however these measurements would be unable to distinguish between few cells producing much gene product and many cells producing little.

**SECTION THREE**  
**CHAPTER 8: GENERAL DISCUSSION**

**APPENDICES**

**REFERENCES**



## CHAPTER 8

### GENERAL DISCUSSION AND CONCLUSIONS

#### 8.1 Summary of the work and its implications

---

##### **8.1. Summary of the work and its implications.**

At the outset of this project the immediate intention was to construct a model of ischaemia / reperfusion injury to the heart and of ischaemic preconditioning at the cellular level.

The model was to be based on the adult cardiac myocyte in culture as ischaemic heart disease is most commonly a condition found in the mature myocardium.

Models of the myocardium existing at the time of starting this work were based largely in cells from neonatal or foetal laboratory animals which were amenable to primary cell culture [79,201]. There are indications that the stage of development of the animal affects some of the putative mechanisms of preconditioning. Expression of the different isoforms of PKC, a proposed mediator of preconditioning have been observed to vary between adult and immature cells in culture[255]. Models have also been based on freshly isolated adult cardiocytes [45,225,256,138] or muscle derived cell lines [226].

The need for a clear insight into the mechanisms and endpoints of endogenous cytoprotection has been driven by the potential these mechanisms may have for exploitation in the development of therapeutic strategies. However interrogation

of mechanism required a model that gave a window onto events at the cellular level and at the same time retained enough of the characteristics of isolated tissues and whole animal models to facilitate comparisons.

The existing models of preconditioning and endogenous cytoprotection at the level of the cell had not been able to demonstrate the very marked protection seen in whole tissues[45]. It also was not clear from these models whether the protection due to endogenous mechanisms was the same phenomenon as that observed in whole tissues or the living animal [256]. In part the difficulties arising from trying to compare whole heart and cellular models are based in the divergence of endpoint measurements used. Variations between species selected for modelling occurs in the size of the response, the apparent role of different triggers of preconditioning and a lack of clarity regarding the end point or end points of preconditioning point to the need for an in-vitro model.

One major difficulty in creating such a model has been simulating the effects of ischaemia in the environment of tissue culture. It remains equivocal as to whether the imposition of a limited number of controlled conditions in tissue culture can be a true simulation of the effects of ischaemia in living tissues.

Long-term culture of terminally differentiated cells remains a controversial technique. The phenotypic alterations observed on adaptation of both immature [194] and adult cardiac myocytes [166,185,187,241] to culture have been shown to reflect underlying alterations in gene expression.

In addition there was the question of whether the processes involved in dissociation of the whole tissue were sufficient stress to result in isolated cells that were already preconditioned. An additional need was to find a method to isolate the cells so that they entered the cell culture environment uncontaminated with either other cell types or bacteria. Either contaminant

would rapidly overgrow the non-replicating myocytes and render the cultures useless and results of any biochemical analyses unreliable.

It was necessary then to determine and remain within a window of opportunity within which the cells were deemed to appear and behave as primary cells. The appearance of the preconditioning response in cells that had been retained in culture for one to two days strongly indicated that the isolation procedure had not generated cells that were already preconditioned and that the overnight period was sufficient to allow the cells to recover from the stresses of isolation and the transition to the culture environment.

In the experiments described in this thesis the conditions selected were those that could be readily controlled in the tissue culture environment and the degree of both injury and protection closely reflects that seen in models based both in whole animals and in the isolated heart.

To characterise a model of ischaemic injury an acceptable simulation of the conditions pertaining in inadequately perfused tissues was required. A definition of ischaemia that is universally subscribed to did not appear to exist [133], although many of the changes in the extracellular milieu had been characterised and described.

The model selected was based on a system that simulated some of the conditions known to exist in ischaemic tissues. Each of the parameters selected could be easily manipulated and applied uniformly to the cells in culture. By definition the preconditioning stimulus is sublethal in character and all of the separate elements of the lethal stimulus were tested for the ability to stimulate endogenous cytoprotection. Anoxia had been used successfully to precondition isolated cells [256,257], in our model it was not possible to confirm a total

absence of oxygen from the immediate environs of the cells and hence the term hypoxia has been applied.

In terms of the preconditioning protocols described here for cells in culture there is one striking difference. The time-scale of events in culture is clearly very different from that described in in-vivo or whole heart models. Many investigators using isolated hearts or in-vivo models of ischaemic preconditioning apply one or more 5 minute periods of global ischaemia followed by 10 minutes of reperfusion. Indeed this technique is used so widely it might even be regarded as standard. The immediate protection resulting from this regimen has been reported as lasting between 1 hour in the whole rabbit model and 180 minutes in the open chest dog.

In the cellular model described here the preconditioning stimulus was applied for one hour and the lethal stimulus applied for six hours. In other cellular models such as the human embryonic and neonatal preparations described by Ikonimides et al similar extensions of the time-scale were observed.

Several possible factors may be involved in this difference. Adult cardiac myocytes in this culture system were quiescent and therefore can be assumed to have had lower energy requirements than the in-vivo or in-vitro beating myocyte. Even where immature, beating cells are cultured the load on each cell is lower than it would be in intact tissue. Another factor that may contribute to the altered time-scale of events is the generation in culture of a microenvironment around each cell. The microenvironment is more resistant to change than the body of solution and it follows that alterations to environmental pH and ion concentration will be transmitted more slowly to the cell. Another possible factor influencing the rate of change in the environment in cell culture is the large extracellular space. In the living tissue the volume of liquid surrounding each cell

is small and changes are transmitted rapidly via the microcirculation. In the tissue culture plate there is an absolute lower limit to the volume that can be applied while still maintaining a moist environment around the cultured cells. Both the shape and size of the tissue culture plate contribute to what this minimum volume will be. Tissue culture wells are not completely flat and the distribution of fluid over the surface is therefore not uniform. Too low a volume will result in the culture drying out in the centre and the concomitant loss of cells to dehydration. To avoid this the minimum volume applied remains relatively large, 0.5 mls on a six well culture plate. Relative to the volume bathing a cell in living tissue this is a large body of solution and will affect the rate of change of conditions as perceived by any individual cell. In addition mixing or stirring of the medium applied to the cells was not possible.

It was possible, using cultured adult cardiac myocytes to construct a simulation of ischaemia/reperfusion injury in which at least 50% loss of cell viability was defined as the lethal stimulus. Subsequent to defining the simulation it was possible to demonstrate that components of the 'ischaemia' when applied for short periods prior to the lethal stimulus and separated from it by a period of recovery or reperfusion protected the cells in culture from the long, lethal stimulus.

These results indicate that mechanisms of endogenous cytoprotection analogous to preconditioning exist as cellular phenomena and that the mechanisms underlying them can be both investigated and manipulated at the level of the cell.

With several days available in which to investigate the response of cultured adult cardiac myocytes to simulated ischaemia / reperfusion it was possible to consider investigation into and manipulation of gene expression in these cells.

The aim was to find a rapid, reliable and non-injurious method of gene transfer to the cells in culture. Experiments were performed using both virus based and non-viral gene transfer vectors. Two virus species known to infect non-replicating cell populations were tested. In the case of non-viral gene transfer systems no significant transfer of indicator gene activity was observed in cultured myocytes. Of the two viral vectors tested only adenovirus based vectors demonstrated rapid and efficient transfer of indicator gene activity to the target cells. The transfection rates obtainable using transfected bacterial  $\beta$ -galactosidase activity as the indicator gene were in excess of half of the exposed cell population. These efficient gene transfer rates implied that by employing a selected gene sufficient cells in the cultured population would be transfected for effects to be apparent. Changing to a fluorescent indicator gene permitted visualisation of transferred gene product in live cells and appeared to improve the transfection rate obtained. It is likely that the visualisation of fluorescent gene product was simply more efficient.

Cell culture whilst removing many layers of interaction and unaccountable variables can justifiably be viewed as an oversimplification and all assessments of the value of such models of complex events should take into account the limitations of the modelling system as well as the potential advantages.

A cellular model of ischaemia and reperfusion injury in which classical preconditioning has been demonstrated offers many possibilities for the elucidation of mechanism. To dissect out the individual components of a signal transduction pathway, particularly where steps in the pathway may be mediated by specific isoforms of widely distributed intercellular mediators is a complex process. To do so in a whole tissue comprising several distinct cell populations would be extremely difficult indeed. The existence of the mechanisms of interest

in the cultured adult myocyte has been demonstrated and within the limitations of the technique it is now possible to look for individual components of the mechanisms of endogenous cytoprotection at the cellular level. A recent publication by Ping et al has shown the profile of PKC isoform expression in the whole heart, using the isolated myocyte it is now possible to follow up this work in one sub-population of cells, perhaps the most important. Up-regulation of individual gene products and regulatory proteins could be measured both in the virgin myocyte and in cells exposed to ischaemic injury and in cells that have been preconditioned.

Having set up the model, it was possible to generate a simulation of ischaemia/reperfusion injury. The simulation was shown to generate a reproducible loss in cell viability. Applying a protocol designed to be analagous to those used to precondition in other models from the same species, taking into account the different conditions pertaining in cell culture, generated protection. This protection could be mimicked by an adenosine receptor agonist and blocked by an adenosine receptor antagonist. In addition the protection due to the preconditioning protocol could also be abolished by the application of a PKC inhibitor. These results indicate that the model retains the characteristics described in other models derived from the same species and can be compared with them. It was possible to demonstrate, by Western blot analysis of samples collected at various stages of the project, that the heat stress protein expression was not increased in response to the isolation and culture procedures, but did increase 24 hours after the preconditioning stimulus was applied. Hence it was demonstrated that the mechanisms underlying preconditioning remained in-tact in isolated heart muscle cells.

It was possible using the culture system developed for the model to identify a suitable and efficient gene transfer vector. The investigation could then go on to identify gene products involved in the processes of endogenous cytoprotection and attempt to modify the response of the cells to the simulation of ischaemic injury.

A very significant proportion of the time available to conduct this project was used in creating the methods required to isolate and culture the cells and to adapt and create reproducible and reliable models of injury that could be shown to parallel the definitions of ischaemia and preconditioning defined in other models.

Nonetheless initial experiments conducted using this model clearly show that it offers the opportunity to use the tools provided by molecular biology to investigate both the effects of injury and the endogenous defences against injury that exist at the level of the single cell.

## **FUTURE DIRECTIONS**

The endogenous cellular mechanisms leading to the profound protection against injury seen in classical preconditioning are poorly understood. The model constructed in the course of this study will be used to test the following :

1. The model of ischaemia / reperfusion injury and classical preconditioning in cultured cardiac myocytes from the adult rabbit heart can be adapted for use with cells derived from human tissues.
2. Delayed preconditioning or the SWOP can be reproducibly demonstrated in the cell culture model
4. Protection can be mimicked by the continuous expression of transfected genes for known mediators of preconditioning transferred to cultured cells.
5. The signal transduction pathways downstream of receptor activation are mediated via specific isoforms of the enzyme PKC. This will involve the identification of the PKC expression profile of cardiac myocytes, quantification of PKC isoform expression and localisation of PKC isoforms in the cells in culture under normal and stressed conditions.
6. The processes of protection occur at the cellular level and can be observed in many cell types.
7. The interactions of stimulated and unstimulated myocyte cells in protected tissue and of different cell populations in that tissue.



## **APPENDICES**

- 1. ACTIVITY REPORT AS SUPPLIED BY WORTINGTON FOR THE  
LYPHILISED PREPARATION OF TYPE II COLLAGENASE**
- 2. COMPUTER GENERATED STATISTICAL ANALYSIS OF ORIGINAL  
EXPERIMENTAL DATA**

# Worthington Biochemical Corporation

Halls Mill Road, Freehold, New Jersey, USA 07728

800-445-9603

908-462-3838

FAX: 800-368-3108

FAX: 908-308-4453

## Certificate of Analysis

Product	Collagenase
Source	Clostridium histolyticum
Storage	Refrigerate (2 to 8°C)
Code	CLS-2
Lot Number	S6H401
Re-Assay Date	July, 1998
Description	Supplied as a lyophilized powder.
Unit Definition	One Unit liberates one micromole of L-leucine equivalents from collagen in 5 hours at 37°C, pH 7.5
A280 @ mg/ml	2.47
U/mg dw	210
U/mg dw Caseinase	1004
U/mg dw Clostripain	5.10
U/mg dw Tryptic	0.40

Approved by: *Robert Rich*

Date: 7/2/96

**APPENDIX TWO  
COMPUTER GENERATED STATISTICAL ANALYSIS**

	IREHIMENT	IRYPHN BLUE	LUH	MII
	X <sub>1</sub>	Y <sub>1</sub>	Y <sub>2</sub>	Y <sub>3</sub>
1	CN	100.000	60.900	100.000
2	CN	100.000	61.500	100.000
3	CN	100.000	36.900	100.000
4	CN	100.000	30.400	100.000
5	CN	100.000	55.000	100.000
6	CN	100.000	55.900	100.000
7	CN	100.000	46.000	100.000
8	CN	100.000	47.100	100.000
9	CN	100.000	50.000	100.000
10	CN	100.000	33.300	100.000
11	IH	36.300	79.400	12.900
12	IH	38.800	78.800	25.800
13	IH	65.800	42.900	49.400
14	IH	65.200	44.900	61.600
15	IH	10.400	66.700	10.400
16	IH	25.600	41.100	22.900
17	IH	58.200	79.400	7.800
18	IH	57.200	64.200	3.900
19	IH	55.900	37.000	57.000
20	IH	68.300	30.000	0
21	PCH	61.300	68.500	258.100
22	PCH	55.100	58.900	200.000
23	PCH	95.800	28.100	135.100
24	PCH	84.600	27.600	144.200
25	PCH	54.300	63.000	57.300
26	PCH	64.000	50.000	63.500
27	PCH	73.000	54.300	96.700
28	PCH	67.600	52.200	102.000
29	PCH	89.700	50.000	85.700
30	PCH	98.900	50.000	85.700
31	•	•	•	•

One Factor ANOVA X<sub>1</sub> : TREATMENT Y<sub>1</sub> : TRYPAN BLUE

Analysis of Variance Table

Source:	DF:	Sum Squares:	Mean Square:	F-test:
Between groups	2	13432.538	6716.269	30.666
Within groups	27	5913.422	219.016	p = .0001
Total	29	19345.96		

Model II estimate of between component variance = 649.725

One Factor ANOVA X<sub>1</sub> : TREATMENT Y<sub>1</sub> : TRYPAN BLUE

Group:	Count:	Mean:	Std. Dev.:	Std. Error:
CN	10	100	0	0
IH	10	48.17	19.473	6.158
PCH	10	74.43	16.669	5.271

One Factor ANOVA X<sub>1</sub> : TREATMENT Y<sub>1</sub> : TRYPAN BLUE

Comparison:	Mean Diff.:	Fisher PLSD:	Scheffe F-test:	Dunnett t:
CN vs. IH	51.83	13.58*	30.664*	7.831
CN vs. PCH	25.57	13.58*	7.463*	3.863
IH vs. PCH	-26.26	13.58*	7.871*	3.968

\* Significant at 95%

One Factor ANOVA X<sub>1</sub> : TREATMENT Y<sub>2</sub> : LDH

Analysis of Variance Table

Source:	DF:	Sum Squares:	Mean Square:	F-test:
Between groups	2	403.779	201.889	.899
Within groups	27	6060.108	224.448	p = .4186
Total	29	6463.887		

Model II estimate of between component variance = -2.256

One Factor ANOVA X<sub>1</sub> : TREATMENT Y<sub>2</sub> : LDH

Group:	Count:	Mean:	Std. Dev.:	Std. Error:
CN	10	47.7	11.141	3.523
IH	10	56.44	19.289	6.1
PCH	10	50.26	13.31	4.209

One Factor ANOVA X<sub>1</sub> : TREATMENT Y<sub>2</sub> : LDH

Comparison:	Mean Diff.:	Fisher PLSD:	Scheffe F-test:	Dunnett t:
CN vs. IH	-8.74	13.747	.851	1.304
CN vs. PCH	-2.56	13.747	.073	.382
IH vs. PCH	6.18	13.747	.425	.922

One Factor ANOVA X<sub>1</sub> : TREATMENT Y<sub>3</sub> : MTT

Analysis of Variance Table

Source:	DF:	Sum Squares:	Mean Square:	F-test:
Between groups	2	52194.045	26097.022	17.087
Within groups	27	41237.882	1527.329	p = .0001
Total	29	93431.927		

Model II estimate of between component variance = 2456.969

One Factor ANOVA X<sub>1</sub> : TREATMENT Y<sub>3</sub> : MTT

Group:	Count:	Mean:	Std. Dev.:	Std. Error:
CN	10	100	0	0
IH	10	25.17	22.826	7.218
PCH	10	122.83	63.726	20.152

One Factor ANOVA X<sub>1</sub> : TREATMENT Y<sub>3</sub> : MTT

Comparison:	Mean Diff.:	Fisher PLSD:	Scheffe F-test:	Dunnnett t:
CN vs. IH	74.83	35.861*	9.166*	4.281
CN vs. PCH	-22.83	35.861	.853	1.306
IH vs. PCH	-97.66	35.861*	15.611*	5.588

\* Significant at 95%

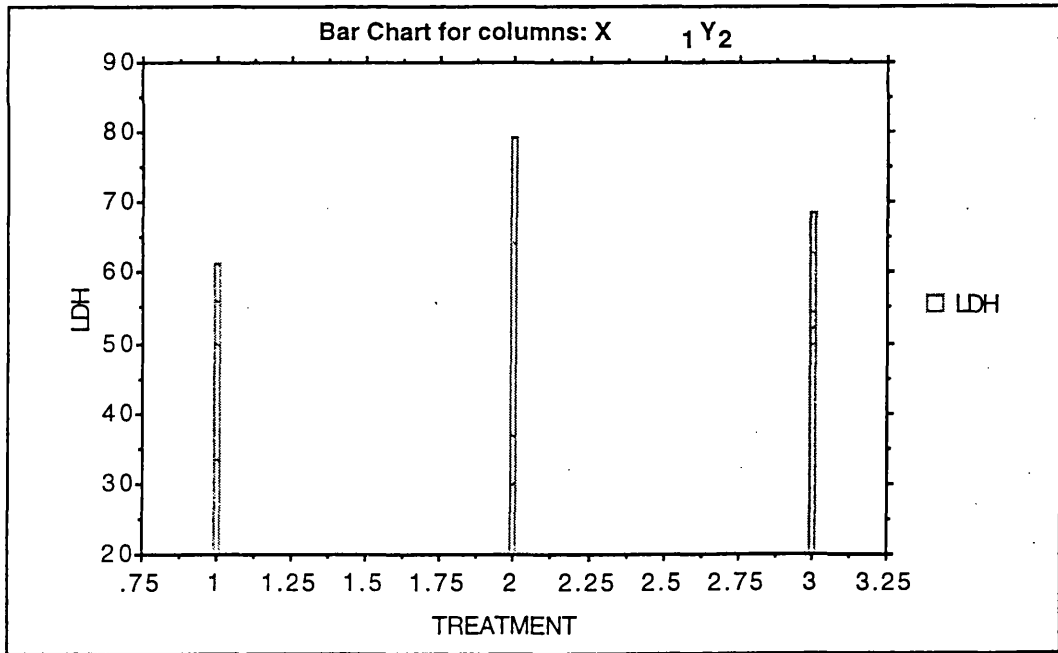
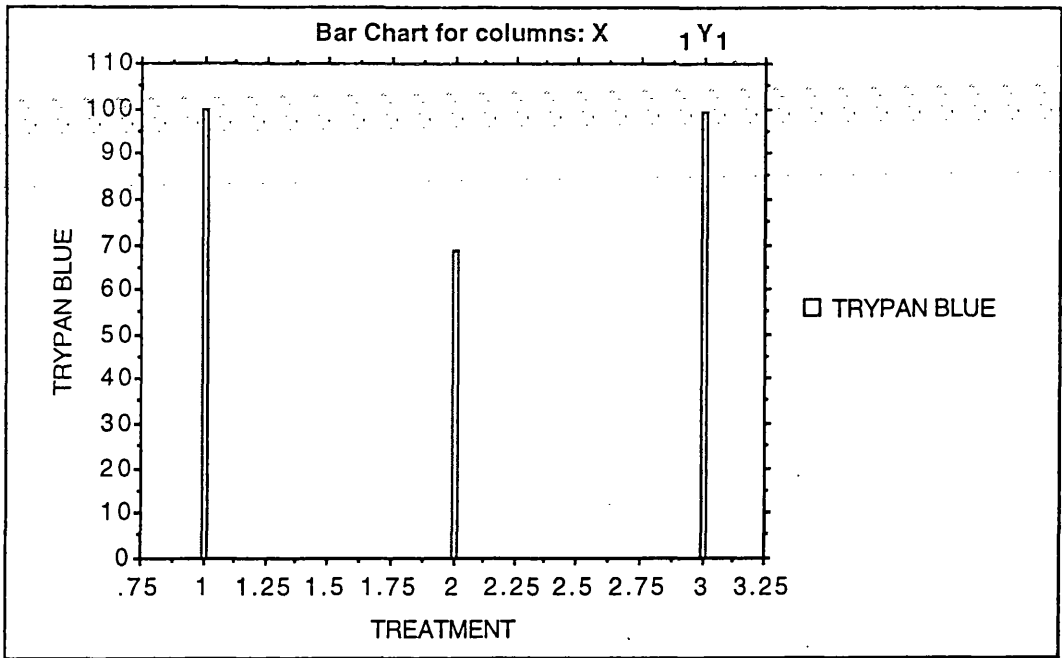



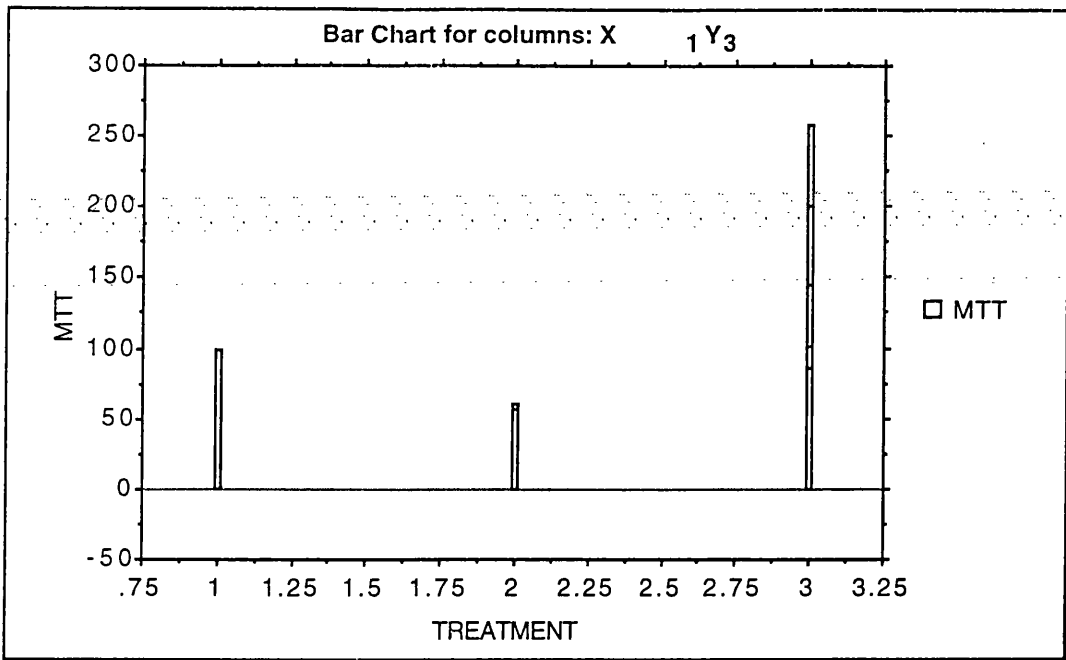

## REFERENCES:

Listed in the order in which they appear in the text.

1. Mortality Statistics: Cause, 1995. Series DH2;22. London: The Stationery Office, 1997

2. Murray CJL, Lopez AD. Alternative projections of mortality and disability by cause 1990 – 2020: Global burden of disease study. *Lancet* 1997;349:1498-1504

3. Libby, P. Molecular bases of the acute coronary syndromes. *Circulation* 1995;91:2844-2850

4. Gruppo Italiano per lo Studio della Streptochinasi nell'Infarto Miocardico (GISSI). Effectiveness of intravenous thrombolytic treatment in acute myocardial infarction. *Lancet* 1986;1:397-402

5. Anversa P, Kajstura J. Ventricular myocytes are not terminally differentiated in the adult mammalian heart. *Circulation Research* 1998; 83: 1-14

6. Kajstura J, Leri A, Finato N, Di-Loreto C, Beltrami CA, Anversa P. Myocyte proliferation in end-stage cardiac failure in humans. *Proceedings of the National Academy of Sciences. USA* 1998; 95: 8801-8805

7. Li F, Wang X, Capasso JM, Gerdes AM. Rapid transition of cardiac myocytes from hyperplasia to hypertrophy during postnatal development. *Journal of Molecular and Cellular Cardiology*. 1996;28:1737-1746

8. Schmoeckel M, Bhatti FN, Zaidi A, Cozzi E, Waterworth PD, Tolan MJ, Goddard M, Warner RG, Langford GA, Dunning JJ, Wallwork J, White DJ. Orthoptic heart transplantation in a transgenic pig-to-primate model. *Transplantation* 1998;65(12):1570-1577

9. Murry CE, Jennings RB, Reimer KA. Preconditioning with ischemia: a delay of lethal cell injury in ischemic myocardium. *Circulation* 1986;74:1124-1136

10. Reimer KA, Murry CE, Yamasawa I, Hill ML, Jennings RB. Four brief periods of myocardial ischemia cause no cumulative ATP loss or necrosis. *American Journal of Physiology* 1986;251:H1305-H1315

11. Schaefer S, Schwartz GG, Wisneski JA, Trocha SD, Christoph I, Steinman Garcia J, Massie-BM, Weiner MW. Response of high-energy phosphates and lactate release during prolonged regional ischemia in vivo. *Circulation*. 1992; 85:342-349

**12.** Parrat JR, Begh A, Kaszala K and Gy Papp J. Suppression of life-threatening arrhythmias by brief periods of ischaemia and by cardiac pacing with particular reference to delayed myocardial protection. *ISCHAEMIA:Preconditioning and adaptation* Ed. Marber MS and Yellon DM Pub. Bios Scientific Publishers UK. 1996

**13.** Barber MJ. Effect of time interval between repeated brief coronary artery occlusions on arrhythmias, electrical activity and myocardial blood flow. *Journal of the American College of Cardiology* 1983;2:699-705

**14.** Shiki K, Hearse DJ. Preconditioning of ischemic myocardium: reperfusion-induced arrhythmias. *American Journal of Physiology* 1987; 253: H1470-14766

**15.** Liu, GS. Thornton, J. Van Winkle, DM. Stanley, AWH. Olsson, RA. Downey, JM. Protection against infarction afforded by preconditioning is mediated by A<sub>1</sub> adenosine receptors in rabbit heart. *Circulation* 1991; 84: 350 – 356

**16.** Cohen MV, Liu GS, Downey JM. Preconditioning causes improved wall motion as well as smaller infarcts after transient coronary occlusion in rabbits. *Circulation.* 1991; 84: 341-349

**17.** Schaefer S, Schwartz GG, Wisneski JA, Trocha SD, Christoph I, Steinman SK, Garcia J, Massie BM, Weiner MW. Response of high-energy phosphates and lactate release during prolonged regional ischemia in vivo. *Circulation.* 1992; 85: 342-349

**18.** Wikstrom BG, Ronquist G, Waldenstrom. A No further improvement of ischaemic myocardial metabolism by combining preconditioning with beta blockade: an in vivo experimental study in the pig heart using a microdialysis technique. *Acta Physiologica Scandinavica.* 1997; 159: 23-32

**19.** Sack S, Mohri M, Arras M, Schwarz ER, Schaper W. Ischaemic preconditioning--time course of renewal in the pig *Cardiovascular Research.* 1993;27:551-555

**20.** Liu Y, Downey JM. Ischemic preconditioning protects against infarction in the rat heart. *American Journal of Physiology* 1992;263:H1107-H1112

**21.** Osada M, Sato T, Komori S, Tamura K. Protective effect of preconditioning on reperfusion induced ventricular arrhythmias of isolated rat hearts. *Cardiovascular Research* 1991; 25: 441-4

**22.** Hagar JM, Hale SL, Kloner RA. Effect of preconditioning ischemia on reperfusion arrhythmias after coronary artery occlusion and reperfusion in the rat.

*Circulation Research* 1991; 68: 61-68

**23.** Deutsch E, Berger M, Kussmaul WG, Hirshfeld JW Jr, Herrmann HC, Laskey WK. Adaptation to ischemia during percutaneous transluminal coronary angioplasty. Clinical, hemodynamic, and metabolic features.

*Circulation*. 1990 ; 82: 2044-51

**24.** Speechly-Dick ME, Grover GJ, Yellon DM. Does ischemic preconditioning

in the human involve protein kinase C and the ATP-dependent K<sup>+</sup> channel?

Studies of contractile function after simulated ischemia in an atrial in vitro model.

*Circulation Research* 1995; 77: 1030-1035

**25.** Liu Ym Kato K, Makata N, Kogure K. Protection of the rat hippocampus against ischaemic neuronal damage by pretreatment with sublethal ischaemia.

*Brain Research* , 1992;586: 121 – 12

**26.** Peralta C, Hotter G, Closa D, Gelpi E, Bulbena O, Rosello-Catafau J.

Protective effect of preconditioning on the injury associated to hepatic ischemia reperfusion in the rat: role of nitric oxide and adenosine.

*Hepatology*. 1997 ;25:934-937

**27.** Pang CY. Yang RZ. Zhong DM. Xu N. Boyd B. and Forrest CR. Acute ischaemic preconditioning protects against skeletal muscle infarction in the pig.

*Cardiovascular Research* 29: 782 – 788, 1995

**28.** Marber MS and Yellon DM *ISCHAEMIA:Preconditioning and adaptation*  
Ed.

Pub. Bios Scientific Publishers UK. 1996

**29.** Lui Y Kloner RA. The cardioprotective effects of ischemic

“preconditioning” are not mediated by adenosine receptors in the rat heart.

*Circulation*. 1993;87:1642-1648

**30.** Asimakis GK, Inners-McBride K, Conti VR. Attenuation of postischaemic dysfunction by ischaemic preconditioning is not mediated by adenosine in the isolated rat heart.

*Cardiovascular Research*. 1993; 27: 1522-1530

**31.** Fu LX, Liang QM, Waagstein F, Hoebeke J, Sylven C, Jansson E;

SotonyiP, Hjalmarson A. Increase in functional activity rather than in amount of Gi-alpha in failing human heart with dilated cardiomyopathy.

*Cardiovascular Research* 1992;26:950-955

**32.** Thornton JD, Liu GS, Downey JM. Pretreatment with pertussis toxin blocks the protective effects of preconditioning: evidence for a G-protein mechanism.

*Journal of Molecular and Cellular Cardiology.* 1993;25:311-20

**33.** Wall TM, Sheehy R, Hartman JC. Role of bradykinin in myocardial preconditioning:

*Journal of Pharmacology and Experimental Therapeutics* 1994 ; 270:681-689

**34.** Bankwala Z, Hale SL, Kloner RA. Alpha-adrenoceptor stimulation with exogenous norepinephrine or release of endogenous catecholamines mimics ischemic preconditioning.

*Circulation.* 1994; 90: 1023-1028

**35.** Schultz JE, Hsu AK, Gross GJ. Morphine mimics the cardioprotective effect of ischemic preconditioning via a glibenclamide-sensitive mechanism in the rat heart.

*Circulation Research* 1996; 78(6): 1100-1104

**36.** Schultz JJ, Hsu AK, Gross GJ. Ischemic preconditioning and morphine-induced cardioprotection involve the delta (delta)-opioid receptor in the intact rat heart.

*Journal of Molecular and Cellular Cardiology.* 1997; 29(8): 2187-2195

**37.** Schultz JE, Hsu AK, Gross GJ. Ischemic preconditioning in the intact rat heart is mediated by delta1- but not mu- or kappa-opioid receptors.

*Circulation.* 1998 ; 97: 1282-1289

**38.** Meldrum DR, Cleveland JC Jr, Meng X, Sheridan BC, Gamboni F, Cain BS, Harken AH, Banerjee A. Protein kinase C isoform diversity in preconditioning.

*Journal of Surgical Research.* 1997;69: 183-187

**39.** Yoshida K, Kawamura S, Mizukami Y, Kitakaze M. Implication of protein kinase C-alpha, delta, and epsilon isoforms in ischemic preconditioning in perfused rat hearts.

*Journal of Biochemistry (Tokyo).* 1997; 122: 506-511

**40.** Bogoyevitch MA, Parker PJ, Sugden PH. Characterization of protein kinase C isotype expression in adult rat heart.

*Circulation Research* 1993;72:757-767

**41.** Ping P, Zhang J, Qiu Y, Tang X-L, Manchikalapudi S, Cao X, Bolli R. Ischaemic preconditioning induces selective translocation of protein kinase C isoforms  $\epsilon$  and  $\eta$  in the heart of conscious rabbits without subcellular redistribution of total protein kinase C activity.

*Circulation Research* 1997;81;404-414

- 42.** Ytrehus K, Liu Y, Downey JM. Preconditioning protects ischemic rabbit heart by protein kinase C activation.  
*American Journal of Physiology* 1994;266: H1145-1152
- 43.** Liu-Y, Cohen MV, Downey JM. Chelerythrine, a highly selective protein kinase C inhibitor, blocks the anti-infarct effect of ischemic preconditioning in rabbit hearts [letter].  
*Cardiovascular Drugs and Therapy*. 1994;8:881-882
- 44.** Speechly-Dick ME, Mocanu MM, Yellon DM. Protein Kinase C: Its Role in Ischemic Preconditioning in the Rat.  
*Circulation Research* 1994;75: 586 – 590
- 45.** Armstrong S, Ganote CE. Preconditioning of isolated rabbit cardiomyocytes: effects of glycolytic blockade, phorbol esters, and ischaemia.  
*Cardiovascular Research* 1994;28:1700-1706.
- 46.** Liu Y, Ytrehus K, Downey JM. Evidence that translocation of protein kinase C is a key event during ischemic preconditioning of rabbit myocardium.  
*Journal of Molecular and Cellular Cardiology*. 1994;26: 661-668
- 47.** Ping P, Zhang J, Qiu Y, Tang XL, Manchikalapudi S, Cao X, Bolli R. Ischemic preconditioning induces selective translocation of protein kinase C isoforms epsilon and eta in the heart of conscious rabbits without subcellular redistribution of total protein kinase C activity.  
*Circulation Research* 1997;81:404-414
- 48.** Simkhovich BZ, Przyklenk K, Hale SL, Patterson M, Kloner RA. Direct evidence that ischemic preconditioning does not cause protein kinase C translocation in rabbit heart.  
*Cardiovascular Research* 1996;32:1064-1070
- 49.** Przyklenk K, Sussman MA, Simkhovich BZ, Kloner RA. Does ischemic preconditioning trigger translocation of protein kinase C in the canine model?  
*Circulation*. 1995;92:1546-1557
- 50.** Kitakaze M, Funaya H, Minamino T, Node K, Sato H, Ueda Y, Okuyama Y, Kuzuya T, Hori M, Yoshida K. Role of protein kinase C-alpha in activation of ecto-5'-nucleotidase in the preconditioned canine myocardium.  
*Biochemical and Biophysical Research Communications* 1997;239:171-175
- 51.** Gross GJ, and Auchampach JA, Blockade of ATP-sensitive potassium channels prevents myocardial preconditioning in dogs.  
*Circulation Research* 1992;70:223 – 233
- 52.** Armstrong SC, Liu G, Downey J, Ganote C.  $K_{ATP}$  channels and preconditioning of rabbit cardiomyocytes.  
*J. Molecular and Cellular Cardiology* 1995;27:A23,

**53.** Cavero I, Djellas Y, Guillon J-M. Ischemic myocardial cell protection conferred by the opening of ATP-sensitive potassium channels.

*Cardiovascular Drugs and Therapy* 1995;9: 245-255

**54.** Grover GJ, McCullough JR, D'Alonzo AJ, Sargent CA, Atwal KS. Cardioprotective profile of the cardiac-selective ATP-sensitive potassium channel opener BMS-180448.

*Journal of Cardiovascular Pharmacology* 1995;25:40-50

**55.** Noma A. ATP-regulated K<sup>+</sup> channels in cardiac muscle. \*

*Nature* 1983; 305:147 – 148

**56.** Edwards G, Ibbotson T, Weston AH. Levromakalim may induce a voltage-independent K-current in rat portal veins by modifying the gating properties of the delayed rectifier.

*British Journal of Pharmacology*. 1993;110: 1037-1048

**57.** Inoue-I; Nagase-H; Kishi-K; Higuti-T ATP-sensitive K<sup>+</sup> channel in the mitochondrial inner membrane.

*Nature*. 1991;352: 244-247

**58.** Garlid KD, Paucek P, Yarov-Yarovoy V, Sun X, Schindler PA. The mitochondrial KATP channel as a receptor for potassium channel openers.

*Journal of Biological Chemistry*. 1996;271:8796-8799

**59.** Grover GJ. Pharmacology of ATP-sensitive potassium channel (KATP) openers in models of myocardial ischemia and reperfusion.

*Canadian Journal of Physiology and Pharmacology* 1997;75:309-315 Review

**60.** Hide EJ, Thiernemann-C. Limitation of myocardial infarct size in the rabbit by ischaemic preconditioning is abolished by sodium 5-hydroxydecanoate.

*Cardiovascular Research* 1996;31:941-946

**61.** Schultz JE, Qian YZ, Gross GJ, Kukreja RC. The ischemia-selective KATP channel antagonist, 5-hydroxydecanoate, blocks ischemic preconditioning in the rat heart.

*Journal of Molecular and Cellular Cardiology*. 1997;29:1055-1060

**62.** Yao Z, Mizumura T, Mei DA, Gross GJ. KATP channels and memory of ischemic preconditioning in dogs: synergism between adenosine and KATP channels.

*The American Journal of Physiology* 1997;272: H334-H342

**63.** Mizumura T, Nithipatikom K, Gross-GJ. Bimakalim, an ATP-sensitive potassium channel opener, mimics the effects of ischemic preconditioning to reduce infarct size, adenosine release, and neutrophil function in dogs.

*Circulation*. 1995;92:1236-1245

**64.** Light PE, Allen BG, Walsh MP, French RJ. Regulation of adenosine triphosphate-sensitive potassium channels from rabbit ventricular myocytes by protein kinase C and type 2A protein phosphatase.

*Biochemistry.* 1995;34:7252-7257

**65.** Thornton J, Striplin S, Liu-GS, Swafford A, Stanley AW, Van-Winkle DM, Downey JM. Inhibition of protein synthesis does not block myocardial protection afforded by preconditioning *American Journal of Physiology* 1990;259:H1822-H1825 Goto.

**66.** M, Cohen MV, van-Wylen DG, Downey JM. Attenuated purine production during subsequent ischemia in preconditioned rabbit myocardium is unrelated to the mechanism of protection.

*Journal of Molecular and Cellular Cardiology* 1996;28: 447-454

**67.** Wolfe CL, Sievers RE, Visseren FL, Donnelly TJ Loss of myocardial protection after preconditioning correlates with the time course of glycogen recovery within the preconditioned segment.

*Circulation.* 1993;87: 881-892

**68.** King LM, Opie LH. Does preconditioning act by glycogen depletion in the isolated rat heart?

*Journal of Molecular and Cellular Cardiology* 1996;28:2305-2321

**69.** Weinbrenner C, Wang P, Downey JM. Loss of glycogen during preconditioning is not a prerequisite for protection of the rabbit heart.

*Basic Research in Cardiology.* 1996;91:374-381

**70.** Ladilov YV, Siegmund B, Piper HM. Protection of reoxygenated cardiomyocytes against hypercontracture by inhibition of Na<sup>+</sup>/H<sup>+</sup> exchange.

*American Journal of Physiology* 1995; 268: H1531-1539

**71.** Garcia-Dorado D, Gonzalez MA, Barrabes JA, Ruiz-Meana M, Solares J, Lidon RM, Blanco J, Puigfel Y, Piper HM, Soler-Soler J. Prevention of ischemic rigor contracture during coronary occlusion by inhibition of Na<sup>(+)</sup>-H<sup>+</sup> exchange.

*Cardiovascular Research* 1997; 35: 80-89

**72.** Garcia-Dorado D, Ruiz-Meana M. The (still) unknown mechanism of ischemic preconditioning: possible involvement of reduced Na<sup>+</sup>/H<sup>+</sup> exchange

*Basic Research in Cardiology.* 1997;92, Suppl 2:43-45

**73.** Bugge E, Ytrehus K. Inhibition of sodium-hydrogen exchange reduces infarct size in the isolated rat heart – a protective additive to ischaemic preconditioning

*Cardiovascular Research* 1995;29:269-274?

**74.** Peterson OH. *Stimulus-secretion coupling in gland cells.* in Fundamentals of Medical Cell Biology. vol 5: Membrane dynamics and signalling. 1992 Ed. Edward Brittar. Pub. JAI Press inc.



- 75.** Tissieres A, Mitchell HK, Tracy UM. Protein synthesis in salivary glands of *Drosophila melanogaster*: relation to chromosome puffs.  
*J Molecular Biology* 1974;84: 389 –398
- 76.** Lindquist S, Craig EA. The heat-shock proteins.  
*Annual Review of Genetics* 1988;22: 631 - 637
- 77.** Hartl F. Molecular chaperones in cellular protein folding.  
*Nature* 1996;381: 571 –579
- 78.** Iwak K, Chi SH, Dillmann WH, Mestri-R. Induction of HSP70 in cultured rat neonatal cardiomyocytes by hypoxia and metabolic stress.  
*Circulation*. 1993;87: 2023-202
- 79.** Marber MS, Latchman DS, Walker JM, Yellon DM. Cardiac stress protein elevation 24 hours after brief ischemia or heat stress is associated with resistance to myocardial infarction.  
*Circulation*. 1993; 88:1264-1272
- 80.** Kuzuya T, Hoshida S, Yamashita N, Fuji H, Oe H, Hori M, Kamada T, Tada M. Delayed effects of sublethal ischemia on the acquisition of tolerance to ischemia.  
*Circulation Research*. 1993 Jun; 72(6): 1293-9
- 81.** Hoshida S, Kuzuya T, Fuji H, Yamashita N, Oe H, Hori M, Suzuki K, Taniguchi N, Tada M. Sublethal ischemia alters myocardial antioxidant activity in canine heart.  
*The American Journal of Physiology* 1993 ; 264: H33-H39
- 82.** Das DK, Engelman RM, Kimura Y. Molecular adaptation of cellular defences following preconditioning of the heart by repeated ischaemia.  
*Cardiovascular Research* 1993; 27: 578-584
- 83.** Das DK, Maulik N, Moraru, II. Gene expression in acute myocardial stress. Induction by hypoxia, hyperthermia and oxidative stress.  
*Journal of Molecular and Cellular Cardiology* 1995;27:181-193
- 84.** Tanaka M, Fujiwara H, Yamasaki K, Miyamae M, Yokota R, Hasegawa K, Fujiwara T, Sasayama S. Ischemic preconditioning elevates cardiac stress protein but does not limit infarct size 24 or 48 h later in rabbits.  
*American Journal of Physiology* 1994;267:H1476-H1482
- 85.** Cumming DVE, Heads RJ, Brand NJ, Yellon DM, Latchman DS. The ability of heat stress and metabolic preconditioning to protect primary rat cardiac myocytes.  
*Basic Research in Cardiology* 1996;91:79-85
- 86.** Marber MS. Stress proteins and myocardial protection.  
*Clinical Science* 1994;86:375-381

- 87.** Yellon-DM, Marber MS. Hsp70 in myocardial ischaemia. *Experientia*. 1994; 50: 1075-1084
- 88.** Marber MS, Mestril R, Chi SH, Sayen MR, Yellon DM, Dillmann WH. Overexpression of the rat inducible 70-kD heat stress protein in a transgenic mouse increases the resistance of the heart to ischemic injury. *Journal of Clinical Investigation*.1995;95:1446-1456
- 89.** Cumming DV, Heads RJ, Watson A, Latchman DS, Yellon DM. Differential protection of primary rat cardiocytes by transfection of specific heat stress proteins. *Journal of Molecular and Cellular Cardiology* 1996;28:2343-2349
- 90.** Heads RJ, Latchman DS, Yellon DM. Stable high level expression of a transfected human HSP70 gene protects a heart-derived muscle cell line against thermal stress. *Journal of Molecular and Cellular Cardiology* 1994;26:695-699
- 91.** Yellon DM, Latchman DS, Marber MS. Stress proteins – an endogenous route to myocardial protection: fact or fiction. *Cardiovascular Research* 1993;27:158-161
- 92.** Mestril R; Dillmann WH. Heat shock proteins and protection against myocardial ischemia. *Journal of Molecular and Cellular Cardiology* 1995;27:45-52
- 93.** Nakano M, Mann DL, Knowlton AA. Blocking the endogenous increase in HSP72 increases susceptibility to hypoxia and reoxygenation in isolated adult feline cardiocytes. *Circulation* 1997;95:1523-1531
- 94.** Yellon DM, Latchman DS. Stress Proteins and myocardial protection. *Journal of Molecular and Cellular Cardiology* 1992;24:113-124
- 95.** Tanaka M, Fujiwara H, Yamasaki K, Miyamae M, Yokota R, Hasegawa K, Fujiwara T, Sasayama S. Ischemic preconditioning elevates cardiac stress protein but does not limit infarct size 24 or 48 h later in rabbits. *American Journal of Physiology* 1994; 267:H1476-H1482
- 96.** Downey JM; Cohen MV. Signal transduction in ischemic preconditioning. *Advances in Experimental Medicine and Biology* 1997; 430: 39-55
- 97.** Headrick JP. Ischemic preconditioning: Bioenergetic and metabolic changes and the role of endogenous adenosine. *Journal of Molecular and Cellular Cardiology* 1996;28:1227-1240
- 98.** Tsuchida A, Liu GS, Wilborn WH, Downey-JM. Pretreatment with the adenosine A1 selective agonist, 2-chloro-N6-cyclopentyladenosine (CCPA), causes a sustained limitation of infarct size in rabbits. *Cardiovascular Research* 1993; 27: 652-656

- 99.** Armstrong S, Downey JM, Ganote CE. Preconditioning of isolated rabbit cardiomyocytes: Induction by metabolic stress and blockade by the adenosine antagonist SPT and calphostin C, a protein kinase C inhibitor.  
*Cardiovascular Research* 1994;28:72-77
- 100.** Armstrong S, Ganote CE. Adenosine receptor specificity in preconditioning of isolated rabbit cardiomyocytes: evidence of A<sub>3</sub> receptor involvement.  
*Cardiovascular Research* 1994;28:1049-1056
- 101.** Rice PJ, Armstrong S, Ganote CE. Concentration-response relationships for adenosine agonists during preconditioning of rabbit cardiomyocytes.  
*Journal of Molecular and Cellular Cardiology* 1996;28:1355-1365
- 102.** Tsuchida A, Liu GS, Wilborn WH, Downey JM. Pretreatment with the adenosine A1 selective agonist, 2-chloro-N6-cyclopentyladenosine (CCPA), causes a sustained limitation of infarct size in rabbits.  
*Cardiovascular Research* 1993; 27: 652-656
- 103.** Bell RM, and Burns DJ. Lipid activation of protein kinase C.  
*Journal of Biological Chemistry* 1991;266:4661 – 4664
- 104.** Bugge E, Ytrehus K. Ischaemic preconditioning is protein kinase C dependent but not through stimulation of alpha adrenergic or adenosine receptors in the isolated rat heart.  
*Cardiovascular Research* 1995; 29:401-406
- 105.** Tani M, Suganuma Y, Hasegawa H, Shinmura K, Hayashi Y, Guo X, Nakamura Y. Changes in ischemic tolerance and effects of ischemic preconditioning in middle-aged rat hearts.  
*Circulation*. 1997;95: 2559-2566
- 106.** Deegenars-ML; Watson-K. Stress proteins and stress tolerance in an Antarctic, psychrophilic yeast, *Candida psychrophila*.  
*FEMS Microbiol Lett*. 1997; 151: 191-196
- 107.** Yealy DM. How much "significance" is significant? The transition from animal models to human trials in resuscitation research.  
*Annals of Emergency Medicine* 1993; 2: 11-6
- 108.** Gresham GA, Howard AN. Using primates in medical research. 2. Recent comparative research. Cardiovascular diseases.  
*Primates Med*. 1969; 3: 1-8
- 109.** Ratcliffe HL. Age and environment as factors in the nature and frequency of cardiovascular lesions in mammals and birds in the Philadelphia Zoological Garden.  
*Annals of the New York Academy of Sciences* 1965; 127:715-735

- 110.** Croll DH, Ausman LM, Nicolosi RJ. Cholesterol metabolism in New World primates: comparative studies in two tamarin species (*Saguinus oedipus* and *Saguinus fuscicollis*) and the squirrel monkey (*Saimiri sciureus*). *Comparative Biochemistry and Physiology* . 1993; 106:845-53
- 111.** Harris EL, Phelan EL, Thompson CM, Millar JA, Grigor MR. Heart mass and blood pressure have separate genetic determinants in the New Zealand genetically hypertensive (GH) rat. *Journal of Hypertension*. 1995; 13:397-404
- 112.** Strassheim D, Houslay MD, Milligan G. Regulation of cardiac adenylate cyclase activity in rodent models of obesity. *Biochemical Journal*. 1992;283: 203-208
- 113.** Hughes HC. Swine in cardiovascular research. *Laboratory Animal Science*. 1986; 36: 348-350
- 114.** Goldman S, Raya TE. Rat infarct model of myocardial infarction and heart failure. *Journal of Cardiac Failure*. 1995;1: 169-177
- 115.** Goto M, Miura T, Iliodoromitis EK, O'Leary EL, Ishimoto R, Yellon DM, Iimura O. Adenosine infusion during early reperfusion failed to limit myocardial infarct size in a collateral deficient species. *Cardiovascular Research* 1991;22: 943-949
- 116.** Rubsamen K, Eschenfelder V. Effect of recombinant hirudin (LU 52369) on reocclusion rates after thrombolysis in rabbits. *Haemostasis*. 1991; 21: 93-98
- 117.** Przyklenk K, Kloner RA. Oxygen radical scavenging agents as adjuvant therapy with tissue plasminogen activator in a canine model of coronary thrombolysis. *Cardiovascular Research*. 1993; 27: 925-34
- 118.** Nee PA. Thrombolysis after acute myocardial infarction. *Journal of Accident and Emergency Medicine*. 1997;14: 2-9
- 119.** Mohabir R, Ferrier GR. Effects of verapamil and nifedipine on mechanisms of arrhythmia in an in vitro model of ischemia and reperfusion. *Journal of Cardiovascular Pharmacology* 1991; 17:74-82
- 120.** Himori N, Walls AP, Burkman AM. Ischaemically induced alterations in electrical activity and mechanical performance of isolated blood perfused canine myocardial preparations. *Cardiovascular Research* 1990; 24:786-792
- 121.** Peterson JN, Hunter WC, Berman MR. Estimated time course of Ca<sup>2+</sup> bound to troponin C during relaxation in isolated cardiac muscle. *American Journal of Physiology* 199;260: H1013-H1024

**122.** Robertson MJ, Lumley P. Effects of hypoxia, elevated K<sup>+</sup> and acidosis on the potency of verapamil, diltiazem and nifedipine in the guinea-pig isolated papillary muscle. *British Journal of Pharmacology*. 1989; 98: 937-949

**123.** Cave AC, Apstein CS. Polymyxin B, a protein kinase C inhibitor, abolishes preconditioning-induced protection against contractile dysfunction in the isolated blood perfused rat heart. *Journal of Molecular and Cellular Cardiology* 1996; 28: 977-987

**124.** Alkhulaifi AM. Preconditioning the human heart. *Annals of the Royal College of Surgeons England* 1997; 79:49-54

**125.** Ylitalo K, Airaksinen J, Ikaheimo M, Ruskoaho H, Peuhkurinen K. No evidence for ischemic preconditioning during repeated vessel occlusion in coronary angioplasty. *International Journal of Cardiology*. 1996 Aug; 55(3): 227-237

**126.** Eltchaninoff-H; Cribier-A; Tron-C; Derumeaux-G; Koning-R; Hécketsweiler-B; Letac-B Adaptation to myocardial ischemia during coronary angioplasty demonstrated by clinical, electrocardiographic, echocardiographic, and metabolic parameters. *American Heart Journal* 1997; 133:4960-4966

**127.** Walker DM, Walker JM, Yellon-DM. Global myocardial ischemia protects the myocardium from subsequent regional ischemia. *Cardioscience*. 1993;4:263-266

**128.** Jenkins DP, Steare SE, Yellon DM. Preconditioning the human myocardium: recent advances and aspirations for the development of a new means of cardioprotection in clinical practice. *Cardiovascular Drugs and Therapy*. 1995;9:739-747

**129.** Brunvand H, Rynning SE, Hexeberg E, Westby J, Grong K. Non-uniform recovery of segment shortening during reperfusion following regional myocardial ischaemia despite uniform recovery of ATP. *Cardiovascular Research* 1995;30:138-146

**130.** Schjott J, Bakoy OE, Jones RA, Southon T, Jynge P. Preconditioning by brief ischaemic episodes in the isolated rat heart assessed by <sup>31</sup>P NMR spectroscopy: dissociation between metabolic and functional recovery? *Scandinavian Journal of Clinical and Laboratory Investigation* 1995;55:67-78

**131.** Davies CH, Harding SE, Poole-Wilson PA. Cellular mechanisms of contractile dysfunction in human heart failure. *European Heart Journal* 1996;17:189-198

**132.** Davia K, Davies CH, Harding SE. Effects of inhibition of sarcoplasmic reticulum calcium uptake on contraction in myocytes isolated from failing human ventricle. *Cardiovascular Research*. 1997;33: 88-97

- 133.** Smolenski RT, Suitters A, Yacoub MH. Adenine nucleotide catabolism and adenosine formation in isolated human cardiomyocytes.  
*Journal of Molecular and Cellular Cardiology* 1992;24:91-96
- 134.** Claycomb WC, Delcarpio JB, Guice SE, Moses RL. Culture and characterization of fetal human atrial and ventricular cardiac muscle cells.  
*In-Vitro Cellular and Developmental Biology*. 1989;25:1114-1120
- 135.** Li R-K, Tumiati LC, Wiesel RD, Mickle DAG. Isolation of cardiomyocytes from human myocardium for primary cell culturing.  
*Journal of Tissue Culture Methods* 1993;15:147-154
- 136.** Ikonimides JS, Tumiati LC, Weisel RD, Mickle DAG, Li R-K. Preconditioning human ventricular cardiomyocytes with brief periods of simulated ischaemia.  
*Cardiovascular Research* 1994;28:11285-291
- 137.** Peeters GA, Sanguinetti MC, Eki Y, Konarzewska H, Renlund DG, Karwande SV, Barry WH. Method for isolation of human ventricular myocytes from single endocardial and epicardial biopsies.  
*American Journal of Physiology* 1995;268:h1757-1764
- 138.** Cave AC, Adrian S, Apstein CS, Silverman HS A model of anoxic preconditioning in the isolated rat cardiac myocyte. Importance of adenosine and insulin.  
*Basic Research in Cardiology* 1996;91:210-218
- 139.** Takewaki S, Kuro-o M, Hiroi Y, Yamazaki T, Noguchi T, Miyagishi A, Nakahara K, Aikawa M, Manabe I, Yazaki Y, et-al  
Activation of Na(+)-H+ antiporter (NHE-1) gene expression during growth, hypertrophy and proliferation of the rabbit cardiovascular system.  
*Journal of Molecular and Cellular Cardiology*. 1995;27: 729-742
- 140.** Hearse DJ. Myocardial ischaemia: can we agree on a definition for the 21<sup>st</sup> Century?  
*Cardiovascular Research* 1994;28:1737-1744
- 141.** Opie, LH. *THE HEART: Physiology and metabolism* Pub. Raven Press, New York. 2<sup>nd</sup> edition 1991
- 142.** CRC Handbook: *Eukaryotic Gene Regulation Vol1*. Ed. Gerald M Kolodny. Pub. CRC Press, Florida USA. 1980
- 143.** Yeh P, Perricaudet M Advances in adenoviral vectors: from genetic engineering to their biology.  
*FASEB-Journal* 1997; 11: 615-623
- 144.** Recombinant growth factor gene expression in vascular cells in vivo.  
Nabel EG, Plautz GE, Nabel GJ  
*Annals of the New York Academy of Science*. 1994;714: 247-252

- 145.** Rich DP, Couture LA, Cardoza LM, Guiggio VM, Armentano D, Espino PC, Hehir K, Welsh MJ, Smith AE, Gregory RJ. Development and analysis of recombinant adenoviruses for gene therapy of cystic fibrosis. *Human Gene Therapy*. 1993; 4: 461-476
- 146.** Gilgenkrantz H, Duboc D, Juillard V, Couton D, Pavirani A, Guillet JG, Briand P, Kahn A. Transient expression of genes transferred in vivo into heart using first-generation adenoviral vectors: role of the immune response. *Human Gene Therapy* 1995; 6:1265-1274
- 147.** Uckert W, Walther W. Retrovirus-mediated gene transfer in cancer therapy. (Review)  
*Pharmacology and Therapeutics*. 1994;63:323-347
- 148.** Teifel M, Heine LT, Milbredt S, Friedl P. Optimization of transfection of human endothelial cells. (able to obtain only the abstract)  
*Endothelium*. 1997; 5:21-35
- 149.** Wrobel I, Collins D. Fusion of cationic liposomes with mammalian cells occurs after endocytosis.  
*Biochimica et Biophysica Acta*. 1995; 1235: 296-304
- 150.** Friend DS, Papahadjopoulos D, Debs RJ. Endocytosis and intracellular processing accompanying transfection mediated by cationic liposomes.  
*Biochimica et Biophysica Acta*. 1996;1278:41-50
- 151.** Stephan DJ, Yang ZY, San H, Simari RD, Wheeler CJ, Felgner PL, Gordon D, Nabel GJ, Nabel EG. A new cationic liposome DNA complex enhances the efficiency of arterial gene transfer in vivo.  
*Human Gene Therapy*. 1996 ;7:1803-1812
- 152.** Lascombe I, Mougin P, Vuillermoz C, Adessi GL, Jouvenot M. Gene transfer into subcultured endometrial cells using lipofection.  
*Biotechniques*. 1996;20: 88-91
- 153.** Paukku T, Lauraeus S, Huhtaniemi I, Kinnunen PK. Novel cationic liposomes for DNA-transfection with high efficiency and low toxicity.  
*Chemistry and Physics of Lipids* 1997; 87:23-29
- 154.** Wright MJ, Rosenthal E, Stewart L, Wightman LM, Miller AD, Latchman DS, Marber MS. beta-Galactosidase staining following intracoronary infusion of cationic liposomes in the in vivo rabbit heart is produced by microinfarction rather than effective gene transfer: a cautionary tale.  
*Gene Therapy*. 1998 ; 5: 301-308
- 155.** Shewring L, Collins L, Lightman SL, Hart S, Gustafsson K, Fabre JW. A nonviral vector system for efficient gene transfer to corneal endothelial cells via membrane integrins.  
*Transplantation*. 1997; 64:763-769

- 156.** Haddad J, Decker ML, Hsieh L-C, Lesch M, Samarel AM, Decker RS. Attachment and maintenance of adult rabbit cardiac myocytes in primary cell culture.  
*American Journal of Physiology* 1988; 255: C19 – C27
- 157.** Burnette WN. "Western blotting": electrophoretic transfer of proteins from sodium dodecyl sulfate--polyacrylamide gels to unmodified nitrocellulose and radiographic detection with antibody and radioiodinated protein A.  
*Annals of Biochemistry*. 198;112:195-203
- 158.** Dulley JR, Grieve PA. A simple technique for eliminating interference by detergents in the Lowry method of protein determination.  
*Analytical Biochemistry*. 1975; 64:136-141
- 159.** Phillips HJ. *Tissue Culture: Methods and Applications*. Ed. Kruse, PF. and Patterson, MK. Pub. Academic Press, New York, 1973
- 160.** Alley MC, Scudeiro DA, Monks A. Feasibility of drug screening with panels of human tumor cell lines using a microculture tetrazolium assay.  
*Cancer Research* 1988;48: 589 –601
- 161.** Marshall NJ, Goodwin CJ, Holt SJ. A Critical Assessment of the Use of Microculture Tetrazolium Assays to Measure Cell Growth and Function.  
*Growth Regulation* 1995;5:69-84
- 162.** Slater TF, Sawyer B, Stråuli U. Studies on succinate-tetrazolium reductase systems III. Points of coupling of four different tetrazolium salts.  
*Biochimica et Biophysica Acta*.1963;77:383-393
- 163.** Baltrop JA, Owen TC, Cory AH, Cory JG. 5-(3 Carboxymethoxyphenyl)-2(4-5-dimethylthiazolyl)-3-(4-sulfophenyl) tetrazolium, inner salt (MTS) and related analogs of MTT reducing to purple water-soluble formazans as cell-viability indicators.  
*Bioorganic Medical and Chemical Letters* 1991;1: 611 – 614,
- 164.** Glick MR, Burns AH, Reddy WJ. Dispersion and isolation of beating cells from adult rat heart.  
*Annals of Biochemistry*. 1974; 61: 32-42
- 165.** Powell T, Twist VW. A rapid technique for the isolation and purification of adult cardiac muscle cells having respiratory control and a tolerance to calcium.  
*Biochemical and Biophysical Research Communications* 1976;72 :327 – 333,
- 166.** Nag AC, Healy CJ, Cheng M. Organ culture of adult amphibian heart: a fine structural analysis.  
*Tissue and Cell*. 1979; 11: 231-248
- 167.** Claycomb WC, Palazzo MC. Culture of the terminally differentiated adult cardiac muscle cell: a light and scanning electron microscope study.  
*Developmental Biology*. 1980; 80: 466-482



**168.** Schwarzfeld TA, Jacobson SL. Isolation and development in cell culture of myocardial cells of the adult rat.

*Journal of Molecular and Cellular Cardiology* 1981;13:563-575

**169.** Bihler I, Ho TK, Sawh PC. Isolation of  $Ca^{2+}$ -tolerant myocytes from adult rat heart.

*Canadian Journal of Physiology and Pharmacology* 1983;62: 581 – 588

**170.** Jacobson SL, Piper HM. Cell cultures of adult cardiomyocytes as models of the myocardium.

*Journal of Molecular and Cellular Cardiology* 1986;18:661-678

**171.** Powell T. Electrophysiological properties of isolated ventricular myocytes.

*Basic Research in Cardiology.* 1985; 80: 87-91

**172.** Isenberg G, Klockner U. Calcium Tolerant ventricular myocytes prepared by preincubation in a "KB Medium".

*European Journal of Physiology (Pfleugers Archives)* 1982,395:6-18

**173.** Powell T, Steen EM, Twist VW, Woolf N. Surface characteristics of cells isolated from adult rat myocardium.

*Journal of Molecular and Cellular Cardiology* 1978;10:287-292

**174.** Bugiasky LB, Zak R. Differentiation of adult rat cardiac myocytes in cell culture.

*Circulation Research* 1989;64:493-500

**175.** Lundgren L, Terracio L., Mårdh SV, Borg TK. Extracellular matrix components influence the survival of adult cardiac myocytes in vitro.

*Experimental Cell Research* 1985;158:371-381

**176.** Wittenberg BA, Robinson TF. Oxygen requirements, Morphology, Cell coat and Membrane Permeability of Calcium-Tolerant Myocytes from Hearts of Adult Rats.

*Cell and Tissue Research* 1981;216: 231 – 251

**177.** Lundgren L, Borg TK, Mårdh S. Isolation, Characterisation and Adhesion of Calcium --Tolerant myocytes from the Adult Rat Heart.

*Journal of Molecular and Cellular Cardiology* 1984;16: 355 – 362

**178.** Nag AC, Cheng M. Adult mammalian cardiac muscle cells in culture.

*Tissue and Cell* 1981;13: 515 – 523

**179.** White RL, Wittenberg BA. NADH Fluorescence of isolated ventricular myocytes: Effects of pacing, myoglobin and oxygen supply.

*Biophysical Journal* 1993;65:196-204

**180.** Horackova M, Mapplebeck C. Electrical, contractile and ultrastructural properties of adult rat and guinea-pig ventricular myocytes in long-term primary

cultures.

*Canadian Journal of Physiology and Pharmacology* 1989;67:740-750

**181.** Horackova M, Huang MH, Armour JA. Purinergic modulation of adult guinea pig cardiomyocytes in long term cultures and co-cultures with extracardiac or intrinsic cardiac neurones.

*Cardiovascular Research* 1994;28:673-679

**182.** Mitcheson JS, Hancox JC, Levi AJ. Cultured adult cardiac myocytes: Future applications, culture methods, morphological and electrophysiological properties.

*Cardiovascular Research* 1998;39: 280 – 300,

**183.** Mitruka, BM. and Rawnsley, HM *Clinical Biochemical and Heamatological Reference Values in Mormal Experimental Animals*. Pub. Masson, New York 1977

**184.** Woolfensohn S, Lloyd M. Handbook of laboratory animal management and welfare. Pub: Oxford University Press. 1994

**185.** Mitra R, Morad M. A uniform enzymatic method for dissociation of myocytes from hearts and stomachs of vertebrates.

*American Journal of Physiology* 1985;249:H1056-H1060

**186.** Loewenstein WR. Membrane channels in the junction between cells: formation, gating and functions.

In Burton-RM, Packer L. *Biomembranes lipids proteins and receptors*.

Ed : Webster Groves . BI Science Publications, 1975

**187.** Viko H, Osnes J-B, Sjetnan AE, Skomedal T. Improved Isolation of Cardiomyocytes by Trypsination in Addition to Collagenase Treatment.

*Pharmacology and Toxicology* 1995;76: 68 – 71

**188.** Bustamante JO, Wanatabe T, McDonald TF. Non-specific proteases: a new approach to the isolation of adult cardiocytes.

*Canadian Journal of Physiology and Pharmacology* 1982;60:997-1002

**189.** Zimmerman AN, Hulsman WC. Paradoxical influence of calcium ions on the permeability of the cell membranes of the isolated rat heart.

*Nature* 1966;211:646 – 647

**190.** *The Biology of Isolated Adult Cardiac Myocytes*. Ed. Clark WA, Decker RS, Borg TK. Pub. Elsevier, New York. 1988

**191.** Mitchell MR, Powell,T, Terrar DA, Twist-VW. Electrical activity and contraction in cells isolated from rat and guinea-pig ventricular muscle: a comparative study.

*Journal of Physiology London*. 1987;391: 527-544

- 192.** Clark WA, Rudnick SJ, LaPres JJ, Lesch M, Decker RS. Hypertrophy of isolated adult feline heart cells following  $\beta$ -adrenergic-induced beating. *American Journal of Physiology*; 1991;261:C530-C542.
- 193.** Pollack PS, Carson NL, Nuss HB, Marino TA, Houser SR. Mechanical properties of adult feline ventricular myocytes in culture. *American Journal of Physiology* 1991;260: H234-H241
- 194.** Decker ML, Behnke-Barclay M, Cook MG, LaPres JJ, Clark WA, Decker RS. Cell shape and organization of the contractile apparatus in cultured adult cardiac myocytes. *Journal of Molecular and Cellular Cardiology* 1991; 23: 817-832
- 195.** Messerli JM, Eppenberger-Eberhardt ME, Rutishauser BM, Schwarb P, von-Arx P, Koch-Schneidemann S, Eppenberger HM, Perriard JC. Remodelling of cardiomyocyte cytoarchitecture visualized by three-dimensional (3D) confocal microscopy. *Histochemistry*. 1993; 100: 193-202
- 196.** Bodin F, Travo C, Stoclet J-C, Travo P. High sensitivity of hypertensive aortic myocytes to norepinephrine and angiotensin. *American Journal of Physiology* 1993;264:C441-C445
- 197.** Borg TK, Rubin K, Lundgren E, Borg K, Obrink B. Recognition of extracellular matrix components by neonatal and adult cardiac myocytes. *Developmental Biology* 1984;104:86-96
- 198.** Lundgren E, Gullberg D, Rubin K, Borg TK, Terracio MJ, Terracio L. In vitro studies on adult cardiac myocytes: attachment and biosynthesis of collagen type IV and laminin. *Journal of Cell Physiology*. 1988;136: 43-53
- 199.** Spahr R, Probst I, Piper HM. Substrate utilization of adult cardiac myocytes. *Basic Research in Cardiology* 1985;80:53-56
- 200.** Reikeras O, Gunnes S, Ytrehus K, Nordstrand K. Preservation of high energy phosphates during ischaemic cardiac arrest with glucose. *Scandinavian Journal of Thoracic and Cardiovascular Surgery*. 1987;21:169-171
- 201.** Schaefer S, Ramasamy R. Glycogen utilization and ischemic injury in the isolated rat heart. *Cardiovascular Research* 1997 ;35: 90-98
- 202.** Atherton BT, Meyer DM, Simpson DG. Assembly and remodelling of myofibrils and intercalated discs in cultured neonatal rat heart cells. *Journal of Cell Science* 1986;86:233-248

**203.** Harder BA, Schaub MC, Eppenberger HM, Eppenberger-Eberhardt M. Influence of fibroblast growth factor (bFGF) and insulin-like growth factor (IGF-I) on cytoskeletal and contractile structures and on atrial natriuretic factor (ANF) expression in adult rat ventricular cardiomyocytes in culture.

*Journal of Molecular and Cellular Cardiology.* 1996;28:19-31

**204.** Mosbach K. *Methods in Enzymology*. Pub. Academic Press London, New York. 1976 vol 44

**205.** Nilsson K, Mosbach K. Preparation of immobilised animal cells.  
*FEBS Letters* 1980;118:145-150

**206.** Piper HM, Schwartz P, Spahr R, Hutter JF, Spieckermann PG. Early enzyme release from myocardial cells is not due to irreversible cell damage.  
*Journal of Molecular and Cellular Cardiology.* 1984 Apr;16:385-388

**207.** Acosta D, Puckett M, McMillin R. Ischemic myocardial injury in cultured heart cells: leakage of cytoplasmic enzymes from injured cells.  
*In-Vitro.* 1978;14:728-32

**208.** Esumi K, Nishida M, Shaw D, Smith TW, Marsh JD. NADH measurements in adult rat myocytes during simulated ischemia.  
*American Journal of Physiology* 1991;260:H1743-H1752

**209.** Webster KA, Discher DJ, Bishopric NH. Cardioprotection in an *In-Vitro* Model of Hypoxic Preconditioning.  
*Journal of Molecular and Cellular Cardiology* 1995;27:453-458

**210.** Chaplin MF: *Enzyme Technology*

**211.** Vander-Heide RS, Reimer KA, Jennings RB. Adenosine slows ischaemic metabolism in canine myocardium in vitro: relationship to ischaemic preconditioning.  
*Cardiovascular Research* 1993;27:669-673

**212.** Yang XM, Baxter GF, Heads RJ, Yellon DM, Downey-JM, Cohen MV. Infarct limitation of the second window of protection in a conscious rabbit model.  
*Cardiovascular Research.* 1996;31: 777-83

**213.** Baxter GF, Yellon DM. Time course of delayed myocardial protection after transient adenosine A1-receptor activation in the rabbit.  
*Journal of Cardiovascular Pharmacology.* 1997; 29: 631-638

**214.** Sandhu R, Diaz RJ, Wilson GJ. Comparison of ischaemic preconditioning in blood perfused and buffer perfused isolated heart models.  
*Cardiovascular Research.* 1993 ; 27:602-607

**215.** Characterisation of the infarct-limiting effect of delayed preconditioning: timecourse and dose-dependency studies in rabbit myocardium.  
Baxter-GF; Goma-FM; Yellon-DM  
*Basic Research in Cardiology* 1997; 92:159-167

**216.** Cave AC, Hearse DJ. Ischaemic preconditioning and contractile function: studies with normothermic and hypothermic global ischaemia.

*Journal of Molecular and Cellular Cardiology* 1992; 24:1113-23:

**217.** Cave AC, Collis CS, Downey JM, Hearse DJ Improved functional recovery by ischaemic preconditioning is not mediated by adenosine in the globally ischaemic isolated rat heart.

*Cardiovasc Research.* 1993; 27: 663-668

**218.** Starkopf J, Bugge E, Ytrehus K. Preischemic bradykinin and ischaemic preconditioning in functional recovery of the globally ischaemic rat heart.

*Cardiovascular Research* 1997;33:63-70

**219.** Baxter GF, Yellon DM. Time course of delayed myocardial protection after transient adenosine A1-receptor activation in the rabbit.

*Journal of Cardiovascular Pharmacology.* 1997; 29: 631-8

**220.** Ikonimides JS, Shirai T, Weisel RD, Derilo B, Rao V, Whiteside CI, Mickle DAG, Li R-K. Preconditioning cultured human pediatric myocytes requires adenosine and protein kinase C.

*American Journal of Physiology* 1997;272:H1220-H1230

**221.** Khalid MA, Ashraf M. Direct detection of endogenous hydroxyl radical production in cultured adult cardiomyocytes during anoxia and reoxygenation.

*Circulation Research* 1993;72:725-736

**222.** Kirshenbaum LA, Hill M, Singal PK. Endogenous antioxidants in isolated hypertrophied cardiac myocytes and hypoxia-reoxygenation injury.

*Journal of Molecular and Cellular Cardiology* 1995;27:263-272

**223.** Siegmund, B. Koop, A. Kleitz, P. Schwartz, P. and Piper, HM. Sarcolemmal integrity and metabolic competence of cardiomyocytes under anoxia re-oxygenation.

*American Journal of Physiology* 1990; 258: H285-91

**224.** Tsuchida A, Liu GS, Wilborn WH, Downey JM. Pretreatment with the adenosine A1 selective agonist, 2-chloro-N6-cyclopentyladenosine (CCPA), causes a sustained limitation of infarct size in rabbits.

*Cardiovascular Research* 1993 ;27:652-656

**225.** Ladilov-YV; Balsler-C; Piper-HM Protection of rat cardiomyocytes against simulated ischemia and reoxygenation by treatment with protein kinase C activator.

*Circulation Research.* 1998 9;82:451-457

**226.** Heads RJ, Yellon DM, Latchman DS. Differential cytoprotection against heat stress or hypoxia following expression of specific stress protein genes in myogenic cells.

*Journal of Molecular and Cellular Cardiology* 1995;27:1669-1678

**227.** Nabel, E.G. Gene therapy for cardiovascular disease.  
*Circulation* 1995;91: 541 - 548

**228.** Maniatis T, Fritsch EF, Sambrook J. *Methods in molecular cloning: A laboratory manual*.  
Pub. Cold Spring Harbour Laboratory, NY 1982

**229.** Old RW. and Primrose SB. *Principles of Gene Manipulation* Pub.  
Blackwell Scientific Publications, Oxford 4<sup>th</sup> edition 1993.

**230.** Berkner KL. Development of adenovirus vectors for the expression of heterologous genes.  
*Biotechniques*. 1988;6:616-629

**231.** Coffin-RS, Howard MK, Cumming DV, Dollery CM, McEwan J, Yellon DM, Marber MS, MacLean AR, Brown SM, Latchman-DS. Gene delivery to the heart in vivo and to cardiac myocytes and vascular smooth muscle cells in vitro using herpes virus vectors.  
*Gene Therapy*. 1996;3:560-566

**232.** Nishi T, Yoshizato K, Yamashiro S, Takeshima H, Sato K, Hamada K, Kitamura I, Yoshimura T, Saya H, Kuratsu J, Ushio Y. High-efficiency in vivo gene transfer using intraarterial plasmid DNA injection following in vivo electroporation.  
*Cancer Research*. 1996; 56:1050-1055

**233.** Hashimoto T, Yoshida Y, Tagawa K. Regulatory proteins of F1F0-ATPase: role of ATPase inhibitor.  
*Journal of Bioenergetics and Biomembranes* 1990; 22: 27-38

**234.** Horstman LL, Racker E. Partial resolution of the enzyme catalyzing oxidative phosphorylation. XXII. Interaction between mitochondrial adenosine triphosphatase inhibitor and mitochondrial adenosine triphosphatase.  
*Journal of Biological Chemistry*. 1970; 245:1336-1344

**235.** Sah JF, Kumar C, Mohanty P. pH dependent conformational changes modulate functional activity of the mitochondrial ATPase inhibitor protein.  
*Biochemical and Biophysical Research Communications*. 1993;194:1521-1528

**236.** Rouslin W, Broge CW. Mechanisms of ATP conservation during ischemia in slow and fast heart rate hearts.  
*American Journal of Physiology* 1993;264:C209-C216

**237.** Vuorinen K, Ylitalo K, Peuhkurinen K, Raatikainen P, Ala-Rami A, Hassinen IE. Mechanisms of ischemic preconditioning in rat myocardium. Roles of adenosine, cellular energy state, and mitochondrial F1F0-ATPase .  
*Circulation*. 1995; 91: 2810-2818

**238.** Vander-Heide RS, Hill ML, Reimer KA, Jennings-RB. Effect of reversible ischemia on the activity of the mitochondrial ATPase: relationship to ischemic preconditioning.

*Journal of Molecular and Cellular Cardiology.* 1996 ; 28: 103-112

**239.** Green DW, Murray HN, Sleph PG, Wang FL, Baird AJ, Rogers WL, Grover GJ. Preconditioning in rat hearts is independent of mitochondrial F<sub>1</sub>F<sub>0</sub> ATPase inhibition.

*American Journal of Physiology* 1998;274:H90-H97

**240.** Rouslin W, Broge CW. Factors affecting the species-homologous and species-heterologous binding of mitochondrial ATPase inhibitor IF<sub>1</sub> to the mitochondrial ATPase of slow and fast heart-rate hearts.

*Archives of Biochemistry and Biophysics* 1993;303:443-450

**241.** Rouslin W. The mitochondrial adenosine 5'-triphosphatase in slow and fast heart rate hearts.

*American Journal of Physiology* 1987; 252:H622-627

**242.** Lebowitz MS, Pedersen PL. Regulation of the mitochondrial ATP synthase/ATPase complex: cDNA cloning, sequence, overexpression, and secondary structural characterization of a functional protein inhibitor.

*Archives of Biochemistry and Biophysics* 1993;301:64-70

**243.** van-Raaij MJ, Orriss GL, Montgomery MG, Runswick MJ, Fearnley IM, Skehel JM, Walker JE. The ATPase inhibitor protein from bovine heart mitochondria: the minimal inhibitory sequence.

*Biochemistry.* 1996 Dec 10; 35(49): 15618-25

**244.** Graham FL, Prevec L. Manipulation of adenovirus vectors. *Methods in Molecular Biology.* Ed. Murray JE. Pub. The Humana Press Clifton NJ. 1991

**245.** Graham FL, Smiley J, RussellbWC, Nairn R. Characteristics of a human cell line transformed by DNA from human adenovirus type 5.

*Journal of General Virology.* 1977;36:59-74

**246.** Gao X, Huang L. Cationic liposome-mediated gene transfer.

*Gene Therapy.* 1995;2:710-22

**247.** Ali M, Lemoine NR, Ring CJA. The use of DNA viruses as vectors for gene therapy. (Review)

*Gene Therapy* 1994;1:367-384

**248.** Yoshimura K, Rosenfeld MA, Seth P, Crystal RG. Adenovirus mediated augmentation of cell transfection with unmodified plasmid vectors.

*The Journal of Biological Chemistry* 1993;268:2300-2303

**249.** Baker A, Cotten M. Delivery of bacterial artificial chromosomes into mammalian cells with psoralen-inactivated adenovirus carrier

*Nucleic Acids Research* 1997;25:1950-1956

**250.** Cristiano RJ, Smith LC, Kay MA, Brinkley BR, Woo SLC. Hepatic gene therapy : Efficient gene delivery and expression in primary hepatocytes utilizing a conjugated adenovirus-DNA complex.

*Proceedings of the National Academy of Sciences USA.* 1993;90:11548-11552

**251.** Yoshimura A. Adenovirus-induced leakage of co-endocytosed macromolecules into the cytosol.

*Cell Structure and Function.* 1985;10 391-404

**252.** Wagner E, Zatloukal K, Cotten M, Kirlappos H, Mechtler K, Curiel DT, Birnstiel ML. Coupling of adenovirus to transferrin-polylysine/DNA complexes greatly enhances receptor-mediated gene delivery and expression of transfected genes.

*Proceedings of the National Academy of Sciences. U.S.A.* 1992; 89: 6099-6103

**253.** Baker A, Saltik M, Lehrmann H, Killisch I, Mautner V, Lamm G, Christofori G, Cotten M. Polyethylenimine (PEI) is a simple, inexpensive and effective reagent for condensing and linking plasmid DNA to adenovirus for gene delivery.

*Gene Therapy* 1997;4:773-782

**254.** Latchman DS. Herpes simplex virus vectors for gene therapy.

*Molecular Biotechnology.* 1994;2:179-195

**255.** Puceat M, Hilal-Dandan R, Strulovici B, Bruton LL, Heller Brown J. Differential regulation of protein kinase C isoforms in isolated neonatal and adult rat cardiomyocytes.

*The Journal of Biological Chemistry* 1994;24:16938-16944

**256.** Piper HM, Ladilov YV. Ischemic preconditioning on the cellular level.

*Basic Research in Cardiology.* 1997; 92,Suppl 2: 32-33

**257.** Gottlieb RA, Gruol DL, Zhu JY, Engler RL. Preconditioning rabbit cardiomyocytes: role of pH, vacuolar proton ATPase, and apoptosis.

*Journal of Clinical Investigation.* 1996 15;97: 2391-2398



.....

**PUBLICATIONS ARISING FROM THIS WORK**

## A MODEL OF HYPOXIC PRECONDITIONING IN ADULT RABBIT CARDIAC MYOCYTES IN CULTURE

M.Cooper and M:S:Marber Department of Cardiology, Rayne Institute, St Thomas's Hospital, London. Department of Physiology, University College London.

To investigate the effects of transient gene expression in cardiac myocytes and the potential for gene transfer to protect against ischaemic injury we have developed an *in-vitro* model of preconditioning. We report the characterisation of the model.

Left ventricular myocytes were isolated from the hearts of adult male rabbits by enzymatic dissociation. Cells were cultured on plates prepared by coating with 1% gelatin followed by 10µg/ml laminin. The cells were allowed to attach for two hours in M199 containing 5% foetal calf serum (FCS). At the end of this period the medium was replaced with M199 containing 1% FCS and the cells were incubated overnight. Cells were exposed to lethal simulated ischaemia and hypoxia. Simulated ischaemia consisted of a modified, glucose free Krebs solution containing 20mMK<sup>+</sup>, 12mM lactate, pH 6.2, low volume and placed in an hypoxic chamber under 95% Argon/5%CO<sub>2</sub> at 37°C for 6 hours. Cell injury was measured by three endpoints, Trypan blue uptake, LDH (Lactate dehydrogenase) release and the conversion of MTT (2,3-[4,5-Dimethylthiazol-2-yl]-2,5-diphenyltetrazolium bromide) to an insoluble formazan dye.

The protocol reduced the number of viable cells present after 12 hours of reperfusion compared to controls p<0.05. Cells were preconditioned by exposure to hypoxia in a low volume of tissue culture medium for one hour followed by recovery in fresh medium for 30 mins prior to the lethal ischaemia. Protection was observed as an increase in the number of viable cells p< 0.05.

Similarly exposure to 1µM CCPA (2-Cloro-N<sup>6</sup>- cyclopentyladenosine) an adenosine A<sub>1</sub> agonist for one hour plus 30 mins recovery prior to lethal ischaemia caused a reduction in cell injury p< 0.05. Preconditioning in this model can be blocked by the adenosine A<sub>1</sub> antagonist DPCPX and by the protein kinase C (PKC) inhibitor Chelerythrine. In conclusion we have constructed a model of ischaemic injury in short-term cultured adult cardiac myocytes. In this model the effect of preconditioning seems to be mediated via adenosine and PKC inkeeping with *in-vivo* preconditioning in the same species.