

December 2020

Person-based Prominence in Ojibwe

Christopher Hammerly

Follow this and additional works at: https://scholarworks.umass.edu/dissertations_2



Part of the [Cognitive Psychology Commons](#), [Language Description and Documentation Commons](#), [Morphology Commons](#), [Psycholinguistics and Neurolinguistics Commons](#), [Syntax Commons](#), and the [Typological Linguistics and Linguistic Diversity Commons](#)

Recommended Citation

Hammerly, Christopher, "Person-based Prominence in Ojibwe" (2020). *Doctoral Dissertations*. 2024.
https://scholarworks.umass.edu/dissertations_2/2024

This Open Access Dissertation is brought to you for free and open access by the Dissertations and Theses at ScholarWorks@UMass Amherst. It has been accepted for inclusion in Doctoral Dissertations by an authorized administrator of ScholarWorks@UMass Amherst. For more information, please contact scholarworks@library.umass.edu.

PERSON-BASED PROMINENCE IN OJIBWE

A Dissertation Presented

by

CHRISTOPHER MATHIAS HAMMERLY

Submitted to the Graduate School of the
University of Massachusetts Amherst in partial fulfillment
of the requirements for the degree of

DOCTOR OF PHILOSOPHY

September 2020

Linguistics

© Copyright by Christopher M. Hammerly 2020
All Rights Reserved

PERSON-BASED PROMINENCE IN OJIBWE

A Dissertation Presented

by

CHRISTOPHER MATHIAS HAMMERLY

Approved as to style and content by:

Brian Dillon, Chair

Rajesh Bhatt, Member

Adrian Staub, Member

Joe Pater, Department Chair
Department of Linguistics

For the Anishinaabeg of Nigigoonsiminikaaning and Seine River

“How odd I can have all this inside me and to you it’s just words.”

— David Foster Wallace, *The Pale King*

ACKNOWLEDGMENTS

This thesis is at once a beginning and an end. It is the beginning of what I hope to be a lifetime of work on obviation, agreement, and my ancestral language Ojibwe; and the end of what I have figured out so far. It is the end of five incredible years of graduate studies at UMass; and the beginning of the relationships that I have built over the past half-decade.

I am most deeply indebted to the Anishinaabe communities at Nigigoonsiminikaaning and Seine River in Ontario, especially those who participated in this study. *Gimiigwechiwi'ininim*. Nancy Jones is a keeper of endless knowledge and experience, and I am so lucky that she has been willing to take me in and share it. Not only has she made this dissertation possible, she has made it possible for me to reconnect to my own roots. Don Jones and Andrew Johnson both gave their time, energy, and patience to make the experimental portion of this thesis possible, and by providing additional judgments and feedback. I am endlessly grateful for their assistance and kindness. Finally, thanks to Elijah Forbes for the amazing drawings, which were done on an insanely tight timeline.

My committee, Brian Dillon, Rajesh Bhatt, and Adrian Staub were patient, encouraging, supportive, and engaged. It is difficult to find words to describe my experience. They were everything that I needed exactly when I needed it. This project came with its fair share of frustrations, and I am beyond grateful for their mentorship and advising.

Brian believed that I could do the hard thing. He gently made sure I pushed myself to the next level and never let me fall. He was calm and measured when my brain was on fire with worry and doubt. From the moment I stepped onto Western Mass soil, we

have had meetings nearly every single week — an absolute testament to his devotion as an advisor. Brian’s way of approaching the science of language by combining linguistic theory, statistics, computational modeling, and psycholinguistics has formed the bedrock of my thinking.

Rajesh should probably have been a co-chair on this dissertation. He was the primary advisor for everything syntax, and I am so thankful for the huge amount of time he spent reading, commenting, and discussing the many drafts of this manuscript. His guidance is all over Chapters 2–5, and I would have never been able to get as deep as I did without his support. Rajesh has unending enthusiasm for every single idea. His willingness to take my half-baked thoughts seriously, and then help me turn them into something properly rigorous and formal, is something that I am endlessly grateful for.

Adrian has given me license to be intelligently subversive, as long as the evidence and arguments are on my side. I will miss walking into his office, discussing the latest New York Times article, then diving into the fine details of experimental methods and analysis. I probably should have taken more advantage of his expertise than I did over the past year. But Adrian has forever shaped the way I collect and evaluate behavioral evidence, and this project would not have been successful without his critical input at every point.

I kept my committee slim, but both Ellen Woolford and Kyle Johnson were instrumental in getting the work in Chapter 5 off the ground by advising my second general paper on word order in Ojibwe. Ellen taught me how to write like a syntactician without being (I hope) entirely impenetrable. To me, Kyle is like Socrates, for lack of a less fawning comparison. He has been both a professional and personal mentor, and I will miss hearing his laugh from down the hall. There are many more professors at UMass to thank — nearly everyone in the department has influenced me in one way or another, which is what attracted me to UMass in the first place. To Lyn Frazier for her always incisive and constructive feedback. To Barbara Partee for a comment about first person

plurals in my third year that sowed the seed for this thesis (and for taking care of my cat Nogi during one summer when I was away doing fieldwork!). To John Kingston and Gaja Jarosz for the many evenings of belaying. To Shota Momma for help with a production study that didn't quite pan out, but I still hope to run. To Andrew Cohen in psychology for much statistical guidance and feedback over the years. To Chuck Clifton for his wealth of knowledge that seems to span every moment following the cognitive revolution.

One of the best parts about UMass are the fellow graduate students. Alex Göbel has been my cohort-mate, office-mate, climbing partner, collaborator, and friend all rolled into one. His companionship has been a presence from my first prospective weekend to our last day in Northampton as graduate students. Rodica Ivan is an absolute saint. She makes sure that I have the opportunity to “be bad”, stores a wealth of knowledge and good advice, and was the first one to know that I had chosen UMass for graduate school. Kaden Holladay is one of the kindest people I have ever met. I owe him many debts for house/cat-sitting, rides home, and great conversations.

I have been lucky to have a great cohort in Carolyn Anderson, Alex Göbel, Jaieun Kim, Brandon Prickett, Michael Wilson, and Rong Yin. Trivia partners (though I have been woefully absent lately) in Mike Clauss, Erika Mayer, Andrew Lamont, Maggie Baird, Georgia Simon, Coral Hughto, Io Hughto, and others already named. There are so many people that deserve more than just a shout-out for their friendship and support, but that is how these things often go. Thanks to Stefan Keine (who also provided helpful comments on early versions of the content in Chapters 4 and 5), Ethan Poole, Nick LaCara, Jyoti Iyet, Sakshi Bhatia, Alex Nazarov, Ivy Hauser, Leland Kusmer, Deniz Özyıldız, Amanda Rysling, Shayne Sloggett, Caroline Andrews, Petr Kusliy, Zahra Mirrazi, Anissa Neal, Max Nelson, Alex Nyman, Jonathan Pesetsky, Shay Hucklebridge, Duygu Goksu, Bethany Dickerson, Leah Chapman, Mariam Asatryan, Ria Geguera, John Burnsky, and Thuy Bui for fellowship and community.

I also feel compelled to thank the land that UMass stands on and is surrounded by. I will miss being hemmed in by the mountains and the river. The early morning fog, and the immense snow storms. The roadside porcupines and bears. I've taken my bike all over the valley and hill towns, and I've found beauty, inspiration, solitude, and peace in nearly every peak and valley. The city of Northampton and the surrounding area has also been a great community to be a part of. I will miss the weirdos and radicals. Plus, I have been well fueled. Thanks to *Familiars* for the nitro coffee, *The Dirty Truth* for cheese sauce (and pretzels), *Bistro Les Gras* for burgers and wine, *Green Room* for cocktails, *The Deuce* and *Quarters* for beer and trivia, and *Mission Cantina* for burritos.

Before UMass, I spent a year at the University of Maryland in the Baggett Fellowship. That opportunity was a major launching point, gave me confidence and independence as a researcher, and set me up for success. Thanks to Naomi Feldman, Omer Preminger, Ellen Lau, and William Matchin for mentorship that has extended beyond that single year. A very special thanks to my fellow Baggetts Tom Roberts, Julia Buffinton, and Natalia Lapinskaya for creating what will likely remain the best shared office I will ever inhabit. There were many wonderful graduate students at UMD: Kasia Hitczenko, Nick Huang, Lara Ehrenhofer, Allyson Ettinger, Anton Malko, Chris Heffner, Zoe Schlueter, Dustin Chacón, and Aaron Steven White all were very influential in getting me to this point. I also learned a ton in conversations and courses with Alexander Williams, Colin Phillips, Norbert Hornstein, and Howard Lasnik.

All of this really started when I was an undergraduate at the University of Minnesota. My first ever research project was supervised by Kathryn Kohnert in a first-year seminar, and she got me hooked. Maria Sera generously offered me an RA position in her lab, where I worked for two years, and I am grateful for that experience. I was beyond lucky to have landed in Claire Halpert's syntax course. She had the ability to take my petulance (or, more generously, skepticism) seriously, and has been an incredible mentor to me since that day. I probably would not have not been as deeply infected

with “Syntacticians Disease” without many long nights in the basement study rooms of Follwell Hall with Colin Davis and Ben Eiechens. I owe a huge thanks to many folks who guided my journey in reconnecting with my Ojibwe heritage while I was at the U: Stephanie Zadora, Jerimiah Strong, Warlance Miner, Tia Yazzie, Raul Aguilar, Jillian Rowan, Liz Cates, Andrew Coveyou, and Naomi Fairbanks. My fieldwork has also been facilitated by all of the folks at OOG in Fond du Lac, and with the guidance and mentorship of Dr. John Nichols.

The analysis in Chapter 5 in particular could not be where it is without the work and guidance of Will Oxford. He is the most recent “giant” that I am standing on the shoulders of. While his work is often a foil in this thesis, it has served as the biggest inspiration of all. A parenthetical citation does not really do justice to the influence his work on my thinking. I also want to thank many other “Algonquianists” including Heather Bliss, Rose-Marie Déchaine, Ryan Henke, Margaret Noodin, and Connor Quinn, whose work, guidance, and collegiality has been inspiring and inviting. I owe a huge intellectual debt to Daniel Harbour for fueling the content of Chapters 2 and 3 with his work on person and number. His 2016 book in particular has been a field guide for φ -features. While we have only met once, that meeting, and his published work, have served as a map for how to approach problems at the confluence of syntax, semantics, morphology, and the mind.

There are many others in the linguistics and psychology community who deserve thanks for conversation, discussion, support, and/or friendship including Nico Baier (who gave helpful comments on early versions of Chapter 4), Kate Stone (who gave pointers for the statistical analysis in Chapter 6), Becky Tollan (who gave advice on how to code the preferential looking data and rightly convinced me to add a distractor image), Maayan Keshev, Nayoun Kim, Travis Major, Morgan Moyer, André Eliatamby, Deniz Rudin, Michelle Yuan, Sherry Yong Chen, Emily Clem, Chris Baron, Hannah Sande, Steven Foley (who gave feedback on a very early version of the experiment in

Chapter 6), Aya Meltzer-Asscher, Daphna Heller, Ming Xiang, Dave Kush, Matt Wagers, Judith Klavans, and Fernanda Ferreira.

Different parts of this work were presented at UC Santa Cruz S-Lab, University of Toronto Scarborough, University of British Columbia, University of Southern California, University of Minnesota, NELS 50, Algonquian Conferences 49 and 50, UMass Syntax and Psycholinguistic Workshops, and the joint experimental lab meetings at UMass. Thanks to everyone who attended those talks and posters for feedback and questions.

This dissertation was supported by generous funding. Two grants in 2017 and 2018 from the Selkirk Linguistic Outreach Fund helped with my early fieldwork. The graduate school at UMass provided me with a Dissertation Fieldwork Grant that funded the work in Chapter 6. The National Science Foundation supported my graduate career through the Graduate Research Fellowship Program (1451512) as well as the project in Chapter 6 through a Doctoral Dissertation Research Improvement Grant (1918244).

I am lucky to have friends and mentors from many different stages of life. Sam Gold-enberg is fiercely loyal and has kept me afloat many times. A shout out to my friends from high school and earlier: Brian Forsberg, John Bian, Jon Radmer, Stephen Krishnan, Devin Hess, Alex Strange, Laura Willenbring, and Tory Sharkey. Allison Marino is my funkiest friend in the valley. Anne Bayerle, Brian Thompson, and Hobbs are the best neighbors ever. Norma Brooks has opened me to an entirely new world of thinking.

My family has supported me in so many ways. I have much to learn from each of them: the kind and quiet poetry of my father, the fire and conviction of my mother, the passion and drive of my sister, and the curiosity and wit of my brother. My parents especially deserve a special thanks for feeding me, loaning me their car, and housing me during my many research trips. My in-laws, the Yarars, deserve a special thanks for smiling and nodding during my defense.

Finally, Esra Emel Yarar. She is my hot air balloon. She picks me up and brings me out. I would be lost without her love and support.

ABSTRACT

PERSON-BASED PROMINENCE IN OJIBWE

SEPTEMBER 2020

CHRISTOPHER MATHIAS HAMMERLY

B.A., B.S., UNIVERSITY OF MINNESOTA, TWIN CITIES

Ph.D., UNIVERSITY OF MASSACHUSETTS AMHERST

Directed by: Professor Brian Dillon

This dissertation develops a formal and psycholinguistic theory of *person-based prominence* effects, the finding that certain categories of person such as FIRST and SECOND (the LOCAL persons) are privileged by the grammar. The thesis takes on three questions: (i) What are the possible categories related to person? (ii) What are the possible prominence relationships between these categories? And (iii) how is prominence information used to parse and interpret linguistic input in real time?

The empirical through-line is understanding *obviation* — a “spotlighting” system, found most prominently in the Algonquian family of languages, that splits the (animate) third persons into two categories: PROXIMATE, the person who is in the spotlight, and OBVIATIVE, the persons who are introduced into the discourse, but are not in the spotlight. I provide a semantics for the feature [proximate], and detail a lattice-based theory of feature composition to derive the categories related to obviation in Border Lakes Ojibwe and beyond. This leads to insights about the syntactic and semantic relationships between person, animacy-based noun classification, number, and obviation.

The novel contribution to the theory of person-based prominence effects is to decompose person features into sets of *primitives*. This proposal allows the stipulated entailment relationships between categories and features, as encoded in prominence hierarchies and feature geometries, to be derived from the first principles of set theory.

I further motivate the account by showing that it has increased empirical coverage, and apply it to capture patterns of agreement and word order in Border Lakes Ojibwe.

Finally, I present a psycholinguistic study on how obviation is used to process filler-gap dependencies in Border Lakes Ojibwe. I show that obviation, and by extension, prominence information more generally, is used immediately to predictively encode movement chains, prior to bottom-up information from voice marking about the argument structure of the clause. I argue for a modular and syntax-first model of parsing, revising the Active Filler Strategy to be guided by pressures to minimize syntactic distance and maximize the expected well-formedness of each link in the chain. These pressures compete, accounting for effects of prediction, integration, and reanalysis in long-distance dependency formation.

TABLE OF CONTENTS

	Page
ACKNOWLEDGMENTS	vi
ABSTRACT	xii
LIST OF TABLES	xx
LIST OF FIGURES	xxi
LIST OF ABBREVIATIONS AND SYMBOLS	xxii
CHAPTER	
1 INTRODUCTION	1
1.1 Background: What is person-based prominence?	1
1.2 Study I: Representing prominence and possible persons	9
1.3 Study II: Prominence effects in agreement and word order	19
1.3.1 A set-based model of prominence effects in agreement	19
1.3.2 Word order and agreement in Border Lakes Ojibwe	28
1.4 Study III: Prominence in argument structure processing	38
1.5 Additional Background on Ojibwe	49
1.5.1 Historical, typological, and cultural context	49
1.5.1.1 Algonquian and Algonquian	49
1.5.1.2 Ojibwe dialects	51
1.5.1.3 Cultural context	54
1.5.2 Phonology	55
1.5.2.1 Vowels	56
1.5.2.2 Consonants	57
1.5.2.3 Writing systems	58
1.6 Overview of the dissertation	60
2 THE REPRESENTATION OF PERSON IN OJIBWE	61
2.1 Introduction: What is person?	61
2.2 Deriving person categories: An overview of the puzzle	64
2.2.1 The Partition Problem	65

2.2.1.1	The superposition method	66
2.2.1.2	The lattice representation	67
2.2.1.3	The original partition problem	69
2.2.1.4	The proximate-obviative distinction	71
2.2.1.5	The quintipartition of Ojibwe	72
2.2.2	Interactions with number and noun classification	73
2.3	A lattice-based representation of features	74
2.3.1	Ontological commitments	74
2.3.2	Organizing the ontology: Features as lattices	75
2.3.2.1	Deriving Harbour’s original lattices	76
2.3.2.2	Proposal: A lattice for [proximate]	79
2.3.2.3	Why (these) features? Why (these) lattices?	80
2.3.3	The functional sequence	83
2.4	The composition of features	85
2.4.1	Contrastive interpretations of features	86
2.4.2	Deriving contrastive hierarchies	91
2.4.3	Application to the lattice-based representation	93
2.4.3.1	Monpartition and bipartitions	95
2.4.3.2	Tripartition	97
2.4.3.3	Quadripartition	98
2.5	The representation of person in Ojibwe	101
2.5.1	The Ojibwe quintipartition	104
2.6	Comparison to Harbour (2016)	107
2.6.1	Harbour’s solution to the original partition problem	108
2.6.1.1	Values as operations	108
2.6.1.2	The parameters of π	109
2.6.1.3	Capturing the original five partitions	110
2.6.2	Harbour and the proximate feature	114
2.6.2.1	Evaluating the possibilities	116
2.6.2.2	A different definition of proximate? No.	121
2.7	Interactions with number and noun classification	122
2.7.1	Noun classification	123
2.7.1.1	The [\pm animate] feature	124
2.7.1.2	Person and noun classification	125
2.7.1.3	Obviation and noun classification	128
2.7.2	Number	131
2.7.2.1	The number feature: [\pm group] or [\pm atomic]?	131
2.7.2.2	Application to Ojibwe	135
2.7.3	Summary	137
3	OBVIATION BEYOND OJIBWE	139
3.1	Introduction: Actual and predicted typologies of obviation	139
3.2	The Octopartition of Blackfoot	141
3.2.1	Obviation in Blackfoot	141

3.2.2	A contrastive hierarchy for the octopartition	142
3.2.3	Number and the Blackfoot octopartition	146
3.2.4	Interlude: An issue for the feature geometric account	151
3.3	The proximate quadripartition/hexapartition of Ktunaxa	153
3.3.1	The proximate quadripartition	154
3.3.2	The hexapartition	156
3.4	The remaining partitions	158
3.4.1	One and two-feature systems	159
3.4.2	Three-feature systems and intermediate scope of proximate . . .	163
3.5	Where does [\pm proximate] live?	165
4	A SET-BASED THEORY OF AGREE	169
4.1	Introduction: Agreement and prominence	169
4.2	Empirical underpinnings	172
4.2.1	Omnivorous agreement	174
4.2.1.1	Kichean Agent-Focus	174
4.2.1.2	Nez Perce Complementizer Agreement	176
4.2.1.3	Cuzco Quechua Subject Marking Anomalies	177
4.2.2	Alignment effects	179
4.2.2.1	The PCC	180
4.2.2.2	Direct-inverse marking	186
4.2.3	Summary	189
4.3	Features as sets (in syntax)	190
4.3.1	Feature sub-parts: Labels and values	192
4.3.2	φ -features on person probes: Defining the possibilities	194
4.3.3	φ -features on goals: Encapsulation and collection	196
4.3.3.1	Previous approaches: Concord	198
4.3.3.2	A set-based solution	200
4.4	Defining AGREE	207
4.4.1	Search and Satisfy	208
4.4.2	Match	210
4.4.3	Copy	213
4.5	Hierarchy effects and the set-based feature representation	215
4.5.1	Feature gluttony	216
4.5.2	Possible probes and the typology of inverse	219
4.5.3	Beyond pure person probes	221
4.5.4	Why gluttony (inverse) causes issues	224
4.5.4.1	The PCC	224
4.5.4.2	Direct-inverse	228
4.5.4.3	Omnivorous agreement	231
4.5.4.4	Fission	233
4.5.4.5	Portmanteau	235
4.5.5	Summary	236

4.6	Agreement and the feature geometric representation	237
4.6.1	A review of the feature geometry	237
4.6.2	Possible and impossible probes	240
4.6.3	Abandoning second-order representations of entailment	241
5	AGREEMENT AND WORD ORDER IN OJIBWE	245
5.1	Overview	245
5.1.1	The verbal spine	247
5.1.2	Overview of agreement: ν , Voice, Infl, and C	249
5.1.2.1	Animacy agreement on ν	251
5.1.2.2	Direct-inverse agreement on Voice	252
5.1.2.3	Person and number agreement on Infl	255
5.1.2.4	Obviative and number agreement on C	256
5.1.3	Word order	257
5.1.4	Agreement and movement	259
5.2	Overview of non-local only alignments	261
5.3	Agreement on ν	265
5.4	Agreement on Voice	267
5.4.1	Subject agreement in direct alignments	268
5.4.2	Gluttony and the relativized EPP in inverse alignments	269
5.4.3	The spell-out of Voice	272
5.5	Agreement on Infl	273
5.5.1	The probe on Infl	273
5.5.2	Schematizing the patterns	275
5.5.3	The spell-out of Infl	277
5.5.4	Infl and the Activity Condition	280
5.6	Agreement on C	282
5.6.1	Direct alignment	282
5.6.2	Inverse alignment	286
5.7	Comparison to previous accounts	287
5.7.1	Previous accounts of the theme sign	288
5.7.2	Previous accounts of word order	289
6	PROCESSING OBVIATION AND VOICE	291
6.1	Introduction	291
6.2	Existing approaches to prominence in sentence processing	295
6.2.1	The parameters of discussion	296
6.2.2	The classic modular model	297
6.2.3	The classic constraint-based model	303
6.2.4	The Extended Argument Dependency Model	306
6.2.5	The maximize incremental well-formedness model	310
6.2.6	Summary & synthesis	316
6.3	Obviation and voice in sentence processing	318
6.3.1	Background	318

6.3.1.1	Dissociating syntactic position and thematic role	319
6.3.1.2	Obviation and direct/inverse voice	322
6.3.2	Processing obviation and direct/inverse	324
6.3.3	Processing voice beyond direct/inverse	328
6.4	The current study	332
6.4.1	Relative clauses in Ojibwe	333
6.4.2	Summary of questions and predictions	335
6.5	Experiment	336
6.5.1	Methods	336
6.5.1.1	Participants	336
6.5.1.2	Auditory stimuli	337
6.5.1.3	Visual stimuli	339
6.5.1.4	Equipment and software	341
6.5.1.5	Procedure	341
6.5.2	Analysis	344
6.5.2.1	Picture selection	344
6.5.2.2	Preferential looking: Calculating ROIs	345
6.5.2.3	Preferential looking: Cluster-based permutation	347
6.5.3	Results	352
6.5.3.1	Preferential Looking	352
6.5.3.2	Picture Selection Accuracy	356
6.5.3.3	Picture Selection Response Initiation Time	358
6.6	Discussion	359
6.6.1	Key empirical generalizations	359
6.6.2	An evaluation of existing models	361
6.6.3	A maximize incremental well-formedness account	364
6.6.3.1	A revised active filler strategy	365
6.6.3.2	Minimize Syntactic Distance	366
6.6.3.3	Maximize Well-Formedness	369
6.6.3.4	Scales and constraints	369
6.6.3.5	Setting weights: A role for experience	371
6.6.3.6	A step-by-step account of Ojibwe	373
6.6.4	The consequences of incremental prediction	375
6.6.5	The return of the modular parser	379
6.6.6	The nature of obviation (in processing)	380
6.6.7	Further extensions	382
6.6.7.1	Ditransitives and animacy in English	384
6.6.7.2	Voice and animacy in English	388
6.6.7.3	Ergativity and the Subject Gap Advantage	391
6.6.7.4	Person, pronouns, and the Subject Gap Advantage	395
6.7	Conclusion	402

7 CONCLUSIONS	404
7.1 Summary	404
7.2 Categories, features, and primitives	405
7.3 The role of the grammar in processing	409
APPENDICES	
A DERIVATIONS WITH PROXIMATE IN HARBOUR'S SYSTEM	413
B MIXED AND LOCAL ONLY ALIGNMENTS	433
C EXPERIMENTAL STIMULI	453
BIBLIOGRAPHY	456

LIST OF TABLES

Table	Page
1.1 Proposed set-based and feature-based representations for (singular) person/obviation/animacy categories	12
1.2 Broad transcription vowel inventory of Border Lakes Ojibwe	56
1.3 Consonant inventory of Border Lakes Ojibwe	57
1.4 Correspondences between orthographic symbols and phonemes in the double vowel writing system	59
2.1 Conventional person categories and their referent sets in the ontological notation	62
3.1 Blackfoot (Siksika dialect) pronominal inventory	142
4.1 Summary of PCC effects, shown two different ways	181
4.2 Distribution of inverse and non-inverse across Algonquian in the conjunct order	187
4.3 Possible goals with set and feature based syntactic representations	204
4.4 Correspondence between possible probes, alignment effects, and the distribution of inverse.	220
5.1 Distribution of object agreement, subject agreement, and inverse marking on Voice in the conjunct and independent orders.	252
5.2 Distribution of object agreement, subject agreement, and multiple agreement on Infl in the conjunct and independent orders.	256
5.3 Distribution of object and subject agreement on C in the conjunct and independent orders.	257

6.1	Results of Summer 2018 production pilot	327
6.2	Results of cluster permutation test	354
6.3	Picture selection proportions	357
6.4	Results of logistic regression on picture accuracy selection data	357
B.1	Theme sign forms	435
B.2	Independent and conjunct order theme sign distribution	436
B.3	Independent order Infl: Set A versus Set B for local persons	447
B.4	Independent order VTA Infl	448
B.5	Conjunct order Infl	450
B.6	Conjunct order VTA Infl	450
B.7	Independent order VTA C	452

LIST OF FIGURES

Figure	Page
1.1 Algic genetic relationships	50
2.1 Hasse diagrams for exclusive, inclusive, second, and third	69
2.2 Hasse diagrams of the proximate and obviative lattices	72
2.3 Proximate and obviative lattices with singular-plural number distinction . .	135
2.4 Local proximate lattices with singular-plural number distinction	136
6.1 Example visual stimuli set	340
6.2 Schematization of experimental trials	342
6.3 Average look proportions over time in the familiarization period.	352
6.4 Average look proportions over time in the ambiguous region.	353
6.5 Average look proportions over time in the resolution region.	355
6.6 Box plots of response accuracy in the picture selection task	356
6.7 Empirical CDF of response initiation time	358
6.8 Average look proportions towards agent image.	377

LIST OF ABBREVIATIONS AND SYMBOLS

$\sqrt{\quad}$	=	root
φ	=	phi-features
π	=	person (probe/head)
γ	=	gender/noun classification (probe)
ρ	=	obviation (probe)
ω	=	number (probe)
#	=	number (head)
0	=	third person (inanimate)
0'	=	third person (inanimate obviative)
1	=	first person
2	=	second person
3	=	third person (animate proximate)
3'	=	third person (animate obviative)
ANIM	=	animate
CL	=	clitic
DEM	=	demonstrative
DIR	=	direct
DUB	=	dubitative mode
EA	=	external argument
EXCL	=	first person exclusive
IA	=	internal argument

INAN	=	inanimate
INCL	=	first person inclusive
IND	=	indicative
INV	=	inverse
MOD	=	mode
NEG	=	negation
OBJ	=	object
OBV	=	obviative
PAH	=	person-animacy hierarchy
PL	=	plural
PRET	=	preterit mode
PROX	=	proximate
SG	=	singular
SUBJ	=	subject
SAP	=	speech act participant
TS/T.S.	=	theme sign

CHAPTER 1

INTRODUCTION

1.1 Background: What is person-based prominence?

The focus of this dissertation is on understanding *person-based prominence* — how it is encoded in the representation of person categories, how it influences syntactic phenomena such as agreement and word order, and how it affects our ability to process language in real time. Beginning with the work of Silverstein (1976), person categories have been organized via *Person-Animacy Hierarchies* (PAHs) such as

(1) SPEECH-ACT PARTICIPANTS > ANIMATE BEINGS > INANIMATE OBJECTS

where speech-act participants are the author and addressee of an utterance, animate beings are the (culturally determined) set of living or sentient things, and inanimate objects are everything else that does not fall into the other two categories.

Person-based prominence is the observation that certain person categories such as first and second person are often privileged by the grammar. The PAH provides the means to encode these preferences by stipulating a ranking between different categories. From this ranking, rules such as *show agreement with the highest ranked argument in the clause* can be defined. Such a rule provides a basic description of the patterns of agreement in a diverse range of languages, including the language at the

center of this dissertation, Border Lakes Ojibwe, a Central Algonquian language spoken along what is now the border of Minnesota and Ontario. Regardless of whether the first person is the *external argument* (2a) or the *internal argument* (2b), the person prefix (in bold) shows the first person form *ni-*.

- (2) a. $1 \rightarrow 3 = 1$
ni- waabam -aa
1- see -DIR
 'I see h/ (PROX)'
- b. $3 \rightarrow 1 = 1$
ni- waabam -ig
1- see -INV
 's/he (PROX) sees **me**'

The examples above further reveal a second type of prominence-based grammatical generalization: direct versus inverse alignment effects. These effects are described by considering how the categories from two scales map to one another. Besides the basic person categories, the relevant categories to add here are those of the external argument (EA), the syntactic position of the more agentive argument, which is ranked above the internal argument (IA), the syntactic position of the patient or theme. As schematized in (3), the sentence from (2a) shows a DIRECT alignment of the more prominent local person with the more prominent EA position, while the sentence in (2b) shows an INVERSE alignment such that the higher ranked person is associated with the lower ranked IA position.

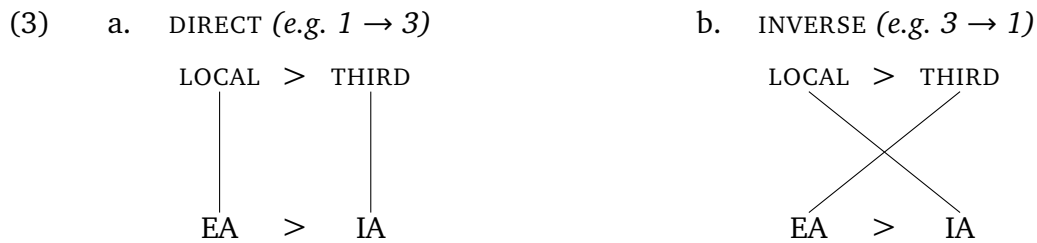

In Border Lakes Ojibwe, direct alignments are associated with what is called the “direct marking” in what is known as the theme sign morphology; the form *-aa* in the example in (2a). In contrast, inverse alignments are associated with “inverse marking” on the theme sign; a special form *-ig* as shown in the example in (3b).

While the examples above are couched within the grammatical patterns easily observed in Ojibwe, prominence effects described by the PAH are widespread both in terms of construction and language family. The PAH is able to describe the typology of a wide range of grammatical patterns including split ergative case marking (Silverstein, 1976; Dixon, 1994), differential object marking (DOM; Bosson, 1991), word order alternations (Young and Morgan, 1987), the person-case constraint (PCC; Farkas and Kazazis, 1980; Coon and Keine, 2020), direct-inverse marking (Dawe-Sheppard and Hewson, 1990; Macaulay, 2009), and omnivorous agreement (Preminger, 2014), and has been directly employed in understanding the processing of argument structure (Bornkessel, 2002). In short, the prominence relationships between person-animacy categories described by the PAH rankings appears to be deeply engrained in the human language faculty — it is not quirk of a particular language or construction, and demands a deep explanation.

While essentially all formulations of the PAH recognize some version of the three categories encompassing the speech-act participants, animate third persons, and inanimate third persons, a complicating factor is that the PAH appears to be articulated to different degrees of specificity for particular languages or language families. For example, the Empathy Hierarchy of DeLancey (1981) and the Animacy Hierarchy of Comrie (1989) both split the ANIMATE BEINGS category with a ranking of HUMAN > ANIMAL. Similarly, both rankings of AUTHOR > ADDRESSEE (Zwicky, 1977) and ADDRESSEE > AUTHOR (Dawe-Sheppard and Hewson, 1990) have been proposed as a further articulation to the SPEECH-ACT PARTICIPANTS.

These refinements can be empirically motivated for two basic reasons. First, they can be due to the fact that different languages distinguish different sets of categories related to person. For example, some languages (e.g. Ojibwe) distinguish exclusive and inclusive persons, while others (e.g. English) conflate these meanings into a single generic first person. Second, a given agreement slot or paradigm may fail to show

evidence of a ranking between two categories that can otherwise be observed to be ranked. For example, in Ojibwe embedded clauses, also known as the conjunct order, direct marking occurs with both the $1 \rightarrow 3$ and $3 \rightarrow 1$ alignments, as shown in (4).¹ This contrasts with the matrix clause or independent order patterns seen in (2), where the inverse marker appears in the $3 \rightarrow 1$ alignments.

- | | | | | |
|-----|----|--------------------------------|----|---------------------------------|
| (4) | a. | $1 \rightarrow 3 = \text{DIR}$ | b. | $3 \rightarrow 1 = \text{DIR}$ |
| | | waabam -aa -si -wag | | waabam -i -si -g |
| | | see -DIR -NEG -1>3 | | see -DIR -NEG -3 |
| | | ‘if I don’t see h/ (PROX)’ | | ‘if s/he (PROX) doesn’t see me’ |

The scale implied by the patterns in (4) suggests a collapse in the ranking between the SPEECH-ACT PARTICIPANTS and the ANIMATE BEINGS. Given that the PAH is intended to provide a universal description of prominence-based effects, contending with the splitting and collapse of categories across languages and differences in where inverse alignments arise — that is, dealing with variation and typology in possible person distinctions and possible prominence effects — is a central component of any complete theory. The theory presented over the course of the thesis connects the two puzzles of deriving possible person categories and possible person-based prominence effects by tying both to the underlying feature-based representation. The idea is one inherited from current theories of person representations such as the feature geometry (Harley and Ritter, 2002; Béjar, 2003). The logic, which should become concrete over the course of these introductory remarks, is that feature combinations give rise to the range of possible categories; these feature sets in turn guide interactions with syntactic operations such as AGREE, giving rise to prominence effects.

Given the above discussion, it is possible to present a somewhat refined formulation of the goals of this dissertation: To derive the possible person categories and the

¹It is relevant to note that direct marking does not take a single form, but generally varies as a function of the person category of the IA. To clarify this in the examples so far, *-aa* indexes proximate arguments and *-i* first person arguments. Inverse, in contrast, has a number of allomorphs but always appears with the same basic form *-ig(oo)*.

prominence relationships between them both within and across languages, and then to understand the consequences of these relationships for grammatical phenomena such as agreement and word order and the processing of argument structure. To this end, the particular articulation of the PAH at the center of this dissertation is in (5).

(5) ***Universal prominence hierarchy for person, obviation, and animacy***

{1 > 2 | 2 > 1} (LOCAL) > 3 (PROXIMATE) > 3' (OBVIATIVE) > 0 (INANIMATE)

There are two basic expansions from the initial hierarchy in (1), which I consider in turn. The first is that the SPEECH-ACT PARTICIPANTS, which I refer to interchangeably as the LOCAL persons, can show a ranking of either 1 > 2, 2 > 1, or both. The second is that the ANIMATE BEINGS category is divided by a ranking of the PROXIMATE third person above the OBVIATIVE third persons. The discussion here, and in much of the thesis, largely sets aside the inanimate category for reasons of scope, but it is included above for explicitness. While further articulations may well be motivated (e.g. a split between humans and animals, as discussed above, or with honorific categories such as elder versus non-elder), the hierarchy in (5) is claimed to describe the *maximal* universal ranking of the categories related to person, obviation, and animacy-based noun classification.

The operative word for understanding the universality of the scale is *maximal*. As was shown with the contrast between matrix and embedded clauses in Ojibwe, not all prominence rankings are realized in every context. Setting aside for the moment the proximate/obviative split and focusing in on the core person distinctions, over the course of the thesis, I show that the all and only the range of prominence effects summarized in (6) can be observed across languages and constructions.

(6) **Summary of possible/predicted person-based prominence effects**

<i>Ultra Strong (Author):</i> $1 > 2 > 3$	<i>Blackfoot, Classical Arabic</i>
<i>Ultra Strong (Addressee):</i> $2 > 1 > 3$	<i>Nez Perce</i>
<i>Strong:</i> $\{1 > 2, 2 > 1\} > 3$	<i>Slovenian</i>
<i>Weak:</i> $1/2 > 3$	<i>Massachusetts, Kichean, Italian</i>
<i>Me-First:</i> $1 > 2/3$	<i>Romanian</i>
<i>You-First:</i> $2 > 1/3$	<i>Cuzco Quechua</i>
<i>No Effect:</i> $1/2/3$	<i>Ojibwe, Moro</i>

As indicated, these possibilities are in turn described by all and only the possible rankings and category collapses implied by the scale in (5). Variation in the ranking of the local persons gives rise to the two types of *Ultra Strong* effects and the *Strong* effect. Collapsing the ranking of first and second gives rise to *Weak* effects. Collapsing only the second or first person with the third gives rise to *Me-First* and *You-First* effects, respectively. Finally, a full collapse leads to a lack of prominence-based effects.

All other logically possible rankings given the categories 1, 2, and 3 are so far unattested in human language. These (im)possibilities are summarized in (7).

(7) **Summary of impossible person-based prominence effects**

- * $3 > 1 > 2$
- * $3 > 2 > 1$
- * $3 > 1/2$
- * $3/1 > 2$
- * $3/2 > 1$

What all of these impossible and unattested rankings have in common is that the third person category is ranked above at least one of the local persons. This is critically distinct from the possible rankings, which allow the ranking between the local and third

One revealing fact about obviation is that every language that distinguishes the *categories* of proximate and obviative in turn show evidence of a *ranking* between the two. That is, there is no language with an obviative marking system that shows evidence that the ranking in (10) is collapsed.

(10) *Obviation Hierarchy*: 3 > 3'

This clearly distinguishes obviation from the core person features, where all possible collapses of the ranking were observed. Contending with this lack of variation in obviation sets another goal for our theory of features.

The dissertation is therefore tied together by the more particular through-line of gaining a deeper understanding of person-based prominence by an examination of how *obviation* is encoded within the representation of possible person categories, how it influences agreement and word order, and how it is used along with direct/inverse marking to put together the pieces of argument structure in real time processing. This study of obviation is situated within a broader account of φ -features including the core distinctions of person, which provide the means to distinguish various sets consisting of the author, addressee, and others, the distinction of animacy-based noun classification, which separates sets of animate beings from inanimate objects, and a distinction in number, which in the languages surveyed here distinguishes singletons from groups.

The remainder of the introduction is organized as follows. In Section 1.2 I provide an overview of the proposed representation of person, obviation, and animacy, which is centered around the intimately linked questions of how to derive the range of both prominence effects and possible person distinctions from a single representation. Section 1.3 introduces the theory of how this representation is manipulated to give rise to prominence-based agreement and word order effects. In Section 1.4 I review the evidence for how prominence influences the real-time processing of argument structure, and summarize the proposed model of filler-gap dependency processing to capture these

effects. Section 1.5 then turns to the necessary background on Border Lakes Ojibwe. Section 1.6 concludes with an overview of the thesis.

1.2 Study I: Representing prominence and possible persons

The first question that animates the thesis is: how are prominence relationships encoded in the linguistic representation? This is taken to amount to the question of how *person*, *obviation*, and *animacy* are representationally encoded. The PAH provides rankings of person *categories* such as “first”, “exclusive”, “inclusive”, “second”, “third”, “proximate” and “obviative”. These categories can be used to classify a variety of linguistic forms, including pronouns, agreement, and clitics. However, current theories recognize that categories are not the end of the representational line, but rather are built through the combination of atomic units known as *features*. To make explicit an already implicit analogy, just as molecules are made from the combination of atoms, categories are made from the combination of features. The goal is to identify the atomic units of syntax, and to build a model of how they interact to produce particular collections of categories.

Prominence effects provide a critical insight into this endeavor. Current theories such as the widely adopted feature geometric approach (Harley and Ritter, 2002; Béjar, 2003) pins the emergence of prominence effects on the relationships between features rather than the relationships between categories. A geometrically-based representation that provides the means to distinguish the categories of FIRST, SECOND, PROXIMATE, and OBVIATIVE is given in (11).

(11) ***Representation of person/obviation under the feature geometry***

- a. FIRST: [π [prox [part [auth]]]]
- b. SECOND: [π [prox [part]]]
- c. PROXIMATE: [π [prox]]
- d. OBVIATIVE: [π]

The geometry stipulates that more specific features such as [auth(or)] entail the presence of all less specific features [part(icipant)], [proxi(imate)], and [π]. The result is that the following subset-superset relationships can be observed between the four person categories (cf. Béjar, 2003):

(12) *Proper subset/superset relationships between categories*

- a. FIRST \supset SECOND \supset PROXIMATE \supset OBVIATIVE
- b. $\{\pi, [\text{prox}], [\text{part}], [\text{auth}]\} \supset \{\pi, [\text{prox}], [\text{part}]\} \supset \{\pi, [\text{prox}]\} \supset \{\pi\}$

Operations such as AGREE can then be tuned to target a *specific* feature set. If that more specific set is not available for one reason or another, then the next most specific set is targeted.

A major issue that this thesis reckons with is that all current theories rely on the *stipulation* of the relationships between categories or features via second-order representations such as a hierarchy or geometry. While the geometry is a step forward in understanding the relationships that hold between features, like the PAH, it relies on extrinsic requirements to create the relevant entailments between categories. The novel contribution of this thesis is to provide a feature representation that instead *derives* prominence relationships from first-order set-based relationships, dispensing with direct use of hierarchies and geometries. The claim is that features are not in fact the most atomic representation, but are decomposable into smaller units. The thesis that I defend, summarized in (13), is that the syntactic representation of features consists of a set of *ontologically-based primitives* *I*, *U*, *O*'s, and *R*'s, where *I* is ultimately interpreted as the author, *U* as the addressee, the *O*'s as the animate others, and the *R*'s as the inanimate others. To continue the analogy from before, just as atoms are made of particles, features are made of *primitives*.

(13) ***Thesis for the decomposition of φ -features***

φ -features consist of sets formed from the ontologically-based primitives $I, U, O, O', \dots, O^n, R, R', \dots, R^n$ such that:

The feature [author] is decomposable into the set $\{I\}$

The feature [addressee] is decomposable into the set $\{U\}$

The feature [participant] is decomposable into the set $\{I, U\}$

The feature [proximate] is decomposable into the set $\{I, U, O\}$

The feature [animate] is decomposable into the set $\{I, U, O, O', \dots, O^n\}$

The root Φ is decomposable into the set $\{I, U, O, O', \dots, O^n, R, R', \dots, R^n\}$

To expand, the claim is that all humans share a common *ontology* — this amounts to saying that there is a set of primitive *mental concepts* related to person. In particular, there are primitive concepts for the utterance author, the utterance addressee, animate persons other than the author and addressee, and inanimate others. The symbols I, U , the O 's and the R 's are respectively the syntactic analogues of these primitive concepts. The proposal of these analogues allows for the maintenance of the assumption of the modularity of syntactic generation from the interpretation of structures.

Given the proposal in (13), prominence relationships fall out of the subset-superset relationships between *features*, rather than *categories* per se. This is shown in (14).

(14) ***Proper subset/superset relationships between features***

a. [animate] \supset [proximate] \supset [participant] \supset [author], [addressee]

b. $\{I, U, O, O', \dots, O^n\} \supset \{I, U, O\} \supset \{I, U\} \supset \{I\}, \{U\}$

The resulting representation is therefore freed of all remaining extrinsic stipulations on the relationship between features and categories. The features are made up of sets of primitives, and the relationships between the features follow from foundational relationships defined within set theory. The workings of how this representation interacts

with a theory of AGREE to capture prominence effects such as the PCC and direct/inverse marking is summarized in Section 1.3.1.

What is pertinent for the immediate discussion is that the sets of primitives that these features are made up of interact to form various person categories, which are summarized in Table 1.1. The interactions between features are governed by binary feature *values*, which can be either positive (+) or negative (-).²

Category	Syntactic Set	Features
EXCLUSIVE	{ <i>I</i> }	{+anim, +prox, +auth, -part*}
INCLUSIVE	{ <i>I, U</i> }	{+anim, +prox, +auth, +part*}
SECOND	{ <i>U</i> }	{+anim, +prox, -auth, +part*}
PROXIMATE	{ <i>O</i> }	{+anim, +prox, -auth, -part*}
OBVIATIVE	{ <i>O'</i> }	{+anim, -prox}
INANIMATE	{ <i>R</i> }	{-anim}

Table 1.1: Proposed set-based and feature-based representations for (singular) person/obviation/animacy categories. The difference between $\pm\text{part}$ and $\pm\text{part}^*$ is discussed further below.

Notice that the feature/value combinations in Table 1.1 are restricted in certain cases. For example, [-proximate] does not appear in combination with either the author or participant features, and [-animate] does not appear with proximate, author, or participant features. Understanding the basis for these restrictions ties into the second goal of the first portion of the thesis: to provide a representation of person, obviation, and animacy that generates all and only the possible category distinctions observed in natural language.

It is well known that languages show different sets of φ -based categories. At the same time, not all logically possible distinctions are attested. The classic example of a puzzle of this sort was put forward by Zwicky (1977), who showed that languages with three basic person categories universally treat the meaning associated with the inclusive person (*you + us*) as a form of first person rather than second person. What is surprising about this is that the inclusive includes reference to both the author and

²The *unvalued* variant is reserved for probes. This proposal is summarized below in Section 1.3.1.

addressee — as such, there is no a priori reason to assume that the inclusive meaning should be universally conflated with the first person rather than the second person in languages that lack a clusivity distinction. Explaining this type of gap falls to the theory of the representation of person categories.

Recent work by Harbour (2016) has generalized this basic problem as one of generating *partitions* of a common space of possible persons, showing that only 5 of the 15 possible patterns are attested. I adopt Harbour’s “partition problem” as a core explanandum, seeking to provide an account of the additional partitions encoded by obviation and noun classification, which are not covered in Harbour’s original account. Setting aside animacy and number for the time being and focusing in on obviation and person, this adds a sixth possible partition to the mix, as summarized in (15).

- (15) ***Possible partitions with the addition of Border Lakes Ojibwe. From left-to-right: Monopartition, participant bipartition, author bipartition, tripartition, quadripartition, and quintipartition***

EXCL	EXCL	EXCL	EXCL	EXCL	EXCL
INCL	INCL	INCL	INCL	INCL	INCL
SEC	SEC	SEC	SEC	SEC	SEC
PROX	PROX	PROX	PROX	PROX	PROX
OBV	OBV	OBV	OBV	OBV	OBV

As in (Harbour, 2016), I adopt and defend the thesis that the semantic denotation of person features are lattices formed from the power sets of ontological primitives, as summarized in (16). Ultimately, these primitives allow reference to the author (*i*), the addressee (*u*), animate others (*o*’s) and inanimate others (*r*’s). To be clear, the lower case variants introduced here are the ontological concepts themselves, while the upper case variants discussed above are the syntactic instantiation, which are not themselves interpretable. I retain the denotation of the author and participant features proposed by Harbour. The novel contribution of the work is to provide denotations of both a prox-

imate and animate feature to capture the additional partitions rendered by obviation and animacy-based noun classification.

(16) *Thesis for the denotation of φ -features (extension of Harbour, 2016)*

φ -features denote lattices formed from the power sets of the ontological primitives $i, u, o, o', o'', \dots, r, r', r'', \dots$, such that:

The feature [author] denotes the power set of $\{i\}$

The feature [participant] denotes the power set of $\{i, u\}$

The feature [proximate] denotes the power set of $\{i, u, o\}$

The feature [animate] denotes the power set of $\{i, u, o, o', o'', \dots\}$

The root φ denotes the power set of $\{i, u, o, o', o'', \dots, r, r', r'', \dots\}$

As was seen with the strictly syntactic interaction between features, the features interact based on their values to derive the appropriate lattice for each person categories. As expected based on an isomorphic mapping from syntax to semantics, the relevant feature/value combinations are the same as those specified in Table 1.1. The question is how exactly these features interact to give rise to the appropriate partitions. On this front, I break from Harbour's original account, arguing that only the recent *contrastive* theory of feature interaction advanced by Cowper and Hall (2019) can generate the particular person, obviation, and animacy distinctions found in Border Lakes Ojibwe. I expand on Cowper and Hall's account by considering how animacy, obviation, and number fit into the picture.

I argue that the functional sequence for nominal elements includes projections for animacy (nP), obviation (ProxP), person (πP), and number ($\#P$) in the order specified in (17). This sequence is critical to determining the order of composition of each type of feature with the root node φ . As each feature is composed, the lattice denoted by φ , which exhausts the possible space of person/animacy-based reference, is further restricted. These restrictions are defined by first-order predicate logic: positive action

of a feature F restricts φ to those elements that include a member of the lattice denoted by F , while negative action of F restricts φ to those elements that *do not* contain any members of the lattice denoted by F . Setting aside number, animacy splits i , u , and the o 's form the r 's; obviation further splits i , u , and the single “proximate” o from the other o 's; participant splits i and u from o , and author i from u and o .

(17) *The nominal functional sequence in Border Lakes Ojibwe*

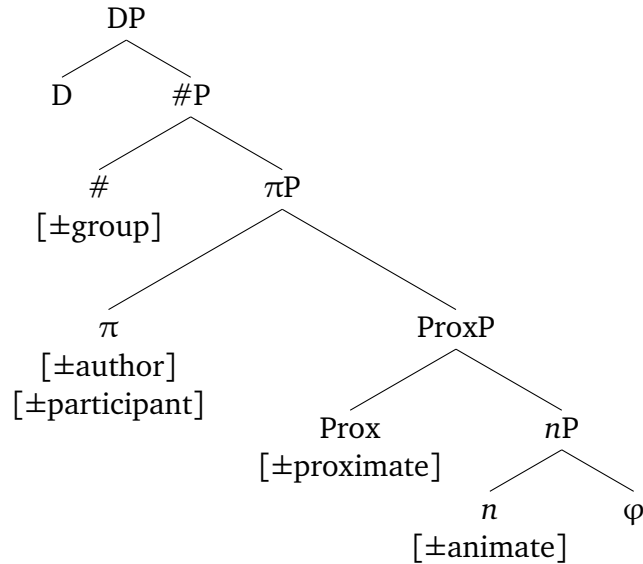

Given this five feature system, with each feature taking a binary value, in theory the system should be capable of giving rise to up to 32 categories (16 if number is ignored). This is far more than is made in Ojibwe and any other known language with animacy and obviation distinctions. The principled restriction imposed on the composition of feature/value combinations comes from the notion of *contrastiveness* — that all features specified in the representation of a given category must serve to mark a meaningful contrast between categories. Ultimately, the determination of contrastiveness is grounded in the principles that guide acquisition (Dresher, 2009, 2018). This plays out in two ways in Border Lakes Ojibwe, which are visualized with the *contrastive hierarchy* in (18). Note that unlike a feature geometry, the contrastive hierarchy is not advanced as a model of the mental representation of language, but is rather a schematization of the algorithm employed by the learner to determine the specification of features.

(18) *Contrastive hierarchy for Border Lakes Ojibwe*

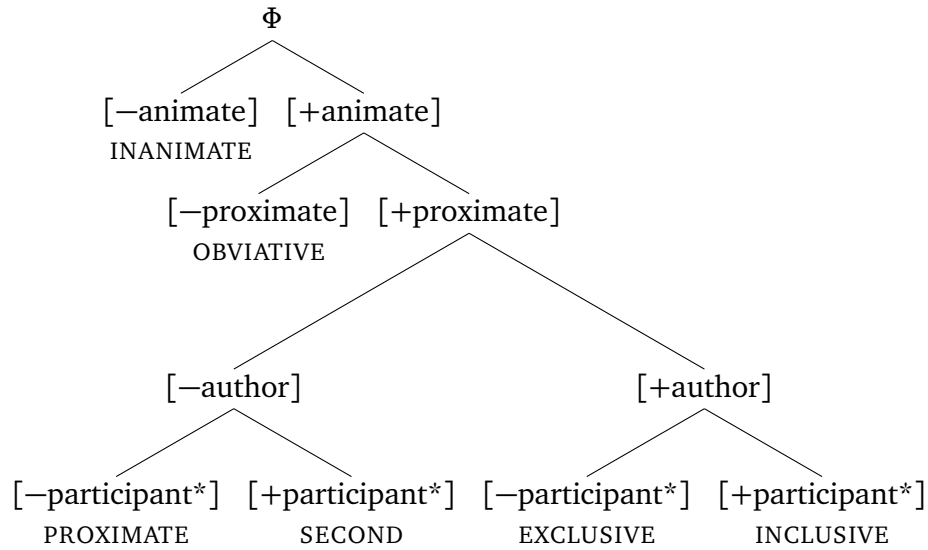

The first way that contrastiveness rears its head is in the restricted feature specifications that occur in the context of $[-animate]$ and $[-proximate]$, which was previously pointed out surrounding the discussion of feature specifications in Table 1.1. Given the requirement that each feature be contrastive (i.e. that non-contrastive features are never advanced by the learner), following the composition of $[-animate]$, which creates a lattice consisting of only the inanimate r 's, none of the other features (excluding number) could possibly serve to make a further split on this lattice. All other features make splits based on i , u , and the o 's rather than the inanimate r 's. An analogous situation holds with $[-proximate]$, where the only remaining elements of the lattice are the non-proximate o 's, which again cannot be further divided by either the participant or author features.

The second impact of contrastiveness is on the interpretation of $[participant]$, which has been notated as $[participant^*]$ in the hierarchy above. The proposal is that the participant feature, which normally denotes a lattice consisting of the power set of $\{i, u\}$, is instead winnowed to denote the power set of $\{u\}$, which I refer to as $[participant^*]$. This occurs because $[participant]$ is “in the scope of” $[author]$ within the contrastive hierarchy (Cowper and Hall, 2019). Given that $[author]$ divides based on inclusion or

exclusion of *i*, [participant] is winnowed so that it divides lattices based on the inclusion and exclusion of *u* alone — including *i* would not provide any contrasts that have not already been made. Based on the requirement of contrastiveness, the learner is obliged to restrict the denotation of [participant] to [participant*].³

The system provides an account of the distinctions made by of animacy, obviation, and person in Border Lakes Ojibwe. The major benefit of the system, and one that ultimately proves to be a critical departure from the feature geometric approach, is that there are no extrinsic restrictions on feature combinations. Restrictions fall out of either the principle of contrastiveness, which is in turn tied to a general learning algorithm (Dresher, 2009, 2018), or the order of feature composition defined by the functional sequence, which can be tied to deeper principles of cognition (Wiltschko, 2014).

The final question is thus whether this system, which works for Border Lakes Ojibwe, is properly tuned to capture the observed range of typological variation by producing all and only attested partitions. Ultimately, variation can occur on two dimensions: (i) whether a given feature is present or absent; and (ii) where a given feature falls within the contrastive hierarchy. Variation on the first point is entirely free: All possible feature combinations are argued to be attested. For example, a language that lacks the feature [proximate] will simply conflate the proximate and obviative person categories into the generic (animate) third person. This describes nearly all languages outside of the Algonquian family.

³The astute reader will notice that, in the context of the syntactic representation of features, an independent [addressee] feature was proposed. In contrast, the account in this paragraph proposes that [participant*], which essentially amounts to an addressee feature, is *derived* from [participant] under particular conditions. This represents a real tension between the features available for the creation of partitions on agreement “goals” and the person features that are available to agreement “probes”, which I call the *Addressee Asymmetry*. The long and short of it is the inclusion of an independent [addressee] feature is required to capture the existence of $2 > 1 > 3$ (*Ultra Strong Addressee*) and $2 > 1/3$ (*You-First*) prominence effects (see Chapter 4, Section 4.5.2). The exclusion of [addressee] on goals is needed to account for Zwicky’s Problem, the observation that the inclusive is conflated with the exclusive rather than the second person (see Chapter 2, Section 2.2.1; also, Harbour, 2016, p. 73-74). This tension will not be fully resolved in this thesis, but the contours of the problem are sharpened. For further discussion, see Chapter 7, Section 7.2.

Variation on the second point is corralled by the functional sequence. For example, animacy-based noun classification is argued to be restricted to association with nP and the core person features with πP . As such, the [animate] feature is universally expected to take scope within the contrastive hierarchy over both [participant] and [author]. However, within the head π , the scope relations between [participant] and [author] can be reversed from that seen with Border Lakes Ojibwe. As discussed at length by Cowper and Hall (2019), this derives the difference between languages that distinguish versus conflate the inclusive and exclusive persons. I show that this alternation captures the partition exemplified by Ktunaxa, a language isolate of British Columbia that lacks a clusivity distinction, but makes a distinction in obviation in the third persons.

The new point of variation proposed in the thesis is that ProxP can either appear between nP and πP , as was argued to be the case in Border Lakes Ojibwe, or high in the nominal spine above $\#P$, as shown in (19).

(19) *The nominal functional sequence in Blackfoot*

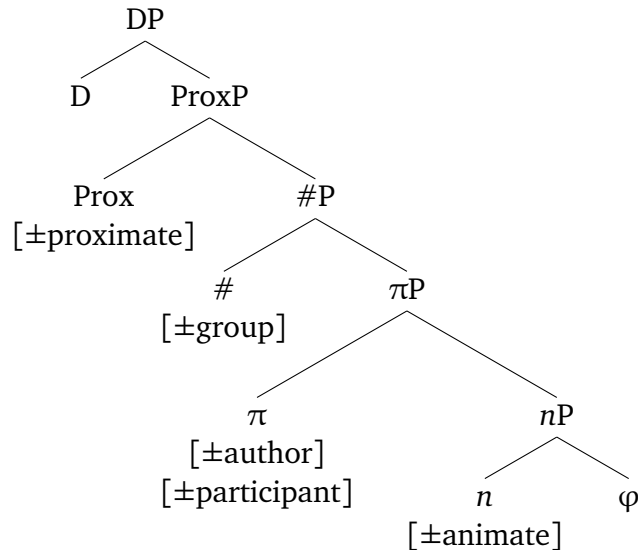

I argue for this alternation in the location of ProxP based on the *octopartition* of Blackfoot, a Plains Algonquian language that makes an obviation distinction in the local persons in addition to the third persons. By taking this high position in the spine, proximate is therefore within the scope (in the relevant sense of the contrastive hierarchy)

of all other features. Given this, the [–proximate] feature is no longer in a position to make restrictions on the specification of features, resulting in feature combinations that contrast obviation in the local persons.

The octopartition of Blackfoot is troublesome for current feature geometric accounts, as the generally adopted feature geometry places the proximate feature between participant and π . Given the representational entailment relationships stated by the geometry, it is not possible to specify the participant and/or author features without also specifying the proximate feature, predicting that all local persons should necessarily be proximate (for a similar line of arguments, see Bliss, 2005a). By breaking these representational entailments between features, the proposed set-based representation of features overcomes this issue.

1.3 Study II: Prominence effects in agreement and word order

The second part of the thesis tackles the question of how to model prominence effects in the grammar. The first objective is to provide a model of AGREE that makes use of the proposed set-based representation of features, where features are argued to be made up of sets of sub-atomic primitives based in the ontology of person. I show that with the set based representation it is possible to capture all and only the attested person-based prominence effects. The second objective is to give an account of the verbal agreement system of Ojibwe. I focus on the patterns related to obviation, where I tie together patterns of word order and agreement.

1.3.1 A set-based model of prominence effects in agreement

The model of agreement proposed in this thesis is descended from the probe-goal AGREE relation of Chomsky (2000, 2001), and critically developed in Béjar (2003), Béjar and Rezac (2009), Preminger (2014), Deal (2015), and Coon and Keine (2020). The sequence of operations subsumed under AGREE is argued to consist of four steps: (i)

Search, where all potential *goal(s)* bearing valued φ -features are located by an agreement *probe* bearing unsatisfied (unvalued) φ -features [uF]; (ii) Match, the evaluation of whether these potential goals can satisfy any [uF] features of the probe; (iii) Copy, where the φ -features of the goal are copied back to the probe; (iv) Satisfaction, where the relevant [uF] features of the probe are deactivated. I adopt the *obligatory operations* model of Preminger (2014), where the sequence of operations defined by AGREE must be triggered as soon as a [uF] segment enters the derivation, but failing to Match, Copy, and ultimately Satisfy [uF] features does not lead to an ill-formed representation.

The representational transformation produced by AGREE is highly dependent on the adopted representation of φ -features. For the past two decades, one of the major reasons the feature geometric representation proposed by Harley and Ritter (2002) has dominated theories of person has been its ability to capture a wide range of prominence effects in agreement (e.g. Béjar, 2003; Béjar and Rezac, 2003, 2009; Preminger, 2014; Coon and Keine, 2020). Given the dependencies between features required by the geometry, there are five possible π -probes, shown in (20).

(20) *Possible π -probes under the feature geometry*

- a. [$u\pi$]
- b. [$u\pi$ [$uParticipant$]]
- c. [$u\pi$ [$uParticipant$ [$uAuthor$]]]
- d. [$u\pi$ [$uParticipant$ [$uAddressee$]]]
- e. [$u\pi$ [$uParticipant$ [$uAuthor$]] [$uAddressee$]]]

Each [uF] segment of the probe can be satisfied by finding a goal that has a “valued” version of the feature. In terms of the adopted AGREE procedure, the probe in (20a) would be *fully* satisfied by any animate person. The probe in (20b) by any local person. The probe in (20c) by a first person; the probe in (20d) by a second person; and the probe in (20e) by a combination of first and second persons. That said, un-

der the fallible model of AGREE adopted here (following Preminger, 2014; Deal, 2015), even a probe with very particular satisfaction conditions can settle for being *partially* satisfied by a goal that matches a subset of its [*uF*] features. Furthermore, given the subset/superset relationships between features repeated in part in (21), a probe with less specific satisfaction conditions still matches the more specific categories.

(21) ***Subset/superset relationships between categories (repeated in part)***

- a. FIRST \supset SECOND \supset THIRD
- b. $\{\pi, [\text{part}], [\text{auth}]\} \supset \{\pi, [\text{part}]\} \supset \{\pi\}$

These relations are again a direct result of the stipulated entailment relationships between features. If the first person category was only specified for the [*author*] feature without entailing the less specific features, while this would be enough to distinguish it from the others as a particular category, it would erroneously predict that first person should *not* provide a match for a less specific probe such as those in (20a,b,d).

A final relevant attribute of AGREE is that a probe can end up targeting more than one goal in the effort to find satisfaction. Following the recent work of Coon and Keine (2020), I adopt a *gluttony* approach, where prominence effects are attributed to a probe entering into agreement relationships with multiple goals. Recall that, given two DPs, direct alignments are described by the structurally higher DP (e.g. the external argument) being “higher ranked” on the PAH than the structurally lower DP (e.g. the internal argument). Inverse alignments reverse this mapping, with the structurally lower DP being “higher ranked” on the PAH than the structurally higher DP. However, what it means for a given φ -based category to be “higher ranked” on the PAH is a relative notion. In the current architecture, it can be entirely pinned to the possible structures of the probe.

Let us see how this plays out. The claim is that *gluttony* arises just in case a probe agrees with multiple DPs. In turn, a probe agrees with multiple DPs just in case it c-commands multiple goals *and* the more distant goal matches more segments of the

probe than the closer goal. Consider the two configurations in (22), where a probe specified with features $[uF, uG]$ is c-commanding two φ -bearing DPs. In the direct alignment in (22), the closer DP_1 matches and satisfies both segments of the probe — this fully satisfies the probe. As a result, the structurally further DP_2 cannot provide any additional matches, so its features are not copied back. With the inverse alignments in (22b), the closer DP_1 only provides a partial match for the $[uF]$ segment of the probe. DP_1 satisfies what it can, leading its features to be copied to the probe. The next goal DP_2 provides an additional match of $[uG]$, so the probe copies back its features as well.

(22) a. DIRECT *alignment*

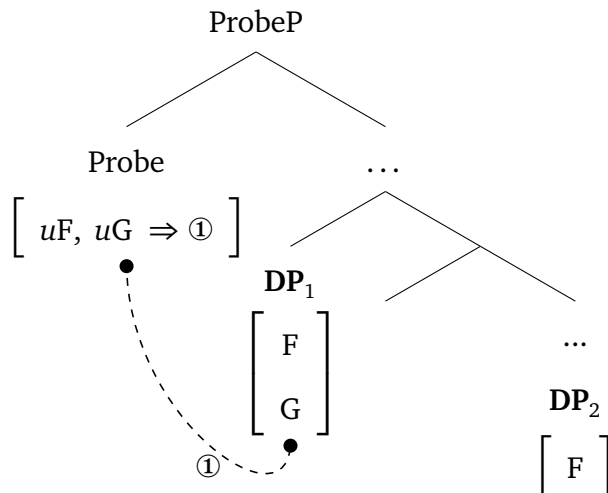

b. INVERSE *alignment*

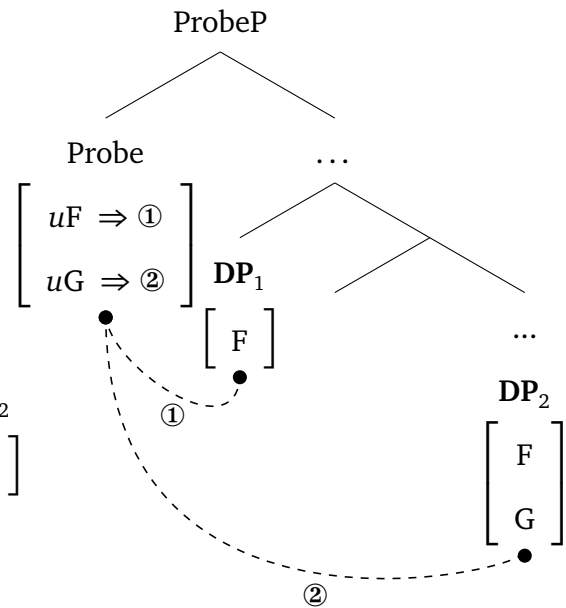

The resulting difference in the representation of the probe following AGREE is summarized in (23) for the direct versus the inverse. In direct alignments, a single set of features is copied back, while two sets of features are specified in the inverse alignments.

(23) a. *Direct*: $\{[F, G]\}$

b. *Inverse*: $\{[F], [F, G]\}$

The result is a wide class of possible types of agreement-based prominence effects including the PCC, direct-inverse marking, portmanteau agreement, and omnivory. For example, with the PCC, gluttony leads to ineffability via a paradox between the conditions on cliticization and the binary nature of the operation MERGE (Coon and Keine, 2020). In the analysis of Ojibwe, gluttony results in the insertion of an elsewhere form (the inverse marker) due to a conflict in the conditioning of spell-out caused by the presence of multiple feature sets, and a dearth of portmanteau forms in this slot.

Bringing it all together, the possible probes, given the restrictions of the feature geometry, define which configurations will give rise to gluttony. The correspondences between the PAH and the possible feature-geometric probes are summarized in (24). This is a subtle but critical shift from a PAH-centric formulation of prominence effects in agreement. The categories themselves do not have an inherent prominence, but rather gain prominence by virtue of how they interact with different possible probes.

(24) *Correspondence between possible feature-geometric π -probes and the PAH*

- | | | |
|----|---|---|
| a. | [$u\pi$] | <i>Flat</i> : 1/2/3 |
| b. | [$u\pi$ [$uPart$]] | <i>Weak</i> : 1/2 > 3 |
| c. | [$u\pi$ [$uPart$ [$uAuth$]]] | <i>Ultra Strong (Author)</i> : 1 > 2 > 3 |
| d. | [$u\pi$ [$uPart$ [$uAdd$]]] | <i>Ultra Strong (Addressee)</i> : 2 > 1 > 3 |
| e. | [$u\pi$ [$uPart$ [$uAuth$] [$uAdd$]]] | <i>Strong</i> : {1 > 2, 2 > 1} > 3 |

A wide range of prominence effects is captured by the feature geometric representation. However, a fatal issue comes into focus: There are two critical *impossible* π -probes given the feature geometric representation, which are shown in (25). These probes violate the principles of the feature geometry by excluding the intermediate [participant] feature, which is implied by the presence of the more specific [author] and/or [addressee] features (cf. Coon and Keine, 2020; Yokoyama, 2019). These two probes are necessary to account for the You-First and Me-First classes of prominence effects.

(25) *Impossible π -probes under the feature geometry*

- a. $*[u\pi [u\text{Author}]]$ *Me-First*: $1 > 2/3$
b. $*[u\pi [u\text{Addressee}]]$ *You-First*: $2 > 1/3$

The solution that is advanced in this thesis is to take advantage of the set-based representation of primitives. The core insight of the feature geometry — that person features stand in entailment relationships — is retained. On the view taken here, the theory erred when the entailment relationships were stipulated by making the geometry a part of the syntactic representation. This resulted in a model of π -probes that is simply too restrictive. Like the entailment relationships between categories described by the PAH, I consider the entailment relationships between features expressed by geometries as something to be derived. This is encompassed in the metatheoretical thesis in (26).

(26) *Metatheoretical thesis for the PAH and feature geometry*

The PAH and the feature geometry are second-order representations that *describe* properties of the representation, but are *not encoded* in the representation itself.

In particular, the PAH describes the relationships that hold between categories, and the feature geometry the relationships that hold between features. The properties implied by both are captured by the proposed representation in conjunction with the foundational relations of intersection and inclusion defined within set theory.

The starting point is to recall the containment relationships that hold between the proposed sets for each person feature, repeated in part in (27).

(27) *Subset/superset relationships between features (repeated in part)*

- a. $\pi \supset [\text{participant}] \supset [\text{author}], [\text{addressee}]$
b. $\{I, U, O, O', \dots, O^n\} \supset \{I, U\} \supset \{I\}, \{U\}$

Given that there are no representational dependencies specified between features, the three person features [*uParticipant*], [*uAuthor*], and [*uAddressee*] can freely combine with the *uπ* set that is inherent to the *π*-probe, giving rise to 8 distinct articulations. These are summarized in (28).

(28) *Correspondence between possible set-based π-probes and the PAH*

- | | | |
|----|--|---|
| a. | { <i>uπ</i> } | <i>Flat</i> : 1/2/3 |
| b. | { <i>uπ</i> , <i>uParticipant</i> } | <i>Weak</i> : 1/2 > 3 |
| c. | { <i>uπ</i> , <i>uAuthor</i> } | <i>Me-First</i> : 1 > 2/3 |
| d. | { <i>uπ</i> , <i>uAddressee</i> } | <i>You-First</i> : 2 > 1/3 |
| e. | { <i>uπ</i> , <i>uParticipant</i> , <i>uAuthor</i> } | <i>Ultra Strong (Author)</i> : 1 > 2 > 3 |
| f. | { <i>uπ</i> , <i>uParticipant</i> , <i>uAddressee</i> } | <i>Ultra Strong (Addressee)</i> : 2 > 1 > 3 |
| g. | { <i>uπ</i> , <i>uAddressee</i> , <i>uAuthor</i> } | <i>Strong</i> : {1 > 2, 2 > 1} > 3 |
| h. | { <i>uπ</i> , <i>uParticipant</i> , <i>uAddressee</i> , <i>uAuthor</i> } | <i>Strong</i> : {1 > 2, 2 > 1} > 3 |

As indicated above, the eight probes are claimed to capture the full range of possible person-based prominence effects. These set-based probes stand in an exactly analogous relationship to the PAH as the probes under the feature geometric account. The key additions to the set of possible probes are those in (28c) and (28d), which lack the “intermediate” participant feature but include the more specific author or addressee features. These are the probes that are impossible given the feature geometric representation, and form a key empirical motivation for the adoption of the proposal.⁴

To capture prominence effects, recall that each possible person category within a language gives rise to a set of primitives. The relevant categories for now are those related to the (singular) first, second, and generic third persons, given in (29).

⁴Note the third probe that arises on this representation — the one that includes *both* author and addressee features, but lacks participant. This provides a second pathway to capture Strong effects. While redundant, it has no effect on the generative capacity of the account. It remains to be seen whether the two Strong probes make predictions that can be pulled apart empirically.

(29) *Sample of syntactic category-set correspondences*

- a. FIRST = $\{I\}$
- b. SECOND = $\{U\}$
- c. THIRD = $\{O\}$

These categories define potential goals to be targeted for agreement. With the representations of both probes and goals in hand, the key proposal is to define the AGREE sequence in terms of the primitives rather than features, as stated in the thesis in (30).

(30) *Thesis for the formulation of AGREE*

AGREE operates over sets of ontologically-based syntactic primitives.

The most important component of AGREE to define at the level of the primitive sets rather than features is the condition on Match. In purely feature-based formulations of AGREE, Match determines whether an unvalued feature $[uF]$ of the probe can be matched by a “valued” counterpart F of the goal. In the new formulation given in (31), AGREE is still *segment based* in that Match is evaluated with respect to each feature of the probe, but rather than determining Match based on feature identity with the goal, it is done by comparing each feature of the probe to the set defined by the goal. The features themselves are not compared. Match holds between a segment of the probe and the goal just in case the intersection of the two sets is non-empty.

(31) *Definition of Match*

A probe determines Match with a goal via intersection between the set F of a feature $[uF]$ of the probe and the set G of the goal. Match holds if $F \cap G \neq \emptyset$.

With this definition in hand, it is possible to replicate the matching relationships between categories and features that formed the critical foundation for the adoption of the feature geometry. As shown in (32a), all persons Match $[u\pi]$. With $[uPart]$, shown

in (32b), first and second Match, but not third. The features [*uAuth*] and [*uAdd*] respectively Match *only* the first or second persons.

(32) ***Match relations between person categories and person features***

- a. $u\pi \cap \text{THIRD} = u\{I, U, O, O', \dots, O^n\} \cap \{O\} = \{O\}$
 $u\pi \cap \text{SECOND} = u\{I, U, O, O', \dots, O^n\} \cap \{U\} = \{U\}$
 $u\pi \cap \text{FIRST} = u\{I, U, O, O', \dots, O^n\} \cap \{I\} = \{I\}$
- b. $u\text{Part} \cap \text{THIRD} = u\{I, U\} \cap \{O\} = \emptyset$
 $u\text{Part} \cap \text{SECOND} = u\{I, U\} \cap \{U\} = \{U\}$
 $u\text{Part} \cap \text{FIRST} = u\{I, U\} \cap \{I\} = \{I\}$
- c. $u\text{Auth} \cap \text{THIRD} = u\{I\} \cap \{O\} = \emptyset$
 $u\text{Auth} \cap \text{SECOND} = u\{I\} \cap \{U\} = \emptyset$
 $u\text{Auth} \cap \text{FIRST} = u\{I\} \cap \{I\} = \{I\}$
- d. $u\text{Add} \cap \text{THIRD} = u\{U\} \cap \{O\} = \emptyset$
 $u\text{Add} \cap \text{SECOND} = u\{U\} \cap \{U\} = \{U\}$
 $u\text{Add} \cap \text{FIRST} = u\{U\} \cap \{I\} = \emptyset$

Essentially all other aspects of AGREE discussed above in the context of the gluttony-based account of Coon and Keine (2020) are maintained, but couched in terms of sets. If Match holds between a probe and a goal, then the set of the goal is copied to the probe. This set is ultimately spelled-out as agreement morphology. When a probe has multiple [*uF*] segments, it will continue searching its domain for a matching goal, agreeing with more than one along the way if that is what it takes to satisfy all of its features.

To take a concrete example, in (33) I show how this derives direct (non-gluttonous) versus inverse (gluttonous) configurations in 1 + 3 alignments. In the 1 » 3 configuration in (33a), the probe executes the AGREE procedure with the first person argument first; this argument Matches, and therefore Satisfies, both the *uπ* and *uPart* features of

the probe. This results in only the set of the first person argument to be copied back. In the 3 » 1 configuration in (33b), the initial AGREE procedure with the third person only satisfies the $u\pi$ feature; this precipitates agreement with the first person to satisfy $uPart$. As a result, both the sets of the third and first person arguments are copied back, resulting in gluttony.

(33) **Weak prominence effect: 1/2 > 3**

- a. [Probe_{ $u\pi$, $uPart$ } [... FIRST [... THIRD]]]
- (i) -----•
- (i) $u\pi \cap \text{FIRST} = u\{I, U, O, O', \dots, O^n\} \cap \{I\} = \{I\} \Rightarrow u\pi \text{ Satisfied}$
 $uPart \cap \text{FIRST} = u\{I, U\} \cap \{I\} = \{I\} \Rightarrow uPart \text{ Satisfied}$
- b. [Probe_{ $u\pi$, $uPart$ } [... THIRD [... FIRST]]]
- (i) -----• (ii) -----•
- (i) $u\pi \cap \text{THIRD} = u\{I, U, O, O', \dots, O^n\} \cap \{O\} = \{O\} \Rightarrow u\pi \text{ Satisfied}$
 $uPart \cap \text{THIRD} = u\{I, U\} \cap \{O\} = \emptyset \Rightarrow uPart \text{ Unsatisfied}$
(ii) $uPart \cap \text{FIRST} = u\{I, U\} \cap \{I\} = \{I\} \Rightarrow uPart \text{ Satisfied}$

To reiterate, the differences between the present account and that based in the feature geometry are twofold. First, the three core person features can freely combine to form probes on the head π . This is empirically necessary to capture the Me-First and You-First classes of prominence effects. Second, the entailment relationships between categories and features is captured by the *inherent* containment relationships between sets and features, rather than stipulated via the PAH or the feature geometry. As a result, prominence effects are derived from first principles.

1.3.2 Word order and agreement in Border Lakes Ojibwe

The second goal of this portion of the thesis is to apply the theory of AGREE and the representation of features to understand the interaction between agreement and word

order in Ojibwe. This brings the focus largely back onto obviation. For the slice of the agreement paradigms accounted for here, just three features are necessary: $[\Phi]$, [animate], and [proximate]. These three features stand in the subset-superset relationships summarized in (34).

(34) **Subset/superset relationships between features (repeated in part)**

- a. $\Phi \supset [\text{animate}] \supset [\text{proximate}]$
- b. $\{I, U, O, O', \dots, O^n, R, R', \dots, R^n\} \supset \{I, U, O, O', \dots, O^n\} \supset \{I, U, O\}$

All argument combinations will involve the proximate and obviate third persons. To review, the singular variants of these categories represent the sets in (35).

(35) **Set-based representation of (singular) proximate and obviate nouns**

- a. $\text{PROX}(\text{IMATE}) = \{O\}$
- b. $\text{OBV}(\text{IATIVE}) = \{O'\}$

With these features and categories, the following Match relations hold:

(36) **Match relations between animacy/obviation categories and features**

- a. $u\Phi \cap \text{PROX} = u\{I, U, O, O', \dots, O^n, R, R', \dots, R^n\} \cap \{O\} = \{O\}$
 $u\Phi \cap \text{OBV} = u\{I, U, O, O', \dots, O^n, R, R', \dots, R^n\} \cap \{O'\} = \{O'\}$
- b. $u\text{Anim} \cap \text{PROX} = u\{I, U, O, O', \dots, O^n\} \cap \{O\} = \{O\}$
 $u\text{Anim} \cap \text{OBV} = u\{I, U, O, O', \dots, O^n\} \cap \{O'\} = \{O'\}$
- c. $u\text{Prox} \cap \text{PROX} = u\{I, U, O\} \cap \{O\} = \{O\}$
 $u\text{Prox} \cap \text{OBV} = u\{I, U, O\} \cap \{O'\} = \emptyset$

Both $u\Phi$ and $u\text{Animate}$ Match with both proximate and obviate categories, while $u\text{Proximate}$ matches with only the proximate category.

Ojibwe (and nearly all other Algonquian languages) distinguish clause-types as a function of whether the verb is a matrix or embedded clause — these are descriptively referred to as the *independent* and *conjunct* orders, respectively. In the portion of the agreement system that is the focus of this account, there are two major differences between the two orders.

To arrive at a description of these differences, consider first the patterns of agreement in matrix clauses for the two $3 \leftrightarrow 3'$ alignments, given in (37).

(37) **$3 \leftrightarrow 3'$ alignments in matrix clauses (independent order)**

- | | | |
|----|--|-----------------------------|
| a. | o- waab -am -aa -waa -n
3- see -ANIM -3 -PL -3'
'They (PROX) see h/ (OBV)' | DIRECT: $3 \rightarrow 3'$ |
| b. | o- waab -am -igo -waa -n
3- see -ANIM -INV -PL -3'
'S/he (OBV) sees them (PROX)' | INVERSE: $3' \rightarrow 3$ |

Excluding the root, there are five pieces of morphology, which ultimately correspond to four distinct agreement probes. First, there is the *person prefix*, realized here as *o-* which indexes the person features of proximate argument and is linked to the *central agreement* marker *-waa*, which indexes the number of the proximate argument. Second, there is the *final*, realized in both examples as *-am*, which indexes the animacy of the IA. In both cases, the IA is animate, so this shows no alternation between the two examples. Third, there is the *theme sign*, which as described in Section 1.1 alternates between a direct form *-aa* which indexes the proximate EA, and the inverse form *-igo*, an elsewhere form. Fourth, there is the *peripheral* marker *-n*, which indexes the obviative argument.

As already discussed in Section 1.1 the agreement on the person prefix and central agreement, as well as the patterns of direct/inverse marking, can be described by a PAH that ranks proximate over obviative. The prefix and central agreement always index the higher ranked proximate argument, and the special inverse form appears just in case

the alignment between the PAH and the hierarchy of argument position is high-to-low rather than high-to-high. In contrast, the peripheral agreement slot presents an apparent violation of the PAH by always showing agreement with the *lower ranked* obviative argument. A first goal of the analysis is to model the hierarchy obeying behavior, but also illuminate why this apparent violation arises.

The patterns of agreement in embedded clauses are shown in (38).

(38) **3 ↔ 3' alignments in embedded clauses (conjunct order)**

- a. waab -am -aa -waad
 see -ANIM -3 -3PL
 'If they (PROX) see h/ (OBV)' DIRECT: 3 → 3'

- b. waab -am -igo -waad
 see -ANIM -INV -3PL
 'If s/he (OBV) sees them (PROX)' INVERSE: 3' → 3

While much is shared with the independent order, evidence for the two aforementioned differences emerges. First, there is no person prefix. Instead, the central agreement marker *-waad* indexes the person and number of the proximate argument. Second, there is no peripheral agreement marker. Otherwise, both the final and theme sign show the same forms and alternations as in the independent order. A second goal of the analysis is to model these points of variation between matrix and embedded clauses.

The analysis links these patterns of agreement to patterns of word order. Word order in Border Lakes Ojibwe generally differs as a function of direct and inverse alignment (Hammerly, 2019b). In the independent order, shown in (39), direct shows an alternation between VOS and VSO orders, with VOS being more common and generally preferred, while inverse shows VSO only. This reveals a general preference for the less prominent obviative argument to precede the more prominent proximate argument.

(39) **Independent: DIRECT (VOS preferred; VSO possible); INVERSE (VSO only)**

- a. o-gii-waab-am-aa-n ikwe-wan gwiiwizens
 3-PAST-see-ANIM-3-3' woman-OBV boy.PROX
 'The boy (PROX) saw the woman' (OBV)' $V_{DIR} O_{OBV} S_{PROX}$
- b. o-gii-waab-am-aa-n gwiiwizens ikwe-wan
 3-PAST-see-ANIM-3-3' boy.PROX woman-OBV
 'The boy (PROX) saw the woman (OBV)' $V_{DIR} S_{PROX} O_{OBV}$
- c. o-gii-waab-am-igoo-n gwiiwizens-an ikwe
 3-PAST-see-ANIM-INV-3' boy-OBV woman.PROX
 'The boy (OBV) saw the woman' (PROX)' $V_{INV} S_{OBV} O_{PROX}$
- d. *o-gii-waab-am-igoo-n ikwe gwiiwizens-an
 3-PAST-see-ANIM-INV-3' woman.PROX boy-OBV
 Intended: 'The boy (OBV) saw the woman (PROX)' $*V_{INV} O_{PROX} S_{OBV}$

The conjunct again differs from the independent in two ways. First, the base order of embedded clauses is verb-medial rather than verb-initial. Second, the proximate argument reliably precedes the obviative argument, resulting in SVO in direct alignments and OVS in the inverse.

(40) **Conjunct: DIRECT (SVO only); INVERSE (OVS only)**

- a. in-gii-noondam ikwe gii-nagamotaw-aa-d abinoojiin-yan
 1-PAST-hear woman.PROX PAST-sing-3-3 child-OBV
 'I heard that the woman (PROX) sang to the child (OBV)'
- b. *ingii-noondam abinoojiinyan gii-nagamotawaad ikwe
- c. in-gii-noondam abinoojiinh gii-nagamotaw-igo-d ikwe-wan
 1-PAST-hear child.PROX PAST-sing-INV-3 woman-OBV
 'I heard that the child (PROX) was sung to by the woman (OBV)'
- d. *ingii-noondam ikwewan gii-nagamotawigod abinoojiinh

With the empirical patterns to be accounted for in hand, the first aspect of the model to cover is adopting an explicit connection between agreement and movement. In this model, movement is *always* preceded by an agreement relation, making movement parasitic on AGREE (e.g. Chomsky, 2000, 2001; Bošković, 2007). This relationship is

schematized in (41). The figure purposefully abstracts away from the type of agreement (φ -based or δ -based) and therefore the type of movement chain created (A-chain or A'-chain), taking a feature-based view of these distinctions following Van Urk (2015).

(41) *Agreement feeds Movement*

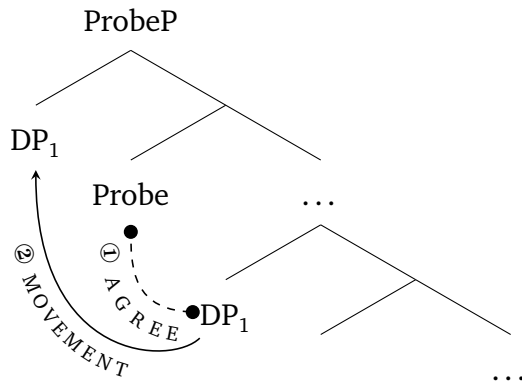

That said, there are cases of agreement that are not followed by movement. Whether or not movement is triggered is gated by whether or not the *features* involved in agreement have an EPP property, which encodes the need for certain projections to have their specifier filled. The novel contribution is to treat the EPP as a property not of heads or projections per se, but rather of the features of heads. This allows it to be relativized to prefer XPs with particular properties. This thesis is summarized in (42).

(42) *Thesis for the Relativized EPP*

The EPP is a property of features not heads. The EPP can be relativized such that only XPs with a particular feature F can satisfy the EPP.

Specifically, I argue that Voice in Ojibwe has a feature [EPP: *uProximate*], which is only checked if a proximate argument fills the specifier of VoiceP. I link this proposal to the recent account of person-hierarchy effects by Zubizarreta and Pancheva (2017); Pancheva and Zubizarreta (2017), where certain phase projections appear to require a local (or proximate) persons to occupy their edge.

Building on the analysis of Oxford (2014, 2019b) for Algonquin, a northeastern dialect of Ojibwe, the four descriptive agreement slots in the independent are tied to four distinct agreement probes, which are in turn tied to particular heads within the functional sequence, as summarized in (43).

- (43) ***Independent order φ -probes, their corresponding heads, and morphology***
- | | | |
|----|---|----------------------------|
| a. | γ -probe = ν = Final = <i>-am</i> | <i>Noun classification</i> |
| b. | ρ -probe = Voice = Theme Sign = <i>-aa/-igo</i> | <i>Obviation</i> |
| c. | π -probe = Infl = Prefix + Central = <i>o- -waa</i> | <i>Person</i> |
| d. | ω -probe = C = Peripheral = <i>-n</i> | <i>Number</i> |

The novel claim is identifying these probes with four distinct *types*, corresponding to noun classification (γ), obviation (ρ), person (π), and number (ω). All of these types have been recognized in previous work (e.g. Béjar and Rezac, 2003), with the exception of ρ . The types define the core sensitivities of the probe, and provide a link between the order of probes in the verbal spine and the proposed order of feature composition within the nominal spine. For example, as seen in Section 1.3.1, the π -probe necessarily includes a $u\pi$ feature, with the specification of additional features being a matter of parameterization. Furthermore the π -probe always executes AGREE prior to the ω -probe due to its relatively low association in the spine.

The conjunct order has the same basic set of probes, but the person and number probes are *fused* on the head Infl (Coon and Bale, 2014; Roversi, 2020).

- (44) ***Conjunct order φ -probes, their corresponding heads, and morphology***
- | | | |
|----|--|----------------------------|
| a. | γ -probe = ν = Final = <i>-am</i> | <i>Noun classification</i> |
| b. | ρ -probe = Voice = Theme Sign = <i>-aa/-igo</i> | <i>Obviation</i> |
| c. | π/ω -probe = Infl = Central = <i>-waad</i> | <i>Fused Person/Number</i> |

As a result, there is no probe specified on C, and therefore no peripheral agreement marker. This is shown to capture the variation in whether Infl appears as a combination of the prefix and central agreement, or central agreement alone.

Proceeding now to an overview of the account, the heads that host these probes stand in the following configuration, with the EA and IA in their base positions:

(45) *Clausal geometry in Ojibwe*

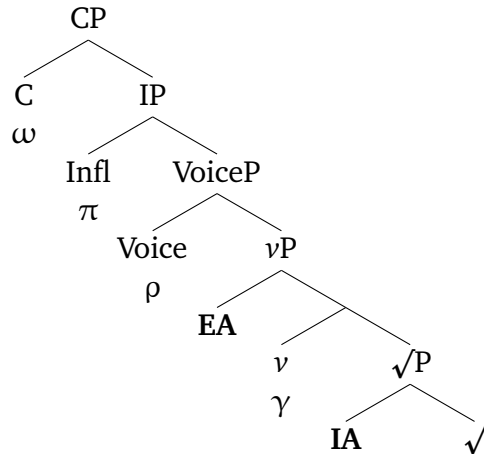

Recall first the pattern of agreement with the γ -probe on v :

(46) *Agreement with γ on v*

Show agreement in animacy with IA.

At the point the γ -probe is merged, the only available goal is the IA, accounting for the uniformity of agreement in this position. No movement is triggered, as any EPP feature of the probe can be satisfied instead by the merging of the EA into this position.

The pattern on Voice is the main locus of prominence-based effects, showing the contrast between direct agreement with the proximate EA and the inverse form, as summarized in (47).

(47) *Agreement with ρ on Voice*

$3 \rightarrow 3'$: Show proximate agreement with EA; $3' \rightarrow 3$: Show the inverse form

The ρ -probe is only fully satisfied by *uProximate*. While the proximate EA fully satisfies the probe in direct alignments, both the obviative EA *and* proximate IA are probed with inverse alignments, leading to gluttony and ultimately the spell-out of the elsewhere “inverse” form of theme sign morphology.

A critical claim is that *only the proximate argument moves* to Spec,VoiceP. This is particularly contentful in inverse alignments, where both the proximate and obviative arguments are probed. This requirement is enforced by the Relativized EPP on Voice, as summarized in (48). Given that only the proximate argument can satisfy this requirement, the obviative argument remains in situ and the proximate argument moves.

(48) ***The Relativized EPP on Voice***

The EPP on Voice is relativized to *uProximate*

The major consequence of this is that the proximate argument in Spec,VoiceP is the highest argument in the clause in both direct and inverse alignments when the probe on Infl is merged. This *feeds* uniform proximate agreement in this slot, as summarized in (49). This agreement patterns holds regardless of whether the probe is a pure π -probe as in the independent order, or a fused π/ω -probe as in the conjunct.

(49) ***Agreement with π (independent) or π/ω (conjunct) on Infl***

Show *full agreement* with the proximate argument.

This agreement relation feeds movement of the proximate argument to Spec,IP. Since Infl hosts the final probe in the conjunct order, this fixes the word order such that the proximate precedes obviative. Assuming that the verb raises no higher than Infl in embedded clauses, this captures the SVO word order of direct alignments and the OVS word order of inverse.

Agreement on Infl has one final consequence: It renders the proximate argument *inactive* for further agreement relations. I enforce deactivation through the *Activity Condition* (cf. Chomsky, 2000, 2001). The proposed condition is given in (50).

(50) ***The Activity Condition***

An agreement relation with a probe P deactivates a goal G iff the probe shows *full agreement* with G.

Full agreement can be defined either in terms of copying or morphological expression. With Infl, it is evident by the fact that the person, number, animacy, and obviation of the goal are expressed by the form of agreement.

This provides an account of why agreement with the ω -probe on C appears to violate the PAH by agreeing with the less prominent obviative argument, as summarized in (51). Since Infl has deactivated the proximate argument, proximate agreement on C is *bled* and the probe agrees with whatever is left over.

(51) ***Agreement with ω on C (independent only)***

Show *full agreement* with the obviative argument.

Though the surface patterns of agreement are identical in direct and inverse alignments (i.e. agreement with the obviative argument appears), the patterns of word order reveal underlying differences in the derivation. In the inverse, things proceed with relatively little complication. The ω -probe on C searches and only finds the obviative EA. Given the EA is sitting on the edge of the phase defined by ν , it can be agreed with directly and is moved to Spec,CP to satisfy the EPP. Now, assuming that the verb raises to a relatively *high* position in matrix clauses such that it takes an initial position (Hammerly, 2019b), the VSO word order observed in the inverse alignment is derived — the obviative EA is high in Spec,CP, while the proximate IA is lower in Spec,IP.

The situation in the direct alignments is more complex. Recall that there is an alternation between VOS and VSO word orders, but no corresponding alternations in φ -agreement. This is captured by a three-step derivation. The first step is φ -agreement. Because the obviative IA is inaccessible within the phase-complement of νP , C ends up targeting νP itself, which has inherited the features of the IA from its previous agreement relation. This ultimately *unlocks* the phase (Rackowski and Richards, 2005; Halpert, 2019; Branam, 2018), allowing the IA to be targeted by a δ -probe on C. This δ -probe is specifically sensitive to a feature [δ : *uObviative*]. When the IA is specified for [δ : *Obviative*], it undergoes *A'*-movement to *Spec,CP*. Given the optional nature of *A'*-features (Van Urk, 2015), this movement of the IA is also broadly speaking optional. This provides the final link between the patterns of word order and agreement. When the relevant δ -feature is specified on the obviative IA, this results in the derivation of the VOS word order, as the IA moves to a position above the EA, which is sitting in *Spec,IP*. When the relevant feature is not found, the IA remains in situ, deriving VSO.

1.4 Study III: Prominence in argument structure processing

The third and final part of the thesis considers the role of person-based prominence in the processing of argument structure. This brings the focus towards considering how the representations developed in the earlier parts of the thesis are built in real-time. The processing of argument structure requires forming a link between a noun on one hand, and thematic roles and syntactic positions on the other. There are three questions at the heart of this section, with the first being the main focus. First, how is obviation used to *predictively* form these links prior to unambiguous bottom-up information. Second, when bottom-up evidence for argument structure is encountered with direct/inverse voice marking, how does the obviation status of the argument affect *integration* with this newly encountered material. Third, if the evidence from voice contradicts the predictively formed parse or interpretation, how does *reanalysis* proceed?

These questions are probed by examining the processing of *filler-gap* dependencies, where an argument is displaced (via movement) from the position that connects it to the argument structure of the verb. More particularly, this portion of the thesis examines how links are formed between the head noun of a relative clause and the embedded verb. One of the most persistent phenomena in this domain is the so-called *Subject Gap Advantage (SGA)*. This is the observation that the processing of subject relative clauses (SRCs) such as that in (52a) is generally easier than object relative clauses (ORCs). This has been found across a wide range of languages and with a variety of methodologies (for an overview, see e.g. Kwon, Lee, Gordon, Kluender, and Polinsky, 2010).

- (52) a. **The senator** that __ quoted the journalist was not well known.
b. **The senator** that the journalist quoted __ was not well known.

However, this asymmetry can be neutralized by a variety of factors. For example, when the filler is inanimate rather than animate, as in (53), the SGA disappears (Mak, Vonk, and Schriefers, 2002; Traxler, Williams, Blozis, and Morris, 2005; Gennari and MacDonald, 2008; Wagers and Pendleton, 2016).

- (53) a. **The report** that __ quoted the journalist was not well known.
b. **The report** that the journalist quoted __ was not well known.

A variety of accounts have been put forward to capture the effect of animacy on the SGA. A leading class of theories ties the SGA to predictive mechanisms (Gennari and MacDonald, 2008; Wagers and Pendleton, 2016; Wagers, Borja, and Chung, 2018). When an animate filler is encountered, the parse is incrementally extended to include a subject gap. If the structure is ultimately an SRC, integration proceeds smoothly; if it is an ORC, the initial prediction must be overcome, resulting in relative processing

difficulty. With an inanimate filler, no single strong prediction about the upcoming structure is made, so integration proceeds on equal footing in both SRCs and ORCs.

The experimental study presented here examines whether differences in obviation status lead to differences in the predictive extension of the parse or interpretation. By analogy with animacy, where animate nouns are more highly ranked on the PAH than inanimate nouns, the more highly ranked proximate category should lead to “subject gap” predictions, while the lower ranked obviative category should result in the neutralization of these predictions.

However, the preceding discussion willfully ignored a distinction that cannot be set aside when considering Ojibwe: That the term “subject”, when used colloquially, confuses the *derived* syntactic subject position Spec,IP with the prototypical AGENT thematic role. This comes about most sharply in active voice sentences, where the noun that takes the agent role is also promoted to the derived subject position. However, different voice distinctions can allow the derived subject position and the agent role to be dissociated. For example, the passive voice of English results in the prototypical PATIENT or THEME to be promoted to subject.

With these general possibilities in mind, consider the stimuli used in the study, present in (54). The study manipulates two factors with two levels each: HEAD noun obviation (proximate versus obviative) and VOICE (direct versus inverse)

(54) *Example transcription of experimental auditory stimulus*

- a. ... **gichi-aya’aa** gaa-baapi’ -**aa** -d inini -wan
elder.PROX REL-laugh -**DIR** -3 man -OBV
 ‘...the elder (PROX) who is laughing at the man’
- b. ... **gichi-aya’aa** gaa-baapi’ -**igo** -d inini -wan
elder.PROX REL-laugh -**INV** -3 man -OBV
 ‘...the elder (PROX) who is being laughed at by the man’
- c. ... **gichi-aya’aa -n** gaa-baapi’ -**aa** -d inini
elder -**OBV** REL-laugh -**DIR** -3 man.PROX
 ‘...the elder (OBV) who the man is laughing at’

- d. ... **gichi-aya'aa -n** gaa-baapi' **-igo -d** inini
elder -OBV REL-laugh -INV -3 man.PROX
 '...the elder (OBV) who the man is being laughed at by'

The assumed syntactic structures for each condition, following the account given in Section 1.3.2, are given in (55). To review, with direct voice, the proximate argument originates in Spec,vP, where the agent role is assigned, and the obviative argument is lower, in the complement of \sqrt{P} , where the patient/theme role is assigned. Inverse reverses the alignment of obviation and thematic role. Additionally, proximate arguments are always promoted via Spec,VoiceP to the subject position, Spec,IP, prior to undergoing relativization to occupy the head noun position of the RC. In contrast, obviative nouns are extracted directly from their base-generated position to the head noun position with no intermediate movement steps.

(55) *Proximate links to a subject gap, obviative to a non-subject gap*

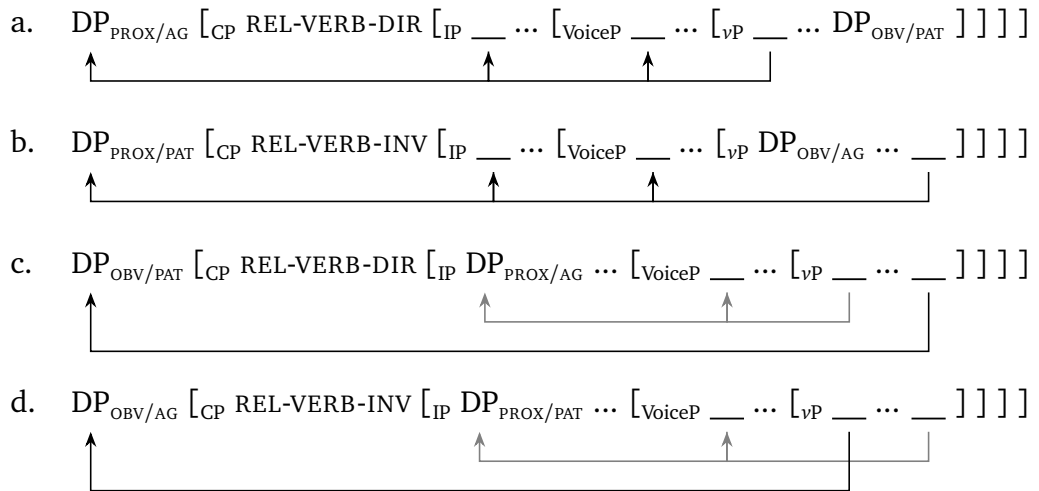

This leads to a necessary refinement of the hypothesis for how prediction proceeds with filler-gap dependencies. Given that proximate nouns are grammatically obliged to be moved via the subject position, proximate nouns should engender a subject gap prediction, in the relevant sense of derived position. In contrast, obviative nouns never grammatically occupy that position, and should therefore never engender a subject gap

prediction. This should lead to the appearance of the SGA for proximate nouns. However, we can additionally consider whether an AGENT or PATIENT prediction will be made as a function of obviation — the precise hypothesis being that proximate head nouns should engender the prediction that the filler will be the agent, with prediction being neutralized with obviative heads.

The study used the visual world method to probe the incremental interpretation of the sentences in (54). The sentences include a critical period of ambiguity where the obviation of the head noun has been encoded, but voice marking has not yet been encountered. This region is the locus of predictive processing of argument structure. The visual stimuli were presented on a large touch screen monitor. Participants first saw three visual stimuli (the position of images was randomized on each trial). Two of the images were role-reversals, where the head noun was either the agent or the patient of the event. A third distractor image depicted the same event, but excluded the character associated with the head noun, and thus could be ruled out incrementally (this image was associated with a correct interpretation of the fillers). After a familiarization period, the sentence began to play over external speakers. Participants then selected the image associated with their final interpretation of the sentence by touching the screen, and confirmed their response by pressing a check mark. Over the course of the trial, a web camera recorded eye movements. Recordings were used to observe which image participants looked at as the sentence unfolded to determine incremental interpretations.

The major findings for the preferential looking behavior and the picture selection task are summarized in (56).

(56) *Main experimental findings*

- a. *Under Ambiguity:* Anticipatory looks towards the “head = agent” image with proximate head nouns, but not obviative head nouns.

- b. *Following Disambiguation*: More accurate (and faster) responses:
 - (i) With proximate head nouns.
 - (ii) When the head noun was ultimately the agent, in both proximate and obviative conditions.

These findings can be described by the interaction of three independently motivated processing pressures, given in (57).

(57) ***Three observed processing preferences***

- a. *Animate/Proximate-Agent Preference*: Dependencies where the animate or proximate noun is the agent are preferred over those where the inanimate or obviative noun is the agent.
- b. *Agent-First Preference*: Dependencies where the first noun is the agent are preferred to those where the first noun is non-agentive.
- c. *Subject Gap Advantage*: Dependencies with a subject gap are preferred over non-subject gap dependencies.

The anticipatory looks towards the agent image with proximate head nouns is due to the “prototypicality” of the proximate noun as the agent (the Proximate-Agent Preference), as well as general preference to assign the agent role first (the Agent-First Preference). The *lack* of prediction with obviative nouns is the result of these two pressures conflicting and cancelling each other out — the Proximate-Agent Preference places this noun in the less agentive patient role, while the Agent-First Preference places this noun in the agent role. Following disambiguation, the higher accuracy with proximate heads is a reflection of the Subject Gap Advantage, while the generally higher accuracy with conditions where the head noun was the agent is a reflex of the agent-first preference.

However, the preferences in (58) do not provide a cognitive source of the observed effects — they are nothing more commonly observed patterns of behavior. I propose a

revised implementation of the Active Filler Strategy (Frazier, 1987; DeVincenzi, 1991) to model the processes that underly these preferences, given in (58).

(58) ***Main Proposal: The Revised Active Filler Strategy***

A filler predictively and incrementally extends a comprehender's syntactic representation to include a movement chain such that:

- a. The chain terminates in a theta-assigning position (an A-position)
- b. Each link *minimizes* distance
- c. Each link *maximizes* well-formedness

The main clause of (58) is the predictive extension of the structure triggered by the recognition of a filler. This builds a movement chain, predictively linking the filler to its anticipated base-generated A-position (58a) — the position of thematic role assignment. For our current purposes, this is either the External Argument (EA) position, where the AGENT role is assigned, or or Internal Argument (IA) position, where the PATIENT role is assigned. As a result, the initial thematic role assignment follows directly from parsing decisions, providing a linking theory between parsing and interpretation.

The particular chains and links that are formed are governed by the pressures in (58b,c). The clause in (58b) prefers links (and, by extension, chains) that are as short as possible. While distance can be optimized on a number of dimensions (e.g. temporally, linearly, structurally), the relevant sense of distance here is with respect to syntactic structure, as defined in (59).

(59) ***Definition of Syntactic Distance***

Given two linked syntactic positions X and Y, Syntactic Distance is the number of maximal projections (XPs) that dominate X but do not dominate Y.

The proposal is that both the Subject Gap Preference and the Agent-First Preference are reflexes of the pressure to minimize syntactic distance whenever possible, as stated in the thesis in (60).

(60) *Thesis for the role of minimizing syntactic distance in processing*

Both the Subject Gap Preference and Agent-First Preference are the consequence of minimizing syntactic distance.

To see this, first consider the contrast between the structures in (61). Holding the terminus of the chain constant, a chain that includes a stop through the subject position will consist of a series of smaller links compared to a chain that does not connect to this position. Therefore a structure with a subject gap, all else being equal, will be preferred over one that lacks a subject gap, deriving the Subject Gap Preference.

(61) *The Subject Gap Preference*

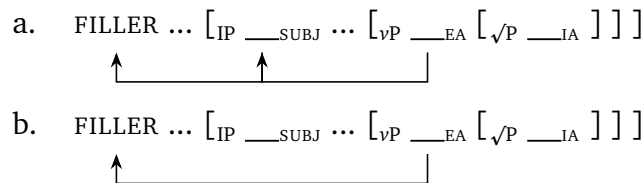

Now, consider the structures below, where the chain terminates in either the EA position (62a) or the IA position (62b). In the relevant sense, the chain terminating in the EA position minimizes distance compared to the chain terminating in the IA position. Given that these positions are associated with the respective assignment of the agent and patient roles (e.g. Harley, 2011), minimization also derives the Agent-First Preference.

(62) *The Agent-First Preference*

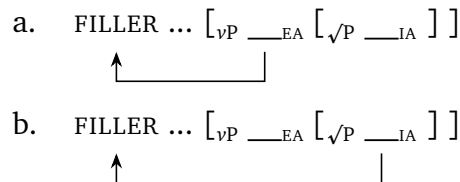

The final clause of the Revised Active Filler Strategy in (58c) dictates that each link in the chain must *maximize well-formedness*. The model of the grammar adopted in this thesis is strictly-speaking categorical in nature, thus structures either are or are not well-formed. However, under the conditions of incremental uncertainty presented by real-time processing — in particular, given that upcoming structures are *predictively* formed rather than constructed once all relevant evidence is in hand (or mind) — it becomes necessary to introduce a competition between possible structures conditioned on the evidence at a given point.

The proposed model takes advantages of the properties encapsulated within various prominence hierarchies to determine expectations about incremental well-formedness. The first relevant hierarchy, the Obviation Hierarchy (a partial form of the PAH), is given in (63) and ranks the proximate category above the obviative category.

(63) ***Obviation Hierarchy***

PROXIMATE > OBVIATIVE

The second relevant hierarchy is the General Syntactic Position Hierarchy, which ranks structurally higher positions above lower positions.

(64) ***General Syntactic Position Hierarchy***

HIGHER > LOWER

For the current purposes, it is necessary to consider a number of more specific hierarchies that can be derived from (64). The first is in fact a set of two equivalent Argument Structure Hierarchies — one couched in terms of structural position (65a) and one in terms of thematic role (65b). To couch the model purely in terms of parsing and structural relations, the positional hierarchy is adopted.

(65) ***Two equivalent Argument Structure Hierarchies***

- a. *Argument Position Hierarchy*: EA > IA
- b. *Thematic Role Hierarchy*: AGENT > PATIENT

Second, there is a hierarchy that ranks the subject position over all non-subject positions, where “non-subject” positions are restricted to any position *contained* within the XP that defines the subject position.

(66) ***Derived Position Hierarchy***

SUBJECT > NON-SUBJECT

By *harmonically aligning* these various scales (Prince and Smolensky, 1993, p. 136), we can derive a ranking of *markedness constraints* that more strongly penalize certain alignments between person category and structural position. Under a Harmonic Grammar, these constraints can be weighted to different degrees, leading to stronger or weaker pressures, or in the extreme case, near categorical requirements. The proposal is that the parsing algorithm *maximizes* incremental well-formedness by *minimizing* the violation score computed from these constraints.

The first set of constraints, given in (67), captures the pressure that underlies the Proximate-Agent Preference. These constraints most strongly *penalize* structures where the obviative argument is the EA (agent) or the proximate argument the IA (patient), and therefore *prefer* alignments where the EA (agent) is aligned with proximate arguments. These penalties are strong enough to create incremental commitments, but not so strong as to create absolute restrictions on possible parses.

(67) ***The Proximate-Agent Preference***

*EA/OBV \gg *EA/PROX

*IA/PROX \gg *IA/OBV

The second set of constraints in (68) enforces the restriction that proximate arguments associate with the subject position, therefore creating an intermediate subject gap. These constraints *penalize* alignments between the subject position and obviative arguments, and as a result *prefer* alignments where the subject position is filled by the proximate argument. The proposal is that these constraints are quite highly weighted, given that the proximate/subject alignment is a hard constraint of the grammar, rather than simply a preference.

(68) ***The Proximate-Subject Requirement***

*SUBJ/OBV \gg *SUBJ/PROX

*NON-SUBJ/PROX \gg *NON-SUBJ/OBV

The push and pull of minimizing the syntactic distance and maximizing well-formedness provides a general model for the interaction between the pressures of real-time processing and obeying the constraints imposed by the grammar. More particularly, it provides the means to account for the observed patterns in Ojibwe. At a high level, proximate nouns have the potential for a maximally harmonic path on all fronts: the well-formedness constraints dictate the formation of an intermediate subject gap terminating in the EA position, which is also the most minimal possible chain — all signs point to a parse where the proximate noun is encoded as the agent, as reflected in looking preferences. In contrast, the various pressures conflict with obviative nouns. The more minimal subject gap is highly marked, as is the more minimal termination of the chain in the EA position. These pressures play out both incrementally and when attempting to integrate new information or revise the parse and interpretation. This leads to difficulty and uncertainty at various points, as reflected in both looking behavior and accuracy in the picture selection task.

1.5 Additional Background on Ojibwe

This section provides some additional background on the Ojibwe language and the *Border Lakes* variety. Given that the core syntactic and morphological phenomena are detailed as they are considered, and for the most part have been introduced in the previous section, I do not repeat those descriptions here. I begin with a brief overview of the historical and typological context of Algonquian languages and Ojibwe, then turn to some important cultural contexts relevant to understanding the language. I then provide an overview of the phonology and writing system of Border Lakes Ojibwe, which is not covered elsewhere but is important for interpreting the examples that appear throughout the thesis.

1.5.1 Historical, typological, and cultural context

1.5.1.1 Algonquian

Algonquian is a family of indigenous languages that are spoken across a wide swath of the North American continent. The primary geographic loci are the central and northern reaches of the Atlantic seaboard, the woodlands east and south of the Hudson Bay and around the northwestern Great Lakes, the plains of the Rocky Mountains, and an isolated region on California's northern coast.

The currently recognized relationships between the Algonquian languages are shown in Figure 1.1. The reconstructed mother language of the family, PROTO-ALGONQUIAN, contains the coastal California languages Wiyot and Yurok, and the reconstructed PROTO-ALGONQUIAN (Sapir, 1913, 1923; Haas, 1958; Goddard, 1975). At present, the historical and grammatical properties of Proto-Algonquian remain unclear (Oxford, 2014). In contrast, the descendants of Proto-Algonquian retain a stark similarity and clear history, facilitating the process of reconstruction. For this reason, the majority of typological and historical work has focused on the languages of the Algonquian family proper.

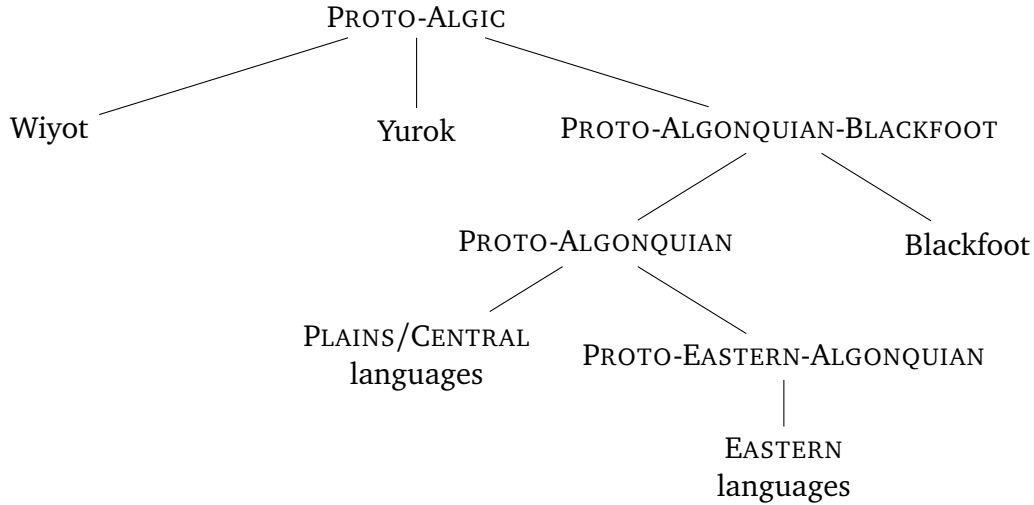

Figure 1.1: Algic genetic relationships (Goddard, 1994, 2015; Oxford, 2019a)

There are three primary branches of Proto-Algonquian, EASTERN, CENTRAL, and PLAINS. Of these groupings, only the Eastern languages are considered a true genetic subgroup, with both Central and Plains describing geographical subgroups (Goddard, 1980). Proto-Algonquian is thought to have been spoken around 3,000 years ago in the region immediately west of Lake Superior (Siebert, 1967; Pentland, 1979). Complex patterns of migrations followed from this period—the migrations relevant to the Ojibwe people and language will be reviewed in the following section. Within the Algonquian family, the deepest division is that between Blackfoot and the rest of the Algonquian languages, as encoded in the sisterhood relation between Blackfoot and Proto-Algonquian (Goddard, 2015). The family then divides into the remaining Plains Algonquian languages, which are genetically grouped with the Central Algonquian languages, and Proto-Eastern Algonquian, which in turn divides into the whole of the Eastern Algonquian languages. The major languages in each of these subgroups are given in (69).

(69) *Major Algonquian languages by subgroup (from Oxford, 2014, p. 19)*

- a. CENTRAL: Meskwaki-Sauk-Kickapoo, Ojibwe-Potawatomi, Miami-Illinois, Cree-Innu-Naskapi, Menominee, Shawnee

- b. EASTERN: Mi'gmaq, Maliseet-Passamaquoddy, Abenaki, Southern New England Algonquian (e.g. Massachusetts), Mahican, Delaware (Munsee and Unami), Nanticoke, Powhatan
- c. PLAINS: Cheyenne, Arapaho-Gros Ventre, Blackfoot

Today, the languages of the Algonquian family are spoken by hundreds of thousands of people, and continue to play a central role in many communities. However, due to a long history of often hostile colonization, attempts at religious conversion, and general persecution, as well as a more recent history of systematic policies to eliminate language and culture carried out by both the Canadian and United States governments (e.g. residential schools and relocation programs), many Algonquian languages are dormant, endangered, or under threat. The most widely spoken language groups (listed roughly from East to West) are Mi'gmaq (thousands), Cree (tens of thousands), Ojibwe (tens of thousands) Blackfoot (low thousands), and Cheyenne (low thousands). Many of the dormant languages belong to the Eastern subgroup, with some having been affected many centuries ago following early contact with European colonizers. However there are also a number of Central and Plains languages that do not currently have living fluent speakers. More recently, there have been revival efforts which have brought languages such as Wampanoag and Myaamia from dormant states to active use once again.

1.5.1.2 Ojibwe dialects

Ojibwe (also spelt Ojibwa or Ojibway) is a collection of closely related dialects and varieties belonging to the Central Algonquian subgroup and spoken by the *Anishinaabe* people. In Canada, Ojibwe is spoken in Southwestern Quebec, through much of Ontario and Manitoba, into Saskatchewan, and in some outlying communities in Alberta. In the United States, it is spoken in Michigan, in northern Wisconsin, Minnesota, and

North Dakota, and in relocated communities in Kansas and Oklahoma. As recently as a generation ago, there were also a number of fluent speakers in the mixed Cree-Chippewa community of Rocky Boy, Montana. It is estimated to be spoken by around 100,000 people, with relatively high mutual intelligibility across the different groups, particularly those which are geographically adjacent.

The major dialects of Ojibwe are Algonquin, Nipissing, Eastern Ojibwe, Odawa (Ojibwe), Northern Ojibwe, Saulteaux (Plains Ojibwe), Ojibwe-Cree (Severn Ojibwe), and Southwestern Ojibwe (Chippewa). It is also common to classify the various dialects of Ojibwe and the Potawatomi language under the wider umbrella of “Ojibwean” languages, due to their linguistic similarities and close cultural and historical ties. A more detailed overview and comparison of these dialects can be found in Valentine (2001).

Anishinaabemowin, known in English as Southwestern Ojibwe or Chippewa, is spoken in the western Great Lakes region, including the Upper Peninsula of Michigan, northern Wisconsin and Minnesota, North Dakota, Northwest Ontario, and Manitoba. It is difficult to estimate the exact number of first and second language speakers. Part of the reason is the community has been split by local, national, and international borders, as it spans both the United States and Canada, and multiple states, provinces, and Ojibwe nations within each. This has led to the recognition of a variety of sub-dialects, largely corresponding to geopolitical divisions resulting from the modern reservation and treaty systems, but also to communities and migrations that predate colonial contact. In total, somewhere around 100,000 people ethnically identify as Southwestern Ojibwe. Ethnologue places the number of speakers at 5,000 (as of 1990), while the 2010 US Census reports 6,986. In contrast, Anton Treuer, a professor of Ojibwe at Bemidji State who undertook an informal survey of communities in Minnesota in 2009, estimates the number of first speakers in the United States at 1,000. In any case, the language is widely considered to be revitalizing, with strong efforts to expose children and adults to the language occurring across Ojibwe communities (see Sullivan, 2016b)

Within the Southwestern dialect group, a number of transitional varieties are also recognized, which are in contact with other dialects of Ojibwe including Saulteaux in Manitoba and Oji-Cree in Northern Ontario and Manitoba, as well as other Central Algonquian languages including Potawatomi and Cree. One such transitional variety, which is the focus of this dissertation, is *Border Lakes* Ojibwe, spoken primarily in Northwest Ontario including the Treaty 3 communities at Seine River and *Nigigoonsiminikaaning* (Red Gut), where the primary fieldwork presented in this dissertation was conducted. Many of the features characteristic of Border Lakes can also be found across the border in northern Minnesota, particularly at Nett Lake and parts of Red Lake.

Based on informal conversations with consultants and elders from Treaty 3 communities, I estimate of the number of speakers of the Border Lakes dialect to be at least 1,000. This estimate should be taken with a grain of salt, as I have not visited every community where the dialect is spoken, so it relies of the impression of members of neighboring communities or web-based reports.⁵ First hand estimates can be provided for *Nigigoonsiminikaaning* and Seine River. At *Nigigoonsiminikaaning* the tribal office reports that 130 members live on the reserve. The nearby Seine River community is a slightly larger with an on reserve population of 327. In both cases, I estimate the percentage of L1 speakers to be around 15%, with most of these speakers being over the age of 50. Almost all speakers learned English after being sent to residential school around the age of 6. A number of L1 speakers report speaking only Ojibwe in their homes and when taking care of children, grandchildren, or great-grandchildren. As a result, there are children under the age of 10 that have received significant exposure to Ojibwe from the time they were born in both communities. In addition, many children are exposed to the language in a more formal setting at schools in Mine Centre and Fort

⁵I have gathered the following information: Couchiching is said to have very few active speakers; the website for the community at Whitefish Bay puts the rate at 48% of the 712 on reserve members; Lac La Croix has 192 on reserve members, with a high percentage of speakers being reported; *Mitaanjigamiing* has a population of 99, with a number of L1 speakers being reported, but the exact number is unknown to me. I have not gathered information on other communities in the area.

Frances. Adolescents and adults frequently gain exposure to the language at regular community language tables and other cultural events.

1.5.1.3 Cultural context

Ojibwe speakers are highly aware of the differences and diversity that exists across varieties. In many communities, there are long standing traditions of traveling to other places for ceremony or social gatherings, which has facilitated this awareness. In general, speakers hold positive attitudes towards this diversity, with many teachings and stories centering around understanding how these differences originated. If asked, many speakers can supply a substantial list of differences in word-usage, grammatical construction, or pronunciation that they have observed when communing with people from other places, with detailed information about where and when they heard it.

One illustrative example is in the names of the months, which are divided by the waxing and waning of the moon. Many communities share a common set of names, but the precise month or moon that a given name is used may depend on the timing of events in the local environment. In other cases, months may have distinct names that are unique to the particular environmental events of the associated dialect locale. This fits into a broader way of understanding, where the form of the language used by a particular group of people is seen as highly dependent on the environment. Differences in the lexicon, and in some cases grammatical differences, are rightly seen as reflex of deeper pressures, some of which are unknown or mysterious. Many elders and community members stress that they do not believe the particulars of a given way of speaking is correct or incorrect if the intentions of the person are good.

This appreciation of variation has often been difficult to implement within the language learning community. As Standardized Ojibwe, or as one of my consultant calls it, “book Ojibwe”, is formed and takes hold, less room for variation remains, at least among adults who are learning Ojibwe as a second language. While there are tens of

thousands of Ojibwe speakers, with any given dialect or variety the number of speakers is much smaller. In the decades ahead, one scenario is that much of the micro-variation in the language will be lost, even as the number of speakers stabilizes or even grows with revitalization efforts. However, this is not a foregone conclusion. In recent years some communities have accessed resources that allow more attention to be paid to early interventions with children ages 0–3 years old, which is a likely path to maintaining the rich variation in the language.

Oration is a skill that is honed and remains highly regarded. Certain speakers are known to be particularly creative and evocative with their language, and the skills of these people are highly sought after for ceremony and entertainment alike. As long as can be remembered, storytelling has been a central part of Ojibwe life. These stories range from recollections of childhood events or other stories from one's past, to legends that have been passed down orally since time immemorial (these are generally reserved for telling during the winter months), to recounting and interpreting dreams or visions. In nearly all cases, the point of a story is to pass on a teaching of some kind, or to share an experience that might provoke deeper thought or engagement in a particular topic. However, this is not to say that all such stories, legends, and recollections are stern and serious — to the contrary, many of them are hilarious, while still exposing personal or cultural truths, principles, and beliefs.

1.5.2 Phonology

In this section I consider the phonological inventory and processes of Border Lakes Ojibwe, with some attention paid to comparison across the major dialect groups. I also introduce the current writing systems of the language, with a primary focus on the *double vowel system*, which will be used in most of the examples throughout this dissertation.

1.5.2.1 Vowels

As shown in Table 1.2, Boarder Lakes Ojibwe has four contrastive vowels, with three of the vowels further contrasting in length. As shown in Swierzbin (2003), long vowels are approximately twice the duration of short vowels.

Short	Long
a	a:
	e:
i	i:
o	o:

Table 1.2: Broad transcription vowel inventory of Border Lakes Ojibwe (Swierzbin, 2003)

It is important to note that the contrasts in Table 1.2 obscures the fact that vowel length alone does not conspire to create minimal pairs. Length is combined with other features such as height. For example, the short vowel /a/ is frequently centralized to [ʌ]. An example of this is taken from Swierzbin (2003), where the contrast between the first person (70a) and second person (70b) forms of the embedded verb is encoded in the vowel of the suffixal agreement morphology. The first person form has a long [a:], while the second person form is realized as a short [ʌ]. Therefore the distinction is encoded by both length and vowel quality.

- (70) a. mʌnise -ja:n
gather.firewood -1.CONJ
‘...if I gather firewood...’
- b. mʌnise -jʌn
gather.firewood -2.CONJ
‘...if you gather firewood...’
- (Swierzbin, 2003, p. 344)

Furthermore, there is debate as to whether the contrast should be encoded as length per se, or rather a contrast in tense (\approx short) versus lax (\approx long)⁶. This is exemplified

⁶Generally speaking, tense vowels tend to be shorter than lax vowels even in languages that do not phonemically contrast vowel length

by the fact that the short vowel /i/ is often realized as the tense counterpart [i], as can be observed in (70) with the verb stem meaning ‘gather firewood’.

One of the major dialect markers of Ojibwe is the presence or absence of vowel syncope. Many of the eastern dialects, including Eastern Ojibwe and Odawa, delete or significantly reduce short vowels in weak or unstressed syllables. To take a salient example, the Ojibwe language is referred to as *Anishinaabemowin* in most non-syncopeating dialects, but *Nishnaabemwin* in those with syncopeation. The Border Lakes dialect is a non-syncopeating variety, where the deletion and reduction of vowels is much more restricted (though not altogether absent). I will not consider these syncopeation processes to any significant degree here, but the interested reader can find a succinct description starting on page 51 of Valentine (2001).

While there were a number of caveats to the interpretation of vowel length as a contrastive feature (presented above), vowel length itself does play a crucial role in the assignment of stress in the Border Lakes dialect. In her detailed study, Swierzbina (2003) shows that vowels with a longer duration are (nearly without exception) associated with perceived stress. Both frequency and volume are less stable, though still informative, correlates of the perception of stress.

1.5.2.2 Consonants

The consonant inventory of Border Lakes Ojibwe is given in Table 1.3.

	bilabial	dental	alveopalatal	palatal	velar	glottal
stop	p b	t d			k g	ʔ
fricative		s z	ʃ ʒ			
affricate			tʃ dʒ			
nasal	m	n				
glide				j	w	

Table 1.3: Consonant inventory of Border Lakes Ojibwe (Swierzbina, 2003)

The table hides one significant complication. The obstruents (stops, fricatives, affricates) are distinguished by strength or length of pronunciation. By convention, the

stronger “fortis” obstruents are written with the voiceless symbol, and the weaker “lenis” obstruents with the voiced symbol. Swierzbin (2003) shows that while there is a significant difference in length between the lenis and fortis counterparts⁷, the primary difference between the two is indeed in voicing: the lenis obstruents ranging from significantly prevoiced to voiceless and aspirated; the fortis obstruents generally being voiceless and aspirated. Voicing (or strength, if you will) does not create minimal pairs within the language, with the appearance of the voiced and voiceless counterparts being either in free variation or determined by phonological rules and phonotactic constraints.

The glides /j/ and /w/ are frequently epenthesized to resolve vowel hiatus. For example, the plural suffix /-Λg/ often appears with an epenthetic /w/, as in the plural form of [ikwe:] ‘woman’ being realized as [ikwe:wΛg] ‘women’. That said, variation in the repair process is attested within the Border Lakes dialect, with the same speaker also producing [ikwe:g] ‘women’ in what at first approximation appears to be free variation, where hiatus is resolved via elision rather than epenthesis. More work is needed to understand whether there are particular conditions under which these repairs vary.

1.5.2.3 Writing systems

For most of its history, Ojibwe has been an almost entirely oral language. Prior to European contact, and for many generations following that time, writing was restricted to particular religious contexts, where teachings and customs were recorded and presented on birchbark scrolls. The details of this system are guarded with great care. It should be noted that these traditions continue to this day, despite centuries of conversion efforts by Christian missionaries, as well as the banning of indigenous religious practice in the United States until the passing of the American Indian Religious Freedom Act in 1978.

⁷The fortis obstruents on average are 1.2–1.4 times longer than their lenis counterpart; a small difference compared to true geminate consonants such as those found in Italian or Turkish (Swierzbin, 2003).

Orthography	Phoneme
a	/a/
aa	/aː/
i	/i/
ii	/iː/
o	/o/
oo	/oː/
e	/eː/
p	/p/
b	/b/
t	/t/
d	/d/
k	/k/
g	/g/
'	/ʔ/
s	/s/
z	/z/
sh	/ʃ/
zh	/ʒ/
ch	/tʃ/
j	/dʒ/
m	/m/
n	/n/
w	/w/
y	/j/

Table 1.4: Correspondences between orthographic symbols and phonemes in the double vowel writing system.

Modern orthographies have undergone a number of transformations. There are two major systems: the syllabic system and the latin-based system. Southwestern Ojibwe is almost always written with the latin-based “double vowel” orthography, therefore I will only review this writing system here. It is consistent enough to be useful in the broad transcription of the language, with a straightforward correspondence between the phonological inventory and the characters, shown in Table 1.4. For this reason, most of the examples presented over the course of this dissertation will be written in the double vowel system.

There are two additional conventions that are observed in the orthography that fall outside of representing the phonemic inventory (Sullivan, 2016b, p. 83). The first is

in the use of “h” in the spelling of certain exclamatory particles such as *howah* ‘wow!’, *ahaw* ‘ok’, and *hay* ‘darn’. The second is the combination of “nh” to encode word-final nasalization present in words such as *abinoojiinh* ‘child’ and *gwiiwenh* ‘supposedly’.

1.6 Overview of the dissertation

The remainder of the dissertation is organized into six chapters.

In **Chapter 2**, I derive the possible distinctions in person, obviation, animacy, and number in Border Lakes Ojibwe. **Chapter 3** explores the typological predictions for obviation that are generated by the account of Border Lakes Ojibwe in Chapter 2. **Chapter 4** marks the shift from deriving categories to deriving the prominence relations between them. This chapter largely focuses on the narrow person features that encode first, second, and generic third persons. In **Chapter 5** I apply the system from Chapter 4 to Border Lakes Ojibwe and the system of obviation. The major goal is to understand the relationship between agreement and movement, and the role that prominence plays in each. **Chapter 6** marks the final shift in scope, where I turn to how prominence information is used in real-time processing. Finally, **Chapter 7** concludes with a discussion of the nature of features, the relationship between the parser and the grammar, and the high-level issues therein that are left to future work.

CHAPTER 2

THE REPRESENTATION OF PERSON IN OJIBWE

2.1 Introduction: What is person?

The goal of this chapter is to put forward a representation for person in Ojibwe that derives the relevant person *categories*. Ojibwe shows (ignoring for now the contrasts introduced by number and animacy-based noun classification) a five-way distinction between the EXCLUSIVE, INCLUSIVE, SECOND, PROXIMATE, and OBLIATIVE categories. While the entire inventory of possible person, number, and noun classification distinctions is considered in this chapter, the primary puzzle at hand, and the main contribution, is to understand the contrast between the proximate and obviative persons.

Person categories are generally thought of in terms of *first person*, *second person*, and *third person*. However, the grammatical categories themselves do not make clear cut distinctions between these three types of person. For example, the so-called “first” person plural pronoun *we* in English indeed makes reference to groups including the speaker (i.e. the “first” person), but is not understood to be reserved for reference *only* to groups of speakers—the group may include the listener or addressee (i.e. the “second” person) and/or a potentially unlimited number of others (i.e. “third” persons).

The view advocated for in this chapter (following Harbour, 2016), is that first, second, and third persons are part of the *mental ontology* that is manipulated and accessed

by *features*. These features in turn give rise to *categories* that allow reference to the ontology. To represent the ontology, the symbols i , u , and o , o' , o'' , etc are used. Features, which denote lattices formed from the ontology, create partitions and allow the ontological space to be accessed, resulting in some number of categories that make reference to particular combinations of first, second, and third persons. These categories are conventionally referred to with labels such as “first singular”, “second plural”, “inclusive”, or “exclusive”. The correspondences between these categories and the ontology are sketched in Table 2.1.

Category	Referent Set
<i>Generic First Singular</i>	$\{i\}$
<i>Second Singular</i>	$\{u\}$
<i>Generic Third Singular</i>	$\{o\}, \{o'\}, \{o''\}, \dots$
<i>Proximate Singular</i>	$\{o\}$
<i>Obviative Singular</i>	$\{o'\}, \{o''\}, \dots$
<i>Generic First Plural</i>	$\{i, o, o', o'', \dots\}, \{i, u, o, o', o'', \dots\}$
<i>Exclusive</i>	$\{i, o, o', o'', \dots\}$
<i>Inclusive</i>	$\{i, u, o, o', o'', \dots\}$
<i>Second Plural</i>	$\{u, o, o', o'', \dots\}$
<i>Generic Third Plural</i>	$\{o, o', o'', \dots\}$ (o optional)
<i>Proximate Plural</i>	$\{o, o', o'', \dots\}$ (o required)
<i>Obviative Plural</i>	$\{o', o'', \dots\}$ (lacks o)

Table 2.1: Conventional person categories and their referent sets in the ontological notation. Note that the full theory will be based in lattices, rather than the sets above, therefore this table only provides an approximation of the proposed representation.

Put another way, the claim is that there are three closely linked levels of representation: the ontology, which defines the space of possible reference, the features that make the interface between the ontology and the linguistic representation, and the categories that emerge from the interactions between these features. In this view, all languages have the expressive power to reference the author of an utterance, the addressee, and others. But languages differ in which features they have available, and therefore which distinctions are drawn.

In his original proposal, Harbour argues that there are two features: $[\pm\text{author}]$ and $[\pm\text{participant}]$ hosted by a head π . These features and the host head denote lattices (derived from particular power sets of the underlying person ontology), which interact via operations denoted by the plus and minus values of the features. The subsets used to derive the lattice for each feature are shown in (1) (where “ \vdash ” can be read as “is derived from”).

(1) ***Ontological subsets proposed by Harbour (2016)***

- a. $[[\pi]] \vdash \{i, u, o, o', o'', o''', \dots\}$
- b. $[[[\text{participant}]]] \vdash \{i, u\}$
- c. $[[[\text{author}]]] \vdash \{i\}$

These features are adopted without adaptation in the present account. The new extension proposed here is the addition of the feature $[\pm\text{proximate}]$, which represents a lattice derived from the a subset of the ontology that includes the first person i , the second person u , and a single third person o , as shown in (2).

(2) ***Main proposal: An ontological subset for the proximate feature***

$$[[[\text{proximate}]]] \vdash \{i, u, o\}$$

The addition of the proximate feature allows the five-way person distinction in Ojibwe to be derived. In particular, it derives a contrast between categories that necessarily includes reference to the “proximate” o , versus one which necessarily *excludes* reference to the “proximate” o , as shown in terms of ontological sets in Table 2.1. However, the proximate feature in particular precipitates a key divergence from the system of feature combination proposed by Harbour (2016). Rather than utilizing lattice-based operations, I instead apply the theory of *contrastive interpretations* to define the interactions between features (Dresher, 2009; Cowper and Hall, 2019). This is useful on two fronts:

(i) to provide principled and systematic restrictions on how the sets denoted by features are interpreted, and (ii) to restrict the composition of certain combinations of features.

The proposal provides new insights into the morphosyntactic footprint of obviation, and its function in partitioning the person space. Unlike competing representations of person, such as the feature geometric approach, the present theory has no extrinsic restrictions or requirements on combinations of person features. Whether a language lacks or includes a particular feature derives the possible person distinctions attested across languages, with all logical combinations being typologically attested. The particular set of features utilized within a given language is then directly tied to general principles guiding language acquisition.

The chapter also considers how the adopted representation of person and obviation interfaces with number and noun classification. Discussions of alternative person representations, in particular the feature geometric approach pioneered by Harley and Ritter (2002) and the theory of Harbour (2016), are sprinkled throughout the current chapter and the next (Chapter 3), where I explore extensions of the account to obviation systems outside of Ojibwe. These discussions also set the stage for Chapters 4 and 5, where I turn to how the current representation of person interacts with a theory of agreement.

2.2 Deriving person categories: An overview of the puzzle

Person systems provide the means to refer to the author of an utterance, the addressee of an utterance, and other people who are neither the author nor the addressee. With our categories we can reference the author, addressee, or an other alone, but we can also refer to combinations such as the author and addressee together, a group of others, or everyone at once. The immediate question is how such distinctions are encoded by the grammar — that is, understanding the mental representations that allow us to make reference to different persons on their own and in combination. Much ink has

been spilled on the topic over the decades, and this body of work has sharpened what a representation of person categories looks like. In this section, I introduce the basic shape of the puzzle.

2.2.1 The Partition Problem

The goal of this line of inquiry is to develop a person representation is to provide the means to distinguish *all and only* the possible person categories within a language, and to capture differences in what is distinguished across languages. For example, in English there is no distinction between inclusive and exclusive persons—both are subsumed under single pronominal form *we*, commonly called the first person plural. In other languages, like Ojibwe, the inclusive and exclusive have distinct pronominal forms (EXCL: *niinawind*; INCL: *giinawind*), and also trigger distinct patterns of agreement.

A critical puzzle of this sort was first introduced by Zwicky (1977), who observed that languages with a three-way person distinction treat ‘you and us’ (i.e. the inclusive) as a form of ‘us’ (i.e. a type of “first” person) rather than a form of ‘you’ (i.e. a type of “second” person). Such lumping goes beyond surface-level morphophonological *syncretism*—two categories that are otherwise distinguished sharing a common form in some paradigm of the language. It is instead a *conflation* of categories, in which a language erases a distinction that other languages may permit (see, e.g. McGinnis (2005) for a detailed discussion). However, gaining a meaningfully abstracted perspective on patterns of conflation, and distinguishing them from mere syncretism, is a challenging empirical task. The basic form of the challenge is that our primary data for understanding the *underlying* linguistic categories—paradigms of agreement, pronouns, diatetic elements, and all the rest—are obscured by accidental homophony, as well as systematic morphophonological processes.

The solution to this challenge has long been to compare across paradigms of pronouns and agreement within a language, rather than relying on the categories revealed

by a single paradigm. The question being: what is the full set of distinctions a language makes when taking into account all of the relevant paradigms? While by no means the first study to undertake such a program (see, e.g. Cysouw, 2003, for a particularly expansive survey), this has recently been productively formalized, and applied to a large sample of languages, through the *superposition* method of Harbour (2016).

2.2.1.1 The superposition method

The basic form of the method is shown in (3), where each of the boxes on the left side of the “equation” are two of the agreement slots of the matrix verbs with animate arguments in Ojibwe (the “independent order VTA” paradigm). For expositional purposes, just the plural variants of each category are shown (exclusive, inclusive, second plural, and third plural; obviation is also set aside momentarily). The first paradigm from the left is for the person prefix, and the second is for the central agreement marker. The right side of the equals sign shows the result of superposition, which derives the underlying *partition*. The two paradigms are slightly offset from one another to preserve the visibility of the original cuts, and are shaded to more clearly reveal the correspondences between the left and right sides.

(3) ***Superposition with Ojibwe person prefix and central agreement***

ni-	+	-aanaa	=	EXCL	
gi-		-waa		INCL	
o-				2PL	
				3PL	

Observe that neither of the morphological slots alone realizes distinctions between all four categories. In other words, there are morphophonological *syncretisms*. The person prefix shows a syncretism between the inclusive and second person; the central agreement slot shows two syncretisms: the inclusive with the exclusive, and the sec-

ond person with the third person. If we were to consider the person prefix alone, we might conclude that Ojibwe exemplifies an exception to Zwicky’s observation that the inclusive and second person are never conflated when a three-way distinction is being made. The method shows this would be misguided; when the two paradigms are superimposed, a four-way split emerges, and we can surmise that the pattern in the person prefix is a morphophonological artifact, and not directly indicative of the underlying “partition” of persons.

What is meant by *partition*? The notion is at the core of Harbour’s method, and is equally adopted here as the central fact that must be captured by a representation of person. Couched in familiar terminology, a partition is the pattern of *conflation* between the possible person categories of natural language. Continuing to ignore the distinctions introduced by obviation, number, and noun classification for the time being, Ojibwe shows what Harbour labels the *quadripartition*: a four-way distinction between exclusive, inclusive, second, and third. English, on the other hand, shows a three-way distinction between a generic first person, second person, and third person, which Harbour labels as the *standard tripartition*. This is schematized in (4).

(4) ***Tripartition in English nominative pronouns***

<i>we</i>	EXCL
	INCL
<i>y’all</i>	2PL
<i>they</i>	3PL

2.2.1.2 The lattice representation

With the exposition of partitions comes a new bit of notation. This is explained in full formal detail during the introduction of the lattice-based account in the coming sections. The motivation for the shift is to refer to how the ontological space of person is partitioned, rather than the morphophonological categories of “inclusive”, “exclusive”,

and so on (though it is difficult to get away from these labels entirely). We can represent the speaker with i , the hearer with u , and all other persons with a series of o 's (o, o', o'' , and so on). The partitions then lump together these primitives into sets and lattices, which are referred to as *partition elements*. These are semantically interpreted and create the restrictions on reference familiar to each category.

The exclusive partition element is represented with i_x . This can be re-written as a set that includes the singleton $\{i\}$, the dyads $\{i, o\}$, $\{i, o'\}$, $\{i, o''\}$, ..., the triads $\{i, o, o'\}$, $\{i, o', o''\}$, $\{i, o, o''\}$, ..., and continuing increases in cardinality from there. Similarly, the second person element u_x includes the singleton $\{u\}$, the dyads $\{u, o\}$, $\{u, o'\}$, $\{u, o''\}$, ..., the triads $\{u, o, o'\}$, $\{u, o', o''\}$, $\{u, o, o''\}$, ..., and so on.

The inclusive element iu_x differs in that the minimal set is the dyad $\{i, u\}$, but from there it increases in a similar fashion from triads $\{i, u, o\}$, $\{i, u, o'\}$, $\{i, u, o''\}$, ..., on up. The generic third person element x_x does not have a unique minimal element. It starts with the singletons $\{o\}$, $\{o'\}$, $\{o''\}$, ..., then to the dyads $\{o, o'\}$, $\{o, o''\}$, $\{o', o''\}$, ..., again continuing from there.

It is worth introducing what I think is a more intuitive way (for the visually inclined) to represent the sets denoted by the four elements discussed above: Hasse diagrams. The diagrams for each of the four persons are shown in Figure 2.1, and become particularly useful in the discussion of number in Section 2.7.2. The rows in the diagram are organized, from bottom to top, in increasing cardinality. The minimal element(s) being on the bottom row, and increasing by one in each ascending row. Each point in the diagram represents an element of the lattice, and the lines that link the points show where subset-superset relationships hold.

Because the number of other persons (o, o', o'' , etc) is unbounded, full Hasse diagrams are not shown for any of the sets relevant here. Instead, an abbreviated representation (introduced by Harbour) is given, where incompleteness is indicated by partially

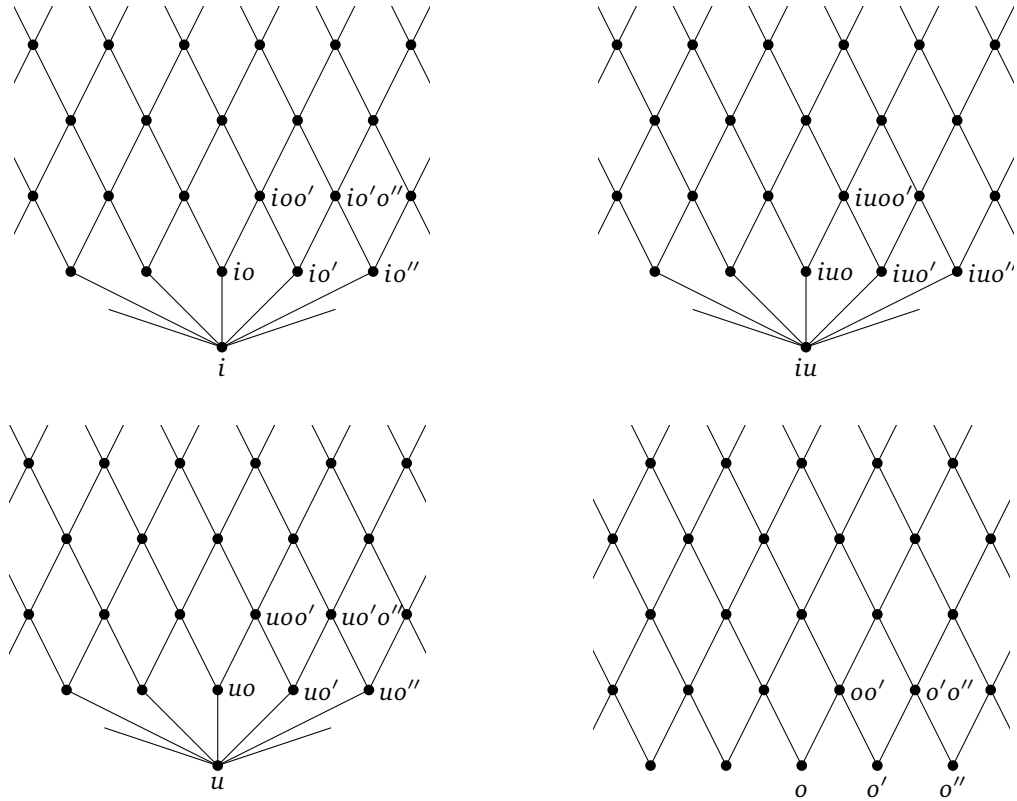

Figure 2.1: Hasse diagrams for exclusive i_x (top left), inclusive iu_x (top right), second u_x (bottom left), and third x_x (bottom right).

extending lines to the left, right, and upper boundaries. Furthermore, only a sample of nodes are labeled—just enough to allow the pattern of the diagram to emerge.

2.2.1.3 The original partition problem

This way of thinking about capturing the person space allows us to formulate what Harbour refers to as the *partition problem*, a generalized form of the question that arises from Zwicky’s classic observation: Why are only some of the logically possible person partitions attested in natural language? In an extended exposition with a large sample of languages, Harbour shows that only 5 of the 15 possible partitions are attested. So far we have discussed only two of these five—the quadripartition and the standard tripartition. The full set is schematized in (5). From left to right, these are referred to as

the monopartition, participant bipartition, author bipartition, and the already familiar tripartition and quadripartition.

(5) ***Attested person partitions across all languages (ignoring obviation)***

i_x iu_x u_x x_x	i_x iu_x u_x <hr style="border: 0.5px solid black;"/> x_x	i_x iu_x <hr style="border: 0.5px solid black;"/> u_x x_x	i_x iu_x <hr style="border: 0.5px solid black;"/> u_x <hr style="border: 0.5px solid black;"/> x_x	i_x <hr style="border: 0.5px solid black;"/> iu_x <hr style="border: 0.5px solid black;"/> u_x <hr style="border: 0.5px solid black;"/> x_x
-----------------------------------	--	--	---	--

Herein lies the original observation of Zwicky: There is no partition that conflates the inclusive and second person to the exclusion of the exclusive. This unattested partition is shown in (6).

(6) ***Example of an unattested partition (as originally observed by Zwicky)***

i_x
iu_x
u_x
x_x

It is important to emphasize that this still leaves open the possibility that, in some paradigm, a language might make a *syncretism* of the sort in (6). The form of agreement on the person prefix in Ojibwe examined above provides such a case: the second and inclusive result in the realization of *gi-*, the exclusive is associated with *ni-*, and the third person with *o-*. However, a wider look at the paradigms reveals that this is not indicative of a conflation of the inclusive and second person. The underlying partition is revealed to be the quadripartition when superposition is employed and the patterns in the central agreement slot are considered.

Again ignoring distinctions introduced by number, in Harbour's system there is a maximum of four *partition elements*, corresponding to the categories exclusive, inclusive, second, and third. The partition problem can be reframed yet again as a question

of why certain partition elements are attested, while others are unattested; and furthermore why certain partition elements are conflated, while others are not. The goal is to formulate a theory of the person representation that provides a reasonable answer to these questions.

2.2.1.4 The proximate-obviative distinction

Ojibwe (and Algonquian more generally) raises a complication to Harbour’s account via the aforementioned distinction in obviation — Harbour’s account is limited to the partitions described above, and does not attempt to capture obviation. That said, the basic morphosyntactic footprint of obviation can be described within the lattice-based representation. Obviation splits the (animate) third persons into two additional categories: PROXIMATE and OBVIATIVE. The claim I would like to put forward is that the burden of capturing this distinction falls to the theory of person.¹ The core function of obviation is to provide a division between the numerous “other” persons (o, o', o'' , etc), raising one to be designated proximate, and the rest to be relegated as obviative. I will adopt the convention of treating the non-prime other o as the proximate third person, though any one of the other o ’s would serve equally well. Proximate persons necessarily *include* reference to this proximate o , while obviative persons necessarily *exclude* reference to o .

In terms of the subscript notation, o_x is the desired partition for the proximate person, while $x'_{x'}$ is the desired partition for the obviative. Moving forward, I refer to the third person x_x discussed above as the *generic* third person to avoid ambiguity. The adopted notation is somewhat subtle, but the differences are important. Again, formal details are given in the coming sections, but the proximate partition element o_x abbreviates the singleton $\{o\}$, the dyads $\{o, o'\}$, $\{o, o''\}$, $\{o, o'''\}$, ..., the triads $\{o, o', o''\}$,

¹This claim is not meant to annul the well-attested fact that there are crucial discourse and perspectival factors that drive the assignment of which particular referent or argument is proximate versus obviative. To the contrary, these yet-to-be fully elaborated factors drive which particular entity fills the unique proximate role that is defined by the present theory.

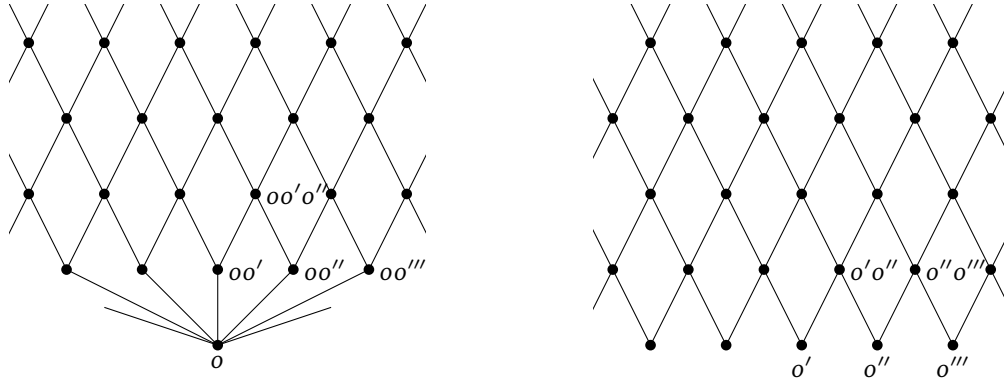

Figure 2.2: Hasse diagrams of the proposed proximate (left) and obviative (right) lattices

$\{o, o', o'''\}$, $\{o, o'', o'''\}$, ..., and so on. The key is that every single set includes the proximate o . In contrast, the obviative partition element $x'_{x'}$ does not have a unique singleton, and excludes the proximate o from all of its sets. It abbreviates the $\{o'\}$, $\{o''\}$, $\{o'''\}$, ..., then to the dyads $\{o', o''\}$, $\{o', o'''\}$, $\{o'', o'''\}$, ..., and on from there.

These sets can be visually represented with the Hasse diagrams in Figure 2.2. The proximate lattice includes a unique bottom element, o . As a result, all further sets in the ascending rows also include this element. The obviative lattice is analogous to the generic third person lattice in Figure 2.1, but crucially differs in that it lacks the proximate third person o . All other third persons (o' , o'' , o''' , and so on) are present.

2.2.1.5 The quintipartition of Ojibwe

We can use the superposition method to motivate the existence of a partition that includes obviation. This time I have chosen to use the paradigm of intransitive matrix verbs with plural arguments (referred to as the independent order VAI paradigm in the Algonquianist literature). In the left side of the equation, the leftmost paradigm gives the forms for the person prefix, the center paradigm the forms for the central agreement slot, and the rightmost paradigm the peripheral agreement slot. The figure on the right side of the equation is the superposition of these three cuts, again offset slightly.

(7) *Superposition with Ojibwe independent VAI prefix, central, and peripheral*

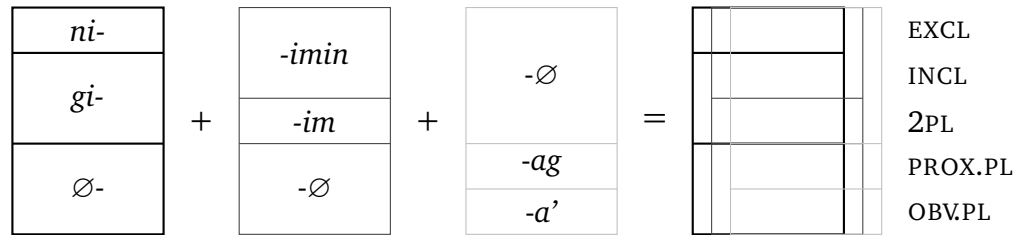

I refer to the resulting partition as the *quintipartition*: a five-way distinction between exclusive, inclusive, second, proximate, and obviative persons. The primary goal of the chapter is to capture this additional partition, while not losing the ability to derive the other partitions of Harbour’s original account. This amounts to treating the generic third person partition element as a *conflation* between the proximate and obviative partition elements. The system thus must be able to generate a maximum of five partition elements given the addition of Ojibwe.²

2.2.2 Interactions with number and noun classification

To derive the full inventory of pronouns and agreement, person representations must be able to interact with the representations of number and noun classification. The preceding discussion, and much of the discussion within this chapter, sets aside these distinctions to focus on the core representation of person. That said, the possible systems of number and noun class found in natural language is at least as rich an empirical and theoretical domain as is seen for person.

Ojibwe turns out to have a simple number system, which makes a cut between singular and plural, and is formally identical to that of English. The basic system of number adopted here will be largely unchanged from that put forward in Harbour (2016), but is important to review in order to account for the full range of category distinctions within

²This picture is complicated in Chapter 3 with the discussion of obviation systems outside of Ojibwe. Blackfoot (Algoquain) shows an eight-way distinction between exclusive, inclusive, second, and third, fully crossed by obviation. Ktunaxa (Isolate) shows a four-way contrast in person, lacking an inclusive-exclusive distinction, but including a proximate-obviative contrasts in the third persons.

Ojibwe. Noun classification has not yet received a treatment within the lattice-based theory, and is covered here in Section 2.7. The proposal suggests that there are close ties between the function of noun classification and person more generally, with both serving the basic function of creating partitions of the person ontology. Differences between the two, at least in Ojibwe, is tied to their association distinct functional heads. Person is specified on π , while noun classification is specified on n (“little” n , the nominalizing head). This rightly put the animacy distinction in Ojibwe within the cline of the prominence hierarchy, with the most basic distinction being made between animate persons (which include first, second, and many third persons) versus everything else (i.e. all other “non-animate” third persons).

2.3 A lattice-based representation of features

The goal of this section is to introduce the core components of Harbour’s (2016) lattice-based approach to the representation of person categories and person features, extending the analysis to include a feature to encode the proximate-obviative distinction. There are three pieces adopted from Harbour’s account: (i) the make-up of the underlying ontology of person; (ii) the lattice-based representation of features; and (iii) assumptions about the functional sequence. This sets the stage for the analysis of how person features combine to provide a solution to the partition problem—i.e. derive all and only the possible distinctions between person categories both within and across languages.

2.3.1 Ontological commitments

The starting point of Harbour (2016) is a claim about the underlying ontology of person: it is assumed that there is a single speaker, i , a single hearer, u , and multiple others, o , o' , o'' , etc. While this assumption is not strictly necessary, Harbour provides an extended

argument in favor of a minimal, egocentric ontology over alternatives that allow the possibility of multiple speakers and/or hearers (i.e. i' , i'' , etc; or u' , u'' , etc).

To briefly summarize the main line of reasoning, a major challenge to the assumption of minimality is accounting for the possibility of “choric” speech, where first person plurals such as *we* appear to reference only those who are speaking (in unison). While rare, such situations are not implausible and simple to construct. For example, a choric *we* could be reasonably licensed by a team of victorious hockey players singing Queen’s *We Are The Champions* as an ensemble.

Harbour reasons from two basic points. First, while choric contexts *could* be described by appealing to an ontology with multiple speakers, it is not necessary. Instead, each speaker can be thought to be egocentrically treating themselves as an i , with all other members of the chorus being conceived of as an o . Second, there is no evidence that any language differentiates between the choric *we* denoting a set of speakers, and the run-of-the-mill *we* denoting a speaker plus others. The existence of such a partition would falsify the minimal ontology, but large-scale typological surveys have failed to uncover such a language (e.g. Cysouw, 2003; Bobaljik, 2008). As a result, I follow Harbour in assuming an ontology that consists of minimal and egocentric speakers and hearers, along with multiple others.

Later in the chapter, I motivate an addition to the ontology in the face of Ojibwe’s animacy-based noun classification system: the inanimate others. These are represented by a sequence of r ’s (i.e. r , r' , r'' , etc). The existence of these members of the ontology are implicitly assumed in Harbour’s original account, but not explored.

2.3.2 Organizing the ontology: Features as lattices

While the ontology provides the basic shape of person-based reference, Harbour posits that it is not directly accessed by the grammar. Instead, the ontology is organized via features, which mediate reference. The denotations of these features are derived from

subsets that include the speaker alone (8a), the speaker and the hearer (8b), and the whole ontology (8c). The first part of this section is devoted to detailing the steps of this transformation with Harbour's original features, then proposing a new feature to account for obviation within the system, and finally considering the nature of the system at large.

(8) *Subsets of the ontology, used to create the denotation of features*

- a. $\{i\} \Rightarrow [\text{author}]$
- b. $\{i, u\} \Rightarrow [\text{participant}]$
- c. $\{i, u, o, o', o'', \dots\} \Rightarrow \pi$

2.3.2.1 *Deriving Harbour's original lattices*

The first and most substantive move is to form the power sets for each of the subsets in (8). The power set of any given set, represented here by the function \mathcal{P} , is a set of all possible subsets (including the empty set).

(9) *Power sets of each ontological subset*

- a. $\mathcal{P}(\{i\})$
 $= \{\{i\}, \{\}\}$
- b. $\mathcal{P}(\{i, u\})$
 $= \{\{i\}, \{i, u\}, \{u\}, \{\}\}$
- c. $\mathcal{P}(\{i, u, o, o', o'', \dots\})$
 $= \{\{i\}, \{i, o\}, \{i, o'\}, \{i, o''\}, \dots, \{i, o, o'\}, \{i, o', o''\}, \dots, \{i, o, o', o''\}, \dots,$
 $\{i, u\}, \{i, u, o\}, \{i, u, o'\}, \dots, \{i, u, o, o'\}, \{i, u, o, o''\}, \dots, \{i, u, o, o', o''\}, \dots,$
 $\{u\}, \{u, o\}, \{u, o'\}, \{u, o''\}, \dots, \{u, o, o'\}, \{u, o', o''\}, \dots, \{u, o, o', o''\}, \dots,$
 $\{o\}, \{o'\}, \{o''\}, \dots, \{o, o'\}, \{o, o''\}, \dots, \{o, o', o''\}, \dots, \{\}\}$

Harbour then makes the move of treating the objects in (9) in *lattice-theoretic* terms (as lattices of sets), rather than in *set-theoretic* terms (as sets of sets).³ Along with this shift comes a change in notation, with the sets in (9) being re-written as lattices via the exclusion of curly braces, as shown in (10).

(10) ***Power sets re-written in lattice-theoretic terms***

- a. $\{i, \emptyset\}$
- b. $\{i, iu, u, \emptyset\}$
- c. $\{i, io, io', io'', \dots, ioo', ioo'', \dots, ioo'o'', \dots,$
 $iu, iuo, iuo', iuo'', \dots, iuoo', iuoo'', \dots, iuoo'o'', \dots,$
 $u, uo, uo', uo'', \dots, uoo', uoo'', \dots, uoo'o'', \dots,$
 $o, o', o'', \dots, oo', oo'', \dots, oo'o'', \dots, \emptyset\}$

Next, a notational convention is introduced to further simplify the representation of the structures—the same subscript notation that was introduced in a previous section. In formal terms:

(11) X_y is the list of sets of the form $\{x\} \cup y$, for $x \in X, y \in \mathcal{P}(Y)$

I break with the conventions introduced by Harbour in how “other” persons are represented. This is necessary to properly capture the proximate-obviative distinction. In the revised notation, i, u, o, o', o'' , and so on always represent *singleton* sets. For Harbour, o represents the set of all possible o 's $\{o, o', o'', o''', \dots\}$, rather than the singleton set $\{o\}$. To represent the set of all possible o 's including the “proximate” o , I use x . Furthermore, to represent the set of all possible o 's *excluding* the “proximate” o , I use x' .

To summarize:

³This move is chiefly for expository purposes — according to Harbour the account can be equally couched in set-theoretic terms. Using lattices rather than sets provides simplified calculations as well as friendly graphical representations.

(12) *Abbreviations for subscript notation (revised from Harbour 2016)*

$$i = \{i\}$$

$$u = \{u\}$$

$$o = \{o\}$$

$$o' = \{o'\}$$

...

$$x = \{o, o', o'', o''', \dots\}$$

$$x' = \{o', o'', o''', \dots\}$$

Therefore u_x provides an abbreviated representation for lattice elements that contain u and any possible number of o 's, including none ($u, uo, uo', uo'', \dots, uoo', uoo'', uoo'o'', \dots, uoo'o'', \dots$). i_x provides an abbreviated representation for lattice elements that contain i and any possible number of o 's, including none ($i, io, io', io'', \dots, ioo', ioo'', io'o'', \dots, ioo'o'', \dots$). Similarly, iu_x represents lattice elements containing iu and any number of o 's ($iu, iuo, iuo', iuo'', \dots, iuoo', iuoo'', iuo'o'', \dots, iuoo'o'', \dots$).

Turning to the third persons, in Harbour's original notation, o_o represents the list of any o on its own (o, o', o'', \dots), any pair of o 's ($oo', oo'', o'o'', \dots$), any triple ($oo'o'', \dots$), and so on. I instead represent this same set as x_x . In this adapted notation, o_x is fully analogous to i_x and u_x in that it is reserved for abbreviating lattice elements that contain the "proximate" element o and any possible number of other o 's, including none ($o, oo', oo'', oo''', \dots, oo'o'', oo'o''', oo''o''', \dots, oo'o''o''', \dots$). Note that *every single element here includes o* . This distinction is crucial for the contrast between proximate and obviative persons, and is discussed further in the coming sections.

The resulting representations are given in (13), with the additional step of removing the empty set applied.⁴

⁴This renders the structures not "lattices" in the technical sense — the absence of the empty set renders them *atomic join-complete semilattices*. The distinction does not affect the upcoming account.

(13) *Lattices re-written in subscript notation*

- | | | | |
|----|---------------------------|---------------------|---------------------|
| a. | $\{i\}$ | author lattice | \mathcal{L}_{au} |
| b. | $\{i, iu, u\}$ | participant lattice | \mathcal{L}_{pt} |
| c. | $\{i_x, iu_x, u_x, x_x\}$ | π lattice | \mathcal{L}_{π} |

As (13) shows, moving forward these will be referred to as the *author lattice* (abbreviated \mathcal{L}_{au}), the *participant lattice* (abbreviated \mathcal{L}_{pt}), and the *π lattice* (abbreviated \mathcal{L}_{π}).

2.3.2.2 Proposal: A lattice for [proximate]

To capture obviation, I propose an additional feature, [proximate], whose denotation is derived from taking the power set of the ontological subset $\{i, u, o\}$. This subset includes the minimal possible specification of each of the ontological primitives. In the case of first and second person, which as discussed above only have a single token to begin with, this restriction does not amount to much. In the case of the other persons, this means including only a single o , which we can conventionally call the *proximate third person*. To reiterate, any of the o 's would serve equally well, as long as only a single o is designated. Indeed, the particular o that is included in this set is a matter determined by the wider discourse context, where the referent that takes on the proximate status is determined. I stick with the non-prime o throughout the presentation for simplicity and clarity. The derivation of the proximate lattice, with the same steps outlined above for π , [participant], and [addressee] is given in (14).

(14) *Derivation of the proximate lattice*

- | | | |
|----|--|-------------------------|
| a. | $\{i, u, o\}$ | define proximate subset |
| b. | $\mathcal{P}(\{i, u, o\})$ | take power set of (a) |
| | $= \{\{i\}, \{i, o\}, \{u\}, \{u, o\}, \{i, u\}, \{i, u, o\}, \{o\}, \{\}\}$ | |

- c. $\{iuo, iu, io, uo, i, u, o, \emptyset\}$ lattice notation re-write of (b)
d. $\{iuo, iu, io, uo, i, u, o\} = \mathcal{L}_{px}$ remove empty set from (c)

The four lattices introduced here (\mathcal{L}_{π} , \mathcal{L}_{px} , \mathcal{L}_{pt} , \mathcal{L}_{au}) can be manipulated to derive the five-way person partition of Ojibwe, but are also sufficient to capture the variation in obviation seen across languages. The general machinery that dictates the interactions between lattices to capture the different partitions is detailed in Section 2.4.3. The application of the system to Ojibwe is found in Section 2.5. Finally, a discussion of obviation beyond Ojibwe can be found in Chapter 3.

2.3.2.3 Why (these) features? Why (these) lattices?

Before moving forward to these endeavors, a few points of discussion are in order.

First, one may wonder whether the operations posited here that transform subsets of the ontology from power sets to lattices are independently motivated, or what their status in the grammar might be. Harbour points out that the employed operations are not novel in being employed within linguistic theory (see e.g. Link, 1983; Chierchia, 1998; Borer, 2005). In any case, I do not take Harbour to be claiming that such calculations must be synchronically employed in adults (nor do I necessarily assume this to be true). The operations that form the lattices can be considered to be a formal model of how the sets represented by particular morphosyntactic features arose diachronically, or perhaps arise over the course of language acquisition. Once settled, the lattices represented by these features are the mental representation that mediates reference to the ontology, and need not be actively derived upon each use.

A second point is why the *particular* subsets $\{i\}$ and $\{i, u\}$ (restricting the discussion for the moment to the original subsets proposed by Harbour) are rendered into features that connect our grammar to the underlying ontology. Harbour conjectures that the evolutionary and developmental trajectory of social interaction may be relevant. We

might reasonably surmise that our most basic level of awareness is inward to ourselves. This is represented by a solitary $\{i\}$, which becomes the author lattice. At some point, awareness expands to immediate interaction between the self and a single other, represented by $\{i, u\}$, which becomes the participant lattice. Finally, an expansion occurs to include those beyond the speaker and hearer to an awareness that includes others, represented by $\{i, u, o, o', \dots\}$, which becomes the π lattice.

This brings to the fore the question of whether the π , participant, author lattices, and their corresponding features, must be part of a learner's initial state (e.g. specified in Universal Grammar), or whether the profile of how social interaction via language occurs results in languages sharing a common ontology of person and a common set of possible features. In any case, it is indisputable that the *particular* set of features that a given language makes use of, and furthermore how these features combine, must be learnable from the primary input. This is true whether features are built by learners from scratch based on this input, or whether the shape of the input triggers the use of particular representations made available by UG. As a result, the present account need not take an unflinching stance one way or the other on the question of innateness, and considers the question to be open for further investigation.

A related point is that the Algonquian languages, with the system of obviation, provide a case where an additional feature is present. The proposed feature, [proximate], is derived from a subset of the ontology that includes the speaker, hearer, and a single other $\{i, u, o\}$. One question that arises, given the preceding discussion, is how this distinction came to be; particularly in light of its typological rarity. If such a feature is made available by UG, this rarity must be accounted for. Furthermore, based on the logic of expanding social awareness given above, it would seem a natural progression to add a single other, forming the proximate subset, rather than jumping immediately to π where all of the others come in at once. I do not provide a response to these questions, but note that recent decades have shown that obviation (and closely related distinc-

tions) may not be as typologically rare as once thought. Understanding this variation on a descriptive level is a first step to understanding the origins of obviation.

A final point related to the particular set of features regards the absence of a feature formed from a subset of the addressee alone, $\{u\}$. We could call such a feature [addressee]. For the purposes of deriving the possible partitions, the omission of this feature is the key to solving Zwicky's problem. To review, Zwicky observed that if the inclusive is conflated with another category, it is the exclusive. There is no language that conflates the inclusive with the second person. This is illustrated in (15).

(15) *Illustration of Zwicky's Problem in the tripartition*

- a. $i_x \text{ } iu_x | u_x | x_x$
- b. $*i_x | iu_x \text{ } u_x | x_x$

Harbour (see also McGinnis, 2005) shows that the problem is general: an analogous asymmetry holds in the bipartition (i.e. there is an *author* bipartition, but no *addressee* bipartition):

(16) *Illustration of Zwicky's Problem in the bipartition*

- a. $i_x \text{ } iu_x | u_x \text{ } x_x$
- b. $*u_x \text{ } iu_x | i_x \text{ } x_x$

In short, there is an asymmetry between *i* and *u* in the patterns of conflation. There are cuts that distinguish authors from everyone else, but not cuts that distinguish addressees from everyone else. This asymmetry is reflected by the presence of [author], but the absence of [addressee]. If both of these features could be present at once, then the theory would incorrectly predict symmetry between these two categories. If the theory instead lacked [author], but included [addressee], then we would expect the opposite asymmetry to hold.

Ultimately, there are two complications to the absolute version of the claim that languages lack an addressee feature across the board. The first rears its head when the theory of contrastive interpretations is considered in Section 2.4.1, where I show that the participant feature is interpreted as an addressee feature in certain cases. I reserve further discussion for that section. A second, more pointed challenge comes from languages which privilege agreement with second persons over all other persons (e.g. Nez Perce; Deal, 2015). Existing accounts of these patterns rely on the presence of a pure [addressee] feature on the probe. Ultimately, I conclude that it is necessary to adopt the same view (see Chapter 4, Section 4.5.2). This reveals a representational mismatch between the features available to agreement probes versus the possible set of goals, which I term the *Addressee Asymmetry*. While agreement probes necessitate the availability of [addressee], deriving the possible person partitions in a language (i.e. the possible goals) relies on the absence of this feature. Further discussion of how this the Addressee Asymmetry might be resolved can be found in Chapter 7, Section 7.2.

2.3.3 The functional sequence

The final piece of the account to put into place before moving on to deriving partitions regards where the head π lives within the functional sequence. I follow Harbour in assuming that π combines with a head φ —the root node of the nominal spine (it could alternatively be written as \checkmark following the conventions of Distributed Morphology). The addition that is made here, which will be revised in due course, is to add the proximate feature to the head π .⁵

⁵The revision will be that proximate heads its own projection, which sits below π . This is motivated by the typology of obviation explored in Chapter 3.

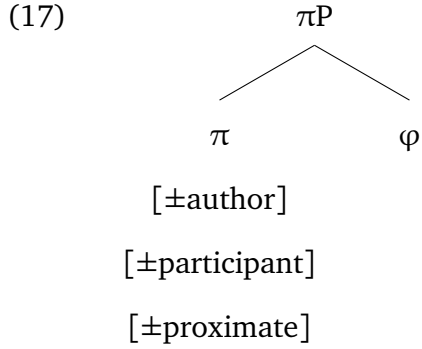

The head φ serves a critical function, in that its denotation, shown in (18), introduces a variable that ranges over the set S denoted by π . This allows reference to be made to any of the values of S . In other words, π constrains the variable to the particular domain denoted by its set (i.e. the members of the lattices we have been referring to as inclusive, exclusive, second person, third person).

(18) $\llbracket \varphi \rrbracket = \lambda S. \lambda x. x \in S$, where $x \in D_e$

This is accomplished via function application, as shown in (19), where F is the set of features $[\pm\text{proximate}]$, $[\pm\text{participant}]$, and/or $[\pm\text{author}]$ specified on π .

(19) $\llbracket \varphi \rrbracket (\llbracket \pi_F \rrbracket)$
 $= \lambda S. \lambda x. x \in S (\llbracket F \rrbracket (\mathcal{L}_\pi))$
 $= \lambda x. x \in \llbracket F \rrbracket (\mathcal{L}_\pi)$

The functional sequence is expanded in Section 2.7 with the addition of projections for number and noun classification, which will provide further constraints on the set over which the variable ranges. In the next section, I consider how features interact to provide the domain restriction outlined above.

2.4 The composition of features

In this section I argue in favor of an account of the partition problem and the interaction of features based in the theory of *contrastive interpretations*. This is a calculated departure from the account given in Harbour (2016). An explicit comparison between Harbour’s theory and the one adopted here is given in Section 2.6. I show the theory of contrastive interpretations is capable of deriving the original five partitions identified by Harbour (following the work of Cowper and Hall, 2019), as well as the additional partition of Ojibwe introduced by obviation and the proximate feature.

The particular account I propose preserves the lattice-based representations proposed by Harbour and introduced in the previous section. I adopt the idea that the principle of contrastive interpretations operates over the lattices denoted by each feature. In other words, the lattices are subject to contextually dictated narrowing, depending on the input available to the learner. The relevant context is determined by an algorithm that finds the minimal feature representation necessary to derive the categories distinguished within a given paradigm.

Put in the terms of the theory, the precise denotation of a given feature differs depending on its “scope” with respect to the other features it combines with. It is important to emphasize that “scope” relations are with respect to the contrastive hierarchy rather than the phrase structure hierarchy. For example, [\pm participant] ends up marking a contrast between hearer and non-hearer (rather than participant versus non-participant) when it is “within the scope” of [\pm author] on the contrastive hierarchy. As I show, following the spirit of the proposal by Cowper and Hall (2019), this allows for a solution to the original partition problem. The theory further provides a principled and properly restrictive way to smuggle a [\pm addressee] feature into the representation—a possibility that can be leveraged when considering the behavior of agreement probes in the coming chapters, which necessitate the existence of an independent addressee feature.

The new aspect of the proposal is showing that the theory captures the quintipartition of Ojibwe when [\pm proximate] is added to the mix. Neither [\pm participant] nor [\pm author] mark a contrast when in the scope of [$-$ proximate], resulting in a lack of partition between proximate and obviative in the local persons, but ensuring that a contrast in the third persons is still derived. In contrast, Harbour’s original theory of feature interaction, with the addition of the proximate feature, is unable to generate the quintipartition of Ojibwe. Again, a direct evaluation of Harbour’s account can be found in Section 2.6. The theory of contrastive interpretations therefore covers the same empirical ground, and more, when it comes to capturing all and only the possible person partitions with obviation (and, ultimately, animacy) added to the mix.

2.4.1 Contrastive interpretations of features

The touching off point for the current section is Cowper and Hall (2019). Like Harbour, they provide a solution to the *partition problem*. That is, they put forward a theory of the representation that generates all and only the five person partitions discussed in Section 2.2.1. These partitions are repeated in (20) for reference.

(20) *The original five partitions. From left-to-right: Monopartition, participant bipartition, author bipartition, tripartition, and quadripartition*

i_x	i_x	i_x	i_x	i_x
iu_x	iu_x	iu_x	iu_x	iu_x
u_x	u_x	u_x	u_x	u_x
x_x	x_x	x_x	x_x	x_x

I review their original account first, then provide a novel formalization of the features they propose that allows it to be couched directly in lattice-theoretic terms, and finally advance the core proposal of the chapter, where I extend the system to capture the five-way partition of Ojibwe.

Like Harbour, Cowper & Hall posit two binary person features, which combine to partition the sets denoted by the head π (i_x, iu_x, u_x, x_x). They treat these features as first-order predicates, as summarized in (21):

- (21) *Person features as first-order predicates (Cowper and Hall, 2019)*
- a. $\llbracket [+author] \rrbracket$ = ‘includes the speaker’
 - b. $\llbracket [-author] \rrbracket$ = ‘does not include the speaker’
 - c. $\llbracket [+participant] \rrbracket$ = ‘includes at least one discourse participant’
 - d. $\llbracket [-participant] \rrbracket$ = ‘does not include a discourse participant’

For the purposes of introducing the basics of the theory, I retain their original informal denotations for each feature. I provide a formalization in Section 2.4.3.

It is pertinent to note now that these denotations differ from the proposed interactions between features and lattices in Harbour’s original system, where features combine via *operations* defined by the positive and negative values of the features. At present, the details of these operations are not important, but the contrast between the predicate-based versus function-based interaction of lattices is worth keeping in back of mind (see Section 2.6 for details and further discussion).

Moving on, Cowper and Hall (2019) show the derivations of the monopartition, author bipartition, and participant bipartition utilize the same basic inventory of features as proposed by Harbour, despite the noted differences in how interactions between features are conceived. Therefore the accounts share a common core. If there are no person features specified on π , then no partitions are made and the monopartition is derived. If the language uses only $[\pm author]$, then a split is made between a partition with all sets that include the speaker (i_x, iu_x) with the positive value, versus those that do not include the speaker (u_x, x_x) with the negative value. Similarly, the participant bipartition is derived for languages that only utilize the $[\pm participant]$ feature, dividing

π between those that include at least one discourse participant (i_x, iu_x, u_x) with the positive value, and those that do not (x_x) with the negative value.

The key difference, and of particular interest here, is in the derivation of the tripartition and quadripartition, where more than one feature enters into the derivation. In this case, the relative *scope* of features (as schematized by the particular contrastive hierarchy at play) determines both the possible partitions that a feature can make as well as the particular interpretation that a feature receives. To preview the arguments put forward explicitly in Section 2.4.2, the determination of these scope relationships is assumed to occur over the course of acquisition, when a learner is faced with generating a particular person partition given the set of grammatical primitives π , [proximate], [participant], and [author].

Consider the tripartition first, with the relevant contrastive hierarchy shown in (22). The inventory of π is first split by [\pm participant], making a division between the first and second persons versus the third persons. The further split introduced by [\pm author] then only serves to separate the members on the [+participant] side of the divide, separating the sets that include i from those that lack it. This allows for a partition that makes a distinction between second and first person, but lacks a clusivity distinction.

(22) *Contrastive hierarchy for the tripartition*

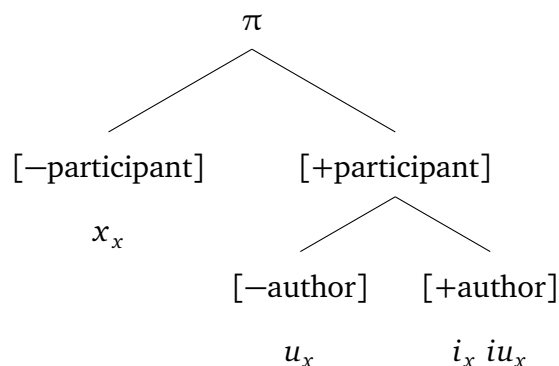

It is worth spelling out in more detail why [\pm author] only makes further cuts when [+participant] has applied, but not [$-$ participant]. In short, [$-$ participant] creates a

partition that completely excludes any discourse participant. As a result, there is *no further contrast* for the feature [\pm author] to make (i.e. there are no sets that include *i*). As a result, any application of the author feature would be entirely vacuous—the generic third person partition element is derived regardless. In contrast, on the [+participant] side, [\pm author] can further partition the sets into those that include versus exclude the author, thus providing a relevant contrast to derive first versus second person.

The quadripartition exemplifies a second way in which the notion of being contrastive affects the representation of person, as schematized in the hierarchy in (23).

(23) *Contrastive hierarchy for the quadripartition*

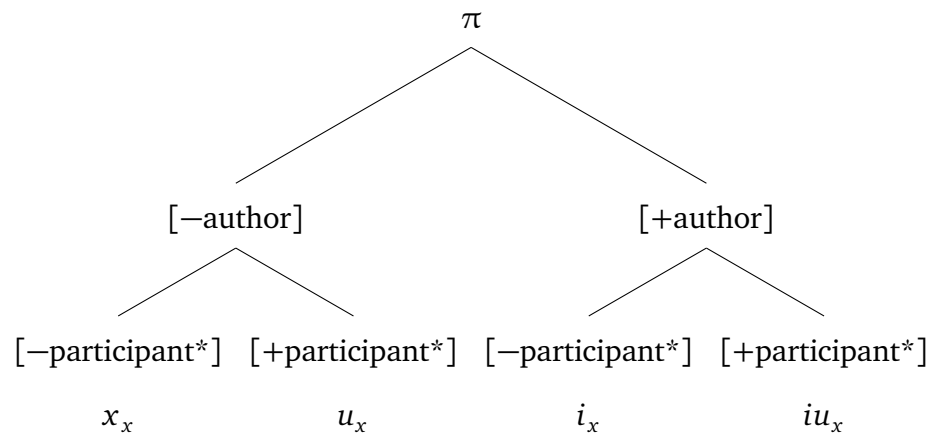

The key difference is that [\pm author] now takes scope above [\pm participant]. The first contrast is therefore between those elements of the π lattice that include the author (i_x , iu_x) versus those that exclude the author (u_x , x_x). In the latter case, [\pm participant] further makes a division between the sets that exclude a discourse participant (the third person x_x) and those that include a discourse participant (the second person u_x). The division made on the [+author] side is more subtle, and crucially relies on the notion that features introduce some relevant contrast. In particular, Cowper and Hall (2019) propose the feature is narrowed to mean ‘includes/does not include a discourse participant *other than the speaker*’. This recasts the feature as marking a contrast between those sets that include versus exclude the addressee (u), allowing the contrast between

the inclusive and exclusive persons to be derived. I represent the narrowed version of this feature as [participant*].

To bring the notion of contrast further into relief, imagine if the contrastive principles did not apply. On the [−author] side, this would leave open the possibility that the predicate denoted by [−participant], which semi-informally means “does not include a discourse participant”, becomes redundant with [−author] by simply excluding the elements that include *i*, thereby failing to create a cut between the third and second person elements. By the same token, the positive variant [+participant] could create a contradiction with [−author] by denoting a predicate that requires the presence of *i*. The issues are analogous on the [+author] side, where the combination of [−participant] could in principle give rise to a contradiction, while [+participant] might fail to create the relevant cut. In short, a system without the contrastive interpretation of features would be far too unconstrained.

Short of conceiving of the absence of a feature as *complete* contextually dictated narrowing, a further property of the system is that the author feature will never have an alternative interpretation. Since this feature only contains a single element *i*, [author] is as narrow as a feature can be while still being present at all. This means that we have now exhausted all of the possibilities of feature combinations and contrastive meanings under the current two feature system, and have thus derived all and only the five original partitions—we have provided a solution to the original partition problem.

To briefly summarize, the notion of contrastive interpretations plays two key roles. First, it restricts a given feature from combining with another feature if the set to be divided *lacks* elements that would be contrasted through the use of that feature. This was seen in the tripartition, where the broad interpretation of [−participant] as lacking both *i* and *u* bled the application of [±author]. Second, it narrows the interpretation of a given feature depending on the context in which the feature applies. This was seen in

the quadripartition, where [\pm participant] was narrowed to mark a contrast in whether or not an addressee is present (represented as [\pm participant*]).

2.4.2 Deriving contrastive hierarchies

The reader may wonder about the representational status of the contrastive hierarchies shown above. In short, they are schematic devices — it is not the case that features are literally organized into such hierarchies. As a result, the contrastive hierarchies are not representations per se, but a way of showing the scope relationships between features, which allows the particular interpretation of the features to be established. This marks an important conceptual difference from what is claimed under the feature geometric approach, where a universal geometric hierarchy is directly represented and manipulated by the grammar.

What, then, is the part of the grammar that gives rise to contrastive interpretations and these scope relationships? Following the work of Dresher (2009, 2018) on the derivation of phonological contrasts, these properties can be derived from the Successive Division Algorithm in (24), which ultimately is active over the course of acquisition. I eschew the formal details to focus on the principles behind the theory.

(24) ***Successive Division Algorithm (SDA), informally***

Assign *contrastive features* by successively dividing an inventory until every member has been distinguished.

The idea is general enough to apply to any number of domains where an inventory must be divided into some number of categories. In phonology, it is applied to allow for the inventory of phonemes in a given language to be distinguished. For the present purposes, it is applied to allow the inventory of person partitions to be distinguished. For an inventory of person categories, the initial state is one in which there are no divisions between the persons. In other words, the monopartition created by the presence of π .

The necessary contrasts (i.e. the patterns of distinction and conflation between partition elements) to be derived are determined by the primary input to the learner, and features are added, further dividing the inventory, until the proper number of partition elements are derived.

There are two major tenants of the theory. The most fundamental, adapted from Clements (2001) and given in (25), is the notion of Feature Activity.⁶ This limits the specification of features to only those that play a role in deriving the inventory—these features are thus considered “active” in a given language.

(25) ***Feature Activity***

A feature is *active* if it plays a role in the derivation of the inventory.

The second tenant adapted from Hall (2007) is given in (26), and provides further clarification on what it means for a feature to be active: only features that provide the means to generate a contrast are active.

(26) ***The Contrastivist Hypothesis***

The derivation of an inventory only operates with those features that are necessary to distinguish the members of the inventory.

In the case that the hypothesis in (26) holds, then the principle in (27) also holds.

(27) ***Corollary to the Contrastivist Hypothesis***

If a feature is active, then it must be contrastive.

The Contrastivist Hypothesis and its corollary provide the means to capture the two restrictions seen in the the derivation of the tripartition and quadripartition. First, it prevents [\pm author] from combining with [$-$ participant] in tripartition languages, as

⁶This is not to be confused with the Activity Condition proposed by Chomsky (2000, 2001), which restricts the types of goals that can be targeted by AGREE.

there is no further contrast that can be marked by the author feature in this context. As previously noted, all participants are partitioned off in these cases, leaving author nothing to divide. While no harm would come from including these features in terms of deriving the final inventory, the learner lacks evidence to drive the addition of these features, and is assumed to adopt the most parsimonious representation consistent with the input. Second, the theory derives restrictions on [\pm participant] when it is in the scope of [\pm author] such that it is contrastive—i.e. it distinguishes between sets the include and exclude the addressee. As previously noted, without this winnowing, the [\pm participant] would either not be contrastive, or generate contradictions.

To summarize the arguments and consider the broader context in which they operate, the application of the Contrastivist Hypothesis restricts the outputs created by particular feature combinations. In essence, it is a variant of the Subset Principle, which results in the generation of maximally restrictive grammars consistent with the input (e.g. Manzini and Wexler, 1987). On the theory of contrastive interpretations, the interpretations of features are restricted to derive the desired outputs, without any extraneous features. In the next section, having introduced the tenants of the Contrastive Hypothesis, I turn to reformulating the denotation of features in terms of the lattice-based representation of features.

2.4.3 Application to the lattice-based representation

The goal of this section is to provide a novel formalization of the theory of contrastive interpretations in terms of the lattice-based representation of person. For the purposes of this section, I again restrict focus to the author and participant features only, reserving discussion of proximate feature and the derivation of the proximate-obviative distinction to the next section. The (power) sets denoted by each feature as well as the host head π are repeated in (28) for reference.

(28) *Features as lattices (repeated)*

- a. $\llbracket[\text{author}]\rrbracket = \{i\}$
- b. $\llbracket[\text{participant}]\rrbracket = \{i, iu, u\}$
- c. $\llbracket[\pi]\rrbracket = \{i_x, iu_x, u_x, x_x\}$

The formulas in (29) define the interactions between lattices. Positive interactions of F with G , shown formally in (29a), results in a lattice consisting of all elements within \mathcal{L}_G that *contain at least one member* of \mathcal{L}_F . Negative interaction of F with G , given formally in (29b), results in a lattice consisting of all elements within \mathcal{L}_G that *do not contain any member* of \mathcal{L}_F .

- (29) a. $\llbracket+F(G)\rrbracket = \{g : \exists f \in g [g \in \mathcal{L}_G \wedge f \in \mathcal{L}_F]\}$
 b. $\llbracket-F(G)\rrbracket = \{g : \neg \exists f \in g [g \in \mathcal{L}_G \wedge f \in \mathcal{L}_F]\}$

In the coming derivations of each partition, I use \oplus to denote positive interactions between lattices, and \ominus to denote negative interactions, as shown in (30).

- (30) a. $\llbracket+F(G)\rrbracket = \mathcal{L}_G \oplus \mathcal{L}_F$
 b. $\llbracket-F(G)\rrbracket = \mathcal{L}_G \ominus \mathcal{L}_F$

The formality of the above definitions may obscure the fact that the proposal is based in first-order predicate logic. They are generalized versions of the feature definitions put forward by Cowper and Hall (2019) (see (21)). Positive action confines \mathcal{L}_G to a lattice that is comprised of sets that contain a member of \mathcal{L}_F . Negative action confines \mathcal{L}_G to a lattice of the sets that *do not* contain a member of \mathcal{L}_F . In other words, the lattice \mathcal{L}_G is restricted to only those sets that have/lack the property defined by F . Put in terms of the features at hand, the lattice denoted by π provides the domain of a variable, which can be restricted by a feature such as $[\pm\text{author}]$ so that it must include/exclude those elements of \mathcal{L}_π that contain i .

An important feature of the present account is that the order of composition of features is commutative, as shown in (31). This property is particularly relevant when evaluating Harbour’s original account of feature/lattice interaction (see Section 2.6), where the order of composition of features is a matter of parameterization that must be extrinsically fixed within a given language.

$$(31) \quad \llbracket \pm H(\pm F(G)) \rrbracket = \llbracket \pm F(\pm H(G)) \rrbracket$$

The major boon is that this property frees the account of a need to stipulate extrinsic parameters or constraints to organize the composition of features on a head. This allows the feature set to be a truly unordered bundle on a given head, providing a more parsimonious representation, and as a consequence simplifying the mapping between syntax and the PF and LF interfaces. Here, heads (and, by extension, the functional sequence) are the sole locus of restrictions in the order of composition — a fact that has been widely noted and well-established in current theories of the syntax-semantics interface, where phrase-structure hierarchies guides semantic composition (e.g. Heim and Kratzer, 1998). There is no need for additional mappings to be established to guide the composition of features within a given head.

The remainder of the section is devoted to showing how the proposed reformulation of features and values as lattices and lattice interactions derives all and only the original five partitions, given the theory of contrastive interpretations which determines both the features available in a language and the particular sets that they denote.

2.4.3.1 Monpartition and bipartitions

As is the case across all accounts considered in this chapter, the monpartition is derived when a language lacks both the author and participant features. In short, there is nothing to derive in terms of feature interaction, as only the head π is specified.

The author and participant bipartitions are derived by the presence of either the $[\pm\text{author}]$ or $[\pm\text{participant}]$ features, respectively. The derivations are shown in (32) and (33). Both make use of the theory of contrastive interpretations in the sense that only active features—i.e. those that serve to make a relevant partition—are present in the grammar. In the case of the author bipartition, the split is between those sets that include i and those that do not. In the case of the participant bipartition, the split is between those that include i , u , or iu and those that do not.

(32) ***Derivation of the author bipartition***

$$\begin{aligned}
 \text{a. } & \llbracket +\text{author}(\pi) \rrbracket \\
 & = \mathcal{L}_\pi \oplus \mathcal{L}_{au} \\
 & = \{i_x, iu_x, u_x, x_x\} \oplus \{i\} \\
 & = \{i_x, iu_x\} \\
 \text{b. } & \llbracket -\text{author}(\pi) \rrbracket \\
 & = \mathcal{L}_\pi \ominus \mathcal{L}_{au} \\
 & = \{i_x, iu_x, u_x, x_x\} \ominus \{i\} \\
 & = \{u_x, x_x\}
 \end{aligned}$$

(33) ***Derivation of the participant bipartition***

$$\begin{aligned}
 \text{a. } & \llbracket +\text{participant}(\pi) \rrbracket \\
 & = \mathcal{L}_\pi \oplus \mathcal{L}_{pt} \\
 & = \{i_x, iu_x, u_x, x_x\} \oplus \{i, iu, u\} \\
 & = \{i_x, iu_x, u_x\} \\
 \text{b. } & \llbracket -\text{participant}(\pi) \rrbracket \\
 & = \mathcal{L}_\pi \ominus \mathcal{L}_{pt} \\
 & = \{i_x, iu_x, u_x, x_x\} \ominus \{i, iu, u\} \\
 & = \{x_x\}
 \end{aligned}$$

2.4.3.2 Tripartition

The derivation of the tripartition uses both the participant and author features, with participant denoting its full lattice. In the case of negative interaction between participant and π , all sets containing participants are removed, leaving only the third person elements. This is shown in (34), and is equivalent to the negative action seen in the derivation of the participant bipartition.

$$\begin{aligned}
 (34) \quad & \textit{Derivation of the third person in the tripartition} \\
 & \llbracket \text{--participant}(\pi) \rrbracket \\
 & = \mathcal{L}_\pi \ominus \mathcal{L}_{pt} \\
 & = \{i_x, iu_x, u_x, x_x\} \ominus \{i, iu, u\} \\
 & = \{x_x\}
 \end{aligned}$$

At this point, it should be relatively clear why any interactions with the author feature are vacuous in this case—this is true regardless of the order in which features compose with π , further demonstrating the commutativity of feature composition. When $\llbracket \text{--participant} \rrbracket$ composes first, vacuity arises as the lattice does not have any sets that include i , so there is nothing for an author feature to partition. The case of the author feature composing first boils down to the fact that the author lattice is a proper subset of the participant lattice. Therefore the negative effects of the participant lattice will always supersede any interaction between author and π .

Both the derivation of the generic first person and the second person involve positive interaction between the participant feature and π , and are indifferent to the order of composition between the author and participant features. The participant first orders are shown in (35a) and (36a) for first and second person, respectively; the author first orders in (35b) and (36b), again for both first and second person.

(35) *Derivation of the first person in the tripartition*

- a. $\llbracket +\text{author}(+\text{participant}(\pi)) \rrbracket$
= $((\mathcal{L}_\pi \oplus \mathcal{L}_{pt}) \oplus \mathcal{L}_{au})$
= $((\{i_x, iu_x, u_x, x_x\} \oplus \{i, iu, u\}) \oplus \{i\})$
= $\{i_x, iu_x, u_x\} \oplus \{i\}$
= $\{i_x, iu_x\}$
- b. $\llbracket +\text{participant}(+\text{author}(\pi)) \rrbracket$
= $((\mathcal{L}_\pi \oplus \mathcal{L}_{au}) \oplus \mathcal{L}_{pt})$
= $((\{i_x, iu_x, u_x, x_x\} \oplus \{i\}) \oplus \{i, iu, u\})$
= $\{i_x, iu_x\} \oplus \{i, iu, u\}$
= $\{i_x, iu_x\}$

(36) *Derivation of the second person in the tripartition*

- a. $\llbracket -\text{author}(+\text{participant}(\pi)) \rrbracket$
= $((\mathcal{L}_\pi \oplus \mathcal{L}_{pt}) \ominus \mathcal{L}_{au})$
= $((\{i_x, iu_x, u_x, x_x\} \oplus \{i, iu, u\}) \ominus \{i\})$
= $\{i_x, iu_x, u_x\} \ominus \{i\}$
= $\{u_x\}$
- b. $\llbracket +\text{participant}(-\text{author}(\pi)) \rrbracket$
= $((\mathcal{L}_\pi \ominus \mathcal{L}_{au}) \oplus \mathcal{L}_{pt})$
= $((\{i_x, iu_x, u_x, x_x\} \ominus \{i\}) \oplus \{i, iu, u\})$
= $\{u_x, x_x\} \oplus \{i, iu, u\}$
= $\{u_x\}$

2.4.3.3 Quadripartition

The quadripartition is also derived by both the participant and author features being present. It differs from the tripartition in that the participant feature is realized in its

narrowed form, [participant*]. As previously discussed, in order to be contrastive and derive the relevant clusivity distinction, the participant feature is interpreted as a subset of its full power set such that it only includes u . Again, I represent this winnowed variant of the feature as $[\pm\text{participant}^*]$ and the lattice it denotes as \mathcal{L}_{pt^*} .

The derivation of the third person is shown in (37) with both composition orders. In both cases, negative interaction with the author feature removes those sets which include i , and negative interaction of the participant* feature removes those sets that include u , leaving only those that include x .

(37) *Derivation of the third person in the quadripartition*

$$\begin{aligned}
 \text{a. } & \llbracket \neg\text{participant}^*(\neg\text{author}(\pi)) \rrbracket \\
 & = ((\mathcal{L}_\pi \ominus \mathcal{L}_{au}) \ominus \mathcal{L}_{pt^*}) \\
 & = ((\{i_x, iu_x, u_x, x_x\} \ominus \{i\}) \ominus \{u\}) \\
 & = \{u_x, x_x\} \ominus \{u\} \\
 & = \{x_x\} \\
 \text{b. } & \llbracket \neg\text{author}(\neg\text{participant}^*(\pi)) \rrbracket \\
 & = ((\mathcal{L}_\pi \ominus \mathcal{L}_{pt^*}) \ominus \mathcal{L}_{au}) \\
 & = ((\{i_x, iu_x, u_x, x_x\} \ominus \{u\}) \ominus \{i\}) \\
 & = \{i_x, x_x\} \ominus \{i\} \\
 & = \{x_x\}
 \end{aligned}$$

The derivation of the second person is shown in (38), again for both composition orders. Negative interaction with the author feature again removes all elements that include i , while positive action of the participant* feature restricts the lattice to only those that include u , leaving only the second person element u_x in both cases, regardless of composition order.

(38) **Derivation of the second person in the quadripartition**

$$\begin{aligned}
 \text{a. } & \llbracket +\text{participant}^*(-\text{author}(\pi)) \rrbracket \\
 & = ((\mathcal{L}_\pi \ominus \mathcal{L}_{au}) \oplus \mathcal{L}_{pt*}) \\
 & = ((\{i_x, iu_x, u_x, x_x\} \ominus \{i\}) \oplus \{u\}) \\
 & = \{u_x, x_x\} \oplus \{u\} \\
 & = \{u_x\} \\
 \text{b. } & \llbracket -\text{author}(+\text{participant}^*(\pi)) \rrbracket \\
 & = ((\mathcal{L}_\pi \oplus \mathcal{L}_{pt*}) \ominus \mathcal{L}_{au}) \\
 & = ((\{i_x, iu_x, u_x, x_x\} \oplus \{u\}) \ominus \{i\}) \\
 & = \{iu_x, u_x\} \ominus \{i\} \\
 & = \{u_x\}
 \end{aligned}$$

Both the exclusive (39) and inclusive (40) share positive interactions with the author feature. When this is combined with negative interaction with [participant*], then the final set is the exclusive element i_x , the lattice that includes the first person i but excludes the second person u ; when this is combined with positive interaction with [participant*], then the final set is the inclusive element iu_x , the lattice with elements that include both i and u .

(39) **Derivation of the exclusive in the quadripartition**

$$\begin{aligned}
 \text{a. } & \llbracket -\text{participant}^*(+\text{author}(\pi)) \rrbracket \\
 & = ((\mathcal{L}_\pi \oplus \mathcal{L}_{au}) \ominus \mathcal{L}_{pt*}) \\
 & = ((\{i_x, iu_x, u_x, x_x\} \oplus \{i\}) \ominus \{u\}) \\
 & = \{i_x, iu_x\} \ominus \{u\} \\
 & = \{i_x\} \\
 \text{b. } & \llbracket +\text{author}(-\text{participant}^*(\pi)) \rrbracket \\
 & = ((\mathcal{L}_\pi \ominus \mathcal{L}_{pt*}) \oplus \mathcal{L}_{au})
 \end{aligned}$$

$$\begin{aligned}
&= ((\{i_x, iu_x, u_x, x_x\} \ominus \{u\}) \oplus \{i\}) \\
&= \{i_x, x_x\} \oplus \{i\} \\
&= \{i_x\}
\end{aligned}$$

(40) ***Derivation of the inclusive in the quadripartition***

- a. $\llbracket +\text{participant}^*(+\text{author}(\pi)) \rrbracket$
- $$\begin{aligned}
&= ((\mathcal{L}_\pi \oplus \mathcal{L}_{au}) \oplus \mathcal{L}_{pt*}) \\
&= ((\{i_x, iu_x, u_x, x_x\} \oplus \{i\}) \oplus \{u\}) \\
&= \{i_x, iu_x\} \oplus \{u\} \\
&= \{iu_x\}
\end{aligned}$$
- b. $\llbracket +\text{author}(+\text{participant}^*(\pi)) \rrbracket$
- $$\begin{aligned}
&= ((\mathcal{L}_\pi \oplus \mathcal{L}_{pt*}) \oplus \mathcal{L}_{au}) \\
&= ((\{i_x, iu_x, u_x, x_x\} \oplus \{u\}) \oplus \{i\}) \\
&= \{iu_x, u_x\} \oplus \{i\} \\
&= \{iu_x\}
\end{aligned}$$

Again, the preceding derivations exhaust all of the possible feature interpretations, composition orders, and values for the participant and author features. Having derived each of the five original partitions, and nothing more, we have provided a solution to the partition problem. In the next section, I return to consideration of the proximate feature and to deriving the quintipartition of Ojibwe in the context of the theory of contrastive interpretations.

2.5 The representation of person in Ojibwe

To review, the present claim is that Ojibwe, and many other Algonquian languages, show what can be characterized as a *quintipartition*: a five-way distinction between the partition elements. The quintipartition builds on the quadripartition by adding a

contrast between the proximate and obviative third persons, in addition to the already familiar distinctions between second, exclusive, and inclusive. This partition is shown in (41) alongside the original five, now reframed to include the patterns of conflation between proximate and obviative third person partition elements.

(41) **Revised partitions. From left-to-right: Monopartition, participant bipartition, author bipartition, tripartition, quadripartition, and quintipartition**

i_x	i_x	i_x	i_x	i_x	i_x
iu_x	iu_x	iu_x	iu_x	iu_x	iu_x
u_x	u_x	u_x	u_x	u_x	u_x
o_x	o_x	o_x	o_x	o_x	o_x
$x'_{x'}$	$x'_{x'}$	$x'_{x'}$	$x'_{x'}$	$x'_{x'}$	$x'_{x'}$

The desired lattices for the proximate and obviative elements in the partitions above, o_x and $x'_{x'}$, are repeated in (42).

(42) **Proximate and obviative partition elements**

- a. $\text{PROX} = o_x = \{o, oo', oo'', oo''', \dots, oo'o'', oo'o''', oo''o''', \dots\}$
- b. $\text{OBV} = x'_{x'} = \{o', o'', o''', \dots, o'o'', o'o''', o''o''', \dots, o'o''o''', \dots\}$

To review, the desired proximate lattice contains all elements that *include* the proximate o , plus some number of others (including none). On the other hand, the obviative lattice consists of those sets that *exclude* the proximate o .

As the partitions imply, joining together the proximate and obviative lattices o_x and $x'_{x'}$ simply results in the generic third person lattice x_x . In other words, the proximate and obviative lattices represent two non-overlapping subsets of the generic third person—the two are entirely disjoint, but together exhaust the space of third persons represented by the generic third person in other languages. This situation is fundamen-

tally the same as the contrast in whether languages distinguish or conflate the inclusive and exclusive first person, but applied within the third person.

In the previous section, it was shown that the two-feature system neatly captured all and only the five original partitions. The proposal put forward here relies on the addition of the feature [\pm proximate], the denotation of which is repeated in (43) for reference.

$$(43) \quad \llbracket[\text{proximate}]\rrbracket = \mathcal{P}(\{i, u, o\}) = \{iuo, iu, io, uo, i, u, o\} = \mathcal{L}_{px}$$

Before moving into the account of Ojibwe, it is important to dwell for a moment on the fact that the addition of this feature increases the number of feature combinations generated by the account, and as a result predicts a number of additional partitions than have been discussed thus far. Like the participant feature, the proximate feature represents a non-singleton set and can thus be subject to narrowing. In principle, two possibilities can arise: (i) if it is in the scope of [author], then it is narrowed to contrast *u* and *o*; (ii) if it is in the scope of participant, then it is narrowed to contrast *o*.

In this chapter, I focus on showing that a feature combination that generates the quintipartition of Ojibwe is present among these new possibilities. In Chapter 3 I return to the question of whether the additional feature combinations that are predicted must be restricted in some way to prevent over-generation or other ill-begotten partitions, or whether they are all necessary to generate the typological profile of obviation. This discussion is somewhat speculative due to the relative rarity of obviation across languages. (Or, perhaps more likely, rarity in the rate at which has been identified and documented). That said, the predictions of the account can still be concretely outlined and tentatively evaluated.

2.5.1 The Ojibwe quintipartition

I propose that the contrastive hierarchy in (44) is sufficient to capture the quintipartition of Ojibwe, where a five-way split is made between exclusive, inclusive, second, proximate, and obviative persons. All three person features are present, with proximate taking widest scope, followed by author, and finally by participant. By the same logic as seen in the quadripartition, the participant feature is narrowed to participant*, making a split based on the presence/absence of the addressee, to become contrastive in the context of the author feature taking wider scope.

(44) *Contrastive hierarchy for the Ojibwe quintipartition*

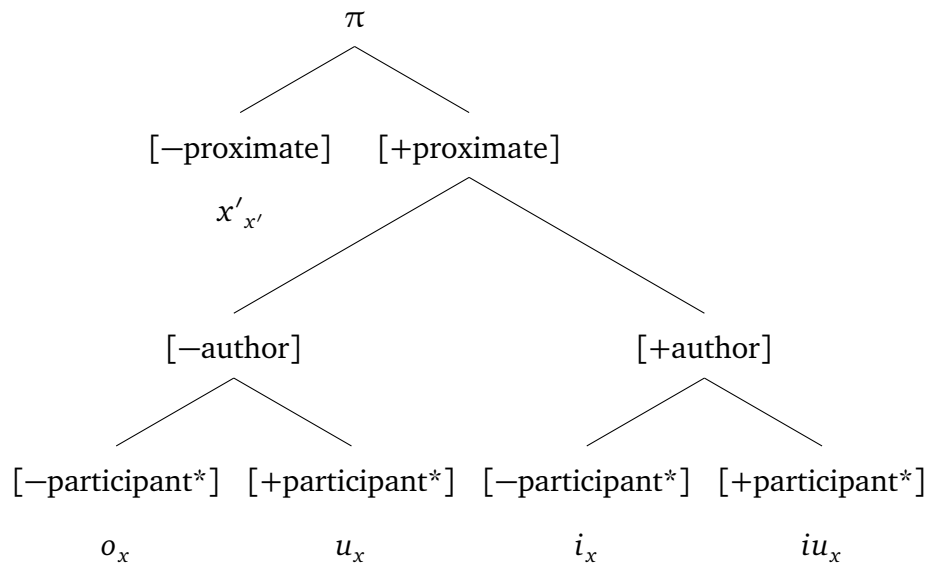

I consider the derivation of each of the five partition elements. The simplest is the obviative third person element $x'_{x'}$, which is derived by negative action of proximate on π . This removes all sets from the person lattice that contain any of the proximate persons i , u , or o , leaving only those that contain the non-proximate o 's.

(45) *Derivation of the obviative person in the quintipartition*

$$\begin{aligned}
 & \llbracket -\text{proximate}(\pi) \rrbracket \\
 & = \mathcal{L}_\pi \ominus \mathcal{L}_{px}
 \end{aligned}$$

$$\begin{aligned}
&= \{i_x, iu_x, u_x, o_x, x'_{x'}\} \ominus \{iuo, iu, io, uo, i, u, o\} \\
&= \{x'_{x'}\}
\end{aligned}$$

Analogously to the split made by [–participant] in the tripartition, where the [±author] feature was not composed, there is no further possible partition that can be gained through an interaction with either [±participant] nor [±author] following the negative action of the proximate feature. Again, this is due to the fact that both the participant and author lattices are proper subsets of the proximate lattice. The application of these features would be entirely vacuous, therefore under the SDA the features are not posited by the learner and not encoded by the grammar. Though formally, there would be no ill effects to adding these features in deriving the relevant partition.

The proximate third person is derived, as shown in (46), by positive action of the proximate feature, which maximally allows for the lattice $\{i_x, iu_x, u_x, o_x\}$, essentially removing the obviative third person element $x'_{x'}$. This is paired with negative action of the author feature, removing those sets of the lattice that include i , and negative interaction with participant*, which removes all sets that contain u . This leaves only the desired output, the proximate element o_x .

(46) ***Derivation of the proximate person in the quintipartition***

$$\begin{aligned}
&\llbracket \text{–participant}^*(\text{–author}(+\text{proximate}(\pi))) \rrbracket \\
&= (((\mathcal{L}_\pi \oplus \mathcal{L}_{px}) \ominus \mathcal{L}_{au}) \ominus \mathcal{L}_{pt*}) \\
&= (((\{i_x, iu_x, u_x, o_x, x'_{x'}\} \oplus \{iuo, iu, io, uo, i, u, o\}) \ominus \{i\}) \ominus \{u\}) \\
&= ((\{i_x, iu_x, u_x, o_x\} \ominus \{i\}) \ominus \{u\}) \\
&= \{u_x, o_x\} \ominus \{u\} \\
&= \{o_x\}
\end{aligned}$$

The derivation in (46) is shown for only a single composition order of proximate first, followed by author, and then finally participant*. But again, all composition orders will

produce the same result. I do not exhaust these possibilities here for reasons of space, but the principles are the same as those seen in the derivation of the tripartition and quidripartition in the previous section.

In essence, the derivation of the second, exclusive, and inclusive are the same as those seen in the quadripartition, and thus should be familiar. The second person, shown in (47), takes positive values for the proximate and author features as was seen in (46), but differs in that the participant* feature positively interacts, leaving only u_x .

(47) ***Derivation of the second person in the quintipartition***

$$\begin{aligned}
& \llbracket +\text{participant}^*(-\text{author}(+\text{proximate}(\pi))) \rrbracket \\
& = (((\mathcal{L}_\pi \oplus \mathcal{L}_{px}) \ominus \mathcal{L}_{au}) \oplus \mathcal{L}_{pt*}) \\
& = (((\{i_x, iu_x, u_x, o_x, x'_x\} \oplus \{iuo, iu, io, uo, i, u, o\}) \ominus \{i\}) \oplus \{u\}) \\
& = ((\{i_x, iu_x, u_x, o_x\} \ominus \{i\}) \oplus \{u\}) \\
& = \{u_x, o_x\} \oplus \{u\} \\
& = \{u_x\}
\end{aligned}$$

The derivation of the exclusive in (48) again includes positive action of the proximate feature. Additional positive action of the author feature selects those sets containing i , and negative action of participant* removes those containing u , leaving only the desired exclusive element i_x .

(48) ***Derivation of the exclusive person in the quintipartition***

$$\begin{aligned}
& \llbracket -\text{participant}^*(+\text{author}(+\text{proximate}(\pi))) \rrbracket \\
& = (((\mathcal{L}_\pi \oplus \mathcal{L}_{px}) \oplus \mathcal{L}_{au}) \ominus \mathcal{L}_{pt*}) \\
& = (((\{i_x, iu_x, u_x, o_x, x'_x\} \oplus \{iuo, iu, io, uo, i, u, o\}) \oplus \{i\}) \ominus \{u\}) \\
& = ((\{i_x, iu_x, u_x, o_x\} \oplus \{i\}) \ominus \{u\}) \\
& = \{i_x, iu_x\} \ominus \{u\} \\
& = \{i_x\}
\end{aligned}$$

Likewise, the inclusive is derived by positive action of the proximate and author features, leaving only sets that include *i*. In contrast to the exclusive, positive action of participant* selects sets that include *u*, leaving only the inclusive element *iu_x*.

(49) ***Derivation of the inclusive person in the quintipartition***

$$\begin{aligned}
& \llbracket +\text{participant}^*(+\text{author}(+\text{proximate}(\pi))) \rrbracket \\
& = (((\mathcal{L}_\pi \oplus \mathcal{L}_{px}) \oplus \mathcal{L}_{au}) \oplus \mathcal{L}_{pt*}) \\
& = (((\{i_x, iu_x, u_x, o_x, x'_{x'}\} \oplus \{iuo, iu, io, uo, i, u, o\}) \oplus \{i\}) \oplus \{u\}) \\
& = ((\{i_x, iu_x, u_x, o_x\} \oplus \{i\}) \oplus \{u\}) \\
& = \{i_x, iu_x\} \oplus \{u\} \\
& = \{iu_x\}
\end{aligned}$$

The above derivations derive all and only the five person categories found in Ojibwe. Crucially, this particular feature combination does *not* predict a distinction between proximate and obviative outside of the third person—the local persons do not alternate on this dimension, and instead show the profile of the typical quadripartition. Finally, the original five partitions retain their analysis. Lacking evidence of a contrast between proximate and obviative, these languages do not make use of the proximate feature, and therefore conflate the proximate and obviative partition elements into the generic third person. As such, all six partitions, the five original plus the quintipartition of Ojibwe, have been derived.

In the next section, I show that the definition of feature interaction advanced in Harbour (2016) is unable to derive the quintipartition of Ojibwe.

2.6 Comparison to Harbour (2016)

Like the theory of feature composition based in the theory of contrastive interpretations, Harbour's proposal provides a solution to the original partition problem. In this

section, I first review his account, and then show that it is unable to capture the additional partitions introduced by obviation, given the addition of proximate feature. Since both Harbour’s proposal and Cowper and Hall’s capture the original five partitions, this provides decisive *empirical* evidence against the adoption of Harbour’s theory of feature composition account (and, as a result, in favor of the currently adopted proposal).

2.6.1 Harbour’s solution to the original partition problem

2.6.1.1 Values as operations

The key difference between the adopted proposal and Harbour’s original system is in the composition of features — the lattice-based representation underlying the features is identical, and the desired partitions the same. In the system Harbour proposes, lattices combine via *operations* defined by the positive (+) or negative (–) values. Semi-informally, the + value, denoted in the coming derivations by the operator \oplus , joins every possible duo of elements in a pair of lattices. The technical definition, taken from Harbour (2016), is shown in (50).

$$(50) \quad \llbracket +F(G) \rrbracket = \{g \sqcup f : f \in \mathcal{L}_F, g \in \mathcal{L}_G\}$$

As written, F is *positively acting on* G . But the addition operation is commutative (as in regular arithmetic addition; $1 + 2 = 2 + 1$), as shown in (51), so it can equivalently be written as G positively acting on F .

$$(51) \quad \llbracket +F(G) \rrbracket = \mathcal{L}_G \oplus \mathcal{L}_F = \mathcal{L}_F \oplus \mathcal{L}_G$$

The – value, denoted by the operator \ominus , cumulatively subtracts every element in one lattice from every element in the other. Conveniently, this operation can be simplified, because each of the sets that will come into play have a *unique maximal element*. Given an action $-F(G)$, subtracting the maximal element of F from each element of G renders

any further subtraction redundant (the rest of the elements in the set are subsets of the maximal element).

$$(52) \quad \llbracket -F(G) \rrbracket = \{g \setminus \max(\mathcal{L}_F) : g \in \mathcal{L}_G\}$$

Analogously to the positive value, $-F(G)$ is *negative action* of F on G . Therefore the maximal element of F is subtracted from each element of G . This operation is critically non-commutative (again, as in arithmetic subtraction; $1 - 2 \neq 2 - 1$). This is shown in (53).

$$(53) \quad \llbracket -F(G) \rrbracket = \mathcal{L}_G \ominus \max(\mathcal{L}_F) \neq \max(\mathcal{L}_F) \ominus \mathcal{L}_G$$

The non-commutativity of the negative value marks a crucial difference between the proposed account, where features could be freely ordered, and the account of Harbour, where features will be critically ordered within a head. These parameters are detailed in the next section.

2.6.1.2 The parameters of π

Harbour (2016) proposes that the features on π are parameterized on two basic dimensions: (i) a feature can either be present in a given language, or absent; (ii) if two (or more) features are present, then languages can differ with respect to the order that the features compose with π . These parameters are given in (54).

(54) *Parameters of π from Harbour 2016*

- a. The author feature is (not) present.
- b. The participant feature is (not) present.
- c. The author/participant feature composes first.

For the moment, I set aside the proposed proximate feature to focus on Harbour’s original account. This gives rise to five possible feature specifications and composition orders, corresponding to the five attested partitions, as summarized in (55).

(55) ***Five partitions and their feature parameterizations from Harbour (2016)***

- a. *Monopartition*: $\pi = i_x i u_x u_x x_x$
- b. *Participant bipartition*: $[\pm\text{participant}](\pi) = i_x i u_x u_x | x_x$
- c. *Author bipartition*: $[\pm\text{author}](\pi) = i_x i u_x | u_x x_x$
- d. *Tripartition*: $[\pm\text{participant}]([\pm\text{author}](\pi)) = i_x i u_x | u_x | x_x$
- e. *Quadripartition*: $[\pm\text{author}]([\pm\text{participant}](\pi)) = i_x | i u_x | u_x | x_x$

In the next section, I walk through the derivations for each case.

2.6.1.3 Capturing the original five partitions

Two final formal pieces for the derivations. First, over the course of the derivations, empty sets are introduced by negative actions between lattices. The presence of the empty set does serve an important role over the course of the derivation, but causes problems when it is present in the final partition. Recall that these features are creating sets that restrict the domain of entities that can be referenced by particular person categories. The presence of the empty set implies that it should be possible to make reference to nothing or no one—a possibility that is not attested. The solution lies in adding a constraint to the domain restrictor D_e that is introduced by φ so that it cannot include the empty set.

The second issue is that certain outputs overlap in their denotations. This is seen specifically in the tripartition and quadripartition, where both the participant and author features are present. The derivations of these two partitions are schematized below in (56) and (58). The details of how the lattice operations give rise to a particular output in each step is not important for now—what is relevant is the difference between

the left and right side of the dashed arrows, after both features have composed with π . The reader is referred to Harbour's book for a step-by-step exposition of the derivations.

Starting with the tripartition in (56), we see that $[+author][+participant](\pi)$ gives rise to i_x, iu_x . This overlaps with the output of $[-author][+participant](\pi)$, which ends up being i_x, iu_x, u_x . The issue here is that none of the feature combinations pick out the second person partition element u_x on its own—it only occurs in combination with the two first person elements. In essence, the features fail to derive the second person category in the tripartition.

(56) *Derivation of the tripartition (Harbour, 2016)*

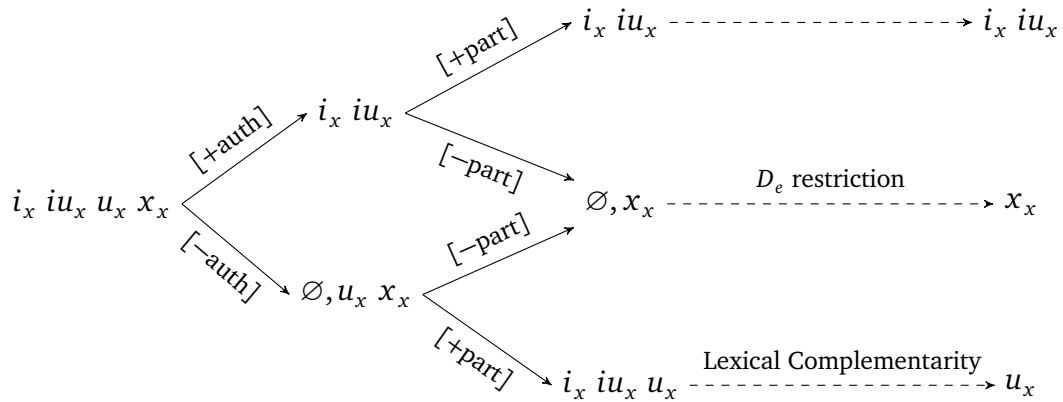

The solution comes from the principle of *Lexical Complementarity*. This is invoked when two distinct feature outputs stand in a subset-superset relationship, and is used to eliminate the overlap between the two denotations. The result is that the feature combination with the larger denotation is restricted to only those elements that are not already covered by the feature combination with the smaller denotation. In formal terms:

(57) *Lexical Complementarity (Harbour, 2016, p. 80)*

Let F and G be feature specifications where $\llbracket F(\pi) \rrbracket \subset \llbracket G(\pi) \rrbracket$. Then use of $\llbracket G(\pi) \rrbracket$ is restricted to $\llbracket G(\pi) \rrbracket \setminus \llbracket F(\pi) \rrbracket$.

The two overlapping feature combinations of the tripartition stand in a subset-superset relationship. Therefore Lexical Complementarity can be applied to restrict the $[-\text{author}][+\text{participant}](\pi)$ feature combination such that it only includes the second person element u_x .

More precisely, if the lattice denoted by a feature combination G is subsumed by the feature combination F , then G is used just in case F cannot be used; subsequently, if F can be used instead of G , then F must be used. This principle has analogues across a number of domains, perhaps most saliently in the literature on scalar implicatures (e.g. the sentence *some students love syntax* gives rise to the implicature that *not all* students love syntax, due to the scalar relationship between *some* and *all*). It also has a direct antecedent in the literature on the interpretation of person features; in particular, the subset principle put forth by McGinnis (2005).

The same issue arises in the quadripartition, shown in (58). Lexical Complementarity applies in two cases: (i) to restrict the $[\text{+participant}][\text{+author}](\pi)$ combination to only the exclusive element iu_x ; and (ii) to restrict the $[\text{+participant}][-\text{author}](\pi)$ combination to only the second person element u_x .

(58) *Derivation of the quadripartition (Harbour, 2016)*

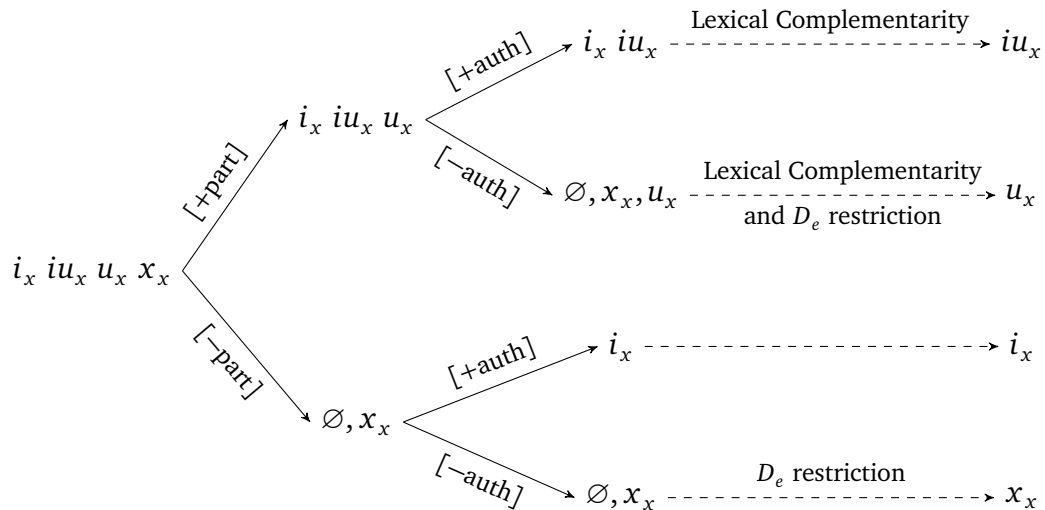

The final three partitions — the monopartition, the author bipartition, and the participant bipartition — do not require the application of Lexical Complementarity. The monopartition is simple: there are no features specified, and the output is exactly the lattice denoted by π . The author and participant bipartitions are derived by the composition of the author and participant features with π , respectively. These derivations do require the application of the restriction on D_e to remove the empty set, but otherwise the feature combinations themselves produce the desired results. Schematizations of the bipartition derivations are given in (59) for reference.

(59) *Derivations of the author and participant bipartitions (Harbour, 2016)*

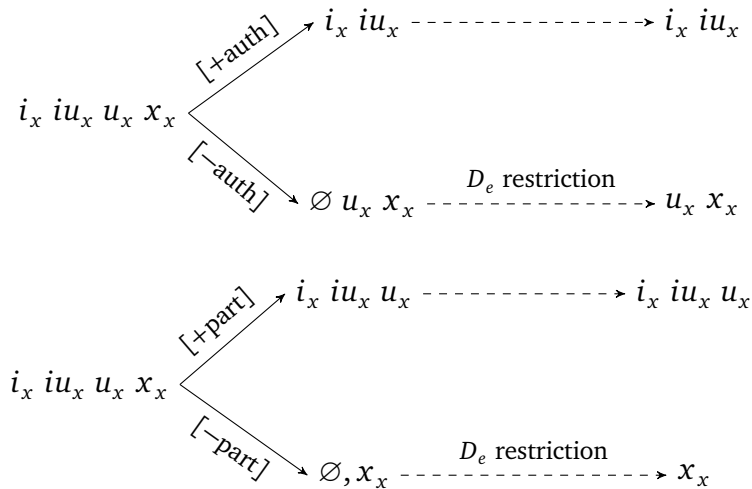

To summarize this section and take a look forward, Harbour’s proposal provides the means to derive all and only the five attested person partitions observed across the world’s languages, setting aside distinctions of number, noun classification, and obviation. The immediate question is whether the system that Harbour proposes to solve the partition problem is capable of capturing all and only the further distinctions introduced by the addition of obviation. Most relevant is capturing the quintipartition of Ojibwe, where obviation provides a further partition of the third persons between proximate and obviative, but leaves the local persons unchanged. Ultimately, this asymmetry be-

tween the local and non-local persons cannot be captured by Harbour’s system. This under-generation problem calls the theory into question.

2.6.2 Harbour and the proximate feature

As already noted in the context of the theory of contrastive interpretations, the addition of the proximate feature leads to a plethora of new feature combinations and composition orders—11 more, with 16 in total counting the original five. The question then is, using Harbour’s theory of lattice actions, does one of these combinations result in the quintipartition? It is easy to immediately rule out a number of the 16 possibilities. First, all of those that *lack* the proximate feature, i.e. the original five combinations of the author and participant features, can be ruled out.

This leaves the 11 new combinations implied by the addition of the proximate feature. Some of these can be ruled out simply on the grounds that they will not predict the right number of partitions (i.e. fewer than five). The combination with the proximate feature alone can only maximally make a partition of two, with the feature taking either a positive or negative value. Similarly, the four two-feature combinations can only maximally create four-way partitions when the value of each feature is fully crossed. So the five single and double feature specifications can all be ruled out.

This leaves the six three-feature combinations, which I have repeated for reference in (60).

(60) ***Feature combinations in contention for deriving the quintipartition***

a. *Proximate + Participant + Author (Participant before Author)*

$\pm\text{proximate}(\pm\text{author}(\pm\text{participant}(\pi)))$

$\pm\text{author}(\pm\text{proximate}(\pm\text{participant}(\pi)))$

$\pm\text{author}(\pm\text{participant}(\pm\text{proximate}(\pi)))$

b. *Proximate + Participant + Author (Author before Participant)*

$\pm\text{proximate}(\pm\text{participant}(\pm\text{author}(\pi)))$

$\pm\text{participant}(\pm\text{proximate}(\pm\text{author}(\pi)))$

$\pm\text{participant}(\pm\text{author}(\pm\text{proximate}(\pi)))$

An immediate suspicion can be raised, again based simply on the number of partitions that these combinations predict. Three features, each taking two values, when fully crossed leads to eight possible combinations. This, of course, is more than the five-way contrast observed in Ojibwe and many other Algonquian languages. This highlights one of the major differences between Harbour's theory and one based in contrastive interpretations. Short of stipulating additional parameters for the way features combine, Harbour's theory is locked in to generating the number of possibilities logically possible given the number of features crossed by their possible values. On the other hand, the addition of contrastive interpretations creates principled limits on these combinations, so that not all possibilities are generated. For example, the author feature does not combine following a negatively valued participant feature (as seen in the tripartition), and neither author nor participant combine following a negatively valued proximate feature. In both cases, the features would fail to make any contrast.

However, this property of Harbour's account has already been observed in the prior discussion, and it does not necessarily lead to complete catastrophe. The tripartition, which fully crosses two bivalent feature, has four unique feature-value combinations. Harbour shows that this does not result in four unique partitions, but rather two paths to deriving the third person—one where the author feature takes a positive value, and one where the author feature takes a negative value. Harbour in turn argues that there is a subsidiary parameter that governs whether a given language creates this partition with the negative versus positive value. From this, we can conclude that it will not *necessarily* be the case that we will have eight distinct partitions flowing from the eight feature-

value combinations in a three-feature system. It is possible that some combinations lead to the same partitions, and most particularly that the relevant five-way distinction will emerge from one of the six combinations above, with some of the elements being doubled. This turns out not to be the case—none of the feature combinations provide the correct result.

2.6.2.1 Evaluating the possibilities

The full derivations for each of the six live possibilities can be found in Appendix A. In each feature order, there are eight unique combinations—going through all 48 derivations in the main text is not crucial to understanding the issues that arise, but considering the resulting partitions is. When presenting the results, I collapse across those values that lead to the same result, therefore most combinations have fewer than 8 partitions. I use an equals sign (=) for the result of the derivation, and a triple bar (\equiv) to show the result after Lexical Complementarity and domain restriction have both applied (if they are applicable).

I begin by considering the three derivations where participant composes before author. The first, shown in (61), builds directly from the derivation of the quadripartition in Harbour's original account, with the proximate feature combining last. All cases where the proximate feature takes a negative value converge to the obviative element $x'_{x'}$, regardless of the values of the lower features. When the proximate feature is positive, two partitions emerge, which are crucially differentiated by the value of the author feature. The positive author feature partition is a subset of the lattice that results from the negative author partition. Therefore the negative value is restricted by Lexical Complementarity to only those elements not already captured by the positive counterpart, as shown below.

$$\begin{aligned}
(61) \quad & \llbracket \pm \text{proximate}(\pm \text{author}(\pm \text{participant}(\pi))) \rrbracket \\
& \llbracket -\text{proximate}(\pm \text{author}(\pm \text{participant}(\pi))) \rrbracket = \{\emptyset, x'_{x'}\} \equiv \{x'_{x'}\} \\
& \llbracket +\text{proximate}(+\text{author}(\pm \text{participant}(\pi))) \rrbracket = \{iu_x, i_x\} \\
& \llbracket +\text{proximate}(-\text{author}(\pm \text{participant}(\pi))) \rrbracket = \{iu_x, i_x, u_x, o_x\} \equiv \{u_x, o_x\}
\end{aligned}$$

Again, the particulars of the derivation are not important. What is crucial is that only a tripartition emerges in this case, which is not sufficient to derive the person contrasts of Ojibwe.

Next, consider the case where the proximate feature is composed in between the participant and author features, shown in (62). Here a quadripartition emerges, so again it is clear that such a combination of parameters is not active in Ojibwe.

$$\begin{aligned}
(62) \quad & \llbracket \pm \text{author}(\pm \text{proximate}(\pm \text{participant}(\pi))) \rrbracket \\
& \llbracket -\text{author}(-\text{proximate}(\pm \text{participant}(\pi))) \rrbracket = \{\emptyset, x'_{x'}\} \equiv \{x'_{x'}\} \\
& \llbracket -\text{author}(+\text{proximate}(\pm \text{participant}(\pi))) \rrbracket = \{\emptyset, u_x, x_x\} \equiv \{u_x, o_x\} \\
& \llbracket +\text{author}(-\text{proximate}(\pm \text{participant}(\pi))) \rrbracket = \{i_{x'}\} \\
& \llbracket +\text{author}(+\text{proximate}(\pm \text{participant}(\pi))) \rrbracket = \{iu_x, i_x\} \equiv \{iu_x, io_x\}
\end{aligned}$$

Of note is one result of the application of Lexical Complementarity that leads to the partition on the final line. Notice that the element i_x within this partition, which results from the feature actions alone, turns to io_x when Lexical Complementarity is applied. This is due to the fact that $i_{x'}$ is a subset of $\{iu_x, i_x\}$. Focusing on the relationship between $i_{x'}$ and i_x , consider the lattices that each represents. The lattice i_x is the element i alone, plus the dyads that include i and some o (e.g. $\{io\}$, $\{io'\}$, $\{io''\}$), the triads that include i and some pair of o 's (e.g. $\{ioo'\}$, $\{ioo''\}$, $\{io'o''\}$), and so on. The lattice $i_{x'}$ is a subset of these cases, including only those sets that *lack* the proximate o . So its dyads include $\{io'\}$, $\{io''\}$, $\{io'''\}$ etc, and its triads include $\{io'o''\}$, $\{io'o'''\}$, $\{io''o'''\}$, and so on. This triggers Lexical Complementarity, resulting in i_x (the generic

exclusive) to be restricted to only those sets not captured by $i_{x'}$ (the obviative exclusive), which are those that *include* the proximate o , as represented by io_x .

Recall that the narrow goal is to see if any of the partitions lead the quintipartition to emerge. (Spoiler: None of them do). But it is also relevant to consider whether the partitions that are created would be sensible for some language to make — all of these should be attested if the parameters of π are kept unrestricted, with all feature-value-order combinations being generated. The quadripartition in (62), I believe, is rather suspicious. There is a partition for the obviative third person alone, but the proximate third person is conflated with the second person. Furthermore, a special category of the exclusive obviative is generated, while the exclusive proximate is conflated with the generic inclusive. These divisions, while by no means formally ill-formed in the sense that the sets and lattices can be readily formulated, do not seem likely to appear as categories in natural language, and have not (to my knowledge) been observed to date.

In the next derivation, where proximate composes first, Lexical Complementarity again results in proximate-obviative splits within the local persons. This time, the splits are more complete, leading to a full set of eight distinct partitions—an octopartition. This feature combination is the closest we come to capturing the quintipartition of Ojibwe: it is the only one that generates both a split between proximate and obviative third persons, as well as the inclusive and exclusive in the first persons.

$$\begin{aligned}
 (63) \quad & \llbracket \pm \text{author}(\pm \text{participant}(\pm \text{proximate}(\pi))) \rrbracket \\
 & \llbracket -\text{author}(-\text{participant}(-\text{proximate}(\pi))) \rrbracket = \{\emptyset, x'_{x'}\} \equiv \{x'_{x'}\} \\
 & \llbracket -\text{author}(-\text{participant}(+\text{proximate}(\pi))) \rrbracket = \{\emptyset, x_x\} \equiv \{o_x\} \\
 & \llbracket -\text{author}(+\text{participant}(-\text{proximate}(\pi))) \rrbracket = \{\emptyset, x'_{x'}, u_{x'}\} \equiv \{u_{x'}\} \\
 & \llbracket -\text{author}(+\text{participant}(+\text{proximate}(\pi))) \rrbracket = \{\emptyset, x_x, u_x\} \equiv \{uo_x\} \\
 & \llbracket +\text{author}(-\text{participant}(-\text{proximate}(\pi))) \rrbracket = \{i_{x'}\}
 \end{aligned}$$

$$\llbracket +\text{author}(-\text{participant}(+\text{proximate}(\pi))) \rrbracket = \{i_x\} \equiv \{io_x\}$$

$$\llbracket +\text{author}(+\text{participant}(-\text{proximate}(\pi))) \rrbracket = \{i_{x'}, iu_{x'}\} \equiv \{iu_{x'}\}$$

$$\llbracket +\text{author}(+\text{participant}(+\text{proximate}(\pi))) \rrbracket = \{i_x, iu_x\} \equiv \{iuo_x\}$$

The issue is that all of the local persons, as noted above, are also split between their proximate and obviative counterparts. This is, generally speaking, not an undesirable result. As previously mentioned, and as explored in detail in Chapter 3 Blackfoot shows a split between proximate and obviative counterparts in the local persons.⁷ That said, the immediate issue is that these partitions are not present in Ojibwe, so this combination over-generates.

We can now shift our attention to the three combinations where author combines before proximate. As before, I consider first the one in which proximate combines last, which builds directly from the tripartition of Harbour's original account. This provides what is probably the most familiar result so far. Like the original tripartition, the exclusive and inclusive are conflated. This differs in that the proximate and obviative third persons are also distinguished from one another, and occupy their own partitions (after Lexical Complementarity has applied). While this result is generally attested (see the discussion of Ktunaxa in Chapter 3), it is not the partition represented by Ojibwe.

$$(64) \quad \llbracket +\text{proximate}(-\text{participant}(\pm\text{author}(\pi))) \rrbracket$$

$$-\text{proximate}(\pm\text{participant}(\pm\text{author}(\pi))) = \{\emptyset, x'_{x'}\} \equiv \{x'_{x'}\}$$

$$+\text{proximate}(-\text{participant}(\pm\text{author}(\pi))) = \{i_x, iu_x, u_x, o_x\} \equiv \{o_x\}$$

⁷But even when applied to Blackfoot, this output runs into issues given how Lexical Complementarity acts on the proximate and obviative locals. Following Lexical Complementarity, the proximate counterpart does not include a set with *only* the local person(s) (i.e. $\{i\}$, $\{u\}$, or $\{iu\}$). Since these sets are found within the *smaller* obviative counterpart, and Lexical Complementarity restricts the *larger* of the two lattices to those elements not included within the smaller lattice, the local-only sets are always restricted to be referenced through use of the obviative counterpart. This provides the wrong result when it comes to interpretation: Both the proximate and obviative counterparts in Blackfoot are capable of making reference to the local-only sets, as evidenced by the existence of singular forms that exclude third persons in both cases.

$$\begin{aligned}
& +\text{proximate}(+\text{participant}(+\text{author}(\pi))) = \{i_x, iu_x\} \\
& +\text{proximate}(+\text{participant}(-\text{author}(\pi))) = \{i_x, iu_x, u_x\} \equiv \{u_x\}
\end{aligned}$$

The final two orders in (65) and (66), with proximate in the middle of author and participant or with proximate composing first respectively, provide the first instances where a five-way partition is derived by the features. In fact, both orders result in the same partitions, with the same relationship between features and values, despite the differences in order of composition.

$$\begin{aligned}
(65) \quad & \llbracket \pm\text{participant}(\pm\text{proximate}(\pm\text{author}(\pi))) \rrbracket \\
& \llbracket -\text{participant}(-\text{proximate}(\pm\text{author}(\pi))) \rrbracket = \{\emptyset, x'_{x'}\} \equiv \{x'_{x'}\} \\
& \llbracket -\text{participant}(+\text{proximate}(\pm\text{author}(\pi))) \rrbracket = \{\emptyset, x_x\} \equiv \{o_x\} \\
& \llbracket +\text{participant}(-\text{proximate}(\pm\text{author}(\pi))) \rrbracket = \{i_{x'}, iu_{x'}, u_{x'}\} \\
& \llbracket +\text{participant}(+\text{proximate}(+\text{author}(\pi))) \rrbracket = \{i_x, iu_x\} \\
& \llbracket +\text{participant}(+\text{proximate}(-\text{author}(\pi))) \rrbracket = \{i_x, iu_x, u_x\} \equiv \{uo_x\} \\
(66) \quad & \llbracket \pm\text{participant}(\pm\text{author}(\pm\text{proximate}(\pi))) \rrbracket \\
& \llbracket -\text{participant}(\pm\text{author}(-\text{proximate}(\pi))) \rrbracket = \{\emptyset, x'_{x'}\} \equiv \{x'_{x'}\} \\
& \llbracket -\text{participant}(\pm\text{author}(+\text{proximate}(\pi))) \rrbracket = \{\emptyset, x_x\} \equiv \{o_x\} \\
& \llbracket +\text{participant}(\pm\text{author}(-\text{proximate}(\pi))) \rrbracket = \{i_{x'}, iu_{x'}, u_{x'}\} \\
& \llbracket +\text{participant}(+\text{author}(+\text{proximate}(\pi))) \rrbracket = \{i_x, iu_x\} \\
& \llbracket +\text{participant}(-\text{author}(+\text{proximate}(\pi))) \rrbracket = \{i_x, iu_x, u_x\} \equiv \{uo_x\}
\end{aligned}$$

The derived partitions, while having the right number, do not give rise to the proper categories. While a partition is made between the proximate and obviative third persons, there are not separate partitions for the inclusive and exclusive persons. More generally, the partitions of the local persons are strange. There is a three-way divide between a category with all obviative locals, generic first person, and a second person

plus proximate. This is not attested in any known language, and I believe it is unlikely to be found as more paradigms are described.

2.6.2.2 A different definition of proximate? No.

One objection to the above discussion is that much depends on the particular subset of the person ontology that the proximate feature denotes. It is the power set generated from $\{i, u, o\}$, which then interacts with the already established features from Harbour's original account. In this section, I argue that *there is not an alternative feature* with the ability to make these cuts, given the machinery that Harbour proposes.

The options for alternatives is rather limited. We can rule out two types of possibilities immediately: (i) the full ontology, which is already taken by π ; and (ii) a subset that only includes the discourse participants i and u , either on their own or together—these would lack the basic property of including a third person. There are thus two types of live alternatives. One which includes *only* the proximate third person (i.e. $\{o\}$), one that includes the proximate third person o and either i or u on its own (i.e. $\{i, o\}$ or $\{u, o\}$).

It is not necessary to consider derivations with each of these features to see why these alternatives will not provide the correct result. We are looking for a feature that creates a proximate/obviative distinction in the third persons, while leaving the local persons unchanged from the quadripartition. In terms of the lattice operations denoted by the feature values, the key is to ensure that the proximate o is removed from the third person only lattices, but retained when the lattice includes a local person as the bottom element. This requires restricting *when* the feature can apply, not which particular elements are added or subtracted. That is, we need to ensure that the minus proximate feature only applies when both author and participant feature also take negative values. As we saw, restrictions of this sort are part and parcel in the theory of contrastive interpretations, but under Harbour's theory would need to be stipulated.

A final point is that the particular subset proposed here, which includes both local persons and the single proximate third person *o*, provides the means to connect the representation with the theory agreement proposed in Chapter 4. The place of the proximate feature in person-based prominence effects requires the original subset, where the two local persons and the proximate person form a natural class to the exclusion of all other third persons. This property is not shared by any of the other alternative formulations of the proximate feature discussed above, where either one or both of the local persons are lacking.

2.7 Interactions with number and noun classification

To finally yield the full set of partition elements, it is necessary for the representation of person to interact with representations of number and noun classification. This section is devoted to showing how these interactions proceed in Ojibwe.

A keystone of the proposal is the functional sequence in (67). I have included projections up to DP, noting that nominals of different types may vary in how much functional structure they contain (see Déchaine and Wiltschko, 2002). The structure is in line with decades of cross-linguistically informed work on the functional sequence of nominal projection (e.g. Ritter, 1991, 1993; Picallo, 1991; Kramer, 2014, 2015), with noun class occupying the lowest position on *n*, followed by person in an intermediate projection, labelled π , and finally number in the highest position, labelled $\#$. The present account utilizes the hierarchy of functional heads in order to determine the order of composition of the set-restricting operations in each case: noun classification restricts first, followed by person, and finally followed by number.

(67) *The functional sequence, now with number and noun classification*

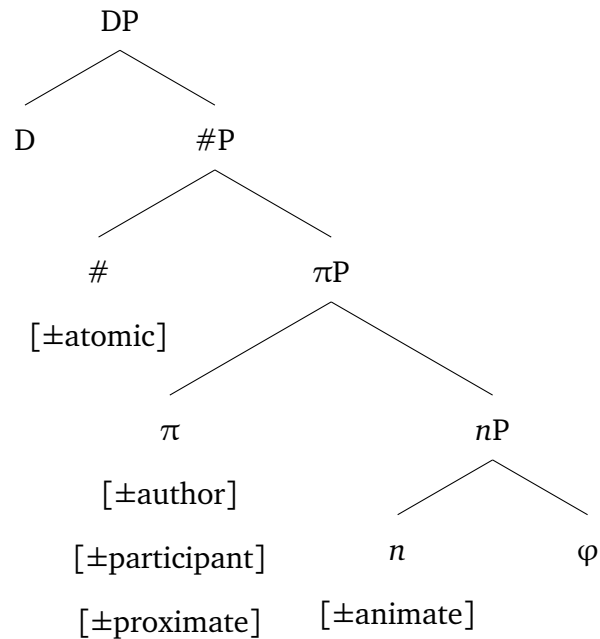

I first consider the role of animacy in Ojibwe, which creates a partition between (approximately speaking) living and non-living things. Noun classification systems have yet to be integrated in a meaningful way with the lattice-theoretic approach. Section 2.7.1 takes concrete steps towards such an account.

The proposal for number in Section 2.7.2 is based on the lattice-theoretic approach of Harbour (2014, 2016). Harbour provides an account of how a variety of number distinctions, including singular, dual, trial, paucal, and plural, are derived with respect to the full suite of possible person partitions. This level of detail is not necessary here, as Ojibwe only has a singular-plural distinction. I argue in favor of a [±group] (in contrast to the [±atomic] feature proposed by Harbour) to capture this contrast, and show how it operates to derive the relevant number distinctions in the quintipartition of Ojibwe.

2.7.1 Noun classification

Noun classification in Ojibwe is semantically grounded in animacy. All living things (e.g. humans, plants, animals) are classified as animate, and *nearly all* other things or

concepts are inanimate. There are a number of interesting exceptions, where conceptually inanimate objects are classified as grammatically animate; but no conceptually animate nouns are grammatically inanimate. In the discussion so far, we have ignored animacy distinctions and have treated all *o*'s (as well as *i* and *u*) as falling within the animate category. This will be rectified in this section.

2.7.1.1 The [\pm animate] feature

The main proposal is that “others” can be further divided on the basis of nominal classification, with certain entities being in the animate category and others being in the inanimate category. I represent this difference through the continued use of *o* for animate entities, with *r* being used to represent inanimate entities.⁸ Therefore the *full* ontology of possible “person” distinctions includes a unique *i*, a unique *u*, as well as an indefinite number of animate *o*'s (*o, o', o'', ...*) and inanimate *r*'s (*r, r', r'', ...*). The goal then is to put forward a feature that partitions the animate elements *i, u*, and the *o*'s from the inanimate *r*'s.

The feature needed, which I refer to as [animate], is in fact already familiar, as it comprises the same power set used to denote π . This is shown in (68).

$$(68) \quad \llbracket [\text{animate}] \rrbracket = \mathcal{P}(\{i, u, o, o', o'', \dots\}) = \{i_x, iu_x, u_x, x_x\}$$

The difference between the animate feature and the head π is [animate] can alternate between positive and negative values, thereby creating a partition. The positive variant [+animate] creates the exact lattice we have been working with for the bulk of the chapter, which comprises of *i, u*, and the animate *o*'s. The negative variant [–animate] leaves only the inanimate elements, the *r*'s.

⁸I have chosen *r* as a shortening for *res*, meaning ‘thing’ in Latin. I opted not to use *t* (would-be for *thing*) in order to avoid any potential confusion with truth values; furthermore *i* (would-be for *inanimate*) is already used for the first person, and should not do double duty.

2.7.1.2 Person and noun classification

As we have seen in great detail already, those elements falling on the grammatically animate side of the divide are further partitioned by the features on π . Those falling on the inanimate side of the divide, on the other hand, will not be affected by these features, regardless of the value that they take. The author and participant features, and, as it is currently configured, the proximate feature, all create divisions between the animate elements i , u , and the o 's. Given the theory of contrastive interpretations, we can thus adopt the notion that the features of π (author, participant, and, with a coming caveat, proximate) are not specified when the animate feature takes a negative value. This results in the extended contrastive hierarchy in (69).

(69) *Extended contrastive hierarchy for Ojibwe, including animacy*

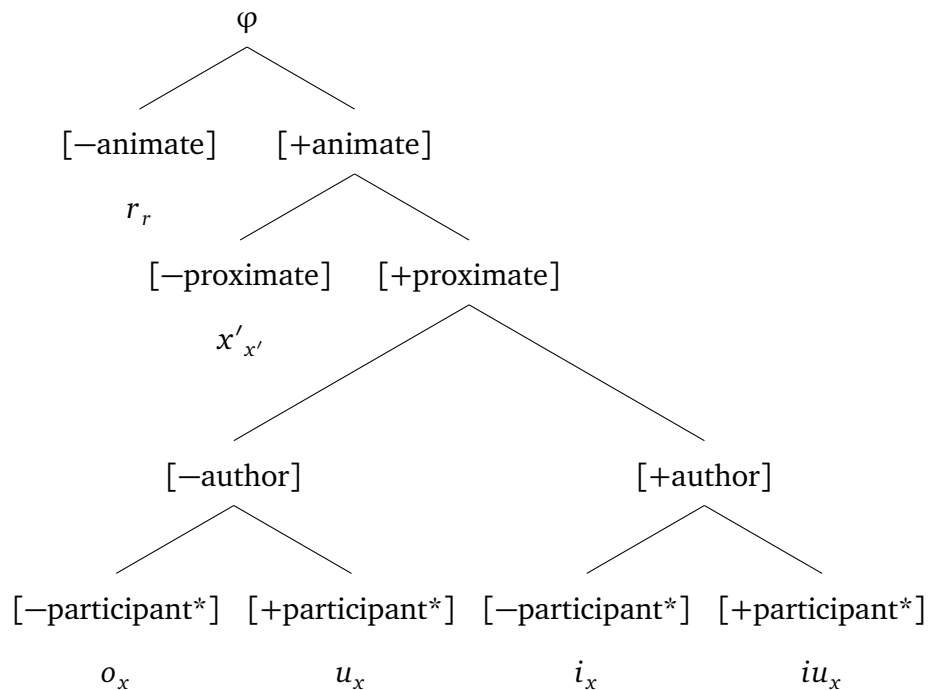

A critical constraint on the theory comes from the association between heads in the functional sequence and particular features. Given that the [animate] feature is specified on the lower projection n , it can *only take wide scope* within the hierarchy over the

features on π . In other words, the addition of the animate feature does not necessitate a consideration of a potential typology where, for example, the participant feature takes scope over the animate feature, thus winnowing the denotation of [animate] to include only non-participants.

This logic gives rise to a path for explaining what becomes an extant constraint on the typology of obviation. I show that the proximate feature *never* takes intermediate scope between the author and participant features, but can alternate between taking widest scope over these features (as seen in Ojibwe), or being within the scope of these features (as will be shown to be the case in Blackfoot; see Chapter 3). The reason for this constraint could thus be that the proximate feature is not in fact associated with the functional head π , but rather alternates between a the lower functional position (deriving widest scope) or a higher functional position (deriving narrow scope). I return to these ideas in the next chapter.

This line of thought leads to more immediate questions about that nature of what we've been referring to as "person". Ojibwe blurs the definition of this category both with the system of obviation and animacy-based noun classification. On a narrow definition of person, one based on which features can be specified on the functional head π , we might say that there are only two person features (i.e. [author] and [participant], given the discussion in the preceding paragraph, where it was hypothesized that proximate is *not* specified on π). However, both obviation and animacy have long been noted to be a part of a shared person-animacy hierarchy, restated in (70) for reference.

(70) 1/2 (LOCAL) > 3 (PROXIMATE) > 3' (OBVIATIVE) > 0 (INANIMATE)

Despite occupying different positions within the functional hierarchy, on the present account, the features [animate], [proximate], [participant], and [author] all share the same basic function of mediating access to the "person" ontology (perhaps now more accurately referred to as the "phi" ontology). Again, this partitioning is accomplished

by defining each feature as denoting a particular subset of the overall ontology, with feature values defining the precise nature of the restriction. As a result, all features, independently of how they associate with functional heads within the nominal spine, stand in the proper subset relationships in (71).

(71) *Proper subset relationships between person/animacy features (and φ)*

- a. $\varphi \supset [\text{animate}] \supset [\text{proximate}] \supset [\text{participant}] \supset [\text{author}]$
- b. $\mathcal{P}(\{i, u, o, o', o'', \dots, r, r', r'', \dots\}) \supset \mathcal{P}(\{i, u, o, o', o'', \dots\}) \supset \mathcal{P}(\{i, u, o\}) \supset \mathcal{P}(\{i, u\}) \supset \mathcal{P}(\{i\})$

The full ontology is represented by φ ; the animate feature represents a subset that excludes the inanimate r 's; the proximate feature a subset that excludes inanimates and all but one animate third person; participant additionally excludes the proximate o ; and finally author excludes everything but the first person i . These relationships are integral in the theory of agreement formulated in the next chapter, where prominence effects takes center stage.

Recent work on Zapotec by Foley and Toosarvandani (2019) has come to converging conclusions about the fundamentally parallel relationship between noun classification and person systems. Foley and Toosarvandani show that the animacy-based noun classification system of a number of closely related Zapotec languages, which maximally creates a four-way distinction between elders, non-elder humans, animals, and inanimates, shows hierarchy-based agreement effects that restrict cliticization in a parallel manner to the *Person Case Constraint* (for a review of the PCC, see Anagnostopoulou, 2017, as well as Chapter 4, Section 4.2.2.1). This indicates that the relationship between noun classification systems and person is by no means unique to the Algonquian languages, with comparisons and unifications expected to provide fruitful grounds for further investigation.

Other dialects of Ojibwe (and other Algonquian languages) have innovated obviative morphology for inanimate nouns. The relevant example, which comes from Innu (a language on the Cree dialect continuum), is given in (73).

- (73) mishkam ût-inu
 find boat-0'
 'S/he (PROX) finds the boat (OBV)' (Clarke, 1982, p. 30)

I do not develop a full analysis here, but a few pointers can be established. Aside from the conspicuous morphological differences in how obviation generally appears with animate versus inanimate nouns, there is a fundamental asymmetry between the two categories. Animate nouns can clearly alternate between proximate and obviative forms in the context of other animate nouns (and even local nouns). This is shown with the Border Lakes Ojibwe example in (74), with the classic direct-inverse alternation characteristic of all Algonquian languages, where either animate noun can be associated with the proximate and obviative categories.

- (74) a. o-gii-waabam-aa-n ikwe-wan gwiiwizens
 3-PAST-see-3-OBV woman-OBV boy
 'The boy (PROX) saw the woman' (OBV)
 b. o-gii-waabam-igoo-n gwiiwizens-an ikwe
 3-PAST-see-INV-OBV boy-OBV woman
 'The boy (OBV) saw the woman' (PROX) (Hammerly, 2019b)

In contrast, inanimate nouns either show a *lack* of proximate/obviative marking (when in the context of a local person), or show evidence of being (in some cases covertly) obviative marked (when in the context of an animate third person). It is therefore not clear that inanimate nouns are proximate qua proximate, so much as unmarked for obviation in certain contexts. This is perhaps most directly evidenced by the fact that, in languages with overt proximate marking, proximate-marked inanimate nouns cannot then trigger obviative marking on a clause-mate animate nouns. In fact,

such cases are entirely ungrammatical, as shown in the Blackfoot example in (75). The sentence in (75a) provides a baseline where the animate noun is marked proximate and the inanimate noun obviative marked. Such a sentence is grammatical. In contrast, (75b) shows that the reverse relationship—marking the inanimate noun proximate and the animate noun as obviative—is ungrammatical.

- (75) a. An-a imitáá-wa náówatoo-m-a an-i í'ksisako-yi
 DEM-PROX dog-PROX PAST-eat-DIR-PROX DEM-OBV meat-OBV
 'The dog ate the meat'
- b. *An-a í'ksisako-wa ot-ówatoo-ok-a an-i imitáá-yi
 DEM-PROX meat-PROX OBV-eat-INV-PROX DEM-OBV dog-OBV
 Intended: 'The meat was eaten by the dog' (Bliss, 2005a, p. 14)

A similar situation arises in Ojibwe, though since inanimate nouns are not themselves marked for obviation the contrast is less stark. In short, when animate and inanimate nouns are co-arguments of a verb, the inanimate noun cannot trigger obviative marking on the animate noun (76b)—an unmarked (by all indications, proximate) noun is grammatical (76a).

- (76) a. o-gii-biinitoon onaagan ikwe
 3-PAST-clean plate woman.PROX
 'The woman (PROX) cleaned the plate'
- b. *o-gii-biinitoon onaagan ikwe-wan
 3-PAST-clean plate woman-OBV
 Intended: 'The woman (OBV) cleaned the plate' [NJ 08.18.19]

To summarize, there is a fundamental asymmetry between animate and inanimate nouns in how they relate to obviation, though the system is active in both cases to some degree. Animate nouns show clear alternations between proximate and obviative marking, which is triggered (in some sense) by the presence of another third person animate noun. Inanimate nouns show alternations between being unmarked for obviation

and showing evidence of being obviative, but do not seem to ever be proximate per se. Similarly, animate nouns trigger obviative marking on inanimate nouns in certain constructions (albeit, in most cases, covertly), but inanimate nouns do not trigger obviative marking with animate nouns. This constitutes a reasonably clear set of generalizations for a future analysis to contend with.

2.7.2 Number

As with π , there are a number of different features that can be specified on $\#$. Also like person, number partitions lattices according to some property, in this case *cardinality*. Ojibwe makes cut between atomic (singular) and non-atomic (plural) sets, thus only a single number feature is necessary. The nature of this feature is the focus of the first subsection. While Harbour posits a feature $[\pm\text{atomic}]$, I adopt a complementary feature $[\pm\text{group}]$ in anticipation of accounting for cross-linguistic patterns of number agreement. Other languages are known to make other cuts, with categories such as dual or paucal, requiring additional features such as $[\pm\text{minimal}]$ and $[\pm\text{additive}]$ to be specified on $\#$. These features are not considered here, as they are not immediately relevant to the data at hand.

2.7.2.1 The number feature: $[\pm\text{group}]$ or $[\pm\text{atomic}]$?

As previously noted, number in Ojibwe makes a cut between atomic/non-group (singular) and non-atomic/group (plural) sets. This is the same cut as is made in English and many other Indo-European languages. In his theory, Harbour makes use of a feature $[\pm\text{atomic}]$ to make this distinction. Informally, the feature creates a partition between atomic sets (i.e. sets with a cardinality of one) and non-atomic sets (i.e. sets with a cardinality of greater than one). Harbour treats atomicity as a basic concept, simply denoting it as a predicate $\text{atom}(x)$. In (77), I provide a formal definition of the predicate in terms of set notation.

$$(77) \quad \llbracket[\text{atomic}]\rrbracket = \{f : |f| = 1 \wedge f \in \mathcal{L}_\varphi\}$$

More precisely, the feature denotes the subset of the φ lattice with a cardinality equal to one. This is shown in (78).

$$(78) \quad \{i, u, o, o', o'', \dots, r, r', r'', \dots\}$$

In many theories of number, such as those based in the feature-geometric approach, the number feature in singular/plural type languages has been thought to make a split based on *group* rather than *atomicity*. Arguments for such a [group] feature are generally based in the fact that plural is morphologically marked, while singular unmarked. Given that these theories use privative features (i.e. features that lack values), morphological markedness is encoded by representational markedness, with singular being the default interpretation of the number node # (literally, the interpretation # when it is unmarked for features).

While these sorts of arguments strictly based in markedness are less directly relevant for the current system, where features are bivalent and both singular and plural are equally marked in the representation, a similar logic comes to the fore when agreement is considered. Number agreement uniformly targets plural goal over singular goals. In order to define an agreement probe that prefers plural over singular (i.e. groups over atoms), a [group] feature is necessary.

With all of this in mind, it is perfectly possible to define a group feature in terms of sets, as shown in (79).

$$(79) \quad \llbracket[\text{group}]\rrbracket = \{f : |f| > 1 \wedge f \in \mathcal{L}_\varphi\}$$

The difference between the group and atomic features is that group includes all sets with a cardinality of greater than 1, rather than all sets with a cardinality equal to 1. As such, the group feature defines a lattice that is the complement of that defined by

[atomic], with respect to the full φ -lattice. As a result, in terms of deriving the proper partitions, the two turn out to be equivalent.

To see this, consider the proposed denotations of feature values for number, shown in (80). The positive value in (80a) is equivalent to set intersection between the lattice denoted by the number feature F (either borne of the atomic or group feature) and the lattice denoted by G (for our purposes, the lattice produced following composition with noun classification and person). The negative value in (80b) is relative complementation or set difference. This produces a partition of the lattice denoted by G with only those elements *not* found in the lattice denoted by F (i.e. the complement of the lattice denoted by F).

(80) *Feature values as lattice interactions with number*

a. $\llbracket +F(G) \rrbracket = \{g : g \in \mathcal{L}_G \wedge g \in \mathcal{L}_F\}$

b. $\llbracket -F(G) \rrbracket = \{g : g \in \mathcal{L}_G \wedge g \notin \mathcal{L}_F\}$

Returning to the contrast between [atomic] and [group], both produce the same two partitions, but with opposite correspondences the feature values. With [atomic], the positive value picks out the “singular” sets, and negative value the “plural” ones. With [group], the positive value picks out the “plural” sets, and the negative value the “singular” ones. Again, with the coming analysis of agreement in mind, I frame the singular-plural number contrast in terms of [group] rather than [atomic], though nothing yet hinges on this difference.

It should be noted that the interactions between lattices with number is different in some key ways from what was seen with person and noun classification, but the two also share a core similarity. The denotation of the values used for person is repeated in (81) for reference.

(81) *Feature values as lattice interactions with person and noun classification*

a. $\llbracket +F(G) \rrbracket = \{g : \exists f \in g [g \in \mathcal{L}_G \wedge f \in \mathcal{L}_F]\}$

b. $\llbracket -F(G) \rrbracket = \{g : \neg \exists f \in g [g \in \mathcal{L}_G \wedge f \in \mathcal{L}_F]\}$

The commonality between person and number is that the negative value is associated with logical negation. But how negation operates points to the crucial difference in how lattices interact with person versus number. Number is simply intersection (with the positive value) or complementation (with the negative value) between \mathcal{L}_G and \mathcal{L}_F . Person is more complex. It creates a partition of \mathcal{L}_G such that every element contains (as with the positive variant) or does not contain (as with the negative variant) some element of \mathcal{L}_F . Homing in on the negative variant, with number, a partition of \mathcal{L}_G that includes only those elements in the *complement of* \mathcal{L}_F is derived; with person, a partition of \mathcal{L}_G is derived such that each element *does not include any member of* \mathcal{L}_F .

The existence of these differences is not problematic—despite both person and number serving to create partitions of lattices, the two features exist on different functional heads and create partitions based on different properties, thus we should not necessarily expect their semantics to be uniform. Indeed, the semantics of values and lattice action/interaction is not uniform in Harbour (2016) either, the clearest antecedent to the present account. Harbour takes positive and negative values on person to represent pairwise addition and cumulative subtraction, respectively (see Section 2.6 for details). In contrast, Harbour takes negative values on number features to be logical negation of the predicate denoted by the number feature (and positive values to be the absence of negation with the predicate). From this point of view, to the degree that unifying the denotation of values across features should be a goal, the current account satisfies this desideratum with values on both person and number denoting logical negation.

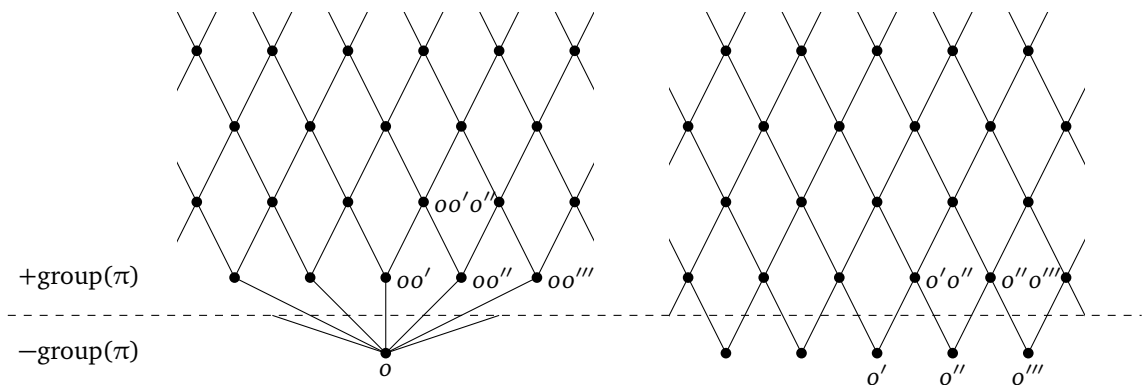

Figure 2.3: Proximate (left) and obviative (right) lattices with singular-plural number distinction

2.7.2.2 Application to Ojibwe

I turn now to showing the derivation of number contrasts in Ojibwe, with respect to the five person categories derived in Section 2.5. The most straightforward way of representing the partitions made by the group feature is through the use of the Hasse diagrams introduced at the start of the chapter (see Section 2.2.1). The lattices denoted by the proximate and obviative third person feature combinations are shown in Figure 2.3. The group feature makes a cut between the singleton elements on the bottom row (e.g. o and o'), and everything else (e.g. oo' and $o'o''$). This cut is represented by the dashed line.

The Hasse diagrams for the local persons are shown in Figure 2.4. The group feature operates as follows. For i_x and u_x , whose bottom elements are respectively the singleton sets $\{i\}$ and $\{u\}$, are partitioned with these bottom elements on the $[-\text{group}]$ side, and everything else falling into the $[\text{+group}]$ partition. In the case of iu_x , none of the elements are atomic: the bottom element is the dyad $\{i, u\}$, so no element in that lattice falls into the $[-\text{group}]$ partition. As a result, on the theory of contrastive interpretations, we might expect the inclusive person in Ojibwe to be unmarked for number: The group feature (and also, for the record, the atomic feature) fails to make a contrast in these cases, and thus is not expected to be active.

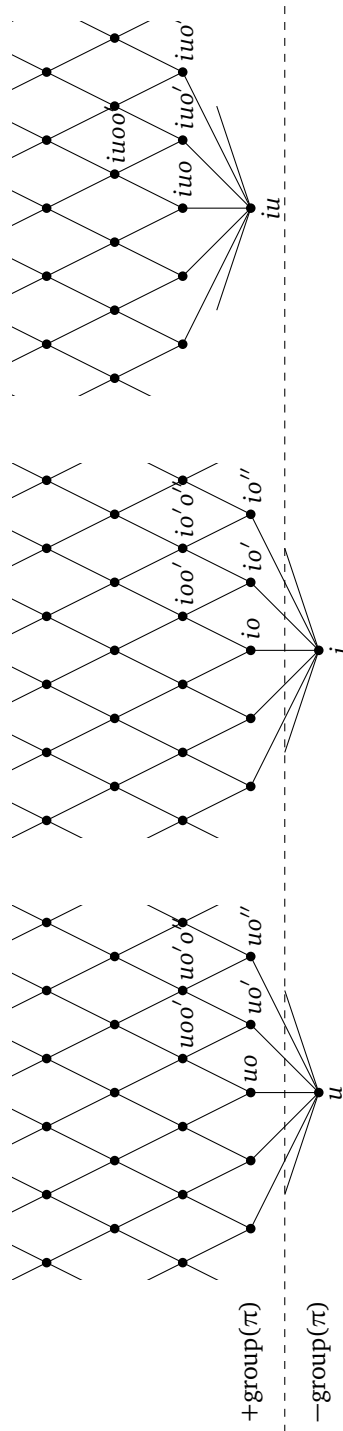

Figure 2.4: Lattices for the local person partitions with singular-plural number distinction. From bottom to top (or left to right if looking sideways) the lattices are u_x (second), i_x (exclusive), and iu_x (inclusive).

Having also considered the animacy in the previous section, I close by noting that the group feature can also serve to make a cut between singular and plural within the inanimate noun class. This would constitute a cut that is analogous to that seen with the obviative persons (but with the lattice being made up of r, r', r'', \dots rather than o', o'', o''', \dots). The $[-\text{group}]$ feature creates a partition of all singleton sets, while the $[\text{+group}]$ feature creates a partition of all non-singleton sets.

2.7.3 Summary

In this section, the interaction of the representation of person with noun classification and number was considered for Border Lakes Ojibwe. This amounted to creating a partition of the φ lattice based on the noun classification feature $[\pm\text{animate}]$, followed by the obviation feature $[\pm\text{proximate}]$, then the two person features $[\pm\text{author}]$ and $[\pm\text{participant}^*]$, and finally the number feature $[\pm\text{group}]$. The composition order of noun classification first, obviation/person in the middle, and noun classification last is independently motivated by the association of the features with different projections within the functional sequence. The overall result can be summarized with the contrastive hierarchy in (82). I have reverted to category labels for the terminals rather than the subset notation for clarity (number contrasts are difficult to represent with the notation), but emphasize that the hierarchy represents the derivation of partition elements rather than the categories per se.

(82) *Final contrastive hierarchy for Border Lakes Ojibwe*

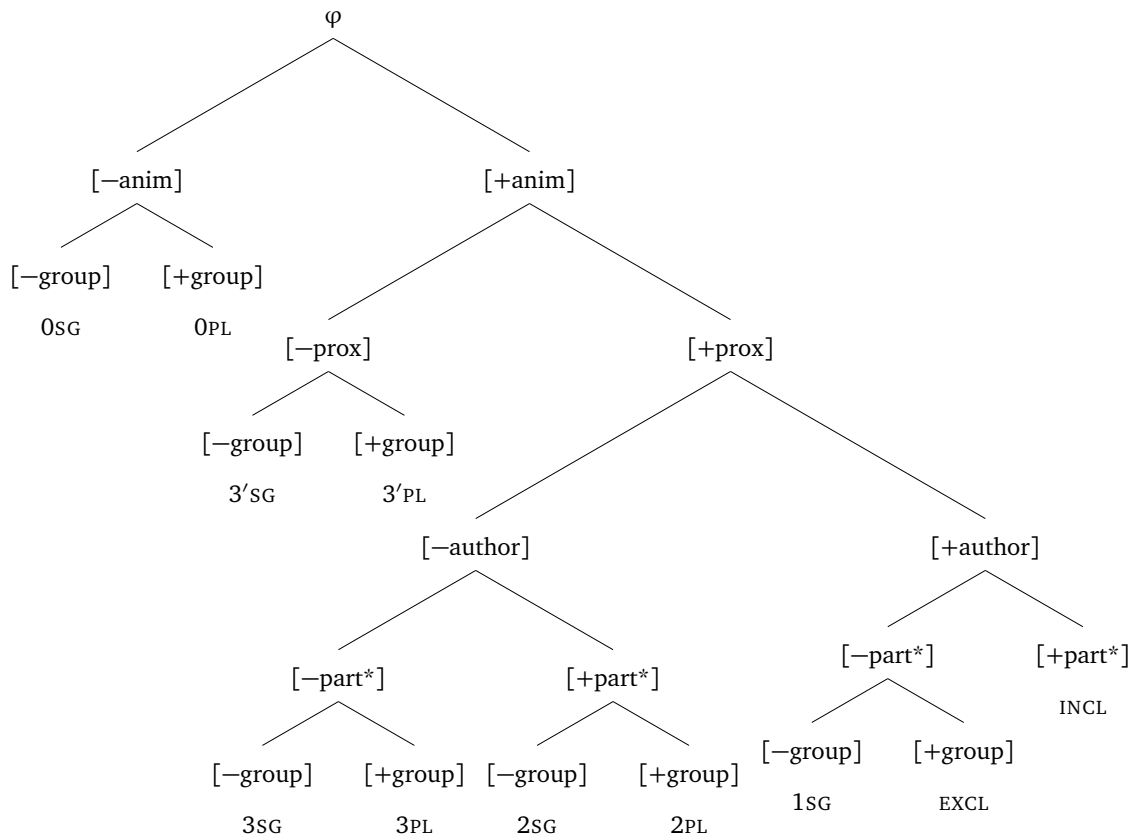

The hierarchy produces 11 non-overlapping and exhaustive partitions of the lattice denoted by the root node φ , which restrict the range of the variable introduced by this head, thereby determining the overall denotation of each of the categories.

CHAPTER 3

OBVIATION BEYOND OJIBWE

3.1 Introduction: Actual and predicted typologies of obviation

The previous chapter introduced a representation of person, obviation, noun classification, and number that captured the φ -based partitions of Border Lakes Ojibwe. The particular focus was on the system of person/obviation, where there is a five-way distinction (a *quintipartition*) that contrasts inclusive, exclusive, second, proximate, and obviative. In this chapter, I consider the wider typological profile of obviation. I show that there are at least three further attested partitions: (i) the *octopartition* of Blackfoot, where obviation is contrasted not only in the third persons, but also in the exclusive, inclusive, and second persons; (ii) the *proximate quadripartition* of Ktunaxa, where obviation is present in the third persons but no contrast is made between the inclusive and exclusive first persons (i.e. the categories are conflated into the generic first person); and (iii) the *hexapartition*, the existence of which remains controversial, but has also been claimed for Ktunaxa, where obviation contrasts third, second, and the generic first persons.

Besides providing an abbreviated typological survey of obviation systems, there is a theoretical motivation to this endeavor. The account put forward in the previous chapter predicts a rather significant expansion of the number of possible partitions.

This is due to the additional factorial possibilities that arise when moving from a two-feature representation of person, with only [\pm author] and [\pm participant], to a three-feature representation, where [\pm proximate] is added to the mix. These possibilities are outlined in (1), with all possible feature combinations and scope possibilities within a contrastive hierarchy. (Note, I have not marked features in their “winnowed” versions such as [\pm participant*], though such winnowing applies in many cases based on these scope relations).

- (1) *Feature combinations predicted with the addition of [\pm proximate]*
- a. *Proximate only*
 $[\pm\text{proximate}]$
 - b. *Proximate + Author*
 $[\pm\text{proximate}] \gg [\pm\text{author}]$
 $[\pm\text{author}] \gg [\pm\text{proximate}]$
 - c. *Proximate + Participant*
 $[\pm\text{proximate}] \gg [\pm\text{participant}]$
 $[\pm\text{participant}] \gg [\pm\text{proximate}]$
 - d. *Proximate + Participant + Author (Participant \gg Author)*
 $[\pm\text{participant}] \gg [\pm\text{author}] \gg [\pm\text{proximate}]$ *Ktunaxa II*
 $[\pm\text{participant}] \gg [\pm\text{proximate}] \gg [\pm\text{author}]$
 $[\pm\text{proximate}] \gg [\pm\text{participant}] \gg [\pm\text{author}]$ *Ktunaxa I*
 - e. *Proximate + Participant + Author (Author \gg Participant)*
 $[\pm\text{author}] \gg [\pm\text{participant}] \gg [\pm\text{proximate}]$ *Blackfoot*
 $[\pm\text{author}] \gg [\pm\text{proximate}] \gg [\pm\text{participant}]$
 $[\pm\text{proximate}] \gg [\pm\text{author}] \gg [\pm\text{participant}]$ *Ojibwe*

The languages for which the predicted feature sets and scope relations are attested are marked in the right margin in (1). Notice the conspicuous lack of an attested language

in many cases. As will become evident over the course of the chapter, these gaps fall into two classes: (i) likely to exist, but not yet attested; (ii) unlikely to be attested in any human language. Sorting the gaps into these two categories leads to further insights on the nature of obviation, both in how the proximate feature relates to the other φ -based categories of person and number, as well as where it is specified within the functional sequence. While strong claims about the typology of obviation should still be taken with a grain of salt, given the likelihood that there are simply accidental gaps in our knowledge, the goal of this chapter is to come away with a system that produces all and only the extant and likely partitions involving obviation—that is, provide a solution to the partition problem.

I begin in Section 3.2 with a discussion of Blackfoot (Algonquian), which again shows an 8-way distinction between exclusive, inclusive, second, and third, fully crossed by a proximate-obviative contrast. In other words, the proximate-obviative distinction extends to contrast the various local persons, in addition to the third persons. Ojibwe and Blackfoot both distinguish the inclusive from the exclusive. I continue with a discussion of the language isolate Kutenai in Section 3.3, which lacks a clusivity distinction, but also has a proximate-obviative contrast, providing evidence of obviation in what would otherwise be classified as a tripartition language. In Section 3.4 I turn to prospects for observing the currently unattested feature/scope combinations predicted under the current account, leading to a discussion of further constraints on the current theory of obviation.

3.2 The Octopartition of Blackfoot

3.2.1 Obviation in Blackfoot

Blackfoot is a Plains Algonquian language spoken in Southern Alberta and Northwestern Montana with approximately 5,800 speakers (Bliss, 2005a). Of interest here is the

	PROXIMATE	OBVIATIVE
1SG	n-iistó-wa	n-iistó-yi
EXCL	n-iistó-nnaan-wa	n-iistó-nnaan-yi
INCL	k-iistó-nnoon-wa	k-iistó-nnoon-yi
2SG	k-iistó-wa	k-iistó-yi
2PL	k-iistó-waaw-wa	k-iistó-waaw-yi
3SG	o-(ii)stó-wa	o-(ii)stó-yi
3PL	o-(ii)stó-waawa-wa	o-(ii)stó-waawa-yi

Table 3.1: Blackfoot (Siksika dialect) pronominal inventory (Frantz, 1991; Wiltschko et al., 2015)

fact that Blackfoot shows that proximate/obviative contrasts can arise within the local persons. I refer to the contrast as the *octopartition*. Ignoring number, it shows an eight-way contrast between exclusive, inclusive, second, and third, fully crossed by obviation. This can be seen from the inventory of independent pronouns, given in Table 3.1.

At this point, it is critical to note that the precise interpretation of the local forms in the context of this contrast is not yet clear. That is, the particular sets that are referenced by the proximate versus obviative flavors of the local persons has not, to my knowledge, been reported in the literature on the Blackfoot obviation system (though see Bliss (2005a, 2013) for critical discussion). This is important to emphasize, as the present account can be shown to generate *an* octopartition that marks a proximate-obviative contrast in the local persons, but it remains to be seen whether it is *the* octopartition that Blackfoot speakers actually make.

3.2.2 A contrastive hierarchy for the octopartition

Caveats aside, the contrastive hierarchy to generate the octopartition is shown in (2). Like the quintipartition, the basis of the octopartition is the original quadripartition. As such, the author feature takes scope over participant, resulting in the narrowing of this feature to participant*. Critically, the proximate feature is in the scope of *both* [author] and [participant*], so the set denoted by this feature is also subject to narrowing to ensure it is contrastive. In particular, [proximate] is narrowed to only differentiate

between those sets that include versus exclude the proximate *o*, and does not mark a contrast between local and non-local as it does in its full form. I represent this narrowed feature as proximate*.

(2) **Blackfoot Octopartition (Take 1)**

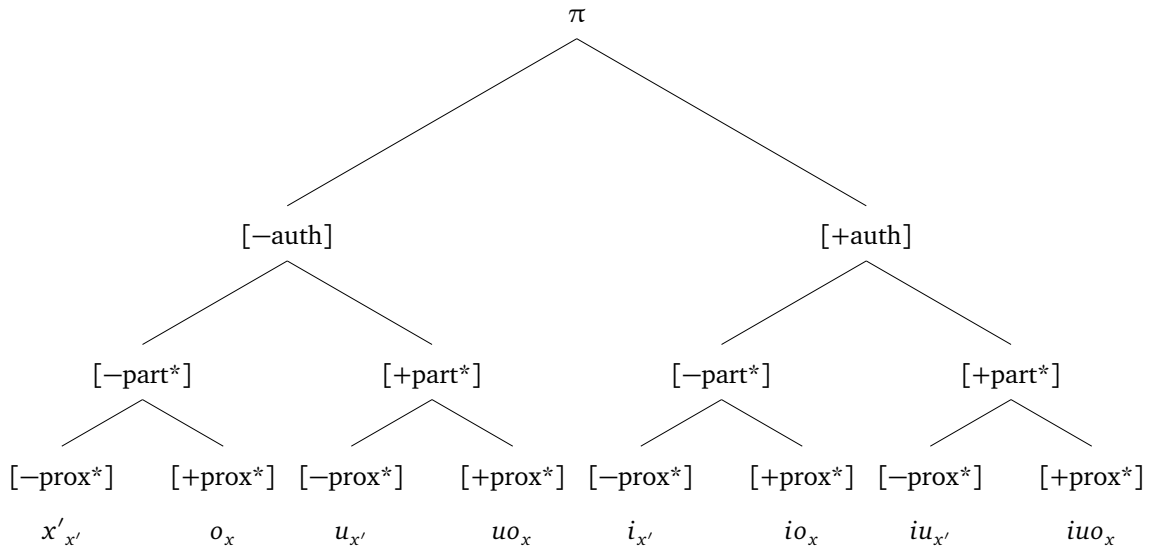

Parsing the categories generated in (2) from left to right, we see first that the basic proximate-obviative contrast in the third persons is generated, but this time with the critical inclusion of negative interaction from the author and participant* features. This interaction is necessary, as the proximate* feature is narrowed to only contrast sets that include/exclude *o*. Each of the three basic categories of local persons—second, exclusive, and inclusive—show an analogous split from positive versus negative interaction with proximate*. The negative side excludes all sets with the proximate *o*, and the positive side includes those with the proximate *o*. The relationship between the subscript notation and the lattices are shown in (3) for clarity.

- (3) a. $u_{x'} = \{u, uo', uo'', uo''', \dots, uo'o'', uo'o''', uo''o''', \dots, uo'o''o''', \dots\}$
 b. $u_{o_x} = \{uo, uoo', uoo'', uoo''', \dots, uoo'o'', uoo'o''', uoo''o''', \dots\}$
 c. $i_{x'} = \{i, io', io'', io''', \dots, io'o'', io'o''', io''o''', \dots, io'o''o''', \dots\}$

- d. $io_x = \{io, ioo', ioo'', ioo''', \dots, ioo'o'', ioo'o''', ioo''o''', \dots, \}$
- e. $iu_{x'} = \{iu, iuo', iuo'', iuo''', \dots, iuo'o'', iuo'o''', iuo''o''', \dots, iuo'o''o''', \dots, \}$
- f. $iuo_x = \{iuo, iuoo', iuoo'', iuoo''', \dots, iuoo'o'', iuoo'o''', iuoo''o''', \dots, \}$

An oddity of the account as it currently stands, which deserves immediate attention, is that the generated lattices for the proximate locals lack an element with *only* the local persons—all elements of these lattices have at a minimum the relevant local person(s) plus the proximate person *o*.

This raises a red flag when considering the interface with number, where there are singular forms for both the proximate and obviative variants of the exclusive and second persons. The basic problem is that the singular-plural number system divides the lattice between those elements with one member (singular) versus those with more than one member (plural). The above account results in all elements of the proximate exclusive and second person lattice having more than one member, which should mean it does not have a singular form—an incorrect result given the data at hand (see Table 3.1).

The solution that I propose is to change where in the nominal spine the proximate feature associates in Blackfoot. Rather than associating with the functional head π , I will argue that the proximate feature can appear in two possible places within the nominal spine: (i) right above *n*, therefore composing after noun classification, but before person (4a); or (ii) above number, therefore composing last, after noun classification, person, and number (4b). Blackfoot is a language where the proximate feature composes after number and person, while Ojibwe is a language where proximate composes before person and number. Ultimately, the difference between Ojibwe and Blackfoot, and the proposed difference in composition order, points to a path for a more general restriction on how the proximate feature can interact with the other φ -features.

(4) *The functional sequence, now with ProxP at two possible locations*

a.

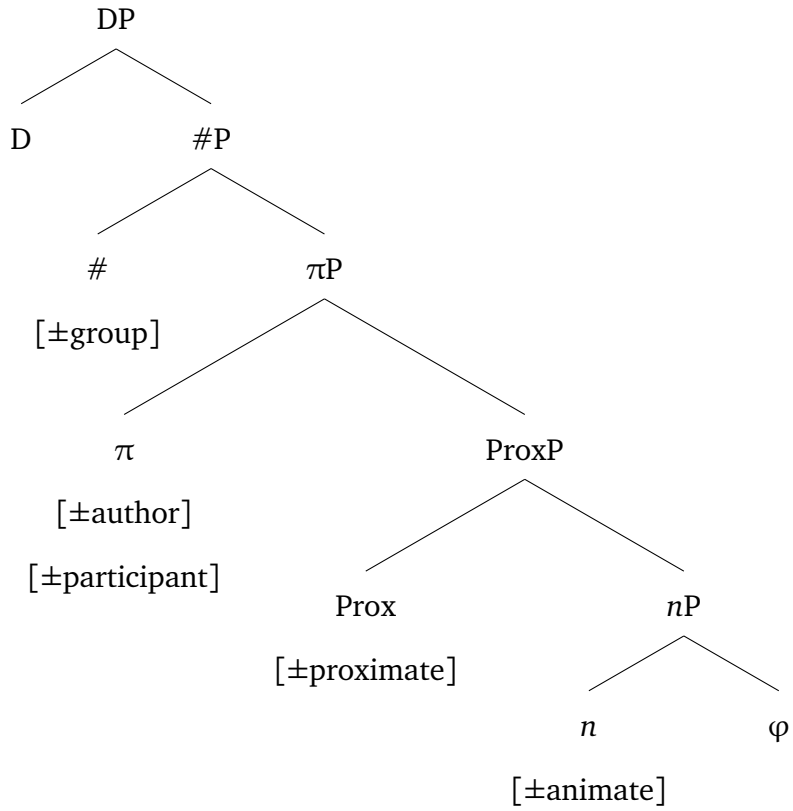

b.

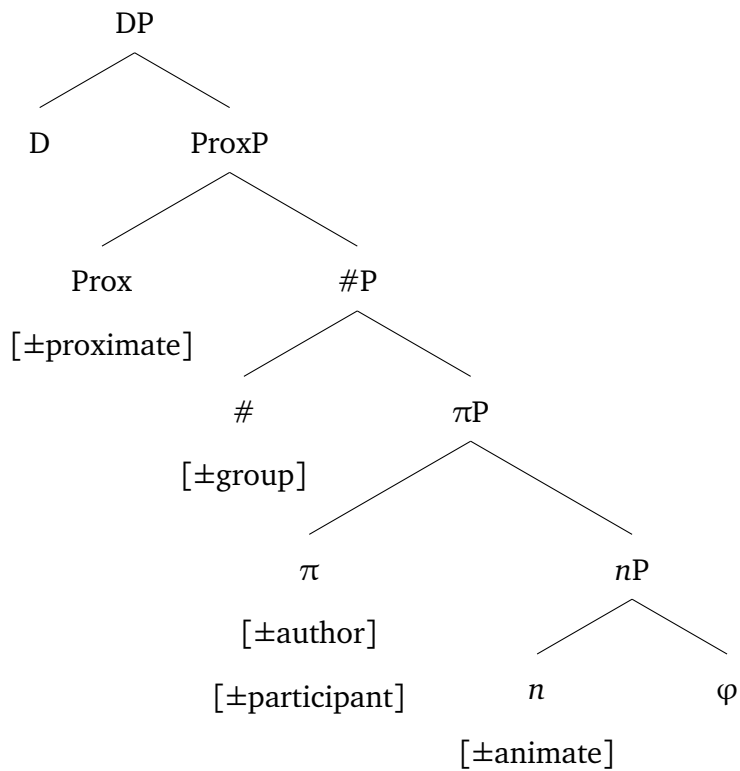

3.2.3 Number and the Blackfoot octopartition

To reiterate, the solution I propose is that the proximate feature is not in fact specified on π , as has been assumed thus far. If instead number makes its partition *prior* to the proximate feature (i.e. proximate composes last), the situation in the previous section, where no proximate singular forms of the local persons are predicted, can be avoided. On this account, the lattices that serve as input to number are simply the original quadripartition. The full contrastive hierarchy, with number composing first, followed by the proximate feature, is given in (5). This derives the 14 possible person/number categories of Blackfoot (noting that certain complications arise for the proximate-obviative distinction in the singular local persons, as discussed in detail below).

(5) *Contrastive hierarchy for the octopartition, with number*

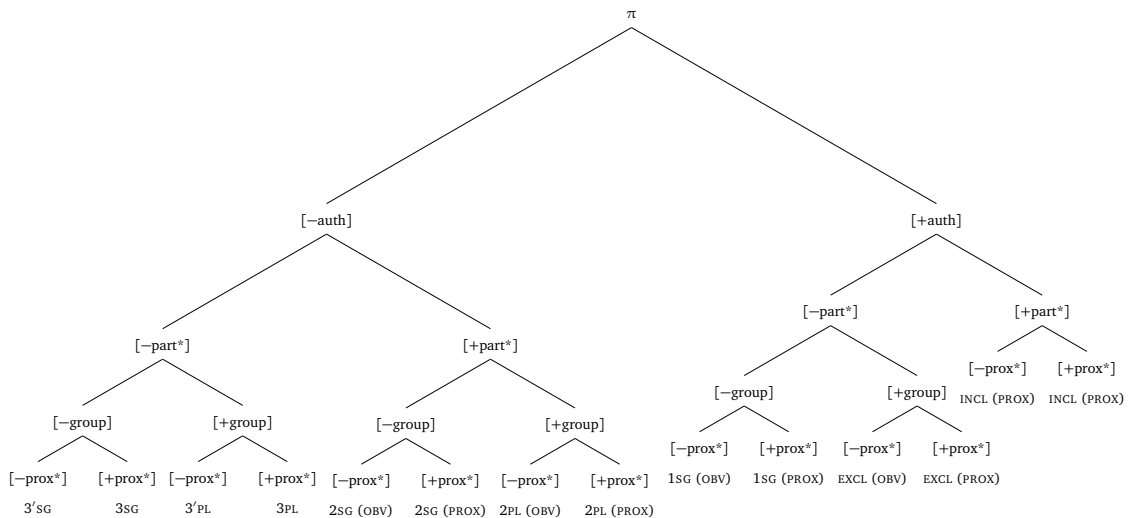

I begin by considering the situation following the composition of number. The initial distinctions are identical to the lattices represented by the Hasse Diagrams from Chapter 2 (Figures 2.3 and 2.4). As such, a singular-plural distinction is derived for both third, exclusive, and second person lattices (again, with the inclusive only falling on the “plural” or group side of the divide). This is summarized using the subscript notation in (6).

- (6) a. THIRD: $x \mid xy_x$ ¹
 b. SECOND: $u \mid ux_x$
 c. EXCLUSIVE: $i \mid ix_x$
 d. INCLUSIVE: iu_x

The partition created by the proximate feature then divides those sets that include the proximate *o* from those that lack it. That is, the [\pm proximate*] feature, the winnowed version of the proximate feature, is composed with each lattice in (6). While the proximate feature is not specified on the π head on this analysis, it is still bound by contrastive principles. This is the same logic already seen, which lead the animate and number features to be part of a contrastive hierarchy with person. Given that the proximate feature is, in the relevant sense, within the scope of the participant feature, it is narrowed to only contrast elements that include/exclude only *o*, rather than *i*, *u*, and *o*.

I begin with the more familiar case of the third person. The subscripts correspond to the following sets (i.e. the singular-plural distinction in the generic third person):

- (7) a. $x = \{o, o', o'', o''', \dots, \}$
 b. $xy_x = \{oo', oo'', oo''', o'o'', o'o''', o''o''', \dots, oo'o'', oo'o''', oo''o''', o'o''o''', \dots, oo'o''o''', \dots, \}$

The application of the proximate feature divides these into those sets that either include the proximate *o*, as in (8a,c), or exclude the proximate *o*, as in (8b,d).

- (8) a. 3SG
 $o = \{o\}$
 b. 3'SG
 $x' = \{o', o'', o''', \dots, \}$

¹The added variable *y* here clarifies that the two third persons *o*'s that form this set must be distinct in order to ensure, at a minimum, a dyad is derived.

c. 3PL

$$ox'_x = \{oo', oo'', oo''', oo'o'', oo'o''', oo''o''', oo'o''o''', \dots, \}$$

d. 3'PL

$$x'y'_{x'} = \{o'o'', o'o''', o''o''', \dots, o'o''o''', \dots, \}$$

This derives the expected partitions for both the proximate and obviative person forms in both the singular and plural.

I now turn to the local plural persons. Applying the proximate feature in each case results in the six partitions shown in (9).

(9) a. 2PL (PROX)

$$uo_x = \{uo, uoo', uoo'', uoo''', \dots, uoo'o'', uoo'o''', uoo''o''', \dots, \}$$

b. 2PL (OBV)

$$ux'_{x'} = \{uo', uo'', uo''', \dots, uo'o'', uo'o''', uo''o''', \dots, uo'o''o''', \dots, \}$$

c. EXCL (PROX)

$$io_x = \{io, ioo', ioo'', ioo''', \dots, ioo'o'', ioo'o''', ioo''o''', \dots, \}$$

d. EXCL (OBV)

$$ix'_{x'} = \{io', io'', io''', \dots, io'o'', io'o''', io''o''', \dots, io'o''o''', \dots, \}$$

e. INCL (PROX)

$$iuo_x = \{iuo, iuoo', iuoo'', iuoo''', \dots, iuoo'o'', iuoo'o''', iuoo''o''', \dots, \}$$

f. INCL (OBV)

$$iux'_{x'} = \{iu, iuo', iuo'', iuo''', \dots, iuo'o'', iuo'o''', iuo''o''', \dots, iuo'o''o''', \dots, \}$$

It should be emphasized again that, at present, whether or not the proximate/obviative forms of each local plural person denote the sets shown in (9) has yet to be confirmed with a speaker of Blackfoot. But at least concrete predictions, which have a priori plausibility, have been made. To summarize these predictions in plain language, based on the lattices in (9), the proximate counterpart of each should necessarily include refer-

ence to whichever third person animate person has been designated proximate within the discourse along with the relevant local person(s), while the obviative counterpart should necessarily exclude reference to this person.

As previewed above, the situation on the local singular side of the divide leads to a conflict with our contrastive principles, and runs even further into the limitations of what can be said given the data at hand. The issue is this: Given that [proximate*] contrasts those sets that include/exclude the proximate *o*, and both the lattices {*i*} and {*u*} lack these elements altogether, then the proximate feature should not be specified in this case, as there is no *partition-based* contrast to be made. This is the same logic that, for example, restricts the author and participant features from applying in the context of [–proximate] in the Ojibwe quintipartition. Given that there is indeed a contrast in obviation within the singular local persons, this presents a problem for the analysis.

At present, it is not possible to provide a fully informed solution to this issue. The major roadblock is a lack of clarity about the contexts for use of the proximate versus obviative counterparts of the local persons within Blackfoot. Some clues do exist, mostly in the form of positive evidence. The picture suggests that there may be motivation outside of creating partitions, in the domain of discourse, for specifying a feature related to obviation. This would mean the contrastive hierarchy is sensitive not just to those contrasts relevant to creating partitions, but also to contrasts relevant to other domains of the grammar.

The first relevant generalization related to this point that can be gleaned from the existing literature is that local thematic patients or goals, in the context of an animate third person actor, take the obviative form, as shown in (10), while local actors in the same context must be proximate, as shown in (11).

- (10) a. om-a nináá-wa nit-ákomimm-ok-a n-iistó-yi
 DEM-PROX man-PROX 1-love-INV-PROX 1-PRO-OBV
 ‘That man (PROX) loves me (OBV)’

- b. *An-i nináá-yi nit-ákomimm-ok-ini n-iistó-wa
 DEM-OBV man-OBV 1-love-INV-OBV 1-PRO-PROX
 Intended: ‘That man (OBV) loves me (PROX)’
- (11) a. n-iistó-wa nit-ákomimm-a-yini an-i nináá-yi
 1-PRO-PROX 1-love-DIR-OBV DEM-OBV man-OBV
 ‘I (PROX) love that man (OBV)’
- b. *n-iistó-yi nit-ákomimm-a-wa om-a nináá-wa
 1-PRO-OBV 1-love-DIR-PROX DEM-PROX man-PROX
 Intended: ‘I (OBV) love that man (PROX)’ (Wiltschko et al., 2015, p. 276)

This differs crucially from obviation between two third persons, where, as in Ojibwe and all other Algonquian languages, both actors and goals can alternate with respect to obviation—the categories of proximate and obviative are not tied to particular thematic roles.

Furthermore, when both arguments are local, these restrictions do not appear to be active. This is demonstrated in (12), where either the first person actor (12a) or the second person goal (12b) can appear in a proximate form of the pronoun. Note that sentences with two pronouns are ungrammatical, therefore the obviation status of the second argument is unknown in both cases. In any case, the fact that the object pronoun in (12b) appears in the proximate rather than obviative form stands in contrast to the generalization gleaned from local persons combining with an animate third person in the examples in (10) and (11).

- (12) a. n-iistó-wa kit-ik-wáákomimm-o
 1-PRO-PROX 2-INTNS-love-DIR
 ‘I (PROX) love you (?)’
- b. k-iistó-wa kit-ik-wáákomimm-o
 2-PRO-PROX 2-INTNS-love-DIR
 ‘I (?) love you (PROX)’ (Bliss, 2013, p. 253–254)

It is therefore possible that the derivation of the local obviative forms may be subject to additional factors — in the most extreme case, we may question whether the the

proximate feature in the local cases serves the function of making partitions at all. This is akin to what was seen with obviation in the inanimate nouns in Chapter 2, Section 2.7.1.3, where there are asymmetries and constraints in how obviation behaves in the local persons that suggest something else is at play. One likely candidate is the extension of the obviative system to mark discourse related roles (in essence, this is what is conjectured by Bliss, 2005a, *et seq*). As such, the specification of the proximate feature would not be bound by the need to create contrasts between partitions per se, marking instead strictly discourse-based contrasts. Again, determining these factors, and fitting an account into the present analysis, must be left to future work where more clarity on the usage conditions and denotations for the proximate and obviative forms of the local persons can be established.

3.2.4 Interlude: An issue for the feature geometric account

At this stage, it is pertinent to consider again the major alternative account: the feature geometry. In this section I show that the presence of the octopartition of Blackfoot creates issues for the feature-geometric analysis. Recall the proposed entailment dependencies of Oxford (2019b), repeated in (13).

(13) *Feature geometry (repeated)*

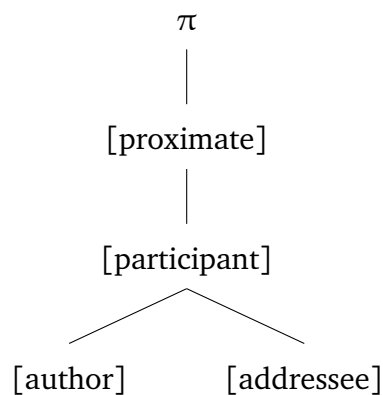

While this geometry works for Ojibwe and many other Algonquian languages, where obviation is only visibly creating contrasts between third persons, it is too strong for Blackfoot. In particular, it makes the incorrect prediction that both the first and second persons should always be proximate, as the [participant] (and [author] and [addressee]) features entail the presence of [proximate]. On this representation, it is simply not possible to specify a feature that marks a local person without also specifying the proximate feature, thus the presence of obviative local persons cannot be accounted for.

An initially promising solution that maintains the geometric representation comes from Bliss and Jesney (2005), as well as my own previous work that further builds on the account of Bliss and Jesney (Hammerly, 2018). Both analyses attempt to alleviate issues with the strict entailment between [participant] and [proximate] by placing the feature that encodes obviation elsewhere in the geometry. Bliss and Jesney (2005) place it within the domain of persons under a separate branch (14a), which breaks the entailment relationship with the rest of the person features.² Hammerly (2018) places it under the individuation (i.e. #) node (14b), which also allows these entailments to be broken.

(14) *Alternative feature geometries to capture local obviation*

a. *Adapted feature geometry from Bliss and Jesney (2005)*

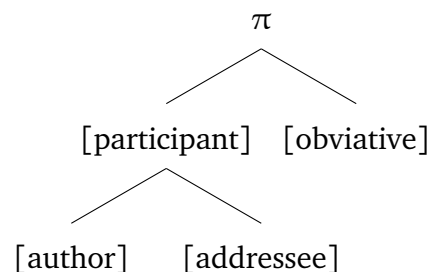

²Bliss and Jesney (2005) in fact have an additional node, STAGE, which dominates [obviative], but the presence of this is not relevant to the current argument.

b. *Adapted feature geometry from Hammerly (2018)*

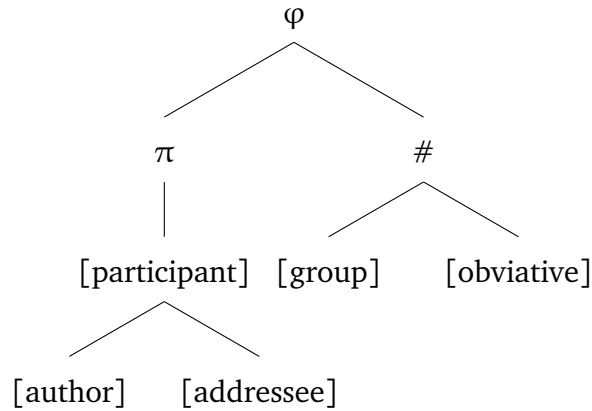

These proposals both ensure that local persons can be obviative in addition to proximate, and therefore cannot be ruled out by the existence of the Blackfoot octopartition. However, they run into issues when implanted into theories of agreement that make use of feature geometries. In particular, there is nothing that allows third person proximate and local arguments to be targeted by an agreement probe to the exclusion of obviative third person. This is shown to be the pattern in Ojibwe in Chapter 5. This issue arises because while there is a feature, [obviative], that uniquely picks out third obviative arguments to the exclusion of third proximate, there is no feature that picks out third proximate *and local* to the exclusion of third obviative.³ In effect, one of the core prominence-based generalizations for agreement in Ojibwe (and, ultimately, Algonquian more generally) is lost. These issues are discussed at greater length in the coming chapters.

3.3 The proximate quadripartition/hexapartition of Ktunaxa

In this section I show that the proximate feature is active in systems that lack an inclusive-exclusive distinction. Put in terms of Harbour's original terminology, to show that more

³One many wonder whether changing the feature in the geometry to make [proximate] marked rather than [obviative] might alleviate these issues. It does not. There is still no feature that will pick out third proximate and local together to the exclusion of obviative, as local arguments do not obligatorily have a proximate feature.

than just the baseline quadripartition languages contrast proximate and obviative. I show that a baseline *tripartition* language can also give rise to the additional partition between proximate and obviative. I refer to this as the *proximate quadripartition*. The example language is Ktunaxa, which is a language isolate of British Columbia and the adjacent areas of Montana, spoken today by approximately 345 individuals.

While there is clear evidence for an obviation distinction in the third persons in the language, it has also been claimed that the local persons show a proximate-obviative contrast. I refer to this as the hexapartition. I show that, if this does turn out to be the proper analysis, this too can be captured by the present analysis.

3.3.1 The proximate quadripartition

Ktunaxa resembles the Algonquian family in some key areas, including the use of proximate-obviative marking on third persons and a direct-inverse agreement system. Both of these features are shown in (15). (15a) is a direct alignment, which is unmarked on the verb, where the subject is proximate and the object obviative. (15b) exemplifies an inverse alignment, marked by *-aps-* on the verb, where the subject is obviative and the object proximate.

(15) *Direct/inverse in Ktunaxa*

- a. wu·kat-i pałkiy-s titqał
 see-IND woman-OBV man
 ‘The man (PROX) saw the woman (OBV)’
 - b. wu·kat-**aps**-i titqał-s pałkiy
 see-INV-IND man-OBV woman
 ‘The man (OBV) saw the woman (PROX)’
- (Dryer, 1994, p. 65)

More broadly, the language shows object agreement, exemplified in (16) with plural local person objects. I assume that both the subject and object in these cases are encoded by a null *pro*. For the purposes of this discussion, I treat the null direct and inverse

marker in (15) as a form of object agreement, effectively making the agreement in (15) and (16) as part of a single paradigm of agreement.

(16) *Object agreement in Ktunaxa*

- a. wu·kat-awas-ni
see-1PL.OBJ-IND
'He/she/it/they saw us'
- b. wu·kat-iskił-ni
see-2PL.OBJ-IND
'He/she/it/they saw you (PL)' (Dryer, 1994, p. 67)

In the object agreement in (15) and (16), first, second, proximate, and obviative persons are distinguished from one another, but there is no difference in the exclusive versus inclusive. The same basic pattern holds with the subject proclitics in (17), but with no evidence of a distinction in obviation in the third persons, which does not have an overt subject proclitic form.

(17) *Subject clitics in Ktunaxa*

- a. **hu** cxa-nał[?]-ni
1.SUBJ talk-1PL-IND
'We (EXCL/INCL) talked'
- b. **hin** cxa-kił-ni
2.SUBJ talk-2PL-IND
'You (PL) talked' (Dryer, 1994, p. 67)
- c. cxa-ni
talk-IND
'He/she/they talked' (Dryer, 1997, p. 34)

On the whole, we can return to use of the superposition method introduced earlier, and see that the language conflates inclusive and exclusive, but makes distinctions between the second, proximate, and obviative persons.

well as the third persons (Boas, 1926; Mast, 1988; Underhill, 2019). The relevant data point is in (20), with the verbal affix *mił* being claimed to be a “local obviative” marker.

- (20) Hun hanłupqa?-mił-ni Mali
 1.SUBJ run-MIŁ-IND M.
 ‘I (OBV?) ran to Mary (PROX)’ (Underhill, 2019)

I do not take a stand on whether or not this analysis is correct. In any case, a contrastive hierarchy is available to capture such a partition, should it turn out to be the right analysis for Ktunaxa, or should it be found elsewhere in the world. This is given in (21), and differs from the initial analysis of Ktunaxa in that the proximate feature is specified after both person and number.

- (21) *Ktunaxa hexapartition (Note: existence is controversial)*

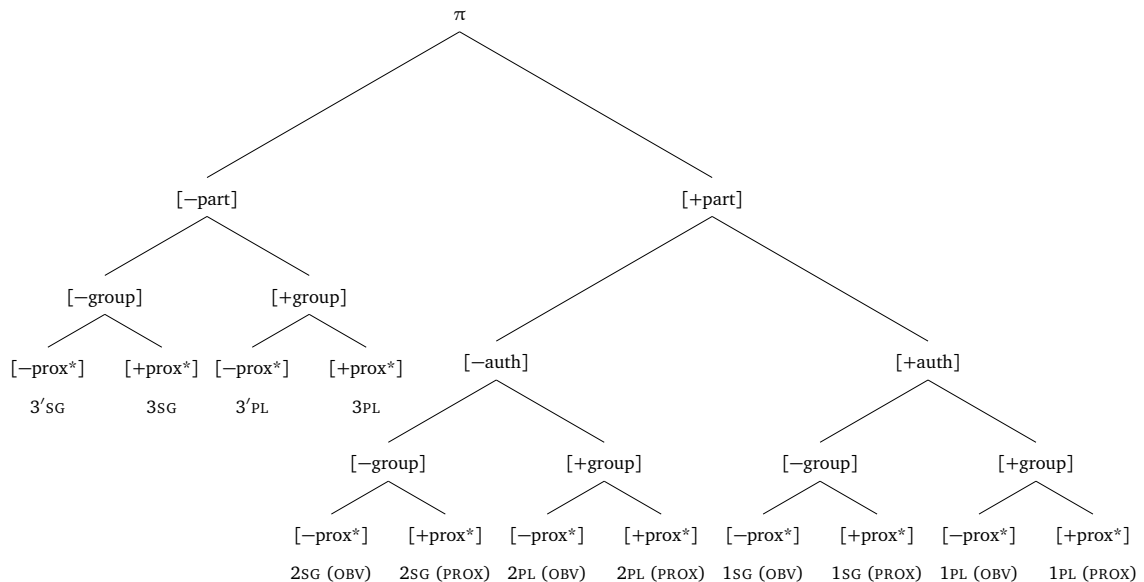

As with the contrast between Ojibwe and Blackfoot, the difference is in the scope of the proximate feature, which is now within the scope of both author and participant, rather than taking scope over the two features. This results in the same narrowing of the feature to proximate*, to create a contrast between those sets that lack *o* in the negative case, and those that include *o* in the positive. Overall, the system predicted is

exactly like that of Blackfoot, except the inclusive and exclusive persons are collapsed into the generic first person.

Again, like Blackfoot, more careful work needs to be done to understand whether this predicted partition is extant. In any case, the predicted partition is not a priori unreasonable.

3.4 The remaining partitions

In the preceding sections, evidence was given to support the existence of an octopartition, proximate quadripartition, and a hexapartition, in addition to the quintipartition of Ojibwe. To my knowledge, these four partitions exhaust the current typological profile of how obviation serves to further partition the person space.⁴ However, given that obviation has so far been observed in generally understudied language families and geographical regions, it is possible that the absence of additional partitions is due to a failure to observe these patterns, rather than true typological gaps.

Furthermore, in Harbour's (2016) survey, almost all examples of monopartitions and bipartitions are in the domain of deixis and motion, which Harbour considers to be grounded in the same basic ontology and representation of person. For example, spacial terms like *here-there* or *this-that* or verbs of motion *come-go*. It is possible that the predicted cuts to be outlined in this section will be found by a careful survey of these broader domains, but so far a survey of this type has not been undertaken.

With the constraint on the order of composition with proximate that was proposed within the context of capturing the contrast between Ojibwe and Blackfoot, the additional predictions are already partially constrained. To review, the idea is that the proximate feature either composes immediately after noun class and before person and

⁴One notable gap in the current survey is that grammatical animacy has been largely set aside. To reiterate, Ojibwe shows obviation most clearly in the animate nouns, inanimate nouns also participate "covertly", and certain dialects have innovated obviative morphology for inanimate nouns (Bliss and Oxford, 2017). This is discussed in Chapter 2, Section 2.7.1.3.

number, or after noun class, person, and number. The revised possibilities with this constraint in hand are summarized in (22).

(22) ***Revised possible feature combinations***

a. *Proximate only*

[±group] » [±proximate]

[±proximate] » [±group]

b. *Proximate + Author*

[±proximate] » [±group] » [±author]

[±group] » [±author] » [±proximate]

c. *Proximate + Participant*

[±proximate] » [±group] » [±participant]

[±group] » [±participant] » [±proximate]

d. *Proximate + Participant + Author (Participant » Author)*

[±group] » [±participant] » [±author] » [±proximate] *Ktunaxa II*

[±proximate] » [±group] » [±participant] » [±author] *Ktunaxa I*

e. *Proximate + Participant + Author (Author » Participant)*

[±group] » [±author] » [±participant] » [±proximate] *Blackfoot*

[±proximate] » [±group] » [±author] » [±participant] *Ojibwe*

We have seen all possibilities under a three feature system. The task is therefore to consider the plausibility of the predicted partitions under one and two feature systems.

3.4.1 One and two-feature systems

The goal of this section is to sketch the predictions of the system, and provide a tentative evaluation of how plausible they might be. This section is meant to set the stage for future work: a wider search for evidence of these partitions, or, in the event that we

can be convinced that certain predictions are improbable, to plot out the edge of what a revised theory should account for.

The first predicted partition builds off of the baseline *monopartition*, thus only a proximate feature makes a cut. This is shown in (23). (Note: In this and the other hierarchies, I abstract away from the interaction with number to simplify the representation.)

(23) *Proximate only*

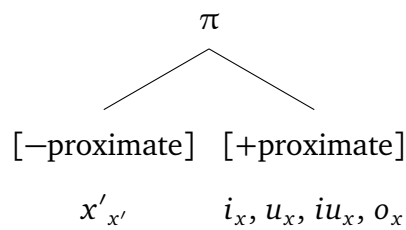

Intuitively, the predicted cut here is between a partition of the π lattice that include at least one of the proximate persons i , u , or o , and the partition that excludes these persons. Considering plausibility within the domain of space or path, this seems to be a likely cut. For example, the relationship that has been observed between obviation and perspective-taking (e.g. Bliss, 2005a,b; Hammerly and Göbel, 2019) provides a line of evidence for unifying the first and second persons (which are undeniably perspectival) with the proximate third person to the exclusion of the obviative persons.

The next two combinations involve the baseline author bipartition. Given the possible compositions orders, the proximate feature can either compose prior to the author feature, or after the author feature. The former case is discussed first, and derives the expected contrastive hierarchy in (24).

(24) *Proximate-over-author*

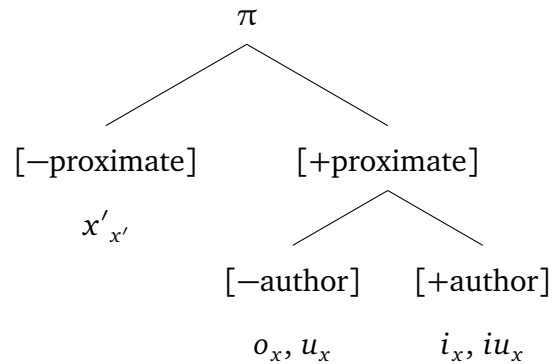

This hypothetical partition adds to the proximate only case in (23) with the a distinction between those “proximate” persons that exclude versus include the speaker, predicting a three-way split between obviative *o*’s, sets that include the proximate *o* or *u*, but lack *i*, and those that include *i*. This is just like the author bipartition, with the added partition of those elements in the lattice that exclude *i*, *u*, and the proximate *o*. As a result, it seems likely to be attested upon careful consideration of deixis and motion systems.

The first case that initially appears implausible is the author-proximate feature combination with author composing first. This is shown in (25).

(25) *Author-over-proximate*

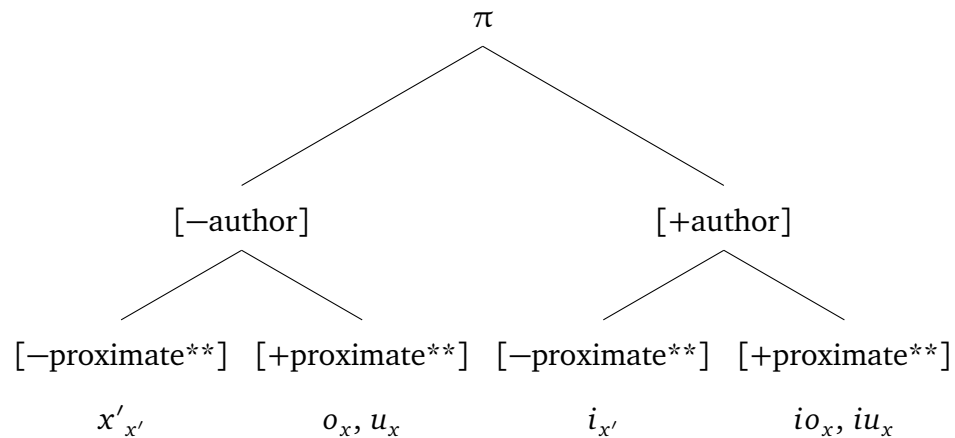

This contrastive hierarchy leads to the winnowing of the proximate feature to what is marked as [proximate**]. Given that the proximate feature is within the scope of

author, the theory of contrastive interpretations predicts that the feature should be restricted to *u* and *o* (excluding *i*), since the author feature already marks a contrast between sets that include/exclude *i*. This leads to a four-way split between (i) the third person obviative, (ii) the non-speaker proximates *o* and *u*, (iii) the speaker on their own, and (iv) the speaker with the other proximate persons *o* and *u*. When phrased this way, the cut is certainly complex, but not entirely implausible. The chief cut is between whether the author is or is not present, then, within each of these possibilities, whether the other proximate persons *o* and *u* are present.

The final two possibilities extend the baseline participant bipartition, again adding the proximate feature either prior to the participant feature or after the participant feature. The proximate-before-obviative possibility in (26) is considered first.

(26) *Proximate-over-participant*

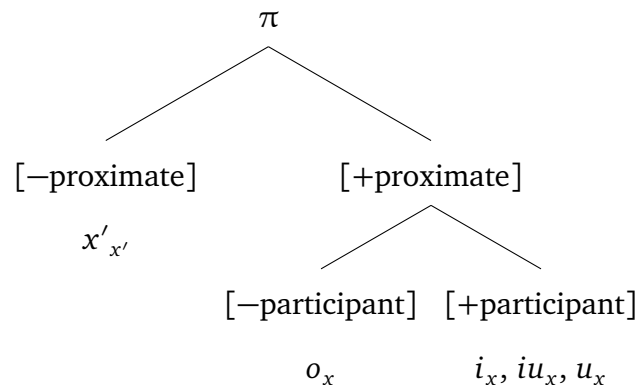

This predicts what appears to be a plausible three-way set of partitions between the obviative third person, the proximate third persons, and the local persons. This is simply the original participant bipartition with the additional cut introduced by obviation.

The last case is that of participant-before-proximate. This leads to the narrowing of the proximate feature to [proximate*] (i.e. making only a cut between those elements that do or do not include the proximate *o*), given that it is within the scope of the participant feature and need not make a cut between those elements that include or exclude the local persons.

(27) *Participant-over-proximate*

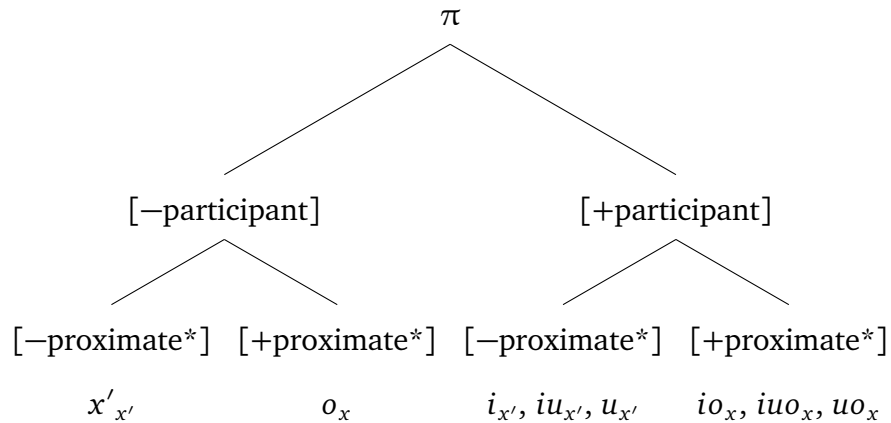

Again, the predicted partition here does not seem particularly implausible. In an analogous manner to Blackfoot, it simply adds a general distinction between the local persons that do or do not combine with the proximate *o*.

3.4.2 Three-feature systems and intermediate scope of proximate

Even though they are ruled out based on the assumption that the proximate feature either composes before or after the core person features, it is worth considering the additional two three-feature partitions that could in principle be generated under the current theory to further bolster the assumption. Both involve the proximate feature taking an intermediate position between the two person features with respect to scope within the contrastive hierarchy.

The first is the possibility of participant taking scope over the proximate, and both participant and proximate taking scope over author. This is schematized with the contrastive hierarchy in (28). This particular case results in an identical partition to the already discussed hexapartition, which is potentially exemplified by Ktunaxa. The reason is that the critical scope relationship has not changed: participant takes scope over both proximate and author. The former relationship ensures that proximate is winnowed to proximate* (contrasting sets that include/exclude *o*), and the latter relationship ensures that participant is realized with its full set.

(28) *Intermediate proximate, with participant taking widest scope*

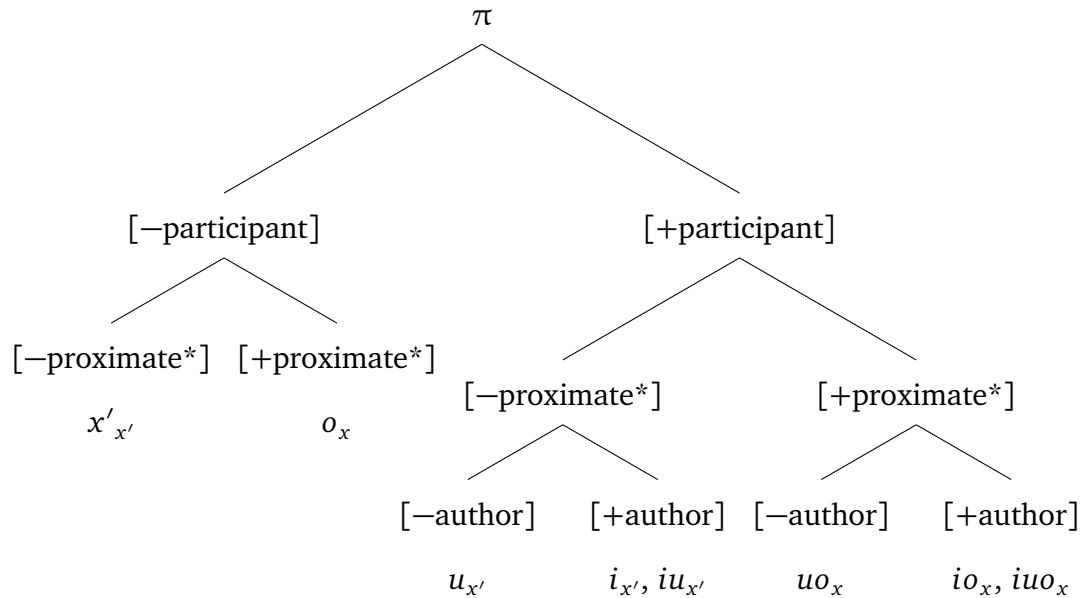

Ignoring the issues that would arise with these elements combining with number, there is in fact no principled reason to rule out the possibility that a learner might end up with a grammar consistent with the hierarchy in (28) if faced with primary linguistic data that supports a hexapartition. The content of the features (i.e. the adult grammar) is identical to that derived from a hierarchy in which proximate is within the scope of author (and author is still within the scope of participant).

The second possibility is a contrastive hierarchy in which author takes scope over proximate, and both author and proximate take scope over participant, as shown in (29). This case also produces a hexapartition, but one that is unlikely to be observed in natural language. The key issue is that author takes scope over the proximate feature without participant also taking scope. This results in a different winnowing of the proximate feature than we have seen thus far: it is narrowed to contrast sets that include versus exclude u and/or o . I represent this with proximate**.

(29) *Intermediate proximate, with author taking widest scope*

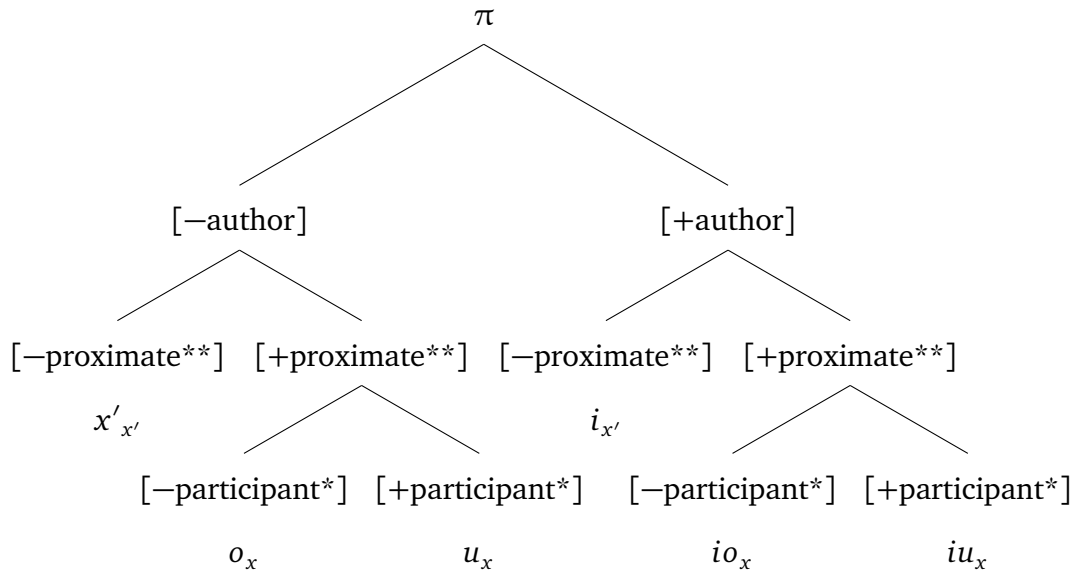

The strange result that this predicts is a contrast between proximate and obviative forms of the exclusive person (and the third person), but no obviation contrast with second or inclusive person. I believe such a partition is unlikely to be observed in any language of the world.

In light of these two results, one which is redundant with another contrastive hierarchy, and one which produces an unlikely partition, the generalization put forward, that the proximate feature cannot take scope *between* either the author or participant features, finds support.

3.5 Where does [\pm proximate] live?

The relationship between different categories of φ -features and the functional sequence is well-established in many cases. It has long been noted that person features show evidence of being lower in the phrase structure hierarchy than number (see Harbour, 2016, p. 153–168 for an extended discussion). Similarly, noun classification has been recognized as being structurally lower than both person and number (e.g. Kramer, 2015). All signs point towards a nominal spine in Ojibwe that is consistent with this basic func-

tional sequence that places noun classification before person, which are both before number.

An emergent issue over the course of the past two chapters has been to determine where the *proximate* feature should associate within the functional sequence. The initial hypothesis associated the proximate feature with π . This assumption turned out to lead to issues with Blackfoot, and languages with an obviation system in the local persons more generally, when interactions with number were considered. Furthermore, associating the proximate feature with π leads to the possibility that the proximate feature should take intermediate scope between the other two person features, which generated partitions that were either redundant (when ignoring number) or unlikely to be attested. The solution that was put forward is to specify the proximate feature on its own projection that can sit either right above nP , where noun classification lives, or $\#P$, where number lives. This ensures that it can only take wide or narrow scope with respect to the features of π , and more generally, it ensures that proximate will compose either right before person (as was evidenced in Ojibwe) or after number (as in Blackfoot).

The case of the “high” proximate feature did lead to questions about whether this feature ultimately serves the same role as the “low” proximate feature. In particular, the fact that there are proximate/obviative distinctions within the singular local persons in Blackfoot raised the possibility that obviation in these cases is related to contrasts in rooted in discourse factors rather than the partitioning of the ontological space of person. The remarks that follow remain in the realm of speculation, given that much is still unknown about the possible differences in reference that the obviative local persons render, and furthermore that the particular discourse contexts that might license the proximate versus obviative local forms are currently underspecified.

The hint that the difference in syntactic height corresponds to either a “partitioning” function versus “discourse” function corresponds more broadly to what is known

about the relation between syntactic height and function. This has been perhaps most extensively articulated by the Universal Spine Hypothesis of Wiltschko (2014), outlined in (30). The highest levels of the functional sequence correspond to a *linking* function, which connects propositions or referents to the discourse. Below that is the *anchoring* layer, which connects events and individuals to the utterance. The next layer is for point-of-view, which establishes the perspective of the event or individual. Finally, the classification layer broadly categorizes events and individuals.

(30) *The Universal Spine Hypothesis (Wiltschko, 2014)*

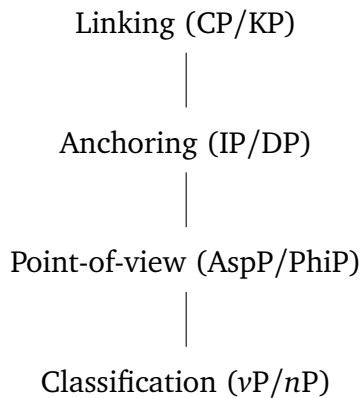

The multifaceted nature of the proximate feature can therefore be connected to much higher level generalizations about the functional sequence, and sheds light on the shape-shifting nature of obviation systems, which have often appeared to defy description. On one hand, obviation is deeply rooted in the lower function of making divisions between different categories of persons, with a cut being made between the proximate and obviative persons. On the other hand, it is highly discourse sensitive, with the particular identity of the “proximate” *o* ostensibly being determined by these factors. To muddy matters even more, yet other work has suggest that obviation systems are related to point-of-view (Bliss, 2005a) or the anchoring of events (Zubizarreta and Pancheva, 2017). The present work has focused almost completely on the classificatory properties of obviation. Detailed analysis of the precise nature of the discourse, perspectival, and

anchoring facets of obviation systems, which must be left to future work, will in turn allow for the eventual unification of these functions, shedding more light on the wider nature of obviation.

CHAPTER 4

A SET-BASED THEORY OF AGREE

4.1 Introduction: Agreement and prominence

Person does not only live on the arguments on which it originates: it appears elsewhere in the clause via agreement. The goal of this chapter is to build a theory of how the person representation motivated in the previous chapter participates in agreement, with some attention also paid to agreement with number and noun class. This puts the pieces in place for the analysis of the Ojibwe verbal agreement system in Chapter 5.

The major empirical goal is to formulate a syntactic representation of person and a theory of agreement that captures person-based prominence effects, as described by the scale in (1).

(1) 1/2 (LOCAL) > 3 (PROXIMATE) > 3' (OBVIATIVE) > 0 (INANIMATE)

Two basic types of prominence effects are attested in agreement systems: (i) *omnivorous* agreement, where particular agreement slots show preferences for agreement according to which argument is highest ranked on the scale in (1), and (ii) *alignment* effects, where agreement shows sensitivities to the relationship between the syntactic position of arguments and their rankings on the person-based prominence scale. The full range of these effects will be captured by the proposed person representation and theory of

AGREE presented in this chapter. In Chapter 5, I show that the system also captures prominence effects in Border Lakes Ojibwe.

Up to this point, the system has treated the features [proximate], [participant], and [author], as well as the head π , as the primitives of the syntactic representation of person—they are only realized as sets or lattices of elements of the person ontology when their denotations are inserted at LF. In this chapter, I argue that there is a syntactic instantiation of the set-based representation, resulting in a richer representation for features in syntax. The same basic sub-sets that were used to form the denotations of features in the previous two chapters are realized syntactically. These sets are shown with their corresponding features in (2).

(2) *A syntactic set-based representation for person*

- a. [Author] = $\{I\}$
- b. [Addressee] = $\{U\}$
- c. [Participant] = $\{I, U\}$
- d. [Proximate] = $\{I, U, O\}$
- e. [Animate] = $\{I, U, O, O', O'', \dots, O^n\}$
- f. $\Pi = \{I, U, O, O', O'', \dots, O^n\}$
- g. $\Phi = \{I, U, O, O', O'', \dots, O^n, R, R', R'', \dots, R^n\}$

Providing a definition of features in terms of these primitives allows us to redefine the operation AGREE with respect to the internal structure of features and the set-based representation. In this view, it is no longer sensible to formulate the Match condition on AGREE as a process of checking feature identity per se (i.e. checking whether the features of the probe match the features of the goal, in label and/or value). Instead, Match is reformulated as a process of determining whether the sets represented by the features of the probe intersect with the goal's set. This reformulation has a number of interesting downstream effects.

The major boon is that the relevant entailments between features and person categories fall out of the first-principles of the system, without stipulating these relationships via second-order representations such as the feature geometry or prominence hierarchy. This is because the sets that the features represent are in proper subset-superset relationships, as shown in (3). Under the proposed reformulation of Match, a goal that Matches (and Satisfies) any given feature on a probe will also Match (and Satisfy) all of the features that are in a superset relationship. For example, a match with [author] entails a match with all other features, because I is a member of every other set as well.

(3) *Subset/superset relationships between person features*

- a. $\Phi \supset [\text{Animate}] \supset [\text{Proximate}] \supset [\text{Participant}] \supset [\text{Author}], [\text{Addressee}]$
- b. $\{I, U, O, \dots, O^n, R, \dots, R^n\} \supset \{I, U, O, \dots, O^n\} \supset \{I, U, O\} \supset \{I, U\} \supset \{I\}, \{U\}$

In the feature geometry, the entailments between person categories are due to the fact that probes and goals cannot be specified for a feature such as [author] without also entailing the presence of [participant], [proximate], and π . The relationships are stipulated, rather than derived. Therefore if a goal has the ability to Satisfy the [author] feature of a probe, it also necessarily has the features to Satisfy [participant], and so on—a goal cannot have an author feature without also having all others. Here this will not be the case, with features being allowed to vary freely on both probes and goals.

In the previous two chapters, we saw that languages parameterize which features are or are not present within the nominal domain to capture the range of available person distinctions within a languages. Freeing the system of the geometry similarly opens up new possibilities for which sets of features can be specified on the probe. Within the feature geometric system, probes with [author] also necessarily include [participant], [proximate], and π —the same entailments that hold for goals hold for probes. This is not the case in the set-based theory presented here. The system allows for the features on the person probe to be attested in all combinations, and without any internal

organization—for example, a person probe π can include [author] but not [participant]. I show that this captures the exact range of person-hierarchy effects observed across languages.

The chapter is divided into five parts. Section 4.2 provides a comprehensive review of the possible range of person-based prominence effects in agreement systems, setting the parameters for what a complete theory of person agreement must account for. Section 4.3 details the proposed syntactic set-based representation of features for both agreement probes and goals. In Section 4.4, I review and reformulate the components of AGREE with this new representation in hand. Section 4.5 shows how the system accounts for all and only the range of person-based prominence effects reviewed in Section 4.2. I close with Section 4.6, which provides a direct comparison to previous accounts based in the feature geometric representation, where, besides having conceptual disadvantages, I show the geometry fails to capture the full range of possible prominence effects.

4.2 Empirical underpinnings

In this section, I provide an overview of the agreement phenomena that can be described by the person-based prominence hierarchy. Consider the logically possible rankings, given the “basic” categories of first, second, and third (ignoring obviation and number):

(4) *Logically possible rankings*

1 > 2 > 3

2 > 1 > 3

*1 > 3 > 2

*3 > 1 > 2

*2 > 3 > 1

*3 > 2 > 1

$$1/2 > 3$$

$$1 > 2/3$$

$$2 > 3/1$$

$$*3/1 > 2$$

$$*3/2 > 1$$

$$*3 > 2/1$$

$$1/2/3$$

Those rankings which are unattested across all languages are indicated with “*” above, with all others appearing in one language or another. It should be clear that the variation in possible effects is wide, but still circumscribed. There are two maximal rankings, $1 > 2 > 3$ and $2 > 1 > 3$, which alternate in which of the local persons is highest ranked. All other rankings flow from the possible collapses of these two rankings, with a collapse grouping together adjacent categories onto one level. This means that while the local persons and the third person can be *unranked* with respect to one another by being collapsed into a single level of the scale, a ranking where third is above a local person is not possible. While rankings are seen here as a descriptive tool, it provides the means to express the generalizations that our syntactic representation and theory of AGREE must account for, and guides the discussion of this section.

I split hierarchy-based effects into two basic classes: (i) *omnivorous agreement*, where a probe shows a preference for a higher ranked argument regardless of its syntactic role, and (ii) *alignment effects*, where agreement is affected by a combination of prominence ranking and the syntactic position of the arguments (e.g. indirect versus direct object or subject versus object). These effects provide the motivations, and define the basic needs and limits, for a theory of agreement.

4.2.1 Omnivorous agreement

Omnivorous agreement (a term coined by Nevins, 2011) occurs when a given agreement slot shows a preference to agree with a particular category. This section overviews three cases where a pattern of this sort appears: (i) Kichean Agent-Focus, (ii) Nez Perce Complementizer agreement, and (iii) Cuzco Quechuan Subject Marking Anomalies. The latter two patterns ultimately support the existence of a more refined person-based prominence hierarchy, where it becomes necessary to specify a ranking between first and second persons.

4.2.1.1 Kichean Agent-Focus

As discussed at length in Preminger (2011, 2014), agreement in the *Agent-Focus* construction of Kichean (Mayan) displays such a pattern for person. To start, consider the baseline cases in (5), where both arguments are third person (animate) arguments. Here, the agreement marker takes the third person form, which happens to be null.

(5) ***Kichean Agent-Focus: 3 ↔ 3 = 3***

- a. ja ri tz'i' x-∅-etzel-an ri sian
FOC the dog COM-3SG.ABS-hate-AF the cat
'It was the dog that hated the cat.'
- b. ja ri xoq x-∅-tz'et-ö ri achin
FOC the woman COM-3SG.ABS-see-AF the man
'It was the woman who saw the man.' (Preminger, 2014, p. 18)

Consideration of agreement in mixed clauses, where one argument is a local person and the other a third person, sharpens the picture. The examples in (6) and (7)—with second and first persons, respectively—show that local agreement arises regardless of whether the local argument is the subject as in (6a) and (7a), or the object, as in (6b) and (7b). In all cases, realizing third person agreement is ungrammatical.

(6) *Kichean Agent-Focus: 3 ↔ 2 = 2*

- a. ja rat x-at/*∅-ax-an ri achin
FOC you.SG COM-2SG/*3SG.ABS-hear-AF the man
'It was you (SG) that heard the man.'
- b. ja ri achin x-at/*∅-ax-an rat
FOC the man COM-2SG/*3SG.ABS-hear-AF you.SG
'It was the man that heard you (SG).'
- (Preminger, 2014, p. 18)

(7) *Kichean Agent-Focus: 3 ↔ 1 = 1*

- a. ja yin x-in/*∅-ax-an ri achin
FOC me.SG COM-1SG/*3SG.ABS-hear-AF the man
'It was me that heard the man.'
- b. ja ri achin x-in/*∅-ax-an yin
FOC the man COM-1SG/*3SG.ABS-hear-AF me.SG
'It was the man that heard me.'
- (Preminger, 2014, p. 20)

The connection to the person-based prominence hierarchy should be immediately apparent: show agreement with the highest ranked noun in person.¹ When the subject is higher ranked, agreement indexes the subject; when the object is higher ranked, agreement indexes the object.

One restriction not captured by the generalization above is the observation that *local only* combinations are entirely ungrammatical, regardless of choice of agreement. This is shown in (8).

(8) *Kichean Agent-Focus: *1 ↔ 2*

- a. *ja rat x-in/at/∅-ax-an yin
FOC you.SG COM-1SG/2SG/3SG.ABS-hear-AF me.SG
Intended: 'It was you (SG) that heard me.'
- b. *ja yin x-in/at/∅-ax-an rat
FOC me.SG COM-1SG/2SG/3SG.ABS-hear-AF you.SG
Intended: 'It was me that heard you (SG).'

¹I do not review the patterns here, but Preminger shows that considering non-singular nouns gives evidence that number is also realized. So this generalization would more accurately be stated as agreement in person *and* number.

This restriction is more broadly linked to the observation that all local persons must be “licensed” by an agreement probe. Certain probes are only able to license a single argument, leaving the other *unlicensed*. This results in ungrammaticality.

4.2.1.2 Nez Perce Complementizer Agreement

A related, though importantly distinct, omnivorous agreement pattern can be seen with complementizer agreement in Nez Perce (Deal, 2015). As with Kichean Agent-Focus, agreement in a transitive clause with two third person singular arguments is null:

(9) *Nez Perce C Agreement: 3 ↔ 3 = 3*

ke-∅ kaa A.-nim pee-cewcew-téetu T.-na
 C-3 then A.-ERG 3/3-call-TAM T.-ACC
 ‘When A. calls T.’

(Deal, 2015, p. 4)

The initial patterns are omnivorous in the same way as seen above, with local persons being agreed with regardless of whether they are the subject or object when they are combined with a third person. This can be seen for the combination of first and third person in (10), and with second and third person in (11).

(10) *Nez Perce C Agreement: 1 ↔ 3 = 1*

a. ke-x kaa *pro* ’e-cewcew-téetu A.-ne
 C-1 then 1SG 3OBJ-call-TAM A.-ACC
 ‘When I call A.’

b. ke-x kaa A.-nim hi-cewcew-téetu *pro*
 C-1 then A.-ERG 3SUBJ-call-TAM 1SG
 ‘When A. calls me’

(Deal, 2015, p. 4)

(11) *Nez Perce C Agreement: 2 ↔ 3 = 2*

a. ke-m kaa *pro* ’e-cewcew-téetu A.-ne
 C-2 then 2SG 3OBJ-call-TAM A.-ACC
 ‘When you call A.’

- b. ke-m kaa A.-nim hi-cewcew-téetu *pro*
 C-2 then A.-ERG 3SUBJ-call-TAM 2SG
 ‘When A. calls you’ (Deal, 2015, p. 4)

The new pattern comes with the local-only configurations. Rather than being ungrammatical, with $2 \rightarrow 1$ configurations, only second person agreement appears. With $1 \rightarrow 2$, both first and second person agreement appears.

(12) *Nez Perce C Agreement: $2 \rightarrow 1 = 2, 1 \rightarrow 2 = 2 + 1,$*

- a. ke-m kaa *pro* cewcew-téetum *pro*
 C-2 then 2SG call-TAM 1SG
 ‘When you call me’
- b. ke-m-ex kaa *pro* cewcew-téetu *pro*
 C-2-1 then 1SG call-TAM 2SG
 ‘When I call you’ (Deal, 2015, p. 6)

It is clear that Nez Perce contrasts with Kichean in allowing argument combinations with more than one local person—in these cases, it generally privileges second person agreement over first, but shows agreement with both if the first person argument is a subject. Again, our agreement theory must allow for such variation. In terms of the hierarchy, the pattern can be described as $2 > 1 > 3$: both first and second are preferred over third, while second is in turn preferred over first.²

4.2.1.3 Cuzco Quechua Subject Marking Anomalies

A third and final pattern within the “omnivorous” agreement family comes from so-called *Subject Marking Anomalies (SMAs)* in Cuzco Quechua. The concern here is the form of the outer agreement suffix, which, as shown in the examples in (13), generally

²A challenge is to account for why *both* first and second person agreement appear in the $1 \rightarrow 2$ configurations, rather than second person alone. If it were a “pure” omnivorous preference for $2 > 1$, then we might expect no first person agreement at all to appear in these cases. This is discussed further in Section 4.5.4.3.

shows agreement with the subject. With $1 \rightarrow 3$ the marker shows agreement with the first person, and in the reverse case ($3 \rightarrow 1$) it shows agreement with the third person.

(13) *Cuzco Quechua SMA: $1 \rightarrow 3 = 1, 3 \rightarrow 1 = 3$*

- a. maylla- \emptyset -rqa-**ni**
wash-3-PAST-**1**
'I washed h/'
- b. maylla-wa-rqa-**n**
wash-1-PAST-**3**
'S/he washed me'

(Hoggarth, 2004; Myler, 2017)

So far, this pattern is *not* omnivorous. However, omnivorism appears with second person arguments. As shown in (14), when a second person is combined with a third person either as a subject (14a) or an object (14b), agreement is shown with the second person (shown in bold).

(14) *Cuzco Quechua SMA: $3 \leftrightarrow 2 = 2$*

- a. maylla- \emptyset -rqa-**nki**
wash-3-PAST-**2**
'You washed h/'
- b. maylla-rqa-su-**nki**
wash-PAST-2-**2**
'S/he washed you'

(Hoggarth, 2004; Myler, 2017)

The same basic generalization holds between local-only combinations, shown in (15), where second person agreement is shown regardless of whether it is the subject (15a) or the object (15b).

(15) *Cuzco Quechua SMA: $2 \leftrightarrow 1 = 2$*

- a. maylla-wa-rqa-**nki**
wash-1-PAST-**2**
'You washed me'

- b. maylla-rqa-Ø-yki
 wash-PAST-2-2
 ‘I washed you’

(Hoggarth, 2004; Myler, 2017)

Like the patterns in Nez Perce, agreement preferences target the second person over the first person. However, the pattern can be more straightforwardly be described as a $2 > 1/3$ pattern, where agreement targets a second person over all others, while if no second person is available, then agreement defaults to targeting the subject.

4.2.2 Alignment effects

Alignment adds an additional layer of complexity to hierarchy effects. These effects are described by considering the relationship between two scales, in this case the person-based prominence hierarchy, repeated in part in (16a), and a syntactic position hierarchy, which ranks syntactically higher nouns above syntactically lower nouns.

- (16) a. $1/2 > 3$ *Partial person-based prominence hierarchy*
 b. HIGH > LOW *Syntactic position hierarchy*

The contrast between “high” and “low” is not specific to sitting in a particular projection within the phrase structure—rather, it is relativized. The relation is broadly schematized in (17). Here, DP_2 is more deeply embedded than DP_1 ; therefore we can derive a ranking of $DP_1 > DP_2$, based on their relative positions in the hierarchy. Such configurations are observable in a variety of familiar constructions, including between subject (high) and object (low) of a transitive clause, or indirect object (high) and direct object (low) of a ditransitive.

- (17) [... DP_1 [... DP_2]]

The scales in (16) can be aligned in two different ways, which we are broadly referred to as DIRECT and INVERSE. These alignments are schematized in (18). The DIRECT

alignment (18a) matches the higher ranked element on one scale with the higher ranked element on another (and, correspondingly, matches lower to lower). In our case, this means the syntactically higher argument is also a “more prominent” person (i.e. first or second). The INVERSE alignment (18b) crosses high and low between the two scales—here, this results in the syntactically higher argument being “less prominent” than the syntactically lower argument.

(18) a. DIRECT *alignment*

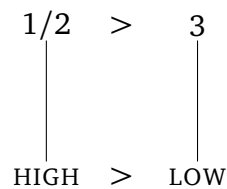

b. INVERSE *alignment*

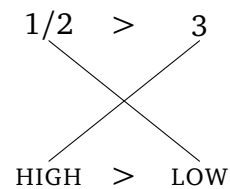

In the next few sections, I review two categories of alignment effects: (i) the Person-Case Constraint (PCC), generally recognized as a family of restrictions on indirect/direct object clitics; and (ii) direct-inverse marking, a pattern of Voice agreement (and one of the main focuses of the upcoming analysis of Ojibwe).

4.2.2.1 The PCC

While not the main focus of the dissertation, the PCC provides critical background for understanding the basic form of alignment effects. It is the most studied of these effects, and therefore provides a solid baseline and exemplifies the range of variation that these effects can show.

The basic phenomenon can be observed in Basque, a language isolate of the Pyrenees. As previously noted, the PCC restricts the possible combinations of indirect/direct objects (IOs and DOs). Here, we see that the alignment where the structurally higher IO is first person and the lower DO is third person as in (19a) is grammatical. This is a DIRECT alignment. In contrast, the combination where the IO is a third person and the DO a first person as in (19b)—the INVERSE alignment—is ungrammatical.

(19) *The PCC in Basque (examples from Coon and Keine, 2020)*

- a. Zu-k ni-ri liburua saldu d-i-da-zu
 you-ERG me-DAT book.ABS sold 3ABS-aux-1DAT-2ERG
 ‘You have sold the book to me.’ *Basque: 1DAT > 3ABS*
- b. *Zu-k harakina-ri ni saldu n-(a)i-o-zu
 you-ERG butcher-DAT me.ABS sold 1ABS-aux-3DAT-2ERG
 Intended: ‘You have sold me to the butcher.’ *Basque: *3DAT > 1ABS*

Many languages around the world show PCC effects, but the exact combination of arguments that is ungrammatical is a matter of variation. There are four basic “strengths” of the effect, summarized in Table 4.1. Basque shows what is referred to as the *Strong* PCC. We have only see a subset of the relevant examples, but the Strong PCC restricts all combinations where the DO is a first or second person. Like the Strong variant, the Weak PCC bans combinations where the DO is a first or second person, but only when the DO is a third person. The Ultra Strong PCC bans the same configurations as the Weak PCC, plus configurations where the IO is a second person and the DO first. Finally, the Me-First PCC bans all combinations with a first person DO. (Then, there are languages like Moro, that have cliticization but are not reported to have PCC effects).

	IO > DO	Languages
<i>Strong</i>	*2/3 > 1, *1/3 > 2	Slovenian, Basque, Greek, Kiowa
<i>Ultra Strong</i>	*3 > 1/2, *2 > 1	Classical Arabic
<i>Weak</i>	*3 > 1/2	Catalan varieties, Italian, Sambia
<i>Me-First</i>	*2/3 > 1	Romanian, Bulgarian
<i>No PCC</i>	—	Moro

IO	DO	<i>Strong</i>	<i>Ultra Strong</i>	<i>Weak</i>	<i>Me-First</i>	<i>No PCC</i>
1	3	✓	✓	✓	✓	✓
2	3	✓	✓	✓	✓	✓
1	2	*	✓	✓	✓	✓
2	1	*	*	✓	*	✓
3	1	*	*	*	*	✓
3	2	*	*	*	✓	✓

Table 4.1: Summary of PCC effects, shown two different ways. Summaries based on those found in Coon and Keine (2020) and Deal (2020).

At first blush, the distribution of these restrictions may appear to be somewhat scattered. However, the cline of effects can be described, with one caveat to capture the Strong PCC in certain languages, via the alignment of the person-based prominence and syntactic position hierarchies. This is shown in (20). The Strong PCC (20a) shows evidence of both $1 > 2$ and $2 > 1$ rankings, with both local persons being ranked above the third person. The ranking of $1 > 2 > 3$ captures the Ultra Strong PCC (20b), a collapse of first and second the Weak PCC (20c), a collapse of second and third the Me-First PCC (20d), and a full collapse a language that lacks PCC effects entirely (20e).

(20) ***Observed PCC types and correspondence to possible rankings***

- a. *Strong*: $\{1 > 2, 2 > 1\} > 3$
- b. *Ultra Strong*: $1 > 2 > 3$
- c. *Weak*: $1/2 > 3$
- d. *Me-First*: $1 > 2/3$
- e. *No PCC*: $1/2/3$

It should be emphasized that collapsing adjacent rankings in this way is *not* a violation of the person-based prominence hierarchy, but rather shows that the realization of a given ranking is variable across languages (and, ultimately, particular constructions). Patterns that would constitute a *true* violation of the hierarchy, for example a ranking of $3 > 1/2$, which puts third persons above local persons, are unattested. The lack of this ranking can be observed by the fact that, in all languages, regardless of strength of the PCC, it is grammatical for a third person to be a DO under a first or second person IO. This is shown in the first two rows of the bottom table in 4.1, where there are checkmarks across the board.

There is one final step. Taking each of the possible rankings in (20) and deriving alignments with the syntactic position hierarchy shows that there is an unbroken correspondence between INVERSE alignment and ungrammaticality (and, similarly, DIRECT

alignment and grammaticality). This is schematized for each case in (21), noting that a language with no ranking will not give rise to any inverse alignments, deriving the lack of PCC effects.

(21) *INVERSE alignments are ungrammatical across all PCC varieties*

a. *Strong*

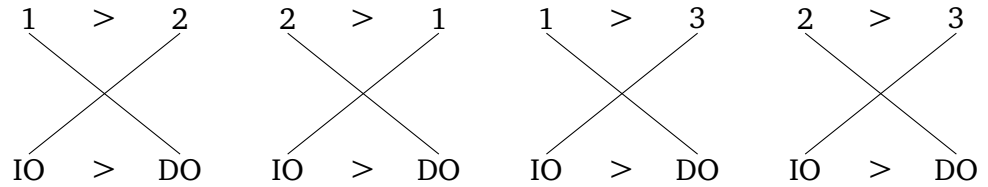

b. *Ultra Strong*

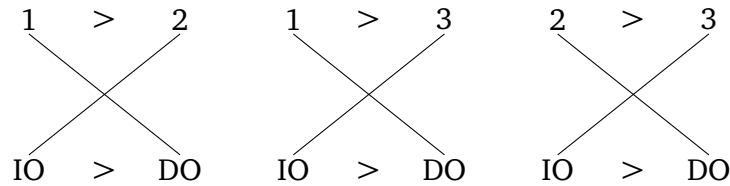

c. *Weak*

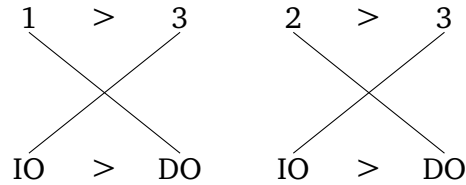

d. *Me-First*

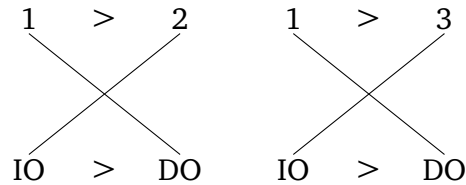

But, as previously noted, the Strong PCC has some internal variation, with different languages showing these basic effects of the surface receiving different explanations. The “Canonical” Strong PCC of Basque has been analyzed by treating dative marked arguments as third persons for the purposes of agreement (Coon and Keine, 2020). There is independent evidence for this move, which I set aside here in the interest of

streamlining the discussion. Considering the example in (21), the dative first person is thus treated as a third person.

- (22) *Haiek ni-ri zu saldu z-ai-da-te
 they.ERG me-DAT you.ABS sold 2ABS-aux-1DAT-3ERG
 Intended: ‘They have sold you to me.’ *1DAT > 2ABS

The violation within the local-only configurations therefore reduces to an INVERSE alignment under the $2 > 3$ ranking. In the second person IO over first person DO (again, not shown), where the second person is then dative, this can be captured by an INVERSE alignment under the $1 > 3$ ranking. Therefore the Canonical Strong PCC of Basque is derived from the same basic ranking as the Weak PCC ($1/2 > 3$), with the additional assumption that dative arguments are treated as third persons. There is this no need for any ranking between first and second person to account for the Basque pattern.

That said, the so-called “Reversible” Strong PCC of Slovenian (Stegovec, 2020) provides evidence for a case where the $1 > 2$ and $2 > 1$ rankings truly co-exist within a single paradigm. With certain groups of speakers, restrictions against $1 + 2$ combinations occur independently of case marking, supporting an analysis where certain varieties of the Strong PCC are not due to independent properties of dative nouns, but to person restrictions proper. From the point of view of the hierarchy itself, the existence of this pattern is problematic, as it requires paradoxical rankings to be maintained (i.e. 1 must be ranked both above and below 2). However, as is discussed further in Section 4.5.2, the possible probe structures under the current account can capture these patterns. This further bolsters the view that such hierarchies are simply approximations of the actual representation that underlies prominence effects.

That said, it is worth highlighting the logically possible rankings of the three basic categories that are, so far, not attested in PCC configurations in any language of the world. These are given in (23). Most of these unattested rankings boil down to the

generalization that first and second person are never ranked below third person, either together or alone. However two rankings, which are bolded in (23), stand out as exceptions to this general rule. These are the so-called *You-First* patterns, where the second person is ranked above third person. Again, no language has yet surfaced that provides evidence for a PCC effect of this sort. The $2 > 3/1$ ranking would be analogous to the Me-First PCC, but instead banning second persons from appearing in the object position. The $2 > 1 > 3$ ranking would be exemplified by a language with restrictions like the Ultra Strong PCC, but with a ban on a first person IO over a second person DO, rather than the other way around.

(23) *Remaining logically possible rankings, some attested outside of the PCC*

$2 > 1 > 3$

Nez Perce

$3 > 2 > 1$

$3 > 1 > 2$

$1 > 3 > 2$

$2 > 3 > 1$

$2 > 3/1$

Cuzco Quechua

$3/1 > 2$

$3/2 > 1$

$3 > 2/1$

The puzzle is that while evidence for such rankings has not been found within the PCC family, a number of languages show agreement patterns and restrictions where second person appears to be privileged. The first such example was seen with Nez Perce, where local-only combinations always showed agreement with second person over first person in local-only configurations, and local over third person in mixed configurations. The second case was with Cuzco Quechua, where agreement targeted second person over both third and first, with no evidence of a ranking between first and third persons. This

raises the possibility that the failure to observe PCC effects of these sorts are simply accidental gaps in our typological knowledge, rather than true gaps in the typology of possible PCC types (for a recent discussion, see Deal, 2020). We should therefore expect future work to reveal clear patterns of this sort within the PCC family.

4.2.2.2 Direct-inverse marking

Like the PCC, direct-inverse marking agreement systems can be described via the alignment of arguments with the person-based prominence and syntactic position hierarchies, and show variation (both within and across languages) in the distribution of the marking. The basic form of the direct-inverse alternation is exemplified in (24) in Border Lakes Ojibwe. Note that these are *independent order* verbs (matrix verbs), which differ from the *conjunct order* in where inverse marking arises. Here, we see that the direct alignment $1 \rightarrow 3$ leads to what is descriptively referred to as a direct marker *-aa* (which in fact is third person proximate agreement—agreement with the object), while the inverse alignment $3 \rightarrow 1$ leads to the inverse marker *-ig*—a form that is unmarked for person.

(24) ***Ojibwe Independent Order: 1 → 3 = DIRECT, 3 → 1 = INVERSE***

- a. ni- waabam **-aa**
 1- see **-3**
 'I see h/ (PROX)'
- b. ni- waabam **-ig**
 1- see -INV
 's/he (PROX) sees me'

For now, I forgo the morphological details of direct-inverse marking — this is the focus of the Chapter 5. While inverse marking is found across a wide number of language families, here I restrict focus to variation within the Algonquian languages. The general

range of variation of inverse marking within the conjunct verbal order (i.e. embedded clauses) is summarized in Table 4.2, which is adapted from the work of Oxford (2014).

EA	IA	<i>Ojibwe</i>	<i>Delaware</i>	<i>Massachusetts</i>	<i>Blackfoot</i>
1	3	—	—	—	—
2	3	—	—	—	—
1	2	—	—	—	—
2	1	—	—	—	INV
3	1	—	—	INV	INV
3	2	—	INV	INV	INV
3	3'	—	—	—	—
3'	3	INV	INV	INV	INV

Table 4.2: Distribution of inverse (“INV”) and non-inverse (“—”) across Algonquian in the conjunct order, setting aside number (all forms above are singular, which obscures some additional complications). Adapted from Oxford (2014).

The first and most striking observation is that all languages that distinguish proximate and obviative show evidence of a ranking between proximate and obviative persons. This can be seen by the uniformity of the final two rows. There is no language within the family that fails to show inverse marking with the 3' → 3 combination. This corresponds to the ranking in (25) being present for all languages that make a proximate/obviative distinction in the first place.

(25) *Obviative hierarchy: 3 > 3'*

This differs from what we have seen so far with rankings between other types of person categories. While the patterns emerging from the PCC showed that third person is never ranked *above* either of the local persons, there was evidence suggesting these rankings could be collapsed, rendering all categories “equally prominent”. In other words, even in a language that, for example, distinguishes the categories of first and second person, it is not necessarily the case that the agreement system will provide the means to show a ranking between these categories. With obviation, it appears that such a collapse in the ranking never occurs if those categories are present within a language.

The remaining patterns in Table 4.2 largely follow from ranking variation within the original hierarchy, and is summarized in (26).

- (26) a. *Blackfoot*: $1 > 2 > 3 > 3'$
b. *Massachusetts*: $1/2 > 3 > 3'$
c. *Ojibwe*: $1/2/3 > 3'$

Of interest is the fact that Algonquian *lacks* one of the possible collapses of the hierarchy, given a $1 > 2$ ranking. The *Me-First* type pattern that collapses second and third with first person ranked above both ($1 > 2/3$), is unattested. Furthermore, it entirely lacks evidence of the *You-First* class of patterns where second is ranked above first and/or third persons. As with apparent gaps in the variation within the PCC family of effects, at this point, it is unclear whether such gaps are accidental, or if they are indicative of a wider generalization about how hierarchy effects arise.

There is one exceptional case, which is missing from the summary in (26): The pattern exemplified by Delaware in Table 4.2. Here, inverse is (aside from the universal $3' \rightarrow 3$ cases) only triggered by $3 \rightarrow 2$. This implies a hierarchy, shown in (27), where second person is ranked above third person, but there is no specification of first person within the ranking at all.

- (27) *Delaware*: $2 > 3 > 3'$

This differs from the previously seen collapses, where two categories end up co-ranked. Any collapse of this sort would overgenerate the expected distribution of inverse. For example, if there were a collapse between first and second rather than simply an absence of first person within the ranking, we would additionally predict inverse with $3 \rightarrow 1$ (the pattern seen in Massachusetts). If there were a collapse between first and third, we

would expect inverse to arise with $1 \rightarrow 2$ (the inverse analogue of a You-First alignment effect).

While the pattern exemplified by Delaware is exceptional, it is not singular. Hierarchy effects described by $2 > 3$, without any reference to first person, can also be seen with *argument co-occurrence restrictions* in languages such as Halkomelem (Gerdt, 1988; Wiltschko and Burton, 2004) and Chamorro (Chung, 1998). Past accounts of this pattern, such as Wiltschko and Burton (2004), have argued that the analogy of these restrictions to other hierarchy effects is a red herring, instead treating them as accidental paradigmatic gaps. I do not take a strong stance on the correct analysis for the various $2 > 3$ patterns. However, given that they have received treatments that allow them to fall outside of the direct scope of person-based prominence effects, I set them aside and exclude them as part of the core patterns to be explained in this chapter.

4.2.3 Summary

In this section, we have seen evidence that the full range of expected prominence-based effects is observed. Given three basic person categories of first, second, and third, with a strong constraint against a ranking that places third person above either of the local persons, there are six possible patterns. The two maximal rankings can either put first above second or second above third (Ultra Strong effects) or realize both of these rankings at once (Strong effects). The ranking of first and second person can be collapsed (Weak effects), second or first person can be collapsed with third (deriving Me-First or You-First effects), or the categories can be unranked (No Effect). This range of variation, and the name associated with each possibility, is summarized for reference in (28).

(28) **Summary of Person-Based Prominence Effects**

<i>Ultra Strong (Author):</i> $1 > 2 > 3$	<i>Blackfoot, Classical Arabic</i>
<i>Ultra Strong (Addressee):</i> $2 > 1 > 3$	<i>Nez Perce</i>
<i>Strong:</i> $\{1 > 2, 2 > 1\} > 3$	<i>Slovenian</i>
<i>Weak:</i> $1/2 > 3$	<i>Massachusetts, Kichean, Italian</i>
<i>Me-First:</i> $1 > 2/3$	<i>Romanian</i>
<i>You-First:</i> $2 > 1/3$	<i>Cuzco Quechua</i>
<i>No Effect:</i> $1/2/3$	<i>Ojibwe, Moro</i>

The addition of a proximate-obviative distinction, if present in a given language, always results in a ranking of the proximate category over the obviation category. There is no example of a language that contains this distinction, but collapses the ranking between these categories.

(29) *Obviative hierarchy:* $3 > 3'$

The goal now is to formulate a theory of agreement, and adopt a representation of person, that allows the semi-constrained variation in person-based prominence effects to be captured.

4.3 Features as sets (in syntax)

To reprise the main claim of the chapter, the major representational move to be made is to treat each φ -feature as a set *in syntax*. The focus here is almost entirely on person, where the sets that constitute each feature are made up of a combination of *I*, *U*, and/or some number of *O*'s. This means that features will no longer be the most primitive representation within morphosyntax. This job is now taken up by the syntactic analogues of the ontological primitives, which ultimately denote the author, addressee, and others.

To understand the consequence of this claim, it is important to start by considering the feature representation that is generally accepted within current theories of morphosyntax. The same basic motivations drive the current proposal. Again taking person features as our example, we have three basic features [proximate], [participant], and [author]. For the purposes of syntactic computations such as agreement, the *labels* “proximate”, “participant”, and “author” are completely arbitrary. They could equally be called “F”, “G”, and “H”, or any other trio of labels, as long as they are distinct from one another. These labels are nothing more than addresses or look-up codes (i.e. *indices* in the relevant sense), which, when transferred to the interfaces, condition the insertion of particular denotations and morphophonological exponents. In this way, they are associated with particular meanings and forms, without themselves containing that information at each given point in the derivation.

Given this assumption of modularity, the manipulation of features in syntax occurs without any direct reference to a feature’s eventual semantic and morphophonological interpretation. Operations such as agreement, movement, and selectional restrictions on MERGE thus involve simple identity-matching between feature labels. In the case of AGREE, the need for such “checking” is ultimately driven by one of these features having the additional property of being *uninterpretable*, *unvalued*, or *unsatisfied*—features with the attribute define probes. The other feature involved in checking is a counterpart that matches in label, with the ability to delete, value, satisfy, or otherwise alleviate the needs of the feature that triggers the checking relationship—these features define potential goals for agreement.

The system I propose has the same basic feature structure as reviewed above, consisting of a value and a label, and also has the goal of retaining the modularity and autonomy of syntactic generation. The difference is in what the sub-pieces of the feature represent. Rather than each feature representing a single index such as “proximate”, “participant”, or “author”, they instead represents a set of primitive indices $\{I, U, O\}$,

$\{I, U\}$, or $\{I\}$, respectively. These collections of syntactic *primitives* are the analogues of the basic distinctions within the ontology of person, but are not themselves semantically interpretable to preserve the modularity of syntactic generation.

It is important to highlight that while syntactic representations have the *potential* to be infinite via, for example, the recursive properties of the grammar, the representation itself is finite and bounded. Therefore one restriction on the syntactic theory of features put forward here is ensuring that each feature represents a bounded set. This differs from the semantic representation discussed in the previous two chapters, where the number of *o*'s within the ontology was unbounded, and therefore created a non-finite lattice of the power set of the entire π/φ ontology.

4.3.1 Feature sub-parts: Labels and values

As discussed above, a feature consists of two basic parts: I refer to these as the label and the value. Both of these properties were discussed at length in Chapter 2 for the purposes of creating partitions of the semantic space of person. The label denoted a (power set of) some subset of the person ontology, and values denoted operations that allowed features to interact and partition this ontological space. In this section, I cover the properties of labels and values relevant to formulating a theory of syntactic agreement.

The label is proposed to be shorthand for a set that consists of a collection of primitive indices. To represent the syntactic instantiations of each of these primitives, which crucially do not have a semantic interpretation, I use capital letters *I*, *U*, and *O*, respectively. All features are minimally comprised of these set-based labels. In the coming sections, I continue to use the notation [proximate], [participant], and [author] a convenience, keeping in mind that these labels are now shorthand for the sets $\{I, U, O\}$, $\{I, U\}$, and $\{I\}$, respectively.

The second property is the value. So far, we have seen binary values where features are either positive (+) or negative (–). These values will play a role in syntax by defining the sets on possible agreement goals (see Section 4.3.3). However, the major focus of the chapter is with cases where a feature lacks a value altogether—i.e. when a feature is *unvalued*. Unvalued features trigger checking relationships, often leading to agreement. The notational conventions for each type of feature is shown in (30).

(30) *Positive, negative, and unvalued features with the label F*

- a. *Positive*: [+F]
- b. *Negative*: [–F]
- c. *Unvalued*: [uF]

Despite the potential for confusion, I retain the notational convention of using [uF] to represent features that trigger checking/agreement, using it to represent a feature that is unvalued (or, if you wish, unsatisfied). This should not be confused with the notion of *(un)interpretability*, which has no role in the current theory either as a driver of checking/agreement (Preminger, 2011, 2014) or as a way to restrict the interpretation of features at LF (Hammerly, 2019a). In other words, there is no “interpretable” [iF] counterpart within the theory.

To summarize, much should be highly familiar already. Unvalued features are used to define the features on agreement probes, while valued features define the features of goals. For the current purposes, we can roughly split these features between “verbal” and “nominal” domains, keeping in mind that agreement probes are not necessarily limited to the verbal spine (i.e. many analyses of nominal concord make use of same mechanisms as verbal agreement). In the next section (Section 4.3.2), I expand on the nature of probes under this representation. In Section 4.3.3 I detail the nature of *goals*, those element that are targets of agreement.

4.3.2 φ -features on person probes: Defining the possibilities

The major benefit of the move towards a set-based representation of features is that the number of possible person probes opens up. The focus of this section is not to define how these probes participate in agreement — those aspects of the theory are covered in Section 4.4 — but rather to outline the possible feature combinations that can be specified on the person probe. I also largely set aside direct comparisons to the leading alternatives such as the feature geometry, which are discussed in Section 4.6.

The following features/heads are relevant to the person probe.

(31) *Person features as sets (probe domain)*

- a. $[u\text{Author}] = u\{I\}$
- b. $[u\text{Addressee}] = u\{U\}$
- c. $[u\text{Participant}] = u\{I, U\}$
- d. $[u\text{Proximate}] = u\{I, U, O\}$
- e. $[u\text{Animate}] = u\{I, U, O, O', O''\}$
- f. $[u\Pi] = u\{I, U, O, O', O''\}$
- g. $[u\Phi] = u\{I, U, O, O', O'', R, R', R''\}$

There are two things to note immediately. First, both the [participant] and [addressee] features are generally available to be specified on a probe. This differs from the representation seen within the nominal domain, where the addressee feature was derived via contextually triggered winnowing of the [participant] feature to [participant*], which is functionally an addressee feature. In Chapter 1, I termed this *Addressee Asymmetry*. One might imagine a theory of the features of the probe that mirrors this tradeoff between having a full participant feature versus a winnowed feature. However, the empirical patterns do not support this view, as shown in more detail in Section 4.5.2. While this raises questions about how to manage having different representa-

tions of person within two syntactic domains (i.e. nominal versus verbal; goal versus probe), it is motivated not by theory-internal considerations but the empirical footprint of prominence-based agreement effects. Again, for further discussion, see Chapter 7.

Second, the [animate] feature represents the same set as the head π . As a result, the animate set and the set Π can be used more or less interchangeably. That said, both are broadly necessary given that [animate] defines a feature, while π defines a functional head. In particular, I assume following Béjar and Rezac (2003) that the person probe (π) can be specified separately from the number probe ($\#$).³ This mirrors the claims made for the nominal spine, where person and number features were specified on separate functional projections. I assume that a “pure” person probe minimally and necessarily contains the set $u\Pi$, which is the set defined by the person probe defining functional head π . In contrast, the [animate] feature can appear in places other than a pure person probe, allowing agreement based on this set to appear in the absence of π .

For the time being, I focus on the *core* person features [author], [addressee], and [participant], and only so-called pure person probes that are defined by the functional head π and as a result necessarily contain the $u\Pi$ set. As discussed at length in the previous two chapters, there is evidence from the typology of possible person distinctions that both [animate] and [proximate], while operating over the same representation and serving the same basic function of the core person features, are not necessarily associated with the functional head π . We will see that these features can appear on a probe with the core person features (as well as elsewhere in the clause), but I reserve deep discussion of these probes to Chapter 5, where I explore the agreement patterns of Ojibwe. Given these three features, and the restriction that the pure person probe must be specified for $u\Pi$, there are 8 possible probes, summarized in (32).⁴

³This is not meant to exclude the possibility of *fused probes*, where person and number interact conjunctively (Coon and Bale, 2014); These are discussed in Section 4.5.3.

⁴Note, there are two probes that can capture the Strong patterns of the distribution of inverse. This is discussed further in Section 4.5.2.

(32)	a.	{ $u\Pi$ }	1/2/3
	b.	{ $u\Pi, uParticipant$ }	1/2 > 3
	c.	{ $u\Pi, uAuthor$ }	1 > 2/3
	d.	{ $u\Pi, uAddressee$ }	2 > 1/3
	e.	{ $u\Pi, uParticipant, uAuthor$ }	1 > 2 > 3
	f.	{ $u\Pi, uParticipant, uAddressee$ }	2 > 1 > 3
	g.	{ $u\Pi, uAddressee, uAuthor$ }	{1 > 2, 2 > 1} > 3
	h.	{ $u\Pi, uParticipant, uAddressee, uAuthor$ }	{1 > 2, 2 > 1} > 3

The goal is to show how these 8 probes capture the typology of person agreement systems, as particularly exemplified by the typology person-based prominence effects reviewed in Section 4.2. The correspondence between these different patterns, and the different types of person probes, is also indicated in (32).

To preview what is explored further in Section 4.6, where a direct comparison to the feature geometric approach is made, the major difference between the set-based representation above and the feature geometry is the availability of the probes such as those in (32c) or (32d), which lack “intermediate” features (i.e. [participant]). On the feature geometric approach, representationally encoded entailments between features block probes of this sort from being specified. Since the current account allows features to freely combine within the limits of a particular functional head, probes of this sort become possible.

4.3.3 φ -features on goals: Encapsulation and collection

Agreement requires the interaction between a probe *and* a goal. In the case canonical verbal agreement, goals are φ -bearing nominal element. More particularly, I claim that goals are a set comprised of the basic primitives I , U , and a finite set of O 's collected on DP. The goal of this section is to define the sets that govern different possible goals.

The idea that having a single set on DP (or, perhaps more broadly, the maximal projection highest functional head on the nominal spine) provides a path to explain how probes on the verbal spine gain access to information encapsulated within the nominal spine. The basic shape of the nominal spine is repeated in (33). Again, certain nominal categories such as pronouns, clitics, and nouns may be layered with different levels of structure both within and across subtypes (Déchaine and Wiltschko, 2002), in Algonquian nominals can be specified up to the full DP structure (see, for example, Oxford, 2017)⁵.

(33) *The nominal spine*

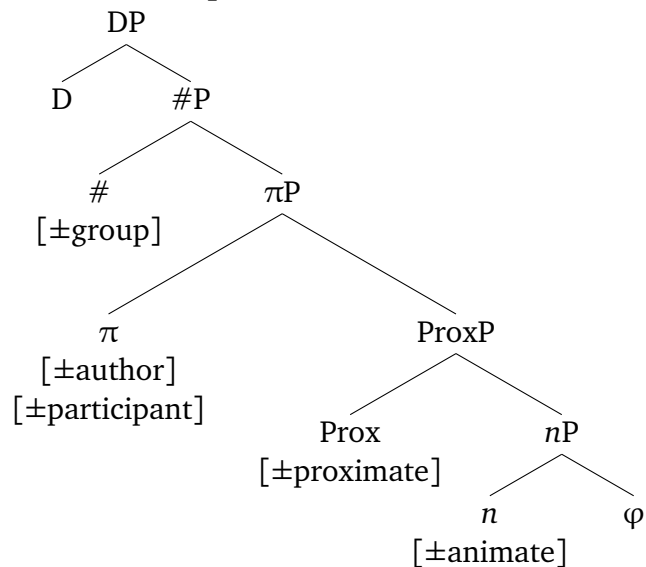

If we assume that DP defines a phase (e.g. Svenonius, 2004), and we further assume that AGREE is subject to phase-based locality requirements (e.g. Chomsky, 2000, 2001), then a probe that sits outside of the nominal spine such as that on Voice, Infl, or C should be blocked from accessing the features contained within the complement of DP and thus agreement with these features should be blocked.

However, the phasehood of DP is not without controversy, so reasonable objections may be raised to the arguments in the previous paragraph, which ties the need to collect nominal features to phase impenetrability. That said, the fact that φ-features are dis-

⁵In fact, it is claimed that nominals can be specified up to KP. We could equally adopt this notion without any untoward consequences. For simplicity, I treat DP as the highest nominal projection.

tributed across the nominal spine causes other issues. In particular, it violates the notion of φ -completeness first put forward by Chomsky (2000, 2001). Chomsky used this notion to create a cut between complete and defective (i.e. incomplete) goals. In current theories of AGREE, the notion of a goal being defective is questionable at best—such φ -incomplete goals were argued to be unable to delete the uninterpretable feature of the probe, causing derivational crashes. Under current models, the failure of AGREE to find a suitable goal is not thought to create a crash, but rather is tolerated (Preminger, 2011, 2014).

This shift in the theory calls into question the relevance of a requirement for goals to be φ -complete. However, I believe the insight that φ -features otherwise distributed across the nominal spine are collected onto a single head is still crucial, if not for the reasons originally put forward by Chomsky. Again following the proposal of Béjar and Rezac (2003, 2009) to have split person and number probes, AGREE may conduct the search for a goal based on person or number features alone. That said, these probes frequently express a greater set of features than those used to select the goal—for example, person probes may express the number features of the goal or vice versa. The prevalence of this *featural coarseness*, the observation that agreement often leads the *full set* of the goal's φ -features to be copied to the probe, provides evidence in favor of φ -features ultimately being collected on a single head or phrase, which is then the target of AGREE. If the person and number features remain distributed across separate heads, then one must explain how a probe can agree with one head (e.g. π), but copy the features of another (e.g. $\#$). If all features are collected on a single head, such issues do not arise.

4.3.3.1 Previous approaches: Concord

One solution to the general problem of φ -feature distribution has been to commit to some notion of *feature collection*, which consolidates these features on the D head (or

whatever the highest projection within the nominal is thought to be). This includes “feature-sharing” versions of AGREE put forward by Frampton and Gutmann (2006) and Pesetsky and Torrego (2007), and applied to these issues directly by Danon (2011). On these formulations, D is a probe, and through nominal-internal agreement relationships collects person, number, and gender features. This provides a solution to both potential issues: (i) D is outside of the phase-complement, thus the features are rendered accessible to probes outside of the nominal projection; and (ii) D has collected all of the phi-features otherwise distributed across the nominal spine, and is therefore *φ-complete*.

The criticism of this system advanced here is that “external” agreement relationships are rendered dependent on the presence of nominal concord, but the empirical basis for such a relationship is lacking. Perhaps most suspiciously, this system requires concord with person. However, person-based concord is exceedingly rare, if it can even be considered to be observed at all (Baker, 2008; Norris, 2017). Furthermore, putting nominal concord in a feeding/bleeding relationship to verbal agreement should predict a lack of verbal agreement in languages that lack concord (unless one advances a conspiracy about invisible concord in these cases). In the same vein, languages that lack gender or number concord alone should then lack verbal agreement in these categories.

This can readily be shown to be false. Norris (2019) provides a large-scale survey of concord across languages. One example of a language from this survey that entirely *lacks* concord across demonstratives, numerals, and adjectives is Ainu, a language isolate of Northern Japan. As seen in the examples below, taken from Shibatani (1990), nouns can be marked plural (34a) or singular (34b), but the demonstrative *nean* is invariant in both cases—it does not show concord. In contrast, the verb in (34a) shows plural agreement. This falsifies the generalization that concord is a necessary prerequisite for φ -features to be accessed external to the noun phrase.

(34) *Dissociation of verbal agreement and nominal concord*

- a. Nean orohko-utah nean lumi ki-hci kusu...
those Orokko-PL that war do-PL in order to...
'In order for those Orokkos to start that war...'
- b. Neon henke...
that old man...
'That old man...'

Ainu (Shibatani, 1990, p. 53)

4.3.3.2 A set-based solution

To summarize, the goal is to provide the means to represent the φ -features of the goal otherwise distributed across the nominal spine such that they are: (i) complete, in the sense that all of the features are collected in a single location, and (ii) accessible, such that the location of collection is not subject to locality conditions such as phase impenetrability. The solution I put forward is to represent the φ -features of the nominal spine with a set of the syntactic primitives *I*, *U*, and the *O*'s, which is then accessed by the syntactic agreement mechanism. The set is formed by (i) collecting the features in one place, and (ii) transforming this collection into a set.

The proposed mechanism for collection is based in the Feature Percolation Principle of Norris (2014), shown in (35). This provides a general solution to collecting features distributed across a given extended projection into the highest projection within the spine, and is not specific to the set-based representation advocated for here.

(35) *Feature Percolation Principle (adapted from Norris, 2014, p. 135)*

- a. All projections of a head X have the features that X has.
- b. Let $[\pm F]$ be a valued feature on XP

Let Z be a head lacking the feature $[F]$.

Let X and Z be members of the same extended projection. When Z merges with XP, projecting ZP, ZP also has the valued feature $[\pm F]$.

The principle has two pieces, which I take this to be part of a wider labeling algorithm. The exact nature of the labeling algorithm (and its relation to these principles) is left to future work. Informally, the first part in (35a) ensures that all projections of a given head share the same features. The second part in (35b) allows for the features of originating in a lower projection to be passed on to the next, given that the next projection is not headed by a phrase that contains that feature already and is part of the same extended projection. The result is all features of the nominal spine are collected on the highest projection of the functional sequence, as schematized in (36).

(36) *The nominal spine following feature percolation*

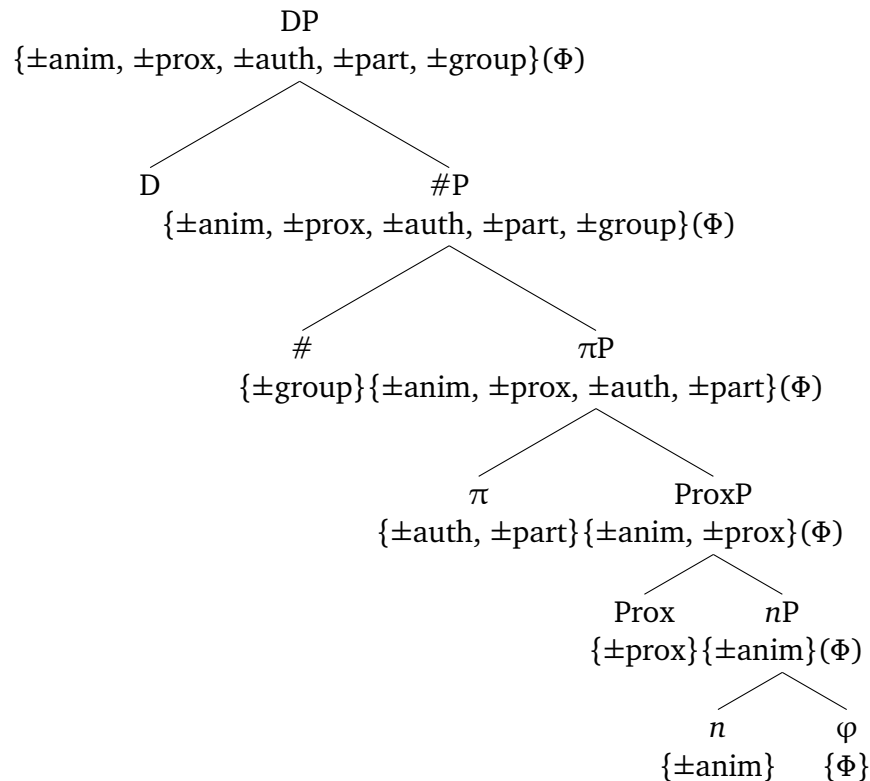

One immediate question is whether the adopted percolation account is fundamentally different than the invisible concord account discussed (and rejected) in the previous section. While there are similarities in that features end up collected into the D(P) domain, the two accounts critically differ in where this collection of features lives. With

a concord-based account, the D head itself is agreeing (concording) and collecting features; with a percolation-based account, features are passed along the nominal spine up to DP_i and do not feed back to the head D itself. The result is that we do *not* predict a relationship between the form of D, the terminal node that is target by spell-out, and the types of features that can be collected by agreement probes on the verbal spine. This ensures that concord on D and φ -completeness are entirely independent.

However, the present account has contended that features are not unary indices (a label), but rather *sets* of indices (primitives). I therefore propose that feature percolation results in the restriction of the full set of possible primitives represented by Φ based on the set of value of each of the collected feature. The set Φ can be restricted either via set intersection with a feature F , as in (37a), or via the set difference (relative complement) of F , as in (37b), depending on the value that the feature is specified for.

(37) *Syntactic definition of feature values*

- a. $+F(\Phi) = \Phi \cap F = \{x : x \in \Phi \wedge x \in F\}$
- b. $-F(\Phi) = \Phi \setminus F = \{x : x \in \Phi \wedge x \notin F\}$

An arbitrary number of features could combine to restrict the set Φ , with the order of the features within the percolated set being arbitrary as well (this follows from the fact that each membership relationship is combined via conjunction, which is fully commutative).

(38) *Order doesn't matter with multiple features*

- a. $+F(+G(\Phi)) = +G(+F(\Phi)) = \{x : x \in \Phi \wedge x \in F \wedge x \in G\}$
- b. $-F(-G(\Phi)) = -G(-F(\Phi)) = \{x : x \in \Phi \wedge x \notin F \wedge x \notin G\}$
- c. $-F(+G(\Phi)) = +G(-F(\Phi)) = \{x : x \in \Phi \wedge x \notin F \wedge x \in G\}$
- d. $+F(-G(\Phi)) = -G(+F(\Phi)) = \{x : x \in \Phi \wedge x \in F \wedge x \notin G\}$

To review, each feature, and the root node Φ , represents the sets in (39). Whether a given language utilizes the full participant feature, or the winnowed participant*, is a matter of variation that tracks with whether the language encodes a distinction between the exclusive and inclusive, as discussed at length in Chapter 2.

(39) *Person features as sets (goal domain)*

- a. [Author] = { I }
- b. [Participant] = { I, U }
- c. [Participant*] = { U }
- d. [Proximate] = { I, U, O }
- e. [Animate] = { I, U, O, O', O'' }
- f. Φ = { $I, U, O, O', O'', R, R', R''$ }

For our current purposes, we can derive the correspondences between (pro)nominal category, set of primitives, and percolated feature sets, shown in Table 4.3. This takes into account the possible feature combinations posited under the theory of contrastive interpretations (again, see Chapter 2). As a result, the author and participant features are not specified in the presence of [−Proximate]. This is reflected by the absence of these features below in the obviative (3′) categories.

I take for granted the existence of a definition of [Group] that allows for the cuts shown in Table 4.3, where singleton sets are represented with [−Group] and non-singleton sets [+Group]. The precise definition of this feature in syntax is left to future work (though see Chapter 2, Section 2.7.2 for the denotation of this feature).

Setting aside number distinctions, I show the derivation of the syntactic sets for the five possible person categories seen in Ojibwe (the “quintipartition”) in (40).

Category	Set	Features
1SG	$\{I\}$	$\{+anim, +prox, +auth, -part^*, -group\}(\Phi)$
2SG	$\{U\}$	$\{+anim, +prox, -auth, +part^*, -group\}(\Phi)$
3SG	$\{O\}$	$\{+anim, +prox, -auth, -part^*, -group\}(\Phi)$
3'SG	$\{O'\}$ or $\{O''\}$	$\{+anim, -prox, -group\}(\Phi)$
EXCL	$\{I, O, O', O''\}$	$\{+anim, +prox, +auth, -part^*, +group\}(\Phi)$
INCL	$\{I, U, O, O', O''\}$	$\{+anim, +prox, +auth, +part^*\}(\Phi)$
2PL	$\{U, O, O', O''\}$	$\{+anim, +prox, -auth, +part^*, +group\}(\Phi)$
3PL	$\{O, O', O''\}$	$\{+anim, +prox, -auth, -part^*, +group\}(\Phi)$
3'PL	$\{O', O''\}$	$\{+anim, -prox, +group\}(\Phi)$

Table 4.3: Possible goals with set and feature based syntactic representations in a quintipartition language with a singlar-plural number distinction (e.g. Border Lakes Ojibwe).

(40) *Syntactic sets in a quintipartition system*

- a. $INCL = \{+anim, +prox, +auth, +part^*\}(\Phi)$
 $= \{x : x \in \Phi \wedge x \in \{I, U, O, O', O''\} \wedge x \in \{I, U, O\} \wedge x \in \{I\} \wedge x \in \{U\}\}$
 $= \{I, U\}$
- b. $EXCL = \{+anim, +prox, +auth, -part^*\}(\Phi)$
 $= \{x : x \in \Phi \wedge x \in \{I, U, O, O', O''\} \wedge x \in \{I, U, O\} \wedge x \in \{I\} \wedge x \notin \{U\}\}$
 $= \{I\}$
- c. $2 = \{+anim, +prox, -auth, +part^*\}(\Phi)$
 $= \{x : x \in \Phi \wedge x \in \{I, U, O, O', O''\} \wedge x \in \{I, U, O\} \wedge x \notin \{I\} \wedge x \in \{U\}\}$
 $= \{U\}$
- d. $3 = \{+anim, +prox, -auth, -part^*\}(\Phi)$
 $= \{x : x \in \Phi \wedge x \in \{I, U, O, O', O''\} \wedge x \in \{I, U, O\} \wedge x \notin \{I\} \wedge x \notin \{U\}\}$
 $= \{O\}$
- e. $3' = \{+anim, -prox\}(\Phi)$
 $= \{x : x \in \Phi \wedge x \in \{I, U, O, O', O''\} \wedge x \notin \{I, U, O\}\}$
 $= \{O', O''\}$

The inclusive person in (40a) includes both *I* and *U*, and therefore is a non-singleton set without any action from number. Given the assumption from the theory of contrastive interpretations that the number feature need not be present in these cases to form the partition, this bodes well for a parallelism between the two domains in terms of feature specification. Perhaps more puzzling at first is the fact that the obviative person also results in a non-singleton set without any action from number. However, given that the vast majority of Algonquian languages fail to show a singular/plural distinction in the obviative persons — Border Lakes Ojibwe is an outlier in extending the number system to these cases, rather than the other way around. This could provide a path for understanding why that might be the case: in the absence of a number feature the obviative person is derived as a non-singleton set.

For clarity, I include the other two most common partitions. The sets for the standard quadripartition are shown in (41). This differs from the quintipartition in that there is no proximate feature present (and as a result, no obviation distinction in the third persons).

(41) *Syntactic sets in a standard quadripartition system*

- a. INCL = {+anim, +auth, +part*}(Φ)
 - = { $x : x \in \Phi \wedge x \in \{I, U, O, O', O''\} \wedge x \in \{I\} \wedge x \in \{U\}$ }
 - = {*I, U*}
- b. EXCL = {+anim, +auth, –part*}(Φ)
 - = { $x : x \in \Phi \wedge x \in \{I, U, O, O', O''\} \wedge x \in \{I\} \wedge x \notin \{U\}$ }
 - = {*I*}
- c. 2 = {+anim, –auth, +part*}(Φ)
 - = { $x : x \in \Phi \wedge x \in \{I, U, O, O', O''\} \wedge x \notin \{I\} \wedge x \in \{U\}$ }
 - = {*U*}

$$\begin{aligned}
\text{d. } 3 &= \{+\text{anim}, -\text{auth}, -\text{part}^*\}(\Phi) \\
&= \{x : x \in \Phi \wedge x \in \{I, U, O, O', O''\} \wedge x \notin \{I\} \wedge x \notin \{U\}\} \\
&= \{O, O', O''\}
\end{aligned}$$

Finally, the syntactic sets for the standard tripartition are shown in (43).

(42) ***Syntactic sets in a standard tripartition system***

$$\begin{aligned}
\text{a. } 1 &= \{+\text{anim}, +\text{part}, +\text{auth}\}(\Phi) \\
&= \{x : x \in \Phi \wedge x \in \{I, U, O, O', O''\} \wedge x \in \{I, U\} \wedge x \in \{I\}\} \\
&= \{I\} \\
\text{b. } 2 &= \{+\text{anim}, +\text{part}, -\text{auth}\}(\Phi) \\
&= \{x : x \in \Phi \wedge x \in \{I, U, O, O', O''\} \wedge x \in \{I, U\} \wedge x \notin \{I\}\} \\
&= \{U\} \\
\text{c. } 3 &= \{+\text{anim}, -\text{part}\}(\Phi) \\
&= \{x : x \in \Phi \wedge x \in \{I, U, O, O', O''\} \wedge x \notin \{I, U\}\} \\
&= \{O, O', O''\}
\end{aligned}$$

Note that the generic first person, though ambiguous in *reference* between sets that include versus exclude the addressee, only contains the first person *I* within the syntactic representation. This captures the fact that, for the purposes of agreement, this category is treated unambiguously as a “first” person.

These various possible sets, which again ignore number, are sufficient to show how the system derives the full range of possible person-based prominence effects. First, it is necessary to provide a definition of the operation AGREE in terms of this new representation.

4.4 Defining AGREE

With our representation of both probes and goals in hand, we can now provide a formal model of agreement. I consider AGREE not to be a single operation per se, but rather the sequence of operations shown in (43). There are four basic steps: Search, Match, Copy, and Satisfy.

(43) *Sub-components of AGREE (cf. Deal, 2015; Coon and Keine, 2020)*

- a. *Search*: A φ -probe with unsatisfied features $[uF]$ searches its locality-restricted⁶ c-command⁷ domain for the (next) closest goal with a set G , where $G \subseteq \Phi$ ⁸
- b. *Match*: A probe determines Match with a goal via set intersection between each feature $[uF]$, and the set G of the goal. Match holds if $G \cap F \neq \emptyset$
- c. *Copy*: If Match holds, the goal's set G is Copied to the probe
- d. *Satisfy*: An unsatisfied feature $[uF]$ is Satisfied if Match holds, and Search is halted if all unsatisfied features of the probe $[uF]$ are Satisfied (i.e. if the probe is Satisfied)

Given these steps, the basic outline of an AGREE relation is first that a probe with $[uF]$ features searches for the (next) closest φ -bearing goal within its domain. Search occurs no matter what — if there is no Matching goal, then the procedure is halted. If there is a goal satisfies the Match condition, then the set from the goal is copied back to the probe and the $[uF]$ feature is satisfied (i.e. checked). The procedure repeats until either all potential goals have been searched, or all $[uF]$ features of the probe have been checked.

⁶i.e. the domain defined by a Phase, Horizon, Barrier, etc.

⁷(Preminger, 2014, p. 96) argues (following Chomsky, 1995) that c-command is extraneous if we assume that derivations are cyclic and AGREE is triggered immediately when a probe is merged. All available structure in this case will be in the c-command domain of the probe.

⁸A generalized version could include in this set the δ -features, on a system where A' -movement is driven by AGREE.

This section considers each of these pieces in turn, setting the stage for the account of person-based prominence effects in Section 4.5.2.

4.4.1 Search and Satisfy

The current formulation leaves Search as unrestricted as possible — it crucially separates the notions of Search and Match such that a probe with unsatisfied interrogates φ -bearing elements even if they do not provide a Match. In other words, I assume that agreement can “fail” (Preminger, 2011, 2014; Deal, 2015), in that features of the probe do not need to be Satisfied (i.e. Match with a goal) in order to have a well-formed derivation. This is stated in (44).

(44) *Tolerance of Dissatisfaction*

AGREE can apply without resulting in Match (and by extension, without Copying or Satisfaction).

While Satisfaction is not a necessary consequence of AGREE being applied, the need for a feature to be Satisfied is fundamentally responsible for driving the application of AGREE. This is stated in (45).

(45) *Obligatoriness of AGREE*

If a probe P has unsatisfied features [uF] then AGREE must apply.

This condition requires that the sequence of events in (43) be commenced if an element containing [uF] is merged into the structure. Given that Search in the current formulation is divorced from Match, I believe that a particularly precise characterization of failed agreement is available. Failed agreement occurs when there is an unsatisfied feature with no available matching goals. This differs from previous formulations, in-

cluding $\text{FIND}(f)$ proposed by Preminger (2011, 2014) (see also Deal, 2015), where a matching condition was baked into the search operation.

(46) ***FIND(f) original formulation; replaced by principle in (45)***

Given an unvalued feature F on a head H° , find an XP bearing a valued instance of F , and assign that value to H°

With the current formulation of fallible AGREE in (45), no reference to feature matching is involved— Match is not a precondition for interacting with or evaluating a potential goal. Instead, Match is contingent on Search recovering a φ -bearing goal to evaluate against the probe.

There are two relevant considerations for when Search is triggered and when AGREE halts. First, we can speak of an individual feature being satisfied when Match holds. This is defined in (47).

(47) ***Definition of Feature Satisfaction***

A feature $[uF]$ is *Satisfied* by the set G on a goal iff $G \cap F \neq \emptyset$ (i.e. *Match* holds)

Relatedly, we can say that a probe is satisfied when all of the individual features in its set are satisfied.

(48) ***Definition of Probe Satisfaction***

A probe P is *Satisfied* when all features $[uF]$ on P are Satisfied

The sequence of operations we call AGREE halts either when the probe is Satisfied, or if all φ -bearing goals (within a locally accessible domain) have been Searched. Furthermore, the AGREE sequence may apply more than one time with a given probe, in order to satisfy the maximum number of features possible. As will be shown in more detail in Section 4.5.1, if interactions with a first goal satisfies some, but not all, of the features

of the probe, then Search is initiated again. If this second goal can satisfy additional features, then a second set of features is interacted with and copied to the probe.

4.4.2 Match

Satisfaction occurs as a direct consequence of a Match between the features of the probe and the goal. The definition of Match is repeated in (49).

(49) *Match*: A probe determines Match with a goal via set intersection between each feature $[uF]$, and the set G of the goal. Match holds if $G \cap F \neq \emptyset$

In other words, if the set of primitives for a given feature overlaps with the set of primitives of the goal, then the two can be said to Match. The overlap need not be complete — it is possible for either the probe or the goal to have indices that are not shared between the two. All that is necessary is for the intersection to be non-null.

To preview what is discussed in more detail in the Section 4.5.2, the derivation of person-based prominence effects can be attributed to Match, given the definition of features we have been working with. To review, the features (and the sets they represent) stand in the following subset-superset relationships.

(50) *Proper subset/superset relationships between person features*

- a. $\Phi \supset [\text{Animate}] \supset [\text{Proximate}] \supset [\text{Participant}] \supset [\text{Author}], [\text{Addressee}]$
- b. $\{I, U, O, \dots, O^n, R, \dots, R^n\} \supset \{I, U, O, \dots, O^n\} \supset \{I, U, O\} \supset \{I, U\} \supset \{I\}, \{U\}$

The basic entailment relationships that are the hallmark of person-based prominence effects are captured. Consider the difference in Match between a first person singular $\{I\}$ and third (proximate) singular $\{O\}$. The first person Matches all features that are a superset of $[\text{Author}]$, while the third person proximate matches all features that are a superset of $[\text{Proximate}]$, but not those that are a subset of this feature.

In many ways this definition of Match is identical to that used with other feature representations, in that it evaluates whether there is overlap in the representation of the probe and the goal. The critical difference is that Match is not defined over the labels “ π ”, “proximate”, “participant”, or “author” — everything is defined with respect to the set-based representation.

One theory-internal motivation for the move towards the set-based representation is that, with a bivalent feature structure alone, it is not possible to identify a single feature that picks out all of the local persons to the exclusion of the third person (regardless of obviation distinctions). Consider the feature specifications for the inclusive, exclusive, second, proximate, and obviative persons in (51), where both the current set-based representation, a “pure” bivalent specification, and the privative feature specification under the feature geometry are shown for each case.

- (51) a. INCLUSIVE
Set-Based: $\{I, U\}$
Bivalent: $\{[+Anim], [+Prox], [+Auth], [+Part^*]\}$
Privative: $\{[Anim], [Prox], [Part], [Auth], [Add]\}$
- b. EXCLUSIVE
Set-Based: $\{I\}$
Bivalent: $\{[+Anim], [+Prox], [+Auth], [-Part^*]\}$
Privative: $\{[Anim], [Prox], [Part], [Auth]\}$
- c. SECOND
Set-Based: $\{U\}$
Bivalent: $\{[+Anim], [+Prox], [-Auth], [+Part^*]\}$
Privative: $\{[Anim], [Prox], [Part]\}$
- d. PROXIMATE
Set-Based: $\{O\}$

Bivalent: {[+Anim], [+Prox], [−Auth], [−Part*]}

Privative: {[Anim], [Prox]}

e. OBVIATIVE

Set-Based: {*O'*, *O''*}

Bivalent: {[+Anim], [−Prox]}

Privative: {[Anim]}

With bivalent features, there is no one feature/value combination that picks out the three local persons. The second and inclusive persons are both [+Participant*], but the exclusive is [−Participant*]; both the inclusive and exclusive share [+Author], but the second person is [−Author]. The local persons all share a [+Proximate] and [+Animate] feature, but these features are also shared by the proximate and/or obviative persons, so the local persons alone cannot be isolated as a natural class. This differs from the privative geometric representation, where the local persons all share the [Participant] feature, and this feature is not specified on the proximate and obviative persons. The set-based representation creates a natural class by ensuring that the sets that define the local person categories intersect with the set {*I*, *U*} that defines the feature [Participant], while neither the proximate or obviative persons intersect with this set.

A second reason for adopting the set-based feature representation is that it does not require the stipulation of extrinsic dependencies between features to ensure that Match captures entailment relationships between categories. Again, this is explored in greater detail in Section 4.6, but previous accounts based in the feature-geometric representation capture person-based prominence effects through second-order representations that hardcode the entailments between features. The current definition and representation takes advantage of the subset-superset relationships between the sets that each

feature represents, and does not need to explicitly encode these dependencies into the syntactic representation.

4.4.3 Copy

Copying is the mechanisms by which the φ -representation of the goal is transferred to the probe. When Match holds, I adopt the view that the full set of the goal is copied to the probe. This is the direct analogue of the *featural coarseness* principle, now commonly employed in theories AGREE. Because features themselves are not the objects that are Copied in the present system (sets are copied), I simply refer to this principle as *coarseness*. The difference from its original formulation is that coarseness is not restricted only to situations of clitic doubling (cf. Preminger, 2014), but rather applies to all instances of φ -agreement (see also Coon and Keine, 2020). This does not mean that there is no difference between clitic doubling and standard agreement, but rather that coarseness alone is not a sufficient condition for positive identification of clitic doubling.

Moving on from coarseness, it is now well established that probes can agree with more than one goal—as already noted, this occurs when an initial Matching relationship leaves some of the features of the probe unsatisfied *and* there is another goal which Matches these yet unsatisfied features. This raises the question of what is done with the sets Copied from each goal. I propose the following principle:

(52) ***Preservation of History***

If a probe P Matches with and Copies the set of a goal *G* on the first cycle, and then the set of a goal *H* on the second cycle, the Copied sets are kept in an ordered set (*G, H*)

This is an extension of a claim by Deal (2015), who argues that when a probe agrees with multiple goals, it keeps the features of each goal in a structured list. The addition

is that the set of features is ordered—it matters what was agreed with on the first versus second cycle. Formally:

$$(53) \quad (G, H) \neq (H, G)$$

This is necessary to capture differences in how portmanteau morphology arises in Ojibwe. I show that even if a probe agrees with the same two goals, the order in which this agreement occurs leads to different portmanteau forms. That does not *necessitate* that order matters to the insertion of morphology—spell-out can be easily formulated to be impartial to order—but Ojibwe shows that it must be available in the system.⁹

There are other cases where agreement with multiple goals causes break-downs down the line—this will give rise to the alignment-based hierarchy effects discussed at length in Section 4.2, and which I return to in the context of the current system in the next section. The existence of cyclic agreement of this particular sort, and the sets of sets that it gives rise to, results in a number of possible effects including portmanteau, inverse marking, or in some cases outright ungrammaticality.

A final point concerns the correspondences between sets and features. While sets are the representations that are manipulated by AGREE, nothing prevents them from being re-written as particular combinations of valued features for the purposes of spell-out at PF. This can be seen by considering the correspondences between the combinations of bivalent features and the sets in (51). Each particular combination of valued feature gives rise to a unique set, and each relevant set gives rise to a single combination of valued features. Similarly, the syntactic sets as a whole can be used to define insertion rules for the semantically contentful lattices of *i*, *u*, and various *o*'s to be manipulated at LF to create partitions. Which particular representation is used in each module of

⁹Related to this discussion is the difference between *cyclic* AGREE, where on each cycle of the probe a single goal is considered, and *multiple* AGREE, where a multiple goals are entertained by the probe. The principle in (52) is most straightforwardly consistent with a strictly cyclic theory.

the grammar is therefore fluid, but information preserving rewrite rules can be defined to give rise to each.

4.5 Hierarchy effects and the set-based feature representation

The goal of this section is to put all of the pieces together by showing that the set-based representation and the revised sequence of operations underlying AGREE can capture the exact range of person-based prominence effects described in Section 4.2. The range of possible effects, as described through the prominence-based hierarchy, is repeated in (54). Setting aside obviation for the moment, if there is a ranking between the local persons and the third person, it is $1/2 > 3$ ($*3 > 1/2$). There are two basic points of variation: (i) whether a possible ranking is realized or collapsed, and (ii) if there is a ranking between 1 and 2, whether it is $1 > 2$ or $2 > 1$.

(54) **Summary of Person-Based Prominence Effects (repeated)**

<i>Ultra Strong (Author):</i> $1 > 2 > 3$	<i>Blackfoot, Classical Arabic</i>
<i>Ultra Strong (Addressee):</i> $2 > 1 > 3$	<i>Nez Perce</i>
<i>Strong:</i> $\{1 > 2, 2 > 1\} > 3$	<i>Slovenian</i>
<i>Weak:</i> $1/2 > 3$	<i>Massachusetts, Kichean, Italian</i>
<i>Me-First:</i> $1 > 2/3$	<i>Romanian</i>
<i>You-First:</i> $2 > 1/3$	<i>Cuzco Quechua</i>
<i>No Effect:</i> $1/2/3$	<i>Ojibwe, Moro</i>

In Section 4.3.2, the possible set of probes was outlined. In this section, I walk through the expected behavior of the possible probes and show how each gives rise to a particular hierarchy effect. The analysis is couched in the broader *feature gluttony* analysis of hierarchy alignment effects (Coon and Keine, 2020), where markedness, special forms, or ungrammaticality arise just in case a probe interacts with multiple goals by Match-

ing and Copying multiple feature sets. I therefore begin by reviewing the major tenants of the gluttony approach to alignment effects, which can be adapted to apply to the current representation and definition of AGREE.

4.5.1 Feature gluttony

The present account adopts the view that alignment effects have their root cause in a situation termed *feature gluttony*, or for our purposes a more general notion of *gluttony*, which is neutral to the particular representation at play. Gluttony is defined by a given probe having what ultimately amounts to “too much agreement”. These configurations, while not ill-formed by virtue of gluttony alone, give rise to issues as the derivation goes on. The grammar’s “response” to gluttony, be it impoverishment, portmanteau forms, fission, or ineffability, defines the different classes of alignment effects (e.g. the PCC and direct-inverse marking).

Gluttony arises when two basic conditions are met. The first is that a probe c-commands multiple potential goals, as shown in (55) with DP₁ and DP₂. The second is that the probe agrees with (i.e. Matches and Copies the features of) more than one goal, also shown in (55) with the two dashed arrows.

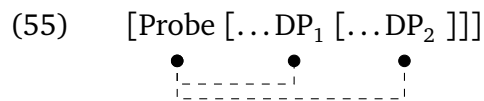

These multiple agreement relationships, and therefore gluttony, arise just in case the further goal (DP₂) provides a better match for the probe than a closer goal (DP₁). As such, these configurations can be labeled INVERSE alignments—as will be shown explicitly in a moment, gluttonous configurations are all marked by a lower-to-higher alignment between the person-based prominence scale and the syntactic position hierarchy. On the current account, this specifically arises as a function of the subset-superset relationships between person features, and ultimately as a function of the particular

feature set that is specified on the probe. In contrast, *DIRECT* alignments are the result of a high-to-high (and low-to-low) alignment between the person-based prominence hierarchy and the syntactic position hierarchy, and never lead to gluttony.

Two hypothetical direct and inverse alignments are shown in (56) with a toy set primitives F and G that make up the features. Notice that the two features of the probe stand in a subset-superset relationship, with both including F , but only one including both F and G . Recall that *Match* holds when the set of a given feature and the set of the goal overlap (i.e. intersect), even if they do not fully overlap. Therefore in the direct alignment in (56a), where the closer DP_1 is specified for a set containing F , both features are satisfied with this single relationship, and only one feature set is copied. There is no motivation to interact with DP_2 , as DP_1 fully satisfies the probe. This contrasts with the inverse alignment in (56b), where the same feature structure of the probe leads to multiple agreement relationships. In this case, DP_1 , which is specified for G , only satisfies a single feature of the probe. Subsequent agreement with DP_2 , which is specified for F , is able to satisfy the second feature. This leads to gluttony, as both goal sets are copied to the probe.

(56) a. *DIRECT alignment*

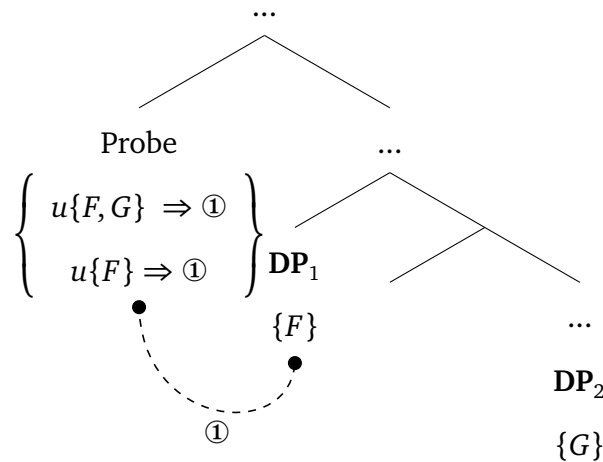

b. INVERSE alignment

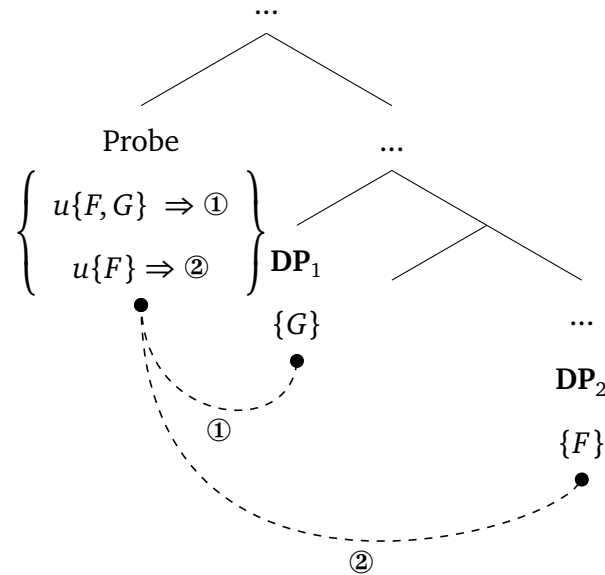

To further clarify the situation, consider the copied sets, shown in (57), which define the probe following the agreement relationships in (56). In the direct alignment, there is a single set copied; in the inverse, two sets, one from each goal, are copied and kept in an ordered set (following Preservation of History).

- (57) a. DIRECT: $P = (\{F\})$
 b. INVERSE: $P = (\{G\}, \{F\})$

As previously mentioned, there is nothing absolutely ill-formed about the multiple agreement relations that occur with inverse alignments, nor the gluttonous sets that are produced from these configurations. The issues arise elsewhere. In the next section I consider the behavior of each possible probe. I then provide an accounting of the known behaviors that arise from gluttony, including PCC effects, direct/inverse marking, fission, and portmanteau forms.

4.5.2 Possible probes and the typology of inverse

The possible set of probes, and the proposed correspondences to the person-based prominence hierarchy, are repeated in (58).

(58) *Correspondence between probes and Person-Based Prominence effects*

- | | | |
|----|---|---|
| a. | {uΠ} | <i>Flat</i> : 1/2/3 |
| b. | {uΠ, uParticipant} | <i>Weak</i> : 1/2 > 3 |
| c. | {uΠ, uAuthor} | <i>Me-First</i> : 1 > 2/3 |
| d. | {uΠ, uAddressee} | <i>You-First</i> : 2 > 1/3 |
| e. | {uΠ, uParticipant, uAuthor} | <i>Ultra Strong (Author)</i> : 1 > 2 > 3 |
| f. | {uΠ, uParticipant, uAddressee} | <i>Ultra Strong (Addressee)</i> : 2 > 1 > 3 |
| g. | {uΠ, uAddressee, uAuthor} | <i>Strong</i> : {1 > 2, 2 > 1} > 3 |
| h. | {uΠ, uParticipant, uAddressee, uAuthor} | <i>Strong</i> : {1 > 2, 2 > 1} > 3 |

The subset-superset relationships between each different feature, repeated in abbreviated form in (59), provide the link that allows different classes of effects to arise. The relevant question to ask is this: Which configurations will lead the *further* or *structurally lower* goal to provide a more complete match for the probe than the *closer* or *structurally higher* goal? This is relative to the particular features that are specified on the probe.

(59) *Proper subset/superset relationships between person features*

- a. $\pi \supset [\text{Participant}] \supset [\text{Author}], [\text{Addressee}]$
- b. $\{I, U, O, O', \dots, O^n\} \supset \{I, U\} \supset \{I\}, \{U\}$

For the sake of the current discussion, I am limiting consideration to animate goals, and again setting aside the proximate-obviative distinction. With these restrictions, the correspondence between inverse/gluttony and probe structure is shown in Table 4.4—note that this tracks perfectly with the expected distribution of direct/inverse based

on the hierarchies indicated in (58) (see Section 4.2 for details on the correspondence between the hierarchy and inverse structures).

		(58a)	(58b)	(58c)	(58d)	(58e)	(58f)	(58g,h)
HIGH	LOW	<i>Flat</i>	<i>Weak</i>	<i>Me-First</i>	<i>You-First</i>	<i>Ultra Strong (Author)</i>	<i>Ultra Strong (Addressee)</i>	<i>Strong</i>
1	3	—	—	—	—	—	—	—
2	3	—	—	—	—	—	—	—
1	2	—	—	—	INV	—	INV	INV
2	1	—	—	INV	—	INV	—	INV
3	1	—	INV	INV	—	INV	INV	INV
3	2	—	INV	—	INV	INV	INV	INV

Table 4.4: Correspondence between possible probes, alignment effects, and the distribution of inverse.

Considering a *Flat* probe first, which only contains $u\Pi$, all possible higher DPs will fully satisfy the probe. The set represented by π contains I , U , and the O 's, therefore any (animate) goal will have a non-null intersection, thereby satisfying the probe. This means there will never be a gluttonous/inverse configuration.

A *Weak* probe additionally has the feature [u Participant]. As a result, configurations where there is a high local person, be it first or second person, will fully satisfy the probe without a second cycle. However, if the higher argument is a third person and the lower argument a local person, then two probing cycles will be triggered and gluttony will result—the higher third person cannot satisfy the participant feature, but the lower local person can, and therefore interacts with the probe.

Both the *Me-First* and *You-First* probes behave in a similar fashion, but differ in whether they include (in addition to $u\Pi$) a u Author or u Addressee feature, respectively. The *Me-First* probe results in an inverse/gluttonous configuration whenever the lower argument is a first person, and the *You-First* probe is gluttonous when the lower argument is a second person. Again, this follows from the fact that only a first or second person, respectively, will provide a match to satisfy u Author or u Addressee.

The two *Ultra Strong* probes include both *u*Π and *u*Participant, as well as either the *u*Author or *u*Addressee feature. This pattern is a hybrid between the Weak probe, which includes *u*Participant, and Me/You-First patterns, again respective to whether *u*Author or *u*Addressee is present. As a result, both are inverse with a high third person and low local combination, but additionally lead to gluttony with either second over first (with the *u*Author variety) or first over second (with the *u*Addressee variety).

The final case is the *Strong* probe, which can be derived either by a probe with all possible features, or one that lacks *u*Participant but includes both *u*Author and *u*Addressee. As such, it can be seen as either a combination of the patterns produced by the Me-First and You-First probes, or the two Ultra Strong probes. With either of these probes, there is only one situation where the lower DP *does not* provide an additional Match for the probe following agreement with the higher DP: When the lower DP is a third person. Because there is both *u*Author or *u*Addressee, there will always be an additional Match to be had with a lower local person, resulting in the widest distribution of gluttony. This is true regardless of whether the *u*Participant probe is present, because the inclusion of both *u*Author and *u*Addressee ensures this drive for an additional local person will always be present.

4.5.3 Beyond pure person probes

To close the discussion of probes, I would like to ruminate briefly on the question of how obviation and (animacy-based) noun classification fits into this system of probes. A general assumption has been adopted here to separate person probes from number probes, and a new assumption has been made to restrict “pure” person probes to only the four features *u*Π, *u*Participant, *u*Author, and *u*Addressee. That said, number and noun classification also participate in agreement, sometimes interacting with pure person features in interesting ways. What should be made of these additional possible probes in languages where features related to noun classification and obviation are active?

The past few chapters have made progress on understanding how the core person features, noun class, and obviation all share a common type of relationship to the person ontology. That said, the precise relationship that governs the interactions between these three classes of features within the probe system is still underdetermined. To take an analogy that sharpens the point, consider the proposal that, within the nominal domain, number, person, obviation, noun classification were each associated with separate functional projections (in descending order). Importing this to the verbal domain, we might expect each to associate with a unique “type” of probe. As discussed, this is widely assumed to be the case with person and number, where person probes precede number probes (Béjar and Rezac, 2003, 2009), with noun classification being less studied, but also having been argued to head its own probe. The proposal is to extend this further to give us the hypothesis that each domain of φ -features can head its own probe, with a universal order of these probes, as shown in (60) (where “ γ ” = noun classification, “ ρ ” = obviation, and “ \triangleright ” is read as “precedes”).

(60) *Four φ -probes and the ordering relations between them*

$$\gamma \triangleright \rho \triangleright \pi \triangleright \#$$

The hypothesis is that each type of probe differs in its minimal feature specification. For example, as proposed for the π -probe, there is necessarily a $u\Pi$ feature, with the other three person features being subject to variation. For the γ -probe, the minimal specification may be equivalent to $u\Phi$; for the ρ -probe, $uProximate$; and the number probe $u\#$. There may be additional differences between probe types, for example in how they evaluate match, what features or portion of the set they copy from the goal, or in how their features are defined, but this constitutes a reasonably broad starting point for a theory of probe-type variation.

The assertion that the ρ -probe is necessarily specified for a $uProximate$ feature can account for the fact that all Algonquian languages show inverse marking with the $3' \rightarrow 3$

configurations (see Section 4.2.2.2 for a review of these patterns). In Chapter 5, I argue that the ρ -probe governs direct-inverse marking on Voice in Ojibwe — the argument is also summarized below in Section 4.5.4.2, and the reader is referred there for details. In short, the presence of *uProximate* ensures that gluttony will always arise when the proximate argument is more distant than the obviative argument, as is the case in the $3' \rightarrow 3$ alignments. Assuming that the ρ -probe governs agreement on Voice across the Algonquian languages, this can explain the invariance with which inverse appears in these cases.

That said, it is also widely known that probes can become *fused* (Coon and Bale, 2014) such that they are sensitive to features from multiple φ -domains. This makes it possible to have a probe that blurs the boundaries between different classes of features. This has been well documented in the domain of person and number, where certain probes appear to prefer agreement with, for example, a plural participant rather than participants in general (this is the case in Mi'gmaq, the case explored by Coon and Bale). More recently, fused person/number probes have shown “disjunctive” preferences. For example, in Äiwoo (Austronesian), encountering *either* a participant or augmented argument satisfies the probe, suggesting that either satisfying the person or number features satisfies the probe as a whole (Roversi, 2020).

The fact that probe types can mix together does not falsify the intuition that different domains of the clause are more strongly associated with particular types of φ -features. Again, the probe types are meant to define the minimal specification, rather than put a ceiling on what can be specified. This makes fused probes perfectly possible within the theory. Furthermore, probes may be entirely absent within a language. For example, it is reasonable to assume that languages that do not show a distinction in noun classification or obviation will lack the probe corresponding to that feature type. In Chapter 5, all four of the probes in (60) will be argued to be active in Ojibwe in matrix clauses, with embedded clauses showing a fused $\pi/\#$ probe.

4.5.4 Why gluttony (inverse) causes issues

The previous section showed that the present account captures all and only the typology of inverse/gluttony as it is currently understood. With eight different possible π -probes, all seven possible instantiations of the person-based prominence hierarchy are accounted for. However, as noted previously, gluttony does not create ineffable structures on its own. As a result, an additional link is needed to explain the three key patterns that formed the empirical basis of this chapter: (i) PCC violations, where ineffability arises with inverse alignments; (ii) direct-inverse marking, where inverse alignments lead to an elsewhere form; and (iii) omnivorous agreement, where only the features of the highest ranked argument are exponed. In addition, there are at least two other effects that arise out of gluttony: (i) fission, where a single probe is split in two resulting in the feature sets of each DP to be spelled-out separately; and (ii) portmanteau forms, where a form that covers the entire set of features is spelled-out.

4.5.4.1 The PCC

To review, the PCC can be described as a ban on IO and DO clitic combinations when the IO and DO stand in an inverse alignment. The question is then why cliticization *fails* in inverse alignments. The argument summarized here directly follows that of Coon and Keine (2020), with the only new pieces being the framing of Matching and Copy in terms of the set-based representation of features.

The starting point is to consider cliticization, or clitic doubling, in direct alignments, where nothing goes wrong. Cliticization is triggered by the features of the probe (the exact trigger is not important here): When a feature of a probe with a cliticization requirement enters into an agreement relationship with a DP, the D head of the goal undergoes long head movement to the head of probe's projection (Anagnostopoulou, 2003; Preminger, 2019; Coon and Keine, 2020). This is schematized in (61).

(61) *Cliticization as long head movement*

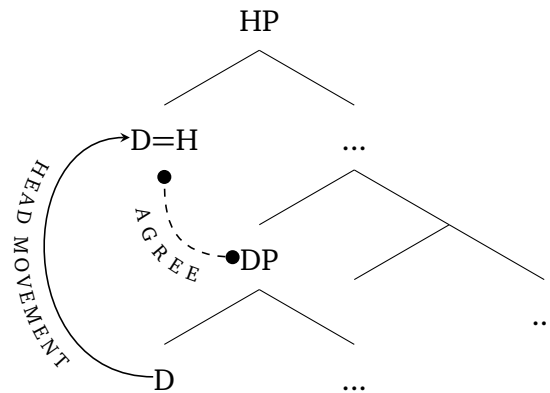

Coon and Keine formulate this requirement with the generalization in (62).

- (62) If a feature of a clitic-doubling probe on a head H has agreed with a DP, this DP must cliticize onto H (Coon and Keine, 2020, p. 17).

Besides triggering movement of D, cliticization also results in removing the targeted goal DP as an intervenor for further agreement relationships (Anagnostopoulou, 2003; Béjar and Rezac, 2003; Preminger, 2009). Therefore once a DP has undergone cliticization, it cannot be targeted by another agreement probe.

A final piece of background, which as already been discussed to some degree, is that person and number agree separately with probes π and #, and furthermore that π *always* probes before # (Béjar and Rezac, 2003).

The head ν governs cliticization in PCC-type languages, and contains both the π and # probes. Licit IO/DO combinations arise when the π probe agrees with the IO and the # probe agrees with the DO, resulting in separate sequences of probing and cliticization; illicit combinations arise when π agrees with (and attempts to cliticize) *both* the IO and DO. I consider the licit and illicit cases in turn with a Weak probe, as exemplified by Catalan (Bonet, 1991). The relevant contrast is shown in (63), where

2 » 3 combinations are grammatical (63a), and 3 » 2 combinations are ungrammatical (63b).

(63) *Catalan Weak PCC: √2 » 3, *3 » 2 (Bonet, 1991, p. 178)*

- a. En Josep, te 'l va recomenar la Mireia.
the Josep, 2DAT.CL 3ACC.CL recommended the Mireia
'She (Mireia) recommended him (Josep) to you.'
- b. *A en Josep, te li va recomanar la Mireia.
to the Josep, 2ACC.CL 3DAT.CL recommended the Mireia
intended: 'She (Mireia) recommended you to him (Josep).'

The derivation of the IO and DO clitics for the grammatical 2 » 3 combinations is shown in (64). The π probe Searches first (64a), finding the second person DP_I which satisfies both the $u\Pi$ and $uPart$ features, resulting in a fully satisfied probe. The IO is then cliticized onto ν and the IO is deactivated. The # probe then Searches (64b), skipping the deactivated IO and agreeing with and cliticizing the DO.

(64) *No PCC violation with √2 » 3; π agrees with IO and # with DO.*

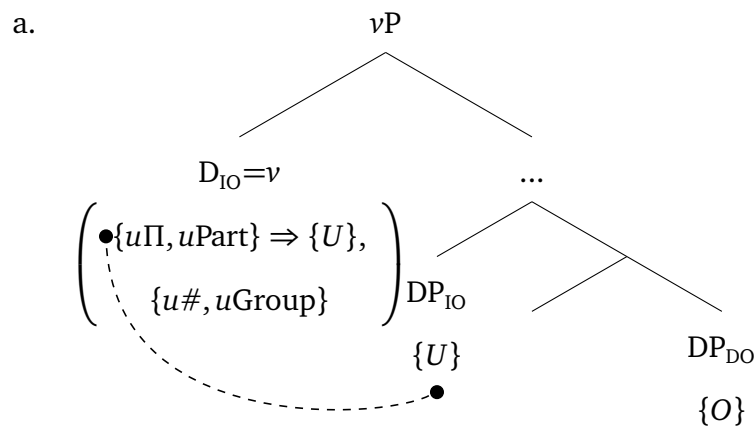

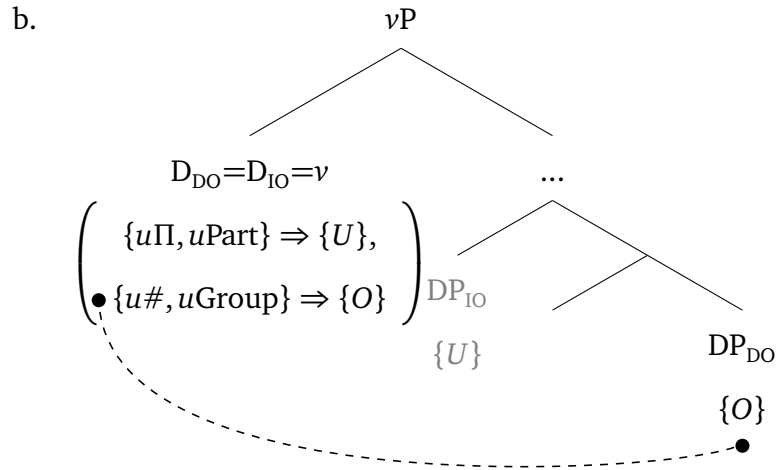

This contrasts with the ungrammatical 3 » 2 configuration schematized in (65), where the π probe agrees with both the IO, which satisfies the $u\Pi$ feature, and the DO, which satisfies the $uPart$ feature. The conflict that arises in this case is with the cliticization operation. This operation requires both the IO and DO to be cliticized to the probe, as both have agreed with a feature that triggers this requirement. Given the assumption that all features of a given probe are agreeing simultaneously, for the derivation to be well-formed (i.e. for the cliticization requirement to be met at all points), simultaneous head movement of the IO and DO clitic is necessary. Given that head movement structures are formed by MERGE, and MERGE is a binary operation, combining two clitics with v at once is impossible. This results in an ungrammatical structure. Note that the simultaneity issue does *not* arise with the 2 » 3 configurations, as the π and $\#$ probes agree and cliticize in separate stages of the derivation. Therefore at each given step, the derivation is well-formed and only a single clitic is being formed.

(65) *PCC violation with *3 » 2; π agrees with both IO and DO.*

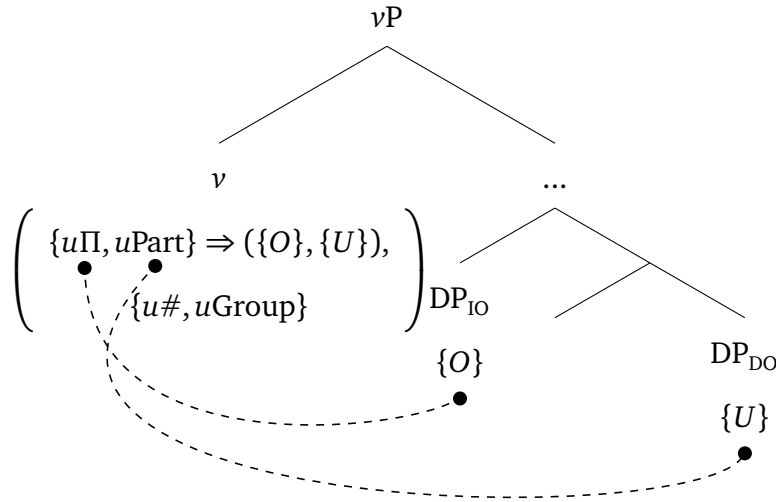

This conflict caused by the need for cliticization holds of all cases where an inverse alignment is found (in languages where the features of a probe trigger cliticization). Therefore the logic presented here in terms of the Weak PCC of Catalan extends to the entire PCC family. As discussed at length, what differs is which particular argument configurations trigger gluttony, given that probes can be relativized for different sets of features.

4.5.4.2 Direct-inverse

The second key empirical pattern borne out of gluttony is direct-inverse agreement. While indicated as a gluttonous pattern by Coon and Keine (2020), they do not provide an analysis. An account of the direct-inverse system of Ojibwe is one of the major focuses of Chapter 5, but I review the basics of how my proposal of how gluttony leads to inverse marking under the current system.

The basic pattern of direct-inverse marking can be observed in (66), where the two arguments of the transitive verb are proximate and obviative. The relevant agreement marker on Voice is in bold. When the proximate noun is the External Argument (EA) and the obviative the Internal Argument (IA) as in (66a), Voice shows a so-called “direct”

agreement marker *-aa*, indexing the proximate subject. When the alignment is reversed as in (66b), so the EA is obviative and the IA proximate, the “inverse” marker *-igoo* appears—this marker does not index any features in particular.

(66) **Ojibwe Independent Order: 3 → 3' = 3; 3' → 3 = INVERSE**

- a. o- waabam **-aa** -n
 3- see **-3** -3'
 's/he (PROX) sees h/ (OBV)'
- b. o- waabam **-igoo** -n
 3- see **-INV** -3'
 's/he (OBV) sees h/ (PROX)'

For the purposes of this basic illustration of the direct-inverse system, a probe with [*u*Π] and [*u*Proximate] on the head Voice is sufficient. Unlike the PCC, these cases involve so-called *pure agreement probes*, which do not trigger cliticization.

Agreement with the direct and inverse alignments from (66) are shown in (67). With the direct alignment, the single agreement relationship with the proximate EA is sufficient to satisfy both features of the probe. In contrast, with the inverse alignment, both the obviative EA, which satisfies [*u*Π], and the proximate IA, which satisfies [*u*Proximate], must interact with the probe for full satisfaction.

(67) a. DIRECT alignment

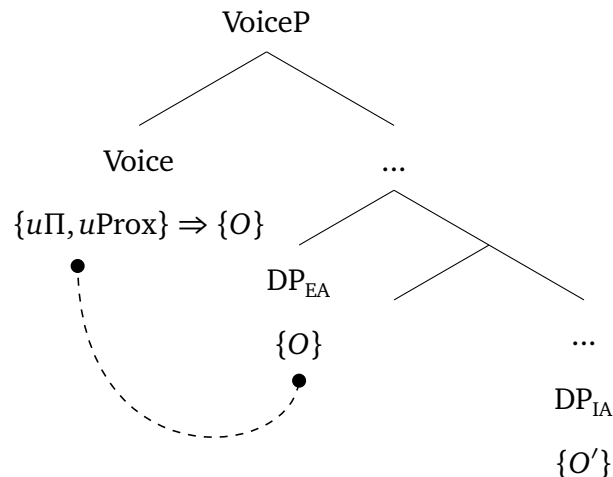

b. INVERSE alignment

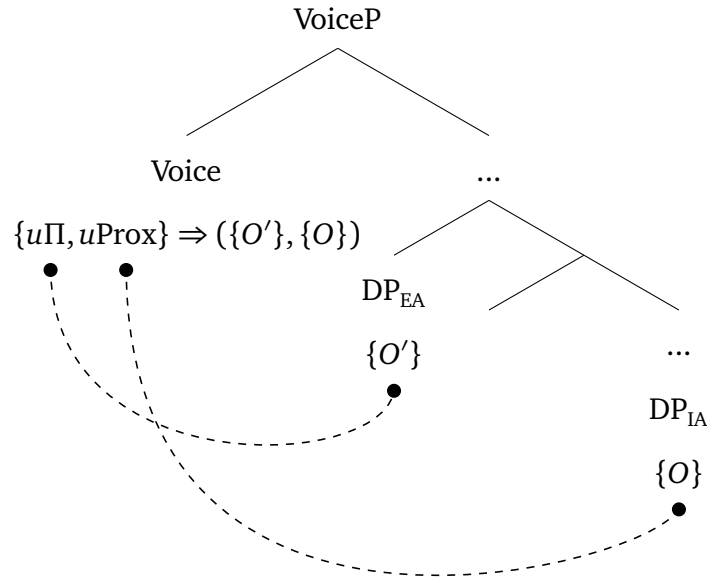

As expected, this results in gluttony with the inverse alignment. The resulting copied sets of primitives for the direct and inverse alignments are shown in (68). The direct alignments have a single set, consisting of the single (proximate) *O*, while the inverse alignment has an ordered set from each of the two arguments of the verb.

- (68) a. DIRECT: Voice = {*O*}
 b. INVERSE: Voice = ({*O'*}, {*O*})

To account for the spell-out of Voice, a simple pair of Vocabulary Item (VI) insertion rules suffices. These are given in (69).¹⁰

- (69) Voice_{*O*} ⇔ -*aa*
 Voice_{elsewhere} ⇔ -*igoo*

When Voice is specified for {*O*} alone, then the direct marker -*aa* is inserted. In all other cases, the elsewhere form -*igoo* appears — the VI insertion operation does not make a

¹⁰As noted previously, it is possible to define these rules either in terms of the set representation or the feature-value representation, as one can define re-write rules to go between these two representations. Nothing hinges on this here, and for consistency with what is used for agreement, I retain the set-based representation.

choice about which set to spell-out, and instead inserts an unmarked form. The full set of VI insertions rules ultimately must include forms for the obviative, first, and second persons as well, as shown in (70). These are relevant to alignments that include local persons.

- (70) $\text{Voice}_{\{O'\}} \Leftrightarrow -im$
 $\text{Voice}_{\{I\}} \Leftrightarrow -i$
 $\text{Voice}_{\{U\}} \Leftrightarrow -in$

To summarize, the gluttonous collection of goal sets that ends up on the probe in inverse alignments is dealt with through the insertion of an elsewhere form. As should be clear, the gluttonous configuration does not cause any issues, but does lead to the emergence of the unmarked form of Voice.

4.5.4.3 Omnivorous agreement

As described in detail in Section 4.2.1, omnivorous agreement occurs when an agreement slot shows a preference for showing agreement with DPs with certain features. A summary of the case of omnivorous person agreement in the Kichean Agent-Focus (AF) construction is given in (71), where third person only combinations show a null form, the presence of a first person results in a first person agreement marker, and the presence of a second person a second person agreement marker. Note that this sets aside the case with local persons only, which is ungrammatical outright for independent reasons, again related to person licensing requirements.

- (71) a. $3 \leftrightarrow 3 = \emptyset$
b. $1 \leftrightarrow 3 = -at$
c. $2 \leftrightarrow 3 = -in$

If we assume a probe relativized with [*u*Π] and [*u*Participant], then this probe will interact with both the third person and the local person in the 3 → 1/2 configurations, but only the local persons in the 1/2 → 3 configurations. However, the same spell-out occurs in both cases. As such, we can define spell-out rules, shown in (72), that are both insensitive to the hierarchical order of the goals (as indicated by the shift from “()” to “{ }” below), as well as indifferent to the particular second set that is present. This set could be either null (as in 1/2 → 3 configurations), or the third person (as in 2 → 1/2 configurations).

$$(72) \quad \begin{aligned} \{\{U\}, \{X\}\} &\Leftrightarrow -at \\ \{\{I\}, \{X\}\} &\Leftrightarrow -in \\ \text{Elsewhere} &\Leftrightarrow \emptyset \end{aligned}$$

This proposed reformulation of Kichean AF agreement brings it more in line with direct-inverse marking, where the particular VI insertion rules of the language determine how gluttonous configurations are realized. Here, the rules privilege the spell-out of first or second person over all else.

There is however another way of looking at Kichean AF agreement where the probe entirely skip arguments that lack the participant feature, rather than interacting with them on the way. This is much closer to Preminger’s original analysis, and can be accomplished by specifying a probe that lacks *u*Π, but includes [*u*Part]. While this probe is not in the original set of 8, such a probe is in principle possible if probe-based person features are specified on a head other than π. The result of such a probe is that gluttonous configurations will not be created in 3 → 1/2 configurations. In fact, (singular) third persons will never be interacted with at all. Instead, the probe would interact with and copy only the features of local persons, if there is one in the clause. The spell-out rules can then be simplified to never make reference to a complex set-of-sets, and can simply spell-out the single set of the goal, or the elsewhere form if no

local person was found. I do not decide between these two possible analyses, as either would in principle work under the current system.

4.5.4.4 Fission

Fission is a case where a single agreement probe is split, with each set ending up on its own head for the the purposes of spell-out. While couched in terms of omnivorous agreement during the review in Section 4.2.1, Nez Perce complementizer agreement first put forward in Deal (2015) provides a case that can be analyzed with fission.

The pattern of agreement is summarized in (73). With third persons only (73a), agreement is null. When there is a second person either as an EA or IA with a third person (73b), the second person marker *-m* appears. Similarly, the first + third combinations (73c) invariably lead to the first person marker *-x*. The critical case is that of the local-only combinations, shown in (73d), where $2 \rightarrow 1$ results in only the second person markers, while $1 \rightarrow 2$ both the first and second person markers.

- (73)
- a. $3 \leftrightarrow 3 = ke-\emptyset$
 - b. $2 \leftrightarrow 3 = ke-m$
 - c. $1 \leftrightarrow 3 = ke-x$
 - d. $2 \rightarrow 1 = ke-m$
 - $1 \rightarrow 2 = ke-m-ex$

As previously discussed, the agreement shows a $2 > 1 > 3$ hierarchy effect, where the probe is only fully satisfied when it has encountered a second person. This can be captured by a probe specified for $[u\Pi]$, $[uParticipant]$, and $[uAddressee]$. Focusing on the critical cases with local arguments only, this results in gluttony with the $1 \rightarrow 2$ configuration, where the probe must interact with both the first person EA and second person IA to be fully satisfied, but not with $2 \rightarrow 1$, where the probe only needs to interact

with the IA to be fully satisfied. This results in the now familiar single versus multi-set structures following agreement, shown in (74).

- (74) a. $2 \rightarrow 1$ (DIRECT): $C = \{U\}$
 b. $1 \rightarrow 2$ (INVERSE): $C = (\{I\}, \{U\})$

The puzzle arises when we consider the plausible set of spell-out rules, shown in (75). The presence of the set $\{U\}$ results in the insertion of $-m$, similarly $\{I\}$ results in the insertion of $-(e)x$, and all other cases are the null elsewhere form. Given this, the combination of both the first and second person VIs in the case of the inverse/gluttonous $1 \rightarrow 2$ configurations is surprising: the conflict should lead the elsewhere inform to be inserted, as was previously seen with direct-inverse marking.

- (75) $C_{\{U\}} \Leftrightarrow -m$
 $C_{\{I\}} \Leftrightarrow -(e)x$
 Elsewhere $\Leftrightarrow \emptyset$

The solution is for fission to apply, as shown in (76) (Noyer, 1992; Halle, 1997). This splits the single C head into two different heads for the purposes of spell-out, with each carrying one of the two sets. As a result, each of the heads separately spells out the first and second person VIs, allowing for the pattern of Nez Perce complementizer agreement to emerge (setting aside the issue of the order in which the morphemes appear).

- (76) $C_{(\{I\}, \{U\})} \Rightarrow C'_{\{I\}} C''_{\{U\}}$

At present, the exact motivation for why fission should apply in these cases is not entirely clear. Indeed, this points to a wider question of why different languages deal with gluttonous collections in different ways—an answer to this typological question is not provided here, but the basic shape of what must be explained should be clear.

4.5.4.5 Portmanteau

The final way that gluttony emerges is with portmanteau forms, which are pieces of morphology that index multiple arguments. This effect has not yet been introduced in the preceding discussion, but can be seen with Ojibwe, and provides what is perhaps the strongest evidence in favor of a single probe collecting the index sets of multiple goals, and for the need to collect these sets within an ordered set (following Preservation of History). As with the direct-inverse system, I review the basic profile of portmanteau here, with a deeper discussion in Appendix B.

Consider the central agreement slot (which is identified as agreement with Infl) in the conjunct order of Border Lakes Ojibwe. Two alternating alignments with first singular and second plural arguments are shown in (77). The 1SG \rightarrow 2PL alignment in (77a) shows a portmanteau form, which indexes both the first person singular and second person plural. The 2PL \rightarrow 1SG shows a form associated with only the second person plural.

- (77) a. waabam -in -agog
see -2 -1SG>2PL
'...if I see y'all'
- b. waabam -i -yeg
see -1 -2PL
'...if y'all see me'

Again setting aside the details, which raise a number of complications, following the work of Oxford (2019a) on the closely related Ojibwe dialect Algonquin, I assume for now that Infl is agreeing with both arguments in both alignments above. This results in the same collection of sets, but in reverse order depending on the alignment of the two arguments with the EA and IA positions, as shown in (78).

- (78) a. 1SG \rightarrow 2PL: Infl = ($\{I\}, \{U, O, O', O''\}$) \Leftrightarrow -agog

b. 2PL → 1SG: Infl = ({U, O, O', O''}, {I}) ⇔ -yeg

In the case of (78a), a form is available that indexes the two sets of features collectively, and in that particular order. Note that if the sets were unordered, we would expect the portmanteau form to be inserted in both cases, as the sets involved are the same. In contrast, the set in (78b) only ends up spelling out the first of the two sets, the second person plural.

4.5.5 Summary

In this section, I reviewed the feature gluttony account of Coon and Keine (2020), where inverse alignments uniformly lead to situations where multiple goals are agreed with by a single probe. I further reviewed their account of how gluttony can give rise to PCC effects, but couched it within the revised set-based representation of probes and goals. I then outlined new proposals for how gluttony (and by extension inverse alignments) give rise to direct-inverse marking systems, fission, and portmanteau morphology. Each of these “reactions” to gluttony are further detailed in the discussion of the Border Lakes Ojibwe agreement system in the next chapter.

One bigger question that has not been answered is: *why* are there different reactions to gluttony in different languages and with different probes? A full typology of the downstream effects of inverse configurations is only just beginning to emerge. One clear difference is between cliticization, which can give rise to PCC effects and outright ineffability, versus pure agreement, which gives rise to either unmarked forms, fission, or portmanteau, but not complete ungrammaticality. This review very likely does not exhaust the full range of possibilities in the classes of effects that gluttony can give rise to, but it constitutes a starting point for a theory that seeks to provide such an account.

4.6 Agreement and the feature geometric representation

The goal of this section is to evaluate the feasibility of the feature geometric representation of person, which has been the leading account of hierarchy effects in agreement for the past two decades (Harley and Ritter, 2002; Béjar and Rezac, 2003). I first detail the core attributes of the feature geometric representation (Section 4.6.1). I then fully outline the range of probes predicted under this system (Section 4.6.2), which turns out to be a more narrow set than predicted under the current account. Ultimately, I show that, while the feature geometric representation can capture much of the variation in person-based prominence effects, it fails to capture Me-First and You-First patterns, which lack so-called “intermediate” features.

4.6.1 A review of the feature geometry

Feature geometries provide the means to give internal organization to features. An extended feature geometry, which includes nodes for both person and proximate features, is shown in (79) (Harley and Ritter, 2002; McGinnis, 2005; Oxford, 2019a). I again set aside number for the purposes of this discussion, but note that there is a separate geometry to define these contrasts. The geometry can be used to define both the features of the probe and the goal.

(79) *A feature geometry for person (Harley and Ritter, 2002; Oxford, 2019b)*

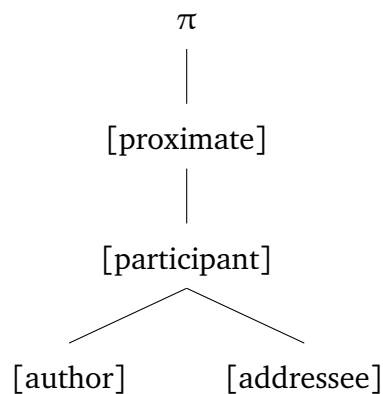

It is first important to note that, while these have been drawn in a tree structure similar to that familiar from phrase-structure representations, the lines between these features are used to represent implicational relationships rather than a phrase structure hierarchy. The key attribute of the representation is that the presence of a lower feature on the geometry entails the presence of all other higher features. These representationally encoded entailments are based on the semantic entailments between features, but must be syntactically realized. For example, the first person exclusive is differentiated by the presence of the [Author] feature, but is also necessarily specified for [Participant], [Proximate], and π . The only two features that do not stand in an entailment relationship of this sort are [Author] and [Addressee], which are both immediate co-dependents of the [Participant] node.

The feature specification for each local person category in a language with the maximal possible person distinctions (ignoring number) is in (80). The inclusive is represented with the full feature structure, the exclusive lacks the [Addressee] feature, and the second person lacks both [Author] and [Addressee].

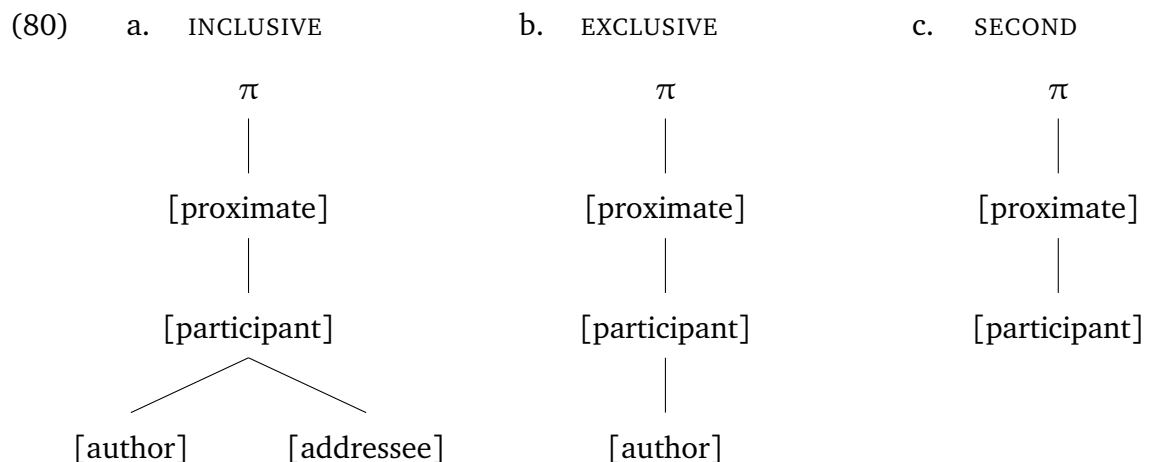

The specification of the second person points to how relative markedness guides the ultimate interpretation of these structures. While there is an [Addressee] feature within the system, which could in principle be employed to represent the second person, second

peeling directly to the prominence hierarchy. The next section is devoted to outlining the predicted probes under this representation, and showing that it under-generates based on the observed range of hierarchy effects outlined in Section 4.2.

4.6.2 Possible and impossible probes

Like person categories, person probes under the feature geometric representation can differ in the degree to which they are articulated. Given the maximal geometry from the previous section, and ignoring the proximate feature for the sake of discussion, the five probes in (82) are predicted. All of these probes conform to the entailment relations encoded by the geometry, where a lower feature such as [Author] implies the presence of all lower features.

(82) *Possible probes under the feature geometric representation*

- | | | |
|----|--|------------------------|
| a. | $\{u\pi\}$ | $1/2/3$ |
| b. | $\{u\pi, uPart\}$ | $1/2 > 3$ |
| c. | $\{u\pi, uPart, uAuthor\}$ | $1 > 2 > 3$ |
| d. | $\{u\pi, uPart, uAddressee\}$ | $2 > 1 > 3$ |
| e. | $\{u\pi, uPart, uAuthor, uAddressee\}$ | $\{1 > 2, 2 > 1\} > 3$ |

Adopting the same basic model of AGREE, but instead formulating match as operating over the features rather than sets, each probe corresponds to a different predicted hierarchy effect, depending on to what degree it is articulated. On the geometric account, this is the direct result of the entailment relationships between features as expressed by the geometry. Since all persons contain the feature $[\pi]$, then the flat $u\pi$ probe can be satisfied by any animate person, and thus shows no hierarchy effects. To the other extreme, a probe specified with $uAuthor$ will only be fully satisfied by interacting with a first person, therefore it will Search and Copy until a first person is found. So far, this

is exactly analogous to what was seen with the set-based representation of features and the proposed formulation of AGREE.

The difference between the two accounts is with the probes in (83), which lack the intermediate [Participant] feature and thus cannot be specified under the feature geometric representation. The issue is that the feature geometry encodes universal entailments that hold between the features — it is not possible, short of stipulation, to break these entailments on a case-by-case basis.

(83) *Impossible probes under the feature geometric representation*

- a. $\ast\{u\pi, u\text{Addressee}\}$ $1 > 2/3$
- b. $\ast\{u\pi, u\text{Addressee}\}$ $2 > 1/3$
- c. $\ast\{u\pi, u\text{Author}, u\text{Addressee}\}$ $\{1 > 2, 2 > 1\} > 3$

Given the existence of both Me-First (as exemplified by the PCC of Romanian) and You-First (as exemplified by Subject Marking Anomalies in Cuzco Quechua), the feature geometric representation fails to generate the full range of observed person-hierarchy effects. This provides a strong empirical argument for the proposed set-based feature representation, and against the feature geometric representation.

4.6.3 Abandoning second-order representations of entailment

The major contribution of this chapter was to propose a set-based syntactic representation of person features. By shifting away from a representation where each feature label represents a single index, to a model of where labels are instead shorthand for sets of primitives, it was possible to define features with inherent entailment relationships.

Both prominence scales/hierarchies and feature-geometric representations are second order in that they *describe* the entailment relationships that hold between either person categories (as in the case of a scale) or person features (as in the case of the geometry). The claim here is that the most basic (i.e. *first order*) level of representa-

tion is sets of primitives, not features. With the set-based representation of features, features do not have entailment relations with one another as the result of an extrinsic arrangement, but rather as a result of the intrinsic properties of the sets they represent. Entailment follows from the proper subset-superset relationships between features.

To see this more clearly, it is worth highlighting the differences between the hierarchy-based versus feature-geometric representation of entailment, as there is a sense in which the move from unstructured feature bundles to the feature geometric representation mirrors the current move from the feature geometry to the set-based representation of features. In short, the feature-geometric representation results in the following subset-superset relationships between categories, one of the core insights of the original proposal to apply the geometric approach to agree by Béjar (2003):

(84) *Proper subset/superset relationships between person categories*

a. $1 \supset 2 \supset 3 \supset 3'$

b. $\{\pi, [\text{Prox}], [\text{Part}], [\text{Auth}]\} \supset \{\pi, [\text{Prox}], [\text{Part}]\} \supset \{\pi, [\text{Prox}]\} \supset \{\pi\}$

With the feature-geometric representation, the relationships between the categories in (84a) are directly derived from the feature representations in (84b), which stand in the relevant subset-superset relationships given their proposed representation. In this sense, the bones of the account are identical, by deriving hierarchy effects through subset-superset relationships. However, hiding under the hood of (84) is the extrinsic (second-order) requirement that a lower feature of the geometry cannot be specified without also specifying all of its dependents, as encoded within the feature geometry. This forces, for example, the representation of first person to include not only the feature that actually does the work of distinguishing it as referring to the speaker (i.e. [Author]), but also all other features, which only serve the purpose of ensuring the proper entailment relationships hold between categories.

The current theory takes this set-based representation to the next level—to the internal structure of each individual feature—as repeated again in (85).

(85) *Proper subset/superset relationships between person features*

- a. $\Pi \supset [\text{Proximate}] \supset [\text{Participant}] \supset [\text{Author}], [\text{Addressee}]$
- b. $\{I, U, O, O', \dots, O^n\} \supset \{I, U, O\} \supset \{I, U\} \supset \{I\}, \{U\}$

The features themselves are no longer the most primitive building blocks of the syntactic representation—it is now the ontologically-based primitives *I*, *U*, and the *O*'s which serve this role. Features are defined as different sets of these primitives, thereby deriving the entailment relations from intrinsic properties of the representation, rather than directly encoding them with the addition of a geometric representation. Because these features in turn determine how the Match function of AGREE operates, the entailments between features flows up to the level of person category, providing a first-order explanation of person-based prominence effects as described by a hierarchy or scale.

The result is a system with no stipulated dependencies between the features themselves. Feature combinations on both probes and goals vary freely on all relevant dimensions. In the domain of the probe, all possible combinations of unvalued features are attested, as evidenced by the variation in prominence-based effects. On the goal, all logical combinations of features and feature-value pairs are attested, as evidenced by the variation in the possible partitions of the person space.

On the current theory, the only glaring extrinsic restriction is on the particular set of features that is available—a restriction that is shared with all representations of person discussed so far. The set-based feature representation has the expressive power to, in principle, encode other types of features. For example, one could imagine a “third person” feature, let’s call it [Other], which would represent the set $\{O, O', O''\}$. However, no known language shows a pattern that motivates the existence of such a feature. If such a feature did exist, we would expect to find a case where third person agreement

is privileged above local person agreement—i.e. a pattern that would be described by a ranking of $3 > 1/2$.

Why should this be the case? At present, the answer to this question remains speculative—perhaps the maximal set of features is defined by UG and makes up part of the initial state, or perhaps an explanation can be found by appealing to independent functional pressures. However the possible set of features comes to be restricted, the line between possible and impossible grammars, as is currently understood, is defined by the proposed representation.

CHAPTER 5

AGREEMENT AND WORD ORDER IN OJIBWE

5.1 Overview

The goal of this chapter is to provide a formal account of the patterns of agreement and word order in Border Lakes Ojibwe. The analysis is couched in terms of the set-based person representation and AGREE procedure put forward in the previous chapter, and the gluttony-based theory of person-based prominence effects.

The verbal agreement system of Ojibwe is notoriously complex. The present account recognizes up to four possible probes within the verbal projection, corresponding (roughly) to agreement with noun classification, obviation, person, and number. In this chapter, a small, but representative, part of the paradigm is examined. The traditional description of Algonquian verbs is divided into four “classes” and two “orders”, not counting the imperative and reflexive constructions. Classes indicate transitivity of the verb and animacy of the arguments: VAI (Verb Animate Intransitive) are verbs with a single animate argument; VII (Verb Inanimate Intransitive) are verbs with a single inanimate argument; VTA (Verb Transitive Animate) are verbs with two (or more) arguments, with the theme/goal arguments being animate (the agentive argument is generally animate); the VTI (Verb Transitive Inanimate) are verbs with two (or more) arguments, with an inanimate theme/goal (the agentive argument again is generally

animate). The orders vary between the independent (matrix clauses) and conjunct (embedded clauses). Examples of the four classes in the conjunct and independent orders, all formed from the root *agaas* translating to “small”, are in (1). All varying morphology seen across forms is tied to agreement and argument structure alternations.

- (1) a. *Verb Animate Intransitive (VAI)*
- (i) Independent: *agaashiinyi* ‘s/he (PROX) is small’
 - (ii) Conjunct: *agaashiinyid* ‘...if s/he (PROX) is small’
- b. *Verb Inanimate Intransitive (VII)*
- (i) Independent: *agaasin* ‘it is small’
 - (ii) Conjunct: *agaasing* ‘...if it is small’
- c. *Verb Transitive Animate (VTA)*
- (i) Independent: *odagaasi’aan* ‘s/he (PROX) makes h/ (OBV) small’
 - (ii) Conjunct: *agaasi’aad* ‘...if s/he (PROX) makes h/ (OBV) small’
- d. *Verb Transitive Inanimate (VTI)*
- (i) Independent: *odagaasitooon* ‘s/he (PROX) makes it small’
 - (ii) Conjunct: *agaasitood* ‘...if s/he (PROX) makes it small’

The study is limited in scope to agreement in clauses with two grammatically animate arguments in matrix and embedded contexts (i.e. the independent and conjunct order VTAs, as exemplified in (1c)). Even more narrowly, the focus is on agreement in clauses with two third person arguments, as exemplified above. This slice of the agreement paradigms provides a representative sample of the basic workings of the system, and has been the major object of study in previous analyses of Algonquian languages within the generative tradition (e.g. Bruening, 2005; Oxford, 2014, 2019b). The starting point of the account is therefore informed by two decades of analysis within the generative theories, and well over a century of documentation within the Algonquianst tradition.

The goal of this first section is to introduce the agreement system of Ojibwe as a whole, and narrow in on the main patterns, questions, and proposals that drive the remainder of the chapter. I begin with an overview of the verbal spine, which gives way to a description of the four major agreement slots within the language, and a survey of the theoretical proposals to account for each. I then turn to a description of word order and introduce the adopted theoretical link that between agreement and movement.

5.1.1 The verbal spine

The Ojibwe verbal complex consists of a single prosodic word with a complex morphological structure. The examples in (2) provide the morphological template for the independent order, and (3) the template for the conjunct. In both cases, the sub-example (a) gives the terms common to the Algonquianist literature. This can be correlated with sub-example (b), where the phrase-structural heads are given. Finally, sub-example (c) provides a verb form where every slot is overtly evidenced, with glosses indicating the Algonquianist terms for each.

(2) *Ojibwe verbal template for the independent order—adapted from Oxford (2014)*

- a. Prefix + root + Final + Theme + Negation + Central + Mode + Peripheral
- b. Infl + $\sqrt{\text{ROOT}}$ + v + Voice + Neg + Infl + Mode + C
- c. gaawiin o- waab -am -aa -si -waa -waaban -en
 neg Pre- root -Final -Theme -Neg -Cent -Mode -Periph
 ‘They (PROX) are not seeing h/ (OBV)’

(3) *Ojibwe verbal template for the conjunct order—adapted from Oxford (2014)*

- a. root + Final + Theme + Negation + Central + Mode
- b. $\sqrt{\text{ROOT}}$ + v + Voice + Neg + Infl + Mode
- c. waab -am -aa -si -gwaa -ban
 root -Final -Theme -Neg -Cent -Mode
 ‘...if they (PROX) are not seeing h/ (OBV)’

One high-level goal is to understand the similarities and differences between the two verbal orders. In addition to the surface-level differences in morphophonological form in shared slots, the conjunct order only realizes a subset of the morphological slots found in the independent order — it lacks both the person prefix and the peripheral agreement marker. Furthermore, the conjunct and independent orders show distinct patterns of agreement in the slots they do share, which reveals deeper differences in the probes that underly each clause type.

All of the morphological slots introduced above come into play on some level over the course of the chapter, but the focus is on the four that participate in agreement: *v* (the Final), Voice (the Theme Sign), Infl (the Person Prefix + Central Agreement), and C (Peripheral Agreement). Both mode and negation do not show interactions with the agreement system.

For the current purposes, mode is useful to consider as a conditioner of the phonological environment, allowing allomorphs to appear and disappear and informing the spell-out of each slot. More generally, Mode comes in four flavors. The indicative or neutral mode; the dubitative, which expresses doubt or uncertainty; the preterit, which is shown in the examples above, and is used for uncompleted or attempted actions; and the preterit-dubitative, which combines the meaning of the two non-neutral modes. Negation, which is bipartite in the independent order and monopartite in the conjunct (for an analysis, see Tilleson, 2019), is leveraged to examine scope with respect to the arguments of the verb.

The maximal possible verbal spine in Ojibwe is given in (4), again with the Algonquianist labels written below each node.

(4) *Ojibwe verbal spine*

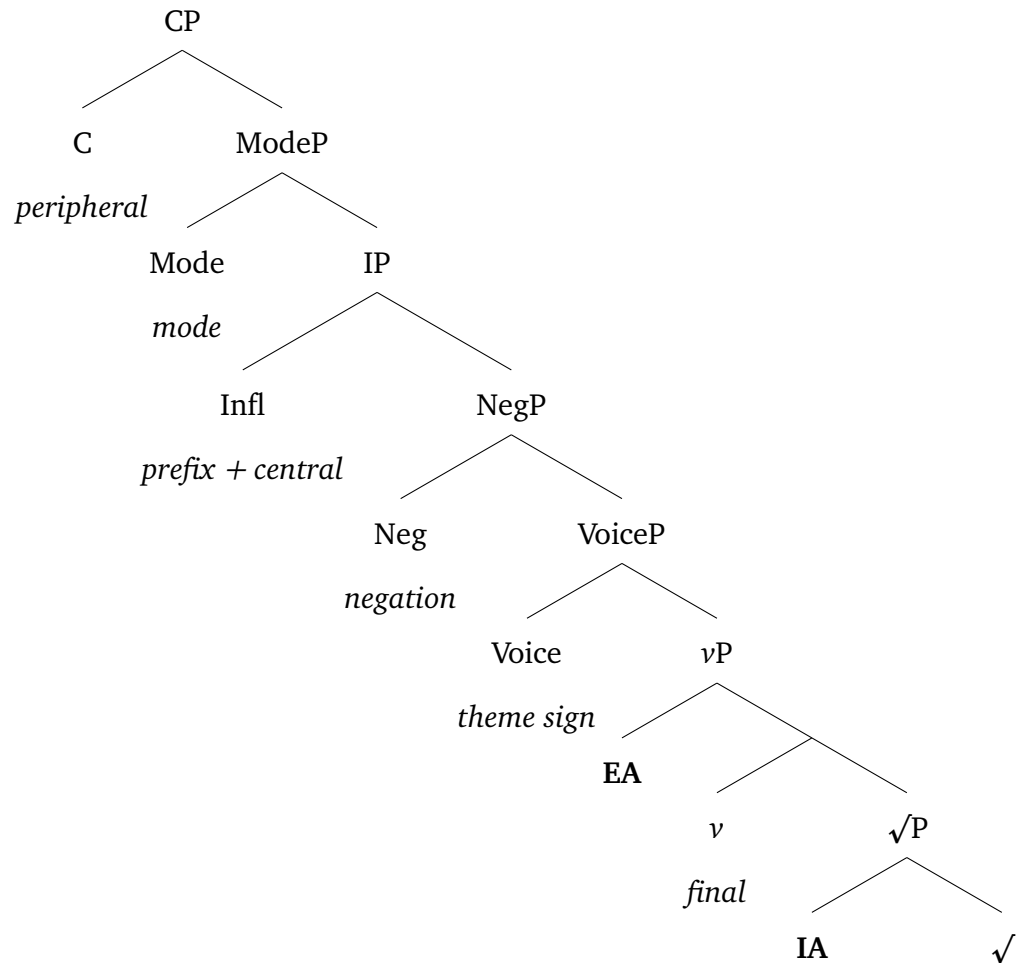

5.1.2 Overview of agreement: *v*, Voice, Infl, and C

As noted above, the focus of the chapter is to account for the agreement system of Ojibwe. The following generalizations govern the basic agreement behavior of the four agreement probes:

- (5) a. *v*: Agree with the IA in animacy.
- b. Voice: If the EA is ranked lower than the IA, show INVERSE marking, otherwise show DIRECT agreement in obviation/person.
- c. Infl: Agree in person and number with the highest ranked argument. If both the EA and IA are equally ranked, index both.

- d. C: Agree in number, animacy, and obviation with the lowest ranked argument.

At a high level, the four agreement slots correspond to the four possible types of φ -probes posited in Chapter 4. This correspondence is shown in (6). The probe on v , which is sensitive to noun class, is the γ -probe. Voice marking, which consistently indexes the alignment of argument positions and obviation (and varies in whether it indexes the alignment between position and the core person features), is the ρ -probe. The probe on Infl is the π -probe, but also expones number information. Finally, the $\#$ -probe on C generally marks number contrasts, but also expones information about animacy and obviation.

(6) *Four types of φ -probes and their relation to functional heads in Ojibwe*

- a. *Noun classification: $\gamma \approx v$*
- b. *Obviation: $\rho \approx \text{Voice}$*
- c. *Person: $\pi \approx \text{Infl}$*
- d. *Number: $\# \approx C$*

The relationship between the four probes of Ojibwe and the four probe types is approximate. It represents general trends in the sensitivities and exponence of each probe, rather than clean cuts. For example, Voice not only evaluates matches with the goal based on obviation status, but also to person distinctions proper (e.g. the local versus non-local distinction). To review, the insight here is *not* that a ρ -probe can never be sensitive to distinctions outside of obviation; rather, that it *always* will be particularly sensitive to obviation, if nothing else. There is more work to be done on understanding the consequences of these posited relationships, but these types serve as guideposts for understanding the layers of complexity in the agreement system, and connects the probe structure to wider theories of the functional spine (e.g. Wiltschko, 2014).

In the remainder of the section, I expand the descriptions of each of these agreement probes, laying the groundwork for an analysis. For completeness, I present the patterns across the full VTA paradigms, while the analysis focuses on a case study of the “non-local only” configurations that combine proximate and obviative arguments only. Some discussion of the “local-only” and “mixed” patterns can be found in Appendix B.

5.1.2.1 Animacy agreement on *v*

Agreement with *v* is frequently overlooked or passed over in analyses of the Algonquian agreement system. *v* is realized as a closed-class set of morphemes, which are referred to in descriptive circles as the *verb finals*. Finals alternate based on two properties: (i) noun classification, with the animacy of the internal argument being marked in transitive verbs, and the sole argument with intransitives, and (ii) argument structure, with both transitivity and other semantic information related to thematic roles being indicated. Following the split-VP hypothesis, Spec,*v*P is the position where the external argument is introduced, and agent/causer theta roles assigned. I further assume that this projection defines a phase boundary, a fact which comes into play over the course of the analysis.

A full presentation of the possible verb finals goes beyond the scope of this work (see Riccomini, 2016, for a recent analysis of finals in Eastern Ojibwe), but the basic form that the alternations take can be observed with the examples in (7) with the alternation between the animate and inanimate forms of the causitive final, and (8) with the alternation between the animate and inanimate forms with of the experiencer final.

- (7) a. od- agaas -i' -aa -n
 3- small -CAUSE.ANIM -3 -3'
 'S/he (PROX) makes h/ (OBV) small'
- b. od- agaas -it -oon
 3- small -CAUSE.INAN -0
 'S/he makes it small'

- (8) a. o- waab **-am** -aa -n
 3- see -EXRANIM -3 -3'
 ‘S/he (PROX) sees h/ (OBV)’
- b. o- waab **-and** -aan
 3- see -EXRINAN -0
 ‘S/he sees it’

The present analysis limits its scope to animate arguments only, therefore the final will not show any significant alternations as a function of argument alignment. That said, as a marker of a phase-boundary, the projection plays an integral role in gating accessibility of the internal argument for agreement over the course of the derivation. This is particularly explored in Section 5.6.

5.1.2.2 Direct-inverse agreement on Voice

There major factor that determines the form of Voice is the *alignment* of arguments, as described by the combination of the person-based prominence scale and a scale that encodes syntactic hierarchy (i.e. subject vs. object; external argument vs. internal argument; or, most simply, higher vs. lower). This factor determines whether a so-called direct marker appears (which can arise as person agreement with either the subject or object) or whether inverse marking appears, as summarized in Table 5.1.

	EA → IA	Independent	Conjunct
Local	LOCAL → LOCAL	Object	Object
Mixed	LOCAL → 3/3'	Object	Object
	3 → LOCAL	Inverse	Object
Non-local	3 → 3'	Subject	Subject
	3' → 3	Inverse	Inverse

Table 5.1: Distribution of object agreement, subject agreement, and inverse marking on Voice in the conjunct and independent orders.

It is important to highlight that the hierarchy is articulated to different degrees in the independent and conjunct order—this is reflected in the difference whether the inverse arises in the “mixed” argument combinations. In the independent order hierarchy in

(9a), the local persons are ranked over the proximate, resulting in inverse marking in the $3 \rightarrow \text{LOCAL}$ configurations. This ranking is not realized in the conjunct order hierarchy in (9b), and as a result the inverse does not arise in these cases. However, in both cases the proximate (and the locals) are ranked above the obviative, therefore inverse appears with $3' \rightarrow 3$ in both the independent and conjunct orders.

(9) *The Person-Based Prominence Hierarchy for Ojibwe*

- a. *The Independent Hierarchy:* $\{1, 2\} > 3 > 3'$
- b. *The Conjunct Hierarchy:* $\{1, 2, 3\} > 3'$

The collapse of the hierarchy in this way is easily captured in under the current theory of agreement by changing how the relevant agreement probe is relativized in the conjunct versus independent order. As the ρ -probe, in both orders the probe will be specified for a $u\text{Proximate}$ feature. In the independent order, the addition of a $u\text{Participant}$ feature extends the hierarchy effects to contrast local and non-local persons.

Readers who are familiar with Algonquian languages may question the description above, where Voice marking in the $3 \rightarrow 3'$ configurations is claimed to mark the subject. The received analysis of the theme sign, as the name implies, is that it alternates between inverse marking and indexing the object (the “theme”). One of the major innovations of the current study is a reanalysis of the theme sign in the $3 \rightarrow 3'$ alignments as subject agreement, rather than object agreement. This is based on analysis of the direct marker *-aa* a proximate marker, rather than a generic third person animate marker. The relevant example of a $3 \rightarrow 3'$ alignment is shown below.

- (10) o- gii- waabam -aa -n Ziibiins -an
 3- PAST- see -3 -3' Ziibiins -OBV
 ‘S/he (PROX) saw Ziibiins (OBV)’

Analyses that treat *-aa* as a generic third person marker cannot account for the fact that there is a specific obviative theme sign, glossed here as a single morpheme *-imaa*, which appears in all other cases where there is an obviative object. For example, the LOCAL → 3' alignments such as in (11), where the obviative object is a complex possessive phrase.¹

- (11) nin- gii- waabam -imaa -n Ziibiins o-gii-n
 1- PAST- see -3' -3' Ziibiins.PROX 3-mother-OBV
 'I saw Ziibiin's (PROX) mother (OBV)'

The theme sign *-imaa* cannot appear with a proximate object, where instead *-aa* appears, as shown in (12).

- (12) nin- gii- waabam -aa/*-imaa -n Ziibiins
 1- PAST- see -3/-3' -3' Ziibiins.PROX
 'I saw Ziibiins (PROX)'

What is immediately important is that *-imaa* appears with an obviative object in all cases *except* the 3 → 3' alignment, repeated in (13) with the ungrammaticality of *-imaa* indicated.

- (13) o- gii- waabam -aa/*-imaa -n Ziibiins -an
 3- PAST- see -3/-3' -3' Ziibiins -OBV
 'S/he (PROX) saw Ziibiins (OBV)'

The most natural analysis of these patterns is to treat the theme sign *-aa* in this case as proximate subject agreement. If instead one adopted the object agreement analysis for these cases, it becomes necessary to explain why the less specific “generic” third person form appears instead of the more specific obviative form, even though agreement is occurring with an obviative argument. On the proposed analysis of *-aa* as a subject

¹Ultimately, I believe that this theme sign is bipartite, with *-im* indexing obviative nouns and *-aa* being the familiar proximate marker. An analysis of this construction can be found in Appendix B.

marker, the burden instead becomes configuring the probe to target the subject in some cases, the object in others, and for inverse to arise elsewhere.

Again, the focus of this chapter is on the non-local only configurations, where Voice alternates between subject marking and inverse. This alternation follows from the gluttony-based system adopted in the previous chapter. To capture the mixed and local only alignments, where *object* marking arises, additional assumptions are necessary. An analysis based in an extension of the Person Licensing Condition (Béjar and Rezac, 2003, 2009) is sketched in Appendix B.

5.1.2.3 Person and number agreement on Infl

The third agreement probe is on Infl, which shows person-based agreement sensitivities described as indexing the “highest ranked” argument in the clause. This slot is by far the most morphophonologically complex. Infl shows *portmanteau* forms, in the sense of having a single morpheme that indexes the features of more than one argument, as well as *fission*, where person and number are spelled out in separate slots, but are collected by a single agreement relationship.

The patterns of underlying agreement are given in Table 5.2. The simple cases, and the main focus here, are the non-local only forms, where agreement simply targets the proximate argument (the EA in direct alignments and the IA in inverse alignments). In both the mixed and local-only configurations, Infl agrees with both arguments (with spell-out rules showing complex patterns of portmanteau and fission).²

These agreement relationships are fed by the movement triggered by Voice. Following Oxford (2019b), I argue that Infl simply agrees with the closest goal, which in this case is the argument (or, as the case may be, arguments) sitting in the specifier of VoiceP.

²In the independent order, this creates the contrast between Set A and Set B morphology indicated in Table 5.2. Following a recent analysis by Despić, Hamilton, and Murray (2019) of cognate morphology within Cheyenne (Plains Algonquian), the insertion of Set B is conditioned by multiple agreement with a local and non-local person, while Set A occurs elsewhere. The conjunct order does not show a Set A/B distinction, but the proposal that agreement occurs with both arguments is clear from the rampant presence of portmanteau forms

	EA → IA	Independent	Conjunct
Local	LOCAL → LOCAL	Portmanteau (Set A)	Portmanteau
Mixed	LOCAL → 3/3'	Subject (Set B)	Portmanteau
	3 → LOCAL	Object (Set B)	Portmanteau
Non-local	3 → 3'	Subject (Set A)	Subject
	3' → 3	Object (Set A)	Object

Table 5.2: Distribution of object agreement, subject agreement, and multiple agreement on Infl in the conjunct and independent orders.

In the non-local only alignments, only the proximate argument sits in that position; in the mixed and local only alignments, the EA and IA are in a multiple specifier configuration on Voice, and therefore both are targeted for agreement with Infl via Multiple AGREE (Hiraiwa, 2001).

More generally, I argue that the presence of *full agreement* with Infl results in the deactivation of arguments. I provide a formulation of the Activity Condition (Chomsky, 2000, 2001) that instantiates this claim: When Infl spells-out the full set of features of a given argument, this argument cannot be targeted by further agreement relationships. This knocks out the proximate argument in the non-local only alignments, and the local arguments in the mixed and local only alignments, bleeding the possible agreement relationships that C can engage in.

5.1.2.4 Obviative and number agreement on C

The final slot is number/animacy/obviation agreement on C. This slot only appears in the independent order — I assume this difference follows from a wider theory of clause typing between the independent and conjunct orders, where the probe on Infl in the conjunct order is a fused person/number probe. The distribution of the agreement is shown in Table 5.3.

As previewed in the previous section, the possible agreement relationships in this slot are bled by the deactivating properties of Infl. In the non-local only configurations, where the proximate has been deactivated, C always agrees with the obviative argu-

	EA → IA	Independent	Conjunct
Local	LOCAL → LOCAL	—	—
Mixed	LOCAL → 3/3'	Object	—
	3 → LOCAL	Subject	—
Non-local	3 → 3'	Object	—
	3' → 3	Subject	—

Table 5.3: Distribution of object and subject agreement on C in the conjunct and independent orders.

ment; in the mixed configurations, where the local argument has been deactivated, C agrees with the non-local argument; in the local only configurations, where both arguments are deactivated, there is no visible agreement on C.

C plays crucially into understanding the patterns of word order observable in the non-local only configurations, which are reviewed in the next section. I argue that C has not only a φ -probe, but also a δ -probe. In the direct alignments, the δ -probe is responsible for the alternation between VOS and VSO word orders. The absence of this probe in the conjunct order in turn is linked to the lack of word order alternations in these cases, where agreement and movement triggered by Infl has the final say.

5.1.3 Word order

A major goal of this chapter is to link the patterns of word order and agreement in Ojibwe, in both the independent and conjunct orders. In this section, I introduce the patterns of word order in the non-local only cases. Given the rampant argument and pronoun drop present in the language, the non-local only cases provide the only opportunity to observe word order alternations between both arguments of a transitive clause, therefore the patterns in the mixed and local only alignments are not considered.

The independent order has basic verb-initial word orders, with the ordering of the arguments differing depending on whether the alignment is direct or inverse. In direct alignments, there is a general preference for the VOS word order, but VSO is also fully

grammatical. In contrast, the inverse shows rigid VSO word order, with VOS being ungrammatical.

- (14) **Independent: DIRECT (VOS preferred; VSO possible); INVERSE (VSO only)**
- | | | |
|----|---|-----------------------------------|
| a. | o-gii-waabam-aa-n ikwe-wan gwiiwizens
3-PAST-see-3-OBV woman-OBV boy.PROX
'The boy (PROX) saw the woman' (OBV) | $\sqrt{V_{DIR} O_{OBV} S_{PROX}}$ |
| b. | o-gii-waabam-aa-n gwiiwizens ikwe-wan
3-PAST-see-DIR-OBV boy.PROX woman-OBV
'The boy (PROX) saw the woman (OBV)' | $\sqrt{V_{DIR} S_{PROX} O_{OBV}}$ |
| c. | o-gii-waabam-igoo-n gwiiwizens-an ikwe
3-PAST-see-INV-OBV boy-OBV woman.PROX
'The boy (OBV) saw the woman' (PROX)' | $\sqrt{V_{INV} S_{OBV} O_{PROX}}$ |
| d. | *o-gii-waabam-igoo-n ikwe gwiiwizens-an
3-PAST-see-INV-OBV woman.PROX boy-OBV
<i>Intended:</i> 'The boy (OBV) saw the woman (PROX)' | $*V_{INV} O_{PROX} S_{OBV}$ |

Without going into detail, the verb-initiality of the independent order can be tied to local head movement, which begins at the root and culminates within the CP domain (Hammerly, 2019b).³ This accounts not only for the initial position of the verb, but the head adjunction structure leads to the prevalence of mirror-principle obeying suffixal morphology. More generally, I argue that obviative-precedes-proximate word orders are the result of the probe on C, which as described in the previous section shows agreement with the obviative argument, bringing it to a high position in clause. The alternating order in the direct alignment, and the rigid order in the inverse, is in turn attributed to whether the trigger of movement is ultimately a function of optional A'-movement triggered by the δ -probe on C, or A-movement triggered by φ -agreement directly.

The conjunct order shows different patterns of word order on a number of dimensions. First, the verb is found in a medial rather than initial position — I attribute this

³The analysis in Hammerly (2019b) articulates a split-CP. Therefore the final point to where the verb is raised (FinP) is higher than the C probe discussed here.

to a difference in the height of verb raising, with the operation stopping at Infl rather than traveling all the way to the CP domain. Second, the proximate argument is always to the left of the obviative argument, both with direct and inverse alignments.

(15) **Conjunct: DIRECT (SVO only); INVERSE (OVS only)**

- a. in-gii-noondam ikwe gii-nagamotaw-aa-d abinoojiin-yan
 1-PAST-hear woman.PROX PAST-sing-3-3 child-OBV
 ‘I heard that the woman (PROX) sang to the child (OBV)’
- b. *ingii-noondam abinoojiinyan gii-nagamotawaad ikwe
- c. in-gii-noondam abinoojiinh gii-nagamotaw-igo-d ikwe-wan
 1-PAST-hear child.PROX PAST-sing-INV-3 woman-OBV
 ‘I heard that the child (PROX) was sung to by the woman (OBV)’
- d. *ingii-noondam ikwewan gii-nagamotawigod abinoojiinh

Given that there is no probe on C, the word order in these cases are driven by A-movement of the proximate argument to Spec,IP, with the obviative argument remaining in situ.

5.1.4 Agreement and movement

One of the major insights of the analysis is to tie together the patterns of φ -agreement and movement in Ojibwe. As was implicit in the overview of the previous section, this is accomplished by assuming a model where movement is *always* preceded by an agreement relation (e.g. Chomsky, 2000, 2001; Bošković, 2007; Van Urk, 2015). However, there will be cases of agreement that are not necessarily followed by movement. This relationship is schematized in (16). The AGREE relation will be indicated with a dashed line terminating in both ends with filled dots, and the movement relation a solid line with an arrow indicating the landing site.

(16) *Agreement feeds Movement*

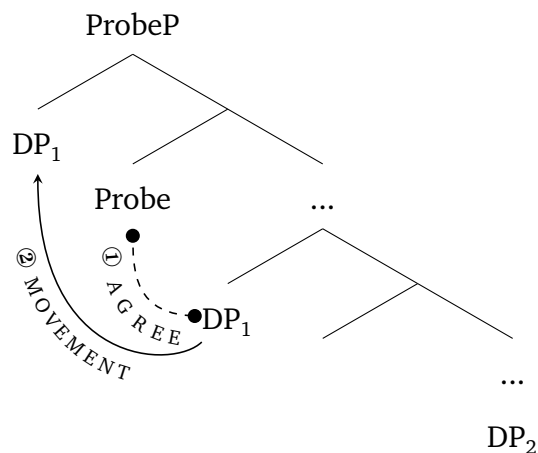

Note that the above schematization specifically abstracts away from the *type* of movement and agreement relationship involved. Following the featural view of movement proposed by Van Urk (2015), I assume the difference between A-movement and A'-movement stems from the features at play, rather than the particular position to which movement occurs. In this view, A-movement occurs following φ -agreement, while A'-movement occurs following δ -agreement. The major addition to the system over the course of the chapter is a “discourse” version of the obviative feature [δ : Obviative], which again is ultimately responsible for the VOS/VSO word alternation introduced in the previous section. The novel idea is that obviation is a property that spans both sides of the φ/δ divide.

The relationship between agreement and movement is the consequence of the features that participate in AGREE being optionally specified with an EPP property. This results in the one-way implicational relationship, where again all movement is preceded by agreement, but not all agreement is followed by movement. The refinement to this theory proposed over the course of the analysis is to *relativize* the EPP. The proposal is that a given φ -probe may be picky about which arguments can satisfy its EPP feature. Rather than being a general requirement for the specifier position to be filled, a probe with a relativized EPP feature will only be satisfied if the specifier is filled by a

D(P) with a particular type of feature such as [Participant] or [Proximate]. I link this proposal to the recent account of person-hierarchy effects by Zubizarreta and Pancheva (2017); Pancheva and Zubizarreta (2017), where certain phase projections appear to require a local person to occupy their edge.

Besides capturing the surface word order facts, the adopted relationship between agreement and movement provides the means to create feeding/bleeding relationships between agreement probes. Agreement/movement of Voice in particular feeds the possible agreement relationships that arise on Infl, with Voice having a relativized EPP that moves proximate and/or local arguments to its specifier, but not obviative arguments. This has the consequence of ensuring Infl never shows agreement with obviative nouns.

5.2 Overview of non-local only alignments

The non-local only configurations provide a baseline for the basic workings of the system, with both mixed and local only configurations adding further layers of complexity. Additionally, non-local only configurations provide the possibility of directly observing the relationship between word order and agreement, as arguments can be realized as regular, overt DPs rather than null or emphatic pronominals. This section presents the patterns of agreement for $3 \leftrightarrow 3'$ argument combinations in both the independent and conjunct orders. The inflectional template are repeated in (17) for reference.

(17) *Inflectional templates (repeated in part)*

- a. *Independent*: Infl- \checkmark - ν -Voice -Infl -C
- b. *Conjunct*: \checkmark - ν -Voice -Infl

I first note again that there are no alternations in the form of ν (the final) in the examples that follow, as all arguments are animate, and it is therefore always realized in its animate form. As discussed, the precise form can also differ as a function of which

thematic role is assigned to the external argument. Given that all elicited examples use the same verb *waabam* translating to “see”, with the experiencer final *-am*, no alternation is present in the examples.

The basic alternation between the direct and inverse on Voice can be seen with the two examples in (18), with the 3SG → 3’SG alignment leading to the “direct” marker *-aa*, which is recognized to be proximate agreement, and 3’SG → 3SG leading to the inverse marker *-igoo*. This contrast between direct and inverse holds in all forthcoming examples, regardless of the number marking of the arguments and the independent versus conjunct order distinction. The remaining agreement is invariant across the two alignments. Agreement with Infl in these examples shows the proximate person prefix *o-*, paired with a phonologically null singular central agreement marker. Finally, C is realized as the obviative singular form *-n* in both cases.

(18) *Independent: 3SG ↔ 3’SG*

- | | | | |
|----|-----------------------------|----------------------|------------|
| a. | o- waab -am | -aa -∅ -n | |
| | 3- see | -ANIM -3 -SG -3’SG | |
| | ‘S/he (PROX) sees h/ (OBV)’ | | 3SG → 3’SG |
| | | | |
| b. | o- waab -am | -igoo -∅ -n | |
| | 3- see | -ANIM -INV -SG -3’SG | |
| | ‘S/he (OBV) sees h/ (PROX)’ | | 3’SG → 3SG |

Changing the proximate argument from singular to plural, shown with both direct and inverse alignments in (19), results in a single change (ignoring the phonologically conditioned shift in the inverse marker from *-igoo* to *-igo*), with central agreement on Infl now being realized in the plural form *-waa* rather than the null singular form.

(19) *Independent: 3PL ↔ 3’SG*

- | | | | |
|----|-----------------------------|--------------------|------------|
| a. | o- waab -am | -aa -waa -n | |
| | 3- see | -ANIM -3 -PL -3’SG | |
| | ‘They (PROX) sees h/ (OBV)’ | | 3PL → 3’SG |

- b. o- waab -am -igo -waa -n
 3- see -ANIM -INV -PL -3'SG
 'S/he (OBV) sees them (PROX)' 3'SG → 3PL

Considering now the patterns with a plural obviative, we see this changes the form of C, now realized as a glottal stop -', with all other morphemes remaining constant.

(20) *Independent: 3SG ↔ 3'PL*

- a. o- waab -am -aa -∅ -'
 3- see -ANIM -3 -SG -3'PL
 'S/he (PROX) sees them (OBV)' 3SG → 3'PL
- b. o- waab -am -igoo -∅ -'
 3- see -ANIM -INV -SG -3'PL
 'They (OBV) sees h/ (PROX)' 3'PL → 3SG

Finally, both the proximate and obviative nouns can be plural, as shown in (21), resulting in the expected forms of both the central agreement marker of Infl and C, given the examples in (19) and (20).

(21) *Independent: 3PL ↔ 3'PL*

- a. o- waab -am -aa -waa -'
 3- see -ANIM -3 -PL -3'PL
 'They (PROX) sees them (OBV)' 3PL → 3'PL
- b. o- waab -am -igo -waa -'
 3- see -ANIM -INV -PL -3'PL
 'They (OBV) sees them (PROX)' 3'PL → 3PL

The conjunct order is similar in many ways to the independent in the non-local only configurations: the direct/inverse alternation occurs in the same contexts, and Infl uniformly indexes the person and number of the proximate argument. However, there are two major differences. First, there is a complete lack of C agreement, resulting in a lack of obviative agreement, and thus a lack of contrast (in agreement) with the

singular and plural forms of the obviative. The second is Infl is realized only in the central agreement slot. The baseline form, with a singular proximate argument, is shown in (22). As expected, the direct and inverse alternation tracks with the alignment of proximate and obviative arguments, and the central agreement slot is realized as proximate agreement *-d*.

(22) *Conjunct*: 3SG ↔ 3'SG/PL

- a. waab -am -aa -∅ -d
 see -ANIM -3 -SG -3
 '...if s/he (PROX) sees him/her/them (OBV)' 3SG → 3'SG/PL
- b. waab -am -igo -∅ -d
 see -ANIM -INV -SG -3
 'if she/he/they (OBV) see h/ (PROX)' 3'SG/PL → 3SG

Shifting the proximate argument from singular to plural results in the addition of a plural marker *-waa* to the central agreement slot in addition to the proximate marker *-d*, with all other slots being unaffected by this difference.

(23) *Conjunct*: 3PL ↔ 3'SG/PL

- a. waab -am -aa -waa -d
 see -ANIM -3 -PL -3
 'They (PROX) sees him/her/them (OBV)' 3PL → 3'SG/PL
- b. waab -am -igo -waa -d
 see -ANIM -INV -PL -3
 'She/he/they (OBV) see them (PROX)' 3'SG/PL → 3PL

The above claim is not without controversy. Previous accounts (e.g. Oxford, 2019b) have glossed the central agreement marker in this case as a single morpheme *-waad* rather than two separate morphemes *-waa* and *-d*. However the single morpheme analysis misses two surface-level generalizations: (i) that *-waa* always combines in a transparently decompositional manner between the singular and plural forms; and (ii)

that the two morphemes can reverse their linear order via phonologically conditioned metathesis. I return to these points and more in Section 5.5.3.

A summary of the morphology from each of the examples above is given in (24). The form of ν , in (24a), was constant across all examples, as all had an animate internal argument. Voice, shown in (24a), alternates between proximate subject agreement with $3 \rightarrow 3'$ alignments, and inverse marking with $3' \rightarrow 3$ alignments, regardless of number and clause type. Infl agreement, shown in (24c) is the major locus of morphological variation between the independent and conjunct orders. However, agreement always occurs with the proximate argument and alternates depending on the number of that argument. C, shown in (24d), appears only in the independent order. Agreement always appears with the obviative argument and alternates according to the number of that noun.

- (24)
- a. ν : $-am = \text{ANIM.EXP}$
 - b. Voice: $-aa = 3$; $igo(o) = \text{INV}$
 - c. Infl_{IND}: $o- -\emptyset = 3\text{SG}$; $o- -waa = 3\text{PL}$
 Infl_{CON}: $-d = 3$; $-waa-d = \text{PL-3}$
 - d. C: $-n = 3'\text{SG}$; $-' = 3'\text{PL}$

Given this basic description, I now turn to a step-by-step derivation of the non-local only independent and conjunct order agreement.

5.3 Agreement on ν

The first step of the derivation is agreement with ν , which always occurs with the IA, as shown in (25). The probe itself can be completely flat, with invariance in which argument is targeted by the probe being due to the downward nature of AGREE. Given that ν c-commands the IA, and given that the IA bears ϕ -features (as is the case in all

possible argument combinations), the probe on v will always be fully satisfied by this relationship and no further probing is necessary.

(25) *Animacy-based agreement on v with the IA*

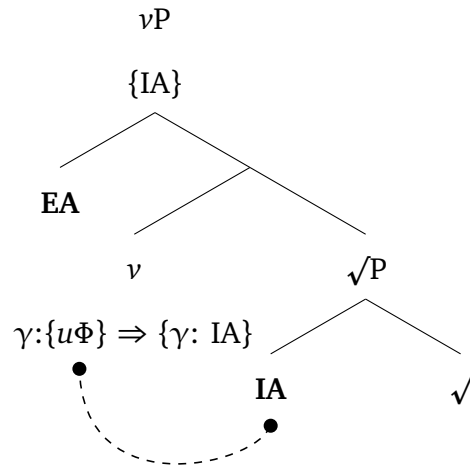

Two claims that are implicit in the representation in (25) deserve some attention. First, I assume that the set copied to the probe is projected to the phrasal level. This follows from the Percolation Principle presented in Chapter 4, where all features of a head are present on the projections of that head. Given that the AGREE relation occurs prior to the projection of the head, the projected features (or more precisely, the projected set) will be those copied from the IA. This assumption is ultimately critical for understanding the relationship between C agreement and movement, explored in Section 5.6, where I argue that in direct alignments C φ -agrees with the IA indirectly via the features inherited by vP . The second is that agreement does not result in movement of the IA to the specifier of vP . I assume any EPP requirement of v can be satisfied by the EA. This follows from the common economy principle that ensures, if possible, direct MERGE is employed over movement (Chomsky, 2000).

5.4 Agreement on Voice

There are two different versions of the probe on Voice: one for the independent order, and one for the conjunct order. As shown in (26), the probe on Voice in the independent order includes a [*uParticipant*] feature, while the conjunct order probe only includes [*uΠ*] and [*uProximate*]. Each probe is given in both the feature and set-based notation.

- (26) a. $\text{Voice}_{\text{IND}} = \rho: \{u\text{Anim}, u\text{Prox}, u\text{Part}\}$
 $= \rho: \{u\{I, U, O, O', O''\}, u\{I, U, O\}, u\{I, U\}\}$
- b. $\text{Voice}_{\text{CON}} = \rho: \{u\text{Anim}, u\text{Prox}\}$
 $= \rho: \{u\{I, U, O, O', O''\}, u\{I, U, O\}\}$

This difference is critical for capturing the difference in the distribution of the theme sign, where $3 \rightarrow \text{LOCAL}$ leads to inverse marking in the independent, but not the conjunct. However, for the $3 \leftrightarrow 3'$ configurations we are concerned with here, the change in the probe as a function of clause type has no impact — because there is no local person in the clause, the presence/absence of the participant feature is irrelevant. That both probes contain both *uΠ*, and *uProx* is the relevant fact, which allows the patterns of direct-inverse to remain constant in both the independent and conjunct orders with the non-local only configurations. Furthermore, the lack of a number probe accounts for the invariance in direct-inverse marking when it comes to number.

While the derivation was already previewed in Chapter 4, I walk through the steps again here in the context of the full paradigms of agreement and with added consideration of movement. The inverse alignment in particular, where a single probe enters into agreement relationships with multiple arguments, requires further comments. I argue that the EPP on Voice is relativized such that it is only satisfied by a proximate or local argument. This is formally implemented by the presence of a feature [*EPP: Proximate*], which requires a DP with either *I*, *U*, or the proximate *O* in its set to be satisfied. This

results in the movement of proximate arguments, but not obviative arguments, to the specifier of VoiceP

Given that the probe on Voice and the spell-out of the head is impartial to number, the same steps result regardless of the number of the two arguments. I show agreement with singular arguments only for simplicity, beginning with the mechanics of AGREE, then turning to the spell-out of Voice and a brief comparison to previous accounts.

5.4.1 Subject agreement in direct alignments

With direct alignments ($3 \rightarrow 3'$), as shown in (27), the probe hits the proximate EA first. This satisfies all unvalued features and results in the EA's set to be copied to Voice, which is ultimately spelled-out as proximate (subject) agreement. Finally, the EA undergoes A-movement to the specifier of VoiceP (I discuss the nature of the EPP feature driving this movement below).

(27) *Voice agreement targets and moves the EA in $3 \rightarrow 3'$ alignments*

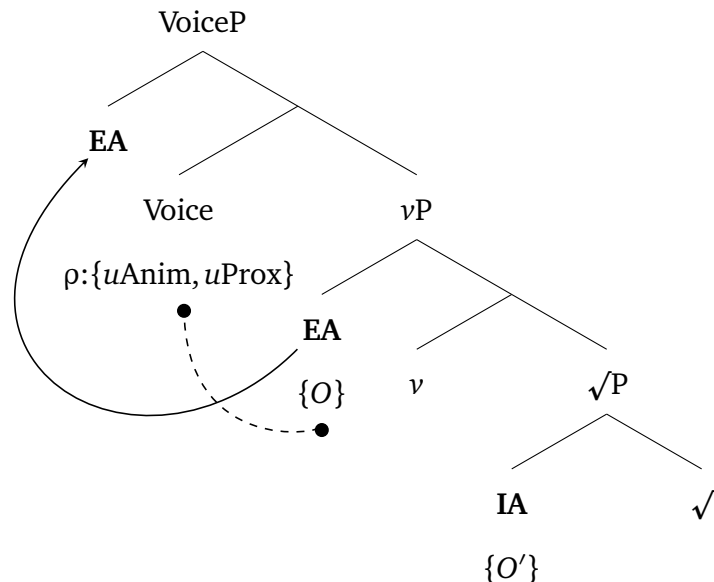

We can see that in the direct alignments the IA is not probed at this stage of the derivation, and therefore remains in situ. The main consequence is that the IA becomes

trapped within the vP phase complement—a fact that becomes relevant when agreement with C is considered in Section 5.6.

5.4.2 Gluttony and the relativized EPP in inverse alignments

The derivation of inverse alignments ($3' \rightarrow 3$) is shown in (28). These cases involve the same probe on Voice, but differ in that the obviative argument is the EA and the proximate the IA. As a result, the first agreement relationship between Voice and the EA only satisfies $u\Pi$, with $uProx$ being satisfied by a second cycle of agreement with the proximate IA. This results in a gluttonous set from two goals on Voice.

(28) *Voice agreement results in gluttony in $3' \rightarrow 3$ alignments and moves the IA*

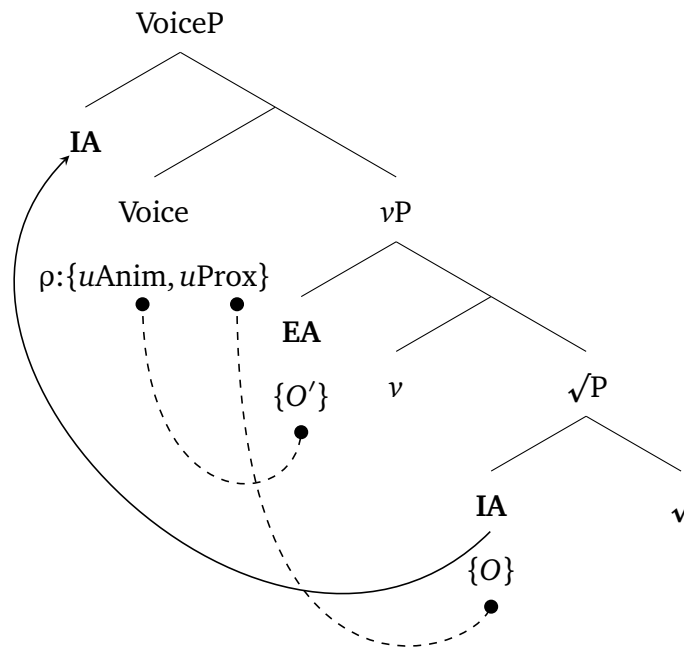

The final piece in (28) is determining movement, given that both arguments have been targeted by the probe. I argue that only the proximate IA undergoes movement to Spec, VoiceP, despite both the EA and IA being target by agreement. One can imagine a number of possible ways to derive the movement of the proximate argument alone, rather than ending up with movement of the *obviative* argument alone, or movement

of *both* the proximate *and* obviative arguments into a double specifier configuration. I put forward the idea that the EPP feature on Voice, which is ultimately responsible for triggering movement, is articulated such that it specifically requires a proximate argument (i.e. an argument with either *I*, *U*, or the proximate *O* within its set) rather than any DP

In this view, the canonical EPP requirement of a language such as English is analogous to a flat probe, as shown in (29a). In these cases, the particular features of the DP that fills the specifier position are not important, and anything will suffice. When the EPP is relativized, it specifically requires a participant DP (29b), or as argued for Voice in Ojibwe, a proximate DP (29c).

(29) ***Relativized EPP***

- a. *Generalized DP*: [EPP: Φ]
- b. *Participant Specific*: [EPP: Participant]
- c. *Proximate Specific*: [EPP: Proximate]

Returning to (28), adopting the idea that Voice in Ojibwe has a feature [EPP: Proximate], only movement of the proximate IA would suffice to check this feature, and only a proximate argument will be triggered to move. This means a derivation where the obviative argument moves to Spec, VoiceP is ruled out — it cannot check the relativized EPP feature, and thus there is nothing to trigger its movement.

On the theory sketched here, one can imagine a range of relativized EPP features equal to the range seen with probes. However, I do not believe that the EPP is necessarily an independent property of the probe. An important avenue for future work is to examine whether the full range of variation in EPP preferences is indeed borne out, or whether there are restrictions that need to be put in place to limit generation. This avenue of work will surely provide more insight between the relationship between agreement and movement. For example, one restriction that constitutes a worthy hypothesis

for future work is that the EPP is never relativized to be pickier than the φ -probe. This would rule out the possibility of, for example, a flat φ -probe being relativized to require a participant in its specifier. On the other hand, a picky φ -probe may not necessarily result in a picky EPP all occasions.

This idea has echos with a recent proposal by Zubizarreta and Pancheva (2017) and Pancheva and Zubizarreta (2017), who propose the *P(erson)-Constraint*, which states that certain phases require a participant D(P) within their edge (i.e. Specifier) position. For Zubizarreta and Pancheva, the requirement is formulated as a bespoke interface condition — a direct filter on the derivation following the syntactic component. They argue that if a phase-head bears an *interpretable* participant feature, then this filter requires that projection to have a participant-bearing D(P) in its edge position, or else the structure is ill-formed. The current proposal argues that this rather specific filter can be derived from the more general patterns of the EPP, with no need for a new type of constraint on well-formedness at the interfaces. Like the P-Constraint, the EPP is ultimately enforced by a filter at the interfaces such that it must be satisfied for a derivation to be well-formed, therefore the proposal does not rid us of such constraints entirely. The particular extension proposed here is that the EPP can be relativized such that a specific type of argument—for example, a participant or proximate—must occupy the specifier position of the phrase.

The relativized EPP proposed here also has an antecedent with the *EPP Best Match* principle proposed by Coon and Bale (2014). This principle states that, in cases where multiple arguments provide a (partial) match to the probe, the one that matches the most segments of the probe is moved to satisfy the EPP. Both the current proposal and the EPP Best Match share the assumption that it is not necessarily the closest argument that is attracted to the specifier of the probe: The probe prefers to move an argument with some particular feature, rather than the closest one. In the non-local only alignments, the proposal of Coon and Bale and the current proposal make equivalent predictions.

A difference arises in the mixed alignments, where I argue that *both* the local and proximate arguments are moved to Spec,VoiceP. The EPP Best Match predicts that only the local argument (the one that matches the most segments of Voice) should move.

5.4.3 The spell-out of Voice

Returning again to the patterns of agreement and away from movement, recall the two sets of primitives, isolated in (30), which are derived for the direct and inverse alignments. The direct alignments have a single set, consisting of the single (proximate) *O*, reflecting the single agreement relation that probe engaged in. On the other hand, the inverse alignment has an ordered set from each of the two arguments of the verb.

- (30) a. DIRECT: Voice = {*O*}
 b. INVERSE: Voice = ({*O'*}, {*O*})

Again, the remaining discussion follows what was previously laid out in Chapter 4. The spell-out rules in (31) are immediately relevant, but note that additional rules for each possible person distinction will be added when the mixed and local-only configurations are considered, and the inventory of theme signs is widened.

- (31) Voice_{*O*} ⇔ -*aa*
 Voice_{elsewhere} ⇔ -*igoo*

When Voice is specified for {*O*} alone, then the so-called direct marker -*aa* is expounded, which can be described as proximate subject agreement. With the gluttonous collection of features, the elsewhere form -*igoo* appears—the VI insertion operation is unable to make a choice about which set to spell-out, and therefore inserts an unmarked form that does not index any particular set. This is descriptively referred to as the inverse marker.

5.5 Agreement on Infl

To review, agreement on Infl is described as indexing the person and number of the highest ranked argument. In the independent order, it appears as the combination of the person prefix and central agreement, while the conjunct order only shows a form in the central agreement slot. Besides this difference in the number of agreement slots, the particular forms in the independent and conjunct differ quite significantly. This contrasts with the theme sign on Voice, where the same basic forms are shared across both the independent and conjunct orders.

Morphophonological differences aside for the moment, the underlying geometry of probe and goal is parallel between the independent and conjunct orders. In all cases, regardless of clause type and the initial alignment of the arguments, Infl agrees with the proximate argument. This is the result of agreement and movement driven by Voice, which was shown to be parallel across the two clause types in the previous section. I argue that Infl simply ends up agreeing with (and moving) whichever argument is closest (i.e. whichever argument has moved to Spec, VoiceP). As a result, Voice feeds agreement with the proximate subject in the case of a direct $3 \rightarrow 3'$ alignment, and the proximate object in the case of the $3' \rightarrow 3$ alignment.

In the conjunct order, Infl agreement is also the final agreement relationship within the clause. This means the movement patterns derived from this relationship are reflected in the final surface word order. This contrasts with the independent order, where the final word order is established following agreement with C.

5.5.1 The probe on Infl

Given that Infl simply agrees with the closest argument, the person probe that governs Infl agreement can therefore be “flat”, as shown in the examples in (32). As a result, the probe simply agrees with the first argument that Matches its uninterpretable person feature $u\Pi$. However, there are underlying differences between the two clause types in

how they relate to the number probe. The two possible probes are shown in (32), with the difference between the two orders being whether Infl hosts just a flat person probe (32a), or a *fused* person and number probe (32b) (cf. Coon and Bale, 2014).

- (32) a. $\text{Infl}_{\text{IND}} = \pi:\{u\Pi\}$
 b. $\text{Infl}_{\text{CON}} = \pi/\#:\{u\{\Pi, \#\}\}$

The *fused* probe in (32b) is distinct from one in which person and number constitute separate probes on a single head, which I will refer to as an *ordered probe*. The notational difference between two can be seen abstractly in (33). The probes of the ordered probe are in an ordered set, with person preceding number, and each with a separate need for satisfaction. In the fused probe, both person and number are in a single set, with a single satisfaction requirement taking scope over both.

- (33) a. $P_{\text{ORDERED}} = (\pi:\{u\Pi\}, \#:\{u\#\})$
 b. $P_{\text{FUSED}} = \pi/\#:\{u\{\Pi, \#\}\}$

For the purposes of AGREE, the major difference is in whether the probing for person and number occurs at once (as in a fused probe) or separately (as in an ordered probe). Separate person and number probes on a single head show effects consistent with person probes first, and continuing until it satisfies all of its features, followed by number, which does the same (for extensive discussion, see Béjar and Rezac, 2003; Coon and Keine, 2020). This was seen in the analysis of the PCC given in Chapter 4, but will not appear as part of the analysis of Ojibwe.

With a fused probe, both person and number probe in parallel. This can result in two possibilities: Conjunctive or disjunctive satisfaction conditions. The original case of a fused probe discussed by Coon and Bale (2014) was a *conjunctive* probe, that would only be fully satisfied by a plural participant, rather just any participant, regardless of

number. The case here is a *disjunctive* probe (see also Roversi, 2020), where a goal fully satisfying *either* the person or number features results in full satisfaction of the probe.

In other words, fusion links together the satisfaction conditions of person and number so if one is satisfied, the other is too. For our purposes, this means probing stops after a single cycle, as all arguments involved in the current derivation will satisfy the $u\Pi$ feature of the probe. That said, both the person and number features of the probe request copies of a goal if it Matches their particular features. This has consequences when it comes to spell-out, which provides the means to account for the difference in how Infl surfaces in the independent versus conjunct orders.

5.5.2 Schematizing the patterns

To review, the probe on Infl simply agrees with the first argument that Matches its uninterpretable person feature $u\Pi$ —this is invariably the DP sitting in the specifier of VoiceP. This holds true regardless of the clause type and the number marking of the object (though, as detailed above, the copying procedure is affected by number — this is discussed in the next section).

The basic probing geometry is schematized with the direct alignment in (34). As noted above, agreement and movement on Voice has moved the proximate external argument to the specifier of VoiceP in these cases, therefore it is targeted for AGREE. The EA fully satisfies the probe, and its features are copied to Infl.

(34) *DIRECT feeds “subject” agreement on Infl*

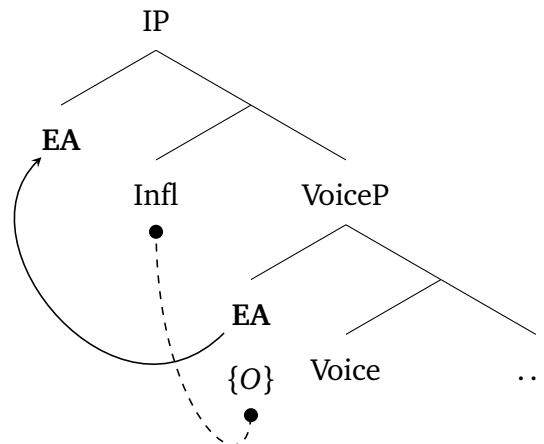

Infl agreement in the inverse alignment occurs with the same geometry as seen in (34), with the closest goal sitting in the specifier of VoiceP. The difference is that agreement and movement on Voice promoted the proximate IA to this position, thus Infl shows what can be described as “object” agreement. Again, the proximate IA fully satisfies the probe, and its features are copied to Infl.

(35) *INVERSE feeds “object” agreement on Infl*

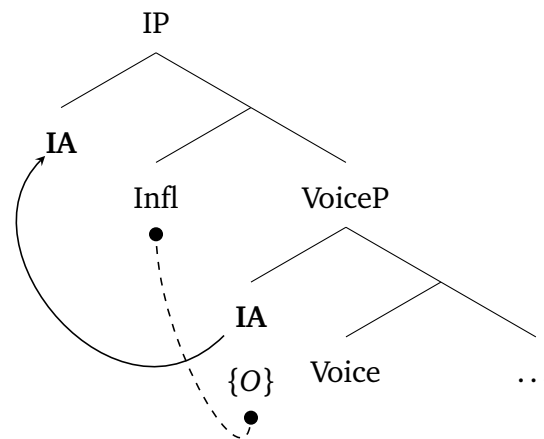

With these derivations in hand, we can return to see that the surface word order generalizations for the conjunct order have been derived. The proximate argument, sitting in Spec,IP, is higher than (linearly, to the left of) the obviative argument, which is in its base-generated position within the VP. Again, assuming that the verb is raised

via head movement to a projection between these two arguments, an SVO word order is derived in direct alignments, and an OVS word order in the inverse alignments.

This analysis of the conjunct order will be levied in Chapter 6, where the processing of obviation and argument structure in Border Lakes Ojibwe is examined. In short, the specifier of IP will be recognized as the derived subject position. As a result, relative clause extractions in these clause types will be “subject” relative clauses with proximate nouns, and “non-subject” relative clauses with obviative nouns, by virtue of the fact that proximate nouns always occupy this prominent syntactic position, while obviative nouns remain in situ.

5.5.3 The spell-out of Infl

The discussion up to this point has ignored number, but it must now be brought to bear given that Infl in both the independent and conjunct order expresses person and number agreement. As previewed above, this is also where the fused person/number probe in the conjunct order rears its head, allowing for an explanation of why Infl agreement is realized discontinuously as the person prefix and central agreement in the independent order, and sequential person-number suffixes in the conjunct order.

Following the assumption of *coarseness*, the full set of the probe is copied in all cases. In the independent order, this set is copied onto π , while the conjunct order copies back to both π and $\#$. This results in the structure of copies in (36).

(36) ***Copy structure and spell-out rules on Infl***

- a. 3SG: $\text{Infl}_{\text{IND}} = \pi: \{O\} \Leftrightarrow o- -\emptyset$
 3PL: $\text{Infl}_{\text{IND}} = \pi: \{O, O', O''\} \Leftrightarrow o- -waa$
- b. 3SG: $\text{Infl}_{\text{CON}} = \pi: \{O\}, \#: \{O\} \Leftrightarrow \emptyset-d \text{ or } -g-\emptyset$
 3PL: $\text{Infl}_{\text{CON}} = \pi: \{O, O', O''\}, \#: \{O, O', O''\} \Leftrightarrow -waa-d \text{ or } -g-waa$

Setting aside the differences in phonological form, which can be attributed to sensitivity in clause-typing, the major explanandum is the discontinuous and flanked spell-out of person and number in the independent order, and the sequential spell-out in the conjunct. I argue that both follow the same basic principles of vocabulary insertion, and attribute the difference to whether person and number are spelled-out in a single step, or in two sequential steps.

The analysis follows from Harbour (2008), which has been suggested to be applied to account for the spell-out of Infl agreement in Algonquin by Oxford (2019b). Harbour proposes that there are two basic constraints that must be obeyed as person and number morphology is spelled-out and linearized. First, each piece of morphology must be linearly adjacent to the stem. The stem consists of the root plus whatever pieces of morphology have been spelled-out so far, with that spell-out proceeding from the root out. Second, the (universal) functional order of person and number must be obeyed such that person precedes (is to the left of) number.

Given that both person and number are specified within a single set in the independent order, the spell-out of both person and number occurs *at once*, and both of these constraints must be satisfied. There are four logically possible linearizations of the person and number morphology, as shown in (37). These possibilities assume that spell-out is operating over a head-adjunction structure, which is formed by head movement of the root through each layer of the verbal spine. This results in all heads being spelled-out with suffixal morphology, if all else is equal (Hammerly, 2019b). However, not all is equal in this case. Only the linearization where person and number flank the stem *and* person is realized as a prefix, shown in (37a), satisfy both the adjacency requirement and the ordering requirement assuming that both morphemes are being realized in the same step. Having both morphemes follow the stem, as in (37b,c), violates adjacency (and, in the case of (37c), the ordering constraint); the alternate flanking option with # realized to the left, as in (37d), violates the ordering constraint.

- (37) a. π -STEM-#
 b. *STEM- π -#
 c. *STEM-#- π
 d. *#-STEM- π

The conjunct order is subject to the same constraints, but differs in that the person and number markers are realized one by one. The ordering constraint dictates that person is realized to the left of number — however, in the examples so far we have seen that this constraint appears to be violated in the final surface realization. However, the #- π ordering of *-waa-d* is conditioned by a particular phonological environment. This can be seen in an alternation between *-waa-d* or *-g-waa*, as condition in the examples in (38a) and (38b) by the respective absence of presence of clausal negation.

- (38) a. waab -am -aa -waa -d
 see -ANIM -3 -PL -3
 ‘...if they (PROX) see h/ (OBV)
- b. waab -am -aa -si -g -waa
 see -ANIM -3 NEG -3 -PL
 ‘...if they (PROX) don’t see h/ (OBV)

I therefore assume that the insertion of morphology follows the ordering constraint, with person being inserted before number, with phonologically conditioned metathesis causing the observed surface alternations. Given this ordering, each of the two morphemes can individually satisfy the requirement to be adjacent to the stem while remaining suffixal. The person morphology is inserted first, becoming part of the stem and allowing the number morphology to be subsequently inserted to its immediate right.

- (39) ①: STEM- π
 ②: STEM- π -#

5.5.4 Infl and the Activity Condition

The final piece of the picture for Infl is the idea that agreement results in the *deactivation* of the targeted goal. Much recent work on agreement, going back to the Activity Condition of Chomsky (2000, 2001), has recognized that certain probes leave arguments open to additionally satisfy a subsequent probe, while others appear to block their goal(s) from entering into further agreement relationships. An example of this is clitic doubling, where cliticization deactivates arguments for further agreement.

The literature on Infl agreement in Ojibwe, and Algonquian more generally, has oscillated over the past few decades on whether the agreement is an instance of clitic doubling or “pure” agreement (Oxford, 2014, 2019b; Bruening, 2019). One conspicuous piece of evidence in favor of a clitic doubling analysis is that the form of the morphology bears a resemblance to the strong pronouns—a common occurrence in languages with more clear-cut instances of cliticization (e.g. Kichean, see Preminger, 2014, p. 58). This can be shown to be the case in Ojibwe, as shown by the comparison in (40), noting that *w-* and *o-* are allophones.

(40) *Independent order Infl versus strong pronouns in Border Lakes Ojibwe*

	Infl _{IND}	Strong Pronoun
3SG	<i>o-</i>	<i>w-iin</i>
3PL	<i>o-waa</i>	<i>w-iina-waa</i>

This analogy works well in the limited case of the non-local only forms of agreement in the independent order, but becomes more difficult to maintain in the local-only and mixed alignments, where agreement often takes a portmanteau form. This is described in more detail in the coming section, but generally speaking it is not clear what sort of cliticization operation would allow for the formulation of portmanteau clitics, which combine the features of multiple arguments in a single form (for a related line of argumentation, see Deal, 2015). In contrast, a pure-agreement based account readily

accommodates the realization of these forms by copying the sets of multiple goals to a single head, as will be shown in more detail in the coming sections.

That said, there is an additional commonality between clitic doubling and Infl agreement in Ojibwe, which could serve as the link to the deactivation of arguments: Both show *full agreement*. That is, both Infl agreement in Ojibwe, and clitic doubling generally, express the full set of features of the goal argument. I therefore propose the following formulation of the Activity Condition:

(41) ***The Activity Condition***

An agreement relation with a probe P deactivates a goal G iff the probe expresses the full set of φ -features of G

I acknowledge that this formulation makes the *syntactic* activation of the goal dependent on its ultimate *morphophonological* form, which presents a derivational look-ahead problem. I assume that this could be avoided with a more nuanced view of Copying than has been taken here, where all copying is assumed to be coarse (i.e. the complete set of features/primitives is copied). If this is relaxed, then, for example, the Activity Condition could be formulated such that when copying is fully coarse, then the goal is deactivated. Anything less than the full set would not lead to deactivation of the targeted argument. I leave the expansion of this idea to future work that takes a more careful look at copying and spell-out.

In the next section, I show that the proposal that Infl deactivates the argument with which it agrees provides an explanation for the apparent hierarchy violating behavior of C agreement in the independent order.

5.6 Agreement on C

In this section, I provide an analysis of agreement and movement with the number probe on C. There are two key properties to account for with C agreement qua agreement. First, agreement on C descriptively indexes the *lowest ranked* argument, appearing to violate the person-based prominence hierarchy. I argue that, rather than following from any particularly special properties of the probe on C, it is the result of the fact that Infl has deactivated the more prominent proximate argument, bleeding the possibility of agreement with the argument on C. Second, C does not appear in the conjunct order at all. I assume that C agreement is an expression of the number probe #. Given that Infl is analyzed as a *fused* person-number probe in the conjunct order, this provides a path for explaining the absence of a pure number probe on C in those types of clauses.

The second aspect of C is its role in providing an explanation for the word order effects in the independent order described in Section 5.1.3. I argue that C has a δ -probe in addition to a φ -probe. This provides the means to explain the VOS/VSO alternation characteristic of direct alignments as optional A'-movement of the obviative IA following agreement with the δ -probe. In contrast, the rigid VSO word order of inverse alignments is due to (obligatory) A-movement of the obviative EA stemming from φ -agreement.

Given the above objectives, I propose the probe in (42) governs φ/δ -agreement on C, with the flat #-probe searching before the δ -probe, which searches specifically for an obviative argument that has been specified for the appropriate δ -feature [*uObviative*].

$$(42) \quad C_{\text{IND}} = (\#: \{u\# \}, \delta: \{u\text{Obv}\})$$

5.6.1 Direct alignment

I begin with a walkthrough of the direct alignments, schematized in (43). There are three basic steps to walk through: ① φ -agreement, ② δ -agreement, and ③ A'-movement.

(43) DIRECT leads to unlocking + (optional) A'-movement of obviative IA

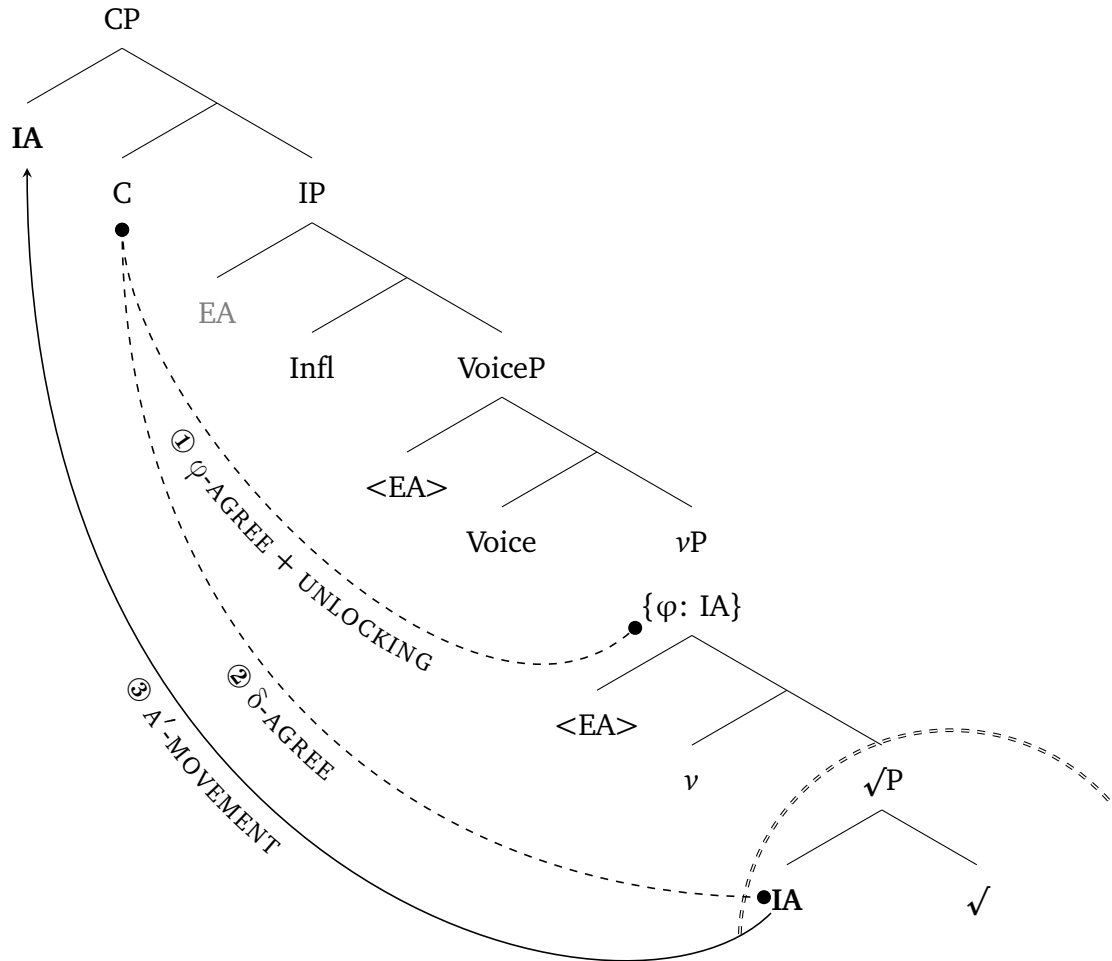

The first step is φ -agreement with vP . Given that the EA has been deactivated by Infl, and the IA (at this point) is trapped within the phase complement of v , the closest active φ -bearing element is vP , which previously collected the φ -set of the internal argument via agreement (see Section 5.3). This step of the derivation always occurs, accounting for the invariance of the agreement morphology in these cases—there is no relationship between the word order alternations discussed in Section 5.1.3 and the obviative agreement on C. I further argue that this agreement alleviates the Phase Impenetrability Condition (Chomsky, 2000, 2001) on the vP phase complement via *unlocking* (Rackowski and Richards, 2005; Halpert, 2019; Branam, 2018). This allows the phase complement to be open for subsequent operations, most pertinently A'-extraction.

Given that the φ -probe on C has an EPP feature, one may wonder why the ν P targeted by agreement does not move to satisfy the EPP in this case. I advance the claim that there is a certain degree of relativization of the EPP on C, such that only nominal elements (i.e. syntactic elements with the relevant nominal-defining features) can satisfy the requirements of this projection (cf. Halpert, 2019, for Zulu). The ν P, being part of the verbal spine, is not specified for such a feature, and therefore is not fronted to this position. Consistent with this, in previous work I have shown evidence against a VP fronting analysis for Ojibwe (Hammerly, 2019b).

Moving forward, step ② is δ -agreement, which targets the obviative IA. I assume that the δ -feature has an EPP feature, therefore probing is followed by A'-movement, shown in step ③. Given that δ -features are optional on DPs (Van Urk, 2015), these final two steps are optional. In derivations where the feature is present on the obviative argument, then the IA is attracted to Spec,CP and undergoes A'-movement, as shown in (43). In derivations where the IA lacks this feature, it remains in situ. Whether or not this A'-movement to Spec,CP occurs (i.e. whether the obviative IA has the relevant δ -feature) accounts for the optional VOS/VSO word order alternations in the direct alignments. Furthermore, given that the feature is specifically [*uObviative*], I propose that proximate arguments cannot be specified for the relevant feature, and therefore are never targeted by the δ -probe on C.

Given this analysis, different word orders should correspond to different scope relationships between the an existential quantifier on the IA and negation. As reviewed in Section 5.1.1, negation is projected immediately above Voice. Therefore when the object undergoes movement, it should be able to take wide scope (44a), while it should be interpreted with narrow scope when it remains in situ (44b).

- (44) a. *Moved object (VOS), \exists » NEG predicted*
gaawiin ogii-waabamaasiin ikwewan_{IA} gwiiwizens_{EA} [_{NegP} NEG... <IA>]
↑ _____]
- b. *In situ object (VSO), NEG » \exists predicted*
gaawiin ogii-waabamaasiin gwiiwizens_{IA} [_{NegP} NEG... ikwewan_{OBJ}]

As reported in Hammerly (2019b), the two different word orders are associated with distinct scope interpretations with respect to negation. An indefinite object with the VOS word order is rigidly interpreted with wide scope, as shown in (45), while an indefinite object in the VSO word order is rigidly interpreted with narrow scope, as shown in (46).

- (45) gaawiin o-gii-nageshkaw-aa-sii-n bezhig gwiiwizens-an Ziibiins
GAAWIIN 3-PAST-meet-DIR-NEG-OBV one boy-OBV Ziibiins.PROX
‘Ziibiins (PROX) didn’t meet one boy (OBV)’
- a. *NEG » \exists : There is no boy *x* such that Ziibiins met *x*.
- b. \exists » NEG: There is a boy *x* such that Ziibiins did not meet *x*. VOS
- (46) gaawiin o-gii-nageshkaw-aa-sii-n Ziibiins bezhig gwiiwizens-an
GAAWIIN 3-PAST-meet-DIR-NEG-OBV Ziibiins.PROX one boy-OBV
‘Ziibiins (PROX) didn’t meet one boy (OBV)’
- a. NEG » \exists : There is no boy *x* such that Ziibiins met *x*.
- b. * \exists » NEG: There is a boy *x* such that Ziibiins did not meet *x*. VSO

Given that movement is ultimately the result of an δ -probe rather than a φ -probe, one may wonder why it is not possible to reconstruct and get a narrow scope reading in (46)—one of the hallmark properties of *A'*-movement is reconstruction. I propose that, in principle, the reconstructed interpretation is possible, but access to this interpretation is blocked by the availability of the in situ counterpart, which can *only* have the narrow scope reading. This is analogous to the situation with scalar implicatures,

where, for example, the meaning of *some* in a sentence such as *some students like syntax* results in the implicature that *not all students like syntax*, because use of *all* provides an unambiguous way of expressing the meaning *all students like syntax*. In the case of Ojibwe, the VSO word order unambiguously has a narrow scope interpretation, while VOS is associated with both narrow and wide scope readings. However, given that there is a more specific alternative to indicate narrow scope, the VOS order is only felicitous under the wide scope interpretation, appearing to block reconstruction.

5.6.2 Inverse alignment

The inverse alignment differs from the direct in that the remaining active argument is the external argument, and is therefore not trapped within the vP phase. As a result, the φ -probe on C agrees with the EA directly, triggering A-movement independently of the δ -probe to satisfy the general EPP feature of C. This is schematized in (47).

(47) INVERSE *leads to φ -agreement and movement of obviative EA*

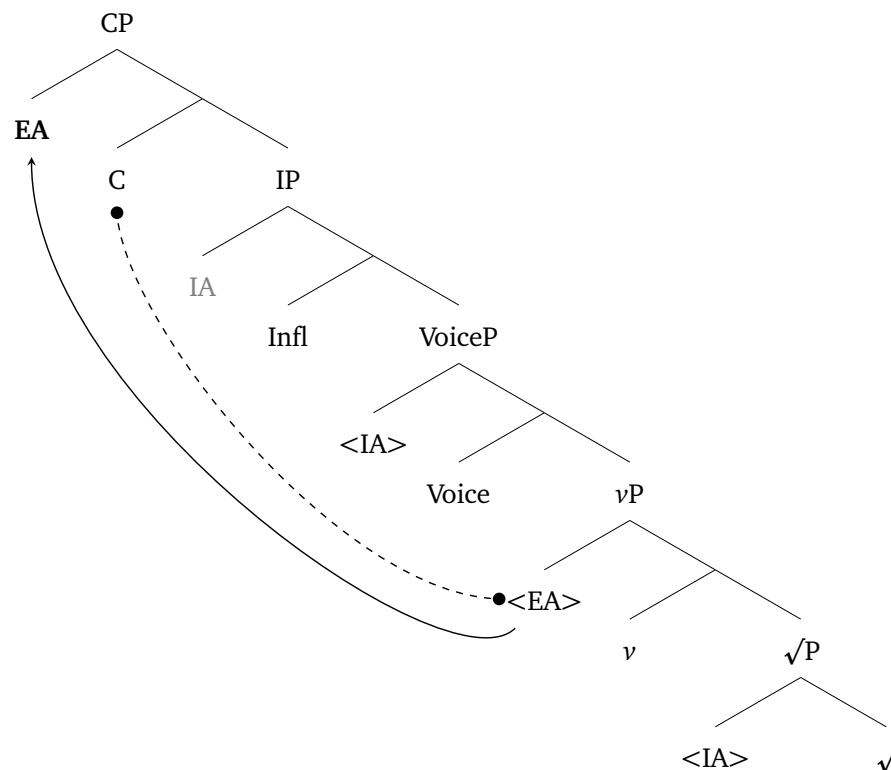

5.7.1 Previous accounts of the theme sign

The biggest change made within the current account is to treat the direct marker *-aa* as agreement with the proximate subject in $3 \rightarrow 3'$ alignments. As reviewed in Section 5.1.2.2, the motivation for this is the fact that in all other conditions with an obviative IA, that is, the LOCAL $\rightarrow 3'$ alignments, the more specific theme sign *-imaa* appears. To my knowledge, no previous account of Ojibwe, most relevantly Béjar and Rezac (2009) and Oxford (2019b), has considered the presence of the obviative theme sign in the LOCAL $\rightarrow 3'$. As a result, both of these accounts treat *-aa* as a generic third person marker resulting from agreement with the obviative IA.

The recognition of *-aa* as a specific proximate agreement marker has consequences for both of these proposals. Both Béjar and Rezac (2009) and Oxford (2019b) argue that the probe that governs theme sign agreement is part of the projection that introduces the external argument. To maintain this geometry while accounting for the presence of agreement with the EA, it would be necessary to relax the assumptions that (i) AGREE is immediately triggered when the probe is merged so that the IA is not agreed with prior to the EA being merged, and (ii) AGREE proceeds downwards first, given that this would require the probe to AGREE first with its specifier. This alone is not necessarily untenable if an upward model of AGREE is adopted (e.g. Bjorkman and Zeijlstra, 2014). What becomes problematic is that Béjar and Rezac (2009) and Oxford (2019b) require the assumptions of downward AGREE with the mixed and local only alignments to capture what is clearly object agreement in these cases. By my estimation, it is not obvious how one could create a principled split such that non-local alignments trigger upward AGREE, while all others trigger downward AGREE.

The present account circumvents these issues by placing the probe on Voice above both the EA and IA, introducing the EA in ν rather than Voice. This produces a geometry that allows the probe to c-command both potential goals, and also places the EA in the specifier of the head that is associated with the “verb final”, which introduces the

experiencer and agent thematic roles. This allows for a single model of AGREE to be maintained across all alignments, and places the EA in a sensible argument position for the assignment of a thematic role. While the mixed and local-only cases were not covered here, with some additional independently motivated assumptions about person licensing, it is possible to motivate IA agreement in these cases (see Appendix B for a sketch of this analysis).

The question then arises about whether it is possible to change the geometry and maintain the analysis of *inverse* marking in Béjar and Rezac (2009) and Oxford (2019b). For Béjar and Rezac (2009), the inverse marker is the spell-out of an *added* probe of Voice, which is triggered by the presence of an unlicensed argument, where licensing is required for local arguments and occurs via agreement. Even if licensing conditions are extended to include proximate persons in addition to local persons, there is no way to motivate the insertion of an added probe in this case: The proximate argument has already been agreed with, and therefore licensed, by the “core” probe on Voice.

For Oxford (2019b), inverse agreement is triggered by an impoverishment operation which deletes the features of Voice just in case both Infl and Voice agree with the same argument. The inverse marker is thus the spell-out of an elsewhere form that arises with impoverishment. Recalling the Infl agrees with the proximate argument in all cases, if Voice is treated as subject agreement in the $3 \rightarrow 3'$, the analysis erroneously predicts that impoverishment should apply and the inverse marker should appear.

5.7.2 Previous accounts of word order

Another major advance with the current analysis is providing an analysis of the peripheral agreement marker (C), and tying its absence or presence to the patterns of word order. The account of Oxford (2019b), which outlines general word order predictions for Ojibwe, was not able to test these predictions with word order judgments from

speakers of the Algonquin dialect. Moreover, Oxford (2019b) provides an analysis of agreement and movement with Voice and Infl, but does not consider the role of C.

As a result, on the face of it, the current analysis contradicts the word order predictions of Oxford (2019b), who argues that VOS should occur in inverse clauses, and VSO should occur in direct—the opposite of what was observed here. These claims are driven by A-movement of the proximate argument triggered by agreement with Infl, the same basic movement that was proposed here. In direct alignments, the EA is targeted, predicting VSO. In the inverse, the IA is targeted, predicting VOS.

The difference is that the present account considered the role of C agreement. There is no fundamental disagreement between the current analysis and Oxford's in this respect. As noted above, the current account also maintains that proximate arguments are promoted to Spec,IP (for a related claim for the Eastern Algonquian language Pas-samaquoddy, see Bruening, 2005). The difference is that agreement on Infl is (i) responsible for deactivating the proximate argument under the Activity Condition, making it unavailable for further agreement relations, and (ii) followed by agreement with C, which ultimately results in the (optional) movement of the obviative argument to Spec,CP.

CHAPTER 6

PROCESSING OBVIATION AND VOICE

6.1 Introduction

Language processing occurs incrementally: information relevant to determining the structure and meaning of a sentence unfolds over time. However, as comprehenders, we do not always wait for direct evidence to build a parse or interpretation. In many cases, we engage in predictive processing, where certain aspects of a sentence are anticipated in advance of unequivocal bottom-up input. Following these predictions, the major task is to integrate new information as it constantly comes online. Often, our predictions match the new input, and integration proceeds with ease. However, in cases where there is a mismatch between expectations and reality, we must then engage in reanalysis to attempt to reach a grammatical parse and sensible interpretation.

The main goal of this chapter is to investigate how prominence-based information, and more particularly obviation, is used to put together the pieces of argument structure in real time. Understanding argument structure involves creating a link between a noun on one hand, and syntactic positions and thematic roles on the other. Three basic questions animate the discussion, with the first being the primary focus: (i) how does prominence information factor into *predictive* processing of syntactic structure and thematic roles? (ii) how does prominence information affect the *integration* of previously

encountered material as direct evidence of structure and interpretation comes online? And (iii) if predictions are violated as new information becomes available, what role does prominence information play in *reanalysis*?

The petri dish in which these effects will be isolated and examined are *filler-gap dependencies*, exemplified with the English relative clause in (1). These structures require the formulation of a “long-distance” link between a displaced filler noun and a gap site in order to create a final representation of syntactic and thematic structure. Many theories of parsing and interpretation include a predictive component of some sort which can be exploited in these cases: for example, when the moved element (i.e. the filler; *the senator* in (1)) is identified, comprehenders make predictions about the thematic role (e.g. agent, experiencer, patient) and/or syntactic launching site (i.e. a gap; the blank underline in (1)).

(1) Aaron voted for **the senator** from Minnesota who _ spoke with the journalist.

Different aspects of fillers have been argued to affect the way prediction, integration, and reanalysis occur over the course of a sentence. One well-studied type of information is *animacy*. Many studies have observed that animate fillers (e.g. *the senator*) lead to the appearance of a *subject-gap advantage*, where subject relative clauses (SRCs) such as those in (1) and (2a) are easier to process than object relative clauses (ORCs), as in (2b). Crucially, inanimate fillers (e.g. *the report*) decrease or eliminate these effects, with processing difficulty being roughly equal for both SRCs and ORCs (e.g. Mak et al., 2002; Traxler et al., 2005; Gennari and MacDonald, 2008; Wagers and Pendleton, 2016).

- (2) a. **The report/senator** that _ quoted the journalist was not well known.
b. **The report/senator** that the journalist quoted _ was not well known.

Decades of research on animacy and filler-gap processing has led to the broad conclusion that animacy information on the noun has an immediate impact on incremental parsing and interpretation. When an animate noun is encountered, a parse or interpretation with subject gap is predicted or activated. If this is followed by direct evidence of a subject gap, integration proceeds smoothly, accounting for the ease of SRC processing. If instead this prediction is violated, and an ORC is encountered, then the predicted structure must be reanalyzed, or a competition arises between these possible structures. In either case, this resolution process takes time, and is not always successful, accounting for the relative difficulty of ORCs with an animate head noun. Inanimate nouns, on the other hand, have not been found to engender strong subject gap predictions, and therefore both SRCs and ORCs end up on equal footing, as neither violates the initially predicted parse or interpretation.

The contrast between animate and inanimate nouns has long been connected to a broader class of *person-animacy hierarchy* (PAH) effects, as described by the scale in (3). From this articulated scale, other more general sub-hierarchies can be extracted, such as the *animacy* sub-hierarchy in (3a), which ranks animate nouns over inanimate nouns, or the *obviation* sub-hierarchy in (3b), which ranks proximate nouns over obviative nouns. These two sub-hierarchies are the focus of the current chapter. One general hypothesis is that the higher a given filler is on the scale, the more likely it is to be predictively connected to the subject position and/or an agentive thematic role.

(3) ***Person-Animacy Hierarchy***

1/2 (LOCAL) > 3 (PROXIMATE) > 3' (OBVIATIVE) > 0 (INANIMATE)

a. *Animacy Sub-Hierarchy*: 3/3' (ANIMATE) > 0 (INANIMATE)

b. *Obviation Sub-Hierarchy*: 3 (PROXIMATE) > 3' (OBVIATIVE)

The major question of the chapter is whether obviation is used to anticipate the assignment of thematic roles and guide the parser towards a syntactic representation of

filler-gap dependencies. This is investigated through a preferential looking experiment with speakers of the Border Lakes dialect of Ojibwe. On a theory that broadly subscribes to the view that person, animacy, and obviation all make up a part of the prominence hierarchy, we should generally expect the contrast between proximate and obviative nouns to behave in a similar fashion to the contrast between animate and inanimate nouns: proximate nouns should associate with agentive roles and more prominent syntactic positions, leading to a subject gap advantage, while obviative nouns should not lead to such predictions and advantages.

A secondary goal of the work is to examine how the connection is made between fillers and the final parse/interpretation. While obviation information may allow comprehenders to predictively anticipate the interpretation or parse, voice morphology disambiguates the ultimate syntactic and semantic representation. There are two basic types of voice morphology known as *direct* and *inverse*. As schematized below, direct marking appears when the proximate noun is acting on the obviative noun (4a), and inverse marking appears when the obviative noun is acting on the proximate noun (4b).

(4) ***Relationship between voice, obviation, and thematic role*** (AGENT → PATIENT)

a. DIRECT = 3 → 3'

b. INVERSE = 3' → 3

A proximate filler should therefore be readily integrated when a verb with direct voice is encountered compared to inverse voice, as direct marking is congruent with the hypothesis that proximate nouns are predictively encoded with an agentive thematic role.

However, the picture painted above turns out to be even more complex, which provides a tie to an even higher level consideration that serves as a motif over the course of the chapter: What is the nature of the relationship between syntactic structure and thematic roles? Or even more broadly, syntactic structure and interpretation? Classical theta-theory within the Government & Binding (GB) era framework utilized so-called

“theta grids”, where the relationships between arguments of the verb and theta roles were lexically specified (for a critical review, see Harley, 2011). Current Minimalist theories have developed a generative account of argument structure by connecting theta roles one-to-one with particular functional positions within the VP, leading the core lexical material of the verb to be largely separated from thematic structure. The proposal of a deep link between syntactic structure and theta structure raises interesting questions for the linking between parsing and interpretation, which are explored over the course of the chapter.

These issues are yet further complicated by the fact that, in modern generative grammar, *derived* syntactic positions such as “subject” (a term which I have been using loosely thus far) are not representationally primitive, and are readily dissociable from thematic roles such as “agent” and “patient”. These dissociations are observed by examining voice systems. The voice system of English dissociates derived syntactic position and thematic role via the active-passive distinction, with the active being associated with agentive subjects, and the passive being associated with non-agentive subjects. In this chapter, the direct-inverse voice system of Ojibwe takes the stage, where a similar dissociation can be found. As discussed at length in Chapter 5, direct voice is associated with the promotion of the proximate agent to the “subject position”, and inverse voice with the syntactic promotion of the proximate patient. This dissociation allows us to gain traction in examining the independent and interacting processing effects of syntactic structure building and thematic role assignment.

6.2 Existing approaches to prominence in sentence processing

In this section, I outline the range of previous approaches to how prominence-based information is used in sentence processing. The discussion is framed in terms of the animate-inanimate distinction, which has been the most extensively studied aspect of prominence. I first cover the overarching parameters over which the models vary. I start

with an outline of the *class modular model* (e.g. Frazier and Fodor, 1978), where prominence information is hypothesized to come into play only in later stages of processing. I then turn to its historical competitor, the *classic constraint-based model* (e.g. MacDonald, Pearlmutter, and Seidenberg, 1994), where prominence information instead plays an immediate role in parsing and interpretation. Next, I shift to the *(Extended) Argument Dependency Model* (e.g. Bornkessel, 2002), which hypothesizes a direct link between prominence hierarchies and online processing. Finally, I consider the *maximize incremental well-formedness* framework (Wagers and Pendleton, 2016; Wagers et al., 2018), which also makes direct appeal to grammatical prominence constraints, but under a distinct architecture.

6.2.1 The parameters of discussion

One of the fundamental discrepancies between the theories covered in this section is in the deeper representation of animacy information. In the previous chapters of the dissertation, the major focus was understanding how prominence information, and in particular obviation status and animacy, are representationally encoded such that they can be (i) manipulated by syntactic operations such as AGREE, and (ii) give rise to the proper semantic interpretations. These two facets of animacy highlight a fundamental tension present among the models to be discussed: is animacy part of the lexical semantics of a noun, thus constituting part of our world knowledge? Or is animacy part of the syntactic representation, thus constituting a core component of the grammar? Both the classic modular and constraint-based models take the former view, albeit with very different consequences. On the other hand, the eADM and incremental well-formedness framework adopt the latter view without necessarily ruling out a wider role for the lexical semantics of animacy.

Taking for granted that animacy information is represented at some level, there are two basic questions that can guide the discussion of the four models at hand: one con-

cerning the *timing* of when animacy information is used, and another of which aspects of processing are *influenced* by animacy information.

The question of timing can be framed in terms of the three core components of language processing: prediction, integration, and reanalysis. The question is whether animacy information is used immediately to inform language processing by guiding the initial parsing and interpretive decisions (i.e. to restrict the space of possible parses or interpretations that are being entertained, or to guide the processor towards the single most likely parse), or whether it is only used in a later stage of processing to evaluate semantic plausibility and guide reanalysis.

The question of influence can be thought of as determining what types of processing commitments are triggered by animacy: does it influence the adoption of a syntactic parse, an interpretation, or both? This closely interacts with the question of timing, in that possible processing activities may or may not be sequenced within a model. To take a concrete example, the modular model posits that parsing precedes interpretation, while the constraint-based model is fully interactive, with parsing and interpretation occurring in parallel. Therefore, though both treat animacy information as conceptual, initial processing decisions are expected to be influenced by animacy in the constraint-based model in a way that they are not in the modular model.

With these questions and considerations as background, I turn now to an exposition of each model and the key results that support their advancement.

6.2.2 The classic modular model

The classical modular model of sentence processing, also known as the “garden-path theory” (e.g. Frazier and Fodor, 1978; Frazier and Rayner, 1982; Ferreira and Clifton, 1986, *a.o.*), advances the view that sentence processing occurs in two basic stages. The first is an initial parsing stage, which makes use of basic category information and

the parsing principles in (5) to construct a single syntactic representation of the input, which is then interpreted in the second stage.

(5) *Parsing principles under the classic modular model (Frazier, 1979)*

- a. *Minimal Attachment*: Do not postulate any potentially unnecessary nodes.
- b. *Late Closure*: If grammatically permissible, attach new items into the clause or phrase currently being processed.

These basic principles can lead the parser to make commitments earlier in a sentence that turn out to be inconsistent with information encountered at a later point. This triggers a process of selective reanalysis, which is guided by additional information such as animacy, plausibility, frequency, and other world-knowledge, to revise the parse to be consistent with the new input.

In the current context, the key claim of the classic modular model is that animacy information should not show evidence of informing the initially adopted parse, but should show effects at a later stage in sentences where reanalysis is required. In other words, animacy is part of world knowledge rather than the narrow syntactic representation that constraints the possible syntactic representations of a language.

The classic case of sentences that trigger reanalysis are the titular *garden-path sentences*, where comprehenders initially parse a structurally ambiguous sentence in a way that turns out to be inconsistent with the later input. At the point at which this misparse is recognized, the modular theory suggests that the parser must engage in reanalysis, a process which takes time and must overcome the bias of the initially adopted representation. An early and influential test of this hypothesis was presented by Ferreira and Clifton (1986), who used eye tracking to examine the processing of sentences that were ambiguous between a main clause and reduced relative clause interpretation (Rayner,

Carlson, and Frazier, 1983). The key twist that Ferreira and Clifton added was to manipulate the animacy of the initial noun, as shown in the example in (6).

(6) *Sample item from Ferreira and Clifton (1986)*

- a. The defendant examined by the lawyer turned out to be unreliable.
- b. The evidence examined by the lawyer turned out to be unreliable.

Based on the principle of Minimal Attachment from above the sentences should receive a *main clause* analysis, where the string *the defendant examined...* is parsed with *the defendant* as the subject (and agent) of the verb *examined*. This parse is ultimately inconsistent with the presence of the subsequent string *by the lawyer*, which must be analyzed as a passive *by*-phrase of the verb *examined*, providing direct and unambiguous evidence for a reduced relative analysis. Therefore the modular model predicts a disruption in processing due to reanalysis at the *by*-phrase, compared to the unambiguous baseline of a non-reduced relative clause (i.e. *The defendant that was examined by the lawyer...*).

Ferreira and Clifton reasoned that if animacy is used in the first stages of processing, it should influence the choice of main clause versus reduced relative analysis in a way that does not fall out of the two structural parsing principles of the modular theory. In particular, the disruption in reading that is predicted to be present with the animate noun in (6a) should disappear with the inanimate noun in (6b), because *evidence* is not a plausible subject (or agent) of the verb *examined*. It is, however, a plausible theme of the verb, and therefore should provide a boost to the reduced relative parse, which would place this noun into that thematic role. Ultimately, Ferreira and Clifton found no discernible difference between the amount of disruption in (6a) versus (6b), which they took as evidence to support the modular theory, where the initial noun is treated as the subject in the main clause analysis despite the violation of plausibility that this incurs.

These findings were subsequently questioned in a number of studies, most prominently Trueswell, Tanenhaus, and Garnsey (1994) and Just and Carpenter (1992). I consider these studies in more depth in the discussion of the classic constraint-based model in Section 6.2.3. For the current purposes, what is relevant is that these critiques led to the follow-up study of Clifton, Traxler, Mohamed, Williams, Morris, and Rayner (2003), who used a refined set of stimuli and compared individuals with high versus low memory spans, but otherwise examined the same basic contrast as discussed above.¹ Besides replicating the pattern of disruption at the *by*-phrase in both animate and inanimate conditions, and failing to replicate the memory-span effect reported by Just and Carpenter (1992), Clifton et al. found that later processing measures were slower in the ambiguous animate condition, with these conditions also proving harder to accurately interpret. These findings were taken to indicate that the reanalysis process, which requires reinterpreting the initial noun as a patient rather than agent, is affected by animacy such that the initial agent parse is more difficult to override when the noun is animate, as animate nouns are strongly associated with more agentive roles.

A related insight developed within the context of the modular sentence processing architecture, and which is immediately relevant to the question of how prominence information affects processing, is the *Active Filler Strategy* (Crain and Fodor, 1985; Stowe, 1986; Frazier, 1987). The basic principle is that, in sentences where a filler has been encountered, gaps are posited by the parser as soon as possible. Here, I present a general formulation of this strategy with the Minimal Chain Principle (MCP), stated in (7).

(7) ***Minimal Chain Principle (MCP; DeVincenzi, 1991)***

When a filler is encountered, postulate a chain link (e.g. a gap) at the earliest point grammatically possible, but do not postulate unnecessary links.

¹Readers familiar with the Clifton et al. (2003) study will note that they also used a *boundary change* paradigm, which is discussed further in Section 6.2.3

The MCP can be readily couched within predictive terms: the first clause of the MCP dictates that when a filler is encountered, the syntactic representation should be incrementally extended to include a gap at the earliest point possible. Postulating a gap in the subject position, and therefore forming an SRC, is generally minimal (i.e. forms the shortest chain). To take a simple example of the effect, with ambiguous relative clauses in Dutch, Frazier (1987) found that responders choose SRC-consistent interpretations 74% of the time (with ORC interpretations making up the remaining 26%). This class of effects has come to be known as the *Subject-Gap Advantage* (SGA).

Yet stronger evidence for this effect comes from the *filled-gap* experimental design. In these types of sentences, a filler is introduced early on, but the first grammatically possible gap site (usually the subject position) is filled by another noun, with the actual gap appearing later in the sentence. Therefore these sentences are globally grammatical, but given the modular model, finding a noun at the position where the parser has posited a gap should trigger reanalysis, slowing down processing at that point. The examples in (8) are taken from Lee (2004), who showed that readers slow down following a filled subject position in sentences such as (8a), but not in the pied-piping control of (8b), where the preposition within the filler is grammatically inconsistent with a subject gap parse, blocking the possibility of resolving to a subject gap.

(8) *Sample item from Lee (2004)*

- a. That is **the cult which**, in the early eighties, *Elaine* inspired many friends to make a deep commitment to ___.
- b. That is **the cult to which**, in the early eighties, *Elaine* inspired many friends to make a deep commitment ___.

Evidence directly from relative clause processing that supports the prediction + reanalysis account of filled subject gaps comes from Staub (2010), who found in a series of eye tracking studies that processing difficulty with ORC structures begins at the em-

bedded subject, prior to encountering the critical verb, and therefore prior to direct bottom-up evidence of the gap site. While other interpretations of the results are possible, this can be seen as a classic *filled-gap effect*, which triggers reanalysis, requiring the parse to be revised such that the next closest grammatically possible gap site is predicted to house the filler.

The simple version of the MCP makes the prediction that prominence information should not factor into the active filler strategy, therefore the SGA should be impervious to the animacy of the filler. However, animacy of the head noun does appear to influence the strength of the SGA. For example, it has been shown that the contrast between SRCs and ORCs is less pronounced in sentences like those in (9), where the head noun is inanimate (Mak et al., 2002; Traxler, Morris, and Seely, 2002; Traxler et al., 2005; Wagers and Pendleton, 2016)

(9) ***SRC-ORC contrast with an inanimate head noun***

- a. **The report** that __ quoted the journalist was not well known.
- b. **The report** that the journalist quoted __ was not well known.

The question is then one of timing: does animacy modulate the *prediction* of a subject gap, or does it influence the process of reanalysis? Early studies using eye tracking, such as Mak et al. (2002), declined to decide between these possibilities, stating simply that animacy had an effect on the relative ease of processing. More recent work by Wagers and Pendleton (2016) argue based on a filled-gap design in self-paced reading that animate heads are predictively linked to the highest subject position, while inanimate arguments are not. If correct, the proposed analysis complicates the MCP by making the structural prediction of a subject gap conditional on the animacy of the filler, rather than borne of chain-length alone (the particular account put forward in Wagers and Pendleton (2016) is discussed and evaluated in detail in Section 6.2.5).

To summarize, the classic modular model makes concrete predictions on the dimensions of timing and influence of prominence information such as animacy. Initial parsing decisions are not influenced by animacy, while the process of interpretation, and if necessary reanalysis, are guided by this information.

6.2.3 The classic constraint-based model

The immediate competitor to the classic modular model is the *classic constraint-based model* MacDonald et al. (1994), which is broadly based on the connectionist approach to cognition. The two classic models differ on a number of fundamental levels, but the focus here will be on the source, timing, and influence of animacy effects. The key properties of the constraint-based model with respect to these effects are (i) *experience*, that animacy effects are fundamentally the results of statistical generalizations and associations over verbal behavior, (ii) *immediacy*, that animacy has an effect right away, and is not reserved only for use at a later stage of processing, and (iii) *interactivity*, that animacy information is used for both syntactic and semantic processing (and that these processes occur in a fully parallel fashion).

These properties provide a key wedge between the two theories, which was exploited in many studies in the 90's and 00's. While the classic modular theory predicts that animacy information is only used on reanalysis (i.e. at a later stage of processing), the classic constraint-based model argues that this information should be used immediately to inform parsing and interpretation decisions. Furthermore, the classic constraint-based model explicitly links parsing and interpretation to co-occurrence frequencies between words, the so-called lexical properties of words, and the distributional properties of the linguistic input more generally, predicting that processing difficulty should follow from the strength of association between, for example, a particular noun-verb combination, or the number and strength of the competing structures

that are (partially) activated by the lexical items encountered over the course of the sentence.

A study that was taken as early evidence for the classical constraint-based approach, and *against* the modular model, was Trueswell et al. (1994), which as discussed above attempted to replicate the results of Ferreira and Clifton (1986) with new materials. Trueswell et al. argued that the stimuli used in the original Ferreira and Clifton study were not adequately biased *away* from the main verb analysis. In other words, they argued that participants could have reasonably entertained the main verb analysis based on their world knowledge, rather than the independent parsing principles of the modular approach. With normed materials that were meant to ensure the conceptual implausibility of the main clause analysis, Trueswell et al. found a weakened disruption in the inanimate noun condition. The authors argue that this finding provides support for the view that the semantic fit of a noun is used to guide initial parsing decision — a finding which formed a large part of the foundation for the classic constraint-based model.

As detailed in the previous section, the subsequent follow-up study of Clifton et al. (2003), which also used the same improved materials of Trueswell et al. (1994), *succeeded* in replicating the symmetry between the animate and inanimate conditions observed by Ferreira and Clifton (1986). The reasoning that Clifton et al. put forward for this difference between these three studies ultimately lies in the nature of the eye tracking method. Reading time in eye tracking is calculated by grouping words into regions of interest, and adding up the time of individual fixations within that region.² However, the information that is being processed at any given fixation is not only dependent on what is at the center of the fixation point, but also what is within the *parafoveal preview*

²Which fixations are added up allows for different measures. The initial fixation in an ROI is used to calculate *first fixation*; the sum of all fixations before fixating outside of the ROI is *first pass*; the sum of all fixations after entering an ROI until fixating to the *right* of the ROI is *go-past*; the sum of all fixations within an ROI is *total time*.

of that point. As a result, fixations on the right edge of a region can also index the initial processing of upcoming material.

Setting aside the most technical details, all of this adds up to the idea that, in the critical sentences, processing at the verb *examined* included parafoveal preview of the *by*-phrase in the failed replication by Trueswell et al., but not in the original study of Ferreira and Clifton. As a result, early parsing decisions in the Trueswell et al. study about whether to adopt the main clause versus reduced relative analysis could be made on the basis of this preview, leading to the appearance of a reduced relative advantage based on grammatical information alone, rather than the animacy of the noun. Clifton et al. provided a direct test of this hypothesis by including a *boundary change* manipulation in their initial experiment, where participants were allowed either a valid or invalid preview of the upcoming materials. The authors found that the valid preview condition replicated the result of Trueswell et al., while the invalid preview replicated the findings of Ferreira and Clifton, supporting the view that the availability of parafoveal processing of the *by*-phrase can explain the difference in results, rather than an issue with the content of the items as claimed by Trueswell et al..

Despite this contentiousness, the constraint-based model has been widely adopted, with many studies testing the predictions of the model at an increasingly granular level. One such family of work, which is particularly relevant to the current studies, was conducted by Mak et al. (2002), Gennari and MacDonald (2008, 2009), Gennari, Mirković, and MacDonald (2012), and Reali and Christiansen (2007). These studies all sought to examine whether various distributional properties of relative clauses, such as the frequency of co-occurrence between inanimate nouns and ORC structures (as measured by their distribution in experimental production and corpus studies), are in turn associated with the ease or difficulty with which comprehension proceeds.

For example, Gennari and MacDonald (2008, 2009) examined the relationship between the production of object relative clauses headed by animate versus inanimate

nouns and the relative ease of comprehension. In their 2008 study, Gennari and MacDonald used an initial gated sentence completion study to measure the range and dominance of alternative sentence interpretations as a sentence unfolds. This provides a measure of *semantic indeterminacy* at different points in the sentence. Higher semantic indeterminacy is associated with more possible competing interpretations at a given point. Gennari and MacDonald found that ORCs with animate nouns were associated with higher incremental semantic indeterminacy compared to inanimate nouns. In a second experiment, they measured comprehension difficulty of these sentences via self-paced reading (SPR), finding a correlation between the distribution of competing interpretations in the production task and button press latency in the SPR task. This provides an alternative means to capture the difficulty difference between animate and inanimate nouns based on systematic differences in the presence of competing alternative interpretations.

The constraint-based model therefore makes a number of testable predictions. First, that there should be a tight link between the co-occurrence frequencies and processing difficulty. Most relevantly, the strength of association between prominence information and various argument structure possibilities. Second, that prominence information should be used immediately to constrain and inform both parsing and interpretation in real time.

6.2.4 The Extended Argument Dependency Model

The Extended Argument Dependency Model (eADM; Bornkessel, 2002; Schlesewsky and Bornkessel, 2004; Bornkessel and Schlesewsky, 2006; Bornkessel-Schlesewsky and Schlesewsky, 2008, 2009), can be interpreted as finding a middle ground between the classic modular and classic constraint-based models. The two classic models occupy opposite ends of a continuum of how much information is used to formulate the initial syntactic representation in real time processing. The modular model has a more

restricted view (i.e. functional category information is used, animacy and plausibility are not), while the constraint-based theory contains no principled distinctions between different types of information for the purposes of sentence processing.

Like the the classic modular model, the eADM is a syntax-first model at its core, and thus shares the basic assumption that world knowledge and plausibility are reserved for later stages of processing. The novel insight, which brings it a notch closer to the classic constraint-based model, is a principled expansion of what constitutes grammatical knowledge, by allowing a restricted set of *prominence* information to be employed in the early stages of processing. This prominence information includes case, specificity, definiteness, person, and, most importantly for our immediate consideration, animacy.³ The scales that govern these various types of prominence information are shown in (10), as adapted from Bornkessel-Schlesewsky and Schlesewsky (2009).

(10) ***Prominence Hierarchies within the eADM***

- a. *Thematic*: AGENTIVE > NON-AGENTIVE
- b. *Case*: NOMINATIVE > ACCUSATIVE; ERGATIVE > NOMINATIVE
- c. *Linear*: INITIAL > NON-INITIAL
- d. *Definiteness*: DEFINITE > INDEFINITE
- e. *Animacy*: ANIMATE > INANIMATE
- f. *Person*: LOCAL > THIRD
- g. *Obviation*: PROXIMATE > OBVIATIVE

What unites these different types of information is that they can all be demonstrated to be grammatically active in some language of the world. That is, they constrain the possible syntactic representations that are available. For example, as examined at length in preceding chapters, animacy and person (and obviation) are all active in syntactic phe-

³Bornkessel-Schlesewsky and Schlesewsky (2009) do not discuss obviation, but given their adoption of the PAH more broadly, it can be assumed to be included in this class of information.

nomena such as the person-case constraint and direct-inverse marking, and are argued within generative theories to have a direct representation via features in the syntactic computation module. Similar effects of this prominence information can be seen in split-ergative case marking systems, differential object marking, argument mapping and co-occurrence restrictions, and more. Even in English, animacy and person can be seen as being grammatically active: animacy creates selectional restrictions on complementizers, as shown in the contrast in (11a), while person is involved in subject-verb agreement, as shown in (11b).

(11) *Grammatical effects of animacy and person in English*

- a. The report that/*who quoted the journalist.
- b. I am/*are/*is the one who stole the rutabaga.

The idea is then that languages differ in how *strong* these various constraints are, and where in the grammar they take effect. These differences can be encoded by tuning the relative weights of constraints derived from the various prominence hierarchies (I discuss the general nature of these constraints in more detail in Section 6.2.5). In a language like English, the grammatical influence of a property such as animacy is relatively weak, but on the eADM it can still factor in to the earlier stages of processing.

I now walk through the basic flow of the model to exemplify how prominence information affects processing. Following an initial stage of word category identification, given that a nominal argument is identified, the language processing mechanism engages in a step known as COMPUTE PROMINENCE. In a language like English, this step leads to the assignment of a *prototypical* role to the argument as either a generic actor or undergoer. The actor role is associated with being an animate, definite, and/or local person, while undergoers have no particular defining properties, and are defined in contrast to an actor. This predicts an “actor-centered” computation of role, where a sentence with multiple arguments results in a competition, based on the prominence

features of each argument, for who occupies the actor role. Once a predicate (e.g. a verb) is reached, again following the initial stage of category identification, the processor engages in a step called COMPUTE LINKING, where nouns are connected to the argument structure of the verb, allowing the actual thematic roles to be identified, with the initial stage of prototypicality-based assignment as a guide.

Capturing the differences between languages falls into the specification of COMPUTE PROMINENCE. As outlined above, animacy and other prominence-based information in a language like English simply determines the role that argument would prototypically take, not what it *must* take. Languages may differ in the strength with which different types of prominence information associates with the generic actor role. In the most extreme case, a language may not just determine roles at the level of prototypicality, but require certain arguments to fill the actor (or undergoer) role. This accounts for the language (or construction) particular restrictions, while still allowing prominence information to have a weaker effect in languages and constructions where it is not, strictly speaking, a part of restricting the possible syntactic representations.

A wide swath of cross-linguistic research has observed particular neurological signatures under ‘role prototypicality mismatches’, which have been associated with the N400 (a negative ERP deflection 300-500ms following the critical stimulus) in fully grammatical sentences (for a comprehensive review see Bornkessel-Schlesewsky and Schlewsky, 2009). An example of such a contrast can be seen with the ORCs in (12). In (12a) there is a *mismatch* between grammatical role and animacy: the inanimate noun *movie* is the agent and the animate noun *novelist* the patient. This pattern is reversed with the *match* condition in (12b).

(12) *Example stimuli from Weckerly and Kutas (1999)*

- a. The novelist that the movie inspired praised the director for staying true to the complicated ending.

- b. The movie that the novelist praised inspired the director to stay true to the complicated ending.

Weckerly and Kutas (1999) found that N400s were triggered at the initial inanimate noun in sentences like (12b), as well as at the inanimate agentive argument in sentences like (12a). The former effect can be attributed to a general preference for higher ranked arguments to appear earlier in the sentence, while the latter effects is due to a direct prototypically mismatch between animacy and role, with an inanimate argument taking on the more agentive role. Similar findings have been found for role prototypicality violations in German (Frisch and Schlesewsky, 2001), Mandarin Chinese (Philipp, Bornkessel-Schlesewsky, Bisang, and Schlesewsky, 2008), and Tamil (Muralikrishnan, Schlesewsky, and Bornkessel-Schlesewsky, 2008), which have all been argued to be captured under the eADM model (Bornkessel-Schlesewsky and Schlesewsky, 2009).

The major shift that the eADM exemplifies is to treat prominence information as part of the grammar, rather than the lexical specification of nouns. This follows from the fact that there are hard grammatical constraints that beg to be described in terms of prominence. Variation in the strength of these restrictions follows from the weight given to different constraints, but the range of possible constraints is hemmed in by the grammar, as described, for example, by a prominence scale. The flow of the eADM instantiates the view that thematic roles are determined first (with COMPUTE PROMINENCE), and then integrated into the argument structure of a predicate (with COMPUTE LINKING). Therefore it is most clearly an interpretation-first model, with parsing decisions flowing from the assignment of thematic roles, rather than the other way around.

6.2.5 The maximize incremental well-formedness model

The final model I consider is the *maximize incremental well-formedness* model, put forward in a nascent form in Wagers and Pendleton (2016), and also articulated in Wagers

et al. (2018). The idea behind the model is that the parser attempts to incrementally build a structure that is, given the input at any given point, most likely to be well-formed. Well-formedness is determined on the basis of grammatical constraints. This model shares many of the same assumptions of the eADM, making use of prominence-based constraints at early stages of processing, but without necessarily carrying forward the precise architectural claims of the eADM (e.g. the steps of COMPUTE PROMINENCE and COMPUTE LINKING). Given the recency with which this approach has been proposed, the model can be seen as a work in progress, with a number of degrees of freedom that require further articulation. Here I focus on the current state of the model, which I extend and evaluate in more detail in the discussion of the current study.

The supporting evidence for the model comes again from animacy effects in filler-gap processing. Using a filled-gap design inspired by that of Lee (2004), Wagers and Pendleton (2016) examined whether both animate and inanimate heads are predictively linked to the highest subject position. The design of the stimuli is given in (13), with the animate versus inanimate filler shown within the curly braces. The examples in (13a) versus (13b) differ in whether the preposition from the ultimate gap site remains in situ or is pied piped, with the pied piping condition serving as a baseline that foils any expectation of a subject gap independently of animacy.

(13) *Sample item from Wagers and Pendleton (2016)*

- a. The scholar looked to {his aging mentor who | the controversial text which}, only recently, *the academic community* owed much of their findings to ___
- b. The scholar looked to {his aging mentor to whom | the controversial text to which}, only recently, *the academic community* owed much of their findings ___

Using button press latency in SPR, Wagers and Pendleton found a filled gap effect at the relative clause subject (in italics above) in the animate filler conditions, but no effect in the inanimate filler conditions. From this finding, they reason that animate fillers led to a subject-gap prediction, resulting in a reanalysis cost at the filled-gap position, while inanimate nouns are not predictively linked to the subject position, accounting for the lack of filled-gap effect in these conditions, and a lack of reanalysis. As previewed in Section 6.2.2, this leads to a complication for a purely structural account of the active-filler strategy under the classic modular model, as animacy information appears to come online immediately, affecting the probability of a predictive encoding of the subject gap. This view is summarized in (14), where (14a) provides the formulation of the AFS.

(14) *Wagers & Pendleton’s account of the animacy effect on the SGA*

- a. Relativized arguments, Rel, predictively and incrementally extend comprehenders’ partial syntactic representation to include a gap.
- b. There is a probability, s , that the gap is inserted into the subject position.
- c. $s_{\text{ANIM}} = p(\textit{InsertSubjGap} | \textit{Rel} = \textit{ANIM})$
 $s_{\text{INAN}} = p(\textit{InsertSubjGap} | \textit{Rel} = \textit{INAN})$
 $s_{\text{ANIM}} > s_{\text{INAN}}$
- d. The chance, r , that reanalysis will be required is directly proportional s .
- e. $r_{\text{ANIM}} > r_{\text{INAN}}$
- f. Reanalysis exacts some cost.

Wagers and Pendleton put forward two possible accounts of how the differing probability of a subject gap between animate versus inanimate nouns encompassed in (14a-b) is established. The first idea is fundamentally based on linguistic experience, where the probability of positing a subject gap is conditioned on experiential probability (what is most likely given what they have observed in the past) — a theory that, as the authors acknowledge, bears a clear relation to the classic constraint-based account. The

second account, and the one of particular interest here, is one in which the probability of a subject gap is conditioned on maximizing *expected well-formedness* as dictated by language-general constraints.

The question, then, is what such constraints could look like. The avenue that Wagers and Pendleton put forward is to derive these constraints from language-general hierarchies, following the work of Aissen (1999), who uses prominence scales to account for markedness effects within various voice systems. Aissen takes advantage of the fact that prominence scales are indeed fundamentally an expression of relative *markedness* between different categories. However, prominence scales alone, such as those in (15), do not provide direction as to where restrictions should be applied. The idea is that, for example, animate nouns are not inherently marked compared to inanimate nouns; animate nouns are less marked as *agents* or *derived subjects* compared to inanimate nouns. To capture this, we must combine the prominence scale with a scale that expresses the relative markedness of a grammatical relation, such as those in (16).

(15) ***Person-Animacy Hierarchy***

1/2 (LOCAL) > 3 (PROXIMATE) > 3' (OBVIATIVE) > 0 (INANIMATE)

a. *Animacy Sub-Hierarchy*: 3/3' (ANIMATE) > 0 (INANIMATE)

b. *Obviation Sub-Hierarchy*: 3 (PROXIMATE) > 3' (OBVIATIVE)

(16) ***Relational Hierarchies***

a. *Thematic*: AGENTIVE > NON-AGENTIVE

b. *Syntactic*: HIGH > LOW (e.g. SUBJECT > OBJECT)

c. *Linear*: INITIAL > NON-INITIAL

The combination of two hierarchies to derive a constraint can be accomplished via *harmonic alignment* (Prince and Smolensky, 1993, p. 136). The full definition is given in (17)

(17) ***Harmonic Alignment***

Suppose given a binary dimension D_1 with a scale $X > Y$ on its elements $\{X, Y\}$, and another dimension D_2 with a scale $a > b > \dots > z$ on its elements. The harmonic alignment of D_1 and D_2 is the pair of Harmony scales:

$$\begin{aligned} H_x: X/a > X/b > \dots > X/z \\ H_y: Y/z > \dots > Y/b > Y/a \end{aligned}$$

The constraint alignment is the pair of constraint hierarchies:

$$\begin{aligned} C_x: *X/z \gg \dots \gg *X/b \gg *X/a \\ C_y: *Y/a \gg *Y/b \gg \dots \gg *Y/z \end{aligned}$$

Where $>$ is “more harmonic than” and \gg is “ranked higher than”

Given the PAH and the syntactic prominence hierarchy, we can therefore derive the following constraints:

(18) ***Constraints via harmonic alignment of the PAH and syntactic hierarchy***

- a. $*SUBJ/INAN \gg *SUBJ/OBV \gg *SUBJ/PROX \gg *SUBJ/LOCAL$
- b. $*OBJ/LOCAL \gg *OBJ/PROX \gg *OBJ/OBC \gg *OBJ/INAN$

Given the full power of the PAH, the derived constraints and rankings account for a wide range of markedness effects under competition (e.g. as arises when there is structural ambiguity with multiple parses and/or interpretations to select from). To take an extreme case, all else being equal, if given an inanimate and a first person noun and asked to formulate a sentence, these constraints would lead to a preference to place the local noun in the subject position and the inanimate noun in the object position, incurring violations of the two lowest ranked constraints $*SUBJ/LOCAL$ and $*OBJ/INAN$. Such a sentence is less marked than the reverse alignment, which would incur violations of the *highest* ranked constraints $*SUBJ/INAN$ and $OBJ/LOCAL$.

Returning to the more immediate case at hand, we can simply consider the constraints that are derived from the harmonic alignment of the Animacy Sub-Hierarchy and the syntactic hierarchy, shown in (19).

(19) *Constraints from the animacy and syntactic hierarchies*

- a. *SUBJ/INAN \gg *SUBJ/ANIM
- b. *OBJ/ANIM \gg *OBJ/INAN

This set of constraints encompasses the idea that aligning an inanimate noun with the subject position is marked relative to aligning it with an object (or non-subject) position. By the same token, an alignment of an animate argument with the object (non-subject) position is more marked than aligning it with the subject position.

The final step is to treat these constraints not as a *filter* on well-formedness, but as a *predictor* of well-formedness. As a result, when an animate filler is encountered, of all the structures consistent with the input at that point, the structure that is most likely, and therefore the one that is adopted (or most competitive) is the one that is the least marked (i.e. the most harmonic or well-formed). This would be a structure where the animate filler is resolved to the subject position, therefore a subject gap is predicted. On the other hand, an inanimate noun is relatively marked in the subject position, therefore no expectation is made for a subject gap in that case.

Before moving forward, I would like to raise an alternative interpretation of the findings of Wagers and Pendleton (2016) that is not considered by the authors: That it is in fact the *reanalysis* cost of recovering from the subject gap prediction that differs between the animate versus inanimate conditions, not the prediction of the subject gap. This interpretation would maintain the original assumption of the classic modular model, in that the commitment to the subject gap is equal in both cases, but the reanalysis process goes forward more smoothly in the inanimate compared to the animate conditions, resulting in a difference in button press latency at that point. Ultimately,

this shows a limitation of the filled-gap design: we are unable to see what incremental commitments are being made until bottom-up evidence that the prediction is incorrect comes online. The study of Ojibwe presented in the forthcoming sections provides the means to (indirectly) observe these commitments by examining incremental preferential looking behavior over the course of an open filler-gap dependency — the logic being that comprehenders direct their gaze towards the scene that is congruent with their incrementally formed interpretation. To preview the results, I ultimately find support for the idea that Wagers and Pendleton put forward: that prominence-sensitive prediction at the filler plays a role in processing filler-gap dependencies.

This concern aside, a model where the central guide for parsing and interpretation is the evaluation of well-formedness, as deduced by markedness constraints, provides the means for prominence information to factor into the initial parsing decisions in a principled way that connects to the deep-seated role of prominence across all languages of the world: constraints are derived from universally obeyed hierarchies, which are in turn informed by the typology of possible human grammars. More broadly, on this model prominence information shows an immediate influence, with the potential to guide both parsing and interpretation decisions via the alignment of the PAH with both syntactic and thematic hierarchies.

6.2.6 Summary & synthesis

The goal of this section was to present four of the existing models of how prominence influences the processing of argument structure, and in particular filler-gap dependency processing. The first, the classic modular model, argues that prominence information does not come into play when forming an initial parse, but does guide the subsequent interpretation of the parse and, if necessary, reanalysis. The classic constraint-based model takes a fully interactive approach, with all types of information immediately having the potential to inform initial parsing and interpretation decisions. The eADM

argues that prominence information, being integral to the grammar of many languages, is used to immediately inform interpretive decisions, with nouns competing to be assigned the agentive role, and a linking process at the predicate relating these roles to argument structure. Finally, the maximize incremental well-formedness model predicts an immediate influence of prominence information, with both parsing and interpretation decisions being made on the basis of constraints derived from the harmonic alignment of independently motivated and universal grammatical hierarchies.

In addition to outlining the assumptions of these models, a portion of the empirical landscape of how prominence affects processing was covered. I argue these results can be described through the interaction of the three processing preferences in (20).

(20) ***Three hypothesized processing pressures***

- a. *Animate/Proximate-Agent Preference*: Animate nouns are more prototypically agentive than inanimate ones; proximate nouns are more prototypically agentive than obviative ones.
- b. *Agent-First Preference*: The prototypical agent role is assigned first.
- c. *Minimal Dependency Preference*: Shorter dependencies are preferred over longer dependencies.

Each of these preferences can be tied to a more fundamental processing pressure. Different aspects of the four models reviewed so far make significant progress on this front. For example, the Minimal Dependency Preference, or more specifically the subject-gap advantage, falls out of the Minimal Chain Principle, which prefers shorter dependencies to longer ones. The Animate/Proximate-Agent Preference can be derived the alignment of a thematic role hierarchy with the PAH within either the eADM or the well-formedness account. The Agent-First Preference is captured by the primacy of actor within the eADM, where nouns compete to be assigned this role. Each model has something to say about how (or whether) each of these pressures should arise.

These three particular pressures differ in some fundamental ways that tie into one of the high-level questions of the chapter: What is the relationship between syntactic structure and thematic roles? Or parsing and interpretation more generally? In particular, the Minimal Dependency Preference is a structural preference, while the animate-agent and agent-first preferences are interpretive preferences. To fully evaluate the validity of these preferences, and to understand the interactions between each, it is necessary to take a more careful view of the relation and dissociation between syntactic positions and thematic roles. This is the major focus of the next section, which also leads neatly into a more detailed discussion of obviation, setting up the immediate context of the present experiment.

6.3 Obviation and voice in sentence processing

The review so far has focused largely on understanding the basic role of prominence information, and more particularly animacy, in the processing of argument structure. One important fact that has been purposefully set aside is the relationship between voice alternations and argument structure. Using voice alternations, it is possible to dissociate thematic role and derived syntactic positions such as “subject”. These properties of language have effects on the production and comprehension of filler-gap dependencies, as well as affecting the interpretation a number of experimental results. In Ojibwe, argument structure, the system of obviation, and direct-inverse voice marking are intimately linked, thus understanding the representations that underly these facets of the language, and reviewing the relevant experimental evidence, is essential to understanding the motivation behind the current study.

6.3.1 Background

In this section, I provide the relevant background related to voice alternations. I begin with an overview of thematic roles and syntactic positions in current linguistic theory,

then turn to a more Ojibwe-specific discussion of the direct-inverse voice system, which reviews the essentials of the analysis put forward in Chapter 5.

6.3.1.1 Dissociating syntactic position and thematic role

The starting point is the observation that the notions of “subject” and “object” as categories, despite centuries of use, lack necessary conditions and do not currently serve as primitive representations in current theories of grammar (e.g. McCloskey, 1997). While there is a cluster of derivationally linked properties associated with subjecthood pertaining to case, thematic role, structural position, scope-taking and binding capabilities, and promotion via movement, none of these properties can be uniquely associated with the classical notion of a grammatical subject.

The immediately relevant consequence is that there is no necessary relationship between the thematic role of agent and the traditional syntactic subject position (i.e. the specifier of TP/IP). This is not a novel observation: one must look no further than the active/passive voice alternation in English (e.g. Chomsky, 1957). In the active voice, the agent is promoted to a syntactic subject position and the patient a direct object position; in the passive voice, the patient is associated with a syntactic subject position, with the agent, if realized, as an oblique argument.

That said, there is a close link between structural position and thematic role, as encompassed by generalizations such as the Uniformity of Theta Assignment Hypothesis (UTAH; see Baker, 1988), which postulates (i) that thematic roles are assigned at “deep-structure” (or, in current terms, in the base-generated positions of arguments); and (ii) that there is a one-to-one correspondence between structural position and thematic role. Crucially, there are syntactic positions that do not participate in thematic role assignment, thus the claim is not at odds with the point that the *derived* “subject” position of Spec,TP/IP can be filled by either agentive or non-agentive arguments, and thus does not show a one-to-one correspondence with thematic role.

For current purposes, I consider just two thematic roles: AGENT and PATIENT. Their association to base-generated argument positions is given in (21), with agent being assigned to the specifier of vP and patient to the specifier of \sqrt{P}

(21) *Relation between structural position and thematic roles*

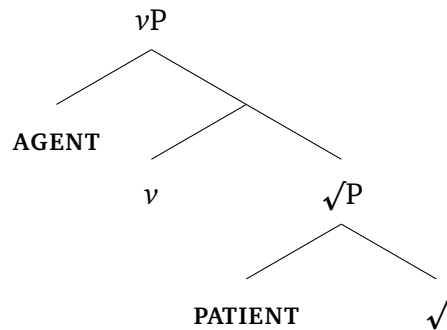

Both of these specifier positions have conventional names, with Spec, vP being the EXTERNAL ARGUMENT position, and Spec, \sqrt{P} being the INTERNAL ARGUMENT position. Again, these two positions are associated one-to-one with the agent and patient thematic roles. In contrast, the conventional SUBJECT position (in languages like English) is Spec,IP. Arguments of the verb are not base-generated there, but can undergo A-movement to occupy it as a derived position.

(22) *Conventional labels for currently relevant structural positions*

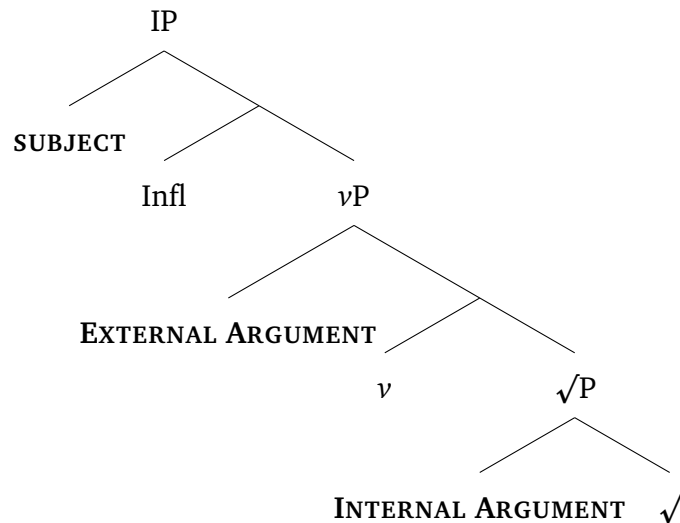

Moving forward, I exclusively use the term “subject” to refer to the argument sitting in the specifier of IP, providing clear disambiguating language if any deviation from this convention is required. To be perfectly clear, “subject” does not imply a particular thematic role, argument type, or any other of the numerous possible properties that have been associated with the term in its classical use.

With this background in hand, it is possible to provide a basic analysis of the active-passive distinction in English to guide the coming review, and to provide a baseline with which to contrast the direct/inverse system of Ojibwe, which is presented in the next section. For concreteness, I adopt the *smuggling* approach of Collins (2005). The core of the account is schematized in (23). Eschewing the details, active (23a) receives a standard analysis, with the external argument (agent) being promoted to the subject position. The passive (23b) is derived in two basic steps: (i) movement of the participle phrase, which includes the internal argument (patient), to the specifier of VoiceP, followed by (ii) movement of the internal argument to the derived subject position.

(23) *A smuggling approach to English active/passive (Collins, 2005)*

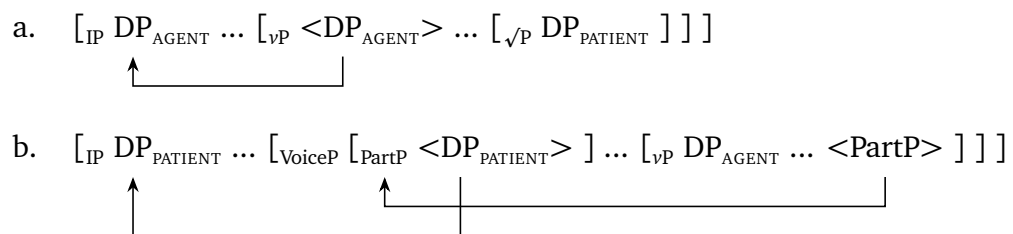

The major takeaway is that passive voice results in a reversal of which argument occupies the highest position in the clause (i.e. the subject position), with active resulting in the agent (external argument) to be promoted, and the passive leading to the patient (internal argument) to be promoted. This critically allows the effects of derived structural position and thematic role to be untangled.

6.3.1.2 Obviation and direct/inverse voice

From a functional perspective, direct/inverse voice marking in Ojibwe indicates the alignment of obviation status and thematic role. Consider the sentences in (24), where (24a) shows the direct marker *-aa* and (24b) the inverse marker *-igoo*.

- (24) a. o- gii- waabam -aa -n ikwe -wan gwiiwizens
 3- PAST- see -3 -OBV woman -OBV boy.PROX
 ‘The boy (PROX) saw the woman (OBV)’
- b. o- gii- waabam -igoo -n gwiiwizens -an ikwe
 3- PAST- see -INV -OBV boy -OBV woman.PROX
 ‘The woman (PROX) was seen by the boy (OBV)’

As noted throughout this thesis, encountering direct marking indicates an alignment of proximate acting on obviative ($3 \rightarrow 3'$), and inverse marking indicates an alignment of obviative acting on proximate ($3' \rightarrow 3$). Given that word order is relatively flexible, or at least not reliably useful in establishing thematic roles, voice marking provides *the* critical cue in Ojibwe to the alignment of nouns with the argument structure of the verb. How these connections are made in real time is largely the focus of the remainder of the chapter.

An additional piece of voice marking is the syntactic promotion of the proximate argument to the subject position — in the examples in (25), this process is referenced by the use of the passive with the inverse voice and active in the direct. Indeed, the promotion is reminiscent of the active/passive alternation, with the direct alignments (and therefore direct voice) being associated with promotion of the proximate agent, as schematized in (25a), and inverse alignments (and therefore inverse voice) being associated with promotion of the proximate patient, as shown in (25b).

- (25) *Proximate arguments are promoted to subject in both direct and inverse*

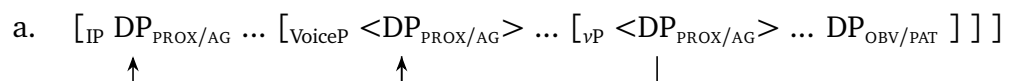

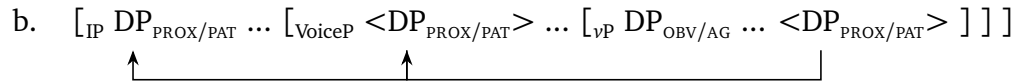

While full details on the motivations for this analysis can be found in Chapter 5, the basic motivation is related to patterns of agreement. In these cases, the slot corresponding with Infl always shows agreement with the proximate argument, regardless of whether it is the external or internal argument. This agreement is highlighted below with embedded clauses in both the direct (26a) and inverse (26b) voice, where the “central agreement” slot (in bold) shows a proximate plural form *-waad* in both cases.

- (26) a. waabam -aa **-waad**
 see -3 **-3PL**
 ‘...if **they (PROX)** see h/ (OBV)’
- b. waabam -igo **-waad**
 see -INV **-3PL**
 ‘...if **they (PROX)** are seen by h/ (OBV)’

This can be compared to the active/passive distinction in languages such as English, where agreement with Infl (T) occurs with the noun that occupies the subject position rather than the agent per se, as shown in (27).

- (27) a. They **were** looking at her
- b. They **were** being looked at by her

The force of this analysis is that proximate nouns always occupy the syntactic subject position in Ojibwe. This has consequences for interpreting the role of the subject-gap advantage in Ojibwe relative clauses: proximate nouns are grammatically tied to the subject position, while obviative nouns never occupy this position. As a result, filler-gap dependencies formed by proximate nouns will always be resolved with a chain that includes the syntactic subject gap, and obviative nouns a non-subject gap.

6.3.2 Processing obviation and direct/inverse

The goal of this section is to review the literature on the processing of obviation and direct/inverse voice. The existing literature provides preliminary evidence for processing preferences that are consistent with the agent-first preference and the proximate-agent preference (the analogue to the animate-agent preference).

The first experimental study of an Algonquian language comes from Christianson and Ferreira (2005). In a production study of Odawa, an eastern dialect of Ojibwe that is largely mutually intelligible with the Border Lakes dialect and other Southwestern varieties, Christianson and Ferreira used a picture description task to probe structural choice and word order preferences. They prompted Ojibwe speakers to describe a transitive event by asking either an “agent question”, “patient question”, or “general question”. I focus on the neutral general question condition, shown in (28).

- (28) Aaniish ezhiwebag zhinda?
what happening here
‘What is happening here?’

In this case, Christianson and Ferreira found that when transitive verbs were produced, agent arguments were nearly always produced before patients, despite no absolute word order generalizations requiring this to be the case. This means in clauses with direct voice the proximate argument was produced linearly to the left of the obviative argument, and with inverse voice the obviative was produced prior to the proximate. Given the general possibility of dissociation between the subject position and the agent role, this is consistent with an Agent-First Preference.

However, there was also a strong preference for the *direct* voice over the *inverse* voice, which resulted in the agent role nearly always being associated with the proximate role. Given that proximate nouns occupy the syntactic subject position, it therefore difficult to claim an independent Agent-First Preference from these data alone. It

is possible that this is simply a preference to produce the subject first, rather than the agent first. That said, these findings are broadly consistent with a preference to align the agentive thematic role with higher prominence status such as proximate and the more prominent syntactic subject position.

In subsequently published work by Christianson and Cho (2009) more direct evidence for an agent-first preference can be observed. In this study, speakers of Odawa listened to a sentence with word-by-word self-paced listening, then completed a picture-verification task where they were asked to decide whether a single picture was or was not congruent with the meaning of a sentence. Sentences consisted of a single noun, alternating factorially between being proximate/obviative crossed with human/animal, followed by a main verb, which alternated between direct and inverse voice. An example set of stimuli with an animal noun is shown in (29).

- (29) a. *mkwa gii-mdaabaan-aa-n pro*
 bear.PROX PAST-drag-DIR-3' *pro.OBV*
 'The bear (PROX) dragged h/ (OBV)'
- b. *mkwa-n gii-mdaabaan-aa-n pro*
 bear-OBV PAST-drag-DIR-3' *pro.PROX*
 'S/he (PROX) dragged the bear (OBV)'
- c. *mkwa gii-mdaabaan-igoo-n pro*
 bear.PROX PAST-drag-INV-3' *pro.OBV*
 'The bear (PROX) was dragged by h/ (OBV)'
- d. *mkwa-n gii-mdaabaan-igoo-n pro*
 bear-OBV PAST-drag-INV-3' *pro.PROX*
 'S/he (PROX) was dragged by the bear (OBV)'

Setting aside the animacy manipulation, in both the obviative and proximate conditions, accuracy in the picture selection task was higher when this initial, overt noun was associated with the agent role compared to the patient role (29a,d). With initial obviative nouns, accuracy was 89% when this argument was ultimately associated with an agent role (29d), and 66% when it was associated with the patient role (29b). With

proximate nouns the association between thematic role and voice is reversed, but the basic pattern is the same. Accuracy was 65% when the proximate argument was ultimately associated with the agent role (29a), and 22% when it was associated with the patient role (29c).

Christianson and Cho frame the result in terms of the relative ease or difficulty in identifying null arguments, but the decrease in accuracy associated with the initial noun ultimately ending up in the patient role is also consistent with a theory where the predictive encoding of this initial argument as an agent makes reanalysis less successful. This initial agent preference is difficult to overcome, and accuracy suffers as a result. Because the effect occurred with both direct and inverse voice, the study allows for the isolation of the agent-first preference—the explanation of this finding cannot be reduced to a subject-proximate-agent alignment, which would only predict an effect in the direct voice conditions. While the agent role is confounded with the subject position with the direct voice, this alignment is broken in the inverse, where the patient is instead promoted to subject position.

As part of the current line of work, an initial pilot study was conducted in Summer 2018 to further test whether the preference for direct versus inverse voice is affected by obviation. The data were collected from a single first speaker who participated in two separate sessions, about one month apart. In each session, the experimenter read a series of 24 preambles of the form in (30), and asked the speaker to repeat back the preambles and complete the sentence.

(30) *Sample item from Summer 2018 production pilot study*

- a. Nin-gikenim-aa ikwe gaa-gii-waabam...
 1-know-3 woman.PROX REL-PAST-see
- b. Nin-gikenim-imaa-n ikwe-wan gaa-gii-waabam...
 1-know-3'-3' woman-OBV REL-PAST-see

		Head Noun		
		Proximate	Obviative	Total
Morphology Produced	Direct	12	16	28
	Inverse	2	8	10
	Other	10	0	10

Table 6.1: Results of Summer 2018 production pilot

The head noun in these items alternated between proximate (30a) and obviative (30b). Instead of complete sentences, the preamble ends where the direct/inverse morphology would appear. Therefore the speaker was free to choose the morphology of the verb inside the RC, essentially choosing whether to complete the dependency with a direct or inverse alignment.

The results are given in Table 6.1. In general, the sentence was continued with either direct or inverse, but it was also possible with some items to continue with an intransitive or indefinite actor construction (combined into the “other” category). These non-transitive continuations occurred exclusively in the proximate head condition. Considering the transitive continuations alone, the results show an interactive shape: 86% of the proximate head items resulted in the head noun being aligned with the more agentive role (14% non-agentive), while only 33% of the obviative head items resulted in the head being aligned with the more agentive role (67% patient).

While care should be taken in interpreting these data given the sample size of one, the difference in the adoption of non-transitive structures with the proximate head nouns, and the increase in the use of the inverse voice with obviative compared to proximate nouns, provide a tantalizing insight into the relation between obviation and voice in Ojibwe. While proximate nouns are nearly universally tied to the agentive role (by use of the direct voice or an intransitive structure), obviative nouns show a mixture of association with the patient role (via direct voice) and the agent role (via inverse). This asymmetry is consistent with a the proximate-agent preference.

6.3.3 Processing voice beyond direct/inverse

Beyond the relatively small literature on direct/inverse voice, much work has looked at other related voice alternations such as the active/passive in English. To review, it is assumed that active voice in transitive clauses results in the promotion of the external argument (agent) to the subject position, while the passive voice results in the promotion of the internal argument (patient). Like direct versus inverse, active versus passive structures differ in their processing profile and interact with prominence in ways that can add additional motivation for our processing pressures — particularly the Agent-First Preference and the Minimal Dependency Preference.

A simple but striking example of how processing differs as a function of active/passive voice alternations can be seen in the work of Ferreira (2003). Ferreira presented simple sentences auditorily and prompted participants to respond with who was either the “doer” (agent question) or the “undergo-er” (patient question) in the sentence. There were three basic item types, as exemplified in (31). The main contrast of interest here is that items varied in whether they appeared in active voice (shown below) or passive voice (e.g. *The man was bitten by the dog*). The experiment had an additional manipulation of noun reversal which has a different effect depending on the item type. For both the biased and nonreversible sentences this resulted in an implausible meaning (e.g. *The man bit the dog*), while the symmetrical sentences simply reversed the actor and undergoer roles with the meaning retaining plausibility.

(31) **Sample item from Ferreira (2003)**

- a. *Biased reversible*: The dog bit the man
- b. *Nonreversible*: The mouse ate the cheese
- c. *Symmetrical*: The woman visited the man

The major finding reveals a baseline difficulty for passive compared to active sentences: in all three item types, and with both the agent and patient questions, there were more errors and longer response latencies in the passive conditions compared to the active. Ferreira argues that this finding supports the view that language comprehension is at least in part guided by associative heuristics such as assigning the first noun into the prototypical agent role. Rather than engaging in deep processing that derives a meaning from the syntactic parse, in certain instances, comprehenders take shortcuts that result in something that is not perfect, but “good-enough”. For the present purposes, the particular shortcut of assigning the first noun to the agent role can be seen as a surface-level formulation of the pressure that derives the agent-first preference.

Further relevant evidence on the comprehension of passives again comes from Gennari and MacDonald (2008) (see Section 6.2.3 for additional discussion of their study). In their second experiment, Gennari and MacDonald examined the comprehension profile of animate versus inanimate heads with active voice ORCs and passive voice SRCs using a word-by-word self-paced reading design with end-of-sentence comprehension questions. An example item for each of the four conditions is shown in (32).

(32) *Sample item from Gennari and MacDonald (2008)*

- a. The director that the movie pleased had received a prize
- b. The movie that the director watched had received a prize
- c. The director that was pleased by the movie had received a prize
- d. The movie that was watched by the director had received a prize

Gennari and MacDonald found the animate headed active ORCs exemplified in (32a) was lower in comprehension accuracy than all other conditions at 69%, indicating that these sentences are associated with more difficulty in comprehension. The SPR button press RTs dovetail and add to this result: The passive SRC sentences were read faster than the active ORC sentences within both the animate and inanimate head noun

conditions; the active animate ORCs were associated with the biggest slow-down. In general, both animate head conditions were slower than their inanimate head noun counterparts.

In their analysis of these results, Gennari and MacDonald show a significant correlation between SPR button press latency and frequency-based co-occurrence distributions from an initial production study. They use this finding to advance the hypothesis that the major determinant of difficulty in ORCs is the degree of *semantic indeterminacy*, as measured by the distribution of alternative interpretations at each incremental point in the sentence, which in turn is deduced from the sentence completions in their initial production study.

However, I argue that there is another equally plausible interpretation of their results in terms of our three processing pressures. The particular difficulty with the animate-active ORC, where the animate head noun is non-agentive and forms a non-subject gap, can be attributed to compounding difficulty borne of “violating” the Minimal Dependency Preference and the Animate-Agent Preference. This contrasts with the animate-passive SRC, which still results in a non-agentive animate noun, violating the Animate-Agent Preference, while the formulation of the more minimal subject-gap dependency results in a relative ease of processing compared to the animate-active ORC. Within the inanimate nouns, the relative ease of processing observed in the passive SRC compared to the active ORC suggests that the Minimal Dependency Preferences is indeed present with inanimate heads — with the non-agentive thematic role being assigned in both cases, the difference boils down to the structural position of the gap within the RC.

The overall takeaway is that these data can be seen as consistent the view that there are complex interactions between animacy (i.e. person-based prominence), thematic role, and structural position, and thus a variety of factors must be appealed to in order to account for the complex patterns of argument structure processing. The Minimal Dependency Preference can be observed with both animate and inanimate nouns when the

thematic role is kept constant. However, because inanimate nouns are most optimally aligned with non-agentive thematic roles, this results in a pressure for the passive voice to be used. That said, the passive is still generally marked compared to active structures — it comes with its own complexities including an additional step of movement (assuming the smuggling analysis of Collins (2005) from Section 6.3.1.1), and it results in the argument with a noun with a less prominent thematic role occupying a more prominent syntactic position.

Particularly direct evidence for the cost associated with promotion of non-agentive arguments to the subject position comes from the work of Sauppe (2017), who examined the effort associated with producing voice marking in Tagalog (Austronesian) and German (Germanic). Unlike both English and German, which have *asymmetrical* voice systems that shows decreases to the valency of the verb, Tagalog has a *symmetrical* voice system, where voice alternations are not associated with detransitivization. This makes it more similar to the direct/inverse system of Ojibwe. The relevant consequence is that there is no strongly observable markedness distinction between the *agent* and *patient* voices of Tagalog, where either the agent or patient argument is highlighted as the syntactically prominent “pivot” argument. This contrasts with the Germanic voice system, where active voice, the closest analogue to the agent voice of Tagalog, is unmarked compared to the passive, the closest analogue to the patient voice.

Sauppe (2017) finds a number of processing differences between symmetrical and asymmetrical voice systems in terms of when difficulty arises, but also finds a core similarity in that promotion of the patient to the highest syntactic function (as in the patient voice in Tagalog and the passive in German) is associated with more effortful processing in general, as measured by pupil diameter response and speech onset latency. Sauppe ties this effort to a general preference for mapping the agent to the highest syntactic position (or, a dispreference for mapping the patient to this position).

The results reviewed in this section highlight some of the general difficulties with comprehending dependencies with inanimate as compared to animate head nouns (or less prominent compared to more prominent nouns). Consider again the case of relative clauses with head nouns alternating in animacy. With animate heads, an active voice SRC allows for a full alignment between animacy, syntactic position, and thematic role (i.e. an animate-agent forming a subject gap with the active voice). With inanimate heads, one of these alignments must always be broken. An inanimate patient with the passive voice violates an alignment between thematic role and structural position, while the active voice in the same case creates an object gap, and therefore goes against the subject gap preferences flowing from the Minimal Dependency Preference. Similarly, an inanimate agent in either the active or passive voice results in a violation of the Animate-Agent Preference, where a more prominent thematic role is associated with a less animate argument. The question that emerges is how these different pressures are related to the computation of thematic roles: At what point is different information used, how does it impact prediction, integration, and reanalysis, and how is a “compromise” found when there is no single optimal parse. The next section presents the background for the current study, which seeks to shed light on these questions.

6.4 The current study

The review conducted over the past sections was intentionally broad in scope: there is a wide range of proposals for the role of prominence information in sentence processing, with many complex interactions between prominence information such as animacy or obviation and the different alignments of syntactic structure and thematic roles produced by various voice systems. The most immediate goal of this study is to examine what role, if any, the obviation status of nouns has in immediately restricting processing choices. Does obviation have an immediate impact on parsing, interpretation, or both? The secondary question is then how filler-gap dependencies are resolved via integration

and reanalysis, and the final links to argument structure determined, once bottom-up information related to the alignment of thematic role with obviation is encountered. In the present study, this comes in the form of direct/inverse voice morphology. In this section, I provide the immediate background for the study, and outline the core predictions.

6.4.1 Relative clauses in Ojibwe

Relative clauses in Ojibwe can be headed by either proximate or obviative nouns, with the embedded clause being grammatical with either direct or inverse marking. The four logical possibilities that this entails are shown in (33).

- (33) a. Nin-gikenim-aa **gichi-aya'aa** gaa-baapi' -aa -d inini -wan
 1-know-3 **elder.PROX** REL-laugh -DIR -3 man -OBV
 'I know the elder (PROX) who is laughing at the man'
- b. Nin-gikenim-aa **gichi-aya'aa** gaa-baapi' -igo -d inini -wan
 1-know-3 **elder.PROX** REL-laugh -INV -3 man -OBV
 'I know the elder (PROX) who is being laughed at by the man'
- c. Nin-gikenim-imaa-n **gichi-aya'aa -n** gaa-baapi' -aa -d inini
 1-know-3'-3' **elder** -OBV REL-laugh -DIR -3 man.PROX
 'I know the elder (OBV) who the man is laughing at'
- d. Nin-gikenim-imaa-n **gichi-aya'aa -n** gaa-baapi' -igo -d inini
 1-know-3'-3' **elder** -OBV REL-laugh -INV -3 man.PROX
 'I know the elder (OBV) who the man is being laughed at by'

According to judgements collected in Summers of 2018 and 2019 with two speakers of the Border Lakes dialect, the same basic word order of head noun, embedded verb, and other argument, which all the examples in (33) conform to, is the only grammatical option for transitive RCs. This means that there are no word order cues to determining the association between the head noun and argument structure. This broadly conforms to the fact that Ojibwe is a verb-initial language. While the relativized argument is

promoted to a high position, the other argument remains in the (relatively) low position with verbal spine, therefore appearing to the right of the embedded verb.

Another property of relative clauses, which is relatively unique to the Border Lakes dialect, is the existence of an explicit relativizer *gaa-*. Like relative pronouns in English, this morpheme serves as a cue that a relative clause is being formed. For the purposes of sentence processing, this serves as the cue that renders the head noun as a filler, triggering the expectation that a gap should be upcoming.

The final question relevant to the current study is how these various relative clauses link the SRC/ORC distinction. More particularly, in the examples in (33), when is the head noun parsed into the subject gap position? Ojibwe shows a marked difference from languages such as English, in that there is a strict relationship between prominence distinctions and derived syntactic positions. As outlined in Section 6.3.1.2, proximate nouns are always promoted to the subject position of the clause. As a result, proximate head nouns are grammatically bound to ultimately fill the subject-gap position, and therefore form an SRC. On the other hand, obviative nouns are extracted from their base-generated position within the VP. The basic derivations in (34) are therefore respectively assumed to underly the derivation of each of the RCs exemplified in (33).

(34) *Proximate links to a subject gap, obviative to a non-subject gap*

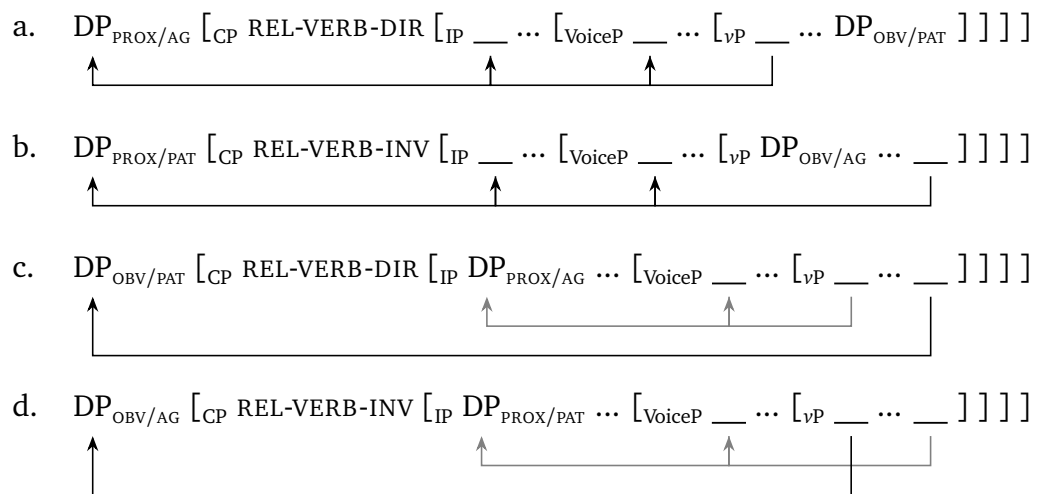

The representations in (34) advance the claim that RCs headed by a proximate noun are formed by a three-link chain, with the filler occupying (i) its “deep-structure” or base-generated position, which is the location of thematic composition; (ii) the specifier of VoiceP, an intermediate landing site linked to direct/inverse voice marking; (iii) the specifier of IP, the derived subject position; and (iv) the relative clause head noun position. On the other hand, RCs headed by obviative nouns are derived by a single, long movement chain, which brings the argument from its base-generated position directly to the head noun position of the RC. In these cases, the proximate noun also undergoes a separate movement sequence to the derived subject position.

6.4.2 Summary of questions and predictions

To recapitulate the through line of this chapter, the major goal is to understand what role prominence information, and obviation more particularly, has in forming a predictive link between a filler and the argument structure of the verbal predicate. A secondary goal is to understand how, when bottom-up evidence of a verb’s argument structure is reached, the link between arguments and argument structure is formed — that is, understanding how new information is integrated with previous material and the predictions engendered at early points in the sentence, and if necessary how initial processing decisions are revised and reanalyzed based on this new information.

For Ojibwe, the first question can be narrowed to what parsing and/or interpretation commitments are made at the head noun of the relative clause, and whether these commitments differ as a function of the obviation of the head noun. If prominence information is used to guide predictions in the early stages of sentence comprehension, and if the relative prominence of proximate over obviative is akin to that seen with animacy, then there should be evidence that comprehenders commit to an interpretation of the proximate noun as an agent before there is direct bottom-up evidence from direct/inverse voice marking. On a direct analogy to previous findings with inani-

mate nouns, evidence of an early commitment to a particular argument-theta alignment should be absent with obviative nouns.

At the point where voice marking is reached, in the inverse voice with proximate head nouns, there should be evidence of reanalysis (or general difficulty with resolving the dependency) due to a disruption of the predicted alignment between proximate and the agent theta role. On the other hand, processing should proceed smoothly in the case of direct marking, where voice matches expectations. Assuming no predictive effects with the obviative noun, resolution of the dependency should show similar profiles regardless of voice marking in this case.

The additional complicating factor is the fact that proximate head nouns are mediated in their connection to the embedded clause by an initial promotion to the subject position, while obviative nouns must be directly associated with their base-generated position in the clause. Assuming a general subject gap advantage, we might expect evidence of an overall ease of processing with proximate head nouns compared to obviative head nouns, as the connection between the displaced filler and the argument position is mediated by a series of smaller movement dependencies, rather than a single, long chain.

6.5 Experiment

6.5.1 Methods

6.5.1.1 Participants

Participants were recruited with the help of community liaisons at *Nigigoonsiminikaaning* (also known as *Red Gut*) and *Seine River*. Both communities are Treaty 3 nations, with indistinguishable dialects, and are located within a short drive of Fort Frances in Northwestern Ontario. In total, 19 individuals participated, with 16 being included in the final analysis. Two participants were excluded for declining to have video recordings

taken, thus no preferential looking data was collected. One participant was excluded for low performance on filler items. All participants, including those ultimately excluded, were paid \$40 USD for their participation.

Six participants were from *Nigigoonsiminikaaning*, with the remainder being from Seine River. Seven reported their gender as female, and nine as male. The mean age was 61.3 years, with the youngest being 42 and the oldest 80. All participants were deemed by the relevant community liaison to be a fluent speaker of Ojibwe, and all participants self-reported their first language as Ojibwe. All participants reported using Ojibwe at least multiple times per week, with most using the language on a daily basis in the context of familial and community gatherings. All participants were fluent in English as a second language, albeit to varying degrees. The average age of first exposure to English was 6.3 years, with the range varying from 4 to 10 years old. Exposure to English was invariably tied to residential school. For more information about this history see Chapter 1.

6.5.1.2 Auditory stimuli

The core of the experiment comprised of a fully crossed 2x2 within subjects design with factors HEAD (OBVIATIVE versus PROXIMATE) and VOICE (DIRECT versus INVERSE). Each participant saw 32 experimental trials, which were randomly interspersed with 16 filler trials. An example transcription of an experimental auditory stimulus, with each of the four conditions represented, is shown in (35).

(35) *Example transcription of experimental auditory stimulus*

- a. ... **gichi-aya'aa** gaa-baapi' -aa -d inini -wan
 elder.PROX REL-laugh -DIR -3 man -OBV
 '...the elder (PROX) who is laughing at the man'
- b. ... **gichi-aya'aa** gaa-baapi' -igo -d inini -wan
 elder.PROX REL-laugh -INV -3 man -OBV
 '...the elder (PROX) who is being laughed at by the man'

- c. ... **gichi-aya'aa -n** gaa-baapi' **-aa** -d inini
elder -OBV REL-laugh -DIR -3 man.PROX
 '...the elder (OBV) who the man is laughing at'
- d. ... **gichi-aya'aa -n** gaa-baapi' **-igo** -d inini
elder -OBV REL-laugh -INV -3 man.PROX
 '...the elder (OBV) who the man is being laughed at by'

The form of the auditory stimuli was initially devised by the experimenter following extensive fieldwork with a first speaker community consultant (who was paid \$40 USD per hour for their work). This confirmed the felicity of the basic relative clause construction, ensured the naturalness of word order, and controlled for other grammatical factors. As shown in (35), all sentences began with an instructive preamble *onaabandan mazinaakizon. . .*, translating to *choose the picture with. . .* in English. This was then followed by the head noun of the relative clause, which alternated between being either proximate or obviative. In all cases, the head noun was immediately followed by the relativizer *gaa-*, then the relative clause verb, to which the direct or inverse morphology (along with an invariant proximate agreement marker *-d*) is appended. The final word of each sentence is the non-head argument of the relative clause verb, which takes the opposite obviation status to that of the head noun. Both experimental and filler items used this same basic form (as explained below, fillers differed from experimental items in which class of visual stimulus was associated with the correct response).

Fieldwork was further conducted to generate a list of familiar nouns and verbs that could comprise the items. This provided a basic guard against extremely low frequency words. The end result was a set of 6 nouns and 24 transitive verbs from which the final sentences were constructed. The full set of stimuli is given in Appendix C. The sentences were constructed by the experimenter to balance which of the two nouns appeared together, which noun occupied the head noun position, and, given that each verb appeared twice, whether a verb was used in two experimental items or one experimental item and one filler. This was done to ensure that counterbalancing was achieved

such that no combination of two nouns, head noun, or verb appeared in the same experimental condition, or the same type of filler condition, more than once. The goal was to ensure that no strategies could be used to predict the outcome of how a sentence would be interpreted given the particular action denoted by the verb or thematic role that a given noun previously played, or about what sort of voice marking would appear on a verb given what marking it showed when it appeared the first time.

All items were then deemed by the community consultant to be culturally appropriate, readily comprehensible, and were translated and explained in detail so they could be accurately depicted with simple images. Voice recordings of the 128 experimental sentences and the 16 filler sentences were created with the community consultant using a Zoom H5 Handy Recorder with a Shure SM93 lavalier microphone. The raw .WAV files were cut into individual files for each item and condition, edited for volume balancing, and in some cases digitally slowed (keeping frequency controlled) to ensure the critical analysis regions were as lengthy as possible (the analysis regions are explained in Section 6.5.2.2).

6.5.1.3 Visual stimuli

Once all sentences were recorded, an artist with connections to the Ojibwe community was contracted to create the visual stimuli, which comprised 150 drawings, 3 for each of the 48 trials, plus 6 that were used in the practice session. All images were black and white line drawings depicting the transitive action in the sentence. An example set is shown in Figure 6.1, which corresponds to the example auditory stimulus in (35). With respect to the experimental items, one image was associated with the head noun being the agent (the *agent* image), one with the head noun ultimately being the patient (the *patient* image), and finally one that entirely lacked a character corresponding to the head noun, but included the non-head noun character (the *distractor* image). For the

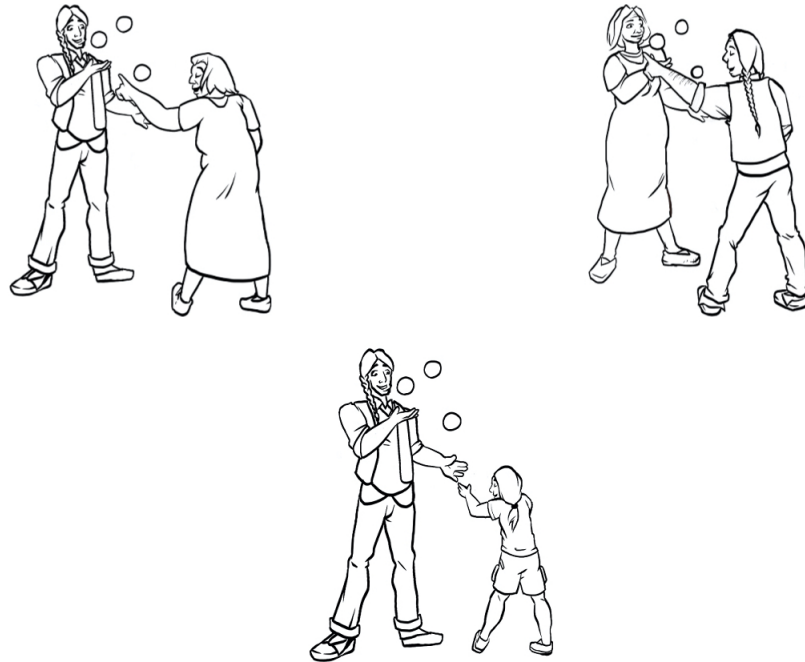

Figure 6.1: Example visual stimuli set. The upper left image is the agent image, upper right the patient image, and at the bottom the distractor, all with respect to the example sentence in (35).

distractor, whether the non-head noun character was depicted as an agent or patient was counterbalanced across items.

One of the two role-reversed images, either the agent or patient image, ultimately corresponded to the correct response in the experimental trials, while the distractor image was always the correct response for the filler trials. Therefore each of the three types of images was the correct response on one-third of trials. For the filler items, the head noun of the auditory stimulus was always found in the distractor image, but *never* in either of the role-reversed images; again, for the experimental trials, the head noun was in both of the role-reversed images, but not in the distractor image. While participants could not know at the start of a trial which image would be correct, following the head noun they could confidently rule in (as in the filler trials) or rule out (as in the experimental trials) the distractor image. The hope was that this aspect of the experimental design, besides counterbalancing the response options, would encourage

incremental interpretation and eye gaze behavior among the participants, given that certain images could be ruled-in/out in the middle of the sentence.

6.5.1.4 Equipment and software

The visual stimuli were presented on a 27” Acer T272HL Touch Screen Monitor, and the auditory stimuli over USB-Powered Creative Pebble Desktop Speakers. Both visual and auditory presentation were controlled by a 2015 Macbook Pro running the PsychoPy2 experimental software. Preferential looking data was collected with a Logitech C920S HD Pro Webcam mounted at the top of the screen. The OBS Studio application was used to record the participant’s head and face as well as the experimental display within a video, written into a .MOV file. The sample rate of the video was 30 frames per second, the maximum the camera would allow. Other behavioral data from the picture selection task was collected through the experimental software and was output to a .CSV file. Interaction with the touch screen was coded as mouse clicks, with both the region and timing of every touch over the course of each trial being recorded. Touches were time-locked to the onset of the auditory stimulus.

6.5.1.5 Procedure

The experiment was conducted at three different sites over a three week period in February 2020. Six participants were run at the cultural center at *Nigigoonsiminikaaning* and one at the round house. All Seine River participants were run in the home of the community liaison. Participants were run one at a time in a single session lasting approximately one hour.

Participants were first given an overview of the goal of the experiment: to learn how speakers of Ojibwe understand complex sentences by looking at how eyes move around to pictures associated with different possible meanings of the sentence. A brief outline of the mechanics of the task was given. This was followed by a consent process

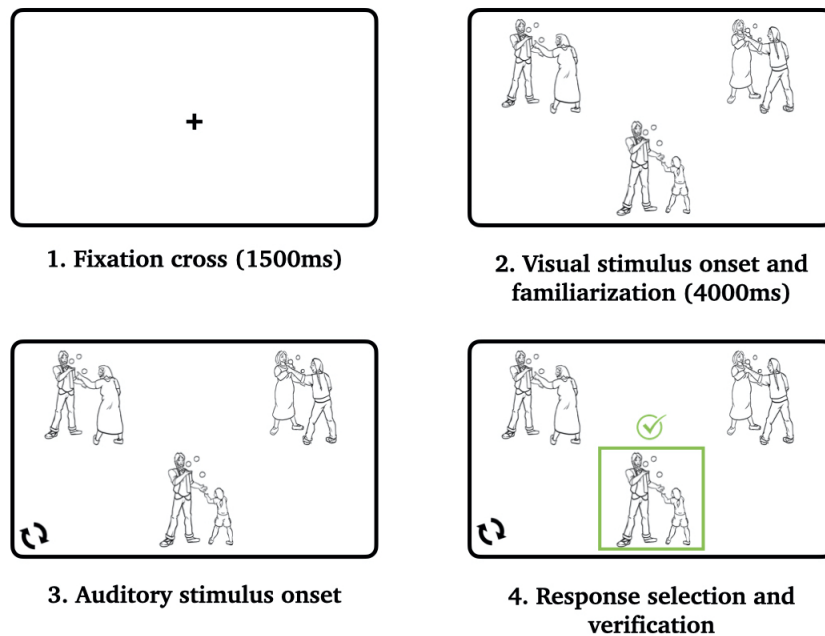

Figure 6.2: Schematization of experimental trials.

approved by the Institutional Review Board of the University of Massachusetts Amherst, as well as a brief demographic survey. The session began with a practice session that introduced the six characters within the images, as well as the nouns associated with each character, to ensure that there was no confusion about who was who. This also served as an opportunity to further detail the mechanics and goals of the task, ensure the auditory stimuli were being presented at the appropriate volume, and to familiarize participants with the touch screen computer before the main experimental block. During the practice, participants were shown three images, each corresponding to one of the six characters, and heard a sentence of Ojibwe that asked them to select the image corresponding to one of the characters. There were 12 practice trials in total, with each of the six characters appearing as the correct answer twice. The experimenter monitored the selection and corrected the participant if they selected the wrong character to ensure appropriate mappings were being made.

Participants were given a chance to ask questions about the task before moving onto the experimental block. A visual schematization of the trial structure is shown in Figure 6.2. Each of the 48 trials in this block could be started at the leisure of the participant, with a wait screen between each trial allowing breaks to be taken at any point (the screen read *touch the screen when ready to start* in Ojibwe). All text appeared in black font, and the background of the screen was white across the whole experiment to maximize contrast with the line-drawn images. Both the order of trials and dispersment of fillers were randomized over the block. The trial commenced when the participant touched the screen. Immediately following the registration of the touch, a fixation cross appeared at the center of the screen for 1500ms. Participants were instructed to train their gaze on this point. This allowed preferential looking data to be coded more easily. Following a 100ms blank screen buffer, the three visual stimuli appeared. One appeared in the bottom center of the screen, one in the upper left corner, and one in the upper right corner. The images were arranged to ensure easy coding of looks, with maximal distance between each image. The association between image type (agent, patient, and distractor) and location (left, right, bottom) was randomized on each trial, but recorded for use during data analysis using the experimental software. Participants were told to examine each of the images to familiarize themselves with the scenes and the characters. The familiarization period lasted 4000ms, after which the sentence began to play over the speakers.

Participants were instructed to select the image corresponding to the meaning of the sentence as soon as they could to encourage active parsing. Once selected, a green border would appear around the image, as well as a check mark either below the image (as in the case of the two upper images) or above the image (as in the lower image). At this point, participants could change their response by touching a different image, confirm their response by pressing the checkmark, or hear the sentence again by pressing a repeat button in the lower left corner of the screen. Participants were encouraged to

go with their gut response and limit use of the repeat button. The images remained on the screen until the check mark was pressed, at which point the screen would go blank for 750ms and the wait screen would appear for the next trial. Following the final trial, the experimenter conducted a debriefing session to gather the participant's impressions of the study. Participants were then paid and the session was concluded.

6.5.2 Analysis

6.5.2.1 Picture selection

For the main analysis of the picture selection task, I retain focus on the accuracy results. While latency data was collected and is reported in the results, there are a number of issues in interpreting this measure. First, there is not a single principled point when a response might be initiated. Participants could make a selection at any point from when the sentence began. This leaves a long time span during which a response could be initiated. Second, participants were able to change their answer, and also had to confirm their answer with a second button press, complicating the choice of how to define the end point of a response. Finally, significant variability in how motor responses were prepared when moving hands from their resting position to the screen strongly affects latency, making it difficult to interpret timing as measuring the main cognitive variables of interest. As a result, the latency measures are presented without a statistical analysis and with an abundance of caution.

Accuracy was measured using the final response on each trial. That is, the last image that was touched prior to the check mark being pressed. In order to fit a logistic mixed effects model for the analysis of the experimental trials, each trial was also coded in a binary fashion as either correct or incorrect, despite the fact that three response options were available. For proximate-direct and obviative-inverse, the agent image was coded as a correct response. For proximate-inverse and obviative-direct, the patient image was

coded as the correct response. All other responses (i.e. the role-reversed counterpart and the Distractor) were coded as incorrect.

6.5.2.2 Preferential looking: Calculating ROIs

The raw .MOV files for each participant were first separated into individual files for each of the 48 trials. Each of the 32 experimental trials were then hand-coded frame-by-frame to establish the gaze direction at each sampled time point. Coding was done by the experimenter using the VCode software, and was done with full blindness to experimental condition and item number. Coding began at the onset of the fixation cross and continued until the first response touch was made, be it the pressing of the repeat button or selection of one of the images. Each frame could be coded as (i) *right*, where the look was towards the image in the upper right corner; (ii) *left*, where the look was towards the image in the upper left corner; (iii) *bottom*, where the look was towards the image on the bottom; or (iv) *other*, which included looks towards the fixation cross at the start of the trial, blinks, saccades, off-screen looks (of which there were very few), looks towards the repeat button, or otherwise uncategorizable frames due to issues such as rapid head movements or the loss of camera focus. This direction-based coding was then transformed using the record of the experimental block so that looks were recategorized as towards the agent, patient, distractor, or other. This process also associated the pattern of looks with critical time points within the auditory stimulus.

The main region of interest (ROI) is the *ambiguous region*, which is defined as the span of time between when the obviation status of the head noun becomes apparent, up to when the direct/inverse marking occurs. In the proximate conditions, this started at the relativizer *gaa-*, where it becomes apparent that the head noun is unmarked. In the obviative conditions, this started at the onset of the obviative suffix on the noun. During this time, the thematic role of head noun is unknown, but the obviation information can

in principle be used to predictively parse the sentence. There are two additional ROIs that are not integral to the core analysis, but are present in the results. The first is the *resolution region*, which begins with the direct-inverse marking and ends whenever the first touch of the screen is made by the participant. This is where disambiguation occurs and the thematic roles can be established. The second is the *familiarization region*, which begins with the onset of the visual stimuli and ends with the preamble of the sentence.

For each of the auditory stimuli, these critical time points were established by the experimenter by examining spectrograms in Praat, along with careful auditory confirmation, to find the onset of the relevant words and morphemes that define the boundaries of each ROI. For the calculation of each region for each item, an additional 200ms was added to the end points of the regions on the assumption that there is a delay in saccade planning and execution such that looks during this additional time reflect earlier processing.

An important consideration for the analysis is that the length of each of the ROIs differs as a function of both item and condition, with no single combination being exactly identical to another. This is due to a number of factors including the experimental manipulation (e.g. the obviation suffix on the head noun makes the ambiguous region systematically longer in these conditions), lexical variation (e.g. the embedded verb differs in length depending on the item), and the latency of response (e.g. the resolution region ends once a response is made, which varies from trial to trial). While these issues strongly affect the *end point* of a region—that is, how long the region lasts—it is still possible to define a *relative starting point* that is shared across all trials for a given region. The relative starting point is treated as time zero for the analysis of that region. Again, for the ambiguous region, this is the point at which information about obviation comes online; for the resolution region, it is the point at which direct/inverse marking begins. A semi-arbitrary cutoff was selected as the *maximal* end point for each region.

This was deemed necessary as the further from the zero point one gets, the smaller the data set to calculate the proportion of looks becomes, causing the reliability of the measure to suffer. For the analysis of the ambiguous region, a cut was made at 1200ms (at which point 81% of trials are contributing). For the resolution region, a cut was made at 5000ms (at which point 97% of trials are contributing). Finally, the data input to the statistical models included only those trials where the repeat button was *not* pressed, resulting in a loss of 11.3% of trials.

6.5.2.3 Preferential looking: Cluster-based permutation

Times series data, such as the preferential looking data collected here, have a number of properties that makes statistical analysis tricky (see Stone, Lago, and Schad, 2020; Huang and Snedeker, 2020, for recent discussions). The first is the multiple comparisons problem. For example, if we ask the question of *when* a particular effect is or becomes statistically reliable, and a test is run at each of the sampled time points to examine this effect to determine this, then the Type I error rate (i.e. the rate of *false positives*) will be inflated. The second is that parametric tests of this sort rely on the assumption that each sampled point is an independent observation. However, the points are highly *autocorrelated*—that is, data points that are adjacent in time are likely to stem from the same cognitive source (again, see Stone et al., 2020, for a relevant discussion and quantification of autocorrelation). Individual saccades (and by extension, the cognitive processes that control eye movements) extend across multiple sample points. As a result, all sampled points within a saccade are interdependent, violating a key assumption of the test. While Type I error can be controlled by computing significance based on corrected *p*-values, auto-correlation must be solved by other means.

A solution to both of these issues (Type I error inflation and autocorrelation) can be found in non-parametric statistical tests. Following most closely the visual world analysis presented in Barr, Jackson, and Phillips (2014), I utilize a cluster-based permutation

test. The starting point of the test is to identify sequences of the sampled time points that satisfy a chosen statistical criterion within the original data set. Each sequence forms a cluster. These clusters are usually restricted such that they extend for at least a certain length of time, deemed by the researcher to be relevant to the question at hand, and with effects that occur in the same direction. For each of these clusters, a *cluster mass statistic* (CMS) can be calculated by taking the sum of the individual test statistics (e.g. the *t*- or *z*-value) within the cluster. For a given ROI, it is possible to identify multiple separate clusters.

Significance for each cluster found in the original data set can be determined by a permutation test, where the relevant condition labels are randomized to create a large number (> 1000) of alternative data sets formed from the original data. Each of these alternative data sets represent a sample under the null hypothesis, where it is assumed that there is no difference between the levels of a given conditions (i.e. that the condition labels do not matter, and are therefore interchangeable). With each of these randomized data sets, the *maximal* CMS is calculated and stored. Collectively, these maximal CMS's form a null hypothesis distribution, which can be used to determine a *p*-value for the CMS of the original data set. Under the conventional alpha threshold of .05, if fewer than 5% of the CMS values in the null hypothesis distribution are *more extreme than* the observed CMS, then the effect is deemed significant. It is important to emphasize that the result of this procedure does not provide direct information about when an effect arose—for example, it is incorrect to interpret the edges of the cluster as the “beginning” or “end” of when the effect was significant. The procedure identifies a window of significance, but significance does not necessarily extend to the individual points within that window.

To return to the original impetus of the test, cluster-based permutation provides a solution to the multiple comparisons problem as significance is assessed with respect to clusters, rather than the individual time points. Therefore there are only as many

“tests”, in the sense of evaluating a test statistic against a null hypothesis distribution, as there are clusters. Furthermore, by respecting the original temporal structure of the data (by only permuting the condition labels), the null hypothesis distribution is constructed in a way that holds autocorrelation constant across each permuted sample, essentially factoring out the effects.

For the current experiment, which used a within-subjects factorial design, we followed the synchronized permutation logic outlined by Barr et al. (2014) to create randomized data sets (see also Pesarin, 2001; Salmaso, 2003). To this end, we randomized the labels of the relevant experimental factor by subject, rather than trial-by-trial. That is, for a given subject, either all labels of the relevant factor were completely reversed, or the original labels were retained. The idea behind the method is that a given subject may differ in how sensitive they are to the experimental manipulation, therefore individual trials may not be exchangeable under the null hypothesis. Furthermore, the adopted permutation logic respects the original structure of the data, ensuring the validity of the null hypothesis distribution.

Given the categorical nature of the gaze-based data, we choose a generalized logistic mixed effects model to generate the test statistic z at each time point. Since a sample was taken every 33ms, we choose to only consider clusters (in the original data set) that span at least three frames, or 100ms. To construct the clusters, we choose a liberal cutoff of $p < .2$. The validity of the test against the null hypothesis distribution is not affected by this choice, as long as the same cutoff is used to form clusters in both the original and alternative data sets. This does, however, affect the size of the clusters, with a larger value corresponding to wider clusters (and therefore decreased resolution related to the timing of the effect). In some cases, no significant cluster of any size could be found within the randomized data set. In these cases, the most extreme z -value (either in the positive or negative direction) was stored to contribute to the null

hypothesis distribution. For each model described below, we fit 2,000 randomized data sets using this procedure.

The analysis focuses on the ambiguous region. Given that there is no information about how the thematic dependencies resolve at this point (i.e. direct-inverse marking has not yet been encountered), the main analysis collapses across the contrast in Voice and proceeds with respect to the contrast in head noun obviation alone. The goal of the analysis in the ambiguous region is to establish (i) *within* obviative and proximate conditions separately, whether there is a difference in the proportion of looks to the agent versus patient image (i.e. whether obviation is being used to predict the thematic role of the head noun); (ii) again *within* the proximate and obviative conditions separately, whether there is a difference in the proportion of looks between the agent versus distractor images and the patient versus distractor images (i.e. whether the distractor is being ruled out); and (iii) whether each of the above contrasts differer *between* the two head noun conditions (e.g. does the proportion of looks to the agent versus patient images differ between the proximate and obviative conditions).

To isolate each relevant difference (agent versus patient, distractor versus agent, and distractor versus patient), the looking data were coded three different ways. For the difference between agent and patient looks, each time point was coded such that a look towards the agent image was 1, a look towards patient as 0, and distractor and other looks as NA. For the difference between distractor and agent, the distractor image was coded as 1, the agent 0, and the patient and other looks as NA. Finally, for the difference between distractor and patient looks, the distractor was coded as 1, the patient 0, and agent and other looks as NA.

To test the first two sets of questions, that is whether the proportion of looks between each of the three pairings of images differed *within* each head noun condition in the ambiguous region, six logistic regression models were specified, one for each of the three differences for the two levels of head noun obviation with subject and item random

slopes and intercepts. The basic model syntax is shown in (36), where $\text{Pr}(\text{Look})$ is filled by one of the three look codings described in the previous paragraph, again with models run separately for the two levels of head noun.

$$(36) \quad \text{Pr}(\text{Look}) \sim 1 + (1|\text{Subj}) + (1|\text{Item})$$

These six models were run at each time point in the original data set as well as the 2,000 alternative data sets under the cluster-based permutation procedure described above. This created six null hypothesis distributions for each of the six contrasts/models. In all cases, permutation proceeded with respect to the relevant image labels, with agent/patient, distractor/agent, or distractor/patient labels being randomly swapped, depending on the contrast at hand.

To test the third question outlined above, that is whether these three contrasts differed *between* levels of head noun obviation (i.e. to establish whether there is a main effect of head noun obviation), for each contrast in looks, a mixed effects logistic regression with a single fixed effect of head noun (Proximate = 1, Obviative = -1), along with maximal subject and item random effects, was used to generate a test statistic for the cluster-based permutation test. The basic model syntax is given in (37).

$$(37) \quad \text{Pr}(\text{Look}) \sim \text{Head} \\ + (1|\text{Subj}) + (0 + \text{Head}|\text{Subj}) \\ + (1|\text{Item}) + (0 + \text{Head}|\text{Item})$$

In this case, there were three models in total. The permutation procedure swapped the head noun condition labels to generate the relevant alternative data sets.

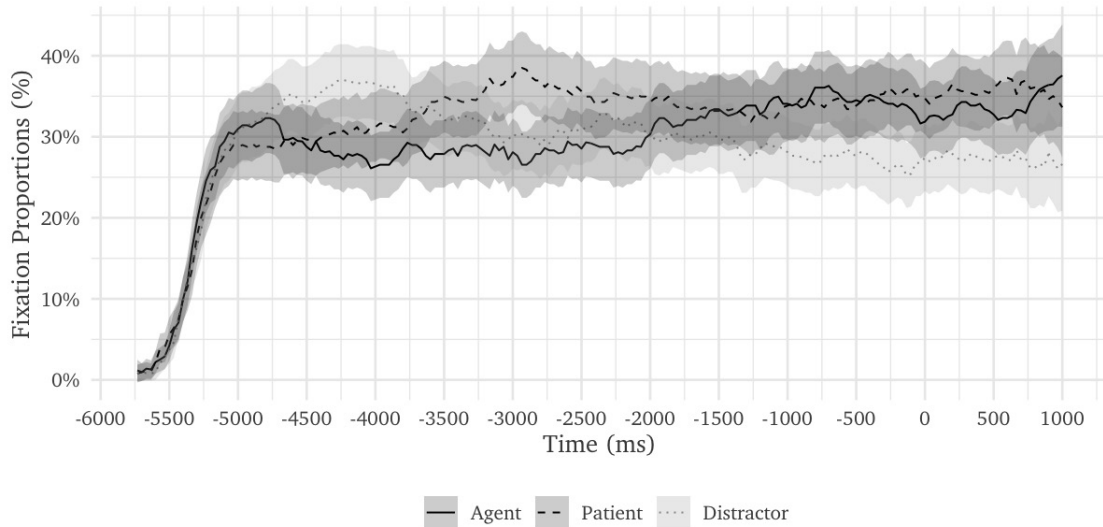

Figure 6.3: Average look proportions over time in the familiarization region with 95% CIs. Time zero marks the onset of the audio stimulus.

6.5.3 Results

6.5.3.1 Preferential Looking

While not subject to statistical analysis, the looking preferences in the *familiarization region*, the period prior to the onset of the auditory stimulus, but after the onset of the visual stimuli, is shown in Figure 6.3. The patterns reveal equal preferences to each of the three images over the course of this period. If anything, the distractor (the odd one out, in that it includes a character not in the other two) is receiving decreased looks over the course of this region. The looks towards the agent versus patient images are on par throughout the region. Overall, this supports the presence of roughly equal visual attention to each image, which can then facilitate informed eye movements towards different images as the sentence unfolds.

The looking proportions towards each image in the critical ambiguous region, the period starting from where obviation information comes online and ending 200ms after voice marking begins, is given in Figure 6.4. The figure includes all data submitted to the statistical analysis. As detailed previously, this means regions longer than 1200ms

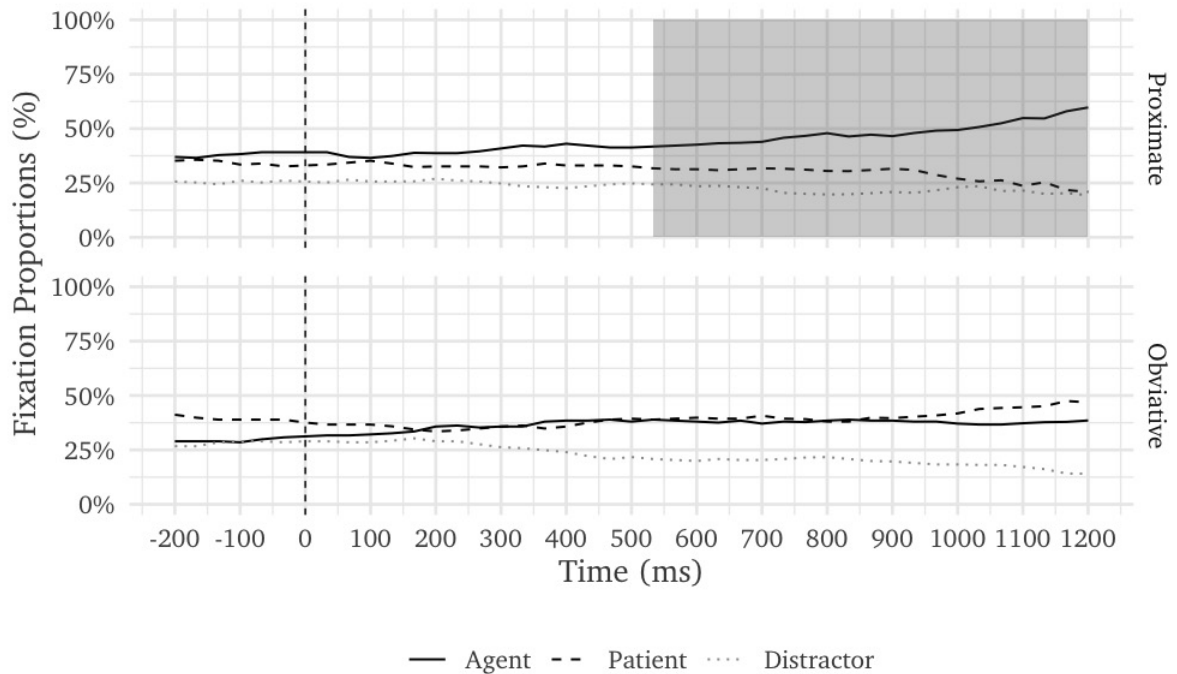

Figure 6.4: Average look proportions over time in the ambiguous region regardless of accuracy and collapsed across levels of voice. Time zero marks the end of the head noun (the start of obviative morphology or the relativizer). The area in grey marks the significant cluster for the analysis of agent versus patient looks in the proximate conditions. No cluster of significance was found in the obviative conditions for this contrast. Significant clusters for contrasts between agent/distractor and patient/distractor and the the test of main effect of head noun for each comparison is given in Table 6.2.

were cut short, and regions shorter than 1200ms stopped contributing at the point where voice marking begins. The gray box in Figure 6.4 corresponds to the cluster of significance found for the comparison of agent versus patient looks with proximate heads (no significant cluster was found for this comparison in the obviative head condition). The results of the cluster-based permutation tests for each of the six contrasts, as well as the test of the main effect for each comparison, is given in Table 6.2.

In both the proximate and obviative head noun conditions, looks towards the distractor decreased over the course of the region as measured by the comparison between the distractor versus agent looks and distractor versus patient looks. As detailed in Table 6.2, for the distractor versus agent contrast, a significant cluster ($p = 0.001$)

Contrast	Head	Cluster (ms)	CMS (z)	p-value
Agent v. Patient	Proximate	533–1200	48.54	*0.013
	Obviative	—	—	—
Distractor v. Agent	Proximate	0–1200	−112.39	*0.001
	Obviative	367–1200	−74.17	*0.009
Distractor v. Patient		0–133	−7.60	0.185
	Proximate	267–933	−38.52	*0.010
	Obviative	0–100	−5.96	0.221
		267–1200	−96.87	* < 0.001

Main Effect of Head	Cluster (ms)	CMS (z)	p-value
Agent v. Patient	433–1200	55.55	*0.005
Distractor v. Agent	—	—	—
Distractor v. Patient	0–1200	29.02	0.078

Table 6.2: Results of cluster permutation test. All located clusters are shown, along with the CMS with significance values determined from the constructed null hypothesis distribution.

spanned the entire analysis region, while in the obviative conditions the cluster of significance ($p = 0.009$) ranged from 367ms after the onset of the obviative marker till the end of the region. For the distractor versus patient looks, a significant cluster ($p = 0.010$) was found spanning 267–933ms for proximate heads, with the significant cluster ($p < 0.001$) spanned the time slice starting at 267ms to the end of the region. The test of a difference between the proximate and obviative head noun conditions did not reveal any significant clusters. Overall, the results provide basic evidence that gaze data can provide a window into incremental interpretation. At this point, the head noun will have been heard (and encoded). Given that the distractor *lacks* the character associated with the head noun, this image can be ruled out at this point.

The contrast between agent and patient image looks in the ambiguous region, again as indicated by the gray box in Figure 6.4, revealed a significant cluster in the proximate head condition ($p = 0.013$) spanning the period of 533ms to the end of the region. No cluster, let alone a significant cluster, was found in the obviative head noun conditions. The test of the main effect of agent versus patient looks was also significant, supporting

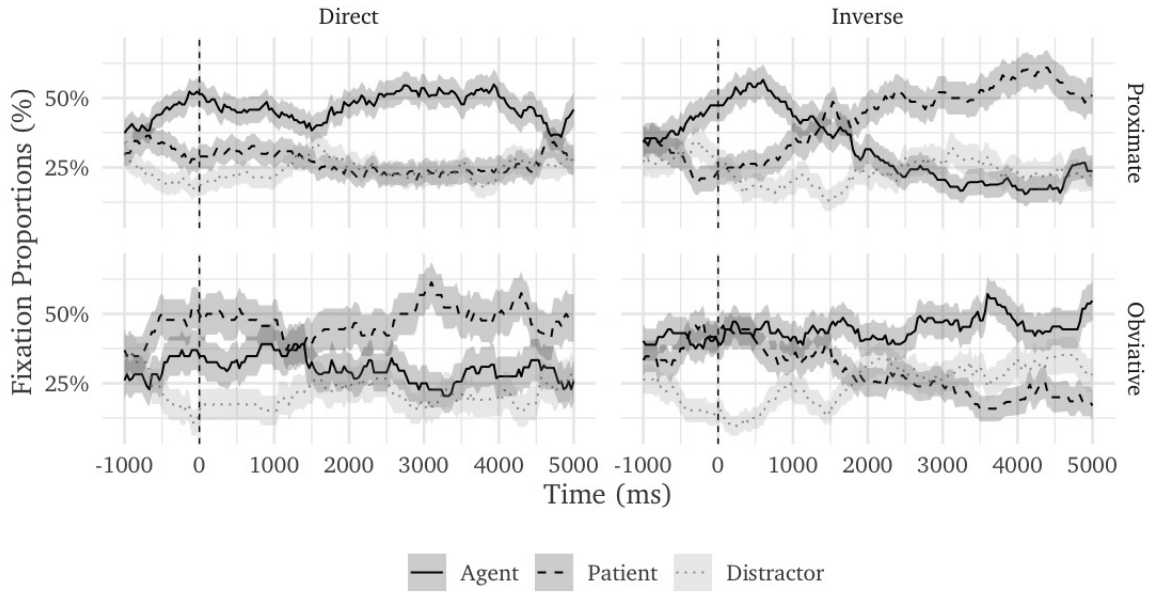

Figure 6.5: Average look proportions over time in the resolution region with 95% CIs for correct responses only, split by head noun and voice. Time zero marks the onset of direct/inverse marking.

the conclusion that there is a reliable difference in the looking behavior between the two conditions.

The gaze proportions in the resolution region, the region beginning at the onset of voice morphology and ending with the participant’s response, split by both head noun and voice marking for correct answers only is given in Figure 6.5. At present, the statistical analysis of this region is ongoing; to understand the profile of dependency resolution, I focus on the picture selection accuracy results, presented in the next section. That said, a brief description of the difference between looks towards the agent versus patient images is warranted.

The proportion of looks in the proximate head condition both start with greater looks towards the agent image. This pattern is sustained in the direct condition, where that image is associated with a correct response, but reverses in the inverse condition, where the patient image is ultimately associated with the correct response. The patterns

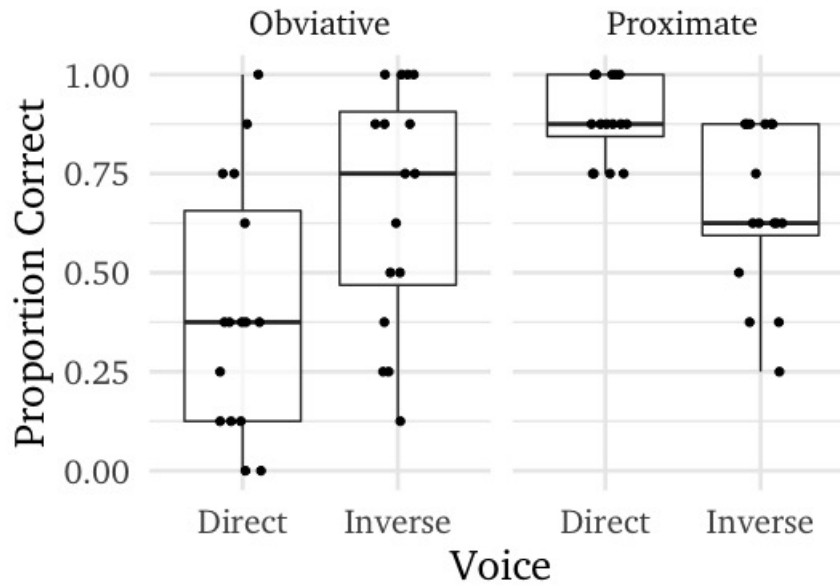

Figure 6.6: Box plots of by-participant response accuracy in the picture selection task, split by the four experimental conditions. Correct responses vary as a function of condition, with agent image being correct in the proximate/direct and obviative/inverse, and patient being correct with proximate/inverse and obviative/direct.

in the obviative head conditions are not as neat, partially due to the greater loss of data in these conditions (as discussed in the next section, there was a lower proportion of accurate responses in these cases. At the start of the region, and consistent with the results in the ambiguous region, neither the agent nor patient image are receiving a particularly large share of the overall looks. As the region wears on, a looking preference appears to emerge towards the image associated with the correct response: the agent image in the inverse condition, and the patient image in the direct condition.

6.5.3.2 Picture Selection Accuracy

Box plots with by-participant accuracy in the picture selection task, broken down by the four experimental conditions, is given in Figure 6.6. The mean response proportions for each of the three image types, also split by condition, are shown in Table 6.3. Overall, relatively few of the responses were associated with the distractor image, therefore

Head	Voice	Agent	Patient	Distractor
Proximate	Direct	.891 (.025)	.039 (.019)	.070 (.022)
	Inverse	.273 (.052)	.664 (.052)	.063 (.016)
Obviative	Direct	.539 (.088)	.406 (.078)	.055 (.020)
	Inverse	.672 (.076)	.242 (.079)	.086 (.039)

Table 6.3: Mean response proportions and by-subjects SEM by condition for agent, patient, and distractor images.

Effect	<i>z</i>	<i>p</i> -value
HEAD	3.39	* < 0.001
VOICE	0.60	0.548
HEAD:VOICE	3.67	* < 0.001

Table 6.4: Results of logistic regression on picture accuracy selection data.

participants had little trouble connecting the characters in the sentence to the images. Consistent with this, accuracy on the fillers, where the distractor image was the correct response, was 92%. Descriptively, obviative head noun conditions were associated with lower accuracy and much greater variance, with higher accuracy in the inverse compared to the direct conditions. Proximate head nouns had less variance overall, with direct conditions being associated with higher accuracy than inverse.

The results of the the logistic regression on response accuracy are given in Table 6.4. Consistent with the description above, the model revealed a main effect of head noun ($p < 0.001$) such that proximate conditions were more accurate than obviative conditions overall, and a significant interaction of head noun and voice ($p < 0.001$). Contrasts to resolve the interaction on the difference between accuracy between levels of voice were significant for both obviative heads ($t(15) = 3.01, p = 0.009$) and proximate heads ($t(15) = -4.42, p < 0.001$) such that the accuracy in the inverse conditions was higher compared to the direct conditions with an obviative head, and lower with inverse compared to direct with a proximate head.

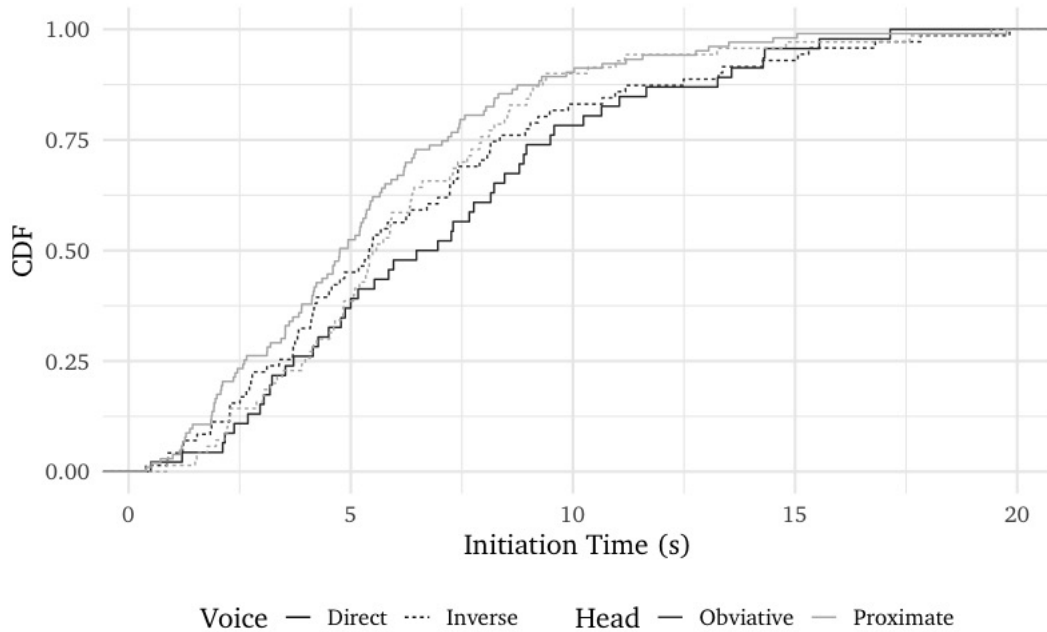

Figure 6.7: Empirical Cumulative Density Function of response initiation time for correct responses, time-locked to the end of the auditory stimulus. Includes trials where the first engagement with the touchscreen was ultimately the final response (i.e. does not include trials where the repeat button was pressed or the response was changed).

6.5.3.3 Picture Selection Response Initiation Time

While not part of the analysis, in the interest of transparency Figure 6.7 provides cumulative density functions for response initiation time in the experimental conditions. Response initiation time is time-locked to the end of the auditory stimulus, and represents the latency between this time point and the first time the participant touches the screen, given that the touch was a response to the picture verification task (i.e. cases where the repeat button was the initial response is not included). Only trials where the initial response was the final response are included — cases where the participant changed answers are excluded from the curves. These exclusions result in a loss of 14% of experimental trials.

The initiation times for accurate responses mirror the response accuracy patterns. The median initiation time for accurate responses was 4.94s for proximate direct, 5.53s for proximate inverse, 6.72s for obviative direct, and 5.42s for obviative inverse. That

is, correct responses in proximate direct conditions were on average faster than those in the proximate inverse counterparts, while the obviative conditions showed the opposite pattern, with correct responses in the inverse condition being faster on average than with direct. Finally, independent of voice, the proximate conditions were generally associated with faster initiations than the obviative conditions.

6.6 Discussion

6.6.1 Key empirical generalizations

There are a number of important findings to highlight from the study. First, preferential looking patterns in the ambiguous region revealed a significant effect of head noun obviation. Following a proximate noun, but before the disambiguating influence of direct/inverse voice was encountered, participants showed a significant preference for looking towards the image consistent with the interpretation of that noun as the agent of the depicted action. Following an obviative noun, no such preferences were found. This finding provides evidence for an immediate impact of prominence information.

The accuracy results revealed two major effects. First, that relative clauses headed by proximate nouns were interpreted with greater accuracy than those headed by obviative nouns. Second, that the impact of direct/inverse marking on interpretation accuracy had distinct effects in the proximate and obviative head noun conditions. With proximate head nouns, direct marking was associated with higher accuracy of interpretation compared to inverse marking. With obviative head nouns the reverse was true, with inverse voice being associated with more accurate interpretation when compared to the direct voice conditions. Recalling that direct voice indicates that the proximate noun fills the more agentive role, and inverse voice indicates that the obviative noun fills the agentive role, this interaction provides evidence that interpretation is more accurate when the head noun is ultimately associated with the agent role.

Consistent with the accuracy findings were the patterns of response initiation time. Though caution should be taken, as they were not subject to a statistical analysis, the patterns dovetailed with the shape of the accuracy results. First, proximate head nouns were associated with faster response initiation compared to obviative head nouns. Second, response initiations were faster when the head noun was ultimately associated with the agentive role. That is, for the proximate conditions the direct was faster than the inverse, and for the obviative conditions inverse was faster than direct.

Overall, the accuracy findings provides an insight into the process of integration between the the filler and the argument structure of the verb, and ultimately the difficulty of reanalysis given the finding of predictive processing in the ambiguous region. The results provide clear evidence for (i) the general difficulty of accurately resolving filler-gap dependencies with obviative fillers (or the relative ease of proximate fillers), and (ii) the relative ease of associating the filler with the agentive role (or the difficulty of associating it with a non-agentive role).

Taking everything together, the major findings can be summarized as follows:

- (38) a. *Under Ambiguity*: Anticipatory looks towards the agent image with proximate head nouns, but not obviative head nouns.
- b. *Following Disambiguation*: More accurate (and faster) responses:
- (i) With proximate head nouns.
 - (ii) When the head noun was ultimately the agent.

There are thus three aspects of the results that demand explanation:

1. Why do proximate fillers result in the appearance of predictive encodings, while obviative fillers fail to show evidence of such an effect?
2. Why are proximate fillers associated with greater accuracy in forming a link between displaced arguments and argument structure?

3. Why are alignments where the head noun is interpreted as the agent more accurate in both the proximate and obviative head noun conditions?

I argue that each of these results can find an explanation via the interaction of the three pressures discussed in Section 6.2.6, repeated in (39) for reference.

(39) ***Three processing pressures***

- a. *Animate/Proximate-Agent Preference*: Animate nouns are more prototypically agentive than inanimate ones; proximate nouns are more prototypically agentive than obviative ones.
- b. *Agent-First Preference*: The prototypical agent role is assigned first.
- c. *Minimal Dependency Preference*: Shorter dependencies are preferred over longer dependencies.

While I ultimately provide an explanation for the source of each pressure in terms of the *maximize incremental well-formedness* framework proposed by Wagers and Pendleton (2016) and Wagers et al. (2018), they are intended to be general pressures. Any comprehensive model of language processing must provide an explanation for why each one arises across a variety of measures, languages, and constructions, ideally in terms of general principles. The main goal of the discussion is therefore to provide a unified explanation of these pressures, and in turn account for the experimental results. I begin with broader discussion of the prospects for each model described in the introduction to explain the results, which motivates the specific adoption of the maximize incremental well-formedness framework.

6.6.2 An evaluation of existing models

The finding that informs the central question of if and how prominence information is used predictively is the fact that proximate head nouns were associated with increased

looks towards the image where the referent of that noun is the agent, prior to direct evidence from voice marking about the argument structure of the clause. Unlike previous evidence put forward for a predictive role of prominence information (e.g. Wagers and Pendleton, 2016), it is not possible to interpret this effect as part of an integration or reanalysis process. Voice marking, which provides the critical disambiguating evidence of the relationship between obviation and argument structure, has not been reached, therefore any preferences that are encoded are necessarily predictive. In short, the finding makes it clear that whatever model of processing is adopted, there must be a role for immediate use of prominence-based information.

This finding rules out the classical version of the modular theory, where prominence information such as animacy, and by analogy, obviation, is not considered part of the syntactic information used to construct an initial parse. Instead, prominence information forms a part of the world-knowledge used in interpretation and reanalysis. That said, one can imagine a reformulation of the modular account that allows prominence information to inform initial parsing decisions. The basis for this move would be identical to that which drove the inclusion of this information in the early stages of processing in the eADM: Given that prominence information can provide hard grammatical constraints on the possible syntactic representations of a language, and parsing is a procedure to build these representations in real time, prominence information should factor into the initial parsing decisions. In many respects, the version of the maximize incremental well-formedness model that is put forward in the coming sections brings this extension to life.

It is currently difficult to evaluate the classic constraint-based model based on these findings alone, given the lack of corpus data on Ojibwe. That said, this model would predict that co-occurrence patterns should reveal a strong correlation between proximate nouns and agentive roles, leading to an early preference for associating the proximate argument with this role, which is then reflected in the gaze patterns. Some initial

production studies do seem to support this generalization. For example, the results of Christianson and Ferreira (2005) show a strong pattern of association between proximate and agent through the general preference for direct voice over inverse in regular transitive clauses. Matching this finding, Sullivan (2016a) found a strong preference for direct voice in regular transitive sentences using a picture elicitation task with a single speaker of Ojibwe. Finally, in the production pilot presented in the introduction, proximate was nearly always associated with direct voice in the formation of relative clauses in particular. That said, further work is needed to determine if these correlations are borne out in larger and more naturalistic samples.

However, even if these correlations *are* supported upon further investigation, the classic constraint-based model on its own leaves a deeper question unexplained: What is the *source* of the patterns of frequency that are ultimately used to build these associations? This question bites on a number of levels. Within a language, one must find an explanation for how a particular pattern of association might have arose diachronically. Across languages, one must explain the consistency, if not universality, with which certain patterns arise, and, perhaps even more importantly, provide an explanation for why certain patterns are *never* observed.

Indeed, various iterations of these questions have motivated the past 60 years of work within generative linguistics. These questions were also at the heart of understanding the wide, yet still limited, variation in prominence effects across agreement systems explored in Chapter 4, as well as the range of possible distinctions in person and obviation explored in Chapters 2 and 3. What unified all patterns reviewed in those chapters was obedience to the PAH. In this very basic sense, the PAH is universal: the possible person-based prominence patterns that *can* arise in natural language are exhausted by the possibilities defined by the PAH. While the previous chapters advocated for the view that the scale itself is derivative of something more basic — in particular, different sets of person, animacy, and obviation features, which are in turn made up of

sets of ontological person primitives — we do not need to take on those assumptions here. The PAH itself is descriptively adequate, in the sense of Chomsky (1965), in that it can be used to specify all and only the known degrees of variation of prominence effects in human language.

The PAH is thus well-suited to allow us make progress on understanding the universal constraints that underly language processing, and in turn to understand why the same patterns of argument structure processing crop up across a variety of languages, and with different types of prominence information. The eADM and the incremental well-formedness model, both of which make direct use of the PAH, are thus one step closer to arriving at an explanatory theory. Returning to the results of the current study, both make clear predictions that proximate nouns should be predictively associated with the agent role. From the perspective of the eADM, this occurs because proximate nouns are “prototypically” agentive, where the attributes that define prototypical agents are derived from the various prominence hierarchies, including the PAH. For the well-formedness model, an alignment of the obviation sub-hierarchy and thematic role hierarchy results in a prediction of proximate = agent being the most harmonic possibility given the input at that point.

In the next section, I detail the maximize incremental well-formedness model, showing how it can account for the full range of effects seen in the present experiment.

6.6.3 A maximize incremental well-formedness account

The framework for the maximize incremental well-formedness model comes from Wagers and Pendleton (2016) and Wagers et al. (2018). The formulation adopted here provides an account how the incremental optimization of movement dependencies captures filler-gap dependency processing in Ojibwe. The procedure is couched within a serial parsing model, where at each point the single most optimal parse is anticipated. However, given that data at hand one could equally couch the account within a parallel

parsing architecture, where the probability of the various possible parses is proportional to a well-formedness score.

6.6.3.1 A revised active filler strategy

The starting point of the incremental well-formedness model when applied to filler-gap dependencies amounts to the Active Filler Strategy. I propose the following formulation of the AFS:

(40) *The Revised Active Filler Strategy*

A filler predictively and incrementally extends a comprehender's syntactic representation to include a movement chain such that:

- a. The chain terminates in a theta-assigning position (an A-position)
- b. Each link *minimizes* distance
- c. Each link *maximizes* well-formedness

The main clause of (40) is the extension of the structure — the predictive component that is triggered by the recognition of a filler. I propose that this prediction builds a movement chain, as well as the phrase structure marker implied by that chain. The chain predictively links the filler to its anticipated base-generated A-position (40a), which is the position of thematic role assignment. For our current purposes, this is either the External Argument (EA) position, where the AGENT role is assigned, or Internal Argument (IA) position, where the PATIENT role is assigned. When such a chain is formed, the consequence is that the filler is assigned a thematic role. As a result, the initial thematic role assignment follows directly from parsing decisions, providing a direct linking theory between parsing and interpretation, which is fully consistent with the current representations of argument structure in formal theories (e.g. Harley, 2011).

That said, intermediate movement steps, or chain links, may be formulated along the way. Each chain and its links are subject to two optimization constraints. The first (40b) dictates that each link is as short as possible. The second (40c) dictates that each link must maximize well-formedness. One can imagine a number of possible theories of distance and well-formedness. The length of a dependency could, in principle, be defined or estimated by linear/temporal distance in a string (Lewis and Vasishth, 2005; Futrell, Levy, and Gibson, 2020), the number of open dependencies (Gibson, 1998, 2000; Warren and Gibson, 2002), or the number of intervening phrase structure nodes (O’Grady, 1997). The current proposal focuses on a version of the final possibility, but does not exclude the possibility that other factors may be broadly relevant to human language processing. Similarly, “well-formedness” could be replaced by *optimizing* on any number of dimensions, for example by minimizing surprisal (Hale, 2001; Levy, 2008), maximizing informativity (Hale, 2006), or maximizing harmony based on the weighted sum of constraint violations (Smolensky and Legendre, 2006). Again, it is the final possibility that is adopted here, as it allows for the inclusion of structural well-formedness constraints derived directly from the PAH.

6.6.3.2 Minimize Syntactic Distance



The first chain optimization principle is to minimize the length of the dependency, where length is determined by phrase structure distance. I posit that Syntactic Distance can be defined as follows, which is closely related to previous formulations including O’Grady (1997) and Hornstein (2009):

(41) *Definition of Syntactic Distance*

Given two linked syntactic positions X and Y, Syntactic Distance is the number of maximal projections (XPs) that dominate X but do not dominate Y.

For example, the syntactic distance between X and Y in the structure in (42a) is 2, as both ZP and YP dominate Y, but not X, while the distance between X and Y in (42b) is 3. Therefore all else being equal, (42a) will be preferred over (42b).

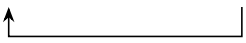
(42) ***Shorter chains are preferred over longer chains***

- a. $[_{XP} X \dots [_{ZP} \dots [_{YP} \dots Y]]]$

- b. $[_{XP} X \dots [_{ZP} \dots [_{WP} \dots [_{YP} \dots Y]]]]$

Minimization of this sort can be seen as following from general economy principles that seek to limit the use of memory resources whenever possible. This guides both the AFS and principles like Minimal Attachment (Frazier and Fodor, 1978; Frazier, 1987). For the current formulation of the AFS, the goal is to minimize the number of XPs intervening between two linked syntactic objects; for Minimal Attachment, the goal is to minimize the number of XPs posited overall.

A further aspect is that not all chains from X to Y are made equal. For example, the chain in (43a) includes an intermediate link at position W, while the chain in (43b) lacks this link in the chain.

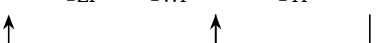
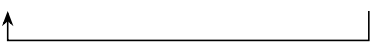
(43) ***Multiple short links are preferred over one long chain***

- a. $[_{XP} X \dots [_{ZP} \dots [_{WP} W \dots [_{YP} \dots Y]]]]$

- b. $[_{XP} X \dots [_{ZP} \dots [_{WP} W \dots [_{YP} \dots Y]]]]$

The hypothesis, which follows from the current formulation of distance as minimizing the distance of links rather than entire chains, is that (43a) is more minimal than (43b), as each link of (43a) is shorter than that on (43b). Assuming that both of these chains

are equally well-formed, and given that both terminate their chains in the same position and therefore assign the same thematic role, the chain that will be preferred is the one with multiple intermediate links rather than a single long link.

This derives a preference for chains with intermediate movement steps between the displaced position of the argument and the final argument position. More immediately, this derives a general *Subject Gap Advantage*. As schematized in (44a), having an intermediate landing side in the subject position of Spec,IP breaks up a chain compared to the equivalent counterpart that lacks such a step (44b). Given the principles sketched above, and all else being equal, the chain in (44a), which contains a subject gap, will always be preferred over one that lacks a subject gap such as (44b).

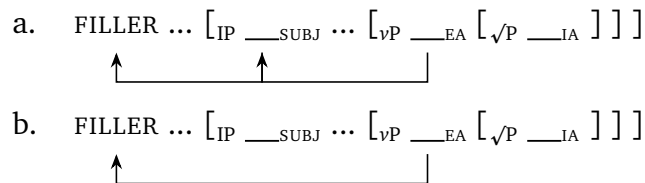
(44) *The Subject Gap Preference*



Furthermore, the minimization of syntactic distance can derive the preference to assign the AGENT thematic role first. This follows from the fact that the EA position, where this role is assigned, is less deeply embedded in the phrase structure compared to the IA position. Therefore from any particular syntactic position, a chain that terminates in the EA position (45a) will *always* be more minimal than one that terminates in the IA position (45b) by a syntactic distance unit of 1, as √P dominates the IA position but not the EA position.

(45) *The Agent-First Preference*

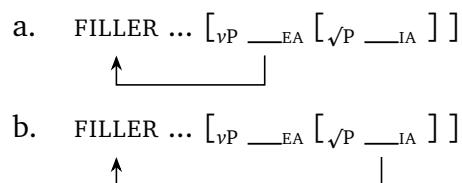

6.6.3.3 Maximize Well-Formedness

The second aspect of chain optimization is to maximize structural well-formedness. I posit that well-formedness is determined by comparing the *Harmony* scores of the possible structures consistent with the input at the point the filler is initially encountered. Harmony is defined by the linear equation in (46), where each constraint C_k ($k = 1 \dots K$) is associated with a weight w_k , and each candidate (i.e. possible parse) has a violation score s_k on that constraint. Harmony (H) is the sum of the the weight multiplied by the violation score for each constraint.

(46) *Definition of Harmony (Smolensky and Legendre, 2006)*

$$H = \sum_{k=1}^K s_k w_k$$

There are two critical questions: (i) what the set of constraints is that are used to determine Harmony? And (ii) what are the weights for each constraint? These questions are discussed in the next two sections.

6.6.3.4 Scales and constraints

This section describes the scales and constraints that are needed to account for the role of person, animacy, and obviation in the processing of filler-gap dependencies. The first, which has already been presented at length, is the PAH, repeated in (47) along with the implied Animacy and Obviation Sub-Hierarchies.

(47) *Person-Animacy Hierarchy (repeated)*

1/2 (LOCAL) > 3 (PROXIMATE) > 3' (OBVIATIVE) > 0 (INANIMATE)

a. *Animacy Sub-Hierarchy*: 3/3' (ANIMATE) > 0 (INANIMATE)

b. *Obviation Sub-Hierarchy*: 3 (PROXIMATE) > 3' (OBVIATIVE)

Given the hypothesis that there is a one-to-one relationship between thematic roles and syntactic position, either the *Thematic Role Hierarchy* in (48a) or the *Argument Position Hierarchy* in (48b) could in principle be used to capture the rankings related to argument structure. Given that the current theory has been framed in terms of parsing, and (48b) provides a ranking in terms of the phrase structure representation, I adopt the Argument Position Hierarchy moving forward.

(48) ***Two equivalent Argument Structure Hierarchies***

- a. *Thematic Role Hierarchy*: AGENT > PATIENT
- b. *Argument Position Hierarchy*: EA > IA

Finally, there is a constraint which ranks the derived subject position, in this case Spec,IP, above any position which it dominates — these are the non-subject positions.

(49) ***Derived Position Hierarchy***

SUBJ > NON-SUBJ

Both the Argument Position and the Derived Position Hierarchies are specific cases of a General Syntactic Position Hierarchy that ranks higher syntactic positions over lower syntactic positions, given in (50).

(50) ***General Syntactic Position Hierarchy***

HIGHER > LOWER

That is, a given position X is ranked higher on the scale than all positions that are dominated by the maximal projection that contains X.

For the present discussion, I restrict consideration to the constraints that are immediately relevant to account for the patterns of Ojibwe. These constraints can be derived by the Harmonic Alignment (see Section 6.2.5) of the Obviation Sub-Hierarchy with

the Argument and Derived Position Hierarchies. The derived constraints are given in (51):

(51) a. *Alignment of Argument Position and Obviation Hierarchies*

*EA/OBV \gg *EA/PROX

*IA/PROX \gg *IA/OBV

b. *Alignment of Derived Position and Obviation Hierarchies*

*SUBJ/OBV \gg *SUBJ/PROX

*NON-SUBJ/PROX \gg *NON-SUBJ/OBV

The constraints in (51a) prefer a movement chain that places a proximate filler in the EA position, assigning it the AGENT role, and an obviative filler in the IA position, assigning it the PATIENT role. This derives the *Proximate/Agent Preference* as a soft constraint. The constraints in (51b) prefer a movement chain that places a proximate filler in the subject position and an obviative filler in a non-subject position, where again non-subject position is defined as any position lower in the phrase structure hierarchy than Spec,IP. This ultimately enforces the *hard* grammatical constraint in Ojibwe where proximate arguments always occupy the derived subject position.

6.6.3.5 Setting weights: A role for experience

The earlier discussion of the classic constraint-based model did not reject a role for learning and experience. Rather, it demanded a linking theory between linguistic experience, learning, and the online processing behavior observed in adults; in particular, a linking theory that recognizes the universal nature of PAH effects across all human languages. To reiterate a critical point that is too often misunderstood, universality in this case refers to the fact that the PAH is sufficient to *describe* all and only the possible person-based prominence effects in human language. It is therefore not *necessarily* a claim about what, if anything, is endowed by Universal Grammar. The previous section

showed that the relevant well-formedness constraints can be derived from the Harmonic Alignment of the PAH with two Syntactic Position Hierarchies — the Argument and Derived Position Hierarchies. In this section I spell out a linking theory between linguistic experience and language processing based in the weighting of these universal constraints.

Harmonic Alignment provides a relative ranking between the constraints, as indicated by “ \gg ”, but the particular influence of a given constraint on the Harmony or well-formedness of a structure is fine-tuned by their weights. A hypothesis that follows from Harmonic Alignment, for example, is that *all* languages with a proximate-obviative distinction will at least prefer the proximate argument to occupy the derived subject position, even if it does not go as far as Ojibwe in requiring this to be the case. To briefly bring in English as a point of reference, this type of soft constraint is reflected in the fact that animate nouns are preferred as subjects compared to inanimate nouns, but are not grammatically required to occupy that position. For the current purposes, the difference between hard and soft constraints can fall on a continuum defined by the relative weights of the constraints.

The constraint weights, and perhaps even the constraints themselves, are posited to be learned over the course of acquisition based on the primary input. There is a great deal of work of learning in the wider literature on Harmonic Grammar and Optimality Theory (for a review and discussion, see Pater, 2009). The basic contour assumed here is that the weight of a constraint is at least partially a function of frequency and other distributional information, for example via a Maximum Entropy model (e.g. Goldwater and Johnson, 2003). This has the potential to provide a deep link to the broadly connectionist framework that the classic constraint-based model is based in.

Again given the lack of suitable corpus data for Ojibwe, I simply stipulate the relative weights of the various constraints based on the observed processing patterns. For now, it is sufficient to say that hard constraints such as those derived from the Derived

preferential looking patterns in the ambiguous region, and a parse consistent with (52a) is adopted. The second point of interest is when voice marking is reached. In direct voice conditions, where the prediction aligns with the actual structure, integration proceeds smoothly resulting in high accuracy. In the inverse voice conditions, this triggers a reanalysis process such that the parse in (52b) must be adopted. In some proportion of cases, this process is not successful, leading to lower accuracy in the form of more erroneous agent image responses.

Moving along, the schematization of the obviative head noun conditions are repeated in (53).

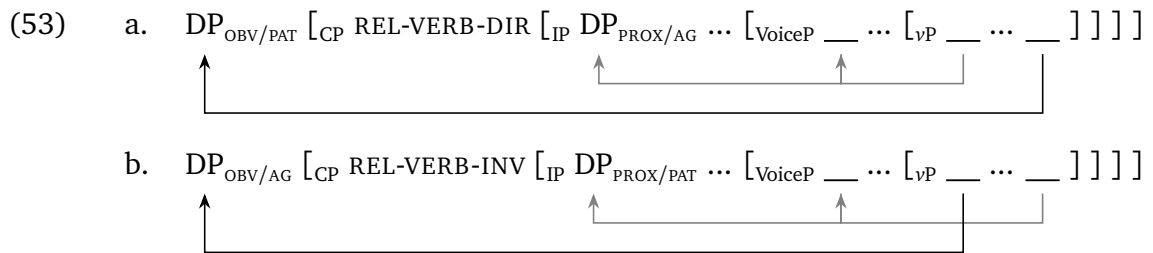

The first point of consideration is immediately after the head noun and obviation has been encoded. In this case, the high weighting of the Derived Position constraints ensures that obviative fillers will never be predicted to form a gap in the subject position. This comes at the cost of making a longer and more costly chain, which ultimately has the general effect of making accuracy lower in these conditions compared to their proximate counterparts.⁴ Obviative fillers are associated with an inherent tension between (i) minimizing dependency length by terminating the chain in the EA position and assigning the AGENT role, a preference that is independent of prominence information; and (ii) avoiding a violation of the Argument Position constraints that prefers obviative arguments to terminate in the IA position and be assigned PATIENT. These conflicting

⁴In addition, the proximate argument is also posited to undergo movement to the subject position in these conditions. The hypothesized presence of two movement chains in these conditions makes these costs even higher.

preferences account for the lack of predictive encoding of thematic roles in the obviative conditions as measured by looking patterns. When voice marking is reached, the patterns of accuracy ultimately revealed a bias towards assigning the agent role to the obviative filler. This can be accounted for by appealing to the fact that, of the two possible chains formed with an obviative filler, resolving the dependency into the EA position is less costly than the IA position. In other words, it is a reflection of the preference to form the most minimal dependency and adopt the parse in (53b). This comes at the cost of violating the Argument Position constraint, which would be satisfied by the parse in (53a), and results in lower accuracy in the direct compared to the inverse conditions.

That said, there is an apparent paradox with obviative head nouns given the *lack* of agent preference in the looking patterns, but the strong agent preference in the response patterns. At present, only a tentative analysis of this tension can be provided. I hypothesize that the finding can be attributed the increased load on memory when forming this long dependency, leading to the prominence information of the filler to be degraded. Given that the chain length advantage of an EA gap is independent of prominence information, the parse that would be most likely to be well-formed under uncertainty about prominence information would be the one with the shortest chain. This results in the takeover of the preference to minimize dependency length, such that an open filler-gap dependency terminates in the EA position, resulting in the assignment of the agent role to the filler. I further hypothesize that this preference takes over once the parser is triggered by voice marking to integrate the open filler into an argument structure position, accounting for the lack of effect in the predictive measures, but the strong effect in end-of-sentence interpretations.

6.6.4 The consequences of incremental prediction

Zooming out, the major difference between proximate and obviative conditions is that with the proximate conditions, all constraints can be obeyed by a parse where the chain

terminates in the EA position. This contrasts with the obviative conditions where there is no single parse that allows all constraints to be satisfied. The parse with a shorter chain (53b) terminates the dependency in the EA position, resulting in a violation of the Argument Position constraints, while the parse that satisfies the Argument Position constraints results in a longer chain (53a). This conditions provides a particularly rich ground for understanding the nature of incremental prediction and its downstream consequences.

The account proposed in the previous section hypothesized that these conflicting constraints can explain the lack of prediction in the obviative conditions. This could be due from a number of sources. One possibility is that the conflict leads the parser to abandon the active filler strategy entirely, adopting a *wait-and-see* approach, leading to a lack of predictive encoding of the thematic role, with looks varying randomly between the two possible images. Another possibility is that both of the parses in (53) are activated over the course of the ambiguous region, and within a given trial participants are entertaining both to an equal degree, with looks reflecting this competition by being split with each trial. This would be a *parallel* parsing approach. Finally, it is possible that on each given trial, stochastic noise or item-by-item variation allows one or the other parses to “win out”. On average, this leads to the appearance of a wash-out, even though a specific predictive encoding is adopted on each trial. This would be a *serial* parsing approach.

In principle, it should be possible to decide between the *wait-and-see* and *parallel* approaches on one hand, which predict that within a given trial looks should be split evenly between the two role-reversed images, and the *serial* parsing approach, where looks on each trial should coalesce towards a single image depending on which parse wins out. Given the relatively small sample size both in terms of number of subjects ($N = 16$) and the number of items ($n = 8$ per condition), any answer to this question based on the current results must remain preliminary. That said, one test of this

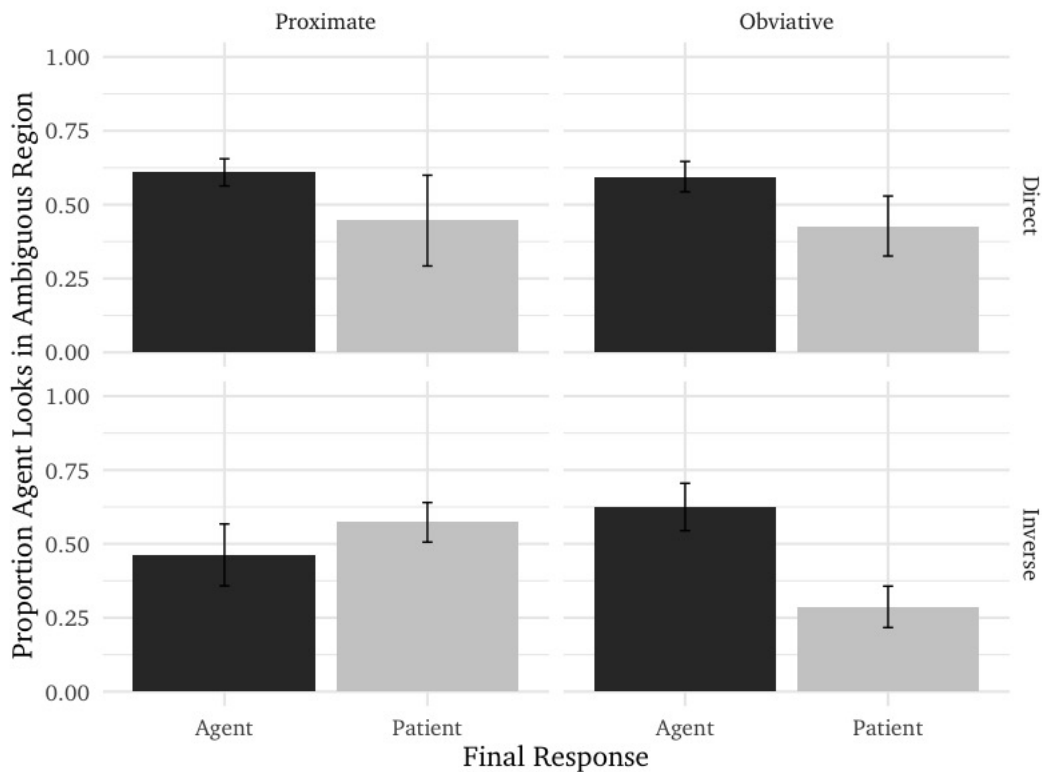

Figure 6.8: Average look proportions towards agent image in the ambiguous region split by condition and the ultimate response.

hypothesis is to examine whether there is a relationship between the looking behavior in the ambiguous region and the ultimate response. On the *serial* parsing account, there should be a relationship such that predictive looks towards a particular image should lead to more responses consistent with that initial encoding, whether correct or incorrect. On the other hand, the *wait-and-see* and *parallel* accounts do not predict any relationship between looking behavior in the ambiguous region and the ultimate response.

The graph in Figure 6.8 shows the breakdown of how the proportion of looks towards the agent image differs as a function of head noun and the ultimate response. Recall that there are three images total, making chance looks approximately 33%. In the proximate conditions, and consistent with all findings so far, the proportion of looks towards the agent image hovers around 50%, regardless of the ultimate response. In

contrast, in the obviative conditions the proportions appear to vary as a function of ultimate response, with higher proportions of agent looks when the response was agent, and a lower proportion when the response was the patient image.

The question is therefore whether image choice can be predicted from looking behavior. To provide a test of the hypothesis, the overall look proportion towards the agent image on each trial for each participant was used as a continuous predictor in a logistic regression on image choice. Image choice was coded as a binary variable such that selection of the agent image was 1 and all other selections were zero. Given that the relationship is only predicted in the obviative head noun conditions, separate models were run on the proximate and obviative conditions. As expected the effect of look proportions did not reach significance in the proximate conditions ($z = -0.55$, $p = 0.799$), but did in the obviative conditions ($z = 2.346$, $p = 0.019$). An analogous test that instead tested the effect of proportion of patient looks with image choice coded such that the patient choice was 1 and all others zero did not reach significance in either the proximate conditions ($z = -1.154$, $p = 0.249$) or obviative conditions ($z = 1.412$, $p = 0.158$).

The significant effect reported above provides preliminary evidence in favor of the hypothesis that there are indeed competing constraints with obviative fillers. Moreover, in these conditions, the initial prediction engendered at the filler, prior to bottom-up evidence of the thematic structure, is difficult to overcome, leading to a relationship between predictive looks and final response. One goal of future work should be to provide a more direct test of the hypothesis that this effect is indeed the result of competing constraints, rather than a failure to predict with lower prominence fillers such as obviatives and inanimates.

6.6.5 The return of the modular parser

The maximize incremental well-formedness model put forward in the previous section is a syntax-first model. In particular, the formulation of a parse is hypothesized to precede the formulation of an interpretation. Put another way, the model recognizes that syntactic structures provide the road map for interpretation, and furthermore that the possible representations at each incremental point not only obeys, but optimizes based on, the constraints imposed by the grammar. While there is a role for experience-based knowledge, and world-knowledge more generally, these types of knowledge do not form the core of the human language processing faculty on the proposed theory. In this way, the account can be seen as a direct descendent of the classic modular model, which made a cut between information used to inform the formulation of a parse and that used to interpret, evaluate, and potentially revise the adopted syntactic representation.

One of the major differences between the current theory and the eADM is in the representation of argument structure. The eADM posits that thematic role assignment occurs prior to the linking of arguments to their structural positions. By adopting a theory where thematic roles are associated one-to-one with syntactic positions, the assignment of thematic roles on the current theory follows from general parsing principles. In particular, this allows the preference for shorter dependencies to give rise to the Agent-First Preference, given that the position where the agent role is assigned is higher than all other theta-assigning positions. There is no need to posit an independent mechanism for thematic role assignment above and beyond those necessary for interpreting structures more generally.

The major innovation from the classic modular model is the inclusion of prominence-based information in the formulation of an initial parse. Like the eADM, this is motivated by the fact that such information is used to restrict the possible syntactic representations seen across languages of the world. Given that the PAH describes all and only the possible range of person-based prominence effects, this scale provides a valid basis

for the formulation of general constraints for the processing of prominence information across all languages. The differences between languages falls to the weighting of constraints, and the weighting of constraints is determined by the input to the learner. At one extreme, the constraints can effectively block particular parses from ever arising, hemming in the possibilities. In the middle, constraints can be weighted to lead to preferences that can be readily overridden. At the other extreme, a language may show no evidence or extremely limited evidence for a particular constraint. In all cases, the question that underlies each parsing decision is *which structure is most likely to be well-formed given the currently available information?*

In this way, the account recognizes a central role for distributional and experience-based information in learning, as posited by the classic constraint-based model. However, rather than appealing to a representation of co-occurrence frequencies as the source of language processing behaviors, this information serves to set the parameters that determine the well-formedness within a given language. I leave open the question of whether the PAH and the derived constraints can be deduced from the primary input, or whether it is necessary to specify this as part of the initial state of a learner. In either case, the universality of prominence effects demands an explanation. By employing the PAH directly, the present account meets these demands.

6.6.6 The nature of obviation (in processing)

The current study is the third experimental investigation of an Algonquian language. The goal of this section is to explore connections to previous work by Christianson and Ferreira (2005) and Christianson and Cho (2009), who studied the closely related Eastern dialect of Ojibwe *Odawa*.

Obviation is multifaceted. The category of proximate is associated with a constellation of closely related semantic and syntactic properties: (i) it occupies the subject position, (ii) it undergoes agreement with Infl, (iii) it is most harmonically aligned with

the external argument position and agent thematic role, (iv) it is the most “discourse prominent” third person if there are multiple third persons, and (v) it is the *default* role if there is only a single third person. All of these properties can be tied to the relative prominence ranking between the proximate and obviative categories, as described by the PAH, where aligning the proximate argument with the more important role or position is preferred or required.

Throughout this dissertation, the focus has been on understanding the *syntactic* effects of obviation once the roles have been assigned. Very little focus has been given to understanding why *particular* referents are elevated the role of proximate or relegated to obviative. The referent for the proximate role itself is generally determined by the discourse context. When there is a choice (i.e. multiple animate third persons in the discourse) the more “topical” referent or the referent whose “point-of-view” is being taken takes the proximate role. That said, in the literature on obviation, the notions of “centrality”, “topicality”, “point-of-view”, and “givenness” often end up being interchangeable catchalls for whatever discourse property(ies) obviation can be associated with, rather than precise properties that correspond to independent primitives of the discourse representation. It is clear that these properties are crucial in some way, but the particular nature of how they relate to obviation is yet to be fully elucidated.

The major finding of Christianson and Cho (2009) was that sentences with *pro*-dropped proximate arguments were easier to interpret than those with dropped obviative arguments. The authors interpret this finding as evidence that the more *topical* arguments are easier to recover than non-topical arguments, where relative topicality can be ascertained by ranking on the PAH, with higher ranked arguments being optimally aligned with the topic role. This finding is also congruent with Christianson and Ferreira (2005), who show that production preferences that placed proximate argument before obviative ones, and put the more “topical” argument in the proximate

role. This too can be readily described by appealing to the interaction of the PAH with other grammatical and discourse properties.

The PAH therefore broadly provides the means to connect the current account with previous work: the formation of chains (as explored in the present work), the production of the interpretation of *pro* (Christianson and Cho, 2009), and the production of word order and voice marking (Christianson and Ferreira, 2005) are all guided by prominence relations in some sense. A goal of future work is to more clearly spell-out the discourse representations that underly obviation, and draw out the connections between the syntactic and discourse representation. This line of work is sure to reveal even deeper relationships between the three studies, and in the real-time processing of syntax and discourse representations, than can be seen at this point in time.

6.6.7 Further extensions

In this section, I consider some additional applications of the maximize incremental well-formedness model and the Revised Active Filler Strategy. There are two basic types of extensions that I consider. The first is how well-formedness constraints are expected to affect syntactic processing more generally, outside of the formation of movement dependencies. The second is understanding the predictions of the account for other instances of filler-gap dependencies and different types of prominence relationships.

To briefly step back and take stock, the focus of the proposed Revised Active Filler Strategy is on the formation of the representation that underlies syntactic displacement. The fundamental push and pull proposed within the account is between the pressure to make the shortest dependencies possible and the pressure to construct well-formed dependencies. In the case of more prominent proximate or animate fillers, these pressures always align. As a result, the patterns observed in these conditions alone do not provide direct evidence that both types of pressures are needed — either one alone could be sufficient. The conflict occurs, and the evidence emerges, with the less prominent

obviative or inanimate fillers. If *only* the minimal dependency preference were active in determining initial parsing decisions, we would expect there to be a strong agent (and subject gap) preference. If only the well-formedness conditions were active, we would expect a strong patient preference. These are not the observed patterns with either animacy (e.g. Wagers and Pendleton, 2016) or obviation (the present study).

Despite this focus, the principles are not intended to be specific to understanding the comprehension of movement chains. First, the chain/link minimization preference, which prefers a parse with the smallest number of XPs between two linked positions, can be tied together with other parsing principles such as Minimal Attachment, which prefers a parse with the smallest number of XPs in general. These in turn can be based in the preference to conserve limited memory resources when possible (e.g. Frazier, 1979). From this point of view, the minimization preference permeates parsing well beyond the creation of chains and into the formation of the base-generated phrase structure.

Second, the well-formedness conditions are general constraints on the formation of the syntactic representation. We should therefore expect them to shape parsing preferences in a wide variety of constructions. To this end, one important prediction of the account is that there should be a *general* relationship between syntactic height and ranking on the PAH such that higher ranked categories are preferred in higher structural positions. Somewhat simplified versions of these constraints, which are adopted for the discussion in this section, are given in (54).

- (54) *Alignment of the PAH and General Syntactic Position Hierarchy*
 *LOCAL/LOWER >> *ANIMATE/LOWER >> *INANIMATE/LOWER
 *HIGHER/INANIMATE >> *HIGHER/ANIMATE >> *HIGHER/LOCAL

These constraints are derived by the harmonic alignment of the scales in (55) and (56).

(55) *Person-Animacy Hierarchy (simplified)*

LOCAL > ANIMATE > INANIMATE

(56) *General Syntactic Position Hierarchy*

HIGHER > LOWER

As detailed above, in filler-gap dependencies, the emergence of these types of well-formedness effects can be attenuated by the preference to minimize the length of syntactic dependencies. However, outside of movement dependencies, where the pressure to create minimal links is irrelevant, this preference should be observed whenever there are multiple argument positions within a clause that differ in height. This is one of the predictions explored over the course of this section.

Finally, the focus of the present work has been on how PAH-based well-formedness conditions impact incremental parsing decisions; and even more particularly, on how obviation and animacy impact parsing. However, the relatively narrow focus should not be taken to indicate that these are the only constraints on well-formedness. Borrowing from the eADM, conditions based in case and definiteness should also be expected. Another goal of this section is to consider a few critical extended predictions of the model, including how well-formedness constraints from case marking and the local persons can impact incremental processing.

6.6.7.1 Ditransitives and animacy in English

One of the earliest studies of prominence effect by Bock and Warren (1985) speaks to a possible extension of the account beyond the immediate data at hand. Bock and Warren examined accuracy in recall of declarative sentences alternating between active (57a) and passive (57b), dative constructions alternating between prepositional dative (57c) and double object dative (57d) forms, and phrasal conjuncts alternating between ‘natural’ (57e) and ‘unnatural’ (57f) orders. The items were constructed such that each

pair differed in whether the more prominent argument, as measured by ‘imageability’, was ‘early’ or ‘late’. In the declarative and dative constructions, the early position corresponded to a structurally higher position, while the phrasal conjunction construction alternated early and late based on linear order within the conjunct.

(57) *Example stimuli from Bock and Warren (1985)*

- | | | |
|----|---|-----------------------|
| a. | The doctor administered the shock. | <i>Active/Early</i> |
| b. | The shock was administered by the doctor. | <i>Passive/Late</i> |
| c. | The old hermit left the property to the university. | <i>PD/Early</i> |
| d. | The old hermit left the university the property. | <i>DO/Late</i> |
| e. | The lost hiker fought winter and time. | <i>Conjunct/Early</i> |
| f. | The lost hiker fought time and winter. | <i>Conjunct/Late</i> |

Participants listened to sentences of the form above, performed a short digit-recall task, then were asked to recall the original sentence by writing in a booklet. Bock and Warren measured the number of ‘inversions’ in each sentence structure depending on whether the more prominent argument was early or late. For example, an inversion would be counted if participants recalled a passive sentence as active, or vice versa. They found that participants were significantly more likely to invert declarative and dative constructions when the more prominent argument was *late* in the target sentence. In the declarative conditions, when the more imageable argument was late, inversions occurred around 30% of the time compared to 15% when it was early. In dative conditions, inversions in the late conditions were around 30% and the early conditions around 20%. In contrast, in both late and early conditions in the conjunct construction there was a low numbers of inversions (less than 10% of trials).

The results were argued to show that there is a tight linking between the prominence of a given noun in memory and the hierarchy of grammatical relations in (58), which

was originally proposed by Keenan and Comrie (1977) to account for cross-linguistic extraction asymmetries in relative clauses.

(58) *Accessibility Hierarchy (Keenan and Comrie, 1977)*

Subject > Direct Object > Indirect Object > Genitive > Comparative Object

In short, subjects mis-recalled sentences in a way that increased the congruence (i.e. harmony) between prominence and structural position — a more prominent argument that was in a structural position lower on the hierarchy in the target sentence was frequently placed in a position higher on the hierarchy upon recall. The results cannot be reduced to linear order preferences, as no effect of early versus late was found in the phrasal conjunction constructions, where both alternating positions are on equal footing with respect to the accessibility hierarchy.

These results can be reinterpreted in terms of the current well-formedness constraints. The dative alternation is particularly interesting, as the alternation between the *prepositional dative* (PD) and *double object dative* (DO) does not turn on a movement-based transformation, as is the case for the passive. While there is significant debate about the particular structures that underly these constructions (e.g. Harley, 1997, 2002; Bruening, 2001, 2010), there is a general consensus that the GOAL/RECIPIENT position is structurally higher than the THEME position in the DO, and the THEME position is higher than the GOAL position in the PD. A severely abstract structure for the alternation, which only assumes these height relationships without claiming the identity of the projections, is given in (59).

- (59) a. The woman (AGENT) sent [the man (GOAL) [the letter (THEME)]]
b. The woman (AGENT) sent [the letter (THEME) [to the man (GOAL)]]

Given that there is a mismatch in the prominence such that, for example, the GOAL is higher ranked on the PAH than the THEME, then the well-formedness conditions dictate that a preference for the DO structure over the PD structure should emerge. This is exactly what was found by Bock and Warren. This provides some preliminary evidence that the proposed well-formedness constraints provide general conditions on parsing commitments rather than being restricted to filler-gap dependencies alone.

One important avenue for future work is to provide a more direct test of the hypothesized interaction between well-formedness conditions and chain minimization preferences. In particular, when there is no chain formation in play, minimization should not play a role, and incremental well-formedness preferences should dominate. When a chain is added to the structure, the potential for conflict between pressures should arise. My intention here is to outline what a test of this hypothesis might look like.

The example sentences in (60) cross two factors: whether the THEME argument of the ditransitive verb is animate (*messenger*) or inanimate (*message*), and whether the THEME is in situ or moved. The proposed method is the forced-choice pseudo-production task introduced by Staub (2009), where participants are presented the beginning of a sentence word-by-word, and are then asked to choose between two possible completions by pressing a button. In the examples below, the portion of the sentences outside of the curly braces would be presented word-by-word, with participants choosing between the two possible completions within the curly braces (minus the visible “gap”), which correspond to either a PD or DO structure.

(60) *Extension 1: In situ versus moved arguments and the PD/DO contrast*

- a. The woman sent {the messenger to the man | the man the messenger}
- b. The woman sent {the message to the man | the man the message }
- c. ... the messenger who the woman sent { __ to the man | the man __ }
- d. ... the message that the woman sent { __ to the man | the man __ }

The hypothesis is that completions in the in situ conditions should be influenced by well-formedness conditions alone, while completions in the moved conditions should be additionally influenced by minimization pressures. This will play out specifically in the inanimate theme conditions. In the in situ inanimate theme conditions, there should be a preference for the DO completion, as this places the animate goal in a higher structural position. In the moved inanimate theme conditions, the preference for the DO completion should be reduced due to the competing pressure to make a more minimal dependency by selecting the PD frame. In the in situ animate condition there should be no preference between the two frames, as both arguments are equal in animacy. (Or, if there is a bias for one structure or another based on some third factor, this condition will reveal the direction of that potentially confounding preference). Finally, in the moved animate condition, minimization should take over, favoring the PD frame.

6.6.7.2 Voice and animacy in English

Building from the discussion of Bock and Warren (1985), as well as the method and design of the current study on Ojibwe, it is pertinent to consider whether the effect of obviation and direct/inverse voice can be (conceptually) replicated in English with animacy and active/passive voice. The example sentences in (61) fully cross three factors with two levels each: head noun ANIMACY (animate versus inanimate), the THEMATIC ROLE of the head noun (agent versus patient), and the VOICE of the clause (active versus passive). Given the word order cues in English that are not present in Ojibwe, all examples include a parenthetical phrase between the head noun and the embedded clause to create an extended period of ambiguity. All sentences would begin with the instructive carrier phrase *choose the picture with...*

(61) *Extension 2: Animacy, Voice, and Thematic Role*

- a. ... the man who, from what you can tell, ___ is hitting the ball.

- b. ...the man who, from what you can tell, the ball is being hit by ___.
- c. ...the man who, from what you can tell, the ball is hitting ___.
- d. ...the man who, from what you can tell, ___ is being hit by the ball.
- e. ...the ball that, from what you can tell, ___ is hitting the man.
- f. ...the ball that, from what you can tell, the man is being hit by ___.
- g. ...the ball that, from what you can tell, the man is hitting ___.
- h. ...the ball that, from what you can tell, ___ is being hit by the man.

Again following the method presented in the main experiment, the sentences would be presented auditorily, with the task being to select among a series of images the one that is congruent with the meaning of the sentence. The critical measures would be the patterns of anticipatory looks towards the “head = agent” or “head = patient” images, and accuracy on the picture selection task.

The main hypothesis for the anticipatory looks is that the animate head conditions (like the proximate head conditions) should be associated with more looks towards the agent images, while inanimate head conditions (like the obviative head conditions) should on average show no preference. One benefit of this study is that a much higher number of items and participants should be available, with tighter controls over factors such as frequency and plausibility than was possible in the study of Ojibwe. The higher number of items and subjects in particular could help tease apart questions such as whether a serial or parallel account of the competition in the inanimate head conditions is more appropriate.

The hypotheses for picture selection accuracy are more complex. There are at least four pressures that will be in competition. Two are based purely on chain minimization: (i) a general preference for subject gaps (i.e. to form an intermediate chain link), and (ii) a general preference of the head noun to be the agent (i.e. for the chain to terminate at the EA position). Two are based on well-formedness constraints: (iii) a preference

for the animate argument to be the agent (i.e. an alignment of the EA position and the animate argument), and (iv) a preference for the animate argument to occupy the subject position (i.e. an alignment of the subject position and the animate argument).

The design allows for these factors to be isolated and interact. Only the condition in (61a) allows every pressure to be satisfied by aligning the animate head noun with the subject and EA positions. All others provide one violation or another. Focusing on the animate conditions, (61b) associates the animate filler with a non-subject position, (61c) associates the animate filler a patient in a non-subject position, and (61d) results in the animate filler being a patient (61d). Of these four, (61c) should be the most difficult as both proposed alignments are violated; whether the violation of the animate/subject alignment in (61b) or the animate/agent alignment in (61d) is more disruptive, or whether they are equally dispreferred, is an open question.

As with the obviative head nouns in Ojibwe, all of the inanimate conditions violate one preference or another. This is the result of the fundamental clash between the general preference for minimal chains by creating an intermediate link in the subject position, and the preference for animate arguments to fill the subject position (or inanimate arguments to be in a non-subject position). In (61e), both the animate/subject and animate/EA alignments are violated; in (61f) the animate/agent alignment and subject gap preference is violated; in (61g) the subject gap and agent-first preferences are violated; in (61h) the agent-first preference and the animate/subject preference is violated. Given that nearly everything in these conditions relies on the interaction of constraints, the results will inform how much weight should be given to each constraint. This should be done by implementing a formal model that can derive these constraint weights from the experimental results and evaluate the fit of various models that include/lack various pressures.

6.6.7.3 Ergativity and the Subject Gap Advantage

In this section I consider evidence from filler-gap processing in (split)-ergative languages. A wide range of languages with ergative case and/or agreement patterns have been studied including Basque (Carreiras, Duñabeitia, Vergara, De La Cruz-Pavía, and Laka, 2010), Avar (Polinsky, Gallo, Graff, and Kravtchenko, 2012), Q’anjob’al (Clemens, Coon, Pedro, Morgan, Polinsky, Tandet, and Wagers, 2015), Chamorro (Wagers et al., 2018), Niuean (Tollan, Massam, and Heller, 2019), and Tongan (Ono, Otaki, Sato, Veá, Otsuka, Koizumi, et al., 2020). These results provide a challenge for the claim that dependency minimization universally underlies the predictive formation of movement chains by generally questioning the universality of the Subject Gap Advantage.

Indeed, the existence of the Subject Gap Advantage is more vexed than I have let on so far. In particular, there is much debate centering around whether or not it is universally attested in all languages. This debate is broadly relevant here as the Minimal Dependency Preference, and by extension the SGA, are posited to be borne of a universal processing pressure that prefers shorter movement chains. Therefore from one angle, it appears that the account makes the rather strong (and misguided) claim that the SGA should be universal.

That said, the very question of whether the SGA is universal is ill-formed in at least two ways. First, as stated previously, there is no single property that defines a “subject” in all languages (McCloskey, 1997). If there is no universal and independent notion of subjecthood within our linguistic representation, then the idea of a universal Subject Gap Advantage in processing is at worst nonsensical, and at best non-homogenous.

Second, the SGA, as it is formulated in this chapter, is an often observed pattern of behavior rather than a mental constraint on parsing. The parsing constraint that leads to the SGA is chain minimization. If we take on a definition of subject as the syntactically highest argument position in the clause, as has been done here, then the question we *should* be asking is whether there is a universal preference for syntactic dependency

minimization. Similarly, if we define the subject as the most agentive argument in the clause (e.g. Tollan, 2020), the empirical question becomes about the universal emergence of the Agent-First Preference. This too is a surface pattern that is hypothesized to be derived by the pressure to minimize chain length, given that the agent role is assigned in a higher structural position than the patient role.

That said, as noted now a number of times, the emergence of minimization pressures in observed behavioral preferences can be obscured by other factors such as well-formedness conditions. When these other factors end up advantaging a non-minimal dependency, it is possible for minimization effects to disappear. In the most extreme case, if these competing constraints are strong enough, the advantage could even be imagined to reverse. Such a reversal would not falsify the theory that there is a general preference for minimal dependencies. It simply shows that there are other, sometimes stronger, pressures that guide our incremental parsing commitments.

Briefly before moving forward, a posited example of this in Ojibwe can be found in the proposal that obviative arguments are grammatically blocked from forming syntactic subject gaps. Therefore, while forming a chain with an intermediate link in this position would be the more minimal option, it is blocked by the well-formedness conditions imposed by the grammar.

With all of this in mind, I consider the results and claims of Tollan et al. (2019), who examine the processing of *wh*-movement dependencies in Niuean, a Polynesian language of the South Pacific with a split-ergative case system. Their study is among the most recent to examine the effects of ergativity, and was in part the methodological inspiration for the current study on Ojibwe.

There are three different case alignments in Niuean, which vary as a function of the particular verb — for convenience and consistency with the terminology of Tollan et al., I refer to the more agentive argument as the subject and the non-agentive argument the object. With Transitive-ERG verbs, the subject is ERG(ATIVE) and the object

is ABS(OLUTIVE). With Transitive-ABS and Intransitive-ABS verbs, the subject is ABS and the object OBL(IQUE). These two differ in that the object is obligatory in the transitive counterpart, and optional with the intransitive. In their study, these three verb types were crossed either a subject or object *wh*-question, exemplified in (62).

(62) *Example auditory stimuli from Tollan et al. (2019)*

- a. Ko e pusi fe ne tutuli tumau {e lapiti | he kuli}?
 PRED cat which PAST chase always ABS rabbit | ERG dog
 ‘Which cat {always chased the rabbit | did the dog always chase}?’
- b. Ko e pusi fe ne ffitaki tumau {ke he lapiti | e kuli ki ai}?
 PRED cat which PAST copy always OBL rabbit | ABS dog RP
 ‘Which cat {always copied the rabbit | did the dog always copy}?’
- c. Ko e pusi fe ne poi tumau {ke he lapiti | e kuli ki ai}?
 PRED cat which PAST run always OBL rabbit | ABS dog RP
 ‘Which cat {always ran to the rabbit | did the dog always run to}?’

Because the *wh*-phrase is not marked with overt case morphology, all three sentences are temporarily ambiguous between subject and object extractions. The critical window of ambiguity occurs in the time between the encoding of the verb and the case morphology of the non-extracted argument. During this time period, the case *frame* can be deduced, but the case *marking* of the extracted argument, and therefore its thematic role, is not yet evident. The question, which should be familiar, is whether Niuean speakers make assumptions about the thematic role of the extracted argument during this period of ambiguity, and whether this differs as a function of case frame and transitivity.

There are two major results. First, there was a lower proportion of looks towards subject-images in Transitive-ERG conditions (.41) compared to the Transitive-ABS and Intransitive-ABS conditions (.48). The Transitive-ABS (.47) and Intransitive-ABS (.49) conditions did *not* show a reliable difference in subject-image looks. Second, there was a higher proportion of looks towards the object-image in Transitive-ERG (.50) compared to Transitive-ABS and Intransitive-ABS conditions (.41). However, in this case,

Transitive-ABS and Intransitive-ABS *did* show a reliable difference such that there were more looks towards the object-image in Transitive-ABS condition (.44) than Intransitive-ABS condition (.38). In other words, Tollan et al. found two main effects: (i) a preference for the filler argument to be predictively encoded with absolutive case, resulting in an “object” preference in the Transitive-ERG condition and “subject” preferences in the Transitive-ABS and Intransitive-ABS conditions, and (ii) an attenuated expectation for the “object” argument in the Intransitive-ABS conditions. It is the first finding — a preference for the “object” parse — that calls into question the universality of the SGA.

Tollan et al. account for these results by positing that the parser prefers dependencies that are more likely to materialize. Likelihood, in turn, is couched in terms of presumed frequency — absolutive arguments have a wider syntactic distribution, and are almost certainly the most common; similarly, objects are not obligatory with intransitives, and therefore are less likely to be included in the sentences.

I note that this is a rather different use of frequency than has been employed elsewhere, for example by Gennari and MacDonald (2008, 2009) and Real and Christiansen (2007). A parallel argument would be based on the distribution of subject versus object extractions *given* a particular case-frame. While it may well be that object extractions are more frequent than subject extractions with Transitive-ERG verbs in Niuean, this is neither shown nor presumed in their account. Instead, Tollan et al. reason that non-case marked arguments are predictively assigned the most common case (absolutive). In turn, given a Transitive-ERG verb, this argument is linked to the object position and assigned the patient role.

From this vantage point, the lack of SGA under ergative alignments boils down to incremental commitments related to case assignment, which then directly feed expectations about where a gap should arise. This allows the pattern to be immediately folded into the maximize well-formedness framework. Because Transitive-ERG verbs are only consistent with a parse where the ergative argument occupies the agent-assigning po-

sition, well-formedness conditions block the more minimal parse that would otherwise blindly prefer the (presumed) absolutive argument to occupy this position.

To take this even further, the commitments about case assignment can be tied to a general hierarchy of case, given in (63). Note that, like the PAH, the hierarchy belies the underlying grammatical source, but proves handy for online implementation.

(63) ***Morphological case accessibility hierarchy (Bobaljik, 2008; Tollan, 2020)***

UNMARKED (NOM, ABS) > DEPENDENT (ERG, ACC) > LEXICAL/OBLIQUE (DAT)

Given a case-ambiguous noun, I contend that the parser assigns the least marked case consistent with the input at that point. This obviates the need for a direct appeal to frequency in explaining incremental parsing commitments related to case assignment. Frequency is treated as a pattern of behavior to be explained by grammatical or processing principles rather than the source of the effect.

6.6.7.4 Person, pronouns, and the Subject Gap Advantage

The final extension I consider is to go beyond animacy and obviation to the expected effects of the core person categories. This literature has revealed configurations where object relative clauses are preferred over subject relative clauses, which has been argued to support experience-based accounts such as the classic constraint-based model.

Given what has been discussed so far, the well-formedness account makes the clear prediction that local persons (first and second) should be preferred as agents and syntactic subjects above all other person categories, as they are the highest ranked categories on the PAH. However, the local persons also introduce a number of additional factors that must be taken into consideration — most saliently, they are encoded as pronouns (i.e. *I, me, we, us, you*) and their reference is computed indexically. While animate and inanimate persons may also appear as indexical pronouns (i.e. *they, them, he, him, she,*

her, it), in the studies reviewed so far they have appeared as full, definite nominals (e.g. *the message/messenger*).

These types of factors have long been known to factor into prominence-based effects. For example, the *Empathy Hierarchy* proposed by DeLancey (1981), among other distinctions, introduces a ranking of third person pronouns above the other full nominal categories. I give a simplified form that ignores additional distinction made between humans and animals and natural forces versus inanimate objects.

(64) ***The (simplified) Empathy Hierarchy (cf. DeLancey, 1981)***

LOCAL > 3RD PRONOUNS > ANIMATE > INANIMATE

DeLancey uses the scale to account for patterns of split-ergativity, noting that the splits between local persons versus everything else and local/third pronominals versus everything else are the most consistently evidenced across languages. If we take the hierarchy in (64) on board, we still make the prediction that local versus third persons should differ in prominence, but that this should be additionally cut by a distinction between nouns and pronouns.

With all of this in mind, I first consider the results of a series of experiments by Reali and Christiansen (2007) and a later follow-up by Heider, Dery, and Roland (2014), who examine the processing of SRCs versus ORCs with “pronominal” relative clauses (see also Gordon, Hendrick, and Johnson, 2001). In four separate self-paced reading experiments, Reali and Christiansen (2007) compare the processing profile of ORCs versus SRCs with an embedded (i) second person pronoun (65a), (ii) first person pronoun (65b), (iii) third person (plural) animate pronoun (65c), and (iv) a third person inanimate (or impersonal) pronoun (65d).

(65) *Sample stimuli from Reali and Christiansen (2007)*

- a. The consultant that { you called | called you } emphasized the need for additional funding.
- b. The lady that { I visited | visited me } enjoyed the meal.
- c. According to the Taylors, the landlord that { they telephoned | telephoned them } offered a nice apartment.
- d. The research was very illuminating. The studies that { it motivated | motivated it } converged to similar results

With second, first, and animate pronouns, they found that ORCs were associated with faster button presses than SRCs in two-word embedded clause region. In contrast, inanimate pronouns showed the opposite patterns, with SRCs showing faster button presses than ORCs. Reali and Christiansen link these results to the corpus-based statistical distribution of SRCs versus ORCs given each type of pronominal argument, on the hypothesis that less frequent constructions should be associated with more processing difficulty, and therefore longer button press latency in SPR. Congruent with this reasoning, they show that first, second, and animate RCs more commonly appear as ORCs, while inanimate RCs are more commonly SRCs.

In a later follow-up, Heider et al. (2014) argue that there are issues with both the corpus-based counts and the experimental items in the inanimate RC conditions of Reali and Christiansen (2007). For the corpus counts, Heider et al. show that if both full *and reduced* relative clauses are included in the counts, the inanimate ORCs show the same asymmetry as the other pronominal RCs (i.e. ORCs being more frequent than SRCs). Therefore, at first blush, there appears to in fact be a mismatch between the distributional patterns and the processing measures, upending the experience-based account.

However, Heider et al. also argue in a series of studies that Reali and Christiansen's finding of longer RTs in SRCs versus ORCs with inanimate pronouns is confounded by a garden-path effect. In many of their items, including the one in (66d), the first noun in the critical second sentence can be initially interpreted as co-referential with the subject of the carrier sentence — e.g. the string *The research was very illuminating. The studies...* can be interpreted such that *the studies* is referring back to *the research*. In the SRC conditions, this parse is disrupted at the pronoun, where the misanalysis first becomes apparent, leading to longer reading times in the critical region. Heider et al. show that with stimuli that control for this confound, the inanimate pronoun conditions show the same asymmetry as the other pronominal conditions, such that ORCs are associated with faster button presses than SRCs. They argue these results are therefore still consistent with an experience-based account, but not a so-called *fine-grained* experience-based account where the different associations for reduced versus unreduced RCs is maintained.

As with the processing of absolutive arguments in ergative languages, the finding of an ORC advantage with pronominal RCs calls into question the Subject Gap Advantage, and therefore the universality of the proposed chain-minimization principles. Once again, the model can handle such cases in a principled manner by appealing to independent well-formedness conditions. In this case, the relevant factor is that pronominal forms are ranked above non-pronominal forms; therefore alignments where pronouns are in the syntactic subject position and assigned the agent role will be preferred over parses with the opposite alignment. For the cases examined by Reali and Christiansen and Heider et al., all of the ORC constructions have this preferred alignment, while the SRCs are in violation. Therefore the finding of the ORC preference in these cases is broadly consistent with the incremental well-formedness account.

Further evidence in support of the proposal that the nominal-pronominal distinction obscures the impact of minimization can be found in Clothier-Goldschmidt and Wagers

(2017), who compare full DPs, third person pronouns, and second person pronouns inside of SRCs and ORCs using self-paced reading. Sample items for each condition are given in (66).

(66) *Sample stimuli from Clothier-Goldschmidt and Wagers (2017)*

- a. ... the nurse that { welcomed the mailman | the mailman welcomed } ...
- b. ... the nurse that { welcomed him | he welcomed } ...
- c. ... the nurse that { welcomed you | you welcomed } ...

Clothier-Goldschmidt and Wagers found a subject gap advantage for the full DP conditions. The penalty for ORCs compared to SRCs in the full DP conditions in both SPR button presses at the embedded verb ($RT_{\text{ORC}} - RT_{\text{SRC}} \approx 44\text{ms}$) and in end-of-sentence comprehension questions (SRC = 80%, ORC = 68%). No differences were found between SRCs and ORCs for either of the pronominal conditions in either button press latency or comprehension question accuracy (cf. Reali and Christiansen (2007) who claim an *object* gap advantage in SPR RT in these cases).

Clothier-Goldschmidt and Wagers argue that this goes *against* the predictions of the PAH, on the logic that the third persons should pattern together by both showing the SGA, with only the second person leading to neutralization of the effect. However, when the additional factor of pronominalization is taken into account (i.e. as in the Empathy Hierarchy of DeLancey (1981)), it is possible to reconcile the pattern with the PAH. In short, it appears that the pressure to put pronominal forms in the subject position overrides minimization pressures, which would otherwise prefer a subject gap across the board.

While I have argued that the findings of Reali and Christiansen (2007), Heider et al. (2014), and Clothier-Goldschmidt and Wagers (2017) are generally consistent with an account where PAH-based well-formedness pressures can attenuate or eliminate the SGA, an issue arises if care is taken to consider the incremental availability of different

pieces of information. All of these studies had a third person animate full DP as the filler and modulated the identity of the non-displaced argument. But at the point at which this filler is encoded, and therefore when a chain is predictively formed, it is not yet known what the identity of the non-displaced argument will be, or even if there will be another argument at all (i.e. the verb could be intransitive). This information matters a great deal to what incremental predictions will be entertained given the PAH. For example, if the other argument is an animate full DP, then the filler and the non-displaced argument are on equal footing; if it is an inanimate full DP, then the filler is ranked *above* the non-displaced argument; if it is a second person, then the filler is ranked *below* the non-displaced argument.

Given that information about the non-displaced filler is not available until further down the line, initial parsing decisions cannot be informed by relational factors. With an animate filler, the non-relational effects of the PAH in conjunction with chain-minimization should result in the predictive formation of a chain terminating in the EA position with an intermediate subject gap. Herein lies the rub: This predicts that there should be a filled-gap effect with ORCs and a processing disruption regardless of the identity of the argument ultimately found to be filling this position.

This issue has echoes of another long-running challenge for the prediction-based accounts of filler-gap processing, and in particular the Active Filler Strategy. In the classic sentences from Stowe (1986), exemplified in (67), the filled-gap effect appears not at the filled subject position (*Ruth*), but the filled direct object position (*us*).

(67) My brother wanted to know **who** Ruth will bring us home to ___ at Christmas.

However, as discussed in the introduction, a later study by Lee (2004), which was then replicated and extended in Wagers and Pendleton (2016), showed that filled-gap effects *could* be observed in this position if an adjunct is inserted between the filler and the filled subject position. The relevant example is given in (68).

(68) That is **the cult which**, in the early eighties, *Elaine* inspired many friends to make a deep commitment to ___.

Following Wagers and Pendleton (2016), it is reasonable to assume that the process of predictive chain formation takes time, and that, without the extra time afforded by the presence of the adjunct phrase, the parser does formulate a prediction before reaching the subject position, which occurs in the very next word.

Returning to the sentences in Reali and Christiansen (2007), Heider et al. (2014), and Clothier-Goldschmidt and Wagers (2017), none of these studies included a buffer region between the filler and the embedded clause, with the filled subject position in the ORC conditions immediately following the region where the filler could be identified. It is therefore possible that the parser simply did not have enough time to generate the subject gap prediction, leading to a lack of subject gap effect. One priority for future work should be to provide a test of this hypothesis by conducting a version of these studies where the items include an intervening adjunct phrase.

A further avenue of interest is to examine whether local person *fillers* lead to the expected effects. One challenge to overcome is the oddity of relativization with pronouns in English. To my ears, both *you who saw the woman* and *you who the woman saw* are both rather marked, if not ungrammatical. One initial idea that could be used to get around this is to embed the pronoun within a quantificational phrase, as in (69), where either a first person, second person, third person animate pronoun, animate DP, or inanimate DP is within the quantificational phrase.

(69) ***Extension 3: Modifying the PAH ranking of the filler***

- a. All of us who { inspired the woman | the woman inspired }
- b. All of you who { inspired the woman | the woman inspired }
- c. All of them who { inspired the woman | the woman inspired }
- d. All of the painters who { inspired the woman | the woman inspired }

- e. All of the paintings that { inspired the woman | the woman inspired }

Assuming that these quantificational phrases, in some sense, have the features of the embedded person, we should expect to see differences between SRCs and ORCs as a function of person and ranking on the PAH — the local persons should be most strongly preferred in the SRC parse, followed by the third person pronouns, then the animate DPs, and finally the inanimate DPs.

6.7 Conclusion

The goal of this chapter was to explore the processing of obviation and voice marking in Border Lakes Ojibwe, and explore the wider role of person-based prominence information in theories of sentence processing. The major finding was that Ojibwe speakers predictively encode proximate arguments as agents, with obviative arguments showing no clear preference to be placed in one role or another prior to the bottom-up evidence from voice marking. This provides some of the most direct support to date for theories where prominence information such as obviation has an immediate impact on processing decisions. Further, it provides evidence that the proximate-obviative distinction mirrors the impact of animacy on filler-gap processing in languages like English (Wagers and Pendleton, 2016).

These results were argued to be best captured by the Revised Active Filler Strategy, where fillers trigger a process of predictive chain formation that terminates in a theta-assigning position. These chains were argued to be subject to two basic pressures: (i) the pressure to make the smallest links possible, and (ii) the pressure to *maximize incremental well-formedness*. The particular well-formedness conditions considered here were derived from the harmonic alignment of the Person-Animacy Hierarchy and a number of specific instantiations of the General Syntactic Position Hierarchy. These basic pressures on chain formation were shown to align with higher ranked arguments such

as proximate and animate, and conflict with lower ranked arguments such as obviative and inanimate, providing an explanation for the immediate experimental results and the cross-linguistic profile of prominence effects on filler-gap dependency processing. The model linked both the Agent-First Preference and the Subject Gap Advantage to the chain minimization pressure, providing a syntax-first model where initial parsing decisions impact interpretation, integration, and reanalysis as new information is encoded.

CHAPTER 7

CONCLUSIONS

7.1 Summary

This dissertation set out to understand *person-based prominence* effects: the observation that certain person categories such as first, second, or proximate are often privileged by the grammar. In leading theories of the past fifty years such as the feature geometry and prominence hierarchy, these effects have been argued to arise from extrinsic entailment relationships between features or categories. I argued for a lower layer of representation for person, obviation, and animacy — ontologically-based *primitives* that correspond to the author, addressee, animate beings, and inanimate objects. These primitives were argued to be combined into sets to form features related to person, obviation, and noun classification, providing a first-order representation of the entailment relationships between features and categories described by feature geometries and prominence hierarchies. With this representation, the full range of known prominence-based agreement effects related to person and obviation were captured, as well as the possible category distinctions within natural language. Finally, prominence relations were shown to be active in sentence processing by forming restrictions on predictive chain formation in filler-gap dependency processing, and by guiding the computation of argument structure relationships more generally.

The remainder of this conclusory chapter is devoted to briefly outlining two major areas for future consideration, including wider speculations on the impact of the findings and arguments in this thesis.

7.2 Categories, features, and primitives

There are three major levels of representation that underly person: *categories*, *features*, and *primitives*. Primitives connect the linguistic representation to the basic concepts within the ontology of person. Features consist of particular sets of these primitives. Finally, categories are different combinations of features. The lowest level of mental representation is the ontology. The concepts within the ontology constrain the possible features that can be created. In turn, the possible categories (and probes) are constrained by the available set of features. An overarching goal of this thesis was to understand each level of representation and provide a further elucidation of the relationships between the levels.

With any representation, one must be careful not to confuse the formal attributes (the “structure” of the representation) from the actual values that are assigned within the structure (the “type” of the representation). For example, the structure of features argued for in this thesis consists of a set and a value. The type of the feature is defined by the particular primitives that fill the set. Over the course of the dissertation, claims were made both about what types can exist (i.e. claims about what concepts should be included in the ontology) as well as about the structure of the representation (i.e. how features are structured and how they interact semantically and syntactically). I consider outstanding issues in both of these domains.

While the idea of the ontology of person comes from Harbour (2016), the novel proposal was to create analogues of the ontology in the syntactic representation, and to further elaborate the ontology by adding the inanimate objects, represented by r , r' , r'' , and so on. So far, the ontology gives us the means to conceptualize basic so-

cial interaction with the author and addressee, and creates a fundamental cut between living and non-living things. Other strong contenders for being ontologically specified are cuts between humans and non-humans within the living things, and natural forces versus inanimate objects in the domain of the non-living.

That said, care should be taken when claiming that a concept is ontologically specified versus emergent from the particulars of the linguistic representation itself. For example, on the present account the concept of “proximate” is not a fundamental part of the ontology. It is a function of a feature that groups together the *i*, *u*, and a single *o*. The question of whether a given distinction is ontological versus emergent from the structure of features arises most sharply in noun classification and classifier systems. The question of how exactly the types defined by distinction in sex, gender, honorific or social status, and more should be treated within the theory remains open. However, the data structures provided within the theory have the potential to accommodate such cuts in a number of ways.

A second critical question that is largely open is why particular subsets of the ontology become features. The proposed data structure could in principle give rise to a huge variety of different features, but in fact there is only a limited set that are observed across the world’s languages. The features discussed here were [Animate], [Proximate], [Participant], [Author], and [Addressee]. These syntactic sets for each of these features is repeated in (1).

(1) *Attested “person” features*

- a. [Animate] = $\{I, U, O, O', \dots, O^n\}$
- b. [Proximate] = $\{I, U, O\}$
- c. [Participant] = $\{I, U\}$
- d. [Author] = $\{I\}$
- e. [Addressee] = $\{U\}$

There are therefore many unattested features. A sample of some of the most salient missing features is given in (2).

(2) *Sample of unattested “person” features*

- a. [Other] = $\{O, O', \dots, O^n\}$
- b. [Obviative] = $\{O', O'' \dots, O^n\}$
- c. [Y'all] = $\{U, O, O', \dots, O^n\}$
- d. [Exclusive] = $\{I, O, O', \dots, O^n\}$

There is, at present, no evidence for a feature that uniquely picks out the non-local others (2a), nor the non-proximate others (2b). In agreement, these features would be respectively expected to give rise to patterns where the third person is ranked above the local persons or the obviative person above the proximate person. Furthermore, the known patterns are inconsistent with a feature that picks out the addressee and others to the exclusion of the author (2c), as well as one that picks out the author and others to the exclusion of the addressee (2d). These would give rise to a probe that prefers agreement with a second/third person over the first person, or a first/third person over the second person, respectively.

The account does not provide a principled explanation for why we have the features we have, but two one-way implicational relations, which are reminiscent of the feature geometry, emerge. These are summarized below, with (3a) showing that the presence of a “non-proximate” O implies the presence of I , U , and O , and (3b) showing that the presence of the “proximate” O implies the presence of I and U .

(3) *Implicational relationships between primitives*

- a. $O', \dots, O^n \rightarrow I, U, O$
- b. $O \rightarrow I, U$

Like feature geometries and prominence hierarchies, the relationships in (3) should be considered purely descriptive. They do not constitute an explanation of why these properties should hold. I suspect that the implicational relationships between primitives could find an explanation in the nature of acquisition. For example, it is possible that the learning algorithm is constrained in such a manner that leads these relationships to emerge, though spelling-out this suspicion is left to future work.

A subsidiary outstanding puzzle within this family is the *Addressee Asymmetry*. To review, this is the observation that an independent [Addressee] feature is necessary to define the possible *person probes*, in order to capture the You-First and Ultra Strong Addressee patterns, but cannot be independently specified in the derivation of *person categories*, to account for the asymmetry encompassed by Zwicky's Problem. To generalize the issue, we have a case where there is clear motivation to include a feature within the representation, but it is not free to be used in every domain of the grammar.

Again, I imagine this problem could be solved by an appeal to the acquisition path. It is plausible to assume that the set of categories within a language are established by the learner prior to the acquisition of the system of agreement with those categories. The learning of categories could be constrained such that there can be no independent [addressee] feature, accounting for the asymmetry observed by Zwicky (1977). However, if a contrast emerges within the language to support the winnowing of [participant] to [participant*], as proposed here under the theory of contrastive interpretations (Copper and Hall, 2019), this “unlocks” an independent [addressee] feature that can be specified on agreement probes in this later stage of acquisition. Seeing if this proposed path, or something similar, could be responsible for this asymmetry is another avenue to explore to refine the claims of the thesis.

The above problems were issues in the domain of representational types. However, there are also a number of issues to grapple with in how the representation is structured and how it is manipulated. First, while a theory of the semantics of number was devel-

oped, a syntactic theory of number agreement was almost entirely taken for granted. The major question left is how the set-based formulation of AGREE applies within this domain. Second, very little was said about the insertion of morphology. However, the phenomena of gluttony, and the different types of repairs and reactions that lead to the PCC, portmanteau forms, omnivory, and so on are intimately tied to the workings of spell-out. A detailed account in this vein is again left to future work.

7.3 The role of the grammar in processing

A grammar within the Chomskyan tradition is a finite system of rules or operations that can generate all and only well-formed linguistic representations. Classically, a major constraint on theories of the grammar is that they should be learnable from the primary input — a child must be able to arrive at a generative system under the conditions presented by the *poverty of the stimulus* (Chomsky, 1965).

However, being acquirable (given limited input) is not the only demand that our theory of the grammar must meet. The act of language processing involves understanding and producing well-formed representations under the pressures and uncertainty presented by *incrementality*. The grammar must be deployable over time — we do not wait till the end of a sentence to generate a phrase-marker, but rather generate structures in what appears to be a continuous manner, revising and integrating based on the new information that we encounter. One underlying goal in this thesis was to ensure that the model of the grammar met this condition of *incremental validity*.

All of this reveals an apparent tension within the dissertation: While the “static” theory of the grammar presented here rejected direct use of prominence hierarchies, treating them as descriptive rather than explanatory, the model of *incremental well-formedness* was centered around using prominence hierarchies to generate constraints. This leads to questions about the relationship between the current theory of the grammar and the theory of how that grammar is deployed in real-time.

I believe the main issue here is one of granularity. The proposed theory of filler-gap processing is operating at the level of the person categories: a filler is displaced from its base-position, and that filler must be associated with that gap site. In contrast, the formal theory of agreement, which was the focus of the earlier chapters, was operating at the level of features/primitives. Given that the particular PAH was shown to be descriptively adequate in capturing prominence relationships at the category level, the PAH minimally provides a sufficient approximation of the actual well-formedness conditions that are employed by the parser at that level of representation. Whether these are the *actual* constraints in the minds of language users should be questioned, though treating them as such is sure to provide fruitful grounds for refining our understanding of how prominence relations affect real-time processing behavior in filler-gap dependencies.

Broadening out, the processing theory developed in this thesis is a marked shift from the theories of filler-gap dependencies that have lead the field over the past 25 years. These theories have largely followed the lead of the classical constraint-based approach by treating patterns of behavior as both the explanation and the explicandum. If the new lines of inquiry opened in the 1950's and 60's marked the *cognitive revolution*, freeing the psychological sciences from the confines of behaviorism, perhaps what is needed now is something of a *cognitive revival*. This does not mean abandoning or dismissing lines of inquiry related to experience and association. These studies uncover the critical patterns of linguistic behavior and inform the nature of the primary input to the learner. However, these patterns do not at the same time constitute an *explanation* for why certain strings of language are well-formed or ill-formed, or why some strings are more difficult to process than others — this begs the question of why these particular patterns should arise in the first place. Moreover, it leaves entirely unanswered the question of why some patterns arise (or arise with a greater degree of frequency), while others do not (or do to a lesser degree).

By accepting the argument in the previous paragraph, one does not necessarily need to commit to the existence of an innate Universal Grammar or a built-in roadmap specific to language development, which are commonly associated with the paradigm shift of the cognitive revolution. The main claims of the thesis did not hinge on positing domain-specific and innate universals, though many of the claims could be framed in that way. However, one *does* need to commit to the idea that the initial state and/or mechanisms that govern language acquisition are biased in such a way that leads to certain readily imaginable linguistic patterns to be ruled out. Specifically, these biases must result in only a limited set of possible person features, which in turn give rise to a restricted set of possible person-based categories and prominence effects. We can and should (and do) debate whether these biases are language-specific or domain-general, but the fact that such biases exists is a matter of fact. This thesis gave a formal account of the “end state” that these biases give rise to — the representations that they produce synchronically in mature language users, and how these representations influence incremental processing. However, the question of how and why these biases arise is one that we are sure to continue grappling with for many years to come.

APPENDICES

APPENDIX A

DERIVATIONS WITH PROXIMATE IN HARBOUR'S SYSTEM

This appendix provides the derivations in Harbour's (2016) system to examine whether the quintipartition of Ojibwe can be derived from any of the possible feature orders. Only orders within the three feature specification are considered. As explored in detail in the main text of Chapter 2, these are the only combinations that allow for the possibility of deriving a five-way split. One feature systems max out at two partitions, and two feature systems max out at four partitions. This leaves the following feature combinations in contention:

(1) *Feature combinations in contention for deriving the quintipartition*

a. *Proximate + Participant + Author (Participant before Author)*

$\pm\text{proximate}(\pm\text{author}(\pm\text{participant}(\tau)))$

$\pm\text{author}(\pm\text{proximate}(\pm\text{participant}(\tau)))$

$\pm\text{author}(\pm\text{participant}(\pm\text{proximate}(\tau)))$

b. *Proximate + Participant + Author (Author before Participant)*

$\pm\text{proximate}(\pm\text{participant}(\pm\text{author}(\tau)))$

$\pm\text{participant}(\pm\text{proximate}(\pm\text{author}(\tau)))$

$\pm\text{participant}(\pm\text{author}(\pm\text{proximate}(\tau)))$

I consider each in turn.

A.1 \pm proximate(\pm author(\pm participant(π)))

The first combination is where the proximate feature composes last, with participant composing before author. The derivation can be truncated, as it builds from the output of the original quadripartition of Harbour. These outputs are shown in (2).

(2) *Output of quadripartition combination, before Lexical Complementarity*

- a. $-\text{author}(+\text{participant}(\pi)) = \{\emptyset, u_x, x_x\}$
- b. $-\text{author}(-\text{participant}(\pi)) = \{\emptyset, x_x\}$
- c. $+\text{author}(+\text{participant}(\pi)) = \{i_x, iu_x\}$
- d. $+\text{author}(-\text{participant}(\pi)) = \{i_x\}$

The derivations are given in the following four examples:

(3) \pm proximate +author –participant

- a. $\llbracket -\text{proximate}(+\text{author}(-\text{participant}(\pi))) \rrbracket$
 $= (((\mathcal{L}_\pi \ominus \max(\mathcal{L}_{pt})) \oplus \mathcal{L}_{au}) \ominus \max(\mathcal{L}_{px}))$
 $= \{i_x\} \ominus \{iuo\}$
 $= \{i_x \setminus iuo\}$
 $= \{\emptyset, x'_{x'}\}$
- b. $\llbracket +\text{proximate}(+\text{author}(-\text{participant}(\pi))) \rrbracket$
 $= (((\mathcal{L}_\pi \ominus \max(\mathcal{L}_{pt})) \oplus \mathcal{L}_{au}) \oplus \mathcal{L}_{px})$
 $= \{i_x\} \oplus \{iuo, iu, io, uo, i, u, o\}$
 $= \{i_x \sqcup iuo, i_x \sqcup iu, i_x \sqcup io, i_x \sqcup uo, i_x \sqcup i, i_x \sqcup u, i_x \sqcup o\}$
 $= \{iuo_x, iu_x, io_x, iuo_x, i_x, iu_x, io_x\}$
 $= \{iu_x, i_x, \}$

(4) \pm *proximate* +*author* +*participant*

$$\begin{aligned}
 \text{a. } & \llbracket \neg \text{proximate}(+\text{author}(+\text{participant}(\pi))) \rrbracket \\
 & = (((\mathcal{L}_\pi \ominus \max(\mathcal{L}_{pt})) \oplus \mathcal{L}_{au}) \ominus \max(\mathcal{L}_{px})) \\
 & = \{i_x, iu_x\} \ominus \{iuo\} \\
 & = \{i_x \setminus iuo, iu_x \setminus iuo\} \\
 & = \{\emptyset, x'_{x'}, x'_{x'}\} \\
 & = \{\emptyset, x'_{x'}\}
 \end{aligned}$$

$$\begin{aligned}
 \text{b. } & \llbracket +\text{proximate}(+\text{author}(+\text{participant}(\pi))) \rrbracket \\
 & = (((\mathcal{L}_\pi \ominus \max(\mathcal{L}_{pt})) \oplus \mathcal{L}_{au}) \oplus \mathcal{L}_{px}) \\
 & = \{i_x, iu_x\} \oplus \{iuo, iu, io, uo, i, u, o\} \\
 & = \{i_x \sqcup iuo, i_x \sqcup iu, i_x \sqcup io, i_x \sqcup uo, i_x \sqcup i, i_x \sqcup u, i_x \sqcup o, \\
 & \quad iu_x \sqcup iuo, iu_x \sqcup iu, iu_x \sqcup io, iu_x \sqcup uo, iu_x \sqcup i, iu_x \sqcup u, iu_x \sqcup o\} \\
 & = \{iuo_x, iu_x, io_x, iuo_x, i_x, iu_x, io_x, \\
 & \quad iuo_x, iu_x, iuo_x, iuo_x, iu_x, iu_x, iuo_x\} \\
 & = \{iu_x, i_x\}
 \end{aligned}$$

(5) \pm *proximate* –*author* –*participant*

$$\begin{aligned}
 \text{a. } & \llbracket \neg \text{proximate}(\neg \text{author}(\neg \text{participant}(\pi))) \rrbracket \\
 & = (((\mathcal{L}_\pi \ominus \max(\mathcal{L}_{pt})) \ominus \max(\mathcal{L}_{au})) \ominus \max(\mathcal{L}_{px})) \\
 & = \{\emptyset, x_x\} \ominus \{iuo\} \\
 & = \{\emptyset \setminus iuo, x_x \setminus iuo\} \\
 & = \{\emptyset, x'_{x'}\} \\
 \text{b. } & \llbracket +\text{proximate}(\neg \text{author}(\neg \text{participant}(\pi))) \rrbracket \\
 & = (((\mathcal{L}_\pi \ominus \max(\mathcal{L}_{pt})) \ominus \max(\mathcal{L}_{au})) \oplus \mathcal{L}_{px}) \\
 & = \{\emptyset, x_x\} \oplus \{iuo, iu, io, uo, i, u, o\} \\
 & = \{\emptyset \sqcup iuo, \emptyset \sqcup iu, \emptyset \sqcup io, \emptyset \sqcup uo, \emptyset \sqcup i, \emptyset \sqcup u, \emptyset \sqcup o \\
 & \quad x_x \sqcup iuo, x_x \sqcup iu, x_x \sqcup io, x_x \sqcup uo, x_x \sqcup i, x_x \sqcup u, x_x \sqcup o\}
 \end{aligned}$$

$$\begin{aligned}
&= \{iuo, iu, io, uo, i, u, o, \\
&\quad iuox_x, iux_x, iox_x, uox_x, ix_x, ux_x, ox_x\} \\
&= \{iu_x, i_x, u_x, o_x\}
\end{aligned}$$

(6) \pm **proximate** $-$ **author** $+$ **participant**

a. $\llbracket -\text{proximate}(-\text{author}(+\text{participant}(\pi))) \rrbracket$

$$\begin{aligned}
&= (((\mathcal{L}_\pi \oplus \mathcal{L}_{pt}) \ominus \max(\mathcal{L}_{au})) \ominus \max(\mathcal{L}_{px})) \\
&= \{\emptyset, u_x, x_x\} \ominus \{iuo\} \\
&= \{\emptyset \setminus iuo, u_x \setminus iuo, x_x \setminus iuo\} \\
&= \{\emptyset, x'_x\}
\end{aligned}$$

b. $\llbracket +\text{proximate}(-\text{author}(+\text{participant}(\pi))) \rrbracket$

$$\begin{aligned}
&= (((\mathcal{L}_\pi \oplus \mathcal{L}_{pt}) \ominus \max(\mathcal{L}_{au})) \oplus \mathcal{L}_{px}) \\
&= \{\emptyset, u_x, x_x\} \oplus \{iuo, iu, io, uo, i, u, o\} \\
&= \{\emptyset \sqcup iuo, \emptyset \sqcup iu, \emptyset \sqcup io, \emptyset \sqcup uo, \emptyset \sqcup i, \emptyset \sqcup u, \emptyset \sqcup o \\
&\quad u_x \sqcup iuo, u_x \sqcup iu, u_x \sqcup io, u_x \sqcup uo, u_x \sqcup i, u_x \sqcup u, u_x \sqcup o \\
&\quad x_x \sqcup iuo, x_x \sqcup iu, x_x \sqcup io, x_x \sqcup uo, x_x \sqcup i, x_x \sqcup u, x_x \sqcup o\} \\
&= \{iuo, iu, io, uo, i, u, o, \\
&\quad iuo_x, iu_x, iuo_x, uo_x, iu_x, u_x, uo_x, \\
&\quad iuox_x, iux_x, iox_x, uox_x, ix_x, ux_x, ox_x\} \\
&= \{iu_x, i_x, u_x, o_x\}
\end{aligned}$$

A.2 \pm **author**(\pm **proximate**(\pm **participant**(π)))

The second derivation is with the proximate feature in a medial position, with participant composing prior to author. These derivations are truncated slightly, taking for granted the initial operation of the participant feature in each case.

(7) **–author ±proximate –participant**

a. $\llbracket \text{–author}(\text{–proximate}(\text{–participant}(\pi))) \rrbracket$
 $= (((\mathcal{L}_\pi \ominus \max(\mathcal{L}_{pt})) \ominus \max(\mathcal{L}_{px})) \ominus \max(\mathcal{L}_{au}))$
 $= (\{\emptyset, x_x\} \ominus \{iuo\}) \ominus \{i\}$
 $= \{\emptyset \setminus iuo, x_x \setminus iuo\} \ominus \{i\}$
 $= \{\emptyset, x'_{x'}\} \ominus \{i\}$
 $= \{\emptyset \setminus i, x'_{x'} \setminus i\}$
 $= \{\emptyset, x'_{x'}\}$

b. $\llbracket \text{–author}(+\text{proximate}(\text{–participant}(\pi))) \rrbracket$
 $= (((\mathcal{L}_\pi \ominus \max(\mathcal{L}_{pt})) \oplus \mathcal{L}_{px}) \ominus \max(\mathcal{L}_{au}))$
 $= (\{\emptyset, x_x\} \oplus \{iuo, iu, io, uo, i, u, o\}) \ominus \{i\}$
 $= \{iu_x, i_x, u_x, o_x\} \ominus \{i\}$
 $= \{iu_x \setminus i, i_x \setminus i, u_x \setminus i, o_x \setminus i\}$
 $= \{u_x, x_x\}$

(8) **+author ±proximate –participant**

a. $\llbracket +\text{author}(\text{–proximate}(\text{–participant}(\pi))) \rrbracket$
 $= (((\mathcal{L}_\pi \ominus \max(\mathcal{L}_{pt})) \ominus \max(\mathcal{L}_{px})) \oplus \mathcal{L}_{au})$
 $= (\{\emptyset, x_x\} \ominus \{iuo\}) \oplus \{i\}$
 $= \{\emptyset \setminus iuo, x_x \setminus iuo\} \oplus \{i\}$
 $= \{\emptyset, x'_{x'}\} \oplus \{i\}$
 $= \{\emptyset \sqcup i, x'_{x'} \sqcup i\}$
 $= \{i_{x'}\}$

b. $\llbracket +\text{author}(+\text{proximate}(\text{–participant}(\pi))) \rrbracket$
 $= (((\mathcal{L}_\pi \ominus \max(\mathcal{L}_{pt})) \oplus \mathcal{L}_{px}) \oplus \mathcal{L}_{au})$
 $= (\{\emptyset, x_x\} \oplus \{iuo, iu, io, uo, i, u, o\}) \oplus \{i\}$
 $= \{iu_x, i_x, u_x, o_x\} \oplus \{i\}$

$$\begin{aligned}
&= \{iu_x \sqcup i, i_x \sqcup i, u_x \sqcup i, o_x \sqcup i\} \\
&= \{iu_x, i_x\}
\end{aligned}$$

(9) **−author ±proximate +participant**

a. $\llbracket -\text{author}(-\text{proximate}(+\text{participant}(\pi))) \rrbracket$

$$\begin{aligned}
&= (((\mathcal{L}_\pi \oplus \mathcal{L}_{pt}) \ominus \max(\mathcal{L}_{px})) \ominus \max(\mathcal{L}_{au})) \\
&= (\{i_x, iu_x, u_x\} \ominus \{iuo\}) \ominus \{i\} \\
&= \{i_x \setminus iuo, iu_x \setminus iuo, u_x \setminus iuo\} \ominus \{i\} \\
&= \{\emptyset, x'_{x'}\} \ominus \{i\} \\
&= \{\emptyset, x'_{x'}\}
\end{aligned}$$

b. $\llbracket -\text{author}(+\text{proximate}(+\text{participant}(\pi))) \rrbracket$

$$\begin{aligned}
&= (((\mathcal{L}_\pi \oplus \mathcal{L}_{pt}) \oplus \mathcal{L}_{px}) \ominus \max(\mathcal{L}_{au})) \\
&= (\{i_x, iu_x, u_x\} \oplus \{iuo, iu, io, uo, i, u, o\}) \ominus \{i\} \\
&= \{i_x, iu_x, u_x\} \ominus \{i\} \\
&= \{\emptyset, u_x, x_x\}
\end{aligned}$$

(10) **+author ±proximate +participant**

a. $\llbracket +\text{author}(-\text{proximate}(+\text{participant}(\pi))) \rrbracket$

$$\begin{aligned}
&= (((\mathcal{L}_\pi \oplus \mathcal{L}_{pt}) \ominus \max(\mathcal{L}_{px})) \oplus \mathcal{L}_{au}) \\
&= (\{i_x, iu_x, u_x\} \ominus \{iuo\}) \oplus \{i\} \\
&= \{i_x \setminus iuo, iu_x \setminus iuo, u_x \setminus iuo\} \oplus \{i\} \\
&= \{\emptyset, x'_{x'}\} \oplus \{i\} \\
&= \{i_{x'}\}
\end{aligned}$$

b. $\llbracket +\text{author}(+\text{proximate}(+\text{participant}(\pi))) \rrbracket$

$$\begin{aligned}
&= (((\mathcal{L}_\pi \oplus \mathcal{L}_{pt}) \oplus \mathcal{L}_{px}) \oplus \mathcal{L}_{au}) \\
&= (\{i_x, iu_x, u_x\} \oplus \{iuo, iu, io, uo, i, u, o\}) \oplus \{i\} \\
&= \{i_x, iu_x, u_x\} \oplus \{i\} \\
&= \{iu_x, i_x\}
\end{aligned}$$

A.3 $\pm\text{author}(\pm\text{participant}(\pm\text{proximate}(\pi)))$

The third set is proximate composing first, with participant again composing before author. All of these derivations begin with the result of either positive action of the proximate feature on π , shown in (11a), or negative action, shown in (11b).

(11) *Positive/negative action of proximate on π*

$$\begin{aligned}
 \text{a. } & \llbracket +\text{proximate}(\pi) \rrbracket \\
 & = \mathcal{L}_\pi \oplus \mathcal{L}_{px} \\
 & = \{i_x, iu_x, u_x, x_x\} \oplus \{i, u, o, iu, io, uo, iuo\} \\
 & = \{i_x \sqcup i, iu_x \sqcup i, u_x \sqcup i, x_x \sqcup i, \\
 & \quad i_x \sqcup u, iu_x \sqcup u, u_x \sqcup u, x_x \sqcup u, \\
 & \quad i_x \sqcup o, iu_x \sqcup o, u_x \sqcup o, x_x \sqcup o, \\
 & \quad i_x \sqcup iu, iu_x \sqcup iu, u_x \sqcup iu, x_x \sqcup iu, \\
 & \quad i_x \sqcup io, iu_x \sqcup io, u_x \sqcup io, x_x \sqcup io, \\
 & \quad i_x \sqcup uo, iu_x \sqcup uo, u_x \sqcup uo, x_x \sqcup uo, \\
 & \quad i_x \sqcup iuo, iu_x \sqcup iuo, u_x \sqcup iuo, x_x \sqcup iuo\} \\
 & = \{i_x, iu_x, iu_x, ix_x, \\
 & \quad iu_x, iu_x, u_x, ux_x, \\
 & \quad io_x, iuo_x, uo_x, ox_x, \\
 & \quad iu_x, iu_x, iu_x, iux_x, \\
 & \quad io_x, iuo_x, iuo_x, iox_x, \\
 & \quad iuo_x, iuo_x, uo_x, uox_x, \\
 & \quad iuo_x, iuo_x, iuo_x, iuox_x\} \\
 & = \{i_x, iu_x, u_x, o_x\} \\
 \text{b. } & \llbracket -\text{proximate}(\pi) \rrbracket \\
 & = \mathcal{L}_\pi \ominus \max(\mathcal{L}_{px}) \\
 & = \{i_x, iu_x, u_x, x_x\} \ominus \{iuo\}
 \end{aligned}$$

$$\begin{aligned}
&= \{i_x \setminus iuo, iu_x \setminus iuo, u_x \setminus iuo, x_x \setminus iuo\} \\
&= \{\emptyset, x'_{x'}, \emptyset, x'_{x'}, \emptyset, x'_{x'}, \emptyset, x'_{x'}\} \\
&= \{\emptyset, x'_{x'}\}
\end{aligned}$$

Given this, the derivations are as follows:

(12) ***−author(−participant(±proximate(π))***)

$$\begin{aligned}
\text{a. } & \llbracket \text{−author(−participant(−proximate(π))} \rrbracket \\
&= (((\mathcal{L}_\pi \ominus \max(\mathcal{L}_{px})) \ominus \max(\mathcal{L}_{pt})) \ominus \max(\mathcal{L}_{au})) \\
&= ((\{\emptyset, x'_{x'}\} \ominus \max(\mathcal{L}_{pt})) \ominus \max(\mathcal{L}_{au})) \\
&= ((\{\emptyset, x'_{x'}\} \ominus \{iu\}) \ominus \{i\}) \\
&= \{\emptyset \setminus iu, x'_{x'} \setminus iu\} \ominus \{i\} \\
&= \{\emptyset, x'_{x'}\} \ominus \{i\} \\
&= \{\emptyset \setminus i, x'_{x'} \setminus i\} \\
&= \{\emptyset, x'_{x'}\} \\
\text{b. } & \llbracket \text{−author(−participant(+proximate(π))} \rrbracket \\
&= (((\mathcal{L}_\pi \oplus \mathcal{L}_{px}) \ominus \max(\mathcal{L}_{pt})) \ominus \max(\mathcal{L}_{au})) \\
&= ((\{i_x, iu_x, u_x, o_x\} \ominus \max(\mathcal{L}_{pt})) \ominus \max(\mathcal{L}_{au})) \\
&= ((\{i_x, iu_x, u_x, o_x\} \ominus \{iu\}) \ominus \{i\}) \\
&= \{i_x \setminus iu, iu_x \setminus iu, u_x \setminus iu, o_x \setminus iu\} \ominus \{i\} \\
&= \{\emptyset, x_x, \emptyset, x_x, \emptyset, x_x, \emptyset, o_x\} \ominus \{i\} \\
&= \{\emptyset, x_x, o_x\} \ominus \{i\} \\
&= \{\emptyset, x_x\} \ominus \{i\} \\
&= \{\emptyset \setminus i, x_x \setminus i\} \\
&= \{\emptyset, x_x\}
\end{aligned}$$

(13) **$-author(+participant(\pm proximate(\pi)))$**

a. $\llbracket -author(+participant(+proximate(\pi))) \rrbracket$

$$\begin{aligned}
&= ((\mathcal{L}_\pi \oplus \mathcal{L}_{px}) \oplus \mathcal{L}_{pt}) \ominus \max(\mathcal{L}_{au}) \\
&= (\{i_x, iu_x, u_x, o_x\} \oplus \mathcal{L}_{pt}) \ominus \max(\mathcal{L}_{au}) \\
&= (\{i_x, iu_x, u_x, o_x\} \oplus \{i, u, iu\}) \ominus \{i\} \\
&= \{i_x \sqcup i, i_x \sqcup u, i_x \sqcup iu, \\
&\quad iu_x \sqcup i, iu_x \sqcup u, iu_x \sqcup iu, \\
&\quad u_x \sqcup i, u_x \sqcup u, u_x \sqcup iu, \\
&\quad o_x \sqcup i, o_x \sqcup u, o_x \sqcup iu\} \ominus \{i\} \\
&= \{i_x, iu_x, u_x\} \ominus \{i\} \\
&= \{i_x \setminus i, iu_x \setminus i, u_x \setminus i\} \\
&= \{\emptyset, x_x, u_x\}
\end{aligned}$$

b. $\llbracket -author(+participant(-proximate(\pi))) \rrbracket$

$$\begin{aligned}
&= ((\mathcal{L}_\pi \ominus \max(\mathcal{L}_{px})) \oplus \mathcal{L}_{pt}) \ominus \max(\mathcal{L}_{au}) \\
&= (\{\emptyset, x'_{x'}\} \oplus \{i, u, iu\}) \ominus \{i\} \\
&= \{\emptyset \sqcup i, \emptyset \sqcup u, \emptyset \sqcup iu, \\
&\quad x'_{x'} \sqcup i, x'_{x'} \sqcup u, x'_{x'} \sqcup iu\} \ominus \{i\} \\
&= \{i_{x'}, u_{x'}, iu_{x'}\} \ominus \{i\} \\
&= \{i_{x'} \setminus i, u_{x'} \setminus i, iu_{x'} \setminus i\} \\
&= \{\emptyset, x'_{x'}, u_{x'}\}
\end{aligned}$$

(14) **$+author(-participant(\pm proximate(\pi)))$**

a. $\llbracket +author(-participant(+proximate(\pi))) \rrbracket$

$$\begin{aligned}
&= ((\mathcal{L}_\pi \oplus \mathcal{L}_{px}) \ominus \max(\mathcal{L}_{pt})) \oplus \mathcal{L}_{au} \\
&= (\{i_x, iu_x, u_x, o_x\} \ominus \max(\mathcal{L}_{pt})) \oplus \mathcal{L}_{au} \\
&= (\{i_x, iu_x, u_x, o_x\} \ominus \{iu\}) \oplus \{i\} \\
&= \{i_x \setminus iu, iu_x \setminus iu, u_x \setminus iu, o_x \setminus iu\} \oplus \{i\}
\end{aligned}$$

$$= \{\emptyset, x_x\} \oplus \{i\}$$

$$= \{\emptyset \sqcup i, x_x \sqcup i\}$$

$$= \{i_x\}$$

b. $\llbracket +\text{author}(-\text{participant}(-\text{proximate}(\pi))) \rrbracket$

$$= ((\mathcal{L}_\pi \ominus \max(\mathcal{L}_{px})) \ominus \max(\mathcal{L}_{pt})) \oplus \mathcal{L}_{au}$$

$$= (\{\emptyset, x'_{x'}\} \ominus \max(\mathcal{L}_{pt})) \oplus \mathcal{L}_{au}$$

$$= (\{\emptyset, x'_{x'}\} \ominus \{iu\}) \oplus \{i\}$$

$$= \{\emptyset \setminus iu, x'_{x'} \setminus iu\} \oplus \{i\}$$

$$= \{\emptyset, x'_{x'}\} \oplus \{i\}$$

$$= \{\emptyset \sqcup i, x'_{x'} \sqcup i\}$$

$$= \{i_{x'}\}$$

(15) **$+\text{author}(+\text{participant}(\pm\text{proximate}(\pi)))$**

a. $\llbracket +\text{author}(+\text{participant}(+\text{proximate}(\pi))) \rrbracket$

$$= \{i_x, iu_x, u_x\} \oplus \{i\}$$

$$= \{i_x \sqcup i, iu_x \sqcup i, u_x \sqcup i\}$$

$$= \{i_x, iu_x\}$$

b. $\llbracket +\text{author}(+\text{participant}(-\text{proximate}(\pi))) \rrbracket$

$$= \{i_{x'}, u_{x'}, iu_{x'}\} \oplus \{i\}$$

$$= \{i_{x'} \sqcup i, u_{x'} \sqcup i, iu_{x'} \sqcup i\}$$

$$= \{i_{x'}, iu_{x'}\}$$

A.4 $\pm\text{proximate}(\pm\text{participant}(\pm\text{author}(\pi)))$

The fourth case, where proximate composes last, assumes the basic output of the tripartition, derived in detail in Harbour (2016), and summarized in (16).

(16) ***Output of tripartition, before Lexical Complementarity***

- a. $-\text{participant}(\pm\text{author}(\pi)) = \{\emptyset, x_x\}$
- b. $+\text{participant}(+\text{author}(\pi)) = \{i_x, iu_x\}$
- c. $+\text{participant}(-\text{author}(\pi)) = \{i_x, iu_x, u_x\}$

Given this, the derivations are as follows:

(17) $\pm\text{proximate}-\text{participant}\pm\text{author}$

- a. $\llbracket +\text{proximate}(-\text{participant}(\pm\text{author}(\pi))) \rrbracket$
 $= \{\emptyset, x_x\} \oplus \{i, u, o, iu, io, uo, iuo\}$
 $= \{\emptyset \sqcup i, \emptyset \sqcup u, \emptyset \sqcup o, \emptyset \sqcup iu, \emptyset \sqcup io, \emptyset \sqcup uo, \emptyset \sqcup iuo,$
 $x_x \sqcup i, x_x \sqcup u, x_x \sqcup o, x_x \sqcup iu, x_x \sqcup io, x_x \sqcup uo, x_x \sqcup iuo\}$
 $= \{i, u, o, iu, io, uo, iuo,$
 $ix_x, ux_x, ox_x, iux_x, iox_x, uox_x, iuox_x, \}$
 $= \{i_x, iu_x, u_x, o_x\}$
- b. $\llbracket -\text{proximate}(-\text{participant}(\pm\text{author}(\pi))) \rrbracket$
 $= \{\emptyset, x_x\} \ominus \max(\{i, u, o, iu, io, uo, iuo\})$
 $= \{\emptyset \setminus iuo, x_x \setminus iuo\}$
 $= \{\emptyset, x'_{x'}\}$

(18) $\pm\text{proximate}+\text{participant}+\text{author}$

- a. $\llbracket +\text{proximate}(+\text{participant}(+\text{author}(\pi))) \rrbracket$
 $= \{i_x, iu_x\} \oplus \{i, u, o, iu, io, uo, iuo\}$
 $= \{i_x \sqcup i, i_x \sqcup u, i_x \sqcup o, i_x \sqcup iu, i_x \sqcup io, i_x \sqcup uo, i_x \sqcup iuo,$
 $iu_x \sqcup i, iu_x \sqcup u, iu_x \sqcup o, iu_x \sqcup iu, iu_x \sqcup io, iu_x \sqcup uo, iu_x \sqcup iuo\}$
 $= \{i_x, iu_x, io_x, iu_x, io_x, iuo_x, iuo_x,$
 $iu_x, iu_x, iuo_x, iu_x, iuo_x, iuo_x, iuo_x\}$
 $= \{i_x, iu_x\}$

$$\begin{aligned}
\text{b. } & \llbracket -\text{proximate}(+\text{participant}(+\text{author}(\tau))) \rrbracket \\
& = \{i_x, iu_x\} \ominus \max(\{i, u, o, iu, io, uo, iuo\}) \\
& = \{i_x \setminus iuo, iu_x \setminus iuo\} \\
& = \{\emptyset, x'_{x'}\}
\end{aligned}$$

(19) $\pm\text{proximate}+\text{participant}-\text{author}$

$$\begin{aligned}
\text{a. } & \llbracket +\text{proximate}(+\text{participant}(-\text{author}(\tau))) \rrbracket \\
& = \{i_x, iu_x, u_x\} \oplus \{i, u, o, iu, io, uo, iuo\} \\
& = \{i_x \sqcup i, i_x \sqcup u, i_x \sqcup o, i_x \sqcup iu, i_x \sqcup io, i_x \sqcup uo, i_x \sqcup iuo, \\
& \quad iu_x \sqcup i, iu_x \sqcup u, iu_x \sqcup o, iu_x \sqcup iu, iu_x \sqcup io, iu_x \sqcup uo, iu_x \sqcup iuo, \\
& \quad u_x \sqcup i, u_x \sqcup u, u_x \sqcup o, u_x \sqcup iu, u_x \sqcup io, u_x \sqcup uo, u_x \sqcup iuo\} \\
& = \{i_x, iu_x, io_x, iu_x, io_x, iuo_x, iuo_x, \\
& \quad iu_x, iu_x, iuo_x, iu_x, iuo_x, iuo_x, iuo_x, \\
& \quad iu_x, u_x, uo_x, iu_x, iuo_x, uo_x, iuo_x\} \\
& = \{i_x, iu_x, u_x\} \\
\text{b. } & \llbracket -\text{proximate}(+\text{participant}(-\text{author}(\tau))) \rrbracket \\
& = \{i_x, iu_x, u_x\} \ominus \max(\{i, u, o, iu, io, uo, iuo\}) \\
& = \{i_x \setminus iuo, iu_x \setminus iuo, u_x \setminus iuo\} \\
& = \{\emptyset, x'_{x'}\}
\end{aligned}$$

A.5 $\pm\text{participant}(\pm\text{proximate}(\pm\text{author}(\tau)))$

The fifth derivation is with the proximate feature in a medial position, with author composing prior to participant. These derivations are truncated slightly, taking for granted the initial operation of the author feature in each case.

(20) $-\text{participant} \pm\text{proximate} -\text{author}$

$$\begin{aligned}
\text{a. } & \llbracket \neg \text{participant}(\neg \text{proximate}(\neg \text{author}(\pi))) \rrbracket \\
& = (((\mathcal{L}_\pi \ominus \max(\mathcal{L}_{au})) \ominus \max(\mathcal{L}_{px})) \ominus \max(\mathcal{L}_{pt})) \\
& = (\{\emptyset, u_x, x_x\} \ominus \{iuo\}) \ominus \{iu\} \\
& = \{\emptyset \setminus iuo, u_x \setminus iuo, x_x \setminus iuo\} \ominus \{iu\} \\
& = \{\emptyset, x'_{x'}\} \ominus \{iu\} \\
& = \{\emptyset, x'_{x'} \setminus iu\} \\
& = \{\emptyset, x'_{x'}\} \\
\text{b. } & \llbracket \neg \text{participant}(+ \text{proximate}(\neg \text{author}(\pi))) \rrbracket \\
& = (((\mathcal{L}_\pi \ominus \max(\mathcal{L}_{au})) \oplus \mathcal{L}_{px}) \ominus \max(\mathcal{L}_{pt})) \\
& = (\{\emptyset, u_x, x_x\} \oplus \{iuo, iu, io, uo, i, u, o\}) \ominus \{iu\} \\
& = \{\emptyset \sqcup i, \emptyset \sqcup u, \emptyset \sqcup o, \emptyset \sqcup iu, \emptyset \sqcup io, \emptyset \sqcup uo, \emptyset \sqcup iuo, \\
& \quad u_x \sqcup i, u_x \sqcup u, u_x \sqcup o, u_x \sqcup iu, u_x \sqcup io, u_x \sqcup uo, u_x \sqcup iuo, \\
& \quad x_x \sqcup i, x_x \sqcup u, x_x \sqcup o, x_x \sqcup iu, x_x \sqcup io, x_x \sqcup uo, x_x \sqcup iuo\} \ominus \{iu\} \\
& = \{i, u, o, iu, io, uo, iuo, \\
& \quad iu_x, u_x, uo_x, iu_x, iuo_x, uo_x, iuo_x, \\
& \quad ix_x, ux_x, ox_x, iux_x, iox_x, uox_x, iuox_x\} \ominus \{iu\} \\
& = \{i_x, iu_x, u_x, o_x\} \ominus \{iu\} \\
& = \{i_x \setminus iu, iu_x \setminus iu, u_x \setminus iu, o_x \setminus iu\} \\
& = \{\emptyset, o_x, x'_{x'}\}
\end{aligned}$$

(21) **+participant ±proximate –author**

$$\begin{aligned}
\text{a. } & \llbracket + \text{participant}(\neg \text{proximate}(\neg \text{author}(\pi))) \rrbracket \\
& = (((\mathcal{L}_\pi \ominus \max(\mathcal{L}_{au})) \ominus \max(\mathcal{L}_{px})) \oplus \mathcal{L}_{pt}) \\
& = (\{\emptyset, u_x, x_x\} \ominus \{iuo\}) \oplus \{i, u, iu\} \\
& = \{\emptyset \setminus iuo, u_x \setminus iuo, x_x \setminus iuo\} \oplus \{i, u, iu\} \\
& = \{\emptyset, x'_{x'}\} \oplus \{i, u, iu\} \\
& = \{\emptyset \sqcup i, \emptyset \sqcup u, \emptyset \sqcup iu, \\
& \quad x'_{x'} \sqcup i, x'_{x'} \sqcup u, x'_{x'} \sqcup iu\}
\end{aligned}$$

$$\begin{aligned}
&= \{i, u, iu, \\
&\quad ix'_{x'}, ux'_{x'}, iux'_{x'}\} \\
&= \{i_{x'}, iu_{x'}, u_{x'}\} \\
\text{b. } & \llbracket +\text{participant}(+\text{proximate}(-\text{author}(\pi))) \rrbracket \\
&= (((\mathcal{L}_\pi \ominus \max(\mathcal{L}_{au})) \oplus \mathcal{L}_{px}) \oplus \mathcal{L}_{pt}) \\
&= (\{\emptyset, u_x, x_x\} \oplus \{iuo, iu, io, uo, i, u, o\}) \oplus \{i, u, iu\} \\
&= \{\emptyset \sqcup i, \emptyset \sqcup u, \emptyset \sqcup o, \emptyset \sqcup iu, \emptyset \sqcup io, \emptyset \sqcup uo, \emptyset \sqcup iuo, \\
&\quad u_x \sqcup i, u_x \sqcup u, u_x \sqcup o, u_x \sqcup iu, u_x \sqcup io, u_x \sqcup uo, u_x \sqcup iuo, \\
&\quad x_x \sqcup i, x_x \sqcup u, x_x \sqcup o, x_x \sqcup iu, x_x \sqcup io, x_x \sqcup uo, x_x \sqcup iuo\} \oplus \{i, u, iu\} \\
&= \{i, u, o, iu, io, uo, iuo, \\
&\quad iu_x, u_x, uo_x, iu_x, iuo_x, uo_x, iuo_x, \\
&\quad ix_x, ux_x, ox_x, iux_x, iox_x, uox_x, iuox_x\} \oplus \{i, u, iu\} \\
&= \{i_x, iu_x, u_x, o_x\} \oplus \{i, u, iu\} \\
&= \{i_x, iu_x, u_x\}
\end{aligned}$$

(22) ***-participant ±proximate +author***

$$\begin{aligned}
\text{a. } & \llbracket -\text{participant}(-\text{proximate}(+\text{author}(\pi))) \rrbracket \\
&= (((\mathcal{L}_\pi \oplus \mathcal{L}_{au}) \ominus \max(\mathcal{L}_{px})) \ominus \max(\mathcal{L}_{pt})) \\
&= (\{i_x, iu_x\} \ominus \{iuo\}) \ominus \{iu\} \\
&= \{i_x \setminus iuo, iu_x \setminus iuo\} \ominus \{iu\} \\
&= \{\emptyset, x'_{x'}\} \ominus \{iu\} \\
&= \{\emptyset, x'_{x'} \setminus iu\} \\
&= \{\emptyset, x'_{x'}\} \\
\text{b. } & \llbracket -\text{participant}(+\text{proximate}(+\text{author}(\pi))) \rrbracket \\
&= (((\mathcal{L}_\pi \oplus \mathcal{L}_{au}) \oplus \mathcal{L}_{px}) \ominus \max(\mathcal{L}_{pt})) \\
&= (\{i_x, iu_x\} \oplus \{iuo, iu, io, uo, i, u, o\}) \ominus \{iu\} \\
&= \{i_x \sqcup i, i_x \sqcup u, i_x \sqcup o, i_x \sqcup iu, i_x \sqcup io, i_x \sqcup uo, i_x \sqcup iuo, \\
&\quad iu_x \sqcup i, iu_x \sqcup u, iu_x \sqcup o, iu_x \sqcup iu, iu_x \sqcup io, iu_x \sqcup uo, iu_x \sqcup iuo\} \ominus \{iu\}
\end{aligned}$$

$$\begin{aligned}
&= \{i_x, iu_x, io_x, iu_x, io_x, iuo_x, iuo_x, \\
&\quad iu_x, iu_x, iuo_x, iu_x, iuo_x, iuo_x, iuo_x\} \ominus \{iu\} \\
&= \{i_x, iu_x\} \ominus \{iu\} \\
&= \{i_x \setminus iu, iu_x \setminus iu\} \\
&= \{\emptyset, o_x, x'_{x'}\}
\end{aligned}$$

(23) **+participant ±proximate +author**

- a. $\llbracket +\text{participant}(-\text{proximate}(+\text{author}(\pi))) \rrbracket$
- $$\begin{aligned}
&= (((\mathcal{L}_\pi \oplus \mathcal{L}_{au}) \ominus \max(\mathcal{L}_{px})) \oplus \mathcal{L}_{pt}) \\
&= (\{i_x, iu_x\} \ominus \{iuo\}) \oplus \{i, u, iu\} \\
&= \{i_x \setminus iuo, iu_x \setminus iuo\} \oplus \{i, u, iu\} \\
&= \{\emptyset, x'_{x'}\} \oplus \{i, u, iu\} \\
&= \{\emptyset \sqcup i, \emptyset \sqcup u, \emptyset \sqcup iu, \\
&\quad x'_{x'} \sqcup i, x'_{x'} \sqcup u, x'_{x'} \sqcup iu\} \\
&= \{i, u, iu, \\
&\quad ix'_{x'}, ux'_{x'}, iux'_{x'}\} \\
&= \{i_{x'}, iu_{x'}, u_{x'}\}
\end{aligned}$$
- b. $\llbracket +\text{participant}(+\text{proximate}(+\text{author}(\pi))) \rrbracket$
- $$\begin{aligned}
&= (((\mathcal{L}_\pi \oplus \mathcal{L}_{au}) \oplus \mathcal{L}_{px}) \oplus \mathcal{L}_{pt}) \\
&= (\{i_x, iu_x\} \oplus \{iuo, iu, io, uo, i, u, o\}) \oplus \{i, u, iu\} \\
&= \{i_x \sqcup i, i_x \sqcup u, i_x \sqcup o, i_x \sqcup iu, i_x \sqcup io, i_x \sqcup uo, i_x \sqcup iuo, \\
&\quad iu_x \sqcup i, iu_x \sqcup u, iu_x \sqcup o, iu_x \sqcup iu, iu_x \sqcup io, iu_x \sqcup uo, iu_x \sqcup iuo\} \oplus \{i, u, iu\} \\
&= \{i_x, iu_x, io_x, iu_x, io_x, iuo_x, iuo_x, \\
&\quad iu_x, iu_x, iuo_x, iu_x, iuo_x, iuo_x, iuo_x\} \oplus \{i, u, iu\} \\
&= \{i_x, iu_x\} \oplus \{i, u, iu\} \\
&= \{i_x \sqcup i, i_x \sqcup u, i_x \sqcup iu, \\
&\quad iu_x \sqcup i, iu_x \sqcup u, iu_x \sqcup iu\} \\
&= \{i_x, iu_x, iu_x,
\end{aligned}$$

$$\begin{aligned}
& iu_x, iu_x, iu_x \} \\
& = \{i_x, iu_x\}
\end{aligned}$$

A.6 \pm participant(\pm author(\pm proximate(π)))

The sixth set is again simplified slightly by taking for granted the action of the proximate lattice on the π lattice.

(24) \pm participant+author+proximate

$$\begin{aligned}
\text{a. } & \llbracket +\text{participant}(+\text{author}(+\text{proximate}(\pi))) \rrbracket \\
& = (((\mathcal{L}_\pi \oplus \mathcal{L}_{px}) \oplus \mathcal{L}_{au}) \oplus \mathcal{L}_{pt}) \\
& = ((\{i_x, iu_x, u_x, o_x\} \oplus \mathcal{L}_{au}) \oplus \mathcal{L}_{pt}) \\
& = ((\{i_x, iu_x, u_x, o_x\} \oplus \{i\}) \oplus \{i, u, iu\}) \\
& = \{i_x \sqcup i, iu_x \sqcup i, u_x \sqcup i, o_x \sqcup i\} \oplus \{i, u, iu\} \\
& = \{i_x, iu_x, iu_x, io_x\} \oplus \{i, u, iu\} \\
& = \{i_x, iu_x\} \oplus \{i, u, iu\} \\
& = \{i_x \sqcup i, i_x \sqcup u, i_x \sqcup iu, \\
& \quad iu_x \sqcup i, iu_x \sqcup u, iu_x \sqcup iu\} \\
& = \{i_x, iu_x, iu_x, \\
& \quad iu_x, iu_x, iu_x\} \\
& = \{i_x, iu_x\} \\
\text{b. } & \llbracket -\text{participant}(+\text{author}(+\text{proximate}(\pi))) \rrbracket \\
& = (((\mathcal{L}_\pi \oplus \mathcal{L}_{px}) \oplus \mathcal{L}_{au}) \ominus \max(\mathcal{L}_{pt})) \\
& = ((\{i_x, iu_x, u_x, o_x\} \oplus \mathcal{L}_{au}) \ominus \max(\mathcal{L}_{pt})) \\
& = ((\{i_x, iu_x, u_x, o_x\} \oplus \{i\}) \ominus \{iu\}) \\
& = \{i_x \sqcup i, iu_x \sqcup i, u_x \sqcup i, o_x \sqcup i\} \ominus \{iu\} \\
& = \{i_x, iu_x, iu_x, io_x\} \ominus \{iu\} \\
& = \{i_x, iu_x\} \ominus \{iu\}
\end{aligned}$$

$$= \{i_x \setminus iu, iu_x \setminus iu\}$$

$$= \{\emptyset, x_x\}$$

(25) \pm *participant*–*author*+*proximate*

a. $\llbracket +\text{participant}(-\text{author}(+\text{proximate}(\pi))) \rrbracket$

$$= (((\mathcal{L}_\pi \oplus \mathcal{L}_{px}) \ominus \max(\mathcal{L}_{au})) \oplus \mathcal{L}_{pt})$$

$$= (\{i_x, iu_x, u_x, o_x\} \ominus \max(\mathcal{L}_{au})) \oplus \mathcal{L}_{pt}$$

$$= (\{i_x, iu_x, u_x, o_x\} \ominus \{i\}) \oplus \{i, u, iu\}$$

$$= \{i_x \setminus i, iu_x \setminus i, u_x \setminus i, o_x \setminus i\} \oplus \{i, u, iu\}$$

$$= \{u_x, x_x\} \oplus \{i, u, iu\}$$

$$= \{u_x \sqcup i, u_x \sqcup u, u_x \sqcup iu,$$

$$x_x \sqcup i, x_x \sqcup u, x_x \sqcup iu\}$$

$$= \{iu_x, u_x, iu_x,$$

$$ix_x, ux_x, iux_x\}$$

$$= \{i_x, iu_x, u_x\}$$

b. $\llbracket -\text{participant}(-\text{author}(+\text{proximate}(\pi))) \rrbracket$

$$= (((\mathcal{L}_\pi \oplus \mathcal{L}_{px}) \ominus \max(\mathcal{L}_{au})) \ominus \max(\mathcal{L}_{pt}))$$

$$= (\{i_x, iu_x, u_x, o_x\} \ominus \max(\mathcal{L}_{au})) \ominus \max(\mathcal{L}_{pt})$$

$$= (\{i_x, iu_x, u_x, o_x\} \ominus \{i\}) \ominus \{iu\}$$

$$= \{i_x \setminus i, iu_x \setminus i, u_x \setminus i, o_x \setminus i\} \ominus \{iu\}$$

$$= \{\emptyset, u_x, x_x\} \ominus \{iu\}$$

$$= \{\emptyset \setminus iu, u_x \setminus iu, x_x \setminus iu\}$$

$$= \{\emptyset, x_x\}$$

(26) \pm *participant*+*author*–*proximate*

a. $\llbracket +\text{participant}(+\text{author}(-\text{proximate}(\pi))) \rrbracket$

$$= (((\mathcal{L}_\pi \ominus \max(\mathcal{L}_{px})) \oplus \mathcal{L}_{au}) \oplus \mathcal{L}_{pt})$$

$$= (\{\emptyset, x'_x\} \oplus \mathcal{L}_{au}) \oplus \mathcal{L}_{pt}$$

$$\begin{aligned}
&= ((\{\emptyset, x'_{x'}\} \oplus \{i\}) \oplus \{i, u, iu\}) \\
&= \{\emptyset \sqcup i, x'_{x'} \sqcup i\} \oplus \{i, u, iu\} \\
&= \{i, ix'_{x'}\} \oplus \{i, u, iu\} \\
&= \{i \sqcup u, i \sqcup i, i \sqcup iu, \\
&\quad ix'_{x'} \sqcup i, ix'_{x'} \sqcup u, ix'_{x'} \sqcup iu\} \\
&= \{iu, i, iu, \\
&\quad ix'_{x'}, iux'_{x'}, iux'_{x'}\} \\
&= \{i_{x'}, iu_{x'}, u_{x'}\}
\end{aligned}$$

b. $\llbracket \text{-participant(+author(-proximate}(\pi))) \rrbracket$

$$\begin{aligned}
&= (((\mathcal{L}_\pi \ominus \max(\mathcal{L}_{px})) \oplus \mathcal{L}_{au}) \ominus \max(\mathcal{L}_{pt})) \\
&= ((\{\emptyset, x'_{x'}\} \oplus \mathcal{L}_{au}) \ominus \max(\mathcal{L}_{pt})) \\
&= ((\{\emptyset, x'_{x'}\} \oplus \{i\}) \ominus \{iu\}) \\
&= \{\emptyset \sqcup i, x'_{x'} \sqcup i\} \ominus \{iu\} \\
&= \{i, ix'_{x'}\} \ominus \{iu\} \\
&= \{i \setminus iu, ix'_{x'} \setminus iu\} \\
&= \{\emptyset, x'_{x'}\}
\end{aligned}$$

(27) \pm *participant–author–proximate*

a. $\llbracket \text{+participant(-author(-proximate}(\pi))) \rrbracket$

$$\begin{aligned}
&= (((\mathcal{L}_\pi \ominus \max(\mathcal{L}_{px})) \ominus \max(\mathcal{L}_{au})) \oplus \mathcal{L}_{pt}) \\
&= ((\{\emptyset, x'_{x'}\} \ominus \max(\mathcal{L}_{au}) \oplus \mathcal{L}_{pt}) \\
&= ((\{\emptyset, x'_{x'}\} \ominus \{i\}) \oplus \{i, u, iu\}) \\
&= \{\emptyset \setminus i, x'_{x'} \setminus i\} \oplus \{i, u, iu\} \\
&= \{\emptyset, x'_{x'}\} \oplus \{i, u, iu\} \\
&= \{\emptyset \sqcup u, \emptyset \sqcup i, \emptyset \sqcup iu, \\
&\quad x'_{x'} \sqcup i, x'_{x'} \sqcup u, x'_{x'} \sqcup iu\} \\
&= \{u, i, iu,
\end{aligned}$$

$$ix'_{x'}, ux'_{x'}, iux'_{x'}\}$$

$$= \{i_{x'}, iu_{x'}, u_{x'}\}$$

b. $\llbracket \neg \text{participant}(\neg \text{author}(\neg \text{proximate}(\pi))) \rrbracket$

$$= (((\mathcal{L}_\pi \ominus \max(\mathcal{L}_{px})) \ominus \max(\mathcal{L}_{au})) \ominus \max(\mathcal{L}_{pt}))$$

$$= ((\{\emptyset, x'_{x'}\} \ominus \max(\mathcal{L}_{au}) \ominus \max(\mathcal{L}_{pt}))$$

$$= ((\{\emptyset, x'_{x'}\} \ominus \{i\}) \ominus \{iu\})$$

$$= \{\emptyset \setminus i, x'_{x'} \setminus i\} \ominus \{iu\}$$

$$= \{\emptyset, x'_{x'}\} \ominus \{iu\}$$

$$= \{\emptyset \setminus iu, x'_{x'} \setminus iu\}$$

$$= \{\emptyset, x'_{x'}\}$$

APPENDIX B

MIXED AND LOCAL ONLY ALIGNMENTS

The main text of Chapter 5 provided a deep-dive into the agreement, movement, and spell-out of the *non-local only* alignments in Border Lakes Ojibwe. In this appendix, I expand the empirical scope beyond the non-local only configurations to the “mixed” configurations, which include both local and non-local persons, as well as the local only configurations. I focus mainly on sketching the proposed agreement and movement relations, leaving a detailed analysis of copying and spell-out to future work.

The widening of empirical scope precipitates two major additions to the theory proposed in the previous section. The first is an added object-licensing probe μ on Voice. I argue that μ has the morphological reflex of object agreement in the theme sign position. Extending the basic proposal of Coon and Preminger (2017), who argue that a special person licensing probe μ is added when there is an unlicensed local object, I argue that the presence of an unlicensed local *or proximate* argument conditions the presence of an added probe on Voice in Ojibwe.¹ The need for an added probe in these cases follows from the proposed extension to the Person Licensing Condition of Béjar

¹Béjar and Rezac (2009), the originators of the added probe, also argue that the probe is added to meet the demands of the PLC. That said, the added probe in their proposal licenses otherwise unlicensed local *subjects* rather than objects. This difference is due to a number of factors, which I name here but do not explore further, including differences in the interpretation of the theme sign and the geometry between the probe and the potential goals.

and Rezac (2003, 2009), given in (1), to include the proximate third person along with the local persons (and to fit with the proposed representation of person features).²

(2) ***Extended Person Licensing Condition (ePLC)***

A DP with set G, where G includes *I*, *U*, or *O* as a member, must be targeted by AGREE with a ρ -probe.

The second addition to the theory is to allow for *genuine* Multiple Agree, in the sense that a single feature of the probe Matches with more than one argument at once. This differs from the case where a probe agrees with multiple arguments, but with different features, as was seen with agreement in the inverse alignments of the previous section. Following Oxford (2019b), Multiple Agree is triggered when two equally matched goals are *equidistant* from the probe. Equidistance occurs when two arguments are in a multiple specifier configuration. I differ from Oxford in the distribution of this configuration, arguing that all mixed and local only configurations result in a multiple specifiers of VoiceP. This is argued to underly the rampant portmanteau agreement on Infl in the mixed and local-only constructions.

B.1 Agreement on Voice and the added probe

For reference, the full set of theme signs is given in Table B.1. There are forms for each of basic person categories (first, second, proximate, and obviative), plus the inverse form, which is analyzed as an elsewhere form and does not index any particular features.

²This is meant to superseded the original PLC in languages with a proximate-obviative distinction. That said, the “Standard” PLC, which can be formulated as in (1), is still assumed to be relevant and active in languages that lack obviation.

(1) ***Standard Person Licensing Condition (sPLC)***

A DP with set G, where G includes *I*, *U* as a member, must be targeted by AGREE with a π -probe.

	Theme Sign
1	-i
2	-in
3	-aa
3'	-im
INV	-igo(o)

Table B.1: Theme sign forms

The distribution of the theme sign for all possible animate argument combinations, including the non-local, local, and mixed alignments, is shown in Table B.2 for the independent and conjunct orders. Focusing on the not-yet-discussed local and mixed cases, the theme sign distribution appears as object agreement with direct alignments and the inverse marker with inverse alignments, as described by the independent and conjunct order hierarchies repeated in (3).

(3) *The PAH for the independent and conjunct orders (repeated)*

- a. *The Independent Hierarchy: 1/2 > 3 > 3'*
- b. *The Conjunct Hierarchy: 1/2/3 > 3'*

An important addendum to this description is that theme sign for the LOCAL → 3' cases includes *both* the obviative theme sign *-im* and proximate theme sign *-aa*. As discussed in detail below, this occurs because the object in this case is in fact a complex possessive DP, which includes both an obviative and proximate noun. Thus it still falls under the broader umbrella of “object” agreement, with the theme sign indexing both the obviative and proximate arguments in this case.

There is one exception with the EXCL → 2SG/PL cases, where the theme sign arises in a form otherwise associated with the impersonal passive *-igoo*, also known as the indefinite actor construction. Note that the regular inverse theme sign also often appears as *-igoo*, but this is due to a phonological alternation conditioned by the presence of peripheral agreement. The difference here is that *-igoo* appears in the absence of

EA/IA	1SG	EXCL	INCL	2SG	2PL	3SG	3PL	3'SG	3'PL
1SG				in	in	aa	aa	im-aa	im-aa
EXCL				igoo	igoo	aa	aa	im-aa	im-aa
INCL						aa	aa	im-aa	im-aa
2SG	i	i				aa	aa	im-aa	im-aa
2PL	i	i				aa	aa	im-aa	im-aa
3SG	igo	igo	igo	igo	igo			aa	aa
3PL	igo	igo	igo	igo	igo			aa	aa
3'SG						igo	igo		
3'PL						igo	igo		

EA/IA	1SG	EXCL	INCL	2SG	2PL	3SG	3PL	3'SG	3'PL
1SG				in	in	aa	aa	im-aa	im-aa
EXCL				igoo	igoo	aa	aa	im-aa	im-aa
INCL						aa	aa	im-aa	im-aa
2SG	i	i				aa	aa	im-aa	im-aa
2PL	i	i				aa	aa	im-aa	im-aa
3SG	i	i	in	in	in			aa	aa
3PL	i	i	in	in	in			aa	aa
3'SG						igo	igo		
3'PL						igo	igo		

Table B.2: Independent (top) and conjunct order (bottom) theme sign distribution

the phonologically conditioned environment. Indeed, the verb form as a whole is ambiguous between an impersonal passive reading and a $EXCL \rightarrow 2SG/PL$ interpretation, as shown in (4) with the second singular (this also holds with the second plural, but is not shown).

(4) *X* \rightarrow 2SG **and** EXCL \rightarrow 2SG *have the same form*

gi- gii- waab -am -igoo
 2- PAST- see -ANIM -PASS
 ‘You were seen (by someone)’ or ‘We (EXCL) saw you’

For the present analysis, this argument alignment will be treated as an accidental paradigm gap that is filled by the use of the impersonal passive, and will not receive a principled explanation within the current analysis (c.f. Hammerly, 2018).

I consider the derivation of inverse marking in the independent $3 \rightarrow LOCAL$ first, as it follows the same form as seen with the inverse in the $3' \rightarrow 3$ alignments. I then turn to the $3 \rightarrow LOCAL$ alignments in the conjunct order, which show object agreement

via the added probe μ instead of inverse. This analysis also covers without adaptation the $\text{LOCAL} \rightarrow 3$ alignments. This leaves the case of $\text{LOCAL} \rightarrow 3'$, where the object is a possessive DP and the theme sign shows a complex of both obviative and proximate marking. I argue this also follows from agreement with the added probe μ .

B.1.1 The inverse with independent $3 \rightarrow \text{LOCAL}$

The appearance of inverse marking with the $3 \rightarrow \text{LOCAL}$ combinations in the independent order receives a similar treatment as seen with the $3' \rightarrow 3$ configurations. This is exemplified with a $3 \rightarrow 1$ combination in (5), where the initial agreement cycle with the proximate EA satisfies $u\text{II}$ and $u\text{Proximate}$, and the second cycle with the first person singular IA satisfies $u\text{Participant}$. This leads both the set of the EA and IA to be copied to the probe. As before, this binary set is spelled-out as the inverse/elsewhere form.

The major difference is that the relativized EPP feature of Voice first triggers movement of both of the agreed with arguments to its specifier, as each one sequentially satisfies a different EPP feature of Voice. This mirrors the satisfaction that occurs within the φ -domain, where the initial agreement relationship between Voice and the proximate EA triggers movement via [EPP: Proximate], while the second agreement relationship triggers movement via [EPP: Participant]. This results in a double specifier configuration, where both the EA and IA are in Spec, VoiceP following this stage of the derivation. This is critical for capturing the patterns of Infl agreement and is a marked distinction from the $3' \rightarrow 3$ inverse alignments, where only the proximate IA was moved to Spec, VoiceP .

(5) *Mixed 3 → 1 alignment leads to gluttony in the independent order*

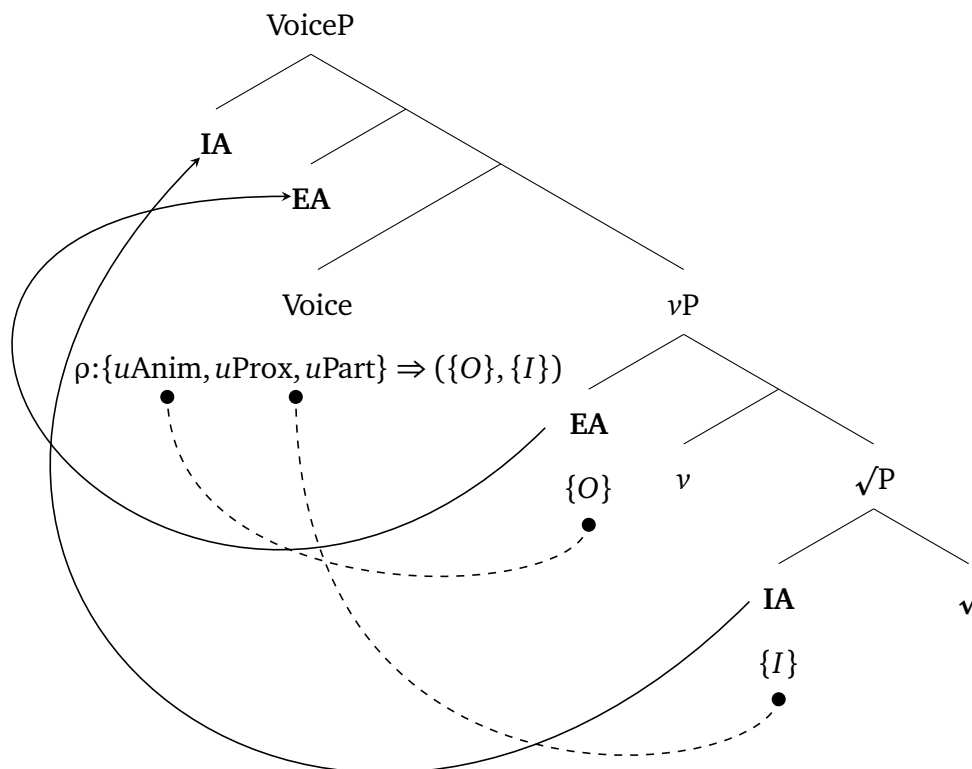

This same basic situation applies throughout the rest of the 3 → LOCAL alignments in the independent order, regardless of what type of local argument occupies the IA position—all will provide a Match for the *uParticipant* feature that is left unsatisfied by the probing of the proximate EA. In all cases, agreement on Voice agreement therefore renders a gluttonous set, leading to the spell-out of the inverse form.

B.1.2 The lack of inverse with conjunct 3 → LOCAL

This basic situation of gluttony in the 3 → LOCAL does *not* occur in the conjunct order, as the probe on Voice is not specified for a *uParticipant* feature. This accounts for the difference in the distribution of the inverse marker in the two orders. As a result, the initial probing by Voice targets the proximate EA, satisfies both the *uAnimate* and *uProximate* features, and moves the proximate EA to Spec,VoiceP, as shown in (6), again with the example of the 3 → 1 alignment.

(6) *Step 1 of mixed 3 → 1 Voice agreement in the conjunct order: EA licensing by the core ρ-probe*

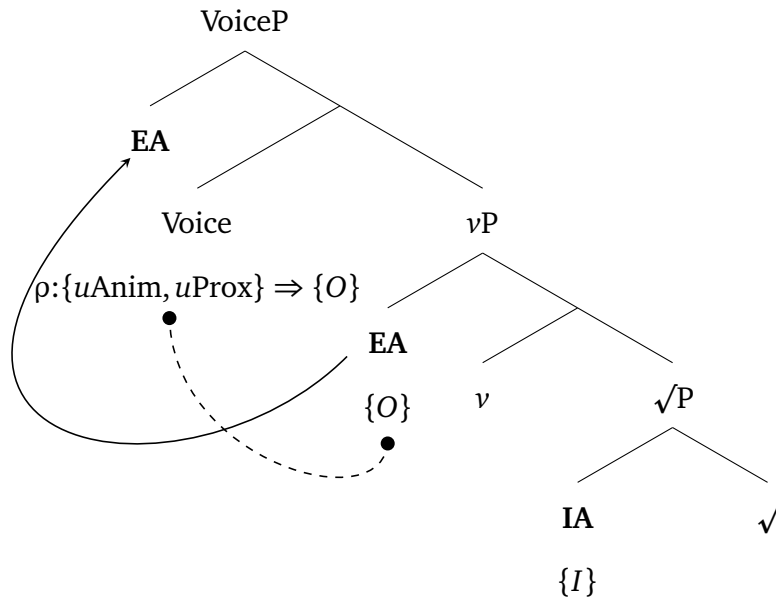

If the probe stopped here, as it did in the 3 → 3' alignments, we would predict the theme sign to take a form consistent with subject agreement. The emergence of a subject agreement pattern is disrupted by the insertion of the added probe μ , which is part of the projection of Voice. In the schematizations that follow, to highlight the presence of μ , I put it as an additional head within the VoiceP projection, but it is formally an added probe in the sense of Béjar and Rezac (2009). The probe enters into the derivation because the first person IA has not entered into an agreement relationship with a proximate-licensing head, and therefore must undergo agreement to prevent a violation of the ePLC, which requires all proximate arguments (those with *I*, *U*, or *O* in their set) to enter into an agreement relationship with the obviation-based ρ -probe. As shown in the lower tree of (7), μ reflects the same articulation as the core probe, agrees with and licenses the first person IA, copies the set $\{I\}$, and moves the IA to the second specifier of VoiceP to satisfy its own separate [EPP: Proximate] feature.

- (7) *Step 2 of mixed 3 → 1 in the conjunct order: IA licensing by the added ρ -probe μ .*

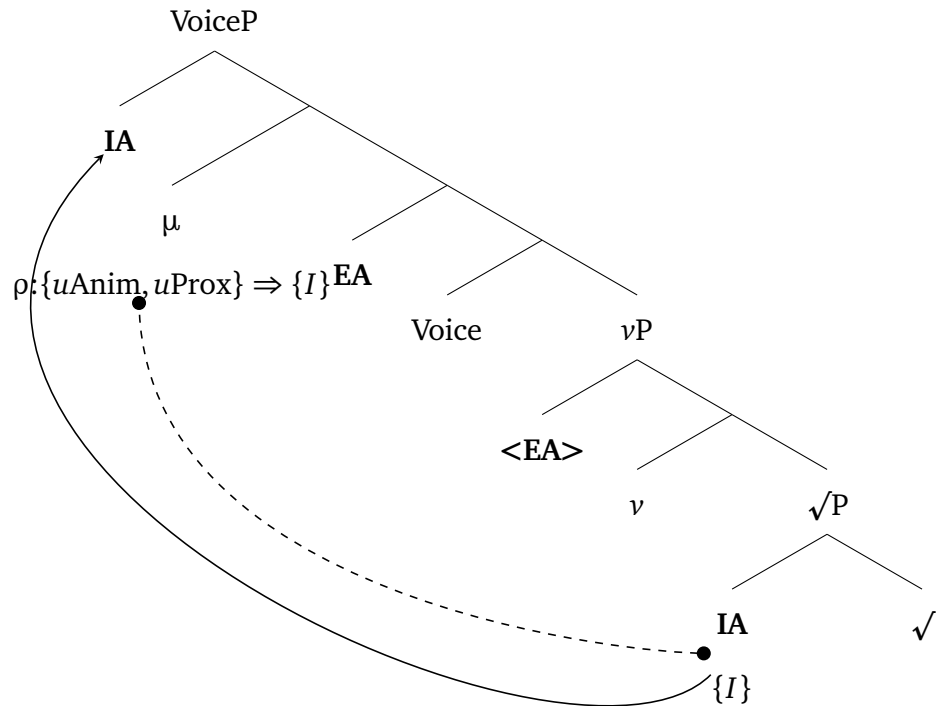

Given this analysis, a first question is why the theme sign is only spelled-out as object agreement with the added probe μ , rather than subject agreement with the initial set produced by agreement with the core probe, or with an inverse form due to the fact that agreement has occurred with both the EA and IA. The latter scenario of spell-out of the inverse can be blocked by the fact that agreement with the EA versus IA occurs with separate probes, rather than two segments of the same probe as in the canonical inverse cases. This difference is laid out in (8).

- (8) a. *Independent order:* Core ρ -probe (Voice) = ($\{O\}, \{I\}$)
 b. *Conjunct order:* Core ρ -probe (Voice) = $\{O\}$; Added ρ -probe (μ) = $\{I\}$

This then leaves the question as why only object agreement of the added probe is spelled out, if the core probe, which has agreed with the subject, is also present. Here it is possible to take advantage of a generalization from Béjar and Rezac (2009), who argue

that the features of the projection that fully deactivates the probe is the locus of spell-out. Here, final deactivation of the probes within the Voice projection occur in the “second cycle”, following the satisfaction of the added probe via agreement with the IA. Therefore only IA agreement (the added probe) is spelled-out.

While the derivation has used the $3 \rightarrow 1$ alignments as the example, this same logic extends to all $3 \rightarrow \text{LOCAL}$ alignments in the independent order, and all $\text{LOCAL} \rightarrow \text{LOCAL}$ alignments regardless of clause type. The reason is that in all of these cases, the EA provides a full match for the core probe on Voice, while at the same time the IA requires licensing to satisfy the ePLC, motivating the insertion of the added probe and giving rise to object agreement. The only part of the paradigm that does not fit neatly into this logic are the $\text{LOCAL} \rightarrow 3'$ alignments, which I turn to now.

B.1.3 The $\text{LOCAL} \rightarrow 3'$ alignments

There is one final piece to deal with that deserves special consideration: Why does object agreement, and by extension the proximate-licensing added probe μ , appear in the $\text{LOCAL} \rightarrow 3'$ configurations? The analysis so far has conditioned the insertion of the added probe on the presence of an unlicensed local or proximate argument. This restricted distribution is particularly motivated by the given analysis of the theme sign as subject agreement in $3 \rightarrow 3'$ alignments. In these cases, the added probe is *not* inserted, and object agreement does *not* arise, because there is no unlicensed proximate or local argument to condition the presence of the probe. The only argument that is not agreed with by a person probe on Voice is the obviative third person, which is not subject to the PLC and therefore is exempt from the need for licensing. At first blush, it seems that the same logic should apply with the $\text{LOCAL} \rightarrow 3'$ alignments, and therefore there should be no object agreement under the present analysis.

The issue turns out to be more complex than the above logic would suggest, due to the nature of the obviative argument that appears within the $\text{LOCAL} \rightarrow 3'$ alignments.

Unlike the 3 → 3' constructions, having a simple obviative DP in this position is ungrammatical, as shown in (9).

- (9) *nin- gikenim -im -aa -n inini-wan
 1- know -3' -3 -3' man-OBV
intended: 'I know the man (OBV)'' [NJ 06.20.18]

The negative judgment in (9) could be from a number of sources. A priori, the most likely source is the general markedness of having an obviative argument out of context with no contrasting proximate argument. This issue can be alleviated by having the obviative argument be a possessive phrase, as shown in (10).

- (10) nin- gii- waabam -im -aa -n Ziibiins o-maamaa-yan
 1- PAST- see -3' -3 -3' Ziibiins.PROX 3-mother-OBV
 'I saw Ziibiin's (PROX) mother (OBV)'' [NJ 11.06.19]

The entire possessive DP *Ziibiins ogiin* is obviative, but it contains within it a proximate possessor DP *Ziibiins*. The precise structure is introduced below. I argue that this proximate nominal must be licensed by an agreement relation, and therefore triggers the insertion of the added probe μ . Given that we have the added probe, we then have to then explain why it shows agreement with the obviative DP instead of the proximate argument, given that μ is ostensibly inserted to license the proximate object via agreement. Relevant to this question is the fact that it is possible for the added probe in these cases to show agreement with *either* the proximate or obviative argument in this construction, as shown with the grammaticality of the two examples in (11), with (11a) repeated from above and (11b) showing the grammaticality of proximate agreement.

- (11) ***Alternation between -imaa and -aa with possessive objects***
 a. nin- gii- waabam -im -aa -n Ziibiins o-maamaa-yan
 1- PAST- see -3' -3 -3' Ziibiins.PROX 3-mother-OBV
 'I saw Ziibiin's (PROX) mother (OBV)''

- b. nin- gii- waabam -aa Ziibiins o-maamaa-yan
 1- PAST- see -3 Ziibiins.PROX 3-mother-OBV
 'I saw Ziibiin's (PROX) mother (OBV)' [NJ 11.06.19]

At present, there are no clear interpretative differences that correspond to the alternation in (11), but further work should be able to tease apart a syntax of possessive phrases in Ojibwe that allows the alternation to have a principled source. For example, it is possible that the alternation corresponds to which noun heads the phrase, similar to the alternation between *the child's mother* versus *the mother of the child* in English. For now, I focus on the analysis of (11a), where the theme sign of interest *-imaa* is present.

I assume a canonical structure for the possessive DP, where the possessor DP is in the specifier of a possessive D, which is spelled-out with the person prefix *o-*. This makes the entire DP obviative, with the possessor DP sitting in the specifier of that larger possessive DP being proximate.

(12) *Possessive DP in Ojibwe*

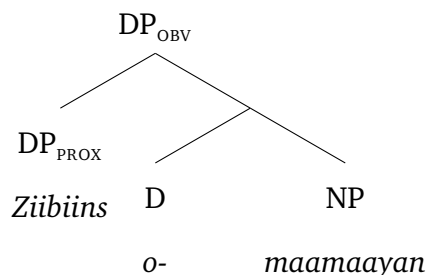

Recall that in the point in the derivation we are focusing on, the core probe on Voice will have been fully checked by agreement with the first person EA, and the added probe μ has entered the derivation to license the proximate argument within the possessive DP. The derivation from here on is schematized in (13). Given the structure in (12), μ will first AGREE with the entire obviative possessive DP. This will only satisfy the $u\text{Anim}$ feature on the added probe, and thus it will probe again, finding the proximate possessor

DP which satisfies the *uProx* feature and licenses the proximate argument, satisfying the ePLC.

$$(13) \quad [\textit{nin-gii-waabam} \textit{-im} \textit{-aa} \textit{-n} [\text{DP}_{(\text{OBV})} [\text{DP}_{(\text{PROX})} \textit{ziibiins}] \textit{omaamaayan}]]$$

The given analysis in (13) asserts that the theme sign *-imaa* is in fact two separate morphemes, an obviative marker *-im* and the already seen proximate marker *-aa*. This is consistent with work in the Algonquianist literature, which has assumed this theme sign to be internally complex, with *-im* (or its cognate across Algonquian languages) to mark and “unpredictively obviative” object—i.e. an obviative argument that occurs in the absence of a proximate subject (Pentland, 1999). It has also been referred to as a supplementary obviative theme sign, that specifically co-occurs with the direct theme sign, as the present analysis also assumes (Nichols, 1980).³

The final piece of the analysis is sorting out why the added probe does not spell out the inverse marker in this case, despite entering into a gluttonous configuration that appears identical to that seen with the $3' \rightarrow 3$ alignments. To review the full picture, the core and added probes are given in (14).

$$(14) \quad \text{Core } \rho\text{-probe (Voice)} = \{I\}; \text{ Added } \rho\text{-probe } (\mu) = (\{O'\}, \{O\})$$

Given that the added probe is the locus of final satisfaction, as explained in detail above, only the added probe will be spelled-out. To account for the lack of inverse in this case, I leverage the fact that gluttony with the $3' \rightarrow 3$ arises on the *core* probe, while in the $\text{LOCAL} \rightarrow 3'$ cases, gluttony occurs on the *added* probe. The proposal, which again follows the possible range of spell-out distinctions leveraged by Béjar and Rezac (2009), is that spell-out need not occur identically on the core and added probes. I propose that unlike the core probe, the added probe in Ojibwe can undergo fission, which allows the

³Thanks to Will Oxford for making me aware of these connections.

two sets of features to be spelled out separately, preventing the insertion of the default inverse marker in these cases and resulting in the sequence of theme signs *-im* followed by *-aa*.

B.2 Agreement on Infl

As in the non-local only alignments, the most important factor for determining agreement on Infl is the configuration produced by Voice. As discussed earlier, the two non-local only configurations had a single argument within its specifier: The direct promoted the proximate EA to this position (15a), and the inverse the proximate IA (15b). In contrast, the mixed and local only alignments, regardless of clause order and argument identity, all converge on a double-specifier configuration, with the EA and IA both sitting in Spec,VoiceP, as shown in (15c).

- (15) a. $[_{IP} \text{ Infl } [_{\text{VoiceP}} \text{ EA } [_{\text{vP}} \langle \text{EA} \rangle \dots \text{IA}]]]$ 3 → 3'
 b. $[_{IP} \text{ Infl } [_{\text{VoiceP}} \text{ IA } [_{\text{vP}} \text{ EA } \dots \langle \text{IA} \rangle]]]$ 3' → 3
 c. $[_{IP} \text{ Infl } [_{\text{VoiceP}} \text{ IA EA } [_{\text{vP}} \langle \text{EA} \rangle \dots \langle \text{IA} \rangle]]]$ MIXED/LOCAL ONLY

I argue that the situation in (15c) gives rise to *genuine Multiple Agree* (Hiraiwa, 2001), in the sense that a single segment on a probe ends up agreeing with more than one argument at once. This can be contrasted with the case where a probe agrees with multiple arguments, with each agreement relation serving to satisfy a distinct feature, as has been seen repeatedly in gluttonous configurations. I assume that genuine Multiple Agree of this type is strictly limited to cases where there are two equidistant goals. I adopt the path-based definition of equidistance put forward by Hornstein (2009), which has been previously applied to the Algonquin dialect of Ojibwe in Oxford (2019b):

(16) *Equidistance* (Hornstein, 2009, p. 40)

A path is the set of maximal projections (XPs) that dominate the target or the launch site

Given that two DPs within a multiple specifier configuration are dominated by the same number of XPs, it follows from (16) that both are equidistant from any given probe. This has the consequence of making Infl agreement in the mixed and non-local configurations *invariably* a function of Multiple Agree. This is schematized abstractly in (17), where any of the current alignments of interest could fill the EA and IA positions.

(17) *Multiple specifiers leads to Multiple AGREE*

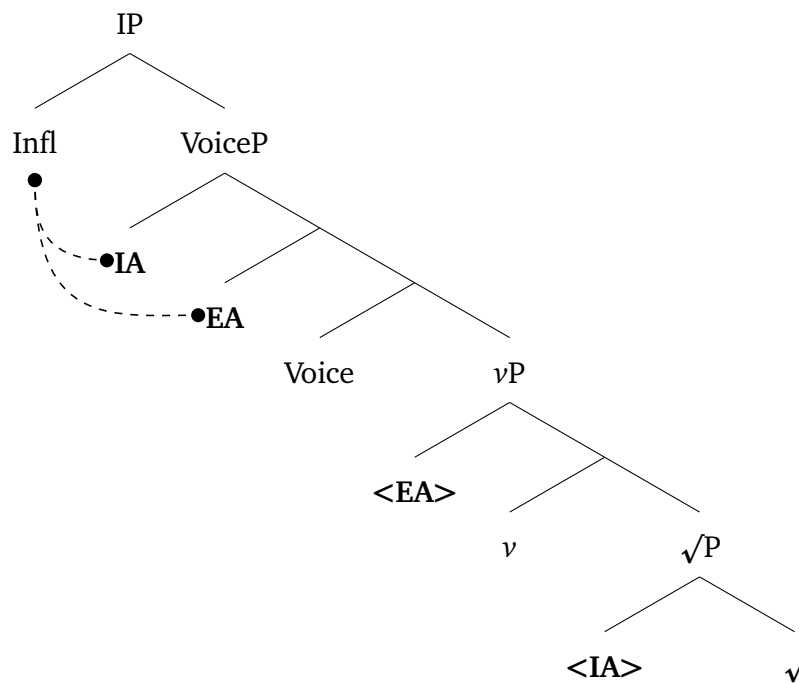

This proposal marks yet another departure from the account of Oxford (2019b), who argues that Multiple Agree occurs with the local-only configurations, but not the mixed configurations, in the independent order. I show that Multiple Agree is motivated in both types of alignments by the difference between Set A and Set B morphology in the independent order, which varies depending on whether Infl has agreed with two local

arguments (Set A) or one local and one non-local argument (Set B) (cf. Despić et al., 2019, for Cheyenne (Plains Algonquian)).

B.2.1 Multiple Agree in the independent order

As mentioned in the introduction, there are two basic forms of local person morphology on Infl, shown on the lefthand side of Table B.3. Following the labels used by Despić et al. (2019) for the cognate sets of morphology in Cheyenne, I adopt the terms Set A and Set B. An addendum to the basic forms of Set A morphology, which only overtly index a single argument, are the true portmanteau forms of Set A morphology, shown on the righthand side of Table B.3.

	Set A	Set B		Portmanteau (Set A)
1SG	<i>ni-∅</i>	<i>ni-∅</i>		
EXCL	<i>ni-imin</i>	<i>ni-aanaa</i>	2SG → EXCL	<i>gi-naam</i>
INCL	<i>gi-imin</i>	<i>gi-aanaa</i>	2PL → EXCL	<i>gi-naam</i>
2SG	<i>gi-∅</i>	<i>gi-∅</i>	1SG → 2PL	<i>gi-inim</i>
2PL	<i>gi-im</i>	<i>gi-waa</i>		

Table B.3: Independent order Infl: Set A versus Set B for local persons

Table B.4 shows where each of these forms appears in the mixed and local only alignments (the non-local alignments are also included for completeness). The general distribution of these two sets can be readily described. Set A appears in the local only alignments, while Set B appears in the mixed alignments.

I adopt the view that the sets copied from each argument are maintained in an ordered set, and furthermore that the multiple specifier configuration has the same order of the EA and IA in all cases being examined here. This requires the assumption that, while equidistant from the point of view of the Search algorithm, the two positions within the multiple specifier configuration are not fully interchangeable. I adopt the convention of representing each set as the ordered set ($\{\pi: \text{EA}\}$, $\{\pi: \text{IA}\}$). Equivalent spell-out rules could be readily formulated for the reverse ordering, as long as it is consistent across all alignments, so the choice is purely aesthetic.

EA/IA	1SG	EXCL	INCL	2SG	2PL	3SG	3PL	3'SG	3'PL
1SG				gi-∅	gi-inim	ni-∅	ni-∅	ni-∅	ni-∅
EXCL				gi-∅	gi-im	ni-aanaa	ni-aanaa	ni-aanaa	ni-aanaa
INCL						gi-aanaa	gi-aanaa	gi-aanaa	gi-aanaa
2SG	gi-∅	gi-naam				gi-∅	gi-∅	gi-∅	gi-∅
2PL	gi-im	gi-naam				gi-waa	gi-waa	gi-waa	gi-waa
3SG	ni-∅	ni-aanaa	gi-aanaa	gi-∅	gi-waa			o-∅	o-∅
3PL	ni-∅	ni-aanaa	gi-aanaa	gi-∅	gi-waa			o-waa	o-waa
3'SG						o-∅	o-waa		
3'PL						o-∅	o-waa		

EA/IA	1SG	EXCL	INCL	2SG	2PL	3SG	3PL	3'SG	3'PL
1SG				Set A	Set A	Set B	Set B	Set B	Set B
EXCL				Set A	Set A	Set B	Set B	Set B	Set B
INCL						Set B	Set B	Set B	Set B
2SG	Set A	Set A				Set B	Set B	Set B	Set B
2PL	Set A	Set A				Set B	Set B	Set B	Set B
3SG	Set B	Set B	Set B	Set B	Set B			Subj	Subj
3PL	Set B	Set B	Set B	Set B	Set B			Subj	Subj
3'SG						Obj	Obj		
3'PL						Obj	Obj		

Table B.4: Independent order VTA Infl (person prefix + central agreement). The portmanteau Set A morphology is indicated in bold

For the time being, I keep the description for rules of Vocabulary Item insertion at a relatively high level. As was the case in the non-local only configurations, both the person and number morphology associated with Infl must be inserted in a single step of the derivation, leading to the same split between the person prefix appearing to the left of the stem, and the number-marking central agreement marker to the right.

The basic contrast between Set A and Set B can then be captured by a rule of the form in (18), which is based closely on the proposal of Despić et al. (2019) for Cheyenne.

(18) *Generalizations for Set A versus Set B VI insertion*

- a. $\{\pi: \text{LOCAL}\} / \{__, \varphi: \text{NON-LOCAL}\} \Leftrightarrow \text{SET B}$
- b. $\{\pi: \text{LOCAL}\} \Leftrightarrow \text{SET A}$

The rule states that if a set contains a local person and a non-local person, regardless of the order of the set, the Set B morphology is associated with the local person is spelled-

out. If there is no non-local person within the set, then the Set A rule (an elsewhere rule) applies.

That said, the rules that govern the insertion of Set A morphology can in turn be specified with more granularity in order to account for cases with and without a portmanteau form. These are given in (19). The first two rules in (19a,b) condition the insertion of the two possible portmanteau forms, and the rules in (19c,d) the non-portmanteau Set A forms.

(19) ***Specific Set A VI insertion rules***

- a. $\{\pi: 2SG/PL\} / (_ , \pi: EXCL) \Leftrightarrow gi- -naam$
- b. $\{\pi: 2PL\} / (\pi: 1SG, _) \Leftrightarrow gi- -inim$
- c. $\{\pi: 2PL\} / (_ , \pi: 1SG) \Leftrightarrow gi- -m$
- d. $\{\pi: 2SG\} \Leftrightarrow gi- -\emptyset$

The difference between the rules in (19b) and (19c) is particularly important, as it provides explicit motivation for the notion that the order of the sets matters and therefore must be preserved when the sets of multiple arguments are copied (see the Preservation of History principle proposed in Chapter 4 for further discussion). When the EA is 1SG and the IA is 2PL, then the portmanteau form appears; the reverse order results in the realization of the regular 2PL form.

A final point about the Set A versus Set B morphology, and the independent order Infl morphology more generally, is that the Set A forms *always show full agreement*. In other words, the expounded form ensures that the number marking of a plural argument is expressed, even if it is within the context of a special portmanteau form. This is not the case in the Set B forms, where a singular/plural distinction in the third persons is systematically absent from the forms, but the number of the local person is expressed if relevant. The consequence is that *full agreement* applies to all local arguments, but not third person arguments—as a result, the Activity Condition does not apply to the

third persons. As such, they are open to be targeted by further agreement operations, most notably C. In contrast, the local arguments are rendered inactive, as their full set of φ -features have been expressed.

B.2.2 Conjunct Order

The conjunct order does not divide as neatly along mixed and local only lines, with no similar distinction between Set A and Set B forms of morphology. The set of forms that governs this slot is shown in Table B.5, and the distribution of these forms across the various alignments is given in Table B.6.

Regular		Portmanteau	
1SG	-aan	1SG → 2PL	-agog
EXCL	-aang	1SG → 3	-ag
INCL	-ang	EXCL ↔ 3	-angid
2SG	-an	2SG → 3	-ad
2PL	-eg		
3	-g		
3PL	-waa		

Table B.5: Conjunct order Infl: regular (left) and portmanteau (right)

EA/IA	1SG	EXCL	INCL	2SG	2PL	3SG	3PL	3'
1SG				aan	agog	ag	ag-waa	ag
EXCL				an	eg	angid	angid-waa	angid
INCL						ang	ang-waa	ang
2SG	an	aang				ad	ad-waa	ad
2PL	eg	aang				eg	eg-waa	eg
3SG	g	angid	ang	d	eg			d
3PL	g-waa	angid-waa	ang-waa	g-waa	eg-waa			g-waa
3'						d	g-waa	

EA/IA	1SG	EXCL	INCL	2SG	2PL	3SG	3PL	3'
1SG				EA	Port	Port	Port + #	Port
EXCL				IA	IA	Port	Port + #	Port
INCL						EA	EA + #	EA
2SG	EA	IA				Port	Port + #	Port
2PL	EA	IA				EA	EA + #	EA
3SG	EA	Port	IA	EA	IA			EA
3PL	EA + #	Port + #	IA + #	EA + #	IA + #			EA + #
3'						IA	IA + #	

Table B.6: Conjunct order VTA Infl (person prefix + central agreement)

I remain at a relatively high level for the current discussion of spell-out rules, leaving the precise specifications to future work. I hope to provide a few of the broader generalizations here. To review, the proposal is that the fused probe on Infl ties together the satisfaction condition of the π -probe and the $\#$ -probe, but the copying algorithm only copies back those sets that match the relevant π or $\#$ segments. This is shown abstractly in (20). The consequence is that π always collects copies of both arguments (both always Match the flat probe), while $\#$ only copies back the sets of plural arguments.

- (20) a. $EA_{SG} + IA_{SG}: \text{Infl} = \{\pi: \{EA, IA\}, \#: \{\emptyset\}\}$
 b. $EA_{PL} + IA_{SG}: \text{Infl} = \{\pi: \{EA, IA\}, \#: \{EA\}\}$
 c. $EA_{SG} + IA_{PL}: \text{Infl} = \{\pi: \{EA, IA\}, \#: \{IA\}\}$
 d. $EA_{PL} + IA_{PL}: \text{Infl} = \{\pi: \{EA, IA\}, \#: \{EA, IA\}\}$

One generalization that must be accounted for is the number marker *-waa* within the central agreement slot is only realized in the presence of a proximate plural argument. With local arguments, number is always realized within a single combined person-number form. Furthermore, within the person slot, there appears to be a general preference for spelling out the EA over the IA, even when the EA is ranked lower on the prominence hierarchy than the IA. The exception is when the IA is plural, where spell-out of the IA takes precedence.

B.3 Agreement on C

In this section, I present the final piece of the transitive animate agreement in Ojibwe: C agreement in the mixed and local only alignments. To review the basics, this slot only appears in the independent order, and always indexes the *lowest* ranked argument within the clause. As discussed with the non-local only alignments, this was always the obviative argument. In the mixed alignments, this is always the non-local argument.

In the local only alignments, the marker does not appear. This distribution is shown in Table B.7.

EA/IA	1SG	EXCL	INCL	2SG	2PL	3SG	3PL	3'SG	3'PL
1SG				—	—	-∅	-g	-n	-'
EXCL				—	—	-∅	-g	-n	-'
INCL						-∅	-g	-n	-'
2SG	—	—				-∅	-g	-n	-'
2PL	—	—				-∅	-g	-n	-'
3SG	-∅	-∅	-∅	-∅	-∅			-n	-'
3PL	-g	-g	-g	-g	-g			-n	-'
3'SG							-n	-n	
3'PL							-'	-'	

EA/IA	1SG	EXCL	INCL	2SG	2PL	3SG	3PL	3'SG	3'PL
1SG				—	—	IA	IA	IA	IA
EXCL				—	—	IA	IA	IA	IA
INCL						IA	IA	IA	IA
2SG	—	—				IA	IA	IA	IA
2PL	—	—				IA	IA	IA	IA
3SG	EA	EA	EA	EA	EA			IA	IA
3PL	EA	EA	EA	EA	EA			IA	IA
3'SG						EA	EA		
3'PL						EA	EA		

Table B.7: Independent order VTA C (peripheral agreement)

The analysis is identical to that given for the non-local only alignments in the main text: C agrees with whatever Infl has not already deactivated. As noted previously, all local arguments are deactivated by Infl, while non-local arguments (in the mixed conditions) are not. This accounts for the fact that C does not appear with the local only configurations, and uniformly indexes the third person proximate argument in the mixed configurations.

APPENDIX C

EXPERIMENTAL STIMULI

This appendix presents the transcription and translation into English for the auditory stimuli used in the study presented in Chapter 6.

Transcription	Translation
<i>ikwe gaa-binaakwe'waad abinoojiinyan</i>	'The woman who is combing the child'
<i>ikwewan gaa-binaakwe'ogod abinoojiinh</i>	'The woman who is combing the child'
<i>ikwe gaa-binaakwe'ogod abinoojiinyan</i>	'The woman who the child is combing'
<i>ikwewan gaa-binaakwe'waad abinoojiinh</i>	'The woman who the child is combing'
<i>abinoojiinh gaa-ginagijiibinaad ininiwan</i>	'The child who is tickling the man'
<i>abinoojiinyan gaa-ginagijiibinigod inini</i>	'The child who is tickling the man'
<i>abinoojiinh gaa-ginagijiibinigod ininiwan</i>	'The child who the man is tickling'
<i>abinoojiinyan gaa-ginagijiibinaad inini</i>	'The child who the man is tickling'
<i>inini gaa-goshko'aad ikwewan</i>	'The man who is surprising the woman'
<i>ininiwan gaa-goshko'ogod ikwe</i>	'The man who is surprising the woman'
<i>inini gaa-goshko'ogod ikwewan</i>	'The man who the woman is surprising'
<i>ininiwan gaa-goshko'aad ikwe</i>	'The man who the woman is surprising'
<i>oshki-inini gaa-nimikawaad oshkiniigkwewan</i>	'The teen boy who is dancing for the teen girl'
<i>oshki-ininiwan gaa-nimikawigod oshkiniigikwe</i>	'The teen boy who is dancing for the teen girl'
<i>oshki-inini gaa-nimikawigod oshkiniigkwewan</i>	'The teen boy who the teen girl is dancing for'
<i>oshki-ininiwan gaa-nimikawaad oshkiniigikwe</i>	'The teen boy who the teen girl is dancing for'
<i>gichi-aya'aa gaa-ojiimaad abinoojiinyan</i>	'The elder who is kissing the child'
<i>gichi-aya'aan gaa-ojiimigod abinoojiinh</i>	'The elder who is kissing the child'
<i>gichi-aya'aa gaa-ojiimigod abinoojiinyan</i>	'The elder who the child is kissing'
<i>gichi-aya'aan gaa-ojiimaad abinoojiinh</i>	'The elder who the child is kissing'
<i>oshkiniigikwe gaa-anamikawaad gichi-aya'aan</i>	'The teen girl who is waving to the elder'
<i>oshkiniigkwewan gaa-anamikawigod gichi-aya'aa</i>	'The teen girl who is waving to the elder'
<i>oshkiniigikwe gaa-anamikawigod gichi-aya'aan</i>	'The teen girl who the elder is waving to'
<i>oshkiniigkwewan gaa-anamikawaad gichi-aya'aa</i>	'The teen girl who the elder is waving to'
<i>ikwe gaa-jiisibinaad oshkiniigkwewan</i>	'The woman who is pinching the teen girl'
<i>ikwewan gaa-jiisibinigod oshkiniigikwe</i>	'The woman who is pinching the teen girl'
<i>ikwe gaa-jiisibinigod oshkiniigkwewan</i>	'The woman who the teen girl is pinching'
<i>ikwewan gaa-jiisibinaad oshkiniigikwe</i>	'The woman who the teen girl is pinching'
<i>abinoojiinh gaa-migwechiwi'aad oshkiniigkwewan</i>	'The child who is thanking the teen girl'
<i>abinoojiinyan gaa-miigwechiwi'igod oshkiniigikwe</i>	'The child who is thanking the teen girl'

abinoojiinh gaa-miigwechiwi'igod oshkiniigkwewan
 abinoojiinyan gaa-migwechiwi'aad oshkiniigkwewan
 inini gaa-binaakwe'waad oshkiniigkwewan
 ininiwan gaa-binaakwe'wigod oshkiniigkwewan
 inini gaa-binaakwe'wigod oshkiniigkwewan
 ininiwan gaa-binaakwe'waad oshkiniigkwewan
 oshki-inini gaa-ginagijiibinaad ikwewan
 oshki-ininiwan gaa-ginagijiibinigod ikwe
 oshki-inini gaa-ginagijiibinigod ikwewan
 oshki-ininiwan gaa-ginagijiibinaad ikwe
 gichi-aya'aa gaa-goshko'aad ininiwan
 gichi-aya'aan gaa-goshko'wigod inini
 gichi-aya'aa gaa-goshko'wigod ininiwan
 gichi-aya'aan gaa-goshko'aad inini
 oshkiniigkwewan gaa-nimikawaad ikwewan
 oshkiniigkwewan gaa-nimikawigod ikwe
 oshkiniigkwewan gaa-nimikawigod ikwewan
 oshkiniigkwewan gaa-nimikawaad ikwe
 ikwe gaa-ojiimaad gichi-aya'aan
 ikwewan gaa-ojiimigod gichi-aya'aa
 ikwe gaa-ojiimigod gichi-aya'aan
 ikwewan gaa-ojiimaad gichi-aya'aa
 abinoojiinh gaa-anamikawaad oshki-ininiwan
 abinoojiinyan gaa-anamikawigod oshki-inini
 abinoojiinh gaa-anamikawigod oshki-ininiwan
 abinoojiinyan gaa-anamikawaad oshki-inini
 inini gaa-jiisibinaad oshki-ininiwan
 ininiwan gaa-jiisibinigod oshki-inini
 inini gaa-jiisibinigod oshki-ininiwan
 ininiwan gaa-jiisibinaad oshki-inini
 oshki-inini gaa-migwechiwi'aad gichi-aya'aan
 oshki-ininiwan gaa-migwechiwi'igod gichi-aya'aa
 oshki-inini gaa-migwechiwi'igod gichi-aya'aan
 oshki-ininiwan gaa-migwechiwi'aad gichi-aya'aa
 gichi-aya'aa gaa-amaji'aad abinoojiinyan
 gichi-aya'aan gaa-amaji'igod abinoojiinh
 gichi-aya'aa gaa-amaji'igod abinoojiinyan
 gichi-aya'aan gaa-amaji'aad abinoojiinh
 oshkiniigkwewan gaa-baapi'aad oshki-ininiwan
 oshkiniigkwewan gaa-baapi'igod oshki-inini
 oshkiniigkwewan gaa-baapi'igod oshki-ininiwan
 oshkiniigkwewan gaa-baapi'aad oshki-inini
 ikwe gaa-mazinaakizwaad ininiwan
 ikwewan gaa-mazinaakizigod inini
 ikwe gaa-mazinaakizigod ininiwan
 ikwewan gaa-mazinaakizwaad inini
 abinoojiinh gaa-biminizha'waad ikwewan
 abinoojiinyan gaa-biminizha'ogod ikwe
 abinoojiinh gaa-biminizha'ogod ikwewan
 abinoojiinyan gaa-biminizha'waad ikwe
 inini gaa-babaaminizhikawaad abinoojiinyan
 ininiwan gaa-babaaminizhikawigod abinoojiinh
 inini gaa-babaaminizhikawigod abinoojiinyan
 ininiwan gaa-babaaminizhikawaad abinoojiinh

'The child who the teen girl is thanking'
 'The child who the teen girl is thanking'
 'The man who is combing the teen girl'
 'The man who is combing the teen girl'
 'The man who the teen girl is combing'
 'The man who the teen girl is combing'
 'The teen boy who is tickling the woman'
 'The teen boy who is tickling the woman'
 'The teen boy who the woman is tickling'
 'The teen boy who the woman is tickling'
 'The elder who is surprising the man'
 'The elder who is surprising the man'
 'The elder who the man is surprising'
 'The elder who the man is surprising'
 'The teen girl who is dancing for the woman'
 'The teen girl who is dancing for the woman'
 'The teen girl who the woman is dancing for'
 'The teen girl who the woman is dancing for'
 'The woman who is kissing the elder'
 'The woman who is kissing the elder'
 'The woman who the elder is kissing'
 'The woman who the elder is kissing'
 'The child who is waving to the teen boy'
 'The child who is waving to the teen boy'
 'The child who the teen boy is waving to'
 'The child who the teen boy is waving to'
 'The man who is pinching the teen boy'
 'The man who is pinching the teen boy'
 'The man who the teen boy is pinching'
 'The man who the teen boy is pinching'
 'The teen boy who is thanking the elder'
 'The teen boy who is thanking the elder'
 'The teen boy who the elder is thanking'
 'The teen boy who the elder is thanking'
 'The elder who is waking up the child'
 'The elder who is waking up the child'
 'The elder who the child is waking up'
 'The elder who the child is waking up'
 'The teen girl who is laughing at the teen boy'
 'The teen girl who is laughing at the teen boy'
 'The teen girl who the teen boy is laughing at'
 'The teen girl who the teen boy is laughing at'
 'The woman who is photographing the man'
 'The woman who is photographing the man'
 'The woman who the man is photographing'
 'The woman who the man is photographing'
 'The child who is following the woman'
 'The child who is following the woman'
 'The child who the woman is following'
 'The child who the woman is following'
 'The man who is chasing the child'
 'The man who is chasing the child'
 'The man who the child is chasing'
 'The man who the child is chasing'

oshki-inini gaa-izhinoo'waad ininiwan
 oshki-ininiwan gaa-izhinoo'igod inini
 oshki-inini gaa-izhinoo'igod ininiwan
 oshki-ininiwan gaa-izhinoo'waad inini
 oshkintiigikwe gaa-ashamaad abinoojiinyan
 oshkintiigikwewan gaa-ashamigod abinoojiinh
 oshkintiigikwe gaa-ashamigod abinoojiinyan
 oshkintiigikwewan gaa-ashamaad abinoojiinh
 gichi-aya'aa gaa-gikinoo'amawaad ikwewan
 gichi-aya'aan gaa-gikinoo'amawigod ikwe
 gichi-aya'aa gaa-gikinoo'amawigod ikwewan
 gichi-aya'aan gaa-gikinoo'amawaad ikwe
 ikwe gaa-migoshkaaji'aad oshki-ininiwan
 ikwewan gaa-migoshkaaji'igod oshki-inini
 ikwe gaa-migoshkaaji'igod oshki-ininiwan
 ikwewan gaa-migoshkaaji'aad oshki-inini
 inini gaa-biindaakoonaad gichi-aya'aan
 ininiwan gaa-biindaakoonigod gichi-aya'aa
 inini gaa-biindaakoonigod gichi-aya'aan
 ininiwan gaa-biindaakoonaad gichi-aya'aa
 abinoojiinh gaa-gagaanjinawe'aad oshki-ininiwan
 abinoojiinyan gaa-gagaanjinawe'igod oshki-inini
 abinoojiinh gaa-gagaanjinawe'igod oshki-ininiwan
 abinoojiinyan gaa-gagaanjinawe'aad oshki-inini
 oshki-inini gaa-daanginaad gichi-aya'aan
 oshki-ininiwan gaa-daanginigod gichi-aya'aa
 oshki-inini gaa-daanginigod gichi-aya'aan
 oshki-ininiwan gaa-daanginaad gichi-aya'aa
 oshkintiigikwe gaa-zinigwaawiganebinaad ikwewan
 oshkintiigikwewan gaa-zinigwaawiganebinogod ikwe
 oshkintiigikwe gaa-zinigwaawiganebinogod ikwewan
 oshkintiigikwewan gaa-zinigwaawiganebinaad ikwe
 gichi-aya'aa gaa-gikinjiinaad oshkintiigikwewan
 gichi-aya'aan gaa-gikinjiinigod oshkintiigikwe
 gichi-aya'aa gaa-gikinjiinigod oshkintiigikwewan
 gichi-aya'aan gaa-gikinjiinaad oshkintiigikwe
 ikwe gaa-gaandinaad ininiwan
 ikwewan gaa-gaandinigod inini
 ikwe gaa-gaandinigod ininiwan
 ikwewan gaa-gaandinaad inini
 abinoojiinh gaa-bakite'waad oshki-ininiwan
 abinoojiinyan gaa-bakite'ogod oshki-inini
 abinoojiinh gaa-bakite'ogod oshki-ininiwan
 abinoojiinyan gaa-bakite'waad oshki-inini

'The teen boy who is pointing at the man'
 'The teen boy who is pointing at the man'
 'The teen boy who the man is pointing at'
 'The teen boy who the man is pointing at'
 'The teen girl who is feeding the child'
 'The teen girl who is feeding the child'
 'The teen girl who the child is feeding'
 'The teen girl who the child is feeding'
 'The elder who is teaching the woman'
 'The elder who is teaching the woman'
 'The elder who the woman is teaching'
 'The elder who the woman is teaching'
 'The woman who is pestering the teen boy'
 'The woman who is pestering the teen boy'
 'The woman who the teen boy is pestering'
 'The woman who the teen boy is pestering'
 'The man who is offering tobacco to the elder'
 'The man who is offering tobacco to the elder'
 'The man who the elder is offering tobacco to'
 'The man who the elder is offering tobacco to'
 'The child who is irritating the teen boy'
 'The child who is irritating the teen boy'
 'The child who the teen boy is irritating'
 'The child who the teen boy is irritating'
 'The teen boy who is touching the elder'
 'The teen boy who is touching the elder'
 'The teen boy who the elder is touching'
 'The teen boy who the elder is touching'
 'The teen girl who is massaging the woman'
 'The teen girl who is massaging the woman'
 'The teen girl the woman is massaging'
 'The teen girl the woman is massaging'
 'The elder who is hugging the teen girl'
 'The elder who is hugging the teen girl'
 'The elder who the teen girl is hugging'
 'The elder who the teen girl is hugging'
 'The woman who is pushing the man'
 'The woman who is pushing the man'
 'The woman who the man is pushing'
 'The woman who the man is pushing'
 'The child who is hitting the teen boy'
 'The child who is hitting the teen boy'
 'The child who the teen boy is hitting'
 'The child who the teen boy is hitting'

BIBLIOGRAPHY

- Aissen, Judith. 1999. Markedness and subject choice in Optimality Theory. *Natural Language & Linguistic Theory* 17:673–711.
- Anagnostopoulou, Elena. 2003. *The syntax of ditransitives: Evidence from clitics*. Berlin: Mouton de Gruyter.
- Anagnostopoulou, Elena. 2017. The person case constraint. *The Wiley Blackwell Companion to Syntax, Second Edition* 1–47.
- Baker, Mark C. 1988. *Incorporation: A theory of grammatical function changing*. Chicago, Illinois: The University of Chicago Press.
- Baker, Mark C. 2008. *The syntax of agreement and concord*. Cambridge University Press.
- Barr, Dale J, Laura Jackson, and Isobel Phillips. 2014. Using a voice to put a name to a face: The psycholinguistics of proper name comprehension. *Journal of Experimental Psychology: General* 143:404–413.
- Béjar, Susana. 2003. Phi-syntax: A theory of agreement. Doctoral Dissertation, University of Toronto.
- Béjar, Susana, and Milan Rezac. 2003. Person licensing and the derivation of PCC effects. *Romance Linguistics: Theory and Acquisition* 49–62.
- Béjar, Susana, and Milan Rezac. 2009. Cyclic agree. *Linguistic Inquiry* 40:35–73.
- Bjorkman, Bronwyn, and Hedde Zeijlstra. 2014. Upward agree is superior. *LingBuzz*, lingbuzz/002350 .
- Bliss, Heather. 2005a. Formalizing point-of-view: The role of sentience in Blackfoot's direct/inverse system. Master's thesis, University of Calgary.
- Bliss, Heather. 2005b. Topic, focus, and point of view in Blackfoot. In *Proceedings of the 24th West Coast Conference on Formal Linguistics*, 61–69. Cascadilla Proceedings Project.
- Bliss, Heather, and Karen Jesney. 2005. Resolving hierarchy conflict: Local obviation in Blackfoot. *Calgary Papers in Linguistics* 26:92–116.

- Bliss, Heather, and Will Oxford. 2017. Patterns of syncretism in nominal paradigms: A pan-Algonquian perspective. In *Papers of the 46th Algonquian Conference*, 1–18.
- Bliss, Heather Anne. 2013. The Blackfoot configurationality conspiracy: Parallels and differences in clausal and nominal structures. Doctoral Dissertation, University of British Columbia.
- Boas, Franz. 1926. Additional notes on the Kutenai language. *International Journal of American Linguistics* 4:85–104.
- Bobaljik, Jonathan David. 2008. Missing persons: A case study in morphological universals. *The Linguistic Review* 25:203–230.
- Bock, J Kathryn, and Richard K Warren. 1985. Conceptual accessibility and syntactic structure in sentence formulation. *Cognition* 21:47–67.
- Bonet, Eulalia. 1991. Morphology after syntax: Pronominal clitics in Romance. Doctoral Dissertation, MIT.
- Borer, Hagit. 2005. *Structuring sense, volume 2: The normal course of events*. Oxford: Oxford University Press.
- Bornkessel, Ina. 2002. The argument dependency model: A neurocognitive approach to incremental interpretation. Doctoral Dissertation, Max Planck Institute of Cognitive Neuroscience Leipzig.
- Bornkessel, Ina, and Matthias Schlesewsky. 2006. The extended argument dependency model: a neurocognitive approach to sentence comprehension across languages. *Psychological Review* 113:787–821.
- Bornkessel-Schlesewsky, Ina, and Matthias Schlesewsky. 2008. An alternative perspective on “semantic P600” effects in language comprehension. *Brain research reviews* 59:55–73.
- Bornkessel-Schlesewsky, Ina, and Matthias Schlesewsky. 2009. The role of prominence information in the real-time comprehension of transitive constructions: a cross-linguistic approach. *Language and Linguistics Compass* 3:19–58.
- Bošković, Željko. 2007. On the locality and motivation of move and agree: An even more minimal theory. *Linguistic Inquiry* 38:589–644.
- Bossong, Georg. 1991. Differential object marking in Romance and beyond. *New analyses in Romance linguistics* 143–170.
- Branan, Kenyon. 2018. Attraction at a Distance: \bar{A} -movement and Case. *Linguistic Inquiry* 49:409–440.
- Bruening, Benjamin. 2001. QR obeys superiority: Frozen scope and ACD. *Linguistic Inquiry* 32:233–273.

- Bruening, Benjamin. 2005. The Algonquian inverse is syntactic: Binding in Pas-samaquoddy. *Manuscript, University of Delaware* .
- Bruening, Benjamin. 2010. Ditransitive asymmetries and a theory of idiom formation. *Linguistic Inquiry* 41:519–562.
- Bruening, Benjamin. 2019. The Algonquian prefix is an affix, not a clitic: Implications for morphosyntax. *Manuscript, University of Delaware*.
- Carreiras, Manuel, Jon Andoni Duñabeitia, Marta Vergara, Irene De La Cruz-Pavía, and Itziar Laka. 2010. Subject relative clauses are not universally easier to process: Evidence from Basque. *Cognition* 115:79–92.
- Chierchia, Gennaro. 1998. Plurality of mass nouns and the notion of ‘semantic parameter’. In *Events and grammar*, ed. Susan Rothstein, 53–103. Dordrecht: Kluwer.
- Chomsky, Noam. 1957. *Syntactic structures*. Mouton.
- Chomsky, Noam. 1965. *Aspects of the theory of syntax*. MIT press.
- Chomsky, Noam. 1995. *The minimalist program*. Cambridge University Press.
- Chomsky, Noam. 2000. Minimalist inquiries: The framework. In *Step by step: Essays on minimalist syntax in honor of Howard Lasnik*, ed. Roger Martin, David Michaels, and Juan Uriagereka, 89–156. MIT Press.
- Chomsky, Noam. 2001. Derivation by phase. In *Ken Hale: A life in linguistics*, ed. Michael Kenstowicz, 1–52. MIT Press.
- Christianson, Kiel, and Hee Youn Cho. 2009. Interpreting null pronouns (pro) in isolated sentences. *Lingua* 119:989–1008.
- Christianson, Kiel, and Fernanda Ferreira. 2005. Conceptual accessibility and sentence production in a free word order language (Odawa). *Cognition* 98:105–135.
- Chung, Sandra. 1998. *The design of agreement: Evidence from Chamorro*. University of Chicago Press.
- Clarke, Sandra. 1982. *Northwest river (Sheshatshit) Montagnais: A grammatical sketch*. University of Ottawa Press.
- Clemens, Lauren Eby, Jessica Coon, Pedro Mateo Pedro, Adam Milton Morgan, Maria Polinsky, Gabrielle Tandet, and Matthew Wagers. 2015. Ergativity and the complexity of extraction: A view from mayan. *Natural Language & Linguistic Theory* 33:417–467.
- Clements, George N. 2001. Representational economy in constraint-based phonology. In *Distinctive feature theory*, ed. T. Alan Hall, 71–146. Berlin: Mouton de Gruyter.

- Clifton, Charles, Matthew J Traxler, Mohamed Taha Mohamed, Rihana S Williams, Robin K Morris, and Keith Rayner. 2003. The use of thematic role information in parsing: Syntactic processing autonomy revisited. *Journal of Memory and Language* 49:317–334.
- Clothier-Goldschmidt, Scarlett, and Matt Wagers. 2017. Persons, pronouns and processing asymmetries. In *Asking the right questions: Essays in honor of Sandra Chung*. UC Santa Cruz.
- Collins, Chris. 2005. A smuggling approach to the passive in English. *Syntax* 8:81–120.
- Comrie, Bernard. 1989. *Language universals and linguistic typology: Syntax and morphology*. University of Chicago press.
- Coon, Jessica, and Alan Bale. 2014. The interaction of person and number in Mi'gmaq. *Nordlyd* 41:85–101.
- Coon, Jessica, and Stefan Keine. 2020. Feature gluttony. Ms., McGill University and University of Southern California.
- Coon, Jessica, and Omer Preminger. 2017. *Split ergativity is not about ergativity*, 226–252. Oxford University Press.
- Cowper, Elizabeth, and Daniel Currie Hall. 2019. Scope variation in contrastive hierarchies of morphosyntactic features. In *Variable properties in language: Their nature and acquisition*, ed. David Lightfoot and Jon Havenhill, 27–41. Georgetown University Press.
- Crain, Stephen, and Janet Dean Fodor. 1985. How can grammars help parsers? In *Natural language parsing*, ed. David Dowty, Lauri Karttunen, and Arnold Zwicky, 94–128. Cambridge University Press.
- Cysouw, Michael. 2003. *The paradigmatic structure of person marking*. Oxford University Press.
- Danon, Gabi. 2011. Agreement and DP-internal feature distribution. *Syntax* 14:297–317.
- Dawe-Sheppard, Audrey, and John Hewson. 1990. Person and gender hierarchies in Micmac. *Journal of the Atlantic Provinces Linguistic Association* 1–12.
- Deal, Amy Rose. 2015. Interaction and satisfaction in φ -agreement. In *Proceedings of NELS*, volume 45.
- Deal, Amy Rose. 2020. Interaction, satisfaction, and the PCC. Manuscript, UC Berkeley.
- Déchaine, Rose-Marie, and Martina Wiltschko. 2002. Decomposing pronouns. *Linguistic inquiry* 33:409–442.

- DeLancey, Scott. 1981. An interpretation of split ergativity and related patterns. *Language* 626–657.
- Despić, Miloje, Michael David Hamilton, and Sarah E Murray. 2019. A cyclic and multiple agree account. *Natural Language & Linguistic Theory* 37:51–89.
- DeVincenzi, Marica. 1991. *Syntactic parsing strategies in Italian: The minimal chain principle*, volume 12. Springer Science & Business Media.
- Dixon, Robert MW. 1994. *Ergativity*. Cambridge University Press.
- Dresher, B Elan. 2009. *The contrastive hierarchy in phonology*. Cambridge: Cambridge University Press.
- Dresher, B. Elan. 2018. Contrastive hierarchy theory and the nature of features. In *Proceedings of the 35th West Coast Conference on Formal Linguistics*, 18–29.
- Dryer, Matthew. 1994. The discourse function of the Kutenai inverse. In *Voice and inversion*, ed. Thomas Givón, 65–99. Amsterdam: John Benjamins Publishing Company.
- Dryer, Matthew. 1997. Obviation across clause boundaries in Kutenai. In *Kansas working papers in linguistics*, volume 22, 33–52. Linguistics Graduate Student Association.
- Farkas, Donka, and Kostas Kazazis. 1980. Clitic pronouns and topicality in rumanian. In *Papers from the 16th Regional Meeting, Chicago Linguistics Society*, 16, 75–82.
- Ferreira, Fernanda. 2003. The misinterpretation of noncanonical sentences. *Cognitive psychology* 47:164–203.
- Ferreira, Fernanda, and Charles Clifton. 1986. The independence of syntactic processing. *Journal of Memory and Language* 25:348–368.
- Foley, Steven, and Maziar Toosarvandani. 2019. Agreement, locality, and the syntax of pronouns: The person–case constraint and beyond. Manuscript, University of California Santa Cruz.
- Frampton, John, and Sam Gutmann. 2006. How sentences grow in the mind. *Agreement systems* 121–157.
- Frantz, Donald. 1991. *Blackfoot grammar*. University of Toronto Press.
- Frazier, Lyn. 1979. On comprehending sentences: syntactic parsing strategies. Doctoral Dissertation, University of Connecticut.
- Frazier, Lyn. 1987. Syntactic processing: evidence from Dutch. *Natural Language & Linguistic Theory* 5:519–559.
- Frazier, Lyn, and Janet Dean Fodor. 1978. The sausage machine: A new two-stage parsing model. *Cognition* 6:291–325.

- Frazier, Lyn, and Keith Rayner. 1982. Making and correcting errors during sentence comprehension: Eye movements in the analysis of structurally ambiguous sentences. *Cognitive psychology* 14:178–210.
- Frisch, Stefan, and Matthias Schlesewsky. 2001. The N400 reflects problems of thematic hierarchizing. *NeuroReport* 12:3391–3394.
- Futrell, Richard, Roger P Levy, and Edward Gibson. 2020. Dependency locality as an explanatory principle for word order. *Language* 96:371–412.
- Gennari, Silvia P, and Maryellen C MacDonald. 2008. Semantic indeterminacy in object relative clauses. *Journal of memory and language* 58:161–187.
- Gennari, Silvia P, and Maryellen C MacDonald. 2009. Linking production and comprehension processes: The case of relative clauses. *Cognition* 111:1–23.
- Gennari, Silvia P, Jelena Mirković, and Maryellen C MacDonald. 2012. Animacy and competition in relative clause production: A cross-linguistic investigation. *Cognitive psychology* 65:141–176.
- Gerds, Donna B. 1988. A nominal hierarchy in halkomelem clausal organization. *Anthropological Linguistics* 20–36.
- Gibson, Edward. 1998. Linguistic complexity: Locality of syntactic dependencies. *Cognition* 68:1–76.
- Gibson, Edward. 2000. The dependency locality theory: A distance-based theory of linguistic complexity. In *Image, language, brain*, ed. Alec Marantz, Yasushi Miyashita, and Wayne O’Neil, 95–126. MIT Press.
- Goddard, Ives. 1975. Algonquian, Wiyot, and Yurok: Proving a distant genetic relationship. In *Linguistics and anthropology in honor of CF Voegelin*, ed. M. Dale Kinkade, Kenneth L. Hale, and Oswald Werner, 249–262. Lisse: Peter de Ridder Press.
- Goddard, Ives. 1980. Eastern Algonquian as a genetic subgroup. In *Papers of the 11th Algonquian Conference*, ed. William Cowan, 143–158. Ottawa: Carleton University.
- Goddard, Ives. 1994. The west-to-east cline in Algonquian dialectology. In *Papers of the 25th Algonquian Conference*, ed. William Cowan, 187–211. Ottawa: Carleton University.
- Goddard, Ives. 2015. Blackfoot and core Algonquian inflectional morphology: Archaisms and innovations. Paper presented at the 47th Algonquian Conference, Winnipeg, October 23.
- Goldwater, Sharon, and Mark Johnson. 2003. Learning of constraint rankings using a maximum entropy model. In *Proceedings of the Stockholm workshop on variation within Optimality Theory*.

- Gordon, Peter C, Randall Hendrick, and Marcus Johnson. 2001. Memory interference during language processing. *Journal of experimental psychology: learning, memory, and cognition* 27:1411–1423.
- Haas, Mary R. 1958. Algonkian-Ritwan: The end of a controversy. *International Journal of American Linguistics* 24:159–173.
- Hale, John. 2001. A probabilistic earley parser as a psycholinguistic model. In *Second Meeting of the North American Chapter of the Association for Computational Linguistics*.
- Hale, John. 2006. Uncertainty about the rest of the sentence. *Cognitive Science* 30:643–672.
- Hall, Daniel Currie. 2007. The role and representation of contrast in phonological theory. Doctoral Dissertation, University of Toronto.
- Halle, Morris. 1997. Distributed morphology: Impoverishment and fission. In *Papers at the interface*, ed. Benjamin Bruening, Yoonjung Kang, and Martha McGinnis, volume 30, 425–449. MIT Working Papers in Linguistics.
- Halpert, Claire. 2019. Raising, unphased. *Natural Language & Linguistic Theory* 37:123–165.
- Hammerly, Christopher. 2018. What ‘other people’ mean to ‘us’. In *A festschrift for Peggy Speas*, ed. Rodcia Ivan. Graduate Linguistics Student Association, University of Massachusetts.
- Hammerly, Christopher. 2019a. Limiting gender. In *Gender and noun classification*, ed. Éric Mathieu, Myriam Dali, and Gita Zareikar. Oxford University Press.
- Hammerly, Christopher. 2019b. A verb-raising analysis of the Ojibwe VOS/VSO alternation. UMass Amherst.
- Hammerly, Christopher, and Alex Göbel. 2019. A new perspective on obviation in Ojibwe from attitude contexts. In *Linguistics Society of America*.
- Harbour, Daniel. 2008. Discontinuous agreement and the syntax-morphology interface. In *Phi theory: Phi-features across modules and interfaces*, 185–220. Oxford University Press.
- Harbour, Daniel. 2014. Paucity, abundance, and the theory of number. *Language* 185–229.
- Harbour, Daniel. 2016. *Impossible persons*. MIT Press.
- Harley, Heidi. 1997. If you have, you can give. In *Proceedings of the 15th West Coast Conference on Formal Linguistics*, 193–207.
- Harley, Heidi. 2002. Possession and the double object construction. *Linguistic variation yearbook* 2:31–70.

- Harley, Heidi. 2011. A minimalist approach to argument structure. In *The oxford handbook of linguistic minimalism*. Oxford University Press.
- Harley, Heidi, and Elizabeth Ritter. 2002. Person and number in pronouns: A feature-geometric analysis. *Language* 78:482–526.
- Heider, Paul M, Jeruen E Dery, and Douglas Roland. 2014. The processing of *it* object relative clauses: Evidence against a fine-grained frequency account. *Journal of Memory and Language* 75:58–76.
- Heim, Irene, and Angelika Kratzer. 1998. *Semantics in generative grammar*. Blackwell Oxford.
- Hiraiwa, Ken. 2001. Multiple agree and the defective intervention constraint in Japanese. *MIT working papers in linguistics* 40:67–80.
- Hoggarth, Leslie. 2004. *Contributions to Cuzco Quechua grammar*. Förderverein Bonner Amerikanistische Studien, Institut für Altamerikanistik.
- Hornstein, Norbert. 2009. *A theory of syntax: Minimal operations and universal grammar*. Cambridge University Press.
- Huang, Yujing, and Jesse Snedeker. 2020. Evidence from the visual world paradigm raises questions about unaccusativity and growth curve analyses. *Cognition* 200.
- Just, Marcel A, and Patricia A Carpenter. 1992. A capacity theory of comprehension: individual differences in working memory. *Psychological Review* 99:122.
- Keenan, Edward L, and Bernard Comrie. 1977. Noun phrase accessibility and universal grammar. *Linguistic inquiry* 8:63–99.
- Kramer, Ruth. 2014. Gender in Amharic: A morphosyntactic approach to natural and grammatical gender. *Language Sciences* 43:102–115.
- Kramer, Ruth. 2015. *The morphosyntax of gender: Evidence from Amharic*. Oxford University Press.
- Kwon, Nayoung, Yoonhyoung Lee, Peter C Gordon, Robert Kluender, and Maria Polinsky. 2010. Cognitive and linguistic factors affecting subject/object asymmetry: An eye-tracking study of prenominal relative clauses in Korean. *Language* 546–582.
- Lee, Ming-Wei. 2004. Another look at the role of empty categories in sentence processing (and grammar). *Journal of Psycholinguistic Research* 33:51–73.
- Levy, Roger. 2008. Expectation-based syntactic comprehension. *Cognition* 106:1126–1177.
- Lewis, Richard L, and Shravan Vasishth. 2005. An activation-based model of sentence processing as skilled memory retrieval. *Cognitive science* 29:375–419.

- Link, Godehard. 1983. The logical analysis of plurals and mass terms: A lattice- theoretical approach. In *Meaning, use and interpretation of language*, ed. Rainer Bäuerle, Christoph Schwarze, and Arnim von Stechow, 302–323. Berlin: Walter de Gruyter.
- Macaulay, Monica. 2009. On prominence hierarchies: Evidence from Algonquian. *Linguistic Typology* 13:357–389.
- MacDonald, Maryellen C, Neal J Pearlmutter, and Mark S Seidenberg. 1994. The lexical nature of syntactic ambiguity resolution. *Psychological Review* 101:676.
- Mak, Willem M, Wietske Vonk, and Herbert Schriefers. 2002. The influence of animacy on relative clause processing. *Journal of memory and language* 47:50–68.
- Manzini, M Rita, and Kenneth Wexler. 1987. Parameters, binding theory, and learnability. *Linguistic inquiry* 413–444.
- Mast, S. 1988. Aspects of Kutenai morphology. Master's thesis, University of Pittsburgh.
- McCloskey, Jim. 1997. Subjecthood and subject positions. In *Elements of grammar*, 197–235. Springer.
- McGinnis, Martha. 2005. On markedness asymmetries in person and number. *Language* 699–718.
- Muralikrishnan, Ramasamy, Matthias Schlesewsky, and Ina Bornkessel-Schlesewsky. 2008. Universal and cross-linguistic influences on the processing of word order and animacy: Neurophysiological evidence from Tamil. In *21st Annual CUNY Conference on Human Sentence Processing*.
- Myler, Neil. 2017. Cliticization feeds agreement: a view from Quechua. *Natural Language & Linguistic Theory* 35:751–800.
- Nevins, Andrew. 2011. Multiple agree with clitics: Person complementarity vs. omnivorous number. *Natural Language & Linguistic Theory* 29:939–971.
- Nichols, John. 1980. Ojibwa morphology. Doctoral Dissertation, Harvard University.
- Norris, Mark. 2014. A theory of nominal concord. Doctoral Dissertation, UC Santa Cruz.
- Norris, Mark. 2017. Description and analyses of nominal concord (part I). *Language and Linguistics Compass* 11.
- Norris, Mark. 2019. A typological perspective on nominal concord. In *Proceedings of the Linguistic Society of America*, volume 4, 1–15.
- Noyer, Robert Rolf. 1992. Features, positions and affixes in autonomous morphological structure. Doctoral Dissertation, Massachusetts Institute of Technology.
- O'Grady, William. 1997. *Syntactic development*. University of Chicago Press.

- Ono, Hajime, Koichi Otaki, Manami Sato, Peseti Ve'a, Yuko Otsuka, Masatoshi Koizumi, et al. 2020. Relative clause processing in Tongan: an effect of syntactic ergativity on the object preference. In *Proceedings of the Twenty-Sixth Meeting of the Austronesian Formal Linguistics Association*, ed. Ileana Paul.
- Oxford, Will. 2014. Microparameters of agreement: A diachronic perspective on Algonquian verb inflection. Doctoral Dissertation, University of Toronto.
- Oxford, Will. 2017. Size matters: Deriving person hierarchies from nominal structure. Unpublished Manuscript, University of Manitoba.
- Oxford, Will. 2019a. Algonquian. In *Routledge handbook of North American languages*, ed. Daniel Siddiqi, Michael Barrie, Carrie Gillon, Jason Haugen, and Eric Mathieu. Routledge.
- Oxford, Will. 2019b. Inverse marking and multiple agree in Algonquin. *Natural Language & Linguistic Theory* 37:955–996.
- Pancheva, Roumyana, and Maria Luisa Zubizarreta. 2017. The person case constraint. *Natural Language & Linguistic Theory* 1–47.
- Pater, Joe. 2009. Weighted constraints in generative linguistics. *Cognitive Science* 33:999–1035.
- Pentland, David. 1979. Algonquian historical phonology. Doctoral Dissertation, University of Toronto.
- Pentland, David. 1999. The morphology of the Algonquian independent order. In *Papers of the 30th Algonquian conference*, ed. David Pentland, 222–266. Winnipeg: University of Manitoba.
- Pesarin, F. 2001. *Multivariate permutation tests: With applications in biostatistics*. Chichester, England: Wiley.
- Pesetsky, David, and Esther Torrego. 2007. The syntax of valuation and the interpretability of features. *Phrasal and clausal architecture: Syntactic derivation and interpretation* 262–294.
- Philipp, Markus, Ina Bornkessel-Schlesewsky, Walter Bisang, and Matthias Schlewsky. 2008. The role of animacy in the real time comprehension of Mandarin Chinese: Evidence from auditory event-related brain potentials. *Brain and Language* 105:112–133.
- Picallo, Carme M. 1991. Nominals and nominalizations in Catalan. *Probus* 3:279–316.
- Polinsky, Maria, Carlos Gómez Gallo, Peter Graff, and Ekaterina Kravtchenko. 2012. Subject preference and ergativity. *Lingua* 122:267–277.
- Preminger, Omer. 2009. Breaking agreements: Distinguishing agreement and clitic doubling by their failures. *Linguistic Inquiry* 40:619–666.

- Preminger, Omer. 2011. Agreement as a fallible operation. Doctoral Dissertation, MIT.
- Preminger, Omer. 2014. *Agreement and its failures*. MIT Press.
- Preminger, Omer. 2019. What the PCC tells us about “abstract” agreement, head movement, and locality. *Glossa* 4.
- Prince, Alan, and Paul Smolensky. 1993. Optimality Theory: Constraint interaction in generative grammar. Technical report, Rutgers University Center for Cognitive Science, Piscataway, NJ.
- Rackowski, Andrea, and Norvin Richards. 2005. Phase edge and extraction: A Tagalog case study. *Linguistic Inquiry* 565–599.
- Rayner, Keith, Marcia Carlson, and Lyn Frazier. 1983. The interaction of syntax and semantics during sentence processing: Eye movements in the analysis of semantically biased sentences. *Journal of verbal learning and verbal behavior* 22:358–374.
- Reali, Florencia, and Morten H Christiansen. 2007. Processing of relative clauses is made easier by frequency of occurrence. *Journal of memory and language* 57:1–23.
- Riccomini, Kate. 2016. The semantics of Ojibwe theme signs, verb finals, and argument structure. Ms., University of Ottawa.
- Ritter, Elizabeth. 1991. Two functional categories in noun phrases: Evidence from Modern Hebrew. *Syntax and semantics* 25:37–62.
- Ritter, Elizabeth. 1993. Where’s gender? *Linguistic Inquiry* 24:795–803.
- Roversi, Giovanni. 2020. How to satisfy probes: person/number hierarchy effects in Äiwoo. In *Proceedings of NELS 50*.
- Salmaso, Luigi. 2003. Synchronized permutation tests in 2^k factorial designs. *Communications in Statistics-Theory and Methods* 32:1419–1437.
- Sapir, Edward. 1913. Wiyot and Yurok, Algonkin languages of California. *American Anthropologist* 15.
- Sapir, Edward. 1923. The Algonkin affinity of Yurok and Wiyot kinship terms. *Journal de la Société des Américanistes de Paris* 15.
- Sauppe, Sebastian. 2017. Symmetrical and asymmetrical voice systems and processing load: Pupillometric evidence from sentence production in Tagalog and German. *Language* 93:288–313.
- Schlesewsky, Matthias, and Ina Bornkessel. 2004. On incremental interpretation: Degrees of meaning accessed during sentence comprehension. *Lingua* 114:1213–1234.
- Shibatani, Masayoshi. 1990. *The languages of Japan*. Cambridge University Press.

- Siebert, Frank T. Jr. 1967. The original home of the Proto-Algonquian people. In *Contributions to Anthropology: Linguistics I (Algonquian)*, ed. A. D. DeBlois, 13–47. National Museum of Canada Bulletin 214, Ottawa.
- Silverstein, Martin. 1976. Hierarchy of features and ergativity. In *Grammatical categories in Australian languages*, ed. R.M.W. Dixon. Canberra, Australian Institute of Aboriginal Studies and New Jersey Humanities Press.
- Smolensky, Paul, and Géraldine Legendre. 2006. *The harmonic mind: From neural computation to optimality-theoretic grammar (cognitive architecture)*, vol. 1. MIT press.
- Staub, Adrian. 2009. On the interpretation of the number attraction effect: Response time evidence. *Journal of Memory and Language* 60:308–327.
- Staub, Adrian. 2010. Eye movements and processing difficulty in object relative clauses. *Cognition* 116:71–86.
- Stegovec, Adrian. 2020. Taking case out of the person-case constraint. *Natural Language & Linguistic Theory* 38:261–311.
- Stone, Kate, Sol Lago, and Daniel Schad. 2020. Divergence point analyses of visual world data: applications to bilingual research. OSF Preprints: <https://osf.io/t4fwk/>.
- Stowe, Laurie A. 1986. Parsing *wh*-constructions: Evidence for on-line gap location. *Language and cognitive processes* 1:227–245.
- Sullivan, Michael. 2016a. Making statements in Ojibwe: A survey of word order in spontaneous sentences. In *Papers of the Forty-Fourth Algonquian Conference: Actes du Congrès des Algonquinistes*, 329. SUNY Press.
- Sullivan, Michael D. 2016b. Relativization in Ojibwe. Doctoral Dissertation, University of Minnesota.
- Svenonius, Peter. 2004. On the edge. In *Peripheries*, ed. D. Adger, De Cat C., and Tsoulas G., number 59 in *Studies in Natural Language and Linguistic Theory*, 259–287. Springer.
- Swierzbin, Bonnie. 2003. Stress in Border Lakes Ojibwe. In *Papers of the 34th Algonquian Conference*, ed. H.C. Wolfart, 341–370. Winnipeg: University of Manitoba.
- Tilleson, Paul. 2019. On bipartite negation. Doctoral Dissertation, University of Minnesota.
- Tollan, Rebecca. 2020. Subjecthood and unmarkedness in Niuean. In *Proceedings of the Twenty-Sixth Meeting of the Austronesian Formal Linguistics Association*, ed. Ileana Paul.
- Tollan, Rebecca, Diane Massam, and Daphna Heller. 2019. Effects of case and transitivity on processing dependencies: Evidence from Niuean. *Cognitive science* 43.

- Traxler, Matthew J, Robin K Morris, and Rachel E Seely. 2002. Processing subject and object relative clauses: Evidence from eye movements. *Journal of Memory and Language* 47:69–90.
- Traxler, Matthew J, Rihana S Williams, Shelley A Blozis, and Robin K Morris. 2005. Working memory, animacy, and verb class in the processing of relative clauses. *Journal of Memory and Language* 53:204–224.
- Trueswell, John C, Michael K Tanenhaus, and Susan M Garnsey. 1994. Semantic influences on parsing: Use of thematic role information in syntactic ambiguity resolution. *Journal of memory and language* 33:285–318.
- Underhill, Rose. 2019. At the intersection of obviation and local person in Ktunaxa. Presentation at the Canadian Linguistics Association.
- Valentine, Randy. 2001. *Nishnaabemwin reference grammar*. University of Toronto Press.
- Van Urk, Coppe. 2015. A uniform syntax for phrasal movement: A case study of Dinka Bor. Doctoral Dissertation, MIT.
- Wagers, Matthew W, Manuel F Borja, and Sandra Chung. 2018. Grammatical licensing and relative clause parsing in a flexible word-order language. *Cognition* 178:207–221.
- Wagers, Matthew W, and Emily Pendleton. 2016. Structuring expectation: Licensing animacy in relative clause comprehension. In *Proceedings of the 33rd West Coast Conference on Formal Linguistics*, 29–46.
- Warren, Tessa, and Edward Gibson. 2002. The influence of referential processing on sentence complexity. *Cognition* 85:79–112.
- Weckerly, Jill, and Marta Kutas. 1999. An electrophysiological analysis of animacy effects in the processing of object relative sentences. *Psychophysiology* 36:559–570.
- Wiltschko, Martina. 2014. *The universal structure of categories: Towards a formal typology*, volume 142. Cambridge University Press.
- Wiltschko, Martina, and Strang Burton. 2004. On the sources of person hierarchy effects in Halkomelem Salish. *Canadian Journal of Linguistics/Revue canadienne de linguistique* 49:51–71.
- Wiltschko, Martina, Valerie Marshall, Andy Matheson, and Audra Vincent. 2015. Independent pronouns in Blackfoot. In *Papers of the Forty-Third Algonquian Conference*, 266–288.
- Yokoyama, Tomohiro. 2019. The Person Case Constraint: Unconditional interfaces and faultless derivations. Doctoral Dissertation, University of Toronto.
- Young, Robert W, and William Morgan. 1987. *The Navajo language: A grammar and colloquial dictionary, revised ed.*. University of New Mexico Press Albuquerque.

- Zubizarreta, Maria Luisa, and Roumyana Pancheva. 2017. A formal characterization of person-based alignment. *Natural Language & Linguistic Theory* 35:1161–1204.
- Zwicky, Arnold. 1977. Hierarchies of person. In *Chicago Linguistics Society*, volume 13, 714–733.