

University of Wollongong

Research Online

Faculty of Engineering and Information
Sciences - Papers: Part A

Faculty of Engineering and Information
Sciences

January 2015

S-band Planar Antennas for a CubeSat

Faisal Em M Tubbal

University of Wollongong, femt848@uowmail.edu.au

Raad Raad

University of Wollongong, raad@uow.edu.au

Kwan-Wu Chin

University of Wollongong, kwanwu@uow.edu.au

Brenden Butters

University of Wollongong, bab900@uowmail.edu.au

Follow this and additional works at: <https://ro.uow.edu.au/eispapers>

Recommended Citation

Tubbal, Faisal Em M; Raad, Raad; Chin, Kwan-Wu; and Butters, Brenden, "S-band Planar Antennas for a CubeSat" (2015). *Faculty of Engineering and Information Sciences - Papers: Part A*. 4771.

<https://ro.uow.edu.au/eispapers/4771>

Research Online is the open access institutional repository for the University of Wollongong. For further information contact the UOW Library: research-pubs@uow.edu.au

S-band Planar Antennas for a CubeSat

Abstract

This paper studies the suitability of shorted patch and CPW-feed square slot antennas for CubeSat communications. To study the effect of the CubeSat body on the antennas performance, we have simulated both antennas in the High Frequency Structure Simulator (HFSS) with and without the CubeSat body. Compared to CPWfeed square slot antenna, the shorted patch antenna achieves higher gain and wider bandwidth. We have also re-dimensioned both antennas to shift their resonant frequencies to 2.45 GHz using Quasi Newton method in HFSS. This thus enables their use in the unlicensed ISM band. The repurposed shorted patch has smaller return loss; e.g., -27.5 dB (without CubeSat), higher gain; e.g., 5.3 dBi and wider bandwidth than the repurposed CPW-feed Square slot antenna. Lastly, further enhancement in the gain of re-dimensioned CPW-feed square slot antenna shows an increase of total gain from 2 to 2.52 dB.

Keywords

band, planar, antennas, cubesat

Publication Details

F. Em M. Tubbal, R. Raad, K. Chin & B. Butters, "S-band Planar Antennas for a CubeSat," International Journal on Electrical Engineering and Informatics, vol. 7, (4) pp. 559-568, 2015.

S-band Planar Antennas for a CubeSat

Faisel Tubbal, Raad Raad, Kwan-Wu Chin, and Brenden Butters

School of Electrical, Computer and Telecommunications Engineering
University of Wollongong, Northfields Ave, NSW, Australia, 2522
femt848@uowmail.edu.au, raad@uow.edu.au, Kwanwu@uow.edu.au,
bab900@uowmail.edu.au.

Abstract: This paper studies the suitability of shorted patch and CPW-feed square slot antennas for CubeSat communications. To study the effect of the CubeSat body on the antennas performance, we have simulated both antennas in the High Frequency Structure Simulator (HFSS) with and without the CubeSat body. Compared to CPW-feed square slot antenna, the shorted patch antenna achieves higher gain and wider bandwidth. We have also re-dimensioned both antennas to shift their resonant frequencies to 2.45 GHz using Quasi Newton method in HFSS. This thus enables their use in the unlicensed ISM band. The repurposed shorted patch has smaller return loss; e.g., -27.5 dB (without CubeSat), higher gain; e.g., 5.3 dBi and wider bandwidth than the repurposed CPW-feed Square slot antenna. Lastly, further enhancement in the gain of re-dimensioned CPW-feed square slot antenna shows an increase of total gain from 2 to 2.52 dB.

Keywords: cross link; Satellite, CubeSat; return loss; radiation pattern; gain, Antenna, S-band, Satellite swarm

1. Introduction

CubeSats have a wet mass ranging from 1.3 (1U) to 6 kg (3U) and employ commercial off-the-shelf electronics [1, 2]. A key advantage of CubeSats is that they are small, lightweight and have the ability to form a constellation of cube satellites that communicate directly with one another [3]. Another advantage of CubeSats is that they can be networked to form CubeSat swarms [4]. They can jointly maintain a fixed or relative position with each other in a distributed manner. Figure. 1 depicts a standard model of 1U CubeSat. This 1U CubeSat has a fixed size of 10cm×10cm×10cm with a mass of about 1kg [5, 6].

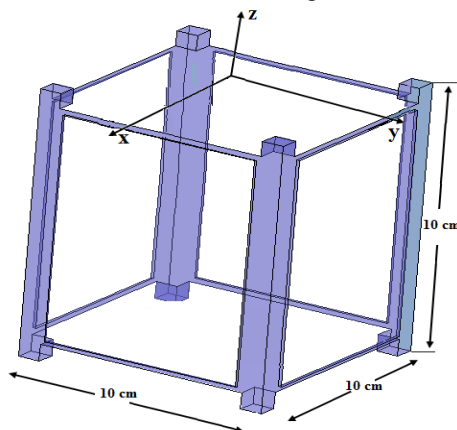

Figure 1. 1U cube satellite

Cross link communication between CubeSats in a swarm is vitally important as it provides direct connectivity between CubeSats without the need for intermediate ground stations.

Received: October 24th, 2014. Accepted: December 8th, 2015

DOI: 10.15676/ijeel.2015.7.4.2

Therefore, it is critical CubeSats employ an antenna system that provides wide directivity and establishes inter CubeSat communication links [7, 8]. However, there are many challenges when designing such an antenna for CubeSat. These challenges include limited power, size and low mass constraints. This means CubeSats can only be equipped with lightweight and small antennas that have low power consumption. Also, the gain and bandwidth are important for between CubeSats and ground stations.

The shorted patch design [9] and The CPW-feed square slot antenna [10] address the stated design requirements of cube satellites. In [10], Laio and Chu present a design of CPW-feed square slot antenna that has wide circular polarization bandwidth. This is important as helps enhance the reception of weak signals and achieves the best signal strength. The antenna has a total size of $60 \times 60 \text{ mm}^2$; it is fabricated on a FR4 substrate that is 0.8 mm thick. More details on [9] and [10] are presented in Section 4.

To the best of our knowledge, no work has compared designs [9] and [10] on a common platform in terms of their suitability for a CubeSat communications. Therefore, we have built and compared both designs (with and without CubeSat) using a finite element method (FEM) based High Frequency Structure Simulator (HFSS) [11]. Typically, the antenna will be fed from a high data rate radio such as the one described in [12]. In the following sections, we first present the shorted patch and CPW-feed square slot Antenna designs [9, 10] with and without CubeSat. Also, the improvements to shift their operating frequency to 2.45 GHz (S-band) are presented. Moreover, further improvements in the total gain of [10] are applied to increase the resulting low gain after re-dimensioning.

2. Shorted Patch Antenna

The simulation model of the shorted patch antenna [9] on 2U CubeSat body is depicted in figure 2. It has two patches; $18 \times 15 \text{ mm}^2$ upper patch and $7.5 \times 6.5 \text{ mm}^2$ lower patch. They are connected to a $30 \times 30 \text{ mm}^2$ ground plane via four shorting pins and a probe feed. The main aim of using the shorting pins at the edge of the upper patch is to achieve miniaturization at wide BW. The centre shorting pin is used to enhance the impedance bandwidth of the shorted patch antenna by generating another two resonant frequencies of 4.45 and 7 GHz.

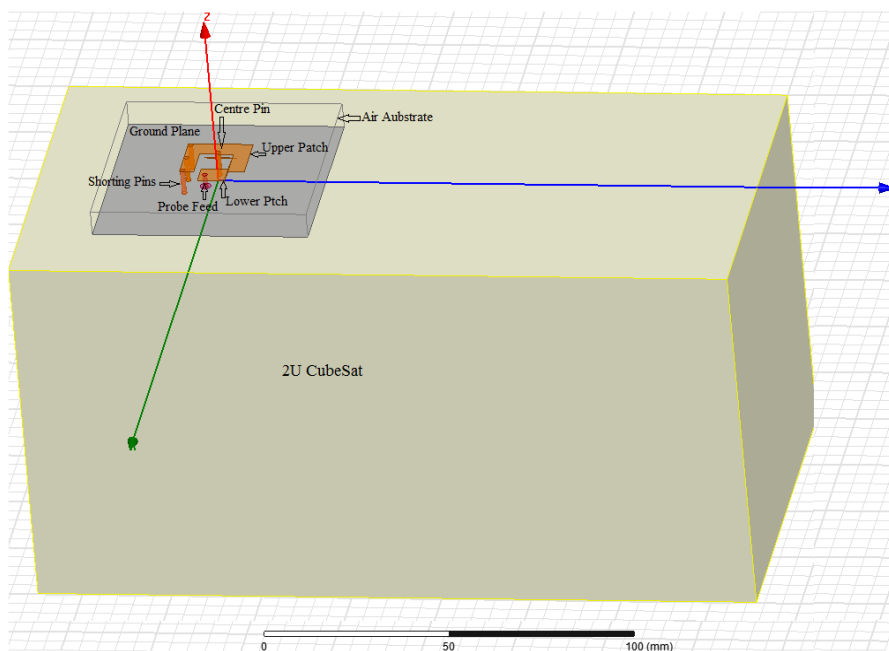

Figure 2. Geometry of shorted patch antenna on 2U CubeSat body

3. CPW-feed Square Slot Antenna

Figure 3 shows the structure of the square slot antenna model [10]. A distance (air gap) between the antenna and the satellite body is kept to prevent any contact between the back side (dielectric) of the antenna and the surface of the satellite body. This thus decreases the capacitance between the upper ground plane and the CubeSat body and leads to higher gains. The CPW-feed square slot antenna has a total size of $60 \times 60 \text{ mm}^2$; it is fabricated on FR4 substrate having thickness of 0.8mm. Coplanar Wave Guide (CPW) feed line technique is used with a fixed width of a single strip; i.e., 4.2 mm and the distance of the gap between the line and ground plane is 0.3 mm in order to achieve 50Ω matching. In addition, the CPW-feed square slot antenna operates at 3.2 and 9.1 GHz; see Figure. 4. Its first operating frequency 3.2 GHz is shifted to 2.45 GHz (S-band) by re-dimensioning the entire antenna parameters. Quasi Newton optimization method is used for the re-dimensioning process to achieve an operating frequency of 2.45 GHz. The antenna size is increased by 1.25 mm and has achieved a return loss S_{11} of -25 dB at an operating frequency of 2.45 GHz.

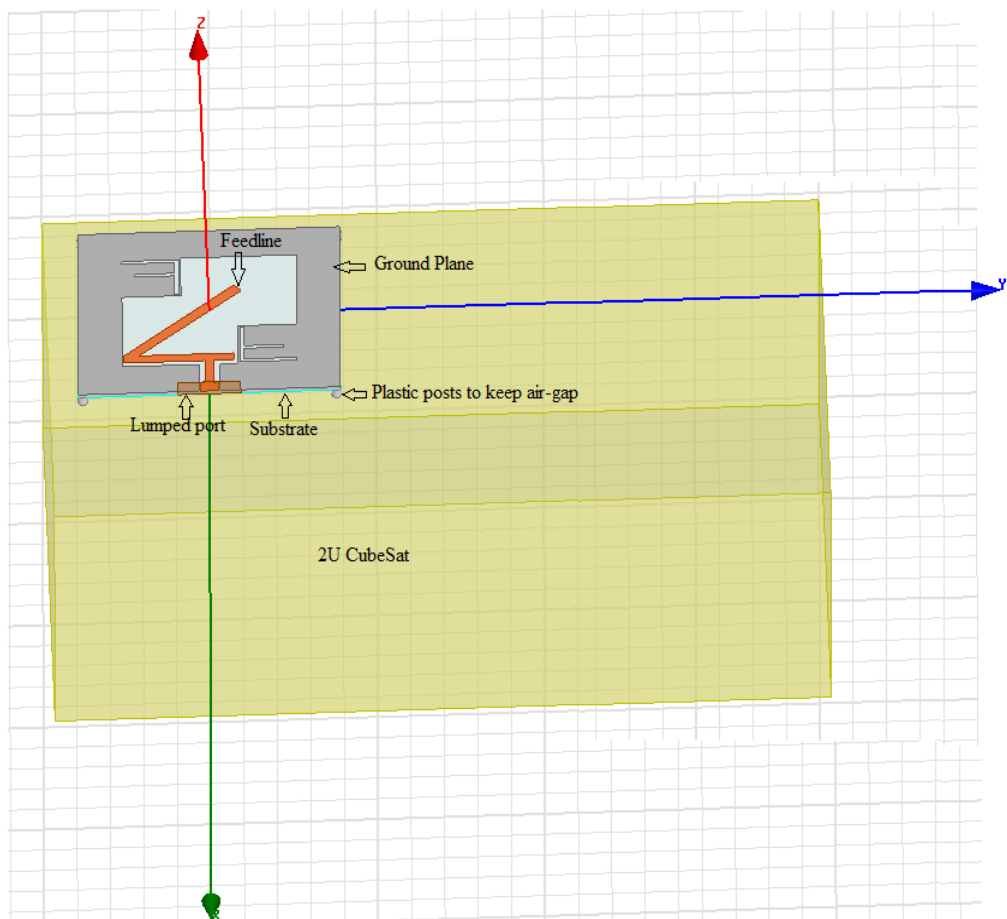

Figure 3. Geometry of CPW-feed square slot antenna on 2U CubeSat body

4. Quantitative Evaluation

We now provide a quantitative comparison and evaluation between shorted patch and CPW-feed square slot antennas.

A. Quantitative Comparison

We now compare the original designs of [10] and [9] in terms of return loss, bandwidth, gain and antenna size. We also study the effect of the CubeSat Aluminium body on the performance of the antenna designs. Figure. 4 plots the return losses of shorted patch and CPW-feed square slot antenna with and without CubeSat body. We see that the CubeSat body has a significant effect on the shorted patch antenna performance and very small effect on CPW-feed square slot antenna performance; see Figure. 4 and 5. The return loss of shorted patch antenna is dramatically improved (decreased) from -26.3 to -43.3 dB when it is placed on CubeSat surface. This is important as more power is radiated into space and less power is reflected.

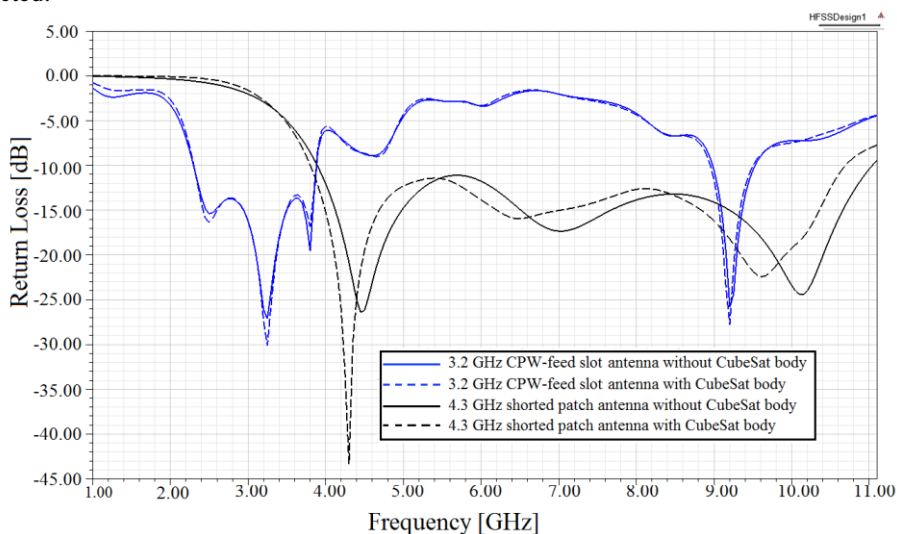

Figure 4. The simulated return loss of shorted patch and CPW-feed square slot antennas with and without CubeSat

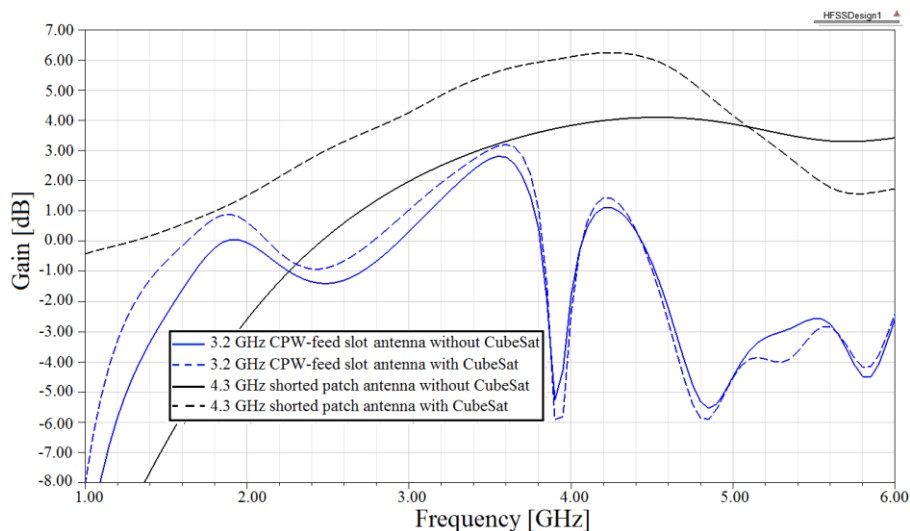

Figure 5. The simulated 2D gain of shorted patch and CPW-feed slot antenna with and without CubeSat body

As shown in Figure 5, the peak gains of shorted patch antenna at 4.3 GHz are 4 dB (without CubeSat) and 6.2 dB (with CubeSat). Moreover, the peak gain of the CPW-feed slot antenna has slightly improved; i.e., 1.93 dB when the antenna is place on CubeSat surface. The peak gains of the CPW-feed square slot antenna are 2.8 dB (without CubeSat) and 3.1 dB at 3.55 GHz. However, this is not at the resonant frequency; i.e., 3.2 GHz. Compared to the CPW-feed square slot antenna, the shorted patch antenna has wider bandwidth; i.e., 1600 MHz, and higher gains; i.e., 4 dB (without CubeSat) and 6.2 dB (with CubeSat). This is important for cube-satellites as it increases the directivity and hence provides longer communication distance between CubeSats in a swarm and ground stations.

B. Re-dimensioning

In this section, we present and compare the results of the re-dimensioned shorted patch and CPW-feed square slot antennas with CubeSat body. The operating frequencies of both antennas are shifted to 2.45 GHz by increasing their physical sizes. We have used the Quasi Newton method which is available in HFSS [13]. This method is used to increase the antenna size until it achieves a minimum return loss at an operating frequency of 2.45 GHz. In order to achieve a minimum return loss at 2.45 GHz, the sizes of shorted patch and CPW-feed square slot antennas are increased from $30 \times 30 \text{ mm}^2$ to $83 \times 83 \text{ mm}^2$ and from $60 \times 60 \text{ mm}^2$ to $75 \times 75 \text{ mm}^2$ respectively.

Figure 6 depicts the simulated return losses of 2.45 GHz shorted patch and CPW-feed square slot antennas with and without CubeSat. Both modified antennas operate at 2.45 GHz as their first resonance frequencies have been shifted to 2.45 GHz. The simulated fractional impedance bandwidth of the re-dimensioned shorted patch and CPW-feed square slot antennas are 900 and 550 MHz respectively.

Figure 7 presents the 2 D simulated gains of the modified shorted patch and CPW-feed square antennas with CubeSat at 2.45 GHz. Compared with the modified CPW-feed square slot antenna, as shown in Figure. 6, Figure. 7, the modified shorted patch antenna has wider -10 dB bandwidth; i.e., 900 MHz, less return loss; i.e., -27.5 dB, and higher antenna gain; i.e., 5.3 dB at resonant frequency 2.45 GHz but it has larger antenna size. The main limitation of the modified CPW-feed square slot antenna is the simulated low gain at 2.45 GHz. Hence, further improvements are proposed and applied in order to enhance its total gain in the following section.

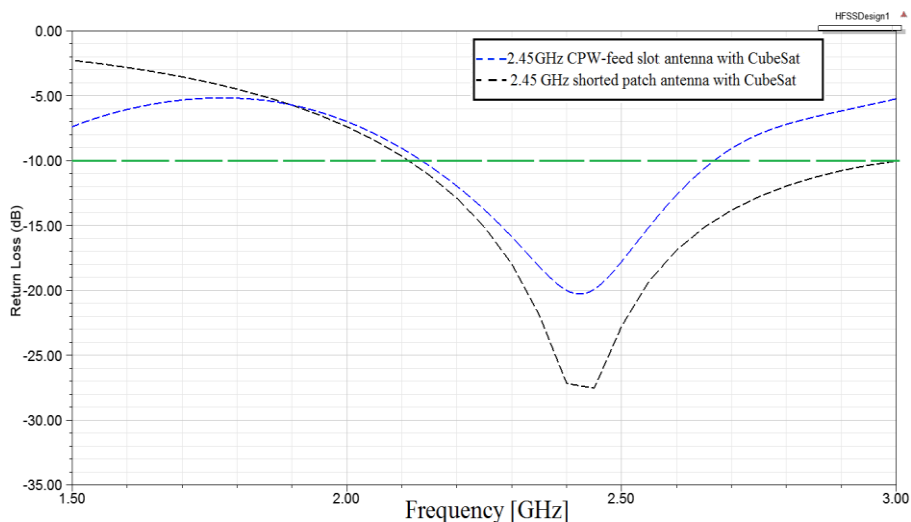

Figure 6. Simulated return losses of re-dimensioned shorted patch and CPW-fed slot antennas on 2U CubeSat

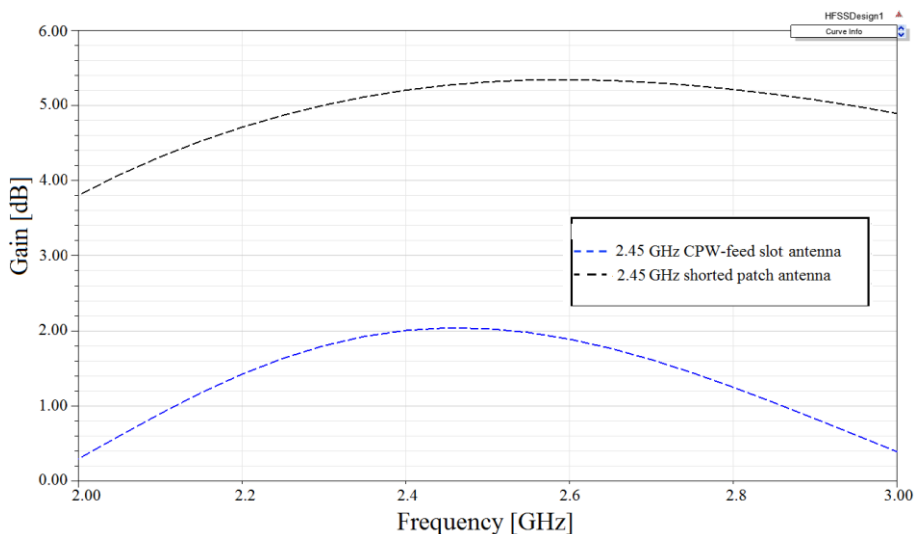

Figure 7. The simulated 2D gain of the modified shorted patch and CPW-feed slot antenna

C. Gain Enhancement of CPW-feed Square Slot Antenna

We now try to improve the gain of the re-dimensioned CPW-feed square slot antenna by changing its geometry and adjusting the length of the horizontal tuning stub L_t .

Figure 7 shows the new structure of the re-dimensioned CPW-feed square slot antenna after removing the F-shaped slits and creating a square slot. F-shaped slits were embedded in the design of [10] to enlarge the bandwidth, i.e., 1700MHz. However, removing F-shaped slits from the antenna structure leads to a significant decrease in the bandwidth, i.e., 550 MHz and hence increases the total antenna gain from 2.00 to 2.52 dB; see Figure. 8. Moreover, the resulted bandwidth has been reduced from 1700 MHz to 550 MHz but still wide enough for CubeSat communications.

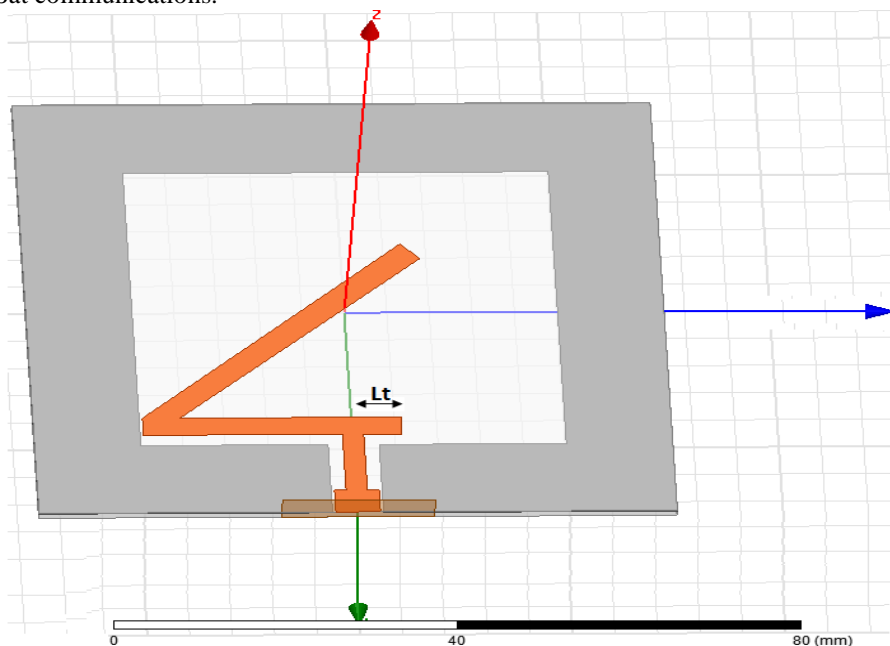

Figure 8. Geometry of re-dimensioned CPW-feed square slot antenna without F-shaped slits

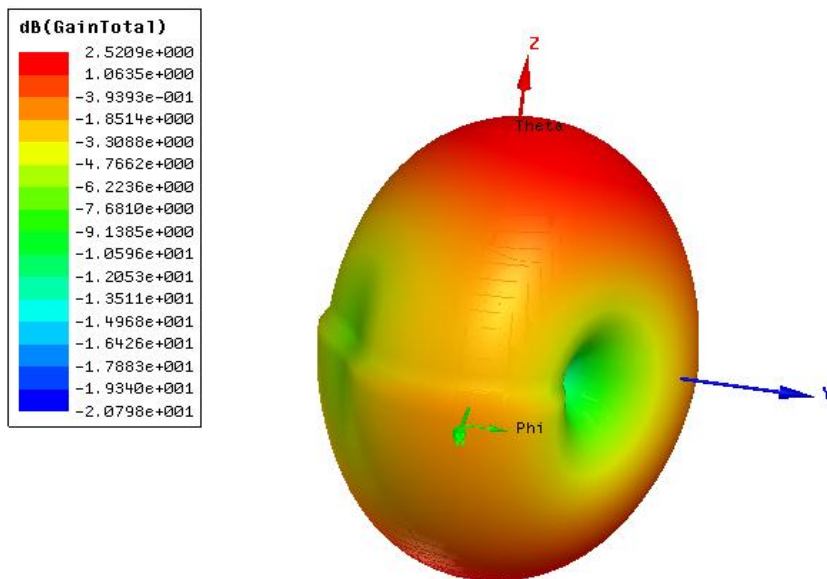

Figure 9. Total 3D gain of re-dimensioned CPW-feed square slot antenna after removing F-shaped slits

The main limitation of removing F-shaped slits is the mismatching and the shift of an operating frequency a way from 2.45 GHz. As shown in Figure. 9, the length of the horizontal tuning stub L_t has a great effect on the impedance bandwidth and the total gain. Figure 9 illustrates that with decreasing L_t the operating frequency increases and return loss (S_{11}) decreases and hence better impedance matching is achieved. The best obtained value for L_t is 7.5 mm. This value shifts the operating frequency to 2.45 GHz with a small return loss, i.e., -27.5 dB, wide-10 dB bandwidth of 730 MHz (1.9-2.63 GHz) and total gain of 2.52 dB. An immediate future work is to apply further gain enhancement and size miniaturization techniques such as the Metasurface Superstare (MSS) [14-16] to increase gain and using series of parallel strip lines [17] or loading wires [18] to achieve further miniaturization.

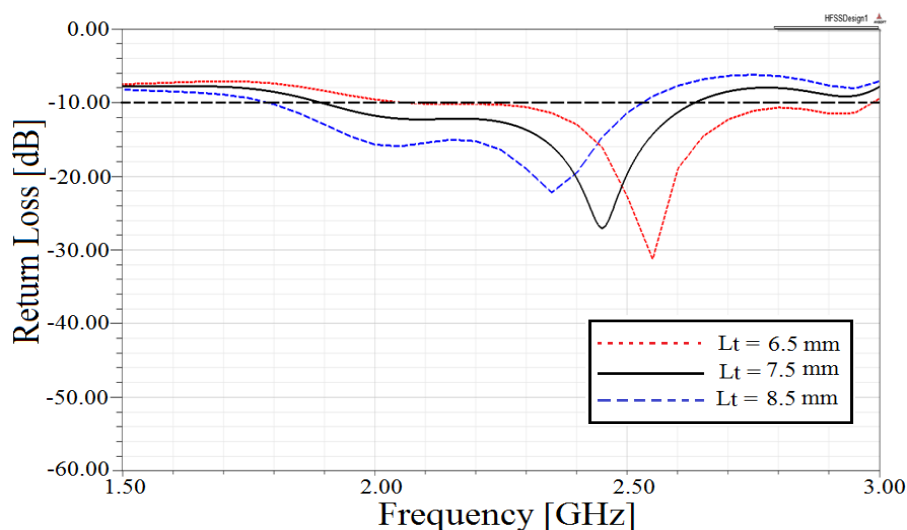

Figure 10. Simulated return loss against frequency for the various L_t

5. Conclusion

This paper studies and compares the repurposed shorted patch and CPW-feed square slot antennas for CubeSat communications. They are implemented on the 2U CubeSat body. The paper presented the effects of the CubeSat surface on the antenna performance. We have used quasi Newton algorithm technique to shift the operating frequency of shorted patch and CPW-feed square slot antennas to 2.45 GHz (S-band). Moreover, simulation results show that the modified shorted patch and CPW-feed square slot antennas have return losses that are well below -10 dB at the operational frequency of 2.45 GHz, and achieves impedance bandwidths of 900 and 550 MHz respectively. We have also presented a gain enhancement of the modified CPW-feed square slot antenna. This improved CPW-feed square slot antenna has a resonance frequency of 2.45 GHz and provides a total gain of 2.52 dB at 2.45 GHz.

6. References

- [1]. National Aeronautics and Space Administration (NASA) [online] available: <http://www.nasa.gov/index.html>.
- [2]. F. Em. M. Tubbal, R. Raad, and K-W. Chin, "A Survey and Study on the Suitability of Planar Antennas for Pico Satellite Communications " unpublished
- [3]. C. Pinciroli, M. Birattari, Te. Uci, M. Dorigo, M. D.R. Zapatero, T. Vinko, and D. Izzo, "Self-Organizing and Scalable Shape Formation for a Swarm of Pico Satellites," *Conference on Adaptive Hardware and Systems, Noordwijk, Netherlands*, pp. 57-61, June 2008
- [4]. R. Fdhila, T. M. Hamdani, and A. M. Alimi, "A multi objective particles swarm optimization algorithm for solving the routing pico-satellites problem," *IEEE International Conference on Systems, Man, and Cybernetics Seoul, Korea*, pp. 1402-1407, October 2012
- [5]. (Surrey Space Centre. Home page:). <http://www.ee.surrey.ac.uk/SSC/>
- [6]. (Surrey Satellite technology Ltd. Home page:). <http://www.sstl.co.uk>
- [7]. H. Heidt, J.P. Suari, A.S. Moore, S. Nakasuka, and And R. J. Twiggs, "CubeSat: A new Generation of Picosatellite for Education and Industry Low-Cost Space Experimentation," *14th Annual/USU Conference on Small Satellites*, Logan, Utah, 2000
- [8]. P. Muri and J. McNair, "A survey of communication sub-systems for intersatellite linked systems and cubesat missions," *Journal of Communications*, vol. 7, no.4, pp.290-308, 2012
- [9]. H. Malekpoor and S. Jam, "Enhanced Bandwidth of Shorted Patch Antennas Using Folded-Patch Techniques," *IEEE Antennas and Wireless Propagation Letters*, vol. 12, pp.198-201, 2013
- [10]. W. Liao and Q. X. Chu, "CPW-feed Square Slot Antenna With Lightning-Shaped Feed line For Broadband Circularly Polarized Radiation," *Progress In Electromagnetics Research*, vol. 18, pp.61-69, 2010
- [11]. High Frequency Structure Simulator (HFSS) [online] available: <http://www.ansys.com/>
- [12]. B. Butters and R. Raad, "A 2.4 GHz High Data Rate radio for pico-satellites," *IEEE 8th International Conference on Telecommunication Systems Services and Applications Bali, Indonesia*, pp. 1-6, October 2014
- [13]. Roger (1987) Fletcher, Practical methods of optimization (2nd ed.). New York: John Wiley & Sons. ISBN 978-0-471-91547-8
- [14]. R. W. Ziolkowski, "Design, fabrication, and testing of double negative metamaterials," *IEEE Transactions on Antennas and Propagation*, vol. 51, no.7, pp.1516-1529, July 2003
- [15]. C. Rakluea, S. Chaimool, P. Rakluea, and P. Akkaraekthalin, "Unidirectional CPW-fed slot antenna using metasurface," *8th International Conference on Electrical Engineering/Electronics, Computer, Telecommunications and Information Technology (ECTI-CON) Khon Kaen, Thailand*, pp. 184-187, May 2011

- [16]. S. Chaimool, K. L. Chung, and P. Akkaraekthalin, "Bandwidth and gain enhancement of microstrip patch antennas using reflective metasurface," *IEICE transactions on communications*, vol. 93, no.10, pp. 2496-2503, October 2010
- [17]. W. Hong, N. Behdad, and K. Sarabandi, "Size Reduction of Cavity-Backed Slot Antennas," *IEEE Transactions on Antennas and Propagation*, vol. 54, no.5, pp.1461-1466, May 2006
- [18]. B. Ghosh, S.K. M. Haque, and N. R. Yenduri, "Miniaturization of Slot Antennas Using Wire Loading," *IEEE Antennas and Wireless Propagation Letters*, vol. 12, no.5, pp.488-491, April 2013



Faisal Tubbal was born in Libya in 1978. He received the B.S. degree in electronics engineering from Tripoli College of Electronic Technology, Ben Ashour, Tripoli, Libya. In 2011, he obtained an Advanced Graduate Diploma in Technology Engineering from the University of Wollongong. In 2012, he obtained a M.S. degree in Telecommunication Engineering from the University of Wollongong. In 2013, he obtained a M.S. in Engineering Management from the University of Wollongong. He is currently working towards the PhD degree in Telecommunication Engineering at the University of Wollongong. Faisal has worked as a researcher with Libyan Centre for Remote Sensing and Space Science (LCRSSC), Tripoli, Libya. He is also an academic assistant at the School of Electrical, Computer and Telecommunication Engineering, University of Wollongong, Australia. Faisal is a member of the IEEE. He is interested in planar antenna designs and CubeSat communications.



Raad Raad graduated from the University of Wollongong, Australia in 1997 with a Bachelor of Engineering (Hon 1) in 1997. He went on to complete his PhD thesis entitled "Neuro-Fuzzy Logic Admission Control in Cellular Mobile Networks" in 2006. Dr. Raad has over five years of industrial research experience and another five years of experience in academic research. Dr. Raad is the author of five United States patent filings of which three have been granted and over 50 refereed publications and technical reports. His expertise is in wireless communications with a focus on Medium Access Control (MAC) and bandwidth management protocols for wireless networks. Dr. Raad has led and collaborated on significant projects in the areas of sensor networks, IEEE 802.11, IEEE 802.15.3, MeshLAN, RFIDs and cellular networks. The technical areas that he covered during the numerous projects include admission control, bandwidth management, low power MAC protocols and routing protocols.



Kwan-Wu Chin obtained his Bachelor of Science with First Class Honours from the Curtin University of Technology, Australia. He then pursued his PhD at the same university, where he graduated with distinction and the vice-chancellor's commendation. After obtaining his PhD, he joined Motorola Research Lab as a Senior Research Engineer, where he developed zero-configuration home networking protocols and designed new medium access control protocols for wireless sensors networks. In 2004 he joined the University of Wollongong as a Senior Lecturer, and he was subsequently promoted to Associate Professor in 2011. His current areas include medium access control protocols for wireless networks, routing protocols for delay tolerant networks, RFID anti-

collision protocols, and resources management issues in wireless networks. To date, he holds four patents, and has published more than 100 articles in numerous conferences and journals.

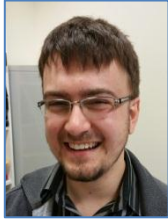

Brenden Butters is a Deans's scholar student at the University of Wollongong. He is a member of IEEE. He has great interest in electronics and antenna design. He is a lab lead on the UOW CubeSat project and has contributed to a number of publications on radio transceivers and antenna design. In addition to this, he is also building an antenna area for through the wall radar.