

University of Wollongong  
**Research Online**

---

Faculty of Informatics - Papers (Archive)

Faculty of Engineering and Information  
Sciences

---

2003

## A hybrid optical network architecture consisting of optical cross connects and optical burst switches

Chuntung Chou  
*University of Wollongong*, [ctchou@uow.edu.au](mailto:ctchou@uow.edu.au)

Farzad Safaei  
*University of Wollongong*, [farzad@uow.edu.au](mailto:farzad@uow.edu.au)

P. Boustead  
*University of Wollongong*, [boustead@uow.edu.au](mailto:boustead@uow.edu.au)

I. Ouveysi  
*University of Melbourne*

Follow this and additional works at: <https://ro.uow.edu.au/infopapers>

 Part of the [Physical Sciences and Mathematics Commons](#)

---

### Recommended Citation

Chou, Chuntung; Safaei, Farzad; Boustead, P.; and Ouveysi, I.: A hybrid optical network architecture consisting of optical cross connects and optical burst switches 2003.  
<https://ro.uow.edu.au/infopapers/64>

Research Online is the open access institutional repository for the University of Wollongong. For further information contact the UOW Library: [research-pubs@uow.edu.au](mailto:research-pubs@uow.edu.au)

---

# A hybrid optical network architecture consisting of optical cross connects and optical burst switches

## Abstract

Optical burst switches (OBSes) have been proposed to improve the utilization of a network of optical cross connect (OXC)s. Current studies on OBS assume a network consisting of OBSes alone. While this is a reasonable assumption for evaluating a new technology, the question of how a network of OXC)s can be evolved to a network of OBSes has not been studied. In this paper, we propose a hybrid architecture consisting of OBSes at the network edge and OXC)s in the network core. This architecture allows carriers to gradually migrate from an OXC-based network to an OBS-based network with an improved network utilization. In addition, we use queueing analysis to study the performance of this new architecture.

## Keywords

optical burst switches, optical network architecture, optical cross connect, performance evaluation, queueing analysis

## Disciplines

Physical Sciences and Mathematics

## Publication Details

This article was originally published as: Chou, CT, Safaei, F, Boustead, P, & Ouveysi, I, A hybrid optical network architecture consisting of optical cross connects and optical burst switches, Proceedings 12th International Conference on Computer Communications and Networks (ICCCN'03), 20-22 October 2003, 53-58. Copyright IEEE 2003.

# A hybrid optical network architecture consisting of optical cross connects and optical burst switches

Chun Tung Chou\*, Farzad Safaei\*, Paul Boustead\*, Iradj Ouveysi<sup>‡</sup>

\* School of Electrical, Computer and Telecommunications Engineering  
University of Wollongong, Northfield Avenue, Wollongong, NSW 2522, Australia

<sup>‡</sup> University of Melbourne, Australia  
Email: ctchou@titr.uow.edu.au

**Abstract**—Optical burst switches (OBSes) have been proposed to improve the utilization of a network of optical cross connect (OXC)s. Current studies on OBS assume a network consisting of OBSes alone. While this is a reasonable assumption for evaluating a new technology, the question of how a network of OXC)s can be evolved to a network of OBSes has not been studied. In this paper, we propose a hybrid architecture consisting of OBSes at the network edge and OXC)s in the network core. This architecture allows carriers to gradually migrate from an OXC-based network to an OBS-based network with an improved network utilization. In addition, we use queueing analysis to study the performance of this new architecture.

**Keywords:** Optical burst switches, Optical network architecture, Optical cross-connects, Performance Evaluation, Queueing analysis

## I. INTRODUCTION

The development of wavelength division multiplexing (WDM) has allowed us to exploit the large amount of bandwidth available in an optical fiber as multiple lower-capacity channels. With the introduction of Optical Cross-connects (OXC)s, end-to-end optical connections (also known as lightpaths) allow packets to be carried without optical-to-electronic conversion in the intermediate hops, thus overcoming the electronic conversion bottleneck. However, due to the static nature of these lightpaths and the burstiness of IP traffic, the utilization of an OXC-based network can be low. A proposed solution to this problem is to deploy optical burst switches (OBSes) [Tur99], [YQ99], [Qia00].

OBS can be viewed as fast wavelength switching where the holding time of a wavelength is in the order of an optical burst. (The precise wavelength holding time depends on the reservation protocol being used). An important feature of OBS is the separation of control and data. A control packet is sent over a separate control channel ahead of the optical burst to perform channel reservation. Since no optical buffer is used, if the number of arriving bursts exceeds the number of optical channels available, the excess bursts will be dropped. An important performance metric of OBS is therefore burst blocking probability.

Current research on OBS focuses on a number of areas, which include OBS network architecture [Tur99], [YQ99], [XVC00], [DB02], resource allocation and reservation mechanisms [DGSB01], burst aggregation mechanisms [OK02], burst shaping [CVR02], Quality of Service (QoS) support [YQD00],

[YQD01], labeled switched OBS [Qia00], performance of TCP over OBS [DL02] and many others. All of these studies assume a network consisting of OBSes alone. While this is a reasonable assumption in evaluating a new technology, one needs to realize migrating from a network of OXC)s to a network of OBSes is a large capital investment. It is therefore important to be able to incrementally deploy a new technology such as OBS. In this paper, we propose a hybrid optical network architecture which consists of OBSes at the network edge and OXC) in the network core. This architecture provides an incremental migration path from a pure OXC) network to a pure OBS) network. We will describe this hybrid architecture in details in section II. In section III, we use queueing analysis to derive an upper bound on the blocking probability for this hybrid architecture. Finally, the conclusions are given in section IV.

## II. HYBRID OPTICAL NETWORK ARCHITECTURE

The aim of this section is to present an optical network architecture which allows a carrier to migrate from an OXC-based network to an OBS-based network. In order to put the discussion in context, we first describe the current OXC-based architecture, which is depicted in Figure 1. This architecture consists of IP routers, edge OXC) nodes and core OXC) nodes. An end-to-end optical channel, or lightpath, is set up between a pair of IP routers so that traffic can be exchanged between them. The lightpaths are switched in the optical domain in the OXC)s without converting into electronic signals. It is instructive to point out that even if a router is to send traffic to two different routers that are attached to the same edge OXC), two different lightpaths are required. For example, in Figure 1, three different lightpaths are used to transport the traffic from routers *a*, *b* and *c* to router *d* even routers *a*, *b* and *c* are all connected to the same OXC).

Note that multiple lightpaths may be set up between a pair of IP routers if there is sufficient traffic demand. Lightpaths are currently set up manually (thought research is being done in establishing these lightpaths dynamically [ZJS<sup>+</sup>01]) and are therefore static in nature. The network utilization of an OXC-based network is generally low due to static lightpaths and burstiness of IP traffic.

### A. Hybrid optical network architecture

In this section, we present a hybrid optical network architecture which consists of both OXC)s and OBSes to facilitate

the migration from an OXC-based network to an OBS-based network. The proposed architecture is depicted in Figure 2, it consists of IP routers, OBSes at the network edge and OXCs in the network core. This new architecture is best understood by describing the differences between it and the OXC architecture given in Figure 1, as follows.

- 1) Burst assembly mechanisms are added to the IP router ports to facilitate burst creation. Note that [XVC00] also suggests to install burst assembly mechanisms in the IP router ports in their proposed OBS-based network architecture.
- 2) In the OXC based architecture, each wavelength between an IP router and an edge OXC carries traffic for only one IP router pair. However, a wavelength between an IP router and an edge OBS in the hybrid architecture can carry traffic destined for one or more IP routers. For example, for the OXC architecture, Figure 1 shows that the traffic from router  $a$  destined for routers  $d$  and  $e$  are carried in two separate wavelengths in the connection from IP router  $a$  to the edge OXC. However, in the hybrid architecture, Figure 2 shows that the same traffic is now carried over one wavelength from router  $a$  to OBS  $A$ . Note that OBS  $A$  will switch the incoming bursts to the approximate wavelengths on its outputs. Note that this requires wavelength converters in the OBS. The number of wavelengths to be used between an IP router and an edge OBS depends on the amount of traffic to be carried but is expected to be no more than that required in the OXC-based architecture.
- 3) Lightpaths are organized differently in the two architectures. In the OXC architecture, a lightpath is established between an IP router pair and carries traffic between that particular IP router pair. However, in the hybrid architecture, lightpaths are established between a pair of edge OBSes to carry the traffic between them. For example, for the OXC architecture in Figure 1, the traffic from routers  $a$ ,  $b$  and  $c$  that is destined for router  $d$  is carried over three different wavelengths, one for each router pair. However, in the hybrid architecture shown in Figure 2, the same traffic is carried in the core network over two wavelengths between OBSes  $A$  and  $C$ . OBS  $A$  therefore does the job of multiplexing the traffic from routers  $a$ ,  $b$  and  $c$  that is destined for router  $d$  onto the two wavelengths between OBSes  $A$  and  $C$ .

The rationale behind the hybrid architecture is as follows: if  $r$  lightpaths are used to carry the traffic between an edge OXC pair in the OXC-based architecture (note that  $r$  is also the number of traffic sources between an edge OXC pair) and if the utilizations of these lightpaths are low, the edge OBS can multiplex the same traffic onto  $m$  ( $< r$ ) lightpaths between an OBS pair. For example, 3 wavelengths are used to carry traffic from routers  $a$ ,  $b$  and  $c$  to router  $d$  in the OXC architecture in Figure 1 while two wavelengths are used to carry the same traffic between OBSes  $A$  and  $C$  in Figure 2. The hybrid architecture can therefore improve the utilization of the wavelengths in the

optical core. For a carrier with an existing OXC-based network, this improved utilization in the optical core means that the migration to the hybrid architecture will allow it to carry more traffic using the existing network resources. The hybrid architecture therefore represents a viable intermediate architecture for migrating from an OXC-based network to an OBS-based network.

Note that if  $m < r$ , blocking of optical bursts may occur at the edge OBS (but not in the core OXC). Therefore,  $m$  should be chosen such that the blocking probability is sufficiently low and is an important input parameter to the Routing and Wavelength Assignment (RWA) problem associated with this hybrid architecture. Since  $m$  wavelengths are used to carry traffic between an edge OBS pair, it would be desirable to have all these  $m$  wavelengths routed along the same path in order to minimize the possibility of TCP packet reordering which results from using paths with large differences in propagation delay. This routing requirement can be incorporated in the RWA problem.

Some reader may argue that the improvement in utilization achieved in the hybrid architecture can also be obtained from using traffic grooming [ML01], [DR02] in the edge IP routers in the OXC architecture described above. This may well be the case. However, the purpose of this paper is to present a migration strategy from an OXC network to an OBS network, and traffic grooming does not provide such strategy.

A number of enhancements can be made to this architecture. If the underlying OXC network is equipped with dynamic lightpath establishment facility [ZJS<sup>+</sup>01], the number of lightpaths between an edge OXC pair can be dynamically adjusted according to the aggregate traffic demands between and edge OBS pair. Alternatively, the edge OBS can monitor the burst dropping rate and adjusts the number of wavelengths being used accordingly.

It is also possible to introduce QoS into this architecture. For example, we can use multiple electronic buffers, one for each QoS service class, at the output ports of the IP routers. A strict priority queue or some scheduling algorithms can be used to differentiate the access to the shared wavelengths. Alternatively, QoS can be achieved by assigning different number of wavelengths to each service class.

An alternative design choice is to use two-way reservation, i.e. requests and acknowledgments, for the bursts to gain access to the wavelengths. The additional delay required will be small because the admission control decision will be made by the edge OBS to which the IP router is directly connected. No optical bursts will be blocked in this case but IP packets may be dropped due to buffer overflow. For an example of two-way reservation mechanism in OBSes, see [DB02].

### III. PERFORMANCE ANALYSIS

In this section, we present analytical results on the performance of the proposed Hybrid Architecture. The general problem is described with the help of Figure 3 which shows an edge OBS  $X$  with  $r$  routers, which are the sources of optical bursts, connected to it. The bursts from these routers are destined for

all other edge OBSes in the network. Let OBS  $Y$  be another edge OBS and  $m$  be the number of wavelengths being used to carry bursts from OBS  $X$  to  $Y$ . The performance analysis problem can be stated as follows: given  $r$ ,  $m$  and the traffic characteristics of the bursts (e.g. arrival rate, fraction of bursts destined for OBS  $Y$  etc.), compute the burst blocking probability for bursts destined for OBS  $Y$ .

#### A. Notation, assumptions and problem statement

The edge OBS nodes depicted in figure 3 are connected to a number of router ports which are the sources of optical bursts. A router port consists of an electronic-to-optical conversion unit and an electronic buffer. The role of the electronic buffer is to store the packets until they are ready to be converted into an optical burst. The electronic-to-optical conversion is done on a first-come-first serve basis. This means that if an electronic-to-optical conversion is taking place while a group of packets is ready to be converted into optical domain, this group of packets will join a queue awaiting its turn to be converted. We define the arrival time of an optical burst as the time at which a burst is ready to be formed rather than the time at which conversion begins (See the discussion below on the justification of this modelling assumption). These two times are identical if the electronic-to-optical conversion is idle when a burst is ready to be formed; otherwise, the difference between these two times is the queueing delay experienced by the burst. Figure 4 shows 2 bursts arriving at the electronic-to-optical interface. Burst 1 arrives when the conversion unit is idle and no delay is experienced by this burst. Burst 2 arrives when the conversion unit is busy, the conversion of burst 2 begins once the unit has finished converting burst 1. We assume (1) one way resource reservation mechanism is used; (2) full wavelength conversion is available at the edge OBSes; (3) The edge OBSes do not have any optical buffers; (4) the electronic buffer has infinite capacity, which implies that any blocking of the optical bursts will only occur at the edge OBS; (5) back-to-back departure of optical bursts from the router port is allowed.

The optical burst characteristics from each router port is assumed to be independent and identically distributed (iid). The bursts from each router attached to OBS  $X$  destined for all the other edge OBSes are given by Poisson distribution with aggregate rate  $\lambda$ . Each burst has an independent probability  $p$  that it is destined for OBS  $Y$ . The service time of each burst is independently distributed according to exponential distribution with mean  $\frac{1}{\mu}$ .

It is instructive to point out here the differences between the arrival model being used here and that in the current literature. Performance modelling of OBS in current literature is mostly based on the  $M/M/m/m$  queuing model [Tur99]. In the context of our work, the use of an  $M/M/m/m$  model corresponds to making the assumption that the arrival time of an optical burst is the time at which electronic-to-optical conversion for that burst begins. However, this model fails to capture two aspects of the problem. Firstly,  $M/M/m/m$  model can give an arbitrarily large error in burst blocking probability. Let us consider the special case where only one router port ( $r = 1$ ) carries

all the traffic destined for OBS  $Y$  (i.e.  $p = 1$ ) and is served by a lightpath (i.e.  $m = 1$ ). Blocking is not expected to occur in this case. However,  $M/M/1/1$  model gives a blocking probability of  $\frac{\lambda}{\lambda+\mu}$ , which approaches 1 for large  $\lambda$ . Secondly, the possibility that an optical burst may have to wait in the electronic buffer before conversion is ignored if an  $M/M/m/m$  model is adopted. In view of this, we have therefore chosen to define the burst arrival time as the time at which a burst is ready to be formed rather than the time at which conversion begins.

The performance of this hybrid architecture is determined by the burst blocking probability. Thus, given  $r$  router ports are going to share  $m$  wavelengths, our problem is then to determine the burst blocking probability. This is a tandem queue problem where the output of  $r$   $M/M/1$  queues are fed into  $m$  wavelengths with identical service time in both queues. (Note that the  $M/M/1$  queues arise from the fact that electronic to optical conversion may be delayed. It also means that the analytical model allows back-to-back arrival of optical bursts at an OBS. This is generally not allowed in practice since finite time is required to adjust the settings in an OBS in between switching two bursts. However, this time is generally small compared with the length of a burst and can be neglected). Tandem queue problems with identical service time at both servers are hard to solve exactly. In this paper, we will show how an upper bound on blocking probability can be derived. The key to arriving at the result is the observation that if no optical buffer is used at an OBS, a burst is either accepted without any delay or dropped.

In order to make the derivation easier to understand, we first show how an upper bound can be derived for the special case where  $p = 1$  in section III-B. The argument for arbitrary  $p$  is a simple modification of this derivation and we present the result in section III-C.

#### B. Upper bound on blocking probability with $p = 1$

In this section, we derive an expression for the upper bound of burst blocking probability for the case  $p = 1$ .

*Lemma 1:* We consider the case where there are  $r$  router ports. At each router port, the bursts arrive according to Poisson distribution with mean rate  $\lambda$  and exponentially distributed service time with mean  $\frac{1}{\mu}$ , where  $\mu > \lambda$ . The arrival and service time distributions at all the ports are iid. Denote  $\rho = \frac{\lambda}{\mu}$ . Furthermore, all the optical bursts from these  $r$  router ports are destined for the same edge OBS and are served by  $m$  wavelengths. Let  $z_t$  denote the number of wavelengths that is busy at time  $t$ . We have

$$\text{Prob}(z_t = m) \leq \sum_{h=m}^r C_h^r \rho^h (1 - \rho)^{r-h} \quad (1)$$

**Proof:** For the case where  $m > r$ , i.e. there are more wavelengths than sources,  $\text{Prob}(z_t = m)$  is zero and equation (1) holds trivially.

For  $r \geq m$ , we will first derive a lower bound for  $\text{Prob}(z_t \leq m-1)$  and use the fact that  $\text{Prob}(z_t = m) = 1 - \text{Prob}(z_t \leq m-1)$  to obtain the upper bound given in equation (1).

Since no optical buffer is used at an OBS, a burst is either accepted without any delay or dropped. Therefore, a sufficient

condition for  $z_t \leq (m-1)$  is that  $(m-1)$  or less sources are sending at time  $t$ . This implies

$$\text{Prob}(z_t \leq m-1) \geq \sum_{h=0}^{m-1} C_h^r \rho^h (1-\rho)^{r-h} \quad (2)$$

where the RHS of (2) gives the probability  $m-1$  or less sources are sending. Equation (1) is then obtained by using  $\text{Prob}(z_t = m) = 1 - \text{Prob}(z_t \leq m-1)$ . *QED.*

*Remark 1:* In the proof to Lemma 1 we claim that the event “ $(m-1)$  or less sources are sending at time  $t$ ” implies the event “ $z_t \leq (m-1)$ ”. However, the converse of this statement does not hold. We show this by using the counter example in figure 5. The figure shows the duration of the bursts from 3 ( $= r$ ) sources and we assume there are only 2 ( $= m$ ) wavelengths. The bursts from sources 2 and 3 will both be accepted, but the burst from source 1 will be dropped. At time  $t$ , marked by the dashed lines,  $z_t = 1 \leq (m-1)$  but 2 sources are sending.

Before we derive an expression for the upper bound of blocking probability, we first need to clarify its definition. For an  $M/M/m/m$  queue, let “ $z_t = m$ ” denote the event that  $m$  servers are busy at time  $t$ , then the blocking probability is defined as [WV00, p.446]:

$$\text{Prob}(z_t = m | \text{a customer arrives in } (t, t + \delta t)). \quad (3)$$

In our case, the OBS receives its bursts as the output of a number of  $M/M/1$  queues, which means that back-to-back bursts from the same queue can arrive at the OBS. In other words, a burst arriving at an OBS in the time interval  $(t, t + \delta t)$  may coincide with the departure of a burst from OBS. However, a burst that arrives immediately after the previous one has departed will never be blocked because: (1) The arriving burst can use the now unoccupied wavelength; (2) Due to the fact that the output process of an  $M/M/1$  queue is Poisson [Kle75], this precludes the possibility that another burst arriving in  $(t, t + \delta t)$ . In view of this, it is necessary to change the definition of blocking probability in our case to reflect the actual condition under which blocking occurs. The revised definition of blocking probability is

$$\text{Prob}(z_t = m \text{ and no bursts depart in } (t, t + \delta t) | \text{a burst arrives in } (t, t + \delta t)). \quad (4)$$

Note that in the above definition, both arrival and departure are with respect to the OBS.

*Theorem 1:* Under the same assumptions stated in lemma 1, the blocking probability is bounded from above by

$$\left(1 - \frac{m}{r}\right) \sum_{h=m}^r C_h^r \rho^h (1-\rho)^{r-h} \quad (5)$$

**Proof:** If  $m \geq r$ , no blocking will occur and the theorem holds trivially.

For  $m < r$ , we have

blocking probability

$$\begin{aligned} &= \text{Prob}(z_t = m \text{ and no departure occurs in } (t, t + \delta t) | \text{a burst arrives in } (t, t + \delta t)) \\ &= \text{Prob}(z_t = m) \times \\ &\quad \text{Prob}(\text{no departure occurs in } (t, t + \delta t) | z_t = m) \times \\ &\quad \text{Prob}(\text{an arrival occurs in } (t, t + \delta t) | \\ &\quad z_t = m \text{ and no departure occurs in } (t, t + \delta t)) / \\ &\quad \text{Prob}(\text{an arrival occurs in } (t, t + \delta t)) \\ &= \text{Prob}(z_t = m) \times \\ &\quad \text{Prob}(\text{no departure occurs in } (t, t + \delta t) | z_t = m) \frac{(r-m)}{r} \\ &\leq \left(1 - \frac{m}{r}\right) \sum_{h=m}^r C_h^r \rho^h (1-\rho)^{r-h} \end{aligned}$$

In going from (6) to (6), we make use of the fact that the arrival process at OBS (which is the output process of  $M/M/1$  queue) is Poisson [Kle75]. *QED*

### C. Upper bound on blocking probability for arbitrary $p$

It can be shown that, for arbitrary value of  $p$ , the above derivation still applies if we replace  $\rho = \frac{\lambda}{\mu}$  by  $\tilde{\rho} = \frac{p\lambda}{\mu}$ . We have the following theorem.

*Theorem 2:* We consider the case where there are  $r$  router ports connected to a given edge OBS  $X$ . At each router port, the bursts arrive according to Poisson distribution with mean rate  $\lambda$  and exponentially distributed service time with mean  $\frac{1}{\mu}$ , where  $\mu > \lambda$ . The arrival and service time distributions at all the ports are iid. Let  $Y$  be another edge OBS. Each burst has an independent probability of  $p$  being destined for  $Y$  and altogether  $m$  wavelengths are used to serve the bursts destined for  $Y$ . Denote  $\tilde{\rho} = \frac{p\lambda}{\mu}$ . The blocking probability for those bursts destined for  $Y$  is bounded from above by

$$\left(1 - \frac{m}{r}\right) \sum_{h=m}^r C_h^r \tilde{\rho}^h (1-\tilde{\rho})^{r-h} \quad (6)$$

An application of equation (6) is to compute the minimum number of wavelengths required to achieve a given blocking probability. Since equation (6) is a monotonically decreasing function in the integer variable  $m$ , the minimum number of wavelengths required can be found readily by, for example, bisection search in  $m$ .

### D. Numerical results and tightness of the bound

We use simulation to study the quality of the upper bound given by equation (6). The simulation parameters are  $\frac{\lambda}{\mu} = 0.3$  and  $r = 32$ . Figures 6 and 7 show how the blocking probability varies with the number of wavelengths for, respectively,  $p = 0.31$  and  $p = 0.9$ . It can be seen that the upper bound is within an order of magnitude of the true blocking probability. In particular the upper bound is tighter for small blocking probability (e.g.  $10^{-5}$ ) which is the region of interest.

As mentioned earlier, an application of equation (6) is to compute the minimum number of wavelengths required to

achieve a given blocking probability. Figure 8 shows the number of wavelengths required to achieve a given blocking probability for  $r = 32$  with  $p = 1$ . The utilization in the horizontal axis refers to the utilization of each source (which is itself an  $M/M/1$  queue). It can be seen that the number of wavelengths required is significantly reduced. We have also used simulation to estimate the number of wavelengths required to achieve a blocking probability of  $10^{-6}$  for source utilization of 0.1, 0.3, 0.5 and 0.7. The simulation predicts that we will require 14, 23, 29 and 32 wavelengths respectively in order to achieve the given blocking probability. The upper bound formula gives exactly the same number of required wavelengths and there appears to be a tight upper bound.

#### IV. CONCLUSIONS AND FUTURE WORKS

In this paper, we have proposed a hybrid architecture consisting of OBSes in the network edge and OXCes in the network core. In comparison with the OXC based architecture, hybrid architecture improves the utilization of the wavelength in the optical core. For a carrier with an existing OXC-based network, this improved utilization means that the migration to the hybrid architecture will allow it to carry more traffic using the existing infrastructure. The hybrid architecture therefore presents a viable intermediate architecture for migrating from an OXC-based network to an OBS-based network. In addition we use queueing analysis to derive a formula which allows us to calculate the minimum number of wavelengths required to achieve a given blocking probability in this hybrid architecture. Simulation shows that this formula gives very accurate prediction. Future works include the study of the proposed architectures under different burst arrival processes.

#### REFERENCES

[CVR02] H.M. Chaskar, S. Verma, and R. Ravikanth. Robust transport of IP traffic over WDM using optical burst switching. *Optical Network Magazines*, pages 47–60, July/August 2002.

[DB02] M. Duser and P. Bayvel. Analysis of a dynamically wavelength routed optical burst switched network architecture. *J. Lightwave Technology*, 20(4):574–585, 2002.

[DGSSB01] K. Dolzer, C. Gauger, J. Spath, and S. Bodaner. Evaluation of reservation mechanisms for optical burst switching. *AEU Int. J. Electron. Commun.*, 55(1):1–8, 2001.

[DL02] A. Detti and M. Listanti. Impact of segments aggregation on TC Reno flows in optical burst switching networks. In *Proc. INFCOM*, pages 1803–1812, 2002.

[DR02] R. Dutta and G.N. Rouskas. Traffic grooming in WDM networks: past and future. *IEEE Network*, pages 46–56, Nov/Dec 2002.

[Kle75] L. Kleinrock. *Queueing Systems. Volume I: Theory*. John Wiley & Sons, 1975.

[ML01] E. Modiano and P.J. Lin. Traffic grooming in WDM networks. *IEEE Communications Magazine*, pages 124–129, July 2001.

[OK02] S.Y. Oh and M. Kang. A burst assembly algorithm in optical burst switching networks. In *OFC 2002*, 2002.

[Qia00] C. Qiao. Labeled optical burst switching for IP-over-WDM integration. *IEEE Communications Magazine*, pages 104–114, September 2000.

[Tur99] J. Turner. Terabit burst switching. *International Journal of High Speed Networks*, 8(1):3–16, 1999.

[WV00] J. Walrand and P. Varaiya. *High performance communication networks*. Morgan Kaufmann, second edition, 2000.

[XVC00] Y. Xiong, M. Vandenhouste, and H.C. Cankaya. Control architecture in optical burst-switched WDM networks. *IEEE Journal of Selected Areas in Communications*, 18(10):1838–1851, 2000.

[YQ99] M. Yoo and C. Qiao. Optical burst switching - a new paradigm for an optical Internet. *International Journal of High Speed Networks*, 8(1):69–84, 1999.

[YQD00] M. Yoo, C. Qiao, and S. Dixit. QoS performance of optical burst switching in IP over WDM. *IEEE Journal of Selected Areas in Communications*, 2000.

[YQD01] M. Yoo, C. Qiao, and S. Dixit. Optical burst switching for service differentiation in the next-generation optical internet. *IEEE Communications Magazine*, 39(2):98–104, 2001.

[ZJS<sup>+</sup>01] H. Zang, J.P. Jue, L. Sahasrabudhe, R. Ramamurthy, and B. Mukherjee. Dynamic lightpath establishment in wavelength-routed WDM network. *IEEE Communications Magazine*, pages 100–108, September 2001.

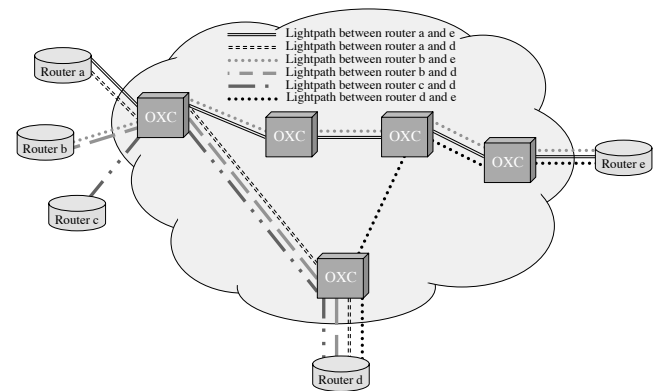

Fig. 1. Current OXC-based optical network architecture.

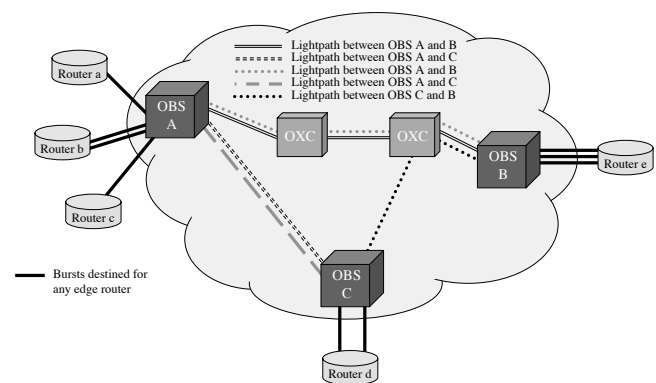

Fig. 2. Hybrid architecture.

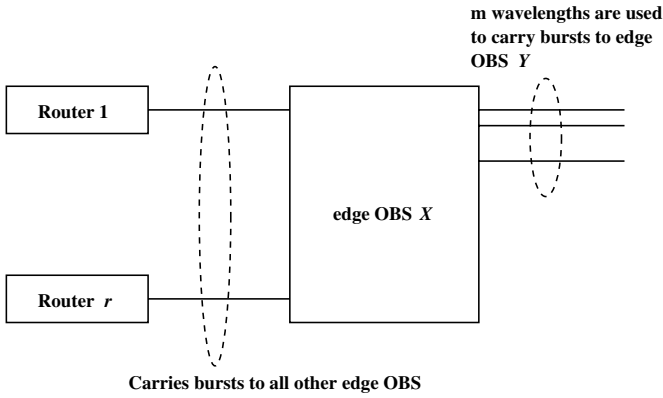

Fig. 3. The general problem.

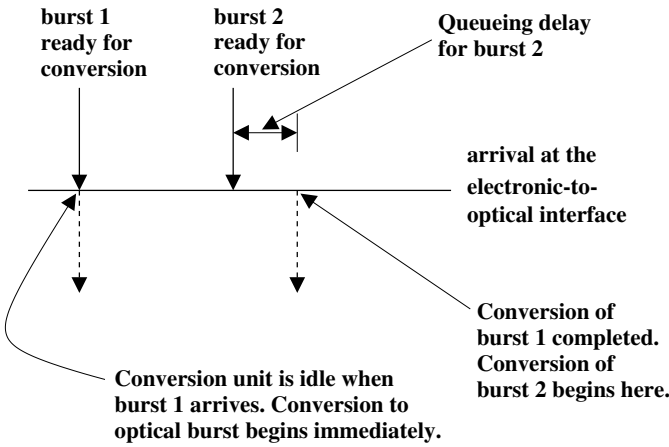

Fig. 4. A diagram illustrating the arrival of optical bursts at the electronic-to-optical interface. Burst 1 arrives when the conversion unit is idle and no delay is experienced by this burst. Burst 2 arrives when the conversion unit is busy, the conversion of burst 2 begins once the unit has finished converting burst 1.

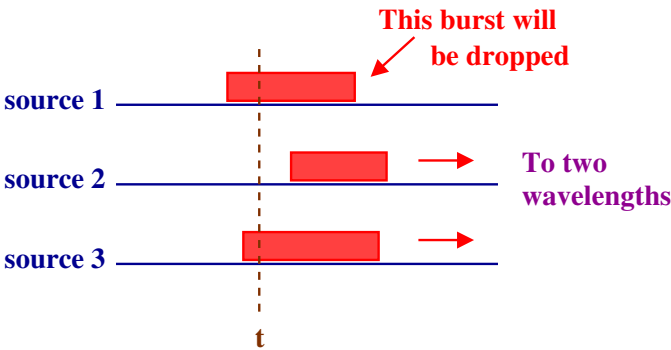

Fig. 5. This figure shows that  $z_t \leq m - 1$  does not imply  $(m - 1)$  or less sources are sending, where  $m$  is the number of wavelengths. There are three sources and  $2 (= m)$  wavelengths. At time  $t$ ,  $z_t = 1 \leq m - 1$  but 2 sources are sending.

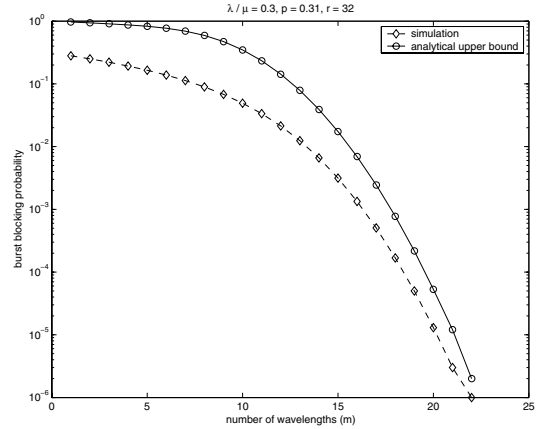

Fig. 6. This figure shows how blocking probability varies with the number of wavelengths. The upper bound is given by formula (6). The parameters are  $\frac{\lambda}{\mu} = 0.3$ ,  $r = 32$  and  $p = 0.31$ .

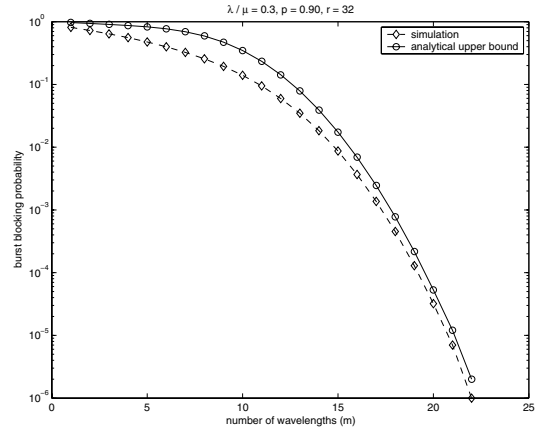

Fig. 7. This figure shows how blocking probability varies with the number of wavelengths. The upper bound is given by formula (6). The parameters are  $\frac{\lambda}{\mu} = 0.3$ ,  $r = 32$  and  $p = 0.9$ .

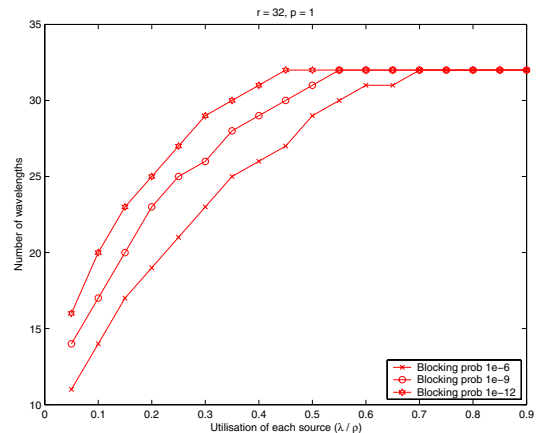

Fig. 8. This figure shows the number of wavelengths required to achieve a given blocking probability. The number of wavelengths required is predicted using the upper bound formula (6). The parameters are  $r = 32$  and  $p = 1$ .