

# ENVISIONING WORK

*An Autism Friendly And Anxiety Free Office*

**Naixin Ren**  
**Spring 2020**

Envisioning work

An autism friendly  
and anxiety free office

A thesis submitted in partial fulfillment of the requirements for the degree Master of Design in Interior Studies [Adaptive Reuse] in the Department of Interior Architecture of the Rhode Island School of Design

By

Naixin Ren

2020

Approved by Master's Examination Committee:

---

Markus Berger  
Associate Professor, Department of Interior Architecture, [Primary/ Secondary] Thesis Advisor

---

Julia Bernert  
Critic, Department of Interior Architecture, [Primary/ Secondary] Thesis Advisor

---

Heinrich Hermann  
Critic, Department of Interior Architecture, [Primary/ Secondary] Thesis Advisor & Thesis Chair

---

Francesca Liuni  
Critic, Department of Interior Architecture, [Primary/ Secondary] Thesis Advisor

---

Liliane Wong  
Department Head, Department of Interior Architecture, [Primary/ Secondary] Thesis Advisor

Acknowledgments:

Ernesto Aparicio  
Critic, Department of Graphic Design, Consultant,  
Graphic Design

Nick Heywood  
Critic, Department of Interior Architecture, Adviser,  
Writing and Thesis Book

Paul Mayencourt  
Critic, MIT Department of Architecture, Consultant,  
Structural Engineering

Stephen Turner  
Critic, Department of Interior Architecture, Consultant,  
Energy, Systems and Sustainability

## **DEDICATION**

*In deep respect and true love  
I would like to dedicate this book to my sister  
and to all those people on the spectrum  
who experience anxiety and isolation*



# CONTENTS

**10**

## INTRODUCTION

Abstract  
Background

**16**

## RESEARCH

Autism employment  
Precedent studies  
ASD friendly elements

**40**

## INTERVIEWS

Dr. Levine  
Ms. Ding

**52**

## SITE

334 Jingyu st  
Existing condition  
Problems to be solved

**66**

## DESIGN

Key elements  
Program  
Detailed drawings  
ASD friendly tool-kit  
Perspectives

**122**

## RESOURCE

Annotated bibliography  
List of images

## ABSTRACT

Autism spectrum disorder (ASD) refers to a broad range of conditions characterized by challenges with social skills, repetitive behaviors, speech and nonverbal communication. It is estimated that worldwide 1 in 160 children has ASD, and in China, about 1 in 69 children has ASD.

There are many successful educational environments specially designed for people on the spectrum to support learning, understanding, and behaving. However, after graduating, it is usually very hard for people on the spectrum to move toward independence because there is a huge difference between school environments and office environments.

Most office environments are designed to meet the majority workers' needs, but they are not supportive for people on the spectrum. There are very few innovative companies that recognize the unique skills that people on the spectrum

and design their office carefully to support them. Most companies don't consider the special needs of people on the spectrum while designing their office, which makes people with ASD struggle to find jobs because of the anxiety that might be caused by unsupportive workspaces.

An office's interior configurations has a great impact on employees' performance. It is important to create a supportive office environment for both people on the spectrum and those who have other forms of anxiety at work. The key to an autism friendly and anxiety free office is balance. The space will be divided in a way to create a balance between working and relaxing, private and open, as well as light and shade. Focusing on productivity, privacy, and flexibility, I will create a system that can be applied to any type of building to make an office ASD friendly. The system provides employees the personal space they need,

and at the same time it encourages employees to communicate. The proposed site is located in Laodaowai District, Harbin, China, and the existing site conditions are not ideal for people on the spectrum for their work performance. The site will be an example of how the autism friendly system can be applied to any type of building, even one in a problematic setting.

Most people on the spectrum have sensory problems. According to Autism Speaks, In 2013, the American Psychiatric Association added sensory sensitivities to the symptoms that help diagnose autism. Autism's sensory issues can involve both hyper-sensitivities (over-responsiveness) and hypo-sensitivities (under-responsiveness) to a wide range of stimuli. It is important to balance the environment through the five senses to make sure that they are not experiencing sensory overload or sensory deprivation. The ideal autism friendly en-

vironment should take care of the special needs of people on the spectrum. People on the spectrum need a lot of personal space, and it is important to make sure that they have enough room to be alone. In addition, people on the spectrum do not like unpredictable moments, sharp corners, long corridors, and irregular shapes that make them feel insecure and puzzled. Complicated circulation should also be avoided because they are easy to get lost. Way-finding is a very important element in an autism friendly office. It is important to use colors, patterns, textures, signs..., to navigate people through the office. Not only people on the spectrum are invited to the office. General population, people who have anxiety problems and people who desire a relaxing working environment are all welcomed to work in the office. The employees will get the comfort of working from home, as well as the productivity of working at a formal office.

## BACKGROUND

In 2006, my family found that my sister had autism. At that time autism was a new word to us, and we were always trying to find the best way to help her. After three years of research into autism, my mother started an autism training center to help my sister and other children on the spectrum. Since then I have been training with my sister for several years, and was able to see how my sister improved each day.

Everything in the autism training center looked so soft and smooth. It became my favorite place to be because I feel completely relaxed there. I loved to do my homework in the training center as I found myself able to work much more productively in the space.

My sister will graduate from her training school in 2020, and she mentioned that she most wants to work in an office right after

graduation. As I started to imagine her life in an office, I began to worry if she could adapt the office environment on her own terms.

Over and over I asked myself these questions:

“There are so many people working in an office; will she have her own space to work?”

“She can get very anxious when she hears other people talking loudly; how can we make sure she can escape from the noise?”

“What if she gets lost in the building?”

“What if she wants to work on her own, in a separate space?”

“What if she wants to eat alone without being disturbed?”

“What if ...”

And then I realized how hard it could actually be for people on the spectrum to work in a normal office, and how important it is to design an ASD-friendly office.

The experience of growing up in an autism training center made me realize that an ASD friendly environment will benefit everyone who uses it, not just those who are on the spectrum. The interior design of the autism training center is flexible and balanced. Everyone can find their own comfort space, and no one needs to worry about uncomfortable encounters with other people. Can an office space be like that? I will figure it out through the making of this book.

## RESEARCH

### CAREERS FOR PEOPLE ON THE SPECTRUM

People on the spectrum used to be considered unemployable, but a lot of business start to value the potentials and skills that people on the spectrum have.

According to Applied Behavior Analysis Program Guide, "people on the spectrum are actually very good, and even better than people on the general population in some field. Each individual on the spectrum has different skills and limitations, but typically jobs that require a lot of communications are not the best job for people on the spectrum."

Because people on the spectrum are good at repetitive movements, there are a lot of jobs that are perfect for people on the spectrum.

## AUTISM SCHOOLS IN HARBIN

There are about 30 thousand people in Harbin who is on the spectrum. Among the 19 special education schools in Harbin, Liaoyuan Special Education is the largest autism school in Harbin. There are 200 students at school, and they are divided into 12 small classes of.

From grade 1-9, students take basic Math classes and Mandarin classes. In addition, they take P.E classes, drawing classes, and basic living skill classes. After they finished the 9 years

of education, they can apply for advanced training programs. There are 3 majors in the advanced training programs - Pastry, Culinary, and Housekeeping. And there are more and more newer field like computer and softwares that are going to be added to the training program. Students will be interviewed to see if they are qualified for any of the advanced training programs.



1.1



1.2

## POPULAR JOBS FOR PEOPLE ON THE SPECTRUM

### 1. "Animal-related Jobs - Dog Trainer, Vet Tech, etc."

Some people on the spectrum get anxious while communicating with other people. Animal-related jobs allow them to concentrate on their job without needing to think about what to say to other people.

### 2. "Computer Programming and Software"

These types of jobs require very little interaction with people, as well as allowing individuals with autism have more personal spaces.

### 3. "Scientist, Lab Technician, or Researcher"

Individuals on the spectrum tend to pay more attention on the smaller details. Jobs related to science require very precise research, which is why these types of jobs are perfect for people on the spectrum.

### 4. "Journalism"

A lot of Journalists put their own thoughts and opinions in while reporting. However, people on the spectrum tend to state the truth without relating their own opinions, which makes them very professional in the field of journalism.

### 5. "Assembly-line Manufacturing"

Individuals on the spectrum tend to be good at repetitive movements, and they enjoy doing manufacturing jobs that allow them to concentrate in doing one repetitive thing for a long time.

# PRECEDENT

## 1 / STRESS FREE OFFICE DESIGN

**Client:** ConsenSys  
**Location:** London, United Kingdom  
**Completion:** 2019  
**Designer :** Neiheiser Argyros

This is an office designed to improve the working atmosphere for better productivity and concentration. It helps with people's anxiety, and it provides a stress free office. The office was divided to distinct working environments, which is great because each person has their preferred environment to work. Some people like to work in smaller, private areas, while some people like to work in open spaces where everyone works together.

A lot of libraries, like fleet library in providence, RI, for example, have these studying spaces for people who don't like open spaces, and who prefer to work by themselves. The fact that people can choose their working environment if brilliant. By using different materials for different working zones, it is easier for people on the spectrum to navigate the space.



1.3

1.4

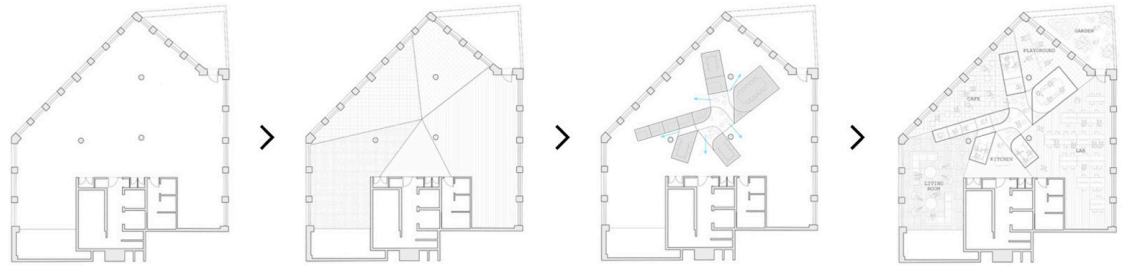

1.5



## PRECEDENT

### 2 / LIGHTING DESIGN

**Client:** Netley Primary School Autism Unit  
**Location:** London, United Kingdom  
**Completion:** 2004  
**Designer :** Haverstock Associates

"Netley Street School opened its doors to children in 1883 and all through its history the school has worked hard to improve the achievements of its pupils. In 1971 a brand new building was opened to provide early years provision. In early 2000, Camden identified a growing need to offer specialist support for children with Autism. The first purpose built resource base for children was opened four years later." ("About Us - Netley Primary School" 2019)



1.6

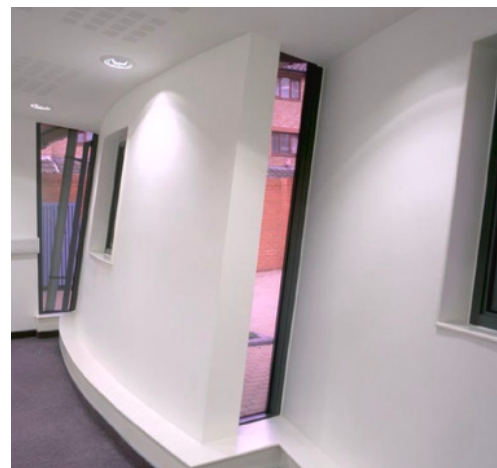

1.7



1.8



1.9

Some teachers at the school mentioned that recently some of the classrooms are too light that they had to cover those floor to ceiling windows. The picture on the right shows how the windows are covered with paper.

"The teachers said the views from the nearly wall-to-wall, floor-to-ceiling windows were too distracting for the students. Their solution was to cover  $\frac{3}{4}$  of the windows with paper. On top of making the building look somewhat rundown,

this solution appeared to hinder the lighting design that originally depended on more daylight" (Christopher N. Henry, 2012)

It is very important to keep in mind that people on the spectrum are very sensitive to light. And too much daylight will make people on the spectrum uncomfortable because the shade that daylight creates can reduce the simplicity of the room.

## AUTISM FRIENDLY DESIGN ELEMENTS

### ORDINARY

*[adjective]*

*No special features*

Temple Grandin did a speech about autism and animal behavior at Colorado State University on sep, 13 2018(Dubois 2018). She said:“Something as simple as a paper towel may not seem distracting at first, but when you put it in an unordinary place, animals may be scared by the unfamiliar nature of the object. This is apparent in both animals and people with autism; they are always on the lookout for danger and fear.”

As Grandin stated, ordinary is very important for people on the spectrum. This applies to architecture as well. It is important to make sure that the environment designed for people on the spectrum is ordinary so that they won't feel unsecure or anxious in the environment.



2.1



## AUTISM FRIENDLY DESIGN ELEMENTS

### ORDERLY

*[adjective]*

*Arranged in a stable order*

From Temple Grandin's quote, "The autistic child is unable to bring order to his world. You must provide that order in his environment", I learned that it is important to design an environment that has a stable order. The environment should have as little change as possible because we don't want people with ASD to get lost in the environment.



## AUTISM FRIENDLY DESIGN ELEMENTS

### **SIMPLE**

*[adjective]*

#### **Easy to navigate**

Donna Williams shared her own experience in her book *[Nobody Nowhere]*. She said, "The whole place was a mass of corridors; a puzzle in which you had to choose the right door. I liked the banisters, which led to hallways with red doors running off them. I was constantly going into strange classrooms and sitting down before being escorted out and pointed in the direction of my own class." (Donna Williams, 2009)

While reading Donna Williams's book, I found that it is easy for people on the spectrum to get puzzled. My sister who is on the spectrum has the same problem. It is hard for her to reme-

ber her classrooms. The school she went to was not designed specifically for children on the spectrum, she gets lost easily and gets very anxious at school. It is very important that the environment is designed as simple as possible that children. The classrooms should not be everywhere, and different classrooms should be labeled with different colors or signs. The New Struan Center for Autism did a great job on designing the classrooms. They are very easy to be located, and there are different paintings on the wall next to each classroom for children to identify different classrooms.

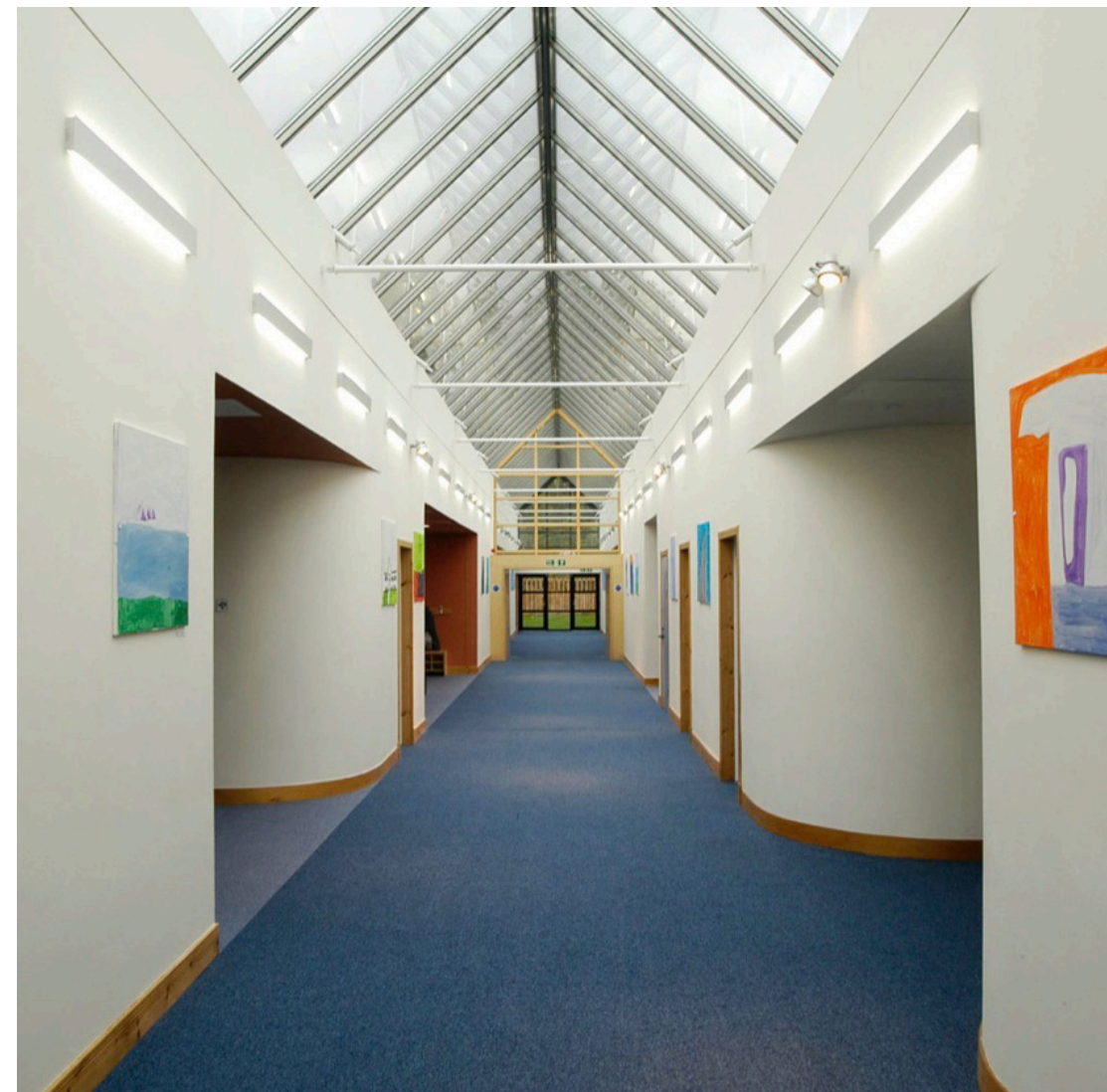

2.3



## AUTISM FRIENDLY DESIGN ELEMENTS

### INDIRECT LIGHTING

[noun]

*Lights that the source are not visible*

As stated earlier, individuals on the spectrum are very sensitive to lighting.

According to Car autism roadmap, fluorescent lightings have flickers and hums that may be uncomfortable to the sensory sensitivities of people on the spectrum.

Indirect lightings are more autism friendly than fluorescent lightings.

If there are windows and direct sunlight will be an issues. designers should utilize windows

with shades placed between the glass rather than traditional vinyl shades.(Car autism roadmap 2016)



2.4

## AUTISM FRIENDLY DESIGN ELEMENTS

### QUIETNESS

[noun]

*Absence of noise*

Individuals on the spectrum are very sensitive to noise. I visited a school designed for children on the spectrum in 2016. During my visit, one child was screaming very loudly, and almost all the other children in the room tried to cover their ears or run out of the classroom. Some of them even cried because of the noise.

To avoid noise problems, background noise, echo, and reverberation should all be minimized so that the room will not be sensory overload.

It is also very important to reduce sounds and related noises from ventilation and related systems.

Sound absorbing systems should be applied to the environment.

Noise of traffic should also be considered as disturbing noise.



2.5

## AUTISM FRIENDLY DESIGN ELEMENTS

### MUTED COLOR

[noun]

*Soft and calm color*

Color can affect people's mood and level of anxiety. Using the right colors when designing an space can increase overall productivities and office wellbeing. Be mindful with the use of color when designing for people on the spectrum because bright colors can make them feel overwhelmed. It is important to use the correct colors for the correct spaces.

"Use calming, muted, and matte colors instead of bright and over-stimulating ones (including bright white)" (Car autism roadmap 2016).

The color palette to the right from [ Designing Environments for Children and Adults with ASD ] by Christopher Beaver (GA Architects) is identified by a group of children on the spectrum as ideal.

### ASD Friendly Palette



## AUTISM FRIENDLY DESIGN ELEMENTS

### ESCAPE ROOMS

[noun]

*Rooms to take a break*

Sometimes people get overwhelmed in an office environment. Individuals on the spectrum are usually more sensitive to their environment and need to take breaks.

Escape rooms are rooms where a person can retreat when being overwhelmed. It is very important to incorporate quiet rooms in the building, especially in autism friendly buildings. Escape rooms can be designed into different forms. It can be sensory rooms or quiet rooms.

Escape rooms should be located throughout the building so people don't have to go a long distance to find one. (Car autism roadmap 2016)



2.6



## AUTISM FRIENDLY DESIGN ELEMENTS

### WAYFINDING

[noun]

*Navigating through the office*

Wayfinding in an office is very important, especially for autism friendly designs. If employees feel puzzled or lost during their day in the office, their productivities and level of anxiety will be impacted. Wayfinding elements including signs, labels, textures, patterns, and colors can indicate different areas and different uses, which helps employees to navigate through the office with minor interruptions and confusions.

Some schools use paintings to indicate different rooms, which is a very successful way of navigating people on the spectrum into the rooms they are trying to find. There are offices that use maps of their country to indicate different rooms. There are a lot of ways to create a appropriate wayfinding system. An autism friendly wayfinding system should be neat and clear, which helps in creating an organic and safe circulation system.



27

## INTERVIEWS

### CONVERSATIONS

In fall 2019, I got a chance to have a conversation with Dr. Levine, an expert with ASD and anxiety. He gave me a lot of good advice and most updated news about ASD.

Thanks to him, I realized that people on the spectrum and people who have anxiety have a lot of similar architectural requirements, and designing ASD friendly environment actually benefits those who have anxiety problems as well.

In Spring 2020, I had a conversation with Ms. Ding, she has been taking care of my sister for 2 years. She had a lot of experiences

with children on the spectrum, and she learned a lot about ASD during the years of teaching in special education schools. She is very patient and professional. She helped me understand what people on ASD really needs during their daily life and how external elements can impact people on the spectrum's overall wellbeing



## **A CONVERSATION WITH DR. LEVINE**

*Fall, 2019*

"Todd Levine, MD, an assistant professor in the Department of Psychiatry and Human Behavior at The Warren Alpert Medical School of Brown University. His research, clinical work, and lectures focus on behavior difficulties in children and adults with autism spectrum disorders with particular attention towards anxiety." ("Researchers@Brown." Levine, Todd. 2019)

R: "From your experience, what is the most effective treatment or therapy for autism spectrum disorder?"

T: "Applied behavior analysis. Applied Behavior Analysis (ABA) is a type of therapy that focuses on improving specific behaviors, such as social skills, communication, reading, and academics as well as adaptive learning skills, such as fine motor dexterity, hygiene, grooming, domestic capabilities, punctuality, and job competence. ABA is effective for children and adults with psychological disorders in a variety of settings, including schools, workplaces, homes, and clinics."

R: "What are the key elements we should consider when designing a space for people with autism spectrum disorder?"

T: "Exterior noise, light, and interior sound are the elements we should consider. A lot of people with ASD are very sensitive to noise. Many ASD schools that I have been working with has noise buffering system to control noise. Some people with ASD are very sensitive to light, so it is important to control the quality of light. Softer, indirect light is preferable than strong, direct light."

R: "What about the variety of space? Do people with ASD prefer more open spaces?"

T: "For most people with ASD, too much open spaces will be overwhelming. If you want to design something with a lot of open space, you should consider have some smaller areas or rooms for them to "get away"."

R: "What about outdoor space? Should we have more or less outdoor space when designing a school for people with ASD?"

T: "It depends. Some people like outdoor space and some don't. A good way to balance that is to have some open, out-door space, but also have some darker indoor space."

## **A CONVERSATION WITH MS. DING**

*SPRING, 2020*

Ms. Ding is a teacher working in Liaoyuan Special Education. She has been working with students on the spectrum for more than 5 years. She is currently in the No.2 advanced training class of Liaoyuan Special Education. She takes care of the 11 students for the 3-year advanced training program. She is one of the most professional and experienced teacher of the school.

R: "Are students sensitive to any type of lighting? Is there any lighting source that they prefer?"

D: "The students don't have any problem with lighting. We don't have any specific lighting designed for students on the spectrum. They have never complained about the lighting so far"

R: "What about noise? Are the students sensitive with noise?"

D: "Definitely. A lot of students at the school have hyperacusis. They are very sensitive to noise. They can hear the sound that a lot of people can't hear. When they hear noise, they will try to cover their ears. Some of them get very anxious and start to cry. We don't have any solutions for this noise problem

yet. Some people will get hearing treatment when they are older."

R: "After they graduated from the training program, will the school keep supporting them, and help them find a job?"

D: "We will contact local Disabled Persons' Federation for them. The federation will provide us a list of jobs that they can offer.

R: "What types of jobs will they offer? Are they paid well?"

D: "They are mostly repetitive job that don't require a lot of talking. They usually work in the countryside that is very far from the city.

And the salary is relatively low."

R: "Have they talked about what jobs they want to do after graduation?"

D: "They almost never talked about it. They are confused as well."

R: "Do they prefer indoor or outdoor activities?"

D: "They prefer outdoor activities. They really enjoyed it when we were volunteering local communities."

R: "Exterior noise, light, and interior sound are the elements we should consider. A lot of people with ASD are very sensitive to noise. Many ASD

schools that I have been working with has noise buffering system to control noise. Some people with ASD are very sensitive to light, so it is important to control the quality of light. Softer, indirect light is preferable than strong, direct light."

R: "What about the variety of space? Do people with ASD prefer more open spaces?"

T: "For most people with ASD, too much open spaces will be overwhelming. If you want to design something with a lot of open space, you should consider have some smaller areas or rooms for them to "get away"."

R: "What about outdoor space? Should we have more or less outdoor space when designing a school for people with ASD?"

T: "It depends. Some people like outdoor space and some don't. A good way to balance that is to have some open, out-door space, but also have some darker indoor space."

R: "Do they enjoy group projects? Or do they like individual projects better?"

D: "Students on the spectrum, as you know, really need their own space. When they are at school, they are doing projects on their own and they don't like to talk. However, we are encouraging group activities, and they enjoyed these activities as well"

R: "Do students help each others when they are doing their schoolworks or homeworks"



3.1

D: "No. They have never helped each other on their homeworks. They prefer doing works on their own"

R: "What type of activities or schoolworks do they concentrate on the most?"

D: "It depends. Some students concentrate the most on dancing and singing. Some of them concentrate the most on drawing and sketching. Some concentrate the most on writing. I think they are most concentrated on whatever they really like to do. They are very concentrated in class. No one talks or uses their phone during classes. They are good listeners."

R: "Are they easy to get losted at school? "

D: "Not at our school. They have been studying at this school for more than 10 years. They are very familiar with the school. They can find their classrooms, and seats easily. But if they go to a new environment, I believe they need sometime to get used to the new environment. Before they get used to the new environment, there is a possibility that they might get confused or lost. "

R: "What makes them anxious the most?"

D: "Different students have different source of anxiety. Some of them get anxious when the weather is not "right". Sometimes if it is cloudy or if it rains, they get depressed and some of them get anxious. Sometimes when they don't have projects or works to do, they get anxious. When some

students did something wrong, I would point it out and tell the student that it was not the right thing to do. However, some students don't have the ability to tell who I am talking to and they assume I'm mad at them while I'm talking to other people. They got confused and they started to get anxious and cry.

D: "They prefer outdoor activities. They really enjoyed it when we were volunteering local communities.

R: "Do most students like phones, ipads, or any electronic product. Are they good with electronic products?"

D: "Yes. Every students have phones, and half of them have ipads. Most of them are very used to electronic products. And although they don't like to talk, they like to message each other. Some of them are active on social media. Most of them enjoy playing games on their phone."

R: "Other than the 3 majors, are there any other fields that students are interested in?"

D: "As we discussed, technology is definitely one of the new fields that students are interested in. We are offering technology classes

and computer classes. As electronic products are more and more popular, there will be more and more classes for students to take. Another very popular field is DIY. Some students learned to make soaps, handmade jewelry, and other handmade crafts. Some students are selling their handmade crafts online."

R: "Do you know if any students graduated before that already found jobs?"

D: "Yes. About 20% of them found jobs and already started working."

R: "Where are they working right now?"

D: "Supermarkets, factories, government offices, and a lot of them are doing housekeeping jobs. After they graduate, they will get a Certification letter stating that they have already had 12 years of education, including 3 years of advanced training. I think the certification letter can help them find jobs. I really hope all of them can find jobs they want. Although right now only 20% of them can find jobs, as we introduce more and more majors and classes, I'm sure they will have better job opportunities"



3.2

## SITE

### 334 Jingyu St, Harbin, China

The building is located on one of the most significant historical district: Laodaiwai district. There are a lot of historical buildings on the district. In the past several years, a lot of the historical buildings were demolished. In 2016-2017, the rest of historical buildings were listed as level 2 historical buildings in Harbin, and has been preserved by the government.

## THE CITY

**Population:** 10,635,971

**Climate:** The annual mean temperature is +4.86 °C (40.7 °F),

**Extreme temperatures** have ranged from -42.6 °C (-45 °F) to 39.2 °C (103 °F).

Harbin is China's northernmost major city, with a metropolitan population in excess of 10 million, and over 4 million in the city center alone.

Historically, the city has been influenced a lot by neighboring Russia, in particular after the Russian Revolution of 1917 when the White Russians escaped the newly formed Soviet Union.

The influence remains clearly visible in the building styles and foods.

The city was founded in 1897 as a camp for Russian engineers surveying the Trans-Siberian Railway. Labor demands brought in a collection of outcasts from across Russia, Poland and even from within Manchuria.

The city eventually was captured by the Japanese during World War II and later returned to China in 1946. Once nothing more than a Russian-built outpost of the railway line, Harbin has expanded far beyond its limits."





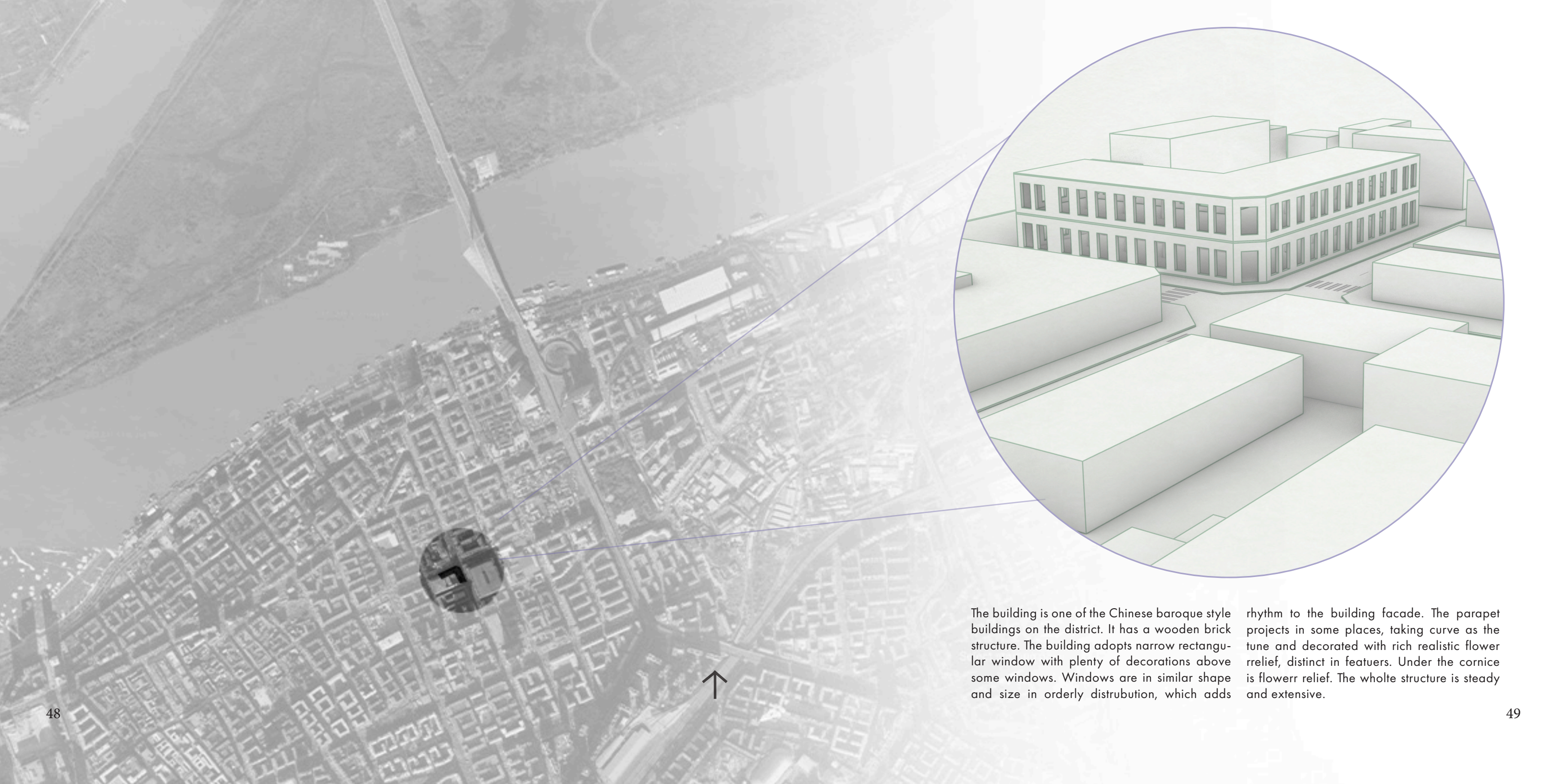

The building is one of the Chinese baroque style buildings on the district. It has a wooden brick structure. The building adopts narrow rectangular window with plenty of decorations above some windows. Windows are in similar shape and size in orderly distribution, which adds

rhythm to the building facade. The parapet projects in some places, taking curve as the tune and decorated with rich realistic flower relief, distinct in features. Under the cornice is flower relief. The whole structure is steady and extensive.





## THE OLD GLASS SHOP

The building was constructed in 1903. It used to be the glass shop of Heng De Li glasses. Heng De Li has its first shop in Shanghai, it was one of the most popular brand for luxury watches and glasses in China. In 1923, Heng De Li decided to open a glass shop in Harbin. In 1925 they decided to use the commercial building on the busiest business street of that time- Jingyu St.

In 2016, the Heng De Li glass shop moved again, the building became abandoned again. Later the boards, screens, and everything about the shop were removed from the building.



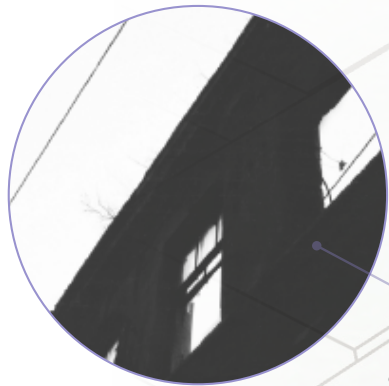

**SHELL**



**UNOCCUPIED**

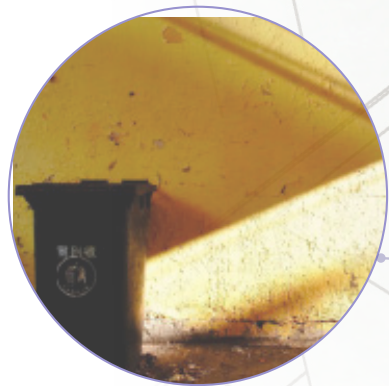

**EXPOSED**

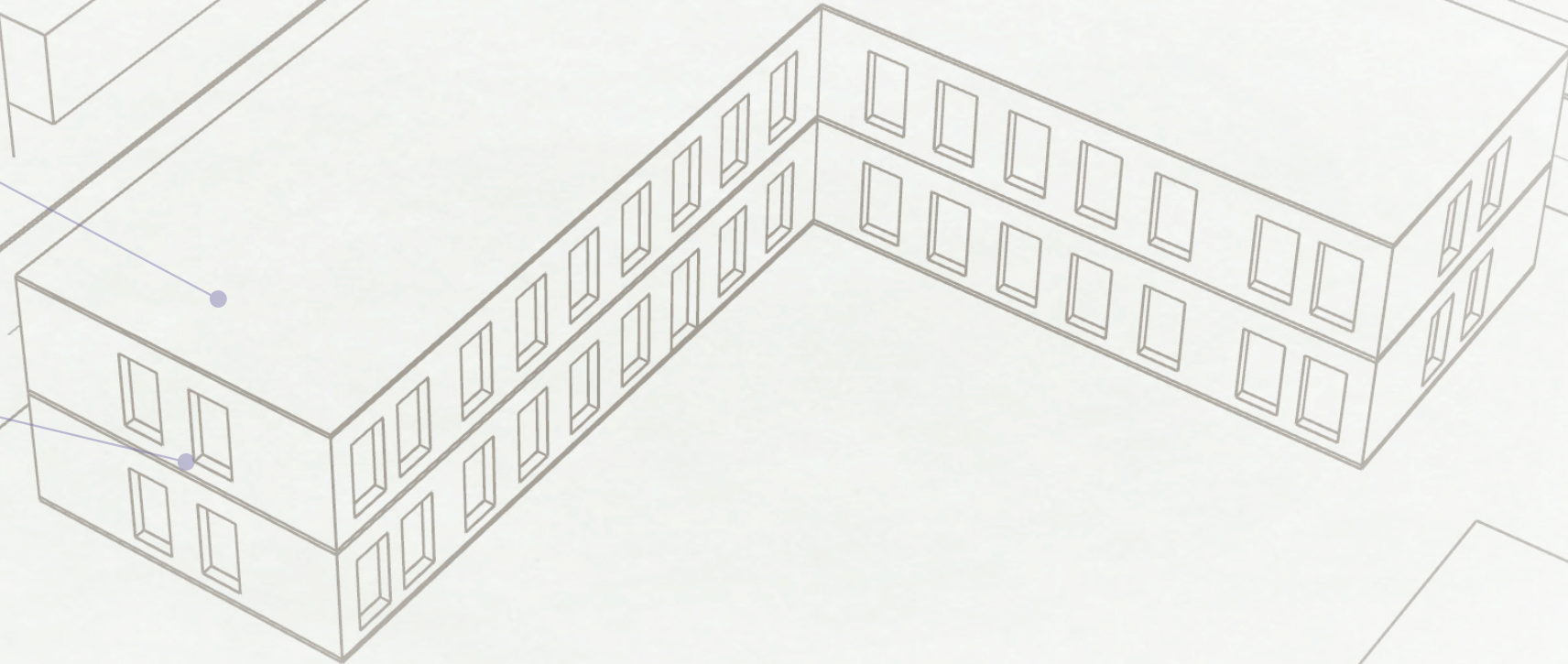

**EXISTING CONDITON**

Currently the building is unoccupied and is being protected as a historical building. The glass of the building were removed, and building only have the shell left.



## **SOUND IMPACT**

The building is located in the middle of two busy streets. There are a lot of noise coming from the two streets to the building. Especially in the morning and afternoon during the high traffic period.

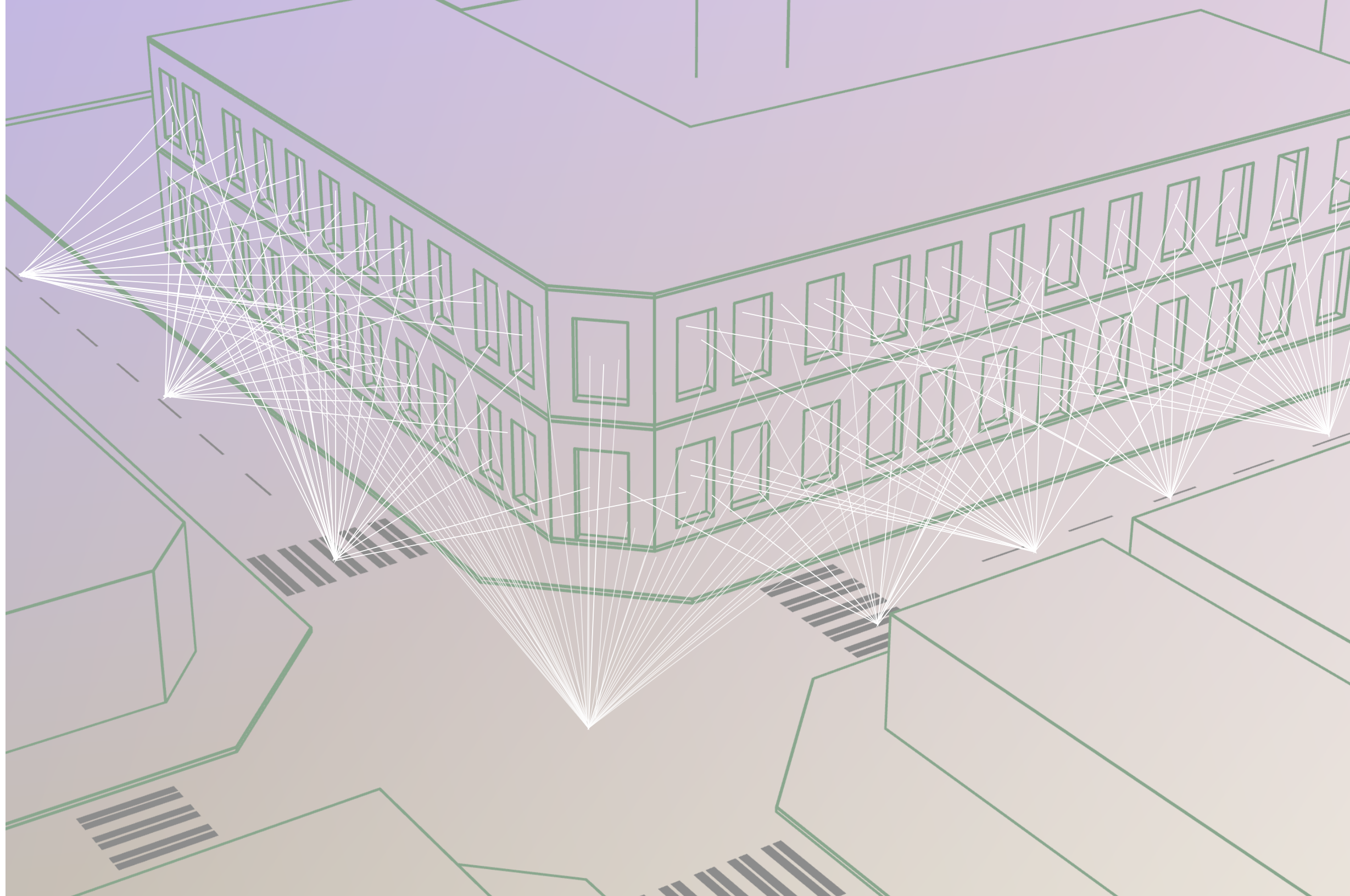

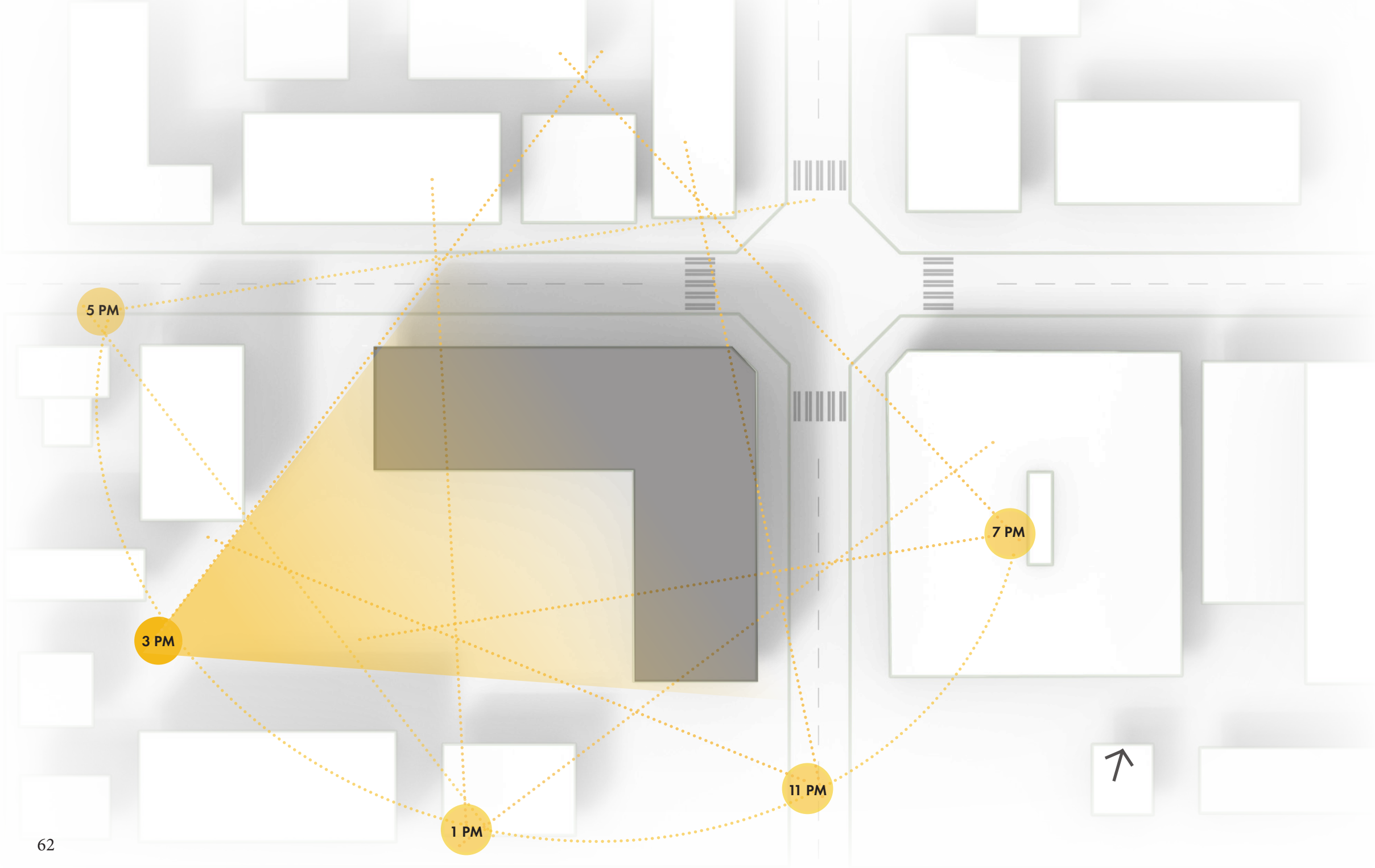

### LIGHT IMPACT

A huge amount of morning and afternoon light is coming in to the building. Introducing natural light is very important, but when designing an ASD friendly environment, too much natural light could be a problem.

## DESIGN

### KEY ELEMENTS

When designing an ASD friendly office, it is important to provide what people on the spectrum needs. For instance, a lot of people on the spectrum need their private working space, so make sure there are rooms for private working. In addition, short corridors, simple circulations, curved walls, and opposite entrance are preferred for an ASD friendly office.

## WORKSPACE

Personal space is very important for people on the spectrum. When there are a great number of people working in the same space, people on the spectrum tend to want to escape because they are losing their personal space. Noise is also an issue of having too much people working in one space. An autism friendly office should give people on the spectrum opportunities to be able to work by themselves in a closed space.

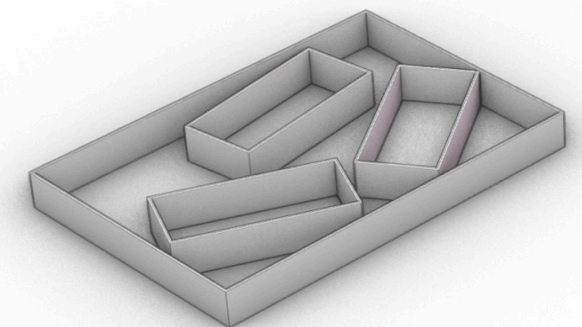
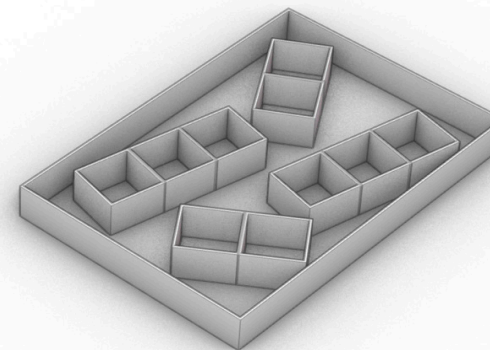
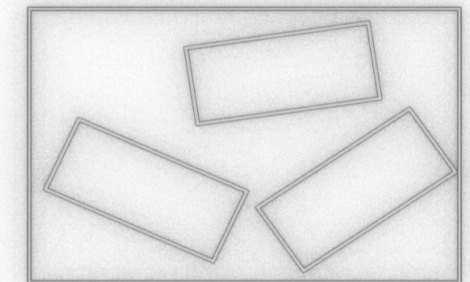
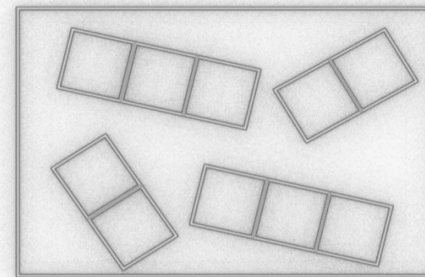

Autism friendly

Not Autism friendly

## CORRIDOR

It is important to avoid long, narrow corridors because people on the spectrum don't feel secured when they are walking through long corridors.

Instead of having rooms placed by the walls, place them in different directions to avoid long corridors. Be careful when designing short corridors, as sometimes too much corridors may make the room look like a puzzle and people will get confused.

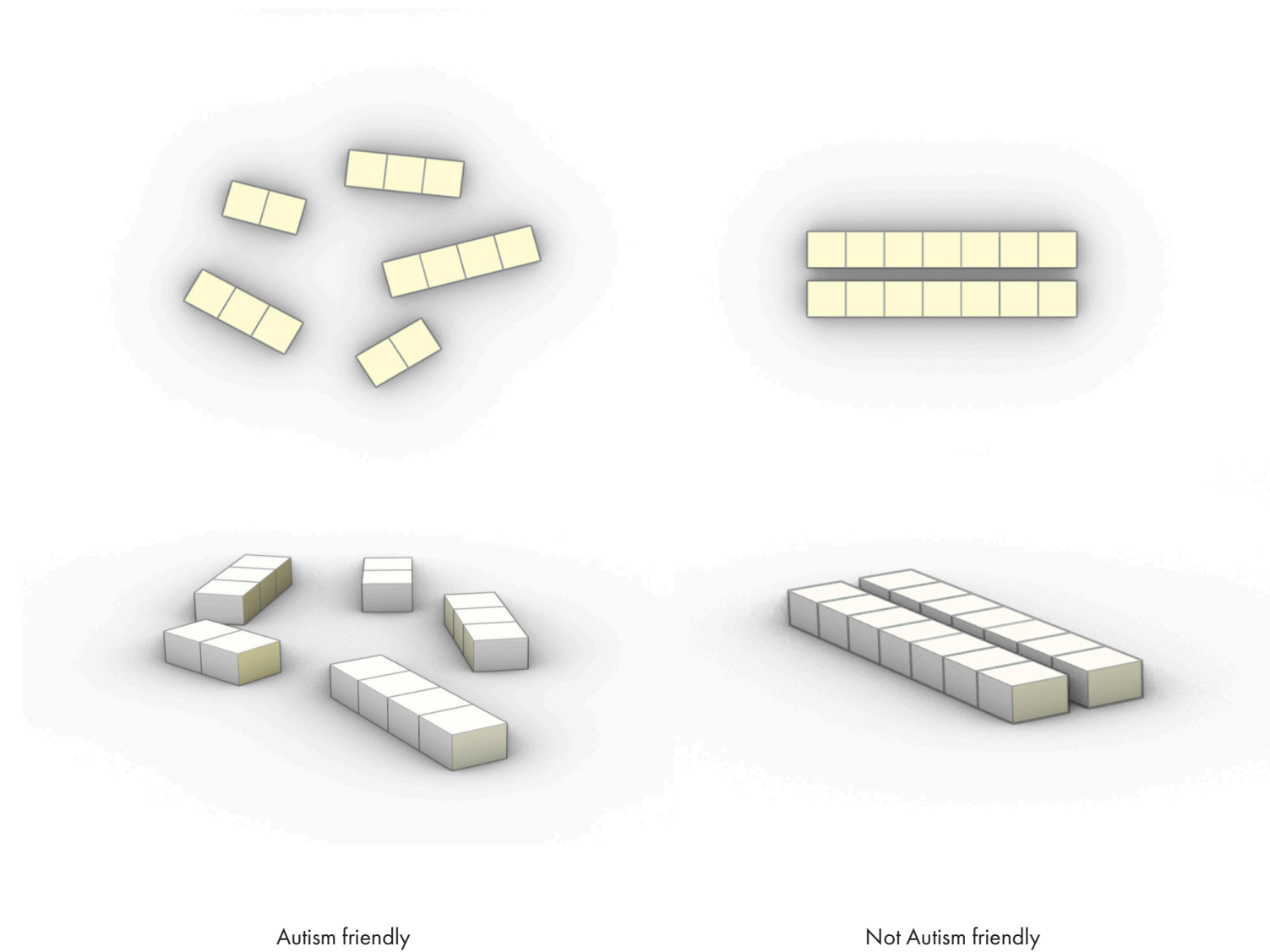



## CIRCULATION

Circulation needs to be simple. Complicated circulation and make people on the spectrum feel puzzled. The circulation system should be clear and organic, making people feel comfortable without getting lost.

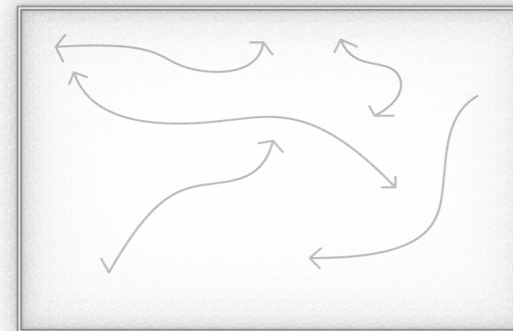

Autism friendly

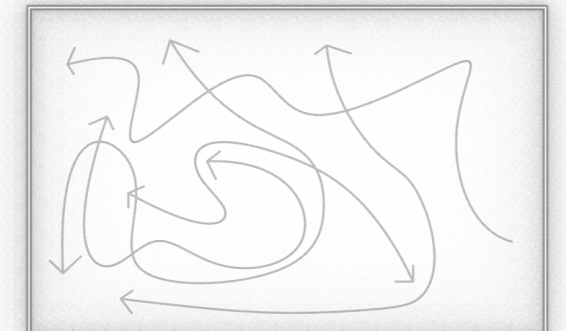

Not Autism friendly



## WALL

Avoid sharp corners. People on the spectrum prefer smooth and curvy corners. Sharp corners will be unpredictable for them and make them feel unsafe because they might jump into someone on the other side of the wall.

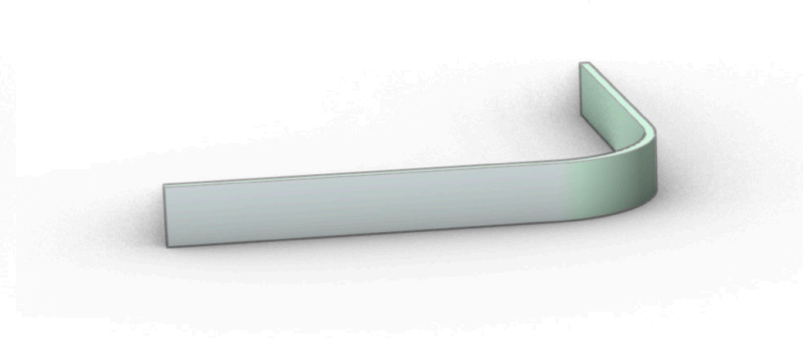
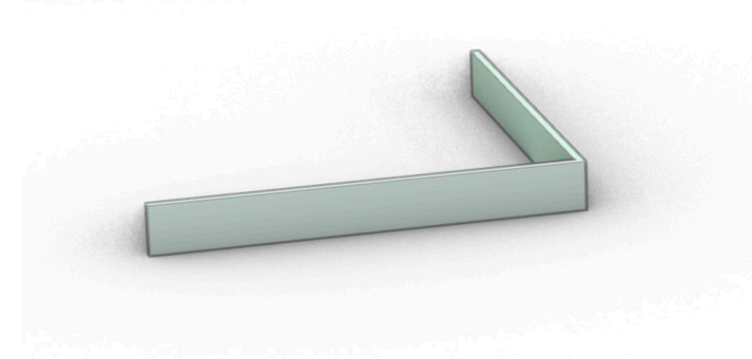
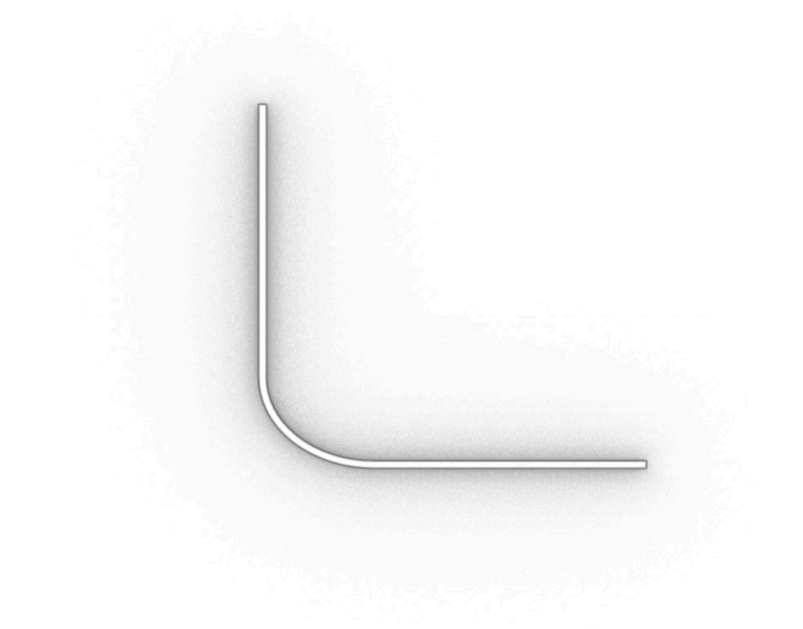
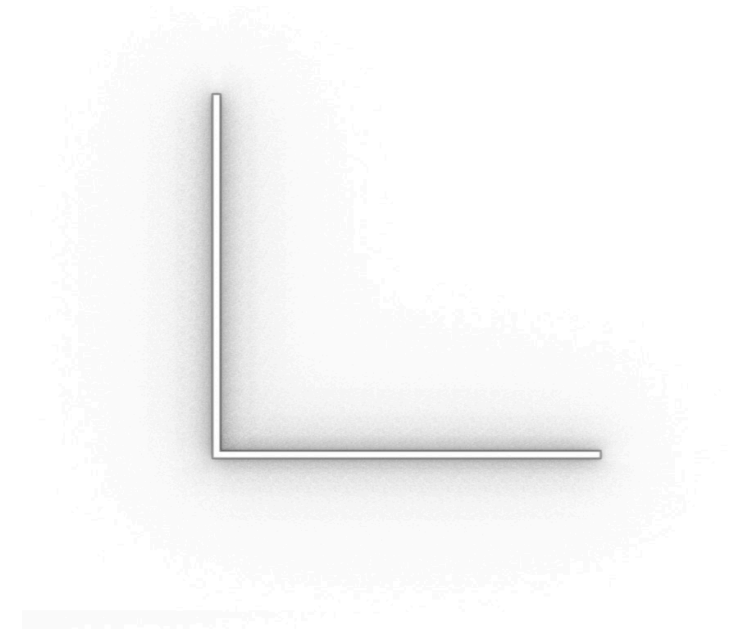

Autism friendly

Not Autism friendly

## ENTRANCE

Put entrance on two different sides of rooms so people will not feel that they are working next to a room that someone else is working in. This will also avoid any accident of jumping into other people when they come out of the room at the same time.

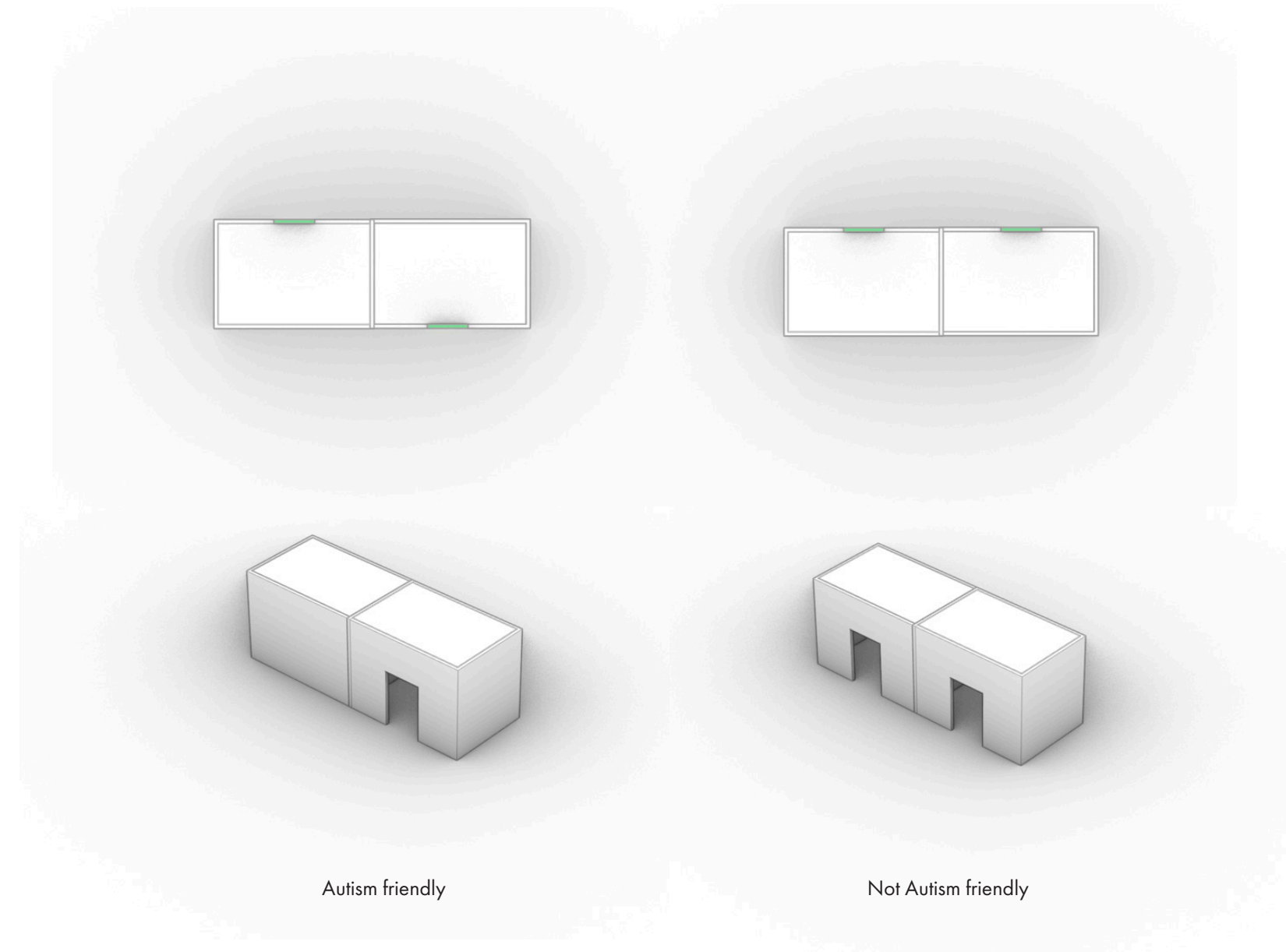

## PROGRAM

There are a lot of people experiencing anxiety at work, and people on the spectrum are being affected by anxiety the most. It is important to create a supportive office environment for both people on the spectrum and those who have other forms of anxiety at work. By using design strategies that were proven and experimental, I will create a system that can be apply to any type of buildings to make an office ASD friendly, and a set of toolkit focus on productivity, privacy, and flexibility.

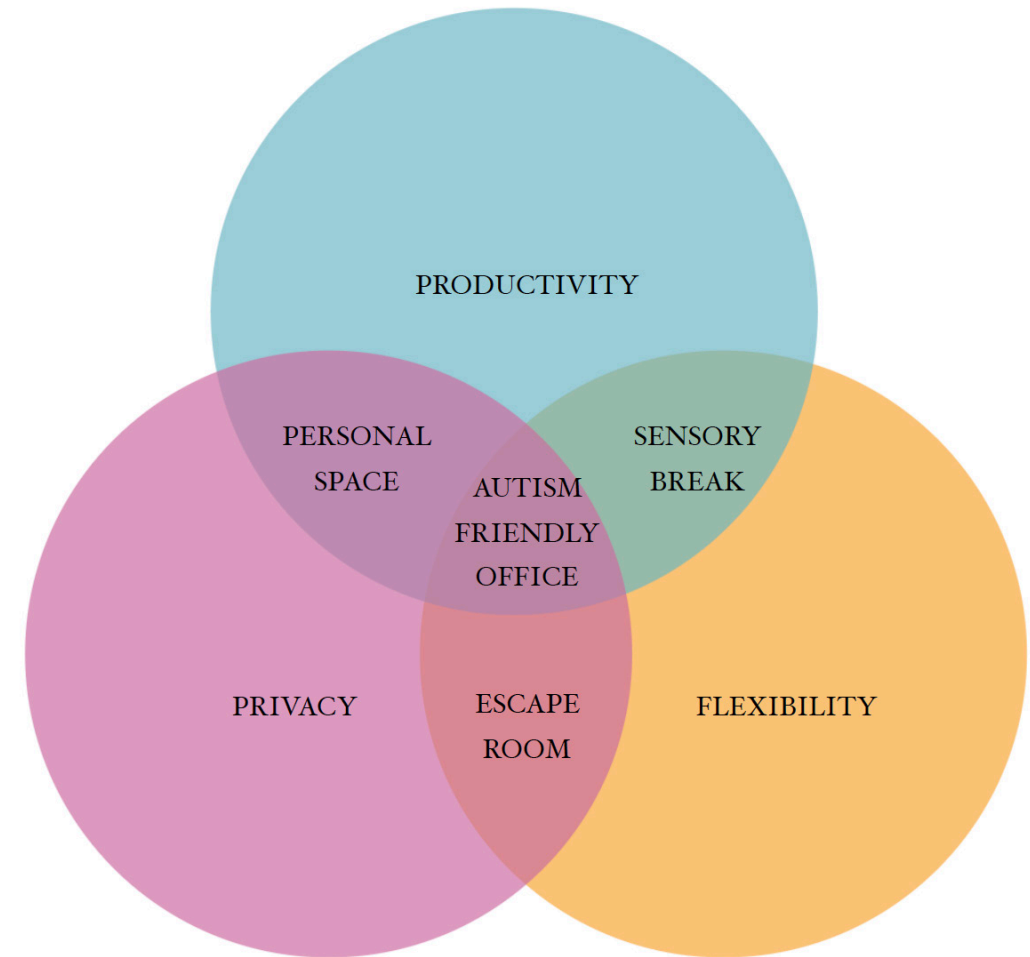



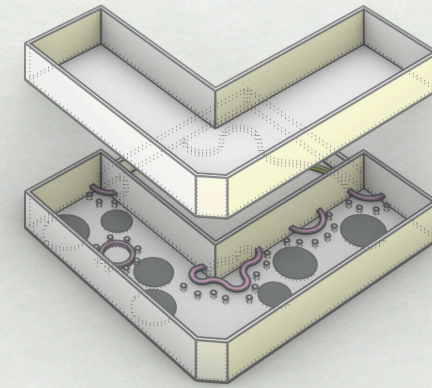
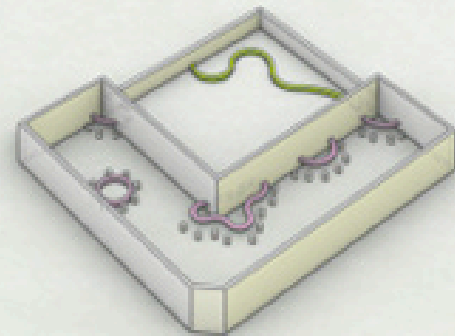
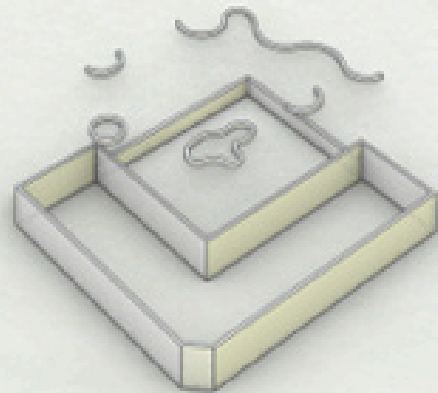
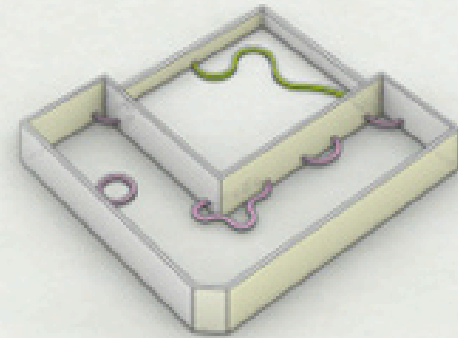
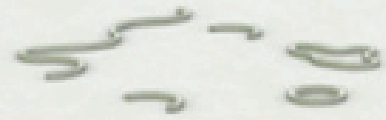
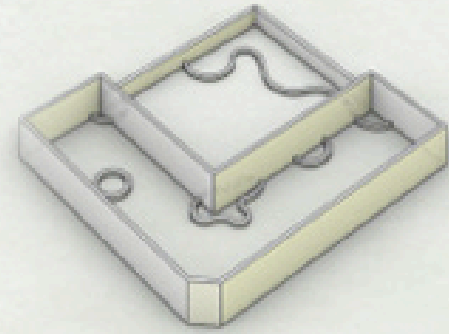
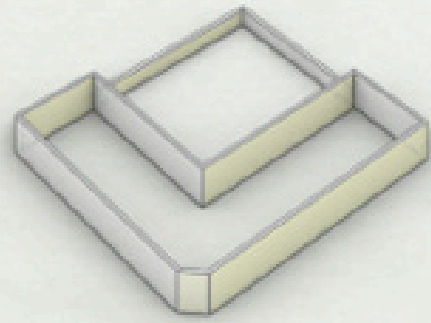

**CONCEPT**

Starting with the first floor, **insert** the curved structure to the space. The space is then divided into different sections by the inserted structure. The indoor structure becomes working desks, and the outdoor structure becomes outdoor seating.

**Extrude** the **negative space** from first floor, extrude them, and they become individual rooms.

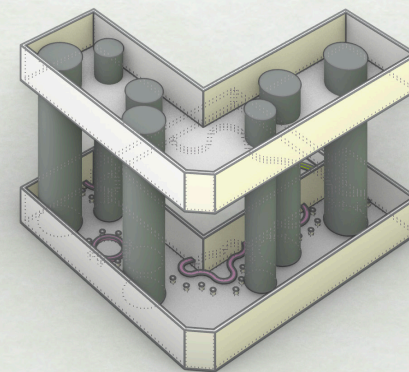
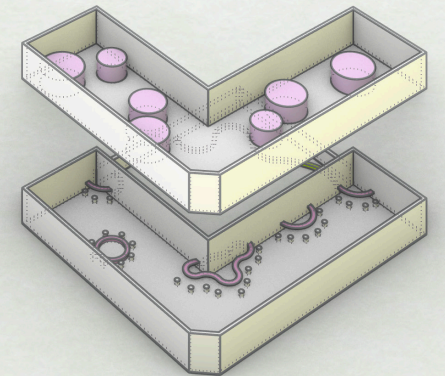

**PLAN**

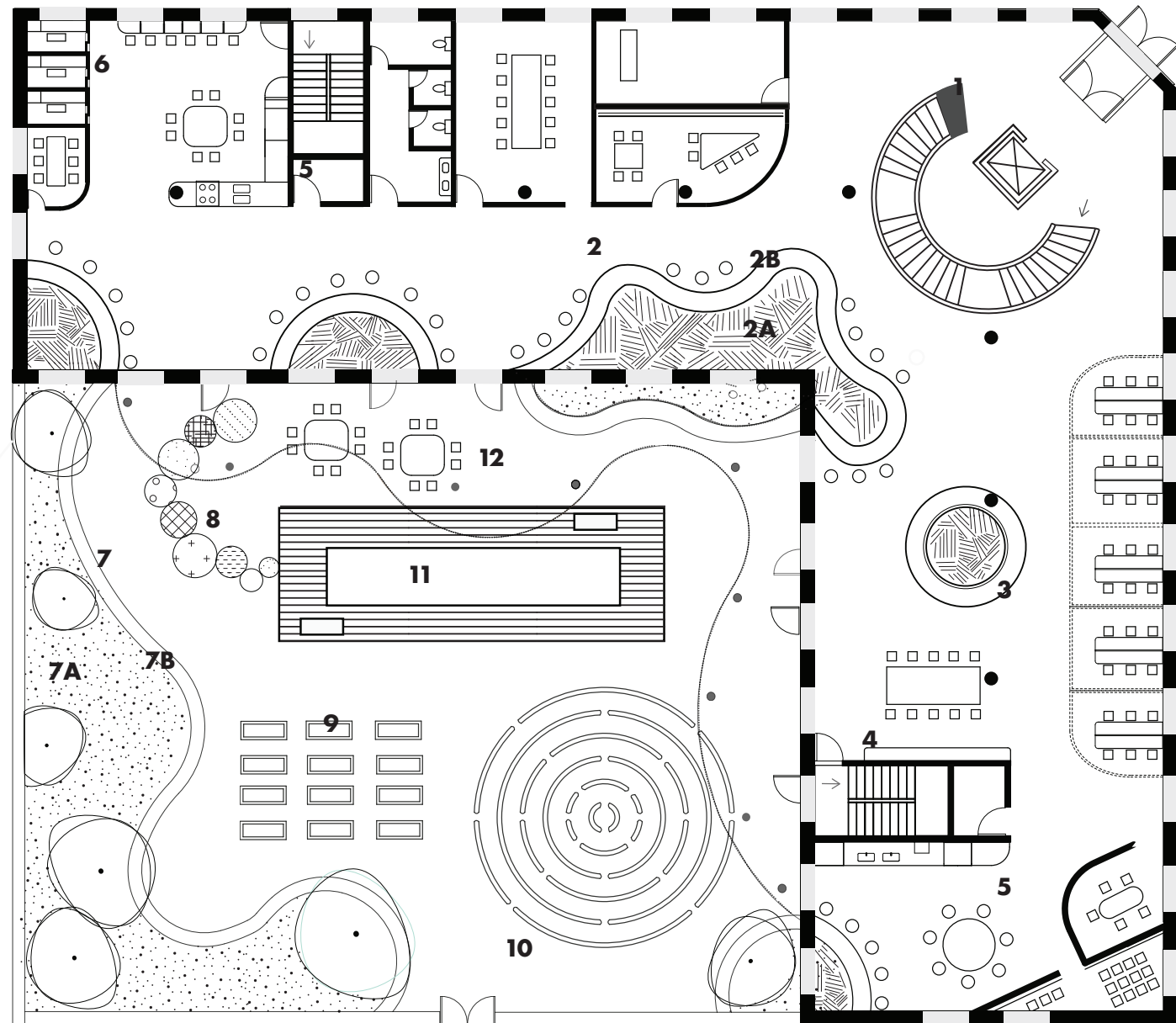

FIRST FLOOR

- 1. RECEPTION
- 2. WORKING AREA
  - 2A. PLANTER
  - 2B. CURVED DESKS
- 3. SEATING/RELAXING AREA
- 4. LOCKER
- 5. CAFE KITCHEN
- 6. KITCHEN
- 7. OUTDOOR SEATING AREA
  - 7A. PLANTER
  - 7B. CURVED BENCHES
- 8. SENSORY PAVING STONE
- 9. PRIVATE PLANTER
- 10. MEDITATION MAZE
- 11. CALMING POND



**PLAN**

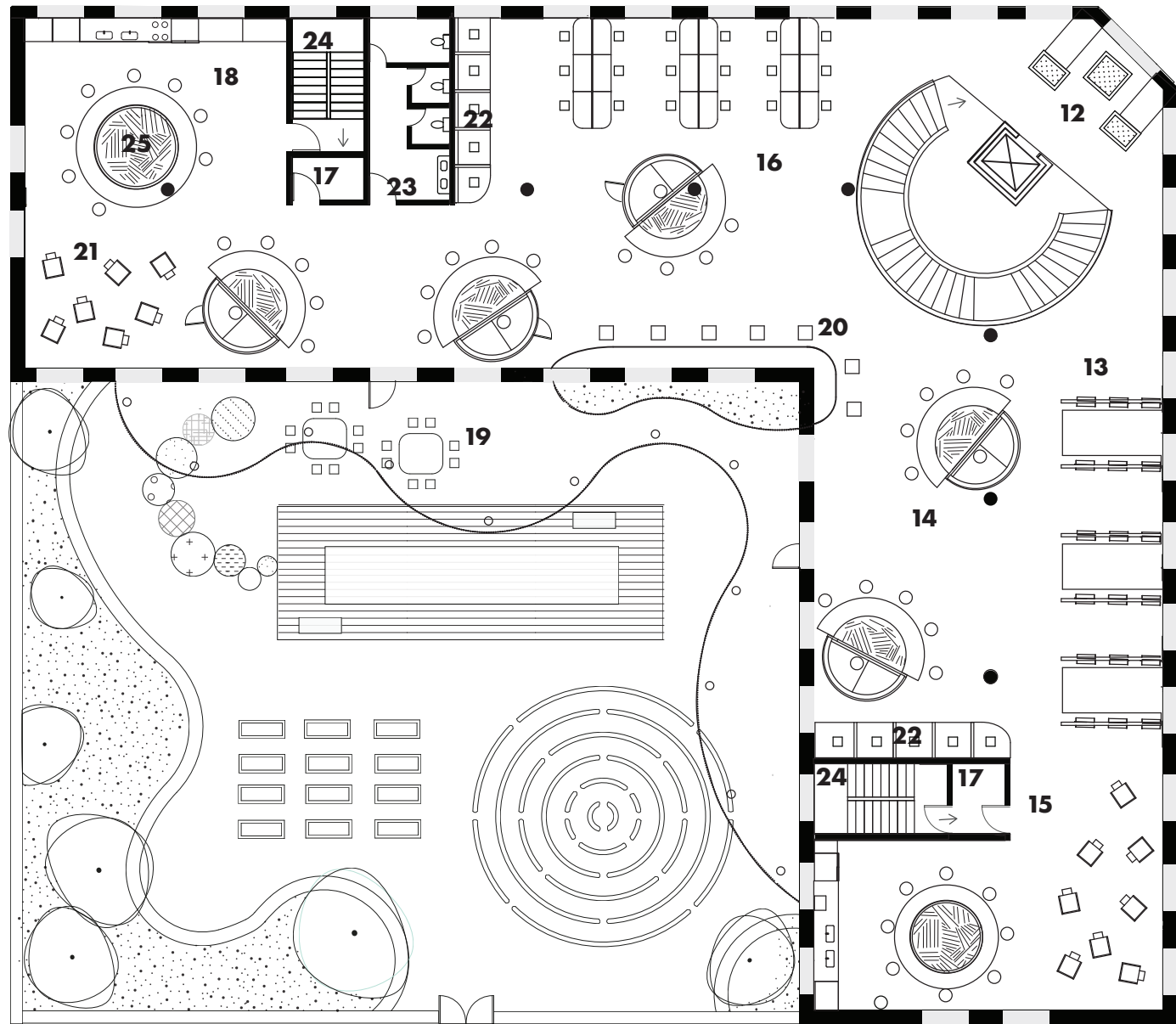

SECOND FLOOR

- 12. SEATING AREA WITH PLANTS
- 13. SWING WORKING AREA
- 14. PRIVATE + GROUP WORKING STATION
- 15. CAFE KITCHEN
- 16. OPEN WORKING AREA
- 17. ESCAPE ROOMS
- 18. KITCHEN
- 19. PATIO
- 20. OPEN WORKING AREA
- 21. EAT ALONE AREA
- 22. PRIVATE BRAINSTORMING AREA
- 23. BATHROOM
- 24. ESCAPE STAIRS
- 25. DINNING TABLE WITH PLANTS

↑  
1/16"=1'-0"



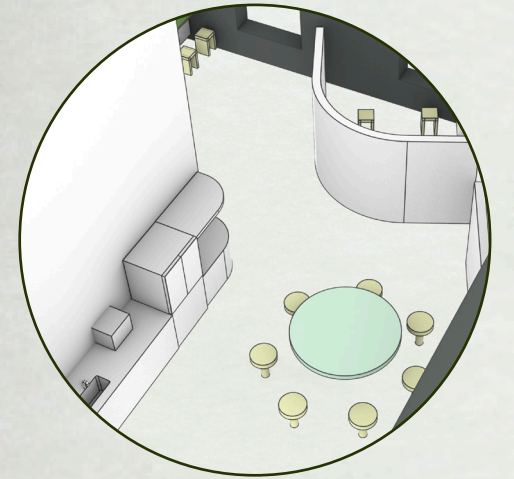
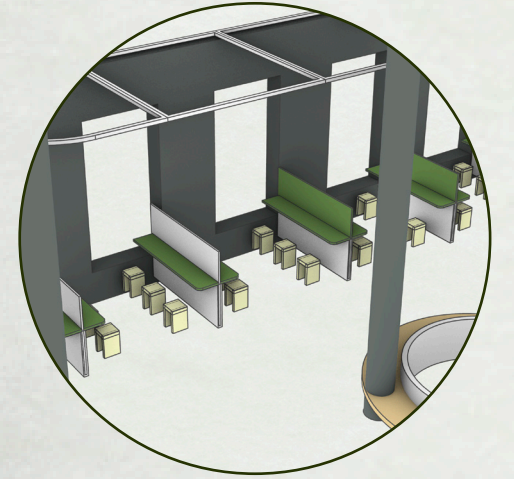
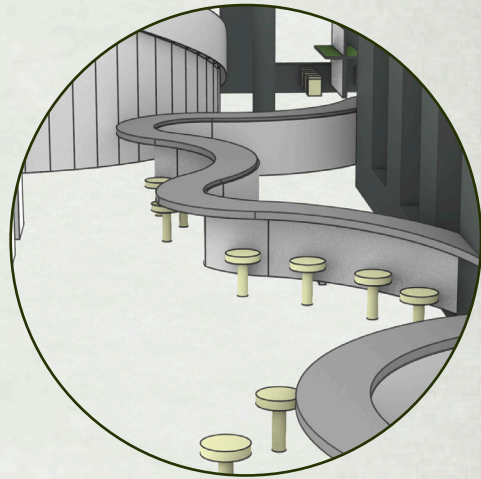
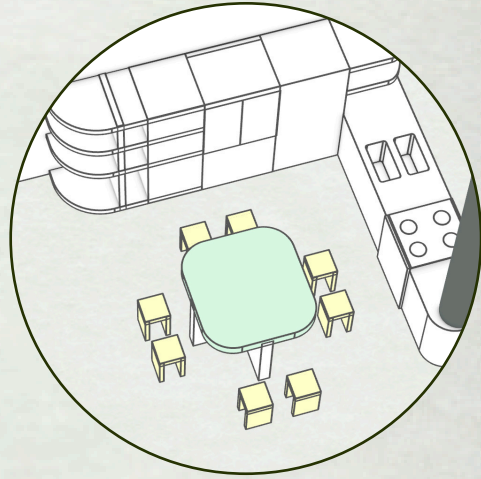

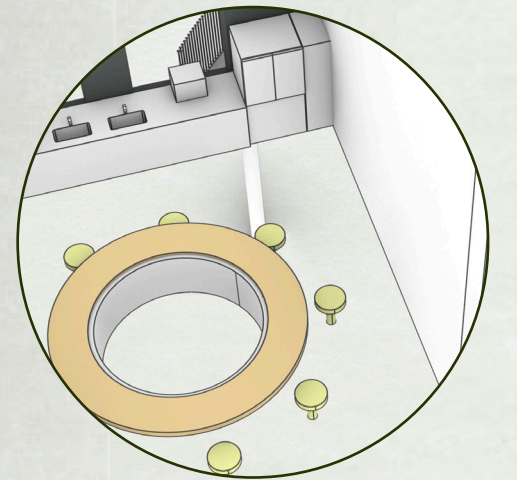
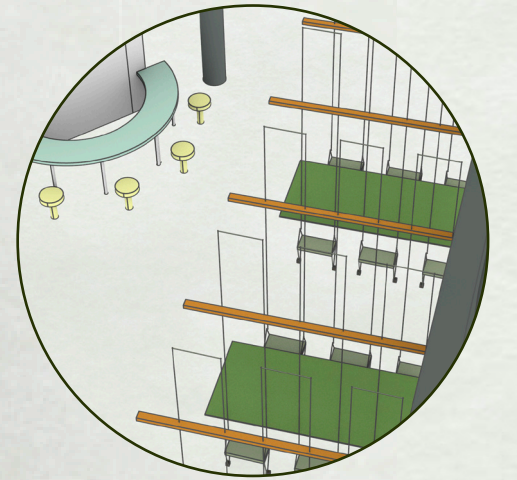
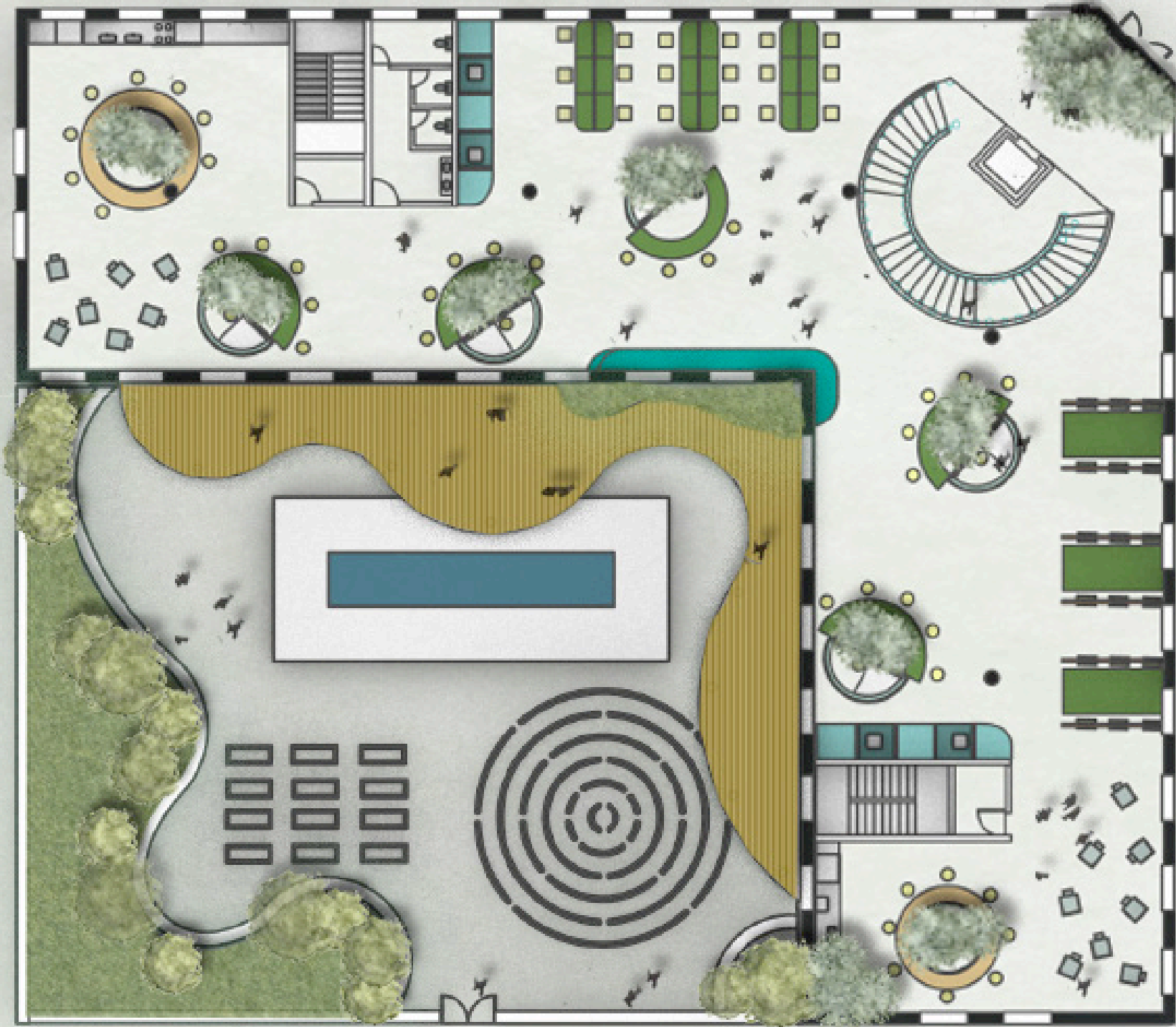
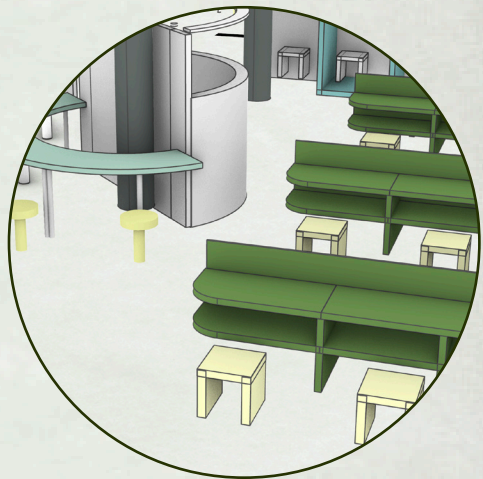
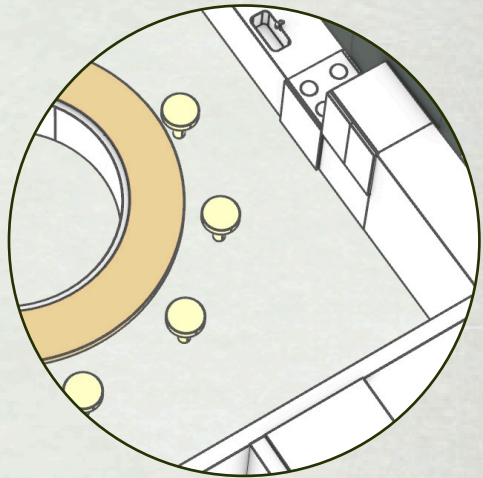





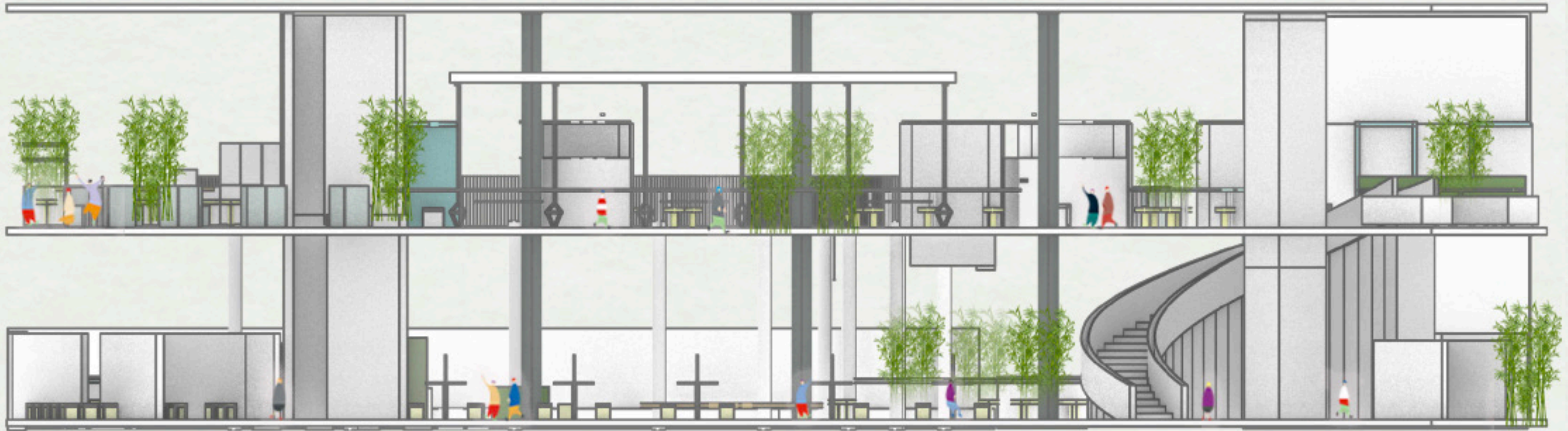





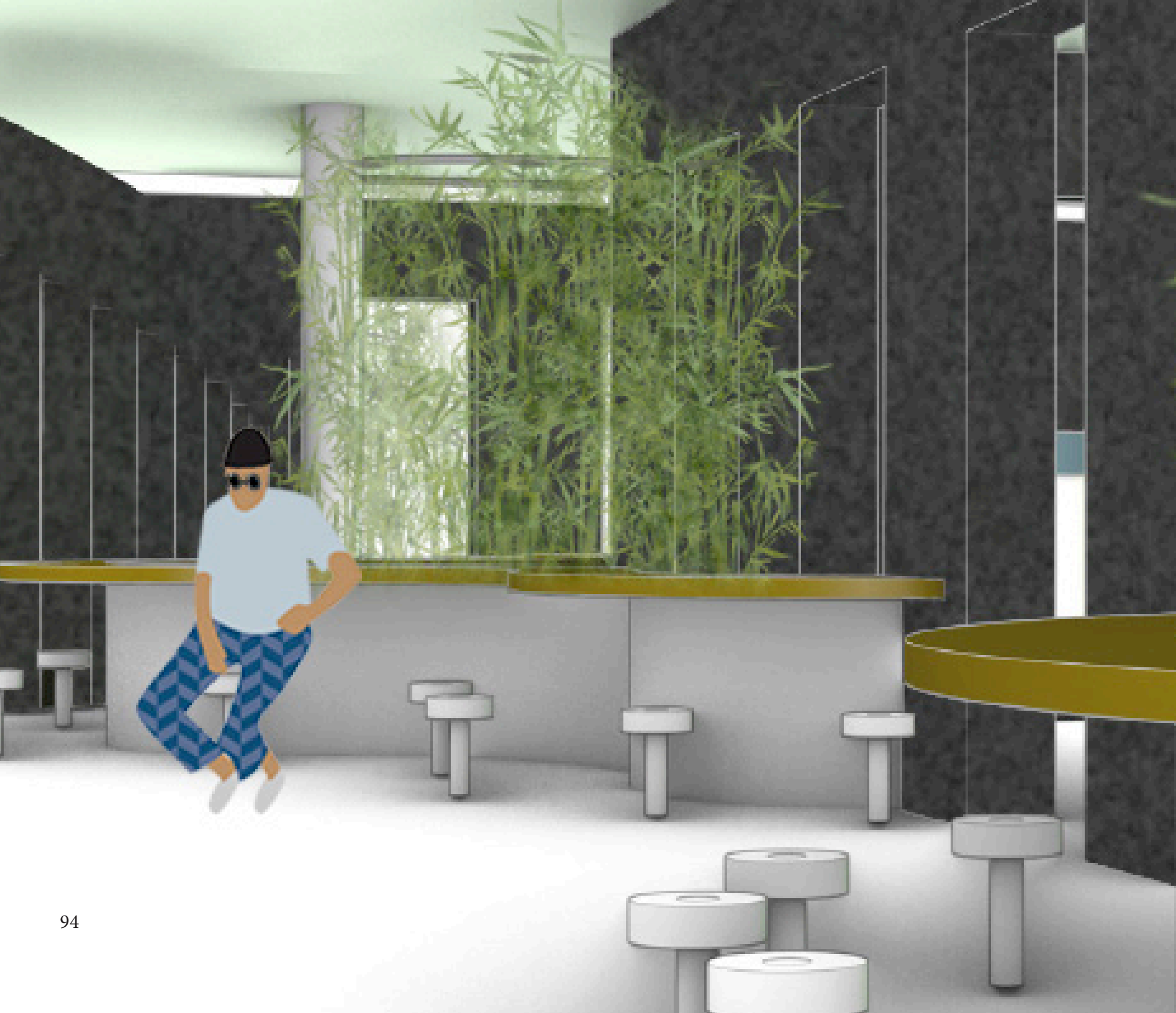

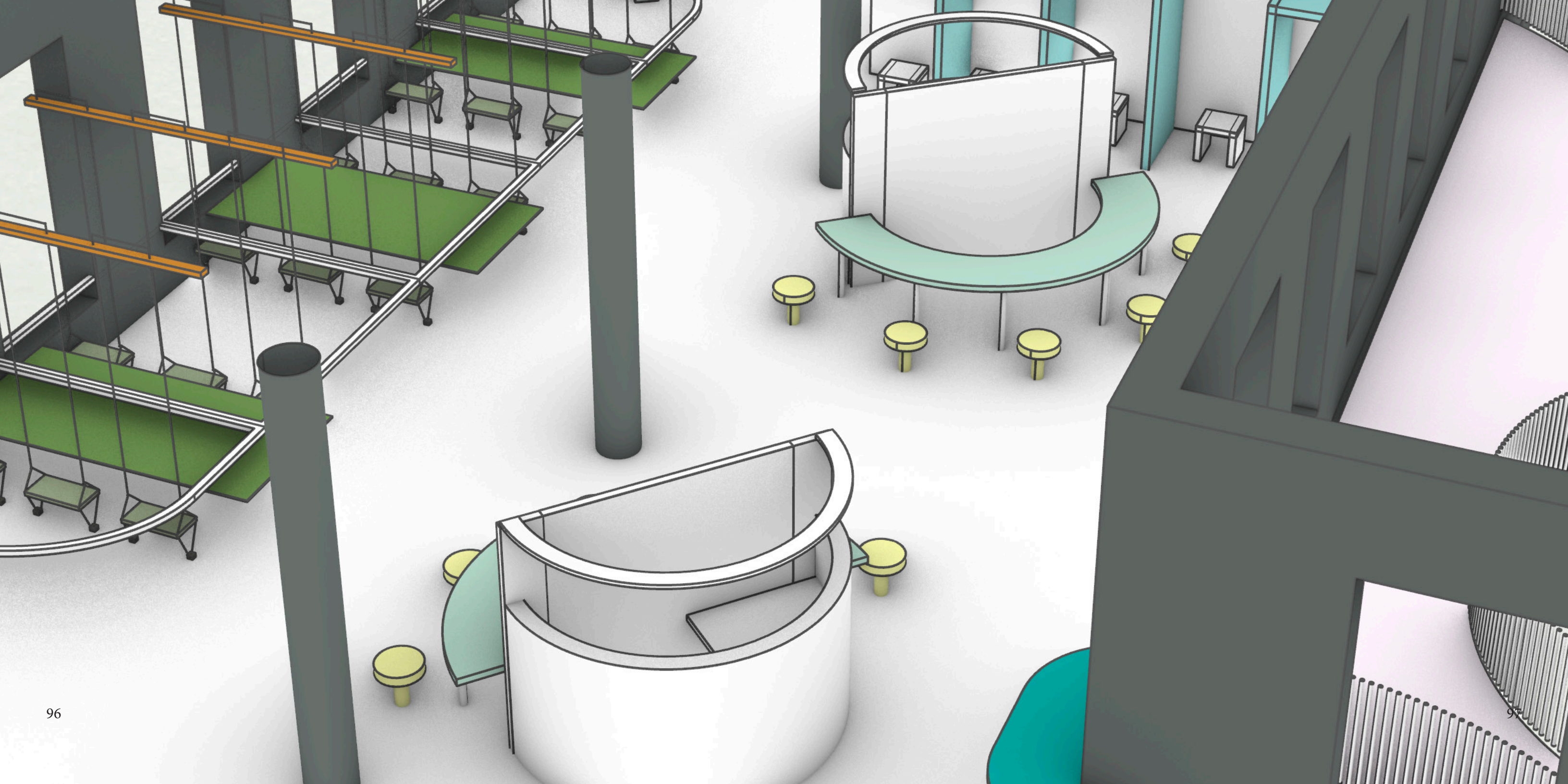



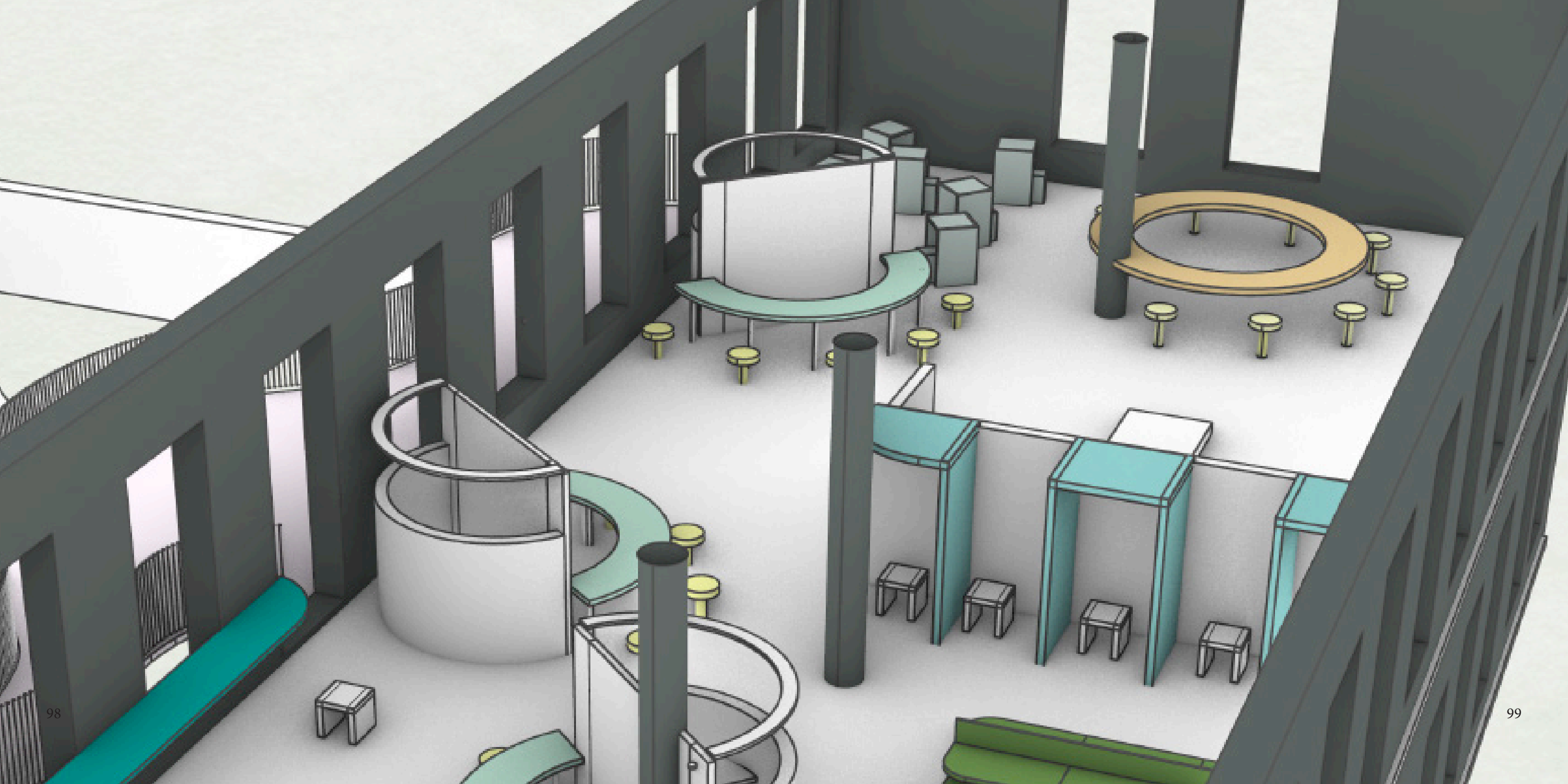

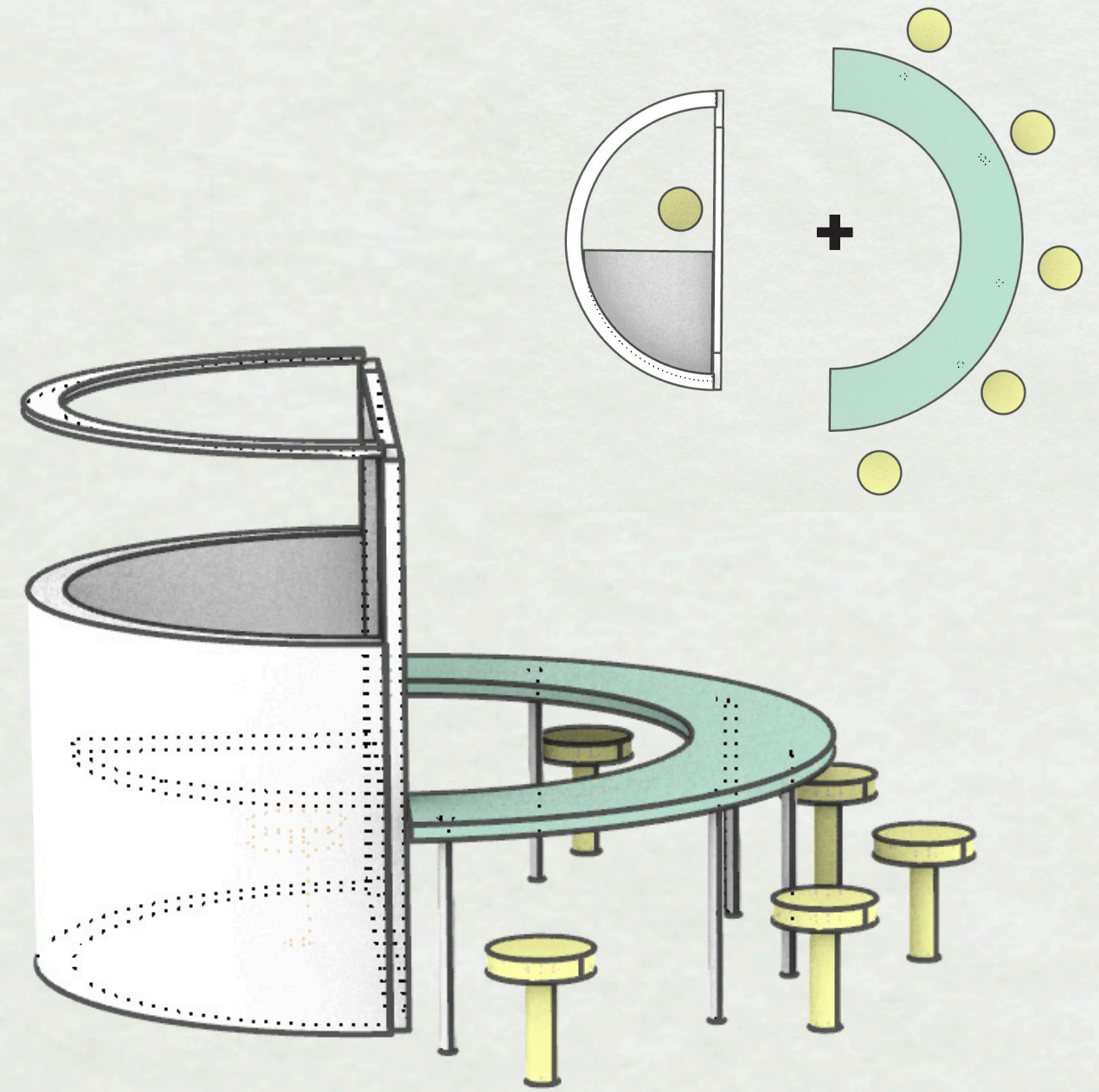
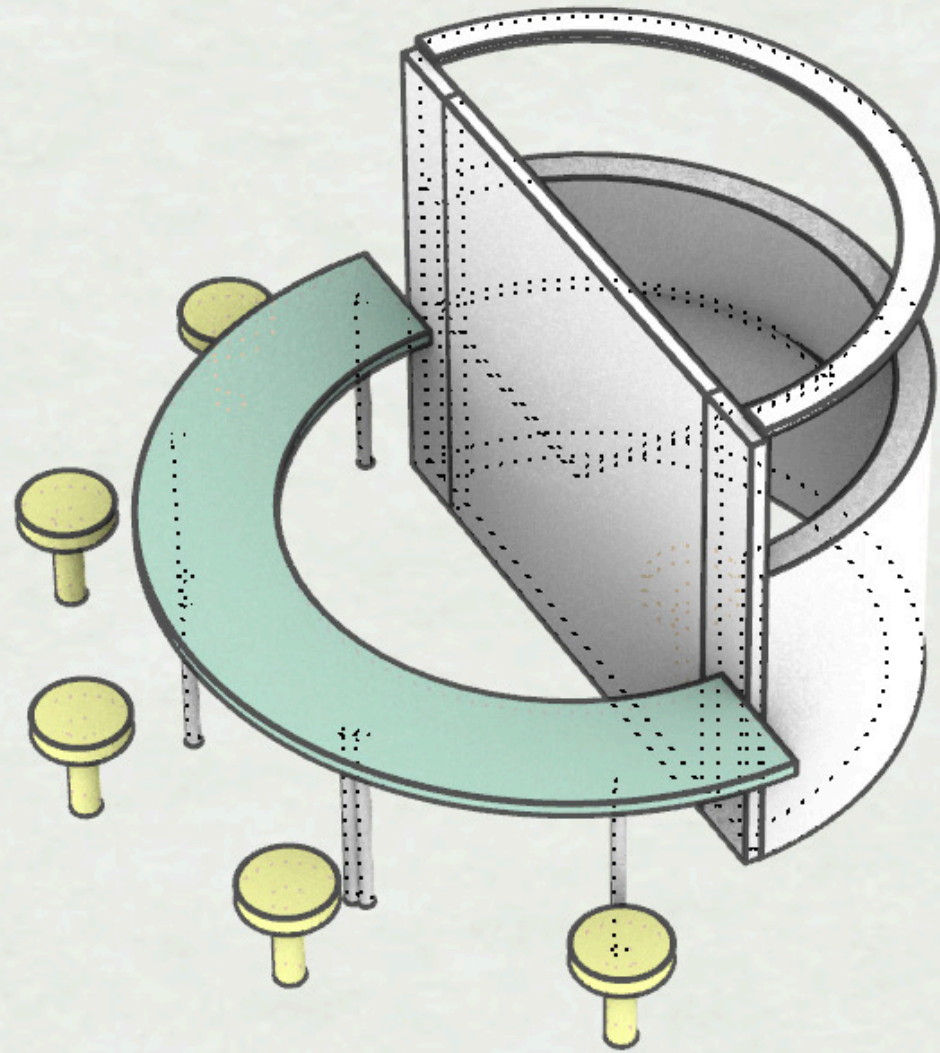



**TOOL-KIT**

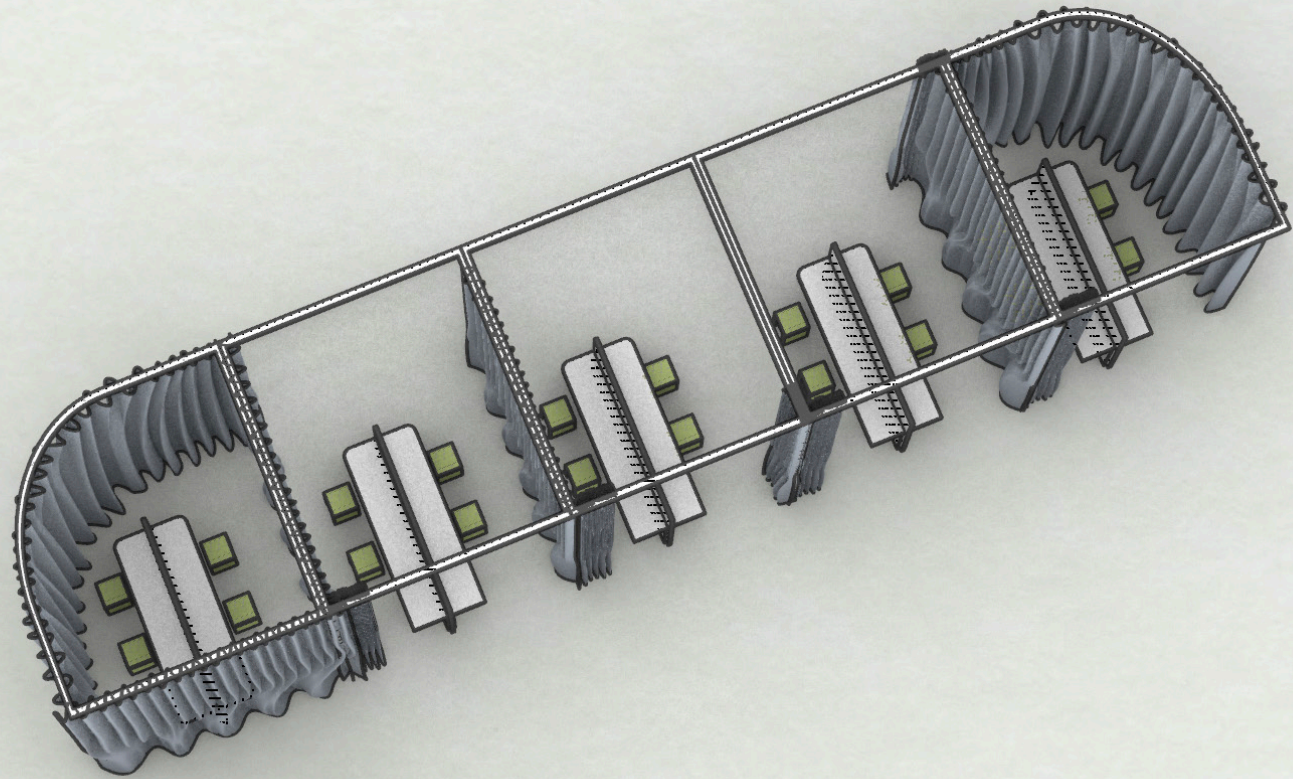

*Quiet working area*

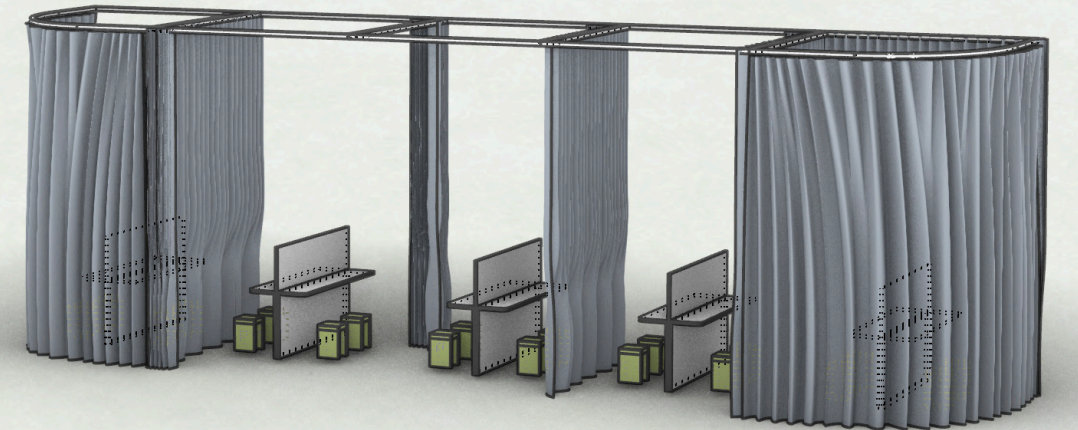
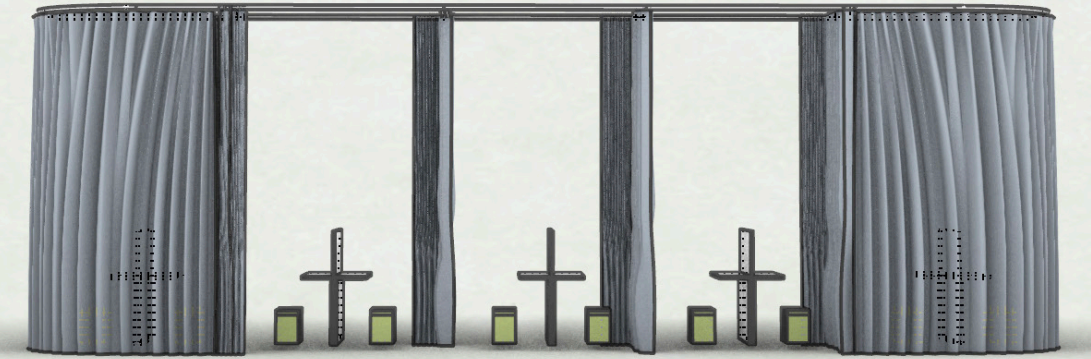



## TOOL-KIT

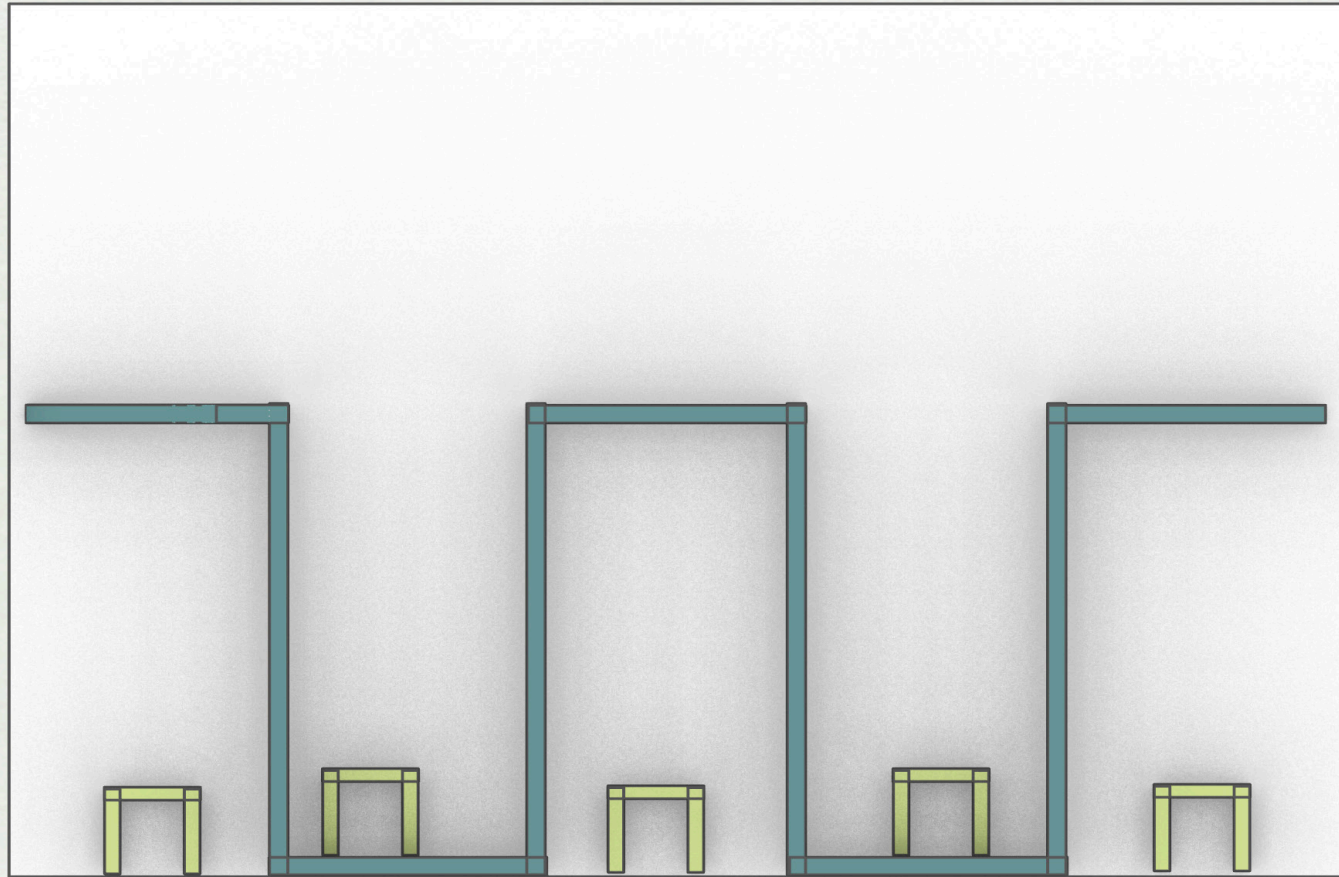

*Brainstorming area*

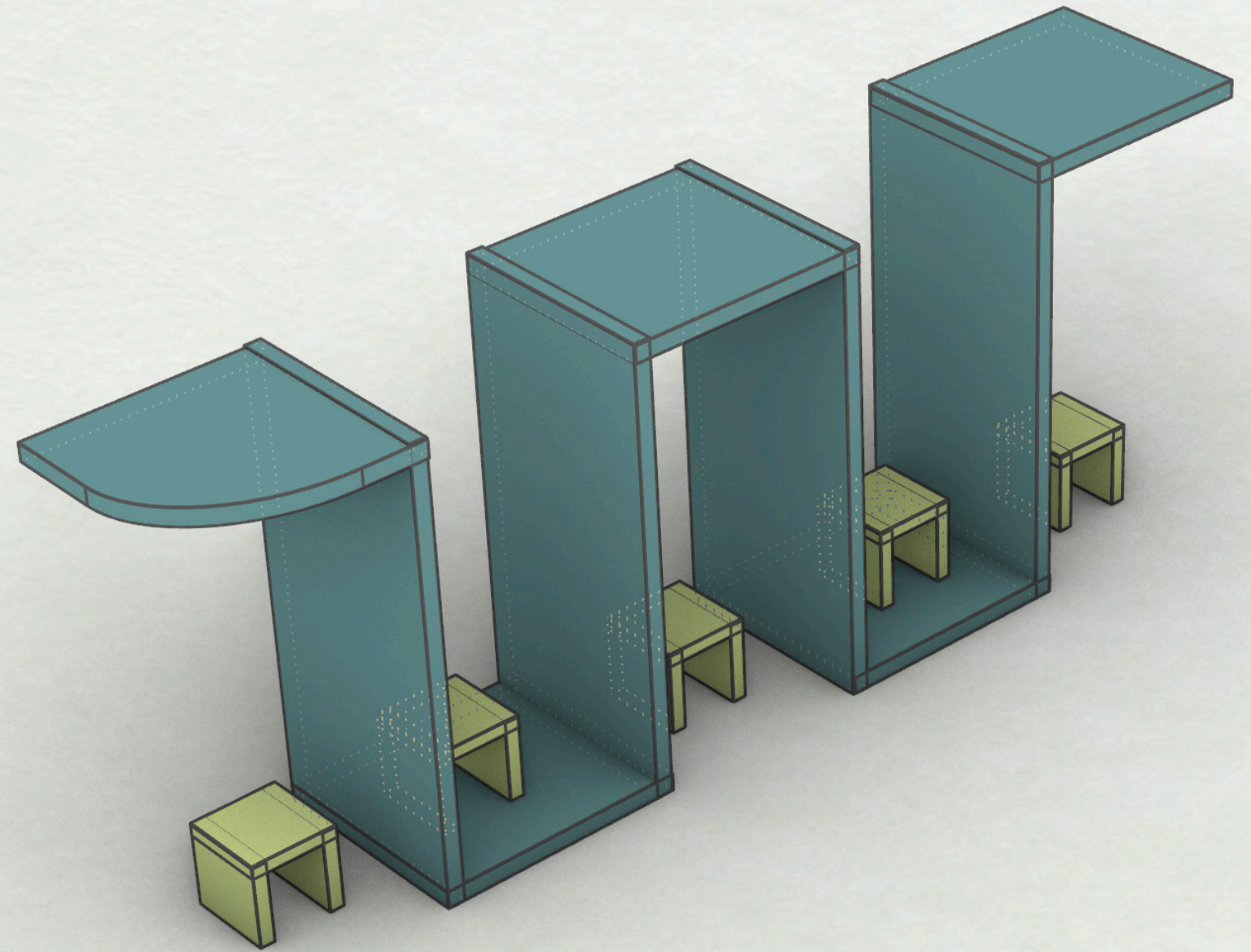



**TOOL-KIT**

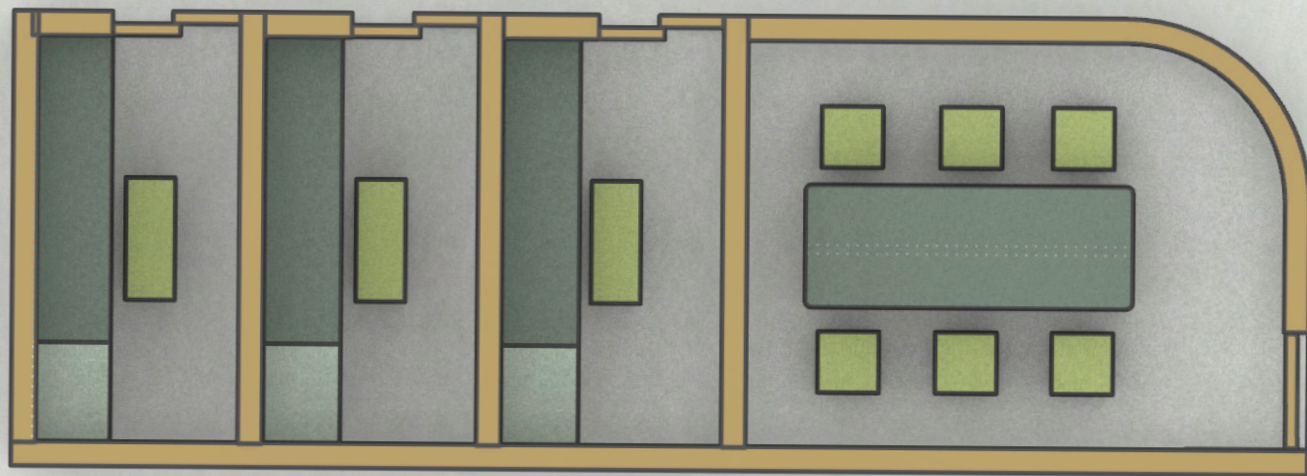

*Private / group eating*

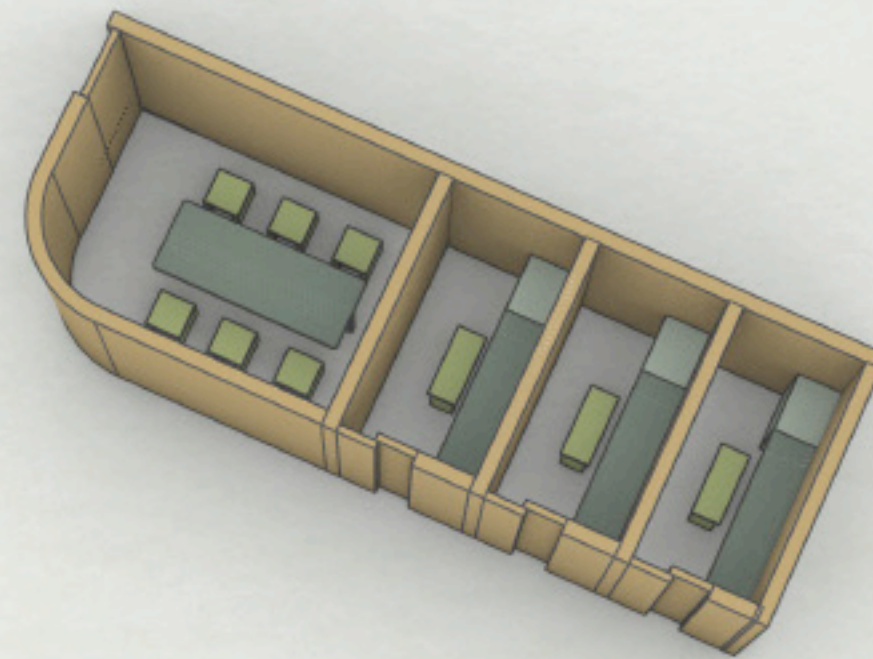
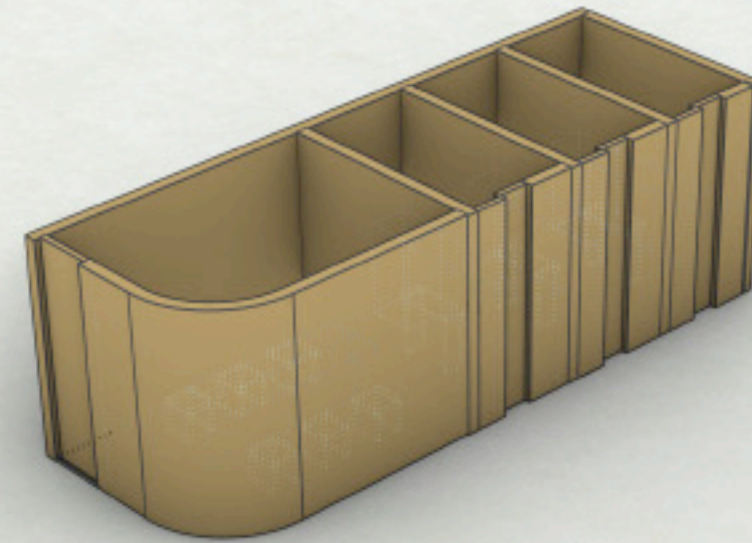



**TOOL-KIT**

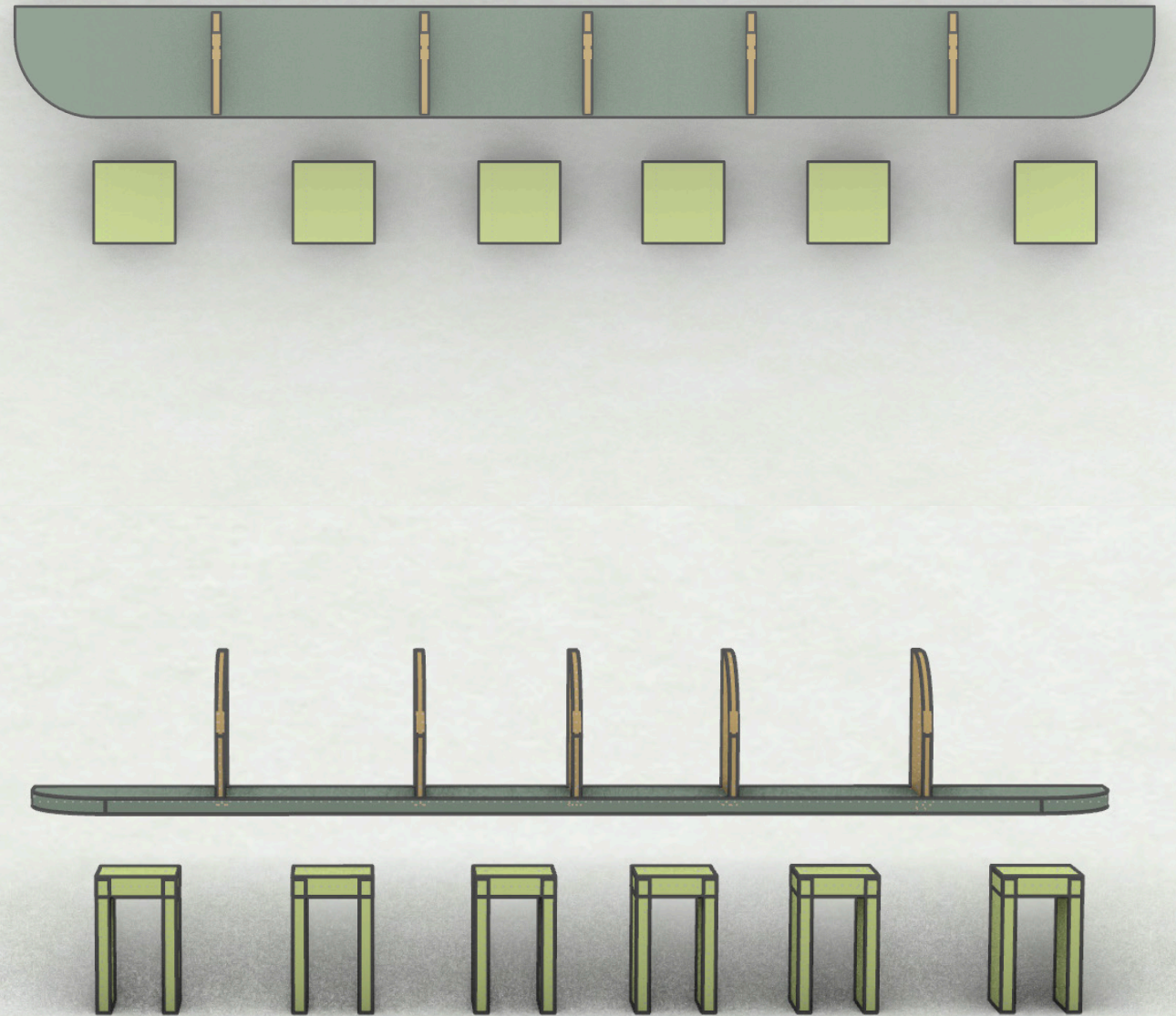
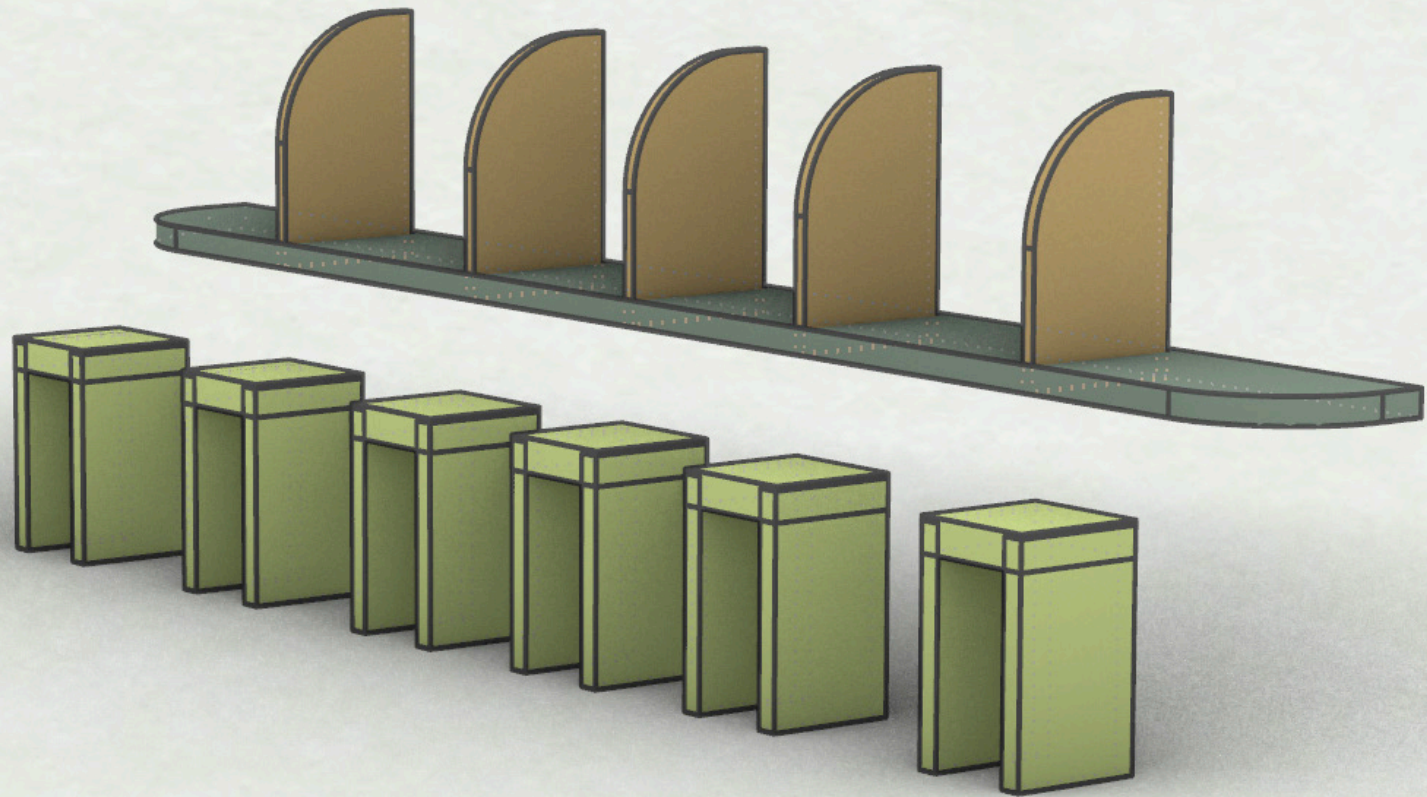

*Private eating*



**TOOL-KIT**

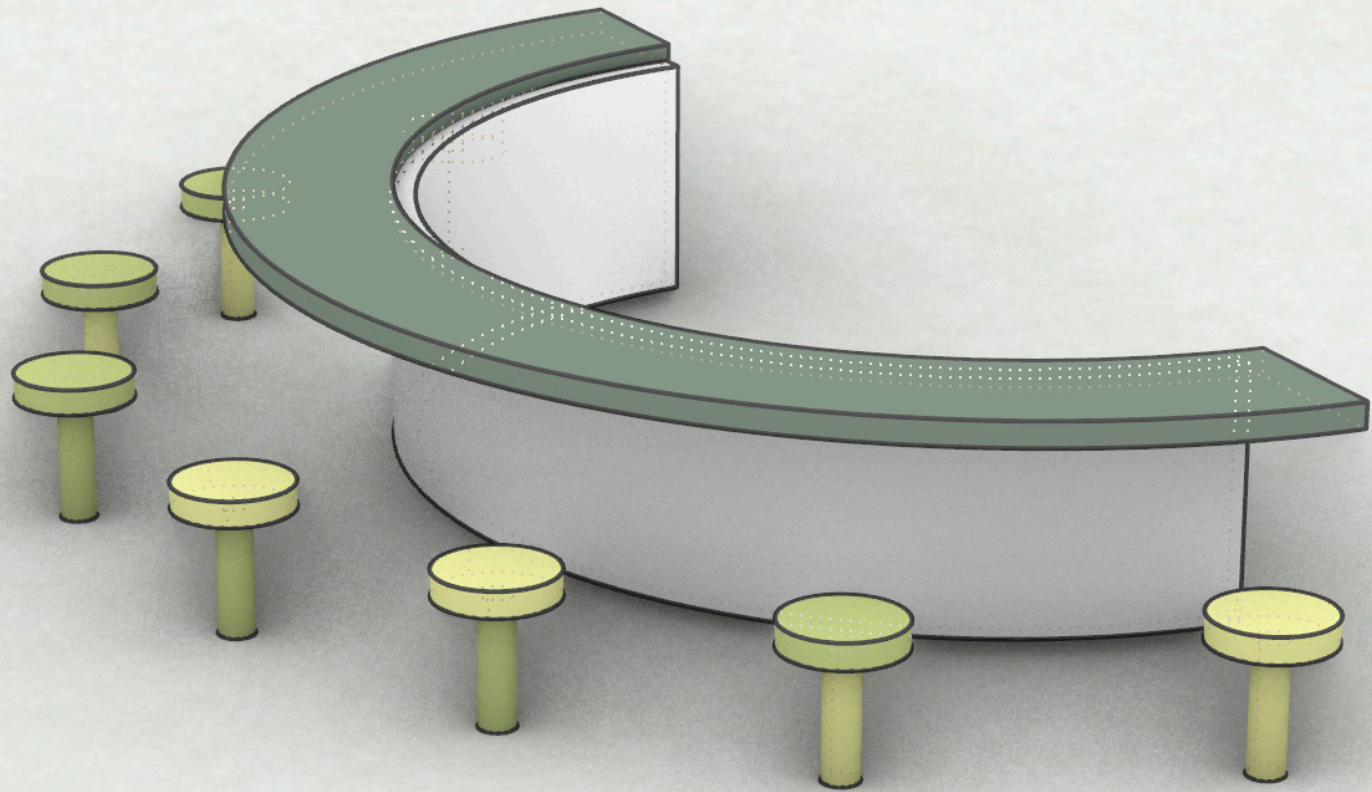

*Working area with planter*

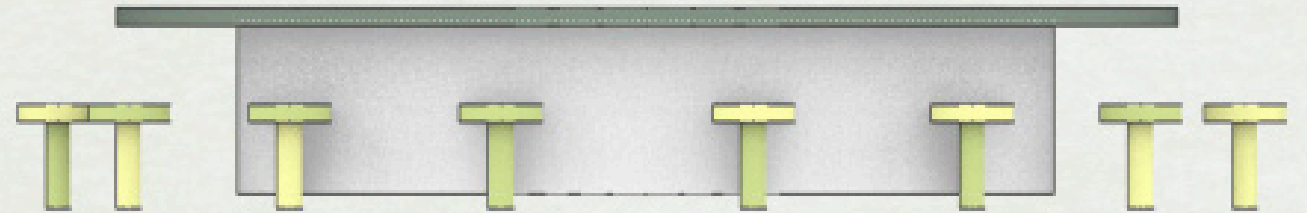
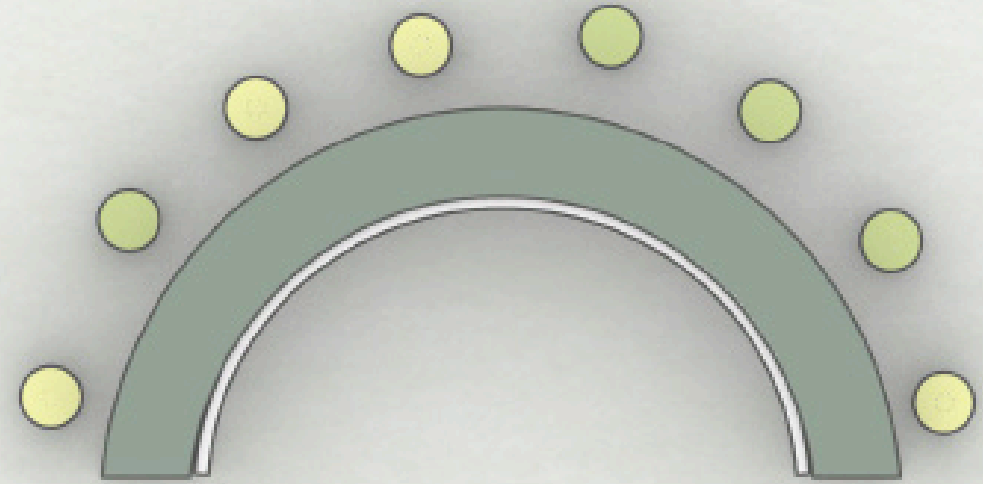



**TOOL-KIT**

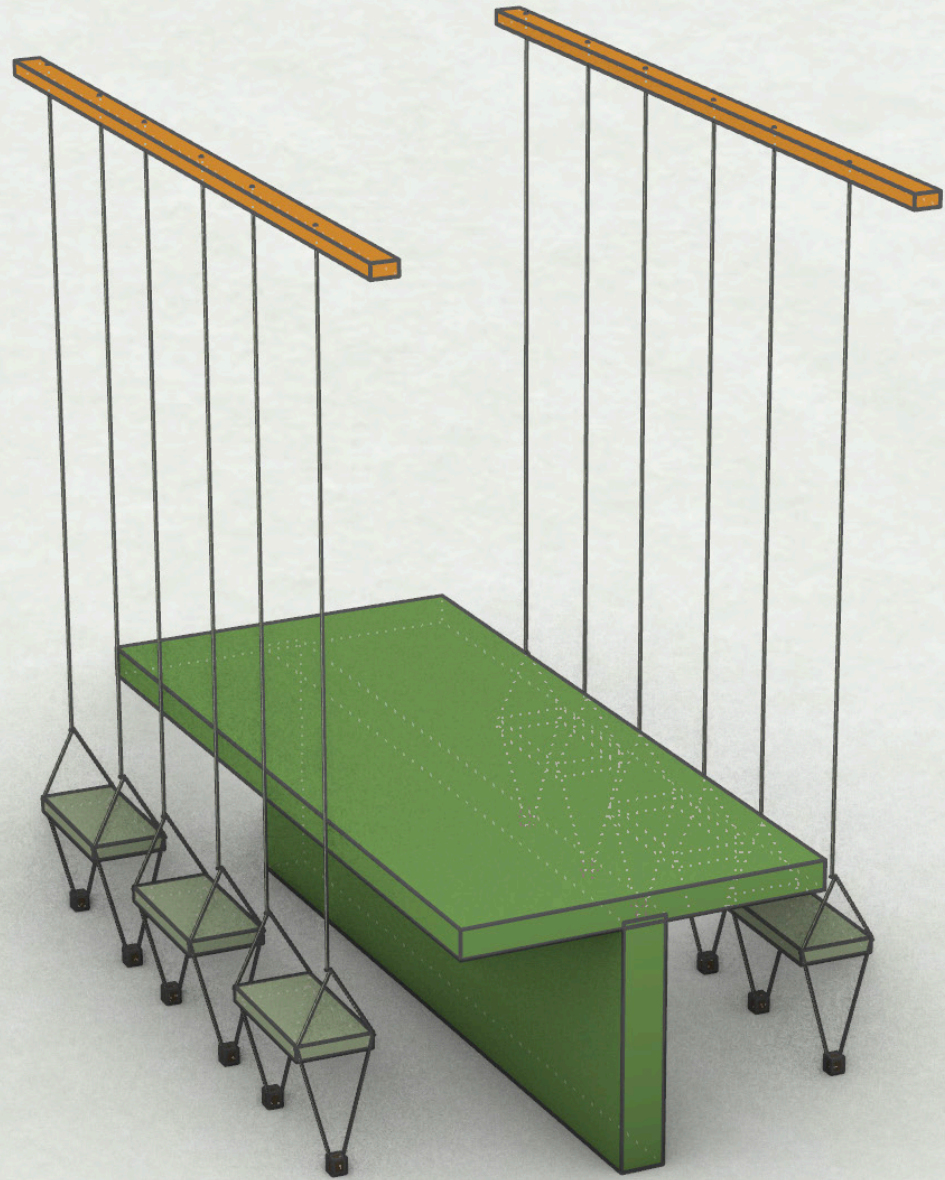

*Swing working area*





**TOOL-KIT**

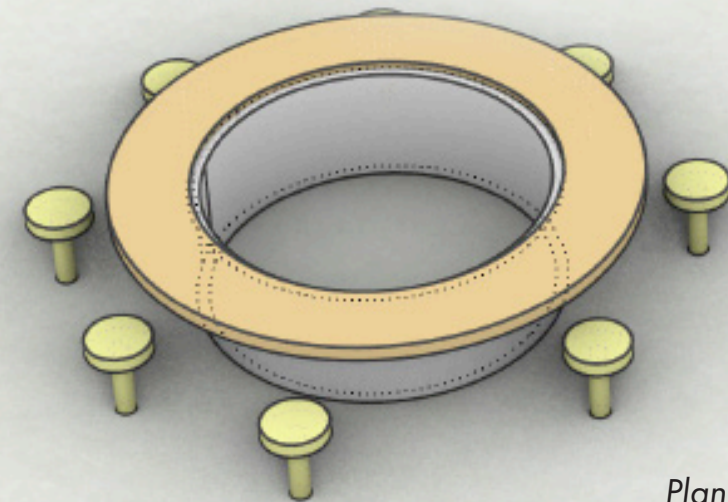
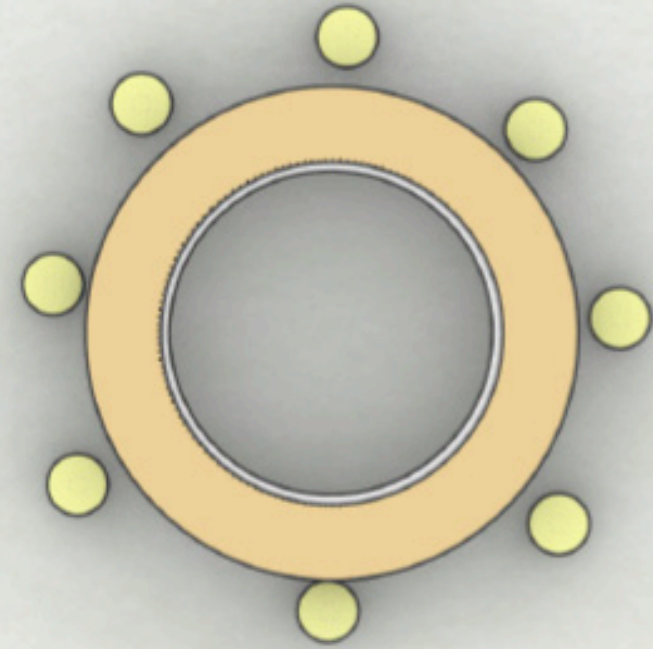

**TOOL-KIT**

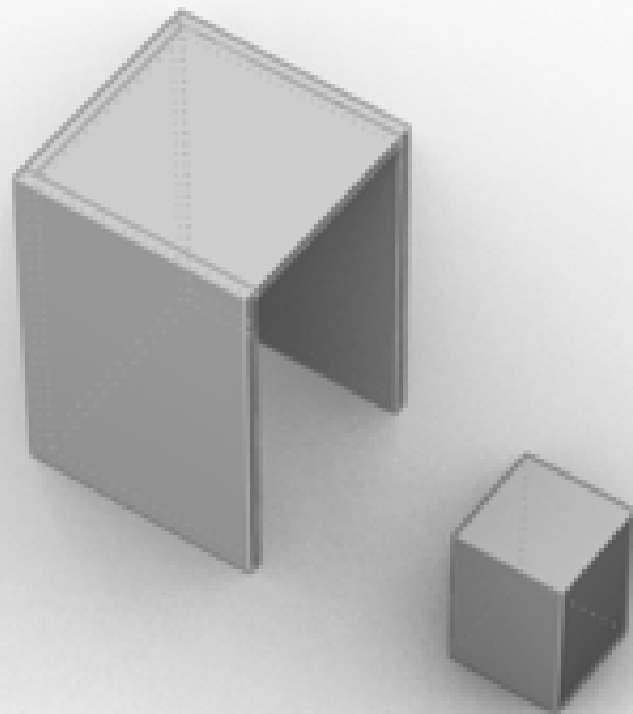

*Eat alone*

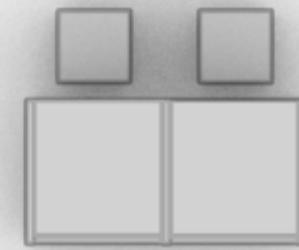



## PRIVACY

Privacy is very important in offices. There are rooms for people to eat and work privately, as well as escape rooms for people to take a break. The bamboo being planted inside the building helps to create privacy between each working areas, as well as privacy between indoor and outdoor.

## CIRCULATION

By introducing the curved inserted structure into the building, the space is divided into different sections. The long corridors have been divided into smaller and curvy corridors. The circulation became organic and smooth, at the same time as simple as it can be so that people won't get lost in the building.

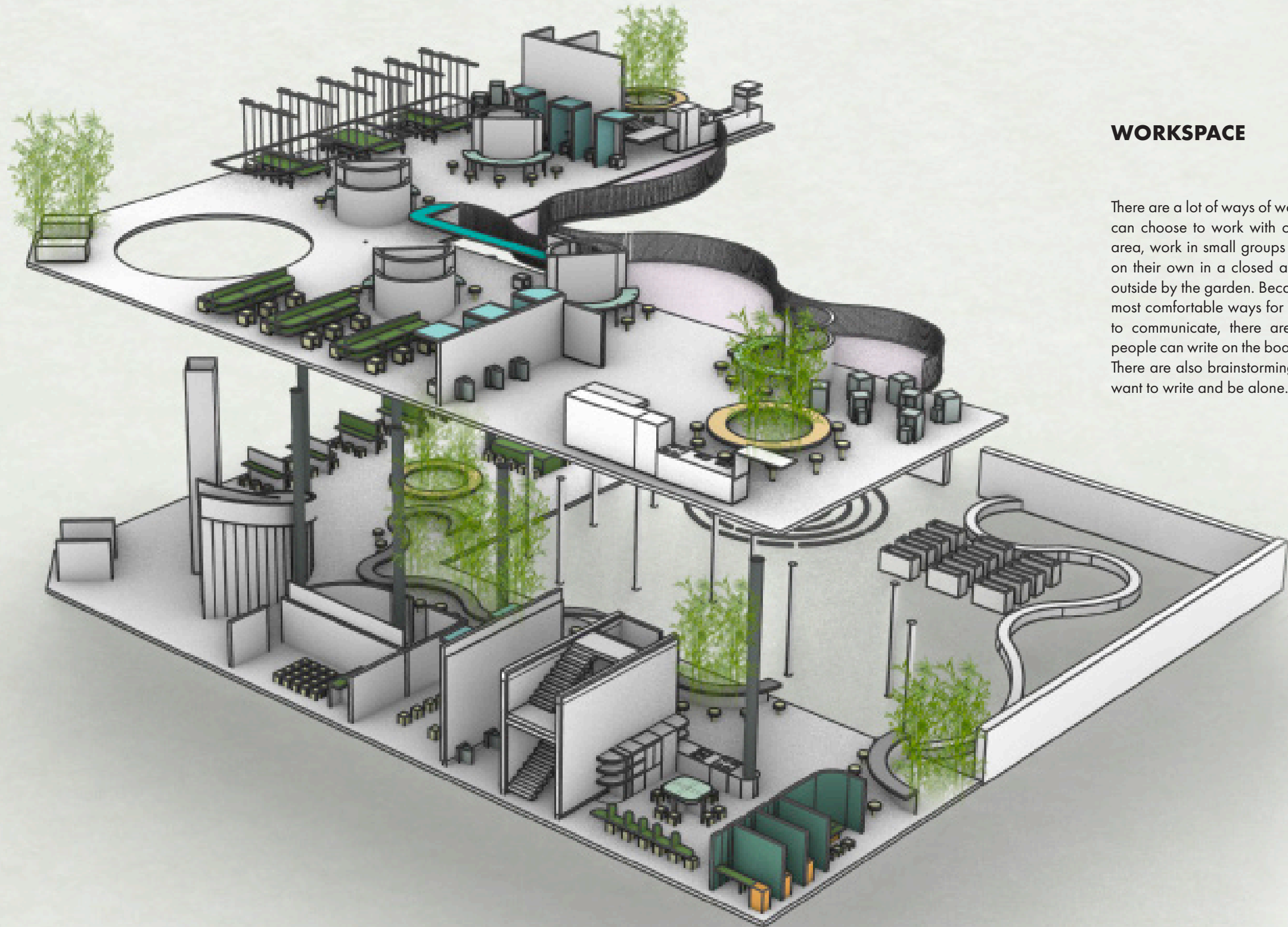

## WORKSPACE

There are a lot of ways of working in this office. One can choose to work with others in an open office area, work in small groups in a closed room, work on their own in a closed and quiet room, or work outside by the garden. Because writing is one of the most comfortable ways for people on the spectrum to communicate, there are several rooms where people can write on the boards attached to the wall. There are also brainstorming areas for people who want to write and be alone.

## **RESOURCE**

Page 17

5 Good Career Choices For People With Autism Spectrum Disorder

<<https://www.appliedbehavioranalysisprograms.com/lists/5-good-career-choices-for-people-with-autism-spectrum-disorder/>>

- Summarizes how people on the spectrum suffer from not being able to find a job in the past. Provide a list of job opportunities that people on the spectrum are good at.

Parker, Kim. "Autism @ Work Virtual Career Fair," n.d.

<<https://accessiblecareer.com/2019/04/02/autism-work-virtual-career-fair/>>

- The author talks about the autism work virtual career fair, what companies and organizations are in the career fair, and how people can access the career fair.

Careereco Virtual Career Fair

<<https://www.careereco.com/Fair/EventDetails?fairId=231d0942-ed35-4c6d-9811-a9e-c015f7312>>

- This website shows the schedules of upcoming autism@work events and descriptions. People can also register for the events through the website.

Page 18-19

Pictures and design drawings:

"ConsenSys Offices / Neiheiser Argyros" 13 Sep 2019. ArchDaily.

<<https://www.archdaily.com/924728/consen-sys-offices-neiheiser-argyros/>> ISSN 0719-8884

- This website shows more information about the ConsenSys office. Including design drawings, pictures, background, and descriptions of the design elements.

Shamah Autism Center - Tes Jobs.

<<https://www.tes.com/en-us/jobs/employer/shamah-autism-center-1064842>>

- The website talks about the background of Shamah autism center. People can learn more about how Shamah autism center is developed. There are some pictures of the autism center as well.

GA Architects Shamah Autism Center Design Drawing. Image.

<<https://www.autism-architects.com/autism-design-projects>>

- GA Architects's website shows the design drawings and diagrams of the Shamah Autism Center. A lot of other autism friendly designs can be found on this website.

Page 20

"About Us - Netley Primary School". 2020.

Netley Primary School. Accessed January 11.

<<http://www.netley.camden.sch.uk/about-us/>>

- The website talks about the history, background, design, and development of Netley Primary school.

Page 21

1. Pictures:

N. Henry, Christopher. 2011. "Designing For Autism: Lighting". Archdaily.

<[https://www.archdaily.com/177293/designing-for-autism-lighting?ad\\_medium=widget&ad\\_name=recommendation](https://www.archdaily.com/177293/designing-for-autism-lighting?ad_medium=widget&ad_name=recommendation)>

- The article written by Christopher N. Henry talks about good and bad lighting designs for people on the spectrum. It shows a lot of examples and pictures of schools and organizations that designed their lighting specially for individuals on the spectrum.

Page 21

N. Henry, Christopher N. Henry. 2012.

"Architecture For Autism: Exterior Views". Archdaily.

<<https://www.archdaily.com/223076/architecture-for-autism-exterior-views>>

- This article Christopher N. Henry wrote in 2012 updated some information about Netley Primary School Autistic Unit. Including his visit to Netley Primary School and some interviews with the teachers.

Page 22

Dubois, Jordyn. 2018. "Temple Grandin Speaks On 'The Design Process, Autism And Animals'". Iowa State Daily.

<[https://www.iowastatedaily.com/news/temple-grandin-iowa-state-lecture/article\\_52fc-b5ae-b7cd-11e8-80b3-ef920184cef5.html](https://www.iowastatedaily.com/news/temple-grandin-iowa-state-lecture/article_52fc-b5ae-b7cd-11e8-80b3-ef920184cef5.html)>

- This is a news reported by Dubois Jordyn in 2018 about Temple Grandin's speech at Colorado State University speak about autism and animal behavior on Sept. 13.

Page 23

Picture:

Lavagna, Augustin. 2019. "Nellyrod / Décryptage / Daily Seduction ; Normal ; Ordinary ; Simple". Nellyrodi.Com. <https://www.nellyrodi.com/en/the-siren-call-of-the-commonplace/>.

- An article write by Lavagna Augustin that talks about the mechanisms used to attract customers are shifting from artifice to simplicity, moderation and the aesthetic of banality.

Lindman Photography. 2013. "Palmgren House By John Pawson | UP Interiors". UP Interiors.

<https://upinteriors.com/space/project/palmgren-house-by-john-pawson/>.

- The website contains more pictures of Palmgren house designed by John Pawson that was taken by Lindman photography. There is also other more detailed information about the Palmgren house on the website.



Page 26

Donna Williams. 2009. Nobody Nowhere. Jessica Kingsley Publishers.

The book written by Donna Williams talks about ASD and her own experience as an individual with autism herself.

New Strain Centre for Autism, picture taken by Wardell Armstrong. "Designing For Autism: Lighting". Archdaily.

<[https://www.archdaily.com/177293/designing-for-autism-lighting?ad\\_medium=widget&ad\\_name=recommendation](https://www.archdaily.com/177293/designing-for-autism-lighting?ad_medium=widget&ad_name=recommendation)>

The article written by Christopher N. Henry talks about good and bad lighting designs for people on the spectrum. It shows a lot of examples and pictures of schools and organizations that designed their lighting specially for individuals on the spectrum.

Autism-Friendly Design Ideas." Center for Autism Research, July 14, 2016.

< <https://www.carautismroadmap.org/autism-friendly-design-ideas/>>

This is a very helpful website for people who wants to learn more about autism friendly designs. A lot of autism friendly design elements are listed on the website. It also provides additional resources related to autism friendly design.

Page 36

"Researchers@Brown." Levine, Todd. Accessed January 11, 2020.

<<https://vivo.brown.edu/display/tlevinem>>

Information and background about Professor Levine, Todd

Page 52

1. The city. "Harbin". 2019. En.Wikipedia.Org.

<<https://en.wikipedia.org/wiki/Harbin>>

- The website talks about the background, history, culture, climate, and other informations about the city of Harbin.2. Map

"Harbin Maps, Maps Of Harbin Attractions". 2019. China Highlights.

<<https://www.chinahighlights.com/harbin/map.htm>>

-The website shows attractions, transportation, maps, and things to do in Harbin.

1.1

A group picture at Liaoyuan Special Education

1.2

Group exercise aa Liaoyuan Special Education

1.3-1.4

ConsenSys. (n.d.). photograph, Luke Hayes, Simone Bossi 2019

1.5

Design Drawing "ConsenSys Offices / Neiheiser Argyros" 13 Sep 2019. ArchDaily.

1.6-1.8

Netley School Autistic Resource Base, Dennis Gilbert/View 2019

1.9

N. Henry, Christopher, Photograph 2012.

2.1

Lavagna, Augustin. 2019.

<https://www.nellyrodi.com/en/the-siren-call-of-the-commonplace/>.

2.2

A chic, nature filled office

<https://inhabitat.com/a-chic-nature-filled-office-building-in-tokyo-boldly-brings-the-outdoors-in/kojimachi-terrace-by-nendo-8/>

2.3

New Struan Centre for Autism © Wardell Armstrong 2019

2.4

Autism light design

N. Henry, Christopher. 2011. "Designing For Autism: Lighting". Archdaily.

<[https://www.archdaily.com/177293/designing-for-autism-lighting?ad\\_medium=widget&ad\\_name=recommendation](https://www.archdaily.com/177293/designing-for-autism-lighting?ad_medium=widget&ad_name=recommendation)>

2.5

Sustainable sound insulation

<https://www.stylepark.com/en/news/creation-baumann-acoustic-fabric-textiles>

2.6

How to design for autism

<https://www.fastcompany.com/3054103/how-to-design-for-autism>

2.7

Wayfinding

<https://fontsinuse.com/uses/21837/wayfinding-in-gemini-park-tychy>

3.1-3.2

Hand drawing on tablet by my sister

