

Eastern Kentucky University

Encompass

EKU Faculty and Staff Scholarship

Faculty and Staff Scholarship Collection

2019

The Leyva Canyon Volcano, Big Bend Ranch State Park, Presidio Co., Texas.

John C. White

Eastern Kentucky University, john.white@eku.edu

Kevin M. Urbanczyk

Sul Ross State University

Kelly Watson

Eastern Kentucky University, kelly.watson@eku.edu

Follow this and additional works at: https://encompass.eku.edu/fs_research



Part of the [Geology Commons](#), and the [Volcanology Commons](#)

Recommended Citation

White, J.C., Urbanczyk, K.M., Watson, K., 2019, The Leyva Canyon Volcano. In: *Geology at the Crossroads—Big Bend Ranch State Park, Presidio and Brewster Counties, Texas* (P.W. Dickerson, B.R. Hall, and B.B. Hunt, Eds.) Austin Geological Society Guidebook 39, p. 48-58.

This Article is brought to you for free and open access by the Faculty and Staff Scholarship Collection at Encompass. It has been accepted for inclusion in EKU Faculty and Staff Scholarship by an authorized administrator of Encompass. For more information, please contact Linda.Sizemore@eku.edu.

TECHNICAL ARTICLES –

The Leyva Canyon Volcano, Big Bend Ranch State Park, Presidio Co., Texas

John C. White¹, Kevin M. Urbanczyk² and Kelly Watson¹

¹Eastern Kentucky University, Department of Geosciences, Richmond, Kentucky, john.white@eku.edu

²Sul Ross State University, Rio Grande Research Center, Alpine, Texas

ABSTRACT

Leyva Canyon volcano is an Oligocene (27.3 to 27.1 Ma) trachyte shield volcano whose eruptive and volcanoclastic deposits of rhyolite and trachyte lavas, ash-flow tuffs, lahars, and associated sedimentary rocks comprise the Leyva Canyon Member of the Rawls Formation. The lavas and tuffs originated from vents located near the present-day “Bofecillos vent” in the central Bofecillos Mountains, approximately 5 km west of the Saucedo Ranger Station in Big Bend Ranch State Park in southernmost Presidio County, Texas. The pyroclastic and volcanoclastic units form the distinctive cliffs and caves at the periphery of the Bofecillos Mountains, with the caves developing in the ash-flow tuffs that underlie the more erosionally resistant lahars; these units are the focus of this discussion.

INTRODUCTION AND GEOLOGIC SETTING

The Bofecillos Mountains are a high, fault-bounded plateau consisting primarily of volcanic rock. Volcanic rocks older than ~32 Ma mostly erupted from sources outside the Bofecillos Mountains (e.g., the Chinati, Chisos, and Sierra Rica ranges); those younger than ~32 Ma are primarily sourced from local volcanoes: the older (32-29 Ma) Fresno shield volcano and the younger (27.80-27.05 Ma) Bofecillos Mountains volcanic field (BMVF) (Henry et al., 1998). These volcanoes developed during the 31-27 Ma “early tensional magmatic phase” of Trans-Pecos volcanism of Henry et al. (1991) and James & Henry (1991) and the 36-27 Ma “post-orogenic” phase of White et al. (2006). The lavas erupted from the Fresno volcano are assigned to the Fresno Formation, which includes alkali basalt lavas (Campo Javelina Basalt Member), trachyte lavas (Rancherías Lavas Member), and several undifferentiated units including rhyolite domes and volcanoclastic sediments that are stratigraphically correlative with the Tascotal Formation (Walton, 1986). The BMVF consists of at least six different volcanoes which correspond to the six members of the Rawls Formation (Table 1). The Leyva Canyon volcano (Leyva Canyon Member) is a trachytic shield volcano that represents the oldest of the felsic volcanoes within the complex (27.33-27.10 Ma), and consists of metaluminous to peralkaline quartz trachyte and rhyolite lavas that form the shield, minor peraluminous high-silica rhyolite lava domes and flows near the central vent area, along with pyroclastic and volcanoclastic rocks

Table 1. MEMBERS OF THE RAWLS FORMATION

Member	Symbol	⁴⁰ Ar/ ³⁹ Ar age (Ma)	Rock Types
Alazan Lavas	Tra	27.23 ± 0.10	Alkalic trachybasalt, trachyandesite, ne-trachyte
Rancho Viejo Tuff	Trr	27.09 ± 0.10	Q-trachyte ash-flow tuff
Segundo Lavas	Trg	27.10 ± 0.10, 27.05 ± 0.10	Ne-trachyte and q-trachyte.
Saucedo Lavas	Trs	27.13 ± 0.10	Alkalic trachybasalt to trachyandesite
Leyva Canyon	Trl	27.33 ± 0.10, 27.09 ± 0.10	Q-trachyte, comendite, high-silica rhyolite, ash-flow tuff
Las Burras Basalts	Trb	<27.80, >27.30	Alkali basalt, trachybasalt

Adapted from Henry et al. (1998), White and Urbanczyk (2001).

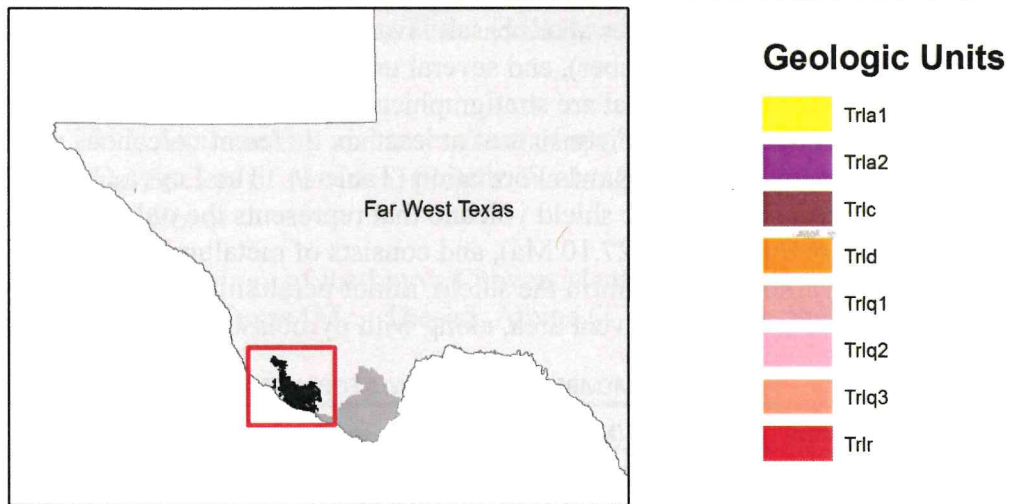
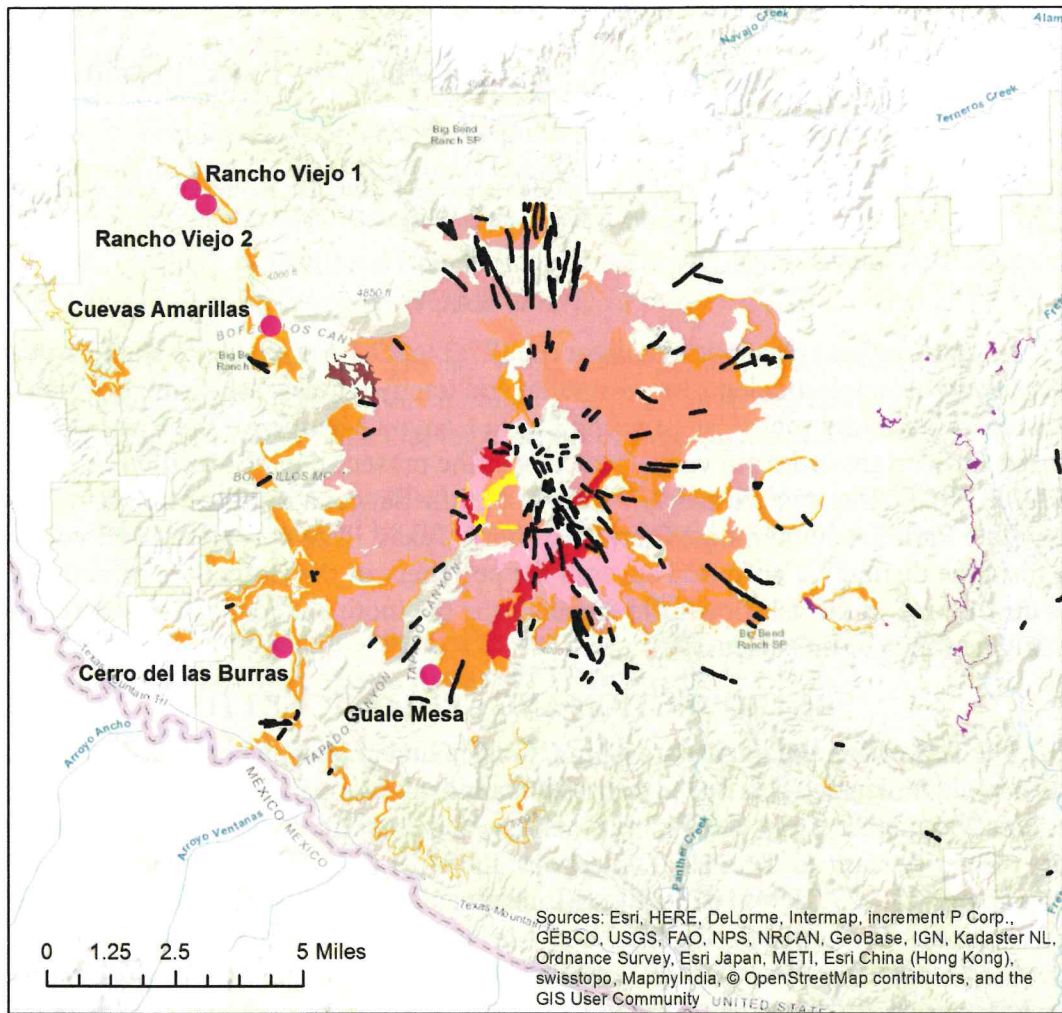

Figure 1. Simplified geologic map of the Leyva Canyon volcano (adapted from Henry et al., 1998) with locations mentioned in the text.

volcanoes within the complex (27.33-27.10 Ma), and consists of metaluminous to peralkaline quartz trachyte and rhyolite lavas that form the shield, minor peraluminous high-silica rhyolite lava domes and flows near the central vent area, along with pyroclastic and volcanoclastic rocks that were emplaced prior to the eruption of the trachyte lavas and crop out primarily to the south and west of the shield (White & Urbanczyk, 2001; Figure 1).

Las Cuevas Amarillas

Las Cuevas Amarillas is located in Bofecillos Canyon along the main road leading into Big Bend Ranch State Park and derives its name from the rock shelters carved into the more easily erodible pale yellow ash flow tuff that crops out beneath the more resistant lahar units. At

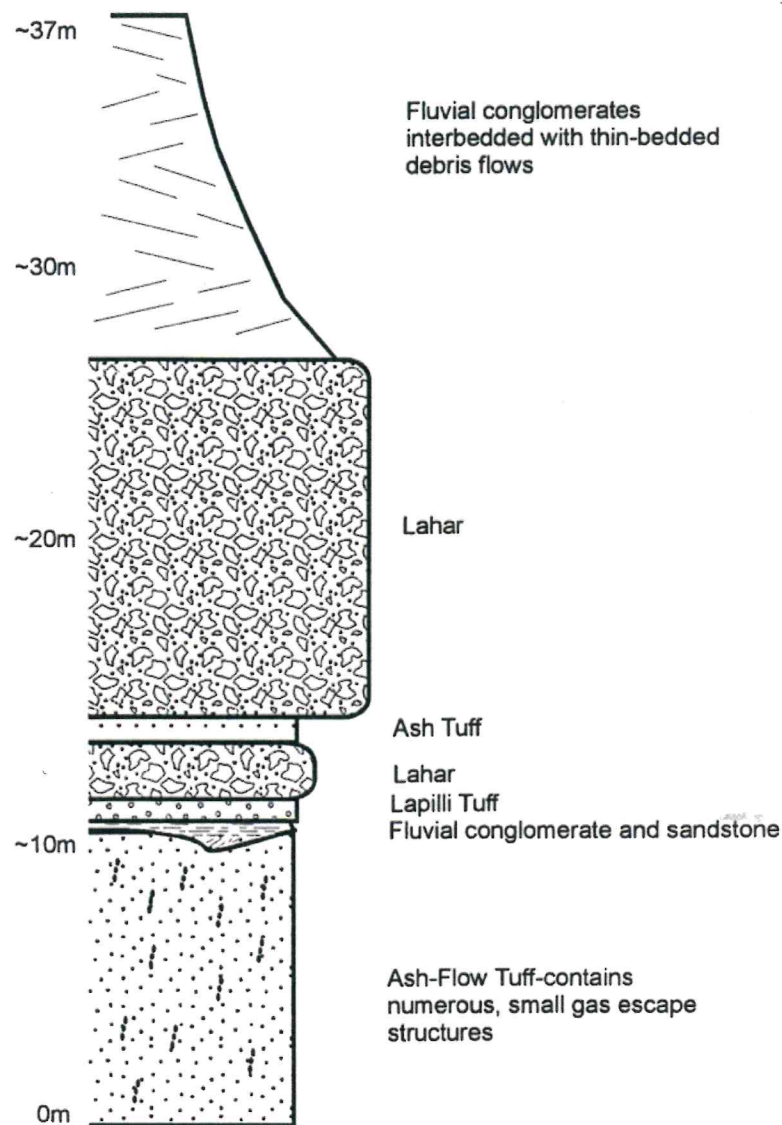

Figure 2. Generalized volcanoclastic section at Las Cuevas Amarillas (Agua Adentro Quadrangle, NAD 83 UTM Zone 13N 587091 mE 3263222 mN).

this locality, the combined pyroclastic/volcaniclastic section is approximately 37 m thick (Figure 2). The ash-flow tuff facies at this locality is up to 10 m thick and unconformably overlies lavas of the Las Burras Basalts Member of the Rawls Formation (<27.8 but >27.3 Ma, Henry et al., 1998). It consists of pumice lapilli, lithic clasts, and crystal fragments (dominantly alkali feldspar) in an unwelded ash matrix with abundant pumice lapilli-rich gas escape structures ranging in size from about 1 cm x 7 cm to 4 cm x 60 cm. The ash-flow unit is overlain by an erosional surface with a fluvial unit ~0.4 m thick that shows evidence of lag deposits, channel fill deposits, cyclic graded bedding, and trough cross bedding. Above this is ~0.6 m of lapilli tuff,

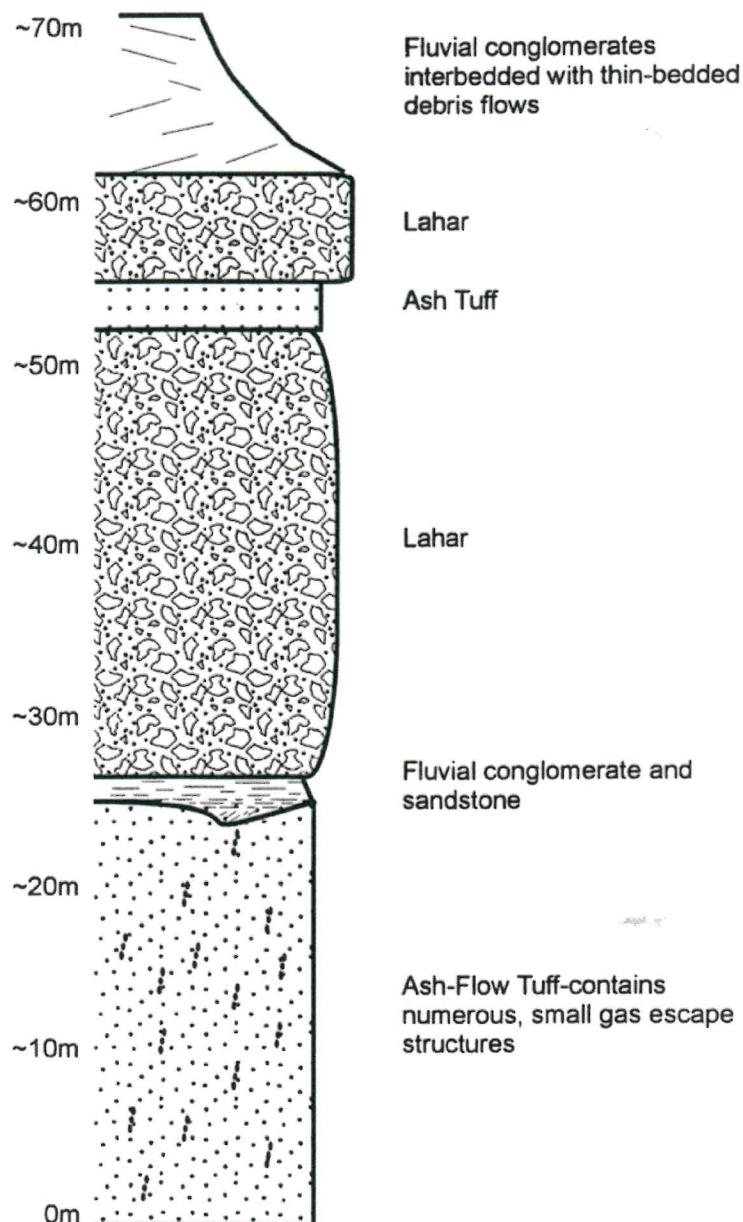

Figure 3. Generalized volcanoclastic section at Cerro del las Burras (Agua Adentro Quadrangle, NAD 83 UTM Zone 13N 587456 mE 3253072 mN).

presumably of air-fall origin. This tuff is overlain by 2 m of a homogenous, vaguely bedded, poorly sorted pebbly mudstone interpreted to represent a lahar. A third pyroclastic deposit, a 1 m thick layer petrographically similar to the lower ash flow tuff overlies the lower lahar and is in turn overlain by a thick (12 m) layer of pebbly mudstone similar to the lower lahar. The upper, massive lahar grades into fluvial conglomerates, which comprise the upper 10-11 m of the Levya Canyon section. This upper layer is overlain by basalt lavas assigned to the Saucedo Lavas Member of the Rawls Formation (27.13 Ma, Henry et al., 1998; White, 1997). This sequence is also observed at several other localities, including Cerro de las Burras (Figure 3), Rancho Viejo (Figure 4), and Guale Mesa (Figure 5) where the upper fluvial unit interfingers with trachyte lava flows.

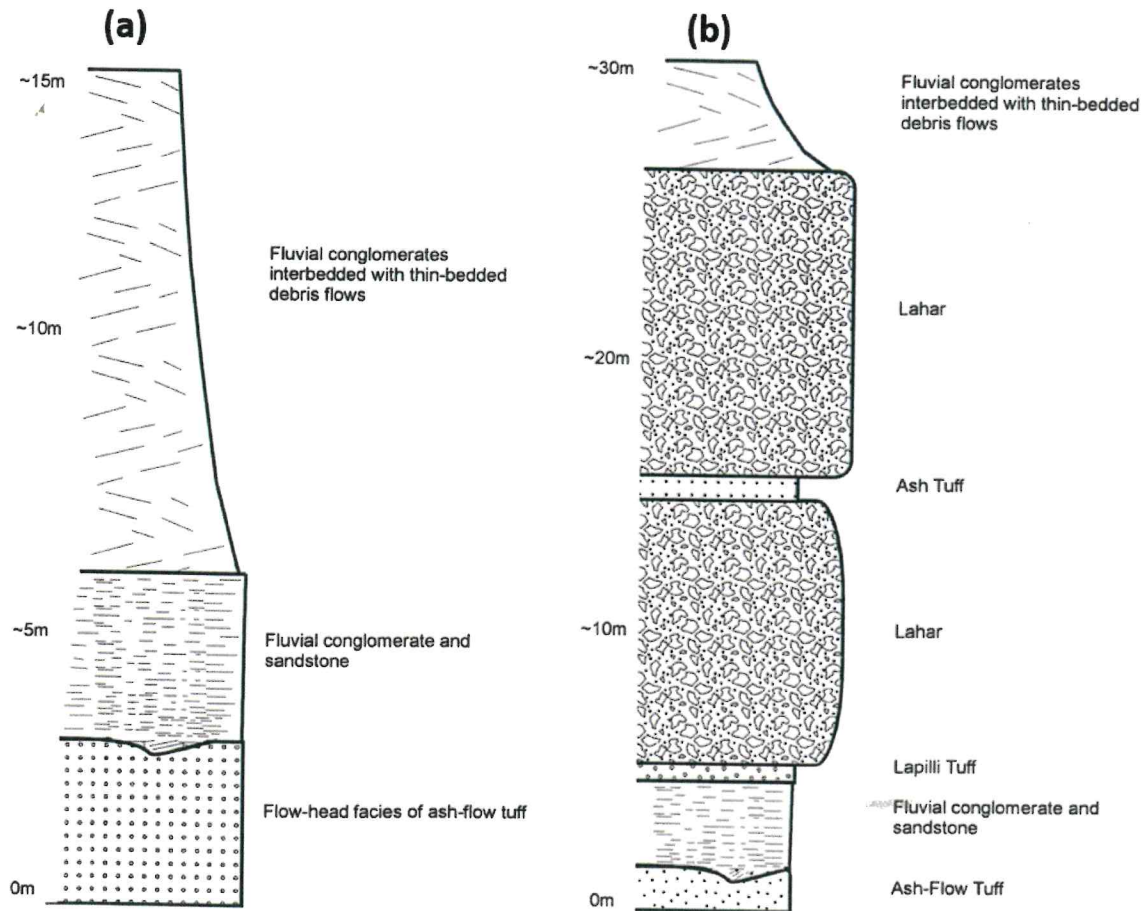

Figure 4. Generalized volcanoclastic section at (a) Rancho Viejo #2, the most distal measured section (Manzanillo Canyon Quadrangle, NAD 83 UTM Zone 13N 585057 mE 3267059 mN); and (b) Rancho Viejo #1 (Cerro Redondo Quadrangle, NAD 83 UTM Zone 13N 584574 mE 3267516 mN).

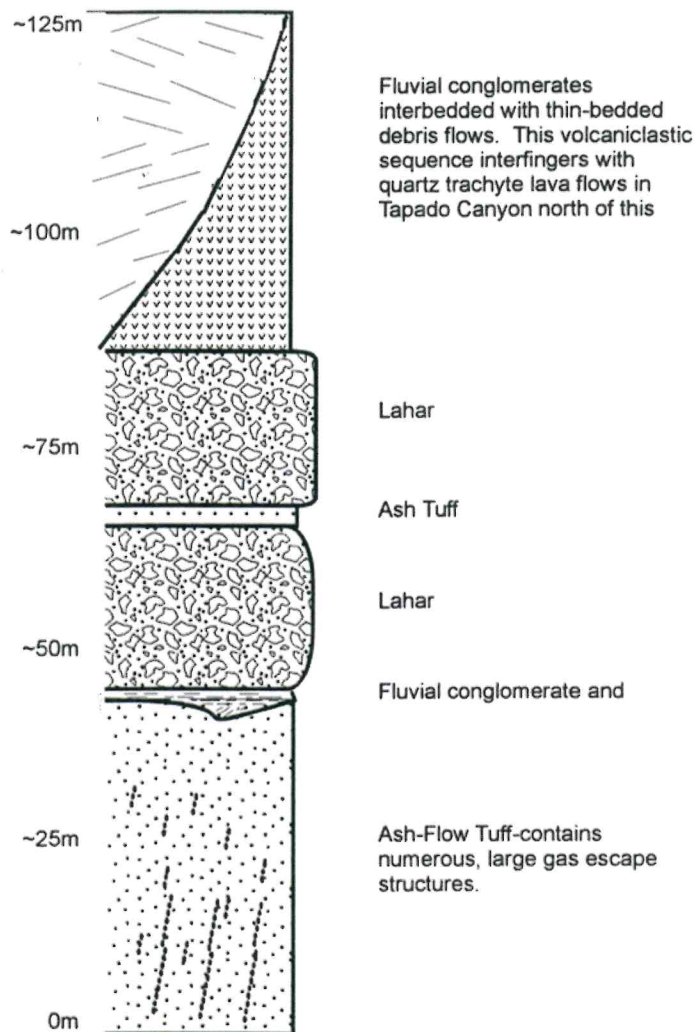

Figure 5. Generalized volcanoclastic section at Guale Mesa (Agua Adentro Quadrangle, NAD 83 UTM Zone 13N 592135 mE 3252201 mN).

PETROGRAPHY

Ash-Flow Tuffs

Ash-flow tuffs of the Leyva Canyon Member are mapped as three separate units (Trla1, Tra2, and Trld) which represent at least two distinct eruptive pulses (Henry et al., 1998). Trla1 is densely welded vitric-lithic ash flow tuff that crops out in only a few places near the southwest flanks of the central vent. Tra2 is a welded to unwelded ash flow tuff that crops out only along the upper canyon walls of Fresno Canyon. The ash-flows of Trld are loosely consolidated to unwelded ash flow tuffs frequently characterized by the presence of abundant gas-escape structures. The welded ash-flow tuffs consist primarily (~70%) of eutaxitic, devitrified volcanic glass with abundant (~25%) crystal fragments and minor (~5%) lithic clasts. Crystals are mostly (~15%) large (0.5 to 5 mm), broken alkali feldspars with subordinate, smaller (<0.5 mm) quartz and altered mafic minerals. Lithic fragments are up to 10 mm in diameter and include rhyolite,

syenite, and trachyte. The unwelded ash flow tuffs have a massive, devitrified ash matrix which comprises between 35 and 50% of the rock. The remainder of the unit consists of abundant (20 to 50%) lapilli (up to 50 mm) pumice fragments; small (<0.5 mm) crystals consisting primarily of broken alkali feldspar, quartz, and opaque minerals; and 2-15% lithic fragments which consist dominantly of rhyolite.

Lahars

The unit interpreted as “lahars” classify as tuffaceous feldspathic litharenites (McBride, 1963) and tuffaceous diamictites (Pettijohn, 1975). Lithic fragments range in abundance from about 10 to 40% and consist primarily of very poorly sorted (~0.5 to >120 mm) subangular to angular clasts of mostly porphyritic quartz trachyte. Angular fragments of alkali feldspar comprise up to 45% of the lahars and show a much more limited range in size (0.05 to 2 mm). Broken pumice fragments are locally abundant (up to 20%) and are up to 6 mm in diameter. The lahars are occasionally vesicular, consisting of up to 30% void space. The remainder of the rock consists of reworked volcanic ash.

Trachyte Lavas

The lavas that comprise the shield of the Leyva Canyon volcano consist of aphyric to phyric quartz trachytes (Henry et al., 1998; White, 1997; White and Urbanczyk, 2001). The more primitive quartz trachyte lavas (Trlq3) are dominated by phenocryst of embayed, progressively zoned plagioclase (An₃₈₋₂₆) mantled by zoned anorthoclase (An₂₂Ab₆₇Or₁₂) with subordinate augite (Wo₄₃₋₄₆En₃₃₋₂₈Fs₂₄₋₂₆, Na <0.6 apfu) and minor titanomagnetite (Usp₇₃). Unzoned, euhedral sanidine phenocrysts (Or₄₀) and minor titanomagnetite (Usp₆₇) are the primary phenocrysts in the more evolved quartz trachytes (Trlq1). Rare microphenocrysts of amphibole, olivine, apatite, biotite, and zircon have been described from some samples in both Trlq3 and Trlq1 (Henry et al., 1998). The most evolved quartz trachytes/rhyolites (Trlq2) are aphyric.

VOLCANIC STRATIGRAPHY AND HISTORY

Main Pyroclastic Phase

The first volcanic activity associated with the Leyva Canyon volcano was the extrusion of minor flows of high-silica rhyolite (Henry et al., 1998). Spatial distribution and flow banding in the rhyolite indicates that these flows originated from near the central vent and flowed towards the south and southwest. The eruption of rhyolite was followed by a pyroclastic eruption of ash-flow tuff what was also directed towards the south and west of the central vent. A welded coarse-tail facies of the ash flow lies adjacent to the southwest margin of the central vent; elsewhere, the tuff is unwelded. South and southwest of the central vent at upper Guale Mesa, Cerro de las Burras, and Three-Dike Hill, the unwelded ash flow tuff ranges in thickness from 24 to 27.5 m. West-northwest of the central vent at Las Cuevas Amarillas, the unwelded ash flow tuff is ~10 m thick, thinning gradually towards the northwest to a 3 m thick flow head facies at the Rancho Viejo #1 locality on the Botella Horst, beyond which it quickly pinches out. Based on the current outcrop area and thickness of the lower pyroclastic unit, the total eruptive volume was <1 km³, suggesting a sub-Plinian (VEI = 3-4) eruption. The distribution of the welded-ash flow tuff facies relative to the unwelded ash-flow tuff facies suggests that the location of the vent that produced this unit was in or near the central vent; indeed, the outcrop of the welded ash flow tuff may represent the location of the vent itself.

Welded Coarse-Tail Facies. The welded facies of the ash-flow tuff (Trld; Henry et al., 1998) is a densely welded tuff with numerous clasts of coarse (>2 mm) lithic fragments, broken quartz, and sanidine crystals, and fiamme pumice in a matrix of welded volcanic glass. The abundance of coarse lithic fragments in this facies, which crops out adjacent to the central vent, and the lack of coarse lithic fragments in the more distal facies, suggests that it also represents the coarse-tail facies of the ash-flow tuff (Fisher and Schminke, 1984). This facies is very restricted in its distribution, cropping out only as a narrow (~0.6 km) deposit less than 1 km long between the central vent and the top of Tapado Canyon. In this location, the welded tuff overlies Leyva Canyon rhyolite.

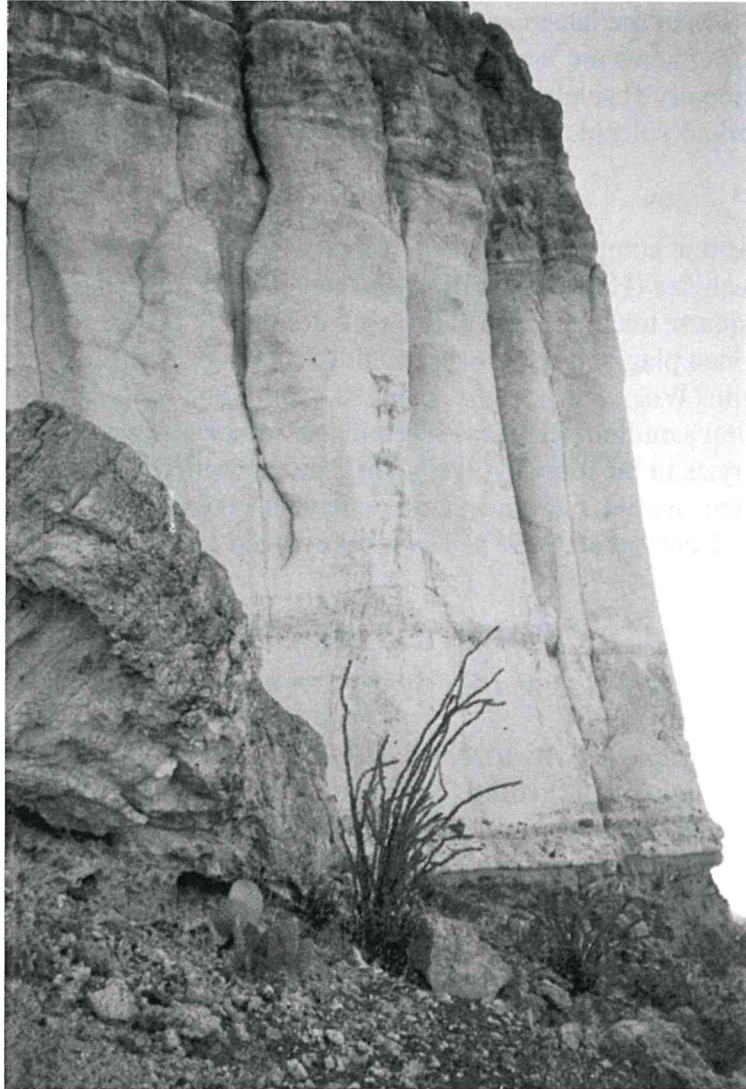

Figure 6. Gas escape pipes exposed along the side of the unwelded ash flow tuff at the southern end of Guale Mesa. The ash flow tuff is approximately 30 m thick.

Unwelded Ash-Flow Tuff Facies. The unwelded tuff facies (Trld; Henry et al, 1998) occupies a similar stratigraphic position at all localities, directly overlaying Las Burras basalt lavas and underlaying a thin erosional fluvial sequence within the Trld unit. Evidence for a primary, ash-flow nature of this facies comes from the presence of numerous gas-escape

structures that range from finger-sized to several meters long. Gas-escape structures have been noted at every section measured except for the distal Rancho Viejo location and are particularly dramatic at upper Guale Mesa (Figure 6), where they occur along with well-developed lithic concentration zones. The presence of gas-escape structures, along with the coarse-trail grading (in the welded facies) and lithic concentration zones indicate that the flow was highly fluidized, classifying as a type 3 pyroclastic flow in the scheme of Wilson (1980). The degree of fluidization was great enough that the gas velocity within the flow exceeded the maximum pressure drop that could be tolerated by the flow itself, which initiated instability within the flow (Cas and Wright, 1988). This instability resulted in the segregation of the flow into discrete channels wherein the escaping gas subsequently elutriated the finer-grained ash, leaving behind "pipes" of lapilli pumice. The segregation of the gas into these channels enabled the flow to maintain a high yield strength, which in turn facilitated the preservation of these structures (Wilson, 1980).

Flow Head Facies. The flow head facies represents the distal facies of the pyroclastic flow, where the flow is further fluidized by air trapped underneath a rapidly-moving pyroclastic current. This results in a nonwelded ash flow tuff characterized by abundant dense, rounded pumice and an increased crystal enrichment (Wilson, 1980). This facies can be best observed at Rancho Viejo, east of Las Cuevas Amarillas.

Lahar / Shield Phase

Eruption of the ash-flow tuff was probably followed by a very intense period of flooding that is marked by the thin fluvial unit that separates the ash-flow tuff from the lahar. The fluvial layer is followed by a thin bed of pumice lapilli tuff, presumably of an air-fall origin. This is overlain with a thick massively bedded lahar which includes a small (<2 m) ash flow tuff that separates the overall unit into two distinct, but identical, parts. Closer to and south of the central vent, the uppermost lahar sequence interbeds with flows of trachyte lavas; further from the vent, the end of this phase is noted by a sharp change in the stratigraphy from the cliff-forming lahars to the slope-forming, thin-bedded fluvial units. Extrusion of trachyte lavas from sources near the Bofecillos vent began during the lahar phase, as evidenced by the interdigitating of lavas and thin-bedded, slope forming conglomerates and breccias, and continued after the cessation of laharc activity. Effusive activity was followed by intrusion of syenitic magma beneath the Bofecillos vent area, and the eruption of a late ash-flow tuff that produced a small collapse caldera (as evidenced by the presence of syenite-bearing volcanic breccias within the vent). The identity of this late ash-flow tuff is uncertain, but is likely either the "tuff of Fresno Canyon" unit within the Leyva Canyon Member (Trla2; 27.09 Ma) or the Rancho Viejo Tuff member (also 27.09 Ma) (Henry et al., 1998).

SUMMARY

The generalized stratigraphy of the Leyva Canyon Member and adjacent units is presented in Figure 7. Volcanic activity related to the Leyva Canyon volcano began with the intrusion of rhyolite dikes and eruption of domes (e.g., La Iglesia) and flows upon the flanks of the older (32 Ma) Fresno volcano (Henry et al., 1998). This was succeeded by an explosive

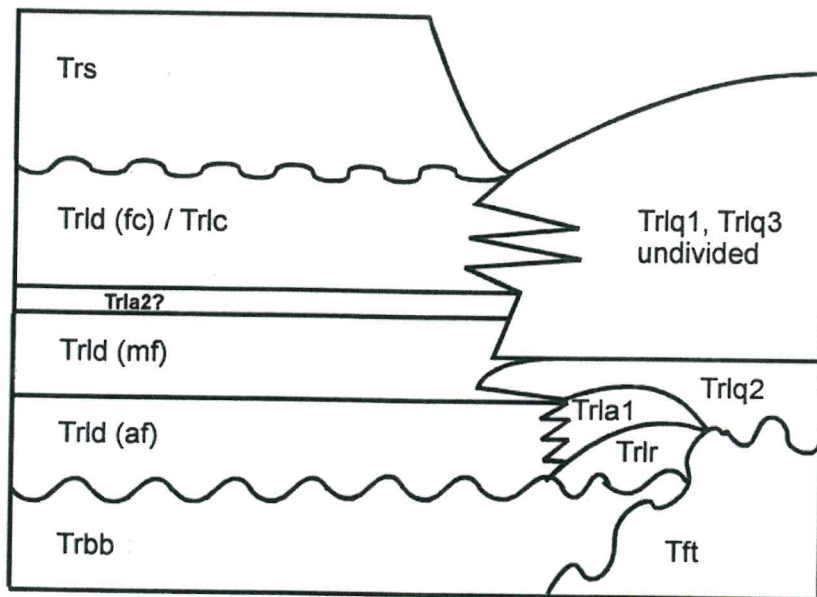

Figure 7. Generalized stratigraphy of the Leyva Canyon Member and adjacent units (adapted from Henry et al., 1998). Units from youngest to oldest are: Tft, Fresno Formation Trachytes; Trbb, Las Burras Basalts Member (Rawls Formation); Trlr, High-silica peraluminous rhyolite (Leyva Canyon Member, Rawls Formation); Trla1, Welded ash-flow tuff (Leyva Canyon member); Trlq2, Aphyric quartz trachyte lavas (Leyva Canyon Member); Trlq1 and Trlq3, Phyric quartz trachyte lavas (Leyva Canyon Member); Trld, Volcaniclastic units, undifferentiated; Trla2?, possible stratigraphic interval for the “tuff of Fresno Canyon”; Trs, Saucedo Lavas Member. Unit Trld is subdivided following Urbanczyk & White (1996) and White (1997): Trld (af), Unwelded ash-flow tuff; Trld (mf), Lahars; Trld (fs) / Trlc, Upper fluvial conglomerate unit.

eruption that produced an ash-flow tuff (dated at 27.33 Ma; Henry et al., 1998) that was deposited primarily towards the south and west. The ash-flow eruption was followed by the generation and deposition of two volcanic debris flows (lahars), which overlie the ash-flow tuff. Extrusion of trachyte lavas began during the later stages of lahar activity. Unlike the earlier eruptions, trachyte lava flows spread in every direction away the central vent and built the current volcanic edifice. Lower lava flows are interbedded with massive lahar sequences whereas higher lava flows are frequently interbedded with thin debris flows and fluvial conglomerates along the margins of the shield. Eruption of the “tuff of Fresno Canyon” (27.09 Ma) occurred during the final shield-building phase and was possibly responsible for the collapse of the central vent (White, 1997; Henry et al., 1998).

ACKNOWLEDGMENTS

The authors thank Kenny Befus for his thoughtful review and comments that improved this manuscript. Field work was conducted from 1994-1997 as part of JCW’s master’s thesis research, which would not have been possible without support from Sul Ross State University and the committee that first reviewed this work: in addition to KMU, David Rohr, the late James Houston, and the late Jim Whitford-Stark. We would also like to thank the people that helped in the field and in the lab, including Edgardo Covarrubias, Mark Curry, Andy Freed, Bill Green, Michael O’Farrell, and Jennifer (Cunningham) White.

REFERENCES CITED

- Cas, R.A.F. and Wright, J.F., 1988, Volcanic Successions: Modern and Ancient: New York, Chapman & Hall, 528 p.
- Fisher, R.V. and Schminke, H.-U., 1984, Pyroclastic Rocks: New York, Springer-Verlag, 472 p.
- Henry, C.D., 1998, Geology of Big Bend Ranch State Park, Texas: Bureau of Economic Geology Guidebook 27, 72 p.
- Henry, C.D., Price, J.G., and James, E.W., 1991, Mid-Cenozoic stress evolution and magmatism in the southern Cordillera: Magmatism and oreintaiton, timing, and style of extension: Journal of Geophysical Research, v. 96, p. 13545-13560.
- Henry, C.D., Davis, L.L., Kunk, M.J., McIntosh, W.C., 1998, Tertiary volcanism of the Bofecillos Mountains and Big Bend Ranch State Park: Revised stratigraphy and $^{40}\text{Ar}/^{39}\text{Ar}$ geochronology: Bureau of Economic Geology Report of Investigations 253, 74 p.
- James, J.G. and Henry, C.D., 1991, Compositional changes in Trans-Pecos magmatism coincident with Cenozoic stress realignment: Journal of Geophysical Research, v. 96, p. 13561-13575.
- McBride, A.R., 1963, A classification of common sandstones: Journal of Sedimentary Petrology, v. 33, p. 664-669.
- Pettijohn, F.J., 1975, Sedimentary Rocks (3rd Ed.): New York, Harper and Row, 628 p.
- Urbanczyk, K.M. and White, J.C., 1996, The stratigraphy of the volcanoclastic units of the Member #2 of the Rawls Formation, Big Bend Ranch State Park, Texas: Geological Society of America Abstracts with Programs, v. 28, n. 1.
- Walton, A.W., 1986, Effect of Oligocene volcanism on sedimentation in the Trans-Pecos volcanic field of Texas: Geological Society of America Bulletin, v. 97, p. 1192-1207.
- White, J.C., 1997, The petrology of the Leyva Canyon Member of the Rawls Formation, Big Bend Ranch State Park, Texas [M.S. Thesis]: Alpine (TX), Sul Ross State University, 166 p.
- White, J.C. and Urbanczyk, K.M., 2001, Origin of a silica-oversaturated quartz trachyte-rhyolite suite through combined crustal melting, magma mixing, and fractional crystallization: the Leyva Canyon volcano, Trans-Pecos Magmatic Province, Texas: Journal of Volcanology and Geothermal Research, v. 111, p. 155-182.
- White, J.C., Benker, S.C., Ren, M., Urbanczyk, K.M., and Corrick, D.W., 2006, Petrogenesis and tectonic setting of the peralkaline Pine Canyon caldera, Trans-Pecos Texas, USA: Lithos, v. 91, p. 74-94.
- Wilson, C.J.N., 1980, The role of fluidization in the emplacement of pyroclastic flows: an experimental approach: Journal of Volcanology and Geothermal Research, v. 8, p. 231-249.