



## Calhoun: The NPS Institutional Archive

---

Faculty and Researcher Publications

Faculty and Researcher Publications

---

1996-07

# Spectra of single-bubble sonoluminescence in water and glycerin-water mixtures

Gaitan, D. Felipe

---



Calhoun is a project of the Dudley Knox Library at NPS, furthering the precepts and goals of open government and government transparency. All information contained herein has been approved for release by the NPS Public Affairs Officer.

**Dudley Knox Library / Naval Postgraduate School**  
**411 Dyer Road / 1 University Circle**  
**Monterey, California USA 93943**

<http://www.nps.edu/library>

## Spectra of single-bubble sonoluminescence in water and glycerin-water mixtures

D. Felipe Gaitan, Anthony A. Atchley, S. D. Lewia, J. T. Carlson, and X. K. Maruyama  
*Physics Department, Naval Postgraduate School, Monterey, California 93943*

Michael Moran and Darren Sweider  
*Lawrence Livermore National Laboratory, Livermore, California 94550*  
 (Received 31 May 1994; revised manuscript received 18 September 1995)

A single gas bubble, acoustically levitated in a standing-wave field and oscillating under the action of that field, can emit pulses of blue-white light with duration less than 50 ps. Measurements of the spectrum of this picosecond sonoluminescence with a scanning monochromator are reported for air bubbles levitated in water and in glycerin-water mixtures. While the spectrum has been reported previously by others for air bubbles in water, the spectrum for air bubbles in water-glycerin mixtures has not. Expected emission lines from glycerin were conspicuously absent, suggesting a different mechanism for light production in single-bubble sonoluminescence. Other conclusions are the spectrum for air bubbles in water is consistent with that previously reported, the radiated energy decreases as the glycerin concentration increases, and the peak of the spectrum appears to shift to longer wavelengths for the water-glycerin mixtures. [S1063-651X(96)09307-5]

PACS number(s): 47.40.Nm, 78.60.Mq, 42.50.Fx, 42.65.Re

### I. INTRODUCTION

A single, stable gas bubble can be trapped, through a process known as acoustic levitation, in a liquid by an acoustic standing-wave field set up in that liquid. Once levitated, a bubble can be held in place for hours. In response to the levitation field, the bubble can be made to undergo both radial (volume) or shape oscillations of varying amplitude by proper choice of standing-wave amplitude and frequency. Gaitan *et al.* [1] demonstrated that within a narrow range of these drive parameters the bubble undergoes large-amplitude, apparently radially symmetric oscillations. At the end of the collapse phase of its oscillation cycle, the bubble emits a short burst of blue-white light, called sonoluminescence (SL).

SL demonstrates a number of remarkable features. Whereas the driving field typically has a period of tens of microseconds, the duration of the SL pulse is less than 50 ps [2,3]. Single SL pulses are isotropic and unpolarized. The SL amplitude and periodicity can be extremely stable. Although a number of mechanisms have been proposed to account for this phenomenon [4–6], there is still no fully satisfactory explanation.

Hiller *et al.* [7] reported measurements of the spectrum of SL emitted from air bubbles levitated in water. The spectrum is relatively broadband and increases into the ultraviolet. The long-wavelength tail of their spectrum is fit very well by a blackbody distribution having a temperature of 25 000 K. They report peak radiated powers of 30 mW and approximately  $10^6$  photons radiated per SL pulse.

The purpose of this paper is to report measurements of the spectrum of SL generated from air bubbles levitated in water and glycerin-water mixtures. The motivation is to confirm Hiller *et al.*'s results and extend them to different liquids.

### II. EXPERIMENTAL APPARATUS

#### A. Generation of sonoluminescence

SL is emitted by a single bubble levitated in an acoustic standing wave generated in a fluid-filled, spherical flask. The

standing wave is excited by hollow, right circular cylindrical, piezoelectric transducers cemented to the outside of a 500-ml flask. The transducers are driven with a function generator, power amplifier combination. The drive frequency is adjusted to set up a radially symmetric standing wave in the flask. A small amount of air is injected into the flask with a hypodermic syringe. A portion of the injected air evolves into a single bubble levitated at the pressure antinode located at the center of the flask. With proper adjustment of the drive amplitude and frequency, this bubble reaches a state in which it undergoes large-amplitude, radial oscillations, emitting one pulse of SL per acoustic cycle.

SL has been generated successfully from bubbles levitated in glycerin-water mixtures, for glycerin concentrations ranging from 0% to 40% by volume [1]. Stable, glowing bubbles, can last for hours. A key requirement appears to be sufficient degassing of the fluid sample.

#### B. Scanning monochromator

A 0.3-m scanning monochromator with a rotating grating (Acton Research Corp., Model VM-503) was used to measure the spectrum [8]. A computer-controlled stepper motor rotated the grating in order to scan the desired wavelength interval at the desired speed. The grating was an AlMgF<sub>2</sub>-coated, plane grating with 1200 grooves/mm and blazed for a wavelength of 300 nm. The output of the monochromator was collected with a photomultiplier tube (PMT). The PMT was a 30 mm end window type (Thorn EMI Model 9798QB) with an S-20 response and a quartz window for greater ultraviolet (UV) sensitivity. The PMT output was preamplified and fed to a Stanford research systems Model SR 530 lock-in amplifier. The PMT output was proportional to the number of photons detected in a particular wavelength bin. The lock-in output was sent to an analog-to-digital converter board installed in a Macintosh II computer.

The monochromator was set up to scan from 180 to 800 nm in 5-nm intervals. The computer sampled the (steady-

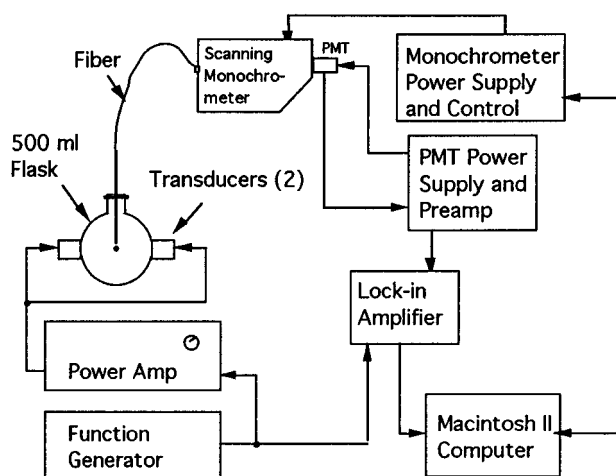

FIG. 1. Apparatus used to measure the spectrum of sonoluminescence.

state) lock-in output for each wavelength bin 20 000 times at 20- $\mu$ s intervals (50 k samples/s). Approximately 10 min were required to obtain one complete spectrum. The SL was coupled to the monochromator via a 1-m-long, 600- $\mu$ m-diam silica core, silica clad, optical fiber (3M FG-600-UAT). One end of the fiber was positioned in the flask, approximately 5 mm from the bubble. The other end of the fiber was centered in the entrance slit of the monochromator. Figure 1 shows the arrangement of the apparatus. The system spectral response was calibrated using a deuterium ( $D_2$ ) lamp in the shorter wavelengths (200–400 nm) and a tungsten-halogen (TH) lamp in the longer wavelengths (400–750 nm).

In order to test the amount of second-order interference effects in the spectrometer, a 400-nm-low-pass filter was used. No significant difference was recorded between the spectra taken with and without the filter and, therefore, no filters were used during the experiments. The reason for the absence of second-order effects may be that very little light is being detected below 225 nm. It should also be noted that the acceptance angle of the fiber was larger than that subtended by any radiating object used in the experiments. The full acceptance angle was 19°, as given by the manufacturer. It was thus assumed that the light gathered by the optic fiber was not dependent on the wavelength.

### C. Calibration of apparatus

The system wavelength resolution was determined by measuring the spectrum produced by a green helium-neon laser (543.5 nm) at 1-nm increments. The observed line full width at half maximum was approximately 7 nm. The calibration of the system spectral response and the absolute output power for the short-wavelength region was accomplished with the  $D_2$  lamp, which was supplied with a calibration curve in  $\mu\text{W}/\text{cm}^2 \text{ nm}$  at a distance of 50 cm from the source. To calibrate the apparatus under conditions similar to those during the actual measurements, a light chopper, with a frequency of 2000 Hz and a duty cycle of 50%, was positioned between the  $D_2$  lamp and the receiving fiber. In addition, two neutral density (ND) filters of densities 2 and 0.5 were used to lower the  $D_2$  lamp intensity to a level comparable to that of SL. This was necessary so that the output of the lock-in

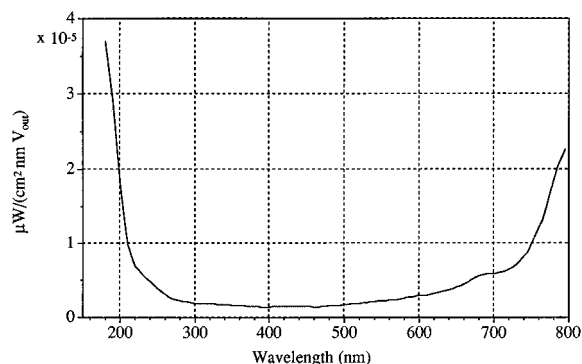

FIG. 2. Calibration curve for the spectrometer-optic fiber system in the range 200–700 nm.

amplifier could be calibrated at the same sensitivity and time constant settings as those used to record the SL spectrum. Matching the  $D_2$  lamp intensity to the SL intensity also eliminated any calibration errors due to fluorescence in the fiber.

The manufacturer's calibration curve that was supplied with the lamp served as the standard for calibrating the entire system, consisting of the lock-in, the fiber, and the spectrometer. The spectral dependence of the ND filters was measured separately (using the  $D_2$  lamp and the monochromator) and taken into account. This procedure yielded a calibration curve in which the Y axis had the units  $\mu\text{W}/(\text{cm}^2 \text{ nm } V_{\text{out}})$ . Here,  $V_{\text{out}}$ , the output voltage of the lock-in amplifier, is proportional to the number of photons detected in a particular wavelength bin per pulse, averaged over a large number of pulses.

The long-wavelength calibration (400–700 nm) was obtained using the TH lamp, but with a much simpler procedure. Measurements with the  $D_2$  lamp showed that the use of the chopper and lock-in introduced no wavelength-dependent effects. The relative system response in the 400–700-nm range was obtained simply by dividing the output of the monochromator by the calibration data supplied by the manufacturer. The error bars for this portion of the calibration are assumed to be 1%, the same as the manufacturer supplied data. This relative response then was scaled so that it matched the absolute response from the  $D_2$  lamp in intensity over the range 360–400 nm. The complete calibration curve, thus obtained, is shown in Fig. 2. Raw SL data were multiplied by this curve to obtain calibrated spectra. These calibration data do not include the effect of the absorption because of the liquid in which the SL spectrum was measured.

In order to determine the effect of light absorption in the liquid, the transmission of light through pure water, 25 and 40 vol % glycerin solutions was measured with a photospectrometer. The transmission was measured through a 1-cm sample of each liquid. Figure 3 shows the result of the photospectrometer measurement. For water, the absorption of UV light at 200 nm was small. For the 25 and 40 vol % glycerin solutions, however, the absorption of UV light below 250 nm was significant and was therefore considered when measuring the SL spectra. As will be seen in the results of the next section, the absorption spectrum of the media determines the short-wavelength limit of the SL spectral measurements.

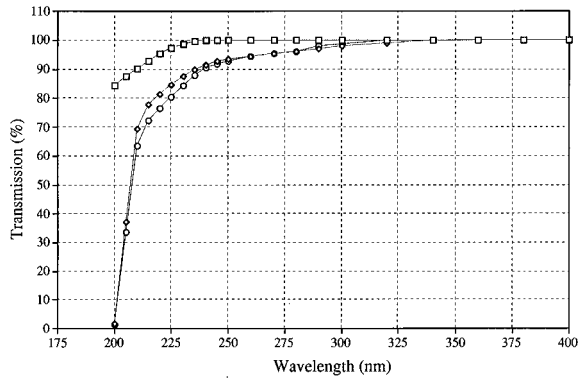

FIG. 3. Spectral transmission through 1 cm of water (squares), 25 vol % (diamonds), and 40 vol % glycerin solution (circles).

### III. RESULTS OF MEASUREMENTS AND INTERPRETATION

The scanning monochromator setup allowed us to measure the SL spectrum using essentially the same technique as reported in Ref. [7]. An example of a raw data set for SL produced in water is shown in Fig. 4. The data represent the average of seven individual spectra normalized to 1.0 at the maximum of each data set. The error bars correspond to the standard deviation of the seven data sets. The drive frequency was approximately 43 kHz.

The corrected SL spectrum for water is shown in Fig. 5 (circles) obtained from Figs. 2–4. The error bars are the uncorrelated combination of the error bars in the raw data and the error bars in the correction curve. The solid line is the SL spectrum for air bubbles in water reported by Hiller *et al.* [7]. Their spectrum was obtained for a bubble driven at approximately 27 kHz. The calibrated range for their data is from 240 to 620 nm. It is important to point out that these are absolute, not relative, spectra. Both spectra peak at nearly the same wavelength and both show approximately the same radiated intensity.

Figure 5 is given in  $\mu\text{W}/\text{nm}$  corresponding to the time average power radiated per unit wavelength interval. Since the data (circles) were taken at a distance of 0.5 cm, a factor of  $4\pi(0.5 \text{ cm})^2 = \pi \text{ cm}^2$  has been included. If the duration of the SL flash is assumed to be 50 ps, the power radiated

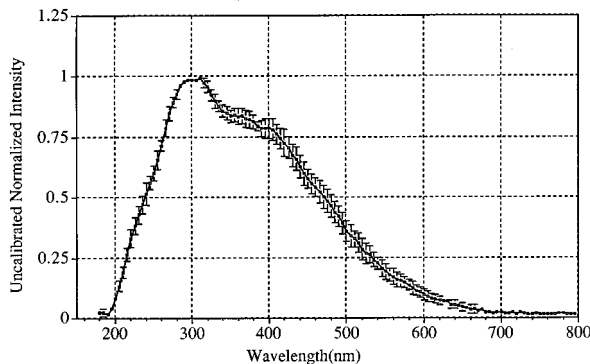

FIG. 4. Uncalibrated sonoluminescence spectrum for a single bubble in pure water. The data have been normalized to 1 and the error bars correspond to the standard deviation from seven runs. The bubble was driven at about 43 kHz.

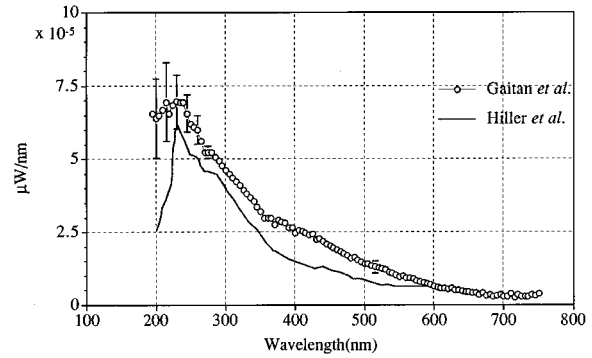

FIG. 5. Time-averaged power radiated per wavelength by a single sonoluminescing bubble in water (squares). The data have been corrected for the absorption of water as given by Fig. 3. The bubble was driven at about 43 kHz, emitting one pulse per acoustic cycle. The pressure amplitude was unknown. The solid line represents the results of Ref. [7].

during each flash can be calculated from

$$\text{power(per pulse)} = \text{power}_{\text{avg}} \times \left( \frac{\text{driving period} = 23.2 \mu\text{s}}{\text{pulse width} = 50 \text{ ps}} \right).$$

Integration over the whole observed spectrum gives a total radiated power during each flash equal to approximately 3 mW. The total energy per pulse is 0.2 pJ, which corresponds to about  $10^6$  photons emitted every pulse. The absolute intensity calibration has an accuracy of about 20%. It should be noted that the SL intensity can be enhanced by as much as a factor of 10 by increasing the sound field intensity and/or decreasing the liquid ambient temperature.

Figure 6 shows the measured spectra for water, 25 and 40 vol % glycerin mixtures after correction using Figs. 2 and 3. The most obvious difference is in the absolute intensities. In the case of water and the 25% mixture, the intensity is higher in the UV region for water, but lower in the visible region. This feature may account for the fact that SL intensity seems brighter to the eye when glycerin mixtures are used. Note, however, that a greater total SL energy is emitted by bubbles in water (due to the high-energy photons in the UV region). The much lower intensity of the spectrum of the 40% mixture could be due to the fact that the 500-ml flask used for

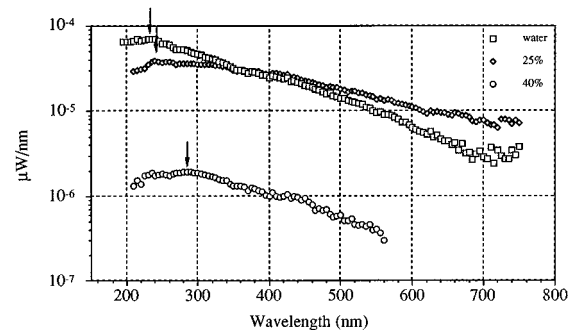

FIG. 6. Time-averaged sonoluminescence spectra for water (squares), 25 vol % glycerin (diamonds), and 40 vol % glycerin solution (circles). The data have been corrected for absorption as given by Fig. 3. The driving frequency was about 43 kHz for water, 46 kHz for 25% glycerin, and 52 kHz for 40% glycerin.

that measurement did not seem to sustain very stable bubbles. Although we have fairly good confidence in the overall shape of the 40% mixture spectrum (as indicated by the error bars), it may be possible to obtain greater intensities, and therefore better signal-to-noise ratios in different flasks.

Another major difference among these spectra is the apparent shift of the peak towards the visible region. However, the peaks are near the end of the calibration range where the uncertainty is the largest due to the low sensitivity of the instruments and the high optical absorption of the liquids. Note also the lack of any peaks in the spectra of the glycerin solutions due to molecular emission lines, which are expected from  $\text{CO}_2$ ,  $\text{CH}$ , and  $\text{OH}^9$ . The absence of these spectral lines may be an indication that the mechanism for light production in single-bubble SL is different from multibubble (transient) SL, such as that studied in Ref. [9]. Similar results have been obtained by Matula *et al.* [10] when they used a 0.1M sodium chloride solution.

Although the nature of the SL radiation mechanism is unknown, a useful means of characterizing the spectrum is to fit it to a blackbody spectrum. The fit to the spectrum radiated by a blackbody is indicated by the dashed line in Fig. 7. The fit is especially good for wavelengths greater than approximately 250 nm. There are two fitting parameters involved. One corresponds to the absolute temperature of the radiator, the other to the product of the surface area of the radiator and the duty cycle of the emission. The best-fit temperature for our water spectrum is 16 200 K and has a radius of about  $1 \mu\text{m}$ . Hiller *et al.* found the best-fit temperature for their data to be 25 000 K. The effective blackbody temperatures of both glycerin spectra are approximately 10 000 K significantly less than for the water data.

#### IV. SUMMARY

We have measured the spectrum of SL using a scanning monochromator technique in glycerin-water mixtures having

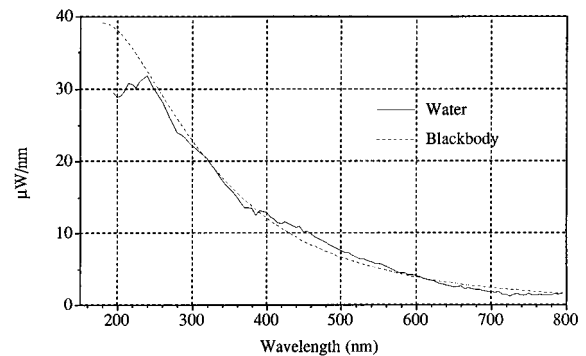

FIG. 7. Comparison between sonoluminescence spectrum for water corrected for absorption (solid line) and fit to a blackbody spectrum (dashed line). The vertical axis for the SL data corresponds to the intensity during a single flash. The radius of the blackbody is approximately  $1 \mu\text{m}$ .

0%, 25%, and 40% glycerin concentrations. The main conclusions are: our spectrum for air bubbles in water is similar to that reported by others [7,10]; expected emission lines from glycerin are not observed; the radiated energy decreases as the glycerin concentration increases; the peak of the spectrum appears to shift to longer wavelengths for the glycerin data, indicating that the bubble is effectively cooler; and the fitted temperatures using a blackbody model of both glycerin spectra are approximately 10 000 K, significantly less than for water with no glycerin.

#### ACKNOWLEDGMENTS

This work was supported in part by the Office of Naval Research, the Defense Nuclear Agency, and the Naval Postgraduate School Research Program. The authors wish to thank David Cleary for the use of the scanning monochromator and D. Scott Davis for many helpful discussions.

- 
- [1] D. F. Gaitan, L. A. Crum, C. C. Church, and R. A. Roy, *J. Acoust. Soc. Am.* **91**, 3180 (1992).
  - [2] B. P. Barber and S. J. Putterman, *Nature* **352**, 318 (1991).
  - [3] B. P. Barber, R. Hiller, K. Arisaka, H. Fetterman, and S. J. Putterman, *J. Acoust. Soc. Am.* **91**, 3061 (1992).
  - [4] William C. Moss, Douglas B. Clarke, John W. White, and D. A. Young, *Phys. Fluids* **6**, 2979 (1994).
  - [5] C. C. Wu and Paul H. Roberts, *Phys. Rev. Lett.* **70**, 3424 (1993).
  - [6] J. Schwinger, *Proc. Natl. Acad. Sci. U.S.A.* **90**, 2105 (1993); R. Hickling, *Phys. Rev. Lett.* **73**, 2853 (1994); L. Frommhold and A. A. Atchley, *ibid.* **73**, 2883 (1994).
  - [7] R. Hiller, S. J. Putterman, and B. P. Barber, *Phys. Rev. Lett.* **69**, 1182 (1992).
  - [8] S. D. Lewia, M.S. thesis, Naval Postgraduate School, 1992 (unpublished).
  - [9] E. B. Flint and K. S. Suslick, *J. Am. Chem. Soc.* **111**, 6987 (1989).
  - [10] T. J. Matula, R. A. Roy, P. D. Mourad, W. B. McNamara III, and K. S. Suslick, *Phys. Rev. Lett.* **75**, 2602 (1995).