



1998-09-15

# The Military Applications of MEO and ICO Commercial Satellite Systems

Kakavas, Ioannis

Monterey, California. Naval Postgraduate School

---

<http://hdl.handle.net/10945/15310>



Calhoun is a project of the Dudley Knox Library at NPS, furthering the precepts and goals of open government and government transparency. All information contained herein has been approved for release by the NPS Public Affairs Officer.

**Dudley Knox Library / Naval Postgraduate School**  
**411 Dyer Road / 1 University Circle**  
**Monterey, California USA 93943**

<http://www.nps.edu/library>

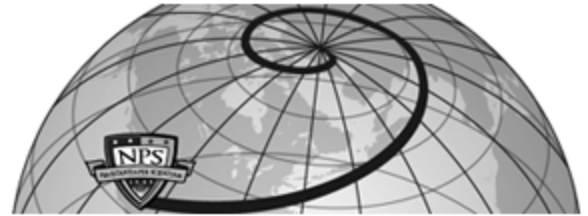

Author(s)	Kakavas, I.; Ha, T. T.; Garcia, V.
Title	The military applications of MEO and ICO commercial satellite systems
Publisher	Monterey, California. Naval Postgraduate School
Issue Date	1998-09-15
URL	<a href="http://hdl.handle.net/10945/15310">http://hdl.handle.net/10945/15310</a>

This document was downloaded on March 15, 2013 at 08:56:36



Calhoun is a project of the Dudley Knox Library at NPS, furthering the precepts and goals of open government and government transparency. All information contained herein has been approved for release by the NPS Public Affairs Officer.

**Dudley Knox Library / Naval Postgraduate School**  
411 Dyer Road / 1 University Circle  
Monterey, California USA 93943

<http://www.nps.edu/library>



<http://www.nps.edu/>

NPS-EC -98-014

# NAVAL POSTGRADUATE SCHOOL Monterey, California



## The Military Applications of MEO and ICO Commercial Satellite Systems

by

I. Kakavas  
T. T. Ha  
V. Garcia

September 15, 1998

19981113 044

Approved for public release; distribution is unlimited.

Prepared for: The Institute for Joint Warfare Analysis

NAVAL POSTGRADUATE SCHOOL  
Monterey, California

RADM ROBERT C. CHAPLIN  
Superintendent

R. Elster  
Provost

This report was sponsored by the Institute for Joint Warfare Analysis.

Approved for public release; distribution is unlimited.

The report was prepared by:



TRI T. HA  
Professor  
Department of Electrical and  
Computer Engineering



VICENTE GARCIA  
NSA Chair and Visiting Assoc. Prof.  
Department of Electrical and  
Computer Engineering

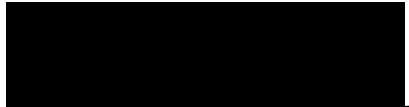

IOANNIS KAKAVAS  
Information and Electronic Warfare  
Academic Group

Reviewed by:

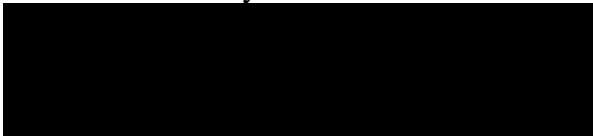

JEFFREY B. KNORR  
Chairman  
Department of Electrical and  
Computer Engineering

Released by:

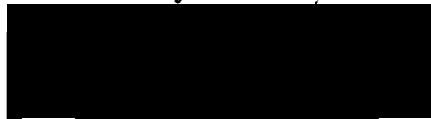

DAVID W. NETZER  
Associate Provost and  
Dean of Research

# REPORT DOCUMENTATION PAGE

Form Approved  
OMB No. 0704-0188

Public reporting burden for the collection of information is estimated to average 1 hour per response, including the time for reviewing instructions, searching existing data sources, gathering and maintaining the data needed, and completing and reviewing the collection of information. Send comments regarding this burden estimate or any other aspect of this collection of information, including suggestions for reducing this burden to Washington Headquarters Services, Directorate for Information Operations and Reports, 1215 Jefferson Davis Highway, Suite 1204, Arlington VA 22202-4302, and to the Office of Management and Budget, Paperwork Reduction Project (0704-0188), Washington DC 20503.

1. AGENCY USE ONLY (Leave blank)		2. REPORT DATE September 15, 1998		3. REPORT TYPE AND DATES COVERED Final Report	
4. TITLE AND SUBTITLE The Military Applications of MEO and ICO Commercial Satellite Systems			5. FUNDING NUMBERS NO 003998WRDD181		
6. AUTHOR(S) I. Kakavas, T.T. Ha, and V. Garcia					
7. PERFORMING ORGANIZATION NAME(S) AND ADDRESS(ES) Department of Electrical and Computer Engineering Naval Postgraduate School Monterey, CA 93943-5000			8. PERFORMING ORGANIZATION REPORT NUMBER  NPS-EC-98-014		
9. SPONSORING/MONITORING AGENCY NAME(S) AND ADDRESS(ES) The Institute for Joint Warfare Analysis Naval Postgraduate School, Monterey, CA 93943			10. SPONSORING/MONITORING AGENCY REPORT NUMBER		
11. SUPPLEMENTARY NOTES The views expressed in this report are those of the author and do not reflect the official policy or position of the Department of Defense or the United States Government.					
12a. DISTRIBUTION/AVAILABILITY STATEMENT Approved for public release; distribution is unlimited.			12b. DISTRIBUTION CODE  A		
13. ABSTRACT (Maximum 200 words) At the dawn of the 21st century several low and medium earth orbit commercial satellite constellations will be operational and they will be able to provide high bandwidth global communications in voice, data, and multimedia services for mobile consumers and also "users in the move." This research evolves as a continuation of previous studies (on Iridium, Globalstar, Teledesic, and Odyssey), and considers the ICO as well as the Teledesic and GBS systems in an effort to provide a comprehensive model architecture. This model accommodates narrowband, wideband, and broadcast requirements, respectively, of the U.S. MILSATCOM in addition to the communication needs of a model UN peacekeeping mission. The application of these systems to U.S. MILSATCOM coincides perfectly with the U.S. defense doctrine of a CONUS-based military with the capability of rapid global power projection to respond to crises throughout the global arena. Instead of investing heavily in new satellite systems, the U.S. military services can use the forthcoming commercial LEO and MEO systems to meet the information requirements of tactical commanders.					
14. SUBJECT TERMS Satellite communications, mobile satellite systems, personal communications services, low/medium earth orbit satellite systems, intermediate circular orbit, global broadcast service				15. NUMBER OF PAGES 140 140	
				16. PRICE CODE	
17. SECURITY CLASSIFICATION OF REPORT UNCLASSIFIED	18. SECURITY CLASSIFICATION OF THIS PAGE UNCLASSIFIED	19. SECURITY CLASSIFICATION OF ABSTRACT UNCLASSIFIED	20. LIMITATION OF ABSTRACT SAR		

## TABLE OF CONTENTS

I.	INTRODUCTION .....	1
	A. BACKGROUND AND OVERVIEW OF THESIS .....	1
	B. CATEGORIES .....	3
	1. Low Earth Orbit Satellite Systems .....	4
	a. “Little” LEOs .....	4
	b. “Big” LEOs .....	4
	c. “Super” LEOs .....	4
	2. Medium Earth Orbit Satellite Systems .....	5
	3. Geostationary Earth Orbit Satellite Systems .....	5
	C. THE COMMERCIAL GLOBAL GRID .....	6
	D. REGULATORY SITUATION FOR LEOs/MEOs .....	8
	E. INTERFERENCE AND FADING IN LEO/MEO SYSTEMS .....	10
	1. Self Interference in LEO/MEO Satellite Systems .....	10
	2. Rain Attenuation in LEO/MEO Satellite Systems .....	11
	3. Fading in LEO/MEO Satellite Systems .....	12
	F. COMPARISON OF LEO/MEO VERSUS GEO .....	13
II.	ICO GLOBAL COMMUNICATIONS .....	15
	A. INTRODUCTION .....	15
	B. MARKETS AND PROPOSED SERVICES .....	15
	C. SYSTEM DESCRIPTION .....	18
	1. The Space Segment .....	18
	a. Satellite Constellation .....	18
	b. Satellite Technology and Frequency Management .....	20
	2. The Ground Segment .....	25
	a. The ICONET .....	25
	b. Telemetry Tracking and Command (TT&C) .....	25
	c. Gateways and Terrestrial Networks .....	<b>28</b>
	d. ICO-Net User Mobility Management .....	28
	3. The User Segment .....	29

D.	SUMMARY .....	31
III.	US MILSATCOM, REQUIREMENTS' MISSIONS' TRENDS .....	33
A.	HISTORICAL OVERVIEW .....	33
B.	SERVICES. MISSIONS' REQUIRED FEATURES .....	34
1.	Services Provided by MILSATCOM .....	34
2.	SATCOM Support to Naval Missions .....	35
3.	Required Features of MILSATCOM .....	37
C.	CURRENT AND NEAR TERM MILSATCOM SYTSEMS .....	38
1.	Narrowband SATCOM .....	41
2.	Wideband SATCOM .....	43
3.	Broadcast SATCOM .....	45
D.	SUMMARY .....	46
IV.	GLOBAL BROADCAST SERVICE .....	47
A.	INTRODUCTION AND BACKGROUND .....	47
B.	SYSTEM DESCRIPTION AND IMPLEMENTATION .....	49
1.	Phase I or Limited Demonstration Phase .....	49
2.	Phase II or Interim Military Capability Phase .....	52
a.	Phase II Space Segment .....	54
b.	Phase II Broadcast Management Segment .....	56
c.	Phase II Terrestrial Communications Segment .....	56
d.	Phase II Terminal Segment .....	56
3.	Phase III or Objective Phase .....	57
C.	SUMMARY .....	58
V.	THE COMMERCIAL ALTERNATIVE .....	59
A.	INTRODUCTION .....	59
B.	ISSUES/CRITERIA ASSOCIATED WITH COMERSAT USE IN MILITARY APPLICATIONS .....	60
1.	Systems Availability .....	60
2.	Capacity/Grade of Service .....	61
3.	Interoperability .....	61

4.	Vulnerability/ Anti-Jam Protection .....	62
5.	Security .....	62
6.	LPI/LPD .....	63
7.	Coverage .....	64
8.	Conference Service Limitations .....	65
9.	Terminal and Service Costs .....	65
10.	Mobility .....	66
11.	Flexibility .....	66
12.	Signal Quality .....	67
13.	Systems Control .....	67
C.	MILSATCOM FUNCTIONS FOR COMMERCIAL MSS APPLICATIONS .....	68
D.	COMERSAT ALTERNATIVE MODEL ARCHITECTURE .....	72
1.	The "ITG" Model Architecture Concept of Operations .....	72
a.	Narrowband "ITG" .....	74
b.	Wideband "ITG" .....	74
c.	Broadcast "ITG" .....	75
2.	The "ITG" Space Segment .....	75
3.	The "ITG" Ground Segment .....	76
4.	The "ITG" User Segment .....	79
E.	SUMMARY .....	79
VI.	APPLICATION TO US ARMED FORCES SATCOM .....	81
A.	INTRODUCTION .....	81
B.	ORGANIZATION OF NAVAL FORCES .....	82
1.	Definitions .....	82
2.	Communications Infrastructure .....	84
a.	Types of Required Services .....	84
b.	Data Rates .....	85
c.	Protection .....	85
d.	Topology and Coverage .....	86
C.	"COMBAT CAPABLE" NAVAL FORCE SATCOM LINKS .....	87
D.	SUMMARY .....	95
VII.	APPLICATION TO UN PEACEKEEPING .....	97



A.	INTRODUCTION AND HISTORICAL OVERVIEW .....	97
B.	UNMIH COMMUNICATIONS PLAN OVERVIEW .....	98
	1. Assumptions .....	98
	2. Responsibilities. Communications Services <b>and</b> Networks .....	100
	a. Static Communications Network .....	101
	b. Mobile Communications Network .....	104
C.	UN PEACEKEEPING WITH THE "ITG" MODEL .....	107
	1. "ITG" Communications Network for UN Peacekeeping .....	108
	a. External Communications .....	109
	b. Internal Communications .....	110
D.	SUMMARY .....	112
VIII.	CONCLUSIONS AND RECOMMENDATIONS.....	113
	LIST OF REFERENCES .....	117
	INITIAL DISTRIBUTION LIST .....	121

## LIST OF FIGURES

Figure 1.1: Satellite Altitudes vs. Time Delay .....	3
Figure1.2: Evolution in the Size of Terminal Equipment.....	7
Figure1.3: Generic Transmission Network .....	10
Figure2.1: The ICO System Overview.....	17
Figure2.2: The ICO Satellite Constellation.....	18
Figure 2.3: Instantaneous View of ICO System Coverage .....	19
Figure 2.4: The ICO Satellite .....	20
Figure 2.5: Service Coverage of one ICO Satellite.....	21
Figure 2.6: The ICO Network .....	26
Figure 3.1: Overview of Current US MILSATCOM Systems .....	39
Figure 3.2: Naval Telecommunications System's NCTAMS & NAVCOMSTA and Covered Areas Worldwide .....	40
Figure 3.3: The Narrowband SATCOM.....	41
Figure 3.4: Anti-jam Capability of MILSTAR Transponder .....	42
Figure 3.5: The Wideband SATCOM .....	43
Figure 3.6: US Navy DSCS Connectivity and Capabilities .....	44
Figure 3.7: The Broadcast SATCOM .....	45
Figure 4.1: GBS Concept of Operations.....	48
Figure 4.2: Bosnia C <sup>2</sup> Augmentation System.....	51
Figure 4.3: The GBS on UFO(Phase 11)Configuration.....	53
Figure 4.4: The GBSNFO Satellite .....	54
Figure 4.5: The GBS/UFO (Phase 11) Coverage .....	55
Figure 4.6: The GBS Phase III Conceptual Coverage .....	58
Figure 5.1: The "ITG" Model Architecture Concept of Operations .....	73
Figure 5.2: The "TTG" Flow of Information Diagram .....	77

Figure 6.1: MEU(SOC) Organization Components .....	83
Figure 6.2: Network Topologies of a “Combat Capable” Naval Force .....	86
Figure 6.3: Types of Coverage for a “Combat Capable Naval Force” .....	87
Figure 6.4: CVBG Circuit Requirements.....	88
Figure 6.5: ARG Circuit Requirements.....	89
Figure 6.6: MEU Circuit Requirements.....	90
Figure 7.1: The UN Mission Static Communications Network.....	101
Figure 7.3: UNMIH Headquarters Satellite Hub Earth Station.....	102
Figure 7.3: Battalion Headquarters Satellite Node Earth Station .....	103
Figure 7.4: UNMIH Repeater Site Configuration .....	106
Figure 7.5: The “ITG” Communications Network for UN Peacekeeping .....	108

## LIST OF TABLES

Table 2.1: ICO System Link Analysis Parameters .....	22
Table 2.2: ICO Forward Link Analysis Calculation .....	23
Table 2.3: ICO Return Link Analysis Calculation .....	24
Table 2.4: The ICO SAN Locations .....	27
Table 2.5: Parameters of the ICO Pocket Phone .....	30
Table 3.1: The Major Naval Missions to be Supported by MILSATCOM .....	36
Table 5.1: Satellite Coverage of Commercial MSS .....	64
Table 5.2: Terminal and Service Costs of Commercial MSS .....	66
Table 5.3: Signal Quality Features of Commercial MSS .....	67
Table 6.1: Data Rates of Naval Forces Communications .....	85
Table 6.2: "Combat Capable" Naval Force Total Circuit Requirements .....	91
Table 6.3: Naval Force Voice Links Supported by the "ITG" Model .....	92
Table 6.4: Naval Force Data Links Supported by the "ITG" Model .....	93
Table 6.5: Naval Force Video Links Supported by the "ITG" Model .....	94
Table 7.1: UN Peacekeeping Mission Components and Communication Services.....	100
Table 7.2: UNIMIH Satellite System Technical Characteristics .....	104



## LIST OF SYMBOLS, ACRONYMS AND/OR ABBREVIATIONS

A.....	
AAW	Anti-Air-Warfare
AAWC&R	Anti-Air Warfare Contact & Reporting
ACE	Aviation Combat Element
AMPS	Advanced Mobile Phone Service
AOE	Fast Combat Logistics Support Ship
AOR	Replenishment Oiler Ship, Atlantic Ocean Relay
ARPA	Advanced Research Projects Agency
ARG	Amphibious Ready Group
ART	Airborne Receive Terminal
ASW	Anti-Submarine Warfare
ASWC&R	Anti-Submarine Warfare Contact & Reporting
ASUW	Anti-Surface Warfare
ASUWC&R	Anti-Surface Warfare Contact & Reporting
ATO	Air Tasking Orders
B.....	
BER	Bit Error Rate
BG	Battle Group
BGIXS	Battle Group Information Exchange System
BMC	Broadcast Management Center
Bn	Battalion
C.....	
CATF/G	Commander Amphibious Task Force/Group
C <sup>2</sup>	Command Control
C <sup>2</sup> W C&R	C <sup>2</sup> Warfare Command & Report
C <sup>3</sup>	Command Control Communications
C4I	Command Control Communications Computers and Intelligence
CDMA	Code Division Multiple Access
CCO	Chief Communications Officer
CO	Command Element
CES	Coastal Earth Stations
CG	Guided Missile Cruiser
CIA	Central Intelligence Agency
CINC	Commander IN Chief
CLF	Commander Landing Force
COMERSAT	Commercial Satellite
ComNavFor	Commander Naval Force
CONOPS	Concept of Operations
CONUS	Continental United States

C&R	Coordination and Reporting
CJTF	Commander Joint Task Force
CUDIXS	Common User Digital Information Exchange System
CV	Multi-purpose Aircraft Carrier
CVBG	Carrier Battle Group
D.....	
DAMA	Demand Assignment Multiple Access
DANDVT	Dual Advanced Narrowband Digital Voice Terminal
D-AMPS	Digital AMPS
DBS	Direct Broadcast Service
DD	Destroyer
DDG	guided missile destroyer
DEA	Drug Enforcement Agency
DII	Defense Information Infrastructure
DISA	Defense Information Systems Agency
DISN	Defense Information System Network
DMS	Defense Messaging System
DoD	Department of Defence
DSCS	Defence Satellite Communications System
DSNET	Defense Secure Network
E.....	
EAC	Echelons Above Corps
EHF	Extremely High Frequency
EU	European Union
EUCOM	European Command
F.....	
FEDSIM	Federal Systems Integration and Management
FFG	Guided Missile Frigate
FIST	Fleet Imagery Support Terminal
FLTBCST	Fleet Satellite Broadcast
FLTCTADIXS	Fleet Core Tactical Data Information Exchange System
FLTGTADIXS	Fleet General Purpose TADIXS
FLTSAT	Fleet Satellite
FOTC	Force Over-the-Horizon Target Coordinator
FOV	Field Of View
FSS	Fixed Satellite Systems
FSO	Force Signals Officer
G.....	
GEO	Geostationary Earth Orbit
GBC	Global Broadcast Coordinator
GBS	Global Broadcast Service
GCCS	Global Command and Control System
GCE	Ground Combat Element

GRT	Ground Receive Terminal
GSM	Global System for Mobile communications
H.....	
HDR	High Data Rate
HLR	Home Location Register
HPN	High Penetration Notification
HSFB	High Speed Fleet Broadcast
Hq	Headquarters
I.....	
IFOV	Instantaneous Field Of View
ICO	Intermediate Circular Orbit
ICOGC	ICO Global Communications
IMC	Information Management Center
INMARSAT	International Maritime Satellite organisation
INTELSAT	International Telecommunications Satellite organisation
IW	Information Warfare
J.....	
JBS	Joint Broadcast Service
JFACC	Joint Force <i>Air</i> Component Commander
JIMC	Joint Information Management Center
JMCIS	Joint Maritime Command Information System
JSIPS-NIS	Joint Service Imagery Processing System-National Input Segment
JWCS	Joint Worldwide Intelligence Communications System
L.....	
LDR	Low Data Rate
LEO	Low Earth Orbit
LHA	Amphibious Assault ship general
LHD	Amphibious Assault ship multipurpose
LPH	Amphibious assault ship with Helicopters
LIC	Low Intensity Conflict
LMDS	Local Multipoint Distribution System
LNB	Low Noise Block
LOS	Line Of Sight
LPD	Low Probability of Detection
LPI	Low Probability of Intercept
LSD	Dock Landing Ship
M.....	
MAGTF	Marine Air-Ground Task Force
MARCEMP	Manual Relay Center Modernization Program
MEO	Medium Earth Orbit
MEU	Marine Expeditionary Unit
MCS	Minewarfare Control Ship
MCH	Mine Hunter ship
MCM	Mine Countermeasures ship
MDR	Medium Data Rate



MDU	Mission Data Updates
MICIVIH	Mission Civil in Haiti
MILSATCOM	Military Satellite Communications
MILSTAR	Military Strategic and Tactical Relay satellite
MISSI	Multilevel Information Systems Security Initiative
MRC	Major Regional Contingency
MSS	Mobile Satellite Systems
MSSG	MEU Service Support Group
MSSC	Mobile Satellite Switching Center
MWR	Moral Welfare and Recreation
N.....	
NAVCOMSTA	Naval Communications Station
NCTAMS	Naval Computer & Telecommunications Area Master Station
N-ISDN	Navy Integrated Switched Digital Network
N-ISDNMP	Navy ISDN Man-pack
NKMS	Navy Key Management System
NM	Nautical Mile
NSA	National Security Agency
NTS	Naval Telecommunications System
O.....	
OTCIXS	Officer-in-Tactical Command Information Exchange System
P. ....	
PABX	Private Automatic Branch Exchange
PCS	Personal Communication Services
PCMCIA	Personal Computer Memory Card International Association
PDC	Personal Digital Cellular
PIP	Primary Injection Points
PLMN	Public Land Mobile Network
POTS	Plain Old Telephone System
PSDN	Public Switched Digital Network
PSTN	Public Switched Telephone Network
PTT	Push-To-Talk
Q.....	
QPSK	Quadrature Phase <b>Shift</b> Keying
R. ....	
RDSS	Radio Determination Satellite System
RHCP	Right Hand Circularly Polarized
RBM	Receive Broadcast Management
S.....	
SALTS	Streamlined Automatic Logistics System
SAN	Satellite Access Node
SATHICOM	Satellite High Command Net
SES	Ship Earth Station
STel	Secure Telephone
SCC	Satellite Control Center

SHF	Super High Frequency
SIGINT	Signals Intelligence
SLEP	Service Life Enhancement Program
SMS	Short Message Service
SO	Special Operations
SOC	Special Operations Capability
S-PCN	Satellite Personal Communications Network
SRT	Shipboard Receive Terminal
SSIXS	Submarine Satellite Information Exchange Subsystems
SSN	Nuclear Submarines
SSPA	Solid-state Power Amplifier
SSRT	Sub-Surface Receive Terminal
S-TADIL	Satellite Tactical Data Link
STU	Secure Telephone Unit
T .....	
TACSAT	Tactical Satellite
TADIXS	Tactical Data Information Exchange Subsystem
TBM	Transmit Broadcast Management
TDDS	Tactical Data Dissemination System
TDMA	Time Division Multiple Access
TDM	Time Division Multiplexed
U .....	
UAV	Unmanned Aerial Vehicle
UFO	UHF Follow-On
UHF	Ultra High Frequency
UN	United Nations
UNMIH	United Nations Mission In Haiti
USA	United States of America
US	United States (of America)
USFORHAITI	US Forces Haiti
V .....	
VIXS	Video Information Exchange System
VLR	Visitor Location Register
VTC	Video-Tele-Conferencing
VVFDT	Voice, Video, Facsimile, Data Terminal
W .....	
WARC	World Administrative Radio Conference
WWMCCS	Worldwide Military C <sup>2</sup> System



# I. INTRODUCTION

## A. BACKGROUND AND OVERVIEW OF REPORT

Over the last three decades Military Satellite Communications (MILSATCOM) have become a vital element in the support of several Strategic and Tactical missions primarily of the U.S. Armed Forces and also of the Armed Forces of other countries [Ref. 13]. The great importance of having reliable, uninterrupted, and high capacity communications has been and will always be one of the main concerns of every Military Commander in peace and in war. This issue becomes more significant in the case of the United States which as the only current Global Power, requires daily, effective communication with all their ships, units and military assets everywhere on, under and above the Earth. Thus MILSATCOM is the only solution to the previously stated task.

At present the vast majority of the needs of U.S. MILSATCOM are accommodated by Geostationary Earth Orbit Satellites (GEO). The systems that we are going to review in detail in chapter 4 are going to need replenishment efforts during the first decade of the 21<sup>st</sup> century. At the same timeframe several commercial Mobile Satellite Systems (MSS) supported by Low Earth Orbit (LEO) and Medium Earth Orbit (MEO) satellite constellations [Ref. 2] are going to be operational and provide Personal Communication Services (PCS) to a market of “mobile users” and “users on the move” around the Globe. It is the objective of this report to produce a model that will be capable of accommodating the less critical needs and requirements of the U.S. MILSATCOM by utilising the services provided by the currently proposed commercial LEO and MEO systems. The use of these systems by U.S. MILSATCOM fits perfectly under the U.S. defence doctrine of a CONUS-based military with capability of rapid global power projection to respond to crises anywhere in the world [Ref. 1].

The first chapter of this report is the introductory part. Whereas it offers the reader the background, definitions of LEO, MEO, GEO systems architectures, introduces the “Global Grid Concept” and gives some information about the USA regulatory situation. It also takes into account information on self interference, rain attenuation and fading of LEO and MEO systems. Finally it summarises the advantages and disadvantages of each category compared with the other two and tries to answer to the question : “Why LEO/MEO and not GEO for the military applications?, .

The characteristics and description of Intermediate Circular Orbit (ICO) Global Communications satellite system are given in the second chapter.

The third chapter provides a broader description of U.S. MILSATCOM today and the MILSATCOM trends into the 21<sup>st</sup> century. It presents the MILSATCOM missions and performance requirements as well as the “future army” war-fighting doctrine. Finally the list of threats and counter threat techniques for MILSATCOM is given. The fourth chapter examines separately the broadcast part of MILSATCOM by providing the characteristics and description of Global Broadcast Service (GBS) satellite system.

The fifth chapter introduces the need of additional commercial SATCOM in order to accommodate future needs. It examines the perceived issues/criteria associated with COMERSAT as they are applied to military communications as well as areas in which commercial systems can be valuable. Moreover it displays the “complete” picture, by performing a comparison of commercial LEO, MEO systems under investigation . Finally provides the commercial alternative model architecture to MILSATCOM, which is a combination of these systems that possess the more favorable characteristics for military applications in support of land-sea-air operations.

The sixth chapter provides the application of the proposed model architecture in US MILSATCOM and particularly to a “Combat Capable” Naval Force comprised by CVBG, ARG, MEU, so as to fulfill the circuit requirements described by the US Naval Space Command functional requirements document.

The seventh chapter provides a model United Nations (UN) Peacekeeping Operation communications plan so as to fulfill the channel requirements described by the UN Mission in Haiti Communications plan. Finally the eighth chapter provides the conclusions and recommendations of this research.

**B. CATEGORIES**

The orbital altitudes of the satellite constellations is the measure which is used to divide them into three main categories. This is a characteristic which affects the propagation time delay of the transmitted and received signal. Figure 1.1 displays the idea of LEO, MEO and GEO satellite altitudes vs. the time delay [Ref. 3] which is calculated from the formula  $t_d = (2 \times d) / c$  where d is the altitude of the satellite orbit and  $c = 3 \times 10^8$  m/s.

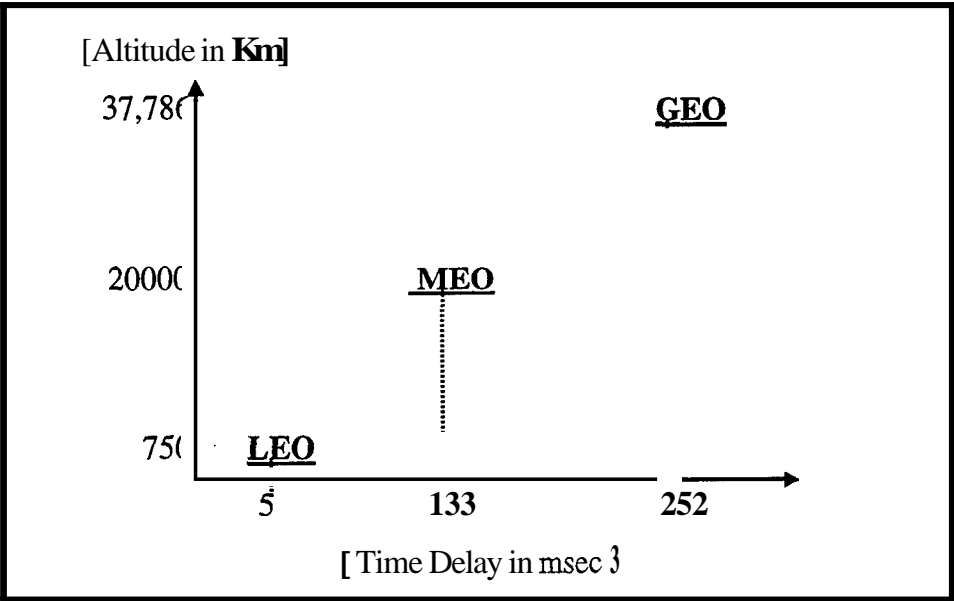

Figure 1.1 Satellite Altitudes vs. Time Delay. “After Ref. [2].”

## 1. Low Earth Orbit Satellite Systems (LEO)

The LEO satellites are orbiting the Earth in altitudes which vary from 500 to 2000 kilometres. The low altitude of the LEO systems gives them advantages and disadvantages compared with the other systems. The advantages are [Ref. 2, Ref. 4, Ref. 5] :

- Minimal propagation time delay between stations because low orbit is closer to the Earth surface than any other orbit.
- Minimal power requirements for satellites and ground terminals therefore smaller antenna dimensions.
- Simplicity and small dimensions of satellites used.
- Moderate cost and complexity of launching vehicles.

The LEO systems are further divided according to their signal frequency into “little”, “big” and “super” LEOs [Ref. 15].

### *a. “Little” LEOs*

They operate at frequencies below 1 GHz and are mainly used for store and-forward messaging services without voice capability.

### *b. “Big” LEOs*

They operate in L band at frequencies from 1.6GHz up to 2.5 GHz and provide full range of telephony based services (voice, data and facsimile) [Ref. 6].

### *c. “Super” LEOs*

They operate in Ka band at frequencies from 20 GHz up to 30 GHz.

A disadvantage of the LEO systems is that the individual LEO spacecraft only flies across the service area for some tens of minutes a few times a day. Therefore real time service is possible only if a complete constellation of LEOs is operational so as to have at least one satellite visible 100% of the time [Ref. 5] either by phased satellite spacing or by predetermined latitude coverage.

From all the above the conclusion is that portable, palmtop, low power and light-weight terminals can be used in order to provide personal communication services (PCS) by utilising the LEO satellite systems [Ref. 2] provided a large number of satellites are available in order to acquire global coverage.

## **2. Medium Earth Orbit Satellite Systems (MEO)**

The MEO satellites are orbiting the Earth at altitudes from 10,000 to **20,000** kilometres. **This** requires a smaller number of satellites for global coverage than the LEOs. The trade-off in altitude versus propagation delay time in which their performance is less than that of the LEOs. They are the intermediate step between **LEO** and GEO not only in altitude of deployment but also in the aspects of power requirements, antenna gain, and required number of satellites for global coverage [Ref. 2]. The Intermediate Circular Orbit Global Communications (ICOGC) system is a MEO satellite system which will be described in the following chapter and becomes an important element in the proposed model in Chapter V.

## **3. Geostationary Earth Orbit Satellite Systems (GEO)**

The GEO satellites orbit the earth at an altitude of **35,786** kilometres [Ref. 7]. At the geostationary orbit the satellite is synchronised with the rotation of the earth and rotates in the same direction. In commercial systems this orbit is circular on the equatorial plane. This orbit is unique because the satellite maintains exactly the same field of view above the earth's surface twenty four hours a day [Ref. 5]. It provides the GEO systems the following advantages:

- Theoretically three, and in practice four satellites, are enough for global coverage therefore the number of required satellites is minimised [Ref. 2].
- Both the up-link and down-link beams are virtually motionless therefore offer simplification of design and operating requirements of antennas both for the ground and space segment of the system [Ref. 5] .

On the other hand the GEO systems have the following disadvantages compared with the MEOs and LEOs:

- Increased requirements concerning the size of the satellite launching vehicles as well as their launching capability [Ref. 5].
- Bigger fuel consumption for placing and also maintaining the satellite in orbit .
- Maximum propagation delay due to the high altitude of the orbit.



- Very poor coverage of high latitudes because their orbit is above the earth equator.
- High power requirements for satellite transponders [Ref. 2].
- High gain requirements for earth station antennas [Ref. 2].
- The geostationary slot availability decreases as time passes from a combination of two reasons: First due to the uniqueness of the geostationary orbit and second due to the large number of existing systems. Therefore it becomes more difficult for a GEO to obtain a desirable location [Ref. 5].

### **C. THE COMMERCIAL GLOBAL GRID**

The idea of a communications connection to anywhere at anytime is a primary concern of a global military power as the USA is today. The rapid growth of communications capabilities will lead into an interconnection of all major commercial communication assets in a world-wide manner [Ref. 8]. This is going to be realised by interconnecting the “terrestrial” and “orbital”, grids into one which is going to be referred as the “global grid”.

The first grid consists of the classic copper and/or fiber-optic lines networks and cellular systems. The second grid consists of, at present, International Maritime Satellite organisation (INMARSAT) and International Telecommunications Satellite organisation (INTELSAT) [Ref. 8] which will be augmented in the very near future by LEO and MEO systems which are expected to be fully operational during the next two to five years. These systems, some of which have been presented in Reference 2, are incorporated with tremendous potential and capabilities in the areas of data rate, variety of provided services, connectivity and standards. The contribution of LEO/MEO systems in the construction of a virtual “commercial global communications grid”, is going to be of vital importance. These systems will offer the advantages of global coverage, extreme mobility and world-wide networking capability [Ref. 8], by the use of small handheld terminals, to a large number of

“mobile users” and “users on the move”. The evolution in the size of terminal equipment is shown in Figure 1.2.

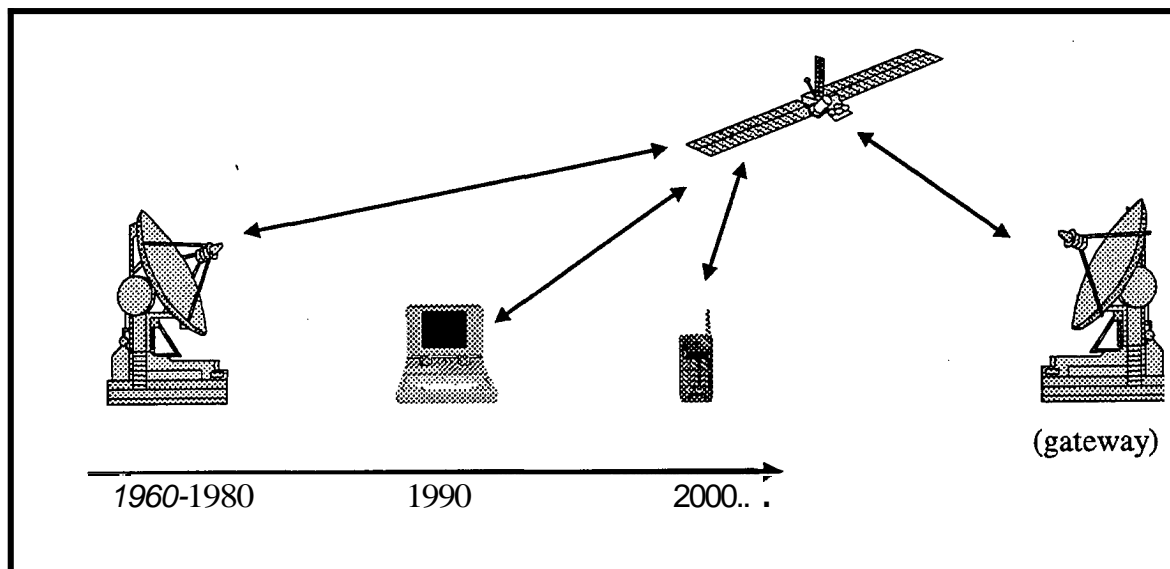

Figure 1.2 Evolution in The Size of Terminal Equipment

At this point, it is appropriate to make the distinction between these two similar but distinctly different categories of users. The term “mobile user” is referred to one who uses communications equipment only after movement has stopped and an antenna has been accordingly deployed in order to link the equipment with the satellite. On the other hand a “user on the move” is one whose communications equipment must function and be linked with the satellite while moving [Ref. 9]. Both of these categories aptly describe the users involved in military communications; therefore, it becomes evident that the concept of a “commercial global grid” is very attractive to military users. This was exemplified by the utilisation of commercial satellite systems, which were successfully merged with military ones, for the accommodation of communication requirements during the Gulf War operations [Ref. 8].

One fact which makes the use of commercial SATCOM systems in military operations both attractive and unavoidable is that over the next ten years the performance

of existing MILSATCOM systems will start degrading due to ageing effects and the subsequent replenishment will be slow as a result of the high cost of replacement of the satellites. The “commercial global grid”, with relatively lower cost, is going to be the next alternative and enhancing step of MILSATCOM both in the USA and internationally.

#### **D. REGULATORY SITUATION FOR LEOs/MEOs**

The radio frequency management of non-GEO satellite systems has been addressed by the World Administrative Radio Conference on February 1992 (WARC-92) in Malaga, **Spain** and partly reconsidered by WARC-93 [ Ref. 10]. One of the decisions of WARC-92 was to allocate the Radio Determination Satellite System (RDSS) to the spectra 1610-1626.5 MHz (L-band) and to allocate the 2483.5-2500 MHz spectra (S-band) to LEO satellite systems on a world-wide primary basis [Ref. 10]. The latest modifications in spectrum allocation were done by WARC-95 in Geneva, Switzerland [Ref. 14]. The first was that the date of access to the L and S bands, for MSS was brought forward to 1<sup>st</sup> January 2000 instead of 2005 that was previously. The second was that additional spectrum was made available in Region 2 of ITU which is the Americas [Ref. 5, Ch. 4].

The development of LEO, MEO systems has been significantly based on licensing from the U.S. Federal Communication Commission (FCC), although their global nature should require an international collective agreement rather than the licensing stemming from the administration of a single country. Of course, with current international regulations emerging from the International Telecommunications Union (ITU) [Ref. 7] every country's consent is equally important by granting licenses for operation across its own territory [Ref. 10] so as to make the global concept of any system become reality. Nevertheless all LEO/MEO companies consider the great importance of being able to fully operate in the USA PCS market. Naturally this requires approval of the FCC for construction, launching and system operation inside the USA [Ref. 10].

The service requirements of the FCC for threshold design qualification standards are [Ref. 6]:

- Continuous voice coverage over the entire globe (except the poles) at least 75% of the time.
- Continuous voice coverage over the USA 100% of the time.
- Strict financial qualification which means that any applicant must have the financial ability to construct and launch the system.
- Ability to operate in co-primary basis with radioastronomy (1610-1613.8 MHz).
- Use of Ka feeder link spectrum; co-ordinate among other Ka band applicants for Fixed Satellite Systems (FSS) and 28 GHz “cellular” TV Local Multipoint Distribution System (LMDS).

Specially for little LEOs the FCC requires the following:

- “Blanket” licensing for transceiver terminals.
- The first satellite under construction should be within one year from licence.
- Launches must be completed within four years from license.
- Licenses will expire after ten years.
- Modifications of satellites and services because of new technology require a request for modification of licensing rules.

On the other side of the Atlantic, the big LEOs of US origin have attracted the attention of countries such as Great Britain, Germany, Italy and France. European consortiums have been created with companies of US origin in order to promote the idea of a satellite personal communications network (S-PCN). The general approach is in favour of a fair competition between the alternative systems, all of which should be permitted to co-exist and no ban for any system should be tolerated [Ref. 6] by the European Commission, which is the governing body of the European Union (EU),

## E. INTERFERENCE AND FADING IN LEO/MEO SYSTEMS

Before proceeding further some issues regarding **LEO** and MEO satellite systems are presented. Specifically those associated with performance under self interference, rain attenuation and fading.

### 1. Self Interference in LEO/MEO Satellite Systems

S. Blondeau et al. present in Reference 11 the total carrier to interference ratio ( $C/I$ ) of the link which is defined as “the ratio of the useful received carrier power on a mobile-to-satellite or satellite-to-mobile link and the overall contribution at the receiver input of interference power generated from other links”. The generic transmission network is pictured in Figure 1.3.

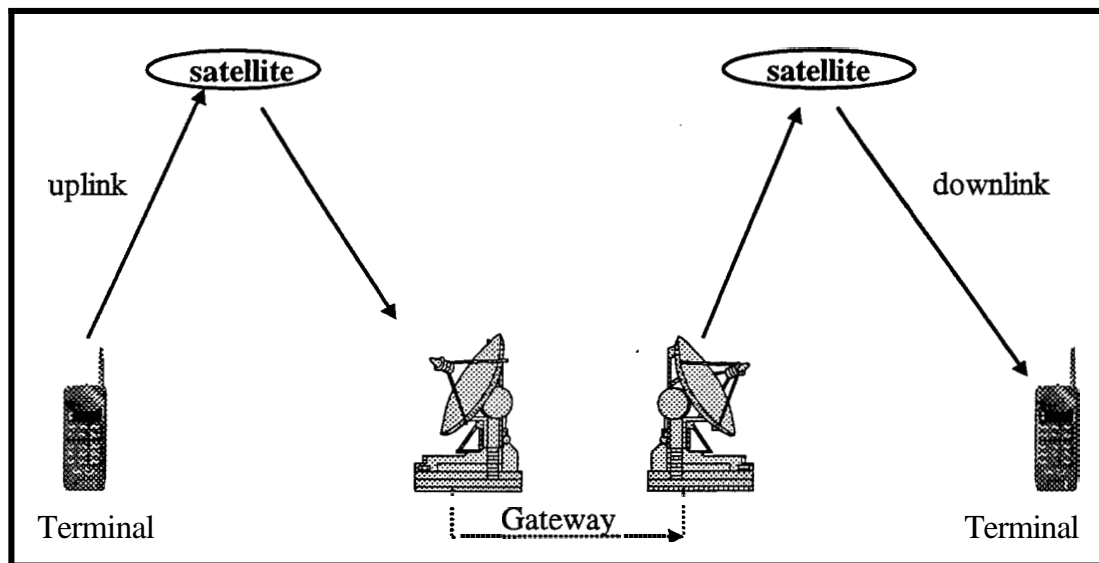

Figure 1.3 Generic Transmission Network. “After Ref. [16].”

The following assumptions for the C/I calculation are made:

- One link is used to support the connection between the mobile terminal and the space segment although the terminal may be in the field of view of more than one satellites.
- The antenna of the mobile terminal is isotropic.
- Worst case scenario is considered to be when complete overlapping of the interfering carrier spectrum is applied onto the interfered carrier.
- Every uplink and downlink operate with a common margin.

The calculations were performed for one LEO constellation consisting of **48** satellites and an ICO constellation of 12 satellites. The following conclusions were determined:

- In order to avoid self interference within the LEO/MEO constellation a frequency reuse policy has to be implemented.
- Because of the time dependency of the traffic pattern in each country with local time, several frequency reuse plans should be considered.
- Each frequency reuse plan should maximise the capacity at any given time.
- The system should not have to change plans too frequently.

## **2 Rain Attenuation in LEO/MEO Satellite Systems**

A. Paraboni et al. present in reference **12** the severe propagation problems that are expected to be encountered in satellite communication systems operating in the Ka band frequencies and above. Some plausible solutions for these problems based on knowledge of the local climatology were also proposed.

Many different problems and different strategies may be undertaken to counter attenuation due to rain. These problems, related to tropospheric propagation are:

- Temporary suspension in the operation of LEO, MEO systems due to rain prediction at variable altitudes. This is common for these systems because the link margin varies with the variable satellite distance.

- Combining attenuation at 20 and 30 GHz for evaluating the red outage time and for the uplink control.
- Assessing the **risk** of failing hand-over between two satellites of the constellation due to the need of maintaining the simultaneous operation of both satellites.

Countermeasures for the above problems are:

- Site diversity for the satellite-to-base link; Consisting of a **pair** or a triplet of earth terminals connected in such way **as** to take the maximum advantage from the rain non- uniformity. This is performed by choosing the less attenuated of the two or three available signals or by adopting particular signal combining strategies.
- Orbital diversity both for the satellite-to-gateway and satellite-to-mobile terminal link which is applicable if an inter-satellite connection exists. The satellite network is entered through the satellite which offers the best channel condition.

Both these solutions require a deep knowledge of the rain cells topology for each area of concern and the data can be derived only by conducting accurate meteorological radar studies of the area under examination.

### **3. Fading in LEO/MEO Satellite Systems**

LEO and MEO satellite systems need a high value of spectrum efficiency both in the case of competition **and** in that of integration of terrestrial cellular systems. If the service region is covered with many relatively small spots, the satellite system virtually becomes a cellular system [Ref. 13]. Vatalaro et al. present in Reference 13 the effects of fading for one LEO and one MEO system without naming them specifically, but it is evident that the characteristics of Globalstar and Odyssey were both used. The two systems are described in detail by H. Stelianos [Ref. 2]. The results and conclusions of the computer simulation have an application for LEO, MEO systems in general.

The consideration of fading phenomena becomes difficult for Mobile Satellite Systems (MSS) because each user is located in a completely different environment from the

others. There is a problem of identifying a unique statistical model for the effects of fading. Moreover, since the elevation angles change continuously and quickly over time the channel is non-stationary in nature. For these reasons an approximate evaluation of the system mean values of outage probability  $P_{\text{out}}$  over space and time is presented. This evaluation is performed under the assumption that the transfer function envelope of the propagation medium has a Rice distribution [Ref. 13]. Vatalaro et al. assume that all users are located in similar environments and they experience non-selective fading due to diffuse multipath. The conclusion is made that “the presence of fading brings a significant increase in outage probability ( $P_{\text{out}}$ ) only when  $P_{\text{out}}$  experienced in the absence of fading is low”.

## F. COMPARISON OF LEO/MEO VERSUS GEO

**This** section tries to answer the question “why LEO/MEO and not GEO for the military applications?”, The advantages of LEOs and MEOs compared with GEO systems make them more attractive for future use both in the commercial and military domains.

The minimal propagation delay time of LEO systems as well as the global coverage provide the edge against GEO systems. The GEO systems, while avoiding satellite hand-over, large constellation size, Doppler effect due to satellite motion and interference reduction methods, they have large free space attenuation compared to LEOs and MEOs, a fact that makes operation with portable terminals difficult. Military operations require highly mobile and portable communication equipment. For tactical land-sea-air operations, the requirement of rapid and continuous communications “on the move” can be accommodated globally, mainly by LEO or MEO systems [Ref. 14]. Moreover the poor coverage of GEOs at high latitudes makes them less attractive than their LEO/MEO adversaries.

On the other hand, the high data rates the GEOs can provide, make these systems more preferable than LEOs/MEOs in applications that require high data rate links in order



to operate effectively. There is **an** obvious compromise to be made by a systems engineering staff either military or civilian. A model featuring both high data rate and high mobility by combining LEOs/MEOs and GEOs would be attractive, than either of them alone.

## II. ICO GLOBAL COMMUNICATIONS

### A. INTRODUCTION

Intermediate Circular Orbit Global Communications or ICO as will be referred to, is both the name of a multinational telecommunications company and the MEO Mobile Satellite System (MSS) itself. The initial name was INMARSAT's "Project 21" [Ref. 6] which implied that it was meant to be the organization's mobile satellite personal communications system for the 21<sup>st</sup> century. After a couple of years deadlock, ICO Global Communications Limited was incorporated in 16 December 1994 as a private company registered in England and Wales, UK. In January 1995 ICO completed a private placing, whereby INMARSAT and 37 investors committed to subscribe for an aggregate amount of 1.4 billion US dollars [Ref. 14]. Finally in October 1995, ICO obtained the required spectrum allocation at 2 GHz, by the World Administrative Radio Conference (WARC-95) in Geneva Switzerland, so as to be operational in the year 2000.

ICO is "a commercial, market driven, private company" as stated by its chief executive officer. It is legally and physically, distinct from INMARSAT, with its own board and management. INMARSAT is only one of the 47 shareholders, represented by 44 nations around the globe, holding 10.5% of the ownership and 15% of the voting shares. A fact with Greek interest is that the Hellenic Telecommunications Organization (OTE) possesses 3.8% of the ownership and 3.62 % of the voting shares [Ref. 14].

### B. MARKETS AND PROPOSED SERVICES

ICO's (see Figure 2.1) objective is to complement the local terrestrial, both cable and cellular, services in every country all over the world. These services will be offered

through national organizations, having enormous experience and adaptation in the local regulatory situation and commercial conditions of their representative countries.

There are four main groups of consumers that ICO plans to accommodate [Ref. 14] as well as an additional, more specialized group, about which the focus is directed. The four main groups are:

- Domestic and international travelers, who need PCS outside the areas covered by the compatible cellular networks.
- Satellite only users.
- General aviation aircraft and small vessels.
- Semi-fixed installations in rural and remote areas

The final group consists of the military users. There has been a long history of successful cooperation between military organizations and local telecommunications organizations, in numerous countries all over the world. The 44 different countries represented in the ICO, offer through the experience of their telecommunications organizations, a concrete foundation towards achieving the previously mentioned cooperation in the PCS SATCOM market.

ICO will provide digital voice, data, facsimile, messaging and information services through a global distribution system [Ref. 15]. These services will complement terrestrial PCS systems. They will be provided in areas where regional terrestrial cellular systems have incomplete, patchy or non-existent coverage [Ref. 16]. ICO will use Time Division Multiple Access (TDMA) as its multiple access technique, Quadrature Phase Shift Keying (QPSK) as its modulation technique and will possess satellite command/control encryption capability. ICO will be compatible with several cellular standards world-wide. These include: Global System for Mobile Communications (GSM) in Europe, Personal Digital Cellular (PDC) in Japan, Advanced Mobile Phone Service (AMPS) and D-AMPS (Digital AMPS) in North America, future Time Division Multiple Access (TDMA) systems. ICO will also have the capability to intersect with regional terrestrial Public Switched Digital Networks (PSDN) as well as Public Switched Telephone Networks (PSTN).

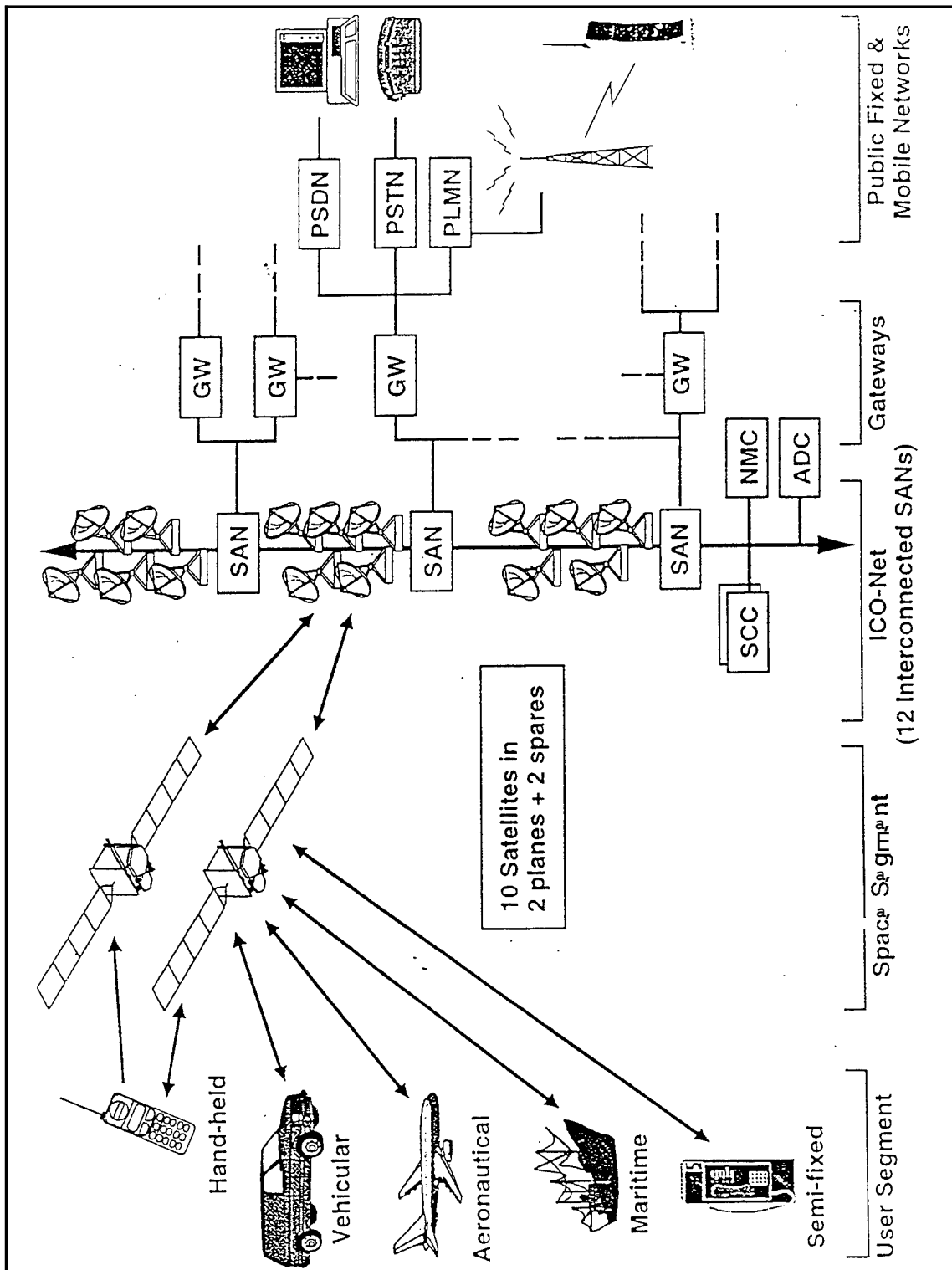

Figure 2.1 The ICO System Overview "From Ref. [17]"

## C. SYSTEM DESCRIPTION

ICO consists of three major parts: the space segment, the user segment and the ground segment. The ground segment consists of three subsegments: the ICO Network (ICONET), the gateways and the terrestrial public, fixed and mobile networks.

### 1. The Space Segment

#### a. Satellite Constellation

The constellation (see Figure 2.2) will be comprised of ten operational satellites and two spares in medium earth orbit (MEO), at an altitude of 10,355 kilometers above the earth's surface.

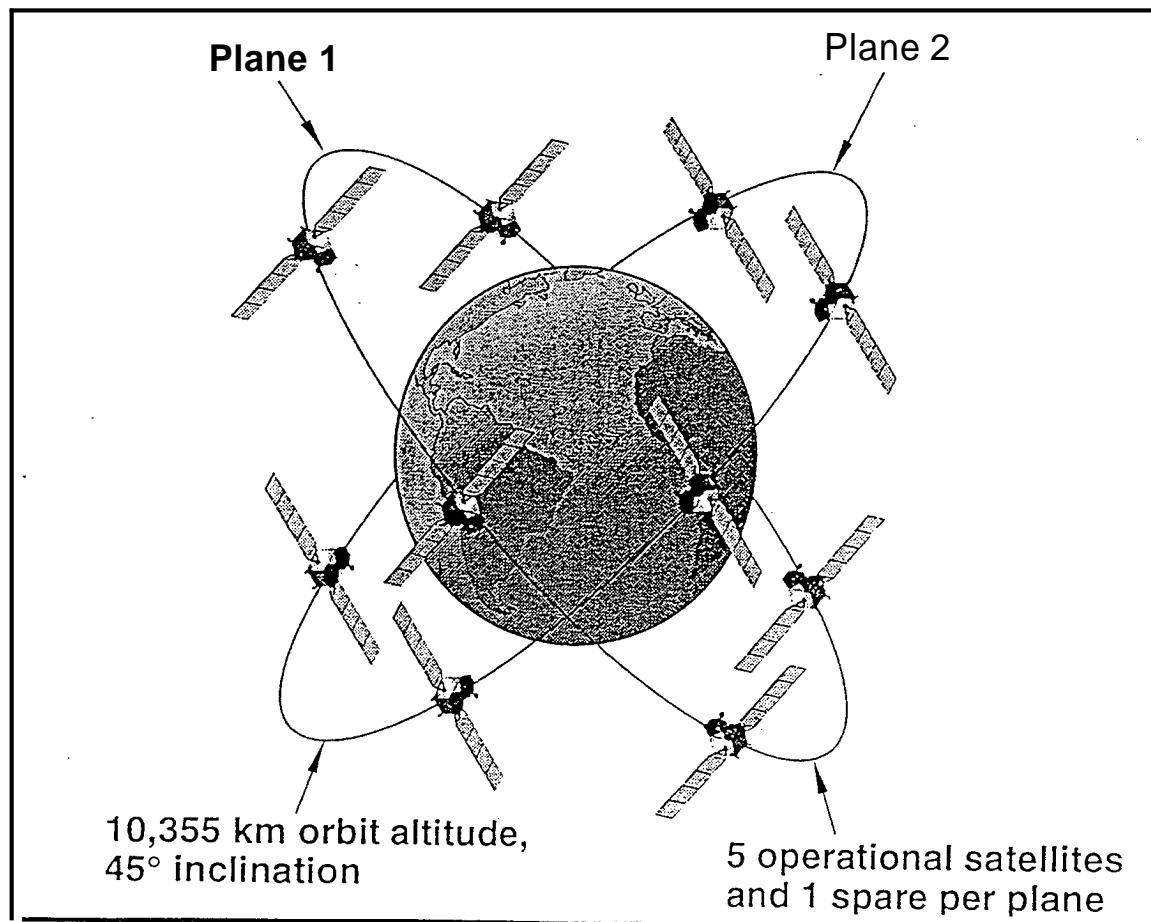

Figure 2.2 The ICO Satellite Constellation "From Ref. [17]."

They will be arranged in two orbital planes in circular orbit. The orbit is designed for satellite diversity in that at least two and up to four satellites will be in the field of view (FOV) of the user and a Satellite Access Node (SAN), 99% of the time. The SANs will provide the link between the space and the ground segment of ICO. Each orbital plane will be inclined 45 degrees to earth's equator, therefore the constellation will have 90 degrees orbital plane separation. The orbital period of each satellite is six hours. Each orbital plane will accommodate five operational and one spare satellites, with 72 degrees operational satellite in-plane separation.

The satellite orbits have been selected to provide coverage of the entire globe on a continuous basis [Ref. 15]. They also allow high elevation angles ( $40^{\circ}$ - $50^{\circ}$ ), a feature which provides lower probability of blockage and call interruption. The constellation's instantaneous field of view (IFOV) of the coverage area for zero degrees elevation angle, is shown in Figure 2.3.

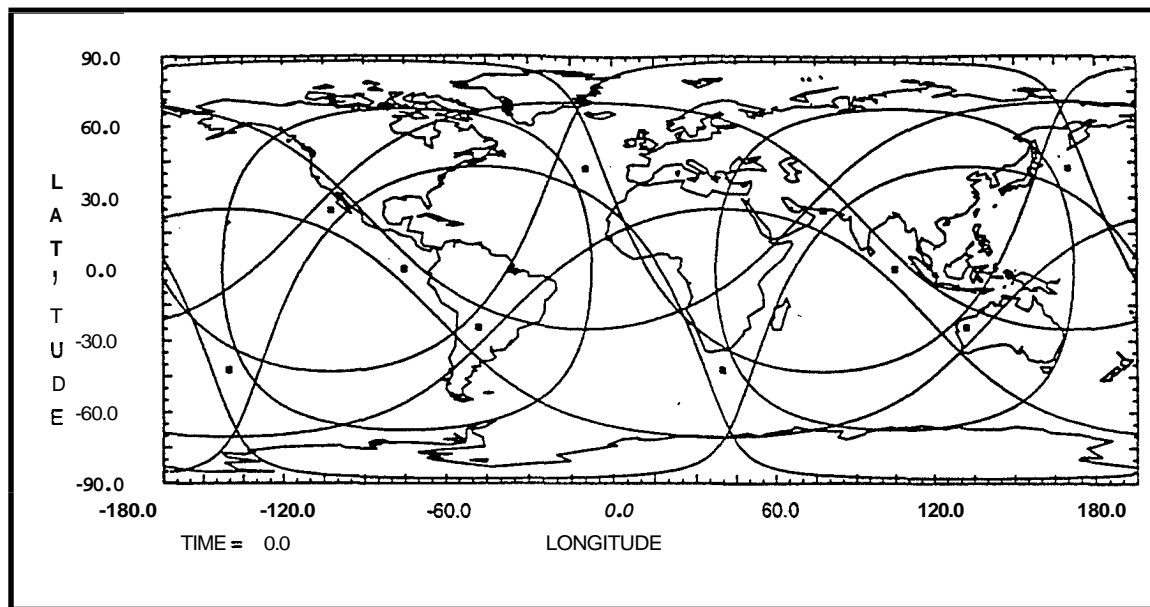

Figure 2.3 Instantaneous View of ICO System Coverage "From Ref. [15]."

The features of high elevation angles ( $40^{\circ}$ - $50^{\circ}$ ), and path diversity thus global coverage, give ICO the benefits of high service availability and global connectivity

(90° N to 90° S). These are two, very important parameters in order for a **MSS** to fulfil the requirements for its military application. The first satellite launch is scheduled for 1998 [Ref. 16].

***b. Satellite Technology and Frequency Management***

The ICO satellites (see Figure 2.4) are currently being built by Hughes Space & Communications International, Inc., under a contract signed in July 1995 [Ref.15]. They are based on the proven HS601 geostationary bus. The communications payload allows flexibility of transmission format and provides full, on-board digitally processed (“transparent processor” type), channelisation and beam forming, which were traditionally performed by analogue technology. These features provide ICO the advantages of flexible traffic routing and reduction of transportation requirements, adding one more point for its possible military application. Another key feature of the design is the separate transmit and receive antennas for the service and feeder links [Ref. 15].

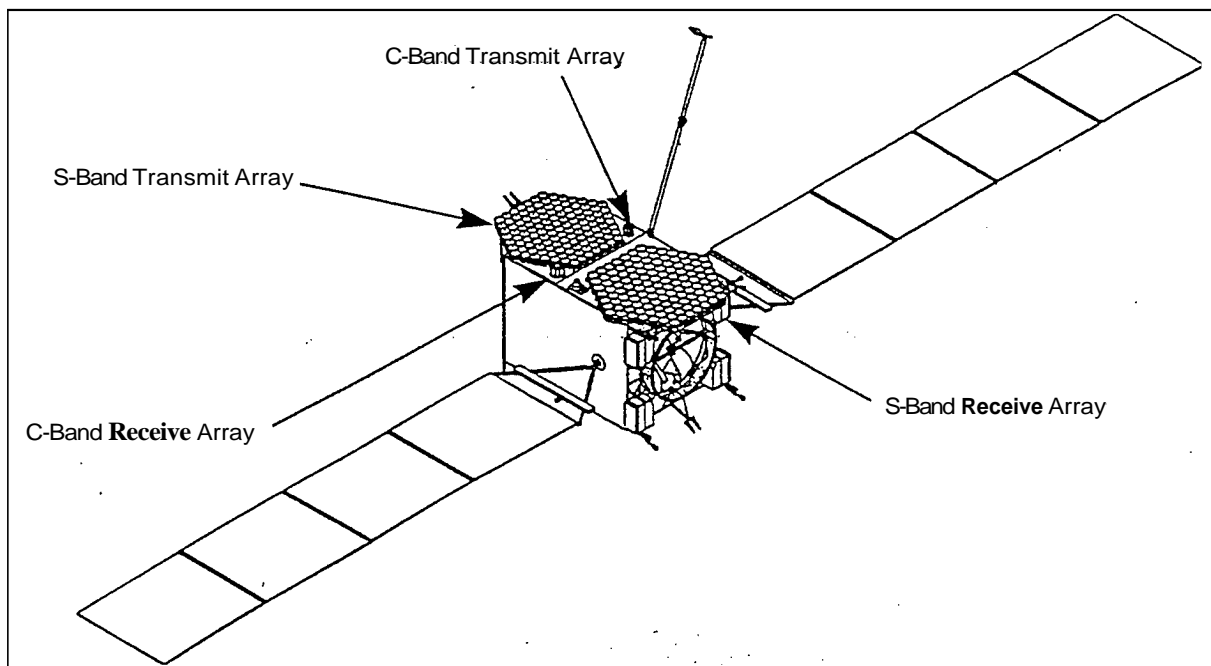

Figure 2.4 The ICO Satellite ‘From Ref. [15].’

The system design provides 163 to 200 transmit and receive service link beams [Ref. 16], with a minimum power margin at least 6 dB and an estimated maximum propagation delay of 200 msec. The service coverage of one ICO satellite is shown in Figure 2.5 .

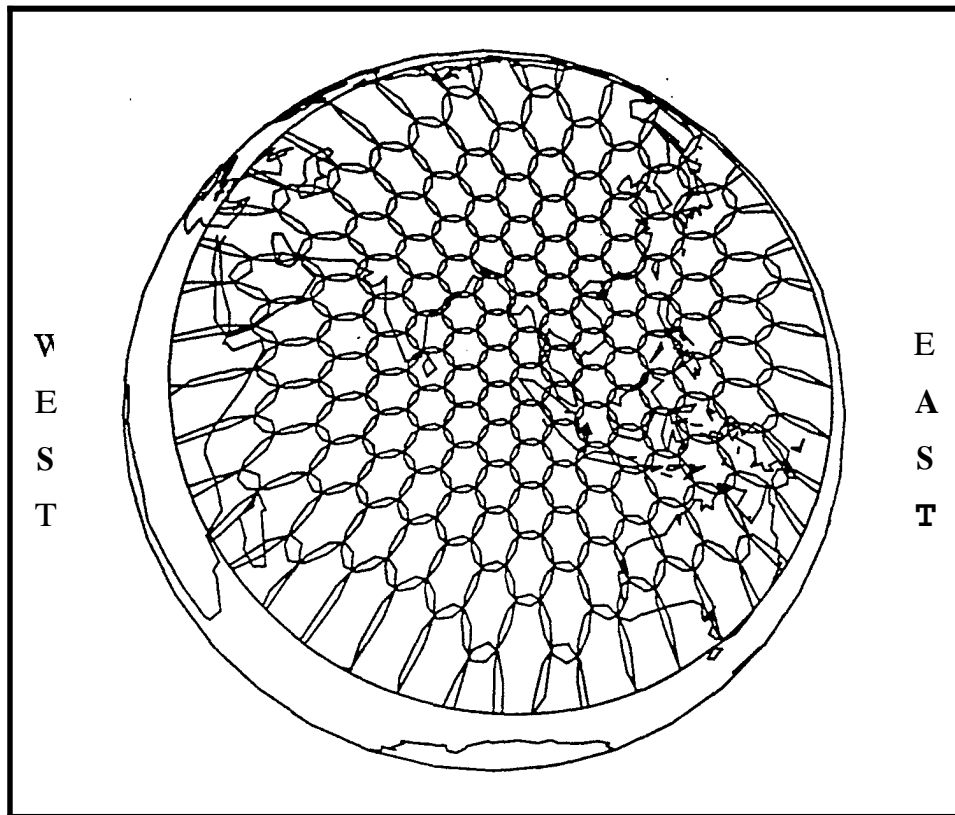

Figure 2.5 Service Coverage of one ICO Satellite “From Ref. [15].”

The service link will operate in the S-band which was recently allocated by WARC-95 to MSS. It provides the connection between the user terminals and the satellites [Ref. 15]. The up-link frequency is 1.98-2.01 GHz and the down-link frequency is 2.17-2.2 GHz [Ref. 16]. The Bit Error Rate (BER) for voice and data is  $10^{-4}$ .

The feeder link will operate in the upper part of C-band which was also recently allocated by WARC-95 to MSS. It provides the connection between the satellite and the SANs. At any time, each satellite will be in line of sight (LOS) contact with at least two and at most four SANs.



Before the satellite passes outside the **LOS** of one SAN it will establish contact with the next one which enters the satellite's FOV. For the feeder link, the up-link frequency is 5.15-5.25 GHz and the down-link frequency is 6.975-7.075 GHz [Ref. 16]. The existence of separate transmit and receive antennas for the service and feeder links allows easier manufacture and better intermodulation protection than combining transmit and receive antennas in one unit.

In order to enable the link analysis calculations, the relevant parameters of the ICO system are presented in Table 2.1 below.

<b>Parameter</b>	<b>Symbol</b>	<b>Value</b>
Carrier Bandwidth	Bw	25.2 kHz
<b>Bit Rate per Carrier</b>	Br/C	36 kbps
Bit Rate per Channel	Br/Ch	4.8-9.6 kbps
Channels per Carrier- forward feeder uplink	Ch/Cup	<b>8</b>
Channels per Carrier- forward mobile downlink	Ch/Cdn	6 = 7.78 dB
Maximum Number of Carriers	<b>Cnr</b>	750

Table 2.1 ICO System **Link** Analysis Parameters.

The ICO link analysis calculations entail two different links [Ref. 30]. These are the forward and the return link. The total forward link (feeder uplink-mobile downlink) calculation is displayed in Table 2.2 and the total return link (service uplink-feeder downlink) calculation in Table 2.3. **All** calculations are performed in dB/dBW/dBHz forms.

FEEDER UPLINK		MOBILE DOWNLINK	
EIRP per carrier	48.7 dBW	EIRP per carrier	33.6 dBW
Free space loss	-190.2 dB	Free space loss	-181.9 dB
Pointing/rain loss	-2 dB	Pointing/rain loss	-0.1 dB
Receive antenna Gain	11 dB	Receive antenna Gain	1.7 dB
Carrier Bandwidth	-44 dBHz	Carrier Bandwidth	-44 dBHz
Noise temperature	-27 dBK	Noise temperature	-25.5 dBK
Boltzmann's constant	228.6 dBW/K-Hz	Boltzmann's constant	228.6 dBW/K-Hz
		Fading margin	-7 dB
<b>(C/N)<sub>up</sub></b>	<b>25.1 dB</b>	<b>(C/N)<sub>d</sub></b>	<b>5.4 dB</b>
		(C/I) <sub>side-lobe, m</sub>	14.78 dB
		<b>(C/(N+I))<sub>d</sub></b>	<b>4.926 dB</b>
<b>TOTAL FORWARD LINK: <math>1/(C/(N+I))_{tot} = 1/(C/N)_{up} + 1/(C/(N+I))_d</math> (real numbers)</b>			
<b>(C/(N+I))<sub>tot</sub></b>	<b>4.884 dB</b>	<b>(C/(No+Io))<sub>tot</sub></b> [C/N = C/N + Bw (dB)]	<b>48.88 dB</b>
<b>(C/(No+Io)) per voice channel is</b>		<b>48.88 - 7.78 =</b>	<b>41.01 dB</b>

Table 2.2 ICO Forward Link Analysis Calculation.

The ICO satellite life span has been approximated to be twelve years and is designed to support at least 4,500 telephone channels using Time Division Multiple Access (TDMA) as the multiple access protocol and QPSK as its modulation scheme. TDMA systems are those in which many Earth stations in the satellite communications network use a single carrier for transmission via a satellite transponder on a time division basis[Ref. 7]. The bit rates per carrier for both the upload and download is 36 Kbps. All the Earth stations operating on the same transponder are allowed to transmit traffic bursts

in a periodic time frame, called the TDMA frame. A detailed discussion of TDMA is in Reference 7.

RETURN UPLINK		RETURN DOWNLINK	
EIRP	6.8 dBW	EIRP per carrier	-1.8 dBW
Free space loss	-181.1 dB	Free space loss	-192.7 dB
Polariz./atm. loss	-0.1 dB		
Receive antenna <b>Gain</b>	26.5 dB	Receive antenna <b>Gain</b>	47.6 dB
Carrier Bandwidth	-44 dBHz	Carrier Bandwidth	-44 dBHz
Noise temperature	-25 dBK	Noise temperature	-21 dBK
Boltzmann's constant	228.6 dBW/K-Hz	Boltzmann's constant	228.6 dBW/K-Hz
Fading margin	-6 dB	Fading margin	-3 dB
(C/N) <sub>up</sub>	5.7 dB	(C/N) <sub>d</sub>	13.7 dB
(C/I) <sub>side-lobe</sub>	15 dB	(C/I) <sub>m</sub>	23.2 dB
(C/(N+I)) <sub>up</sub>	5.21 dB	(C/(N+I)) <sub>d</sub>	13.23 dB
<b>TOTAL RETURN LINK: <math>1/(C/(N+I))_{tot} = 1/(C/N+I)_{up} + 1/(C/(N+I))_d</math> (real numbers)</b>			
(C/(N+I)) <sub>tot</sub>	4.57 dB	(C/(No+Io)) <sub>tot</sub> [CIN=C/ N+ Bw (dB)]	48.57 dB
(C/(No+Io)) per voice channel		48.57 - 7.78 =	40.78 dB

Table 2.3 ICO Return Link Analysis Calculation.

## 2. The Ground Segment

The ground segment as previously mentioned, consists of three separate parts: The ICO network (ICONET) (see Figure 2.6), the gateways and the terrestrial, mobile and fixed telephone networks.

### a. The ICONET

The space segment will be linked to the ground segment through the ICONET. The ICONET consists of twelve Satellite Access Nodes (SANs), interconnected through a backbone network and controlled by the Network Management Center (NMC) and Administration Data Center (ADC). The SANs will be the primary interface between the satellite and the gateway-terrestrial network channel. A SAN will consist of three main elements [Ref. 15]:

- Five parabolic antennas, with associated RF equipment to communicate with the satellites. The diameter of each antenna is eight meters and the RF characteristics are  $EIRP = 83 \text{ dBW}$  and  $G/T = 31 \text{ dB/K}$ .
- The Mobile Satellite Switching Center (MSSC), which is a switch to route traffic within the ICONET and to gateways.
- Two databases to support mobility management.

The twelve SAN locations (see Table 2.4) have been selected so as to ensure service availability in the event that one SAN is lost due to physical or manmade reasons. Additionally the SANs locations will be in parts of the world relatively safe from military conflicts. The first SANs are expected to be ready for network communications during the first quarter of 1999 [Ref. 17].

### b. Telemetry Tracking and Command (TT&C)

TT&C provides the means of monitoring and controlling satellite operations in general [Ref. 5]. Commands are necessary to operate most communications satellites. In order to issue the appropriate commands, information on the satellite's

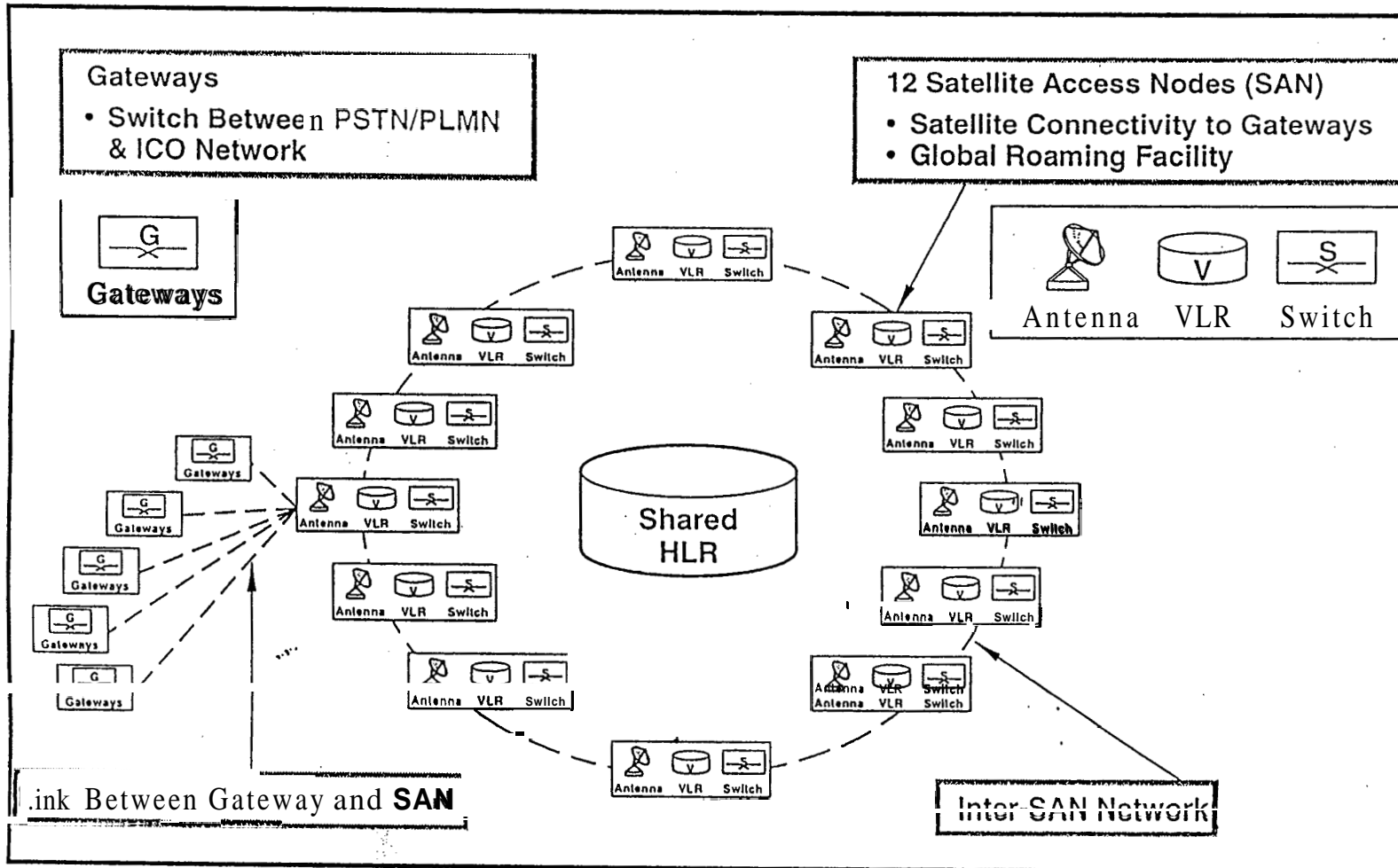

Figure 2.6 The ICO Network "From Ref. [16]."

location and condition is needed. TT&C are usually integrated into a single subsystem and are operated separately from the communications part of the satellite.

	<b>SAN Location</b>	<b>Country</b>	<b>Continent</b>
1	Brewster		N. America
2	Tulancingo	Mexico	C. America
3	Longvilo	Chile	S. America
4	Guaratiba	Brazil	S. America
5	Usingen	Germany	Europe
6	Hartebeesthoek	South Africa	Africa
7	Dubai	UAE	Asia
8	Chattarpar	India	Asia
9	Banyu Urip	Indonesia	Asia
10	Shanghai	China	Asia
11	Kumsan	South Korea	Asia
12	Brisbane	Australia	Oceania Oceania

Table 2.4 The ICO SAN Locations.

The Satellite Control Center (SCC) is part of the ICONET. SCC will manage the satellite system by tracking satellite movements and adjusting their orbits to maintain the constellation. The SCC will also monitor the general condition of the satellites by collecting data on the power supply, temperature, stability and other operating characteristics. It will possess the ability to maneuver the satellites in order to realign the constellation in the event of any satellite malfunctions. The SCC will have an up-link encryption capability a feature which provides for the information security of the system [Ref. 17].

The SCC will control the transponder linkages between the feeder and service antennas onboard the satellites. This function will provide frequency

reconfiguration capability within feeder link beams and optimal channel allocation between high and low traffic service beams [Ref. 15]. Finally it will support the launch and deployment of the satellites. The SCC is planned to be installed during the first quarter of 1998 [Ref. 17]. A consortium led by NEC, Hughes Network Systems and Ericsson will design, construct and deliver the SANs, SCC, and all the related facilities for the ICONET.

**c. Gateways and Terrestrial Networks**

A critical feature of ICO, which makes it particularly attractive for application in military communications, will be the capability to integrate satellite and public land mobile networks (PLMN). The majority of time the satellite network will be considered a complementary service. Subscribers who wish to communicate with areas that are not covered at all or are covered partly by their PLMN service provider will be able to get connected. The gateways are the connecting interface between the ICONET and the mobile and fixed terrestrial networks. Each SAN will be able to communicate with an unlimited number of gateways [Ref. 17]. Current planning seeks to utilize a minimum of two gateways per country. The gateways will be owned and operated by third parties and will be located throughout the world [Ref. 17]. This gives the opportunity of having military owned and operated gateways anywhere this feature is required for the military application of the system.

The mobile and fixed networks that will cooperate with ICO are the PSTN, PSDN, and regional terrestrial cellular networks such as GSM, PDC, AMPS, D-AMPS as well as other TDMA systems that will appear in the future [Ref. 15].

**d. ICO-Net User Mobility Management**

In order to provide global connectivity ICO will include a GSM originated mobility management model. Each SAN will contain two databases. The first one is the Visitor Location Register (VLR) and will be responsible for maintaining details of the user terminals currently registered to that SAN. The SAN will track the satellites within its

LOS and direct communications traffic to the satellite which will provide the most robust link. Following this it will execute hand-offs so as to maintain uninterrupted communications. An other function of the VLR **will** be to register the location of users outside of their home regions. Each SAN will have it's own VLR database.

The second data base will be the Home Location Register (HLR) and Authentication Center (AuC). HLR/AuC is a single logical entity, but it will be physically split between the SANs. HLR will perform two functions. The main function will be to verify user information and status and to locate the user anywhere on the globe. Whenever a subscriber turns on his handset a message is transmitted from this handset to the user's HLR/AuC via satellite and **SAN**. This will verify user's status and allow access the ICO system. After clearance has been communicated to the specific **SAN** the subscriber **will** be registered in the SANs VLR. The second function of the HLR is to inform the VLR location of any subscriber to the **SAN** through which an incoming call is originated. This will enable the call to be directed to the **SAN** closest to the intended call recipient. Then the call **will** be completed through a satellite link.

### **3. The User Segment**

The user segment will have the capability to provide digital services to a number of more than 10 million subscribers world-wide a feature which fulfills the requirement for 80,000 DoD users and additional anticipated commercial demand. In addition to this, ICO fulfills the "simultaneous users" capacity requirement of 3000 DoD, plus excepted commercial ones [Ref. 17]. It **will** be comprised by the following parts:

- Portable hand-held phones.
- Fixed/Semi-fixed phones (rural phone booths and community telephones).
- Vehicular mobile terminals.
- Aeronautical mobile terminals.
- Maritime mobile terminals.

All of the previously listed terminals, could be used either in civilian or in military applications. The data rate for the handheld terminal **will** be **4.8 Kbps** and more-than **9.6**



Kbps for the non-handheld devices at a Bit Error Rate (BER)  $10^{-4}$  both for voice and data services. Security for voice and data transmissions, a vital requirement for military users can easily be offered as an additional feature, through external encryption devices.

The vast majority of the ICO user terminals are expected to be handheld, pocket sized telephones. They will be capable of operating in satellite and cellular/PCS modes. The satellite mode capability will be selected automatically while the cellular/PCS mode will be selected only whenever a cellular/PCS system is available [Ref. 17]. Calls will not be able to be transmitted or received via satellite if there is an obstruction between the user and the satellite such as a mountain, a building or dense woods. Indoors calls may be possible if the user is close to a clear glass window in the LOS of a satellite.

The ICO pocket phones will have the parameters shown in Table 2.5. It is going to be similar in size appearance and voice quality to today's hand-held cellular phones [Ref. 16]. It will be manufactured by COMSAT International Communications Corp. The price of the ICO pocket phone is estimated to be \$ 1,000. The service cost will be \$ 40 per month and \$ 2 per minute [Ref. 17]. These make ICO services very competitive, compared with services offered by other MSSs.

	<b>Parameter</b>	<b>Value</b>
1	Average transmitted power	< .25 Watts
2	MAX per channel EIRP with voice active at 20° elevation angle	-1.0 dBW
3	MIN G/T at 20° elevation angle	-23dB/K
4	Continuous talk time	-1 hour
5	Continuous receive mode	-24 hours

Table 2.5 Parameters of the ICO Pocket Phone [Ref. 16].

The ICO pocket phone does not possess any LPI/LPD capabilities but its relatively low average transmitted power of .25 Watt makes it less susceptible to detection than its competitors. Moreover, the handset will possess some optional features which will make it more versatile than its competitors. These are [Ref. 16] :

- External data ports and internal buffer memory to support data communications at 3.6 kbps, data and single slot allocation.
- Smartcard (SIM) and Personal Computer Memory Card International Association (PCMCIA)'compatibility. This feature enables the connection to the ICO phone, of any security module provided it is PCMCIA compatible[Ref. 17].
- High Penetration Notification (HPN). This function is unique to ICO [Ref. 17]. HPN enables the user to be informed when he is outside of normal satellite coverage.
- Short Message Service (SMS). Message content will be several bits to tens of bytes.
- Facsimile capability.

## D. SUMMARY

ICO Global Communications is a global Mobile Satellite System (MSS), which is going to acquire full service capability by the year 2000. It **will** provide global coverage (including both poles) **24** hours a day, seven days a week. It is going to provide digital voice, data, fax and messaging services and will complement existing regional terrestrial networks, cellular and cable. The heart of the system will be the ICONET consisting of twelve SANs. The ICONET **will** connect the ten operational and two spare satellite constellation with the terrestrial networks via twelve Satellite Access Nodes (SANs), thus

enabling continuous global connectivity mainly with the use of handheld pocket sized telephones.

ICO embodies features which make it very attractive to potential military users. It is a project that is being developed under the support and co-operation of 47 telecommunications and technology companies/organisations around the globe, a characteristic which ensures its financing and full deployment thus its availability for future DoD applications.

### III. US MILSATCOM, REQUIREMENTS, MISSIONS, TRENDS

#### A. HISTORICAL OVERVIEW

This chapter discusses an overview of the US Military Satellite Communications (MILSATCOM). The services which these systems provide, the major warfare missions they are supposed to support and the required features are presented. Current MILSATCOM systems are reviewed as well as the trends for the 21<sup>st</sup> century. It summarizes the existing assets of MILSATCOM, before offering the Commercial Satellite (COMERSAT) based alternative, in the following chapters.

The launch in October 1957 of the Soviet Union's "Sputnik" satellite, was followed by a burst of activities in the space arena in both the USA and the Soviet Union. Both parts conceived that artificial earth satellites offered a unique transmission medium for applications in the military as well as the commercial markets. In many military applications satellite deployment offered a more reliable alternative from microwave LOS, tropo-scatter, and high frequency (HF) links. One of the most prominent services that could be offered through satellite deployment, was broadcast of high bandwidth information to many receiver users dispersed over large geographic areas [Ref. 18]. Other features accommodated by satellite deployment were report-back and teleconferencing [Ref. 18].

Early communication satellites were small, lightweight configurations in LEO. The two factors that propelled the next satellite generation up to GEO orbits were firstly the increase in vehicle launch capability and secondly the evolution of satellite technology with the introduction of solar cells and Solid-state Power Amplifiers (SSPA) [Ref. 5]. The first GEO launched, was the SYNCOM III in August 1964. The first commercial communication satellite launched was the "Early Bird"

(INTELSAT I) in April 1965. The same year, Soviet Union launched their MOLNIYA satellites into a highly inclined elliptical orbit in order to provide coverage for their high latitude regions (near polar) where GEOs umbrella is non-existent [Ref. 5].

The first US MILSATCOM launch was performed in 1965 with the Defense Satellite Communications System (DSCS I) by the US Air Force as testbed for DSCS II and III satellite generations. Three launches placed 26 lightweight spin stabilized satellites in near GEO. The communications payload of DSCS I comprised of a dipole antenna and single 26 MHz transponder. DSCS I supported digital voice and data communications using Frequency Division Multiple Access (FDMA) as well as Code Division Multiple Access (CDMA) techniques [Ref. 18]. In February 1969 the GEO Tactical Satellite (TACSAT) was launched in order to offer an experimental asset with two 10 MHz transponders, for communication with fixed, man-pack, vehicle mounted and airborne terminals [Ref. 18].

These early experiments have led to an era of full satellite deployment, for accommodating the needs of military communications. A certain architectural framework has been developed by the US Department of Defense (DoD) through the 1980's, using not only DoD owned constellations but also commercial leased assets such as International Telecommunications Satellite (INTELSAT) and International Maritime Satellite (INMARSAT) [Ref. 19].

## **B. SERVICES, MISSIONS, REQUIRED FEATURES**

### **1. Services Provided by MILSATCOM**

The MILSATCOM systems, today and for the near future, are required to provide three broad categories of information services in order to support naval assets [Ref. 3]. These are voice, data and video services which are described below.

Voice services involve both secured and unsecured communications [Ref. 20]. They provide essential connectivity for information exchange, Coordination and

Reporting (C&R) between commands, command units and key operators in and over the horizon. They include telephones, voice mail, some fax over the phone lines and telemedicine services [Ref. 3].

Data services can be utilized for tactical communications, Command Control (C<sup>2</sup>), and logistics support [Ref. 3]. Tactical communications are established between maneuver elements and command facilities ashore. They enable a means of information exchange amongst several networks which provide tactical intelligence data, whilst additionally providing data in order to maintain surface, subsurface and air picture of all battlefield spectrums. Command Control (C<sup>2</sup>) services are provided to command elements. These are used to collect, correlate, distribute and present sensor acquired data, weather information, accurate position and simulation. The application of these services is the Joint Maritime Command Information System (JMCIS) [Ref. 20]. Finally, support services provide the vital logistical information and coordination to ensure sufficient and efficient maintenance and provision of units and groups deployed worldwide.

Video services include Video-Tele-Conferencing (VTC), battle damage assessment, Unmanned Aerial Vehicle (UAV) imagery, teletraining, telemedicine, broadcast TV channels and Moral Welfare and Recreation (MWR) programs [Ref. 3].

## **2. SATCOM Support to Naval Missions**

The naval missions demand a numerous number of circuits, therefore, bandwidth, in order to accommodate most of the areas of employment of the naval platforms. The major naval missions, supported by MILSATCOM can be of three major categories (see Table 3.1): warfare, commanding and miscellaneous [Ref. 20].

These missions have two sets of purposes. The first one is the “Operational Maneuver from the Sea” and the second is the “Forward.. . From the Sea” [Ref. 32]. The Operational Maneuver from the Sea includes operations conducted from the *Air*, Surface and Subsurface Navy, Marine Air-Ground Task Force, Joint Army-Navy-Air Force and Allies. It also includes crisis response and escalation operations. Forward.. . From the

Sea's main premise is the presence of the Naval forces overseas. It is also a continuous commitment to US allies and friends worldwide by participation in combined multinational exercises with them.

The warfare missions are a subset of the daily operations of an underway Battle Group (BG). These core missions shape the set of required features for the MILSATCOM systems. Modern warfare demands the exchange of information intensive data sets, video, imagery in order to support teleconferencing, retargeting missions, telemedicine and training [Ref. 20].

<b>Warfare</b>	<b>Commanding</b>	<b>Miscellaneous</b>
Amphibious	Joint Task Force(CJTF)	BG Operations
Anti-Air(AAW)	Naval Force(ComNavFor)	Logistics
Anti-Submarine(ASW)	Carrier BG(CVBG)	Surveillance
Anti-Surface(ASUW)	Amphibious Task Force/Group (CATF/G)	UN Relief Operations
Information(IW)	Landing Force(CLF)	
Mine	Joint Force Air Component(JFACC)	
Special	Combat Logistics Group	
Strike	Material Support	
	Mine warfare	

Table 3.1 The Major Naval Missions to be Supported by MILSATCOM

### 3. Required Features of MILSATCOM

The objective of any MILCOM network, is to be able to maintain communications under the most unfavorable circumstances [Ref. 22]. The same idea applies to MILSATCOM, which is considered as part of an integrated communications network. In order to achieve effective and impervious MILSATCOM, specific requirements must be fulfilled . These are the following [Ref. 3]:

- Protection. All communications links must be resistant to hostile attacks. The threats can be divided into two broad categories [Ref. 22]: Physical and electronic. Physical threats can be physical impact weapons (missiles, mines), direct energy weapons (laser, particle beams) and nuclear weapons. Electronic threats can be primarily jamming of the uplink , the downlink or both, and secondly Information Warfare (IW), comprised by intercepts, intrusions and deceptions and/or by combinations of the three.
- Capacity. It becomes very important as time passes because of two reasons. Firstly, the enlargement of the number of users requires SATCOM capability from large groups of ships to the lower echelons in the battlefield. Secondly the services offered, include more bandwidth devouring applications. These consist of imagery targeting, database transfers and video. Although the near term vision of MILSATCOM encompasses some components, which will contribute, this area can be enhanced by the use of commercial assets.
- Coverage. It is very vital for MILSATCOM to provide complete coverage of the entire globe in order to support distributed forces, independent operations and ships in transit. The current and near term limitation of lack of polar coverage on behalf of MILSATCOM, can offer a field of application for commercial systems that possess this virtue.
- Access. It should be delegated to the lowest appropriate level, based on priority. Dynamic assignment of resources is also a measure of the access capability of the system.



- **Mobility.** The future US Army warfighting doctrine, concerning “AirLand Operations” [Ref. 23] foresees a smaller army than today, with three distinct characteristics: global responsibility, high mobility, and bigger battlefield dispersion. It will no longer be of vital importance to assume control over entire land masses. On the contrary, operations will require that only key positions to be held. This situation seems to be tailored for the use of SATCOM assets and in addition to this commercial MSS.
- **Flexibility.** It is the ability to dynamically trade protection with capacity. A flexible system needs multiple path availability and an open systems architecture. This other area where commercial providers can be versatile contributors to MILSATCOM.
- **Interoperability.** The ability of a specific MILSATCOM system to be able to cooperate with other DoD, governmental, allied nations and commercial systems is also vital.

### C. CURRENT AND NEAR TERM MILSATCOM SYSTEMS

The first comprehensive US MILSATCOM architecture was established in 1976 [Ref. 18]. Today MILSATCOM systems can be categorized in two ways. Firstly it is identified by its user groups and therefore, by the data rates these groups require. These groups are narrowband, wideband and broadcast [Ref. 3]. Secondly by the frequency spectra at which these systems operate. They are divided again into three **main** categories: Ultra High Frequency Fleet Satellite (UHF FLTSAT), Super High Frequency (SHF) Defense Satellite Communications System (DSCS) and Extremely High Frequency (EHF) Military Strategic and Tactical Relay satellite (MILSTAR) [Ref. 19]. The various SATCOM categories, either user oriented or frequency oriented, have an overlap in their usages. This can be perceived from the MILSATCOM overview in Figure 3.1.

Figure 3.1 Overview of Current US MILSATCOM Systems "From Ref. [3]."

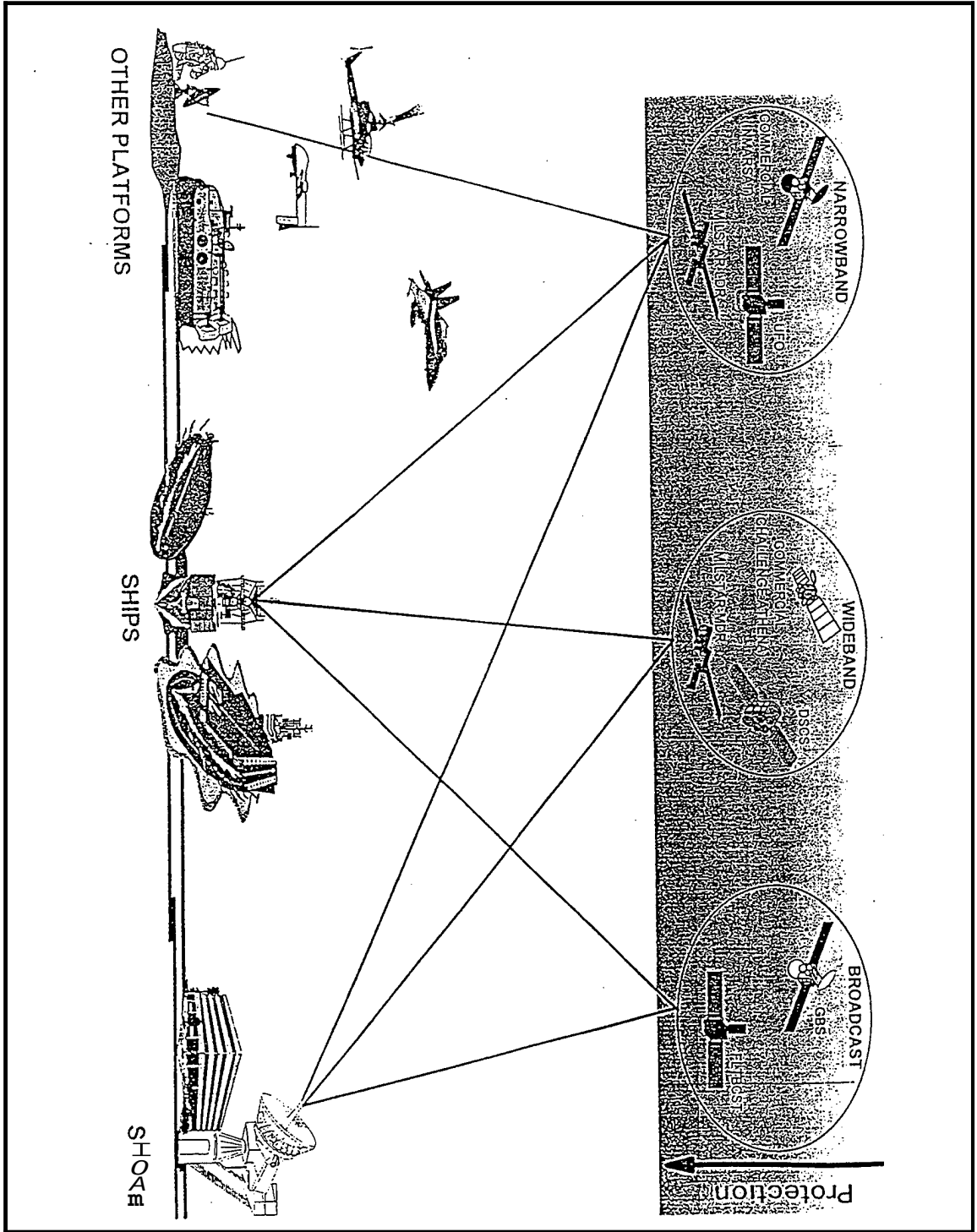

The various MILSATCOM assets are a part of the Naval Telecommunications System (NTS). NTS is controlled and monitored worldwide by the Naval Computer & Telecommunications Area Master Stations (NCTAMS) as well as the Naval Communications Stations (NAVCOMSTA) shown in Figure 3.2. NCTAMS and NAVCOMSTA are responsible, among other missions, for operations of SATCOM transmitters and receivers [Ref. 19]. In a typical NCTAMS compound the SATCOM installations are: the technical control and UHF/SHF/EHF baseband equipment, the satellite communications facility and the naval communications center.

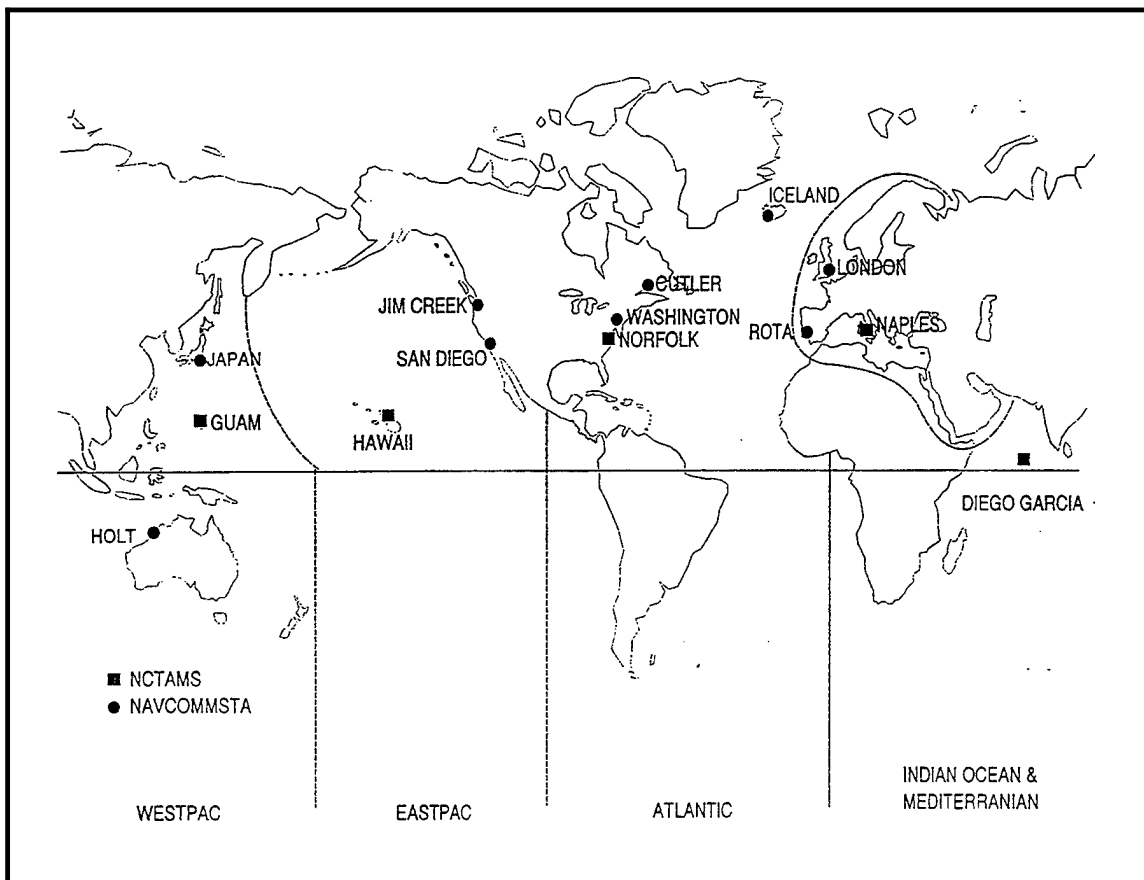

Figure 3.2 Naval Telecommunications System's NCTAMS & NAVCOMSTA and Covered Areas Worldwide. "From Ref. [19]."

## 1. Narrowband SATCOM

The purpose of narrowband SATCOM (see Figure 3.3) is to provide mobility through man-portable terminals, flexibility and tactical command control ( $C^2$ ) connectivity. It is optimized for voice channels and Low Data Rate (LDR) applications. Narrowband SATCOM encompasses all the UHF, part of EHF and some commercial assets of MILSATCOM. Descriptions of all three follow.

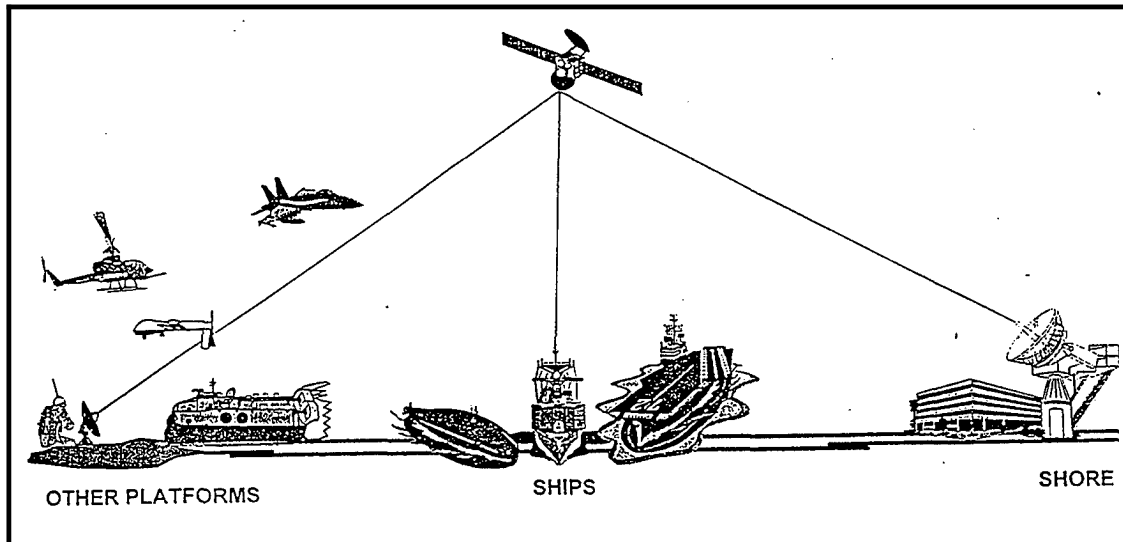

Figure 3.3 The Narrowband SATCOM “From Ref. [3].”

The UHF SATCOM constellation currently consists of a mix of four types [Ref. 21] of satellites:

- The Fleet satellites (FLTSAT). Four, 24-hour equatorial orbit, GEO satellites, built by TRW provide the FLTSAT coverage. They have coverage between 72° N and 76° S apparently with no coverage of the polar regions. The design lifetime of FLTSAT is 5 years [Ref. 19].
- The Leased satellites (LEASAT). They have been in service, since the mid 1980s. LEASAT has one 500KHz, seven 25KHz and five 5KHz transponder channels.
- The UHF Follow-On (UFO) system. This is designed to provide future SATCOM service **will** replace all current UHF assets. It is an eight satellite constellation which is planned to provide near-global coverage, between 71° N

and 71° S. It is designed to cover the Continental United States (CONUS), the Atlantic, Pacific and Indian oceans but not the poles. UFO satellites have a minimum of thirty-four 25KHz and forty-two 5KHz transponders dedicated to individual channels. This prevents mutual channel interference and allows full implementation of Demand Assignment Multiple Access (DAMA). Their mean mission duration is ten years. They also possess limited anti-jam capability [Ref. 20]. The *full* UFO constellation is expected to be operational in 1999 [Ref. 3].

- The Gapfiller satellites. They provided the initial UHF capability to the US Navy. They are at the end of their mission duration and are being replaced by LEASAT and UFO.

The EHF part of narrowband is MILSTAR-LDR. The US Navy participates in MILSTAR with the Navy EHF program (NESP). This offers *small* portable EHF terminals compatible with existing and planned payloads. The use of small terminals enables rapid mobility to crisis and conflict areas. The LDR MILSTAR transponder has a data rate of 2.4 Kbps and the capability to accommodate 15 users at one time [Ref. 19]. The transponders are interconnected and utilize onboard signal processing capability. The feature of on board processing improves the anti-jam capability of the MILSTAR satellite (see Figure 3.4).

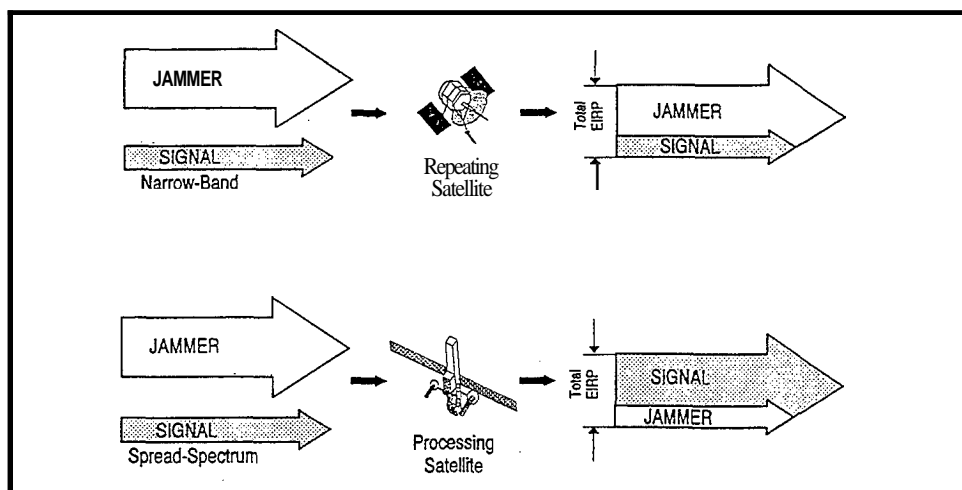

Figure 3.4 Anti-jam Capability of MILSTAR Transponder “From Ref. [19].”

The third part of narrowband SATCOM is the well known commercial provider INMARSAT [Ref. 3]. The US Navy uses the INMARSAT services to augment its tactical shipboard communications. The INMARSAT network uses eight GEO satellites and includes over 2000 Ship Earth Stations (SES) and 30 Coastal Earth Stations (CES) [Ref. 19]. Having the precedence of INMARSAT narrowband SATCOM offers a great area of opportunity for the potential application of other very promising and ambitious COMERSAT systems, especially from the family of LEO and MEO MSS.

## 2. Wideband SATCOM

The mission of wideband SATCOM (see Figure 3.5) is to provide the units afloat with the capability for applications requiring medium and high data rate (MDR & HDR), such as imagery transfer, video-teleconferencing for C<sup>2</sup> systems. Wideband SATCOM encompasses all the SHF, part of EHF and some commercial assets named “Challenge Athena” [Ref. 3].

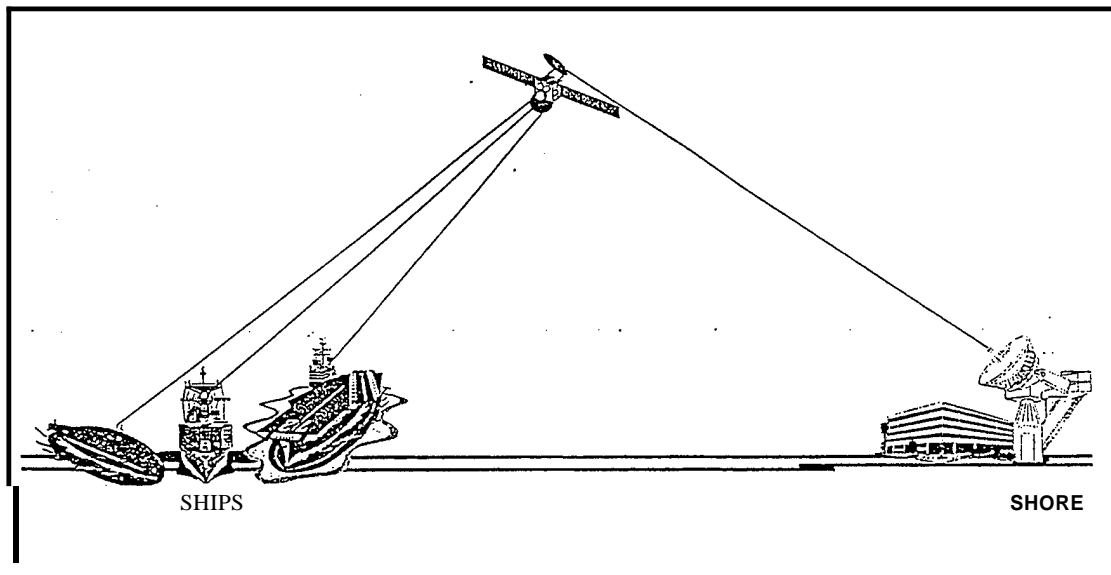

Figure 3.5 The Wideband SATCOM “From Ref. [3].”

The SHF portion of wideband is the DSCS II and III. It supports primarily strategic long-haul communications and some tactical communications. The DSCS is a tri-

service resource, administered by the Defense Information Systems Agency (DISA) [Ref. 19]. The DSCS assets are shared by DoD components as well as defense related agencies, such as National Security Agency (NSA), Drug Enforcement Agency (DEA), and the Central Intelligence Agency (CIA). The DSCS constellation consists of eight GEO satellites in 24-hour equatorial orbit. Their design lifetime is ten years. The DSCS II satellites are currently been replaced by the DSCS III version. The connectivity as well as the communications capabilities of Navy's DSCS communications are shown in Figure 3.6. Some of the characteristics of SHF are anti-jam capability, joint and

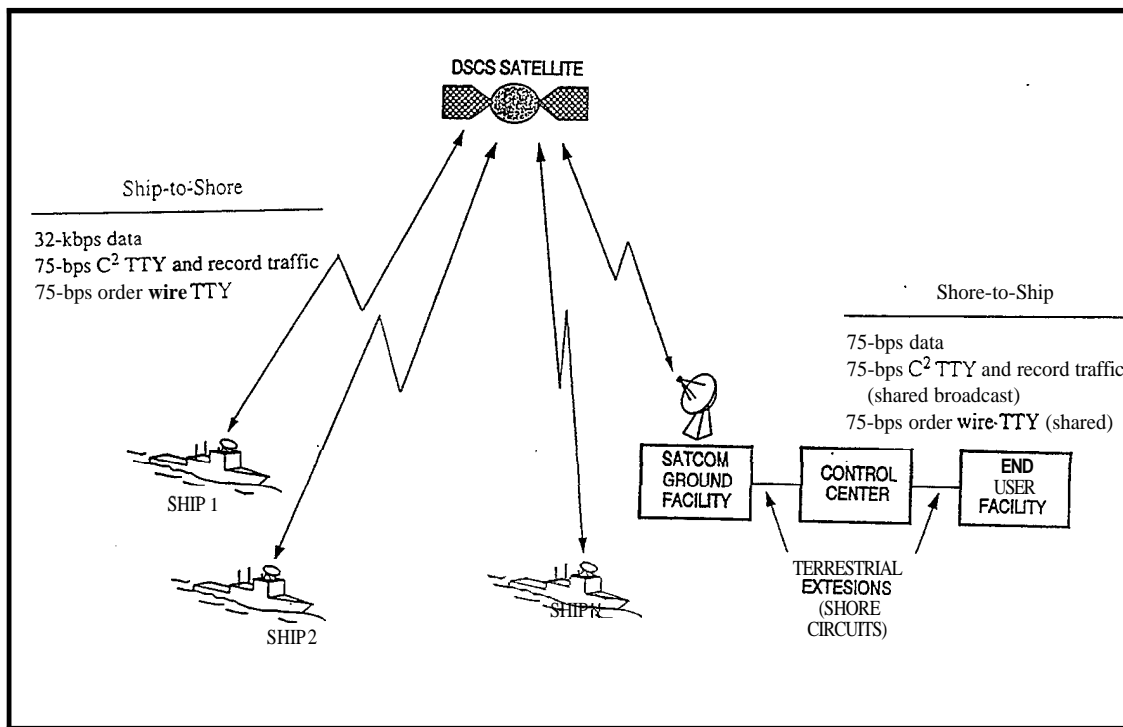

Figure 3.6 US Navy DCSC Connectivity and Capabilities “From Ref. [19].”

allied interoperability, MDR and HDR throughput and high available capacity [Ref. 3]. The DSCS constellation will be modified through the Service Life Enhancement Program (SLEP) until 2003.

The EHF component of wideband is the MDR part of MILSTAR. The only difference from LDR MILSTAR rests in the anti-jam performance of the system. Anti-jam

capability is inversely proportional to data rate, and therefore declines as we go from LDR-MILSTAR to MDR-MILSTAR [Ref. 19]. On the other hand, both systems have less vulnerability to nuclear effects compared with SHF and UHF systems due to EHF frequency use. The combined effects of absorption and scintillation will have shorter duration than at UHF and SHF [Ref. 18]. The MDR-MILSTAR transponder has a maximum through-put of 40 Mbps and the user channel data rates vary from 4.8 kbps to 1.544 kbps [Ref. 19]. The MDR-MILSTAR constellation also named MILSTAR-II is expected to be fully operational by 2002 [Ref. 3].

### 3. Broadcast SATCOM

The mission of broadcast SATCOM (see Figure 3.7) is to provide the deployed forces of US Navy with the capability of receiving large amounts of information worldwide. Broadcast SATCOM encompasses the UHF Fleet Satellite Broadcast (FLTBCST) and the Global Broadcast Service (GBS) [Ref.3].

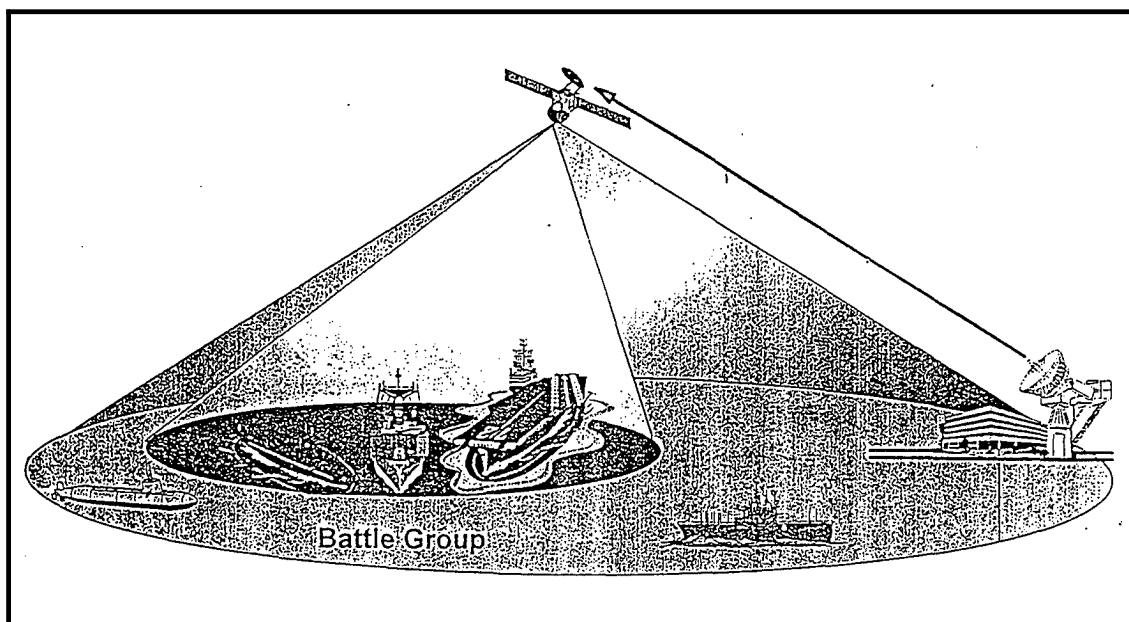

Figure 3.7 The Broadcast SATCOM “From Ref. [3].”

The FLTBCST is generally received by shipboard subscribers, on UHF channel 1 of the US Navy. This is divided into fifteen subchannels, each operating at a data rate of



75 bps. All 15 subchannels are Time Division Multiplexed (TDM) into a 1200 bps data stream. The uplink transmission (from shore stations) is performed at SHF-spread spectrum via the AN/FCS-79 terminal and the downlink at UHF via AN/WSC-5(ship receiver) with data rate 1200bps [Ref. 19]. A second channel operating on UHF both for up and down links provides a backup capability. UHF FLTBCST is used for teletypewriter equipment thus having so limited broadcast capability [Ref. 19]. Its usage will be become redundant and obsolete as the GBS program evolves in the next decade.

GBS is a DoD application' of commercially developed technology. It will be implemented by the US Navy in a three phased plan [Ref. 24] and it is going to enhance the situational and battlefield awareness of the Navy's mobile and on the move users. It will provide accommodation for high bandwidth applications such as imagery and video services. Because of its great importance for the US Armed Forces and DoD connected agencies it will be presented separately and in detail in the following chapter.

## **D. SUMMARY**

The characteristics, missions and services of US MILSATCOM systems have been reviewed in this chapter. In addition to this, the current and near term MILSATCOM systems have been presented. The communication needs of the US Armed Forces are increasing everyday, by the introduction of increased bandwidth consuming applications. Moreover, the US MILSATCOM assets will be in need of replenishment during the first decade of the 21<sup>st</sup> century. These two factors make the applications of LEO and MEO COMERSAT systems in military communications, particularly in narrow and wideband, look very attractive. Some of these systems, although planned for commercial use, possess features and capabilities which, under certain circumstances, can offer MILSATCOM a very promising alternative for the 21<sup>st</sup> century architecture.

## IV. GLOBAL BROADCAST SERVICE

### A. INTRODUCTION AND BACKGROUND

The application of Direct Broadcast Television Service (DBS TV) using sophisticated satellite and electronic technology in order to transmit video programs to its subscribers has been well developed and practiced by commercial providers over the last five years. These providers supply their customers, with Very Small Aperture Terminals (VSAT) and compact “set top” electronic interface boxes, for the reception of hundreds of video channels in their individual homes [Ref. 24].

Existing US military terrestrial and satellite communication systems are expected to be saturated in the early phases of any conflict by the enormous amount of information that has to be transmitted to the various combatant commands and units. The warfighting Command, Control, Communications, Computers and Intelligence (C4I) capability of these units is directly dependent on the ability to receive critical information products such as intelligence, weather or logistics. These products are usually composed of huge data files, therefore they require high channel capacity and data rates in order to arrive at their desired destinations in time for effective operational utilization.

Global Broadcast Service (GBS) is a DoD application of commercially developed technology. It is the idea of DBS TV modified to accommodate military purposes. It will provide near-real-time reception of imagery and data to the lowest echelons of the US Armed Forces. GBS will augment the C4I capabilities of current MILSATCOM systems by providing high speed, one-way information flow to the various military users. This, in effect, will enhance the situational and battlefield awareness of mobile users and the users on the move in land, sea or air [Ref. 25]. GBS concept of operations can be perceived from the overview in Figure 4.1.

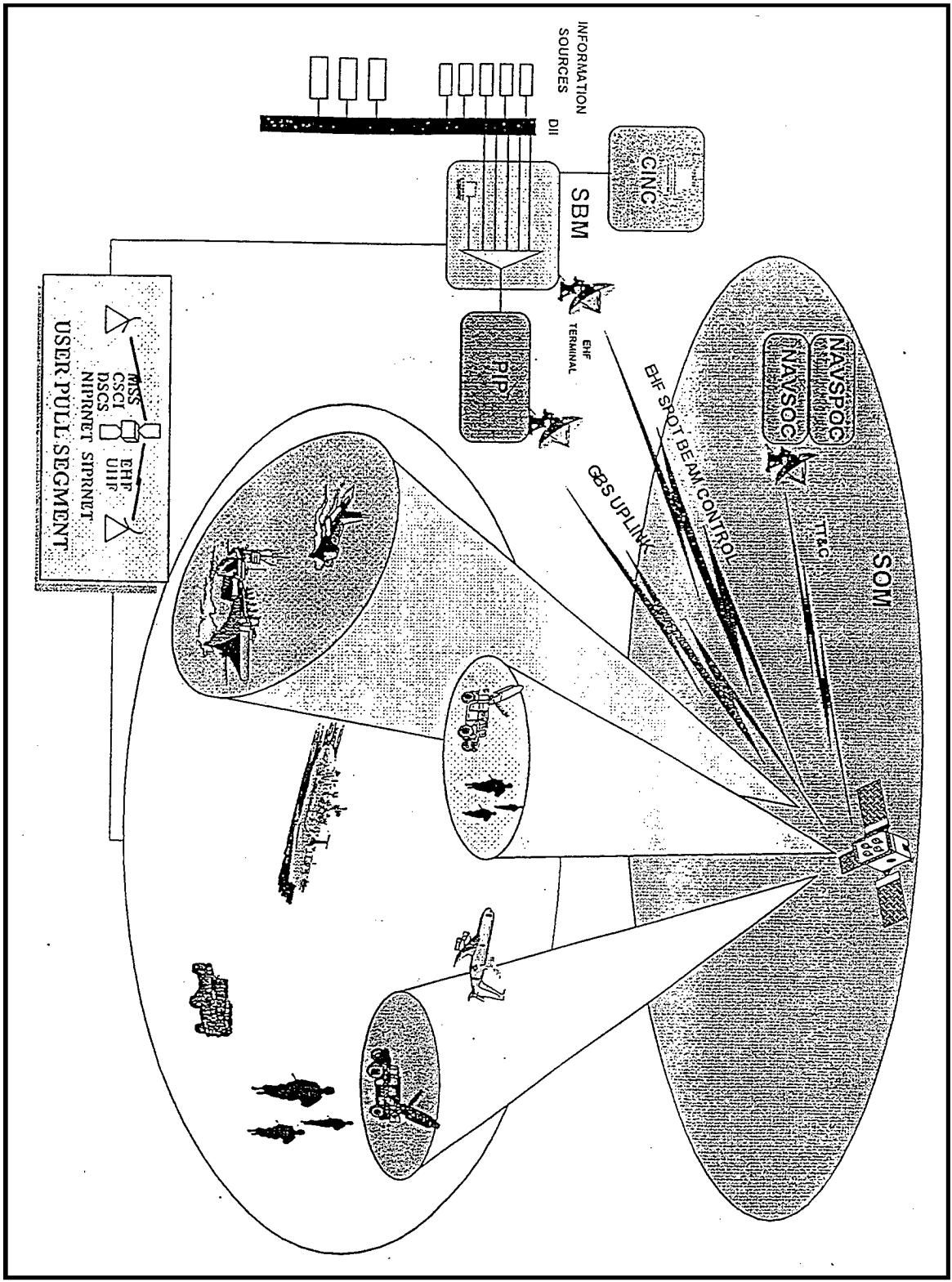

Figure 4.1 GBS Concept of Operations "From Ref. [24]."

## **B. SYSTEM DESCRIPTION AND IMPLEMENTATION**

GBS is going to be implemented by the US Armed Forces in a three phased plan [Ref. 24]. This plan is currently underway and evolving daily as operations proceed and GBS users get an initial hands on experience with the project [Ref. 24]. The prescribed approach is to provide the greatest capability as rapidly as possible with follow on expansion in order to meet the everyday growing needs of the Navy. In addition to this, the GBS concept, although a vital component of the 21<sup>st</sup> century MILSATCOM architecture, does not prejudice the outcome of this architecture.

The Limited Demonstration, the Interim Military Satellite Capability and the Objective System [Ref. 24] comprise the three phases of the plan and are discussed in detail below.

### **1. Phase I or Limited Demonstration Phase**

**This** phase was initiated in 1996 and is planned to end in 1998. It entails the following [Ref. 24]:

- Inaugural acquisition of commercially leased capacity on Continental US (COWS) satellites in order to support selected exercises and concept of operations development.
- Initial acquisition of the future space, ground and user segments.
- Determination of products and applications which best suit the navy commanders requirements.
- Information management tools and algorithms development and refinement of the initial concept of operations [Ref. 24].

Phase I is composed of two components [Ref. 25]. The first one is the “GBS Testbed”. It is operated by the Defense Information Systems Agency (DISA) and managed by US Space Command (USSPACECOM) The uplink facility, which is also the Broadcast Management Center (BMC) is located in the Pentagon. This is performed by leased capacity on Continental US (COWS) satellites, for support of selected exercises

and demonstrations, by the use of Ku-band spot beams. The coverage area of the “GBS Testbed” is the CONUS and the Hawaiian Islands [Ref. 25]. It is focused on the concept of operations development as well as tests and evaluation.

The second part is the “Joint Broadcast Service (JBS)” for the support of the European Command (EUCOM) based in Stuttgart, Germany. It is a part of the Advanced Research Projects Agency (ARPA)/DISA Bosnia C<sup>2</sup> augmentation initiative (see Figure 4.2). It also is transmitted from the BMC in the Pentagon through leased satellite capacity. **JBS** has two Information Management Centers (IMC). The Joint IMC (JIMC) in the Pentagon and the EUCOM IMC(EIMC) in Stuttgart, Germany. In addition to this, **JBS** has a Theater Injection Site (TIS). TIS also has broadcast capability and is the predecessor of the Theater Injection Points of GBS phase II. The coverage area of JBS is the European Continent. Its missions consist of the dissemination of Unmanned Aerial Vehicle (UAV) video, CNN, Operations Intelligence (OPS/INTEL) data as well as Moral Welfare and Recreation (MWR) programs. The receivers are positioned in several ground facilities in Bosnia, Hungary, Italy and United Kingdom, as well as onboard several US Navy ships. The deployed node of the **JBS** configuration contains the following three parts:

- A VSAT antenna one meter in diameter.
- The JBS communications rack with one TV and VCR, which are capable of receiving and recording up to four video channels, as well classified data from **JBS** such as imagery, Signals Intelligence (SIGINT), maps, weather and logistics information.
- An information sever with 60 Gbytes capacity.

The data rate offered for phase I is 23 Mbps [Ref. 25]. The satellites used are two GEOs: the Orion which disseminates the **JBS** broadcast warfighting C<sup>2</sup> information and intelligence to the nodes and the INTELSAT 602 which is responsible for the high bandwidth secure Internet with the deployed and rear echelon nodes.

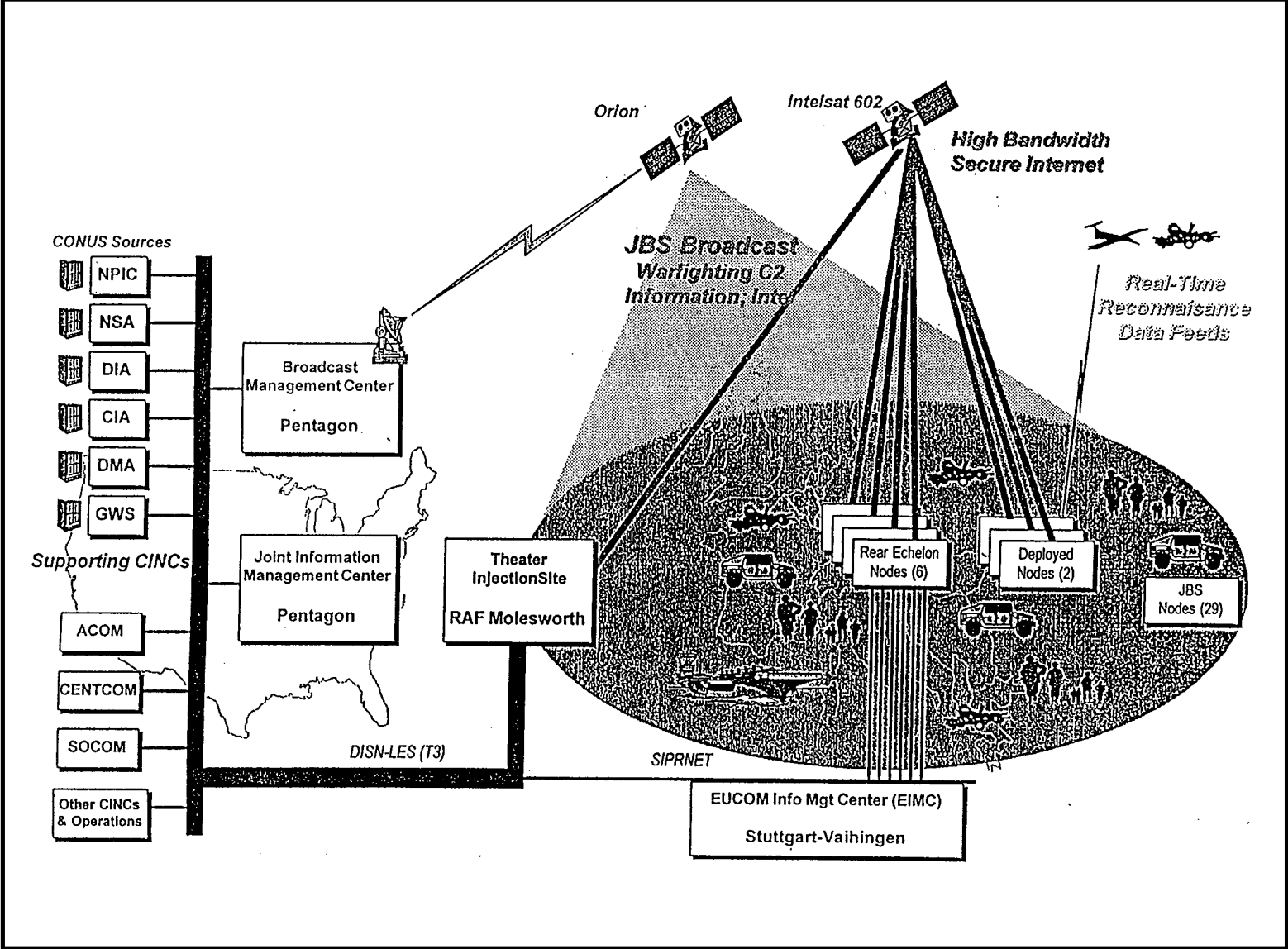

Figure 4.2 Bosnia C<sup>2</sup> Augmentation System "From Ref. [25]."

## 2. Phase II or Interim Military Satellite Capability Phase

This phase starts in 1998 and is estimated to end in 2006 [Ref. 25] although the end of this phase was initially planned for 2000 [Ref. 26]. Phase II entails the following:

- Initial placing of GBS packages in UHF Follow On (UFO) GEO satellites 8<sup>th</sup>, 9<sup>th</sup>, and 10<sup>th</sup>.
- Acquiring user terminals and information management systems.
- Integration of GBS with Defense Information Infrastructure (DII)
- Complete connectivity of the various providers of high volume information.

**An** overview of the GBS on UFO configuration is shown in Figure 4.3. The primary feature of phase II will be the Commander-in-Chief (CINC) responsive broadcast management [Ref. 26]. CINC's will be able to transmit broadcast services for units in the field. These services will contain standard products and theater tailored information as they become available. This is the concept of "Smart Push" broadcast from the CINC to the field units [Ref. 26]. Another characteristic of GBS phase II will be the "User Pull" concept. Users will process their information requests to the appropriate CINC, via MILSATCOM paths other than GBS and receive the information through GBS products. This GBS capability for "Smart Push" and "User Pull" provides the in-field warfighting units with enormous information warfare potential at a near "real time" response.

The representative broadcasts offered by GBS will be warning, intelligence, operations, administrative, logistical, medical, education, training, weather, mapping, software updates, commercial news services and quality of life programs. In addition to these, especially for USN deployed forces, common tactical picture, theater missile defense picture, target updates, Air Tasking Orders (ATO), theater map updates, message traffic and imagery for targeting can also be disseminated via GBS. A deployed Army or Marine Air Ground Task Force (MAGTF) unit can benefit from GBS broadcast products by the reception of warning, tactical picture, ATO updates, theater map updates, intelligence, imagery, tactical UAV products, weather, logistics data bases, and medical information.

Figure 4.3 The GBS on UFO(Phase II) Configuration "From Ref. [25]."

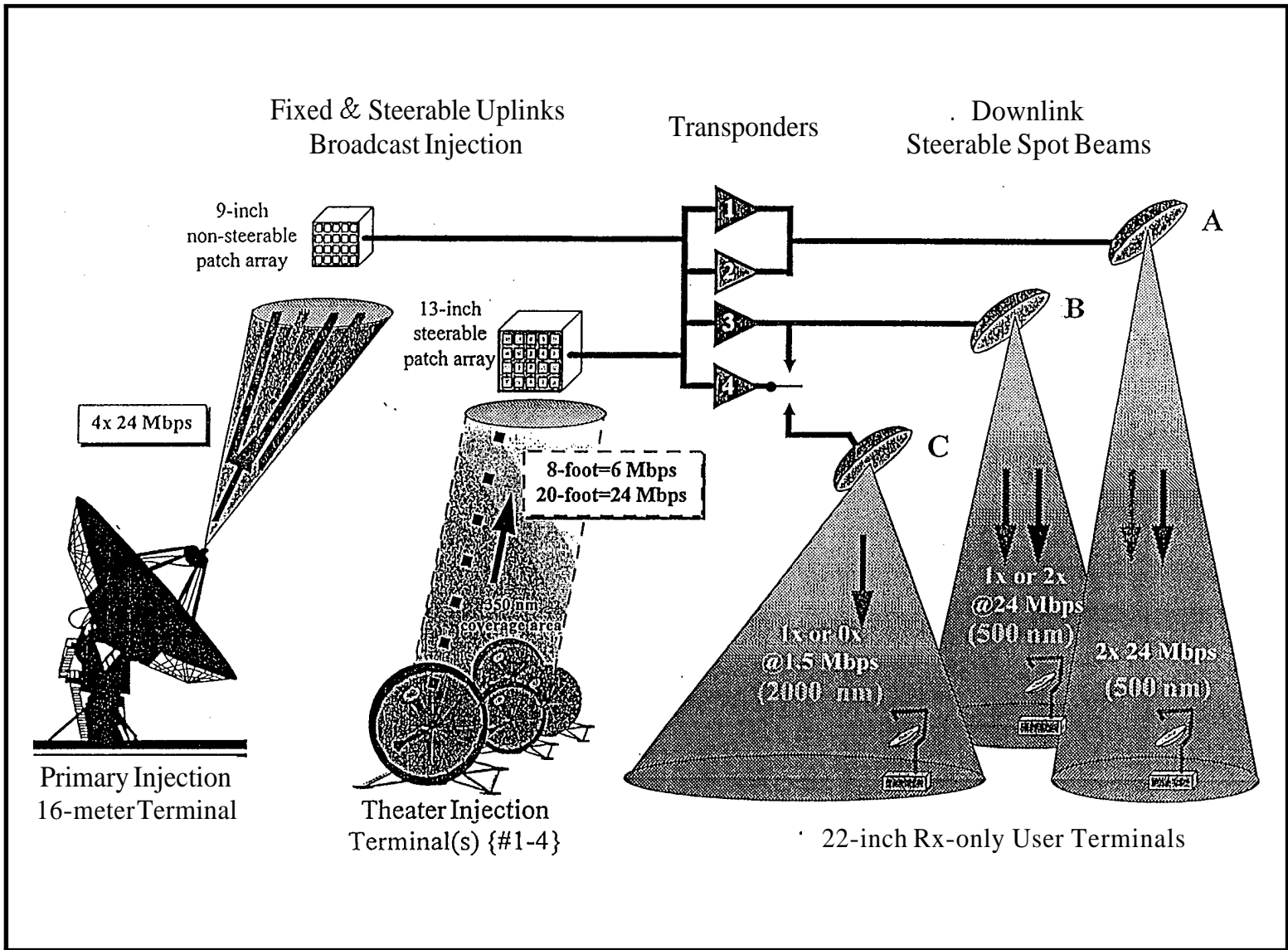



a. *Phase II Space Segment*

The space segment for the second phase consists of the GBS/UFO satellites 8<sup>th</sup>, 9<sup>th</sup> and 10<sup>th</sup> a satellite control element and leased commercial satellite services [Ref. 26]. The GBS/UFO satellites (see Figure 4.4) will be of the GEO family, with an inclination of 6 degrees and a design life of 14 years [Ref. 24].

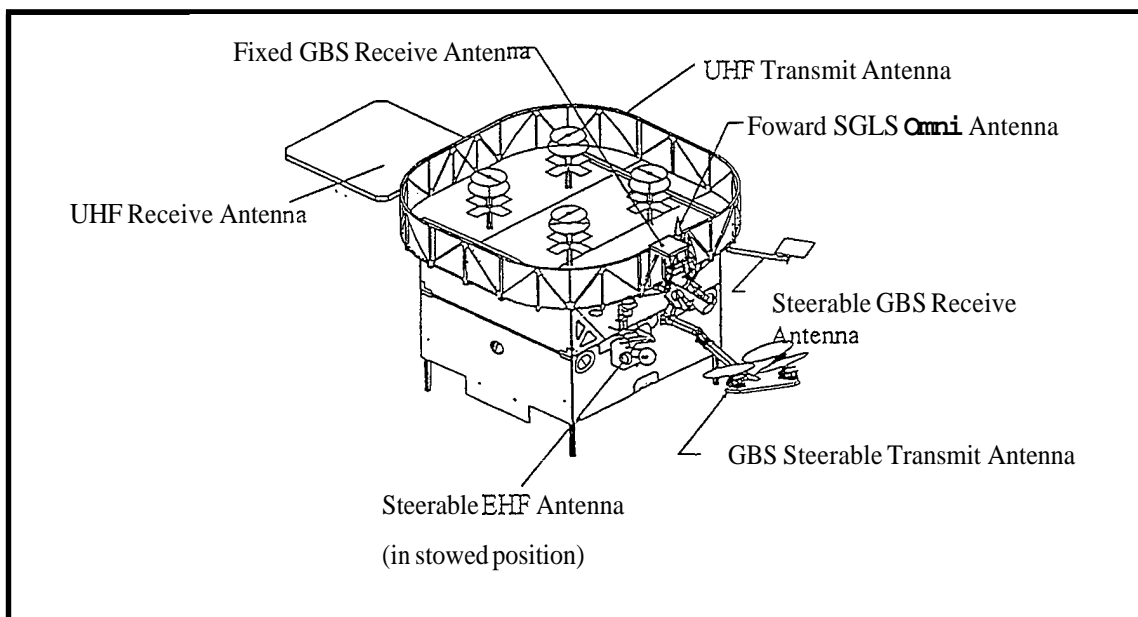

Figure 4.4 The GBS/UFO Satellite “From Ref. [25].”

The payload of the GBS/UFO satellites will consist of the following parts and characteristics:

- One fixed uplink patch receive array with minimum  $G/T$  of  $-2.25 \text{ dB/K}$  and  $2.2^\circ$  full angle beamwidth.
- One steerable uplink patch antenna with minimum  $G/T$  of  $1.75 \text{ dB/K}$  and  $0.9^\circ$  full angle beamwidth. Uplink frequencies for both antennas are 30.095, 30.215, 30.275 and 30.395 GHz Right Hand Circularly Polarized (RHCP).
- Three steerable spot beam downlink antennas. They will have one 2000 Nautical Miles (NM) diameter, wide area beam at a data rate 1.5 Mbps and two 500 NM diameter, spot beams at 24 Mbps each. The downlink

frequencies are 20.295,20.415, 20.475 and 20.595 GHz. The antennas will be controlled either through EHF or T&C protocols.

The conceptual coverage area of GBS phase II is shown in Figure 4.5.

- Four 130 Watts transponders which will have a minimum narrow beam downlink EIRP of 53.2 dBW each. They will also be equipped with configurable uplink antenna-transponder and fixed transponder-downlink antenna mappings.
- “Bent pipe” operation. No demodulation or signal processing will take place onboard the spacecraft. The received uplink signals **will** be converted to the downlink frequency and retransmitted through the appropriate spot beam to the users.
- It will not be hardened and it will also be appropriate for UFO satellite operations.

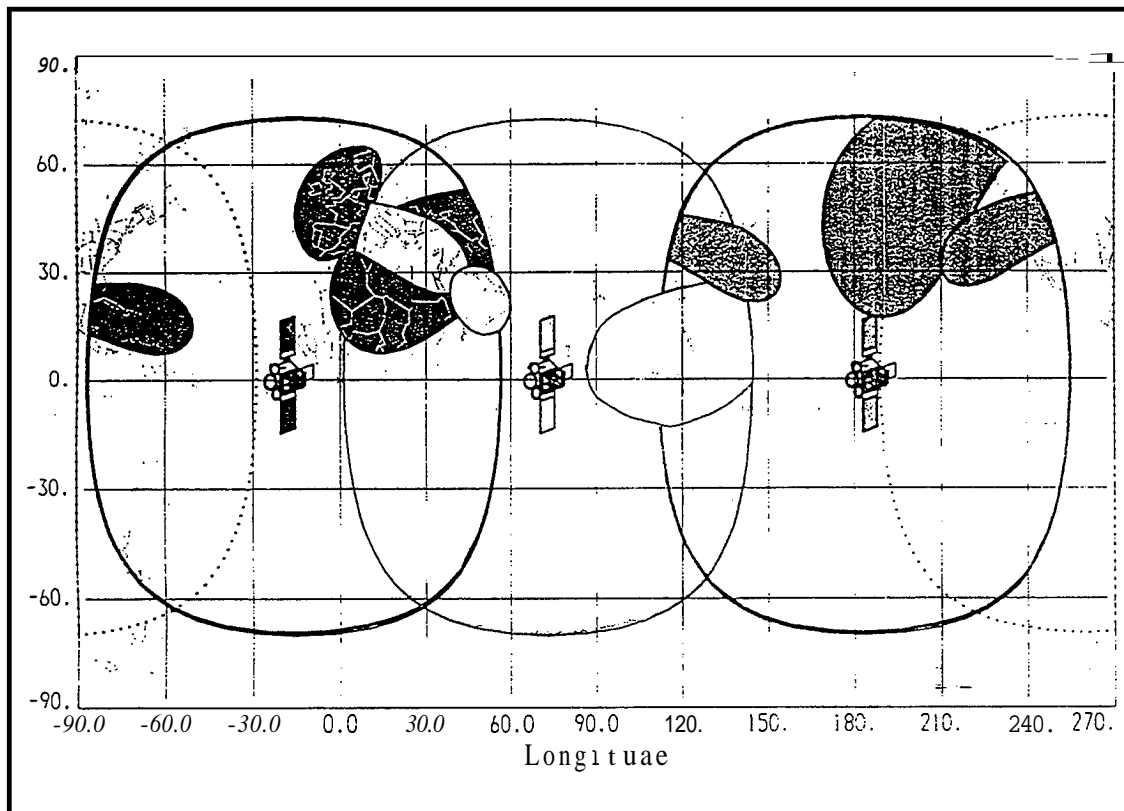

Figure 4.5 The GBS/UFO (Phase II) Coverage “From Ref. [25].”

*b. Phase II Broadcast Management Segment*

The GBS management segment consists of two major elements. These are the Transmit Broadcast Management (TBM) element and the Receive Broadcast Management (RBM) element. The TBM function is to construct and process the broadcast data streams and also manage their forwarding to the appropriate injection points in order to be transmitted via the GBS satellite to the users. It will maximize the in-orbit capabilities to include uplink and downlink beam steering and transponder configurations [Ref. 26]. The spot beam control is scheduled to possess the ability to re-point the beam in 30 minutes [Ref. 24]. Finally the TBM will contain a Global Broadcast Coordinator (GBC) which will manage and provide system level status, monitoring and performance characteristics of the GBS operations worldwide [Ref. 26].

The RBM function is to support the information dissemination from the receiver terminal to the user's receive suite. The RBM will, in essence, be inside this receiver suite [Ref. 26].

*c. Phase II Terrestrial Communications Segment*

The Terrestrial Communications Segment (TCS) is the link between the Primary Injection Points (PIP), TBM, major Defense Information System Network (DISN) nodes and other government networks [Ref. 26]. It will support the data transfer from the information sources to the TBM and uplink elements.

*d. Phase II Terminal Segment*

The Terminal segments consists of the following three elements:

- Primary Injection Points (PIP). It will be equipped with a 16 meter diameter parabolic antenna dish which is able to transmit four uplink beams at a data rate of 24 Mbps each [Ref. 25]. All PIPs will be fixed facilities and will be located inside existing military installations. There will be three PIPs, each one geographically inside the footprint of each GBS/UFO satellite [Ref. 26].

- Theater/Tactical Injection Points (TIP). They will be equipped with one to four antennas. They will have an 8 or 20 feet diameter with data rates of 6 and 24 Mbps respectively [Ref. 25]. They are planned to be fielded in tactical Echelons Above Corps (EAC). The number of planned TIPs for phase II is three.
- Receiver terminal element. It will be equipped with a 22 inch diameter parabolic dish antenna [Ref. 25], Low Noise Block (LNB) converter-amplifier and a demodulator decoder. The receiver terminal element will be fielded in six different configurations: a Non-ruggedized Ground Receive Terminal (GRT), a ruggedized GRT, a Shipboard Receive Terminal (SRT), a Sub Surface Receive Terminal (SSRT), an Airborne Receive Terminal (ART) and finally, a man-portable configuration for use in covert and Special Operations (SO) [Ref. 26].

### 3. Phase III or Objective Phase

Phase III spans beyond 2006. It will provide the total GBS solution and is planned to field a minimum of five satellites with twelve transponders per satellite, seven steerable spot beams, and a data rate of 270 Mbps for each satellite [Ref. 25]. The actual form and size of the GBS space segment and corresponding ground segment is yet to be determined through the DoD Space Architect's study and in cooperation with the GBS program office [Ref. 26]. The primary objective features of phase III will be:

- Full earth coverage and worldwide broadcast capability. The conceptual coverage of phase III is shown in Figure 4.6. The steerable spot beams are expected to have 400 and 1000NM diameter.
- Complete acquisition of space, ground and user segments as well as ARTs. It is planned to provide TIPs down to *Corps* signal brigades as well as to division signal battalions.

- Complete integration with the DISN, Global Command and Control System (GCCS) and other intelligence broadcast and theater information management systems.

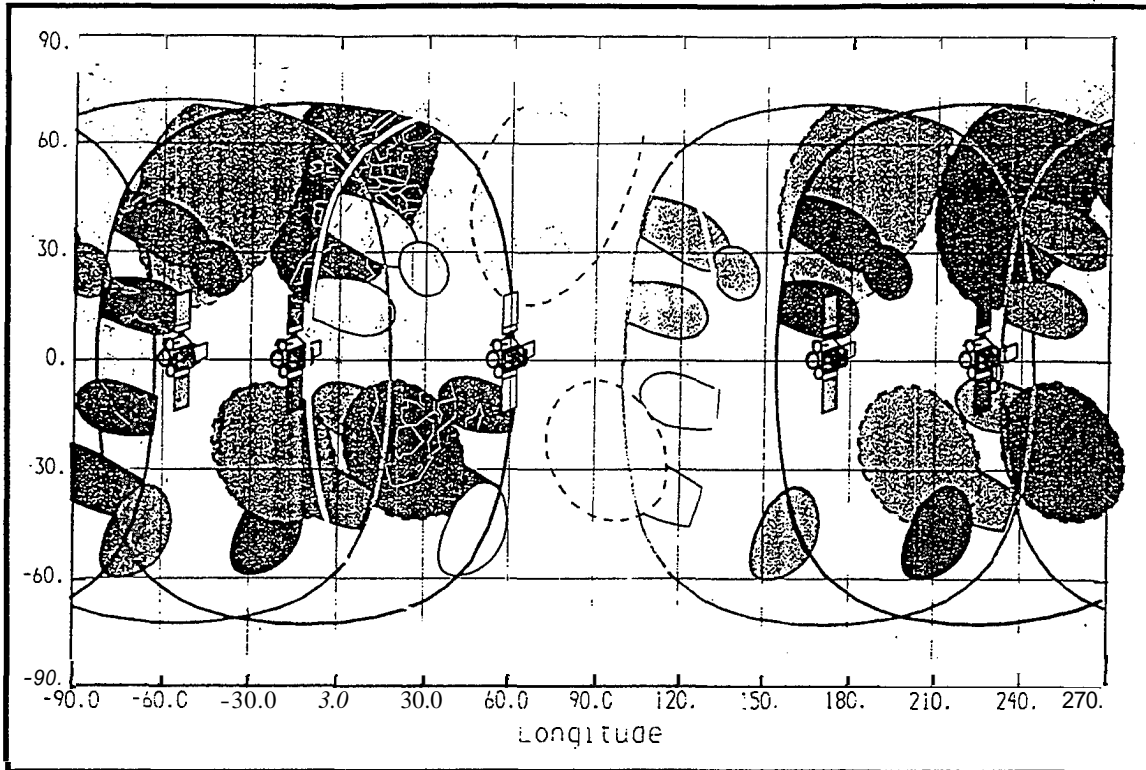

Figure 4.6 The GBS Phase III Conceptual Coverage “From Ref. [25].”

### C. SUMMARY

GBS is a commercially developed technology for accommodating Broadcast MILSATCOM missions and purposes in the 21<sup>st</sup> century. The basic characteristics are high power and data rate satellites as well as VSAT technology receive equipment. It will offer the US Armed Forces, and the USN in particular, smart delivery of information in order to bridge the USN situational awareness and operational effectiveness gaps [Ref. 25].

## V. THE COMMERCIAL ALTERNATIVE

### A. INTRODUCTION

This chapter explores the concept of providing part of the needs of MILSATCOM with COMERSAT LEO and MEO Personal Communications Services (PCS) systems or Mobile Satellite Systems (MSS) by which they are also known. It is not an undertaking to apply a commercially based technology like the GBS project described in chapter 4. On the contrary, it is the military application of the MSS themselves. Satellite based PCS systems possess the capability, under certain circumstances, to satisfy the communication needs for military “on the move” and “mobile” users. The employment of COMERSAT PCS by military users will offer them three major advantages [Ref. 27]. Firstly, the transfer of traffic from military to commercial systems will **free** up the capacity of the former. This, in effect, will enable the military systems to accommodate the needs of a larger number of tactical users. Secondly, the cost of use, although **initially** high, will be gradually reduced due to the competitive nature of COMERSAT PCS systems. Thirdly, the MILSATCOM will benefit from the use of state of the **art** commercial technology. Combining these three advantages with the need for replenishment of the US MILSATCOM during the first decade of the 21<sup>st</sup> century, makes the application of COMERSAT PCS to military communications very attractive.

The perceived issues/criteria associated with COMERSAT as applied to military communications are examined, as well as areas in which commercial systems can be valuable. A comparison of commercial LEO and MEO systems under investigation, in accordance with these issues/criteria, is attempted in order to offer a “complete picture” description. As a conclusion to this comparison, the commercial alternative, model architecture is outlined.

## **B. ISSUES/CRITERIA ASSOCIATED WITH COMERSAT USE IN MILITARY APPLICATIONS**

The objective of this chapter is to produce a model architecture for the needs of MILSATCOM comprised, mainly, by commercial LEO and MEO MSS. Therefore, the systems under investigation need to be compared with each other using issues/criteria suitable for military communications applications. The perceived issues/criteria associated with COMERSAT in military communications applications are: systems availability, capacity/grade of service, interoperability, vulnerability/anti-jam protection, security, Low Probability of Intercept/Low Probability of Detection (LPI/LPD), coverage, conference service limitations [Ref. 27], terminal and service costs, mobility, flexibility, signal quality, systems control [Ref. 2].

### **1. Systems Availability**

Globalstar, Iridium and Odyssey are planned to be available after 1988 to after 2000 [Ref. 2] though they are not yet completely financed. **ICO** will be operational in 2000 and appears to be a strongly founded and viable project backed by many countries [Ref. 14]. The latest information about Teledesic suggests that it **will** be scaled back from its original configuration of 840 LEOs to 288 LEOs at higher orbit. After undergoing its final refinement which emerges from the Boeing-Teledesic coordination, Teledesic is more likely to be operational by 2002 [Ref. 28]. The modification in the Teledesic space segment is not expected to affect the rest of the project, as summarized by H. Stelianos [Ref. 2] for the "Internet in the Sky" concept, given the fact that Teledesic has recently acquired the FCC license for its operational deployment. The FCC license for Teledesic was issued on March 1997.

The above facts make **ICO** the first choice with regard to availability with the remainder of the systems following after it.

## **2. Capacity/Grade of Service**

DoD requires assured and reliable service priority and information exchange for its users[Ref. 17]. During a crisis, military users may get busy signals due to increased demand for service, which exceeds the nominal capacity of a given MSS. In order to avoid service degradation, military COMERSAT PCS users need to have the capability of a priority service provisioning, through a special signaling channel[Ref. 27]. Capacity is another relevant parameter, which is inversely proportional to service degradation. Teledesic places first in the capacity requirement with 100,000 full-duplex, basic-16 kbps connections per satellite. Having the 16 kbps channel as the basic, Teledesic can offer up to 2.048 Mbps and 1.244 Gbps [Ref. 2]. This capacity makes Teledesic the one and only candidate for the wideband portion of MILSATCOM. In the narrowband family, ICO again assumes the first place with 4,500 channels per satellite, with data rates from **4.8** to 9.6 Kbps. In addition to this, ICO possesses the Global System for Mobile communications (GSM) specifications for high priority users, which can **fulfill** the service degradation requirement[Ref. 17]. Odyssey and Globalstar follow with 3,000 and 2,400 channels per satellite, respectively [Ref. 29], with power limited Iridium coming last with only 1,100 channels [Ref. 2]. A complete presentation/evaluation of the five MSS's data rates follows in subsection B. 12 of this chapter.

## **3. Interoperability**

Interoperability between different PCS systems is a highly desired capability, especially for military users. However, it is cumbersome to achieve due to the nature of independent development of these systems [Ref. 27]. This happens because all service providers want to protect their systems' proprietary information. Code Division Multiple Access (CDMA) based systems, such as Globalstar and Odyssey, can theoretically interoperate over each others satellite, but the differences in their technology will make the cost for a single receiver a non-permitting parameter [Ref. 27]. On the other hand, systems supported with Personal Computer Memory Card International Association (PCMCIA) compatibility such as ICO can prove more flexible in the interoperability' challenge. DoD, as well as future PCS military users, such as United Nation peacekeeping forces, will need



an approach such that a multi-mode terminal be available at no additional cost. The Teledesic vehicle mounted terminal is envisioned as a present laptop computer, so it is assumed to have PCMCIA compatibility; a feature which is a current standard for all laptop computers.

#### **4. Vulnerability and Anti-jam Protection**

Not one of the five MSS under investigation is designed to defend itself against intentional jamming. Anti-jam protection is a major issue for every MILSATCOM system. The more sensitive part of a satellite link is considered to be the uplink. Intentional jamming of the uplink by an adversary can render the “user community” without any communication link [Ref. 2]. Spread spectrum techniques, particularly CDMA, can offer a level of anti-jam capability. As already mentioned, Globalstar and Odyssey configurations are equipped with CDMA [Ref. 2]. Another feature which could enhance the anti-jam protection is the intersatellite links. Teledesic and Iridium will be equipped with such links [Ref. 2]. On the other hand, the concept of a transportable DoD operated gateway, not needed in the vicinity of a tactical operation, and placed in a relatively safe backstage location, could prove to be the most preferred solution for this problem [Ref. 27]. ICO will be able to provide global system access, independent of the regional communications infrastructure via dedicated circuits and/or a DoD operated, gateway [Ref. 17].

On board processing is another feature that enhances the anti-jam capability (see figure 3.4) of a processing satellite compared to a repeating satellite [Ref. 19]. Teledesic, ICO and Iridium are equipped with on board processing techniques while Globalstar and Odyssey are not [Ref. 29].

#### **5. Security**

DoD requires Secure Telephone Unit-111 (STU-III) compatibility for any PCS system that is going to be used for military communications [Ref. 17]. This is an encryption algorithm meant to be incorporated into any PCS receiver. Security is an issue of major concern for all PCS users whether in the military domain or not [Ref. 27]. A

traditional threat example that applies to PCS is the “masquerade attack”-during which an unauthorized adversary pretends to be one of the authorized users, thus gaining access to the communications network and performing his information warfare sabotage [Ref. 27]. Secure network access can be accomplished by standardized authentication procedures both in national and allied levels. Teledesic possess a low-level, user authentication function [Ref. 2].

Security procedures for data and messaging services, can be implemented through the National Security Agency (NSA) cryptographic algorithm Multilevel Information Systems Security Initiative (MISSI). This is a low cost method to protect unclassified but sensitive messaging for the Defense Messaging System (DMS). MISSI is implemented through the Fortezza crypto card, which is a portable cryptographic module based on PCMCIA standard configuration [Ref. 27].

Globalstar, Iridium, Odyssey and Teledesic do not support, up to this moment, either STU-111 or PCMCIA compatibility. On the other hand the ICO handset will be able to support STU-III as well as Fortezza crypto requirements through the multiple slot allocation and PCMCIA card features respectively [Ref. 17].

## 6. LPI/LPD

LPI/LPD is another vital requirement for all MILSATCOM systems including MSS. These two coupled issues are related with the coverage as well as the waveform used by any MSS [Ref. 27]. **An** MSS can offer worldwide connectivity to mobile users and “users on the move”, however this feature can make these users very vulnerable if their transmissions are “triangulated” by an adversary. **An** investigation on LPD performed by ATT calculated probability of detection for Iridium and Teledesic up to 90%. On the other hand, CDMA based systems, like Globalstar and Odyssey can achieve only limited signal detection because of the spread spectrum technique they use for their signals [Ref. 2]. Teledesic, Iridium and ICO do not possess an LPI/LPD capability of any kind due their primary commercial nature.

A factor affecting LPI/LPD is the average transmitted power from the handheld receiver of each MSS. ICO has the smallest power at 0.25 W, Iridium at 0.34 W, Odyssey

at 0.5 W and Globalstar at 0.7 W [Ref. 17]. Naturally the wideband Teledesic, comes last with 4.70 W [Ref. 29].

### 7. Coverage

The DoD requirement for satellite coverage is 90° north to 65° south latitudes and intuitively all longitudes, 24 hours a day for seven days a week [Ref. 17]. This requirement is imposed in order to administer the newly introduced US Army warfighting concept of "AirLand operations" which envisions a much larger battlefield with smaller, more effective and dispersed forces [Ref. 23], as well as the USNs "Operational Maneuver from the Sea" and "Forward from the Sea" missions [Ref. 32]. Moreover the MILSATCOM must be capable to support joint operations ranging from peacetime engagements to war [Ref. 2]. Thus the coverage capability of any MSS becomes a driving factor in its evaluation for a military application. The satellite coverage of the five commercial MSS under investigation is shown in Table 5.1 below and the resulting conclusion about coverage superiority is self-evident. The information is derived from References 2 and 17.

	Mobile Sat. System	North Latitude	South Latitude
1	ICO	90"	90"
2	Iridium	90"	90"
3	Globalstar	74"	74"
4	Teledesic	72"	72"
5	Odyssey	70"	55°

Table 5.1 Satellite Coverage of Commercial MSS

## **8. Conference Service Limitations**

Many current DoD operations are supported by means of UHF SATCOM conference networks. Military users are equipped with push-to-talk (PTT) radios. A “push” on the microphone activates the transmit carrier to allow all others to listen. This service can decrease costs by allowing the sharing of one channel among several users [Ref. 27]. Network discipline is required in order to avoid two users occupying the channel at the same time. DoD also requires “call priority determination” as well as priority service provisioning for all military users [Ref. 17].

Iridium, Globalstar, Odyssey and Teledesic do not possess a conference service feature [Ref. 27]. On the other hand, ICO has access control and call prioritizing features imposed by the GSM specifications of multiple access levels for high priority users [Ref. 17].

## **9. Terminal and Service Costs**

Competition for customers is an inherent feature of every commercial service provider which applies directly to the COMERSAT PCS market. This competition comes in direct analogy with terminal as well as service charges. On the other hand, one can argue that cheaper is not always better, but under today’s **diminishing** Defense budgets, not only in the US but also worldwide, cost is constantly a factor of concern for the military systems engineer. After all, the need of a cheaper alternative to a totally owned thus more expensive DoD MILSATCOM is one of the driving elements of this research.

The *terminal* acquisition cost, the service charges per minute and the monthly service charge of the five MSS under investigation are presented in Table 5.2. Information comes from References 2, 17 and 30. All amounts displayed are estimated in \$ US.

	<b>Mobile Sat. System</b>	<b>Terminal Cost (US Dollars)</b>	<b>Per Minute (US Dollars)</b>	<b>Per Month (US Dollars)</b>
1	<i>ICO</i>	1000	0.45/USA 2/International	40
2	Teledesic	500-1000	0.25/USA 3/International	N/A
3	Globalstar	250-750	0.30/USA 1.5/International	23.6
4	Odyssey	450	0.65/USA TBD/Intern.	24
5	Iridium	2000-3000	0.30/USA 3/International	50

Table 5.2 Terminal and Service Costs of Commercial MSS.

### 10. Mobility

The above satellite based PCS systems will offer endless communication mobility to their users [Ref. 2]. The 21<sup>st</sup> century vision for the deployment of military forces emphasizes the issue of mobility. The future warfighter needs to be equipped with small sized, powerful terminals that will offer the ability of communicating continuously and effectively while being either “on the move” [Ref. 9] or “mobile”. These terminals are envisioned to be equivalent in size with today’s cellular phones [Ref. 16]. All proposed five MSS will possess this capability, although the Teledesic terminal will not be handheld but vehicle-mounted [Ref. 27].

### 11. Flexibility

The DoD flexibility requirement for satellite based systems is to be able to provide military users connectivity with Public Switched Telephone Networks (PSTN), Public Land Mobile Network (PLMN) and Defense Information System Network (DISN). Iridium, Teledesic, Globalstar and Odyssey possess the capability of connection

with PLMN and PSTN through gateways and dual mode terminals respectively [Ref. 2]. In addition to these ICO possess the potential capability of DISN connectivity, although this feature is not currently implemented [Ref. 17].

## 12. Signal Quality

The above five MSS systems, plan to offer high signal quality services. Teledesic will offer multimedia services while the other four will offer voice, facsimile, paging and messaging services [Ref. 2]. The typical Bit Error Rates (BER) as well as the supportable data rates for voice and data are displayed in Table 5.3. Information is taken from references 2, 17 and 30.

	Mobile Sat. System	Bit Error Rate		Data Rates in Kbps	
		Voice	Data	Voice	Data
1	Teledesic	$10^{-9}$		16	16-2,048
2	ICO	$10^{-4}$	$10^{-4}$	4.8 handheld >9.6 fixed	4.8 handheld >9.6 fixed
3	Globalstar	$10^{-3}$	$10^{-5}$	4.8	2.4-9.6
4	Odyssey	$10^{-3}$	$10^{-5}$	4.8	2.4
5	Iridium	$10^{-2}$	$10^{-3}$	4.8	2.4

Table 5.3 Signal Quality Features of Commercial MSS.

## 13. Systems Control

Teledesic, Globalstar, Iridium and Odyssey are owned and operated by US companies [Ref. 2]. ICO is owned by a multinational company in which the US is represented by Hughes with 0.838% and COMSAT with 6.609% of the ownership [Ref. 14]. It can be argued that DoD cannot have control of these systems when it is needed. On the other hand, multinational cooperation and agreement is of vital importance when

global military action is underway. The recent example of the “Persian Gulf War” multinational alliance offers a perfect paradigm for this course of action.

### **C. MILSATCOM FUNCTIONS FOR COMMERSIAL MSS APPLICATIONS**

The MILSATCOM requirements are categorized by various sources differently. A LORAL team in 1993 divided the MILSATCOM traffic according to these requirements into two broad categories. These were the “Core” and “General Purpose”, comprising 2/3 and 1/3 of the traffic respectively [Ref. 31]. In addition to these, the Federal Systems Integration and Management (FEDSIM) center in the “Commercial SATCOM technical product” in 1995, provides a third category of traffic with its own requirements. This is the “Hard Core” traffic [Ref. 20]. According to FEDSIM, placement of a SATCOM requirement in a particular category is dependent on the criticality of the information and the survivability as well as the level of protection required for the circuit in accomplishing a particular mission. There are candidates for COMERSAT in all three categories. The application of COMERSAT to military communications is decided dynamically by the Commander IN Chief (CINC) and depends on the mission characteristics as well as the strategic and tactical environments. As the missions and/or tactical situations change the CINC can reallocate these circuits from COMERSAT to MILSATCOM and vice versa in order to meet the new operational security requirements.

The “Hard Core” category includes those that are basic C<sup>2</sup> circuits critical to strategic decision making and the successful coordination required in order to accomplish a Joint mission [Ref. 20]. The “Hard Core” circuits that are candidates for COMERSAT application are the following:

- Joint Maritime Command Information System (JMCIS).
- Officer-in-Tactical Command Information Exchange System (OTCIXS).
- Worldwide Military C<sup>2</sup> System (WWMCCS).

- Global C<sup>2</sup> System (GCCS). This is currently replacing WWMCCS.
- Satellite Tactical Data Link (S-TADIL).

The “Core” category includes operational as well as tactical circuits that require anti-jam protection and LPI/LPD capabilities. The concept of reallocation by the CINC, according to the current tactical conditions as well as the supposed “enemy” capabilities is applied to “Core” candidate circuits. The “imagery applications” circuits that are part of the “Core” requirements and are candidates for COMERSAT application are the following [Ref. 20]:

- Battle Force/Battle Group Force Over-the-Horizon Target Coordinator Broadcast (BF/BG FOTC BCST).
- Battle Group Information Exchange System (BGIXS).
- Common User Digital Information Exchange System (CUDIXS).
- Demand Assignment Multiple Access/Navy Orderwire (DAMA/Navy Orderwire).
- Defense Message System Ship-Shore (DMS Ship-Shore).
- Defense Secure Network (DSNET).
- Fleet Broadcast/High Speed Fleet Broadcast (FLTBCST/HSFB).
- Fleet Imagery Support Terminal (FIST).
- Joint Service Imagery Processing System-National Input Segment (JSIPS-NIS).
- Joint Worldwide Intelligence Communications System (JWICS).
- Submarine Satellite Information Exchange Subsystems (SSIXS).
- Tactical Data Dissemination System (TDDS).
- Video Information Exchange System (VIXS).
- Interactive Video Information Exchange System (ITVIXS). This an emerging Navy requirement [Ref. 20].

The voice circuits that are part of the “Core” requirements and can be candidates for COMERSAT application are the following [Ref. 20]:



- Anti Air Warfare Contact & Reporting Net (AAWC&R).
- Anti-Submarine Warfare Contact & Reporting Net (ASWC&R).
- Anti Surface Warfare Contact & Reporting Net (ASUWC&R).
- C<sup>2</sup> & Tactical Secure Voice.
- Battle Force/Battle Group Command and Tactical Nets.
- C<sup>2</sup> Warfare Command & Report (C<sup>2</sup>W C&R).
- Dual Advanced Narrowband Digital Voice Terminal (DANDVT).
- Joint Air Coordination Net.
- Joint Command Net.
- Low-Speed Tactical Net.
- Marine Air-Ground Task Force (MAGTF) Command Nets 1 & 2.
- MAGTF Detachment Collection Net.
- MAGTF Intelligence Net.
- MAGTF Reconnaissance Net.
- MAGTF C<sup>2</sup> Net.
- MAGTF Air Tasking Order (ATO) Net.
- MAGTF Logistics Net.
- MAGTF Radio Battalion Net.
- MAGTF Tactical nets 1 & 2.
- MAGTF Tactical Air Command Net.
- Manual Relay Center Modernization Program (MARCEMP).
- Navy Key Management System(NKMS).
- Satellite High Command Net (SATHICOM).
- Special & Tailored Tactical.
- Tactical Data Information Exchange Subsystem(TADIXS) A & B.
- Theater Unique.
- Fleet Core Tactical Data Information Exchange System (FLTCTADIXS). This an emerging Navy requirement [Ref. 20].
- SHFDAMA.

Finally the “General Purpose” (GP) category is comprised by circuits that may be allocated either to MILSATCOM or COMERSAT according to the specific mission requirements. All GP circuits are candidates for COMERSAT applications and are the following:

- Battle Force/Battle Group Operations/Administration.
- Plain Old Telephone System (POTS).
- Press Newswire.
- Sailor Phone.
- Streamlined Automatic Logistics System (SALTS).
- Secure Telephone (STel), STU-III.
- Voice, Video, Facsimile, Data Terminal (VVFDT).
- Air/Sea Video Teleconferencing (ASVT). This an emerging Navy requirement.
- Fleet General Purpose Tactical Data Information Exchange System (FLTGTADIXS). This an emerging Navy requirement [Ref. 20].
- Multi-Purpose Marine Video Delivery System. This an emerging Navy requirement and includes Pay-per-view type video services [Ref. 20].
- Navy Integrated Switched Digital Network (N-ISDN). **This** an emerging Navy requirement [Ref. 20].
- Navy Integrated Switched Digital Network Man-pack (N-ISDNMP). This an emerging Navy requirement [Ref. 20].
- Navy Logistics Network .
- Quality of life Network. Distance learning, on line banking etc.
- Tomahawk Mission Data Updates (MDU) [Ref. 26].

## **D. COMERSAT ALTERNATIVE MODEL ARCHITECTURE**

Following review of all the COMERSAT application candidates in the previous section it is time to introduce the commercial alternative model architecture recommended by the author. It is self-evident that no single MSS can, by itself, accommodate all the MILSATCOM needs. The model architecture is comprised by ICO for Narrowband, Teledesic for Wideband and GBS for Broadcast SATCOM. The combination of the three, although not perfect, contains the most advantages and desired features for future military applications, as soon as the three component systems become fully operational by 2002. The recommended architecture will be described in detail in this section and is referred to as "ITG", from the initials of the three systems that comprise it. It should also be taken into account that "ITG" is a idea/recommendation on behalf of the author, conceived under the auspices of the US Naval Postgraduate School and the US Navy, and has nothing to do with certain companies and/or organizations.

### **1. The ITG Model Architecture Concept of Operations**

The "ITG" recommended model architecture Concept of Operations (CONOPS) is displayed in Figure 5.1. The model is chosen so as to provide the military users in USA and throughout the world with the most adequate features, as well as to receive more benefits from the COMERSAT MSS market. As stated previously, the model is comprised of ICO for narrowband, Teledesic for wideband and GBS for broadcast SATCOM. "ITG" will be used by air (surveillance/airborne radar, warplanes, helicopters), ground (individual soldiers, tanks, communications trucks) as well as sea assets (Carrier battle Group), as illustrated in Figure 5.1.

The virtue of the "ITG" model is that each component will operate independent from the other two, while at the same time all three will provide for the communication

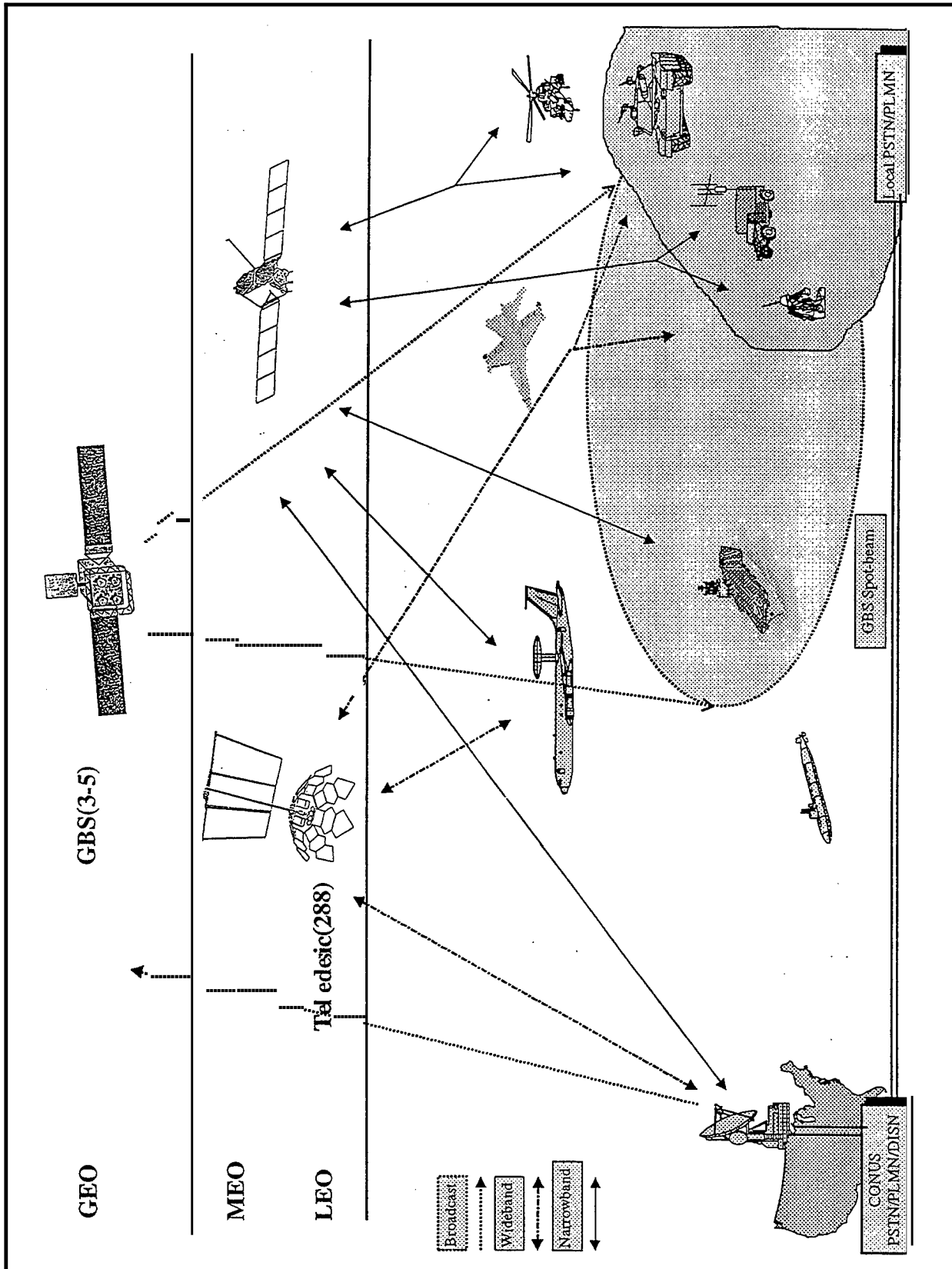

Figure 5.1 The "T'G' architecture Concept of Operations.

needs of a military force, in the three different bandwidth requirement arenas. The word component is used here to describe the individual satellite system. The same idea applies aboard a Naval platform where different transmitters and receivers operate in the radio room, in order to provide for a specific channel each. All of them participate in an integrated communications plan for the needs of a specific Task Force and its mission.

*a. Narrowband “ITG”*

In the narrowband arena, although there are many candidates, ICO has a prominent place with its global coverage, 4,500 channels per satellite and, mainly, its GSM originating configuration [Ref. 16]. Although Iridium has global coverage, it has far less capacity than ICO because of power limitations [Ref. 2]. Moreover ICO is far beyond the competition, the most well-founded and internationally supported MSS project. ICO will be applied to MILSATCOM in order to accommodate the “Hard Core”, “Core” and General Purpose (GP) voice circuits requirements described in section C of this chapter.

In addition to these, ICO is suitable in the implementation of the GBS “User Pull” concept [Ref. 17]. “On the move” warfighters (see Figure 5.1) will be able to request strategic and tactical information through an ICO dedicated “User Pull” channel and will receive the desirable product through GBS “Smart Push” transmission [Ref. 26]. This application is an excellent paradigm of how COMERSAT and MILSATCOM assets can be effectively utilized and co-ordinated by an insightful CINC and his staff when the Task Force communications plan has been managed and organized effectively.

*b. Wideband “ITG”*

By taking into account the comments and facts for each of the five MSS under investigation, it can be seen that the only wideband system suitable for accommodating a certain part of the wideband MILSATCOM needs is Teledesic. It is the only MSS made and tailored to offer videoteleconferencing, interactive multimedia and real time digital data services through the “Internet in the Sky” concept [Ref. 2]. Teledesic has recently announced a transformation of its original system of 840 satellites distributed in 21 LEO constellations to a system comprised of 288 satellites distributed in 12 LEO

constellations. In addition to this, Boeing announced the undertaking of the construction as well as future launching of the **288** satellites [Ref. **28**]. On the other hand, Teledesic acquired its FCC license in March 1997 based on a filing which describes the system parameters and features as they appear in Reference **2**. FCC licensing is a vital element for any MSS in order to be deployed operationally. So even if there is a scaling back in the number of satellite constellation. It is assumed that the future deployment of Teledesic cannot be much different from the system described in Reference **2**, in terms of frequencies, data rates and general communications and management characteristics.

Although it does not have full earth coverage with data rates varying from 16Kbps to **2.048** Mbps (**E1**), and for special applications **1.244** Gbps (**OC-4**) [Ref. **2**] Teledesic is the one and only candidate for wideband SATCOM applications with the user equipment operating on vehicular terminals. The Teledesic-Boeing cooperation is another factor that makes this project appear viable and the system itself likely to be implemented on the PCS market, just at the dawn of **21<sup>st</sup>** century.

*c. Broadcast "ITG"*

None of the commercial MSS has any broadcast capabilities. Additionally, DoD already has an evolving three phased program in order to accommodate its broadcast needs for the next century [Ref. **24**]. **This** system is GBS, which is presented in detail in chapter **4**. The GBS spot beams (see Figure **5.1**) will provide **US** Armed Forces users with full earth coverage. It will also provide specific area coverage for theater operations as desired by the CINC and the tactical or operational mission requirements.

**2. The "ITG" Space Segment**

The space segment will be comprised by the **12** ICO (see Figure **2.2**) in MEO, **288** Teledesic (see Ref. **2**) in **LEO** and initially **3** GBS/UFO (see Figure **4.4**) satellites in **GEO**. Each constellation will operate separately from the other. They will be monitored and controlled by their respective Telemetry Tracking and Command (TT&C) elements.

GBS will be under DoD control, while on the other hand, ICO and Teledesic will be under civilian control. **This** fact is beneficial to military users from the point of

manpower and cost reduction especially under today's diminishing defense budgets and personnel. The costs for training and maintaining personnel for the control of these constellations will be mitigated if not zeroed completely.

### **3. The "ITG" Ground Segment**

The ground segment will contain each ground segment of the three systems. It will provide, through the gateways, the interface to the Defense Information System Network (DISN), local Public Switched Telephone Networks (PSTN), Public Land Mobile Networks (PLMN) and Public Switched Digital Networks (PSDN) infrastructure.

The flow of information for the "ITG" model is displayed in Figure 5.2. DoD operated gateways will provide the "routing" nodes for the dissemination of information throughout the world. The fielded "ITG" user units **will** vary in size from the individual soldier up to area or theater command posts. A more analytical description of the "ITG" user segment follows in subsection **D.4**. The communication links via respective space segments will be forwarded to the "ICONET" for ICO (Ref. 15) and the "GIGALINK" terminals for Teledesic (Ref. 2). GBS broadcast will be forwarded to all relevant subscribers through the Primary or Theater Injection Points (PIP/TIP) which will also be based logically and physically inside the DoD gateway compound. No additional cost is necessary for building the DoD gateways. The existing physical infrastructure of Naval Computer & Telecommunications Area Master Stations (NCTAMS) and Naval Communications Stations (NAVCOMSTA) all over the globe (see Figure **3.2**) provides an excellent base from geographical, security as well as communications and systems engineering points of view. As long as the "ITG" modules are established and operated from the worldwide spread NCTAMS/NAVCOMSTAs the COMERSAT "communications web" will be underway and ready to provide a relatively cheaper alternative to the US MILSATCOM, both from manpower as well as budget aspects.

Figure 5.2 The "ITG" Flow of Information Diagram.

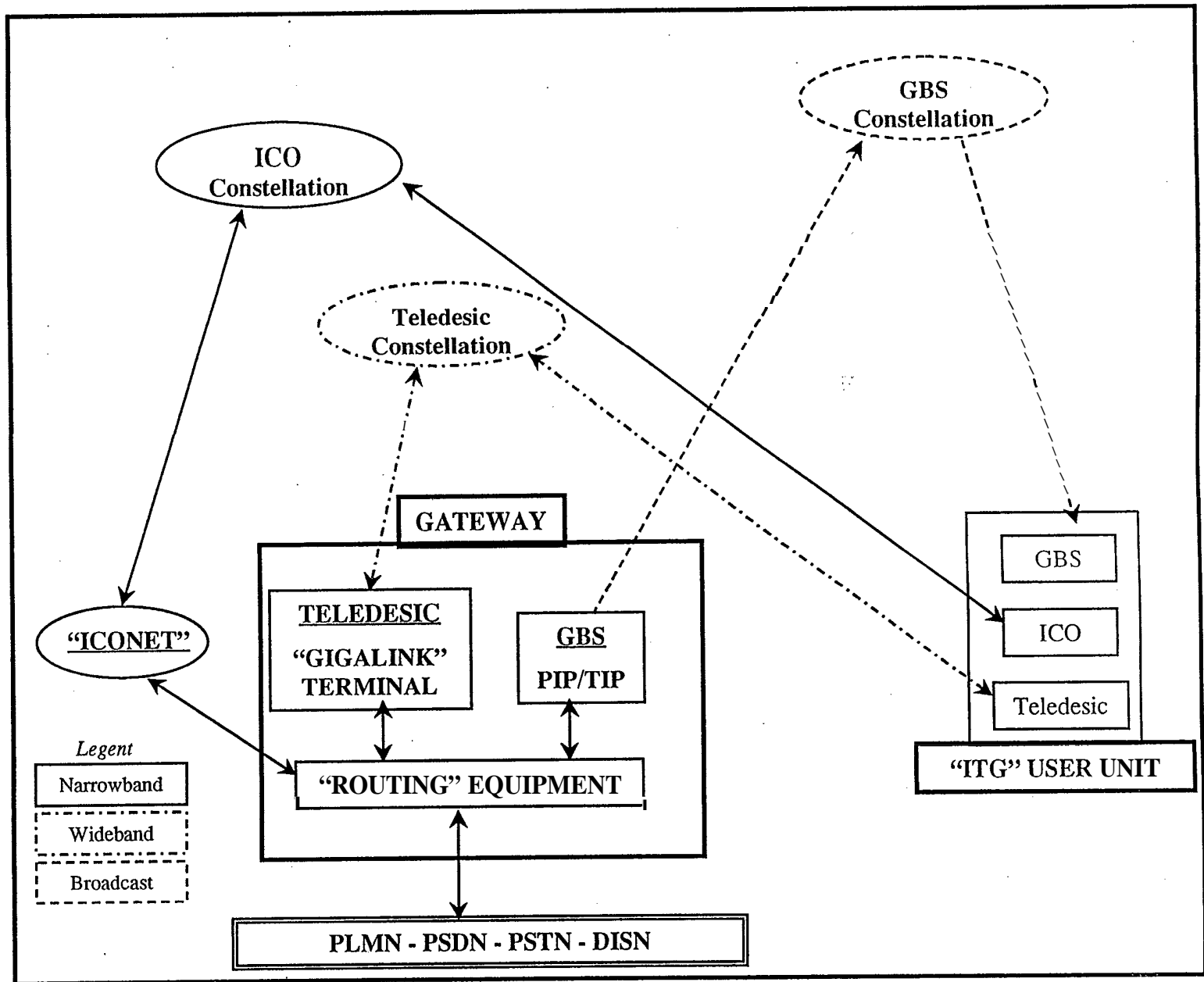



The Narrowband traffic (see Figure 5.2 full line) will be exchanged from the ICO “component” of the “ITG” user unit via the ICO constellation, the ICONET to the “routing” equipment based in the gateway compound and then to the DISN or local PLMN/PSDN/PLMN appropriately and vice versa. The wideband traffic (see Figure 5.2 dotted dashed line) will be routed from the Teledesic “component” of the “ITG” user unit via the Teledesic constellation, Teledesic “GIGALINK” terminal based inside the gateway compound and through the routing equipment to the DISN and local PLMN/PSDN/PLMN and back. Here the assumption is made that the DoD needs to equip all the possible gateway posts with one Teledesic “Gigalink” terminal each. Last but not least, the GBS broadcast (see Figure 5.2 dashed line) will be disseminated from the DISN through the “routing” equipment to the GBS primary or theater injection point (PIP/TIP) and by the GBS spot beams to the fielded GBS “component” of the “ITG” user units. Note that ICO and Teledesic traffic are by definition full duplex while on the other hand GBS traffic is simplex. In addition to these the “ITG” user units will provide for seamless connectivity for their ICO and Teledesic “components” to all other “ITG” user units worldwide via their respective space segments.

It should be taken into account that the idea of DoD operated gateways does not limit the use of the “ITG” model only for US Armed Forces use. The two thirds of the model belong in the public domain. Therefore any individual country or organization (i.e. United Nations) willing to undertake the cost of their private gateway(s) can exploit the undoubted benefits offered by ICO and Teledesic philosophy of being able to offer an interface to the public terrestrial networks mentioned above. Specifically for the case of United Nations (UN) peacekeeping missions, the full deployment of the “ITG” model is possible under the assumption of US Armed Forces participation at no additional cost. This of course, is a fact that happens today in various peacekeeping operations all over the world. The abundance of bandwidth availability for all three systems makes the “ITG” model immune to the problems that are possible to emerge from ICO and Teledesic’s parallel use by commercial subscribers at the same time with military users.

#### **4. The “TTG” User Segment**

The user segment **will** be comprised by US Army-Navy/Marines-Air Force assets worldwide at strategic, operational and tactical levels. These assets **will** carry and operate the **“TTG”** user unit in its various configurations. The user unit configurations will vary from the simpler ICO handset and GBS man-portable terminal for the individual team leader or even each soldier in the US Army, Marine Corps team and will go up to “TTG” communication racks aboard US Army, Navy, Marine Corps and Air Force units such **as** each and every armored vehicle, tank, communication truck, warship **as** well **as** rotary and fixed wing aircraft. The space required for the “TTG” communications rack **will** be minimal if taken into account the small size of the vehicular, maritime and aeronautical ICO, Teledesic and GBS terminals. In addition to this, the small physical size of the “TTG” configuration enables extra flexibility and portability features in the context of keeping the **“TTG”** racks in stock and issuing them to a Task Force according to its specified mission.

There is another community which can utilize “TTG” model architecture, at least in its two thirds, that being the combination of ICO and Teledesic and possibly GBS under DoD permission and authorization. This user community is not strictly military, but it encompasses military forces in its operations. These are forces taking part in the United Nations (UN) missions. The UN commitment in worldwide peacekeeping **as** well **as** humanitarian relief operations, offers another arena of COMERSAT MSS deployment and utilization. The “TTG” application in UN missions will be investigated in Chapter VII.

#### **E. SUMMARY**

The commercial LEO and MEO MSS offer a unique alternative for MILSATCOM applications **as** the world prepares to enter the 21<sup>st</sup> century communications era. No single MSS can offer this alternative by itself. Moreover, not one of them is equipped with Broadcast capabilities. On the other hand, a combination of ICO for Narrowband, Teledesic for Wideband and the military GBS for Broadcast, named by the author, **“TTG”**

, model architecture, encompasses many of the required for **MILSATCOM** features and characteristics.

In the following chapters the quantitative applications of the recommended model architecture, to US **MILSATCOM** as well as UN peacekeeping missions will be investigated.

## VI. APPLICATION TO US ARMED FORCES SATCOM

### A. INTRODUCTION

Previous chapters investigated the US MILSATCOM systems, their functional requirements and missions. The “ITG” model architecture, in order to accommodate the US Armed Forces needs with potential applications of COMERSAT LEO and MEO mobile satellite systems, was introduced by undertaking a qualitative approach to this task. This chapter investigates specific quantitative applications to US Armed forces SATCOM.

The potential application of the “ITG” model to the “Core Combat-Capable Naval Forces” packages for timely initial crisis response is explored. Naval force packages are designed to project “discrete” military objectives evolving from US political/diplomatic objectives worldwide [Ref. 31]. This has as a result, the consistency of US Naval force presence in various regions of the world, as described in Reference 31. Naval forces conducting routine presence missions, including significant exercises, provide linkage between peacetime operations and initial requirements for a developing Major Regional Contingency (*MRC*). The term “Combat-Capable”, by itself, is equivalent to the term “Forcible entry”. A “Combat-Capable” force has been defined by each CINC so as to be comprised of a Carrier Battle Group (CVBG), which supports an Amphibious Ready Group (*ARG*) and a Marine Expeditionary Unit (*MEU*) embarked on the ARG [Ref. 31].

The organization of forces, their definitions and circuit requirements are presented in the following sections. Then, an application of the “ITG” architecture is given in order to accommodate these requirements with commercial LEO and MEO systems.

## **B. ORGANIZATION OF NAVAL FORCES**

### **1. Definitions**

**A** “Combat-Capable” Naval force is comprised by three major parts [Ref. 31]:

- A Carrier Battle Group (CVBG).
- An Amphibious Ready Group (ARG).
- A Marine Expeditionary Unit (MEU) embarked on the ARG.

A CVBG is a group of USN ships capable of conducting C4I, ASW, ASUW, AAW operations in order to support the missions of ARG and MEU. Generally it consists of the following:

- A Multi-purpose (CV) or nuclear powered (CVN) aircraft carrier.
- Two VLS Tomahawk AEGIS guided missile cruisers (CG).
- Three Destroyers or guided missile destroyers (DD/DDG).
- Three Guided Missile Frigates (FFG).
- Three attack nuclear submarines (SSN).
- Two strike (Tomahawk) submarines.
- One submarine for special operations.
- One Fast Combat Logistics Support Ship/Replenishment Oiler (AOE/AOR).
- One Mine warfare Control Ship (MCS) and several Mine Countermeasure (MCM) and Mine Hunter (MCH) ships.

**An** Amphibious Ready Group is a flotilla of ships consisting of a commander staff and amphibious ships designed to exercise operational control and execute all phases of an amphibious operation. This is usually an attack launched from the sea by naval and landing forces, involving a landing on a hostile or potentially hostile shore [Ref. 33]. Other amphibious operations include evacuation of personnel and equipment from hostile or possibly hostile territories. The ARG provides the transportation and accommodation means for the MEU embarked and provides the originating assets for the amphibious assault. The major ships participating in an ARG are Amphibious Assault ships general

(LHA) and multipurpose (LHD), Amphibious Assault ship with helicopters (LHP), Dock Landing Ship (LSD) and various other amphibious ships of smaller displacement.

A Marine Expeditionary Unit (MEU) is a US Marine Corps task organization built around a battalion landing team, reinforced helicopter squadron and logistic support unit. The MEU fulfills routine forward afloat deployment requirements, provides an immediate reaction capability for crisis situations and is capable of relatively limited combat operations. Most of the times a MEU is equipped with special operations capability (SOC) referred to as MEU (SOC) [Ref. 32]. The MEU (SOC) organization of forces (see Figure 6.1) follows the general Marine air-ground task force (MAGTF) structure and is comprised by the following four elements [Ref. 33]:

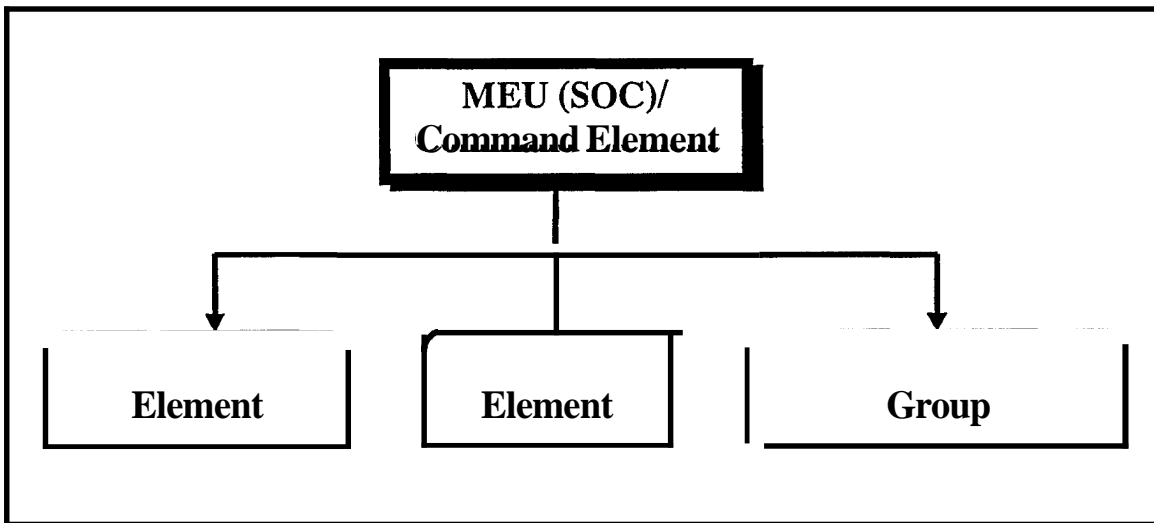

Figure 6.1 MEU (SOC) Organization Components.

- The Command Element (CE). This is the MEU headquarters and is a permanent organization composed of the commander, general or executive and special staff sections, headquarters section and requisite communications and service support facilities. The CE provides command, control and coordination essential for effective planning and execution of operations by the other three MEU elements. There is only one CE in a MEU [Ref. 33].

- The Aviation Combat Element (ACE). This element has the tasking to provide all or a portion of the functions of Marine Corps aviation in varying degrees based on the tactical situation and the MEU mission. These functions are air reconnaissance, anti-air warfare (AAW), assault support, offensive air support, electronic warfare (EW) and control of aircraft and missiles. The ACE is organized around an aviation headquarters and varies in size from a reinforced helicopter squadron to one or more Marine aircraft wings. It includes those aviation command, combat, combat support, and combat service support units required by the tactical situation. Normally there is only one ACE in a MEU [Ref. 33].
- The Ground Combat Element (GCE). This MEU element has the task to conduct ground operations. The GCE is synthesised around an infantry unit and varies in size from a reinforced infantry battalion to one or more reinforced infantry divisions. The GCE also includes appropriate combat support and combat service support units. Normally there is only one GCE in a MEU [Ref. 33].
- The MEU Service Support Group (MSSG). This element has as the task to provide the full range of combat service support in order to accomplish the MEU mission. MSSG can provide supply, maintenance, transportation, deliberate engineer, health, postal, disbursing, prisoner of war, automated information systems, exchange, utilities, legal and graves registration services [Ref. 33].

## 2. Communications Infrastructure

### a. *Types of Required Services*

The services required by a “Combat Capable” Naval Force have already been reviewed thoroughly in Chapter III. These are voice, data and video services.

Voice services provide essential connectivity for information exchange,

Coordination and Reporting(C&R) between commands, command units and key operators in and over the horizon. They include telephones, voice mail, some fax over the phone lines and telemedicine services.

Data services can be utilized for tactical communications, Command Control (C<sup>2</sup>), and logistics support[Ref. 3]. They enable a means of information exchange amongst several networks which provide tactical intelligence data, whilst additionally providing data in order to maintain surface, subsurface and air picture of all battlefield spectrums. Command Control (C<sup>2</sup>) services are provided to command elements.

Video services include Video-Tele-Conferencing(VTC), battle damage assessment, Unmanned Aerial Vehicle(UAV) imagery, teletraining, telemedicine, broadcast TV channels and Moral Welfare and Recreation(MWR) programs[Ref. 3].

**b. Data Rates**

The data rates(see Table 6.1) are divided into high(HDR), medium(MDR) and low(LDR). Medium data rates can be subdivided in two categories. MDR 1 and MDR 2.

	<b>Data Rate</b>	<b>Value</b>
1	Low Data Rate(LDR)	< <b>9.6</b> kbps
2	Medium Data Rate 1(MDR1)	<b>9.6</b> kbps to 64 kbps
3	Medium Data Rate 2 (MDR2)	<b>64</b> kbps to 1.544 Mbps
4	High Data Rate(HDR)	>1.544 Mbps(T1)

Table 6.1 Data Rates of Naval Forces Communications.

**c. Protection**

The protection of a “Combat Capable” Naval Force is divided into four main categories[Ref. 3]. The first is high, in order to operate after explosion of a nuclear weapon. The second is medium, required to establish communications under the presence



of a tactical jammer. The third is low, required to operate under the presence of a nuisance jammer. Finally the last category requires no protection at all.

*d. Topology and Coverage*

The network topologies required to support a “Combat Capable” Naval Force are displayed in Figure 6.2 and include the following: netted, hub and spoke, point to point, broadcast, report-back and virtual[Ref. 3].

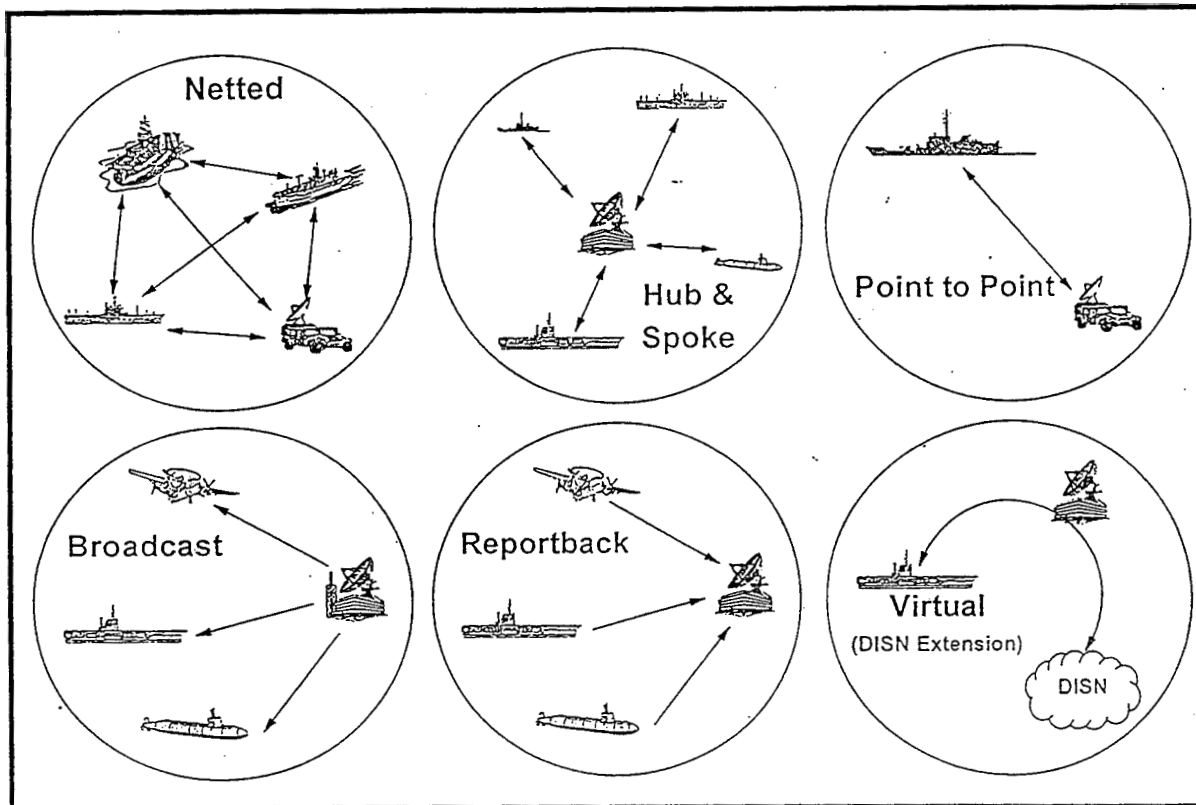

Figure 6.2 Network Topologies of a “Combat Capable” Naval Force “From Ref. [3]”

The types of coverage for the communications infrastructure in support of a “Combat Capable” Naval Force are: within the unit, theater and region, reach-back to CONUS and dispersed(global). These are displayed in Figure 6.3[Ref. 3]. Any commercial SATCOM system must support as many as possible of these types of coverage in order to be utilized efficiently.

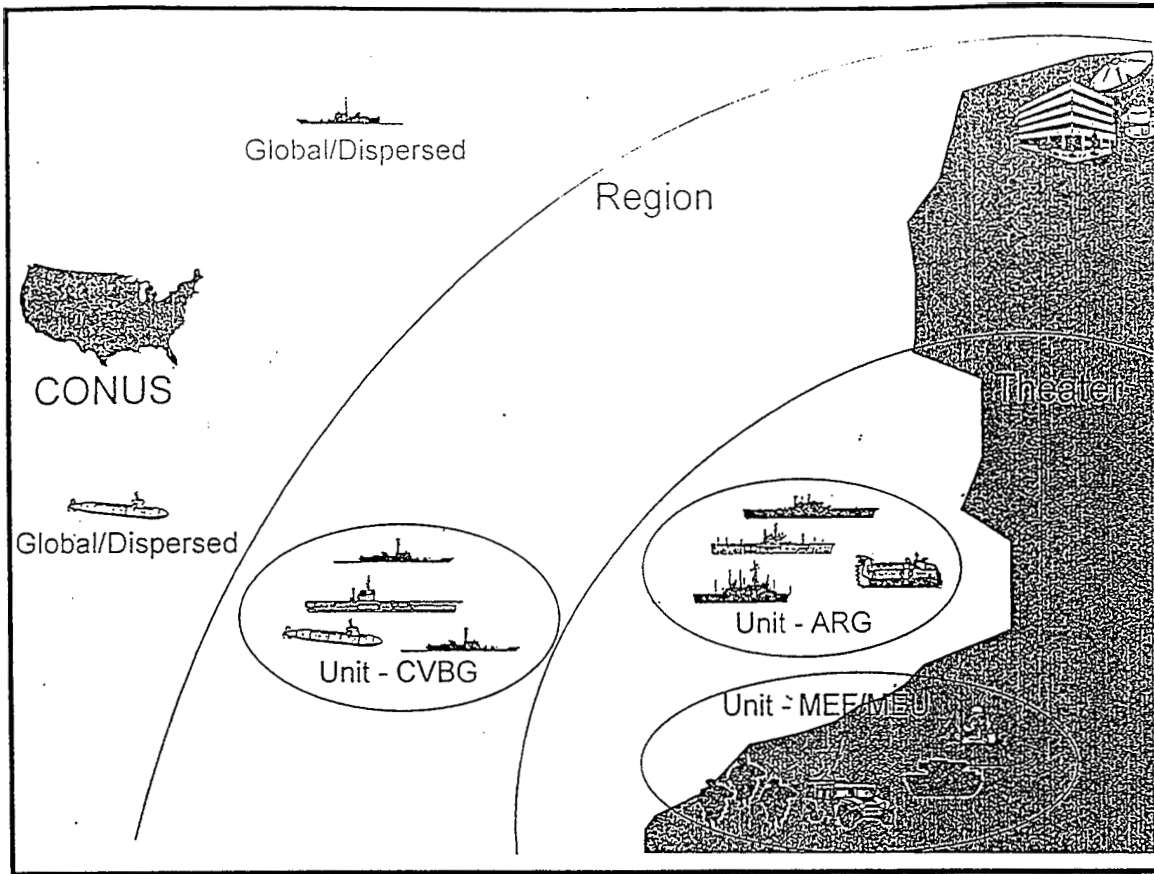

Figure 6.3 Types of Coverage for a 'Combat Capable' Naval Force 'From Ref. [3]'

### C. "COMBAT CAPABLE" NAVAL FORCE SATCOM LINKS

The application of the "ITG" alternative architecture is applied to the "Combat Capable" Naval Force quantitatively. The CVBG, ARG, MEU circuit requirements are shown in Figures 6.4, 6.5 and 6.6 respectively. These are the requirements as outlined by the US Naval Space Command's "Functional Requirements Document"[Ref. 3]. A comprehensive summary is presented in Table 6.2.

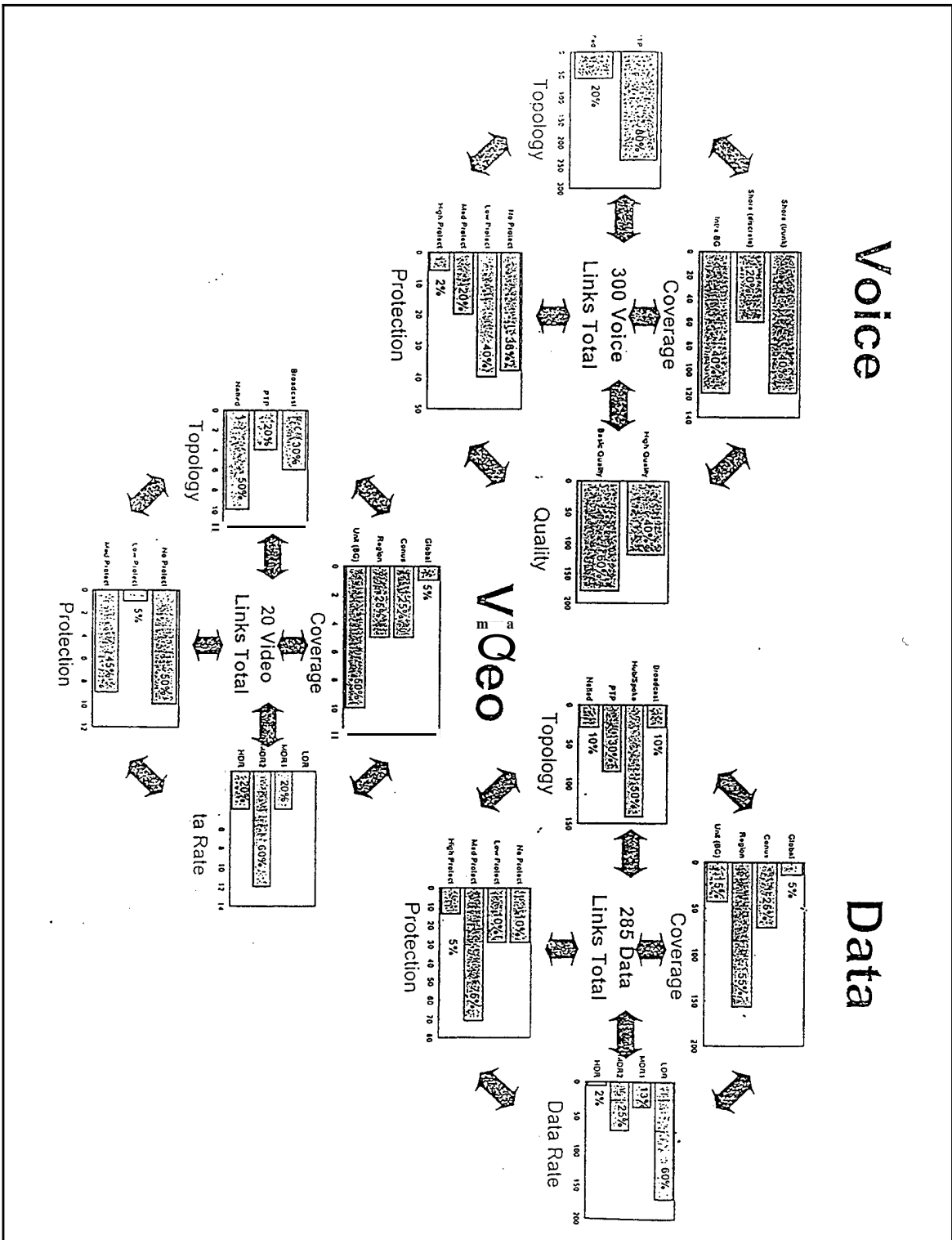
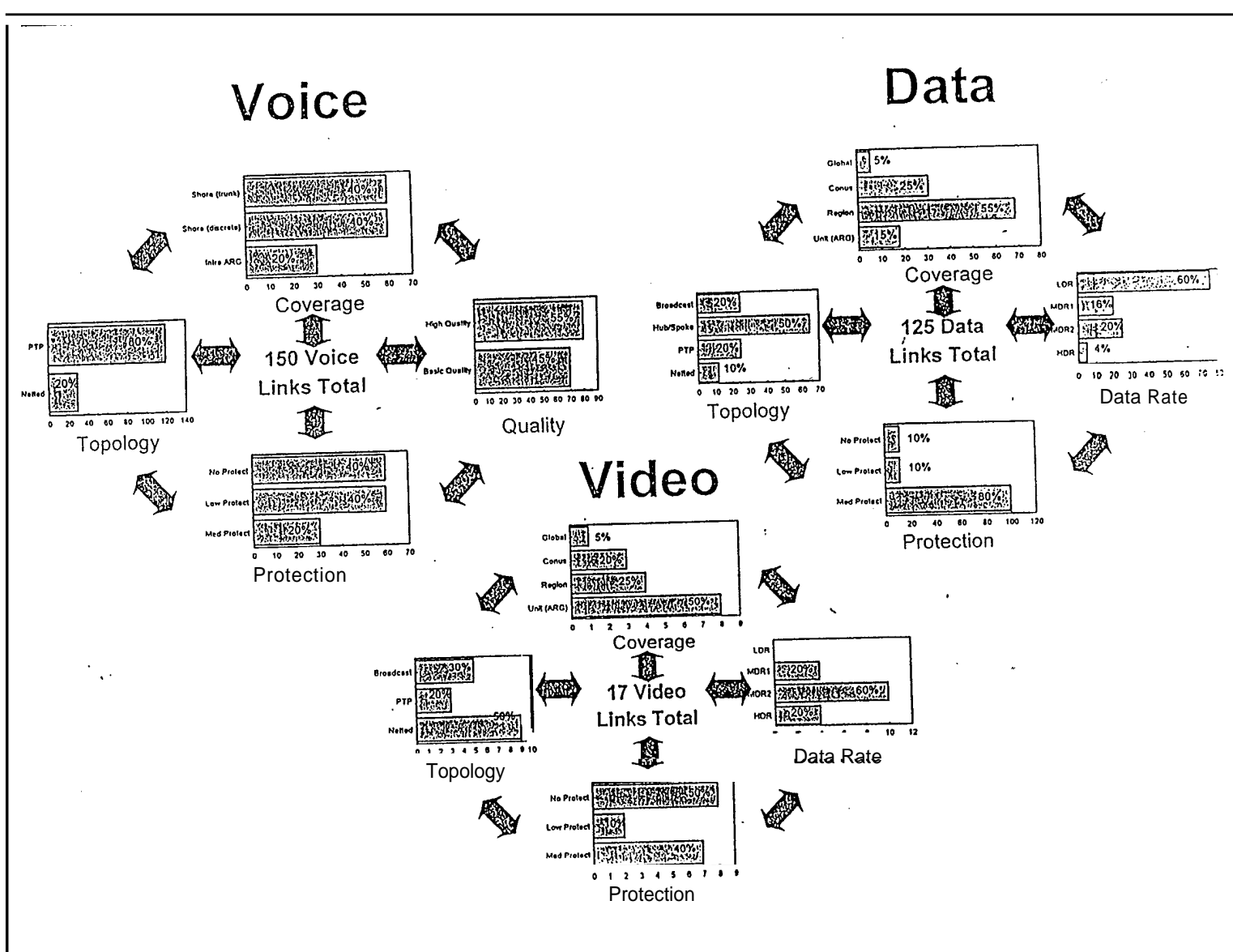

Figure 6.4 CVBG Circuit Requirements "From Ref. [3]"

Figure 6.5 ARG Circuit Requirements "From Ref. [3]"



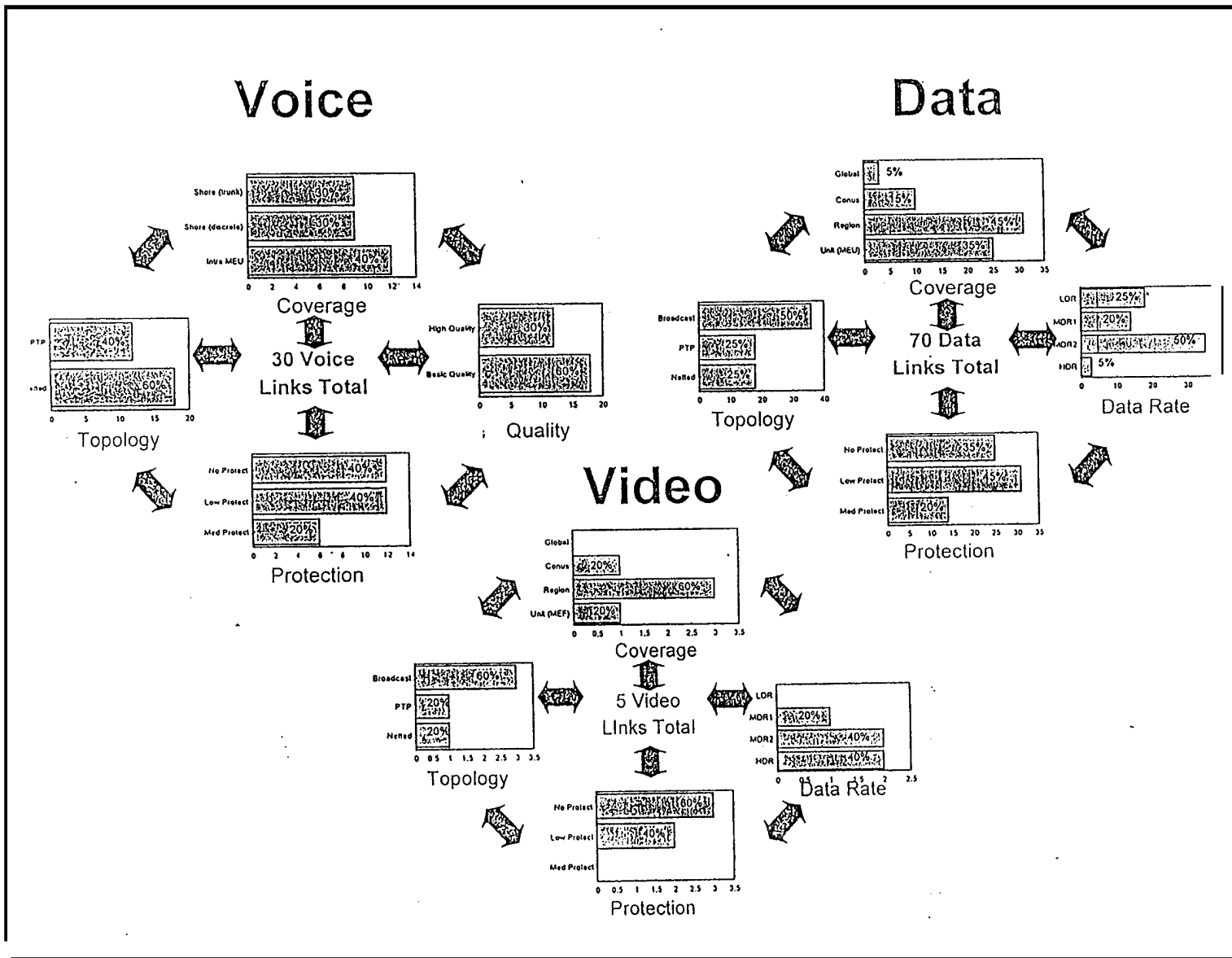

Figure 6.6 MEU Circuit Requirements "From Ref. [3]"

Unit	Voice	Data	Video
CVBG	300	285	20
ARG	150	125	17
MEU	30	70	5
Total	<b>480</b>	<b>480</b>	<b>42</b>

Table 6.2 “Combat-Capable” Naval Force Total Circuit Requirements.

An initial assessment shows that the circuit requirements for a “Combat-Capable” Naval Force, comprised by a CVBG, an ARG and a MEU, displayed in Table 6.2, can be supported by the “ITG” model architecture. The service provision is plausible, even under the assumption that the two commercial MSS employed have an additional usage emerging from their anticipated commercial demand. A detailed quantitative analysis follows in Tables 6.3, 6.4, 6.5 below for “Combat Capable” Naval Force’s requirements in Voice, Data and Video links respectively, that can be supported by the “ITG” model.

Voice links (see Table 6.3) do not have any broadcast requirements. They are 480 in total (300 for CVBG, 150 for ARG and 30 for MEU). They can be covered with three possible cases. The first case is the coverage by ICO with its 4,500 full duplex channels capacity [Ref. 15]. The second is their coverage by a combination of ICO and Teledesic. The proportion of each system’s participation is a decision made by the Commander-in-Chief (CINC) according to the specific mission requirements. The third case is taking into account the 102 (66 for CVBG, 30 for ARG and 6 for MEU) out of 480 voice links that require medium and high protection. It is the decision and responsibility of the CINC of the operations to evaluate the operational and tactical requirements of a mission so as to employ less highly protected circuits for the “Hard Core” links of a Task Force. For the first and second cases, it is in the discretion of the CINC to apply the commercial systems to these 102 links. The third choice is to apply another US MILSATCOM system from these described in Chapter III. This system will possess the required medium or high protection features for the specific mission.

UNIT	CV BG				ARG				MEU			
	Quality	Coverage	Topology	Protection	Quality	Coverage	Topology	Protection	Quality	Coverage	Topology	Protection
Shore(trunk)		120				60				9		
Shore(disc.)		60				60				9		
Global		-				-				-		
CONUS		-				-				-		
Region		-				-				-		
Intra Unit		120				30				12		
High	120				82				12			
Basic	180				68				18			
Broadcast			-				-				-	
Hub/Spoke			-				-				-	
PIP			240				120				12	
Netted			60				30				18	
Nb				114				60				12
Low				120				60				12
Medium				60				30				6
High				6				-				-
Unit Links	300	300	300	300	150	150	150	150	30	30	30	30
<b>Total Naval Force Voice Links : 300 + 150 + 30 = 480</b> ( No Broadcast requirement )												
<b>Coverage</b>	<b>Cases</b>											
CASE 1:	All 480 covered by ICO ( Maximum capacity 4,500 channels per satellite)											
CASE 2:	All 480 covered by ICO and Teledesic (At the discretion of CINC.)											
CASE 3:	378 covered by ICO and/or Teledesic ( At the discretion of CINC ) 102 covered by US MILSATCOM ( medium and high protection )											

Table 6.3 Naval Force Voice Links supported by the "ITG" model.

UNIT FEATURE	CV BG			ARG			MEU				
	Quality	Coverage	Topology	Data Rate	Coverage	Topology	Protection	Data Rate	Coverage	Topology	Protection
Store(trunk)		-			-				-		
Store(disc.)		-			-				-		
Global		14			6				3		
CONUS		71			31				11		
Region		157			69				32		
Intra Unit		43			19				24		
Broadcast			28 (GBS)			25	(GBS)			35	(GBS)
Hub/Spoke			143			63				-	
PIP			85			25				18	
Netted			29			12				17	
Nb											25
Low											31
Medium											14
High											-
IDR	171			75							18
MDR1	37			20							14
MDR2	71			25							35
HDR	6			5							3
Unit Links	285	285	285	125	125	125	125	125	70	70	70
<b>Total Naval Force Data Links : 285 + 125 + 70 = 480</b>											
<b>Coverage</b>	<b>Cases</b>										
CASE1:	392 by Teledesic and 88 by GBS										
CASE2:	from the 342 (medium and high protection) that are not broadcast by combinations of Teledesic and US MILSATCOM										

Table 6.4 Naval Force Data Links supported by the "ITG" model.



UNIT FEATURE	CV BG				ARG				MEU			
	Data Rate	Coverage	Topology	Protection	Data Rate	Coverage	Topology	Protection	Data Rate	Coverage	Topology	Protection
Shore(trunk)		-				-				-		
Shore(disc.)		-				-				-		
Global		1				1				-		
CONUS		5				3				1		
Region		5				4						
Intra Unit		9				9						
Broadcast			6	(GBS)			5	(GBS)			3	(GBS)
H/Hb/Spoke			-							-		
PPP			4							1		
Netted			10				9			1		
Nb				10				9				3
Low				1				1				2
Medium				9				7				-
High				-				-				-
IDR		-						-				
MDR1		4						3				
MDR2		12						10				
HDR		4						4				
Unit Links	20	20	20	20	17	17	17	17	5	5	5	5
<b>Total Naval Force Video Links : 20 + 17 + 5 = 42</b>												
<b>Cases</b>												
CASE 1:	28 covered by Teledesic and 14 by GBS											
CASE 2:	From the 16 that are not broadcast (medium protection) by Teledesic and US MILSATCOM (At the discretion of CINC)											

Table 6.5 Naval Force Video Links supported by the "ITG" model.

Data links (see Table 6.4) total up to 480 (285 for CVBG, 125 for ARG and 70 for MEU). 88 of them are broadcast and will be accommodated by GBS(28 for CVBG, 25 for ARG and 35 for MEU). The “usr pull” operation will be performed via ICO(voice) and/or Teledesic(data/voice) channels and the “smart push” of required information broadcast via GBS channels[Ref. 26]. Teledesic will support the remaining 392 data links with its 16 kbps up to 2,048 kbps configurations. It possesses the flexibility of accommodating 2,000,000 16 kbps up to the equivalent 15,625 2,048 kbps channels, as well as all possible combined configurations in between[Ref. 2]. A second option is introduced by the 342 data links that require medium and high protection(228 for CVBG, 100 for ARG and 14 for MEU) and are not broadcast. These can be accommodated either by Teledesic or by a protected US MILSATCOM system and all possible combinations of the two. Although there is no specific information for the exact number of medium and high protected data links that are not broadcast, the abundance of channels provided by Teledesic and GBS permits all possible combinations. The discretion of CINC concept, also applies here.

Finally the video links of a “Combat Capable” Naval Force(see Table 6.5) are 42 in total(20 for CVBG, 17 for ARG and 5 for MEU). 14 of them are broadcast and **will** be accommodated by GBS(6 for CVBG, 5 for ARG and **3** for MEU). The remaining 28 will be covered by Teledesic. Part of the 16 data links that require medium protection(9 for CVBG and **7** for ARG) and are not broadcast can be accommodated either by Teledesic or by a protected US MILSATCOM system or by a combination of the two, under the discretion of CINC concept.

## **D. SUMMARY**

The “ITG” model architecture has been applied to the satellite communication required voice, data and video links of a “Combat Capable” Naval Force. The expression “Combat Capable” is equivalent with “Forcible Entry” and is comprised by a Carrier Battle Group (CVBG), which supports an Amphibious Ready Group (ARG) and a Marine

Expeditionary Unit(MEU) embarked on the ARG[Ref. 31]. These are the US Naval Forces planned to conduct routine presence missions and provide linkage between peacetime operations and initial requirements for a developing Major Regional Contingency(MRC) all over the world.

A detailed quantitative analysis of the "Combat Capable" Naval Force satellite communication requirements has shown that these can be accommodated by the "ITG" model even under the assumption of expected parallel commercial use of ICO and Teledesic mobile satellite systems (MSS). In addition to this, the abundance of ICO, Teledesic and GBS links and the flexibility of the employed systems permits the simultaneous application of the "ITG" model architecture from one to four "Combat Capable" Naval Forces in different geographical regions around the Globe.

The next chapter **will** investigate a quantitative application to a United Nations peacekeeping mission.

## **VII. APPLICATION TO UN PEACEKEEPING**

### **A. INTRODUCTION AND HISTORICAL OVERVIEW**

The accommodation of the communication requirements for United Nations (UN) peacekeeping missions/operations via commercial satellite links is not a newly introduced concept. It has been applied in the past, at various UN peacekeeping operations worldwide, with prosperous results. The usefulness offered by SATCOM of having wide coverage areas which permit operation in the region of concern without reliance on local communications infrastructure has been successfully implemented. On the other hand, the SATCOM assets engaged were coming from the GEO family only (i.e. INTELSAT and INMARSAT), mainly due to lack of any commercial LEO and MEO systems.

This Chapter investigates the accommodating of the communication needs of a model UN peacekeeping operation by applying the “ITG” model with two of its components (i.e. ICO and Teledesic). The United Nations Mission In Haiti (UNMIH) has been chosen for this task. Before proceeding with the application of the “ITG” model architecture, a brief overview of UNMIH is considered appropriate in order to provide the reader with the political as well as the historical background of this UN peacekeeping operation.

In January 1994, the US Department of Defense (DoD) and the State Department coordinated a plan to re-establish the democratically elected government of the Caribbean island of Haiti which had been violently ousted by a military dictatorship on 30<sup>th</sup> September 1991. On 31<sup>st</sup> July 1994 the UN General Assembly passed Resolution 940, citing, de facto, the illegal regime’s failure to comply with international accords. Under this resolution, UN members authorized the use of all necessary means to facilitate the departure of the military regime and to establish a safe environment in Haiti [Ref. 34]. On 19<sup>th</sup> September 1994 US Forces Haiti (USFORHAITI) entered the island peacefully in order to carry out the operation “Uphold Democracy”. On 27<sup>th</sup> October 1994 the

transition from USFORHAITI to the UN led Multinational Forces (MNF), consisting of units from 16 countries, took place. Finally in March 1995 the MNF transferred control of the island to the UNMIH [Ref. 34]. This mission is still operational on Haiti today, especially for humanitarian concerns.

The overview of the UNMIH's Chief Communications Officer (CCO) Communications Plan (COMMSPLAN V 1.0) [Ref. 35], as well as the "ITG" model architecture application to accommodate the needs of this plan with commercial LEO and MEO MSS are presented. The concept introduced can similarly be applied to any other present or future UN peacekeeping operation under the assumption of appropriate reconfiguration according to specific requirements for the accomplishment of this mission.

## **B. UNMIH COMMUNICATIONS PLAN OVERVIEW**

The communications infrastructure in Haiti was inadequate to provide the required connectivity by the UNMIH in order to fulfill its mandate [Ref. 35]. This fact is valid for every UN peacekeeping mission worldwide. Therefore, every UN mission requires an independent communications network in order to provide reliable and uninterrupted Command Control and Communications (C<sup>3</sup>) infrastructure for the accomplishment of its tasks.

### **1. Assumptions**

The Communications Plan (COMMSPLAN V1.0) was conceived under the following assumptions [Ref. 35]:

- The UNMIH's communications network should accommodate both the UNMIH's and Mission Civil in Haiti (MICIVIH) communications requirements. It was also assumed that MICIVIH offices will not be co-located with UNMIH offices.

- The UNMIH COMMSPLAN V1.0 does not take into consideration the communications requirement of other UN agencies in Haiti. However, if required, suitable communication planning could be formulated under provision of detailed information.
- A suitable location was needed to accommodate the UNMIH headquarters. The evaluation of all possible locations was performed under the requirement of interconnection of main UNMIH, MICIVIH and UNMIH Civilian Police headquarters. The main UNMIH headquarters are comprised by the Office of the Special Representative of the Secretary General, the Office of the Force Commander, the Office of the Chief Administrative officer, Military branches and civilian sections.
- The UNMIH COMMSPLAN has been organized in order to accommodate the needs of the following forces: The UNMIH headquarters, five infantry battalions, a military police battalion, an engineer battalion, a military training unit, an aviation unit, a movement control unit, a logistics battalion, a field hospital and finally UN civilian police component.
- The battalion communications are both internal and external. The internal communications equipment is provided by the troop contributing nations. Each participating nation forwarded their frequency requirements to the Chief Communications Officer (CCO) via the co-ordination of the Force Signals Officer (FSO). In the cases where the participating nation's communications equipment utilize commercial communications providers they should get prior approval by the CCO. The external communications between battalion and UNMIH headquarters are provided by the UN through a UN-owned communications network. Communications between battalion headquarters and troop contributing nations is the responsibility of each nation.

## 2. Responsibilities, Communications Services and Networks

The Chief Communications Officer (CCO) has the overall responsibility to provide communications to UNMIH in accordance with the general policy of the UN peacekeeping missions. He is responsible for the planning, implementation, operation, control, management and budget control of the mission's communication network in accordance with its mandate and UN rules and regulations [Ref. 35]. The Communications Section is responsible for providing the services to the various mission components as shown in Table 7.1 below:

	<b>Mission Component</b>	<b>Communication Services</b>
1	UN Headquarters in New York	Telephone (secure and plain), facsimile (secure and plain), data
2	Infantry Battalion(Bn) Headquarters(Hq)	Telephone (secure and plain), facsimile (secure and plain), data, external two-way radio
3	Civilian Police Divisions	Telephone, facsimile (secure and plain), two-way radio
4	Civilian Police Detachments and mobile teams	Telephone, facsimile, two-way radio
5	Military Police Bn Hq	Telephone, facsimile, limited two-way radio
6	Engineer Bn Hq	Telephone, facsimile, limited two-way radio
7	Logistics Bn Hq	Telephone, facsimile, limited two-way radio
8	Military Training Unit	Telephone, facsimile, limited two-way radio
9	Aviation Unit	Telephone, facsimile, limited two-way radio
10	Movement Control Unit	Telephone, facsimile, limited two-way radio
11	Field Hospital	Telephone, facsimile, limited two-way radio

Table 7.1 UN Peacekeeping Mission Components and Communication Services

In order to provide the above services to the mission components, the Communications Section installed, operates controls and maintains two communications networks: The Static and the Mobile Network.

a. *Static Communications Network*

The Static Network (see Figure 7.1) supplies external as well as internal communications. It consists of satellite, point-to-point radio links and associated switching equipment in order to provide telephone, facsimile and data services to the mission offices throughout the country as well as connection to the Public International network.

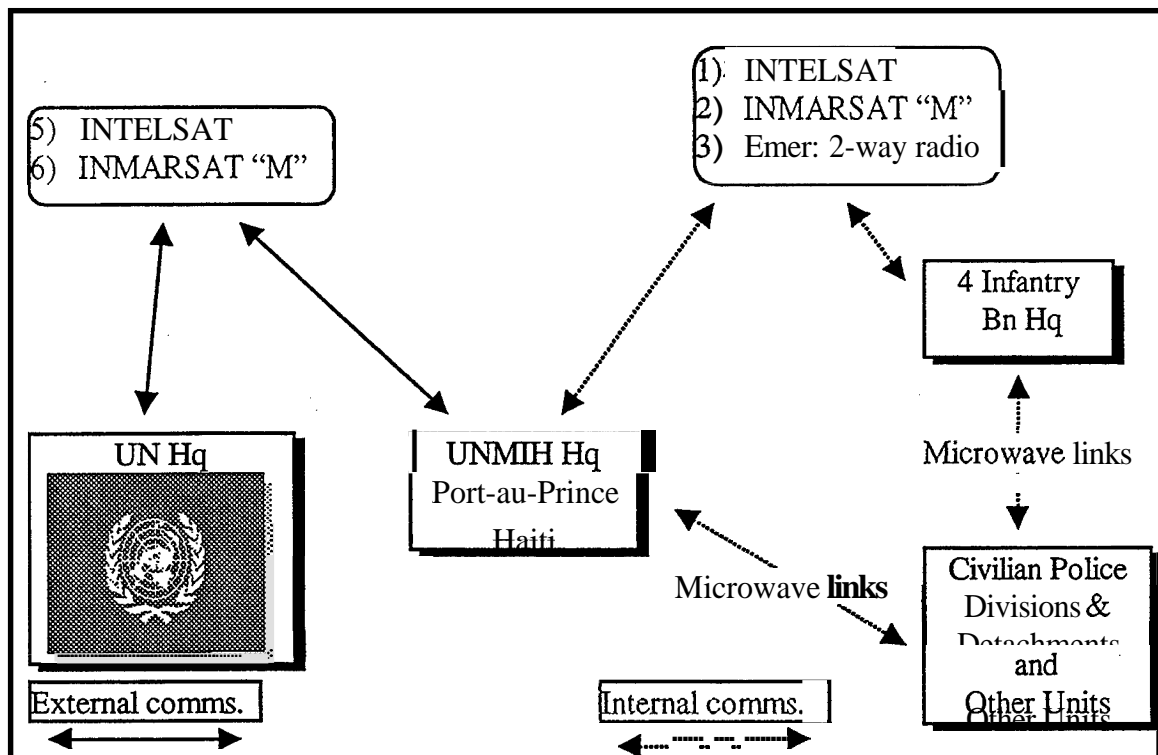

Figure 7.1 The UN Mission Static Communications Network

The External part of the Static Network (see Figure 7.1) provides connectivity between the mission's headquarters in Port-au-Prince, Haiti and UN headquarters in New York, USA. The primary connection is performed via the Atlantic Ocean Relay (AOR) INTELSAT satellite by a 4.5 meter satellite hub earth station installed in the ~~main~~ UNMIH Headquarters in Port-au-Prince. The secondary connection is done via INMARSAT type "M" terminals.



The Internal Part of the Static Network (see Figure 7.1) provides connectivity between the mission headquarters and the infantry battalion headquarters as well as the Civilian Police Divisions and Detachments and the other mission units shown in Table 7.1. **Primary** communications are conducted via a nationwide UN-owned network consisting of satellite earth stations and point-to-point radio links. Satellite equipment includes one 4.6 meter hub earth station located UNMIH headquarters at Port-au-Prince (see Figure 7.2) and four 3.7 meter earth stations (see Figure 7.3) installed at four of the five Infantry Battalion Headquarters in a star configuration [Ref. 35].

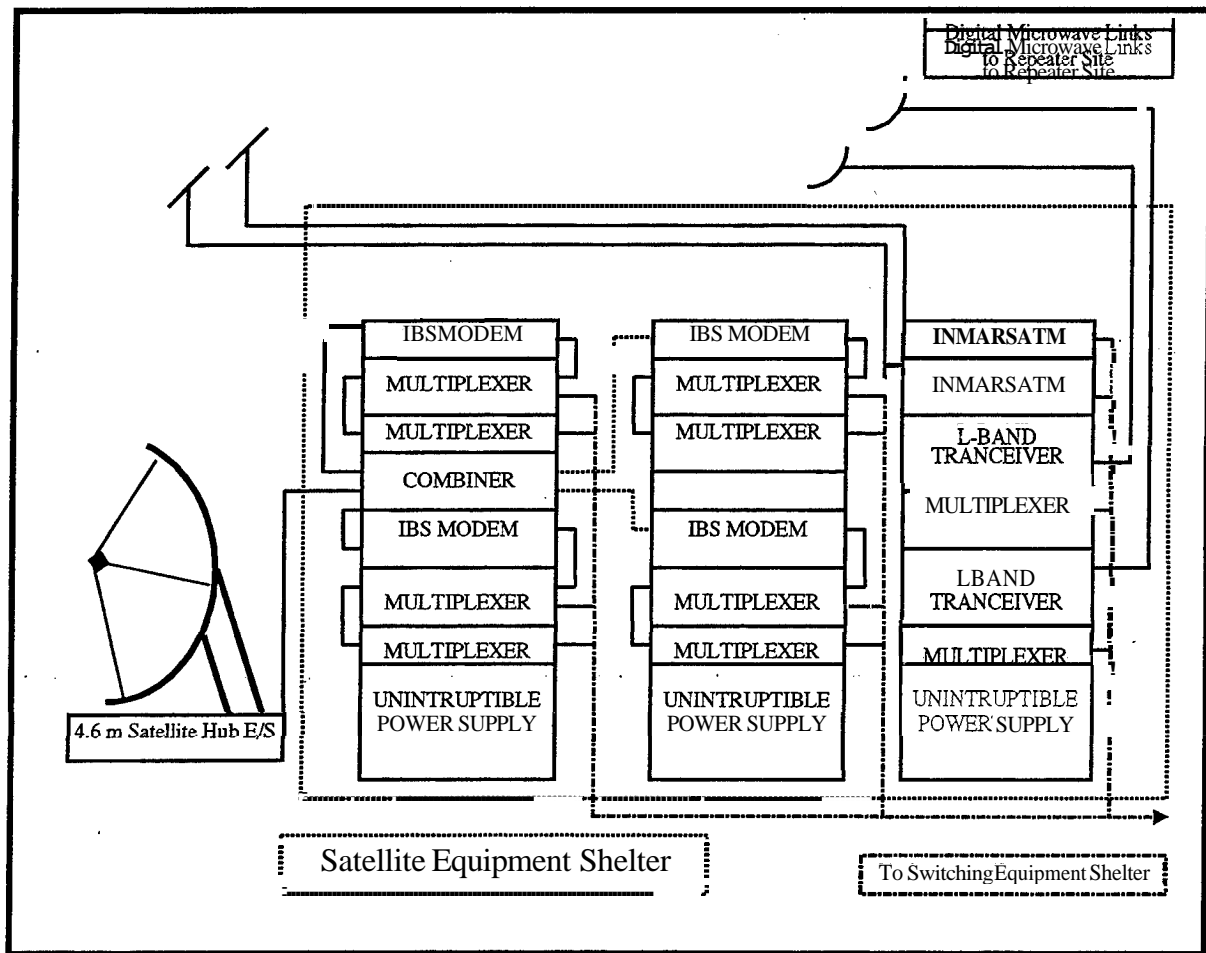

Figure 7.2 UNMIH Headquarters Satellite Hub Earth Station "After Ref.[35]."

The hub earth station (see Figure 7.2) is the same one that provides external communications to the UN headquarters in New York, USA. The Node earth stations (see Figure 7.3) are linked to UNMIH headquarters via a global beam, 'Atlantic Ocean Relay (AOR) INTELSAT satellite system. The fifth Infantry Battalion

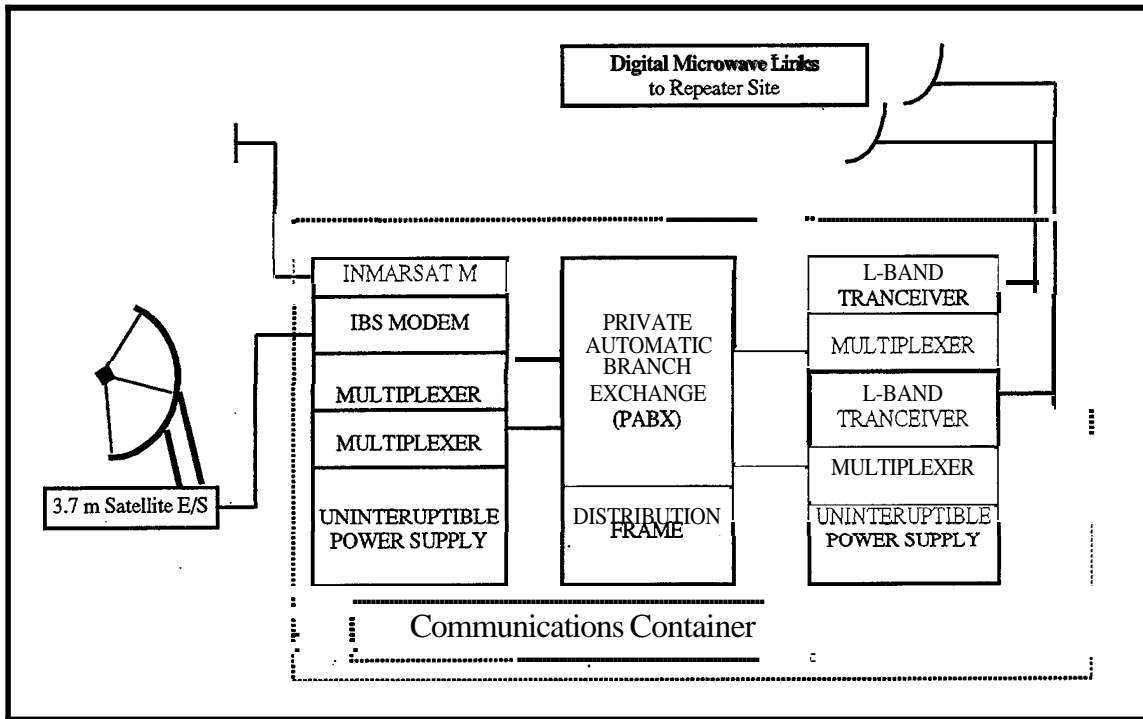

Figure 7.3 Battalion Headquarters Satellite Node Earth Station “After Ref.[35].”

headquarters as well as other support units are linked to the network by line of sight (LOS) digital microwave links utilizing repeater sites. From these repeater sites, rural telephone links extend telephone and facsimile services to remote UNMIH and MICIVIH offices, Switching equipment provides the required connectivity via three Private Automatic Branch Exchanges (PABX) located at the UNMIH headquarters, MICIVIH headquarters and the Civilian Police headquarters. The three PABX’s are connected to each other with 2 Mbps links [Ref. 35].

The space and ground segment technical characteristics of the UN satellite system are summarized in Table 7.2 for the Hub and Node earth stations. Information was derived from Reference 35. The secondary communications for Infantry Battalion

headquarters are provided by INMARSAT “M” satellite terminals and for Civilian police Divisions, Detachments and other units by a two way radio network. Finally, emergency communications are provided via a two way radio network [Ref. 35].

Space Segment		
Satellite	INTELSAT 601 332' East	Atlantic Ocean Region
Beam Connectivity	Global “A”	
Transponder	38/38	
Bandwidth	36 MHz	
Modulation	Quadrature Phase Shift Keying (QPSK)	
	Hub Earth Station(1)	Node Earth Stations(4)
Antenna diameter	4.6 meters	3.7 meters
Antenna G/T	24.1 dB/K	23.0 dB/K
Antenna Gain (G <sub>T</sub> )	48.15 dBi	45.95 dBi
HPA	400 Watts TWTA	20 Watts TWTA
LNA temperature	45° Kelvin	45 <sup>0</sup> Kelvin

Table 7.2 UNMIH Satellite System Technical Characteristics

***b. Mobile Communications Network***

The mobile Network has been established in order to provide communications to UNMIH and MICIVIH components while mobile. It is comprised of a trunking system for the coverage of Port-au-Prince area and a conventional two way radio system for the rest of the island.

The mobile trunking system was estimated to accommodate approximately 700 users. The system must be expandable as required and able to control each portable unit in order to disable lost or stolen units effectively. A single site 12 channel trunking

system at a site overlooking the capital Port-au-Prince has been chosen in order to fulfill this requirement.

The conventional two-way radio system for coverage of areas outside the capital consists of eight repeater sites and three single-channel repeater stations per site. The three channels are devoted to Operations, Civilian Police and MICIVIH Nets. The subscribers of the Operations Net are at the headquarters level for the Infantry Battalion, Military Police Battalion, Engineer Battalion, Logistics Battalion, Military Training Unit, Aviation Unit, Movement Control Unit and Field Hospital. It is not intended for internal battalion use but only to provide the necessary interface between the infantry battalion at headquarters level and the other support units [Ref. 35]. It should be taken into account that there is no provision for handheld units but only for base station equipment and a small number of mobile radio equipment. The Civilian Police Net has base station equipment as well as full provision with mobile and handheld terminals for each mobile team. The MICIVIH Net users have been equipped with base station, mobile as well as handheld terminals [Ref. 35].

The eight repeater sites required have been chosen so as to provide 95% coverage of the country. However nine sites for possible repeater establishment were evaluated in order to have one auxiliary site for backup [Ref. 35]. One typical repeater site configuration is presented in Figure 7.4. As stated in the UNMIH COMMSPLAN “inevitably some areas will not have full radio coverage”. This poses a problem which the planners of the operation had thought of overcoming by a quick relocation of the mission’s communication assets. A more comprehensive solution would be provided undoubtedly, by the application of the “ITG” model architecture utilizing primarily ICO and secondarily Teledesic Mobile Satellite Systems (MSS). This alternative solution is introduced in the next section.

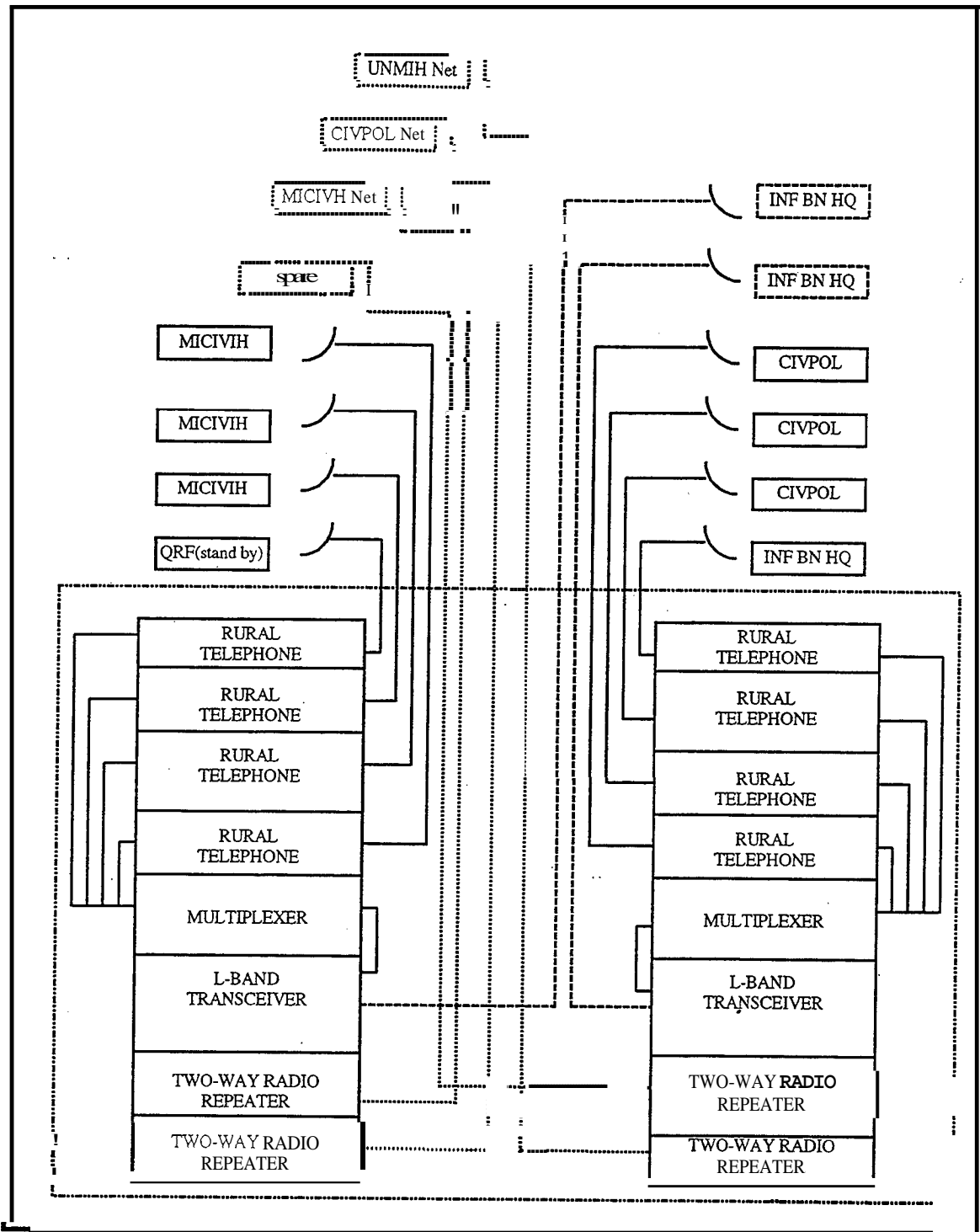

Figure 7.4 UNIMIH Repeater Site Configuration "After Ref. [35]"

## C. UN PEACEKEEPING WITH THE “ITG” MODEL

As shown in the previous section, the UNMIH COMMSPLAN [Ref. 35] is relatively simple and the requirements for voice and data services do not include any protection or high security features. Conclusively, this is accepted for any other UN mission communications plan in general. In addition to this, the mobile part of UNMIH communications plan has coverage problems in some parts of the country, yet another common denominator for the UN communications plans in general. The coverage issue must also be taken into account for countries located at higher latitudes where the **GEO** family satellites (i.e. **INTELSAT** and **INMARSAT**) cannot operate as effectively as they do for latitudes close to the equator.

Additionally, taking into account the requirement for importing and establishing the hardware equipment (i.e. hub and node earth stations and repeater sites) in a country for a potential UN peacekeeping mission further supports the conclusion that the “ITG” model can accommodate the needs and service of such a mission with greater abundance, relatively more ease, more effectively and with possibly lower functional costs. For the employment of the “ITG” model neither node earth stations or repeater sites are required to be established inside the country of interest.

A UN peacekeeping mission does not require, for the time being, any broadcast services. Thus the use of the GBS “component” of the ITG model is not presently needed for such a mission. On the other hand, GBS presents possible utilization under two assumptions. First, the US Armed Forces participation in the mission, under the auspices of United Nations. Second, DoD agreement/permission is provided for employment of the system. The ICO and Teledesic “components” of the “ITG” model architecture are enough to provide primary and secondary platforms, interchangeably, for the accommodation of any UN peacekeeping mission. They will also provide high mobility to “Mobile” as well as “on the move UN users”.

### 1. "ITG" Communications Network for UN Peacekeeping

The "ITG" model applied to a UN peacekeeping mission is shown in Figure 7.5. The "ITG" model can provide internal as well as external communications to the mission's units (see Table 7.1) in an integrated design. "ITG" offers the required telephone, facsimile and data services with seamless connectivity. In addition, ICO

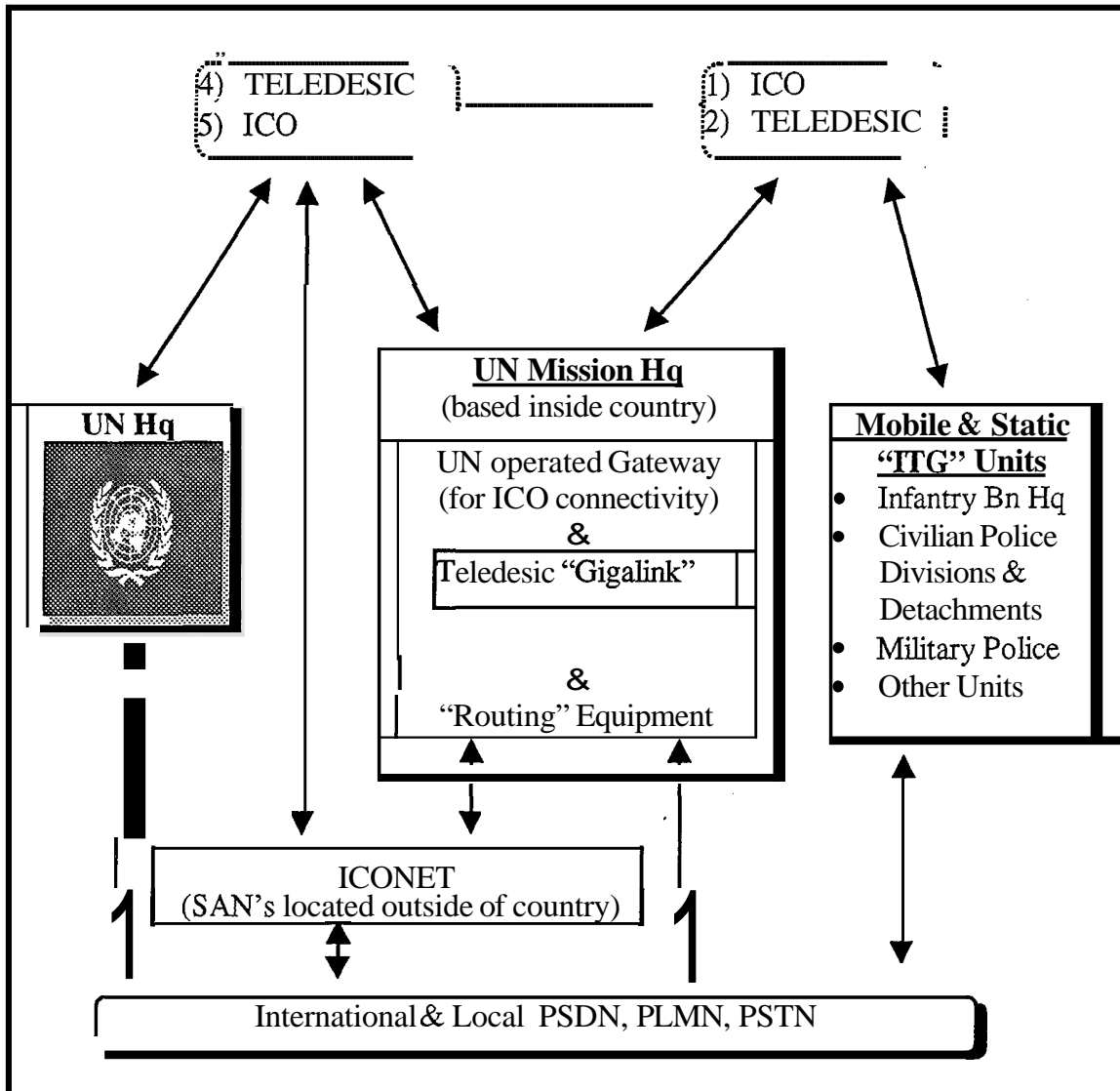

Figure 7.5 The "ITG" Communications Network for UN peacekeeping

can offer messaging services [Ref. 15] and Teledesic can offer video and multimedia services [Ref. 2] if required.

The utilization of the “ITG” model architecture does not require additional hardware or the existence of a mobile network and a separate static communications network with all the limitations emerging from their usage. The user segments of ICO (see Chapter 2) and Teledesic [Ref. 2] are the only two components that are needed to be present in the field in order to provide any UN peacekeeping mission with all the required features for reliable and effective, mobile as well as static communications.

*a. External Communications*

The mission’s external communications will be provided primarily by Teledesic and secondarily by **ICO** (see Figure 7.5). Digital voice, data, facsimile and messaging services will be offered both by ICO and Teledesic. In addition to these, Teledesic can offer if desired, multimedia services such as video-teleconferencing, a feature whose publicity and usage increase every day in the decision making process all over the world. By the use of multimedia services the Force Commander of a UN peacekeeping mission **as well as** the Special Representative of the Secretary General, will have in their possession a more versatile asset than voice or facsimile in order to communicate with the United Nations Headquarters in New York, **USA**, or even with the Secretary General and his staff while they are static or “on the move”. No user in either part of the communications channel will need to be static or terminate his move in order to communicate effectively with the other part. The utilization of airborne as well as vehicular, ICO and Teledesic terminals will virtually zero the response time of any UN Special Representative or Force Commander.

Connectivity will be provided in two ways. First with direct connection via the Teledesic constellation (through the “Internet” in the Sky concept”) [Ref. 2] and/or the ICO constellation (for voice, fax and messaging only). Second via the Teledesic “Gigalink” Terminal inside the UN operated gateway [Ref. 16] through the “Routing” equipment, into the international and local Public Land Mobile Networks (PLMN), Public Switched Telephone Networks (PSTN) and Public Switched Digital Networks (PSDN).



For ICO traffic, the flow of information (voice, fax and data) will be routed via the ICO constellation, to the ICONET's Satellite Access Nodes (SAN) located outside the country of interest and into the UN operated gateway located inside. The SAN location outside the country of interest offers the advantage of enhanced physical security and survivability of the ICO system flow of information, against sabotage from opposing militant groups inside the country of mission operations. This was not the case for UNMIH, but it can be argued for the cases of Somalia, Northern Iraq and Bosnia. For the Haiti mission, as well as the Central American region, the SAN located in Tulancingo, Mexico (see table 2.4) would be the one to provide for UNMIH all the required terrestrial networks connectivity.

The versatility of the "ITG" model "components" is such, that all the gateway equipment including the Teledesic "Gigalink" terminal and the routing equipment need not to be inside the area of operations or even the same country in order to provide connectivity to the outside world. All the equipment can be positioned in a safe area from both a physical and a security point of view. The presence of the user segment "ITG" model architecture's components inside the country is sufficient in order for a United Nations mission to have reliable uninterrupted and seamless external as well as internal communications.

***b. Internal Communications***

Regarding the UN mission's internal communications network, the "ITG" model is even simpler in planning and utilization (see Figure 7.5). As stated above, the stationing of the user unit of the "ITG" model inside the country of interest is sufficient. All the mission units will be equipped with airborne, vehicular, shipborne (if required) as well as man-pack terminals.

For a UN peacekeeping mission's internal communications, the ICO "component" of "ITG" model will provide the primary means of communications and Teledesic the secondary. All connections can be performed via ICO satellites if the country's communications infrastructure is either unreachable or non-existent. Headquarters and command posts will be equipped with vehicular and airborne terminals

for better utilization and management of the communications scheme. All participating units, down to the single UN peacekeeper or Civilian/Military Police officer, will be equipped with the ICO handsets (see Table 2.2), thus establishing seamless connectivity even with the most remotely located unit inside and outside the country.

The versatility of the "ITG" model application renders the limitations imposed by the assumptions presented in Section B.1 of this Chapter obsolete and redundant. First, there will be no real difference between external and internal communications apart from the individual use of dedicated channels for these two tasks.

Second, the communications scheme under the "ITG" model application will not need any further planning in order to accommodate the requirements of additional UN agencies operating in the country. The communications platform will be there and ready to accommodate more subscribers according to their needs.

Third, the troop contributing nations will not have to provide their own equipment for internal communications below battalion level. The versatile and lightweight ICO handsets [Ref. 16] will be issued to everyone of the participating nation's troops. The Global System for Mobile communications (GSM) specifications of the ICO "component" allow multiple access levels for high priority users, and the Personal Computer Memory Card International Association (PCMCLA) feature enables its security whenever required. It could be argued that the budgetary requirement for such a deployment would play a significant role. From an initial assessment it is assumed that the cost involved is comparable to that from deploying the INTELSAT system with its hub, nod earth stations and the appropriate repeater sites with all the required maintenance and technical personnel costs taken into account. On the other hand, the operational benefits of an "ITG" deployment are intuitively far greater than the INTELSAT deployment. This fact is self-evident. Of course, if high bandwidth information was required to be exchanged, a GEO deployment would more preferable, but for a United Nations peacekeeping mission this is not definitely the case. Both ICO and Teledesic possess more than enough of the required bandwidth for the accomplishment of such a mission. A detailed cost estimate is considered by the author to be beyond the scope of this research and is also a task for future study.

Last but not least, an “ITG” model application will be free from the coverage limitations introduced by the present scheme utilizing repeater sites. ICO provides seamless connectivity with 100 per cent earth coverage [Ref. 17] and Teledesic 72<sup>0</sup> North to South latitudes. The line of site(LOS) limitations of the digital microwave links between repeater sites are zeroed because such sites are not needed with the proposed model.

It could also be argued that the application of two Mobile Satellite Systems(i.e. ICO and Teledesic) in a UN peacekeeping mission complicates their utilization and enlarges the cost of the operation. It is obvious that each one of them can perform adequately for the requirements of such a mission, but their parallel application offers the advantage of interchangeable primary and secondary communications to the Chief Communications Officer’s plan.

## **D. SUMMARY**

The UNMIH COMMSPLAN [Ref. 35] was reviewed as a paradigm for a model United Nations peacekeeping mission. In this chapter, it was displayed how the internal as well as external communications requirements can be accommodated by the “ITG” model architecture utilizing the ICO and Teledesic Mobile Satellite Systems(MSS). It was also shown that such an operation can be performed in a very competent and more versatile method than it is currently. The MSS under investigation, will become operational by the year 2000. They will provide a very promising asset which will revolutionize the worldwide communications both in the military and civilian arenas as well as in “operations other than war” (i.e. United Nations peacekeeping missions).

## VIII. CONCLUSIONS AND RECOMMENDATIONS

### A. CONCLUSIONS

The previous Chapters introduced and described the “ITG” model architecture, in order to accommodate the satellite communication (SATCOM) needs of military forces. **This** model architecture, comprised by ICO for narrowband, Teledesic for wideband and GBS for broadcast SATCOM, gathers the most advanced features for its potential applications on US Armed Forces operations and UN peacekeeping missions. It is now time to summarize and conclude all the main points of this research.

None of the Mobile Satellite Systems (MSS) under investigation (ICO, Teledesic, Globalstar, Odyssey, Iridium) possess all the DoD requirements for MILSATCOM. In addition to this, no single MSS can provide the needs and requirements of US MILSATCOM alone. This is the **main** reason that made the author produce the concept of the “ITG” model architecture presented in Chapter IV.

None of the commercial MSS has any broadcast capability by means of transmission and high bandwidth requirements. Moreover, the US Department of Defense (DoD) already has underway a three phase program to accommodate all the broadcast SATCOM requirements of the US Armed Forces in the 21<sup>st</sup> century. The Global Broadcast Service (GBS) will offer high bandwidth broadcast communications with voice, video, and data services to all the CONUS and forward deployed US Armed Forces units all over the world. Therefore, its inclusion in the “ITG” model architecture will be unavoidable but also very beneficial to “mobile” users and “users on the move”. A detailed description of the three phased plan as well as the concept of operations and features of GBS was presented in Chapter III. For the issue of the employment of “ITG” in UN peacekeeping missions the use of GBS can be done under the dual assumption of US Forces participation and DoD permission.

In the narrowband and wideband arenas, as already stated, no single commercial MSS can single-handedly accommodate the needs of US Armed Forces SATCOM. On the other hand, a combination of ICO for narrowband and Teledesic for wideband is suitable for this task. This combination has been chosen after thorough investigation and research presented in Chapter V. Teledesic takes a place in the “ITG” architecture because it is the only wideband candidate [Ref. 2]. ICO takes the first place among the narrowband systems because of its global coverage, high capacity and quality of services. Additionally, the participation in ICO of telecommunication organizations from 44 countries (including the Hellenic Telecommunications Organization-OTE) offers to the project guaranteed founding and planning procedure as well as a long history of successful cooperation with military organizations in their respective countries; two factors that become very important in the potential military applications of the system. ICO will provide digital voice, data, facsimile, messaging and information services through a global distribution system (see Chapter II).

The quantitative and qualitative application of the “ITG” model to the US “Combat Capable” Naval Forces (see Chapters V and VI) has shown that such an application is feasible with the utilization of commercial mobile satellite systems (MSS). The US forces comprised by a Carrier Battle Group (CVBG) supporting an Amphibious Ready Group (**ARG**) and a Marine Expeditionary Unit (MEU) embarked on the ARG provide a circuit requirements scenario (see Chapter VI) that can be accommodated by the “ITG” concept. This applies even under the assumptions of a second/third “Combat Capable” Naval Force at another geographical area and the anticipated commercial/civilian usage occurring simultaneously.

The quantitative and qualitative application of “ITG” to UN peacekeeping operations (see Chapter VII) has also proven that the commercial MSS are suitable for applications to operations “other than war”. The commercial satellite systems employed presently, for providing global connectivity to UN peacekeeping missions do not offer the UN forces the required mobility, flexibility and coverage. The future application of MSS for UN peacekeeping missions will provide them with 21<sup>st</sup> century communication

products and services at costs if not less than the present at least comparable with them, therefore making the UN peacekeeping missions more versatile and flexible.

The cost of the "ITG" model architecture is comparable with GEO applications and the benefits of worldwide coverage, **24** hour availability and **small** delay times (see Chapter I) and can balance the advantage of high bandwidth offered by the GEO systems, especially in applications in which high bandwidth is not a factor, such as narrowband (mainly voice and low data rate data) and mediumband SATCOM.

The **main** conclusion of this research is that mobile satellite systems (MSS) can be successfully and innovatively employed in military communications applications. As Jai Singh, the executive vice president of ICO said in 13<sup>th</sup> May 1996 : "*The hardest part of projecting toward that future is usually the challenge of freeing our minds from the past habits and practices*" [Ref. 36].

## **B. RECOMMENDATIONS**

The creation of a testbed program is required in order to evaluate the "ITG" architecture before actually implementing the concept widely. Initially, the planning of the program can start as soon as the decision for employing this model architecture for the needs of the US Armed Forces has been taken. *All* the required parameters and features have been well described in this thesis. Finally, the actual testing will be performed after the initial operation of the ICO and Teledesic Mobile Satellite Systems(MSS) have become fully operational by the year 2000-2002.

A cost estimation of the "ITG" architecture implementation in the applications of US "Combat Capable" Naval Force as well as the UN peacekeeping mission must be included in the plans of the evaluators for these or future applications.



## LIST OF REFERENCES

1. LTC J.Robert, PhD Bonometti " *Tactical Applications of Defence Microspace Communications* " , Proceeding of Tactical Communications Conference, Vol. 1, pp.203-210.
2. H. Stelianos, ' *The use of Commercial Low Earth Orbit Satellite systems to support DoD communications* ', Master's Thesis , Naval Postgraduate School, Monterey CA, December 1996.
3. Chief of Naval Operations and Naval Space Command ' *Naval Satellite Communications Functional Requirements Documents* ', 26 July 1996.
4. D.B. Crosbie, " *Satellite Mobile Communications from the Year 2000* ", IEEE Colloquium on " *Mobile Communications in the Year 2000* ", pp. 5/1-5/6 , London UK , 9 June 1992.
5. G. D. Gordon and W.L. Morgan, Principles of Communications Satellites, John Wiley & Sons, Inc. Publishing Company, New York NY, 1993.
6. F. Ananasso, " *An Overview of Mobile Satellite Systems and their Evolution Towards Satellite Personal Communication Networks* " *Proceedings of Tenth International Conference on Digital Satellite Communications*, Vol. 2, pp.435-441, Brighton UK, 15-19 May 1995.
7. Tri T. Ha, Digital Satellite Communications, Macmillan Publishing Company, New York NY, 1986.
8. R.L. Turcote and S. Arneson, ' *The role of Commercial LEOs in Global Grid* ' , Proceedings of MILCOM 93, Vol.1, pp.247-251, Boston MA, 11-14 Oct. 1993.
9. R.S. Carlisle, " *A Global Broadcast service for the User on the move* ", Master's Thesis , Naval Postgraduate School, Monterey CA, June 1996.
10. F. Ananasso and F.D. Priscoli, " *Issues on the Evolution Towards Satellite Personal Communication Networks* ", IEEE Proceedings of GLOBECOM 95, Vol. 2, pp. 541-545, May 1995.
11. S. Blondeau, G. Maral, T. Roussel, J.P. Taisant, " *Self Interference in non Geostationary Satellite Systems* ", IEEE Proceedings of Tenth International Conference on Digital Satellite Communications, Vol. 1, pp. 290-297, Brighton UK, 15-19 May 1995.
12. A. Paraboni, C. Capsoni, F. Zaccarini, " *The Horizontal Structure of Rain and its Impact on the Design of Advanced Satellite Systems at Centimetre and Millimetre Wavelengths* ",



Proceedings of SBMO/IEEE MTT-S International Microwave and Optoelectronics Conference, Vol. 2, pp. 519-525, Rio de Janeiro Brazil , 24-27 July 1995.

13. F. Vatalaro, G.E. Corazza, C. Caini, C. Ferrarelli, “ *Analysis of LEO, MEO, and GEO Global Mobile Satellite Systems in the Presence of Interference and Fading*”, Proceedings of IEEE Journal on Selected Areas in Communications, Vol. 13, pp.291-300, USA, February 1995.
14. ICO Global Communications, Annual Report, Hammersmith London UK, 1995.
15. ICO Global Communications, System Description, Hammersmith London UK, 1995.
16. Application of COMSAT Corporation, to Federal Communications Commission, for Authority to Participate in the Procurement of Facilities of the ICO Global Communications Limited System, COMSAT Mobile Communications, Clarksburg ML, May 1995.
17. Hughes Space & Communications International Inc., “*The ICO Global Mobile System*”, presentation slides.
18. C.J. Pravin , “ *Architectural Trends in Military Satellite Communications Systems*”, Proceedings of the IEEE, pp. 1176-89, Vol. 78 , 7 July 1990.
19. J.C. Kim - E.I. Muehldorf, *Naval Shipboard Communications Systems*, Prentice Hall PTR , Englewood Cliffs N.J., 1995.
20. Federal Systems Integration and Management Center (FEDSIM), “*Commercial Satcom Technical Product(DRAFT)*” prepared for Naval Space Command, Falls Church VA, December 1995.
21. B. Shumadine, “*UHF SATCOM*”, presentation slides, Naval Postgraduate School, Monterey CA, 8 April 1997.
22. N.C. Fermor, “ *Trends in Military Satellite Communications*” IEEE Colloquium on Military Communications-The Trend Towards Civil Standards, pp. 9/1-7, London UK, 3 April 1990.
23. M.W. Freeman and Major R.M. Cotton, “*Army Tactical Satellite Communications*”, IEEE Tactical Communications Conference Proceedings, 237-244, Ft. Wayne IN, 30 April 1992.
24. Headquarters, US Space Command, “*Global Broadcast Service (GBS) Concept of Operations*”, Peterson AFB CO, 25 January 1996.

25. J. Trammell, "*Global Broadcast Service (GBS)*", briefing to NPGS students, Naval Postgraduate School, Monterey CA, 15 April 1997.
26. Global Broadcast Service (GBS) Phase II System Specification(DRAFT v0.1), "*System Requirements Document (SRD)*", 20 September 1996.
27. A. Bartko, A.Q. Le, T.N. Thomas, L. Sheet, "*Perceived issues associated with military use of Satellite Based Personal Communications Systems*" Proceedings of MILCOM 95, Vol.3, pp. 1224-1228, San Diego CA, 5-8 November 1995.
28. The Sunday Times Business News, "*Internet Gamble Soars Sky High*", 4 May 1997, London UK.
29. Hughes Space & Communications International Inc. Summary of HSC MISC Efforts, "*Military Use of LEO/MEO Communications Networks*", presentation slides, 11 April 1996.
30. K.G. Johannsen, "*Mobile Satellite P-Service Satellite System Comparison*", International Journal of Satellite Communications, Vol. 13, pg. 453-471, April 1995.
31. M. K. Price and R.G. Leamon, "*Definition of a Commercial Mobile Satellite Services Network to Meet DoD Communications Needs*". Proceedings of MILCOM 93, Vol.3, pp.821-825, Boston MA, 11-14 October 1993.
32. US Navy, Office of the Chief of Naval Operations, "*Force 2001 - A program guide to the US Navy*", Department of the Navy, Washington DC, 3 October 1994.
33. Joint Publication 1-02, Department of Defence Dictionary of Military and Associated Terms, 23 March 1994.
34. J. Arquilla, Psychological Operations and Deception: PSYOP Support to Operation Uphold Democracy, Naval Postgraduate School, Fall 1996.
35. United Nations Field Administration & Logistics Division, Logistics & Communications Section, "*United Nations Mission In Haiti (UNMIH) Communications Plan VI.0*", 4 November 1994.
36. Jai Singh, "*The Challenge of Time Travel*", Fifth International Conference on Satellite Systems for Mobile Communications & Navigation, IEEE, London UK, 13 May 1996.



## INITIAL DISTRIBUTION LIST

	No. Copies
1. Defense Technical Information Center 8725 John J. Kingman Rd, STE 0944 Ft. Belvoir, VA 22060-6218	2
2. Dudley <b>Knox</b> Library, Code 52 Naval Postgraduate School 411 Dyer Road Monterey, CA 93943-5101	2
3. Research Office, Code 09 Naval Postgraduate School 589 Dyer Road Monterey, CA 93943-5138	1
4. Chairman, Code EC Department of Electrical and Computer Engineering Naval Postgraduate School 833 Dyer Road Monterey, CA 93943-5121	1
5. Professor Tri T. <b>Ha</b> , Code EC/Ha Department of Electrical and Computer Engineering Naval Postgraduate School 833 Dyer Road Monterey, CA 93943-5121	2
6. Professor V. Garcia, Code EC/Ga Department of Electrical and Computer Engineering Naval Postgraduate School 833 Dyer Road Monterey, CA 93943-5121	1
7. LT Ioannis Kakavas Dios 28 Ilion 13121 Athens, Greece	1

