



2003-09

Modeling reduced human performance as a complex adaptive system

Wellbrink, Joerg C. G.

Monterey, California. Naval Postgraduate School

<http://hdl.handle.net/10945/9885>



Calhoun is a project of the Dudley Knox Library at NPS, furthering the precepts and goals of open government and government transparency. All information contained herein has been approved for release by the NPS Public Affairs Officer.

Dudley Knox Library / Naval Postgraduate School
411 Dyer Road / 1 University Circle
Monterey, California USA 93943

<http://www.nps.edu/library>

NAVAL POSTGRADUATE SCHOOL
Monterey, California



DISSERTATION

**MODELING REDUCED HUMAN PERFORMANCE AS A
COMPLEX ADAPTIVE SYSTEM**

by

Joerg Wellbrink

September 2003

Dissertation Supervisor:

Michael Zyda

Approved for public release; distribution is unlimited

THIS PAGE INTENTIONALLY LEFT BLANK

REPORT DOCUMENTATION PAGE			<i>Form Approved OMB No. 0704-0188</i>
Public reporting burden for this collection of information is estimated to average 1 hour per response, including the time for reviewing instruction, searching existing data sources, gathering and maintaining the data needed, and completing and reviewing the collection of information. Send comments regarding this burden estimate or any other aspect of this collection of information, including suggestions for reducing this burden, to Washington headquarters Services, Directorate for Information Operations and Reports, 1215 Jefferson Davis Highway, Suite 1204, Arlington, VA 22202-4302, and to the Office of Management and Budget, Paperwork Reduction Project (0704-0188) Washington DC 20503.			
1. AGENCY USE ONLY (Leave blank)	2. REPORT DATE September 2003	3. REPORT TYPE AND DATES COVERED Dissertation	
4. TITLE AND SUBTITLE: Modeling Reduced Human Performance as a Complex Adaptive System			5. FUNDING NUMBERS
6. AUTHOR(S) Joerg Wellbrink			
7. PERFORMING ORGANIZATION NAME(S) AND ADDRESS(ES) Naval Postgraduate School Monterey, CA 93943-5000			8. PERFORMING ORGANIZATION REPORT NUMBER
9. SPONSORING / MONITORING AGENCY NAME(S) AND ADDRESS(ES) MOVES Institute Center for the Study of Potential Outcomes Monterey, CA 93943-5000			10. SPONSORING / MONITORING AGENCY REPORT NUMBER
11. SUPPLEMENTARY NOTES The views expressed in this thesis are those of the author and do not reflect the official policy or position of the Department of Defense or the U.S. Government.			
12a. DISTRIBUTION / AVAILABILITY STATEMENT Approved for public release; distribution is unlimited			12b. DISTRIBUTION CODE
13. ABSTRACT (maximum 200 words) Current cognitive models not only lack flexibility and realism, they fail to model individual behavior and reduced performance. This research analyzes current cognitive theories (namely, symbolism, connectionism, and dynamicism). It hypothesizes that reduced human performance can be best modeled as a complex adaptive system. The resulting multi-agent model "Reduced Human Performance Model (RHPM)" implements reactive agents competing for cognitive resources. Lack of resources is used to trigger the simulation of imperfect perception and imperfect cognition. The simulation system is calibrated with human experimental data in scenarios involving vigilance decrement, wherein vigilance is decreased during the first 30 minutes of a screening task. RHPM is then validated against previous unknown vigilance task scenarios. RHPM generates realistic reduced human performance with a new cognitive modeling hypothesis. The developed multi-agent system generates adaptive and emergent behavior. Its use for computer generated forces (i.e. radar screen operator) would improve the realism of simulation systems by adding human like reduced performance. This research's main contribution is the development of a well suited tool to mediate between vigilance theories such as signal detection theory and experimental data. It generates insights creating likely hypotheses to improve the theories.			
14. SUBJECT TERMS Vigilance, cognitive modeling, complex adaptive system, human performance, personality, cognitive psychology			15. NUMBER OF PAGES 214
			16. PRICE CODE
17. SECURITY CLASSIFICATION OF REPORT Unclassified	18. SECURITY CLASSIFICATION OF THIS PAGE Unclassified	19. SECURITY CLASSIFICATION OF ABSTRACT Unclassified	20. LIMITATION OF ABSTRACT UL

THIS PAGE INTENTIONALLY LEFT BLANK

Approved for public release; distribution is unlimited

**MODELING REDUCED HUMAN PERFORMANCE AS A COMPLEX
ADAPTIVE SYSTEM**

Joerg C.G. Wellbrink
Major, German Army
M.S. Electrical Engineering., German Armed Forces University Munich, 1985
M.S. Operations Research, Naval Postgraduate School, 1998

Submitted in partial fulfillment of the
requirements for the degree of

**DOCTOR OF PHILOSOPHY IN
MODELING, VIRTUAL ENVIRONMENTS AND SIMULATION**
from the

**NAVAL POSTGRADUATE SCHOOL
September 2003**

Author:

Joerg C.G. Wellbrink

Approved by:

Dr. Mike Zyda
Professor of Computer Science
Dissertation Supervisor and
Dissertation Committee Chair

CDR Dr. Lisa Curtin, USN
Dean of Students, NPS

Dr. Rudy Darken
Associate Professor of Computer
Science

Dr. Ted Lewis
Professor of Computer Science

Dr. Maria Rasmussen
Associate Professor of
National Security
Affairs

John Hiles
Research Professor of MOVES

Approved by:

Dr. Rudy Darken, Chair, MOVES Academic Committee

Approved by:

Dr. Carson K. Eoyang, Associate Provost for Academic Affairs

THIS PAGE INTENTIONALLY LEFT BLANK

ABSTRACT

The surprise attacks of September 11, 2001, generated a need for more sophisticated models for the detection of potential threats. A prerequisite of such models is the ability to simulate reduced human performance realistically. Realistic human performance should include the very human traits of imperfect perception, imperfect cognitive processing, and imperfect behavior. Imperfect or lowered performance caused by lack of information, lack of perception, or lack of cognitive resources, is termed “reduced human performance” and takes a variety of forms, which simulated entities must portray, if they are to be realistic.

An unexpected event is called a surprise, and surprises are more likely to occur when performance is reduced. Thus surprises may be seen as a by-product of reduced human performance. A sophisticated cognitive model should generate surprises and unexpected outcomes as part of its portrayal of complex problem domains.

Current cognitive models not only lack flexibility and realism, they fail to model individual behavior and reduced performance. This research analyzes current cognitive theories (namely, symbolism, connectionism, and dynamicism). We then hypothesize that reduced human performance can be best modeled as a complex adaptive system. The resulting multi-agent model Reduced Human Performance Model (RHPM) implements reactive agents (following a notion of Dr. Chris Wicken’s Multiple Resource Model) competing for cognitive resources. Lack of resources is used to trigger the simulation of imperfect perception and imperfect cognition.

The developed multi-agent system generates adaptive and emergent behavior. The simulation system is calibrated with human experimental data in scenarios involving vigilance decrement, wherein vigilance is decreased during the first 30 minutes of a screening task. RHPM is validated against previous unknown vigilance task scenarios.

RHPM generates realistic reduced human performance with a new cognitive modeling hypothesis. Its use for computer generated forces (i.e. radar screen operator) improves the realism of simulation systems by adding human like reduced performance.

This research's main contribution is the development of a well suited tool to mediate between vigilance theories such as signal detection theory and experimental data. It generates insights creating likely hypotheses to improve the theories.

TABLE OF CONTENTS

I.	INTRODUCTION.....	1
	A. THESIS STATEMENT	1
	B. MOTIVATION	1
	C. PROBLEM STATEMENT	2
	D. THE COMPLEX ADAPTIVE SYSTEM HYPOTHESIS (CASH).....	5
	E. APPROACH	9
	1. Reduced Human Performance Model (RHPM)	10
	F. CONTRIBUTIONS.....	12
	1. Contribution Goals	12
	2. Scope.....	13
	G. DISSERTATION OVERVIEW.....	13
II.	RELATED WORK.....	15
	A. COMPLEX ADAPTIVE SYSTEMS.....	15
	1. Definitions for Complex Adaptive System (CAS)	15
	<i>a. Santa Fe Institute’s Definitions</i>	<i>15</i>
	<i>b. Provisional Working Definition</i>	<i>17</i>
	2. Ecological Science	18
	<i>a. Sugarscape</i>	<i>18</i>
	3. Organizational Science	20
	4. Economy.....	22
	5. Medical Science	23
	6. Combat Modeling.....	25
	7. Complexity Theory as Worldview Challenge.....	26
	B. COGNITIVE MODELING.....	27
	1. Developments in Cognitive Modeling.....	27
	2. Symbolism Approach to Cognitive Modeling.....	28
	3. Connectionist Approaches to Cognitive Modeling.....	29
	4. Dynamical Hypothesis	29
	5. Cognitive Theories and Their Levels	31
	6. State-of-the-Art Cognitive Modeling.....	33
	7. Recent Advances in Human Behavior Modeling	35
	<i>a. The Agent-based Modeling and Behavior Representation (AMBR) Project.....</i>	<i>35</i>
	<i>b. Use of Complexity Theory in Cognitive Science.....</i>	<i>40</i>
	C. SUMMARY.....	42
III.	REDUCED HUMAN PERFORMANCE.....	43
	A. INTRODUCTION.....	43
	B. PERFORMANCE FACTORS AND MEASURES	43
	1. Human Performance Formula.....	43
	2. Quantitative Measures.....	45
	3. Qualitative Measures.....	46
	C. AROUSAL, STRESS AND PERFORMANCE	46

1.	Arousal Theories.....	48
a.	<i>Yerkes-Dobson Law</i>	48
b.	<i>Dynamic Stress Model</i>	48
D.	VIGILANCE PERFORMANCE	50
1.	Background to Studies of Vigilance Performance	50
2.	Vigilance Performance Factors	52
a.	<i>Task Factor</i>	53
b.	<i>Environmental Factor</i>	55
c.	<i>Subjective Factor</i>	56
d.	<i>Vigilance Performance Formula</i>	58
3.	Vigilance Theories	59
a.	<i>Inhibition and Habituation</i>	60
b.	<i>Filter Theory</i>	61
c.	<i>Expectancy Theory</i>	62
d.	<i>Resource Theory</i>	62
e.	<i>Arousal Theory</i>	63
E.	REDUCED HUMAN PERFORMANCE AS A COMPLEX ADAPTIVE SYSTEM	64
1.	Comparison with Provisional Working Criteria	64
a.	<i>Autonomous Agents Acting in Parallel</i>	64
b.	<i>Highly Dispersed Control</i>	65
c.	<i>Non-linear Interactions</i>	65
d.	<i>Adaptive System with Emergent Behavior</i>	66
e.	<i>Dynamically Changing Structure</i>	67
f.	<i>Changing Different Equilibria</i>	67
g.	<i>Implicit or Explicit Model for the Future</i>	67
h.	<i>Strong Sense of Path Dependency</i>	68
F.	PERSONALITY AND VIGILANCE EXPERIMENTS	68
1.	Personality Test Experiment	68
a.	<i>Method</i>	70
b.	<i>Results</i>	70
c.	<i>Summary</i>	72
2.	Low Workload Vigilance Experiment	72
a.	<i>Method</i>	73
b.	<i>Results</i>	74
c.	<i>Cross Cultural Differences</i>	75
d.	<i>Influence of Personality Traits</i>	76
e.	<i>Summary</i>	76
3.	High Workload Experiment	77
a.	<i>Method</i>	77
b.	<i>Results</i>	78
c.	<i>Cross Cultural Differences</i>	80
d.	<i>Influence of Personality Traits</i>	81
e.	<i>Summary</i>	81
4.	Changing Condition Experiment	81
a.	<i>Method</i>	81

	<i>b.</i>	<i>Results</i>	82
	<i>c.</i>	<i>Influence of Personality Traits</i>	84
	<i>d.</i>	<i>Summary</i>	84
	5.	Conclusions	85
G.		FINDINGS	85
IV.		DESIGN OF THE REDUCED HUMAN PERFORMANCE MODEL	87
A.		SOFTWARE ENGINEERING ASPECTS	87
1.		Discrete Event Simulation.....	87
2.		Loosely Coupled Components.....	88
B.		DESIGN AND VALIDATION STRATEGY.....	90
C.		DESCRIPTION OF THE COGNITIVE FRAMEWORK.....	93
1.		Original Purpose	93
2.		Submodels	93
<i>a.</i>		<i>Calibration Modules</i>	94
<i>b.</i>		<i>RHPM Modules</i>	94
3.		Knowledge Representation.....	106
4.		Higher-level Cognitive Function.....	106
5.		Output	107
6.		Multitasking.....	107
7.		Multiple Human Modeling	107
8.		Implementation	107
9.		Support Environment	107
10.		Validation.....	107
D.		RHPM AND FERBER'S FORMULA	108
1.		Environment E	108
2.		Objects O	108
3.		Agents A	108
4.		Relations R.....	109
5.		Operations Op.....	109
6.		Laws L.....	109
E.		REDUCED HUMAN PERFORMANCE MODEL AS A COMPLEX ADAPTIVE SYSTEM	110
1.		Comparison with Provisional Working Criteria.....	110
<i>a.</i>		<i>Autonomous Agents Acting in Parallel</i>	110
<i>b.</i>		<i>Highly Dispersed Control</i>	110
<i>c.</i>		<i>Non-linear Interactions</i>	110
<i>d.</i>		<i>Adaptive System with Emergent Behavior</i>	111
<i>e.</i>		<i>Dynamically Changing Structure</i>	111
<i>f.</i>		<i>Changing Different Equilibria</i>	111
<i>g.</i>		<i>Implicit or Explicit Model for the Future</i>	112
<i>h.</i>		<i>Strong Sense of Path Dependency</i>	112
F.		CONCLUSION	112
V.		COMPUTATIONAL EXPERIMENTS AND RESULTS	113
A.		HARMONIZING RHPM.....	113
B.		VALIDATION RUNS	115
1.		Validation Run Low High Low	116

2.	Validation Run High Low High.....	118
3.	Application Runs	121
a.	<i>Variability of RHPM</i>	122
b.	<i>Individual States and Traits (IST) Module</i>	124
4.	Summary	126
C.	VALIDATION ISSUES	128
1.	Conceptual Model Validation	128
2.	Software Verification.....	129
3.	Operational Validation.....	130
4.	Data Validation	131
D.	SUMMARY	132
VI.	CONCLUSIONS AND FUTURE WORK	135
A.	CONTRIBUTION.....	135
B.	SCALABILITY	136
C.	COGNITIVE MODELLING WITH COMPLEX ADAPTIVE SYSTEMS	137
D.	FUTURE RESEARCH DIRECTIONS.....	138
	APPENDIX A: PRIMER ON DISCRETE EVENT SIMULATION.....	141
A.	EVENT GRAPHS	142
	APPENDIX B: EVENT GRAPH FORMULATIONS.....	147
	SYMBOLIC CONSTRUCTOR AGENT (SCA).....	147
	WORKINGAGENT	149
	UPDATEAGENT UA	151
	PERCEPTAGENT PA	152
	COMPARISONAGENT PA	153
	TASKALLOCATORAGENT	154
	TRANSMITAGENT	155
	SEARCHAGENT	156
	STORAGEAGENT.....	157
	WORKINGMEMORYSTORE	158
	RESPONSESELECTION	159
	RESPONSEEXECUTION	160
	REGULATORFLOWAGENT	161
	RESOURCEAGENT	162
	AMPERE	163
	APPENDIX C: DETAILED RESULTS OF NEO FFI PERSONALITY TEST.....	165
A.	STYLE OF DEFENSE	165
1.	Maladaptive	165
2.	Hypersensitive	166
3.	Hyposensitive.....	166
4.	Adaptive	166
5.	Analysis:.....	167
B.	STYLE OF ANGER CONTROL	167
1.	Temperamental.....	167
2.	Timid.....	168

	3.	Easy-Going.....	168
	4.	Cold-Blooded.....	168
	5.	Analysis	169
C.		STYLE OF WELL-BEING	170
	1.	Gloomy Pessimist	170
	2.	Overly Emotional.....	170
	3.	Upbeat Optimist	170
	4.	Low-keyed.....	170
	5.	Analysis:	171
D.		STYLE OF IMPULSE CONTROL.....	172
	1.	Undercontrolled	172
	2.	Overcontrolled.....	172
	3.	Directed.....	172
	4.	Relaxed.....	173
	5.	Analysis:	173
E.		STYLE OF INTERESTS	174
	1.	Mainstream Consumers	174
	2.	Creative Interactors	174
	3.	Introspectors	174
	4.	Homebodies	174
	5.	Analysis	175
F.		STYLE OF INTERACTIONS	176
	1.	Leaders.....	176
	2.	Welcomers.....	176
	3.	The Unassuming	176
	4.	Competitors	176
	5.	Analysis	177
G.		STYLE OF ACTIVITY	177
	1.	Fun Lovers	178
	2.	Go Getters.....	178
	3.	Plodders	178
	4.	The Lethargic	178
	5.	Analysis	179
H.		STYLE OF ATTITUDES.....	179
	1.	Free Thinkers	180
	2.	Progressives.....	180
	3.	Traditionalists	180
	4.	Resolute Believers	180
	5.	Analysis	181
I.		STYLE OF LEARNING	181
	1.	Dreamers.....	182
	2.	Good Students	182
	3.	By-The-Bookers.....	182
	4.	Reluctant Scholars	182
	5.	Analysis	183
J.		STYLE OF CHARACTER	183

1.	Well-Intentioned.....	183
2.	Effective Altruists.....	184
3.	Self-Promoters.....	184
4.	Undistinguished.....	184
5.	Analysis	185
LIST OF REFERENCES		187
INITIAL DISTRIBUTION LIST		193

LIST OF FIGURES

Figure 1.	Stage Model of Human Information Processing (From :Wickens,1992)	7
Figure 2.	Multiple Resource Model (After: Wickens, 2002)	9
Figure 3.	Conceptual Framework for Reduced Human Performance Model.....	11
Figure 4.	Sugarscape and Sugarscape with Agents (From: Epstein and Axtell 1996, p.21)	19
Figure 5.	Levels of Explanation in Cognitive Science	31
Figure 6.	Human Performance Formula (Matthews, Davies et al. 2000).....	44
Figure 7.	A Representation of Stress (From: Wickens 1992, Fig. 10.1 p.414)	47
Figure 8.	Yerkes Dobson Law (From: Wickens 1992, Fig. 10.2)	48
Figure 9.	Human Adaptability to Stress (From: Hancock and Warm 1989).....	49
Figure 10.	Mackworth’s Clock Experiment and Results.....	50
Figure 11.	Signal Detection Theory; (From: Davies and Parasuraman 1982)	51
Figure 12.	Vigilance Factors	53
Figure 13.	Relationship between Task Variables and Human Performance Factors	54
Figure 14.	Relationship between Environmental Variables and Human Performance Factors.....	55
Figure 15.	Relationship between Subjective Variables and Human Performance Factors.....	58
Figure 16.	Semantic Conception Model Centric View on Vigilance Adapted from (McKelvey 2000)	59
Figure 17.	Cross-Cultural Differences between US and Foreign Students	71
Figure 18.	Low Workload Set Up	73
Figure 19.	Reaction Time in Low Workload Condition.....	74
Figure 20.	Cross Cultural Difference Low Workload.....	76
Figure 21.	High Workload Condition.....	77
Figure 22.	Comparison Reaction Times Low vs. High Workload.....	78
Figure 23.	Comparison Misses Low vs. High.....	79
Figure 24.	Comparison False Alarms US versus FS	80
Figure 25.	Comparison Lapses in Mixed Conditions	82
Figure 26.	Reaction Time Comparison HLH to LHL	83
Figure 27.	False Alarm Mixed Conditions	83
Figure 28.	Message Routing between Agents	89
Figure 29.	Fitting a Model to a Real System (adapted from) (McKelvey, 2000)	91
Figure 30.	Harmonization of a Computational Model adapted (From: Carley 1996, Fig 3. p.20).....	92
Figure 31.	Calibrating the Reduced Human Performance Model	94
Figure 32.	Numbered RHPM Modules	95
Figure 33.	Transformation of Multiple Resource Model (MRM)	96
Figure 34.	Main Analog for RHPM.....	97
Figure 35.	Multiple Resource Model as Electrical Circuit.....	98
Figure 36.	Cognitive Module	99
Figure 37.	Data Flow in the Cognitive Module.....	101
Figure 38.	Cognitive Module as Electrical Circuit.....	101
Figure 39.	Computational Rules for Electrical Circuits.....	103

Figure 40.	Individual States and Traits (IST) Module	105
Figure 41.	Comparison Reaction Times Human vs. RHPM LHL	116
Figure 42.	False Alarm Comparison RHPM Human LHL.....	117
Figure 43.	Comparison Misses RHPm Human LHL.....	118
Figure 44.	Comparison RHPM to Human HLH.....	119
Figure 45.	Comparison Misses RHPM Human HLH.....	119
Figure 46.	Comparison False Alarm RHPM Human HLH	120
Figure 47.	Start View for RHPM	121
Figure 48.	Setup View of RHPM.....	122
Figure 49.	False Alarms in the High Workload Condition Generated by RHPM.....	123
Figure 50.	Control Flow for Next-Event, Time-Advance Approach; (After: Law and Kelton 1991, p.12 Fig. 1.3)	141
Figure 51.	Event Graph of an Object (Schruben 1995, p.472).....	142
Figure 52.	Event Graph for Short Term Sensory Store	145

LIST OF TABLES

Table 1.	The Four Outcomes of Signal Detection Theory (Wickens 1992)	52
Table 2.	Differences (sample) in Performance Based on Personality Trait Extroversion.....	57
Table 3.	One Sample T-test for Personality Scores	70
Table 4.	P Values for Comparison of Misses.....	79
Table 5.	P Values for Low High Low Workload	82
Table 6.	Measure of Performance Human Experiment.....	86
Table 7.	Comparison of the Standard Deviation in the LHL Condition.....	123
Table 8.	Comparison of MOE Fitness.....	126

THIS PAGE INTENTIONALLY LEFT BLANK

ACKNOWLEDGMENTS

Psalm 103:

1 Praise the LORD , O my soul;
all my inmost being, praise his holy name.

2 Praise the LORD , O my soul,
and forget not all his benefits-

11 For as high as the heavens are above the earth,
so great is his love for those who fear him;

I am very thankful for guidance and provision of all the resources that I needed to finish my dissertation. I have never dreamt that this would be possible, but all of a sudden doors opened and opportunities arose.

I would like to thank my German superiors for sending me to this marvelous institution for a second time. I thank my committee members for helping me through these challenging times. I thank all the researchers that took time to listen to me and to help improve my dissertation. Thanks to my fellow students that always had an open ear for me, their support was crucial in this success.

I also thank all my friends especially my fellow Shoreliners, my neighbors, and my small group friends who supported me with prayers.

The biggest “Thank you” goes to my wife Jacqueline and my children. Jacqueline is truly a gift from the Lord. She supported me all the time, never complained about long office hours and busy weekends. Her faith provided a source of power and comfort for me. I couldn’t have done it without her.

THIS PAGE INTENTIONALLY LEFT BLANK

I. INTRODUCTION

A. THESIS STATEMENT

Reduced human performance resulting from a sustained attention task can be modeled as a complex adaptive system (CAS) and the resulting computational model can be shown to approximate empirical human performance data under similar conditions.

B. MOTIVATION

The ruling to kill the Americans and their allies—civilians and military—is an individual duty for every Muslim who can do it in any country in which it is possible to do it, in order to liberate the al-Aqsa Mosque and the holy mosque from their grip, and in order for their armies to move out of all the lands of Islam, defeated and unable to threaten any Muslim. This is in accordance with the words of Almighty God, "and fight the pagans all together as they fight you all together," and "fight them until there is no more tumult or oppression, and there prevail justice and faith in God."

(Osama Bin Laden, Text of Fatwah Urging Jihad Against Americans. Published in Al-Quds al-'Arabi on February 23, 1998)

The motivation for this work is steered by the attacks of September 11, 2001. Our research focus is aimed to support the war against terrorism. We hope to simulate potential outcomes and identify blind spots, thereby helping to prevent terrorist acts. Previous simulation systems have not been able to predict unlikely, but very dangerous, terrorist actions. Because the September 11 attacks came as a surprise, we focus our research on the unexpected, with questions such as:

- How can we model surprises?
- How can we categorize surprises?
- What factors and kinds of performance reductions lead to blind spots?

We claim that by employing composite-agent technology with a new cognitive model based on complex adaptive systems theory, we can achieve greater, unbiased insights into problems of human performance. Another expected improvement is implicit in the reality that complex adaptive systems produce emergent behavior that is often synonymous with surprise.

John Holland, a founder of CAS theory, said:

I just love these things where the situation unfolds and I say, ' Gee whiz! Did that really come from these assumptions!?' Because if I do it right, if the underlying rules of evolution of the themes are in control and not me, then I'll be surprised. And if I'm not surprised, then I am not very happy, because I know I've built everything in from the start. (Waldrop 1992, p.152).

The next section explains the background and shows a possible path towards developing a new cognitive model.

C. PROBLEM STATEMENT

Surprise, when it happens to a government, is likely to be a complicated, diffuse, bureaucratic thing. It includes neglect of responsibility so poorly defined or so ambiguously delegated that action gets lost. It includes gaps in intelligence, but also intelligence that, like a string of pearls too precious to wear, is too sensitive to give to those who need it. It includes the alarm that fails to work, but also the alarm that has gone so often that it has been disconnected. It includes the unalert watchman, but also the one who knows he'll be chewed out by his superior if he gets higher authority out of bed. It includes the contingencies that occur to no one, but also those that everybody assumes somebody else is taking care of. It includes straightforward procrastination, but also decisions protracted by internal disagreement. It includes, in addition, the inability of individual human beings to rise to the occasion until they are sure it is the occasion - which is usually too late. (Unlike movies, real life provides no musical background to tip us off to the climax). Finally at Pearl Harbor, surprise may include some measure of genuine novelty introduced by the enemy, and possibly some sheer bad luck.

The results, at Pearl Harbor, were sudden, concentrated, and dramatic. The failure, however, was cumulative, widespread, and rather drearily familiar. This is why surprise, when it happens to a government, cannot be described just in terms of startled people. Whether at Pearl Harbor or at the Berlin Wall, surprise is everything in a government's (or in an alliance's) failure to anticipate effectively.

(Schelling 1962, p. 1)

The attacks of September 11, 2001, showed not for the first time in Western history, a need for threat-analysis simulation models that, unlike current models, are capable of generating or revealing surprises, unintended consequences, and blind spots (Smith 2002).

Israel had suffered a surprise attack in 1973. Egypt and Syrian forces attacked a somewhat ill-prepared Israeli defense force. Intense retrospection led to the conclusion that there was no single cause for the victim's surprise. Chorev concluded that

Israel deceived itself: the adherence to the "conception", the faith in its military deterrence power, the unwillingness to believe that the Arabs would take so great risks and the "wishful thinking" all of these, rather than deception, contributed to its crucial surprise.

Chorev mentioned three safeguards to ward off surprise attacks:

1. Increase awareness of limitations- to the nature of judgmental biases and the limitations of the intelligence process;
2. Improving the formation of hypotheses – in order to increase the perceived likelihood of alternative interpretations and scenarios that may sensitize analysts and decision makers to discrepant information;
3. Improving information processing – especially by using quantitative and empirical methods to facilitate the information process.(Chorev 1996, p.23)

Different types of simulation models, taking these safeguards into account, are needed to support analysts evaluating potential threats to individuals, organizations and even societies. One common technique in intelligence analysis use is "backward thinking", in which the analyst envisions an outcome and traces how this outcome might have become possible (Heuer 1999). A model that generates potential outcomes or hypotheses and provides an event trace would be an invaluable tool. To provide a benefit, this model has to generate outcomes that surprise the analyst and further his critical thinking. To find surprise in a specific context, two kinds of conditions must be modeled:

- Logical conditions that determine whether the surprising action or outcome is physically possible, and therefore credible.
- Subjective conditions:
 - The target must have a weakness he/she was ignorant of.
 - The opportunist must be motivated in such a way as to cause him to discover the weakness and exploit it.

Currently there are no cognitive models that accommodate subjective conditions. The National Research Council report on modeling human and organizational behavior states:

Even the best of them [*cognitive models*] assume ideal human behavior according to doctrine that will be carried out literally, and rarely take account of the vagaries of human performance capacities (Pew and Mavor 1998, p.34).

Current cognitive models have several identified weaknesses. The council's report and other sources describe those in detail (Pew and Mavor 1998; Ritter, Shadbolt et al. 1999). A major criticism to rule-based approaches, for example, is that these systems are mechanistic, brittle, and unable to cope with unforeseen events.

Another major weakness is stated in a psychological bulletin:

Cognitive Psychology has developed as a domain in which basic rules of human information processing are investigated. This kind of approach often neglects the existence and importance of individual differences. At best, such differences are regarded as troublesome though not much interesting source of variation of results observed in various cognitive tasks. The psychology of individual differences, on the other hand, has developed as a domain in which differentiation of human traits as well as intercorrelation between them, are of basic interest. This approach usually neglects cognitive processes underlying human traits, although one can argue that traits are just behavioral expressions of elementary cognitive and physiological processes. It seems that combination of the processual approach, typical of experimental cognitive psychology, with the correlational approach, typical of the psychology of individual differences, is of utmost necessity. Only through such combination is it likely to obtain valid theoretical models, which would be able to link variables from the domain of temperament, personality, and cognition. (Nêcka and Szymura 2001, p.159).

From our perspective there are two main weaknesses to overcome to meet the requirements for threat-analysis simulation models:

- 1) Current cognitive models generate neither adaptation¹ nor emergent behavior², which are essential features of individual human behavior modeling.

¹ Adaptation is defined as a process whereby an organism fits itself to its environment(after : Holland, Holland, 1995).

- 2) Current cognitive models do not model individual human-performance reduction, which leads to homogenous, predictable, and unrealistic model behavior.

We hypothesize that we can overcome these weaknesses by using complex adaptive systems theory as the foundation for a new cognitive architecture. The expected advantages are the simulation of autonomous, emergent, flexible, self-explaining, adaptive, dynamic and robust behaviors.

Modeling surprises and blind spots requires an indirect approach³ that helps us explore a wider problem domain. Classical direct approaches⁴ often have a biased confined area (box) of analyst expectations. The boundaries of direct approaches are predetermined by the modeler and represent the degrees of freedom of the model. This type of approach has been used very successfully for linear problem domains. Non-linear problem domains often require heuristics in order to define the needed constraints. A basic property of CAS is its non-linearity (Holland 1995). Indirect modeling approaches, like multi agent system (MAS) modeling, search the entire domain, constrained by physical boundaries only.

D. THE COMPLEX ADAPTIVE SYSTEM HYPOTHESIS (CASH)

Now we come to the core hypothesis of this research:

Reduced human performance can be modeled as a complex adaptive system.

Murray Gell-Mann claimed in 1994 that “Each of us humans functions in many different ways as a complex adaptive system” (Gell-Mann 1994). There have been a number of researchers (e.g., Melanie Mitchell of Santa Fe Institute, NM, and John Sokolowski of Old Dominion University, VA) working implicitly under this assumption.

² Emergent behavior is a behavior on a higher level that is generated by interactions and behaviors on a lower level. Often it is referred to as micro decisions lead to macro behavior. (Schelling, T. C. 1978).

³ An indirect approach is an approach where there is no pre-programmed path to a solution. Autonomous software agents determine their path within physical boundaries.

⁴ A direct approach is an approach where the modeler conceives an algorithmic solution to a problem and implements that solution into software.

Manifestly the hypothesis is not a new insight, but the formulation of what has hitherto been implied. However, the hypothesis has not yet been established in cognitive sciences.

Holland defined a CAS as a nonlinear dynamical system, composed of many interacting, hierarchically organized agents, continuously adapting to a changing environment. He described a variety of complex adaptive systems, all of which display the central enigma of coherence under change. Holland claims that CAS behavior is determined by general principles and that CAS typically have lever points.⁵ He describes key properties (aggregation, non-linearity, flows, diversity) and mechanisms (tags, internal models, building blocks) central to understanding CAS (Holland 1995; Holland 1998). We will describe details on complex adaptive systems theory later on.

The ultimate goal for a cognitive model is an “integrative architecture that subsumes all or most of the contributors to human performance capacities and limitations” (Pew and Mavor 1998). It appears to be widely accepted that human behavior can be modeled with a stage model of information processing. Broadbent generated the first ideas with his single resource theory. Kahnemann⁶ was a major proponent of the single-resource model and showed that the cognitive capacity varies depending on arousal level and other variables (Wickens 1992). However, research in multitasking showed convincing evidence against a single-source theory. Wickens expanded the model to include then-current insights of psychology and social sciences. He also suggested a widely acknowledged model for the human information process.

⁵ Lever points are points wherein a small change in the input amount can lead to a large directed change. The immune system is a good example of this type of behavior. Upon introduction of a small amount of vaccine, the immune system adapts rapidly to develop immunity.

⁶ In 2002, Kahnemann was awarded the Nobel Prize for his work in economics.

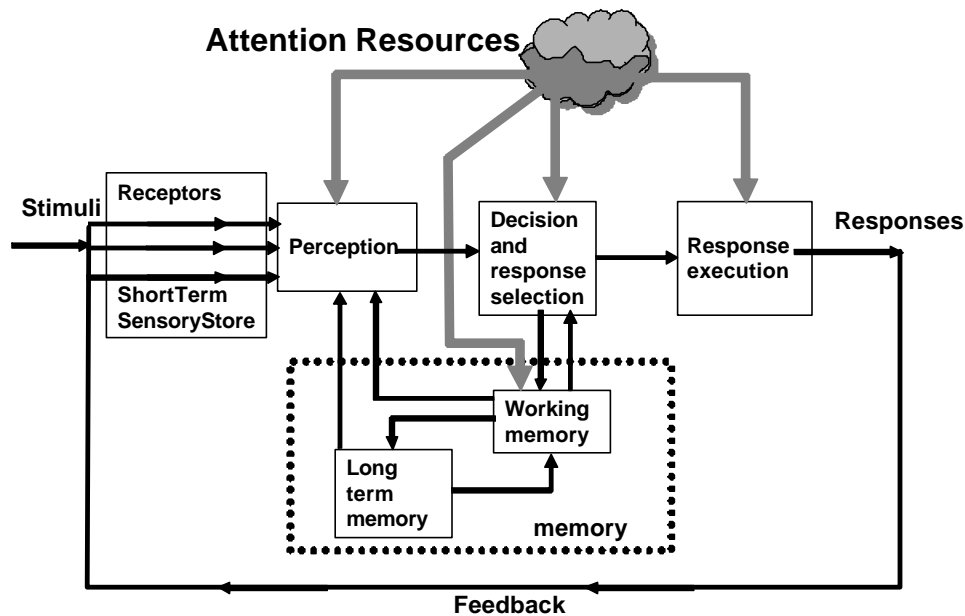

Figure 1. Stage Model of Human Information Processing (From :Wickens,1992)

Figure 1 shows the different stages for the human information processing. A stimulus is stored in the short-term sensory store (STSS) for a few seconds (visual stimulus about 1 second, auditory stimulus about 5 sec; echoic memory). If it is not perceived within this timeframe, it is not a perception. Perceptions are sometimes matched with patterns, likely stored in long-term memory⁷. This is the encoding stage.

Next, during the central processing stage, the perception is forwarded to the decision- and response-selection system, which uses the working memory to determine whether an action should be initiated. The last stage is the response-execution stage, which leads either to a vocal or manual response to the perceived stimuli (Wickens 1992).

(Pew and Mavor 1998) modified this model slightly to show the elements that should be included in an integrative architecture. They left out the STSS and connected the perception to long-term memory via working memory. However, a major alteration to

⁷ One example for a pattern is the recognition of the letter “a”. Long term memory provides different types of a’s (A, a,A…)

the original stage model is the fact that Pew did not show the attentive resources that are central to modeling reduced performance (Pew and Mavor 1998).

Thus, we will use the original stage model in order to show that all the elements of the stage model can be modeled with CAS. The nonlinear interactions between the attentive resources have different effects on the information processing stages, which eventually result in interesting human-like emergent behavior.

We define reduced human performance as performance degradation over time. The reduction is sometimes quantifiable in measures for speed and/or accuracy. Vigilance decrement is an excellent example of performance degradation; our inability to sustain attention for a long time is well known to all. Attention depends very much on available cognitive resources, and sustained attention is a high-workload task (Wickens 2002).

Other factors besides time can degrade performance. Stress, heat, sleep deprivation, injury, and loss of motivation are among the many factors that may be involved. These factors may not have the same effect on a person at all times; some effects may even cancel each other out (e.g. fatigue vs. noise) (Davies and Tune 1970; Davies and Parasuraman 1982; Warm 1984; Parasuraman 1998). Obviously degradation is a dynamic and highly non-linear process, and as a feature of a CAS, well established. The next question to answer is whether the structure of the underlying process is to some degree hierarchical.

Wickens' multiple resource model assumes that cognitive resources can be divided into modalities and codes in different stages of the information process.

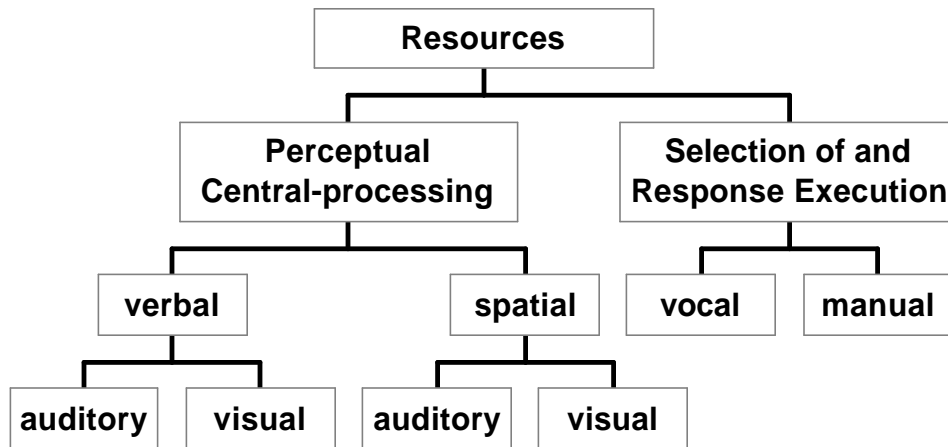

Figure 2. Multiple Resource Model (After: Wickens, 2002)

Figure 2 is an adaptation of the better known cube that can be seen in many textbooks (Wickens 1992; Matthews, Davies et al. 2000; Wickens 2002). It assumes we have two main resource pools: one for the perceptual and central-processing phase, and one for the response-selection and execution phase. These resources can be divided into verbal and spatial, or, respectively, vocal and manual. The structure indicates a hierarchical system. The system is also adaptive since we can focus our attention (selective attention), thus filtering information to a certain extent. Thus, we adapt our cognitive resource consciously or subconsciously (or both) to a changing environment. This research claims that Wickens' multiple resource theory fits into Holland's definition of a complex adaptive system.

E. APPROACH

Our research is based on the hypothesis that reduced human performance can be modeled as a complex adaptive system. Our hypothesis synthesizes strengths of other cognitive theories like connectionism, symbolism, and dynamicism.

Instead of using connected neurons in a neural network, we will model agents that establish timely restricted connections. Thus we use a loosely coupled⁸ network of MAS, which are an ideal implementation tool for CAS (Axelrod 1997). We inherit the strength of the symbolic approach⁹ by using symbolic representation within our agents. Our connected agents will work in parallel, exploiting the main strength of the connectionism approach. Connections are established via communication routers, allowing us to cancel or add new connections during runtime. This addresses the time dimension utilizing the strength of the dynamic approach.

1. Reduced Human Performance Model (RHPM)

Our reduced human performance model first try to capture the effects of vigilance decrement, such as that which plagues security screeners at airports. Many studies involving reduced visual and auditory vigilance provide real-world data as a reference (Matthews, Davies et al. 1990; Koelega 1992; Matthews and Holley 1993; Sawin and Scerbo 1995; See, Howe et al. 1995; Gill 1996; Bahri 1994; See, Warm et al. 1997; Balakrishnan 1998; Lane and Kasian 1998; Mèthot and Huitema 1998; Fenner, Leahy et al. 1999; Temple, Warm et al. 2000; Zoccolotti, Matano et al. 2000). We conduct our own experiment and utilize substantial research data to validate our model. Our approach can be visualized as follows:

⁸ *Loosely coupled* is a software engineering term. It indicates that our architecture is composed of modules that can operate independently from each other. Interaction between modules is based on communication, thus modules can be exchanged and/or replaced at any time Bradley, G., A. Buss, et al. (1998). "An Architecture for Dynamic Planning and Execution using Loosely Coupled Components." Naval Postgraduate School Research Newsletter **8**: 1-7. Chapter 4 describes the concept more closely.

⁹ Symbolic representations are understandable for the users, whereas the interpretation of weights on nodes and connection (as in neural networks) is not intuitive at all.

RHPM High Level Overview

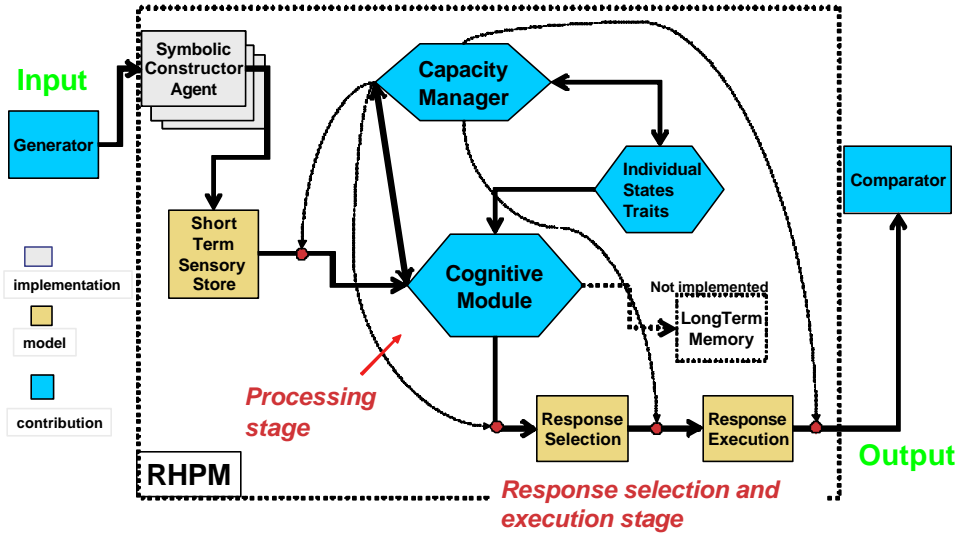

Figure 3. Conceptual Framework for Reduced Human Performance Model

Figure 3 shows the RHPM framework. Symbolic constructor agents (SCA) perceive information (impressions) and relay them to the cognitive module, which holds a symbolic interpretation of the outer environment. The symbolic representation depends on the inner state of the system. For example, a highly aroused person may perceive background noise as a threat, whereas somebody used to the noise might not even register this information. The cognitive module is a multi-agent system itself and contains several diverse composite agents. This module coordinates intentions with actions and creates behavior. The *Capacity Manager* is a multi-agent system, based on Wickens' Multiple Resource Model, which determines the current arousal level and introduces noise into the system. It can also interrupt transitions and access the cognitive module to suppress processes. The impression stream is analyzed and, if appropriate, a capacity decrease is initiated. It also evaluates capacity demands of planned activities, determining whether these activities will be executed.

The *Individual States and Traits (IST)* module represents the personality, emotions and goals. The GoalAgent deals with conflicting goals and actions. It uses a weighting scheme based on personality traits to determine how to act in the face of opposing goals. An example for a goal conflict might occur when an airport security

screener sees a long line of travelers waiting. He wants to decrease the queue, but also wants to find any potential weapons. At some point he detects an item he cannot identify but which does not look like a weapon. What will he do? The answer may lie in his personality.

Personality plays a major role in human performance but does not account for much of the variance. To go back to our example, there is evidence that introverts outperform extraverts when it comes to screening (Methot and Huitema 1998; Gusev and Schapkin 2001; Schapkin and Gusev 2001). The *Stress Agent* will capture the sensitivity of human performance to increasing arousal. Evidence suggests that under conditions of high arousal, an extrovert will outperform an introvert (Matthews, Davies et al. 1990) and probably examine the unidentifiable item. A realistic cognitive model should capture this interplay between conditions and personality.

We strive to create a cognitive model that can identify weaknesses in organizations by modeling the effects of reduced human performance. Decisions and policies of not-so-rational actors can be exploited to further some malevolent goal, so agents must be forced to operate and decide with imperfect knowledge and restricted cognitive resources.

F. CONTRIBUTIONS

This research strives to suggest a new cognitive model that simulates individual reduced human performance. Our reduced human performance model is one of the milestones to build a new kind of threat analysis simulation system.

1. Contribution Goals

Our research has four main goals:

- To inaugurate a paradigm shift in human behavior modeling that takes vagary into account based on convincing evidence from many sources.
- To propose a framework for the next-generation cognitive architecture (reduced human performance model RHPM) and to explain the advantages of the proposed framework.
- To implement parts of the framework to show its contribution by modeling the challenging problem of individual vigilance decrement.

- To validate the implemented RHPM with quantitative and qualitative analysis.

2. Scope

It is beyond the scope of this research to design, implement and validate a new cognitive architecture. However, even a partial implementation should be embedded in a framework using proper design techniques so that the model can be enlarged at any time. The theoretical underpinnings of our hypothesis need to be established by comparing and contrasting new findings in different sciences. This research focuses on three main points:

1. Reduced Human Performance can be modeled as a complex adaptive system.
2. The developed model allows the provisional working criteria for a complex adaptive system to develop.
3. The RHP Model is strongly connected to the observations of human experiments.

Our implementation focuses on cognitive resource modeling with respect to vigilance tasks. This is meant as a proof-of-concept implementation and should add validity to our hypothesis. Considerable future work is required in order to implement the full framework.

G. DISSERTATION OVERVIEW

The remainder of this dissertation is organized as follows:

- **Chapter II, Related Work**, describes current research on complex adaptive systems in different fields. It uses a taxonomy to recognize CAS. We will show the motivation behind applying CAS theory to this particular field and also show the benefits. This chapter also describes current state-of-the-art cognitive modeling, pointing out strengths and weaknesses of cognitive models in terms of human-performance reduction.

- **Chapter III, Reduced Human Performance**, introduces basics of human performance and relevant studies in vigilance performance. It describes the connection between attention, arousal, and vigilance in depth. It then shows and explains the main findings of conducted personality type and vigilance experiments.
- **Chapter IV, Reduced Human Performance Model (RHPM)**, details how the reduced human performance model and our composite agent map onto each other. It states model assumptions and relates the design to psychological models.
- **Chapter V, Experiments and Results**, describes the design of experiments and provides results. It also compares the achievements of RHPM's implementation with current cognitive models.
- **Chapter VI, Conclusion and Follow-on Work**, summarizes our contributions and addresses future expansions of this work.

II. RELATED WORK

Our research expands into two research areas: complex adaptive systems theory and cognitive modeling. In this chapter, we describe applications of CAS theory to different sciences and cognitive modeling and its current state of development. We include strengths and weaknesses of some cognitive theories and resulting architectures in terms of human-performance reduction.

A. COMPLEX ADAPTIVE SYSTEMS

CAS theory has been successfully applied to various sciences like sociology and medicine. Historically, many sciences were founded based on Newton's mechanistic explanation of physics. Newton hypothesized that the universe is mechanistic. He envisioned the universe as a gigantic mechanic clock, where simple rules govern the relationship of the single parts of this clock (Newton 1729). Since his rules were very well suited to explain many phenomena (e.g. movement of stars in relation to each other), his approach became the overwhelming approach for almost 250 years. Einstein's relativity theory showed where Newtonian physics fell short. Thus physics was probably the first science that found complementary theories expanding the mechanistic worldview incorporating dynamics of space and time relationships. Dynamic systems constantly change into different equilibria and never maintain a particular equilibrium (Gell-Mann 1994). Meanwhile many other sciences are beginning to use CAS theory looking at their domain from a different perspective. Economy is a prime example on how CAS theory has changed the perception of a former static theory, called the neoclassical approach. The initial research at the Santa Fe Institute (Arthur 1994; Cowan, Pines et al. 1994; Arthur 1999) specifically used economics as one application area. We will describe some of the applications later.

1. Definitions for Complex Adaptive System (CAS)

a. *Santa Fe Institute's Definitions*

In 1995 researchers at the Santa Fe Institute in New Mexico formulated a new way of using computer programs for research. John Holland, often called the father of genetic systems, explained his ideas on complex adaptive systems during the Ulam

series at the institute. Michel Waldrop outlined the ten most important points of Holland's lecture:

- 1) First each of these systems is a *network of many agents* acting in parallel.
- 2) Furthermore, the *control of a complex adaptive system is highly dispersed*. There is no master neurone in the brain, for example, nor is there any master cell within a developing embryo. If there is to be any coherent behaviour in the system it has to arise from competition and cooperation among the agents themselves.
- 3) Second, a complex adaptive system has *many levels of organisation, with agents at any one level serving as building blocks for agents at a higher level*. A group of proteins, lipids, and nucleic acids will form a cell, a group of cells will form a tissue, a collection of tissues will form an organ, etcetera.
- 4) Furthermore, said Holland - and this is something he considered very important - *complex adaptive systems are constantly revising and rearranging their building blocks as they gain experience*. Succeeding generations of organisms will modify and rearrange their tissues through the process of evolution. The brain will continually strengthen and weaken myriad connections between its neurons as an individual learns from his or her encounters with the world.
- 5) At some deep, fundamental level, all these processes of learning, evolution and adaptation are the same. And one of the fundamental mechanisms of adaptation in any given system is this revision and recombination of the building blocks.
- 6) Third, he said, all *complex adaptive systems anticipate the future*.
- 7) More generally, *every complex adaptive system is constantly making predictions based on its various internal models of the world - its implicit or explicit assumptions about the way things are out there*. Furthermore, these models are much more than passive blueprints. They are active. Like subroutines in a computer program, they can come to life in a given situation and 'execute,' producing behaviour in the system. In fact, you can think of internal models as the building blocks of behaviour. And like any other building blocks, they can be tested, refined, and rearranged as the system gets experience.
- 8) Finally, said Holland, complex adaptive systems typically have many *niches*, each one of which can be exploited by an agent adapted to fill that niche.

- 9) And that, in turn, means that it is essentially meaningless to talk about a complex adaptive system as in a state of equilibrium: the system can never get there. It is always unfolding, always in transition. In fact if the system ever does reach equilibrium, it isn't just stable. It's dead!
- 10) And by the same token, there's no point imagining the agents in the system can optimize their fitness, or their utility, or whatever. The space of possibilities is too vast; they have no practical way of finding the optimum. The most they can ever do is change to improve themselves relative to what the other agents are doing. In short, complex adaptive systems are characterized by continuous novelty (Waldrop 1992, p.42).

Murray Gell-Mann¹⁰ explains CAS:

A complex adaptive system acquires information about its environment and its own interaction with that environment, identifying regularities in that information, condensing those regularities into a kind of "schema" or model, and acting in the real world on the basis of that schema. In each case, there are various competing schemata, and the results of the action in the real world feed back to the influence the competition among those schemata (Gell-Mann 1994, p.165).

These statements indicate that there is no standard definition for complex adaptive systems. Some researchers call the CAS approach the third way of doing science (Arthur 1994; Axelrod 1997). CAS provide insights into a problem domain, but these insights do not necessarily forecast certain behaviors or behavioral ranges. Thus CAS do not function as "weather forecasting tools" rather, they show possible interaction producing emergent behavior that could potentially occur at some point. Next we will describe our own provisional definition and define working criterias to discern whether or not a system is a complex adaptive system.

b. Provisional Working Definition

A complex adaptive system consists of many autonomous agents that act in parallel with decentralized control. The non-linear interaction between these agents leads to adaptive and emergent behavior. The agents are organized in dynamically re-arranging structures that change into different equilibria and never maintain a particular equilibrium. In many systems, the CAS builds an internal (implicit or explicit) model of the future. There is a strong sense of path dependency in CAS. This property is built upon

¹⁰ Murray Gell-Mann won the Nobel Price in 1969 for his contributions to the discovery of the quark.

the interaction of autonomous active entities and the non-linearity of their impact upon each other. As the system's structure evolves it incorporates information that can serve as the foundation for new interaction and new behavior.

The following taxonomy can be derived from this definition:

- Does the system consist of autonomous agents that act in parallel?
- Is the control of the system highly dispersed?
- Do the agents engage in non-linear interactions?
- Does the system adapt and does it produce emergent behavior?
- Is the system changing its structure dynamically?
- Does the system permanently change into different equilibria?
- Does the system anticipate the future?
- Does the system have a strong sense of path dependency?

Next we will describe some applications of CAS in more detail. We focus on the classical examples showing what additional insights they generated.

2. Ecological Science

Ecological science is the study of relationships between living things and their environments. Complex adaptive systems theory has been used to describe the interactions between elements in an ecological system. Examples for the applications include salmon habitats as CAS with the SWARM software (Minar, Burkhart et al. 1996), and livestock breeding industries as CAS (Charteris, Golden et al. 2001). The classic example in ecological science, however, is Sugarscape.

a. Sugarscape

Sugarscape models artificial societies in an environment that consists of resources (sugar and spices). Simple rules govern the behavior of autonomous agents and produce rich emergent behavior. Sugarscape starts with a very simple artificial world consisting of a landscape with sugar resources and agents gathering sugar.

Epstein and Axtell describe their research goal:

The broad aim of this research is to begin the development of a more unified social science, one that embeds evolutionary processes in a computational environment that simulates demographics, the transmission of culture, conflict, economics, disease, the emergence of groups, and

agent co adaptation with an environment, all from the bottom up. Artificial society-type models may change the way we think about explanation in the social sciences. What constitutes an explanation of an observed social phenomenon? Perhaps one day people will interpret the question, “Can you explain it?” as asking “Can you grow it?” Artificial society modeling allows us to “grow” social structures in silico demonstrating that certain sets of micro specifications are sufficient to generate the macro phenomena of interest. And that, after all, is a central aim. As social scientists, we are presented with “already emerged” collective phenomena, and we seek micro rules that can generate them. We can, of course, use statistics to test the match between the true, observed, structures and the ones we grow. But the ability to grow them—greatly facilitated by modern object-oriented programming—is what is new. Indeed, it holds out the prospect of a new, generative kind of social science (Epstein and Axtell 1996, p.5)

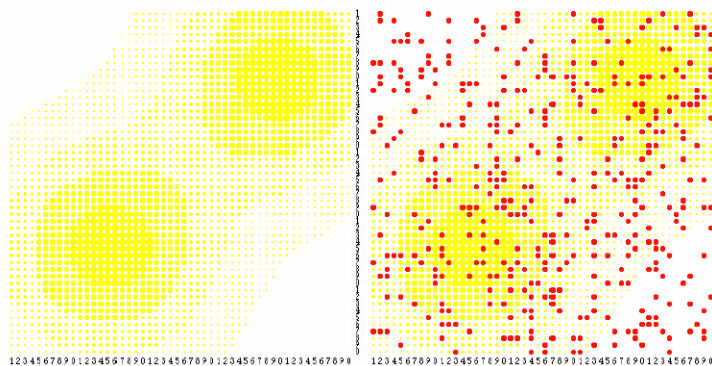

Figure 4. Sugarscape and Sugarscape with Agents (From: Epstein and Axtell 1996, p.21)

Figure 4 shows the basic setup of Sugarscape, with and without an agent population. Sugar-dense areas are yellow; white spaces contain no resources at all. Epstein and Axtell embellish this simple scenario by creating more and more behavioral rules for their agents. They show emergent phenomena like wealth distribution, social networks of neighbors, migration, combat, proto-history, economic networks, and disease-transmission networks.

One example of generated emergent behavior is migration, which shows an aggregated behavior that single agents cannot achieve. Agents can move in only four

directions (north, south, west, and east). However, the population migrates diagonally in waves, from the lower-left corner to the upper right (north east) on their quest for sugar.

The authors conclude:

A wide range of important social, or collective, phenomena can be made to emerge from the spatio-temporal interaction of autonomous agents operating on landscapes under simple local rules (Epstein and Axtell 1996, p.172).

The authors provide a CD containing movies of the dynamic changes in certain situations. The visual impact is impressively dynamic. This is certainly a gain in understanding how certain phenomena in societies arise. It is up to social scientists to compare how the model's rules and assumptions relate to real-world cause and effect. Even if real-world factors are more complicated, CAS provides ways and means to simulate these phenomena in ecology.

3. Organizational Science

Mitleton-Kelly¹¹ provided an overview on how complexity theory changes the perspective on organizational science. She criticizes the assumption that individuals exhibit average behaviors which becomes predictable. In her opinion, this assumption leads to a mechanistic linear model that is counterproductive in providing insights into the different emergent phenomena in an organization. The interaction between individuals with non-average behavior generates unpredictable, non-linear, and multiple outcomes. These traditional models also do not take the system's sensitivity to initial conditions into consideration. Thus important factors for the system's behavior are simply left out of the analysis. The behavior of a dynamic system might be unpredictable, but the range of possibilities is limited. She calls the limited range of behaviors "bounded instability" (Mitleton-Kelly 1997).

In the state of bounded instability, strategy and planning acquires a new meaning and the emphasis changes from established methodologies to new ways of thinking. Some planning tools, such as scenario planning, may still be used, but they will need to be applied in a different way and seen from a fresh perspective. If uncertainty increases to the point of instability, with the associated high turbulence, then all conventional planning approaches become totally ineffective. The difference between

¹¹ This paper was awarded Best Paper in Process Management by the British Academy of Management in recognition of its 'excellence and influence' in 1997.

the states of bounded instability and instability, is that in the transition phase, analogous to the edge of chaos, the behaviour may be new but it does have pattern and structure. It will be the ability to recognize new patterns as they emerge which will provide organisations with a real competitive advantage in the future. Thinking in complexity terms helps in 'seeing' the new patterns (Mitleton-Kelly 1997, p.15).

Marion and Bacon (Marion and Bacon 2000) describe how complexity theory can help to gain insights into the phenomenon of extinction. Thus they try to answer the question how robust, complex systems can become extinct. Classical reductionist theories assume single causes for extinction, like the failure of new organizations (liability of newness), improper organizational structure, and organizational inertia among other theories. The authors claim that these theories overly simplify the underlying processes and that the extinction of a complex systems results from multiple interactive events and involved multiple chains of interaction. A system builds meta-aggregates by integrating agents that provide raw material to an organization (i.e. suppliers). Other agents that potentially have long-range impact on environment, supplies, and the like build the meta-meta-aggregate of an organization. Marion and Bacon hypothesize:

Extinction or decline (defined as failure to achieve stated or assumed goals) can occur when meta- and meta-meta-aggregates are poorly developed, they can occur because complex systems are, by definition, poised on the brink of disaster, and they occur when networks deteriorate (Marion and Bacon, 2000, p.92).

They concluded that poorly developed meta- and meta-meta-aggregates and deteriorating networks caused the failure of two businesses. The fit organization did show evidence that a robust complex adaptive system could resist extinction due to its ability to change, compromise, and adapt. The authors are convinced that a reductionist view on the problem of extinction does not provide a holistic view. Success and failure of an organization are a function of the dynamics of complex, interactive wholes.

The value of a new science certainly depends on its applicability to a specific field. Complexity theory already has provided many useful metaphors for organizational science. (Lissack 2000). However, its real value has not fully being realized. McKelvey challenged complexity theorists to incorporate a systematic agenda linking complexity theory development with mathematical or computational model development.

Furthermore there needs to be a systematic agenda linking model structures with real world structures in order to have an effective way to apply complexity science to organizational science (McKelvey 2000).

4. Economy

The Santa Fe Institute immediately challenged classical economic theory with complexity theory. John Holland and Brian Arthur spent many hours discussing how complexity theory could be facilitated in economy (Waldrop 1992). Brian Arthur used the El Farol bar problem to show a model of an expectational economy:

One hundred people must decide independently each week whether to show up at their favorite bar (*El Farol* in Santa Fe). The rule is that if a person predicts that more than 60 (say) will attend, he will avoid the crowds and stay home; if he predicts fewer than 60 he will go. Of interest are how the bar-goers each week might predict the numbers showing up, and the resulting dynamics of the numbers attending. Notice two features of this problem. Our agents will quickly realize that predictions of how many will attend depend on others' predictions of how many attend (because that determines their attendance). But others' predictions in turn depend on their predictions of others' predictions. Deductively there is an infinite regress. No "correct" expectational model can be assumed to be common knowledge, and from the agents' viewpoint, the problem is ill-defined. (This is true for most expectational problems, not just for this example.) Second, and diabolically, any commonality of expectations gets broken up: If all use an expectational model that predicts few will go, all will go, invalidating that model. Similarly, if all believe most will go, nobody will go, invalidating that belief. Expectations will be forced to differ. In 1993 I modeled this situation by assuming that as the agents visit the bar, they act inductively—they act as statisticians, each starting with a variety of subjectively chosen expectational models or forecasting hypotheses. Each week they act on their currently most accurate model (call this their *active* predictor). Thus agents' beliefs or hypotheses compete for use in an *ecology* these beliefs create. Computer simulation showed that the mean attendance quickly converges to 60. In fact, the predictors self-organize into an equilibrium "ecology" in which of the active predictors 40% on average are forecasting above 60, 60% below 60. This emergent ecology is organic in nature. For, while the population of active predictors splits into this 60/40 average ratio, it keeps changing in membership forever. Why do the predictors self-organize so that 60 emerges as average attendance and forecasts split into a 60/40 ratio? Well, suppose 70% of predictors forecasted above 60 for a longish time, then on average only 30 people would show up. But this would validate predictors that forecasted close to 30, restoring the "ecological" balance among predictions. The 40%–60% "natural" combination becomes an emergent

structure. The Bar Problem is a miniature expectational economy, with complex dynamics (Arthur 1994, p.3).

Arthur claimed that the dynamics of an expectational economy could not have been predicted with the traditional forecasting models. These traditional forecasting models for the financial market work only well on first order, assuming rational expectations. However, second order events like bubbles and crashes cannot be accounted for by those theories. Classical expectational theories are useful if the rate of change (i.e. updating the forecasting hypotheses) is slow. However, once the rate of change is increased, complexity economics is better able to explain the dynamics of an economy (Arthur, 1999).

5. Medical Science

Medical science provides two good examples of how complexity theory provided more inside into the functioning of organ system. We will next describe research on the heart and the immune system as complex adaptive systems.

The view that the heart is merely a muscular pump reactive to external stimuli is changing, as this mechanistic view couldn't explain certain phenomena like myocardial ischemia¹², a dynamic process associated with both destructive and protective cellular-response mechanisms. The heart appears to be a complex organ able to self-regulate and adapt. Cardiac self-regulation is crucial in coping with myocardial ischemia. Doctors now see the heart as a highly interconnected network of cardiac neurons signaling intracellular reactions. This network adapts on the cellular level to certain input patterns and executes specific output patterns. Transplanted hearts provide an excellent example of the emergent property of heart-rate dynamics. Within a hundred days after transplantation, the donated organ dynamically reorganizes its rhythm-generating system back to full functionality, demonstrating that the transplanted heart is not passive in the assimilation process. Even the decentralized heart shows self-regulatory patterns.

¹² Myocardial ischemia is a condition in which oxygen deprivation to the heart muscle is accompanied by inadequate removal of metabolites because of reduced blood flow or perfusion.

This phenomenon has been used as an impetus for reassessing the prevailing paradigm of cardiac regulation and adaptation (Kresh, Izrailtyan et al. 2002). Kresh concludes:

The heart is goal-seeking and purposeful organ that can adapt/select a course of action out of many possible strategies so as to optimize its functional integrity in response to imposed "environmental" stresses. With respect to cardiac function this implies homodynamic selection process. Indeed, there may be a parallel between the brain acting as a self-organizing system and the intrinsic cardiac nervous system of the heart (Kresh, Izrailtyan et al. 2002, p.5)

The immune system is often used as a prime example for describing a complex adaptive system. Holland described the immune system:

The human immune system is made up of large numbers of highly mobile units called antibodies that continually repel or destroy an ever-changing cast of invaders called antigens. The invaders – primarily biochemicals, bacteria, and viruses – come in endless varieties, as different from one another as snowflakes. Because of this variety, and because new invaders are always appearing, the immune system cannot simply list all possible invaders. It must change or adapt (Latin “to fit”) its antibodies to new invaders that appear, never settling to a fixed configuration. Despite its protean nature, the immune system maintains an impressive coherence (Holland 1995.p.2).

The theories on the immune system are mostly mechanistic and reductionist theories. The prevailing mainstream theory is the clonal selection theory. It states that during the prenatal development the self-recognizing capability of the immune system’s receptors is removed, and that therefore anything they identify is treated as hostile. This view has been challenged because there is evidence that the invading pathogens relate to humans on the molecular level (Hershberg and Efroni 2001).

It is becoming clear that the field of immunology is approaching a paradigm shift. It is agreed by most researchers that the immune system is a complex system both in its composition and its behavior. However, the most popular ideas of immune function treat the immune system in a mechanistic and reductionist manner.(Hershberg and Efroni 2001)

The immune system should be viewed as complex adaptive system that sees patterns and understands context in order to survive. Grilo implemented an artificial

immune system (AIS) based on complex adaptive systems theory. Since it wasn't possible to model all the details of an immune system (e.g. an immune system can have more than 10^7 receptors expressed at any given time) he focused on interactions. He explained that a model like his cannot be used for precise quantitative outcomes but for studying patterns of behavior. Therefore the occurring interactions have to be realistically modeled. His simulation system shows strong resemblance between model and real immune system and has been used and validated in various experiments (Grilo, Caetano et al. 2000).

Artificial immune system simulators aim the domain of hypothesis generation and experiment prototyping. This class of systems can help to design rational therapeutic intervention as well as understanding the process of disease. Moreover, the system's large parameter set can be constructed upon what-if hypothesis, otherwise difficult to attain in laboratory. The resulting data, obtained from in silico simulations, can support clinical trials and diagnosis and further bound in vivo laboratory tests to a set of experiments which will probably lead to attractive outcomes (Grilo, Caetano et al. 2000,p.18).

These examples show that the application of complexity theory in medical science challenges prevailing mechanistic paradigms. However, it better explains phenomena previously ignored by theories. More importantly it furthers the understanding and in the long run will improve treatments.

6. Combat Modeling

For the last century, conventional wisdom regarding the basic processes of war and most current models of land combat has been rooted in the idea of Lanchester Equations (LE). In 1914, F.W. Lanchester used differential equations to express attrition rates on the battlefield. These equations have been modified over the years, but the main assumption is that combat is always driven by a force-on-force attrition rate. This theory ignores spatial relationships and the human factor in combat. It certainly was not adequate to support analysis of the United States Marine Corps' vision of small, highly trained, well-armed autonomous teams working in concert, continually adapting to changing conditions and environments. Thus, Prof. Ilachinski challenged the almost century-old theory by arguing that land combat can (and should) be modeled as a

complex adaptive system. He transferred complexity theory into the military domain and showed that land combat properties resemble the properties of CAS (Ilachinski 1997). His work has generated a lot of interest in combat modeling especially because tactical behaviors such as flank maneuvers, containment, encirclement and “Guerilla-like” assaults emerged out of his implementation, called ‘Irreducible Semi-Autonomous Adaptive Combat ‘(ISAAC).

In ISAAC, the "final outcome" of a battle -- as defined, say, by measuring the surviving force strengths -- takes second stage to exploring how two forces might “co-evolve” during combat. A few examples of the profoundly non-equilibrium dynamics that characterizes much of real combat include: the sudden “flash of insight” of a clever commander that changes the course of a battle; the swift flanking maneuver that surprises the enemy; and the serendipitous confluence of several far-separated (and unorchestrated) events that lead to victory. These are the kinds of behavior that Lanchesterian-based models are in principle incapable of even addressing. ISAAC represents a first step toward being able to explore such questions (Ilachinski 1997,p.226).

Ilachinski’s work has not died out. Many research projects continue to explore his ideas. Project Albert is an international military research effort with many participating countries (i.e., United States, Australia, New Zealand, and Germany) (Horne and Lauren 2000). The MOVES Institute especially has produced many follow-on projects. Hiles, VanPutte et al. (2001) provide a good summary of this work.

The paradigm for combat modeling has fundamentally changed and improved insights into the processes. These types of simulation systems will enhance the capabilities exploring policy and concept development as well as force structure development.

7. Complexity Theory as Worldview Challenge

So far we have defined complex adaptive system, explaining the main features of the underlying theory. We also showed that the predominant mechanistic worldview has successfully been challenged in several areas. Complexity theory has in fact improved the realism of simulation systems, like the artificial immune system (AIS) or Ilachinski’s ISAAC. It also has furthered the understanding of previously ignored (or taken for

granted) phenomena (e.g. successful heart transplantations). In the social sciences, the average behavior assumption combined with the rationality assumption of human behavior has led to a linear mechanistic worldview (Tosey 2002). By refusing these assumptions, economics and organizational sciences have advanced to a better understanding of the relationships between individual elements (firms, groups, and individuals). A natural extension to this view is to research how individuals are modeled and whether complexity theory could improve the understanding of individual based behavior. Next we will describe current state of the art in cognitive modeling and show how much current models got stuck in a mechanistic rut.

B. COGNITIVE MODELING

The next paragraphs roughly describe the past and ongoing research in cognitive modeling. After a short history of cognitive modeling, we briefly describe the three main approaches (symbolism, connectionism, and dynamicism) and show recent developments for some cognitive architectures. This can by no means be a complete description of the entire field, but should provide the reader with sufficient background and resource information.

1. Developments in Cognitive Modeling

In the 1950s, William Dember announced the cognitive revolution. Up to then, psychology was mostly influenced by behaviorists. However, many explanations for human behavior proved inadequate and the interdisciplinary collaboration among different sciences (engineering and, especially, computer science) did much to advance cognitive psychology. In 1956 Chomsky, Newell and others defined the application of the computer metaphor for cognitive behavior and thereby initiated the rise of cognitive psychology (Matthews, Davies et al. 2000).

Matthews also describes the correlation between cognitive psychology and cognitive modeling. He formulates a synthesis of different approaches to cognitive modeling and the famous knowledge level, a level introduced by one of the leading artificial intelligence researchers, Alan Newell. We will describe Newell's concept, then explain the different approaches, and finally put it back together to show the interfaces between the three main levels.

In 1972 Newell formulated the computational approach in the famous physical symbol system hypothesis (PSSH). Ten years later he introduced a new computer system level, namely the knowledge level, to the then-known computer levels. Newell argued that there exists a distinct computer system level, lying immediately above the symbolic level¹³, which is characterized by knowledge as the medium and the principle of rationality as the law of behavior (Newell 1982, p.99). The principle of rationality states that humans behave rationally, always choosing behaviors that contribute to goal achievements. This argument seems strange, considering how irrational people can be. However, Newell also made clear that the assumption of rationality is weak and that the knowledge level is fairly extensible, e.g. with emotions, uncertainty and the like. Psychologists used the different levels as an analogue to human behavior. Newell's knowledge model has been used to characterize the depth of explanation that different cognitive approaches use (Matthews, Davies et al. 2000)

Cognitive science was born in the 1970s. It combined psychology, philosophy, linguistics, neuroscience, and artificial intelligence. Traditionally, cognitive science is the study of knowledge-based processes. Much advancement since then indicates that knowledge is only a part of the equation. Other factors like intelligence, emotion, and personality play a major role.

2. Symbolism Approach to Cognitive Modeling

In 1975 Putnam, following Turing's train of thought on Turing machines and Newell's PSSH, was probably the first scientist explaining the computational theory of mind.

The computational theory of mind (CTM) holds that the mind is a digital computer: a discrete-state device that stores symbolic representations and manipulates them according to syntactic rules; that thoughts are mental representations- more specifically, symbolic representations in a language of thought; and that mental processes are causal sequences driven by the syntactic, but not the semantic properties of the symbol (Wilson and Frank 2001, p.1341).

¹³ The symbolic level is the interaction level with humans. This level encompasses variables allows human beings to "talk" to the computer.

This approach to cognitive modeling is best described as symbolic cognitive modeling. One of the most criticized features of this theory is its sequential nature. Melanie Mitchell described the weaknesses of computational theories in cognitive sciences as theories of structure, making claims about the information processing and functional structure of mental states.

Most of these theories assume that information processing consists of manipulation of explicit, static symbols rather than the autonomous interaction of emergent, active ones. Such theories typically cannot easily explain what driving forces and constraints there are on how the mental questions can change, what trajectories they can take, their coupling with the body and environment, and how high-level symbols can emerge from a lower level substrate (Mitchell 2000, p.7).

Later we will describe strengths and weaknesses of a classical symbolic cognitive architecture (SOAR).

3. Connectionist Approaches to Cognitive Modeling

Cognitive modeling progressed by including the connectionists' approaches that contrasted symbolic models with huge parallelism.

Connectionist cognitive modeling is an approach to understanding the mechanism of human cognition through the use of simulated networks of simple, neuron-like processing units (Wilson and Frank 2001).

These types of models are often used for natural cognitive tasks. A major criticism for this theory is that it cannot explain behavior on a level that is understandable for humans. So far, applications of the theory cover subconscious functions, thus the approach is not yet scalable towards an entire cognitive architecture with current technologies.

Researchers have tried to use the strength of both approaches and build hybrid systems. ACT-R is a very prominent hybrid cognitive architecture and we will discuss its strengths and weaknesses shortly.

4. Dynamical Hypothesis

One of the latest developments in cognitive modeling is the dynamical hypothesis (DH) for cognition. Inspired by connectionists' models, it contrasts the symbolic cognitive modeling hypothesis in several ways. The most noticeable difference is the

assumption that cognitive agents are dynamical systems and not digital computers. The dynamical hypothesis applies differential equations to understanding cognitive functions. The approach considers the innate interaction between the embodiment of the mind and the situatedness of human cognition. Port states that:

The dynamical approach to cognition is also closely related to ideas about the embodiment of mind and the environmental situatedness of human cognition, since it emphasizes commonalities between behavior in neural and cognitive processes on one hand with physiological and environmental events on the other. The most important commonality is the dimension of time shared by all of these domains. This permits real-time coupling between domains, where the dynamic of one system influences the timing of another, (Port, 2001, p.1).

There is an overlap between the connectionist and dynamical hypothesis approach. However, van Gelder, a former DH advocate,¹⁴ explains the differences:

Connectionist networks are generally dynamical systems, and much of the best dynamical research is connectionist in form. However, the way many connectionists structure and interpret their systems is dominated by broadly computational preconceptions. Conversely, many dynamic models of cognition are not connectionist networks. Connectionism is best seen as straddling a more fundamental opposition between dynamical and classical cognitive science (Wilson and Frank 2001, p.245).

It is evident that certain reduced human performance could be modeled with differential equations. It is also obvious that situational awareness (environmental situatedness) has to influence the simulated human performance (Endsley 2000). However, it appears to be very difficult to scale a model implementing DH to a holistic model of human performance. It also appears very doubtful that individual behavior can be modeled realistically. This approach would certainly lead into the difficulties combat modelers discovered using Lanchester equations. The coefficients used in these equations are very critical and it appears impossible to validate them. Expressing individual differences as coefficients in an equation¹⁵ appears to be impossible to validate too. However, the notion of time, which DH uses, is certainly important when modeling human performance. Humans tend to have decreased performances over time on task,

¹⁴ Email correspondence with Prof. Van Gelder

¹⁵ RHPM certainly has to parameterize individual differences. Additionally different goals and behaviors can be used to express individualistic personalities.

especially if circumstances (e.g. sleep deprivation) require a lot of compensatory resources (Styles 1997).

5. Cognitive Theories and Their Levels

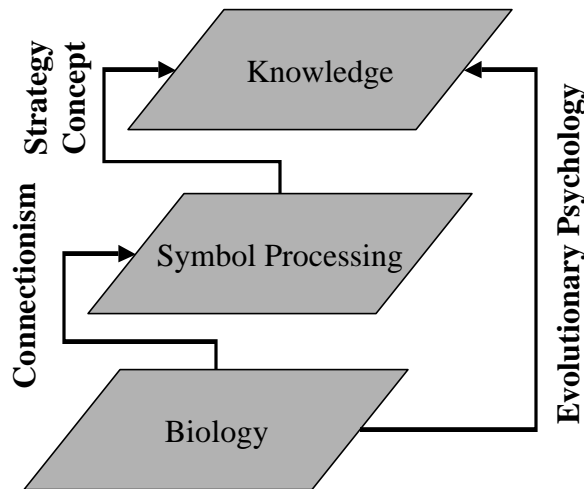

Figure 5. Levels of Explanation in Cognitive Science

Figure 5 shows a translation of Newell's knowledge level model. The biology level contains a physical, neuronal representation of cognitive processing. The symbol processing level is divided into two layers:

- 1) Algorithm, for the formal specification of programs for symbol manipulation.
- 2) Functional architecture, allowing real time processing operations supporting symbol manipulation.

The knowledge level contains goals, intentions and personal meaning, supporting adaptation to external environments. Using this picture, one can explain the different modeling approaches based on the level they try to explain. The connectionist approach (e.g. PDP ++), as well as the dynamical approach, interface the biology level with the symbol processing level (O'Reilly and Munakata 2000). The classical symbolic model

approach remains on the symbol processing level (e.g. SOAR). If cognitive models include a strategy concept, they also use the interface towards the knowledge level.

Our approach potentially links the biology level to the knowledge level. In psychology this approach is studied in the field of evolutionary psychology (EP). It basically claims that there are genetically evolved brain circuits dealing with certain problems by creating adaptive behavior. Thus it contrasts the assumptions of the symbolicism approach. Buss claims that :

First, mainstream cognitive psychologists tend to assume that cognitive architecture is general purpose and content free. This means that the information processing devices that are responsible for food selection are assumed to be the same as those for mate and habitat selection....Evolutionary psychologists make precisely the opposite assumption – that the mind is likely to consist of a large number of specialized mechanisms, each tailored to solving a different adaptive problem (Buss 1999, p.375).

EP emphasizes human cognitive architecture as a product of evolution, drawing on two theories in its attempt to understand the mind: Darwin's theory of evolution by natural selection and Turing's theory of computation. Darwin's theory asserts that psychological mechanisms are adaptations. Turing's theory of computation stresses the treatment of psychological mechanisms as information processors, and minds as computers. EP proponents claim that the physical symbol system hypothesis is an incorrect depiction of the human mind because it encapsulates the mind as a universal machine. EP works under the assumption that the human mind represents only the Turing machine's finite-state control system. This suggests that the human mind is not like an entire personal computer, but rather, similar to a computer's processor. This processor has a small set of instructions and a fixed set of hard-wired operations (suggesting an interesting approach to modeling reactive behavior). A processor also possesses memory storage, enabling it to perform operations according to an instruction set. A comparison of long-term human memory to a hard-wired set of operations, and working memory to a registry set, is obvious and engaging. Our research explores EP findings that support the proposition that specialized cognitive functions are the result of evolution (Cosmides and

Tooby 1998; Crawford and Krebs 1998; Buss 1999; Evans and Zarate 1999; Badcock 2000; Cartwright 2000).

If we take this theory for granted, we should be able to identify cognitive functions that can be modeled as evolvable systems. These systems adapt to their environment and could be characterized as complex adaptive systems. Our approach to cognitive modeling tries to synthesize parts of the three described cognitive theories (symbolism, connectionism, dynamicism), using all three levels of Newell's knowledge level, leveraging findings of EP, within a complex adaptive system.

6. State-of-the-Art Cognitive Modeling

This section briefly describes the current state of the art in cognitive modeling by looking at modeling human and organizational behavior. After a summary of the National Research Council (NRC) findings in 1998, we will show the development of cognitive architectures from 1998. The report provides a far more detailed description (Pew and Mavor 1998). The NRC authors used the following taxonomy to characterize the best-known cognitive architectures:

- What was the original Purpose?
- Which sub-models have been implemented?
 - Sensing and Perception
 - Working/Short Term Memory
 - Long-term Memory
 - Motor
- What type of knowledge representation is used?
 - Declarative
 - Procedural
- Which higher-level cognitive functions are modeled?
 - Learning
 - Situation assessment (overt and inferred)
 - Planning
 - Decision making
- What type of output does it provide?
- Is it multitasking capable?
 - Serial/Parallel
 - Resource representation
 - Goal/Task Management
- Can it model multiple humans?
- How and where does the implementation work?
- Platform

- Language
- What type of support environment is needed?
- Have there been validation efforts?

This taxonomy left out some important questions like:

- Can the cognitive architecture model individual behavior based on a personality-trait model (e.g. five factor model)?
- Does it model individual reduced performance caused by internal or external stressors/moderators?
- How does the model behave when it encounters previously unknown situations?

None of the architectures Pew evaluated has achieved a state where the answer to these questions would be positive. The panel addressed general weaknesses and shortcomings of these models/architectures, and then recommended short, intermediate and long-term research goals. The following statement shows an overall evaluation of models currently used in military applications: Thus it is fair to say that, in terms of models in active use, the introduction of human behavior is in its infancy (Pew and Mavor 1998, p.4).

Many models cannot adapt to mild deviations from the conditions under which they were created. Often they produce unrealistic behavior and simplistic responses to these conditions. As pointed out earlier, even the best models assume ideal human behavior, strictly following doctrine and not taking human limitations and variation performance into account. Hence current models lack the scope of realism that is required for modeling human behavior. Human behavior modeling should include the realistic modeling of observable individual behaviors. Realism should be increased by adding noise (moderator variables such as emotion or workload) to the simulation. This leads to the issue of reduced human performance, a major modeling problem that the described architectures have not yet addressed successfully.

Human behavior representation (HBR) should be doctrinal (where applicable), realistic, creative and/or adaptive. This implies that non-rigid or non-brittle behavior needs to be introduced with a new cognitive architecture. One of the SOAR developers

stated that unanticipated situations were the most difficult feature to put into the computer program. The panel came to the following conclusion:

The development of a truly adaptive model that would solve the general problem has not been actively pursued (Pew and Mavor 1998, p.44).

Analyzing the general shortcomings of current cognitive models, the connection between theory and actual implementation becomes obvious. A mechanistic view (theory) on human behavior can only produce mechanistic behavior. We claim that a multi-agent system with robust behavior can handle unanticipated situations and hence would contribute to solving the general problem. New models of human behavior should include judgmental errors, individual differences, time pressure effects, degradation of cognitive function such as fatigue effects and (in our case) vigilance decrement, and adaptive planning based on learning. The simulated entities should have local situational awareness in the sense that they can interpret the state of the surrounding environment and compare it to their own goals and desires. However trivial or complex the model might be, the purpose is to make explicit:

- The information provided to the human behavior representation from the external world model.
- The processing (if any) that goes on inside the reduced human performance model;¹⁶ and
- the output generated by the model.

7. Recent Advances in Human Behavior Modeling

This section describes the development in human behavior modeling since the panel's report.

a. The Agent-based Modeling and Behavior Representation (AMBR) Project

U.S. Air Force Research Laboratory (AFRL) took the panel's recommendations and funded a new research program: AMBR Model Comparison Project. The goals for this project follow the roadmap, provided by the NRC report:

- To advance the state of the art in cognitive modeling

¹⁶ This clearly requires symbols that we can interpret.

- To develop mission-relevant human behavior representation
- To publish tasks, models and available data to support developers
- To compare performances of different cognitive architectures

Four different teams (Air Force Research Laboratory (AFRL) with Distributed Cognition (DCOG), Carnegie Mellon University (CMU) with ACT-R, CHI Systems with Cognitive Networks (COGNET/iGEN), and Soar Technology with EPIC-Soar) developed or improved their architectures to fit an air-traffic-controller scenario. The scenario was simplistic, but required multi-tasking capability (Gluck and Pew 2001). A simulated air traffic controller had to manage the transition of several aircraft from one traffic sector to another. A fifth participant (BBN technology) mediated between AFRL and the teams. BBN generated different scenarios, collected human data and provided the statistical analysis for the model comparisons. The results showed some similarities between human data and the models' behavior (Gluck and Pew 2001). However, considering that only eight ACT-R, two Epic-Soar, two COGNET/IGEN and two DCOG controllers were simulated, it is doubtful that the results account for the true variability. It appears that the significance of the experiment suffered from these low numbers of experimental runs.

Interestingly enough, AFRL stated that the participating modeling architectures were challenged and improved as a direct result of their participation in this project, which we consider to be an indication of success in advancing the state-of-the-art. (Gluck and Pew 2001) This clearly supports the NRC report's assumption ("HBR in its infancy") since even the simple air traffic controller scenario helped improve the architectures.

(1) Distributed Cognition (D-COG): Next we will describe the new cognitive architecture D-COG and other participating cognitive architectures' improvements. D-COG is a new architecture introduced by AFRL. It is a hybrid approach between symbolic and connectionist approach. Their approach uses ideas of cognitive systems engineering and computational neuroscience. The resulting architecture is expected to provide more robust behavior. The architecture is AMBR domain-specific and consists of four modules:

- A cognitive module that sets goals and prioritizes tasks
- A procedural memory module that contains aircraft status information and knowledge on how to accomplish specific tasks such as transferring an aircraft or accepting an aircraft
- A visual sampling module that controls eye movements and provides for perceptual recognition, and
- A motor module through which the model operates the workstation module (Eggleston, Young et al. 2001, p.7).

D-COG compared well against the other architectures, although the authors indicated a problem with repeatability of results. In any case, it is evident that new cognitive architectures stand a chance against “legacy” cognitive architectures indicating that their exploration is a worthwhile research topic.

(2) States, Operators and Rules (SOAR): The panel’s short-term research goals suggest that hybrid cognitive architectures could improve and advance the state of the art. Participating in the AMBR project, SOAR Technology improved SOAR’s perception module by combining it with Executive Process-Interactive Control (EPIC). The hybrid architecture is now called EPIC-SOAR. Another improvement resulted in an architectural change of SOAR’s memory system. The changed architecture incorporates Adaptive Control of Thought (ACT-R)’s base-level activation and base-level learning concepts.

The general idea is that when an element in working memory is created, it is assigned an initial level of activation; a base-level of activation. The activation of a newly created memory immediately begins to decay logarithmically with time. When the activation falls below a threshold, the memory element is forgotten. Forgetting is implemented by removing a decayed memory element from working memory. When an element is used, its activation receives a small boost, but the activation immediately begins to decay, albeit from the newly boosted level (Chong 2001, p.36).

Thus, the EPIC-SOAR memory system now more closely matches the human memory system. Another very interesting approach to improving SOAR is an ongoing research effort to use its architecture in single-shooter games. It has been used as a computer-generated opponent in the game of *Quake* (Laird 2000). This has certainly

been a very important step forward by combining advances in computer gaming and artificial intelligence. SOAR appears to be the most often used cognitive architecture in military application.

SOAR needs many rules to simulate human behavior: e.g. a fixed-wing aircraft FWA-SOAR uses more than 7000 rules and still needs operator invention to realistically model human behavior (Pew and Mavor 1998). This is certainly a disadvantage of the system. Although it has a learning mechanism incorporated (chunking) it does not claim to generate evolving behavior. Thus, it cannot learn completely new rules without supervision. One of our goals is using evolutionary algorithms to create emergent behavior that has not been thought of by analysts but is still feasible.

(3) Cognition as a Network of Tasks (COGNET): CHI Systems participated with the Computer Generated Forces CGF-COGNET variant of COGNET. CGF-COGNET incorporates several human behavior modeling improvements. A major improvement is CGF-COGNET's capability to model effects of workload on human behaviors. During the conducted experiments, CGF-COGNET realistically showed better performance than COGNET when the simulated air traffic controller had more support during a scenario. CGF-COGNET differs from COGNET by extending the information processing mechanism and better capturing the time and accuracy of a process. It also incorporated a meta-cognitive component introducing cognitive proprioception (situational awareness) and metacognitive controls (manage interruptions and resource conflicts). (Zachary 2001) COGNET has already been used for simulating adversaries in submarine war fighting. It can be characterized as a classical symbolic cognitive architecture with all the pitfalls described earlier.

(4) Adaptive Control of Thought (ACT-R): Carnegie Mellon University also participated with the ACT-R architecture. Some improvements of the architectures were introduced during the AMBR experiment. Since ACT-R's fidelity was clearly below those of significant tasks such as air traffic control, it added effects of time pressure and high information demands to its architecture. It now has the capability to

model task interruptions and workload effects (Lebiere, Anderson et al. 2001). One of the strengths of the model is its goal-oriented structure. This type of structure lends itself to modeling individual differences by prioritizing goals differently. However, it has not yet incorporated a personality model to capture personal differences.

(5) AMBR Achievements: AMBR's fourth goal (comparing cognitive architectures) proved to be very difficult. The experimental design was lacking clear measures of performance and a sound design strategy. It did not address adaptability or flexibility, which we believe is a very important feature of cognitive architectures. It also did not address modeling individual performances needed to show the variety of human behavior. Obviously the developers had problems getting the experimental data on time and the calibration process was short. However, it was certainly worthwhile to see how these architectures improved and how their strength and weaknesses were discovered. This offered the opportunity to characterize cognitive architectures in relation to an application. Ultimately, designers could decide which model makes most sense for an application given its particular goals. One can easily imagine that we could use a cognitive toolbox that provides the best tools for every application. However, this would not only require interoperability but also interchangeability between architectures. With respect to the propriety issues it is doubtful that current architectures really "want" or are able to achieve this goal.

AMBR was finished in May 2003. Round 3 and 4 have brought improvement to participating architectures. However, Pew concluded that:

And indeed, one of the features most often missing in the models that have been procured to date is a reasonable range of responses to a given situation. Attention to individual differences has the potential to contribute to improvements in the range of behaviors that models can provide. Procurements can require individual differences as a means to obtain a range of behaviors (Pew et al, 2003, p.8).

b. Use of Complexity Theory in Cognitive Science

We now describe research already utilizing complexity theory on the scale of cognitive functions. Before we start our discussion we need to define cognitive functions. The NRC Report on Modeling Organizational and Human Behavior identified five high level cognitive functions (Pew and Mavor 1998):

- Learning
- Decision Making
- Situation Awareness
- Planning
- Multitasking

Guy Boy gave a very concise definition for cognitive functions:

A cognitive function is simply a human cognitive process that has a role in a limited context using a set of resources. By definition, a cognitive function enables its user to transform a (prescribed) task into an activity (effective task). For instance, identifying situations, coordinating actions, making decisions and planning are high-level cognitive functions. (Dr. Guy Boy Director of EURISCO, the European Institute of Cognitive Sciences and Engineering, 1997)

He identifies different levels for cognitive functions. Higher level cognitive functions include decision-making. Current insights into decision-making led to a new focus of research towards naturalistic decision making (NDM). One of the important lessons NDM generated was the fact that experts use most of their energy in assessing a situation, not in deciding what to do (Klein 1999). It has become obvious that most experts use intuitive decisions that the rationality principle cannot explain. Clearly, the rationality assumption is a cornerstone in Newell's PSSH (Newell 1982). Instinctive or intuitive decision making shows that sometimes it pays to have hard-wired or reflexive behavior. One example is that of a fireman squad leader who went into a burning building with his men. He felt that something was wrong and retreated from the building. Seconds

later, the building collapsed. Intense investigation helped to explain what happened: The squad leader was very experienced with fires of this type. However, he couldn't explain the extreme heat in the building given the distance from the fire. In other words, his expectations were not met. The heat was the result of a fire in the basement that hadn't been detected at that point (Klein 1999). We hypothesize that his experience led to the development of a specialized cognitive function: a fire-threat detection mechanism. This would explain why he didn't have to think – but just react.

John Sokolowski conducted research on how to implement the Recognition Primed Decision Model by Gary Klein. He compares different approaches and concludes:

A composite agent uses multi-agent system simulation technology to implement various cognitive processes of a single entity or agent. It is this author's contention that a composite agent's decision-making method closely matches that described by the RPD model. This close match is expected to produce a better implementation of the RPD model (Sokolowski 2002).

Sokolowski's hypothesis directly supports CASH. The composite agent technology has been developed utilizing CAS theory.

Another example for the modeling of a low level cognitive function comes from the Santa Fe Institute: Melanie Mitchell, Douglas Hofstadter and James Marshall have been working on modeling the subconscious cognitive function of drawing analogies. Melanie Mitchell claims that a complex adaptive system is capable of making analogies which is a key feature to human intelligence and creativity (Mitchell 2000). The original computer program "Copycat" was expanded by James Marshall and it is now called "Metacat". "Metacat" operates in a micro domain, drawing analogies from sequences of letters. One example might be

abc \Rightarrow abd

jkl \Rightarrow ?

“Metacat” then tries to find a creative answer to the question mark. The sequences jkm or jkd would certainly be possible answers. The “Metacat” approach is sometimes belittled because it appears to be domain restricted. However, the researchers claim that they have discovered concepts that will help them to evolve software that can act creatively (Marshall 1999).

This clearly supports our hypothesis. Analogy-making, modeled as a CAS, is certainly a part of decision-making; decision making is a high level cognitive function that is integral to any cognitive architecture. We claim that a combination of CAS still represents a CAS. Thus, the complex adaptive system hypothesis (CASH) seems to be the natural conclusion of the claims shown so far.

C. SUMMARY

In this chapter, we explained the general shortcomings of cognitive models. It is only recently that researchers have tried to capture more realistic human performance by considering workload for air-traffic controllers. The strength of the three approaches (symbolicism, connectionism and dynamicism) should be exploited in a synergistic effort. We have described cognitive architectures and their current developments to show that, despite their ongoing improvements, they are not able to model individual reduced performance. We also argued by showing D-COG’s success that new architectures performances can compare favourably to legacy cognitive architectures.

Melanie Mitchell of the Santa Fe Institute, pointed out that cognitive phenomena would be understood by rapprochement between “computational talk” and “dynamics talk”. She is convinced that the use of complex adaptive systems will create a better understanding of human behavior (Mitchell 1998).

We want to enhance her assumptions by modeling a known human phenomenon called vigilance decrement. The next chapter explains this phenomenon and discusses current research in this area.

III. REDUCED HUMAN PERFORMANCE

A. INTRODUCTION

This chapter discusses human performance and its complexity. Although the research focuses on reduced human performance, enhanced performance is an integral part of performance. Thus, our framework and the cognitive model have to take performance variability into consideration.

There are numerous definitions for human performance. This research uses a definition that stems from performance psychology:

Human beings are born to perform. In a broader sense, we perform every time we engage in a goal-directed activity (Matthews, Davies et al. 2000, p.1).

Earlier this research pointed out that most cognitive models assumed ideal behavior. Real human performance, however, suffers from breakdowns and failures. Human errors play a major role in accidents such as car or airplane crashes. Performance effectiveness depends on several factors which are described in the next section.

B. PERFORMANCE FACTORS AND MEASURES

1. Human Performance Formula

Human performance is influenced by external factors (i.e. stress factors like heat or noise), by internal factors (i.e., motivation, skills) and certainly by task variables (i.e., task difficulty and task time).

$$\text{Human Performance} = f(O \times C \times W);$$

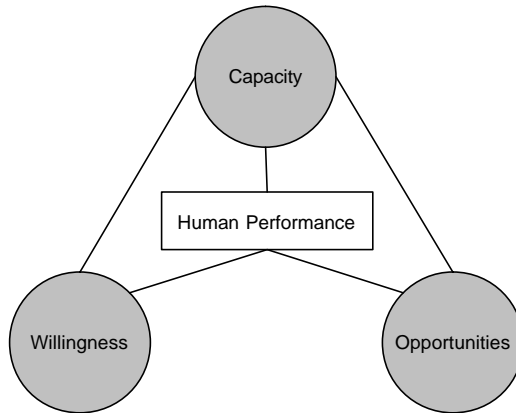

Figure 6. Human Performance Formula (Matthews, Davies et al. 2000)

Figure 6 shows a formula used in performance psychology identifying the contributing factors for performance variability. Matthews used the work of Blumberg on the theory of factors influencing work performance.

The first is capacity (C), which refers here to all the basic characteristics that promote good performance, such as intelligence, learned skills and physical fitness. ...The second is willingness (W) referring to motivational and attitudinal factors, which may allow the person to use their capacities to full advantage, or alternatively hinder them in fulfilling their potential. The third factor, opportunity (O), refers to the physical and social environment provided by the organization: workers need the right tools and social support to give their best. Performance reflects the interaction of these three factors, so the determinants of work performance can be expressed as follows: Performance = $f(O \times C \times W)$ (Matthews, Davies et al. 2000, p.14).

In the context of this research the definition of capacity is enhanced by including attentional resources and its variability over time. This formula will be transferred to demonstrate the non-linearity of vigilance performance and the impact of behavior moderators or stressors.

One of the major challenges to validate human behavior modeling is that there are numerous measures of performance and that this is a widely unexplored field of human factors. Some of the measures are quantitative and measurable (overt). However,

probably the more “interesting” ones are the qualitative measures of human performance (covert). The next sections describe both types and gives examples.

2. Quantitative Measures

Quantitative measures are overt measures of human performance. Some of these are easily measured like reaction time,¹⁷ error rate, throughput, accuracy, short term memory capacity, long term memory recall. More advanced measures include mental arithmetic and physiological measures such as alertness, heart rate, pupil diameter width, or measures established with an electroencephalogram (EEG). Parasuraman reports different vigilance experiments that used event-related potential (ERP) activity and EEG beta waves to determine the state of arousal during vigilance tasks (Parasuraman 1998). These measures are normally taken before and after an experiment to establish a baseline.

However, there are also some normative data used for computerized neuropsychological assessment (i.e. closed head injury evaluation) in the medical community. One example is metric data taken from U.S. Navy divers:

The Automated Neuropsychological Assessment Metrics (ANAM) was identified as a potentially useful screening instrument for assessing the cognitive abilities of divers. Normative data from 113 United States Navy divers were collected and are presented. The instrument is computer based and provides millisecond timing while automatically scoring and summarizing. It is purported to afford the level of sensitivity necessary for detecting cognitive problems that can result from diving, as well as central nervous system decompression sickness and oxygen toxicity. The instrument provides a good screening tool for suspected cognitive problems, and using it along with the other medical assessment tools is encouraged (Lowe and Reeves 2002, p.1).

Unfortunately it is not easy (sometimes for obvious reasons) to extract these data and utilize it for research in cognitive modeling. In the optimal case, a cognitive model could be configured with this screening instrument. The cognitive model could then be tested with a scenario that it hasn't been exposed to.

¹⁷ Reaction time is not an “undisputable” measure of performance because there is evidence that humans voluntarily influence reaction times as part of a performance strategy called Accuracy-Speed-Tradeoff.

3. Qualitative Measures

Qualitative measures encompass performance strategies like speed-accuracy tradeoff in serial tasks or attentional selectivity in dual task situations or “beta shift” in signal detection theory. More complex measures try to measure the cognitive reasoning ability, personnel workload assessment and alike. These measure are not easily extracted from humans, which is one reason why performance psychology is called the science of the unobservable (Matthews, Davies et al. 2000). However, advancement in cognitive modeling will also require the validation of covert behavior.

C. AROUSAL, STRESS AND PERFORMANCE

This section describes the correlation between arousal, stress and resulting performance. We define the arousal level as a physiological level that correlates with the stress imposed on (external stressors) or within (internal stressors) a person.

Examples for external stressors, sometimes called external behavior moderators¹⁸ include: sleep deprivation, sleep disturbances, physical exercise, heat, cold, decompression, compression, acceleration and deceleration, weightlessness, vibration, noise, poor visibility, radiation, drugs and poisons (Poulton 1970). Examples for internal stressors are : task stress, emotions (i.e., fear or anxiety), obsessiveness.

¹⁸ Pew et al. describe stressors as behavior moderators. However, research shows that not every stressor or level of stressor leads to a changed behavior.

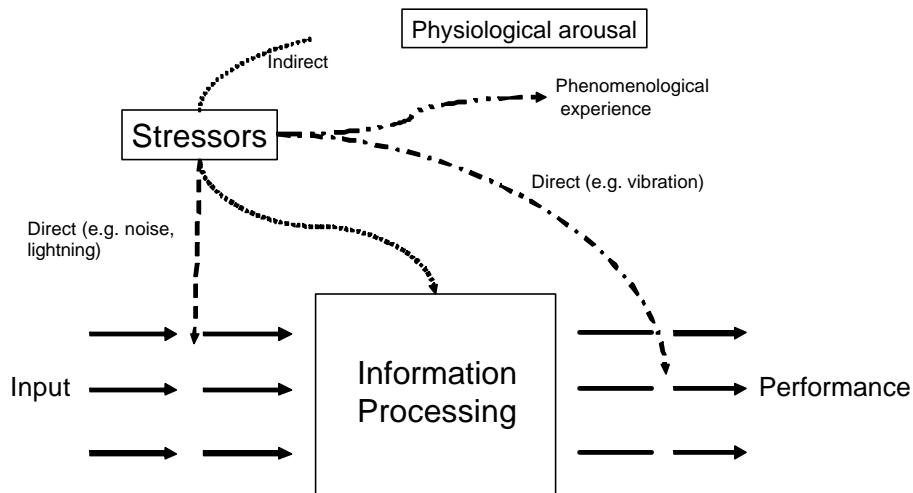

Figure 7. A Representation of Stress (From: Wickens 1992, Fig. 10.1 p.414)

Figure 7 illustrates the different effects of external stressors in terms of human performance. Some stressors have a direct influence on the process. Noise, for example, influences the quality of the perceived information, especially in auditory tasks. Vibration can impact the quality of the response. The perceived level of stress is often expressed as a phenomenological experience. Stressors don't always degrade performance (Wickens 1992), instead they can lead to enhanced performance which is well explained with arousal theory, covered in the next section.

1. Arousal Theories

a. Yerkes-Dobson Law

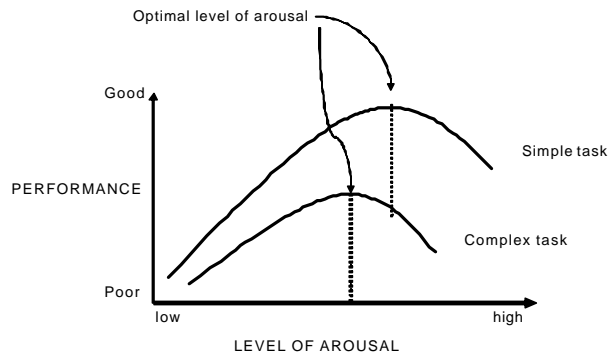

Figure 8. Yerkes Dobson Law (From: Wickens 1992, Fig. 10.2)

Figure 8 illustrates the Yerkes-Dobson law, which is also described as an inverted U-function. It basically states that there is an individual level of arousal which is optimal for task performance. The optimal level is different for different people and for some persons it also differs over time. Arousal that is below or above that threshold leads to degraded (respectively non-optimal) performance. It can easily be seen that causes for the change in performance can not be easily deduced from these (non-linear) curves, since the directions¹⁹ of arousal change needs to be considered.

b. Dynamic Stress Model

There is still no unified theory that could enable prediction of the stressors' effects on performance. A different approach to Yerkes and Dobson is the dynamic stress model by Hancock. This section briefly describes his theory on how humans adapt to stress.

¹⁹ Performance changes around the optimal point can be changed with increasing or decreasing stress levels

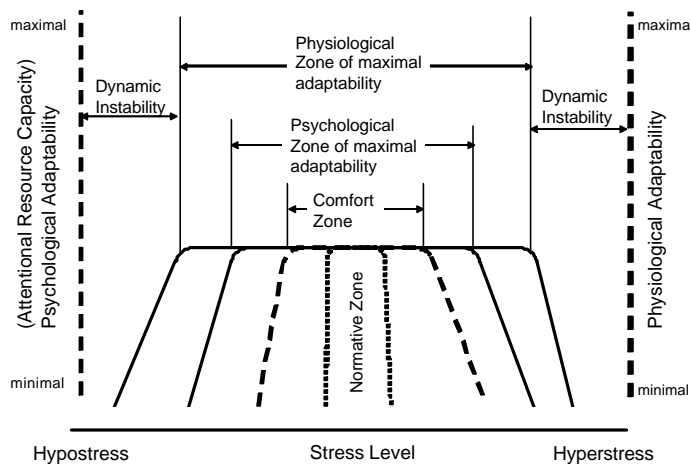

Figure 9. Human Adaptability to Stress (From: Hancock and Warm 1989)

Figure 9 is strongly supports the underlying hypothesis of this research. It shows the different zones of resource capacity for psychological and physiological adaptability as a function of stress.

Hypostress (underload) and hyperstress (overload) comprise areas of dynamic instability. Starting in the middle, one can explore the effects of stress and a change of performance according to the zones. The normative zone describes a region (for most healthy human beings) where the stress input does not cause a compensatory action to maintain the performance level. The comfort zone is unique for every individual. It is a region where first compensatory actions potentially take place. Once the stress reaches into the psychological zone of maximal adaptability it certainly impacts the capacity as well as the willingness factor (i.e., cold has a strong influence on motivation (Palinkas 2000)). Beyond the psychological zone is the physiological zone of adaptability, which is regulated by body functions such as increase of body temperature. Being in this zone does not only impact performance but also potentially impacts one's health.²⁰ This model thus describes the change from a stable state to failure modes and to

²⁰ A rather infamous example for this zone is the heat stroke. Especially in connection with medication heat stroke can be a cause for death for athletes during spring training for baseball.

a breakdown. Unfortunately, this cannot be used as predictive model, because similar to the inverted U shape of the Yerkes-Dobson law, it can only be established after the fact (Hancock and Warm 1989).

A cognitive model should generate these areas accordingly to show the shifts in performance. This research assumes that reduced human performance is like a complex adaptive system, which seems to be an ideal fit to the theory of adaptability zones.

D. VIGILANCE PERFORMANCE

1. Background to Studies of Vigilance Performance

Vigilance research started in the early 1930s and was established by Mackworth's work on naval recruits. Mackworth was tasked to research the question why so many enemy submarines that were on the radar screen of radar operators still remained undetected. He studied the phenomenon of the vigilance decrement in laboratory settings.

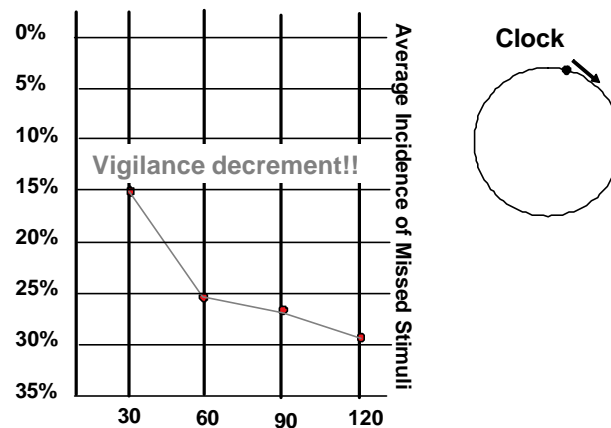

Figure 10. Mackworth's Clock Experiment and Results

Figure 10 (from Mackworth 1950) shows the results of the Mackworth clock test. It was used to establish the increase in misses and the increase in reaction time. Subjects watched a clock's watch hand for two hours. Whenever the watch hand jumped two instead of one second the subjects had to report it. Within the first 30 minutes the decrement in hit rate was most pronounced. After that the decrement leveled off and

stayed at an almost constant level (Mackworth 1950). Closely related to the phenomenon of vigilance is the theory of signal detection:

Signal detection theory has had a large impact on experimental psychology, and its concepts are highly applicable to many problems of human factors as well. Its benefits can be divided into two general categories: (1) It provides the ability to compare sensitivity and therefore the quality of performance between conditions or between operators that may differ in response bias. (2) By partitioning performance and therefore performance change into bias and sensitivity components, it provides a diagnostic tool that recommends different corrective actions depending on whether a deterioration of performance results from a loss of sensitivity or a shift in response bias. (Wickens 1992, p.38)

This research utilizes the ease of implementation of the signal detection theory to generate signals and noise and to measure the resulting performance parameters. Hence it is necessary to briefly explain the main points of the theory.

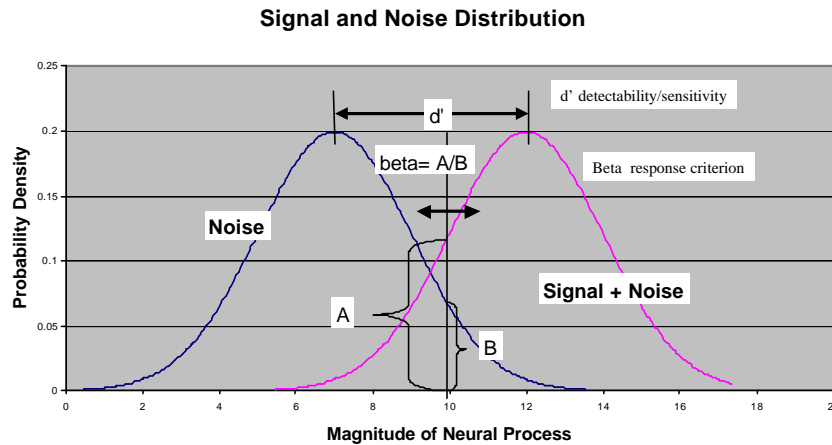

Figure 11. Signal Detection Theory; (From: Davies and Parasuraman 1982)

Figure 11 shows two hypothetical probability density distributions. The left one is the noise distribution. The right one is the cumulative noise+signal distribution. Incoming information can stem from both distributions, however, only the noise+signal distribution

contains a signal (like a blips on a radar screen opposed to the white noise on the screen). The decision criterion (beta) is a decision making threshold. If a piece of an information is perceived to the left of the line, it is perceived as noise, to the other side as a signal. The detectability (sensitivity) of a piece of information is measured between the amplitudes of both distributions. A decrease in sensitivity closes the gap between the distributions and the probability of errors increase. The errors can be differentiated into commission and omission errors.

	Signal	Noise
Yes response	Hit	False Alarm (commission error)
No response	Miss (omission error)	Correct rejection

Table 1. The Four Outcomes of Signal Detection Theory (Wickens 1992)

Table 1 shows the four different outcomes between the information presented and the response. Some experimenters, like Mackworth, only reported the hit rate or the miss rate. However neither the false alarm rate nor the decision criterion can be deduced from that. Both rates (hit, false alarm) are important measures in the psychological understanding of a person’s response. These rates are also used to determine the decision criterion (criterion (beta) and sensitivity (d')).

There are different strategies for signal detection: I.e. a person’s decision criterion could be to the right, thus this person would only report a signal if it’s beyond their doubt. The false alarm rate would basically become non existent. However, this also increases the number of misses. If the opposite strategy is used, basically every piece of information is called a signal. This will create an almost perfect hit rate, but it will also create a high false alarm rate²¹. It is obvious that different personalities have a major impact on the decision criterion, which is subject to changes over time (Warm 1984; Methot and Huitema 1998).

2. Vigilance Performance Factors

Vigilance is a subset of human performance. Thus, we expect that the formula for human performance holds true for vigilance performance. Research in this field clearly established factors that impact vigilance performance. After we explain some of the

²¹ False alarms are not a good way to get superior’s attention.

factors, we will relate them back to the formula and show their non-linear interaction. We will then expand the human performance formula for vigilance.

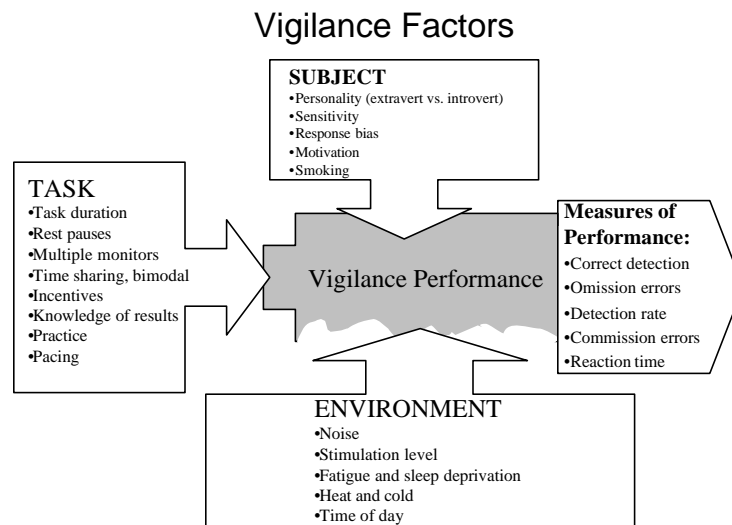

Figure 12. Vigilance Factors

Figure 12 summarizes the findings of several researchers (Davies and Tune 1970; Davies and Parasuraman 1982; Warm 1984; Matthews, Davies et al. 2000). It shows the main factors that influence vigilance performance. It also shows a sample of the different measures of performance (MOP). There are three main factors that impact vigilance performance: Task factor, environmental factor and subjective factor. These factors are determined by their identified variables (i.e. the environmental factor is determined by the stress level). The next sections explain the variables, indicating their impact on vigilance performance

a. Task Factor

Experimental vigilance tasks are often performed in laboratories. Thus this factor can be easily controlled by the experimenter. Task duration, for example, can vary between only a few minutes to many hours. Parasuraman and Davies suggested a taxonomy that discriminates vigilance tasks into successive or simultaneous tasks ²².

²² Successive tasks are absolute judgment tasks in which observers must maintain a standard in working memory to compare incoming information against it. Simultaneous tasks are comparative judgment task, in which the information contains all the features needed to discriminate it.

Successive tasks are more demanding since they use the working memory intensely (See, Howe et al. 1995).

Vigilance decrement can be minimized either by sufficient rest pauses or feedback (called knowledge of results (KR)). Research showed that even false KR can have a positive effect on vigilance performance (Matthews, Davies et al. 2000).

Signal salience and probability impact vigilance performance (Sawin and Scerbo 1995). Signal salience (intensity, duration) impacts sensitivity (detectability). Signal probability has an effect on the decision (response) criterion.

...low overall levels of detection efficiency are attributable to observers adopting extremely conservative response criteria that are appropriate to the low signal probabilities they experience in the majority of sustained attention tasks. (Matthews, Davies et al. 2000, p.114).

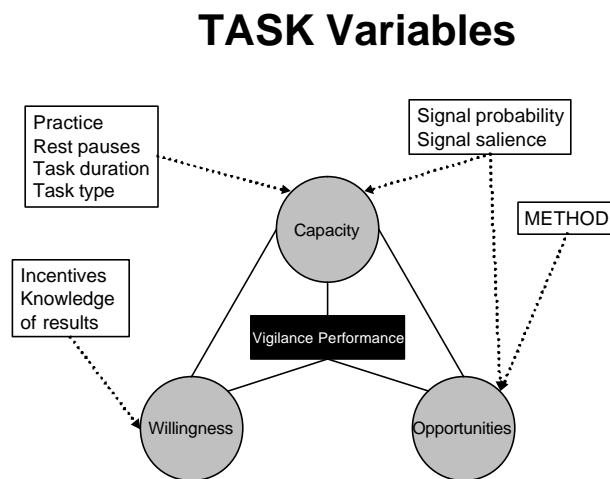

Figure 13. Relationship between Task Variables and Human Performance Factors

Figure 13 graphically relates vigilance research findings to the factors that influence human performance in general. KR or incentives (like receiving money for the experiment) have an impact on a person's willingness to perform well. KR is also an environmental setting. The opportunity factor describes the environment in general. In vigilance research, this environment can be equated to the *method* of a vigilance experiment. I.e., signal salience has an impact on the opportunity factor as well as the capacity factor. Task duration and the use of rest pauses impact the capacity factor.

b. Environmental Factor

The environmental factor in vigilance research is not equivalent to the opportunity factor of the human performance formula. It captures the level of stress caused by the environment onto the subjects. Some of these variables are again controlled by the researcher. Sleep deprivation impacts human performance in general. It has a degrading effect (Belenky 1994) that can, in certain circumstances, be counteracted with noise (Loeb 1986) or caffeine (Temple, Warm et al. 2000).

ENVIRONMENT Variables

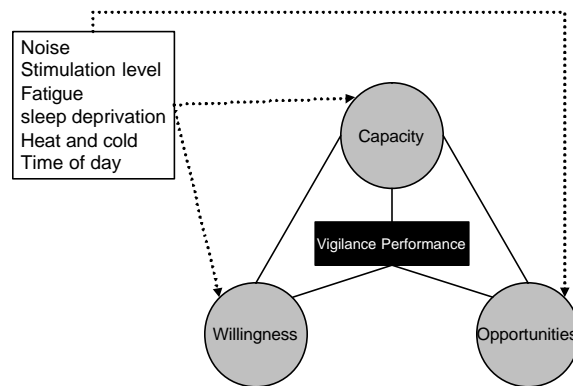

Figure 14. Relationship between Environmental Variables and Human Performance Factors

Figure 14 shows that the environmental factors impact all three performance factors. For example, heat has been used as an external stressor for vigilance tasks. Mackworth showed in one of his experiments, that signal detection increased as temperature was increased from 70 to 79 degrees Fahrenheit. At temperatures above 88 degrees Fahrenheit vigilance performance degraded (Mackworth 1950). Matthews concluded from several studies that there is a curvilinear relationship, very similar to the Yerkes-Dobson law, between heat and vigilance (Matthews, Davies et al. 2000).

Palinkas showed that cold had an impact on motivation before the body temperature decreased (Palinkas 2000). Looking back to Figure 9, we claim that once the stress level has exceeded the maximum zone of psychological adaptability, the

motivation is going to be impacted. Experiments with vibration showed that the capacity factor is impacted by this stress type (see Figure 7).

Another example for the influence on capacity is loss of sensory acuity. A loss of visual acuity occurs when temperature exceeds 122 degrees Fahrenheit (Matthews, Davies et al. 2000).

c. Subjective Factor

The subjective factor includes personality, response biases and motivation. Different researchers showed the variance of human performance between individuals. Examples for this type of research can be found in (Eysenck and Eysenck 1985; Matthews, Davies et al. 1990; Koelega 1992; Matthews and Holley 1993; Sawin and Scerbo 1995; Methot and Huitema 1998; Matthews, Davies et al. 2000; Gusev and Schapkin 2001).

There are many personality theories²³ that try to categorize the difference in individuals. It is beyond the scope of this research to go into detail of personality research. However, there seems to be an agreement in personality theory that the dimension extroversion and introversion is one of the dimensions characterizing individuals (Matthews 1997; Gusev and Schapkin 2001; Nêcka and Szymura 2001; Schapkin and Gusev 2001).

²³ (Boeree, G. (1999) describes about 30 different personality theories.

Tasks / Performance	Extroverts	Introverts
Dual-task performance	++	--
Memory task involving high response competition	++	--
Short-term memory tasks	++	--
Retrieval from memory	++	--
Processing resources	++	--
Sensory reactivity	++	--
Resistance to distraction	++	--
Detection rate in vigilance tasks	--	++
Perceptual sensitivity	--	++
Difficult problem solving	--	++
Long term memory	--	++

Table 2. Differences (sample) in Performance Based on Personality Trait Extroversion

Table 2 describes some of the main differences between extroverts and introverts adapted from (Matthews, Davies et al. 2000, p.267ff.). “++” indicates that the trait is superior. For example extroverts outperform introverts in dual task performance (Eysenck and Eysenck 1985). (Matthews, Davies et al. 1990) documented individual difference in resource availability, which is going to have an impact on our simulation system. Research in vigilance also established the superiority of introverts in terms of detection rate and perceptual sensitivity (Koelega 1992). (Gusev and Schapkin 2001; Schapkin and Gusev 2001) conducted the latest research in terms of individual differences in auditory vigilance tasks.

SUBJECT Variables

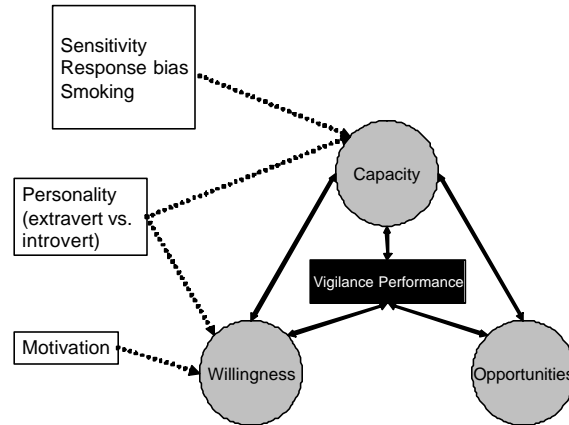

Figure 15. Relationship between Subjective Variables and Human Performance Factors

Figure 15 shows that personality influences both the capacity factor and the willingness factor. As documented in Table 2, extroverts tend to have more processing resources. (Sawin and Scerbo 1995) showed that boredom-prone subjects have a more distinct vigilance decrement. This correlates with the fact that extroverts do not perform as well as introverts. Extroverts presumably are more prone to boredom than introverts (Eysenck and Eysenck 1985).

d. Vigilance Performance Formula

We have described how the different factor variables (task, environment, subject) impact performance factors (opportunity, capacity, willingness). From that we can deduce that a formula for vigilance should include these factor variables.

$$Vigilance\ Performance = f(O \times C \times W);$$

$$O = g(Task, Environment)$$

$$C = h(Subject, Task, Environment)$$

$$W = k(Subject, Task, Environment)$$

This equation shows that opportunity is a function of the task (specifically the method of the task experiment). Capacity and willingness depend on subject, task, and environment. Since these different factors represent dimensions, a different way of representing the formula follows:

$$Vigilance\ Performance = O \begin{bmatrix} Task \\ Environment \end{bmatrix} \times C \begin{bmatrix} Task \\ Subject \\ Environment \end{bmatrix} \times W \begin{bmatrix} Task \\ Subject \\ Environment \end{bmatrix}$$

This equation shows that vigilance performance is a non-linear function of the mentioned factors. From prior description of the impact of these factors, it is evident that vigilance performance is dynamic and adaptive. Hence we found support for the hypothesis that vigilance is a complex adaptive system. The next section describes some of the main theories explaining vigilance performance or more specifically in some cases the vigilance decrement.

3. Vigilance Theories

Several theories of vigilance tried to explain either the low overall level of vigilance or the vigilance decrement or both. Our research could potentially be utilized not only to approximate empirical human vigilance performance data but also to create feedback to the developed theories. This is what McKelvey called the “model-centric view of science” (McKelvey 2000).

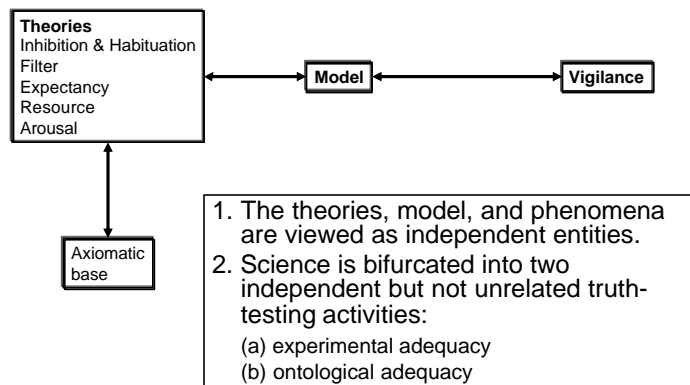

Figure 16. Semantic Conception Model Centric View on Vigilance Adapted from (McKelvey 2000)

Figure 16 shows the feedback between model to the different theories as well as the feedback from the real phenomenon (Vigilance) back to the model. One of the

assumptions of our research is that the model centric view accomplished with a model composed of a multi-agent system is the “third way of doing science” as expressed by researchers like (Axelrod 1997; McKelvey 2000). Thus we will explain these theories with respect to their impacts on the modeling approach. Therefore, it is imperative that RHPM has an open flexible architecture, that potentially allows us to include these theories even in hybrid forms (i.e. expectancy theory + arousal theory+ resource theory).

a. Inhibition and Habituation

Mackworth regarded the vigilance decrement as analogous to the extinction of a conditioned response when that response is no longer reinforced. The decline in detection rate was therefore attributed to the accumulation of inhibition, a fatigue like construct, which eventually results in a failure to produce the detection response, usually a key-press, when a signal is present (Matthews, Davies et al. 2000, p.117).

A conclusion from his theory is that increased signal probability would lead to a decreased detection rate, because the inhibition process would lead to a faster accumulation of fatigue. Experiments showed that this conclusion doesn't hold.

Detection decrements were found to be inversely related to signal probability levels across groups. High signal probabilities generated consistent within-group and within-subject performance, whereas low probabilities generated both lower performance and larger within-subject variance (Methot and Huitema 1998, p.1).

Habituation theory proposed that due to the habituation of neural responses to non-target events, the observer becomes progressively less able to discriminate targets from non-targets, resulting in a sensitivity (d') decrement (Matthews, Davies et al. 2000). This neural response can be measured with the help of an EEG recording the cortical evoked potential like the N100. Parasuraman showed that the rate of habituation in the N100 response was not effected by signal probability (Parasuraman 1998).

Inhibition or habituation theory is mainly concerned with the vigilance decrement. There is evidence, that these theories do not explain the entire phenomenon. McKelvey's view on theories explains why one should not discount the entire theory:

A theory is intended to provide a generalized description of a phenomenon, say, a firm's behavior. But no theory ever includes so many terms and statements that it could effectively accomplish this. A theory:

1. does not attempt to describe all aspects of the phenomena in its intended scope; rather it abstracts certain parameters from the phenomena and attempts to describe the phenomena in terms of just these abstracted parameters”;

2. assumes that the phenomena behave according to the selected parameters included in the theory; and

3. is typically specified in terms of its several parameters with the full knowledge that no empirical study or experiment could successfully and completely control all the complexities that might affect the designated parameters—theories are not specified in terms of what might be experimentally successful (McKelvey 2000,p.15).

The conclusion from these theories for our model are:

- The model should provide an opportunity to manipulate the parameters of the response selection and execution like the response bias beta
- The model should provide an opportunity to impact the sensitivity parameter (d').

b. *Filter Theory*

Filter theory states that sustained attention to the same information source is liable to intermittent interruption, because the hypothetical filter is biased towards new information.

Filter Theory thus attributes the vigilance decrement to periodic failures to select task relevant information which become more frequent with time at work. Filter theory predicts that vigilance tasks in which signals are present only for a brief period will yield a more pronounced decrement than tasks in which signals are present for longer periods ... Filter theory also predicts that the decrement in self-paced vigilance tasks, where observers work at their own pace, should be less marked than in tasks where observers work at a rate that is externally exposed (Matthews, Davies et al. 2000, p.119).

Some experiments support the theory and its conclusions. However, there is also evidence against the latter conclusion. Observers tend to increase their own response rate paralleled with a decrease in detection rate. This implies that observers use the speed-accuracy tradeoff as their performance strategy (Matthews, Davies et al. 2000).

The conclusion from filter theory for our model is that the model needs a component with a filter function. This component should progressively attend more to new information sources than to the relevant source seeking novel stimuli

c. Expectancy Theory

Expectancy theory claims that observers keep track of past signal occurrences in order to predict future ones. This leads to the expectancy of signal occurrence. (Matthews, Davies et al. 2000).(Davies and Tune 1970; Davies and Parasuraman 1982) show many experiments that support this theory. However, they also point out some objections to the theory:

- The knowledge of the temporal structure of a vigilance task gained during one session does not transfer to later sessions. Expectancy theory explains this by claiming that observers completely forget the temporal structure between experiments.
- Expectancy theory emphasizes the importance of an early accurate detection level. However, a vigilance decrement occurs even if the early detection level was almost perfect. This doesn't relate to the fact that the initial prediction of signal occurrence was accurate. (Davies and Tune 1970, p.205)

- They conclude that:

The expectancy hypothesis has provided an ingenious way of integrating data from many vigilance experiments. However, in view of the many difficulties which it faces, certain modifications of the hypothesis, which would have the effect of minimizing the role of expectancy as a determinant of detection rate, would appear to be necessary (Davies and Tune 1970, p.206).

Expectancy theory suggests that a model should include components that conduct statistical analysis of signal probability to create a signal expectancy. Clearly this component should account for the inaccuracy of human estimation.

d. Resource Theory

Figure 2 showed an adaptation of Wickens's general multiple resource model. This theory claims, that there exist different resource pools in four dimensions (modality, code, stage, channel of visual information) (Wickens 2002). There is evidence that

..prolonged performance on detection tasks depletes the pool of resources as the person becomes fatigued. Vigilance tasks look undemanding, however they impose a high workload as measured by a workload measure called NASA-TLX. Fatigue studies indicate, that vigilance performance effects often relate to strategy rather than to loss of resource availability (Matthews, Davies et al. 2000, p.122).

Matthews also concludes that there needs to be further investigation to research the interrelationship of motivational and workload effects on the vigilance decrements.

Our simulation system is already utilizing Wicken's resource theory. The derived vigilance performance formula show that willingness and capacity are main factors for the vigilance performance. Thus we need to model a component that takes the motivational status into account.

e. Arousal Theory

Since previous sections explained two dominating arousal theories (Yerkes-Dobson law, dynamic stress model), there is no further need to describe those in detail. Arousal theory for vigilance performance claims that the prolonged task performance leads to a lowering of arousal or activation. This leads to degraded vigilance performance (Matthews, Davies et al. 1990). Mackworth demonstrated that the use of a stimulant (Benzedrine) counteracts the vigilance decrement. He also showed that KR prevented a decline in vigilance performance (Mackworth 1950). However, there is experimental evidence that only the perceptual sensitivity correlates with the arousal level. The arousal level has no apparent impact on the response criterion (beta).

A conclusion for the model from arousal theory is certainly that there needs to be an opportunity to parameterize the arousal level to manipulate the perceptual sensitivity.

The next section shows that reduced human performance matches the typical properties of a complex adaptive system.

E. REDUCED HUMAN PERFORMANCE AS A COMPLEX ADAPTIVE SYSTEM

This section summarizes findings on reduced human performance with respect to the provisional working criteria of a CAS.

1. Comparison with Provisional Working Criteria

This section uses the provisional working criterias to discern a CAS to establish the main hypothesis.

a. Autonomous Agents Acting in Parallel

The human body consists of a network of organs that act independently and parallel from each other on a physiological level. We find inspiration in the massively complex systems of the human body. Researchers in the field of autonomic computing acknowledge how complex and autonomous some of the human systems:

Think for a moment about one such system at work in our bodies, one so seamlessly embedded we barely notice it: the autonomic nervous system. It tells your heart how fast to beat, checks your blood sugar and oxygen levels, and controls your pupils so the right amount of light reaches your eyes as you read these words. It monitors your temperature and adjusts your blood flow and skin functions to keep it at 98.6 F. It controls the digestion of your food and your reaction to stress – it can even make your hair stand on end if you're sufficiently frightened....But most significantly, it does all this without conscious recognition or effort on your part. (Horn 2001, p.6).

Clearly Horn acknowledges the complexity of the autonomic nervous system. He shows that there are several functions often working to adjust blood sugar, oxygen level, pupil width, and many more. It is obvious that these functions work in parallel with each other steered by different mechanism (or in our Lingo: autonomous agents)

Chris Wickens Multiple Resource Model is another analog that we can use to proof our point. There are several cognitive resource pools that seem to be independent at a high degree from each other. It appears that every resource pool is an autonomous agent providing resources to certain tasks. Research in multi tasking (simultaneous tasks which people work in parallel) shows that the level of performance in two different tasks (modality and code) can be as high as if one would only perform the tasks individually.

There are more examples already mentioned in this research (e.g. heart as a complex adaptive system, immune system as a complex adaptive system) which established that they consist of autonomous agents working in parallel. This leads to the next point. If a system consists of autonomous agents acting in parallel the control of the system must be highly dispersed.

b. Highly Dispersed Control

Again we could use the autonomic nervous system or the immune system as legitimate examples of decentralized controls in the human physiological system. For example the salivary is checking for blood sugar levels and injects insulin automatically when food is taken in. (Kaarlela 1997).

Human performance is a function of willingness (volitional control), capacity, and opportunities. Vigilance research shows that vigilance decrement is a phenomenon that human can not sustain attention for long periods of time. There is evidence that this negative degradation can be counteracted with exterior help for a certain amount of time (e.g., feedback of result or treatment with benzedryne (Mackworth 1950)). However, a performance degradation over time is inevitable even with the most motivated operators.

The information stage processing model assumes that there are different stages of information processing. In every single stage there are distinct errors that can occur and even different resource pools for the stages and modalities. Stimuli in the STSS can be lost because we don't attend to them in time and the "storage time" expired. Even after correctly processing and classifying an information, the response execution still can generate errors know as slips.

c. Non-linear Interactions

Hancock' stress model and the Yerkes-Dobson law clearly indicate individual non-linear performance. Many experiments including ours clearly showed that external stressors like workload or time on task cause non-linear effects. Some of the interactions have an inversed U-shape as the outcome function.

The human performance formula and the derived vigilance performance formula show the complexity and non-linearity within and between the main performance

factors. Two of the factors are interior factors (capacity and willingness) and there is evidence for the non-linear interaction between them.

d. Adaptive System with Emergent Behavior

Humans adapt to stress (internal or external stressors) on an individual basis. Hancock's stress model combines perceived stress with available attentional resources. This is the link between stress and performance. He suggests that there are different level of adaptation or zones of adaptivity (physiological and psychological) which effect the available cognitive capacity (see Figure 9). By humans adapting to stress, human performance adapts indirectly via available attentional resources. Emergent behavior , like increasing error rates, occur when stress level or workload level surpass a certain threshold.

Marianne Frankenhaeuser gives a good overview on degraded human performance in crisis situations:

1. Attention narrowing: When our stress level rises, we develop tunnel vision. Important dimensions of the situation may be completely blocked out from conscious awareness.
2. Perceptual Distortion: Messages tend to become distorted in the direction of our expectations. Such distortions occur, in particular, when stimuli are ambiguous, when past experiences influence interpretations, and when wishful fantasies color what is perceived.
3. Mental rigidity: A related psychological phenomenon is loss of mental flexibility. Coping with the unexpected becomes even more difficult in a crisis. When people are under strong emotional pressure, their cognitive processes become rigid. Their ability to take in new information is reduced, particularly information which is not consistent with established beliefs. The ability to weigh alternative courses of action is impaired, as is the capacity to reevaluate conclusions. We know from the accident at Three Mile Islands that the operators adhered rigidly to a picture that did not tally with the facts.
4. Vigilance fluctuation: It is also significant that the accident at Three Mile Island took place at about 4:00 a.m. It is well known that mental alertness is associated with the diurnal rhythm which characterizes most physiological processes. This rhythm adapts slowly to shifts in the pattern of sleeping and waking hours. (Frankenhaeuser 1997, p.5)

Human performance seems to rely on an adaptive system delivering cognitive resources. Emergent behavior then becomes the level of performance. Vigilance decrement is an emergent behavior characterized by increases in error rates (omission and commission).

e. Dynamically Changing Structure

The brain continually strengthens and weakens myriad of connections between neurons as individuals learn from their encounter with the environment. Different organs of the autonomic nervous system change their structure or features (for example: pupil width, heart rate, brain blood flow).

Posner and Steven Peterson showed how the attention system of the human brain functions on a neuronal activity level (Posner, 1990). Dynamically changing connections and changes in blood flows occur in the same areas at different stages of the detection process. The supporting brain regions for sustained attention dynamically change their structure to support this cognitive function.

f. Changing Different Equilibria

Human performance is all but constant over long periods of time. Athletes try to time and manage their work outs such as to achieve peak performance for important competitions. Vigilance experiments show that the initial decrement is most pronounced within the first 30 minutes. Nevertheless the degradation continues over time. Knowledge of feedback results causes non-linear jumps in performance basically going back to a previous alertness state. However this state doesn't last and the degradation starts again with the first stimulus.

g. Implicit or Explicit Model for the Future

It is very obvious that planning and decision making of humans are based on explicit models of the future. Expectancy theory for vigilance performance claims that humans build a statistical expectation of signal occurrence. This is certainly supportive evidence for our hypothesis.

h. Strong Sense of Path Dependency

Interviews after the conducted experiments showed that there was a broad variety of strategies to cope with the workload. Many mentioned that once they found the rhythm it was easier to conduct all the required tasks. Thus it appears to be evident that by evolving structures in our case even strategies and incorporating the incoming information a strong sense of path dependency has been established.

The next section describes conducted experiments showing individual differences in personality traits, cross-cultural differences and individual vigilance task performances.

F. PERSONALITY AND VIGILANCE EXPERIMENTS

This research claims that human performance is a function of internal factors, external factors and task variables. Internal factors like personality have been shown to impact vigilance performance (Methot and Huitema 1998; Schapkin and Gusev 2001). In order to enhance the understanding of the theories of vigilance and its relation to personality theories and to gather complete data a series of own experiments were conducted. The following sections describe four different conducted experiments (personality test, low workload vigilance experiment, high workload vigilance experiment) and discusses their results.

1. Personality Test Experiment

There are many personality tests that one could potentially use to assess the differences in personality. (Boeree 1999) discusses some 30 different personality theories. Every theory has a battery of different tests associated with it. One of the most acknowledged one is the five factor model of personality. This model is often called an evolution of the well-known Myers-Briggs Type Indicator and suggests a paradigm shift from personality types to personality traits. The model establishes five different dimensions of personality:

- **Openness (O)** refers to the number of interests to which one is attracted and the depth to which those interests are pursued. High openness refers to a person with relatively more interests and, consequently, relatively less

depth within each interest, while low openness refers to a person with relatively few interests and relatively more depth in each of those interests.

- ***Conscientiousness (C)*** refers to the number of goals on which one is focused. High C refers to a person who focuses on fewer goals and exhibits the self-discipline associated with such focus. Low C refers to one who pursues a larger number of goals and exhibits the distractibility and spontaneity associated with diffuse focus.
- ***Agreeableness (A)*** refers to the number of sources from which one takes one's norms for right behavior. High A describes a person who defers to a great many norm sources, such as spouse, religious leader, friend, boss, or pop culture idol. Low A describes one who, in the extreme, only follows one's inner voice. High A persons will march to the drumbeat of many different drummers, while low A persons march only to their own drumbeat.
- ***Extraversion (E)*** refers to the level of sensory stimulation with which one is comfortable. High extraversion is characterized by a larger number of relationships, a larger proportion of one's time spent in enjoying them, and in general a comfort with loud, bustling social scenes. Low extraversion is characterized by quieter social scenes, a smaller number of relationships and a smaller proportion of one's time spent in pursuing those relationships.
- ***Negative Emotionality or Neuroticism (N)*** refers to the number and strength of stimuli required to elicit negative emotions in a person. More resilient persons are bothered by fewer stimuli in their environment, and the stimuli must be strong in order to bother them. More reactive persons are bothered by a greater variety of stimuli, and the stimuli do not have to be as strong in order to bother them. (Howard and Howard 1995, p. 4ff)

After a brief discussion with research psychologists (Shilling 2003) the NEO FFI test was chosen. The electronic version with the short form (60 questions) was installed on a standard personal computer. The test computes the raw scores and standardizes them

under the assumption that scores are normally distributed with a mean t-score of 50 (Costa and McCrae 2000). The NEO FFI not only provides the t-scores of individuals in the five dimensions it also correlates their traits describing certain styles of behavior based on the trait assessment (see Appendix C for a detailed discussion and definitions)

a. Method

Participants: Fifty Naval Postgraduate students (mostly military officers) participated in the study (38 US students (5 female) and 12 foreign students from four different countries (Germany, Greece, Singapore, Turkey). Mean age was 34. Participants volunteered and received a personality report printout after conducting all experiments.

Subjective Measures: Participants completed the NEO FFI electronic version before they started the vigilance experiments.

b. Results

The results indicate that the tested population is in fact not a normal population. There is biases that might be typical for the military community:

One Sample T-test	P-O	P-C	P-E	P-A	P-N
Mean	53.36	52.92	53.82	46.86	45.60
stddev	9.81	10.68	8.53	11.24	9.51
t	2.42	1.93	3.17	-1.98	-3.27
df	49.00	49.00	49.00	49.00	49.00
alpha 0.025	2.01	2.01	2.01	2.01	2.01
Ho mean=50	Reject	Fail to reject	Reject	Fail to reject	Reject
CI Lower	50.57	49.88	51.40	43.67	42.90
CI Upper	56.15	55.96	56.24	50.05	48.30

Table 3. One Sample T-test for Personality Scores

Table 3 summarizes the result of conducted two-tailed t-tests. Every dimension was tested against the following hypothesis at the alpha level of 0.05:

$$H_0 : m_{\text{trait}} = 50;$$

$$H_1 : m_{\text{trait}} \neq 50;$$

There are three traits (openness (O), extroversion (E), and neuroticism (N)) where the null hypothesis was rejected, indicating that the means of these traits differ from a normal population. Thus, the sample is more prone to score high in O, high in E, and low in N. The latter one is certainly a desired trait in the military community since a low score in negative emotionality indicates a more relaxed reaction to negative

experiences. There was not enough evidence to reject the null hypothesis for conscientiousness (C) and agreeableness (A). The 95% confidence intervals consequently (albeit barely) cover a mean of 50.

The result indicates that simulation systems certainly have to take the shown bias instead of an average assumption into account.

Although the sample of foreign students was small (12) the opportunity to investigate cross-cultural differences was taken. The results show statistical significance for the trait of conscientiousness (p-value = 0.03).

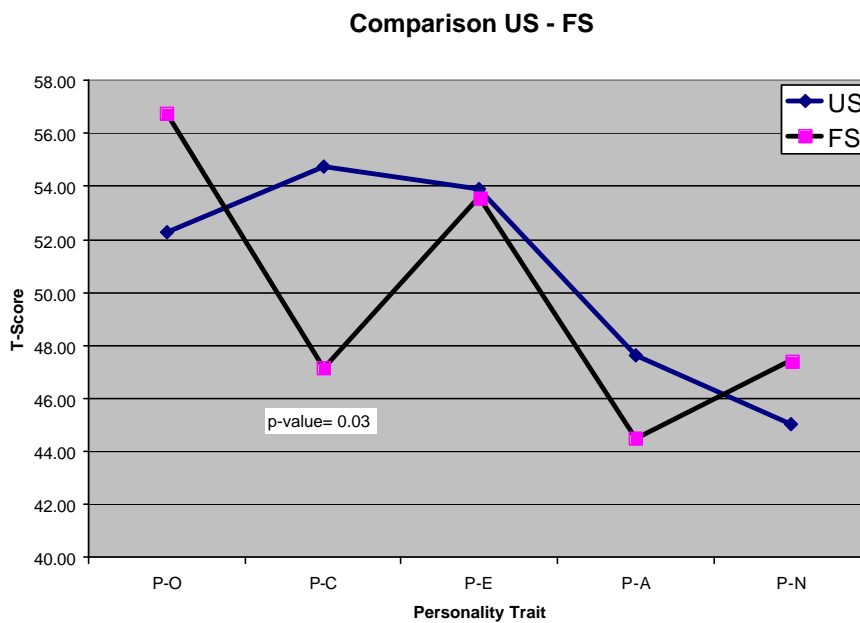

Figure 17. Cross-Cultural Differences between US and Foreign Students

Figure 17 indicates that there are differences in two traits: Openness (O) and conscientiousness (C). While C could be established with statistical significance (p-value 0.03) the difference in O is not as pronounced. The interaction between traits now leads to some interesting differences in personality styles which are detailed in Appendix D.

c. Summary

The purpose of this research was not to evaluate cross-cultural differences. Drawing conclusions from the results is possible but they should be carefully evaluated considering the small sample and the diversity of the participating countries and definitely backed up with follow on research²⁴.

A general result is that the US sample shows a higher level in conscientiousness and a lower level in openness. Thus the behavior is more goal-driven, rule conform and group oriented. Foreign students are more critical and innovative. However, they do not tend to rule-conform behavior and not always towards goal oriented behavior. This population also seems to focus more on their own needs than on group needs.

Another important conclusion can be drawn from this experiment. The experiment showed that the military community has strong biases if compared with a normal population. There is also evidence cross-cultural differences exist and that they might impact the behavior or behavioral patterns. This research will explore whether or not cross-cultural difference actually impacts vigilance performance. Overall the experimental result of a biased military population should be taken into consideration for cognitive models especially in military simulation systems.

2. Low Workload Vigilance Experiment

One of the driving ideas of the vigilance experiments was to establish the vigilance decrement while evaluating the correlation of this decrement with personality traits. Most of the collected data was used to calibrate the RHPM. Some set was used for validation purposes. There were four different treatments:

- Low workload treatment
- High workload treatment
- Going from high to low back to high workload
- Going from low to high back to low workload.

Participants conducted the first two treatments and than either one of the last two treatments. Every experiment lasted 30 minutes which should be sufficient to establish

²⁴ The Naval Postgraduate School certainly has a prime opportunity with over 250 foreign student officers and also officers from all US services.

the vigilance decrement. Participants conducted each of their experiments at the same day time to confine or block any time-related effects. The experiments were conducted with the SynWin-Simulator from Activity Research Inc. This simulator is very flexible and collects the raw data for further evaluation.

a. Method

Participants: 44 participants conducted the low workload conditions. All participants were students (42 officers, 2 civilians) of the Naval Postgraduate School Monterey, California from different countries (US 33, Germany 4, Greece 3, Turkey 2, Singapore 2) and different branches of the respective Armed Forces. They ranged in age from 26 to 47 years with a mean of 34.0 years. All participants had normal or corrected to-normal-vision and normal hearing.

The next figure shows the setup of this experiment:

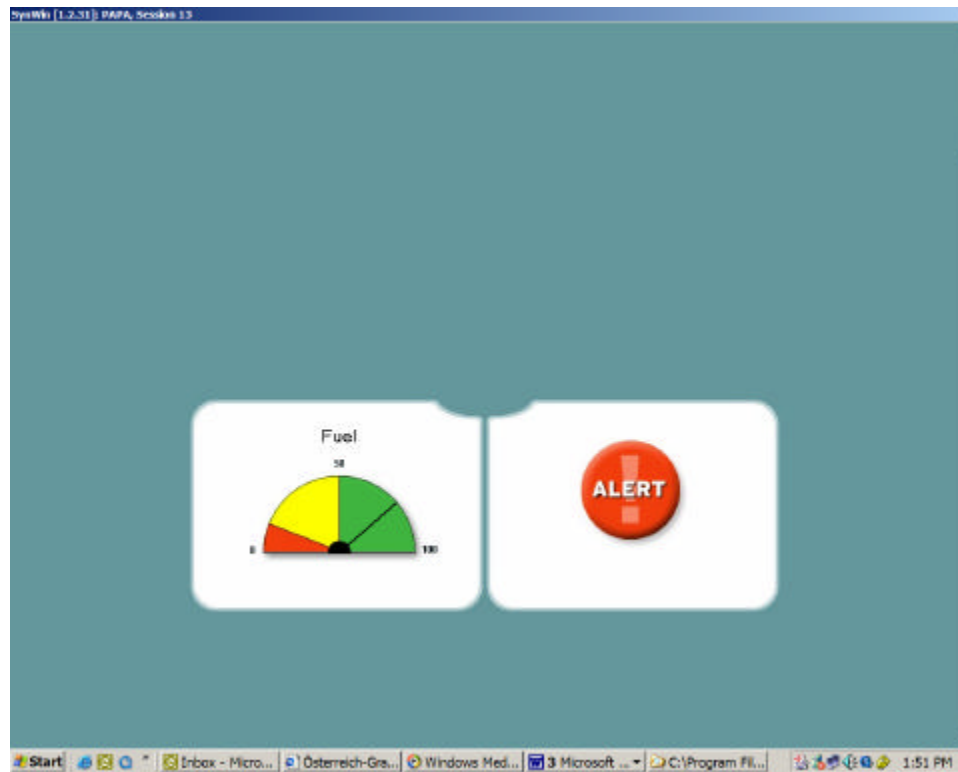

Figure 18. Low Workload Set Up

Procedure: Participants had two mutual-exclusive monitoring tasks. No feedback of result was provided during the experiment. Participants were asked not to wear their wrist watches. The visual monitoring task is on the lower left side. Participants

watched the fuel gauge and mouse-clicked on it when the needle went into the red zone. Lapses were defined as either clicking too early or letting the needle touch the bottom.²⁵

The alert button belonged to the auditory vigilance task. A sound was played periodically every 3 seconds (Miller)²⁶. The noise sound was 1000 hz and 0.15 sec in duration. The signal sound was 1025 hz and 0.15 sec in duration. The participant's task was to click the **ALERT** button following the signal sound, before the next sound occurred. The probability of the signal sound was 0.1. Measured results (a snapshot was taken every 10 minutes) contain number of hits and misses, number of false alarms and correct rejections, reaction times for hits and false alarms.

b. Results

Reaction times

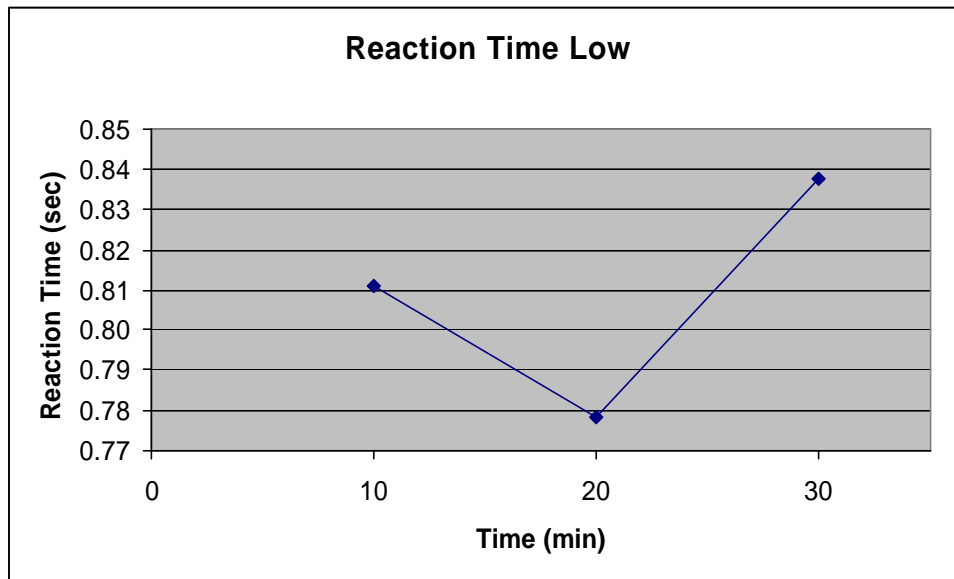

Figure 19. Reaction Time in Low Workload Condition

The mean reaction time changed with time periods. After an initial improvement which could be subject to being used to the task the reaction times increased. This result supports the assumption that a vigilance task is a high workload task. More interestingly it's variation increased over time (sigma first 10 min = 0.199,

²⁵ For details on parameter setting (i.e. movement rate) please see Appendix D

²⁶ Pre- experiments showed that signal salience could be a potential problem. The difference between a 1000hz and 2000hz signal was clearly to salient and different sounds were generated for the experiment.

sigma last 10 min = 0.271). This shows that some subjects were reacting slower at the end of the experiment.

False Alarms: False Alarms didn't show statistical significance in terms of increase or decrease. There is no evidence that the means of the different time phases are different.

Misses:

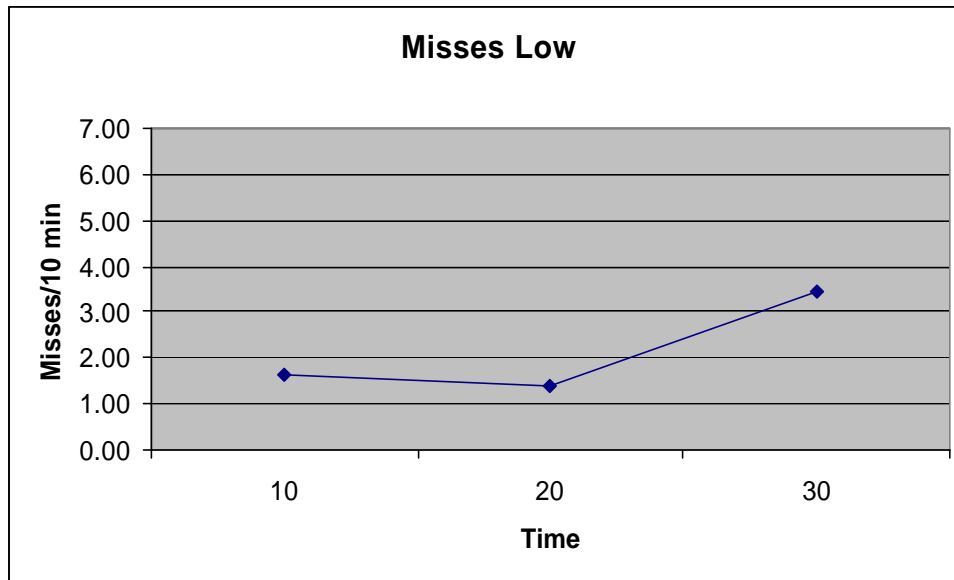

The number of misses remains steady for the first 20 minutes (assuming unequal means yields a p-value = 0.667) In the last period there is a significant increase in misses (p-value 0.03 periods 1 and 2 compared to 3). Hence a performance degradation in terms of misses is pronounced.

c. Cross Cultural Differences

Results don't show statistical significant differences between US and FS students. However, there is a difference for the development of false alarms. The foreign student sample actually decreased the false alarm rate significantly (comparison between false alarm rate (0-10 min versus 20 to 30 minutes) with a p value 0.04.

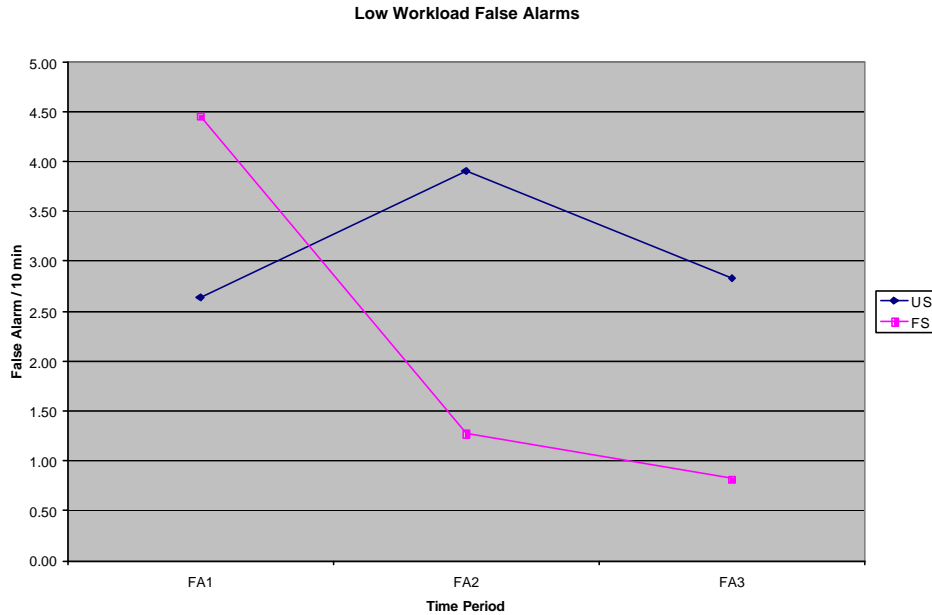

Figure 20. Cross Cultural Difference Low Workload

Figure 20 shows that foreign students improved their performance over time whereas the US students performance remained constant.

d. Influence of Personality Traits

There exist statistically significant correlations between agreeableness (A) and the number of misses in the first two time phases. The significance is also pronounced in a linear regression using A as a predictor. However, it only accounts for 10-15% of the variance in the data. Extraversion and openness each had one significant correlation with reaction time phase 3 / false alarm phase 1 . Their impact is measurable but not significant enough to establish them as driving forces.

e. Summary

This experiment clearly established a vigilance decrement in terms of miss rate and reaction time. The false alarm rate did not change significantly. An analysis of variance showed some evidence for the influence of the personality traits agreeableness, extroversion, and openness. However, their impact only accounts for a small portion of the variance. An evaluation of the different interactions between the personality traits is beyond the scope of this research. However, initial results showed that the small sample

sizes (subjects are categorized in four splitter groups) don't usually allow conclusions with statistical significance.

3. High Workload Experiment

a. Method

Participants: 43 participants conducted the high workload conditions. All participants were students (41 officers, 2 civilians) of the Naval Postgraduate School Monterey, California from different countries (US 32, Germany 4, Greece 3, Turkey 2, Singapore 2) and different branches of the respective Armed Forces. They ranged in age from 26 to 47 years with a mean of 34.0 years. All participants had normal or corrected to-normal-vision and normal hearing. The next figure shows the set up of this experiment:

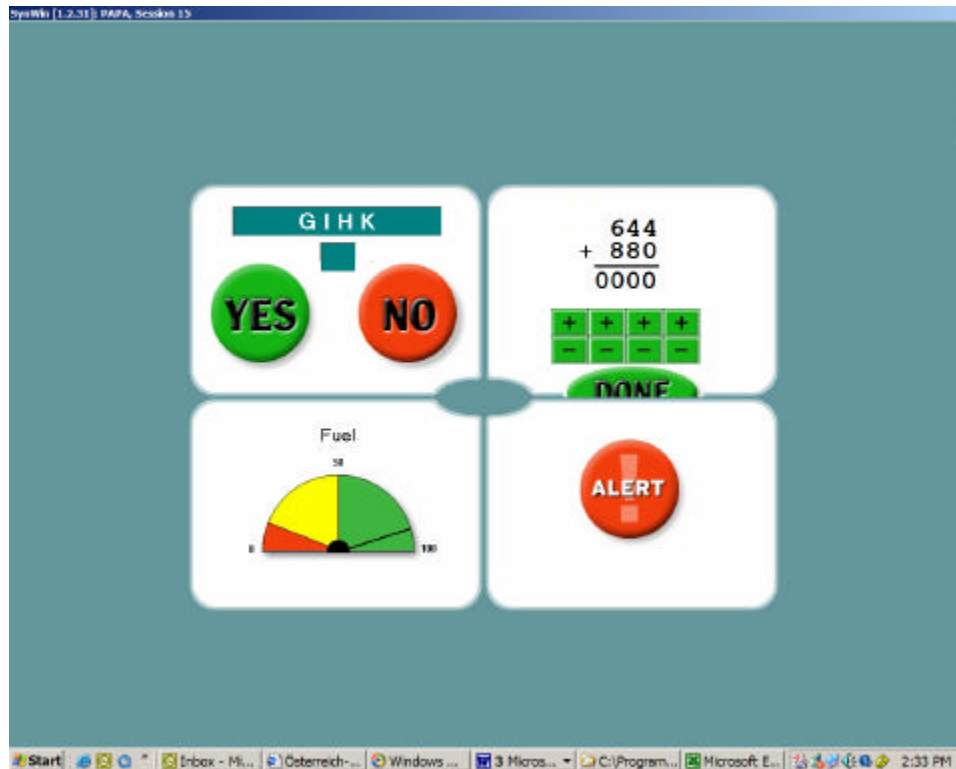

Figure 21. High Workload Condition

Procedure: The visual and auditory monitoring tasks remained the same. The high workload condition included two more displays. The upper left window is a Sternberg memory task. At the beginning of the experiment four letters were displayed. During the experiment probe letters were randomly displayed (trial duration 8 seconds)

and participants had to decide whether or not the letter was in the test sample. Feedback for correct, false or missing answers was given with the help of a point display in the middle of the screen and an auditory signal for mistakes.. The upper right corner shows a simple cognitive task, computing digits. Participants could use the = or – buttons to display the sum of the math task. Feedback for correct and mistaken answers were given via the point display and an auditory signal. Participants were encouraged to score high without ignoring (compromising) the monitoring tasks.

b. Results

The effect of additional task complexity and imposing higher workload showed clear effects on all three MOEs. The reaction time was slightly higher in every single time phase, the differences between the means was statistically significant (highest p-value 0.003). The development over the course of the experiment mirrors the low workload condition.

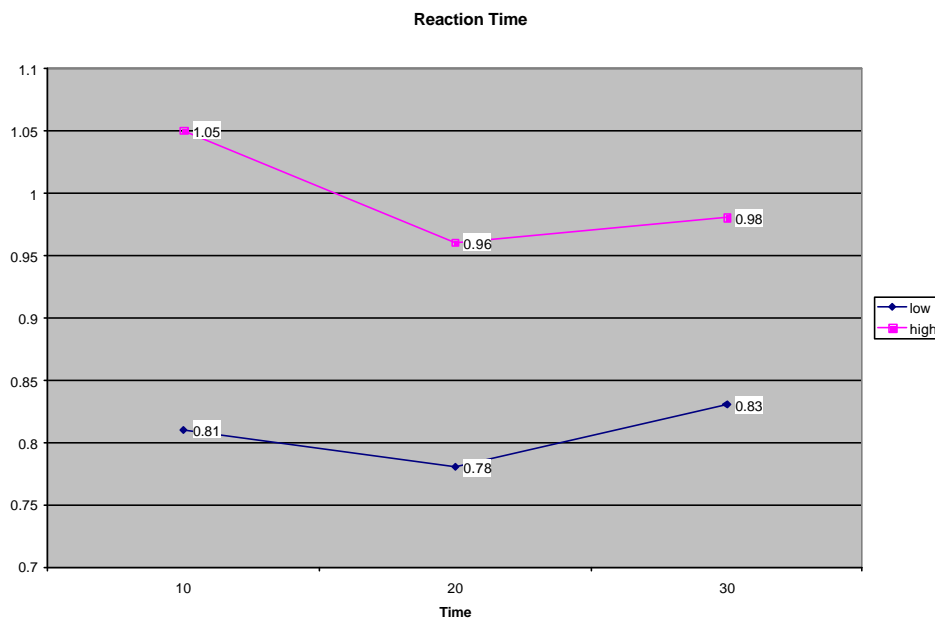

Figure 22. Comparison Reaction Times Low vs. High Workload

The false alarm rate started at a rate of 3.81 false alarms / 10 minutes and remained almost constant for the experiment. The miss rate showed an interesting phenomenon. It started higher than in the low workload condition but then it basically followed the same development.

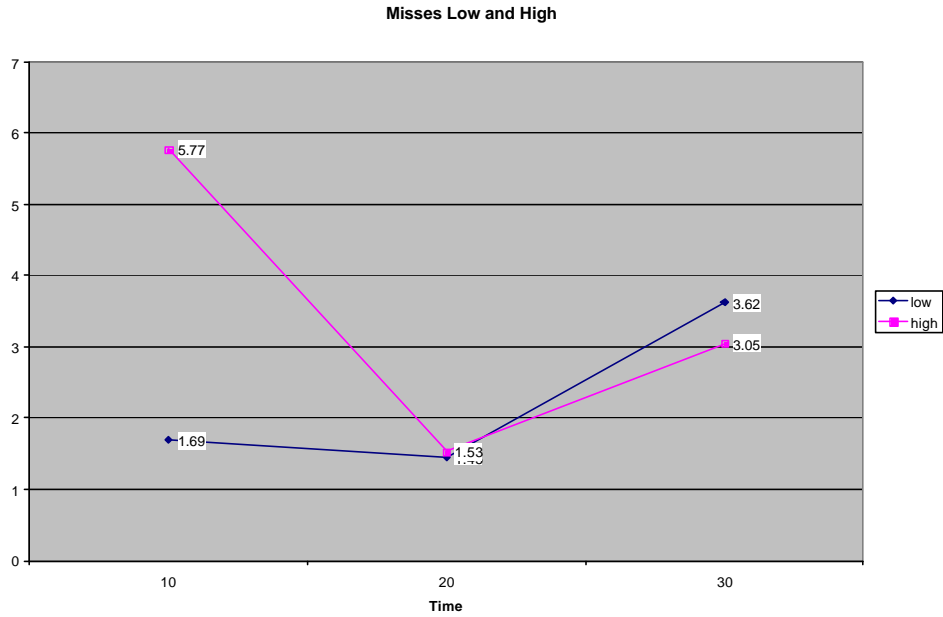

Figure 23. Comparison Misses Low vs. High

This result helped to gain insight into applying arousal theory to the vigilance decrement. If one would expect a steady decrease this result would be counterintuitive. Just by looking at the experimental results it appears to be obvious that initially subjects had problem with the workload and therefore missed critical signal. After that they adapted to the new condition and improved their performance drastically. There seems to be a phase transition from a transient period to an adapted phase. However, at the end the performance level decreased again. Table 4 shows that it is very unlikely that these differences are coincidental.

Ttest Misses	P-Value
Miss 1 to 2	0.000002
Miss 2 to 3	0.034810
Miss 1 to 3	0.006108
Miss 1 high to 1 low	0.000002
Miss 2 high to 2 low	0.778712
Miss 3 high to 3 low	0.783757

Table 4. P Values for Comparison of Misses

The first four p-values show that the differences between the means are significant. For example the comparison of means between high workload miss rate in the first 10 minutes to the second 10 minutes is almost 0 (0.000002). The same result holds

true for comparing the low and high workload condition's results in the first 10 minutes. It also shows that the miss rate between high and low workload in the last 20 minutes can not be distinguished. Arousal theory can deliver one possible explanation for this behavior: Subjects started the high workload condition highly aroused and adapted their strategy over time. This decreased their arousal level to an almost optimal performance comparable to the low workload condition. However, time on task increased the arousal level again such that an increase in miss rate occurred.

c. Cross Cultural Differences

There are no statistically distinct differences comparing US to FS students. However, it appears that again there is a difference in false alarm rate development.

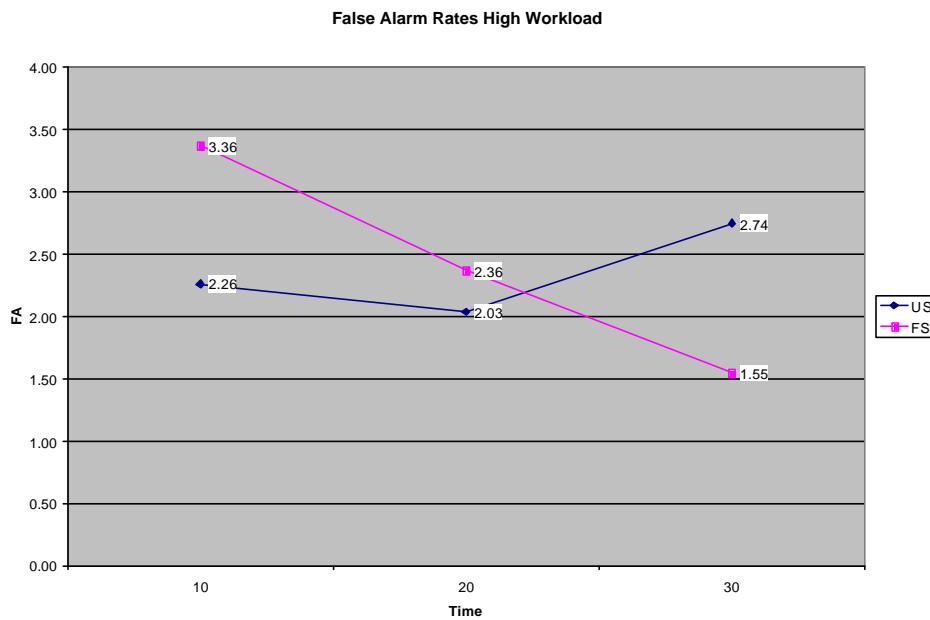

Figure 24. Comparison False Alarms US versus FS

It seems obvious that the performance of foreign students in terms of false alarm rate improved whereas the US sample showed a more or less constant rate over 30 minutes. There is no statistically significant evidence to support this statement. However, it appears that the false alarm rate and its change over time could potentially be a cross-cultural difference in vigilance performance.

d. Influence of Personality Traits

The generated correlation matrix did not indicate significant correlations between the MOEs and the personality traits.

e. Summary

The results clearly show the impact of a higher workload on the overall performance. The higher workload especially impacted the reaction time and initially the miss rate. Cross cultural differences are not significant but together with the low workload condition there is an indication that there are differences in terms of false alarm rate changes. The next chapter describes the results of varying conditions during the experiment.

4. Changing Condition Experiment

a. Method

Participants: 24 participants (low-high-low) and 20 participants (high-low-high) conducted the mixed treatment.

Procedure: These experiments changed conditions every 9 minutes within the experiment. Everybody had conducted the two previous experiments and were not give any special instructions.

b. Results

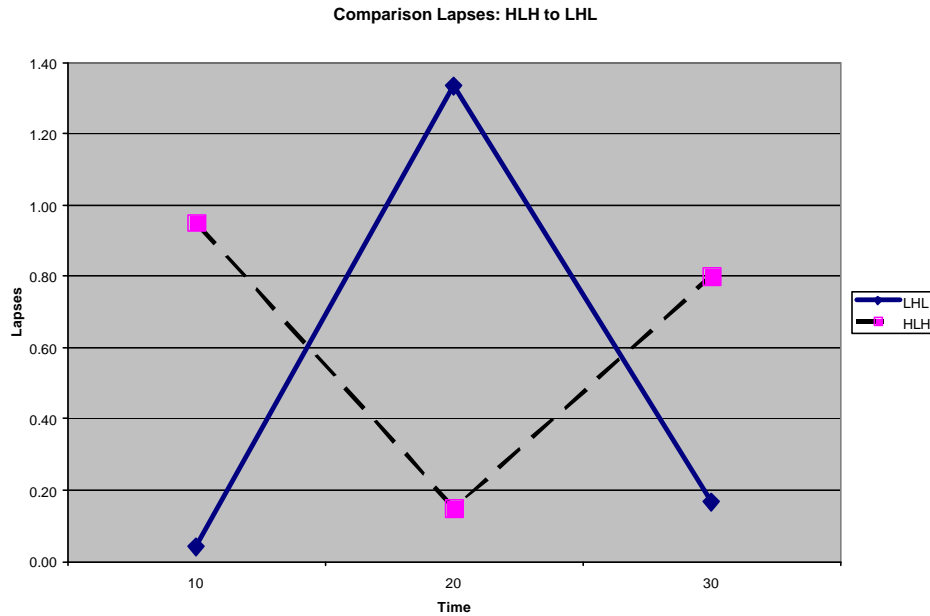

Figure 25. Comparison Lapses in mixed conditions

Figure 25 shows how sharply conditions influenced the amount of lapses (fuel gauge errors). The graph displays two curves. The high-low-high curve has a v-shape indicating that the error rate corresponds negatively (decreased) to the low workload conditions. The reverse is true for the low-high-low workload treatment. Here it is obvious that the shift to the high workload conditions had a positive effect on the error rate (increasing).

LHL		
p-val 1vs 2	pval 1 vs 3	p val 2 vs 3
0.022	0.165	0.037

Table 5. P Values for Low High Low Workload

Table 5 lists p-values for the comparison of means between the first 10 minutes and the second 10 minutes, the first with the third, and the second with the third session. The difference in means is significant between workload conditions (p-values 0.02 and 0.037).

A comparison for the reaction times also indicates the pronounced “V”-shape.

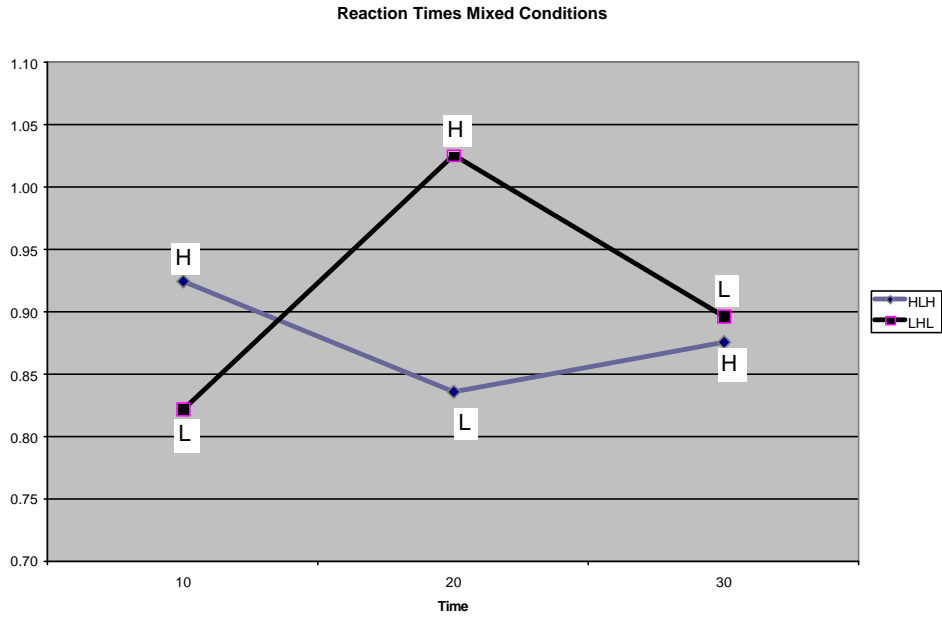

Figure 26. Reaction Time Comparison HLH to LHL

Figure 26 shows that the change of working condition did have an impact on the reaction time. Especially in the HLH condition the differences between low and high are significant. Some of the results are also surprising and it is not easy to explain them with the given theories.

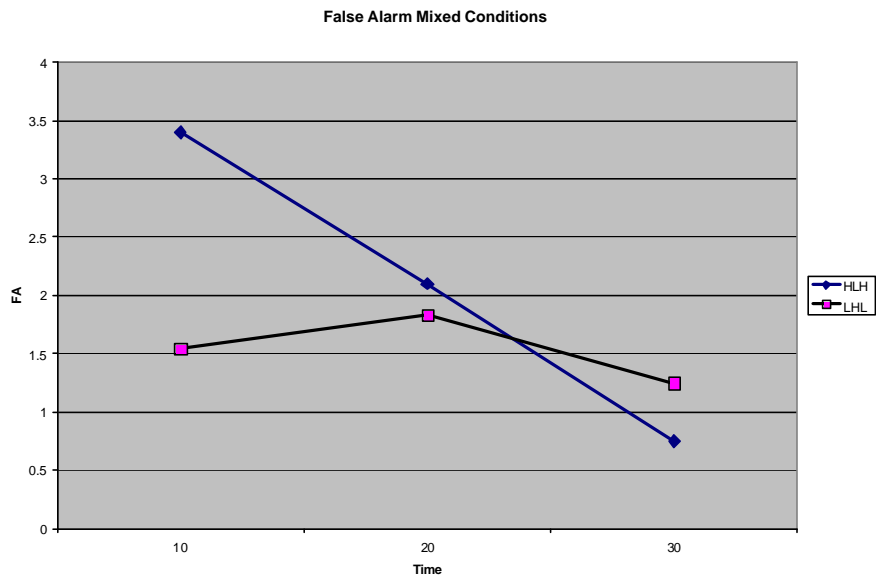

Figure 27. False Alarm Mixed Conditions

The result for the HLH treatment is unexpected. The difference between the first high phase and the second high phase is significant. The false alarm rate improves significantly over time which is a surprise by itself. Even more surprising is that it improved despite increasing the workload. Looking at a performance comparison with the low and high condition shows that the false alarm rate improved within the sequence of experiments. There seems to be a perceptual learning effect impacting the results and a better adaptation to the high workload condition. This result certainly emphasizes the hypothesis that reduced human performance is a complex adaptive system.

c. Influence of Personality Traits

The results of the mixed runs are similar to the pure condition runs in terms of correlation with personality traits. In the LHL treatment there is again evidence that agreeableness (A) correlates with the number of misses in the first 20 minutes. A possible explanation for this correlation could be that subjects with a high score in A are more motivated in a boring vigilance task. Thus they attend better to signals and don't miss them as often as subjects who score lower in A. This could be an potentially interesting result and further investigation is suggested.

d. Summary

The mixed treatments' results show the impact of differing working conditions on vigilance performance. For example there are distinct differences in reaction times. The error rates were generally lower which indicates that subject learned to better distinguish signal from noises. Even subjects that could not clearly hear differences in the first two experiments improved their performance. This learning effect needs to be taken into consideration when harmonizing the model.

One surprising result was the outcome of the false alarm rate in the high low high condition. Despite an increase in workload subjects further decreased their false alarm rate. This result was counterintuitive and further research is needed to explore reasons.

5. Conclusions

This experiment helped to understand the complexity of human performance. Some of the benefits of the experiment is seeing the theories in practice and also experiencing limitations of the theories. For example, there is no clear explanation why the false alarm rate improved over time despite increasing workload. If the theories do not explain the entire phenomenon maybe the model can be used to reproduce the results to help in understanding the phenomenon. The data for the low and high workload conditions will be used to calibrate the model.

G. FINDINGS

This research intended as one main point to show convincing evidence that reduced human performance is a complex adaptive system. After defining and explaining CAS in Chapter II, this chapter started by defining human performance. Then it defined vigilance performance, explained the main theories and showed examples of vigilance performance. The comparison between the features of reduced human performance and working criteria of a CAS showed overwhelming evidence, that human performance is a CAS.

The main measure of effectiveness (MOE) that this research will be using are:

- Mean reaction time (time it takes for a generated stimulus to lead to a reaction)
- False alarm rate (number of commission errors in 10 minutes intervals)
- Miss rate (number of omission errors in 10 minutes intervals).

	REACTION TIME		MISSES		FALSE ALARMS	
	Low	High	Low	High	Low	High
10 min	0.81	1.05	1.69	5.77	3.81	3.63
20 min	0.78	0.96	1.45	1.53	3.21	3.67
30 min	0.83	0.98	3.62	3.05	2.43	3.40

Table 6. Measure of Performance Human Experiment

Table 6 shows a summary of the results achieved via the vigilance experiments. These results will be used to calibrate the model.

The next chapter describes the design of the Reduced Human Performance Model (RHPM) and will apply the same working criteria to investigate whether or not RHPM is a CAS by itself.

IV. DESIGN OF THE REDUCED HUMAN PERFORMANCE MODEL

This chapter looks at early design consideration and software engineering and moves on to model design and validation strategy, describing a holistic view of cognitive frameworks and modules used in computational models of vigilance. By using the hypothesis that reduced human performance can be modeled as a complex adaptive system this model is a unique approach to capture human performance. Currently there no known computational models of vigilance (Parasuraman, 2003). Although this research focuses on building a computational model of vigilance, the bigger picture of embedding this model into a cognitive framework is essential. This research suggests that a future cognitive architecture should consist of interoperable sub-components.

A. SOFTWARE ENGINEERING ASPECTS

Major design decisions such as the use of a discrete event-driven simulation system and the formal description method for RHPM are explained below.

1. Discrete Event Simulation

Discrete event simulation²⁷ proposes an event-driven method:

Discrete event simulation concerns the modeling of a system as it evolves over time by a representation in which the state variables change instantaneously at separate points in time. (In more mathematical terms, we might say that the system can change at only a countable number of points in time.) These points are the ones at which an event occurs, where an event is defined as an instantaneous occurrence that may change the state of the system (Law and Kelton 1991, p.7).

Appendix A contains a primer on discrete event simulation methodology and their formal description event graphs. Many simulation systems are time-step driven: with every step, the entities of the simulation update their state variables and act accordingly. This method uses computing resources rather inefficiently, since the update rate of entities often depends on the rate of animation. There is also evidence that the length of a time step influences a simulation's outcome (Warhola 1997).

A less formal argument for the use of discrete event simulation versus the use of time step simulation would be that people do not usually interrupt an action in a periodic

²⁷ This method also allows mimicking a time-step simulation by inducing events at fixed intervals.

fixed interval. Rather, it appears to be natural that they react continually to changes in their environment, which favors an event-driven approach.

Discrete event simulation has been used intensely in queuing and manufacturing problems. We assume that the information-stage processing model is a kind of queuing system (i.e. the STSS stores stimuli before the model processes them).

Based on the comparative efficiency of discrete event simulation and our assumption that information processing is a kind of queuing system, the primary major design decision for RHPM is the use of an event-driven method. This decision guides the entire design.

2. Loosely Coupled Components

Investigation of loosely coupled components (LCC) is a research project of the operations research department of the Naval Postgraduate School.

Gordon Bradley described the reasoning behind the project in 1995:

The problems faced by planners will be less predictable than in the past, so the systems must be more flexible to address situations the designers cannot anticipate. The systems must have an open architecture that allows additional capabilities to be added without disruption. Legacy systems for planning and execution are too static, monolithic, and inflexible to meet these requirements. Current efforts to integrate legacy planning tools are an improvement, but, even when these efforts are brought to fruition, the results will not be sufficiently interoperable, platform independent, or extensible to meet the challenges of military decision making. As demanding as the individual requirements are, advanced systems for planning and execution must incorporate all these capabilities in an integrated system (Bradley, 1998, p.30).

LCC is a project that should assist modelers in rapidly prototyping and utilizing components as building blocks; fittingly, the latest research paper describes these types of components as LEGOs (listener event graph objects). “The name is also a metaphor for how complex models can be built by rapidly linking simpler component sub-models” (Buss and Sanchez 2002, p.732). Since 1995, many projects have successfully used this design strategy in the domain of military simulation. See (Arntzen 1998; Bohmann 1999; Le 1999; Schrepf 1999).

LCC's design philosophy is based on the "observer" design pattern of the "gang of four" (Gamma, Helm et al. 1995). The pattern is applicable:

- when changing one object requires changing others, and you don't know how many objects need to be changed;
- when an object should be able to notify other objects without making assumptions about who these objects are. In other words, you don't want these objects tightly coupled.

LCC uses even weaker criteria on the coupling mechanism and therefore calls it the "listener pattern." For example, the observer pattern uses interfaces for attaching and detaching observer objects. LCC uses no coupling between the components, though initially it used mediators. This research employs software routers embedded in the listener pattern, in a manner analogous to networking

The next figure explains the notification process of the listener pattern as used by this research.

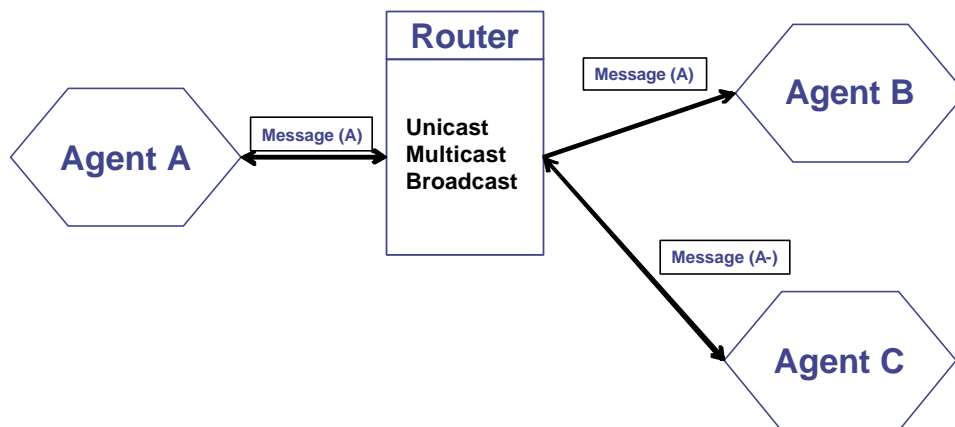

Figure 28. Message Routing between Agents

Figure 28 illustrates why the structure is called loosely coupled. Agent A could be any agent in a simulation system that provides a message (A) as output. The agent sends this message out and even if nobody listened to it, Agent A would still continue its work. It is independent of acknowledgement of its message, which is a feature for the observer pattern. In this example, the Router "listens" to Agent A's messages. It can use several information modes (unicast is a one-to-one connection; multicast is a one-to-many connection; broadcast is a one-to-all connection). The router can also filter the content of

the information and transport the entire message (A) to Agent B and a reduced message (A-) to Agent C. Unidirectional arrows indicate the listener pattern. The arrow tip points to the listener; the end of it is connected to the sender of information. The message object can be formatted using typical agent-communication protocols (i.e. using Knowledge Queering Modeling language (KQML) (Flores-Mendez 1999)). Bidirectional arrows show that the entities communicate two ways, acting either as receivers or senders.

The listener pattern seems to be very apt as a design choice for a next-generation cognitive architecture. Some advantages include:

- An architecture based on the listener pattern is dynamically extendable. Its structure can be changed during run-time, which is essential for CAS modeling.
- Components can be exchanged at any time (event run-time) without creating a new system.
- It facilitates re-use of software.
- This pattern lends itself to a plug-and-play approach, similar to exchanging hardware components via USB.

Considering these important advantages, a major design decision for this research is the use of the listener pattern for most components of the simulation system. After discussing the background for two major design decisions, the next aspect for designing a cognitive architecture is a validation strategy, which should be developed before the first line of code is written.

B. DESIGN AND VALIDATION STRATEGY

It is essential to start the creation of a cognitive framework by focusing on validation. The NRC panel (Pew et al, 1998, p.3) recommended that future research efforts on modeling human behavior should focus on the following areas:

1. Collecting and disseminating human performance data
2. Developing accreditation procedures for models of human behavior
3. Supporting sustained model development in focused areas
4. Supporting theory development and basic research in relevant areas

This research uses a validation strategy called *harmonization* and focuses on vigilance performance. The next sections show how this relates to complex adaptive systems theory and cognitive modeling.

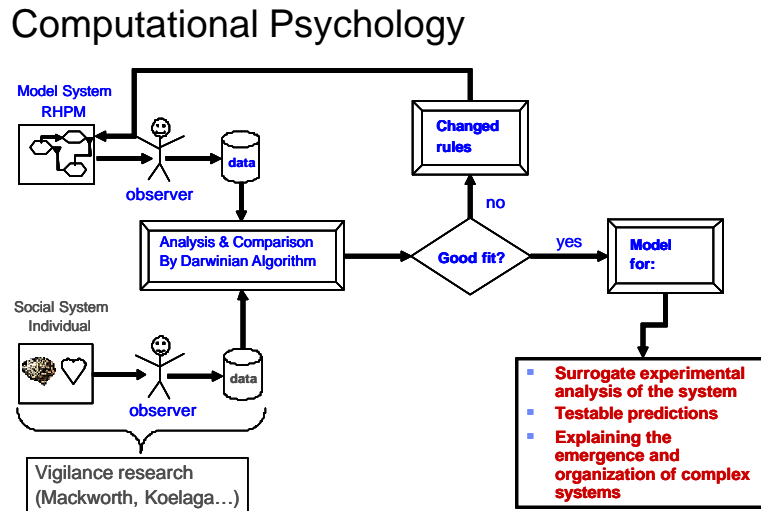

Figure 29. Fitting a Model to a Real System (adapted from) (McKelvey, 2000)

Figure 29 shows how to fit a computational model to a social system; this research fits the reduced-human-performance model (RHPM) to human vigilance performance. The analysis and comparison of the model’s and the system’s output can lead either to a good fit (unlikely in the early stages) or to a change in structures, rules and parameters.²⁸ Thus this research harnesses complexity²⁹ by fitting a complex adaptive system to a range of experiments.

Once model and system output are sufficiently similar, the model can potentially be used as a surrogate of the system (recall the artificial immune system for *in silico* experiments), generate predictions, or explain previously unexplained phenomena.

²⁸ Parameter fitting is only one level of adjusting the model. Thus this research doesn’t attempt curve fitting. After evaluating the literature on vigilance, it is highly unlikely that one can fit any combination of different vigilance tasks’ outcomes with a curve-fitting model of all important measures of performance (i.e. hit rate, false-alarm rate, and reaction time). Curve fitting would work for a very simple experiment like Mackworth’s clock.

²⁹ (Axelrod, R., Cohen, M., 1999) explained how one can influence CAS and avoid common mistakes.

This kind of procedure, harmonization of computational models, is an acceptable validation procedure. (Carley, 1996) suggested a multi-step validation process for computational models.

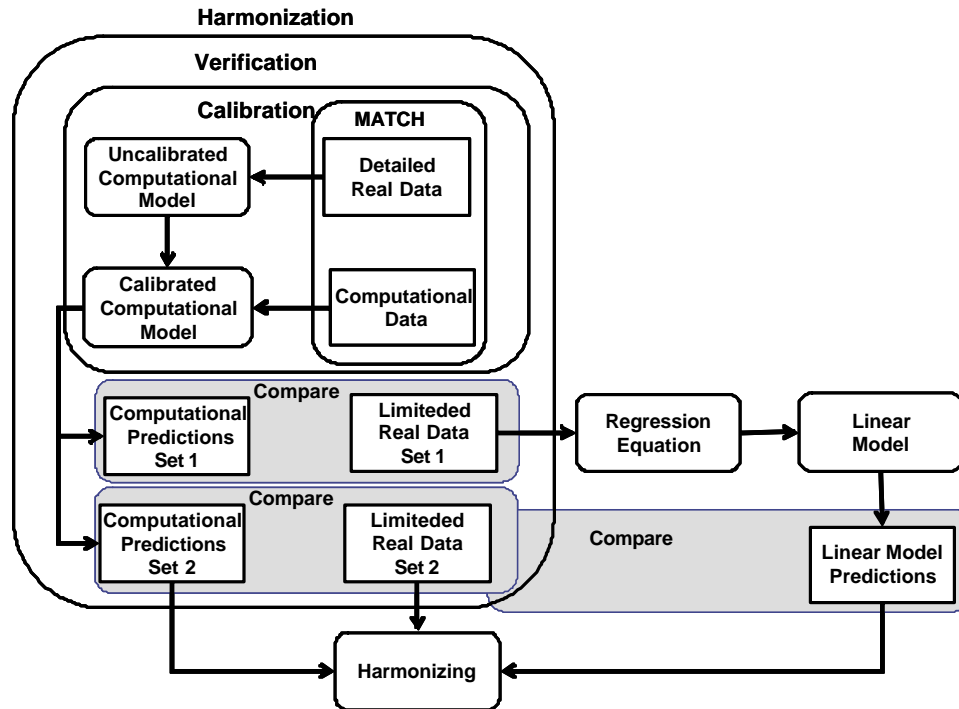

Figure 30. Harmonization of a Computational Model adapted (From: Carley 1996, Fig 3. p.20)

Kathleen Carley³⁰ explains that a multi-step process should guide the validation of a computational model. Figure 30 shows the concept of this multi-step process. The calibration part is used to fit parameters of the model such that its outcome matches real data. The next step is to predict data and compare the prediction with real data. The verification process would currently be called validation.³¹ She claims that a model can achieve four levels of validation:

- Pattern validation (predicted pattern matches real patterns)
- Point validation (predicted points match real points)

³⁰ Carley was a co-author on the National Research Council for modeling human and organizational behavior (Pew et al., 1998)

³¹ Verification checks whether a model does the right thing. Validation checks whether it is the right model.

- Distributional validation (predicted distributions match real distributions)
- Value validation (predicted values match real values)

Value validation is the aim of this research; a major difficulty stems, however, from the linear assumptions of Carley's harmonization. We have discussed why vigilance performance is non-linear, and of course a linear model cannot capture this phenomenon. Nevertheless, the process is useful in calibrating our model with data and conducting test runs against previously unknown data.

C. DESCRIPTION OF THE COGNITIVE FRAMEWORK

This section describes the functionality of the main modules and components for a next-generation cognitive framework. Subtitles reflect (Pew and Mavor 1998)'s suggested list of items for inclusion into architectural descriptions.

1. Original Purpose

This research intends to create a new cognitive framework with the potential to allow the use of different modules and sub-modules to model specific cognitive functions. The information-stage processing model is a rough blueprint for this framework. A proof-of-concept implementation is used to demonstrate the usefulness of complex adaptive systems for modeling robust and adaptive human behavior. Vigilance modeling is the focus of a first design phase.

I have long thought that computational methods should be applied to vigilance but there have been none. Neural networks or other computational models have not been developed, so if you succeed that will be a great accomplishment (Parasuraman 2003).

2. Submodels

A functional description of the modules needed to calibrate the model follows.

a. Calibration Modules

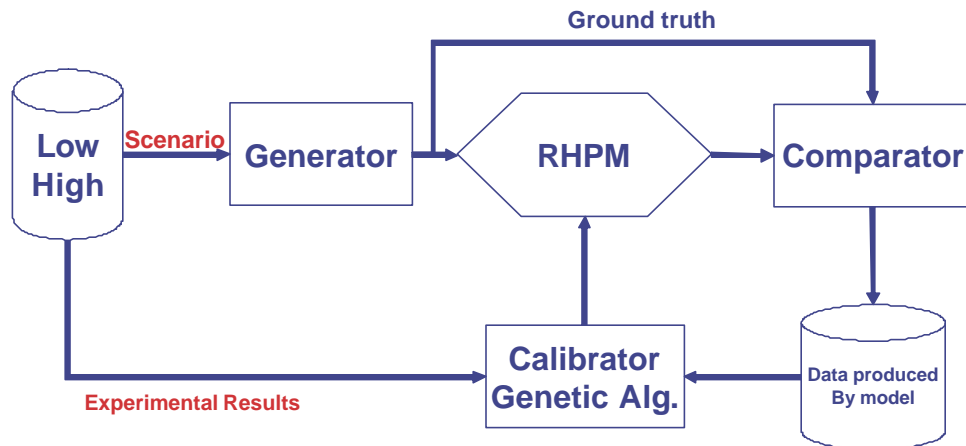

Figure 31. Calibrating the Reduced Human Performance Model

Figure 31 depicts the modules used to calibrate the model. A human-experiment database feeds the *Generator*³² module. The *Generator* recreates scenarios for several experiments (e.g., the Mackworth clock test). The scenario represents the input for RHPM. The human-experimental results represent the input for the *Calibrator* module. The scenario’s ground truth (e.g. a generated observation is a signal or a noise) represents one input for the *Comparator* module. The other input comes from RHPM behavior (e.g. identifying an observation or dropping an observation). The comparator then provides input for the calibrator, which can adjust models’ parameters, rules, and structure-fitting RHPM to human vigilance performance.

b. RHPM Modules

Figure 3 shows the main modules of RHPM (for convenience, this figure is shown again below). The modules are numbered the sub-sections that describe their functionality. The major components, which also show this research’s main contributions in terms of modeling, are blue.

³² We use cursive lettering for software constructs such as agents or objects. Underlined cursive indicate that this element does not belong to the described module, but describes the relationship between modules.

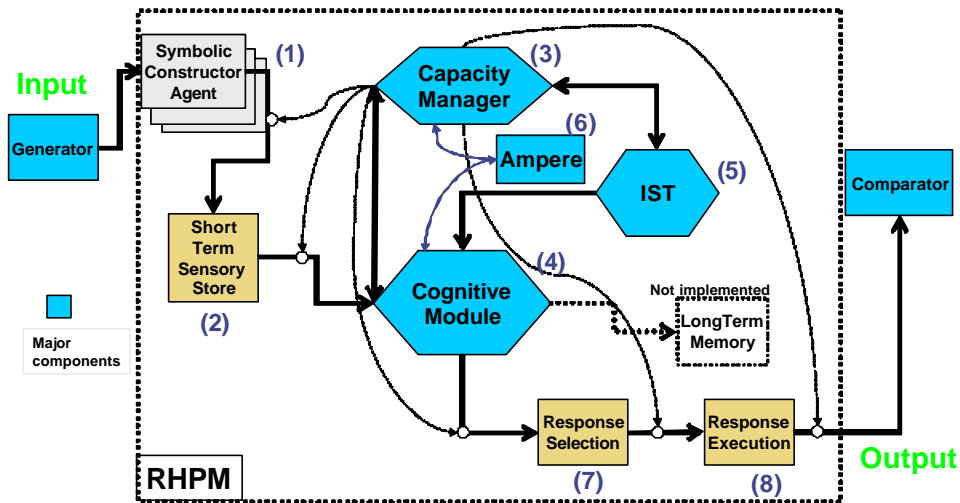

Figure 32. Numbered RHPM Modules

(1) Symbolic Constructor Agents: Symbolic constructor agents (SCAs) encode impressions (input into the system). SCAs represent the perception aspect of this framework. They have been used in a number of projects at the MOVES Institute: see (Hiles et al, 2002) for more details. This model uses two different input modalities, auditory and visual. For every modality, there exists a specialized agent whose performance decreases with time on task to mimic the loss of sensitivity often seen in vigilance tasks. The agent relays the observation to the *short-term sensory store*.

(2) Short-Term Sensory Store: Chris Wickens describes the functionality of the ShortTermSensoryStore (STSS) in context with the information-stage model:

Each sensory system, or modality, appears to be equipped with a central mechanism that prolongs a representation of the physical stimulus for a short period of time after the stimulus has physically terminated. When attention is diverted elsewhere the STSS permits environmental information to be preserved temporarily and dealt with later. Three general properties are characteristic of STSS: (1) It is preattentive; that is no conscious attention is required to prolong the image during the natural “time constant” of the store. (2) It is relatively veridical, preserving most of the physical details of the stimulus. (3) It is rapidly decaying (Wickens, 1992, p.18).

This research uses Wickens' description as the functional requirements for the STSS. Next we describe the transformation of his multiple-resource model (MRM) into a mathematical model.

(3) CapacityManager: The CapacityManager is a model for attentional resources, using the MRM to simulate attentional resources. This model part is a contribution to the field since multi-agent models for the MRM³³ do not exist.

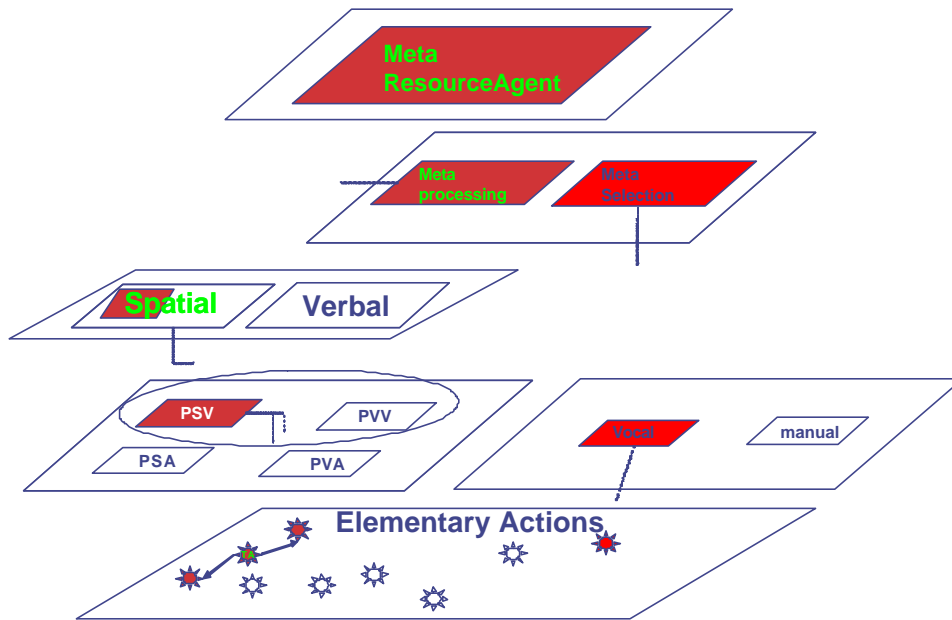

Figure 33. Transformation of Multiple Resource Model (MRM)

Figure 33 shows a transformation of the MRM. The highest-level agent for providing attentional resources is the *MetaResourceAgent*. The next level (*MetaProcessingAgent* and *MetaSelectionAgent*) represents the distinct pools of information processing and response selection and execution. On the processing side, an intermediate level represents the processing code, differentiating between verbal and spatial resource pools (*SpatialAgent*, *VerbalAgent*). The next level depicts the interface between elementary action and resource models. On the processing side, the modality dimension (auditory, visual) is introduced. There are four resource agents: PSV (*ProcessingSpatialVisualAgent*), PSA (*ProcessingSpatialAuditoryAgent*), PVV (*ProcessingVerbalVisualAgent*), and PVA (*ProcessingVerbalAuditoryAgent*.) These

³³ According to a personal email, Dr. Wickens doesn't know of a computational model of the MRM

provide attentional resources, characterized by code and modality, to elementary actions.³⁴ On the selection side are two agents (*ManualAgent* for manual responses, *VerbalAgent* for verbal). Figure 33 shows the analog, indicating the activation level in the brain, that this research attempts to capture.

This research faced a major design problem by deciding on how to implement the multiple resource model. Obviously it must allow for parallel actions and the resulting resource computation should influence the human performance non linearly. There should be an inherent capability to start with an easy model and then enhance it's degree of complexity. Computation should be “easy and fast” to allow good performance characteristic. Time on task should influence the resource depletion increasing the demand the longer a task takes. Another important consideration is how well the implementation can be adjusted to fit into vigilance theories.

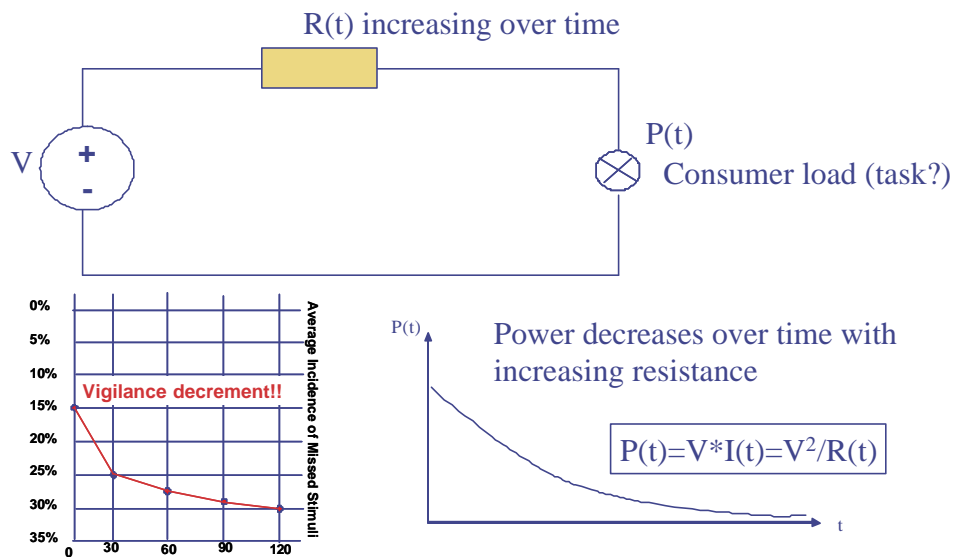

Figure 34. Main Analog for RHPM

Figure 34 visualizes the main analog used for the design and implementation of RHPM. The decrease in performance looks very similar to the power decrease in an electrical circuit with a thermal resistor. When the resistance increase over time, the power decreases. This research develops this analog towards cognitive resources distributed via electrical circuits. Potentiometers and thermal resistances in

³⁴ WorkingAgents conduct elementary actions such as storing, retrieving, or evaluating stimuli.

parallel and seriell circuits mimic the distribution of resources. The electrical analog has advantages in terms of computational ease and clearly using parallel circuits introduces non-linear effects. For example electrical power decreases with the inverse of a resistor's squared value. The potential introduction of new elements like capacitors and coils fulfill one of the design requirements to start with an easier model with the potential to increase complexity.

The electrical analog can also address some vigilance theories easily. Habituation, for example, is a process that occurs when neurons grow acclimated to arousal and simply don't react anymore. The analog to this process in electrical terms would be a thermal resistance increasing over time. The flow needs to increase in order to achieve the initial performance level. Similarly, the idea that over time a task demands more resources to maintain acceptable performance can be modeled by using thermal resistors for tasks that increase their temperature (or resistance) over time. The next figure shows how the MRM was converted into an electrical circuit:

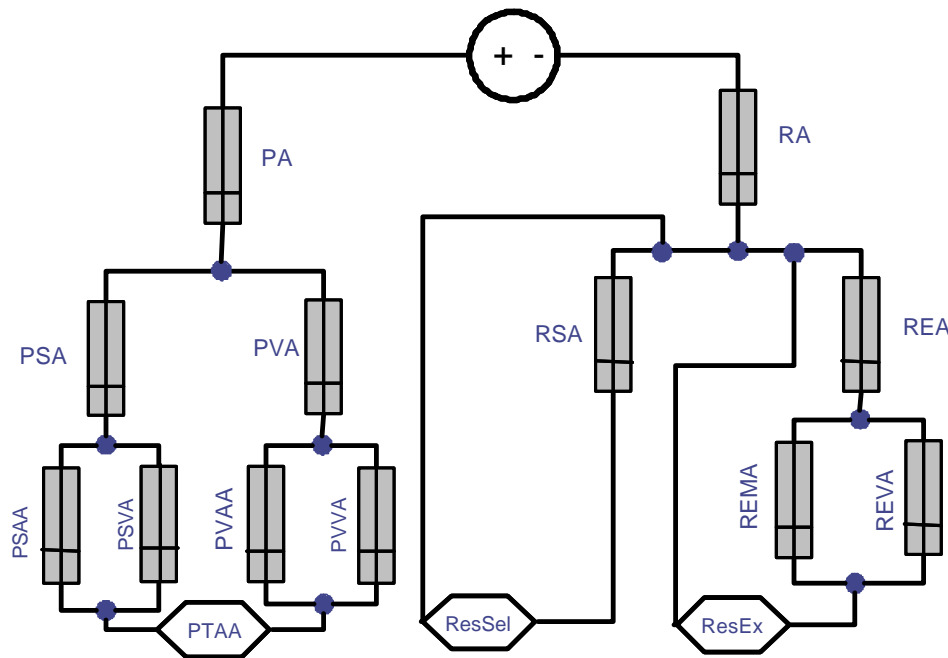

Figure 35. Multiple Resource Model as Electrical Circuit

Figure 35 shows the relationship and functionality between the different resource levels. The *MetaResourceAgent* provides energy for all resource agents. Whenever this agent is influenced (e.g., by stressors) the performance of the

model degrades. *ResourceAgents* are reactive, and modeled as potentiometers, allowing them to vary their resistance to achieve a desired goal flow. The resource levels are shown as serial elements. Agents on the same level are modeled as parallel elements. This structure allows for a clear separation of resources (e.g. between the *ProcessingSpatialAgent* PSA and *ProcessingVerbalAgent* PVA) and also supports agents using the same resource pool (e.g., *ProcessingSpatialAuditoryAgent* PSAA and *ProcessingSpatialVisualAgent* PSVA both use PSA as supplier). The relationship can be described in a rigid mathematical model (shown later). Appendix A provides a formal description for all agents of the *CapacityManager*.

(4) Cognitive Module: The cognitive module captures the functionality of the perception and memory parts of the information-stage processing model. This module is a multi-agent system consisting of heterogeneous, composite reactive agents.

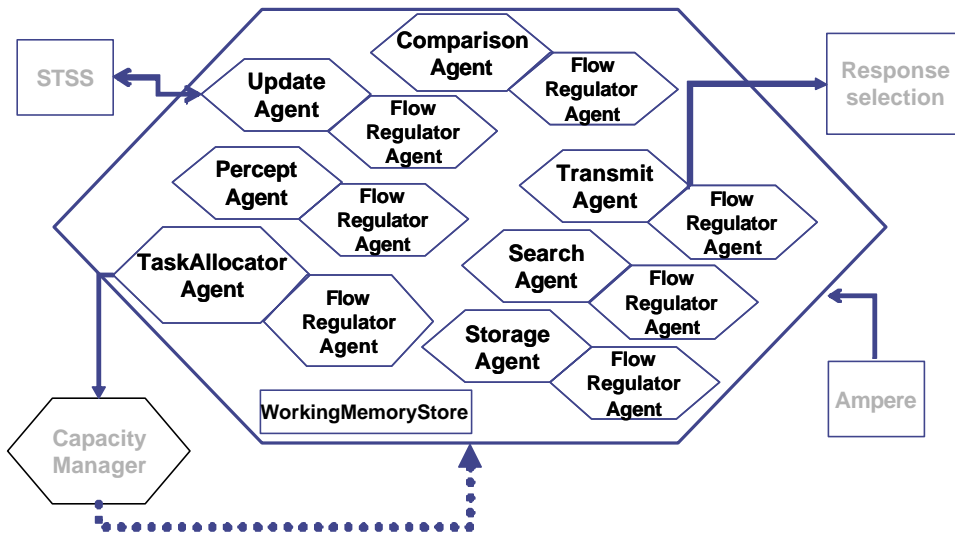

Figure 36. Cognitive Module

The cognitive module comprises seven composite agents. Each agent has a distinct task (or elementary action) to fulfill, granted the resources to do so. These agents compete for resources and their performance depends on their state. Three mechanisms can degrade their performance:

- Stimuli can be dropped because the agent’s buffer is full
- Stimuli can fade, because they were not attended to in time

- Task time depends on resource flow; changes in flow also change the time the task is finished.

Every agent is composed of a WorkingAgent (WA) and a FlowRegulatorAgent (FRA). The FRA is a reactive agent (much like resource agents) that checks the flow periodically, trying to maintain or return to a desired goal flow. It can change its resistance and thereby influence the entire resource-distribution system.

The WorkingMemoryStore is a rudimentary implementation: Vigilance tasks require at most a comparison between a standard and a stimulus in working memory; thus this research doesn't try to use a sophisticated model of working memory. (Miyake and Shah 1999) show an excellent summary on how different architectures implement working memory. One of the main features is an executive control module best described as the homunculus for the working memory. Since our hypothesis claims that there is decentralized control, this would not be a likely implementation idea for a possible expansion. Figure 35 also shows how the cognitive module is embedded in the model. The *UpdateAgent* checks the *STSS* for new stimuli and relays these stimuli to the *PerceptAgent*. *PerceptAgent* determines code and modality of the stimuli, transforms the stimulus into a percept, and informs *TaskAllocatorAgent* and *ComparisonAgent*. *TaskAllocatorAgent* informs the *CapacityManager* module regarding the code and modality of the task at hand. All resource agents that support either the code or modality start regulating their flow. *ComparisonAgent* compares the stimulus either to a standard in working memory (if the vigilance task uses a standard to compare the stimulus with [simultaneous discrimination]) or forwards the percept to *TransmitAgent* or *SearchAgent* (if percept is known). *SearchAgent* is a hook-up for further expansion of the model. This agent normally would try to find the percept and what to do with it from long term memory. In this model, it randomly classifies whether the percept is known and informs *TransmitAgent* and *StorageAgent*. *StorageAgent* stores the percept into *WorkingMemoryStore*, and *TransmitAgent* relays the classified (i.e. known) percept to the *ResponseSelectionAgent*. The next figure shows the described relationships as an information-flow diagram among the working agents of the cognitive module.

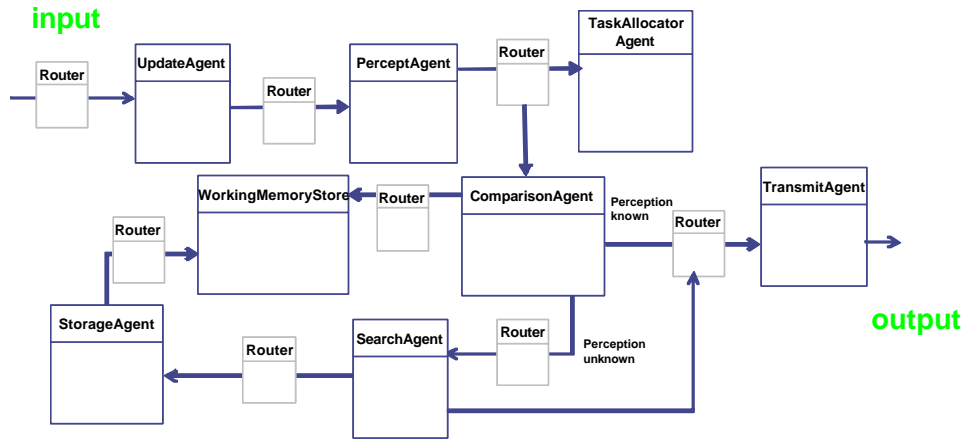

Figure 37. Data Flow in the Cognitive Module

The cognitive module is also embedded with the electrical-circuit analog. TaskAllocatorAgent represents the connection between this circuit level and the next higher level. The other working agents work in parallel, indicating that they have to compete for resources.

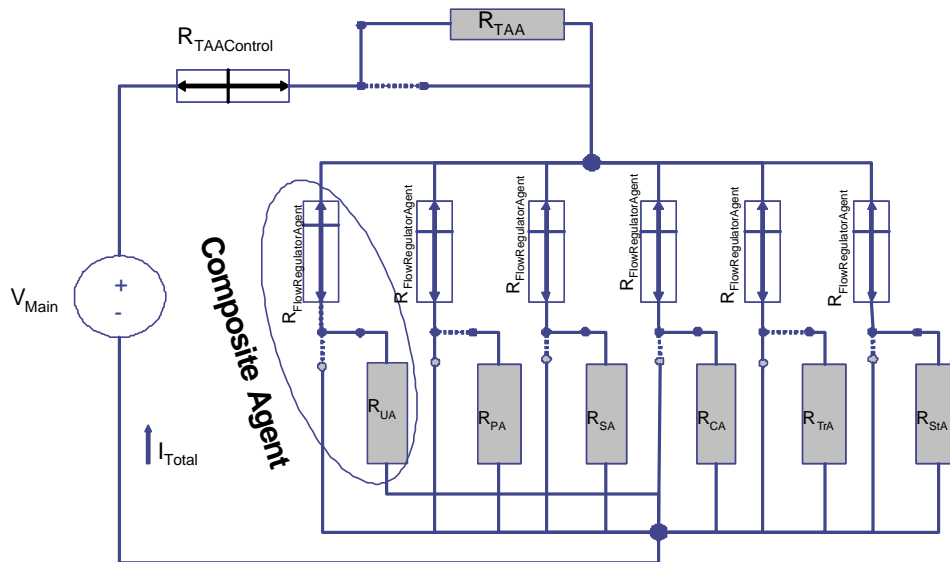

Figure 38. Cognitive Module as Electrical Circuit

Figure 38 shows how agents are modeled in an electrical circuit. The composite agent shown in the figure is the UpdateAgent. When this agent is idle, its resistance is not in the circuit, and its switch is open. As soon as the agent starts a task, the switch closes and resistance becomes active. The resistor is thermal, indicating increasing resistance over time. This figure shows how multi-tasking is actually modeled:

The UpdateAgent (UA), SearchAgent (SA), ComparisonAgent (CA), StorageAgent (StA), and the TaskAllocatorAgent (TAA) are busy, indicated by their closed switch. Again, the mathematical model behind the scenes is rigid and can easily be implemented. The computation is actually implemented in the next module—the Ampere module.

(5) Ampere Module: Ampere is like an instrument for every agent to read their flow and to write changes in the resistance values of resource agents and flow regulator agents. Ampere is a passive object and produces no behavior by itself. Since agents can only have local knowledge, every *WorkingAgent*, *ResourceAgent* and *FlowRegulatorAgent* receives only local information from Ampere (i.e., your current flow is 6.123 amp).

It is used to compute flows when the following events occur:

- Initial flow event : Computes initial flows for all agents
- A working agent starts or ends a task and thereby changes its resistance.
- A FlowRegulatorAgent asks for it's current flow (periodically, with a parameterized update rate)
- A FlowRegulatorAgent changes its potentiometer value to achieve it's desired flow.
- After a change in the system it informs every working agent about their specific flow changes, thereby extending or shortening tasks.

Every resource level is the voltage source for the next lower level. To compute the different flows in different parts of all electrical circuits, the computation starts with the total resistance in every lower-level circuit. The rules for totaling resistance across several resistors are straightforward. The next figure explains the computational rules graphically.

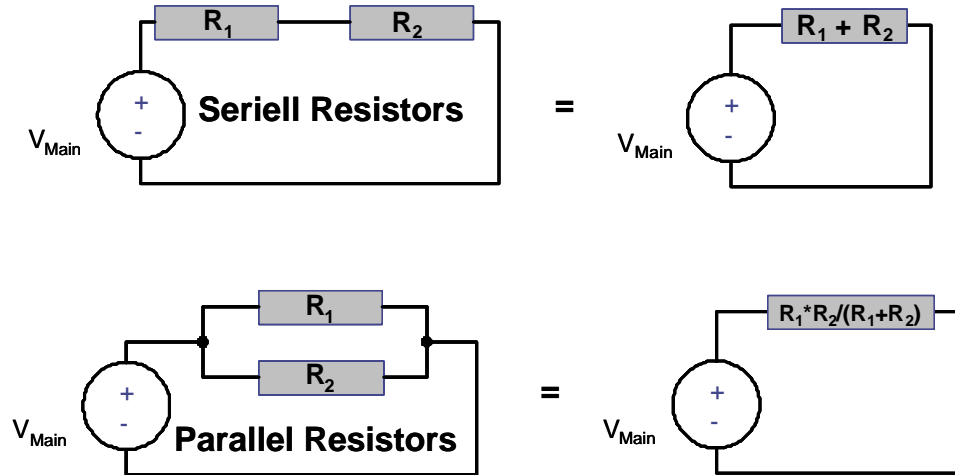

Figure 39. Computational Rules for Electrical Circuits

Figure 39 illustrates the ease of computation in electrical circuits that have resistors as the only elements. The upper part shows that resistors that work serially are simply added together and treated like a single resistor. In the parallel case (lower picture), computation is slightly more difficult, but the rule is similar. The inverse of the total resistance is equal to the sum of inverse resistances.

$$\frac{1}{R_{Total}} = \frac{1}{R_1} + \frac{1}{R_2} ;$$

Equation: Computation for Parallel Resistors

Transforming this equation leads to the formula inside the resistance on the right side of Figure 30. Computing the current (flow) goes back to Ohm's law:

$$V = R * I ;$$

Equation : Ohm's Law

Voltage is the product of current and resistance. In a serial circuit, current is constant but voltage at each element adds up to the total voltage. In a parallel circuit, voltage is constant and its current is the sum of the individual currents at the elements.

Seriell Circuit :

$$V_{Main} = I_{Main} * (R_1 + R_2);$$

$$V_{Ri} = I_{Main} * R_i ; \text{ where } i = 1 \text{ or } 2$$

Parallel Circuit :

$$V_{Main} = I_{Main} * (R_1 * R_2 / (R_1 + R_2));$$

$$I_{Main} = I_{R_1} + I_{R_2};$$

$$I_{R_1} = \frac{R_2}{R_1 + R_2} * I_{Main}; I_{R_2} = \frac{R_1}{R_1 + R_2} * I_{Main};$$

Equation: Computational Formulas for Parallel and Serial Circuits

Applying these formulas to the cognitive module circuit leads to the following computations:

$$R_{Total} = R_{FRA_{TAA}} + R_{TAA} + R_{Parallel};$$

$$R_{Parallel} = \frac{1}{\frac{1}{(R_{FRA_{UA}} + R_{UA})} + \frac{1}{(R_{FRA_{PA}} + R_{PA})} + \frac{1}{(R_{FRA_{SA}} + R_{SA})} + \frac{1}{(R_{FRA_{CA}} + R_{CA})} + \frac{1}{(R_{FRA_{TA}} + R_{TA})} + \frac{1}{(R_{FRA_{SA}} + R_{SA})}};}$$

$$R_{iA} = \begin{cases} 0 ; & \text{if } i \text{ represents an idle agent} \\ R_{iA} + t * c; & \text{if } i \text{ represents a busy agent, where } t = \text{time at task, } c = \text{additional resistance constant} \end{cases}$$

Equation : Total Resistance Computation for the Cognitive Module

The total resistance for the cognitive module is the sum of the parallel circuit's resistance and *TaskAllocatorAgent*'s two resistors, where one is controlled by its *FlowRegulatorAgent*. The parallel resistance is computed by summing up the inverse totals of each composite agent's resistance. A working agent's resistance is 0 when idle. After starting work, its resistance increases over time by adding resistance increments (constant c). Again, the composite agent's potentiometer's value is controlled by its *FlowRegulatorAgent*.

Having established the lower-level circuit's resistance, we can treat it as a single resistance for the next level. The computation bubbles up to the *MainResourceAgent*, which provides the main voltage. The flow (current) computation then goes top down, computing the current for every resource and working agent using described equations. The *MainResourceAgent* has a connection (loosely coupled) to the *EgoModule*, which we describe next.

(6) Individual States and Traits (IST) Module: This module is a pre-planned component where emotions and external and internal stressors can effect RHPM performance. Since these areas are still *terra incognita*, RHPM uses a few rudimentary agents to impact its performance, as shown in the next figure.

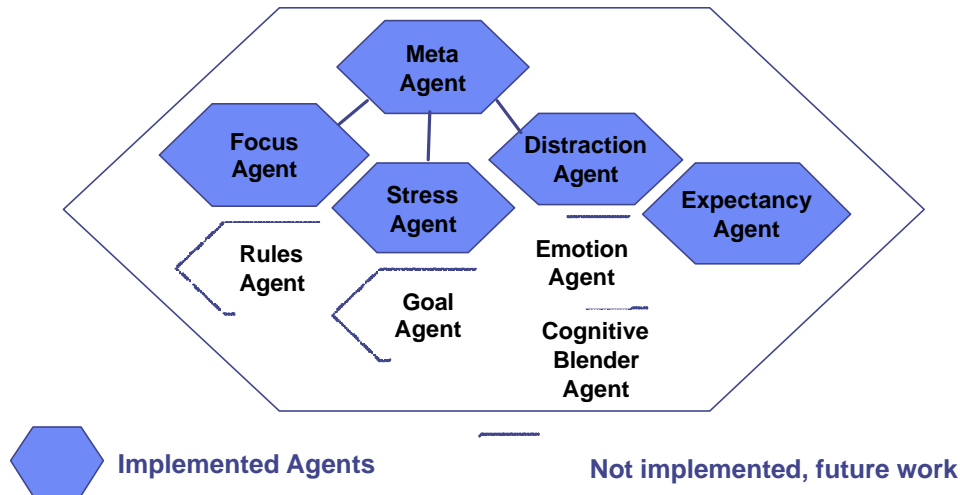

Figure 40. Individual States and Traits (IST) Module

Figure 40 shows all agents that can potentially be used in this module. *DistractionAgent* and *FocusAgent* determine how much of *MetaAgent*'s energy really goes into the system for vigilance tasks.

As mentioned, most people have an bias for new information. Thus in our model, the influence of *DistractionAgent* compared to that of *FocusAgent* increases over time, taking resources from *MetaAgent*.

MetaAgent also offers an opportunity for modeling feedback of result. Since this feedback almost cancels the vigilance decrement, *DistractionAgent*'s influence goes back to its initial influence value and the time process starts again. This agent also provides interesting enhancements of the model by introducing non-constant energy levels (i.e. varying with the time of day).

StressAgent can be used to model individual sensitivity to arousal. It uses an update rate and an perceived stress increment. By changing the *StressAgent* parameters it is possible to simulate a faster impact of stress on the model's performance.

ExpectancyAgent sets up expectations by computing statistics such as perceived signal probability and rate, and influences the update rate of the *UpdateAgent* and the decision criterion of *ResponseSelectionAgent*.

(7) Response Selection: This agent uses a simple mechanism to determine whether it detected a signal, comparing the nominal value of the percept to a criterion. If the value is below threshold, the percept is classified as noise; if above threshold, as a signal. The criterion can be influenced by the *EgoModule*, which accounts for one major assumption of signal detection theory.³⁵ This component can easily be expanded to include more complex responses and should be subject to future work.

(8) Response Execution: The Response Execution produces RHPM's output. It has an inbuilt mechanism for producing slips. A slip is an omission error—in our case knowing the right thing to say (yes or no), but saying either the opposite or nothing.

3. Knowledge Representation

This model uses a limited type of data that can be classified as signals or noise. This type of knowledge can easily be represented as objects with different values on attributes. However, there are substantially new ways of representing knowledge (available at our research institute [tickets and connectors] (Hiles, J. et al, 2002)) that could potentially be utilized by expanding the model.

4. Higher-level Cognitive Function

This cognitive architecture models vigilance as a higher-level cognitive function; thus it is part of signal detection and decision-making. The architecture can easily be extended to include different cognitive functions. This actually captures the gist of what evolutionary psychologists claim. If we have several circuits (different cognitive functions), we can conceive of modeling each one as a complex adaptive system and then adding them onto a framework. We expand on this visionary statement in the future work section.

³⁵ Decision criterion beta increases over time with low signal probability.

5. Output

RHPM's current output differs between vigilance tasks. Sometimes it is a vocal statement of identifying an observation ("yes" or "no"). Sometimes it is a manual response, like pushing a button.

6. Multitasking

RHPM is multi-tasking capable, allowing for parallel and serial working. It uses cognitive buffers (queues) at various places to enable prioritization and interruption with rescheduling of tasks. *CapacityManager* manages the attentional resources; thus the model is limited by available resource.

7. Multiple Human Modeling

RHPM models an individual involved in a vigilance task. Its lightweight architectures permits use in a scenario involving multiple persons. This research could potentially interface to an air-defense simulation system (Calfee, 2003) modeling all or some individuals of the air defense crew.

8. Implementation

The model, formally described in Appendix A, is an event-driven simulation. Professor Arnie Buss has developed a useful library (SIMKIT) that supports modeling and programming discrete-event simulations. Since SIMKIT is written in Java, we choose to implement the model in that language; however, any implementation language that can handle discrete event simulation (DES) could implement the underlying mathematical model.

9. Support Environment

RHPM runs on PCs and workstations that have a Java Virtual machine. In order to run it, the Simkit.jar file is needed.³⁶ Java Version SDK 1.4 or higher is recommended.

10. Validation

RHPM was designed with a validation strategy called harmonizing, which has been described earlier. The results chapter of this dissertation describes details of the validation process.

³⁶ Simkit can be downloaded at <http://diana.gl.nps.navy.mil/Simkit/>

This section explained major design decisions and features. RHPM uses discrete event simulation, documents its design with event graphs and uses the Listener pattern for most simulation components. Appendix A, B, and C provide a more detailed view on design specifics by describing the underlying mathematical model. RHPM's architecture is very transparent. It enables exchange of components, intense re-use of software, easy extensibility. The next section describes RHPM in terms of a multi agent system without going into design details that have just been described.

D. RHPM AND FERBER'S FORMULA

Jacques Ferber describes the major elements of a multi agent system. He explained the design of MAS as a set of factors, now called the Ferber Formula for MAS:

$$\text{MAS} = (\mathbf{E}, \mathbf{O}, \mathbf{A}, \mathbf{R}, \mathbf{Op}, \mathbf{L}) \text{ (Ferber 1999)}$$

This section briefly described the elements of his formula in the context of RHPM's design.

1. Environment E

Environments can be multidimensional (e.g. 2D or 3D). RHPM uses a one dimensional environment meaning that agents and objects don't move. The agents and objects are situated in an electrical circuit that represents cognitive resource flows. Details follow in the next section.

2. Objects O

There are several objects like a ScenarioGenerator or Comparator that are wrapped around the model. Inside the model there is the Ampere object which we described earlier. Other objects include resistors and potentiometer which are operated on (values change) by agents. Objects in MAS can be typically used by the agents.

3. Agents A

There are three different kinds of reactive agents in the model:

- ResourceAgents
- FlowRegulatorAgents
- WorkingAgents

ResourceAgents regulate their potentiometer if there is a task in the system that fits their profile. FlowRegulatorAgents try to maintain a desired flow for a specific

working agent. WorkingAgents process tasks. The time to finish a task is determined by the flow it receives. Changes in flow lead to changes in the task end time.

The IST module contains several kinds of agents such as a:

- Distraction Agent, FocusAgent
- ExpectancyAgent
- MetaResourceAgent

The DistractionAgent competes for resources with the FocusAgent. Over time the influence of the DistractionAgent increases. The Expectancy Agent is a cognitive agent in the sense that it keeps a history of perceived signals and noise and builds its own statistical model. The MetaResourceAgent provides the energy to RHPM. It divides its resources to the competing Distraction and FocusAgent.

4. Relations R

Some agents cooperate explicitly (Expectancy Agent informs UpdateAgent) or implicitly (WorkingAgent FlowRegulatorAgent, ResourceAgent). Every action of an agent influences the local perspective of every other agent.

5. Operations Op

Typical operations of agents is reading from or writing to Ampere. (i.e. FlowRegulatorAgents and ResourceAgents change values of their potentiometers. Working Agents start or end a task causing resistors and switches to change state.

6. Laws L

Potentiometer can only be changed to a certain min (or max) value. Their value can never be negative. Potentially the value could go to infinity simulating a burn-out in the sense of the word.

RHPM fulfills the characteristics that Ferber described as typical for a MAS. The next section addresses the question whether or not RHPM is a CAS by itself.

E. REDUCED HUMAN PERFORMANCE MODEL AS A COMPLEX ADAPTIVE SYSTEM

This section compares the design of RHPM to the provisional working criteria of a CAS and investigates whether the model features potentially allow the model to be a CAS.

1. Comparison with Provisional Working Criteria

a. Autonomous Agents Acting in Parallel

The underlying electrical circuit model for the capacity manager shows that agents work in parallel to each other. RHPM uses several different autonomous reactive agents that base their next action on their goal and their local perspective. Working agents use buffers to establish independence from each other. However, if one agent runs dry, agents that follow in a sequential order will also run dry. A better example for autonomous agents are the flow regulator agents that decide based on a comparison between desired flow and current flow whether or not to change their resistance. These agents clearly act in parallel to other flow regulator agents, working agents, and resource agents.

b. Highly Dispersed Control

Every agent bases its decision on a local perspective. There are agents that provide information to other agents (e.g. the Expectancy Agent informs the UpdateAgent on a perceived signal occurrence probability.)

Even the Ampere module has no central control in terms of behavior. It is used as a read repository for specific individual flows, thereby assuring that agents only have a local perspective. It is also used as a write repository for changes in resistance that change every single flow.

c. Non-linear Interactions

There are several design features that allow non-linear interaction. Agents working in an electrical circuit with parallel elements is a non-linear model feature. The computational formulas for the flows in the system are non-linear functions of resistor values. Switching in a network also causes non-linearity in the system.

d. Adaptive System with Emergent Behavior

There is two levels of adaptations intended to be used within the model. The lower level adapts to the current workload by providing resource flow to specific working agents. Changes in workload or the resource drainage over time lead to changes in the system. The design allows for emergent behavior such as errors or even a total breakdown by blocking incoming stimuli or dropping conscious percepts.

The higher level is the use of a genetic algorithm to fit the model to different human performance measures.

e. Dynamically Changing Structure

Agents frequently change their connections depending on their state. For example if an agent has just ended a task, it uses a recovery time before it becomes a part of the circuit again (closes the switch). Resource agent provide for task that match their perception code and modality. As soon as there is no demand for them they don't compete for resources and don't take measures to change their flow.

A limitation for every computational model of a CAS is the lack of capability to generate entirely new interactions and new behavior. This is still an open research question which the MOVES Institute is addressing in a project called IAGO (Principal Investigator Research Professor John Hiles).

The design decision to use listener pattern for the connections between components could potentially limit this feature. RHPM allows to dynamically connect and disconnect entities during run time with specified method calls. It does not allow connectivity between unspecified methods. Further research would be needed to address this problem. However the decision to use the listener pattern is feasible considering that this remains an open research problem.

f. Changing Different Equilibria

RHPM state variables change permanently during run time. They never truly settle down which shows that this feature can be established. However, since RHPM is a computational model there are phases where the model is in an equilibrium. For example in the pre-instantiation phase the model doesn't do anything. If no stimulus were generated, the system would go into a state of equilibria permanently. Thus RHPM fulfills this feature only during runtime with stimulus generation.

g. Implicit or Explicit Model for the Future

Expectancy theory claims that humans build their own statistical models for signal probability and occurrence. RHPM uses an ExpectancyAgent that listens to decisions and builds an internal statistical model. This statistical model is a perceived depiction of reality because it doesn't account for errors (omission or commission errors) as long as there is no knowledge of result feedback in the model.

h. Strong Sense of Path Dependency

This feature is certainly related to the question of dynamically changing structures with new behavior and interactions. RHPM supports this feature only with previously specified structures. Thus the number of evolving structures is finite and depends on the number of methods and connections that can be established. Further research is needed to improve RHPM's capability to allow the strong sense of path dependency.

F. CONCLUSION

This chapter explained major design decisions and showed a blueprint of RHPM. It described modules in detail and then evaluated the question whether or not RHPM itself is a CAS and not a machine. The model's main features follow the provisional working criteria for CAS. There are limitations to the model in terms of generating entirely new structures and behavior that is not based on the combination of pre-existing behaviors and structures. However, as pointed out, this is still an open research question. After a breakthrough certain design decision (like the use of listener pattern) should be reconsidered.

The model's validation is the benchmark for success. The next chapter describes RHPM's configuration, experimental design and the results. This chapter addresses the remaining main point of this research showing whether or not RHPM is strongly connected to experimental results and whether it can generate surprises.

V. COMPUTATIONAL EXPERIMENTS AND RESULTS

This next chapter describes the setup for calibrating RHPM. As described earlier this research followed the validation strategy for computational models suggested by M. Carley, called harmonization. It then describes the test runs for previously unknown scenarios after the model's structure and parameters were calibrated. The following section describes how RHPM can be utilized to test theory of vigilance thus establishing the system as a surrogate for testing purposes. The summary points out the main experimental results and shows limits of the analysis.

A. HARMONIZING RHPM

RHPM uses many parameters such as signal probability, signal salience that need to be fixed before experiments actually start³⁷. Other parameters distinctly influence the outcome of experimental runs. Initially this research focussed on parameters that clearly influence the measures of effectiveness (MOEs). In the initial calibration step, the uncalibrated computational model was run with the high workload condition from the conducted human experiment. The first calibration process we applied to achieve reasonable (that is close to the mean of measured reaction times) reaction times included the parameter `Main_Voltage` and `Conversion_Factor`. `Main_Voltage` determines the initial energy level of the system, whereas the `Conversion_factor` determines how much time a task takes given a fixed amount of energy. The initial approach to calibrate these parameters was a "brute force" approach, randomly generating different parameter combinations and measuring a score.

The scoring algorithm is well known in statistics as the sum of squared error. The differences between computational scores and human experimental scores were squared (also called Euclidian distances) and added up.

³⁷ These parameters were used as constants for the harmonizing runs. However, they can and should be used as parameters to work with the model.

$$Score = \sum_{i=1}^{i=3} (r_{Ci} - r_{Hi})^2;$$

where $i \in \{10 \text{ min}, 20 \text{ min}, 30 \text{ min}\}$

r_{Ci} computational model's mean reaction time in the i th time frame

r_{Hi} human's mean reaction time in the i th time frame

This equation shows how to compute the resulting score. After every 10 minutes within the experiment statistics are collected and compared to the human data (see Table 6). Thus the dimension of time is enforced on the performance of RHPM. This approach generated a very close approximation for the reaction times (error less than 0.0001) within a hundred runs.

The next step within the calibration process added the low workload condition. The result was again produced by randomly mixing parameter set ups. However, this time the scores of both conditions were combined to calibrate the reaction times not to a specific experimental condition. This time the approach was not as successful and the closest score was not satisfying (meaning that the sum of squared error was too high). Clearly the calibration process now needed to address the structure of the model to better fit the computational outcomes. Obviously a change in experimental conditions from a high to a workload should have an impact on the model. Clearly the stress level for the high workload condition is higher, consequently we adjusted the StressAgent such that it reacted to a difference in workload conditions. The perceived stress level reduced in the low workload condition. Another important difference between low and high workload is the arousal level. RHPM captures the arousal level as an energy level provided by the Meta_Resource_Agent. With this structural changes we were able to produce human like reaction times in two different conditions with the same parameter set up.

Calibrating the next MOEs was more challenging since they were to be influenced by the same parameters. The most important parameters include the decision criterion, the criterion shift based on expectancy and the sensitivity decrement over time.

This research used a simple genetic algorithm (Goldberg 1989) to optimize the parameter set up. The algorithm used to adapt RHPM will also be used for the application runs to assure comparative measurements.

A population of 200 different parameter set ups was generated. Each set up was run with the high and low workload condition. The resulting score was computed with the fitness function (sum of squared errors). After identifying the best score, this score was used as a benchmark for the creation of a new population. While the population size did not equal 200, set up's were drawn from the original population. The drawing followed Goldberg's idea of a wheel. However, we used the min score as nominator and the current score as denominator. If a uniform random number was below that ratio the parameter set up progressed into the mating pool. Thus the higher its score the less likely it was going to be in the mating pool. Then we applied the crossover and mutation to the new population and started the process all over. The goal was to calibrate the model such that it would have a resulting score lower than 50.0. This score is the sum of squares error computed from 18 different measure points (every MOE was collected at 10,20 and 30 minutes in two different conditions.) Thus the goal was not to have a perfect fit of individual performance curves but to have a sufficiently close result for all 18 measurement points. After 78 generations the fitness value was below the selected threshold. The resulting parameters were then fixed for the validation runs which are described next.

B. VALIDATION RUNS

This section shows the result of runs made with previously unseen situations and fixed parameters. The computational results were used as predictions and compared to the true human results.

After utilizing the first two experimental conditions to calibrate the model the next major step was to run the model without changing it's structure from the outside and using the achieved parameter. However, in order to adjust for the learning effect the variance for the signals and noise were slightly decreased depicting the ability of subject to better distinguish signals. The data collected in the high low high and low high low conditions were used for validation purposes. This section will visualize the results showing how close the model actually comes to true human performance.

1. Validation Run Low High Low

The model was run with 24 repetitions (comparable to 24 subjects during the experiment). Every single run result was treated like a subject's result. The MOEs were computed and statistical analysis were conducted. The individual results were used for paired T-tests to see whether there are significant differences in means and variances.

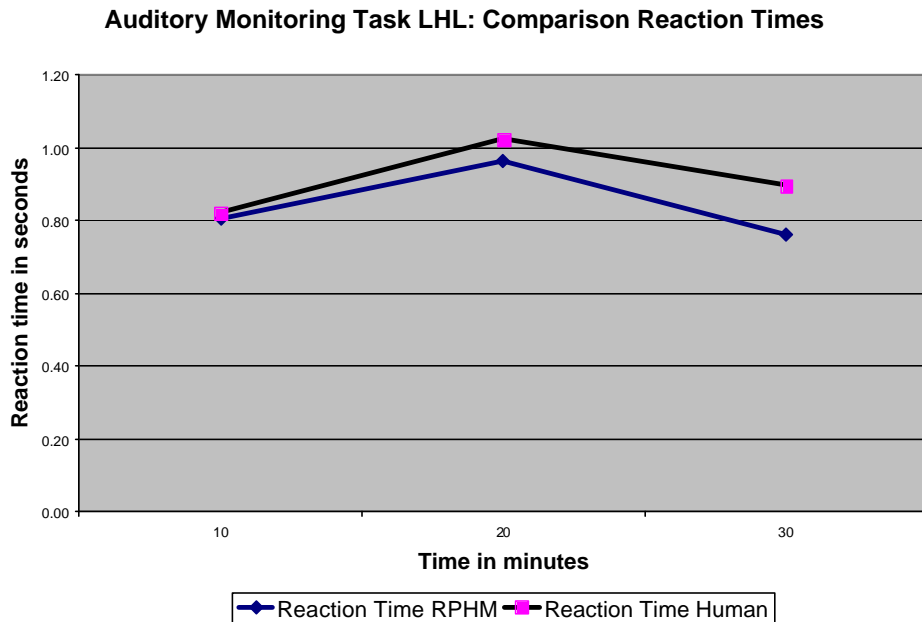

Figure 41. Comparison Reaction Times Human vs. RHPM LHL

Figure 41 shows how closely the mean of reaction times and the behavior of RHPM and subjects were correlated. This correlation could also be seen comparing the false alarm rates.

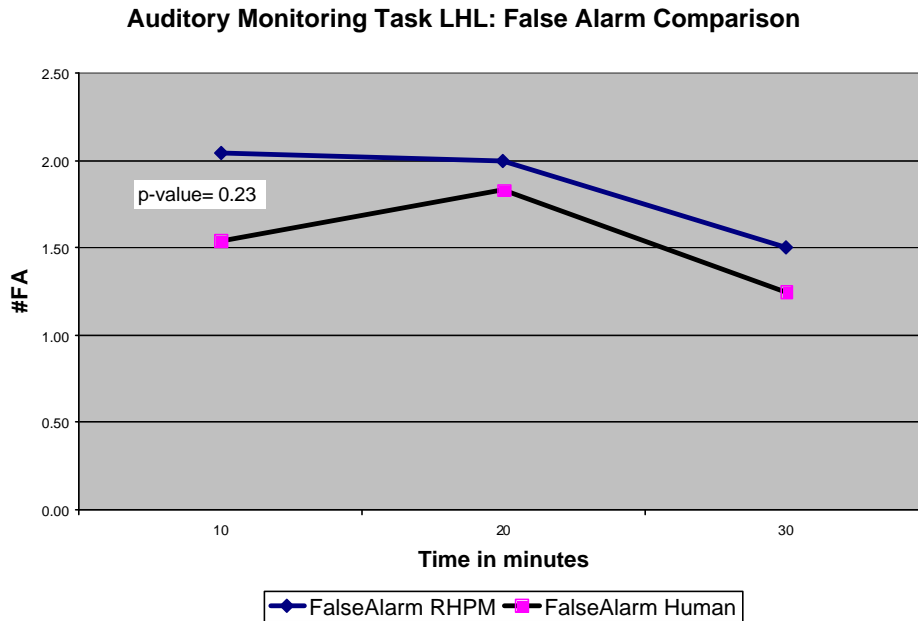

Figure 42. False Alarm Comparison RHPM Human LHL

Figure 42 shows the resemblance of the data produced by RHPM and human subjects. The difference in means was not significant between and within treatment. However, there is a down ward trend that can be shown with linear and non linear regression on both curves with similar results.

The last MOE to validate was the miss rate.

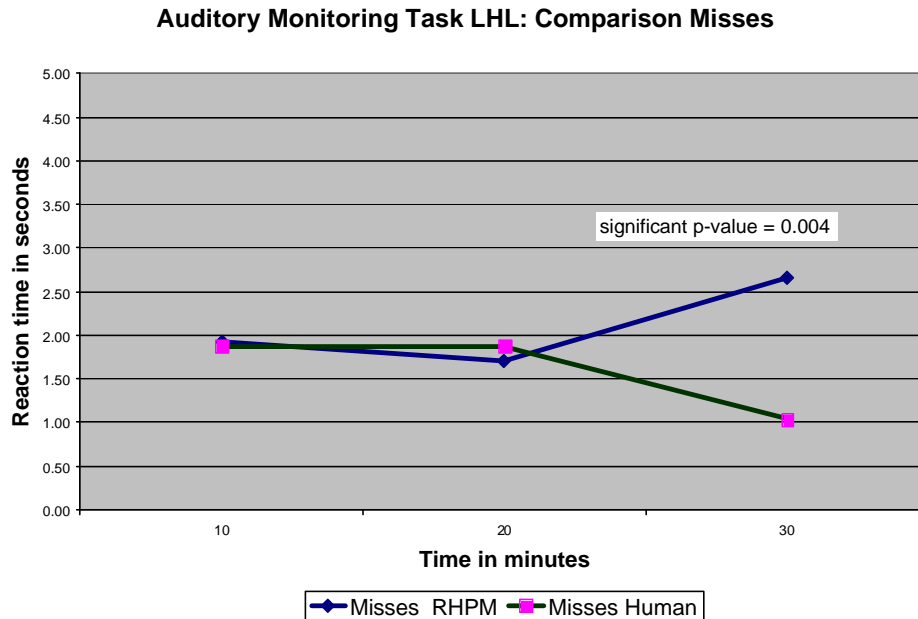

Figure 43. Comparison Misses RHPm Human LHL

Figure 43 shows almost identical behavior in the first 20 minutes. Then the experimental data suggests a decrease in miss rate (statistically significant) whereas RHPM increased its miss rate. This is possibly a perceptual learning effect that is even more pronounced in the other mixed treatment condition. There seems to be an improvement of performance in humans probably due to perceptual learning which the known theories do not cover and consequently RHPM does not fully capture this phenomenon. This question needs to be addressed by future research. The next section shows the results for the high low high workload condition.

2. Validation Run High Low High

RHPM produced data with 20 repetitions in order to compare it with the results of the human experiment.

Again RHPM results in reaction times were very similar to the experimental data.

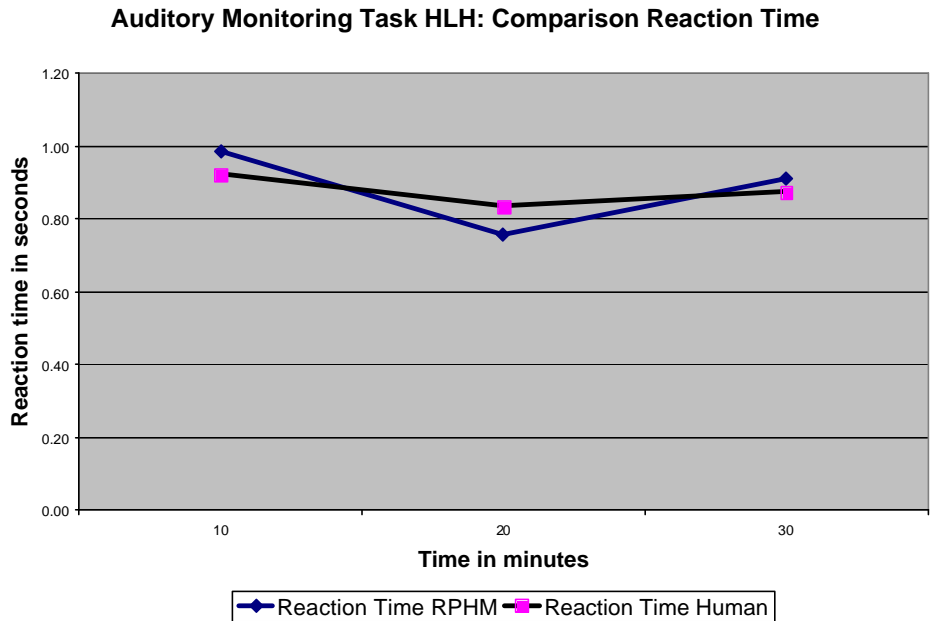

Figure 44. Comparison RHPM to Human HLH

Both curves show a very similar reaction to the decrease of workload in the second phase of the experiment. Reaction times increase slightly and then go back to the high workload level. Again there are no significant differences between the means at different times.

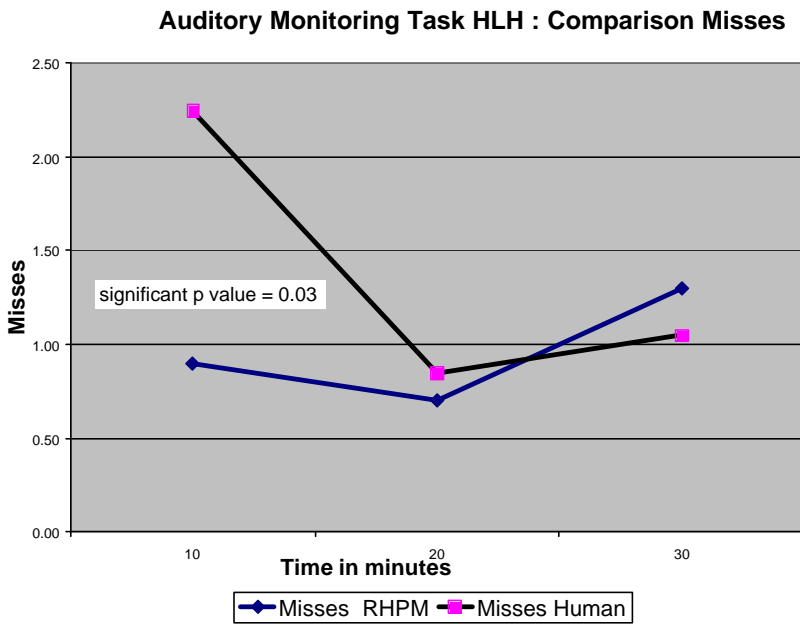

Figure 45. Comparison Misses RHPM Human HLH

The behavior of the miss rate is very similar. However, there is a difference in means in the first 10 minutes (p-value 0.03). After that the two performance curves are indistinguishable. The difference between human subjects and RHPM is a slightly lower initial failure rate that then approaches human error rates. This result is very interesting as it shows a possible effect caused by the way the experiment was conducted. Subjects didn't have a warm up period as it is done in other experiments. Hence there seems to be a cold start effect that could presumably occur with every skilled function. Even in the high workload condition this "initial bias" could be established. The effect occurs for misses which really require an active act of saying yes or clicking the Alert button. Hence the subjects seemed to be pre-occupied with the other task such that they didn't attend to the auditory task sufficiently. The reviewed literature did not cover this type of effect. One possible explanation is that there exists a phase transition. Vigilance theory does not cover a transient phase; consequently RHPM is not covering this phase either.

The next result indicates that RHPM doesn't improve as fast as human subjects in terms of misses.

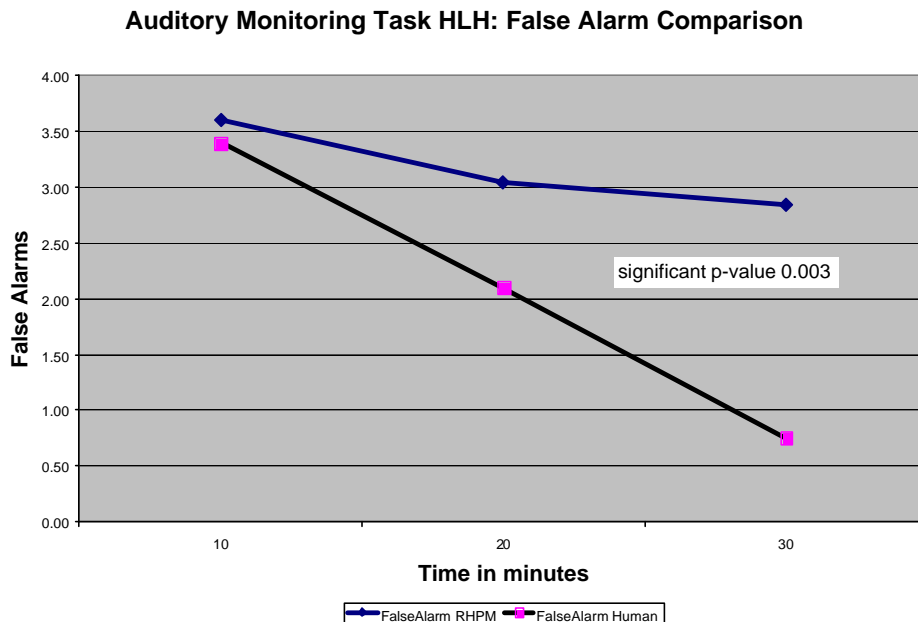

Figure 46. Comparison False Alarm RHPM Human HLH

The experimental result of an improving false alarm rate despite an increase in workload was reproduced by the model. Although it showed an improvement there is a

statistical difference between the means at the end of the run (p-value 0.003). The difference could be explained with an perceptual learning effect which correlates to a sensitivity increment. One possible explanation for the effect is that there is an order effect caused by the sequence of experiments. Every subject had conducted two previous experiments (low and high or high and low). It looks like the perceptual learning generated an automation effect for the distinction of signal and noise and thus even the high workload had no impact on a close to optimal performance.

3. Application Runs

This section shows the model's graphical user interface and then describes additional application runs showing that RHPM is neither brittle nor mechanistic. It also generated an interesting phenomenon that seems to be comparable to degraded human performance.

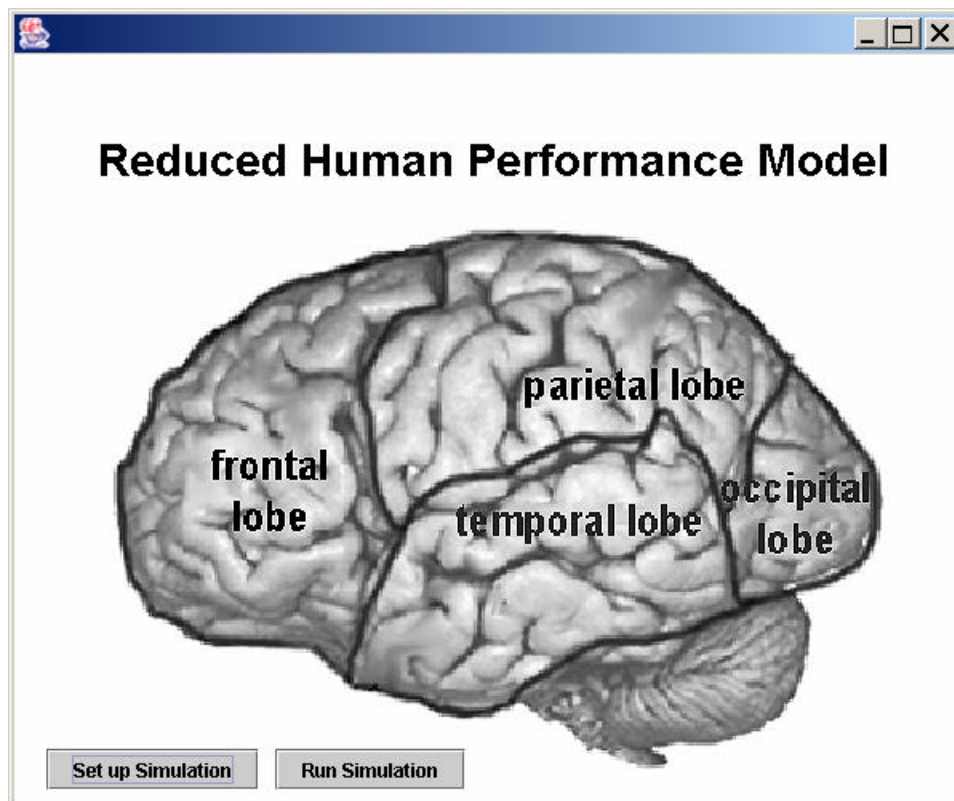

Figure 47. Start View for RHPM

Figure 47 shows the start view for RHPM. There are numerous parameters that can be set before a simulation runs starts (Setup Simulation).

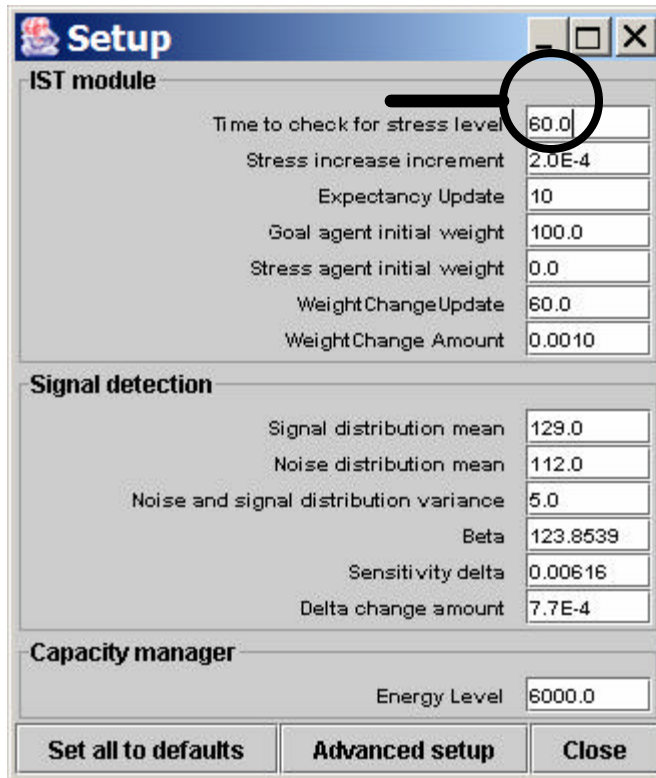

Figure 48. Setup View of RHPM

Figure 48 shows the setup view. For example the top parameter “ Time to check for stress level” determines how often the *Stress Agent* updates it’s perceived stress.

a. Variability of RHPM

This section shows some experimental results indicating that RHPM could potentially be used as a surprise generating simulation entity. The main goal of the calibration and validation process is to match the mean of the MOEs. However, the standard deviation as a measure of how wide data is dispersed is another important factor for every model. If the model stays close to its mean, then it’s actions become predictable. In a simulation system where RHPM would “replace” human operators it would be important to produce unpredictable and human like results. The user should not be able to see a difference between a computer operator or a human.³⁸

³⁸ In the ideal case a reduced Turing test (only for a specific cognitive operation here vigilance) could show the value of having a close approximation to human performance in a simulation system.

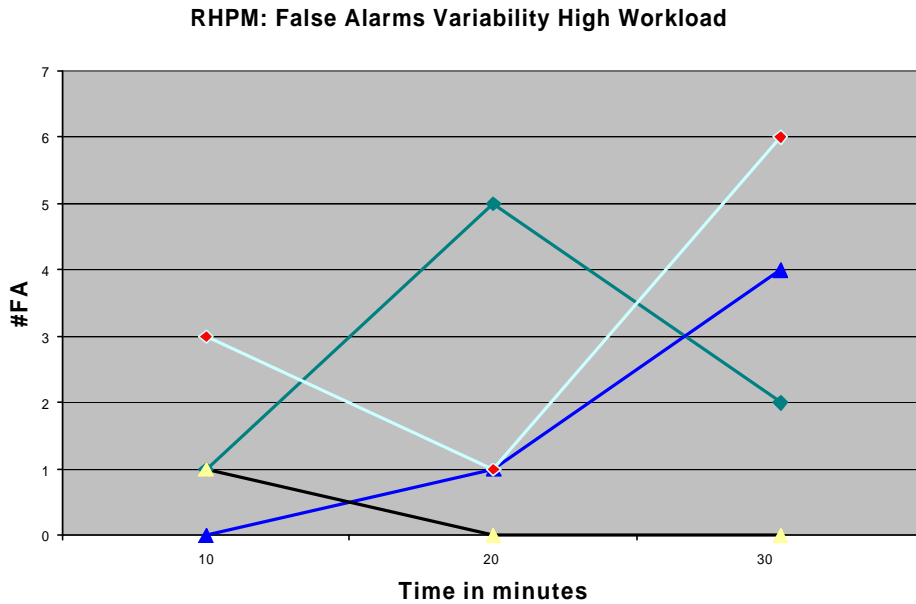

Figure 49. False Alarms in the High Workload Condition Generated by RHPM

Figure 49 shows that RHPM is a stochastic model. The curves are individual (random) outcomes that would converge to the mean MOEs. RHPM produces outcomes with almost no false alarms (yellow triangle) or with an unusually high number in the last 10 minutes (red diamond).

The next table provides a more analytical approach comparing the standard deviation of the MOEs of the human experiment and RHPM to each other.

Standard Deviation LHL		
	FalseAlarm RHPM	FalseAlarm Human
10	1.21	2.04
20	1.29	2.76
30	1.32	2.72
	Misses RHPM	Misses Human
10	1.38	2.30
20	1.33	1.75
30	1.88	1.92

Table 7. Comparison of the Standard Deviation in the LHL Condition

Table 7 shows a comparison of the MOEs' standard deviations of RHPM and human subjects in the LHL condition. Human data is more dispersed, however the

Initially RHPM reacts by slowing down the information process from just below one second to several seconds. In the first time interval RHPM started out slower than normal but still within “normal” range in terms of false alarms, misses and reaction time. However, in the second time interval with the stress level increasing, the reaction times increased steeply and RHPM had a significant number of unprocessed information (83 fades). The last time period shows a complete breakdown. RHPM did not process any information (all stimuli faded in the STSS).

This looks very much like an interesting analog to the human phenomenon of tunnel vision. Increased stress level can lead to narrowing down attention to a point where important dimensions of the situations are completely blocked out of the conscious awareness. RHPM produces a similar outcome with an increased stress update rate and a default value for the stress increment.

4. Summary

RHPM showed its contribution by closely matching human performance degradation within four different experiments.

MOE vs. treatment	Reaction Time			Misses			False Alarms		
	10	20	30	10	20	30	10	20	30
Low	X	X	X	X	X	X	X	X	X
High	X	X	X	/////	X	X	X	X	X
Low-High-Low	X	X	X	X	X	/////	X	X	X
High-Low-High	X	X	X	/////	X	X	X	X	/////

Table 8. Comparison of MOE Fitness

Table 8 shows where during the validation runs between human and computational results there was not enough evidence to reject the hypothesis that the compared data had an equal mean indicated by (X). Statistically significant differences occurring are indicated by (/////). Two of these differences occur at the initial time phase for a high workload. As pointed out earlier, this indicates that there is a transient phase that neither the theory nor the model captures.

The differences between RHPM and experimental data are minor considering that there were 36 measurements (4 experiments * 9 MOEs) and only four differed from each other. There seems to be a perceptual learning effect for human subjects which enables them to distinguish noise and signals more easily after a certain number of experiments or

exposure to number of signals. This could be modeled by changing the values of signal and noise parameters (mean and variance) over time. Thus the sensitivity (or the ability to distinguish signals) would increase with gaining perceptual experience over time. The sensitivity decrement would still occur however it would start at a different point. This is certainly a topic for further research and ongoing discussion with vigilance researchers.

Another interesting finding is the start up effect in the high workload condition. It took subjects a while to re-adjust to four different tasks. Normally subjects get a warm up period before the experiment, however, in this case there was no warm up phase at all. This very closely resonates with operational monitoring tasks, a radar screen operator starts immediately working and might be prone to more errors initially before adapting to the task again. RHPM can be used to show that by adjusting parameters the differences in performance are minimized and thus help gaining insights into the explanation of the phenomenon. The difference could be modeled by giving less resources to the *Focus_Agent* initially or by introducing a task difficulty factor that would require more resources to process the task at hand. However, it would be questionable to just change some parameters without backing it up with the theoretical implications. Hence a change to the structure of model would only make sense if human experiments validate the hypothesis. RHPM generated three notable hypotheses in terms of vigilance theory improvement:

- Humans need initial time to adjust to a vigilance task. This influence seems to correlate with the difficulty of a task or the overall workload, since this effect was very pronounced with high workload.
- There are two forces influencing the sensitivity: One is the known decrementing force over time. However, there could be an incrementing force correlating with the number of perceived signals. The influence of the latter one indicates a perceptual learning effect that gains more importance (compared to the decrement factor) over time.
- The sensitivity decrement as well as the shift of response bias have limits. It appears likely that the rate of change towards these limits decreases which would be a possible explanation for the leveling off effect.

C. VALIDATION ISSUES

This section describes the assessment activities to validate RHPM as a computational model of vigilance. Validation is always a best effort process when there is no mathematical way to prove the correctness of a model. However, as described earlier there are ongoing efforts especially in the domain of cognitive modeling to improve the validation process. However, there are also some resources that describe how to validate simulations (Law and Kelton 1991; Knepell and Arangno 1993). The major assessment activities applied to RHPM are:

- Conceptual model validation
- Software verification
- Operational validation
- Data validation

The next sections describe how these activities were applied to RHPM.

1. Conceptual Model Validation

Conceptual validation attempts to establish the reliability of the model design and the integrity of its development, facilitated by completeness of documentation and augmented by expertise and training of the CA analysts. Consideration is given to development history, level of detail, level of fidelity, inputs, outputs/measure of effectiveness (MOEs), ranges/specification, and premises of design” (Knepell and Arangno 1993, p. 3-I)

Knepell also points out that a “new generation of simulation languages present a breakthrough in the field. These languages support graphical model development using iconic displays. These includes Schruben’s SIGMA” (Knepell and Arangno 1993, p.3-I)

This research uses Schruben’s work on event graphs for a thorough documentation of RHPM’s design. The psychological models (human information stage processing model and the multiple resource model) have been transformed in an event graph based model. Thus, RHPM has a transparent design. A validation strategy was in place before the first line of code was written. The intended use of the model was very

clear from the beginning: Design a computational model of vigilance that is embedded in a new cognitive framework composed of multi-agent systems.

The main design ideas were discussed with leading researchers in the field (Wickens 2002; Parasuraman 2003) and their input influenced the design choices. Even implementation details like “Should the Short Term Sensory Store be modeled as a first in first out (FIFO) queue or a (last in last out) LIFO queue?” were discussed with experts to assure closeness between theories and implementation.

The next section explains how the conceptual model was translated into software and how this software was verified.

2. Software Verification

Software verification includes completeness and compatibility of functions and concepts within the model, development integrity and thoroughness of documentation, as well as maintainability, level of fidelity, ease of use, overall runtime, implementation of design elements and system components (Knepell and Arango 1993, p.3-I).

RHPM has several main components and sub-components that are implemented in JAVA. Every component can be tested independently from each other by running its main method. Thus we tested every component against its design objective. The algorithm were tested with print out statements to assure correctness of computation. A graphical user interface enables animation of scenarios and change of input parameter. This eases the use of the model and gives visual information about the processes.

Run times for the calibration process can be very long (48 hrs for 1000 runs with 30 repetitions), obviously depending on the number of runs and repetitions. A single run without repetition takes less than five seconds. This is quite acceptable considering that 30 minutes of real time are simulated.

We also conducted trace analysis to evaluate when objects were passed between objects to assure that the processes worked properly. The additional JAVA package, designed by Prof. Buss, called Simkit, allows single step processing with a print to the screen event list. The properties of all statistical objects can also be “dumped” to the screen. Thus we have been able to verify every single step through the model.

The next section shows an excerpt of the event list generated by the model during instantiation (setting their attributes to predetermined values and scheduling first actions of the objects and agents

```
Time: 0.000   Current Event: Run   [31]
** Event List -- **
0.000 GenerateSound  Signal or Noise are generated
0.000 StartFull      Fuel gauge starts
0.000 CheckFuel      Initially subject checks the fuel gauge
0.000 StartLetterDisplay  Sternberg memory task gets displayed
0.000 TimeStress     Time ticker for the performance starts.
0.050 DisplayMathTask  Math task is displayed
0.226 Update {flow regulator agent 2} This flow regulator agent will check
                                     its flow
1.108 Update { ResourceAgent code spatial modality meta stage
           processing providing false} This resource agent will check its flow
.....
** End of Event List -- **
```

Together with the property changes of the objects and the event list it is possible to verify even simultaneously occurring simulation steps. Thus it was fairly straightforward to verify the correct implementation of the designed event graphs.

3. Operational Validation

Operational validation is based on a rigorously-defined operational test plan, and provides documentation for all procedures and results; the plan incorporates excursions as deemed necessary, and in general is designed to 1) baseline the model, 2) stress the model, and 3) establish parametric comparisons with previous testing efforts as well as with known or accepted results (Knepell and Arangno 1993, p.3-2).

This type of validation includes inspection tests, demonstration tests and analytical tests. RHPM application runs showed known pitfalls of different theories. One example is that an increase in signal probability leads to a decrease of failure rates. Signal detection theory does not depict that. However, there are ways to improve the fit of the

computational model, for example by allowing signal and noise distribution to change over time. These changes might possible generate insights with vigilance researchers.

The calibration process was in itself a test because it changes structure and parameter of the model until the model fitted the different MOEs reasonably well. If the model could not have been configured to fit the experimental outcome, then questions about it's functional validity would arise immediately.

4. Data Validation

Data validation includes an analysis of data derivation, trustworthiness of data origin, consistency throughout the model and code, and output, as well as analysis of the representation of the constants and variable definitions, units of measure and ranges (Knepell and Arangno 1993, p. 3-2).

Data validation is certainly an overt validation strategy because one only tries to match human data. Again Carley's harmonization process has supported this type of validation by assuring a configured model that could then be used in experiments. The calibrated model produced results that we compared to human data in a thorough data analysis. Since we had all experimental results the data is trustworthy.

Units of measure and ranges for our capacity manager are certainly questionable as we have not tried to tie our parameters to research data on the electrical flow inside the brain. This is also true for some of the constants that we used to represent the resistors or potentiometers. However, this research has not claimed that our brain looks like an electrical circuit but that cognitive resources modeled as electrical circuits can help to simulate performance degradation more realistically.

D. SUMMARY

The validation run results of RHPM match our expectations. The model showed reliable behavior during “normal” simulation runs. It closely approximates individual human data and shows a reasonable range of behaviors. It also generated insights into applying theories to the phenomenon (e.g. the importance of the detectability of a signal). RHPM could be validated against two previously unseen scenarios. RHPM can also demonstrate the pitfalls of certain theories. For example: it is well known, that an increase in signal probability leads to an improvement of the miss and false alarm rate. Signal detection theory does not address this phenomenon. Consequently, RHPM increases the miss rate instead of decreasing it. However, by looking at the design of the model and how different modules work with each other, there are possible solutions on how to improve the model performance. These improvements could potentially reflect improvements in the theories.

The multiple resource model’s implementation influences the reaction time in a normal case. As soon as the main energy level decreases, the error rates increase to a point where the model does not process any signals. This should be facilitated for example, by introducing more stressors to the model than time on task or change of workload.

Some experimental results also indicated the need to introduce perceptual learning (better distinguishing signals) into the model. These mechanisms are not well documented in vigilance research and it requires further research to introduce perceptual learning to a computational model of vigilance.

One possible limitation of the proof of concept implementation is the question of how well it would fit scenarios from a different experimental set up. The time effort to program new scenarios is low and due to the open architecture it can be connected very fast. However, some task characteristics (i.e., signal salience) should be adjusted before RHPM should be used.

RHPM can certainly generate surprises by simply missing signals or giving false alarms too often. The surprise factor can be increased by changing certain parameters. One example is the probability of a slip. The response selection agent passes the decision (e.g. SayYes) to the ResponseExecution agent. The response execution then depends on how busy this agent is. It can conduct a omission error by having the information fade away or simply by a slip saying “No” instead of a “Yes” with a given probability. This probability can be linked to the stress level to indicate an increase in error rates with increasing stress.

THIS PAGE INTENTIONALLY LEFT BLANK

VI. CONCLUSIONS AND FUTURE WORK

This chapter summarizes the main findings and conclusions. It then describes further research questions that stem out of this research.

A. CONTRIBUTION

This research suggested a new cognitive model that simulates individual reduced human performance. The human experiment shows evidence that personality traits (especially extroversion, conscientiousness, and agreeableness) do in fact influence vigilance performance. However, personality traits' multiple regression models only accounted for approximately a third of the variance in the data.

This research also shows evidence for distinct cross-cultural differences in personality and vigilance performance. Further research is needed to integrate this cross-cultural differences into cognitive modeling. It is very obvious that the average assumption for behavior of performance degradation is neither true for a single population nor for cross-cultural populations. The pitfalls of mirror imaging (thinking and here even modeling that others should think and act like ourselves) loom behind simulation systems that do not take these differences into consideration.

Using a discrete event simulation together with the event graph design opens a cognitive architecture to design discussions with the domain experts (in our case human factor specialists and psychologists).⁴⁰

Further contributions contain evidence that a paradigm shift in human behavior modeling taking vagary into account is suggestive. The proposed framework for the next-generation cognitive architecture has shown advantages in terms of robustness and adaptivity. The open and flexible architecture shows a possible path of cooperation between modelers. The implemented parts of the cognitive framework show their contribution by modeling the challenging problem of vigilance decrement.

⁴⁰ This claim is very similar to what the meta language Unified Modeling Language (UML) tries to achieve. However, it appears that UML is not necessarily the right description tool for discrete event simulations.

RHPM has been validated with quantitative and qualitative analysis. It closely approximates individual human performance and shows a reasonable range for its behaviors. The model has limitations and potential improvements were mentioned. These improvements should occur in cooperation with vigilance researchers.

This research suggests a research direction to improve signal detection theory. The model's behavior and the theories predicted behavior are coherent. However, a difference in outcomes between human experiments and RHPM lead to the assumption, that there are perceptual learning effects in signal detection affecting the sensitivity. RHPM can fit the data better with a sensitivity increase based on the number of signals. If the number of signals reaches a certain threshold signal detection seems to become easier. The next step should be human vigilance experiments that try to find out whether or not there is a relation between number of signals and a sensitivity increment.

Two further achievements deserve mentioning:

- 1) RHPM seems to be the first computational vigilance model composed of multi agent systems.
- 2) The implementation of Wickens multiple resource model also seems to be a first try for a computational model on multiple cognitive resources.

Thus this research contributes to the modeling of human behavior as well as to cognitive psychology especially to vigilance research. It is difficult to compare its behavior with current cognitive architecture since it has not the same level of sophistication. However, it has shown its potential by modeling an important phenomenon that hasn't been modeled by others. It also showed that a multi agent system based on complex adaptive system's theory can be used to produce desired results that are within human range of performance.

B. SCALABILITY

The question how a model scales is certainly an important question. Our architecture is lightweight in terms of storage space (less than 200 Kb) and it performs rather fast. However, this question could only be answered if the architecture were integrated into a simulation system that allows for vigilance decrement. One potential example is Calfee's simulation system that takes reduced performance of air defense

operators into account.(Calfee 2003) The source code is available yet uncommented at the current time. A close cooperation with Calfee would certainly enhance the validity of both models and could show evidence for the scalability.

However a big advantage of the loosely coupled approach is the possibility to tailor-make task oriented computer generated forces. If one only needed the function of either detecting or missing a radar signal there is no need for an architecture that can do more than that. Thus the sufficiency criterion for modeled functions is a big advantage of this open model.

Another legitimate criticism is the unanswered question whether the entire approach would scale to a complete cognitive architecture. However, there is no current cognitive architecture that claims that it can model all human behavior with a single architecture. The new approach with complex adaptive systems is certainly promising and will be described next.

C. COGNITIVE MODELLING WITH COMPLEX ADAPTIVE SYSTEMS

This research started with the hypothesis that human performance can be modeled with a complex adaptive system (complex adaptive system hypothesis CASH). Cognitive modeling with complex adaptive system is a new approach that has yet to show its value. This research contributes to its valid claim of being a new promising avenue by successfully modeling the phenomenon of vigilance decrement. It is possible to harness a complex adaptive system in a way that it can produce desired emergent behavior in our case the realistic occurrence of a vigilance decrement. The inherent capability of CAS to learn and to adapt to an ever changing environment seems to be an ideal fit to human performance modeling. However, the implementation of these ideas is not easy and some of the mechanism can only be modeled rudimentarily.

Findings in evolutionary psychology indicate that certain cognitive functions are “hard-wired” functions that have evolved. In order to be a truly successful approach, a close cooperation with researchers of both fields (evolutionary psychology, modeling and simulation) is needed.

D. FUTURE RESEARCH DIRECTIONS

A perceived weakness of cognitive models is their tendency to rely on a stimulus-response sequence. In reality humans are constantly processing information within the context of current plans and intentions (McCauley 2003). RHPM provides a capability to include this higher dimension into the model. However since this research focused on vigilance performance there is a need for further research to include this dimension fully into the model. There are research efforts at NPS (for example IAGO - MOVES Institute) that should integrate this research to enhance cognitive modeling into this higher dimension.

Several improvements of RHPM have been mentioned. It is obvious that RHPM is not the solution to all questions a vigilance researchers might have. However the model shows that a combination of signal detection theory, resource theory and expectancy theory delivers promising avenues for the computational modeling of vigilance.

Distinct cross-cultural differences imply a need for research on how to integrate different personalities and culture into cognitive modeling. RHPM can be adjusted (i.e. with the help of a genetic algorithm) to mimic a given performance. There is also evidence that the combination of certain personality traits influence vigilance performance (for example: extroversion and conscientiousness). Combined with cross cultural differences this is certainly an interesting research direction for vigilance researchers.

There are many potential applications for a model that reliably simulates reduced human performance. Some examples for applications are:

- Airport security screener
- Radar screen operator
- Sonar screen operator
- Intelligence analysts listening to interrogation tapes (often more than 200 hours overall).

- Simulation of hostage situations where the vigilance decrement of terrorists is an intended goal for the negotiator

More generally applications where auditory, visual or cognitive monitoring is essential lend themselves to be using a simulation system that can capture the attentional limitation of human capacities.

RHPM can also help to gain more insights into the phenomenon of vigilance decrement and more generally into human performance degradation. It appears to be a step in the right direction.

THIS PAGE INTENTIONALLY LEFT BLANK

APPENDIX A: PRIMER ON DISCRETE EVENT SIMULATION

This primer gives the interested reader a brief background into the basics of discrete event simulation, their formal description, and an interesting way to implement modules as loosely coupled components.

This method uses resources only when events occur; it does not waste the time between events. Figure 49 depicts the approach and its main components.

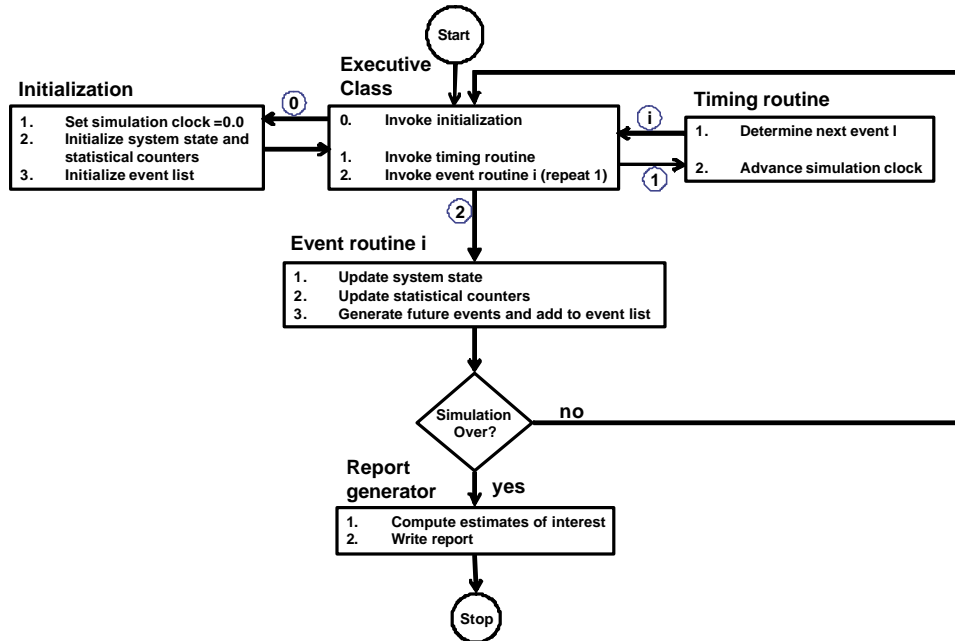

Figure 50. Control Flow for Next-Event, Time-Advance Approach; (After: Law and Kelton 1991, p.12 Fig. 1.3)

Figure 50 shows the flow of control during a discrete event simulation. The executive class starts the simulation by initializing the system state, event list, and simulation clock, and invokes the timing routine that tracks the event list and simulation clock. When an event routine is invoked (i.e., StartTask is an event where working agents process a percept conducting a specified task.) it immediately updates the system state and statistical counters, and generates future events (i.e., a StartTask event always schedules an EndTask event). The decision node checks whether the simulation should be terminated (e.g., because it should only run for a specified or number of events). If not, it goes back to the executive class, asking for the next event. The timing routine determines the next event I and relays it to the executive class, and the process starts all over.

Discrete-event-simulation design can best be visualized by means of event graphs, which are described in the next section.

A. EVENT GRAPHS

There are several ways of visualizing discrete event simulation: process networks, stochastic Petri nets, stochastic state machines, and event graphs (Schruben 1992). This research makes intensive use of event graphs. An example provided by Lee Schruben is shown in the figure below.

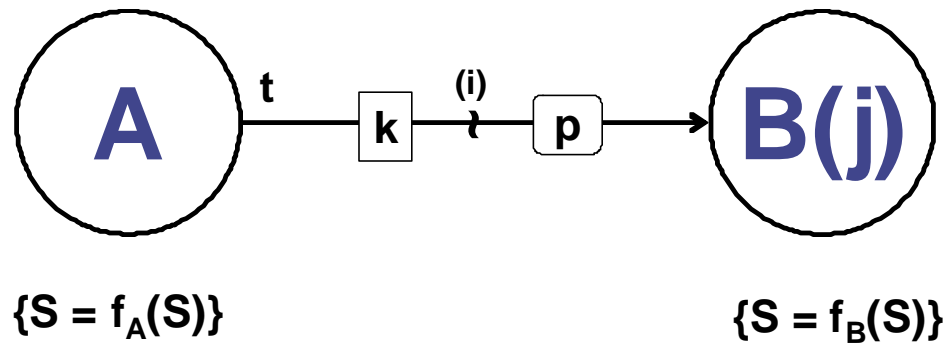

Figure 51. Event Graph of an Object (Schruben 1995, p.472)

Schruben describes the graph as follows:

1. Edges: After each occurrence of event A, if condition (i) is then true, event B will be scheduled to occur after a delay of t . Potential time ties are broken with event B receiving an execution priority, p .
2. Vertices: Whenever event B occurs, the state variable(s) in the set of event parameter(s) j will be assigned the values of the expression(s) k computed when B was scheduled. The state of the system will then change from S to $f_B(S)$. The edge conditions for all edges exiting B will then be tested and those found true will have their destination events scheduled. Also, to make certain modeling tasks easier, events are allowed to cancel one another an event cancellation edge is represented in an event graph as with a dashed arrow. Vertices can schedule or cancel further instances of themselves.

All of the elements of the event graph can be statements or expressions; for instance, event execution priorities, p , can be real-valued expressions allowing for dynamic state-dependent event sequencing” (Schruben 1995, p.472).

Schruben⁴¹ favored event graphs as a means of developing an alternative event-oriented representation of a discrete simulation system. He defined them thus:

The event graph presented here can be used to develop alternative event oriented representations of a system. Several candidate model structures can be considered for possible implementation as discrete-event simulations using an event scheduling approach. Event graph analysis can aid in identifying state variables, in determining what events must be initially scheduled, anticipating possible logic errors due to simultaneous events, and in eliminating unnecessary event routines prior to coding a simulation (Schruben 1983, p.957).

Research projects at Naval Postgraduate School have used event graphs extensively. The NPS's expert on discrete event simulation system, Arnie Buss, describes event graphs and their advantages in two ways:

Event graphs are a way of graphically representing discrete-event simulation models. Also known as "simulation graphs," they have a minimalist design, with a single type of node and two types of edges with up to three options. Despite this simplicity, event graphs are extremely powerful. The event graph is the only graphical paradigm that directly models the event list logic. There are no limitations to the ability of event graphs to create a simulation model for any circumstance. Their simplicity, together with their extensibility, make them an ideal tool for rapid construction and prototyping of simulation models (Buss 1996,p.1).

An event graph is a graph (in the formal mathematical sense of being a set of vertices and edges) that captures the event logic of a given model. In an event graph, the vertices represent the state transition function, while the edges capture the scheduling relationships between events (Buss and Sanchez 2002, p.1).

These definitions identify several important features:

1. Event graphs visually describe the logic of a model.
2. They are simple and extensible.
3. They are ideal for rapid prototyping.
4. They help identify important state variables
5. Event graphs help anticipate problems with distributed (simultaneous) events.

⁴¹ Lee Schruben conducted parts of his work while he held a National Research Council Naval Postgraduate School research associateship in 1992 (Yucesan, E, 1992).

6. They help streamline a model by eliminating unnecessary event routines.

There is evidence that event graphs are equivalent to stochastic Petri nets (Schruben and Yucesan 1994). Petri nets have a reachability problem⁴² which is decidable. This can be expensive. “In the worst case, the time and memory (computational complexity) needed to analyze a Petri net grows exponentially with the size of a net” (Ralston, Reilly et al. 2000). However, since a Petri net can be analyzed, by induction so also can an event graph. The following references explain the features of Petri nets and event graphs in more detail: (Schruben 1992; Schruben and Yucesan 1994; Balbo, Desel et al. 2000).

In cognitive modeling, event graphs have other interesting advantages:

- Event graphs are easy to read and there is no need to go into implementation details to explain how the model works. They provide a transparent look into the model, avoiding black boxes.
- Since event graphs are extensible, it is easy to create new relationships or simulation entities (e.g. introducing emotions into a cognitive architecture), thus allowing flexibility in the mathematical model.

Example: Short Term Sensory Store

At first the parameters of an entity (object, agent) are defined; these parameters can be changed or varied. They represent the buttons used to calibrate a model.

1. Parameters:

$t_{F_j} \in \mathfrak{R}^+$, where $j \in B$, fadetime for a specific buffer

$k_j \in \mathfrak{S}^+$ where $j \in B$ storage capacity;

The important parameters for STSS are:

- the time when a stimulus fades away (a positive real number),
- and its storage capacity (positive integer).

The index j belongs to a set B (which is the set of all agents or objects that use a capacitated queue). Next the system’s state variables in this entity are defined:

⁴² Reachability can be analyzed by asking whether a Petri net that starts with an initial marking (or set-up) can reach desired final makeup (or final state).

2. State Variables

$Q_j \in \mathfrak{S}$ where $j \in B$ num. of elements in FIFO queue

STSS only contains a state variable for its queue. Q has a positive integer value.

Next the statistical variables are declared.

3. Statistic Variables

$Fades \in \mathfrak{S}$ number of faded observations

$Drops \in \mathfrak{S}$ number of dropped observations

$Erases \in \mathfrak{S}$ number of erased (picked) observations

“Fades” are observations in which the time for storage expired. “Drops” describes observations that couldn’t enter the system due to limited capacity. “Erases” counts the number of stimuli that made it into the system as percepts. Finally, the event graph shows the logic of STSS inner workings.

4. Event Graph

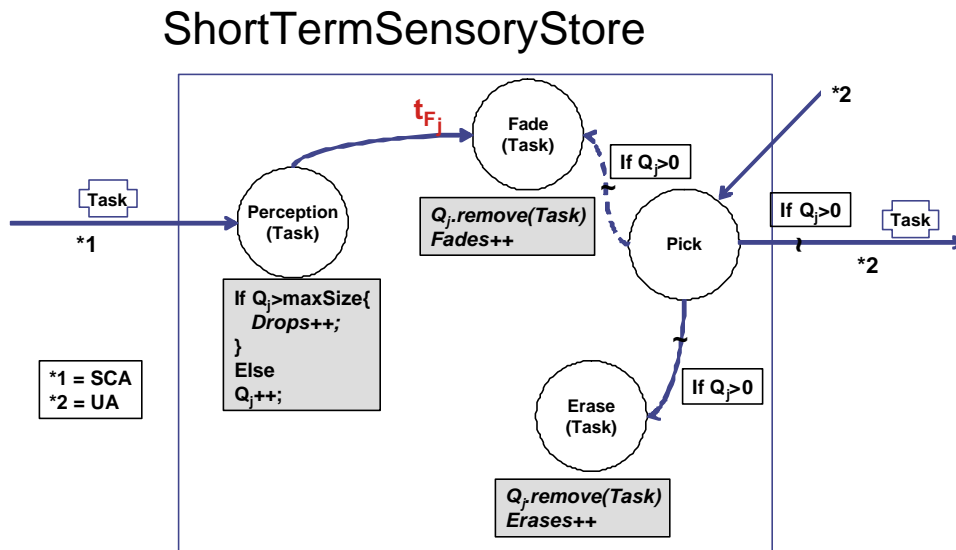

Figure 52. Event Graph for Short Term Sensory Store

5. Event Graph Description:

STSS receives a Task object from the SymbolicConstructorAgent (perception event) and checks whether the capacity of its store is sufficient. If so, it stores the observation; if not, it drops it. A time ticker is instantiated on this specific task. If it expires, the observation fades away (fade event). The Pick event interrupts (dashed line) the Fade event, given a Task in the queue. It then erases this task from the queue and relays it to the UpdateAgent (UA).

This brief example shows how a system's components can be described in a rigid way. Its design is transparent and facilitates discussion. For the interested reader, Appendix A describes all entities of the simulation system as event graphs that can be taken as a surrogate of the simulation system.

APPENDIX B: EVENT GRAPH FORMULATIONS

This appendix shows the blueprint for RHPM's main entities:

SYMBOLIC CONSTRUCTOR AGENT (SCA).

SymbolicConstructorAgent SCA

Parameters:

None

State Variables

Task which is an object containing state variables like taskTime

Statistic Variables

$Obs \in \mathbb{N}$ number of generated observations

Event Graph

Symbolic ConstructorAgent

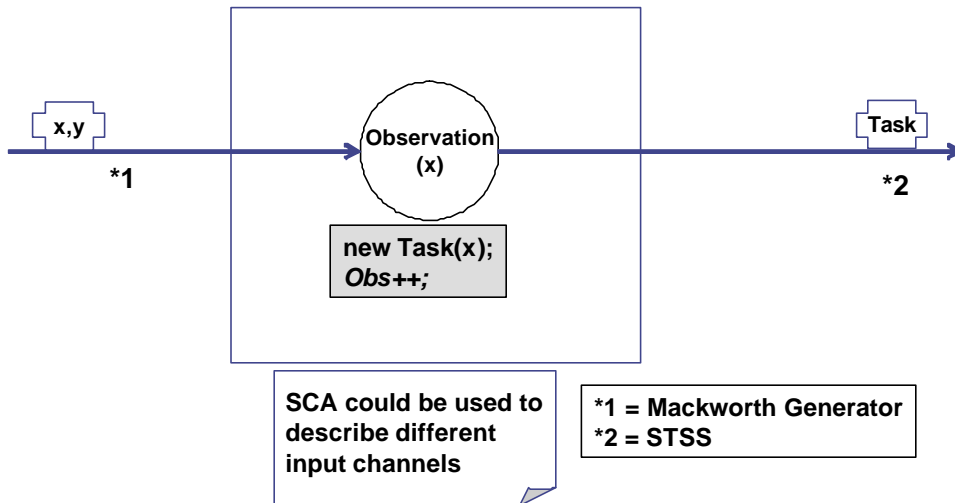

The SymbolicConstructorAgent serves as input channel to the model. It creates an unconscious observation (new Task()) and relays the observation to the ShortTermSensoryStore

Parameters:

$t_{F_j} \in \mathfrak{R}^+$, where $j \in B$, fadetime for a specific buffer

$k_j \in \mathfrak{S}^+$ where $j \in B$ storage capacity;

Literature review shows that visual information can be stored for approx. 1 second, auditory information time ranges from 2 to 8 seconds. It is unclear how much unconscious information can be stored into the STSS. We assume it has a limited capacity similar to working memory (7 ± 2)

State Variables

$Q_j \in \mathfrak{S}$ where $j \in B$ num. of elements in FIFO queue

Statistic Variables

$Fades \in \mathfrak{S}$ number of faded observations

$Drops \in \mathfrak{S}$ number of dropped observations

$Erases \in \mathfrak{S}$ number of erased (picked) observations

Fades are observations where the time for storage expired. Drops describes observations that couldn't enter the system due to limited capacity

Event Graph

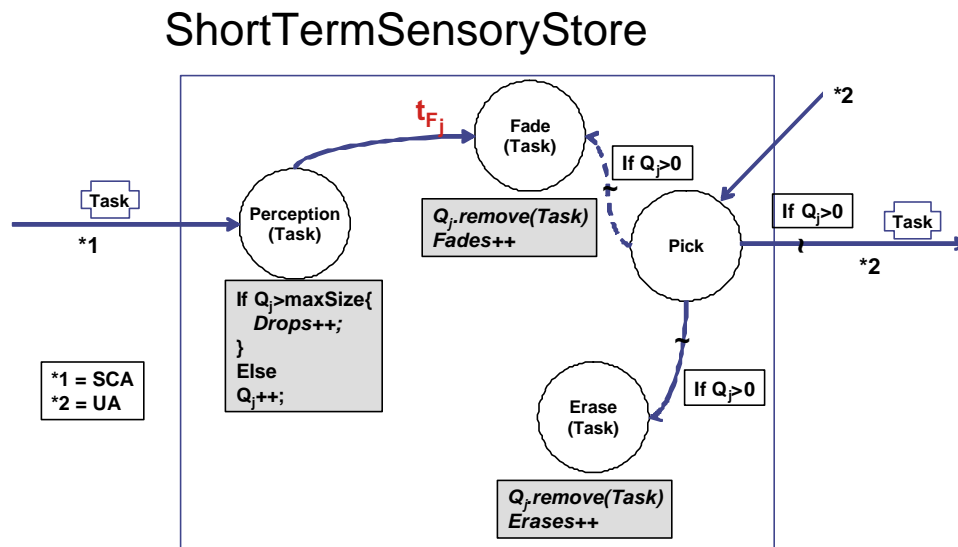

STSS receives a Task object from the SCA (Perception event) and checks whether or not the capacity of its store is sufficient. If there is enough capacity it stores the observation. If not it drops the observation. A time ticker is instantiated on this specific task. If it expires the observation fades away (Fade event) The Pick event interrupts the Fade event, given there is a Task in the queue. It then erases this task from the queue and relays it to the UpdateAgent (UA).

WORKINGAGENT

Every agent in the cognitive module is a kind of working agent with slight differences. Thus we describe the common events first and then only describe events that are changed or entirely specific to this type of agent

Parameters:

$t_{F_j} \in \mathfrak{R}^+$ where $j \in B$ fade time;

$t_{R_k} \in \mathfrak{R}^+$ where $k \in W$ recovery time;

$k_j \in \mathfrak{S}^+$ where $j \in B$ storage capacity;

State Variables

$Q_j \in \mathfrak{S}$ where $j \in B$ num. of elements in FIFO queue

$S_k \in \text{BOOLEAN}$ where $k \in W$ status of agent (0 = idle, 1 = busy)

$R_k \in \text{BOOLEAN}$ where $k \in W$ recovery status of agent (0 = recovering, 1 = not recovering)

$F_a \in \mathfrak{R}^+$ where $a \in A$ current flow

$T_{task_k} \in \mathfrak{R}^+$ where $k \in W$ leftover task time as function of flow

Statistic Variables

$Fade \in \mathfrak{S}$; number of faded observation and percepts

$Drops \in \mathfrak{S}$; number of dropped percepts

$Jobs_k \in \mathfrak{S}$ where $k \in W$; number of finished task of working agent

Fades are observations where the time for storage expired. Drop describes percepts that couldn't enter the system due to limited capacity. Jobs keeps track of the finished tasks of a specific working agent

Event Graph

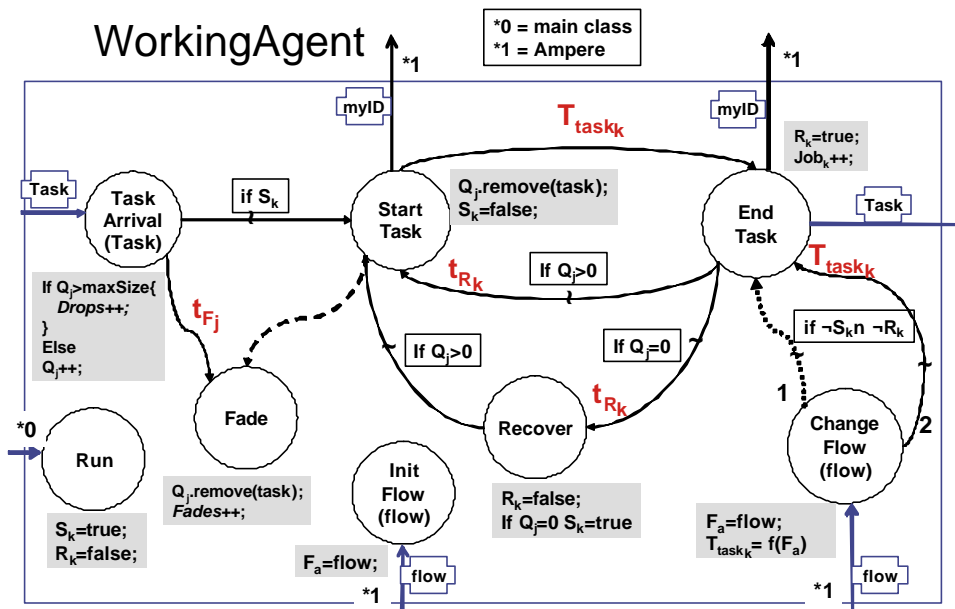

- Run event (coming from the main class) initializes agent status into idle and not recovering.
- InitFlow: Agent receives its initial flow from AMPERE and uses it as goal flow.
- TaskArrival: Agent receives information (percept)
- StartTask: Agent begins to work with the information and signals a “ChangeRes” event to AMPERE.
- EndTask: Agent has finished task, processes it to router, and signals a “ChangeRes” event to AMPERE. It then schedules a Recover event or a StartTask event, depending on whether or not there are further percepts in its queue.
- Recover: After the appropriate time the agent has recovered and can start a new task, given there is a task in queue.
- ChangeFlow comes from AMPERE: Agent’s flow has changed, if agent is not idle and not recovering, it reschedules the EndTask event.
- Fade removes information from queue since it wasn’t processed in time.

UPDATEAGENT UA

Parameters:

Like WorkingAgent

State Variables

Like WorkingAgent additionally:

$T_{UA} \in \mathcal{R}^+$; UpdateRate as a function of expectancy

Statistic Variables

Like WorkingAgent

Event Graph

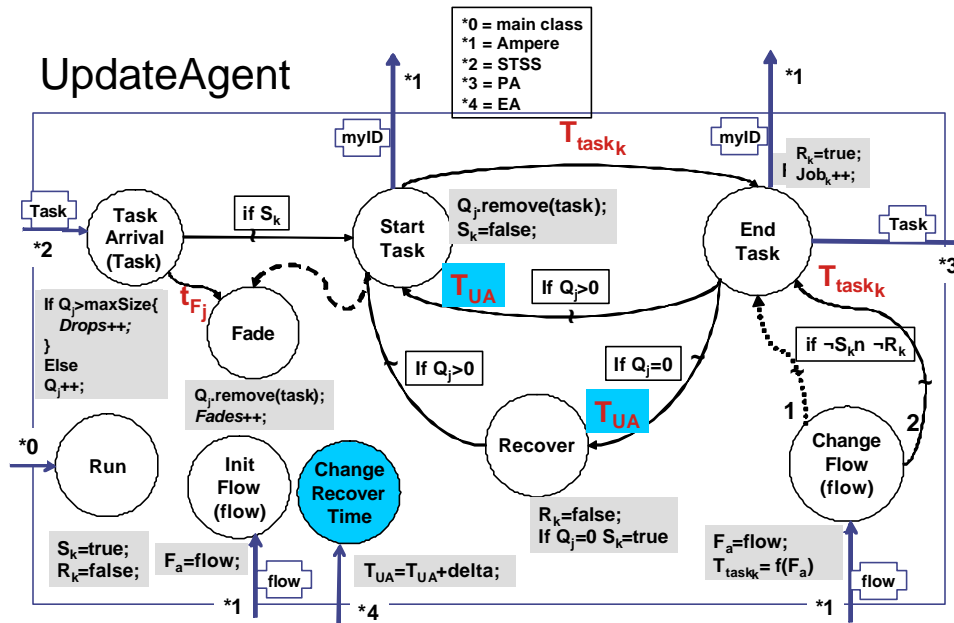

The TaskArrival event comes from the PerceptAgent (PA). Another event that adds on to the WorkingAgent events is the ChangeRecover time. This event enables the agent to have different recover times T_{UA} depending on the perceived signal probability (from ExpectancyAgent EA).

PERCEPTAGENT PA

Parameters:

Like WorkingAgent

State Variables

Like WorkingAgent

Statistic Variables

Like WorkingAgent

Event Graph

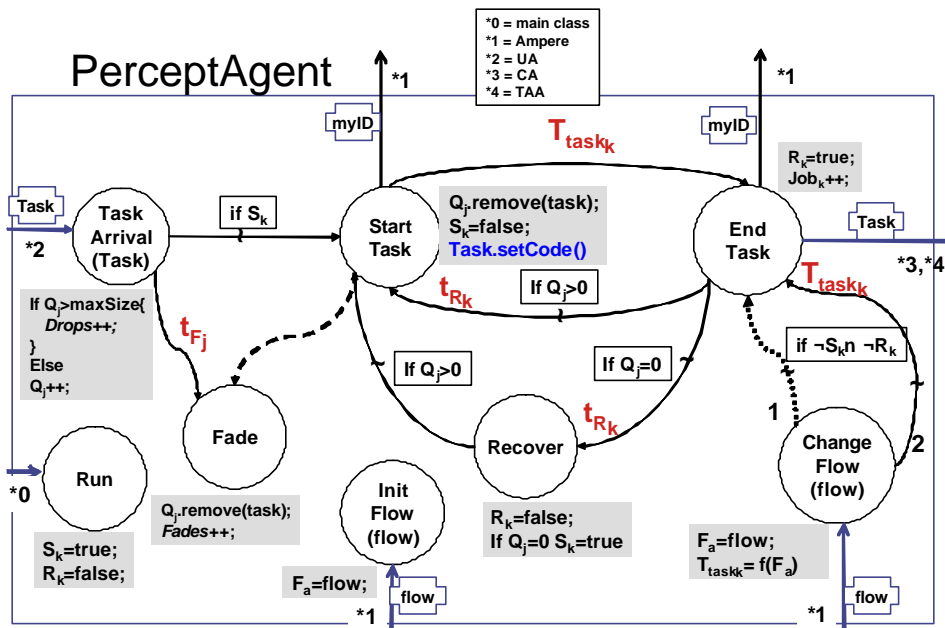

The PerceptAgent receives information from the update agent and recognizes and stamps the task modality and code. It relays this information to the ComparisonAgent and the TaskAllocatorAgent.

COMPARISONAGENT PA

Parameters:

Like WorkingAgent

State Variables

Like WorkingAgent, additionally
Flag Boolean (true known percept, false unknown percept)

Statistic Variables

Like WorkingAgent

Event Graph

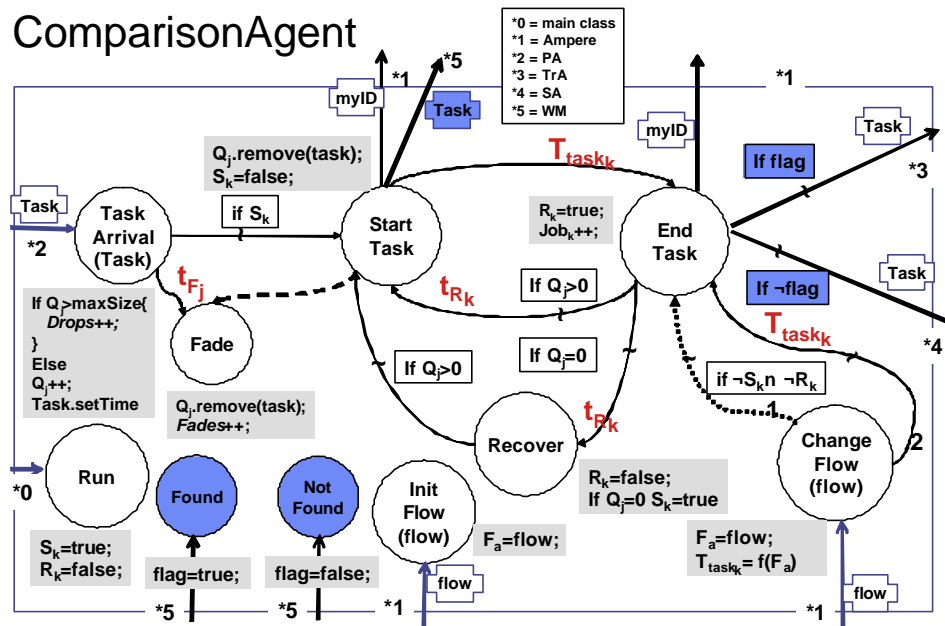

ComparisonAgent receives its tasks from the PerceptAgent. It has two additional events compared to WorkingAgent: Found and NotFound set the value for the Boolean variable flag. The StartTask event also schedules a Search event within the WorkingMemoryStore. We assume that the search time is included into the ComparisonAgent. If the task resides in the WorkingMemoryStore the TransmitAgent will be informed, if not the SearchAgent receives the task.

TASKALLOCATORAGENT

Parameters:

Like WorkingAgent

State Variables

Like WorkingAgent,

Statistic Variables

Like WorkingAgent

Event Graph

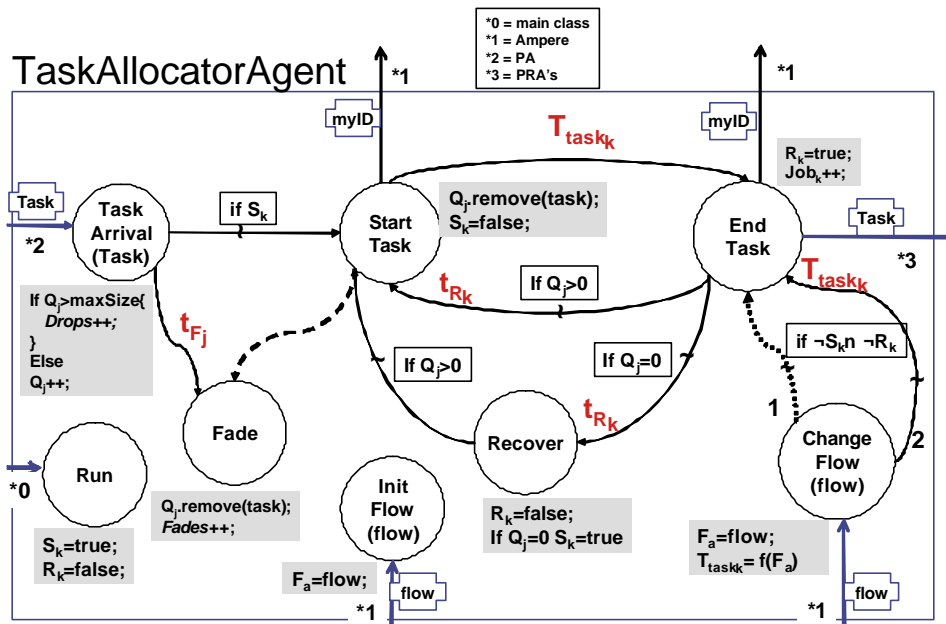

TaskAllocatorAgent gets a task from the *PerceptAgent*. When it finishes its task it informs all *ProcessingResourceAgents* on the resource demand type (i.e. visual spatial)

TRANSMITAGENT

Parameters:

Like WorkingAgent

State Variables

Like WorkingAgent

Statistic Variables

Like WorkingAgent

Event Graph

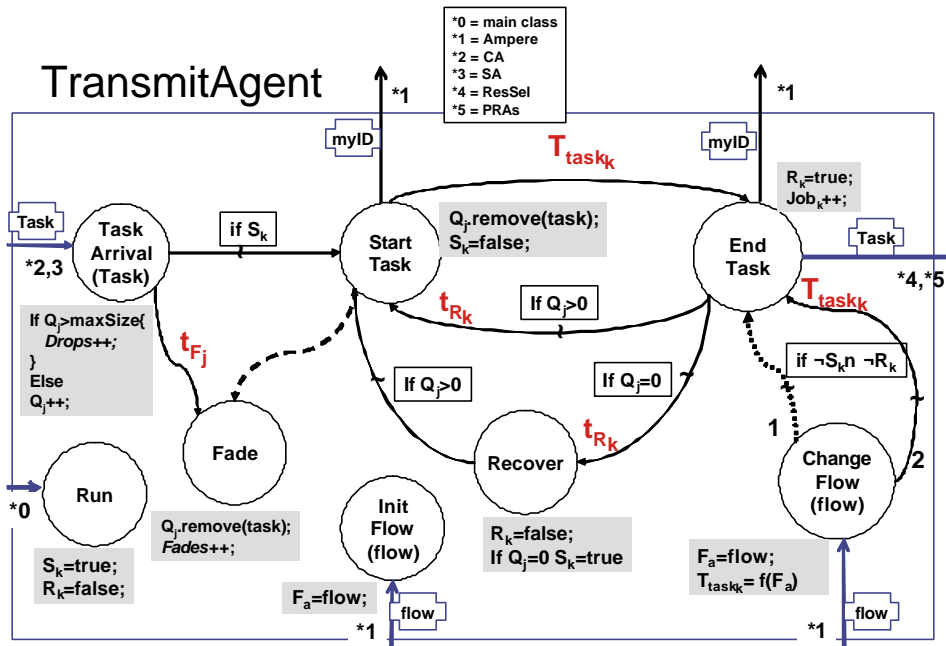

The *TransmitAgent* can get its input either from the *ComparisonAgent* or the *SearchAgent*. It then relays the task to the *ResponseSelectionAgent*.

SEARCHAGENT

Parameters:

Like WorkingAgent

State Variables

Like WorkingAgent,

Statistic Variables

Like WorkingAgent

Event Graph

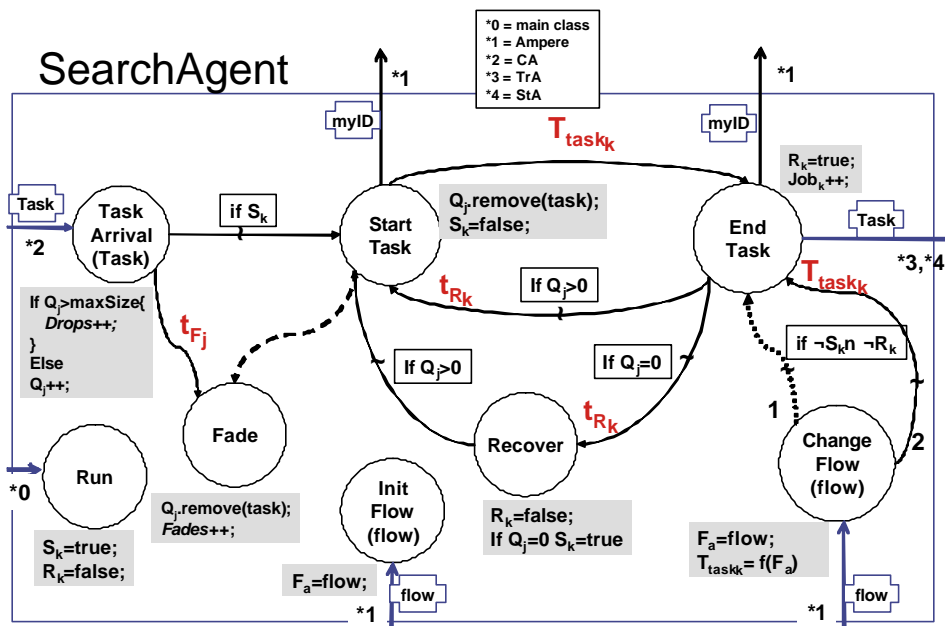

SearchAgent is the agent looking into long term memory whether or not an object is a known object. Right now it is called by the *ComparisonAgent*. However it would be an obvious extension to have the SCA relay information towards long term memory via the *SearchAgent* immediately. Since we have not implemented long term memory it just stores the searched information into *WorkingMemoryStore* and relays the information to the *TransmitAgent*.

STORAGEAGENT

Parameters:

Like WorkingAgent

State Variables

Like WorkingAgent,

Statistic Variables

Like WorkingAgent

Event Graph

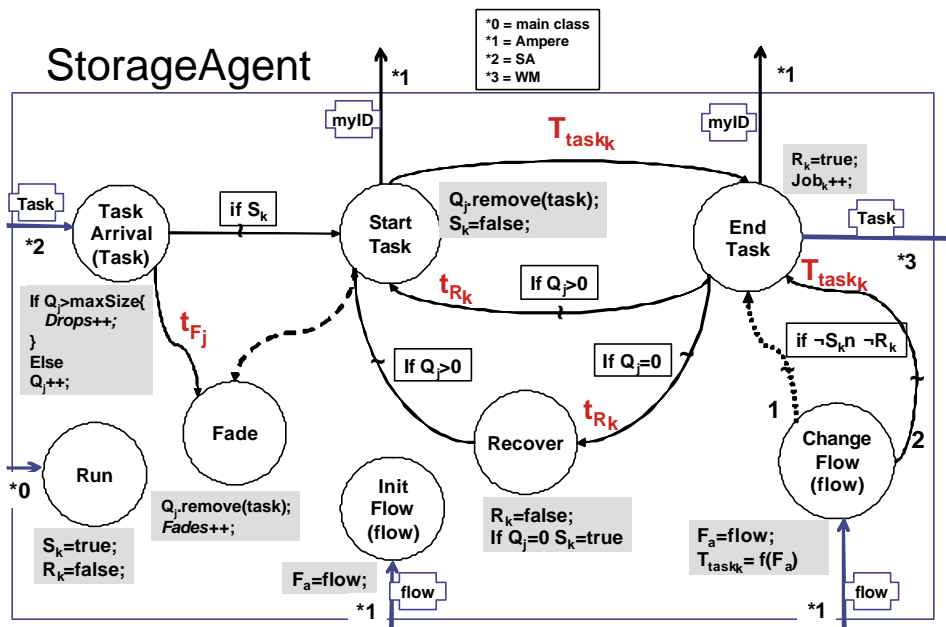

StorageAgent receives a task from the *SearchAgent*. It then stores this new information into *WorkingMemoryStore*.

WORKINGMEMORYSTORE

Parameters:

$t_{F_j} \in \mathfrak{R}^+$, where $j \in B$, fadetime for a specific buffer

$k_j \in \mathfrak{S}^+$ where $j \in B$ storage capacity;

State Variables

$Q_j \in \mathfrak{S}$ where $j \in B$ num. of elements in FIFO queue

Statistic Variables

$Fades \in \mathfrak{S}$ number of faded observations

$Drops \in \mathfrak{S}$ number of dropped observations

$Erases \in \mathfrak{S}$ number of erased (picked) observations

Event Graph

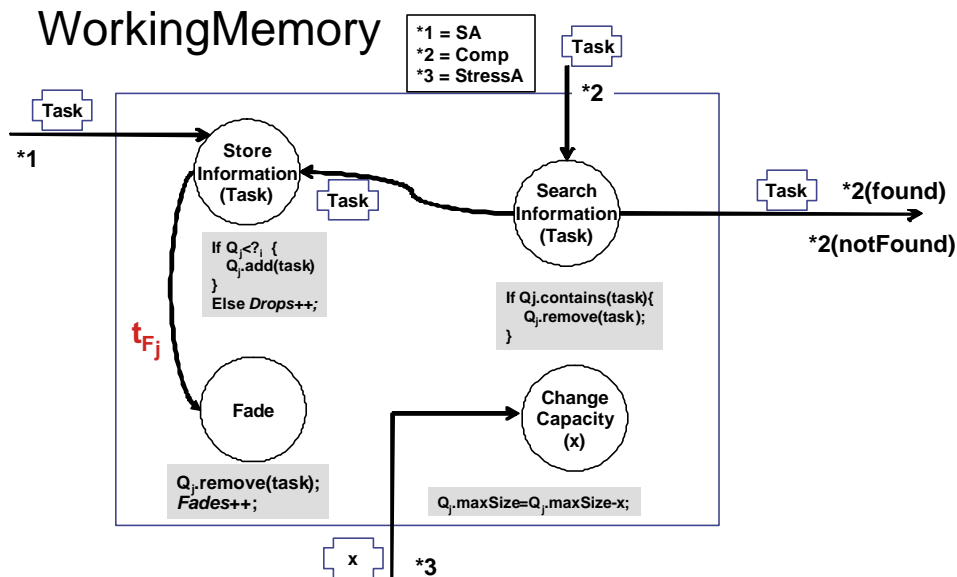

WorkingMemoryStore gets input either from the *SearchAgent* (storing information), from the *ComparisonAgent* (looking for information), or from the *StressAgent* reducing its storage capacity. The *SearchInformation* event returns information (found/not found) to the *ComparisonAgent*. It also stores the current task at the top of the FIFO queue.

RESPONSESELECTION

Parameters:

$dc \in \mathfrak{R}^+$ decision criterion increase based on expectancy; Like WorkingAgent

State Variables

Like WorkingAgent,

Statistic Variables

Like WorkingAgent

Event Graph

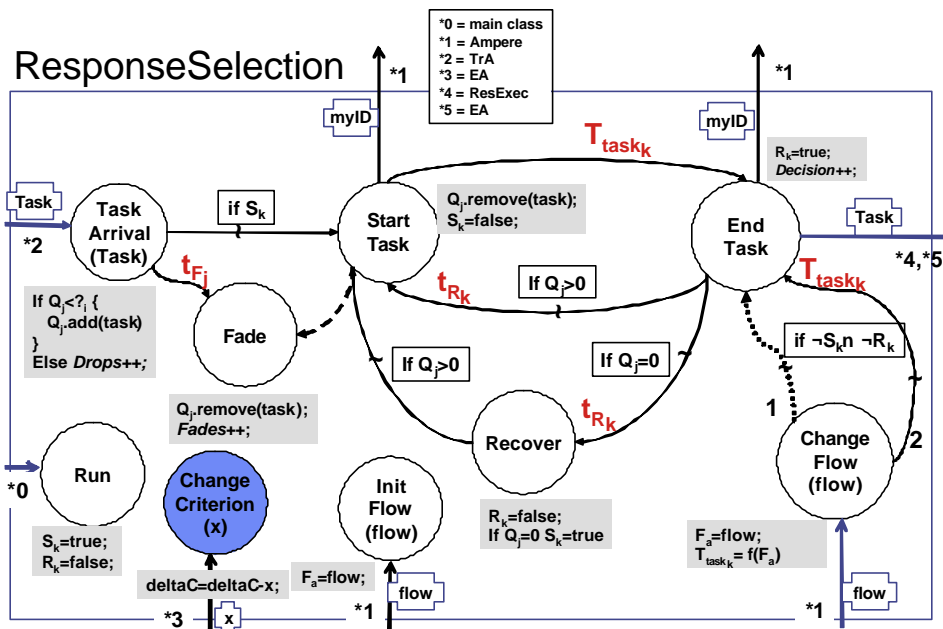

ResponseSelection is a kind of *WorkingAgent*. The difference is an additional event *ChangeCriterion*. This event comes from the *ExpectancyAgent*. It changes the decision bias according to a perceived signal probability. It informs the *ExpectancyAgent* and the *ResponseExecution* about a made decision (SayYes or SayNo).

RESPONSEEXECUTION

Parameters:

$P_{SLIP} \in (0,1)$; probability of a slip

State Variables

Statistic Variables

$SLIP \in \mathfrak{S}$; number of slips

$YES \in \mathfrak{S}$; number of YES

$NO \in \mathfrak{S}$; number of NO

Event Graph

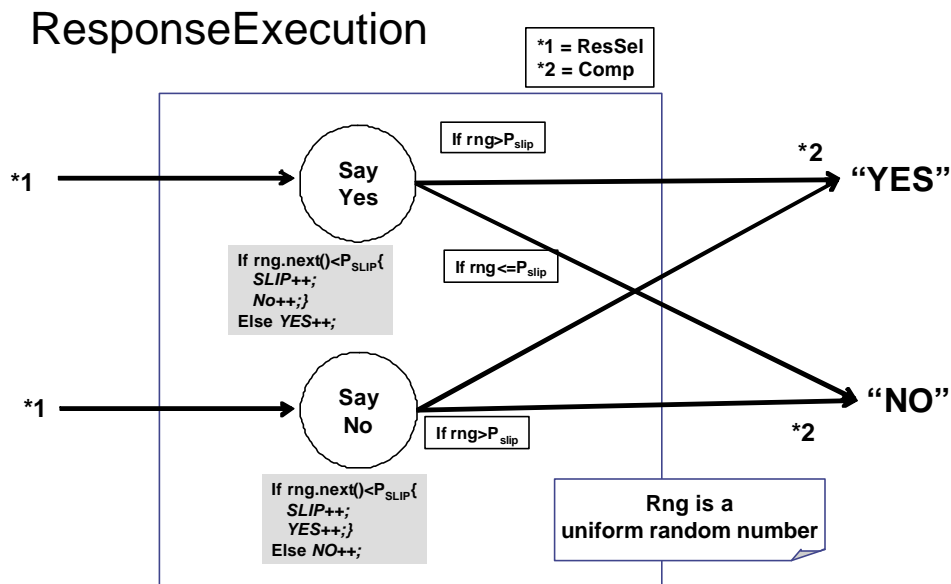

ResponseExecution is an object that takes the input from *ResponseSelection*. It lends itself to introduce slips into the model. A slip is defined as saying the opposite from what has been decided. The probability of a slip is a parameter that can either be set constant or which can increase over time.

REGULATORFLOWAGENT

Parameters:

$t_{U_a} \in \mathfrak{R}^+$ where $a \in A$ flow control update rate;

$f_a \in \mathfrak{R}^+$ where $a \in A$ goal flow;

$d_a \in \mathfrak{R}^+$ where $a \in A$ sensitivity around goal flow;

State Variables

$F_a \in \mathfrak{R}^+$; current flow

Statistic Variables

None

Event Graph

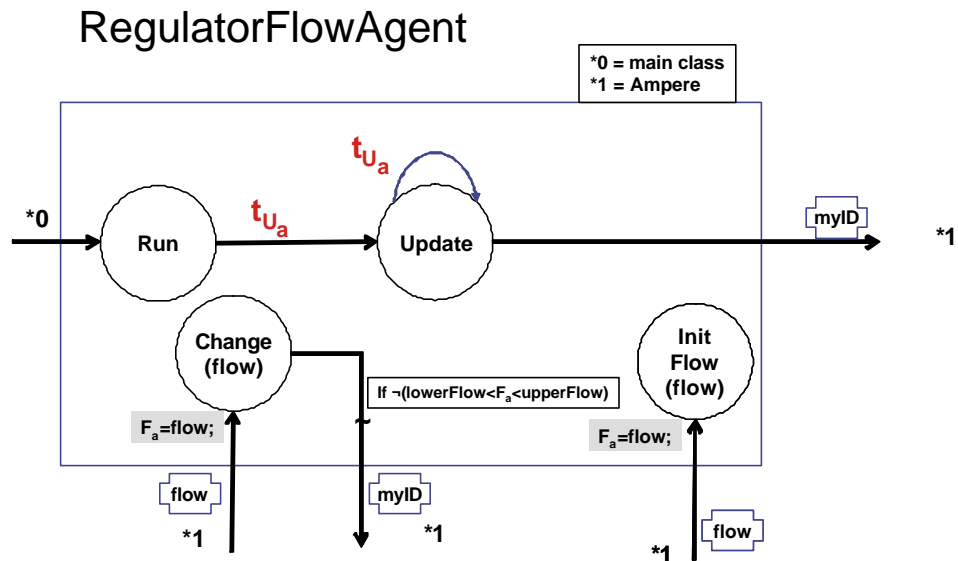

RegulatorFlowAgents are instantiated by the main class. They update their knowledge of flow periodically. The UpdateEvent asks Ampere for the current flow. Ampere creates a ChangeFlow event for the demanding agent (identified by myID). If the current flow is above or below a threshold the agent changes its resistance value accordingly.

RESOURCEAGENT

Parameters:

$t_{U_a} \in \mathfrak{R}^+$ where $a \in A$ flow control update rate;

$f_a \in \mathfrak{R}^+$ where $a \in A$ goal flow;

$d_a \in \mathfrak{R}^+$ where $a \in A$ sensitivity around goal flow;

State Variables

$F_a \in \mathfrak{R}^+$; current flow

SupJob $\in \mathfrak{S}$; number of currently supplied jobs

Statistic Variables

None

Event Graph

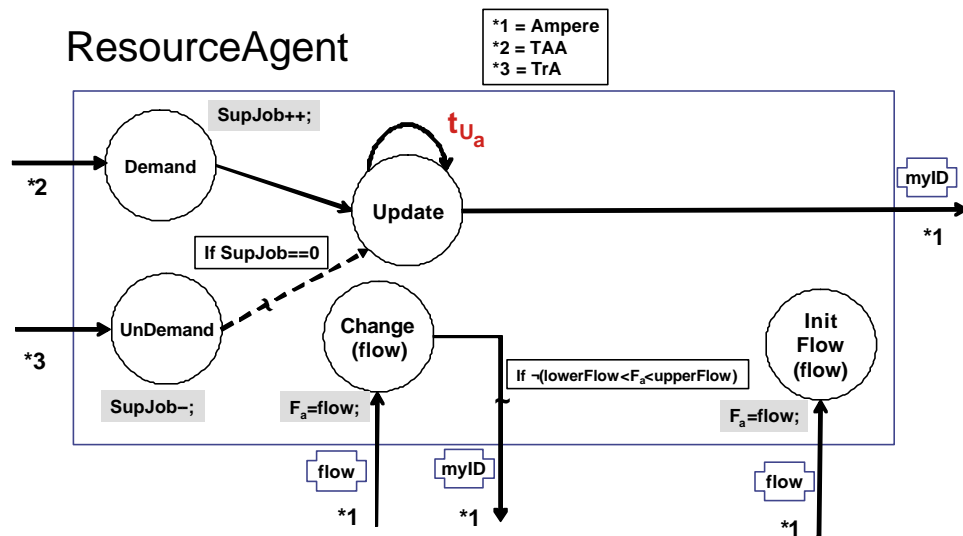

ResourceAgent is informed either by the *TaskAllocatorAgent* or the *TransmitAgent*. *ResourceAgent* only controls its flow, if there are tasks that fit its code or modality. As soon as all of this tasks are finished the *ResourceAgent* does not update (UnDemand event cancels the Update event).

AMPERE

Parameters:

$u_k \in \mathfrak{R}^+$ where $k \in W$ thermal resistance increase;

$c_k \in \mathfrak{R}^+$ where $k \in W$ conversion factor ;

State Variables

$F_a \in \mathfrak{R}^+$ where $a \in A$ current flow

$w_a \in \mathfrak{R}^+$ where $a \in A$ thermal resistance value ;

$q_a \in \mathfrak{R}^+$ where $a \in A$ potentiometer value;

Statistic Variables

None

Event Graph

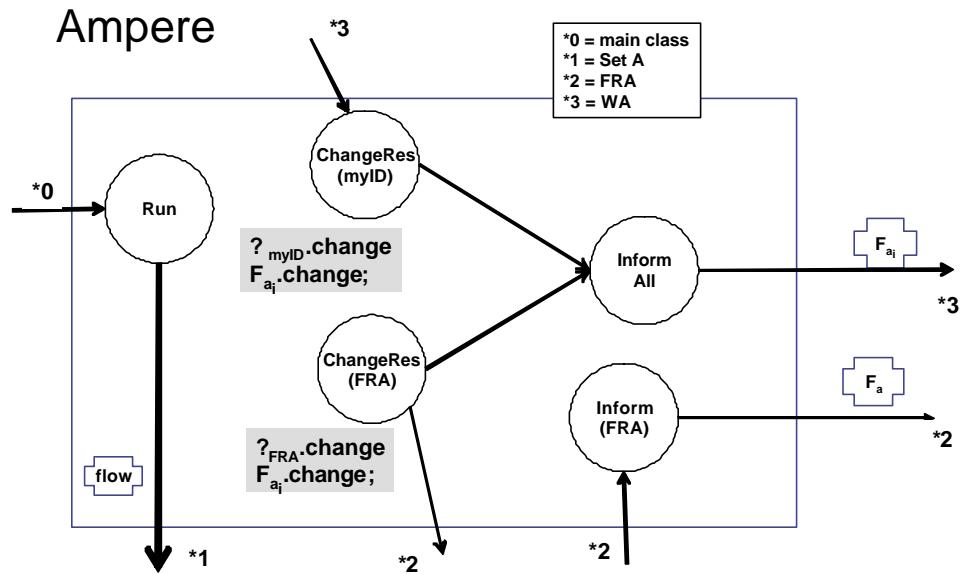

Ampere schedules a priority event (indicated by the thick arrow) to initialize the flow of all agents. *WorkingAgents* (WA) change their resistance when a task starts or ends. Once a resistance is invoked it increases over time. *FlowRegulatorAgents* (FRA) change their resistance based on a decision. Whenever a *ChangeRes* event occurs all *WorkingAgents* are informed about the change. If a specific *FlowRegulatorAgent* asks for its flow, *Ampere* answers this request for information.

THIS PAGE INTENTIONALLY LEFT BLANK

APPENDIX C: DETAILED RESULTS OF NEO FFI PERSONALITY TEST

This appendix shows in detail all the results of the personality experiment. The interested reader is advised to be aware of:

- The sample of foreign students (12) is small and from four very different countries (Germany, Greece, Turkey, Singapore) compared to the sample of US students (38).
- The distinction between high and low is based on the assumption that a score of ≥ 50 is high and < 50 is low. A more thorough investigation with more subjects should certainly distinguish between average (from 45 to 55), high > 65 , $35 > \text{low} < 45$, very high > 65 , very low < 35)
- This is only a quick analysis not utilizing sophisticated data mining technologies. It should serve as a starting point for follow-on research.

This research has not intended to show cross cultural differences. However, the interaction of certain personality traits indicates evidence for some major differences between the two populations and could potentially generated initial research questions.

All definitions are taken from the NEO FFI manual.

A. STYLE OF DEFENSE

The style of defense is defined by the interaction between the factors neuroticism (N) and openness (O). The different categories are defined as:

1. Maladaptive

Individuals qualify for this category if they score high in neuroticism and low in openness (N+, O-).

Maladaptive individuals tend to use primitive and ineffective defenses such as repression, denial, and reaction formation. They prefer not to think about disturbing ideas, and they may refuse to acknowledge possible dangers (such as serious illnesses). They lack insight into the distressing affects they experience, and because they cannot verbalize their feelings they may be considered as alexithymic.

2. Hypersensitive

Individuals qualify for this category if they score high in neuroticism and high in openness (N+, O+).

Hypersensitive individuals seem undefended. They are alert to danger and vividly imagine possible misfortunes. They may be prone to nightmares. Because they think in unusual and creative ways, they may sometimes be troubled by odd and eccentric ideas.

3. Hyposensitive

Individuals qualify for this category if they score low in neuroticism and low in openness (N-, O-).

Hyposensitive individuals rarely experience strong negative affect, and when they do, they downplay its importance. They do not dwell on threats or losses, turning instead to concrete action to solve the problem or simply to distract themselves. They put their faith in higher powers

4. Adaptive

Individuals qualify for this category if they score low in neuroticism and high in openness (N-, O+).

Adaptive individuals are keenly aware of conflict, stress, and threat, but use these situations to stimulate creative adaptations. They grapple intellectually with their own intrapsychic problems, and they may react to life stress as a source of humor or artistic inspiration.

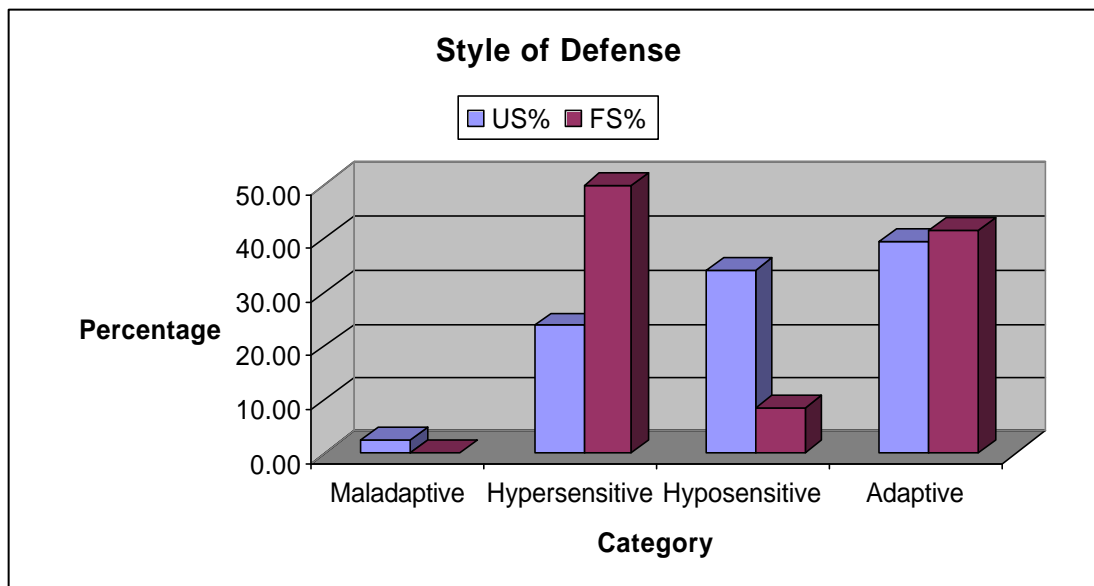

5. Analysis:

The data indicates that the sample of foreign students is significantly more prone to being hypersensitive than hyposensitive. US students are more prone to being hyposensitive. Both populations include a good proportion of adaptive individuals. There is no significant proportion of maladaptive individuals in both samples. In terms of conducting warfare it is certainly desirable to have a population that is biased toward being adaptive or hyposensitive.

B. STYLE OF ANGER CONTROL

The style of defense is defined by the interaction between the factors neuroticism (N) and agreeableness (A). The different categories are defined as:

1. Temperamental

Individuals qualify for this category if they score high in neuroticism and low in agreeableness (N+, A-).

Temperamental people are easily angered and tend to express anger directly. They may fly into a rage over a minor irritant, and they can seethe with anger for long periods of time. They are deeply involved in themselves and take offense readily, and they often

overlook the affects of anger on others. They may be prone to physical aggression or verbal abuse

2. Timid

Individuals qualify for this category if they score high in neuroticism and high in agreeableness (N+, A+).

Timid people are heavily conflicted over anger. On the one hand, their feelings are readily hurt and they often feel victimized. On the other, they are reluctant to express anger because they do not want to offend others. Their anger may be directed inward against themselves.

3. Easy-Going

Individuals qualify for this category if they score low in neuroticism and high in agreeableness (N-, A+).

Easy-going people are slow to anger and reluctant to express it when it arises. They know when they have been insulted and may raise objections, but they would prefer to forget and forgive. They understand that there are two sides to every issue and try to work a common ground in resolving disputes

4. Cold-Blooded

Individuals qualify for this category if they score low in neuroticism and low in agreeableness (N-, A-).

Cold-blooded people “don’t get mad, they get even.” These people often take offense, but they are not overpowered by feelings of anger. Instead they keep accounts and express their animosity at a time and in a way that suits them. They may seek revenge in criminal assaults, or more commonly manipulative office politics or exploitative interpersonal relationships.

Anger	US	FS	NPS Students	US%	FS%	NPS Students%
Cold-Blooded	14	4	18	36.84	33.33	36.00
Easy-Going	14	2	16	36.84	16.67	32.00
Temperamental	5	5	10	13.16	41.67	20.00
Timid	5	1	6	13.16	8.33	12.00
Total	38	12	50	100.00	100.00	100.00

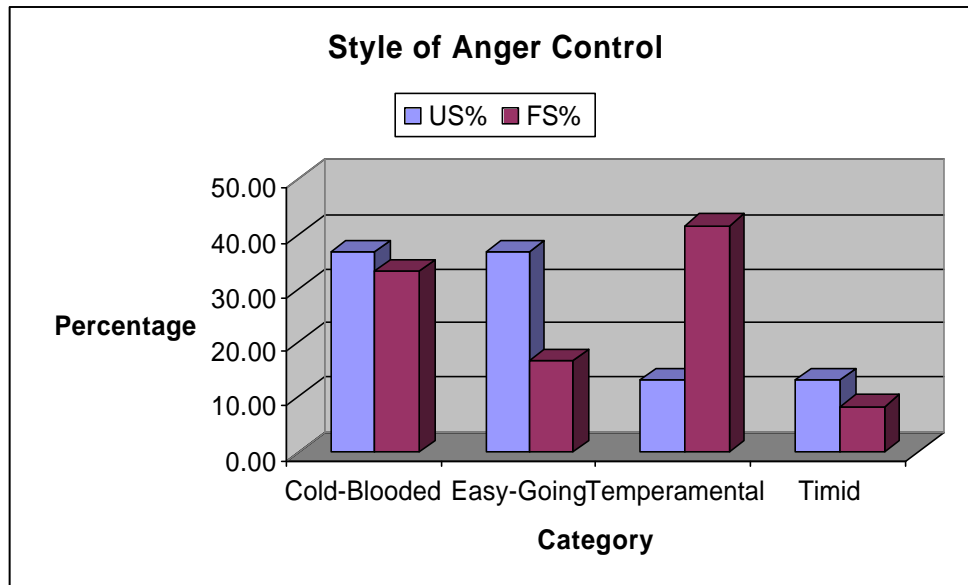

5. Analysis

Most US students are either easy-going or cold-blooded. Easy-going is certainly the desirable style of anger control in any organization. The sample of foreign student has a tendency of either being cold-blooded or temperamental. The latter is certainly undesirable in any organization. Timid individuals are a strong minority with about 12% in both samples. Their overall performance is certainly impacted by the amount of anger they have to deal with.

C. STYLE OF WELL-BEING

The style of well-being is defined by the interaction between the factors neuroticism (N) and extraversion (E). The different categories are defined as:

1. Gloomy Pessimist

Individuals qualify for this category if they score high in neuroticism and low in extraversion (N+, E-).

These people face a dark and dreary life. There is little that cheers them and much that causes anguish and distress. Especially under stressful circumstances they may succumb to periods of clinical depression and even when they function normally, they often find life hard and joyless.

2. Overly Emotional

Individuals qualify for this category if they score high in neuroticism and high in extraversion (N+, E+).

These people experience both positive and negative emotions fully and may swing rapidly from one mood to another. Their interpersonal interactions may be tumultuous because they are so easily carried away by their feelings. They may show features of the Histrionic Personality Disorder, but they may also feel that their lives are full of excitement.

3. Upbeat Optimist

Individuals qualify for this category if they score low in neuroticism and high in extraversion (N-, E+).

These people are usually cheerful because they are not unduly troubled by problems, and they have a keen appreciation for life's pleasures. When faced with frustration or disappointment, they may become angry or sad, but they quickly put their feelings behind them. They prefer to concentrate on the future, which they view with eager anticipation. They enjoy life.

4. Low-keyed

Individuals qualify for this category if they score low in neuroticism and low in extraversion (N-, E-).

Neither good news or bad news has much effect of these people; they maintain a stoic indifference to events that would frighten or delight others. Their interpersonal relationship may suffer because other people might find them to be “cold fish”. Their emotional experience of life is bland.

WellBeing	US	FS	NPS Students	US%	FS%	NPS Students%
Gloomy Pessimist	3	2	5	7.89	16.67	10.00
Low- keyed	7	0	7	18.42	0.00	14.00
Overly Emotional	7	4	11	18.42	33.33	22.00
Upbeat Optimist	21	6	27	55.26	50.00	54.00
Total	38	12	50	100.00	100.00	100.00

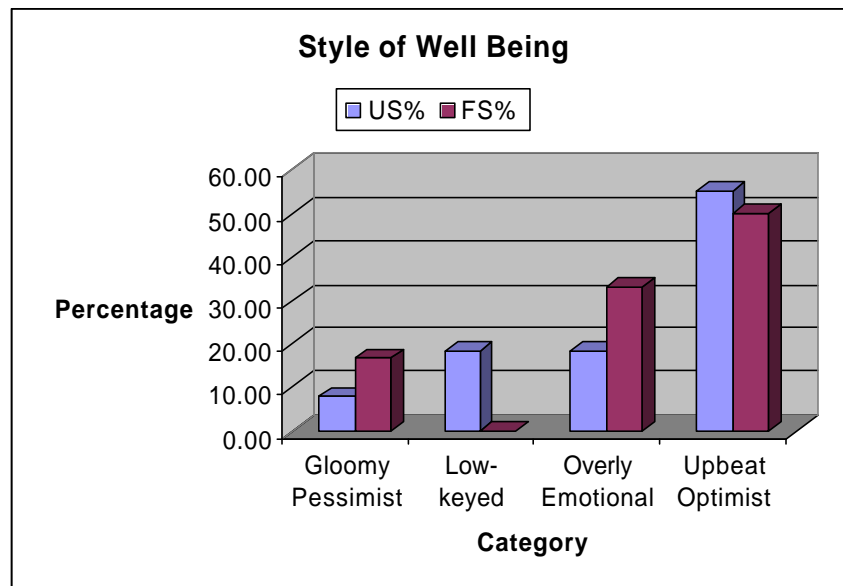

5. Analysis:

The majority of both populations tend to be upbeat optimists. The sample of foreign student tends to score high in neuroticism which causes the significant proportion

of gloomy pessimists and overly emotional people. The trend of US students towards extraversion can be seen by the proportion of optimists and overly emotional people. However, there are also low-keyed people that are quite the opposite scoring low in E and in N. Low-keyed people have some characteristics that could be facilitated in a variety of specialty assignments (i.e. analysts).

D. STYLE OF IMPULSE CONTROL

The style of impulse control is defined by the interaction between the factors neuroticism (N) and conscientiousness (C). The different categories are defined as:

1. Undercontrolled

Individuals qualify for this category if they score high in neuroticism and low in conscientiousness (N+, C-).

These individuals are often at the mercy of their own impulses. They find it difficult and distressing to resist any urge or desire, and they lack the self control to hold their urges in check. As a result they may act in ways that they know are not in their long-term best interests. They may be particularly susceptible to substance abuse and other health risk behavior

2. Overcontrolled

Individuals qualify for this category if they score high in neuroticism and high in conscientiousness (N+, C+).

These individuals combine distress-proneness with a strong need to control their behavior. They have perfectionists' strivings and will not allow themselves to fail even in the smallest detail. Because their goals are often unrealistic and unattainable, they are prone to guilt and self-recrimination. They may be susceptible to obsessive and compulsive behavior.

3. Directed

Individuals qualify for this category if they score low in neuroticism and high in conscientiousness (N-, C+).

These individuals have a clear sense of their goals and the ability to work toward them even under unfavorable conditions. They take setbacks and frustrations in stride, and they are able to tolerate unsatisfied needs without abandoning their plan of action.

4. Relaxed

Individuals qualify for this category if they score low in neuroticism and low in conscientiousness (N-, C-).

These individuals see little need to exert rigorous control over their behavior. They tend to take the easy way, and they are philosophical about disappointments. They may need extra assistance in motivating themselves to follow appropriate medical advice or to undertake any effortful endeavor.

Impulse	US	FS	NPS Students	US%	FS%	NPS Students%
Directed	23	3	26	60.53	25.00	52.00
Overcontrolled	8	2	10	21.05	16.67	20.00
Relaxed	5	3	8	13.16	25.00	16.00
Undercontrolled	2	4	6	5.26	33.33	12.00
Total	38	12	50	100.00	100.00	100.00

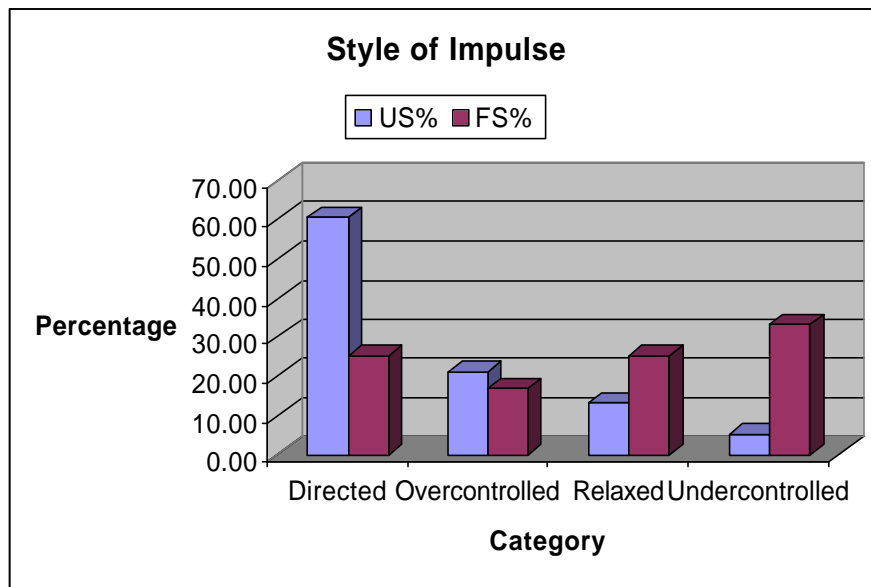

5. Analysis:

The foreign student sample represents an almost normal population distributed evenly over the four categories. However, there is a very distinct difference towards the US student sample. Clearly their behavior is governed by a generally high score in

conscientiousness. They certainly tend to be directed or over controlled. In terms of desirable style the directed person has certainly many advantages especially in military organizations.

E. STYLE OF INTERESTS

The style interest is defined by the interaction between the factors extraversion (E) and openness (O). The different categories are defined as:

1. Mainstream Consumers

Individuals qualify for this category if they score high in extraversion and low in openness (E+, O-).

Their interests reflect the popular favorites: Parties, sports, shopping, blockbuster movies – events where they can enjoy themselves with others. They are attracted to businesses and jobs that let them work with others on simple projects.

2. Creative Interactors

Individuals qualify for this category if they score low in extraversion and high in openness (E-, O+).

Their interests revolve around the new and different and they like to share their discoveries with others. They enjoy public speaking and teaching and fit well into discussion groups. They enjoy meeting people from different backgrounds.

3. Introspectors

Individuals qualify for this category if they score low in extraversion and low in openness (E-, O-).

Their interests are focused on ideas and activities they can pursue alone. Reading, writing, or creative hobbies like painting and music appeal to them. They prefer occupations that provide both challenge and privacy.

4. Homebodies

Individuals qualify for this category if they score low in extraversion and low in openness (E-, O+).

Their interests are focused activities they can pursue alone or in a small group. They are unadventurous and may collect stamps or coins, watch television, or garden. Their vocational interests may include mechanical or domestic work.

Interest	US	FS	NPS Students	US%	FS%	NPS Students%
Creative Interactor	19	9	28	50.00	75.00	56.00
Homebodies	5	0	5	13.16	0.00	10.00
Introspector	5	2	7	13.16	16.67	14.00
Mainstream Consumers	9	1	10	23.68	8.33	20.00
Total	38	12	50	100.00	100.00	100.00

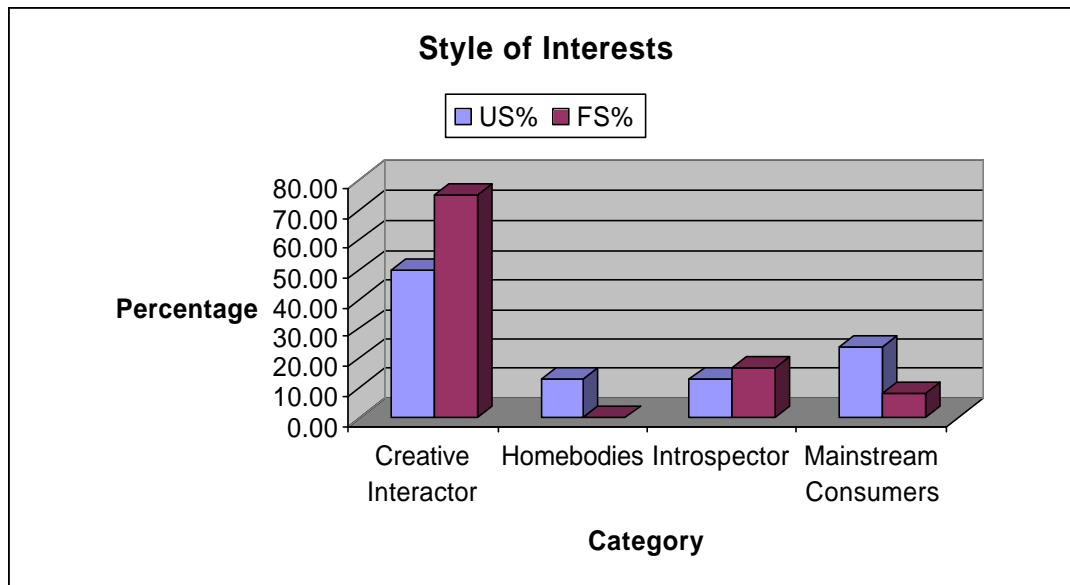

5. Analysis

The overwhelming majority of the foreign student sample tends to be creative interactors. Although this is also very pronounced within the US student's sample, there are also a significant number of mainstream consumers in the sample. Presumably homebodies and introspectors perform better in vigilance tasks as they prefer solitary pursuits.

F. STYLE OF INTERACTIONS

The style of interactions is defined by the interaction between the factors extraversion (E) and agreeableness (A). The different categories are defined as:

1. Leaders

Individuals qualify for this category if they score high in extraversion and low in agreeableness (E+, A-).

These people enjoy social situations as an arena in which they can shine. They prefer giving orders to taking them and believe they are particularly well suited to making decisions. They may be boastful and vain, but they also know how to get people to work together.

2. Welcomers

Individuals qualify for this category if they score high in extraversion and high in agreeableness (E+, A+).

These people sincerely enjoy the company of others. They are deeply attached to their old friends and reach out freely to new ones. They are good-natured and sympathetic, willing to lend an ear and happy to chat about their own ideas. They are easy to get along with and popular.

3. The Unassuming

Individuals qualify for this category if they score low in extraversion and high in agreeableness (E-, A+).

These people are modest and self-effacing. They often prefer to be alone, but they are also sympathetic and respond to others' needs. Because they are trusting, others may sometimes take advantage of them. Their friends should watch out for their interests but still respect their privacy.

4. Competitors

Individuals qualify for this category if they score low in extraversion and low in agreeableness (E-, A-).

These people tend to view others as potential enemies. They are wary and distant and keep to themselves. They prefer respect to friendship and guard their privacy jealously. When interacting with them, it is wise to allow them the space they feel they need.

Interaction	US	FS	NPS Students	US%	FS%	NPS Students%
Competitors	6	1	7	15.79	8.33	14.00
Leaders	13	8	21	34.21	66.67	42.00
Unassuming	4	1	5	10.53	8.33	10.00
Welcomers	15	2	17	39.47	16.67	34.00
Total	38	12	50	100.00	100.00	100.00

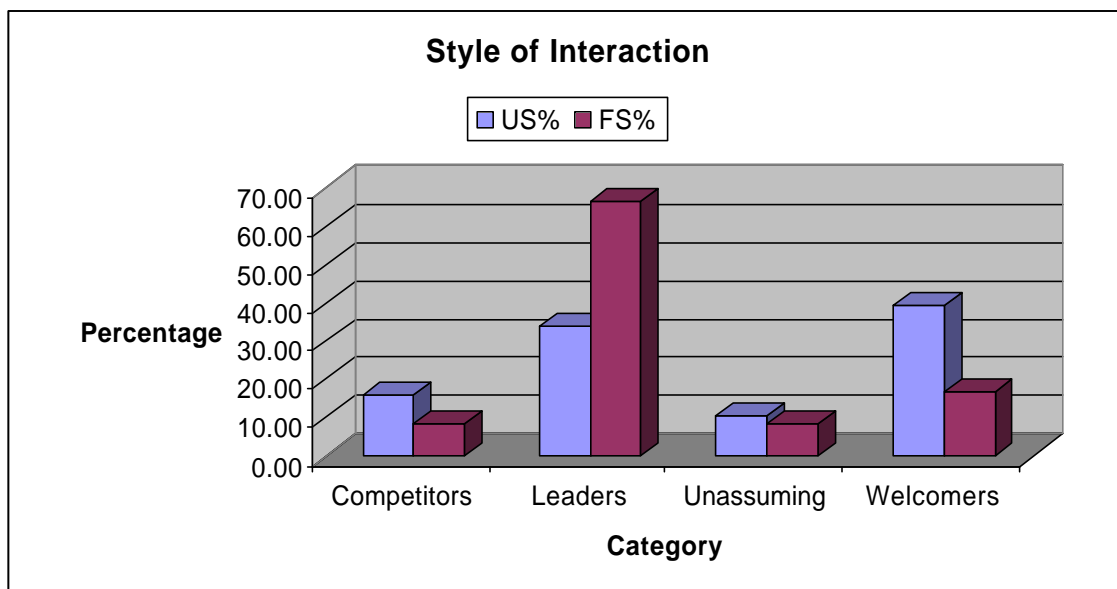

5. Analysis

Clearly the sample of foreign students has a strong tendency to leadership. The US student sample tends towards welcomers or leaders. There exist also a significant proportion of competitors, which is obviously not a style of interactions that any organization would prefer.

G. STYLE OF ACTIVITY

The style of interactions is defined by the interaction between the factors extraversion (E) and conscientiousness (C). The different categories are defined as:

1. Fun Lovers

Individuals qualify for this category if they score high in extraversion and low in conscientiousness (E+, C-).

They are full of energy and vitality, but they find it hard to channel their energy in constructive directions. Instead they prefer to enjoy life with thrills, adventures, and raucous parties. They are spontaneous and impulsive, ready to drop work for the chance of a good time

2. Go Getters

Individuals qualify for this category if they score high in extraversion and high in conscientiousness (E+, C+).

They are productive and work with a rapid tempo. They know exactly what needs to be done and are eager to pitch in. They might design their own self-improvement program and follow it with zeal. They might seem pushy if they try to impose their style on others.

3. Plodders

Individuals qualify for this category if they score low in extraversion and high in conscientiousness (E-, C+).

They are methodical workers who concentrate on the task at hand and work slowly and steadily until it's completed. In leisure as in work, they have a measured pace. They cannot be hurried, but they can be counted upon to finish whatever tasks they are assigned.

4. The Lethargic

Individuals qualify for this category if they score low in extraversion and low in conscientiousness (E-, C-).

They are unenthusiastic and have few plans or goals to motivate them. They tend to be passive and respond only to the most pressing demands. They rarely initiate activities, and in group activities they often find themselves left behind.

Activity	US	FS	NPS Students	US%	FS%	NPS Students%
Funlovers	6	6	12	15.79	50.00	24.00
Go-Getters	22	4	26	57.89	33.33	52.00
Lethargic	3	1	4	7.89	8.33	8.00
Plodders	7	1	8	18.42	8.33	16.00
Total	38	12	50	100.00	100.00	100.00

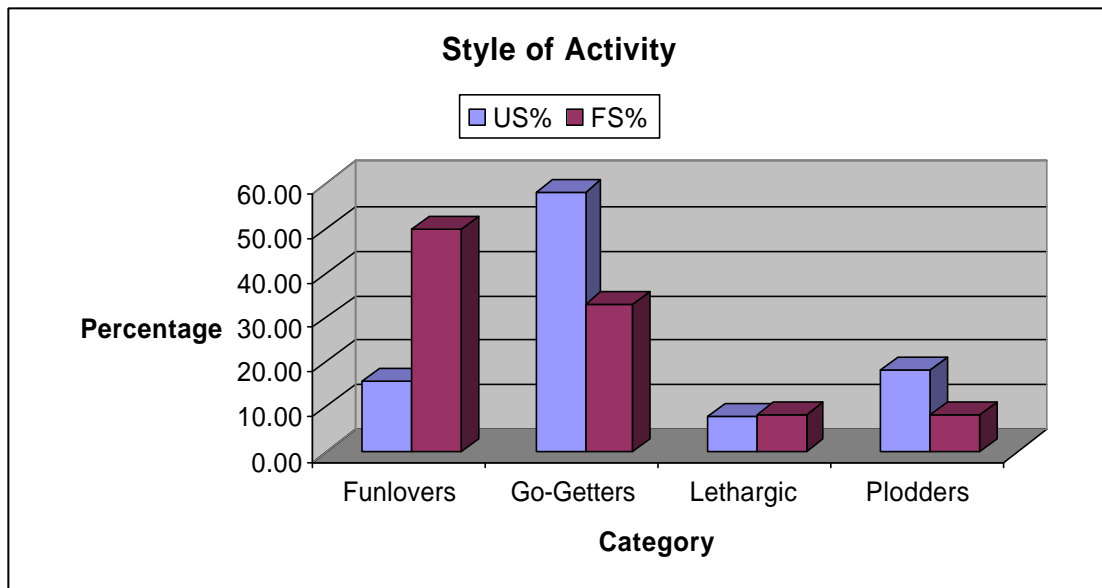

5. Analysis

The majority of the US student sample is go-getters. The international students tend to be fun-lovers or go-getters. This indicates that the US students exhibit a more focused and goal directed behavior compared to the sample of foreign students and, of course, to a normal population.

H. STYLE OF ATTITUDES

The style of attitudes is defined by the interaction between the factors openness (O) and agreeableness (A). The different categories are defined as:

1. Free Thinkers

Individuals qualify for this category if they score high in openness and low in agreeableness (O+, A-).

They are critical thinkers who are swayed neither by tradition nor by sentimentality. They consider all views but then make their judgments about right and wrong, and they are willing to disregard others' feelings in pursuing their own idea of the truth.

2. Progressives

Individuals qualify for this category if they score high in openness and high in agreeableness (O+, A+).

They take a thoughtful approach to social problems and are willing to try new solutions. They have faith in human nature and are confident that society can be improved through education, innovation, and cooperation. They believe in reason and being reasonable.

3. Traditionalists

Individuals qualify for this category if they score low in openness and high in agreeableness (O-, A+).

These individuals rely on the values and beliefs of their family and heritage in seeking the best way for people to live. They feel that following the established rules without questions is the best way to ensure peace and prosperity for everyone.

4. Resolute Believers

Individuals qualify for this category if they score low in openness and low in agreeableness (O-, A-).

These individuals have strong and unchanging beliefs about social policies and personal morality. Because they view human nature with considerable skepticism, they support strict discipline and a get-tough approach to social problems. They expect everyone to follow the rules.

Attitudes	US	FS	NPS Students	US%	FS%	NPS Students%
Free Thinkers	10	9	19	26.32	75.00	38.00
Progressives	14	2	16	36.84	16.67	32.00
Resolute Believers	9	0	9	23.68	0.00	18.00
Tradionalists	5	1	6	13.16	8.33	12.00
Total	38	12	50	100.00	100.00	100.00

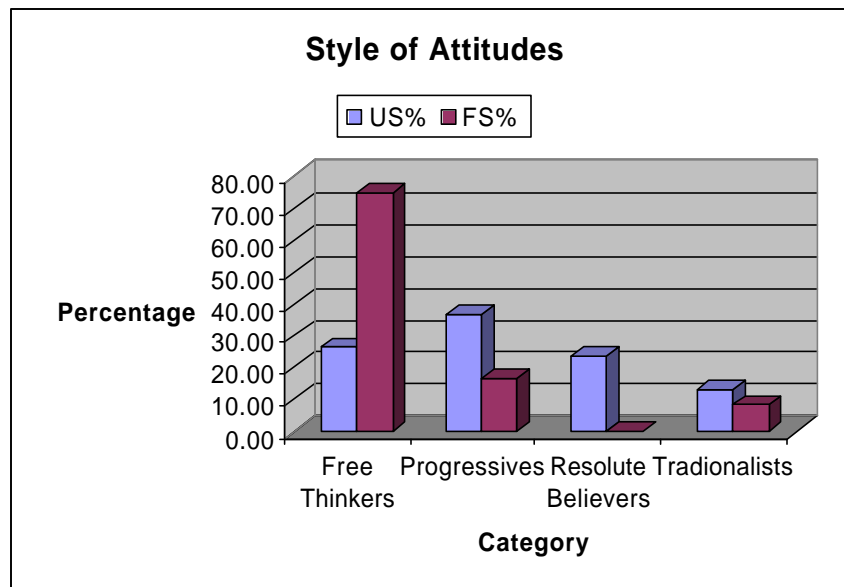

5. Analysis

The attitude of free and critical thinking is very pronounced with the foreign student sample. The US student sample tends slightly to the progressive side followed by free thinkers and resolute believers. There appears to be a significant cultural difference between US and foreign students.

I. STYLE OF LEARNING

The style of learning is defined by the interaction between the factors openness (O) and conscientiousness (O). The different categories are defined as:

1. Dreamers

Individuals qualify for this category if they score high in openness and low in conscientiousness (O+, C-).

They are attracted to new ideas and can develop them with imaginative elaborations, but they may get lost in flights of fancy. They are good in starting innovative projects, but they are less successful in completing them and may need help in staying focused. They are able to tolerate uncertainty and ambiguity

2. Good Students

Individuals qualify for this category if they score high in openness and low in conscientiousness (O+, C-).

Although they are not necessarily more intelligent than others, they combine a real love of learning with the diligence and organization to excel. They have a high aspiration level and are often creative in their approach to solving problems. They are likely to go as far academically as their gifts allow.

3. By-The-Bookers

Individuals qualify for this category if they score low in openness and high in conscientiousness (O-, C+).

These individuals are diligent, methodical, and organize, and they abide by all the rules. But they lack imagination and prefer step-by-step instructions. They excel at rote learning but have difficulties with questions that have no one right answer. They have a need for structure and closure.

4. Reluctant Scholars

Individuals qualify for this category if they score low in openness and low in conscientiousness (O-, C-).

Academic and intellectual pursuits are not their strength or preference. They need special incentives to start learning and to stick with it. They may need help in organizing their work and reminders to keep them on schedule. They may have problems maintaining attention.

Learning	US	FS	NPS Students	US%	FS%	NPS Students%
By-The-Bookers	12	1	13.00	31.58	8.33	26.00
Dreamers	7	7	14.00	18.42	58.33	28.00
Good Students	17	4	21.00	44.74	33.33	42.00
Reluctant Scholar	2	0	2.00	5.26	0.00	4.00
Total	38	12	50.00	100.00	100.00	100.00

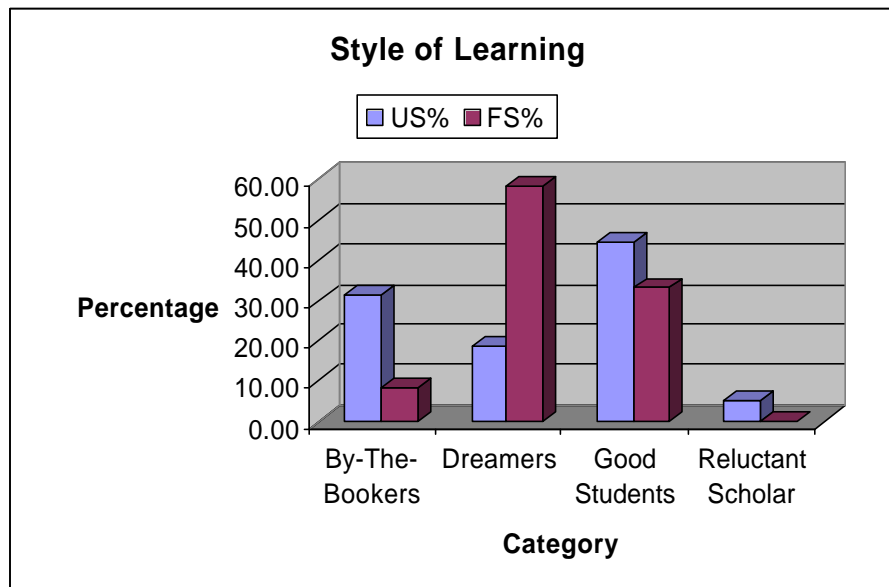

5. Analysis

US students are mainly good students or by-the-bookers. A minority can be categorized as dreamers. This is clearly different with the foreign student sample. Here the main category is dreamers followed by good students. They seem to be more curious and imaginative than their American counterparts.

J. STYLE OF CHARACTER

The style of character is defined by the interaction between the factors agreeableness (A) and conscientiousness (C). The different categories are defined as:

1. Well-Intentioned

Individuals qualify for this category if they score high in agreeableness and low in conscientiousness (A+, C-).

They are giving, sympathetic, and genuinely concerned about others. However, their lack of organization and persistence means that they sometimes fail to follow through on their good intentions. They may be best at inspiring kindness and generosity in others.

2. Effective Altruists

Individuals qualify for this category if they score high in agreeableness and high in conscientiousness (A+, C+).

They are individuals who work diligently for the benefit of the group. They are high in self-discipline and endurance, and they channel their efforts to the service of others. As volunteers, they are willing to take on difficult or thankless tasks and will stick to them until they get the job done.

3. Self-Promoters

Individuals qualify for this category if they score high in agreeableness and low in conscientiousness (A+, C-).

They are concerned first and foremost with their own needs and interests, and they are effective in pursuing their own ends. They may be highly successful in business or politics because of their single-minded pursuit of their own interests.

4. Undistinguished

Individuals qualify for this category if they score low in agreeableness and low in conscientiousness (A-, C-).

They are more concerned with their own comfort and pleasure than with the well being of others. They tend to be weak-willed and are likely to have some undesirable habits they find difficult to correct.

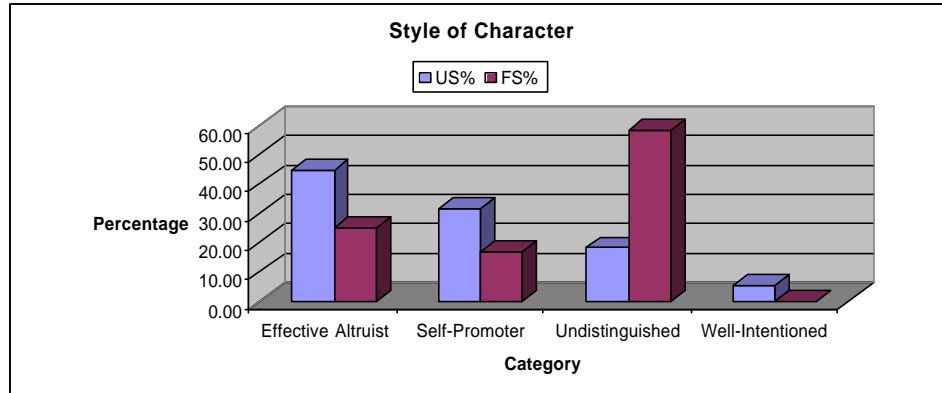

5. Analysis

The US student sample shows that the majority are either effective altruists or self promoters. The data indicates that the majority foreign student sample tend to be undistinguished which is certainly an undesirable feature for any organization. Clearly the tendency of foreign students to score low in conscientiousness effects this interaction.

THIS PAGE INTENTIONALLY LEFT BLANK

LIST OF REFERENCES

- Arntzen, A. (1998). Software Components for Air Defense Planing. Operations Research. Monterey, Naval Postgraduate School.
- Arthur, W. B. (1994). Inductive Reasoning and Bounded Rationality (The El Farol Problem). Amer. Econ. Review (Papers and Proceedings).
- Arthur, W. B. (1999). "Complexity and the Economy." Science 284: 107-109.
- Axelrod, R. (1997). "Advancing the Art of Simulation in the Social Sciences Obtaining, Analyzing, and Sharing Results of Computer Models." Complexity 3(2): 16-22.
- Axelrod, R. (1997). The Complexity of Cooperation: Agent-Based Models of Competition and Collaboration. Princeton, NJ, Princeton University Press.
- Badcock, C. (2000). Evolutionary Psychology A Critical Introduction. Cambridge, UK, Polity Press.
- Balakrishnan, J. D. (1998). "Measures and Interpretations of Vigilance Performance: Evidence against the detection Criterion." Human Factors 40(4): 601-623.
- Balbo, G., J. Desel, et al. (2000). Introductory Tutorial Petri Nets. 21st International Conference on Application and Theory of Petri Nets, Aarhus, Denmark,.
- Belenky, G. (1994). Sleep, Sleep Deprivation, and Human Performance in Continuous Operations. Food Components to Enhance Performance: An Evaluation of Potential Performance-Enhancing Food Components for Operational Rations. B. M. Marriott. Washington, D.C., The National Academies Press: 127-135.
- Boeree, G. (1999). Personality Theories. 2002.
- Bohmann, W. (1999). STAFFSIM, An Interactive Simulation For Rapid, Real Time Course of Action Analysis by U.S. Army Brigade Staffs. Operations Research. Monterey, Naval Postgraduate School.
- Bradley, G., A. Buss, et al. (1998). "An Architecture for Dynamic Planning and Execution Using Loosely Coupled Components." Naval Postgraduate School Research Newsletter 8: 1-7.
- Buss, A. H. (1996). Modeling with Event Graphs. 1996 Winter Simulation Conference.
- Buss, A. H. and P. J. Sanchez (2002). Building Complex Models With LEGOs (Listener Event Graph Objects). Winter Simulation Conference.
- Buss, D. (1999). Evolutionary Psychology The New Science of The Mind. Needham Heights, MA, Allyn & Bacon.
- Calfee, S. H. (2003). Autonomous Agent-Based Simulation of an AEGIS Cruiser Combat Information Center Performing Battle Group Air-Defense Commander Operations. MOVES Institute. Monterey, Naval Postgraduate School.
- Carley, K. M. (1996). Validating Computational Models, Department of Social and Decision Sciences Carnegie Mellon University.
- Cartwright, J. (2000). Evolution and Human Behavior: Darwinian Perspectives on Human Nature. Cambridge, MA, Bradford Book MIT Press.
- Charteris, P. L., B. L. Golden, et al. (2001). Livestock Breeding Industries as Complex Adaptive Systems. Fort Collins CO, The Department of Animal Sciences, Colorado State University,: 1-6.

- Chong, R. S. (2001). "Low-level Behavioral Modeling and the HLA: An EPIC-Soar Model of an Enroute Air-Traffic Control Task."
- Chorev, M., Colonel Israel Armed Forces (1996). Surprise Attack The Case of the Yom Kippur War. Washington, Industrial College of the Armed Forces: 30 pp.
- Cosmides, L. and J. Tooby (1998). Evolutionary Psychology: A Primer. 2002.
- Costa, P. T. and R. McCrae (2000). NEO Software System fo Windows Manual. Odessa, FL, PAR Psychological Assesment Resources Inc.
- Cowan, G. A., D. Pines, et al. (1994). Complexity: Metaphors, Models, and Reality. Boulder, CO, Westview Press.
- Crawford, C. and D. Krebs, L. (1998). Handbook of Evolutionary Psychology Ideas Issues and Applications. Mahwah NJ, Lawrence Erlbaum Associates.
- Davies, D. and R. Parasuraman (1982). The Psychology of Vigilance. New York, Academic Press.
- Davies, D. and G. S. Tune (1970). Human Vigilance Performance. London, Trinity Press.
- Eggleston, R. G., M. Young, et al. (2001). Modeling Human Work through Distributed Cognition. 10th Conference on Computer Generated Forces and Behavioral Representation, Norfolk, VA, SISO.
- Endsley, M. R. (2000). Theoretical Underpinnings of Situation Awareness: a Critical review. Situation Awareness Analysis and Measurement. M. R. Endsley and G. D.J. Mahwah, NJ, Lawrence Erlbaum Associates.
- Epstein, J. M. and R. Axtell (1996). Growing Artificial Societies: Social Science from the Bottom up. Washington, D.C., Brookings Institution.
- Evans, D. and O. Zarate (1999). Introducing Evolutionary Psychology, Totem Books.
- Eysenck, H. and M. Eysenck (1985). Personality and Individual Differences A Natural Science Approach. New York, Plenum Press.
- Fenner, P., S. Leahy, et al. (1999). "Prevention of Drowning: Visual Scanning and Attention Span in Lifeguards." The Journal of Occupational Health and Safety - Australia and New Zealand 15(1): 61-66.
- Ferber, J. (1999). Multi Agent Systems An Introduction to Distributed Artificial Intelligence. Harlow UK, Addison Wesley.
- Flores-Mendez, R. A. (1999). "Towards a Standardization of Multi-Agent System Frameworks." ACM Crossroads Student Magazine 5(4).
- Frankenhaeuser, M. (1997). To Err is Human: Nuclear War by Mistake?*. Stockholm Sweden, Psychology Division, Karolinska Institute, Stockholm.
- Gamma, E., R. Helm, et al. (1995). Design Patterns: Elements of Reusable Object-oriented Software. Indianapolis, IN, Addison-Wesley.
- Gell-Mann, M. (1994). The Quark and the Jaguar Adventures in the Simple and the Complex. New York, W.J.Freemann and Company.
- Gill, G. W. (1996). "Vigilance in Cytoscreening." Advance Med Lab Prof. 8(15): 14-21.
- Gluck, K. and R. Pew (2001). Lessons Learned and Future Directions for the AMBR Model Comparison Project. 10th Conference on Computer Generated Forces and Behavioral Representation, Norfolk, VA.
- Gluck, K. and R. Pew (2001). Overview of the Agent-based Modeling and Behavior Representation (AMBR) Model Comparison Project. 10th Conference on Computer Generated Forces and Behavioral Representation, Norfolk, VA.

- Goldberg, D. E. (1989). Genetic Algorithms in Search, Optimization & Machine Learning. New York, Addison Wesley.
- Grilo, A., A. Caetano, et al. (2000). Immune System Simulation through a Complex Adaptive System Model, CiteSeer Scientific Literature Digital Library.
- Gusev, A. N. and S. A. Schapkin (2001). Individual Differences in Auditory Signal Detection Task: Subject-Oriented Study. Fechner Day 2001. Proceedings of the Seventeenth Annual Meeting of the International Society of Psychophysics, Leipzig Germany, Lengerich.
- Hancock, P. A. and J. Warm (1989). A Dynamic Model of Stress and Sustained Attention. Human Factors 31(5): 519-537.
- Hershberg, U. and S. Efroni (2001). "The Immune System and Other Cognitive Systems." Complexity 6(5).
- Heuer, R. J. (1999). Psychology of Intelligence Analysis. Washington DC, Center for the Study of Intelligence Central Intelligence Agency.
- Hiles, J., M. VanPutte, et al. (2001). Innovations in Computer Generated Autonomy at the MOVES Institute. Monterey, Modeling, Virtual Reality and Simulations (MOVES) Institute, Naval Postgraduate School.
- Holland, J. (1995). Hidden Order: How Adaptation Builds Complexity. Reading, MA, Perseus Book.
- Holland, J. (1998). Adaptation in Natural and Artificial Systems. Cambridge, MA, MIT Press.
- Horn, P. (2001). Autonomic Computing: IBM's Perspective on the State of Information Technology. New York, IBM.
- Horne, G. E. and M. K. Lauren (2000). Operational Synthesis Applied to Mutual NZ/US Questions. Part I.: Quantico, VA, Marine Corp Combat Development Command: 1-10.
- Howard, P. J. and J. M. Howard (1995). The Big Five Quickstart, Center for Applied Cognitive Studies (CENTACS).
- Ilachinski, A. (1997). Irreducible Semi-Autonomous Adaptive Combat (ISAAC): An Artificial-Life Approach to Land Warfare (U). Alexandria, VA, Center for Naval Analyses.
- Kaarlela, C. (1997). New Gene Therapy Technique Could Eliminate Insulin Injections for many Diabetics, Jeffrey Norris and Jennifer O'Brien (415) 476-481. 2003.
- Klein, G. (1999). Sources of Power: How People Make Decisions. Cambridge MA, MIT Press.
- Knepell, P. L. and D. C. Arangno (1993). Simulation Validation A Confidence Assesment Methodology. Los Alamitos, California, IEEE Computer Society Press.
- Koelega, H. S. (1992). "Extraversion and Vigilance Performance: 30 years of Inconsistencies." Psychological Bulletin 112(2): 239-258.
- Kresh, J. Y., I. Izrailyan, et al. (2002). The Heart as a Complex Adaptive System. Philadelphia, PA, Depts. of Cardiothoracic Surgery and Medicine MCP-Hahnemann School of Medicine / Drexel University.

- Laird, J. E. (2000). An Exploration into Computer Games and Computer Generated Forces. Eighth Conference on Computer Generated Forces and Behavior Representation, Orlando, FL.
- Lane, J. D. and S. J. Kasian (1998). "Binaural Auditory Beats Affect Vigilance." Psychology and Behavior 63(2): 249-252.
- Law, A. and D. Kelton (1991). Simulation Modeling and Analysis. New York, McGraw Hill.
- Le, H. B. (1999). Advanced Naval Surface Fire Support Weapon Employment Against Mobile Targets. Operations Research. Monterey, Naval Postgraduate School.
- Lebiere, C., J. R. Anderson, et al. (2001). Multi-Tasking and Cognitive Workload in an ACT-R Model of a Simplified Air Traffic Control Task.
- Lissack, M. R. (2000). "Complexity: the Science, its Vocabulary, and its Relation to Organizations." Emergence 1(1): 110-127.
- Loeb, M. (1986). Noise and Human Efficiency. Chichester, UK, John Wiley & Sons.
- Lowe, M. and D. Reeves (2002). Automated Neuropsychological Assessment Metrics: Norms for U.S. Navy Divers. Panama City, FL, Naval Sea System Command (NAVSEA), Navy Experimental Diving Unit.
- Mackworth, N. H. (1950). Researches on the Measurement of Human Performance. London: HMSO, Medical Research Council.
- Marion, R. and J. Bacon (2000). "Organizational Extinction and Complex Systems." Emergence 7(4): 71-96.
- Marshall, J. B. (1999). Meta-cat: A Self-Watching Cognitive Architecture for Analogy-Making and High Level Perception. Department of Computer Science. Bloomington, Indiana, Indiana University: 306.
- Matthews, G. (1997). Cognitive Science Perspectives on Personality and Emotion. Amsterdam, NL, North Holland.
- Matthews, G., D. Davies, et al. (1990). "Arousal, Extraversion and Individual Differences in Resource Availability." Journal of Personality and Social Psychology.
- Matthews, G., D. Davies, et al. (2000). Human Performance Cognition, Stress and Individual Differences. East Sussex, UK, Psychology Press.
- Matthews, G. and P. J. Holley (1993). "Cognitive Predictors of Vigilance." Human Factors 35(1): 3-24.
- McCauley, M. (2003). Feedback Concerning Dimensions of Cognitive Modeling. J. Wellbrink. Monterey.
- McKelvey, B. (2000). "Complexity Theory in Organization Science: Seizing the Promise or Becoming a Fad?" Emergence 1(1): 5-32.
- Methot, L. L. and B. E. Huitema (1998). "Effect of Signal Probability on Individual Differences in Vigilance." Human Factors 40(1): 102-110.
- Miller, G. A. (1956). "The Magical Number Seven, Plus or Minus Two: Some Limits on Our Capacity for Processing Information." The Psychological Review 63: 81-97.
- Minar, N., R. Burkhart, et al. (1996). The SWARM Simulation System: A Toolkit for Building Multi-Agent Simulation. Santa Fe, NM, Santa Fe Institute.
- Mitchell, M. (1998). A Complex-Systems Perspective on the "Computation vs. Dynamics" Debate in Cognitive Science. Santa Fe, Santa Fe Institute: 6 pp.

- Mitchell, M. (2000). Analogy-Making as a Complex Adaptive System. Design Principles for the Immune System and Other Distributed Autonomous Systems. New York, Oxford University Press.
- Mitleton-Kelly, E. (1997). Complex Adaptive Systems in an Organisational Context. British Academy of Management Conference, London, UK.
- Miyake, A. and P. Shah (1999). Models of Working Memory: Mechanisms of Active Maintenance and Executive Control. New York, Cambridge University Press.
- Nêcka, E. and B. Szymura (2001). "Who Has the Temperament to Attend? Neuroticism, Extraversion, and the Mechanisms of Attention." Polish Psychological Bulletin 32(3): 159-166.
- Newell, A. (1982). "The Knowledge Level." Artificial Intelligence 18: 87-127.
- Newton, I. (1729). Mathematical Principles of Natural Philosophy. 2002.
- O'Reilly, R. C. and Y. Munakata (2000). Computational Explorations in Cognitive Neuroscience: Understanding the Mind by Simulating the Brain. Cambridge, MA, MIT Press.
- Palinkas, L. A. (2000). Mental and Cognitive Performance in the Cold. Performance in the Cold, Oulu, Finland.
- Parasuraman, R. (1998). The Attentive Brain. Cambridge, MA, MIT Press.
- Parasuraman, R. (2003). Personal Email: Modeling Vigilance. J. Wellbrink.
- Pew, R. W. and A. S. Mavor (1998). Modeling Human and Organizational Behavior: Application to Military Simulation. Washington D.C, National Academy of Science.
- Poulton, E. C. (1970). Environment and Human Efficiency. Springfield, IL, Charles Thomas.
- Ralston, A., E. D. Reilly, et al. (2000). Encyclopedia of Computer Science. London, UK, Nature Publishing Group.
- Ritter, F. E., N. R. Shadbolt, et al. (1999). Techniques for Modelling Human Performance in Synthetic Environments: A Supplementary Review. Nottingham, UK, ESRC Centre for Research in Development, Instruction and Training: 1-92.
- Sawin, D. A. and M. W. Scerbo (1995). "Effects of Instruction Type and Boredom Proneness in Vigilance: Implications for Boredom and Workload." Human Factors 37(4): 752-765.
- Schapkin, S. A. and A. N. Gusev (2001). Effect of Hemispheric Asymmetry on Performance in Auditory Vigilance Task. Fechner Day 2001: Proceedings of the Seventeenth Annual Meeting of the International Society of Psychophysic, Leipzig Germany, Lengerich.
- Schelling, T. C. (1962). Surprise. Pearl Harbor: Warning and Decision. R. Wohlstetter.
- Schelling, T. C. (1978). Micro Motives and Macro Behavior. New York, W.W.Norton & Company.
- Schrepf, N. (1999). Visual Planning Aid for Movement of Ground Forces in Operations other than War. Operations Research. Monterey, Naval Postgraduate School.
- Schruben, L. (1983). "Simulation Modeling with Event Graphs." Communications of the ACM 26(11): 957-963.
- Schruben, L. (1992). Graphical Model Structures for Discrete Event Simulation. Winter Simulation Conference 1992, Arlington, VA, USA.

- Schruben, L. (1995). Building Reusable Simulators Using Hierarchical Event Graphs. Winter Simulation Conference 1995 (WSC '95), Arlington, VA, USA.
- Schruben, L. and E. Yucesan (1994). Transforming Petri Nets into Event Graph Models. Winter Simulation Conference 1994 (WSC '94), Lake Buena Vista, FL, USA.
- See, J., S. R. Howe, et al. (1995). "Meta-Analysis of the Sensitivity Decrement in Vigilance." Psychological Bulletin 117(2): 230-249.
- See, J., J. Warm, et al. (1997). "Vigilance and Signal Detection Theory: An Empirical Evaluation of Five Measures of Response Bias." Human Factors 39(1): 14-30.
- Shilling, E. (2003). MyersBriggs vs. NEO FFI. J. Wellbrink.
- Smith, R. (2002). Counter Terrorism Simulation: A New Breed of Federation. Simulation Interoperability Workshop Spring, Orlando, FL.
- Sokolowski, J. A. (2002). Can a Composite Agent Be Used to Implement a Recognition-Primed Decision Model? 11th Computer Generated Forces Conference, Orlando, Florida, SISO.
- Styles, E. A. (1997). The Psychology of Attention. East Sussex, UK, Psychology Press.
- Temple, J., J. Warm, et al. (2000). "The Effects of Signal Salience and Caffeine on Performance, Workload and Stress in the Abbreviated Vigilance Task." Human Factors 42(2): 183-194.
- Tosey, P. (2002). Teaching at the Edge of Chaos. Teaching & Learning Forum for Colleagues in the School of Educational Studies, Surrey, UK.
- Waldrop, M. M. (1992). Complexity: the Emerging Science at the Edge of Order and Chaos. New York, Touchstone.
- Warhola, P. (1997). An Analysis of Alternative Methods to Conduct High Resolution Activities in a Variable Resolution Simulation. Operations Research. Monterey, Naval Postgraduate School.
- Warm, J. (1984). Sustained Attention in Human Performance. New York, John Wiley & Sons.
- Wickens, C. (1992). Engineering Psychology and Human Performance. New York, Harper Collins.
- Wickens, C. (2002). Email on Multiple Resource Model Implementation. J. Wellbrink. Monterey.
- Wickens, C. (2002). Multiple Resources and Performance Prediction. Stanton Handbook (not yet published).
- Wilson, R. and K. Frank (2001). Encyclopedia of Cognitive Science. Cambridge, MA, MIT Press.
- Zachary, W. W. (2001). Developing a Multi-tasking Cognitive Agent Using the COGNET/iGEN Integrative Architecture. 10th Conference on Computer Generated Forces and Human Behavior Modeling, Orlando, FL, SISO.
- Zoccolotti, P., A. Matano, et al. (2000). "Patterns of Attentional Impairment following Closed Head Injury: A Collaborative European Study." Cortex 36(1): 93-107.

INITIAL DISTRIBUTION LIST

1. Defense Technical Information Center
Ft. Belvoir, VA
2. Dudley Knox Library
Naval Postgraduate School, Monterey, CA
3. Dr. Michael Zyda
Director, MOVES Institute
Naval Postgraduate School, Monterey, CA
4. Dr. Ted Lewis
Department of Computer Science
Naval Postgraduate School, Monterey, CA
5. CDR Lisa Curtin
Dean of Students
Naval Postgraduate School, Monterey, CA
6. Dr. Rudy Darken
Department of Computer Science
Naval Postgraduate School, Monterey, CA
7. Dr. Maria Rasmussen
Department of National Security Affairs
Naval Postgraduate School, Monterey, CA
8. Professor John Hiles
MOVES Institute
Naval Postgraduate School, Monterey, CA
9. Major Joerg Wellbrink
MOVES Institute
Naval Postgraduate School, Monterey, CA
10. CAPT Michael Lilienthal
Director, Defense Modeling and Simulation Office
Alexandria, VA

11. CAPT Roland Mulligan
N6M
Washington, DC
13. Jim Weatherly
N60M
Washington, DC