



2010-09

MH-60 Seahawk / MQ-8 Fire Scout interoperability

Hernandez, Mark

Monterey, California. Naval Postgraduate School

<http://hdl.handle.net/10945/6952>



**DUDLEY
KNOX
LIBRARY**

Calhoun is a project of the Dudley Knox Library at NPS, furthering the precepts and goals of open government and government transparency. All information contained herein has been approved for release by the NPS Public Affairs Officer.

**Dudley Knox Library / Naval Postgraduate School
411 Dyer Road / 1 University Circle
Monterey, California USA 93943**

<http://www.nps.edu/library>

NPS-SE-10-006



NAVAL
POSTGRADUATE
SCHOOL

MONTEREY, CALIFORNIA

MH-60 Seahawk / MQ-8 Fire Scout Interoperability

Capstone Design Project

by

MSSE Cohort 311-0911

Marc Hernandez, CAPT Henry Jackson, Oscar Meza,
Craig McKenney, Rebecca Morgan, CDR Billy Palermo,
Sommer Roach, Al Spaterna, Diane Wathen

27 September 2010

Approved for public release; distribution is unlimited

THIS PAGE INTENTIONALLY LEFT BLANK

**NAVAL POSTGRADUATE SCHOOL
Monterey, California 93943-5000**

Daniel T. Oliver
President

Leonard A. Ferrari
Executive Vice President and
Provost

This report was prepared for the Chairman of the Systems Engineering Department in partial fulfillment of the requirements for the degree of Master of Science in Systems Engineering.

Reproduction of all or part of this report is authorized.

Rebecca Morgan

Sommer Roach

Diane Wathen

CAPT Henry Jackson

Marc Hernandez

Al Spaterna

Craig McKenney

CDR Billy Palermo

Oscar Meza

Reviewed by:

Eugene P. Paulo, Ph.D.
Project Advisor

CAPT Ron Carlson, USN (Ret)
Project Advisor

Released by:

Cliff Whitcomb, Ph.D.
Department of Systems Engineering

Karl A. van Bibber, Ph.D.
Vice President and Dean of Research

THIS PAGE INTENTIONALLY LEFT BLANK

REPORT DOCUMENTATION PAGE*Form Approved*
OMB No. 0704-0188

Public reporting burden for this collection of information is estimated to average 1 hour per response, including the time for reviewing instructions, searching existing data sources, gathering and maintaining the data needed, and completing and reviewing this collection of information. Send comments regarding this burden estimate or any other aspect of this collection of information, including suggestions for reducing this burden to Department of Defense, Washington Headquarters Services, Directorate for Information Operations and Reports (0704-0188), 1215 Jefferson Davis Highway, Suite 1204, Arlington, VA 22202-4302. Respondents should be aware that notwithstanding any other provision of law, no person shall be subject to any penalty for failing to comply with a collection of information if it does not display a currently valid OMB control number. **PLEASE DO NOT RETURN YOUR FORM TO THE ABOVE ADDRESS.**

1. REPORT DATE (DD-MM-YYYY) 27-09-2010		2. REPORT TYPE Technical Report		3. DATES COVERED (From - To)	
4. TITLE AND SUBTITLE MH-60 Seahawk/MQ-8 Fire Scout Interoperability				5a. CONTRACT NUMBER	
				5b. GRANT NUMBER	
				5c. PROGRAM ELEMENT NUMBER	
6. AUTHOR(S) Mark Hernandez, CAPT Henry Jackson, Oscar Meza, Craig McKinney, Rebecca Morgan, CDR Billy Palermo, Sommer Roach, Al Spaterna, Diane Wathen				5d. PROJECT NUMBER	
				5e. TASK NUMBER	
				5f. WORK UNIT NUMBER	
7. PERFORMING ORGANIZATION NAME(S) AND ADDRESS(ES) Naval Postgraduate School Monterey, CA 93943-5000				8. PERFORMING ORGANIZATION REPORT NUMBER NPS-SE-10-006	
9. SPONSORING / MONITORING AGENCY NAME(S) AND ADDRESS(ES) N/A				10. SPONSOR/MONITOR'S ACRONYM(S)	
				11. SPONSOR/MONITOR'S REPORT NUMBER(S)	
12. DISTRIBUTION / AVAILABILITY STATEMENT Approved for public release; distribution is unlimited					
13. SUPPLEMENTARY NOTES The views expressed in this report are those of the authors and do not reflect the official policy or position of the Department of Defense or the U.S. Government.					
14. ABSTRACT As part of a Naval Postgraduate School's capstone project in Systems Engineering, a project team from Cohort 311-0911 performed a Systems Engineering analysis. This Project focused on defining alternatives for enhanced Anti-Surface Warfare (ASUW) mission effectiveness through increased interoperability and integration for the Fire Scout Unmanned Air Vehicle and Seahawk helicopter. Specifically, the Project explored the available trade space for enhancing communications back to the ship for analysis and decision-making. Modeling and Simulation (M&S) was used to assess the impact of enhanced communication on specific Key performance Parameters (KPPs) and Measures of Effectiveness (MOEs) associated with the ASUW mission. Once the trade space was defined, alternatives were analyzed and a recommendation provided that supports near-, mid-, and long-term mission enhancement.					
15. SUBJECT TERMS					
16. SECURITY CLASSIFICATION OF: Unclassified			17. LIMITATION OF ABSTRACT UU	18. NUMBER OF PAGES 169	19a. NAME OF RESPONSIBLE PERSON
a. REPORT Unclassified	b. ABSTRACT Unclassified	c. THIS PAGE Unclassified			19b. TELEPHONE NUMBER (include area code)

THIS PAGE INTENTIONALLY LEFT BLANK

EXECUTIVE SUMMARY

This report documents the Systems Engineering research on a Concept of Operations (CONOPS) for interoperability between the MQ-8 Fire Scout Vertical Takeoff Unmanned Air Vehicle (VTUAV) and the MH-60 Seahawk Multi Mission Helicopter, as they are intended to be deployed off the Littoral Combat Ship (LCS). This research provides a foundation for defining an integrated System of Systems (SOS) that with further study, may support a future acquisition program designed to enhance interoperability between the MH-60 and Fire Scout whenever they are deployed together.

This project started with the goal of improving interoperability between the Fire Scout and the MH-60 helicopter as they are planned to be deployed aboard US Navy vessels. The Chief of Naval Operations (CNO) mandated increased use of Unmanned Vehicles in an effort to minimize quantity and risk to aircraft operations and personnel. Improving interoperability has the potential to increase mission success and reduce manpower requirements by more effectively prosecuting assigned missions. Currently, the Fire Scout performs Intelligence, Surveillance, and Reconnaissance missions, whereas the MH-60 helicopter performs a wider variety of mission, including, but not limited to, Anti Surface Warfare (ASUW), Logistics, Anti-Mine Countermeasures (AMCM), and Special Warfare missions. Fire Scout has been deployed during test mission with Helicopter Squadron HSL-42, where it was flown as a stand-alone unit (i.e. not interoperating with the MH-60) during test and evaluation.

The project team interviewed requirements officers from the CNO and the Commander Naval Air Forces staff organizations and determined that a significant area of interest was the protection of a High Value Asset (HVA) from a small boat swarm attack while transiting a choke point, such as the Straits of Hormuz, where threats could be intermingled with commercial shipping and pleasure craft. The newly-commissioned LCS was chosen as the launch platform for the MH-60 and Fire Scout, as it is currently scheduled to deploy with these aircraft in the 2012 timeframe. With this information, we created a Concept of Operations, a Mission Scenario, and an Architecture that defined the interface between the LCS, Fire Scout, and MH-60 helicopter when performing the ASUW mission to protect the HVA from a small boat swarm attack.

The architecture and interface definitions led to analysis of the communications links between the aircraft and LCS as currently configured, and defined a “decision path” required to support the mission activities of detection, classification, and identification of targets in the operational area. This “decision path” was defined to support prosecution of a target identified as a threat. The research stopped after the identification phase; the engagement phase of the mission and target prosecution was beyond the scope of the project and modeling approach, and remains for follow-on study. The project adopted the concept “more”, “better”, and “faster” information provided to decision makers would minimize the time required to detect, classify, and identify the threats, leaving the most time available for prosecuting those threats as necessary.

The research determined three separate opportunities existed to improve the decision-making time. These opportunities were subsequently defined as SOS alternatives. First, the Fire Scout sensor data (video) was data-linked to the Fire Scout Control Station (FSCS) on the LCS. The FSCS is not currently connected to the Combat Information Center (CIC) on the LCS, so there is no direct way to get the Fire Scout sensor data to the decision makers in CIC. Alternative 1 addressed improvements to the LCS to distribute data within the LCS, providing “more” and “faster” data to the decision makers.

Another limiting factor in the communication chain was the use of only one Tactical Common Data Link (TCLD) channel on LCS, even though there are two channels available. The MH-60R helicopter had a “Hawk Link” data link that is compatible with the standard Common Data Link (CDL) message structure, whereas the Fire Scout was equipped with TCDL. Currently, only one aircraft can send sensor data to the LCS down the TCDL data link. (Further, only one of the LCS ship configurations has two data link antennas. The other has only one antenna, and thus is only capable of a half-duplex link between the two aircraft.) Given the opportunity to employ existing data links, Alternative 2 addressed opening up both TCDL channels so that sensor data from both aircraft can be monitored simultaneously. Opening up both TCDL channels on the LCS again provided “more” and “faster” data to the decision makers. Also, since the MH-60R is currently the only MH-60 in the inventory with a CDL-compatible data link and is planned to deploy from the LCS, it became a focal point for our analyses.

The third and final alternative investigated was to provide Fire Scout sensor data to the MH-60 helicopter to support sensor fusion, and to provide control of the Fire Scout sensor system by the MH-60. This approach would allow the MH-60 the capability to merge Fire Scout sensor data with on-aircraft data, and provide a more complete picture for making tactical decisions, but it would require integration of the Fire Scout and MH-60 via data links. Potential implementation, for example may entail TCDL data link onboard the MH-60R to accommodate reception of the Fire Scout sensor data, re-transmission of that data to the LCS, or fusion of the Fire Scout data with MH-60R data for transmission to the LCS. It would also necessitate installation of FSCS components and applications on the MH-60R for control of the sensor suite. This approach provided “more”, “better”, and “faster” data to the decision makers, and also allowed the Fire Scout and MH-60 to work together when prosecuting a threat by using cooperative tactics.

The project employed both an Excel model and the Naval Simulation System (NSS) model to simulate the aforementioned alternatives, using time estimates for the steps in the decision chain. The SOS baseline performance was modeled first for comparison with each of the three alternatives. The Excel model indicated that Alternative 3 would provide the greatest improvement on the key metric, “Time to Identify.” Interestingly, the NSS model did not yield the same results. The differences in outcomes was analyzed and led to the conclusion that the NSS model was not created with the necessary fidelity to accurately capture the parameters of the mission scenario. The finding that warfare analysis models must be purpose-built for systems engineering analysis, by carefully defining the format and content of input and output parameters for the systems, scenarios and architectures, is an important lesson learned. With additional time (and funding), the NSS model could be modified to better reflect the system engineering concerns and yield more informative results. For example, the NSS model should be redesigned to support combining the effects of implementing more than one alternative.

To ensure the research and analysis of alternatives activities supported stakeholder interests and decision-making, the project created a Work Breakdown Structure and defined the tasks required to implement each of the alternatives as a stand-

alone effort. A parametric cost estimates was performed to create a “bang for the buck” assessment of the alternative. A high-level risk assessment was performed to categorize and quantify risks associated with each alternative. Collectively, the research addressed effectiveness of alternatives and provided a framework for assessment of cost, risk and performance impacts.

The project concluded that Alternative 1, linking the FSCS and CIC directly via data link onboard the LCS would provide the best “bang for the buck” to improve interoperability and overall mission effectiveness. This alternative was the least complex in terms of physical and functional integration. It also, therefore, brought the least risk and cost to a solution for the original requirements. Within the limits of the modeling, the NSS results indicated that Alternative 2, enabling the second TCDL channel on the LCS ship, would provide the greatest effectiveness. Taken together, the research provided systems engineering insight that an additive, incremental approach for implementing the three leading alternatives may be feasible and the optimal way to meet the requirements while evolving manning concepts, tactics and training for SOS operations with manned and unmanned assets. Each alternative could be pursued separately, but the combination of Alternative 1 and 2 may address not only the mission in focus, LCS defense against a swarm of small boats, but also provide a robust solution for improved interoperability and effectiveness across multiple missions. Modeling and analysis of cumulative effects may confirm that it would be more beneficial to implement Alternative 1 prior to or in conjunction with Alternative 2, as opposed to only Alternative 2. The same is true for the combined effects associated with Alternatives 1 and 3. Alternative 3 presented the highest cost and technical risk, but could also ultimately achieve the greatest interoperability improvement as mission planning methods and tactics are developed.

Currently, there is very little operational experience with the Fire Scout operating from a small ship such as the LCS, but as more experience is gained, greater utilization of the Fire Scout capabilities as a stand-alone aircraft, and eventually as an interoperable asset, will be achieved. This will open the doors for development of new missions and tactics. The foundation that has been laid by this research supports development of these future capabilities.

LIST OF ACRONYMS/ABBREVIATIONS

A-1	Alternative-1
A-2	Alternative-2
A-3	Alternative-3
AIS	Automatic Information System
AMCM	Airborne Mine Countermeasures
AOA	Analysis of Alternatives
AOP	Avionics Operating Program
APKWS	Advanced Precision Kill Weapon System
ARC- 210	Airborne Radio Communications
ASUW	Anti Surface Warfare
ASW	Anti Submarine Warfare
AV	Air Vehicle
AVO	Air Vehicle Operator
BDA	Battle Damage Assessment
C	Capability
C2	Command and Control
C2W	Command and Control Warfare
C4	Command, Control, Communications and Computer
CCC	Command, Control, Communications
CCOI	Critical Contacts of Interest
CDD	Capabilities Description Document
CDL	Common Data Link
CER	Cost Estimating Relationship
CIC	Combat Information Center
CNO	Chief of Naval Operations
COI	Contacts of Interest
COMREL	Communications Relay
CONOPS	Concept of Operations
COTP	Common Operational Tactical Picture
OTS	Off The Shelf

CS	Command Segment
CSAR	Combat Search and Rescue
CUCS	Common Unmanned Control System
CV	Aircraft Carrier
CVW	Aircraft Carrier Air Wing
DCLT	De-clutter
DOD	Department of Defense
DODAF.....	Department of Defense Architecture Framework
DOTMLPF	Doctrine Organization Training Materiel Leadership Personnel & Facilities
DVR	Digital Video Recorder
EFFBD	Enhanced Functional Flow Block Diagram
ELINT	Electronic Signals Intelligence
EO/IR	Electro-Optical / Infra-Red
ESM	Electronic Support Measures
EXCOMMS	External Communications
FEBA	Forward Edge of the Battle Area
FFBD	Functional Flow Block Diagram
FLIR	Forward Looking Infra Red
FMMP	Fire Scout Modular Mission Package
FS	Fire Scout
FSCS	Fire Scout Control System
GAU-17	Gun, Airborne Unit
GEOSIT	Geographical Situation
GIG	Global Information Grid
HF	High Frequency
HF	Hostile Force
HIS	Human System Integration
HVA	High Value Asset
ID	Identification
IDEF.....	Integration Definition for Function Modeling
IER	Information Exchange Requirements

IFF	Identify Friend or Foe
INMARSAT	International Maritime Satellite
IPPD	Integrated Product and Process Development
ISAR	Inverse Synthetic Aperture Radar
ISR	Intelligence, Surveillance and Reconnaissance
JCIDS	Joint Capability Integration and Development System
JP	Joint Publication
JROC.....	Joint Requirements Oversight Council
JTIDS	Joint Tactical Information Distribution System
KPP	Key Performance Parameter
LAN	Local Area Network
LCS	Littoral Combat Ship
LOGIR	Low Cost Guided Imaging Rocket
LOI.....	Level of Interoperability
LOS	Line of Sight
M&A.....	Modeling and Analysis
MBSE	Model Based Systems Engineering
MC	Mission Commander
MEDEVAC	Medical Evacuation
MIL-HDBK	Military Handbook
MIL-STD	Military Standard
MIO	Maritime Interdiction Operations
MMH	Multi Mission Helicopter
MOB	Mobility
MOE	Measure of Effectiveness
MPO	Mission Payload Operator
MSSE	Master of Science in Systems Engineering
MTS	Multi-spectral Targeting System
N2N6	OPNAV Networking Resource Sponsor
N88	OPNAV Air Warfare Resource Sponsor
NATIP	Naval Aviation Technical Information Product

NATOPSNaval Aviation Training and Operating Procedures Standardization
 NAVAIR..... Naval Air System Command
 NCO Non Combat Operations
 NCWNet-Centric Warfare
 NEO Noncombatant Evacuation Operations
 NITF National Imagery Transmission Format
 NLOS Non Line of Sight
 NPS Naval Postgraduate School
 NR-KPPNet Ready Key Performance Parameters
 NSFSNaval Surface Fire Support
 NSSNaval Simulation System
 NTA Naval Tactical Activity
 NTTL Naval Tactical Task List
 NTTP..... Naval Tactics, Techniques and Procedures
 NVG Night Vision Goggles
 NWPNaval Warfare Publication
 OAMCM Organic Airborne Mine Counter Measures
 OPNAV.....Office of the Chief of Naval Operations
 OTH Over the Horizon
 OTS.....Off-The-Shelf
 OV..... Operational View
 PMA Program Manager Air
 PDLPrimary Data Link
 PEO.....Program Executive Office
 QFD Quality Functional Deployments
 RADARRadio Direction and Ranging
 RF Radio Frequency
 RFIRequest for Information
 ROE Rules of Engagement
 SASituational Awareness
 SAR Search and Rescue

SAR	Synthetic Aperture RADAR
SATCOM	Satellite Communications
SDL	Secondary Data Link
SE	Systems Engineering
SEDP.....	Systems Engineering Design Process
SINGARS	Single Channel Ground to Air Radio System
SME	Subject Matter Expert
SMMP	Shipboard Modular Mission Package
SOS	System of Systems
SUW	Surface Warfare
SysML.....	Systems Modeling Language
TACSIT	Tactical Situation
TAO	Tactical Action Officer
TIM.....	Technical Interchange Meetings
TCDL	Tactical Common Data Link
TCIM	Tactical Communications Interface Module
TCS	Tactical Control System
TDM	Tactical Data Management
TOS	Time on Station
TTI	Time To Identify
TTW	Territorial Waters
TWO	Tactical Watch Officer
UAS	Unmanned Air System
UAV.....	Unmanned Aerial Vehicle
UHF	Ultra-High Frequency
UJTL	Unified Joint Task List
UNTL	Unified Naval Task List
USN.....	United States Navy
VCR	Video Camera Recorder
VERTREP	Vertical Replenishment
VHF	Very High Frequency

VOD Vertical Onboard Delivery
VTUAV..... Vertical Take-off and Landing Tactical Unmanned Air Vehicle
WBS Work Breakdown Structure

THIS PAGE INTENTIONALLY LEFT BLANK

TABLE OF CONTENTS

I. INTRODUCTION	27
A. Background	27
1. Purpose.....	27
2. Project Mission Focus.....	28
3. Project Trade space	30
4. Project Context Diagram and Operational View	31
B. Goals.....	33
C. System Engineering Process	34
II. PROBLEM DEFINITION	40
A. INITIAL PROBLEM STATEMENT	40
B. Needs Analysis.....	41
1. Stakeholder Input	43
a) Stakeholder Background.....	43
b) Initial Scenarios	44
2. Current Capabilities	46
a) MQ-8B Fire Scout	47
b) MH-60R.....	48
c) MH-60S	50
d) Littoral Combat Ship	50
3. Needs.....	52
4. Constraints	54
a) Initial Requirements.....	56
b) Assets in Play.....	57
C. Revised Problem Statement	58
SYSTEM CONFIGURATION AND OPERATION	59
A. Concept of Operations and Mission Scenario Phases.....	59
1. Scenario 1.....	61
a) Scenario 1 - Phase I	62
b) Scenario 1 - Phase II.....	63
c) Scenario 1 - Phase III.....	63
2. Scenario 2.....	64
a) Scenario 2 - Phase I	65
b) Scenario 2 - Phase II.....	66
c) Scenario 2 - Phase III.....	66
3. Communications Analysis	66
a) Phase I.....	66
b) Phase II.....	69
c) Phase III	71
d) Quantification of Communication Effectiveness	72
B. Architecture Analysis.....	75
1. Operational Architecture.....	76
2. Functional Architecture	78
C. Individual Alternatives	81
1. Baseline Physical Description.....	81
2. Alternative-1	83

3. Alternative-2	84
4. Alternative-3	85
MODELING, SIMULATION AND ANALYSIS	87
A. Modeling Approach and Rationale	88
1. Alternatives	89
2. Simulated Scenario and Phases	90
B. NSS	91
C. Simulation Planning	92
1. Logical Flow	92
a) Phase III Complexity	94
2. Modeling Assumptions	94
1. Modeling Input Parameters	95
a) Sensor Ranges	95
b) Information Flow Timing Delays	96
D. Modeling output aNALYSIS	99
1. Search Rate Results	100
2. Time to Search	102
3. NSS Model Analysis and Starting Inputs	103
a) NSS Model Run # 1	106
b) NSS Run #1 Analysis	107
c) Model Inconsistencies	109
d) NSS Model Run #2	110
e) NSS Model Run #2 Analyses	111
4. Modeling Difficulties	114
5. Modeling Conclusions	114
V. ANALYSIS OF ALTERNATIVES	115
A. ALTERNATIVE UTILITY SCORING	115
1. Discussion of Key Metrics	116
2. Utility Scoring	118
3. Weightings	119
4. Utility Scoring Results	120
a) MH-60S and RADAR Equipped Fire Scout	120
b) MH-60R and Fire Scout without RADAR	120
c) Conclusions	121
B. Critical Assessment of Alternatives	121
1. Alternative-1 (A-1) Analysis	123
a) Shipboard Controlling Node	123
b) TCDL Video File Format	124
c) Shipboard Video File Transfer	124
d) General Work Required for A-1	125
e) A-1 Conclusion	125
2. Alternative-2 (A-2) Analysis	126
a) H-60 CDL-TCDL Hawk Link	126
b) LCS Tactical Watch Officer Review of both Fire Scout and MH-60 Video	126
c) Engineering for A-2	127
i. TCDL Data Transfer and Protocols	127

ii. LCS Hardware Upgrade	128
iii. Fire Scout Control	128
d) A-2 Conclusion.....	128
3. Alternative-3 (A-3) Analysis	129
a) COTS Alternative and UAV Control Options	130
b) Fire Scout Control during Launch and Recovery	130
c) Antenna Usage in A-3.....	130
d) Link-16 Tactical Data Management Retained.....	131
e) UAV TCDL Sensor Payload Management Merged with Hawk Link	131
f) Required Fire Scout Modifications	131
g) Required MH-60 Modifications	132
h) A-3 Conclusion.....	132
C. Cost analysis of alternatives	133
D. Risk Assessment	136
1. Initial Risk Areas	137
a) Programmatic Risks.....	138
b) Technical Risks.....	139
2. Refined Risk Areas	140
a) Lack of Shipboard Intel Manpower	140
b) Support for Shipboard Aviation Mission Solution	140
c) Fire Scout Control Station and LCS CIC Interface Incompatibility.....	141
d) Software Modification required to Support Fire Scout video at LCS CIC	141
e) Ship Availability for Modification Install	141
f) Impact to Software baselines by New Software Modifications	142
g) LCS Console Operator Workload.....	142
h) Potential Inaccuracy of NSS Model Due to “Cumulative Alternatives”	143
i) LCS Ability to Accommodate Additional Antennas.....	143
j) Infrastructure to Support Additional TCDL	143
k) Aircraft Weight Additions	144
l) Video Communication between Fire Scout and H-60.....	144
m) Disorientation and Motion Sickness when Viewing Sensor Data Aboard MH-60	145
n) Integration Complexity.....	145
o) Data Latency Across Platforms	146
p) Increased Range.....	147
q) Data link Robustness	147
r) Fire Scout Hand-off Command to MH-60	147
s) Non-Availability of Frequency Spectrum for Operations.....	148
3. Alternative Risk Profiles.....	148
b) Alternative 1 Risk Profile	148
c) Alternative 2 Risk Profile	149
d) Alternative 3 Risk Profile	150
VI. CONCLUSIONS	150
B. FINDINGS Summary.....	154
C. Recommended follow on work	156
1. Use an Engagement Model for Mission Phase 3	156

2. Rebuild the NSS Model to Combine SOS Alternatives for Assessment of Cumulative Effectiveness	156
3. Use Experimentation or Live Demo to Confirm CONOPS.....	157
4. Perform Statistical Analysis on Model Results	157
5. Perform Market Research to Refine the WBS for More Accurate Cost Estimation.	157
APPENDIX A – FUNCTIONAL DECOMPOSITION.....	158
APPENDIX B – NSS SCREEN SHOTS.....	162
REFERENCES	166
INITIAL DISTRIBUTION LIST	168

THIS PAGE INTENTIONALLY LEFT BLANK

LIST OF FIGURES

Figure 1: Context for System and SOS ASUW - SUW System / SOS Solutions	29
Figure 2: ASUW Capabilities and Mission Scenario Enhancements	30
Figure 3: MH60/Fire Scout Integration Operational View.....	32
Figure 4: Systems Engineering "V" Process Model	34
Figure 5: Spiral to Circle Process Model.....	36
Figure 6: Functional Decomposition of Anti Surface Warfare Mission.....	38
Figure 7: MH-60 and UAV Aviation Mix Study - ASUW Effectiveness	42
Figure 8: Baseline - Current Capabilities.....	46
Figure 9: Future Capabilities	47
Figure 10: MQ-8 Fire Scout (AUVSI 2005).....	48
Figure 11: MMH Equipped for ASUW	49
Figure 12: LCS Components and Subsystems.....	52
Figure 13: LCS/MH-60R/Fire Scout CONOPS for ASUW Protection from Small Boat Swarm through a Choke Point	56
Figure 14: Current Sensor/Capabilities by Platform and Applied to Initial Phasing Plan	58
Figure 15: Overlapping Phases of Operations	60
Figure 16: Scenario 1 CONOPS	62
Figure 17: Scenario 2 CONOPS	65
Figure 18: Phase I Functional Flow	67
Figure 19: Phase II Functional Flow.....	69
Figure 20: Phase III Functional Tasks	72
Figure 21: Top-level Architecture Diagram from CORE.....	77
Figure 22: Phase I Top Level Functions	79
Figure 23: Phase II Top Level Functions.....	79
Figure 24: Architecture Artifacts and Key Metrics	80
Figure 25: Baseline Communications Channels	82
Figure 26: Alternative-1 Communications Channels	83
Figure 27: Alternative-2 Communications Channels	85
Figure 28: Alternative-3A/B Communications Channels.....	87
Figure 29: Alternatives Communication Channels.....	89
Figure 30: Planned Simulation Flow	92
Figure 31: Graphical Comparison of Search Rates – Baseline vs. MH-60S and Fire Scout	101
Figure 32: Time to Search an Area	102
Figure 33: NSS Input Mode Display for Regions and Tracks.....	104
Figure 34: Time to Detect (hrs) – Reducing Trend.....	107
Figure 35: Time to Classify (hrs).....	108
Figure 36: Time to Identify (hrs)	109
Figure 37: Time to Detect (hrs)	112
Figure 38: Time to Classify (hrs).....	113
Figure 39: Time to Identify (hrs)	114
Figure 40: Alternative-1.....	124
Figure 41: Alternative-2.....	127
Figure 42: Alternative-3.....	129

Figure 43: Cost versus Utility Plots	136
Figure 44: Initial Risk Profile	137
Figure 44: Alternative 1 Risk Profile.....	149
Figure 46: Alternative 2 Risk Profile.....	149
Figure 47: Alternative 3 Risk Profile.....	150
Figure 48: Activity Diagram (CORE) for 'Discriminate Contacts' Function.....	159
Figure 49: N2 Diagram (CORE) for 'Discriminate Contacts' Function.....	160
Figure B1: NSS Database	162
Figure B2: NSS Input Mode: Comms Passthrough	163
Figure B4: NSS Input Mode: Neutral Ships	163
Figure B5: NSS Input Mode: Regions and Tracks	164
Figure B6: NSS Input Mode: Sortie Schedule.....	164
Figure B7: NSS Instance Properties: VTUAV	165

THIS PAGE INTENTIONALLY LEFT BLANK

LIST OF TABLES

Table 1: MH-60R Current Capabilities Matrix for Identification of Constraints	54
Table 2: MH-60S Current Capabilities Matrix for Identification of Constraints	54
Table 3: Platform Communication Capability Constraints.....	55
Table 4: Phase II Timing Matrix.....	73
Table 5: Alternatives Simulated.....	90
Table 6: Sensor Modeling Ranges (nm)	96
Table 7: Baseline Platform Modeling Timing Delays (min)	97
Table 8: Alternative-1 Platform Modeling Timing Delays (min).....	98
Table 9: Alternative-2 Platform Modeling Timing Delays (min).....	98
Table 10: Alternative-3A/B Platform Modeling Timing Delays (min).....	99
Table 11: Output Data from the Search Rate Model	100
Table 12: Output from First Run of NSS Model	106
Table 13: NSS Model Second Run Output Data	112
Table 14: Utility Scoring System.....	118
Table 15: Attribute Weighting	119
Table 16: MH-60S and RADAR Equipped Fire Scout Scores	120
Table 11: MH-60R and Fire Scout without RADAR Scores.....	121
Table 18: Levels of Interoperability	122
Table 19: Alternative 1 WBS Excerpt	133
Table 20: Cost Estimate for Each Alternative	133

THIS PAGE INTENTIONALLY LEFT BLANK

I. INTRODUCTION

A. BACKGROUND

The Chief of Naval Operations (CNO) has stated the objective of achieving a predominantly unmanned force structure by 2030 ^[1]. More recently, CNO directed development of an integrated vision for unmanned systems with legacy, manned force structure ^{[2][3]}. To counter emerging threats and achieve enhanced war fighting capability, System of Systems (SOS) comprised of legacy systems augmented by advanced technology and concepts are being explored to determine potential “value-added.” In response, Naval Air System Command (NAVAIR) and the Program Executive Office (PEO) have endorsed the need to assess formally integration opportunities by mission area capability as a means of furthering manned and unmanned system integration and filling capability gaps for the naval force structure.

1. Purpose

This research focused on defining alternatives for enhanced mission effectiveness through increased interoperability and integration of the MQ-8 Fire Scout and MH-60 Seahawk variants (MH-60R, MH-60S). Because the Fire Scout and the Seahawk have already demonstrated high potential for delivering enhanced capability when operating synergistically, Navy leadership expressed interest in the integration of these systems so that the MH-60 would be able to monitor data gathered by the Fire Scout and potentially take control of the Air Vehicle (AV) and sensors to support emergent mission requirements ^{[4][5]}.

The MH-60 Multi Mission Helicopter is deployed aboard any air-capable frigate, destroyer, cruiser, fast combat support ship, amphibious assault ship, or aircraft carrier. The Fire Scout Vertical Take-off Unmanned Air Vehicle (VTUAV) is currently being introduced into the US Navy Fleet to deploy on any ship where an MH-60 helicopter deploys, including aircraft carriers, frigates, destroyers, and the Littoral Combat Ship (LCS). The roles for the Fire Scout are still being determined, however, its current suite

of mission equipment enables the Fire Scout perform the Intelligence, Surveillance and Reconnaissance (ISR) mission to detect and monitor potential threats to the battle group contingent. Both the Fire Scout and MH-60 will be integrated on both types of LCS, enabling expansion of capabilities for Anti Surface Warfare (ASUW), Anti Submarine Warfare (ASW), and Airborne Mine Countermeasures (AMCM) ^[6] missions.

Manpower and helicopter requirements affect the ability to support long-term coverage, so the use of Unmanned Aerial Vehicles (UAV) has come to the forefront as a means to increase coverage and to minimize the impact on personnel and manned aircraft. This research addresses the potential mission enhancements that can be derived from using manned and unmanned aircraft in concert to increase operational coverage area, time on station, and Situational Awareness (SA) for decision makers. The project highlights the tactical decision-making process and individual platform capability enhancements that will improve the ASUW war fighting effectiveness in a given scenario. The project assessment applies the Systems Engineering Design Process (SEDP) with emphasis on the early phases of Needs Analysis, Requirements Definition, and Analysis of Alternatives, leading to recommendations for enhancements or solutions that can be accomplished based on the existing Programs of Record.

2. Project Mission Focus

Although the Fire Scout, MH-60 and LCS are multi-mission capable systems, the project focused on the ASUW mission area and further narrowed the scope of investigation to the small-boat swarm threat (SWARM). This focus was specifically requested by the MH-60 and Fire Scout program managers and resource sponsors to provide an option for filling a known gap in current operational capability ^[7]. ASUW, a Naval Surface warfare (SUW) mission area, is defined as, "...That portion of maritime warfare in which operations are conducted to destroy or neutralize enemy naval surface forces and merchant vessels ^[8]. "

The ASUW mission is a key capability of Sea Power 21 and specifically of the Sea Shield pillar. Sea Power 21 is the Navy's Strategic Vision for the 21st century. Sea Power 21 aims to transform the naval force through innovative concepts and technologies that integrate sea, land, air, space and cyberspace. The goal is to use "revolutionary

information superiority and dispersed, networked force capabilities to deliver unprecedented offensive power, defensive assurance and operational independence to Joint Force Commanders.” Sea Power 21 relies on three pillars – Sea Strike, Sea Shield, Sea Base – and the FORCEnet integrating construct. Sea Shield is the Naval Capability at the center of this project. Sea Shield is focused on “...protection of national interests with layered global defensive power based on control of the seas, forward presence and networked intelligence” taking traditional naval unit and task force defense of the Fleet and sea lines of communication to a new level for sea-based theater and strategic defense [9]. A representation of the strategic vision and project operational context is provided by Figure 1.

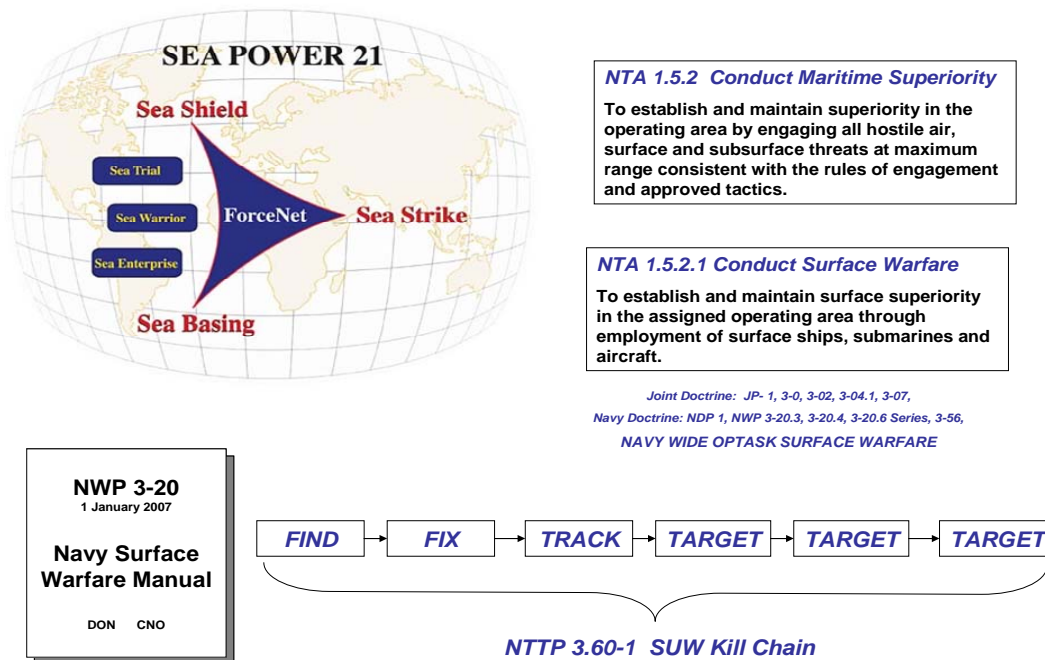

Figure 1: Context for System and SOS ASUW - SUW System / SOS Solutions

Sea Shield capabilities can be defined according to the Universal Navy Task List (UNTL) [10], “... the common language that commanders can use to document their command war fighting requirements as Joint Mission Essential Tasks. The UNTL is a single source document that combines the Universal Joint Task List (UJTL, Joint

Doctrine) with the Navy Tactical Task List (NTTL),” the commander’s reference for strategic, operational and tactical activities and associated metrics for planning, training and readiness assessment ^[11]. The above figure shows the relationship between Sea Power 21 and the NTTL Navy Tactical Activities (NTA) for Surface Warfare (SUW). The Navy Warfare Publication 3-20 is the Surface Warfare Manual prescribed doctrine and links strategic to operational tactics, techniques and procedures to meet mission objectives ^[12]. The manual provides a “Kill Chain” sequence of events from a Systems Engineering viewpoint. It represents the functional flow of work that the project alternative solutions for ASuW must accomplish, defining the SOS purpose. Taken together, this figure lays out the high level operational need and mission capability required by the project stakeholders for which project alternatives are defined.

3. Project Trade space

The project specifically explored the available trade space for the Fire Scout, MH-60 and LCS to share data between platforms as an SOS and achieve a distributed “kill chain” to address threats and targets in contested environments with greater accuracy and decreased timelines. This trade space was predefined by the existing platform configurations of these three contributing systems. Figure 2 provides an overview of the current and planned ASuW capabilities provided by the MH-60 series and Fire Scout.



Figure 2: ASuW Capabilities and Mission Scenario Enhancements

The core mission capability resides with the MH-60 for the depicted Detect, Track, Classify and Kill activities. The Fire Scout is a “force multiplier” that augments the Detect and Track activities through search and long dwell surveillance using the onboard Forward Looking Infra-Red (FLIR) sensor. The enhancements listed in the center of the figure identify the benefits anticipated from integrating these two airborne assets. Using the Fire Scout “on a tether” from the MH-60 expands the search and surveillance area. Persistence aids maintenance of a Common Operating Tactical Picture (COTP) across crews and platforms. Integration of these platforms aims to achieve the desired enhancements for detection, tracking and identification through the synergistic effects of increased range and time on station.

4. Project Context Diagram and Operational View

As part of the SE process adopted for design of SOS alternatives, the project first defined the operational concept and context, including the boundary between the solution system trade space and the external environment ^[13]. Figure 3 presents a conceptual, high-level Operational View (OV-1) of the MH-60 and Fire Scout in the ASUW role of protection of High Value Assets (HVAs). The OV was developed to guide the requirements definition and analysis activities. The boundary that defines the trade space for SOS alternatives to be addressed by the project is depicted as a red oval in the figure.

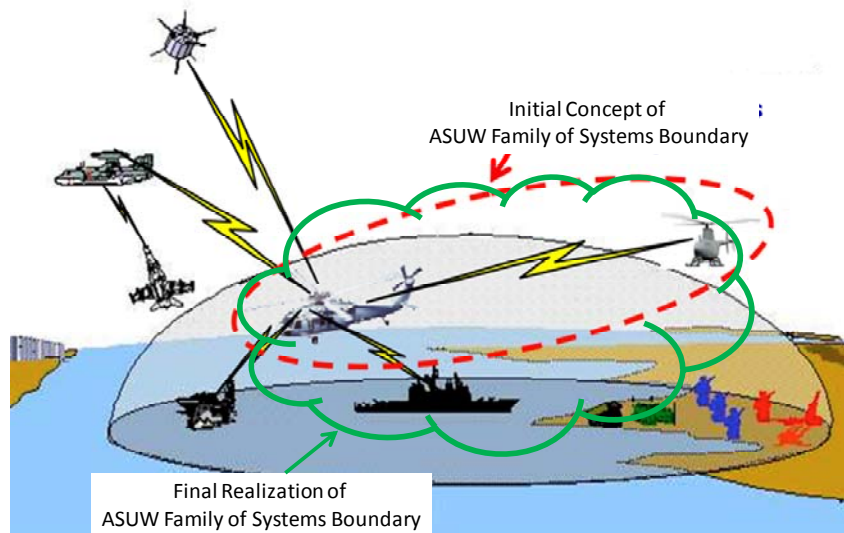

Figure 3: MH60/Fire Scout Integration Operational View

Within the boundary line, the MH-60, Fire Scout and LCS are the key assets for defining alternatives. The diagram also includes real-world capabilities that are not part of the project, but may impact context of any proposed SOS solution. For example, satellite communications and communications between the Aircraft Carrier (CV) and helicopter, as the MH-60 may be based on the LCS or the carrier. As part of coordinated operations with the Carrier Air Wing (CVW), the E-2 Hawkeye Airborne Early Warning/Airborne Command and Control aircraft is depicted. The E-2 also communicates with the F/A-18 Hornet Strike Fighter. Ashore, ground forces are depicted as supported units. The Fire Scout could be based and originate from an ashore unit, as well as the LCS. The CV, CVW and ground forces were not addressed within the scope of the project, but integration and interoperability within this context may impact acceptance of any SOS solution.

The OV-1 supports a high level description of the activities and interactions among the platforms and systems employed for ASUW. This information establishes the basis for assigning mission tasks and roles, allocating functionality and defining information exchanges across the SOS. The following example is one of many that could be derived from the OV-1.

1. MH-60 performs Surface Search.
2. Fire Scout (FS) performs ISR, extending the area of coverage beyond the MH-60.
3. FS Sensors detect possible Hostile Forces (HF), beyond range for FS link to LCS

4. MH-60 monitors the FS sensor data
5. LCS directs MH-60 to relay FS sensor data as FS is sent closer to HF
6. FS relocates and transmits sensor data to MH-60
7. MH-60 monitors, fuses, and relays sensor data to LCS
8. LCS verifies HF demonstrates hostile intent
9. LCS requests MH-60 to send fused data to Decision Maker
10. Decision Maker calls for Strike action and notifies LCS and MH-60
11. MH-60 relays sensor data to E-2, which calls for Air Support
12. E-2 sends sensor data to Strike Aircraft and calls for Strike
13. Strike Aircraft rolls in, receiving constant updates from FS and or E-2
14. FS remains on-station to continue ISR and perform BDA

B. GOALS

The goals of the Fire Scout - MH-60 interoperability project were to perform the SE tasks required to define mission functionality and activities, system preliminary design, analysis of alternatives, and planning for the development and test of an integrated set of solutions that supports a Fire Scout/MH-60 joint ASUW mission. An architecture was developed based on Stakeholder input and project scope definition based on existing system capabilities, which culminated in a draft Concept of Operations (CONOPS). Key Performance Parameters (KPP) and Measures of Effectiveness (MOE) were defined, and Modeling and Analysis (M&A) was used to characterize SOS effectiveness and quantify performance based on the CONOPS. Trade studies between platforms, installed interfaces, equipment and functionality were developed based on mission scenarios associated with the CONOPS and informed by Stakeholder feedback. The project therefore includes the necessary tasking to define and plan for the Materiel Solution Analysis Phase and the Technology Development Phase to initiate an Incremental Acquisition Strategy for solutions that enhance the current ASUW mission set. This report provides the project cycle with control gates and artifacts, including SE plans and processes, applicable phases, and risk, cost, and performance analyses as deliverables.

C. SYSTEM ENGINEERING PROCESS

The Systems Engineering Development Plan (SEDP) used during the Project is a combination of the standard "V" model and a Spiral-to-Circle model ^[15]. A hybrid approach was chosen to provide a process flow tailored to the unique challenges of the project. The "V" model, shown below in Figure 4, was used as a blueprint for SE architecting and design activities early in the project development.

There are no clearly defined requirements for the proposed SOS, as would typically be formally defined in an ICD by the Joint Capability Integration and Development System (JCIDS) process ^[16]. Each of the existing ASUW technical solutions was designed, developed and acquired as a separate and independent program in response to documented requirements. The proposed, integrated SOS solutions, however, will need to be defined, analyzed and documented as requirements for the same capability that may bring benefits in operational utility and effectiveness. The "V" model provided a straightforward means of defining the SOS as a unified, large-scale system to proscribe the integrated functionality to be achieved primarily through data-level communication and interoperability.

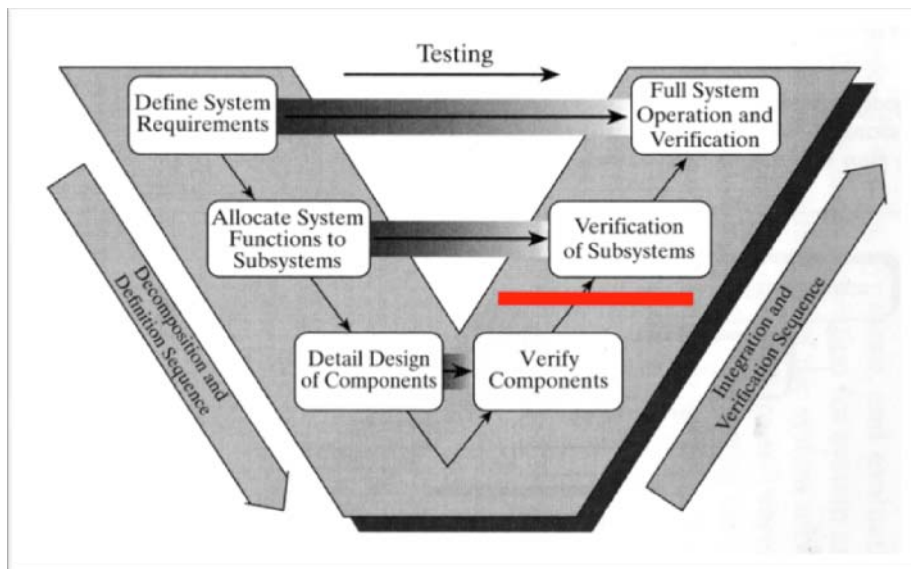

Figure 4: Systems Engineering "V" Process Model

Based on the V model, the initial problem definition led to the development of research questions that were presented to the identified Stakeholders to begin design process. The path down the left side of the V model included the following SE activities.

1. Define the Problem
2. Define Stakeholders
3. Define mission scenarios
4. Define communication and interface capabilities
5. Elicit, collect and rank requirements
6. Iterate requirements with the Stakeholders
7. Architect a method to satisfy the requirements
8. Evaluate alternatives that support the architecture based on cost, schedule, technical performance, and risk assessment
9. Recommend a solution based on Analysis of Alternatives (AOA)
10. Define areas of consideration for follow-on study

The red line between “Verify Components” and “Verification of Subsystems” was chosen to illustrate where the project analysis left off. The proposed options identified component-level integration changes to the existing systems and platforms, which were evaluated using warfare analysis methods in support of SE to project potential effectiveness.

The “V” model provided a simple method for requirements analysis and architecting at the SOS level, where much of the trade space within systems was highly constrained by existing, proven designs that had been produced and deployed for operational use, post Milestone C in the acquisition life cycle ^[17]. As a practical matter, the SE trade space was constrained to bound cost and minimize impact to operational employment and availability of the contributing MH-60 and Fire Scout systems. The following constraints were placed on the trade space:

- The Fire Scout and MH-60 were “given” as existing platforms, treated as Off-The-Shelf (OTS), since they are currently operational and fielded.
- The proposed SOS configurations should be planned to be in place in fiscal year 2012 to deploy on the LCS. A Capabilities Matrix specifying functionality and configuration for each platform is provided later in the report.

- The lifespan of systems under consideration is 10 years (2012-2022). This is the anticipated lifespan for the Fire Scout prior to the first major overhaul or block upgrade.

Under these constraints, the Spiral-to-Circle model was chosen to augment the “V” model because it specifically addresses an SE process flow from the viewpoint of increments of system capability. Figure 5 presents the Spiral-to-Circle model^[15]. This incremental model is key for framing how solutions based on component-level changes result in a level of system capability at a specific level of process maturity.

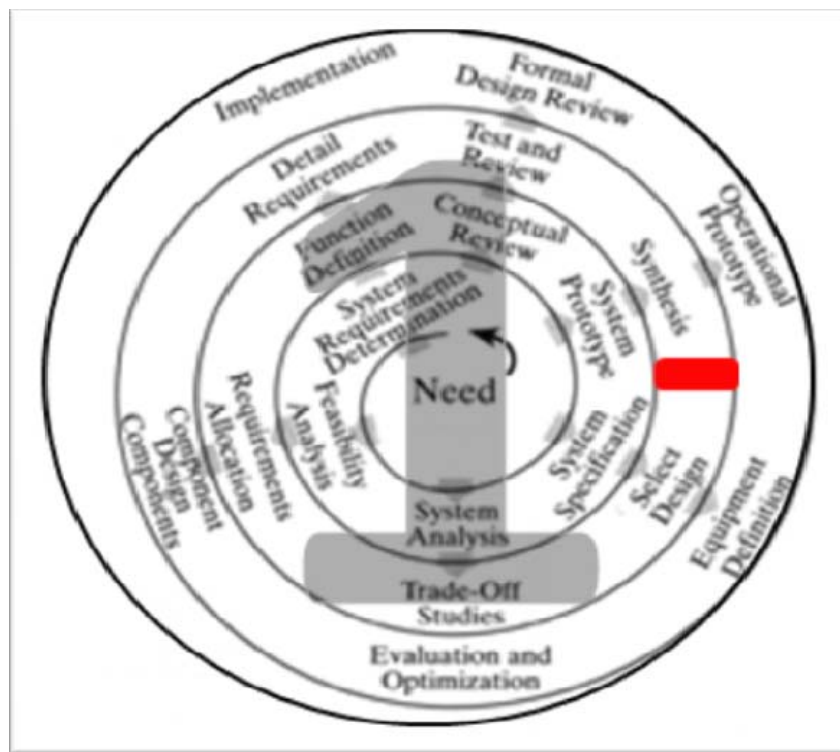

Figure 5: Spiral to Circle Process Model

The SE activities are arranged within the spiral to show the progression of detail and confidence in the system definition. For example, a system specification is the result of requirements definition and analysis activities. To achieve an actual system design, the subsequent activities of prototyping, reviews, function allocation and trade studies, between the need statement and the solution design remain to be accomplished. The alternatives proposed by this project were the result of the SE activities up to detailed

design suitable for defining a materiel solution across the SOS. The red line on the model shows the "stopping point" for this project.

The proposed alternatives were the result of the early SE activities that support definition of an increment of ASUW capability allocated across the SOS platforms and systems. No systems have actually been built or modified beyond their current configuration as part of this project, and thus Verification of Subsystems and Beyond has been left for potential future work.

A brief description of the path through the SE process is provided below, as segue to a more detailed treatment later in the report. Figure 6 shows the functional decomposition of the ASUW mission as it relates to the Fire Scout and MH-60 aboard the LCS ship. This diagram is used to plot the project course along the SE “V” model starting with Requirements Definition. From the functional decomposition of the ASUW mission, the project developed a set of requirements, shown in the gray horizontal bars, for each of the mission functional areas.

The definition of these mission functional requirements led to the need to define a real-world Tactical Situation (TACSIT) and mission scenarios. The result was a scenario for SWARM defense through a geographical choke point, representative of stressing operational conditions. Definition of the scenario supported allocation of requirements to particular mission systems and revealed the need to develop a CONOPS to evaluate interoperability opportunities. The successful development of the mission scenario and CONOPS required definition of the threat, the operational environment, and the operational requirements for the LCS ship in this environment. At this stage, the capabilities of each of the stand-alone AVs was examined to identify interoperability opportunities within the limitations and restrictions established for the project.

Constraints were also identified, such as “establishing baseline AV functionality as of FY2012” and “no incorporation of additional functionality such as weapons or additional sensor systems.” These limitations were derived from interface with the stakeholders, understanding that the first tactical deployments of the Fire Scout and MH-60 were scheduled for FY12, and that incorporating additional functionality as described above would pose high risk to that deployment schedule.

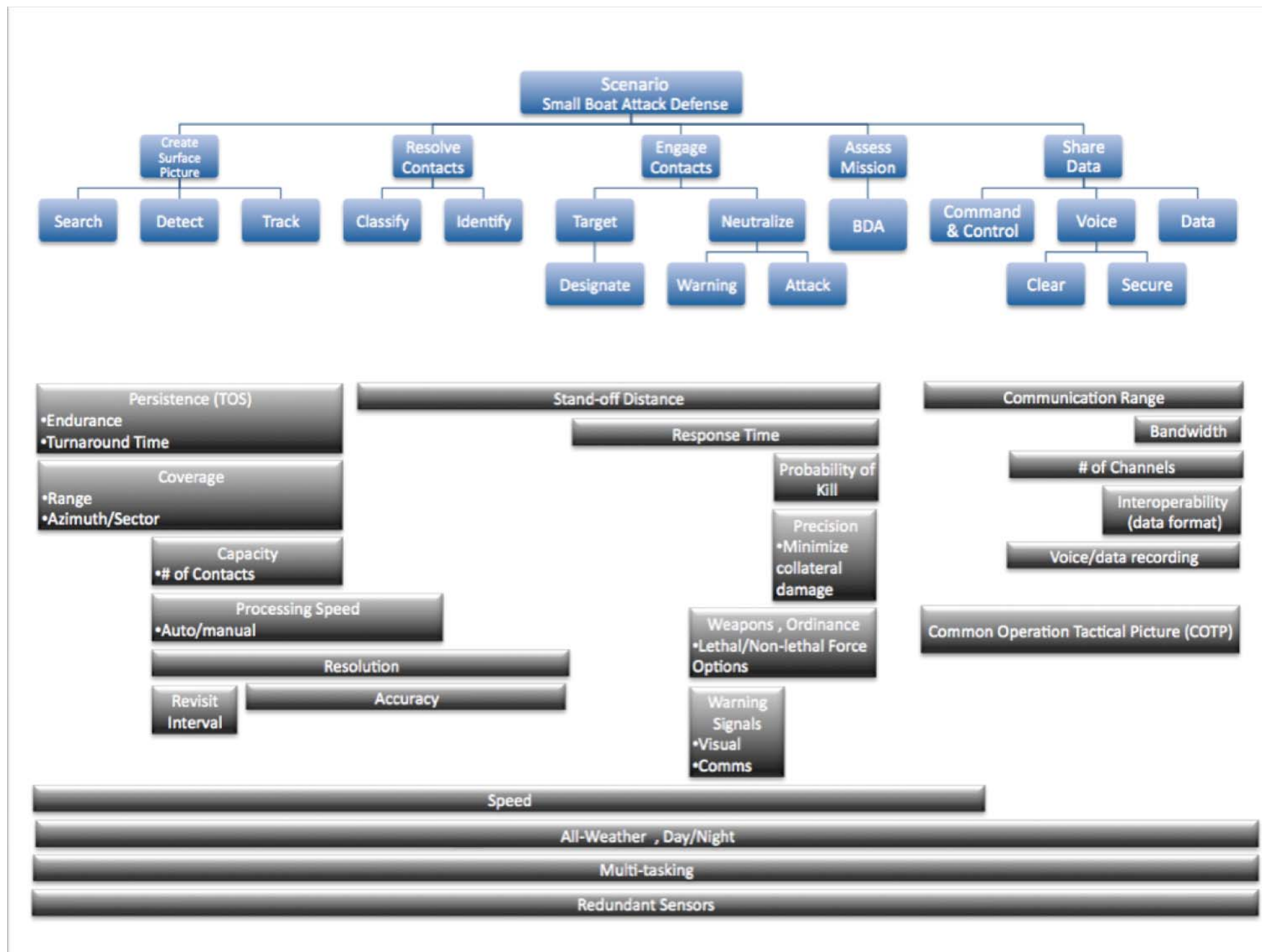

Figure 6: Functional Decomposition of Anti Surface Warfare Mission

Exploring the opportunities and constraints led to evaluating opportunities for interoperability to support the mission scenario and CONOPS, ultimately leading to evaluation of the data sharing functionality. In order for the Fire Scout and MH-60 to operate effectively in the ASUW mission, they must be able to identify the targets in the area of interest and classify those targets as friendly, neutral or hostile. Identification and classification requires communication to decision makers on the LCS ship, so the project focused on effective communication with decision makers. Next, KPPs and MOEs were developed to quantify “effectively communicate” and the AVs were analyzed from the OV-1 interface perspective to define the communications “channels” or “links” required to support the ASUW mission through the decision-making chain. By defining these links the project arrived at the bottom of the “V” model. At this point in the SE process, the project developed a warfare analysis model using the Naval Simulation System (NSS) to simulate the effects of the alternative SOS configuration in order to characterize impacts to decision-making performance. The modeling activity established and then evaluated the impact of changes to the system connectivity or links from a performance or data / information distribution perspective. The analysis of the output of the model led to a set of alternative approaches which were evaluated for performance, cost, and risk. In terms of the SE process, this activity represents activities working back up the right-hand side of the “V.”

An architecture was developed to aid definition and allocation of interfaces and functionality based on the CONOPS, and to confirm definition of KPPs and MOEs to allow objective evaluation of interoperability performance. The architecture was an important tool aiding M&A plans and use of the NSS model. Details about the CORE architecture are provided in APPENDIX A – FUNCTIONAL DECOMPOSITION. The KPPs and MOEs were vetted with the stakeholders to ensure that they were meaningful and measurable. The key project metric was identified as the Time required To Identify (TTI) a target as a threat.

The SOS architecture comprised of MH-60, Fire Scout and LCS was refined for modeling using requirements derived from the KPPs and MOEs. Analysis of the architecture associated with TTI revealed three distinct opportunities to enhance interoperability through improvement of communication paths or “channels.” One

channel enhancement was exclusively a function of the shipboard system integration only, one was between the ship and the MH-60, and the third was between the MH-60 and Fire Scout. Because enhancements to any one of these communication channels had potential to improve interoperability, each one was approached as an independent effort or alternative. Further, it was recognized that the three enhancements could be implemented in combination or altogether to improve effectiveness and achieve a different mix of interoperability versus cost, risk and schedule constraints. This situation led to the adoption of the secondary SE approach shown in the Spiral-to-Circle figure. Moreover, this situation became the basis for modeling the baseline and project alternatives in NSS.

II. PROBLEM DEFINITION

A. INITIAL PROBLEM STATEMENT

Given the CNO objective to achieve a predominantly unmanned force structure by 2030, and the pressing need to counter emerging threats, there was strong potential for an SOS solution comprised of integrated legacy systems augmented by advanced technology and concepts to afford new alternatives within the constraints of operational tempo and fiscal reality. The Fire Scout and the MH-60 helicopter have already demonstrated high potential for delivering enhanced capability when operating synergistically. The Navy has expressed interest during the stakeholder interview in being able to monitor data gathered by the Fire Scout. Interest was also expressed in the ability to potentially take over control of the Fire Scout using an on-aircraft control station to support emergent mission requirements..

This research focused on defining alternatives for enhanced mission effectiveness through increased interoperability and integration for the Fire Scout and MH-60. The initial problem statement, modified later in this chapter, was framed by this question:

Does an integrated SOS of MH-60, Fire Scout and LCS working on a shared COTP with enhanced data communication achieve a more effective solution against SWARM threats?

Specifically, the project explored the available trade space for the MH-60 to support mission-based AV and mission systems control and data/payload exploitation. For example, when equipped with enhanced data link capability, the MH-60 could provide bi-static target isolation and laser targeting for the Fire Scout. Sensor fusion would also be available by combining data collected by the Fire Scout with that collected by the MH-60, transmitting all back to the ship for analysis and decision-making. The potential to share data between platforms and achieve a distributed “kill chain” supported increased capability to address threats and targets in contested environments with greater accuracy and decreased timelines.

The project requirements were developed through iteration with stakeholders, including Program Office representatives and Operational Requirements Sponsors. These requirements have been documented such that they could eventually be refined and submitted using the JCIDS process as a program Capabilities Description Document (CDD), and approved for program initiation.

B. NEEDS ANALYSIS

The “LCS Aviation Mix Operations Assessment”^[18] was commissioned by OPNAV N88 requirements officers and the Program Manager from the Navy’s UAV office (PMA-263) to establish the foundational analysis for the “optimal mix” of manned and unmanned aircraft to perform ASUW at an enhanced operational level. This assessment studied the effectiveness of MH-60 and Fire Scout aboard both versions of the Navy’s LCS for employment in long and short duration operational scenarios. Excursions of the study supplemented a notional baseline aviation mix of one MH-60R or MH-60S helicopter and one Fire Scout with multiple Fire Scouts or Small Tactical UAVs. Several TACSITs and mission areas, including ASUW, ASW and MIW were explored for impacts to mission effectiveness, suitability, and affordability. In each operational employment assessment the study evaluated the number of contacts detected, number of flight hours flown, number of threat kills, and amount of area searched or monitored as the primary MOEs for varying aviation asset mixes. The summary conclusions of the study were that UAV and MH-60 aviation mixes benefited ASUW

scenarios more than ASW and MIW scenarios. Further, the study concluded that the Fire Scout was the UAS platform of choice for the mix with the MH-60. Specific results in the ASUW scenario showed the addition of the Fire Scout or multiple Fire Scouts led to more hours flown, more area searched, more contacts detected, and more threat kills occurring -- all these benefits performed with less manpower and reduced fuel costs as compared with manned assets. The summary results of the study is presented in Figure 7, which shows key MOEs relevant to the project.

Short Duration ASUW TACSIT Hostile Escort of Unarmed HVU			
MOE	Baseline	Firescout Excursion	STUAS Excursion
Average radar coverage by SAG (nm²)	38053	40880	38053
Average EO coverage by SAG (nm²)	974	1155	990
Average IR coverage by SAG (nm²)	278	350	294
Number of contacts ID'd	43	49	47
Threat minutes	24	2.5	12
# Blue asset mission kills	2.5	1.9	2.4
LCS Force AvDet Manning	69	54	54+

Figure 7: MH-60 and UAV Aviation Mix Study - ASUW Effectiveness

Since the conclusion of this study in 2007, there has not been any further analysis or proposed method of implementation beyond presenting the results of the aviation mix as shown. The research conducted for this project recognized the fundamental value of the “optimal mix” analysis and extended this work from warfare analysis into the early phases of the SE process. The goal was to provide a “pathfinder” to potentially feasible solutions that could be implemented by the contributing programs. There are feasible approaches to fulfilling the needs described above at an affordable cost and within an acceptable level of risk. This first needs analysis supports the requirement for integrating

the Fire Scout and MH-60 on an LCS by resolving the question of "How to do it?" which was presented after evaluating a collaborative CONOPS and defining any additional effectiveness improvements beneficial to the warfare area.

These three platforms together (Fire Scout, MH-60 and LCS) with current programmed communication capabilities can be expected to provide commanders with near-real time imagery and data required to support ISR requirements to detect and engage swarming boats, ensure landing areas are free of amphibious craft, provide overhead communications relays, and conduct intelligence gathering and targeting.

1. Stakeholder Input

Stakeholder input was important for ensuring the true requirements were understood during investigation. Gathering stakeholder input involved not only taking initial written or verbal direction regarding what was required, but also involving the stakeholders continually during the project for additional information, as well as “heading checks” to make sure the project was meeting expectations as necessary. This project continually used the stakeholders to bound the problem and focus on the solution set.

a) Stakeholder Background

The stakeholders for this project encompassed fleet operators, requirements officers, and acquisition managers. The fleet operators were represented by Air Test and Evaluation Squadron One and their interests were in representing the scenario correctly, ensuring the assumptions incorporated into the NSS model were acceptable and as realistic as possible, and additionally, that any results were meaningful and reasonable for implementation. Several project officers from the squadron including the UAV and MH-60R project officers were the primary stakeholders for the period of the study. The requirements officer stakeholder group represented requirements officers from OPNAV N88 Air Warfare and the N2N6 Intelligence and Networks Divisions. CAPT David Fisher, Head Maritime Requirements N88 represented the navy’s primary vertical lift platform, the MH-60, and CAPT Mike Carsley, Head Short Range UAS requirements, represented the Navy’s interests for the MQ-8 Fire Scout. These two stakeholders

manage fleet requirements and recommend the direction of the Navy's future for these two platforms. During this study these stakeholders' primary interests were in defining a CONOPS for the MH-60 and Fire Scout aboard the LCS and identifying what contributions these two air platforms bring to guarding against a hostile SWARM attack. During the project the stakeholders defined a relevant real-world area and numerous starting criteria/conditions for scenario development.

The acquisition stakeholders for this project were CAPT Dean Peters, Program Manager (PMA-299) for Multi-Mission Helicopters (MMH), and CAPT Tim Dunigan, Program Manager (PMA-266) for Short Range Vertical UAS at NAVAIR. As Program Managers, these stakeholders procure solutions for the previously mentioned requirements offices and are responsible for total life cycle management of the two platforms, including sustainment and continued war fighting relevance. CAPT Peters' and CAPT Dunigan's primary interest during the course of the project was ensuring the project accurately represented the capability of the platforms and research defined the performance, technical and cost characteristics of solutions. Both PMAs planned concurrent live demonstration of capabilities similar to one of the project alternatives. It was expected that lessons learned from the project would be applied for the demonstration.

b) Initial Scenarios

The initial scenario for the project was determined by the project stakeholders at a meeting held on March 24, 2010. During this meeting the stakeholders requested the project determine a CONOPS for the upcoming deployment of the MH-60 and Fire Scout on LCS. There was currently no existing combined CONOPS and definition of one would benefit the Navy. Additionally, the stakeholders specified the mission scenario for the CONOPS that called for LCS deployment to an area where the risk of a SWARM attack was high. The objective was to research how employment of the air systems could improve situational awareness for all assets and commanders, improve threat identification, and ultimately, improve threat engagement. Starting conditions for this scenario were agreed upon by all and included:

Assets

- One LCS operating independently, “sole ship steaming”
- One MH-60 variant helicopter*
- One Fire Scout *

Time Period

- The length of a mission transit of a risk area, “choke point”

Operational Control of Units

- Air assets under orders from the LCS
- Weapons release approved by the ASUW Commander

Sensors

- Currently in the program of record for the assets
- The Fire Scout RADAR, not currently part of the baseline configuration, had been selected with planned integration in fiscal year 2012, within the project timeline

Weapons

- Ship – Gun, Non Line of Sight (NLOS)
- Air - Gun, Hellfire Missile, Low Cost Guided Imaging Rocket (LOGIR), Advanced Precision Kill Weapon System (APKWS)

For the combination of airborne assets, marked with an asterisk in the above list, stakeholders requested that one asset mix employ a Fire Scout with RADAR and an MH-60S (which does not have RADAR), and one asset mix employ be a Fire Scout without RADAR and an MH-60R (equipped with a RADAR and Electronic Support Measures (ESM)). These alternative configurations ensured an airborne maritime RADAR was employed for the CONOP.

Based on this stakeholder input, the project OV was refined to identify a physical SOS architecture for the proposed scenario. Figure 8 presents the current capabilities as a baseline case and Figure 9 presents the proposed capability upgrades to improve system effectiveness. The yellow lines in both figures call out the communication paths important to the project research.

2. Current Capabilities

The following section describes the current capabilities of the MH-60R, MH-60S, Fire Scout, and LCS, based on extensive research of program, technical and literature sources.^[19-23]

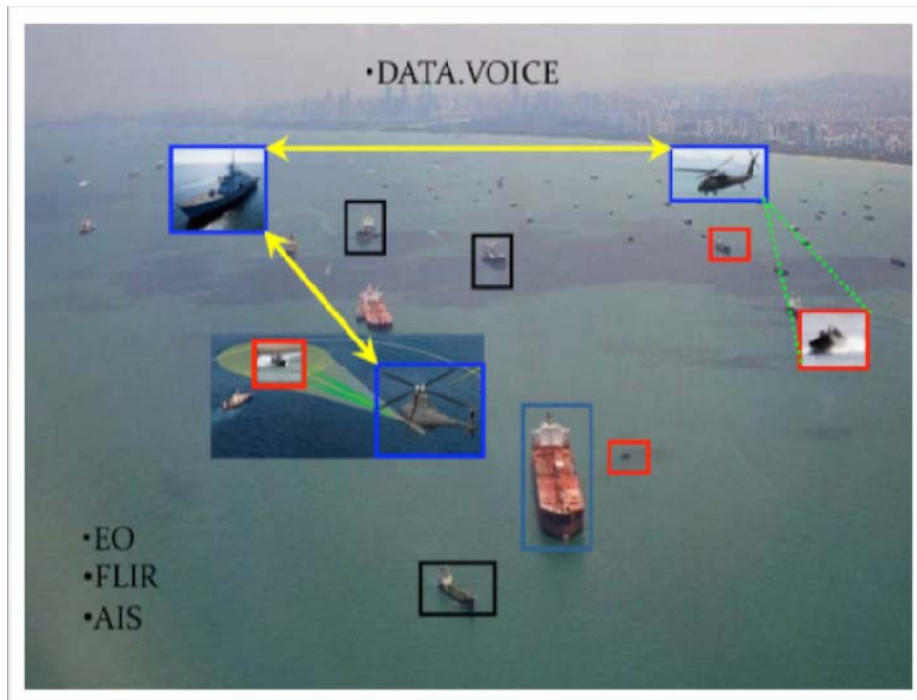

Figure 8: Baseline - Current Capabilities



Figure 9: Future Capabilities

a) MQ-8B Fire Scout

The Fire Scout VTUAV was developed by Northrop Grumman for both Army and Navy customers. The Navy variant is presented in Figure 10. The Navy program is managed by PMA-266. The Fire Scout is currently being introduced into the US Navy Fleet, to be deployed on any ship that an MH-60 helicopter can deploy on including aircraft carriers, frigates, destroyers, and the LCS.

The roles for the Fire Scout are still being determined, but with its present suite of mission equipment, it is performing an ISR mission to detect and monitor potential threats to the battle group. Currently, the Fire Scout has the ability to autonomously take-off from and land on any aviation-capable warship and also at unprepared landing zones close to the Forward Edge of the Battle Area (FEBA). It is equipped with the Tactical Common Data Link (TCDL) for both AV and payload Command and Control (C2). Mission equipment includes Electro-Optical (EO) and Forward Looking Infra-Red (FLIR) sensors. It can carry out surveillance, find tactical targets, track and designate targets and provide accurate targeting data to strike platforms such as strike aircraft, helicopters and ships. The Fire Scout is also able to carry out battle damage assessment.

Recent concerns about small fast boats used for piracy and for swarm attacks highlight the need for extended coverage and ISR capability. Initial system-specific CONOPs focus Fire Scout employment on self-protection and keeping the sea-lanes clear, enabling sea control and littoral superiority.



Figure 10: MQ-8 Fire Scout (AUVSI 2005)

b) MH-60R

The MH-60R helicopter is manufactured by the Sikorsky Aircraft Corporation. Its common cockpit avionics, mission avionics, and survivability avionics are integrated by Lockheed Martin Systems Integration. The MH-60R MMH was designed for the Navy's sea control mission and extends the search and attack capabilities of U.S. naval combatants, deploying helicopters directly from these ships with airborne mission systems integrated directly into the ship's Combat Information Center (CIC) via data link. Along with deployment from air-capable combatants, the helicopter can operate from aviation ships and a variety of other naval ships.

The MH-60R primary missions include Surface Warfare (SUW), Anti-Submarine Warfare (ASW), Command, Control, Communications (CCC), Command and Control Warfare (C2W), Mobility (MOB) and Non-Combat Operations (NCO). Eight secondary missions are also assigned to the aircraft. Traditional roles in Search and Rescue (SAR), Medical Evacuation (MEDEVAC), Vertical Replenishment (VERTREP), Naval Surface Fire Support (NSFS), and Communications Relay (COMREL) are encompassed within these mission areas.



Figure 11: MMH Equipped for ASUW

When used in an SUW mission, as depicted in Figure 11, the aircraft provides a mobile, elevated platform for observing, identifying, and localizing surface platforms beyond the parent ship's radar and/or ESM horizon. When a suspected threat is detected, classification and targeting data is provided to the parent ship via the data link for surface-to-surface weapon engagement. Air-to-Surface missile equipped aircraft may conduct independent or coordinated attack, depending upon the threat and tactical scenario. In the ASW mission, the aircraft deploys from the parent ship to localize, classify, track, and, if necessary, attack when a submarine has been detected by the ship's towed-array sonar, hull-mounted sonar, or by other internal or external sources.

In the SAR mission, the aircraft searches for and locates a target/object/ship or plane and rescues personnel using the rescue hoist. In the VERTREP mission, the aircraft transfers material between ships, or between ship and shore, via the cargo hook. In the MEDEVAC mission, the aircraft evacuates ambulatory and/or litter-bound patients. In the NSFS mission, the aircraft provides a platform for spotting and controlling naval gunfire for either the parent ship or other units. In the COMREL mission, the aircraft serves as a receiver and transmitter relay station for Over-the-Horizon (OTH) communications between units.

c) MH-60S

Another member of the MMH product line, the MH-60S is also managed by PMA-299. The MH-60S relies on the same airframe as the MH-60R, but is configured differently to address the assigned missions. The MH-60S missions include Vertical Replenishment (VERTREP), Vertical Onboard Delivery (VOD), amphibious Search and Rescue (SAR), Airhead operations, Non-combatant Evacuation Operations (NEO), Medical Evacuation (MEDEVAC), Special Warfare Support, Combat Search and Rescue (CSAR), Maritime Interdiction Operations (MIO), Anti-surface Warfare (ASUW), CV Plane Guard/SAR, Air Ambulance, and Organic Airborne Mine Countermeasures (OAMCM).

d) Littoral Combat Ship

The LCS is a networked, agile, stealthy surface combatant capable of defeating anti-access and asymmetric threats in the littorals. (Anti-access refers to a hostile force boundary that prevents communication or physical entry into an area of interest. Anti-access may be achieved through blockade, mines, or barrage jamming, for example.) This relatively small, high-speed combatant can operate in environments where it is less desirable to employ larger, multi-mission ships. It has the capability to deploy independently to overseas littoral regions, remain on station for extended periods of time either with a battle group or through a forward-basing arrangement. It can operate with Carrier Strike Groups, Surface Action Groups, in groups of other similar ships, or independently for diplomatic and presence missions.

The LCS relies heavily on manned and unmanned vehicles to execute assigned missions and operate as part of a netted, distributed force (e.g., Fire Scout, MH-60). The LCS is capable of operating at low speeds for littoral mission operations, transit at economical speeds, and high-speed sprints, which are necessary to avoid or prosecute a small boat swarm or submarine threat, conduct intercept operations over the horizon, or for insertion or extraction missions.

The LCS communicates with the Fire Scout through the Fire Scout Control Station (FSCS). It sends control signals (for both the AV and the sensor package) over a

bi-directional UHF link, receiving command acknowledgment from the Fire Scout across that same link. The Fire Scout sends sensor data back to the LCS ship over a Tactical Common Data Link (TCDL) channel. The TC DL link is maintained using directional antennas on both the Fire Scout and the LCS. The LCS has two antennas, one forward and one aft, to maintain communication through blockages associated with the ship's structure. There are two configurations of LCS ship, one of which has two separate TC DL channels available, and the other, which has only one TC DL channel available. This was a significant consideration when analyzing alternatives.

LCS communications with the MH-60 consists of VHF and UHF voice and data communications in various modes via ARC-210 radio, as well as Link-16 for aircraft data, and Hawk Link for sensor data. These data links are not common with TC DL in either transmit or receive modes. A diagram of the LCS's major subsystems is shown below in Figure 12.

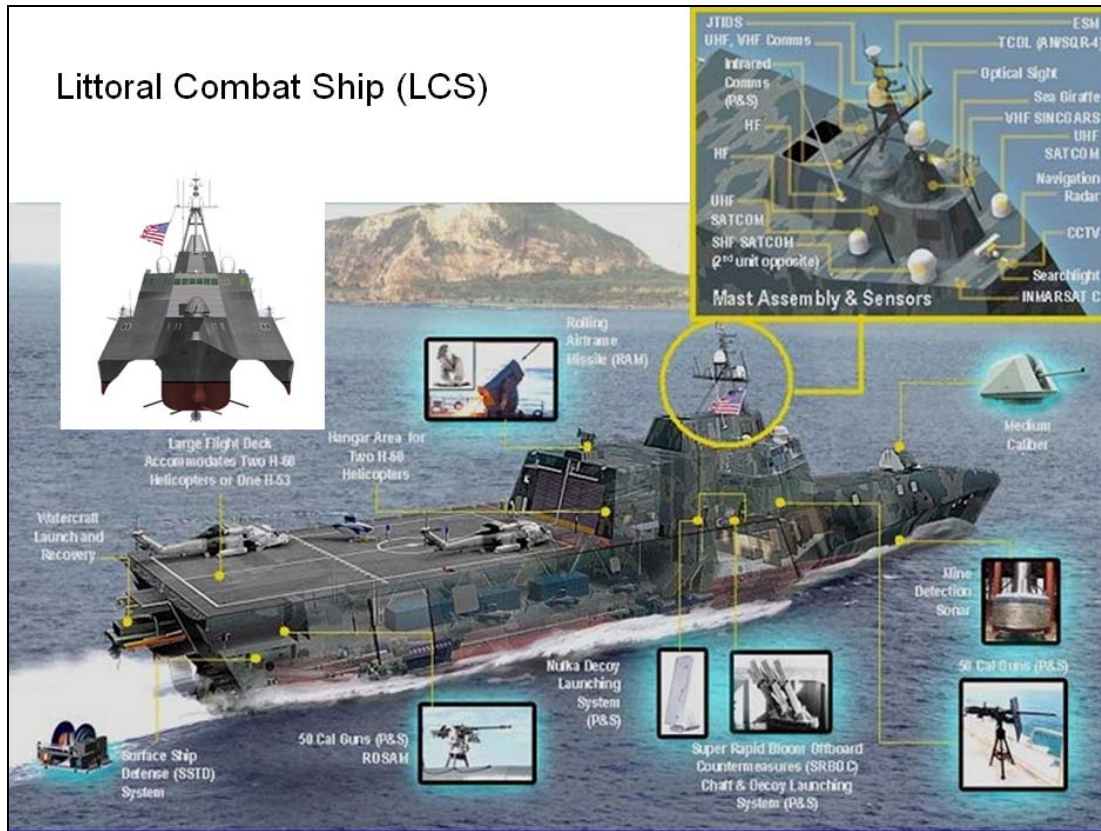

Figure 12: LCS Components and Subsystems

3. Needs

The stakeholders identified the most pressing need as a mission scenario: Defending the LCS against multiple small boat threats. Once the HVA is secure, the operational scenario could be to pursue further engagement of threats in order to destroy all hostile units. This ultimate objective defined the mission scenario and became the focus of the project research. This top-level requirement was decomposed into requirements allocated to scenario phases for further study and analysis.

Analysis of this mission scenario determined that it was composed of three phases to accomplish mission success. The first phase was the Planning Phase. This phase involved all the activities that shipboard mission planners and aircrews perform before launching or transiting the hostile risk area, in this case, the choke point. Typical activities consist of familiarization with area intelligence for the latest probable locations of hostile units and their recent tactics. Another important activity was the configuration

of system mission packages including fuel load and weapons, for example, and selection of weapons, such as rockets or guided missiles based on the size of the expected threat. During this phase, the projected search areas and expected divisions of search area responsibilities between platforms were defined.

The second phase of the scenario was the “Build the Surface Picture” phase. The objective of this phase was developing situational awareness for all assets involved in order to place the LCS in an appropriate state of war fighting or protective readiness, as well as to place its commanders in the proper state for required operational decision making. Typical activities in the phase include ship and air assets employed to search, detect, and track all contacts nearest to the ship, initially, and then contacts in the areas of interest along the ship’s Projected Intended Movement (PIM). Derived requirements to perform this phase included: (1) ship and air asset performance to reach areas of interest, which equates to speed, endurance, movement; (2) sensors capable of detecting contacts, which equates to sensitivity, resolution, range; and finally, (3) a communications system and network that can move orders/direction and contact information to the appropriate assets or commanders, which for interoperability, equates to the ability to transmit data, voice and images.

The third phase entailed resolving contacts found in the previous phase of the mission in order to classify and identify each contact to a sufficient degree for making a hostile or friendly determination. Derived requirements for these top-level requirements encompassed sufficient sensor capability to provide the necessary data characteristics for commanders to make those determinations with confidence. These necessary characteristics included, at a minimum, contact behavior and detailed contact visual descriptions, such as seeing human images and contact cargo or weapons.

The final phases of the mission entailed engaging hostile contacts, assessing the situation at the conclusion of an engagement, and then conducting after action reports and reviews of the mission. Derived requirements for this portion of the mission scenario included: provide sufficient communications and targeting information to employ a weapon; provide sufficient sensor capability to assess damage to contacts; and provide sufficient platform capability to re-engage contacts. Research on these final phases, and specifically into the benefit of interoperability on target engagement, was beyond the

time period allotted for the project. The project research was conducted with the complete set of needs and activities in mind and artifacts were developed for future use by sponsors, stakeholders, or research students.

4. Constraints

Along with addressing the needs of the scenario, the project team recognized the scenario constraints. The constraints of the scenario were almost a mirror-image of the needs. Although the derived requirements identified above listed the needed capabilities, the actual performance of the contributing platforms and systems became the constraints identified and assessed in this project. To specify these constraints and identify limits to performance or integration due to the original design or operational use, the project team performed a thorough study of the capabilities of the platforms. Tables 1 and 2, presented below, are sample artifacts from this activity.

Table 1: MH-60R Current Capabilities Matrix for Identification of Constraints

Mission	Threat/ Objective	Sensor Systems			Communication Systems					Weapons				Recording Systems	
		FLIR	RADAR	AIS	V/UHF RADIO ARC-210	SATCOM	Data Link "Hawklink"	Link-16	Blue Force Tracker	Hellfire	M240	GAU-17	Torpedo	DVR	VCR
ISR	Standard	X	X		X	X	X	X		X	X		X	X	
	Extended Range	X	X		X	X	X	X						X	
Threat Interdiction	Small, Fast	X	X		X	X	X	X		X	X		X	X	
	Swarm	X	X		X	X	X	X		X	X		X	X	
	Military Ship	X	X		X	X	X	X						X	
	Board & Search	X	X		X	X	X	X						X	

Table 2: MH-60S Current Capabilities Matrix for Identification of Constraints

Mission	Threat/ Objective	Sensor Systems			Communication Systems					Weapons				Recording Systems	
		FLIR	RADAR	AIS	V/UHF RADIO ARC-210	SATCOM	Data Link "Hawklink"	Link-16	Blue Force Tracker	Hellfire	M240	GAU-17	Torpedo	DVR	VCR
ISR	Standard	X			X	X				X	X	X			X
	Extended Range	X			X	X									X
Threat Interdiction	Small, Fast	X			X	X				X	X	X			X
	Swarm	X			X	X				X	X	X			X
	Military Ship														
	Board & Search														

The tables show the mission systems configurations of sensors, communications and weapons by mission type for the MH-60R and MH-60S helicopters, respectively. The tables highlight the major differences between the two MMH variants, most importantly the fact that the MH-60R is equipped with RADAR and data links for the same missions, where the MH-60S is not.

Using these artifacts, the project further identified the physical and performance limitations and used this information as input to the modeling activities. Table 3, for example, was compiled to identify the capabilities of the air platforms' communication systems that would set the baseline for modeling and constrain definition of interoperability alternatives.

Table 3: Platform Communication Capability Constraints

	MH-60R	MQ-8B (no radar)	MH-60S	MQ-8B (radar)
VOICE Comms	•ARC-210 direct or relay	•Internal comms from CS	•ARC-210 direct or relay	•Internal comms from CS
Track Data	•TCDL to CIC •Link 16 to CIC	•TCDL to CS	•Link 16 to CIC	•TCDL to CS
Video Data	•TCDL to CIC	•TCDL to CS	•None	•TCDL to CS
Video Data/ Control to shooter	•None	•None	•None	•None

Once the needs and constraints research was completed, the project team concluded that sufficient platform performance was available to conduct the desired mission scenario, sensors supported the phase requirements, and further, that weapons existed to accomplish the engagement, if required. At the same time, the project team identified constraints in the communications capabilities of the total weapons systems for the defined scenario that were deemed to have significant opportunity for improvement.

a) Initial Requirements

After assessing the need and constraints, the project defined the initial requirements for development of the research models in the context of the mission scenario. An example of the stakeholder mission scenario is presented in Figure 13. The scenario portrays the LCS transit through a geographical choke-point where the HVA may be most vulnerable to a SWARM, with little room for recourse and maneuver.

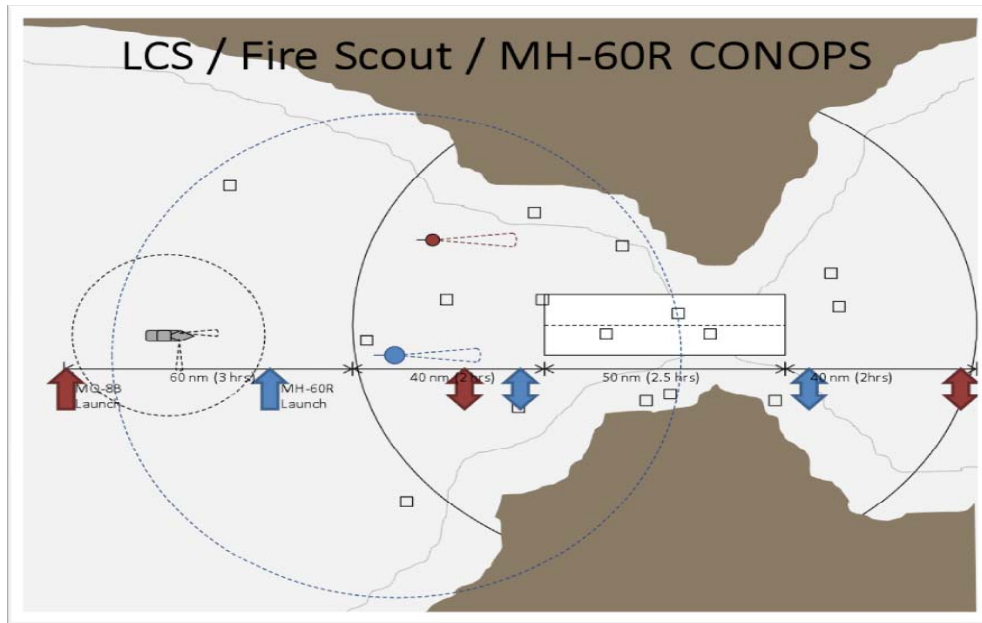

Figure 13: LCS/MH-60R/Fire Scout CONOPS for ASUW Protection from Small Boat Swarm through a Choke Point

This real-world scenario requires a HVA to transit a choke point with heavy transit by commercial shipping vessels. Threat analysis indicated that the HVA, in this case LCS, would be vulnerable to a small boat swarm attack, where several small vessels intermingle with commercial shipping and then attack using either random or coordinated maneuvers. In this scenario, the critical measure was determined to be the time required to identify targets and classify them as threats, or TTI. The presence of commercial shipping created a target-rich environment, and the time required for a single aircraft, either Fire Scout or MH-60, to identify all of the targets and classify them as threats via coordination with an appropriate Decision Maker could be excessive. Sending out multiple assets, both a Fire Scout and an MH-60, in an uncoordinated manner could

provide some reduction in the time to identify and classify. Providing a means to coordinate between the Fire Scout and MH-60 was proposed to provide even more improvement in the time to identify and classify, and that is the focus of the remainder of this report, to analyze and quantify potential benefit associated with the KPPs and MOEs defined to support a relevant CONOPS (to be described more fully later in this report). In this context, the list of high-level initial requirements is provided below:

Defend Against Small Boat Attack:

- **Build Surface Picture**
- **Resolve Contacts of Interest**
- **Engage Hostiles**
- **Assess Mission (Post Engagement)**
- **Share Command and Control Data**

b) Assets in Play

Identification of existing platforms and sensor and communications capabilities was performed by use of sources such as the Naval Aviation Training and Operating Procedures Standardization (NATOPS) manuals and platform program office consultation. The CORE SE tool was used to develop a high level architecture model and manipulate functionality for analysis of potential alternatives and to understand existing system capability, as well as capability gaps. This effort was rolled up into the development of an initial plan for further functional analysis. Figure 14, below, maps the current sensor configuration and relevant capabilities for the airborne platforms.

^{[18][19][20][21]} The key sensor from each platform that most benefits success for each scenario phase is highlighted. The key sensor from each platform that most benefits success for each scenario phase is highlighted. For Phase I, “Create Surface Picture,” the RADAR plays the key role for detection and tracking. For Phase II, “Resolve Contacts,” the FLIR and EO/IR sensors play the key role, contributing imagery for analysis of contact behavior and visual identification. For Phase III, “Engage Contacts,” the laser designator and Hellfire weapons are critical capabilities.

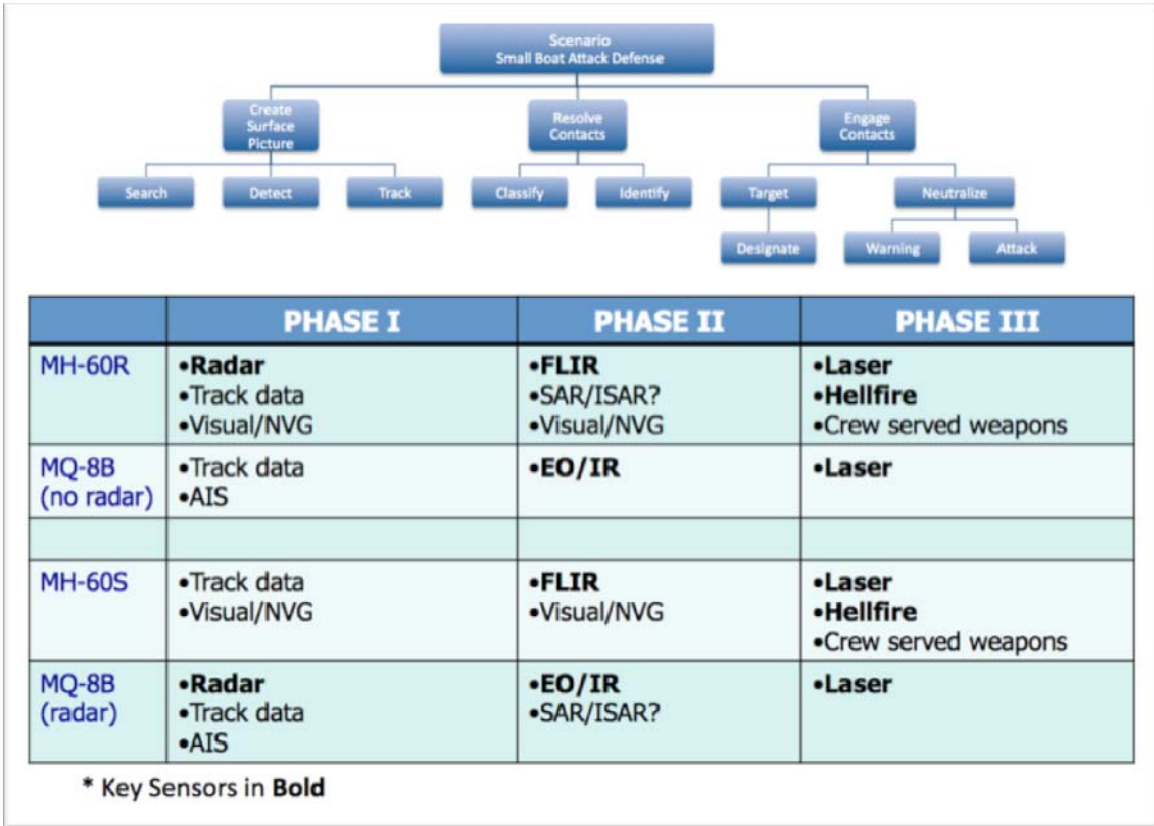

Figure 14: Current Sensor/Capabilities by Platform and Applied to Initial Phasing Plan

C. REVISED PROBLEM STATEMENT

Given the substantial guidance from Stakeholders, results from Needs and Constraints identification and the results of mission-based requirements analysis, the Initial Problem Statement was revised to focus the scope of effort and support development of a CONOPS and systems architecture associated with the deployment of the Fire Scout and MH-60 as part of an integrated SOS, while providing a framework for more complete assessment of enhanced performance based on interoperability. The initial problem statement was refined to address the specified threat and mission scenario:

Does an integrated SOS of MH-60, Fire Scout and LCS, working on a shared COTP with enhanced data communications achieve a more effective solution defending LCS against SWARM threats?

SYSTEM CONFIGURATION AND OPERATION

The following sections describe the process, approach and results for refining the SOS comprised of Fire Scout, MH-60 and LCS in response to the revised problem statement. The SE analysis focused on system configuration and mission operations, making the translation of operational requirements and functional architecture to physical allocation and activities.

A. CONCEPT OF OPERATIONS AND MISSION SCENARIO PHASES

Based upon the stakeholder-given scenario and capabilities-based assumptions, CONOPS were developed to capture and analyze interoperability effectiveness, focusing on the combined effects of the MQ-8B Fire Scout and MH-60 Seahawk. Because the mission commander, the key decision maker, is onboard the LCS, and much of the communication and coordination is accomplished through the host ship equipment, components of LCS are considered part of the system alternatives.

The ASUW swarm attack scenario was centered on the protection of the LCS as it transits through the choke point, depicted as “worst case” straights geography. To accomplish this mission, the project addressed the SOS control of the battle space beyond the sensor and weapons range of the LCS with the objective of neutralizing threats before they reach weapons engagement range of the HVA. Through functional decomposition, the defense from small boat attack operation was broken down into activities and grouped into three distinct primary phases, as discussed in the previous chapter. Phase I was defined as the development of the tactical surface picture, which includes the generic tasks of search, detect and track. Phase II was defined as the resolution of contacts, which includes classification of vessel type as well as identification as hostile, neutral or friendly designation for surface contacts. Phase III was defined as threat engagement, which includes threat vessel targeting and neutralization or attack and destruction. A complete analysis would also include a mission assessment phase for battle damage assessment (BDA) as well as pre-mission planning and post mission analysis. These final phases were beyond the scope of the project, but influenced the SE and modeling and

analysis activities in support of future, follow-on work. For the purpose of this report, the project focus was system effectiveness during the first three primary operational phases.

As depicted in Figure 15, the three mission scenario phases of coordinated SOS operations run concurrently in execution. The ASUW mission commander depends upon airborne RADAR coverage to provide a continuous surface tactical picture (Phase I) throughout the entire transit. The importance of this phase in providing situational awareness is highlighted by the stakeholder guidance to examine scenarios where at least one air asset is configured with surface search RADAR. The MH-60R RADAR has 360-degree coverage and longer range than the RADAR to be incorporated into the Fire Scout, but both have the capability for automatic detection and tracking. This automated capability enables parallel processing of Phase I activities. While the surface picture is maintained by either the MH-60R or the Fire Scout (when fully integrated across the SOS), both can be employed to conduct the Phase II functions of classification and identification of contacts using EO/IR as the primary sensor source for imagery. These activities are more operator-intensive and require serial processing and significant coordination with the mission commander. The Phase III engagement functions are triggered by the results of Phase II in conjunction with satisfaction of Rules of Engagement (ROE).

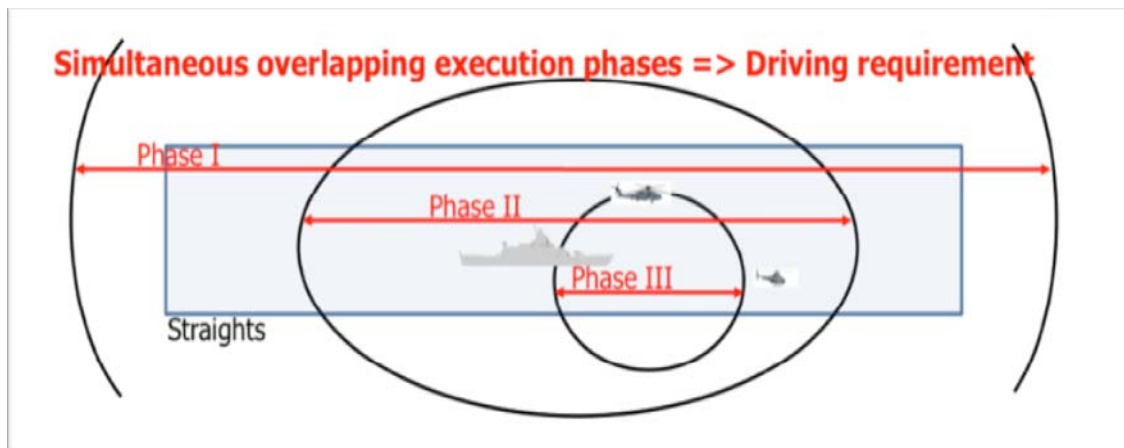

Figure 15: Overlapping Phases of Operations

Given the mission-scenario proscribed by the stakeholders, the project team determined that there were, in fact, two versions of the same situation from an analytic viewpoint. The airborne assets operating as coordinated SOS drove the need to establish two scenarios in response to the Stakeholder requirements. The combination of platform and sensor “footprint” or area of interest covered by the optimum platform-sensor coverage determined the two distinct variations, hereafter referred to as Scenario 1 and Scenario 2. These two scenarios share the same Stakeholder defined geo-political basis, but vary in terms of platform-sensor capability projected as geometric coverage (i.e., platform and sensor ranges). Scenario 1 was defined by the combination of an MH-60R equipped with RADAR and a Fire Scout without RADAR. Scenario 2 was defined by an MH-60S without a RADAR and a Fire Scout equipped with a RADAR. The key constraint was the Stakeholder demand for employment of an airborne RADAR as the key sensor for search and detection as critical to Phase I. Because the SOS configurations differ in terms of coverage and performance, separate analytic scenarios were defined. Each of these SOS configuration-specific scenarios is described below, including the activities important to each phase. The CONOPS description is the basis for understanding how system configuration, functionality and performance pertains directly to mission activities and outcomes, setting the basis for measuring and assessing alternatives in later Modeling and Simulation (M&S) activities.

1. Scenario 1

The specific CONOPS for Scenario 1 is represented in Figure 16, below. In this scenario an MH-60R is teamed with a Fire Scout that is not equipped with RADAR to protect the host LCS platform during transit through the straights. This notional operation begins 100 nautical miles prior to entry into the straights and lasts 12.5 hours with the LCS traveling an average of 20 knots. The take-off, landing and re-launch timing for both aircraft is designed to maximize overhead coverage while de-conflicting time on deck and keeping both assets airborne through the constrained 50 mile traffic pattern where the LCS is most vulnerable. The MH-60R, with a maximum endurance of 3.5 hours, cannot provide coverage for the entire operation without more than 3 sorties so the initial take-off is held until the LCS is 70 nm from the entrance of the straights or until

indications of threat dictate that earlier launch is required. Whenever only one asset is airborne, TCDL is used for communications and data exchange with LCS since it is capable of transmitting streaming video from the EO/IR sensors. When both assets are airborne, the MH-60R conducts operations using UHF voice and Link16 for data.

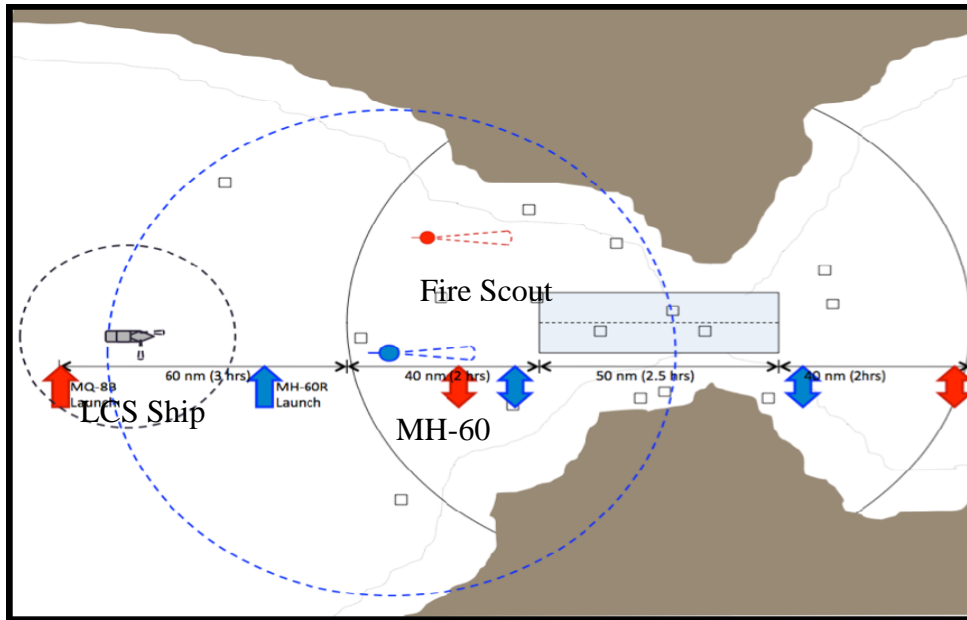

Figure 16: Scenario 1 CONOPS

a) Scenario 1 - Phase I

In the Scenario 1 CONOPS, the primary asset assigned to accomplish the Phase I activities of building and maintaining the surface picture is the MH-60R Seahawk, equipped with a surface search RADAR. The majority of the operation is conducted at an optimal altitude for RADAR coverage so that a continuous surface tactical picture can be maintained. Automatic track generation, long range and 360-degree RADAR coverage capabilities result in highly efficient Phase I activities. The Fire Scout augments the surface search with AIS tracks only, since it has no RADAR in this scenario. The Fire Scout also performs limited search functionality with the EO/IR payload during periods when the MH-60R is not airborne. In this scenario, the COTP is maintained on the LCS by the ASUW commander with inputs from both aviation platforms.

b) Scenario 1 - Phase II

An essential element of the CONOPS is that Phase II operations are conducted concurrently with Phase I. The tracks generated by the MH-60R are shared with the LCS CIC and used to cue the EO/IR sensors for both assets. The track information must be passed verbally to the Fire Scout operators at the tactical control station because there is no direct data path from CIC. The ASUW commander aboard LCS directs the airborne asset tasking priorities and assigns sectors for split coverage to maximize the efficiency of contact investigation. Each air asset then begins methodical classification and identification of all vessels within their assigned sectors starting in close and moving outward from the HVA. The MH-60R uses SAR, visual and night vision goggles (NVG) during night operations to supplement the primary EO/IR sensor in classification and identification functions. Track information is transmitted verbally or via Link-16. The Fire Scout relies exclusively on the Britestar II EO/IR sensor, but is able to transmit streaming video to the tactical control station via TCDL. Fire Scout video is not available on the LCS network so the ASUW commander must visit the control station to observe the video. Except for critical contacts, most information will be passed via verbal communications. To effectively prosecute the operation, the ASUW commander must ensure the classification and identification information for all vessels is correlated with the tracks maintained in the COTP. He is also responsible for ensuring that ROE criteria are met prior to contact designation as hostile. These criteria are not addressed here but include both vessel characteristics and observed activities.

c) Scenario 1 - Phase III

There are many potential CONOPS for the conduct of Phase III activities. Actual execution of targeting and engagement is situation and weapon dependent, and specific tactics are beyond the scope of this study. Since the focus of this research is interoperability, the CONOPS associated with a coordinated attack are briefly addressed.

Only the MH-60R is equipped with weapons and therefore, in all cases, fills the role of the shooter. Once a hostile contact is identified, the preferred method of engagement is a coordinated attack due to the added safety advantage of sensor-to-

shooter standoff range from the target, but requires both assets to be on scene. To execute this task the Fire Scout maintains a safe stand-off distance, holds continuous EO/IR track and illuminates the target. Concurrently, the MH-60R readies the weapon (i.e, the Hellfire missile), ingresses covertly to the target, fires the weapon when in range and egresses the area immediately. Since data cannot be directly transmitted between vehicles, verbal coordination is required to assure the right contact is targeted and to confirm the laser designator is on target. The MH-60R may take immediate action to conduct an attack if Fire Scout is not in the area, but will be more vulnerable.

2. Scenario 2

The CONOPS for Scenario 2 features the same threat and features the MH-60S and Fire Scout equipped with RADAR, depicted in Figure 17. The operational flow and LCS transit is identical while the take-off, landing and re-launch timing for the aircraft is shifted to account for and take advantage of different capabilities. The MH-60S has longer endurance so it can remain on station longer, therefore it may launch first. With the addition of surface search RADAR capability on the Fire Scout, its endurance is slightly decreased due to payload weight, but it can still remain on station for the entire evolution with three sorties. Again, the plan keeps both assets airborne while the LCS is in the straight transit traffic scheme. In this scenario, only the Fire Scout is capable of transmitting video from the EO/IR sensor via TCDL communications and data exchange with LCS, because the MH-60S is not equipped with data links.

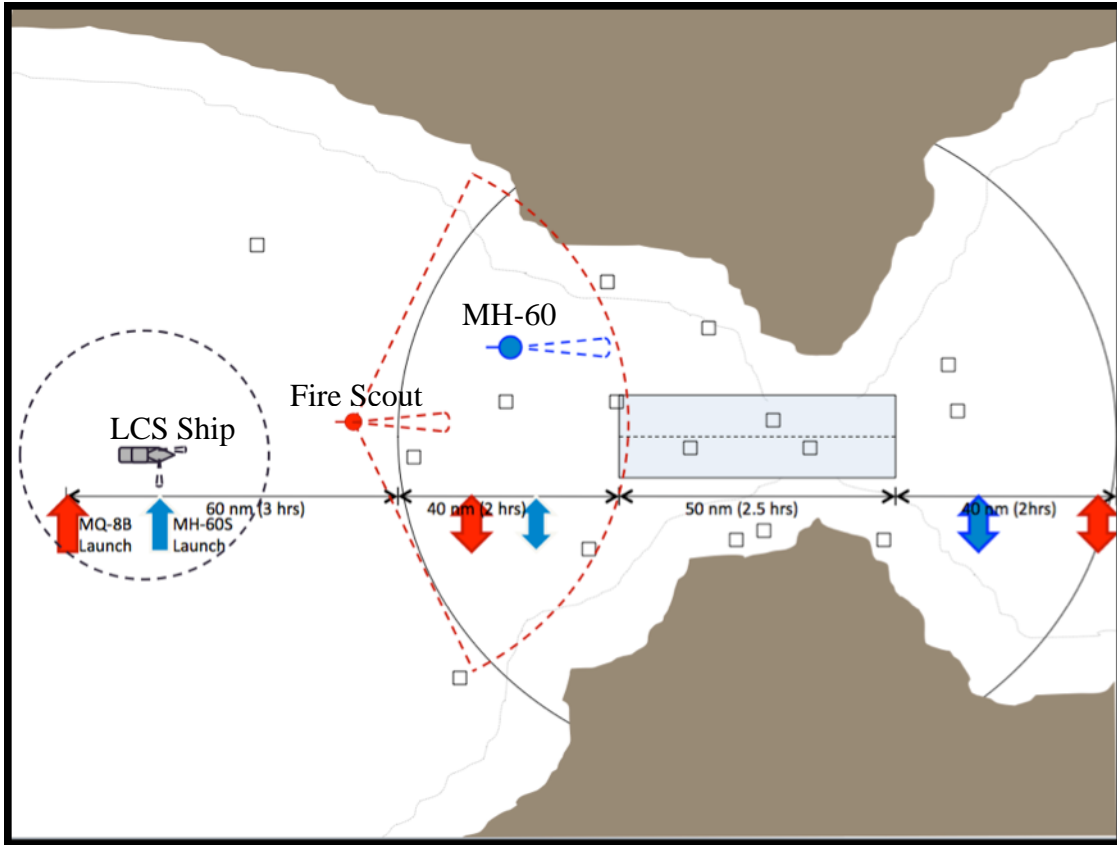

Figure 17: Scenario 2 CONOPS

a) Scenario 2 - Phase I

In the CONOPS developed for this scenario, the primary asset assigned to accomplish the Phase I activities of building and maintaining the surface picture is the Fire Scout. It remains at best RADAR coverage altitude for the majority of the operation, but must continually change direction to maintain the surface tactical picture since its RADAR does not provide 360-degree coverage. It has shorter range than the MH-60R but does have automatic track generation capability. The contacts generated must be verbally passed to CIC so that the ASUW commander can maintain the COTP. The MH-60S augments the surface search visually or via NVGs at night. It also performs limited search functionality with the EO/IR payload during periods when the Fire Scout is not airborne.

b) Scenario 2 - Phase II

As in Scenario 1 the CONOPS includes Phase II operations concurrent with Phase I. Since the Fire Scout must maintain the surface picture by changing RADAR aspect angles, its efficiency will be decreased in classifying and identifying contacts. In this scenario the tracks generated by the Fire Scout are shared from CIC to the MH-60S for cueing of its EO/IR sensor. All other Phase II CONOPS are identical to those in Scenario 1.

c) Scenario 2 - Phase III

The CONOPS for Phase III activities are identical to Scenario 1. Again, the Fire Scout is unarmed so it fills the roll of target designator for the MH-60S in the execution of coordinated attacks.

3. Communications Analysis

Through systems analysis and CONOPS development, it was determined that system interoperability has critical limitations in communications. Timing delays in the information flow required to execute each operational phase have a significant impact on the MOEs chosen for evaluation of mission effectiveness. In order to understand these limitations, a deeper investigation was conducted to understand the timing logic associated with the specific tasks involved in each phase. SE Functional Flow Block Diagrams (FFBD) were used to depict and analyze the communications timing logic for impacts to performance and effectiveness.

a) Phase I

Figure 18 represents the functional flow of tasks involved in Phase I. The FFBDs were developed to clarify the sequence of activities and associated system employment. (This type of information informs later specification of system modification, especially software functionality.) This diagram is applicable to whichever asset has RADAR capability and is assigned with generation of contacts and building the surface picture. It

includes the tasks required to ensure that the Tactical Action Officer (TAO), acting as the ASUW commander, has complete situational awareness and can maintain control of the operation. Although the tasks are linked in a serial fashion multiple contacts can be processed simultaneously.

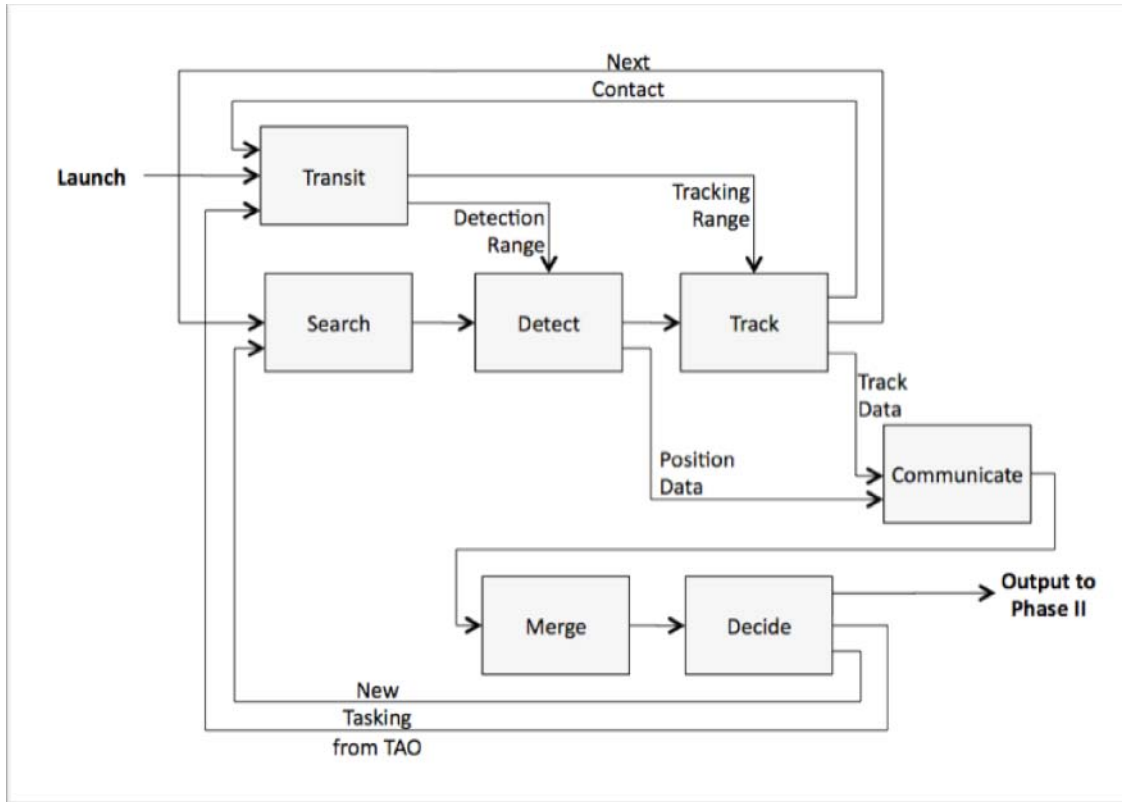

Figure 18: Phase I Functional Flow

After launch and climb to RADAR altitude, the RADAR-equipped helicopter transits to station and begins its search. Detection and tracking are dependent upon both the RADAR sensor capability and the physical distance from contact. The physical limitation is overcome by the movement of the air platform, transit, and may introduce time delay in accomplishing those tasks. The transit delay is calculated from the range to the contact, sensor detection and tracking range and transit speed. There is no associated time delay for contacts already located within the sensor field of view. It should be noted that when the Fire Scout is providing the RADAR picture the transit task must also

account for direction since the RADAR does not have 360-degree coverage. A ladder type search pattern (or some search pattern that optimizes coverage) was assumed to be flown to update contacts in all directions.

Since the RADAR sweep functionality is automated, there is no time delay for the Search task after RADAR initialization. Similarly there is no time delay for subsequent detections after the first contact is generated because all contacts in the field of view are simultaneously developed by the processor when RADAR energy is received. Time required to generate track solutions depends on RADAR mode but use of the automatic track generation functionality makes the track task almost instantaneous. The loop back to the transit and search task illustrated on the functional flow diagram represents the continuous process of track generation that is not interrupted as the data is communicated.

After a track is generated it must be passed to the TAO in CIC to be added to the COTP. The MH-60R transmits multiple contacts simultaneously via Link 16, or TCDL when not in use by the Fire Scout. The Fire Scout contacts are transmitted to the fire Scout control station (CS) on board LCS but must be passed verbally to CIC (latitude, longitude, course and speed) to be manually entered into the COTP. Verbal communication can be time consuming and prone to error. Although multiple contacts can be passed quickly, this represents a significant limitation to system interoperability because they must be manually updated.

The Merge task is accomplished by operators in CIC and represents the function of combining tracks from multiple sources, including the LCS RADAR, into the COTP surface picture for the ASUW commander. The Decide task for the ASUW scenarios considered is generally delegated via pre-planned response to the operators to transition to Phase II classification and identification for all contacts. Additionally, it is understood that all unresolved Contacts of Interest (COIs) must be continuously tracked and updated until neutralized.

Delays associated with passing essential Phase I information via verbal communications are significant but are not limiting factors for the overall mission execution because multiple contacts can be handled simultaneously or in parallel.

b) Phase II

Figure 19 represents the function flow of tasks involved in Phase II. As for Phase I this FFBD is applicable to whichever asset is assigned with contact resolution responsibility, in this case both. Again, it includes the tasks required to ensure that the TAO, acting as the ASUW commander, has complete situational awareness and can maintain control of the mission. Although the tasks involved in the functional flow appear similar to that of Phase I, operator workload and sensor capabilities limit the processing capacity to one contact at a time per air vehicle. The serial nature of the tasks and the need for human evaluation make Phase II the driver in system performance with respect to the MOEs.

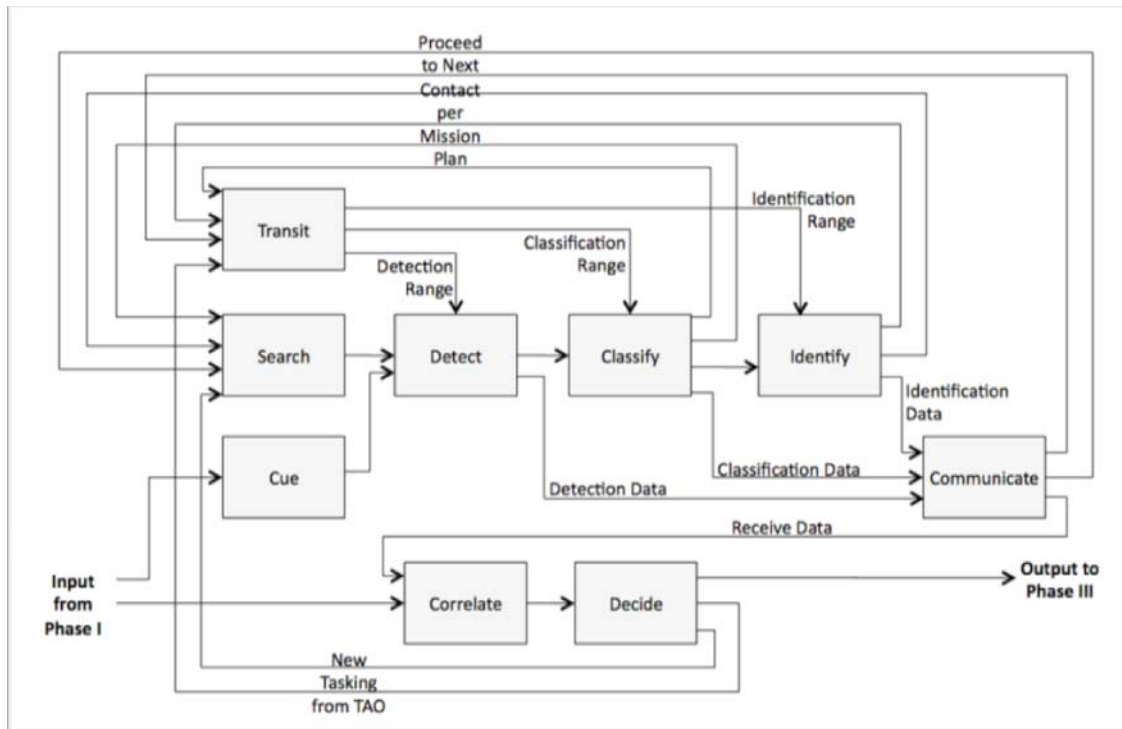

Figure 19: Phase II Functional Flow

In order to perform the essential mission tasks of classification and identification the MH-60 or Fire Scout must detect and acquire each individual contact with the EO/IR sensor. The detection can result from direct pointing of the sensor, cueing, or from a track

generated in Phase I. With the automated slew capability available for both air assets, the time to affect this cueing can be very short and depends primarily upon the communication delays in passing a track and the operator's ability to input the track into the system. When the track is self-generated there is very little time delay. The detection can also result from a methodical search using various sensor-sweeping patterns when there is no asset to provide RADAR tracks for cueing. The associated time delay can be very large and depend on many unknown factors like surface vessel traffic density. Either means requires the asset to have transited into EO/IR sensor range. The transit delay is calculated from the range to the contact, sensor detection range and transit speed. There is no associated time delay for contacts already located within the range. A well-prosecuted mission will minimize transit delays by coordinating the order of contact investigation from the COTP.

Once a contact is detected in the field of view, the EO/IR sensor operator must analyze the image to classify it. The objective of this task is simply to determine basic attributes such as size, type of vessel, and behavior or activity profile. Time to complete this task is considered relatively constant for trained operators but additional transit time will be required for smaller vessels. For the purposes of this mission, large vessels such as tankers, where profiles match the AIS reporting information for commercial traffic, there is no additional contact investigation required.

For all other contacts, the next task of identification must be accomplished. This task is also accomplished through analysis of EO/IR imagery but requires closer range investigation to observe details leading to assessment of the contact's potential intentions. Therefore, there may be additional transit delay, especially if multiple aspect angles are required to obtain identification. A contact that can be positively identified as friendly or neutral requires no further analysis. The rest are classified as COIs. These contacts must be continuously monitored as potential threats. Depending upon ROE, a hostile act may be required to change a contact's status to hostile and designate it for engagement. The preplanned response in the developed mission CONOPS dictates that for any vessel identified as a COI, the identifying air vehicle must stay on station until the mission commander makes his decision on course of action. The remaining tasks in the Phase II functional flow facilitate that decision.

The communicate task relays classification and identification information to the TAO or ASUW commander in CIC onboard LCS. For the MH-60, information is transmitted via UHF verbal communications. In Scenario 1 the MH-60R has the option of temporarily assuming the TCDL link from Fire Scout to pass video directly to CIC. Though the Fire Scout can use TCDL to transmit video data at all times to the ship, it is only received at the UAV control station and must still be verbally passed to CIC over internal communications. For both assets, communication delays are significant.

The next step, accomplished by LCS tactical operators, is the correlation of contact classification and identification information with contacts maintained in the COTP. This compiled surface picture is the visual representation of the battle space available to the mission commander. His decision is the last task in Phase II functional flow. After validating the identification he must decide whether to engage and proceed to Phase III, or direct the air vehicle to the next contact. This decision will be based upon many factors including identification features, relative position and movement to the HVA, and ROE in effect. If a COI is left to investigate other vessels, the COI track requires close monitoring and an EO/IR revisit schedule is established to ensure its profile has not changed.

c) Phase III

Due to complexity and situational dependence of potential CONOPS, a detailed functional flow was not generated for Phase III. After the initial requirements and system architecture analysis, as part of planning the M&S activities to incorporate as part of the SE process, the project team decided to concentrate effort on Phases I and II, since the greatest benefits of integration and interoperability would first impact the detect, track, identify and classify activities during these portions of the mission timeline. To account for a complete end-to-end kill chain and to provide a basis for future assessment, the tasks involved in conducting a coordinated missile attack were identified and are presented in Figure 20. These tasks are ordered and described below, but a full analysis is beyond the scope of this report. Time constraints for the project precluded detailed modeling and analysis. Detailed analysis in this area is considered a potential candidate for follow on work.

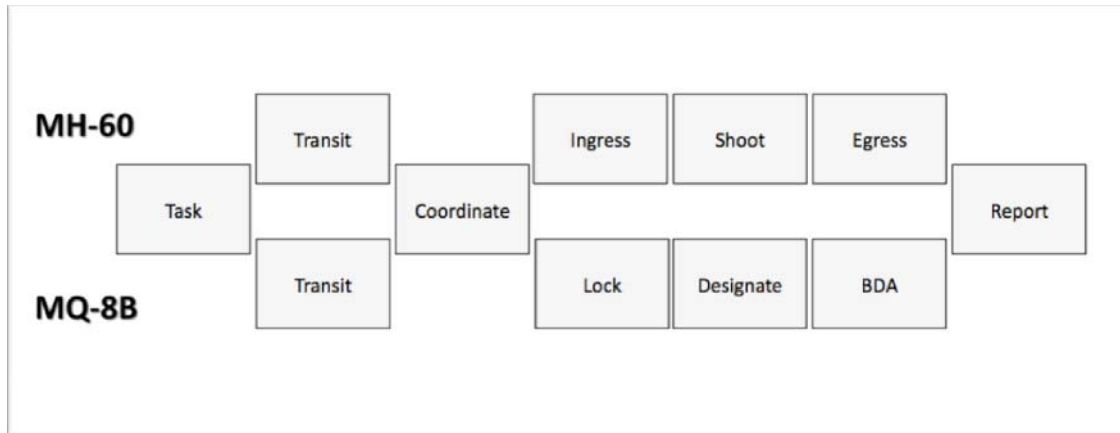

Figure 20: Phase III Functional Tasks

d) Quantification of Communication Effectiveness

The detailed understanding of the information flow and CONOPS provided the basis for determining the limitations inherent in the communications architecture. As shown in the functional flow analysis, the serial nature of Phase II contact processing make that phase the driving constraint. In order to assess system interoperability effectiveness with respect to the TTI MOE, the timing associated with each of the Phase II tasks needed to be quantified. This analysis was conducted using the given scenario, the developed CONOPS, and data gathered from the Stakeholders. Table X shows the matrix of assessed time delays for each task in the Phase II functional flow. Times were assigned based on the type of contact being investigated. These assignments are general rough order estimates intended to represent the average time intervals to complete the tasks, independent of sensor ranges. Sensor ranges are compensated for in transit time.

Ten different categories of surface vessels were defined for traffic that would typically be encountered during the given scenarios. The vessels were grouped by size as well as interest level based on type of vessel and its profile. Vessels identifiable as friendly or neutral are shown in green while hostile contacts are shown in red (in these scenarios small armed boats). Vessels that could not be ruled out as hostiles are considered contacts of interest and are shown in yellow. The allotted times to accomplish Phase II tasks are dependent upon the category of the vessel being investigated.

Table 4: Phase II Timing Matrix

Time (minutes)	Non-Contact of Interest					Contact of Interest *			Hostile	
	Large Vessel		Medium Vessels			Small Vessels			Threat Vessels	
	AIS	No AIS	Transit	Fishing	Other	Fishing	Other	In TTW	No Guns	Guns
Detect **	0.5	0.5	0.5	0.5	0.5	0.5	0.5	0.5	0.5	0.5
Classify	2	2	2	2	2	2	2	2	2	2
Identify		2	2	2	3	3	4	4	4	4
Communicate			2	2	2	2	2.5	2.5	2.5	2.5
Correlate							2	2	2	2
Decide							3	3	3	3
Total ***	2.5	4.5	6.5	6.5	7.5	7.5	14	14	14	14

* Contacts classified as COIs require constant RADAR track coverage and revisit with EO/IR; reclassify to hostile after scripted profile change

** Add 2 minutes if cued from external sensor; Add X? minutes to detect if no cueing sensor available

*** Total time does not include time to transit into sensor range

The non-contact of interest group consists of the large and medium vessels as well as any small vessel that can be positively identified by the sensor operators as uninteresting (labeled in table as “fishing”). Following the predetermined tactics of the developed CONOPS, certain Phase II tasks can be conducted while in transit to the next contact or skipped altogether. These are the tasks that would normally require coordination with the ASUW commander prior to moving on to the next contact, shown grayed out in the table.

Two types of large vessels were considered important to reducing the total number of contacts must be identified: those reporting themselves via AIS and those not reporting were not interesting as threats. A vessel whose classification matched its AIS report does not require further investigation. Medium size vessels were also generally

considered uninteresting because by definition, they do not match the threat profile of a small attack boat. During classification and identification of these vessels it was expected that their activity such as straits transit or fishing, was communicated to the mission commander on LCS before proceeding to the next contact. Small vessels without the capability to conduct swarm attack such as sailboats and unpowered fishing boats were also treated as non-contacts of interest. These, too, were categorized as “fishing” for the purpose of the project.

The rest of the small boat categories were considered hostile or potentially hostile contacts of interest. The hostile category contained any vessel that could have been visually identified as a threat regardless of its actions; this type of contact was labeled with “guns.” The others must have been observed in a hostile act to confirm threat status. It is also possible that due to location, a vessel was not approached closely enough for a positive identification, for example, a vessel inside territorial waters (TTW). For all of these contacts, a decision was required from the ASUW commander before proceeding to the next contact, adding significant time to the process because the decision depended on time for continuous tracking and adherence to strict criteria to revisit contacts identified as COIs with the potential to enter the threat engagement zone.

The completed Phase II timing matrix for this project provided method for quantitatively assessing mission performance. The application of this assessment to the interoperability of the Fire Scout and MH-60 in the given ASUW scenarios was realized in the sharing of information between assets. This was most noticeable in the time required for Phase II detection, which required track information output from Phase I. Knowing where to point the EO/IR sensor for cueing was key to reducing timeline. In independent operations, a single platform quickly cued its EO/IR sensor directly from its own RADAR tracks. In coordinated operations, however, where only one asset has RADAR capability per the given scenarios, communication time became critical in passing the track information. In this case the detect time was defined to account for that communication delay.

Another mission limitation evident in the Phase II timing matrix was the sharing of information with the ASUW commander. The “communicate” and “correlate” tasks represent actions required to incorporate classification and identification data into the

COTP. This provides the situational awareness that enables tactical decision-making regarding threat response in the context of ROE. Therefore, the ability to pass information efficiently impacts mission effectiveness. In the timing matrix the communicate time directly captures the time delay for passing Phase II information to the ship. The decide-time is affected by the quality of information provided; with better information a faster decision can be made.

Transit times, which are not accounted for in the timing matrix, are also impacted by data sharing. None of the Phase II tasks can be accomplished until the contact is in sensor range. For the asset without RADAR capability, track information must be communicated to the operator in order to efficiently direct the vehicle into sensor range.

In summary, the timing matrix table captured the CONOPS –based logic and assumptions about the mission timeline that was later modeled to more effectively characterize the impacts of interoperability.

B. ARCHITECTURE ANALYSIS

This section describes the Model Based Systems Engineering (MBSE) approach, top-level Architecture, Operational Architecture, Requirements Hierarchy, and Functional Architecture. MBSE was adopted for the project to gain experience with this recommended best practice, which aims to use requirements engineering and modeling tools, such as CORE, to enhance the capture, decomposition, traceability and configuration control of technical data. This section also contains samples of the preliminary CORE Architecture that was developed as part of this project. Graphical and textual descriptions of the element relationships and hierarchy diagrams, as well as rationale for the architecture model, are included.

For conducting research on the stakeholder needs and the capabilities of the MH-60, Fire Scout and LCS systems, the project team used tools such as system diagrams to depict data flow as well as functional flow diagrams. The architecture development process translated the outputs of the stakeholder requirements definition and analysis processes into functional diagrams and ultimately, alternative physical design solutions.

The functional architecture was key in determining how capabilities were allocated within a physical system that was already defined. The MH-60, Fire Scout and LCS are complete systems in development or deployed. Components of the physical architecture were assigned to functions within the functional architecture. Then, the constraints on the arrangement of the functional architecture was identified, which helped drive the arrangement of functionality into different alternative physical configurations.

The architecture views developed for this project consist of select operational, system and technical views that expressed the functional and physical architecture, as well as information exchange and net-centric requirements. The project team worked to ensure the traceability between architecture views and requirements.

As part of the Architecture Analysis, the integrated architecture was assessed against the stated capability need and requirements for the proposed materiel solution, as gathered from the stakeholders. The primary objective was to evaluate the translation of operational information into system functionality and preliminary system design information, using Enhanced Functional Flow Block Diagrams (EFFBD). A secondary objective was to provide initial observations on the model's utility for follow on systems engineering activities.

Identification of communication and interface requirements were a key component for this interoperability project, so it was important to ensure that all internal and external interface requirements were properly captured during the requirements engineering phase and documented as a part of the architecture development process. During this activity, missing, redundant or inconsistent requirements were discovered. Follow on efforts related to the architecting process will be required to ensure the functional architecture is in balanced with the stakeholder requirements.

1. Operational Architecture

The top-level architecture, shown in Figure 21, illustrates the operational nodes that have been identified for this architecture. Through the use of CORE, the associated operational concept requirements and the guidance and constraints that form the framework for this systems architecture were also documented. The operational

architecture captured the operational requirements and high level functional analysis in CORE, and established major threads through the system. The results culminated in an integrated behavior model of the system and its actions. The top-level architecture was decomposed hierarchically into the functions performed by the system. These functions were identified in direct response to the originating requirements in order to establish requirements traceability throughout the model.

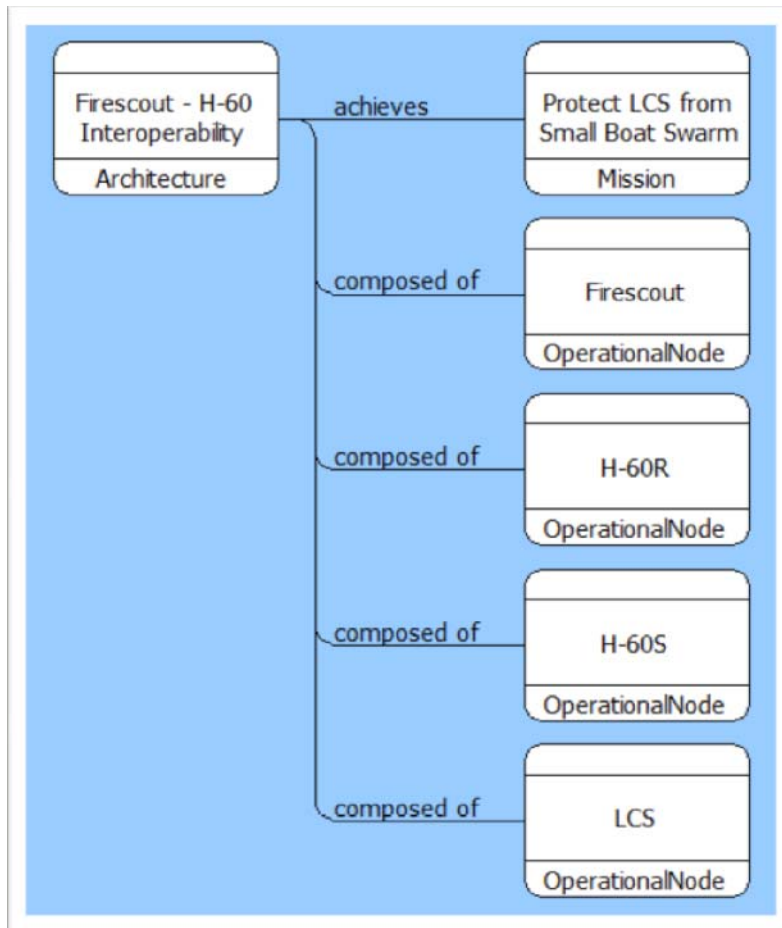

Figure 21: Top-level Architecture Diagram from CORE

The top-level CORE Operational and System Architecture was developed by referencing the Capability Needs Statement and project OV-1. High-level elements, attributes, and relationships were created in CORE. The top-level Architecture contained General Elements, Operational Architecture Elements, and Systems Architecture

Elements. Once the top-level Architecture was developed, it was further refined by the addition of hierarchies for each class. The requirements structure was developed and refined by adding requirements elements, attributes, hierarchies, and traceability.

Given the need to satisfy the operational mission within the context of the stakeholder identified operational requirements, the project derived the necessary operational behavior for the operational architecture to accomplish the mission or missions. This process was accomplished by working with operational activities to derive, define and capture key capabilities. Finalized capabilities were integrated to become the integrated behavioral model for the architecture.

This operational architecture achieved a desired effect under specified standards and conditions through combinations of means and ways to perform a set of tasks. These tasks were a sequence of operational activities (e.g., Discriminate Targets) needed to respond to or to provide an external stimulus.

2. Functional Architecture

APPENDIX A – FUNCTIONAL DECOMPOSITION shows the top level operational architecture structure that was decomposed in order to describe the major functions needed to simulate functional operation in a protect LCS from small boat swarm mission. Elements, attributes, and relationships were defined to connect the functions to the other architecture model elements, as appropriate. The functional sequence needed to accomplish the related operational activities was identified. Decomposed structure was developed in CORE to create FFBD and EFFBD. Function elements, attributes, hierarchies, and traceability were updated and iterated to assemble the final structure.

The interoperability requirements lead to the derivation of the following top level functional diagrams, depicted in Figure 22 and Figure 23, which were used for description of activities for Phases I and II of the project CONOPS.

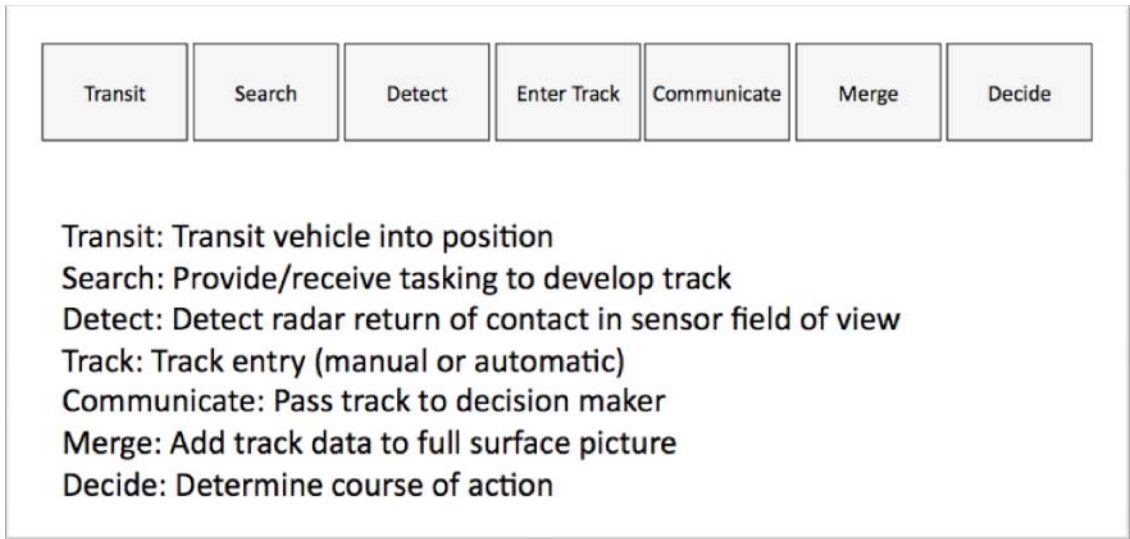

Figure 22: Phase I Top Level Functions

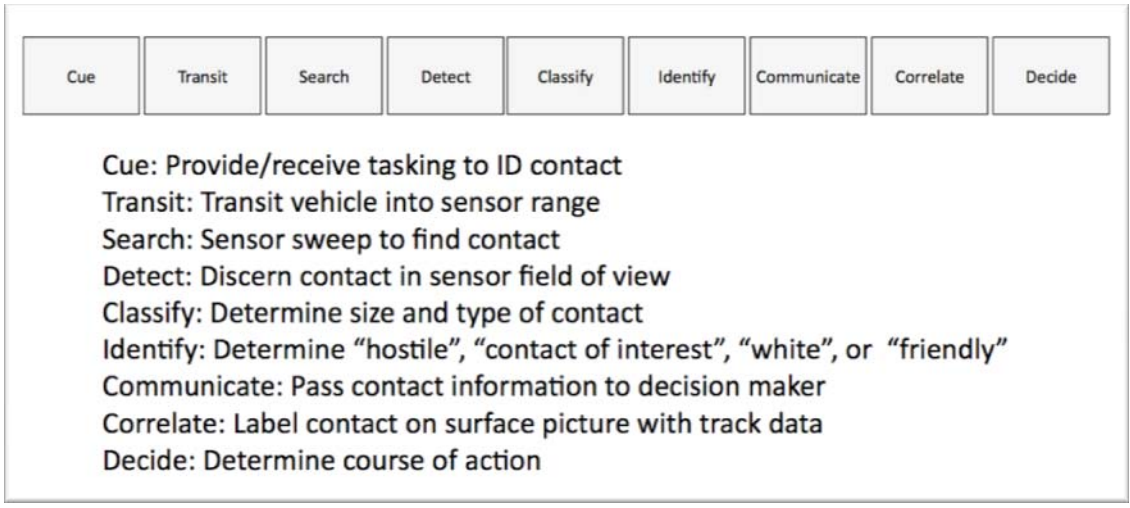

Figure 23: Phase II Top Level Functions

These top level functions trace back to the capability need statement and operational nodes as well as the capabilities of existing H-60, LCS, and Fire Scout systems/platforms. The CORE model was further refined to identify and define the activities, relationships among activities, and the inputs and outputs that have been

proposed and allocated to each platform. For example, Figure 24 depicts the relationships between SE artifacts for the project. The figure shows how the CORE functional architecture was used to link platform sensors as data sources, such as EO/IR images and AIS reports, to key mission activities, such as classify and identify, thereby defining inputs to these SOS functions. Functional outputs were defined as “target classification” and “track ID” – the content of interoperability information exchanges the SOS must accomplish. In this diagram, the sample CORE functional view maps directly to the functional flow block diagram for Phase II of the CONOPS. The CONOPS FFBD laid out the flow of inputs and outputs in context of the complete set of mission activities, providing context for identifying key metrics.

Functional Architecture Links Sensors to Functions

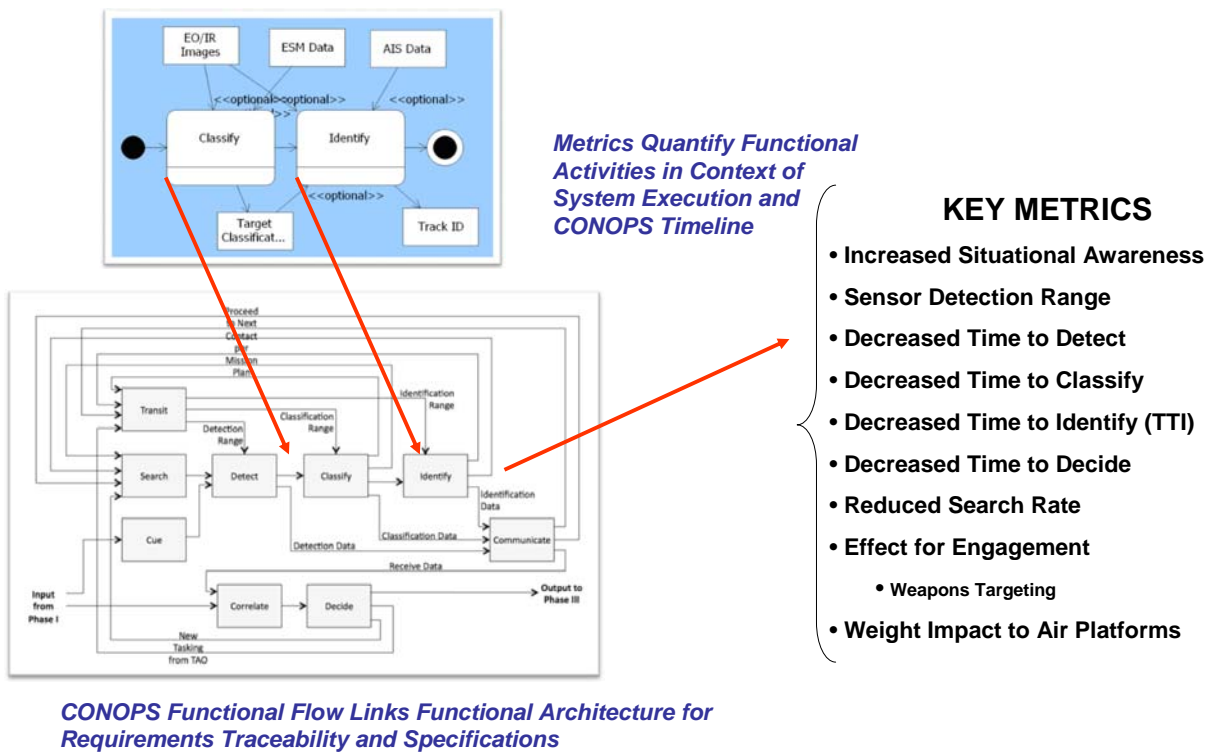

Figure 24: Architecture Artifacts and Key Metrics

Use of the architecture artifacts in this way supported M&S planning and analysis for exploring the trade space available in the MH-60, Fire Scout and LCS, as well as assessing alternatives. For example, the sample from the CORE functional architecture

indicates that where there is more than one sensor contributing input to a function, there is a potential to trade off use of one, either or both types of input and the impact to the output, as well as the functional segment of activities, may be evaluated for opportunities to improve performance and effectiveness (i.e., Does use of ESM speed time to classification? If so, is an ESM payload for Fire Scout a feasible option?).

C. INDIVIDUAL ALTERNATIVES

Once a set of potential scenarios was defined and analysis of the possible solutions completed, the project team defined realistic physical alternatives for the SOS communications capabilities within the trade space established by the architecture. These alternatives were generated based on knowledge of the current capabilities and experience with the platforms. The goal of this effort was to propose physical alternatives that when applied functionally to the scenarios would result in improved MOE(s) over the baseline. This section provides a description of the physical alternatives. A description of the baseline used for subsequent M&S is provided below, as well, for reference.

1. Baseline Physical Description

The baseline communications configuration consists of the following physical components that drive functionality. This configuration can be seen in Figure 25. This communications profile is unique to the baseline.

- LCS with one TCDL channel that can communicate with the Fire Scout or the MH-60, but not simultaneously
- LINK 16 providing communications between the LCS and MH-60
- Voice channel communications between the MH-60 and LCS, where Fire Scout can be used to relay the channel for increased range
- Voice channel between the Fire Scout CS and the CIC aboard the LCS

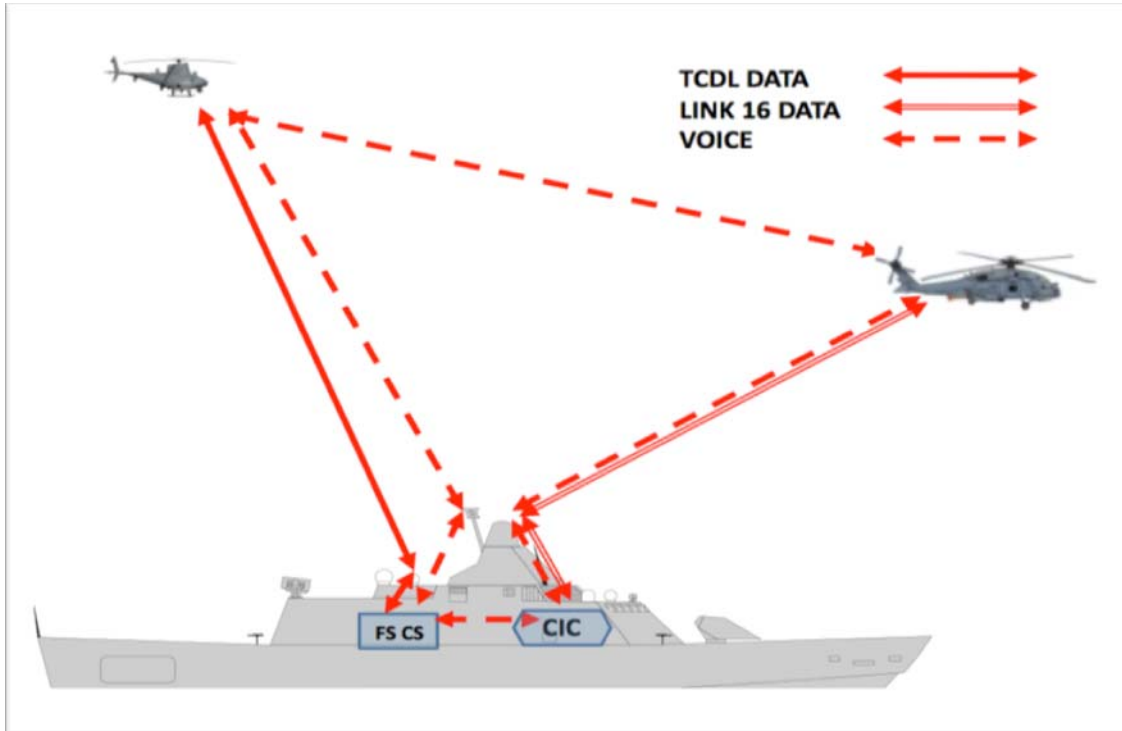

Figure 25: Baseline Communications Channels

The baseline also defines the sensor configuration. This sensor configuration is applied across all of the Alternatives. Below is an outline of the sensor configuration for baseline and all alternatives.

- MH-60
 - RADAR
 - SAR/ISAR
 - FLIR
 - Tracks
 - ESM
 - IFF
- Fire Scout
 - EO
 - FLIR
 - AIS

2. Alternative-1

Alternative-1 improves upon the baseline configuration by adding data transfer functionality between the Fire Scout CS and the LCS CIC. This communications profile is unique to Alternative-1 and can be seen in Figure 26. The profile is outlined below, highlighted to show the modification to the baseline that distinguishes this alternative.

- LCS with one TCDL channel that can communicate with the Fire Scout or the MH-60, but not simultaneously
- LINK 16 providing communications between the LCS and H-60
- Voice channel communications between the H-60 and LCS with Fire Scout able to relay the channel for increased range
- Voice channel between the Fire Scout control station and the CIC aboard the LCS
- ***Datalink between Fire Scout control station and CIC***

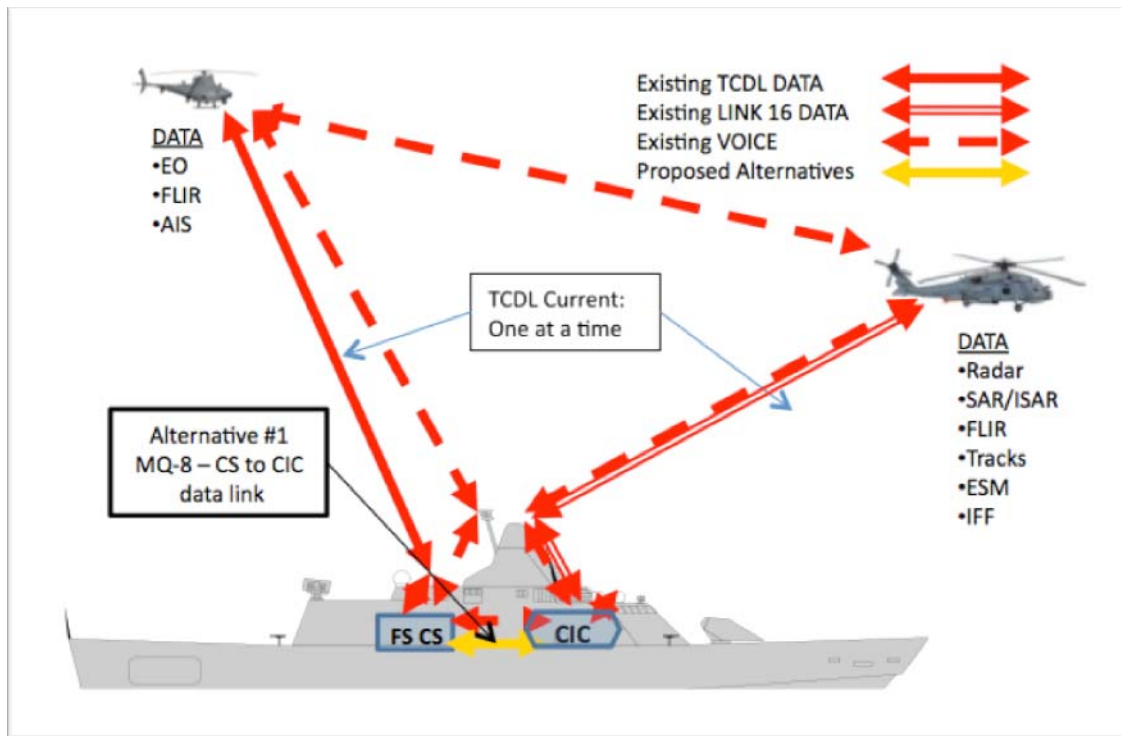

Figure 26: Alternative-1 Communications Channels

Alternative-1 addresses the KPP of “Minimize Risk to High Value Asset” and attempts to improve upon the MOE of “Time to Detect/Classify/ID Contacts”. The impact of Alternative 1 on the KPP by Alternative-1 is outlined below.

Minimize Risk to High Value Asset

- Better Situational Awareness for ASUW Commander
- Faster Decision Loop for ASUW Commander
- ***Fire Scout Sensor Data shared directly with CIC***
- H-60 Data Sharing is unchanged

3. Alternative-2

Alternative-2 improves upon the configuration of Alternative-1 by adding capability to the LCS such that it is able to operate on TCDL with the Fire Scout and MH-60 simultaneously. This configuration is unique to Alternative-2. This improved communication profile can be seen in Figure 27. The profile is also outlined below.

- LCS with one TCDL channel that can communicate with the Fire Scout or the H-60, but not simultaneously
- LINK 16 providing communications between the LCS and H-60
- Voice channel communications between the H-60 and LCS with Fire Scout able to relay the channel for increased range
- Voice channel between the Fire Scout control station and the CIC aboard the LCS
- ***Datalink between Fire Scout CS and CIC***
- ***Additional TCDL functionality aboard the LCS – simultaneous MH-60 and Fire Scout communication***

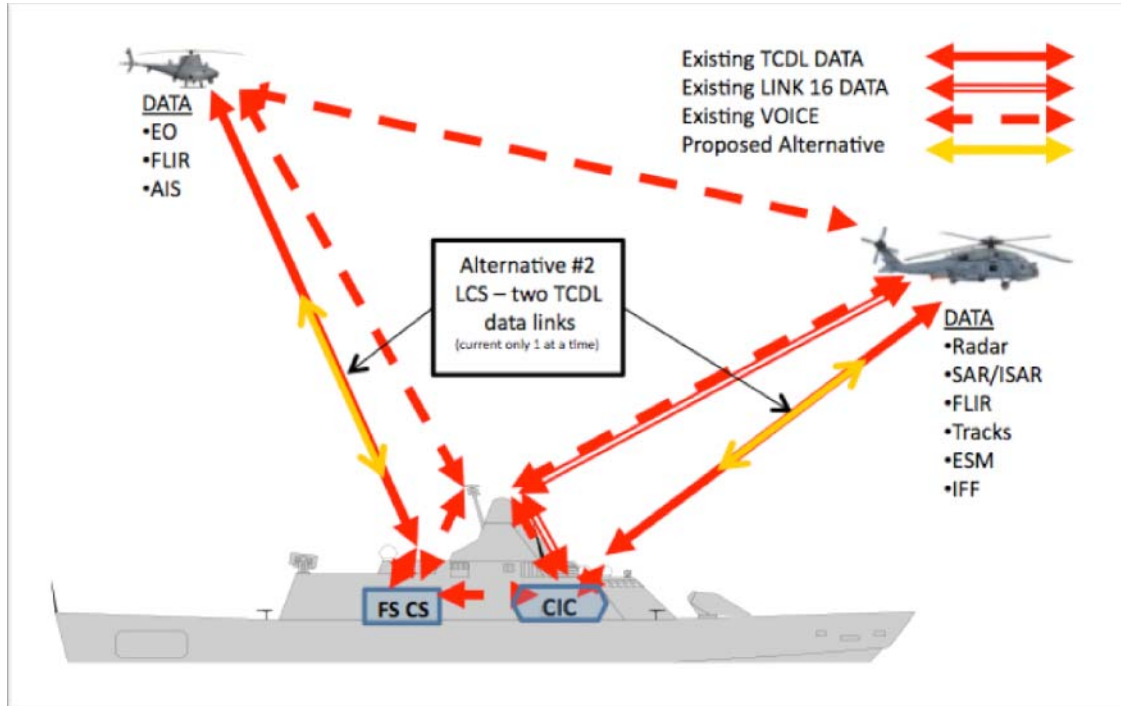

Figure 27: Alternative-2 Communications Channels

Alternative-2 addresses the KPP of “Minimize Risk to High Value Asset” and attempts to further improve upon the MOE of “Time to Detect/Classify/ID Contacts” over Alternative-1. The effects on the KPP by Alternative-2 are listed below.

Minimize Risk to High Value Asset

- Better Situational Awareness for ASUW Commander
- Faster Decision Loop for ASUW Commander
- ***EO/IR Video Available from both the MH-60 and the Fire Scout.***
- MH-60S Data Sharing unchanged

4. Alternative-3

Alternative-3 improves upon Alternative-2’s functionality by adding a link between the Fire Scout and the MH-60. Alternative-3 is broken into two sub-alternatives (3A and 3B). 3A adds a link that allows viewing of the Fire Scout’s sensor data aboard the MH-

60. 3B adds a link that allows both viewing of the Fire Scout's data aboard and control of the Fire Scout sensor payload from the MH-60. This configuration can be seen in Figure 28. It is also outlined below.

- LCS with one TCDL channel that can communicate with the Fire Scout or the MH-60, but not simultaneously
- LINK 16 providing communications between the LCS and MH-60
- Voice channel communications between the MH-60 and LCS with Fire Scout able to relay the channel for increased range
- Voice channel between the Fire Scout control station and the CIC aboard the LCS
- *Datalink between Fire Scout control station and CIC*
- *Additional TCDL functionality aboard the LCS*
- *Datalink between Fire Scout and MH-60*
 - *3A: Fire Scout sensor data is viewable aboard MH-60*
 - *3B: Fire Scout is controllable by MH-60 and sensor data is displayed*

Alternative-3 addresses the KPP of “Minimize Risk to High Value Asset” and attempts to further improve upon the MOE of “Time to Detect/Classify/ID Contacts” over Alternative-2. Alternative-3 also attempts to improve the MOE of “Time to Engage”. The effects on the KPP by Alternative-3 are listed below.

- Reduced Risk to LCS
- *Direct Data Coordination between MH-60 and Fire Scout*
- Improved targeting and engagement

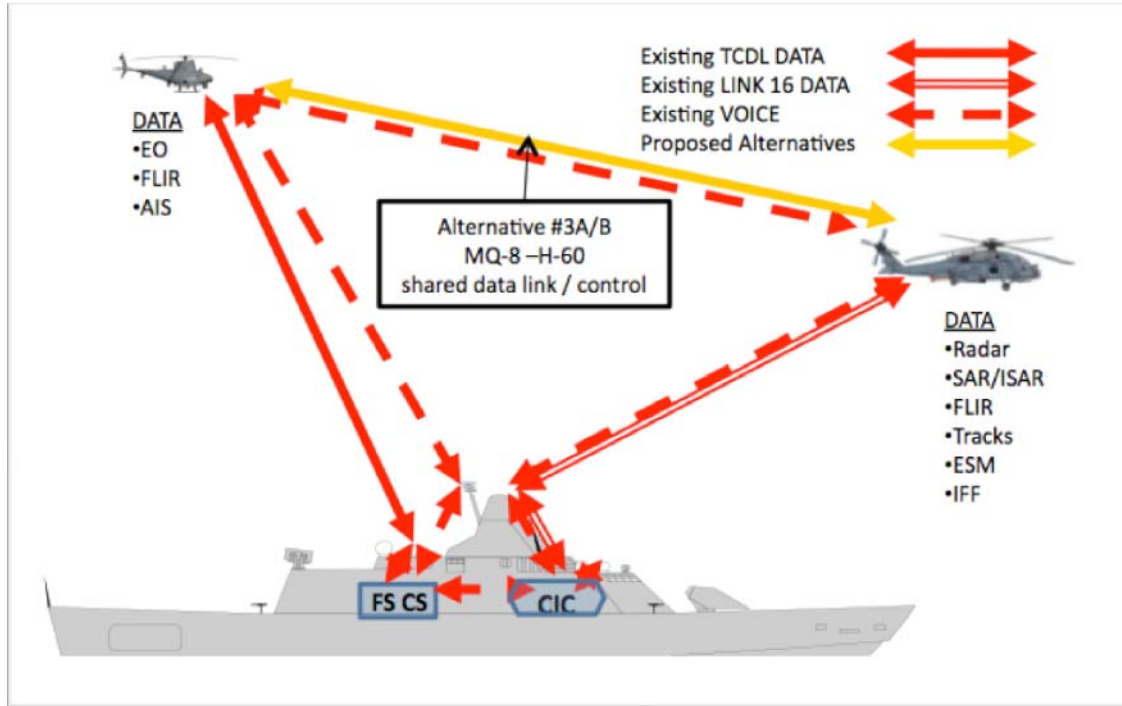

Figure 28: Alternative-3A/B Communications Channels

MODELING, SIMULATION AND ANALYSIS

Given the nature of the problem statement for this project, the team decided it was practical and appropriate to use an M&S approach to gather results on the potential benefits of SOS alternatives to improve interoperability. Ideally, using real-world assets and scenarios would be the way the gather the best and most informative results. The magnitude of effort, however, assets and time required to employ actual MH-60 and Fire Scout air vehicles for test in a scenario was not in the project scope. Real-world testing could be preformed to add weight and clarity to the results of the modeling and simulation effort performed as part of this effort. And the project approach and artifacts, including methods and metrics, architecture and models, were developed specifically with the intention of later re-use.

The use of M&S allowed the project team to represent the system while evaluating multiple variables, sensitivities, and effects. This approach is extremely powerful when attempting to gather statistical data to support analysis. The use of M&S also allowed for flexibility in the construction of the scenario and alternatives, leading to the ability to

represent a potential physical, real world situation accurately. The use of operations research / warfare analysis modeling and analysis aimed to complement the SE approach by assess alternatives based on Stakeholder priorities for war fighting effectiveness and capability, over SE priorities for ease of integration or degree of re-design and qualification for fielded platforms and systems. Additionally, by using M&S, follow-on work could be picked up from the initial simulation with little rework required to further the efforts that were initiated by the project team.

This portion of the report elaborates on the modeling approach and the rationale for that approach. The alternative physical configurations are described from the modeling viewpoint, as well as the scenario for those configurations. Discussion on the NSS modeling suite and the relevance to the SE process for this project will also be provided.

A. MODELING APPROACH AND RATIONALE

The approach to the M&S effort began with discussion on what needed to be modeled. It was determined that the three system alternatives and a baseline configuration would be modeled in the context of one scenario. The results of these various runs would provide output in the form of the previously discussed MOEs for each alternative to support analysis and comparison of results. A summary diagram of the three alternatives is presented in Figure 29.

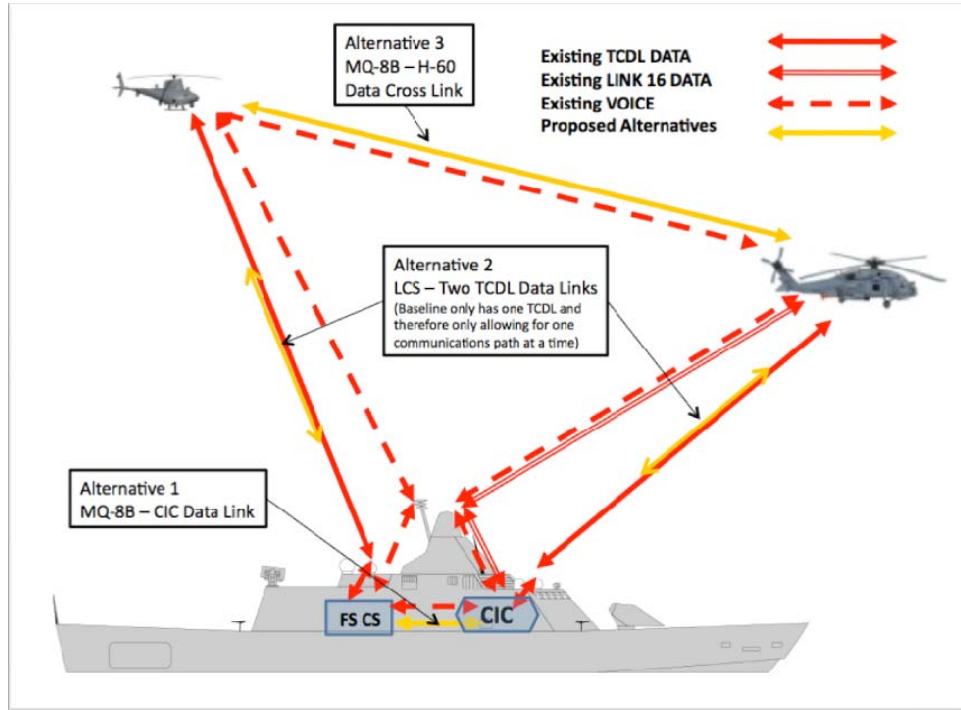

Figure 29: Alternatives Communication Channels

1. Alternatives

The three alternatives and baseline are shown below in Table 5. These alternatives are detailed in an earlier section of this report. Along with the description of the alternatives, interoperability enhancements are shown. It is helpful to keep in mind that the sum of all portions of time required to identify each contact in the scenario is the MOE being investigated through simulation of mission-level modeling runs.

Table 5: Alternatives Simulated

Configuration	Description	Interoperability Enhancements
Baseline	Year 2012 Configuration of MH-60 and Fire Scout	Not Applicable
Alternative 1	Addition of link between Fire Scout CS and LCS CIC	Fire Scout sensor data shared directly with CIC/TAO
Alternative 2	Addition of one TCDL channel to LCS	EO/IR video to LCS from both air platforms simultaneously
Alternative 3	Addition of video link from Fire Scout to MH-60	Direct data feed from Fire Scout to MH-60

2. Simulated Scenario and Phases

The baseline and three alternative configurations discussed above were developed and studied in a simulation using an environmental scenario that was kept constant. Keeping the simulation scenarios constant allowed for all alternatives to be tested against the same situation. The scenario is based on the problem statement.

The problem statement presented the LCS as the HVA traveling through narrow straits and surrounded by many vessels, some presumably commercial and private and some potentially hostile. The specific concern was that a group of small vessels, possibly disguised as fishing boats or another non-threat, converge into a swarm and attack the LCS, with the possibility that a single vessel could come close enough to the LCS to detonate an explosive device and critically damage or sink the ship.

The baseline scenario was broken down into three phases, as first described previously in this report. The first phase encompassed the activities required for the SOS to gain a clear picture of the surface environment based on data gathered on the number and location of contacts in the scenario. The second phase consisted of the activities to classify and identify these contacts. This phase was the focus of the M&S activity, as the

completion of this phase was highly relevant to the MOE. The third and final phase was where the SOS engages hostile contacts. Although this portion of the model gathers useful data, the analysis was beyond the scope of this project. Planning to address each phase is described in the remainder of this section, including a description of the planning of the simulation process.

B. NSS

In applying the overarching SE process, the project evaluated several M&S options to help transition from Stakeholder stated capability gaps and need statements to identification and design of an operationally effective and suitable system to meet those needs. During the Stakeholder Requirements Definition process, relevant stakeholder input was translated into technical requirements and scenarios that could be implemented in an M&S tool. The two tools considered were ExtendSim, which had been used in other NPS coursework, and the Naval NSS. NSS was identified as the optimum solution for this project for a number of reasons including:

- NSS is the Navy's primary, accredited simulation tool for warfare and operations analysis, used by OPNAV and NAVAIR.
- NSS is an object-oriented simulation that models surveillance, communications, tactical picture processing, engagement, sea-based logistics, and C2, including explicit modeling of plans and tactics. NSS provides for more explicit characterization and relevant system detail, reflective of a system functional or physical architecture.
- NSS supports developing and analyzing operational courses of action at the mission, group and force level.
- NSS provides the ability to represent the system and evaluate multiple variables, system configurations, sensitivities, and their effects.
- The model and simulation program enables metrics capture and calculation for KPPs and MOEs, as well as supporting data elements (i.e., time to identify and classify, ranges, etc...).

- The simulation enables rapid analysis and evaluation of the differences of excursions.
- The NSS model and simulations are readily available to the project team because the NAVAIR Warfare Analysis Department had existing platform models with potential re-use for follow-on analysis.

Based on the above rationale, NSS was chosen as the tool for this project. The analysis conducted with NSS helped verify the operational and functional architectures for each alternative and provided useful insight into the performance of each alternative. Data generated and qualitative analysis through use of NSS contributed directly to the AOA conducted for this project.

C. SIMULATION PLANNING

1. Logical Flow

The M&S planning required deliberation about the logical flow of the simulation. The initial approach stemmed from the scenario and its phases as discussed early in this section and in further detail earlier in this paper. Figure , below, is a flowchart showing how the phases of the scenario were addressed by the simulation.

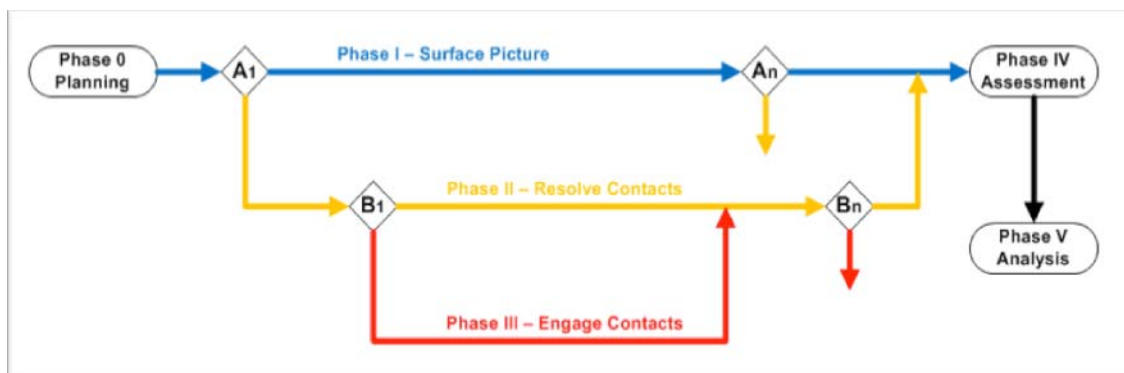

Figure 30: Planned Simulation Flow

This flowchart represents time-flow from left to right. Phase 0 is used to represent an entry point, where mission planning occurs. From Phase 0, the simulation began with Phase I, represented by the blue line. Phase I operations involved developing a surface picture or COTP. The Phase I line intersects at decision point A_1 (diamond-shape) that allows for branching into another Phase. A decision point may allow for one phase to end while another begins or for a new phase to begin while another continues. A decision point may also allow for nothing to change unless a specific event occurs to change the flow of the timeline. Decision point A_1 would branch into Phase II, for example, if surface contacts were found within range of the LCS for ship self-defense. Further down the path of Phase I, the blue line intersects decision point A_n . A_n is a decision point that represents any number of points in time where a Phase II could begin, based on the necessity of making a positive identification of a contact as hostile, for example. A new surface target may be located at any point during Phase I operations and therefore present the requirement to branch into Phase II.

The same type of logic was defined for the Phase II line, which is yellow. The operations in Phase II dealt with determining whether a surface target was hostile or not. Again, the yellow line can intercept at decision point B_1 . Decision point B_1 allows for branching into Phase III if a target is determined to have hostile intent and is within a specified range of the LCS. Just like decision point A_n represents any number of points in time, so does B_n . It is possible, at any point in time in Phase II operations for a target to be determined to be hostile and within range of the LCS.

The path for the simulation's conclusion begins when the phases collapse. This happens for Phase III once targets are no longer a threat. On the flowchart, this occurs where the red Phase III line joins back with the yellow Phase II line. For Phase II this happens once all targets have been identified, where the yellow Phase II line joins back with the blue Phase I line. Phase I ends once a surface picture has been obtained with sufficient or high confidence in its accuracy. At this point, technically, the simulation ends. After Phase I there are notional Phase IV and Phase V that handle mission assessment and analysis, respectively. This discussion illustrates how the model logically addresses the interactions between the SOS and its operational context, embodied in the operational scenario as contacts and responses.

a) Phase III Complexity

The main activity in Phase III was to engage contacts that were determined in Phase II to be hostile. In the scenario these hostile contacts presented a threat to the LCS and must be prosecuted. Because the actions of the Fire Scout and MH-60 are highly dependent on tactics and become increasingly complex, the scope of simulating this phase was determined to be beyond the scope of this project. Although NSS was useful for assessing alternative effectiveness, it was not designed to simulate weapon engagement. The project determined that by gathering the output of the model up to Phase II, including the MOE of “Time to Identify,” a reasonable statistical conclusion could be made about the impact of each alternative on the time to run the kill-chain as defined by the scenario, even though the whole kill-chain was not being simulated.

2. Modeling Assumptions

Simulating the actual CONOPS and tactics used in prosecution of the given ASUW mission scenarios was very complex. All of the situational dependencies could not be effectively modeled. Therefore, it was essential for the project team to develop an alternative, representative model that would permit the assessment of mission performance relative to the parameters in focus for the project, in this case, the communication links that enable the flow of data between the MH-60, the Fire Scout and the tactical mission commander in CIC aboard LCS. A key assumption made in the development of the simulation was that simplifying the details of the tactics and the environmental conditions would not invalidate the simulation results.

As shown above, “time to identify” was chosen as the key MOE because of the desire to assess the efficiency of the system relative to the prosecution of the SWARM threat to the LCS. Assessment of the kill chain timeline became the focus of the simulation. It was determined that a basic NSS simulation could be used to assess the relative effects of communication improvements provided by different alternatives relative to the baseline system interoperability. Key modeling assumptions and simplifications included:

- Open water transit versus confined straits transit environment

- Fixed number of surface contacts of varying types with random transit profiles to simulate congested traffic through the straits transit environment
- Overlapping, independent and random search profile logic for air vehicle versus coordinated sector assignments from the mission commander
- Simplified threat vessel tactics were not situation-dependent or scripted to change during the scenario
- Contact identification information provided by the air vehicles did not change based on vessel profile changes
- All Phase I surface tracks were generated by the air asset with RADAR capability
- All Phase II classifications and identifications were accomplished by either air asset using only the EO/IR sensor (day or night)

1. Modeling Input Parameters

In order to assess mission performance using simulation the project team needed to determine the critical input parameters. The NSS model produced a simulation environment for multiple selected platforms based on user-defined capabilities. Platform capabilities were drawn from NATOPS as well as discussions with the program offices and experienced operators. Key characteristics included range, endurance, turnaround time and speeds used for search and transit.

a) Sensor Ranges

For this project it was also necessary to input parameters for the MH-60 and Fire Scout ASUW sensors selected for the simplified model. Critical characteristics included slant ranges (tangential distance including aircraft altitude) for the RADAR and EO/IR sensors. The inputs used in this simulation, shown in Table 6, are approximate values that are based on limited program office provided test points and experienced operator feedback. Classified information was not included.

As shown in Table 6 sensor ranges depend on contact size. RADAR capabilities are not affected by day or night operations, but there are substantial differences in both the

range and coverage between the Fire Scout and the MH-60 sensors. The EO/IR sensor range was comparable for both platforms, the modeled input data was the same. The clarity of the EO video imagery was significantly improved during daytime operations over the infrared imagery available during nighttime operations; sensor identification ranges were shorter than for classification because finer details are required to resolve the information. While sensor range capabilities were not the focus of this report, they defined the required transit time for investigation of contacts. Sensor range impacts on performance for classification and identification was a major contributor to the overall mission TTI MOE , “time to identify”.

Table 6: Sensor Modeling Ranges (nm)

		Large Vessel		Medium Vessel		Small Vessel	
		Day	Night	Day	Night	Day	Night
Detect	RADAR (MH-60R)	75		65		55	
Detect	RADAR (Fire Scout)*	60		50		40	
Classify	EO/IR (Both)	17	13	14	10	12	8
Identify	EO/IR (Both)	12	8	10	6	8	4.5

*120 Degree Coverage

b) Information Flow Timing Delays

The other major contributing factor to the “time to identify” MOE was the collection and transmission of sensor data between platforms. As discussed in earlier analysis, the time delays associated with each task in the information flow are shown in Table 7. While it was important to understand the contribution of each subtask component to the overall timing, simplified data was required for the NSS model inputs, which are shown in the table below.

Table 7: Baseline Platform Modeling Timing Delays (min)

	Detect	Classify	Identify	Decide**	Engage
MH-60R	0.5	2	3	7.5	?
MH-60S	2.5*	2	3	7.5	?
Fire Scout RADAR	0.5	2	3	6.5	?
Fire Scout no RADAR	4*	2	3	6.5	?

*Cued from LCS COTP

**Includes communication and correlation time

Details associated with the contents of Table 7 are provided as follows: **Error! Reference source not found.** Table 8, Table 9, and Table 10 detail the input parameters used to model the interoperability improvement alternatives developed for this project. Changed parameters are highlighted in yellow.

Once a contact was detected and in sensor range, the time to accomplish the classification and identification was dependent upon operator proficiency, aspect angle and contact complexity. Average times of 2 and 3 minutes were used as modeling inputs for these activities.

The “Time to Decide” metric is a roll up of the communication, correlation and decide subtasks. This delay was needed to ensure the classification and identification details were available to the ASUW commander for decision on tactical response. Since actual sensor video data was modeled to be available on board the LCS from the Fire Scout, the input time delay was reduced, but only estimated to be about one minute because the commander must walk to the Fire Scout CS. Although time to engage was not modeled, it was listed in the tables for completeness, but without data. Alternatives that improved this time were qualitatively shown with yellow highlights.

Table 8 provides the modeled time delays for Alternative 1, and shows that the detect times for the both assets without RADAR is reduced. In the case of the Fire Scout, the track data from the COTP was now available at the control station because of the added communication link. Since Fire Scout track data was provided directly to CIC, it was more easily shared with the MH-60S reducing sensor cueing time. The decision time

was also reduced when Fire Scout video imagery was available at the ASUW commander's watch station.

Table 8: Alternative-1 Platform Modeling Timing Delays (min)

	Detect	Classify	Identify	Decide**	Engage
MH-60R	0.5	2	3	7.5	?
MH-60S	1.5*	2	3	7.5	?
Fire Scout RADAR	0.5	2	3	5	?
Fire Scout no RADAR	1*	2	3	5	?

*Cued from LCS COTP

**Includes communication and correlation time

Table 9 shows the modeled time delays for Alternative 2. The only factor affected by this improvement was the scenario-based decision time. In the model, the ASUW commander can now see MH-60R video because a second TCDL channel to the LCS was opened. The MH-60S cannot take advantage of this capability since it is not TCDL equipped.

Table 9: Alternative-2 Platform Modeling Timing Delays (min)

	Detect	Classify	Identify	Decide**	Engage
MH-60R	0.5	2	3	5	?
MH-60S	2.5*	2	3	7.5	?
Fire Scout RADAR	0.5	2	3	6.5	?
Fire Scout no RADAR	4*	2	3	6.5	?

*Cued from LCS COTP

**Includes communication and correlation time

Table 10 shows the modeled time delays for Alternatives 3A and 3B in scenario 2 with Fire Scout track data directly cross linked to the MH-60S. Cueing time for detection by the EO/IR sensor was significantly reduced. Although the improvements in engagement times were not quantified, the data column is highlighted to show that impact of the data cross link. The cross linked EO/IR video data along with laser designator indications from the Fire Scout greatly increased the tactical effectiveness of the SOS to conduct coordinated Hellfire missile attacks. Time to set-up for ingress, as well as

designation communication delays were reduced. The quantification of this data requires operational testing and does not lend itself well to simulation modeling via NSS.

Table 10: Alternative-3A/B Platform Modeling Timing Delays (min)

	Detect	Classify	Identify	Decide**	Engage
MH-60R	0.5	2	3	7.5	?
MH-60S	1	2	3	7.5	?
Fire Scout RADAR	0.5	2	3	6.5	?
Fire Scout no RADAR	4*	2	3	6.5	?

*Cued from LCS COTP

**Includes communication and correlation time

D. MODELING OUTPUT ANALYSIS

The project team first investigated the potential operational effectiveness of the SOS alternatives by using a static Excel-based model to look at the effect of the assumed improved levels of communication and interoperability. The initial investigation using this tool was performed as a preliminary indicator that the scenario, baseline and alternatives were defined sufficiently to achieve the expected outcomes, prior to pursuing the NSS modeling. From an SE perspective, it was imperative that the models accurately incorporate key system, scenario and integration attributes so that outcomes and effects were traceable to requirements and key metrics.

This Excel model was a tool currently used by the NAVAIR Air 4.10 Warfare Analysis & Integration Department for other Naval Aviation System analysis projects. Recent US Navy studies that utilized this tool included an effectiveness analysis of the Coast Guard’s C-130J aircraft, the P-3C, and a P-8 High Altitude ASW effectiveness study. Based on this experience, the project determined this model could be useful for an initial effectiveness assessment of the alternatives, highlighting comparisons against the baseline. To employ the Excel model, the search effectiveness metrics for “Search Rate” and “Time to Search” for the Fire Scout and MH-60 variants and alternatives scenarios were used. This investigation resulted in an initial effectiveness estimate, providing assurance that further and deeper analysis and more complex modeling would provide

useful outcomes. The SOS Baseline and the three Alternatives were investigated with this Excel model:

- Alternative 1 - Fire Scout with an improved cross-link to the LCS CIC
- Alternative 2 - Fire Scout with TCDL and MH-60 with TCLD, using both available LCS compatible data link channels
- Alternative 3 - Fire Scout and MH-60 with compatible data links for communication supporting MH-60 sensor data transfer and sensor payload control of the Fire Scout.

Model inputs for the scenario included: shipping density (ships per square mile), an average EO/IR sensor range (nautical miles), Search Area (square miles), and average Time to Classify a contact (Minutes), a time represented by a roll up of detect and classify time delay assumptions. The baseline input was the initial time delay assumption representing the current communication capability.

1. Search Rate Results

Summary results of each case described above indicated that search rates increased for each alternative over the base line and also increased from progression of Alternative 1 to Alternative 3. A sample of model results for the Baseline, Alternative 1 and Alternative 3 are presented in Table 11. Figure 31 provides graphic illustration of the time for the search rate, identification delay and time required to clear the specified area of interest as an example, for the MH-60S working cooperatively with the Fire Scout.

Table 11: Output Data from the Search Rate Model

		MH-60/Fire Scout Link		CS Link to CIC	
		Baseline	Alt. 3	Baseline	Alt. 1
MH-60S	ID Delay (min)	4.5	3.0		
	Search Rate (nm/hr)	1906	2175		
	Time to Clear Area (hr)	11.34	9.93		
	Sorties Required	4	3		

MH-60S	ID Delay (min)			4.5	3.5
	Search Rate (nm/hr)			1906	2077
	Time to Clear Area (hr)			11.34	10.4
	Sorties Required			4	3
Fire Scout	ID Delay (min)			6.0	3.0
	Search Rate (nm/hr)			1596	2014
	Time to Clear Area (hrs)			13.53	10.72
	Sorties Required			2	2

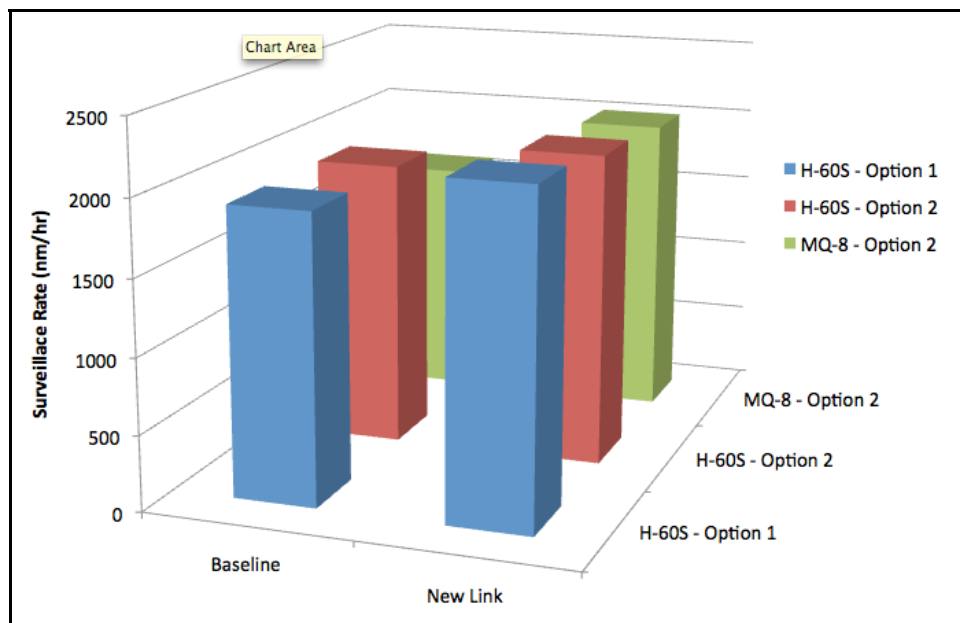

Figure 31: Graphical Comparison of Search Rates – Baseline vs. MH-60S and Fire Scout

Specific improvements to search rates for Alternative 1, where the Fire Scout CS and LCS CIC were integrated with a data link, the Fire Scout search rate improved about 26% and the MH-60S search rate improved about 9%. And for Alternative 3, Fire Scout and MH-60S integrated with a C2 link for the sensor payload, the MH-60S search rate improved about 14%. This type of data confirmed the initial assumptions for the project. Because the Search (Surveillance) Rates for the MH-60S, and Fire Scout improved with Alternatives 1 and 3, the project team was confident to proceed with more complex modeling.

2. Time to Search

The second performance metric utilized from the model was the 'Time to Search'. This figure represents operationally how fast a search platform can cover a defined area of interest. This measure is important because in an operational environment, the ability to search an area in the shortest amount of time provides commanders with critical situational awareness necessary for tactical decisions. Additionally, finding a hostile contact early reduces risk for all friendly platforms and increases the variety of options to deal with the risk. Model runs were performed for the same alternatives as in the Search Rate calculations. Raw results for 'Time to Search' are shown in 11, above. A graphical representation of the results follows in Figure 3 in comparison with the baseline.

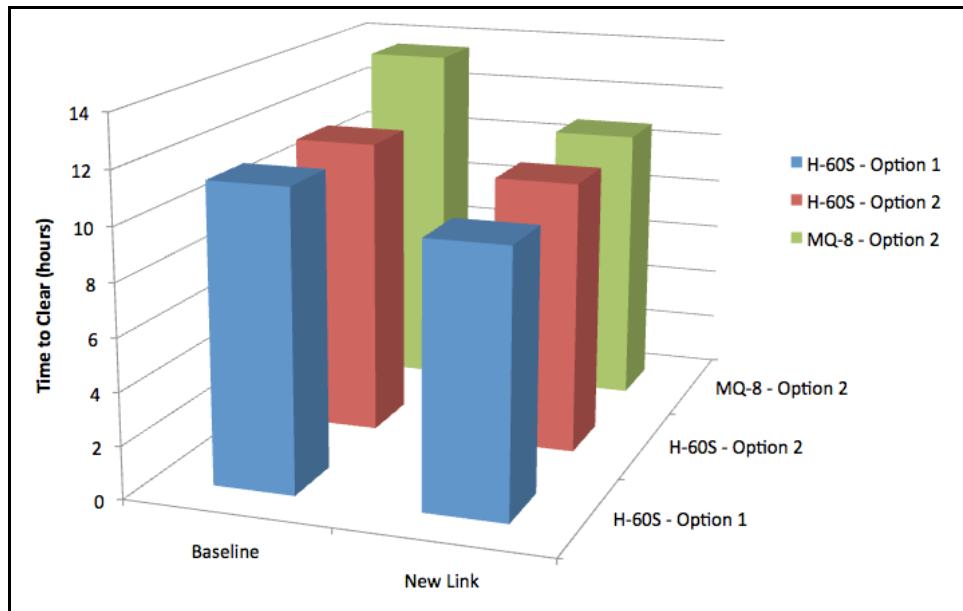

Figure 32: Time to Search an Area

Results indicated that time to clear the operational area, measured in hours, decreased for all SOS alternatives. Specifically, for Alternative 1, the Fire Scout CS link with the LCS CIC, the Fire Scout Time to Search improved by about 27% and the MH-60S improved

by about 9%. For Alternative 3, the Fire Scout and MH-60S linked for C2 of the sensor payload, the MH-60s Time to Search is improved by about 14% .

In addition to Time to Search improvements, Alternative 3 reduced MH-60S sorties required to search the box by 1 sortie. This reduction could be significant in terms of cost and manpower required to perform the mission. In the current environment of fiscal constraints, this result could be a basis for additional analysis. This result is similar to the findings of the Aviation mix study that preceded the project ^[10]. This data also supports the assumptions for the project and confirmed the value of more complex modeling finding similar trends.

3. NSS Model Analysis and Starting Inputs

Having confirmed the predicted interoperability improvements for a sample of the project alternatives using the Excel model, more complex modeling was executed to seek results using a more dynamic simulation that addressed the CONOPS more explicitly, including probabilistic tactics. This analysis was performed by using NSS to build a mission level model and emulate the operational scenario defined by the stakeholders. Model planning and development required three months of project team interaction with an expert NSS modeler, with two months of iteration on inputs and assumptions to refine observed data outputs. Figure 33 presents a sample screenshot from the NSS model display, showing the NSS input mode for region and track data. Additionally, Appendix B provides a collection of NSS screens as an overview of the model features, structure and sample content employed for this research.

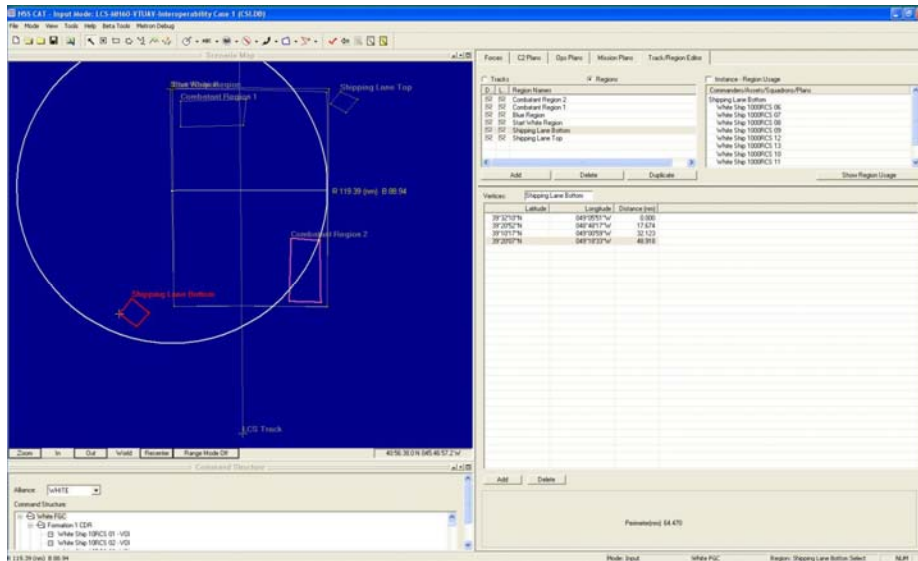

Figure 33: NSS Input Mode Display for Regions and Tracks

Entity behaviors were programmed into the NSS model to populate the simulated operational environment. Platform capability data researched and documented in this project was used to populate entity behavior fields of the model. As a lesson-learned, the project team observed that SE artifacts such as functional and physical architecture views and FFBDs are useful, but do not translate directly, to the format and rules for programming the mission modeling tool. As evidenced by the investment in dialog several months, the use of warfare analysis in support of SE demands significant effort to ensure consistency and utility in order to achieve the benefit of operational context informing the SE process.

The modeled entities consisted of blue forces: one LCS, one MH-60R or MH-60S, and one Fire Scout with and without RADAR, as well as neutral and red forces consisting of 65 ships. The blue platform and sensor performance characteristics, previously identified in the current capabilities section of this paper, were the baseline inputs to the model's database of required entity characteristics. Additional characteristics input into the entity behavior fields of the model were the platform functions of detect, identify, and classify and estimates of time required to accomplish these activities. These characteristics were the assumed delays times associated with communication flows and improvements to those as described by the project alternatives.

Neutral and red contacts were represented in the scenario for shipping traffic and probable SWARM hostiles. The neutral entity characteristics consisted of contacts of various sizes, large, medium, and small, as defined by a RADAR cross-section data element. These characteristics represented real-world shipping traffic that would be encountered by Naval Forces in a geographic region where a SWARM threat could occur. Large, medium, and small entities equated to tanker or commercial sized shipping and fishing or hostile traffic. These three classes of ship platform in the simulation were also given varying speeds of performance and model tags for neutral or hostile. It is important to understand that these model tags of hostile or neutral drove whether an air platform needed to do more than just detect the contact or needed to identify and classify the contract. Critical Contacts of interest (CCOI) were tagged to all hostile contacts and various other small contacts. The hostile or neutral tag then forced the behavior of the air platform to follow the delay times associated with the communication structure for each alternative. It was decided that there could be no other sensor used for detecting or classifying due to the additional time it would require in constructing and refining the model; ESM would not be used but recommended for follow on study. For all model runs, all detections were accomplished via RADAR and EO/IR sensors.

Twenty-five hostile entities were sized as small vessels and were given random speeds from 0 to 45 knots. Other model behaviors and CONOPS input into the model consisted of : 24 hour flight operations with both blue air assets flying during the periods of transit; and real-world endurances, re-fueling, and delays associated with landing and taking off from the LCS. Simulating a transit of a straight, the LCS was programmed to transit the operation area at 15-20 knots. For search tactics, blue air assets were programmed to search in front of the LCS and return to intercept any unknown entity that approached the LCS within 5 miles. Additionally, to introduce more realism, the simulation-based COTP contacts were programmed to expire if any contact did not have a blue sensor on it for more than 30 minutes. This simulation rule meant if all blue assets lost contact of a previously detected contact for more than 30 minutes the contact reverted to an unknown contact needing re-detection, identification, or classification.

a) NSS Model Run # 1

The scenarios run for the first NSS model run were for a MH-60R paired with non-RADAR capable Fire Scout and a RADAR capable Fire Scout paired with an MH-60S. Flight operations began as the LCS transited the simulated straights and the platforms were to detect, identify and classify contacts to guard against a SWARM threat. Again, both air vehicles were airborne continuously for the scenario and began search operations in front of LCS. This was run for the baseline case, with no communication improvements, and alternatives 3A and 3B. These three model runs were performed 100 times each to produce statistically significant data and confidences. The summary results of these runs are given in Table 12.

Table 12: Output from First Run of NSS Model

		Baseline MH-60S & Fire Scout-R	3a MH-60S & Fire Scout-R	3b MH-60S & Fire Scout-R	Baseline MH-60R & Fire Scout	3a MH-60R & Fire Scout	3b MH-60R & Fire Scout
MH-60S	Detect	7.67*	7.10	6.72			
	Class	9.17	8.56	8.71			
	Identify	9.52	9.53	9.48			
MH-60R	Detect				6.83	6.81	6.37
	Class				8.65	8.68	8.83
	Identify				9.11	5.85	8.52

* - All units in Hours

Figure 34, Figure 35, and Figure 36 show the relationships between “Time to Detect,” “Time to Classify,” and “Time to Identify” for the baseline case and each

Alternative/Scenario in hours. Times are averages of the combined MH-60 and Fire Scout mix for each scenario.

b) NSS Run #1 Analysis

The data and graphs produced for the first NSS run confirmed trends, but did not completely validate the project hypotheses. While improvements in the air platform search functionality from improved communications were evident, the results were inconsistent. Figure 32 does shows a decrease in “Time to Detect” for both alternatives 3A and 3B as compared to the baseline. The best result, however, was the MH-60S “Time to Detect” result shifting from 7.67 hours to 6.72 hours with alternative 3B. The MH-60S result is almost a reduction of an entire hour to do all required detections. This would be a significant advantage in an operational scenario.

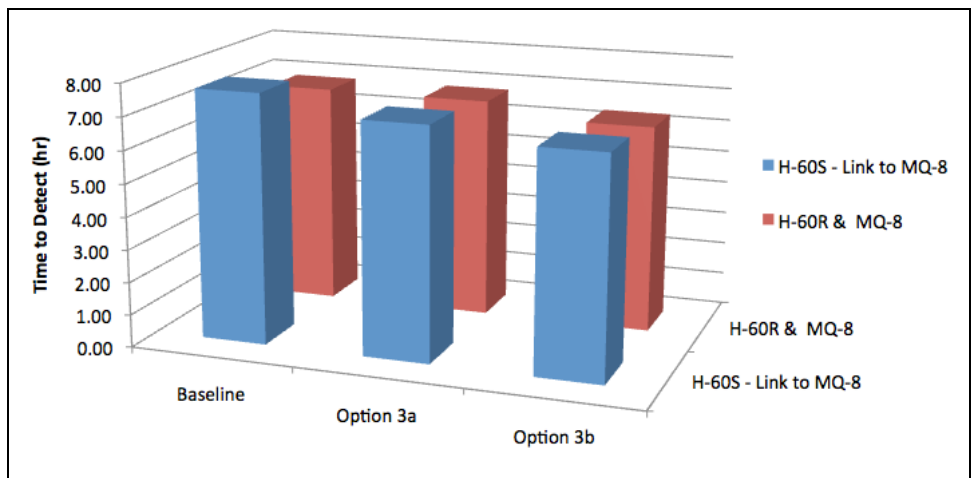

Figure 34: Time to Detect (hrs) – Reducing Trend

Figure 35, below, shows the Excel model predicted decrease in “Time to Classify” for Alternative 3A, defined for Level of Interoperability 2 (LOI-2) with the MH-60S receiving Fire Scout sensor data, and Alternative 3B, defined for Level of Interoperability 3 (LOI-3) with the MH-60S receiving Fire Scout sensor data and controlling the Fire Scout sensor payload, as compared to the baseline case. The “Time to Classify” at LOI-3 for MH-60S increased as compared with LOI-2, but the cause of this unexpected longer

duration is not discernable based on the modeling. For the MH-60R, the “Time to Classify” also increases for all cases when compared to the baseline case. Further study is needed to understand the system interactions and effects. The MH-60S is lower than MH-60R for the LOI-2, but higher for LOI-3 and the Baseline case. Although the results do not completely match the expectations or predictions from the Excel model, and appear inconclusive, they are consistent with trends in keeping with the project top level objectives. This confirmation is useful for Stakeholders deciding to expend resources on more costly, but informative, analysis and assessment.

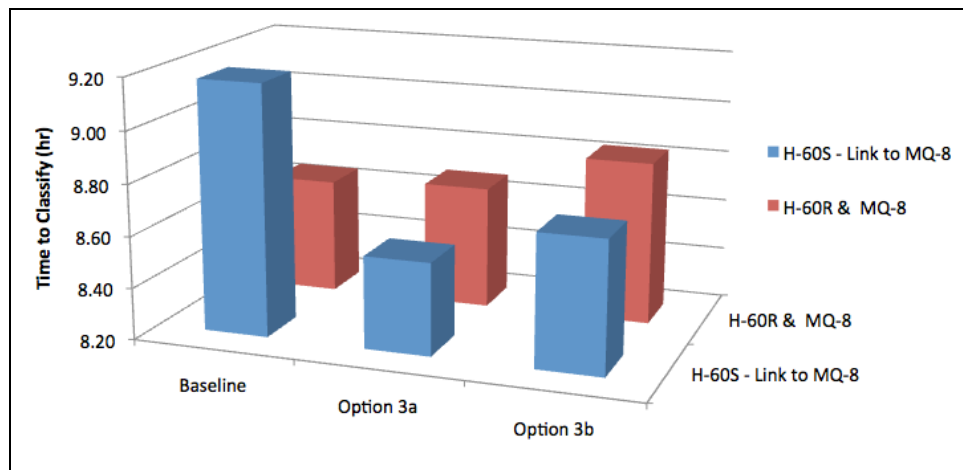

Figure 35: Time to Classify (hrs)

The final performance metric in run #1 was “Time to Identify.” Figure 36 shows a marginal increase for Alternative 3A (LOI-2) for the MH-60S when compared with the Baseline case but significantly the MH-60R shows a decrease in “Time to Identify” for LOI-2 and LOI-3, when compared with the baseline. The MH-60R reduction of Time to Identify from 9.11 hrs to 5.85 hrs was the best improvement of all the scenarios. Identifying all required contacts 3 hours faster would provide an operational commander with a huge tactical advantage.

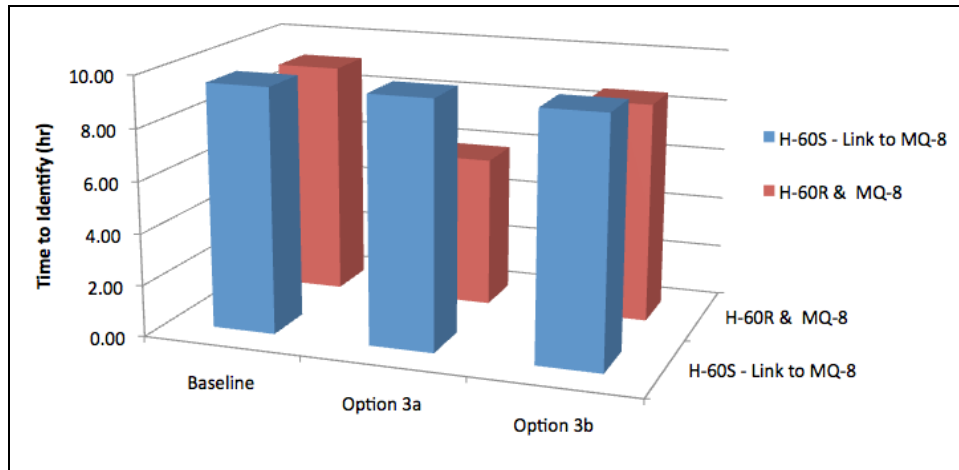

Figure 36: Time to Identify (hrs)

c) Model Inconsistencies

For several runs the results could not explain the lack of predicted improvement in alternative 3B as compared to 3A. Model results did show an improvement for alternative 3A (LOI-2) over the Baseline for the MH-60R/Fire Scout without RADAR, but it did not show any significant improvements elsewhere. The team spent extensive review time with the model raw data to determine why the predicted results did not appear. It was determined that possible NSS programmed behaviors may have been the reasons why. It was also observed that currently, there is no experience in the Navy with LOI-3 manned-unmanned system integration, so specific functionality and expected performance is unknown. (Research found that the closest example of comparable capability is the long-standing capability of the Aegis ship CIC to command SH-60B sensors over Hawk Link, but that example was not explicitly addressed by the project modeling. Modeling that behavior for this purpose may inform future manned-unmanned integration opportunities.) Some of the indicators and reasons for the NSS outcomes impacting the project include:

- In several instances air assets at the geographic extremes of the scenario returned to the LCS to identify a contact that was entering within the 5 mile exclusion zone of the ship even though the other air asset was closer. The team identified this as unrealistic.

- In several instances the 30-minute expiration of contact knowledge for contacts that had no blue sensor tracking did not seem realistic. Some contacts were “dead-in-the-water” and had not changed geographically, but were subject to the re-detection and identification rule because a sensor was not in continuous contact. The team deemed this unrealistic as well.
- For some model data elements, the project team noticed that some contacts were being identified more than once by the same air asset when it had not previously lost contact. The team believed that this was unrealistic in that contacts identified by an air asset or air crew would not have been identified more than twice within any sortie, especially if they never lost contact with a sensor.

NSS communication behaviors were cited as a possible cause of why air assets naturally identified contacts that were closest to them but in other instances they did not. This NSS model capability was deemed suspect because the team did not have enough time to ultimately determine if it was working correctly. Despite the reasons for the data not completely aligning and validating assumptions, the team believed results did identify improvements due to improved communications architectures. The NSS modeling confirmed the basic expectations and indicated consistent trends where the behaviors of the systems were well understood and the modeling reflected that detailed definition of system performance and interactions.

d) NSS Model Run #2

This model run took lessons learned from model run #1 and attempted to correct errors and inconsistencies. Mindful of the irregularities of identified model behaviors cited above, model behaviors were modified for this run to correct them for realism. In this run the 5-mile exclusion zone around the ship was removed to alleviate air assets from unrealistically retuning to identify a contact that either the LCS could have identified using own-ship sensors or a closer air asset could have identified. The model was altered to keep the COTP constant for the entire model run. This alteration removed

the 30-minute expiring contact rule when no blue sensor was not in contact with a target for greater than 30 minutes. This alteration attempted to correct unrealistic double contact detection behaviors observed in the first run. Another alteration to the NSS model was to have contacts only identified once between air assets as the levels of communication improvements increased. This alleviated some minor tactical behavior inconsistencies seen in the first run. The final alteration made to the model was the removal of the NSS communications logic behaviors as part of the base model. This capability was inherited from a baseline model that the project modified at the start of the project. Removal of this NSS capability from the scenario was done because the team could not identify if it was working properly. The effect of this removal was that all model detect, identify and classify outputs were based solely on the assumption delay times presented earlier in the paper.

e) NSS Model Run #2 Analyses

The outputs of this run were made with alterations to the model to correct inconsistencies from model run #1. Results for the run, however, did not show much improvement from run #1. Although Alternative 3B had a higher predicted improvement from the initial Excel based model, NSS results showed that alternative 3B was consistently the worst performing of the alternatives. This was backward and completely opposite of the expected result and seemed indicative that another error may have been introduced during alterations from the first run of the NSS model for this alternative run. The reasonable expectation was when the MH-60 could actively control the Fire Scout sensor payload real-time, contacts would be prosecuted more efficiently and with greater benefit to the COTP. Lack of time and access to the source model prevented diagnosis of the root cause problem and prevented correction. The NSS modeler it was not uncommon that such analysis often takes many months to rid the model of bugs. Run #2 though did show areas of promise – confirming the utility of the project endeavor.

Figure 37, Figure 38 and Figure 39 show the relationship between “Time to Detect,” “Time to Classify,” and “Time to Identify” for the baseline case and each

scenario in hours. The times are averages of the MH-60 and Fire Scout mix for each scenario. Table 13 is the raw data used to produce the bar graphs.

Table 13: NSS Model Second Run Output Data

		Option 1	Option 2	Option 3b	Option 1	Option 2	Option 3b
MH-60S	Detect	3.64	3.74	4.16			
	Class	4.64	4.77	3.67			
	Identify	4.80	4.95	5.02			
MH-60R	Detect				3.76	3.74	3.85
	Class				4.54	4.57	4.73
	Identify				4.70	4.71	4.48

Unpredictably, “Time to Detect” showed a reversal in improvement for the MH-60S and RADAR Fire Scout and for the MH-60R with the Fire Scout not equipped with RADAR. Again, Alternative 3B was consistently higher than Alternatives 1 or 2 and that remained unexplained for the analysis of the run. It is possible that an error connected to the alterations made to the model from run #1 to run #2 may have occurred. All data from this ‘Time to Detect’ metric lacked confidence to make conclusions.

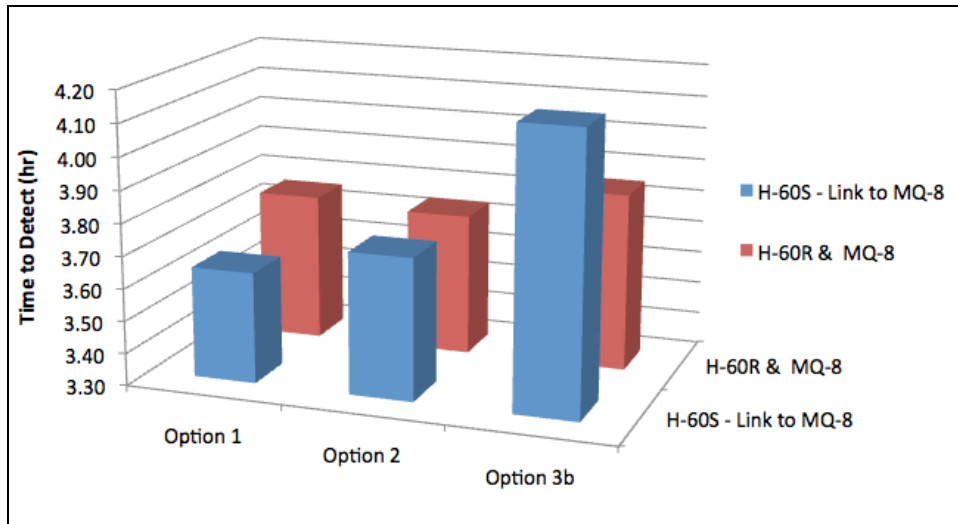

Figure 37: Time to Detect (hrs)

“Time to Classify” data illustrated in Figure 34 did not show any similarity to the project team’s predictions or expectations, except for the MH-60S. No change was noted for any alternative except for Alternative 3B for the MH-60S. For the MH-60S and Fire Scout without RADAR, Alternative 3B showed reduced “Time to Classify” by over an hour. This result would seem plausible since the MH-60S currently has no RADAR or a data link back to the ship. Alternative 3B would give some of those advantages.

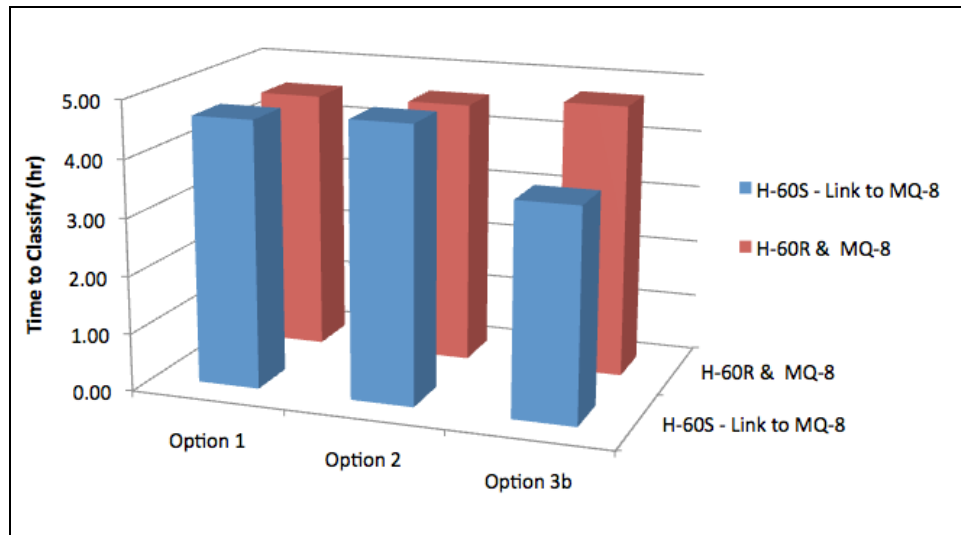

Figure 38: Time to Classify (hrs)

Figure 39, “Time to Identify,” like “Time to Classify,” displayed some irregular behaviors. Although the improving communication architectures showed worse performance for the MH-60S and RADAR equipped Fire Scout, there were minor improvements for the MH-60R operating with the Fire Scout not equipped with RADAR. The MH-60R and Fire Scout without RADAR improvement amounted to 12 minutes better for Alternative 3B versus Alternative 1 or 2.

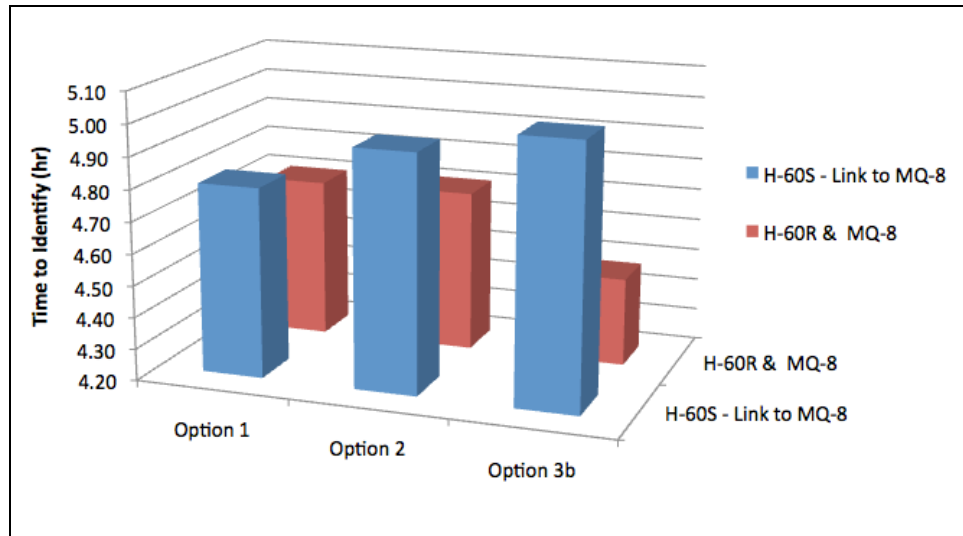

Figure 39: Time to Identify (hrs)

4. Modeling Difficulties

The complexity of the NSS model was a difficulty the team needed more time to work out. The team was dependent on the professional NSS modeler who was unavailable at various times of the project due to his workload. The NSS model, though complex, produced large quantities of data that would be necessary to properly perform quality analysis. The team accepted the power of the mission-level model as the right tool for determining the effectiveness of alternative designs through simulation. As mentioned earlier, the NSS modeler that assisted the team noted that studies of the complexity level that the team undertook, usually takes 8-10 months of dedicated model work to fully complete runs and produce analytic results.

5. Modeling Conclusions

The team concluded that several model output results were consistent with the team's original hypothesis. The trade space for communication path improvements, as described by the architectures of Alternatives 1, 2, and 3, had data throughout the various runs that did support predicted improvements and the initial assumptions outlined in the time delay tables. Because of the data irregularities, however, the team at best can only deduce that

some improvement does exist for Alternatives 1, 2, and 3 and more modeling is required to completely define it. The Excel model that was performed at the start of the analysis phase is one artifact that suggests that up to a 26% improvement may be possible. This tool also predicted that Alternative 3B would facilitate the most improvement to air platform search functions, as did NSS model run #1 results for “Time to Detect” and NSS model run #2 results for “Time to Identify” for the MH-60S and Fire Scout equipped with RADAR. With this knowledge, further analysis is warranted as Alternative 3B may be still the most significant future work for further study.

V. ANALYSIS OF ALTERNATIVES

A. ALTERNATIVE UTILITY SCORING

Analysis of the effectiveness of the project alternatives involved a combination of three different research approaches: 1) review and analysis of literature, program and technical publications; 2) use of an Excel based static model; and 3) use of the NSS dynamic simulation model. Each of these analyses and their results produced information that collectively was used to arrive at an overall effectiveness score for each Alternative. This effectiveness score is referred to in this section as the Alternative Utility. Utility analysis was selected as the method for scoring alternatives because is a common and recognized approach with credentialed foundations in academia.^[13] Utility scoring of the alternatives for this project was accomplished by evaluating the three alternatives against key metrics and those evaluations were supported by one of the three analysis approaches. The mission scenario decomposition identified the functional needs for the SWARM scenario, discussed earlier in the report. The key metrics were derived from an analysis of the necessary operational and functional requirements derived from the mission scenarios and CONOPS, and further confirmed by project stakeholders using the method described previously in the report and depicted in Figure 24. The key metrics chosen for utility scoring were:

1. Situational Awareness of the ASUW Commander
2. Time to Detect/Classify
3. Time to Identify/Decide
4. Search Rate
5. Effect for Engagement (Weapons Targeting)
6. Weight Impact to Air Platforms

1. Discussion of Key Metrics

Improvements to the SA of the TAO aboard LCS or the Battle Group's ASUW Commander were identified early in the project by the stakeholders as an important outcome and motive for defining SOS alternatives and interoperability improvements. Reducing the time to detect and identify threats and to plan a course of action that could include ordering a strike on hostile targets meant the difference between loss of life and ship or a successful defense. For this reason SA was chosen as the highest-level discriminator for scoring and comparing the alternatives. Better understanding the tactical situation more quickly, earlier in the mission timeline, can give commanders more options to complete the mission successfully. An evaluation of the alternatives against this key metric was supported by the literature studies.

Next, performance of the platform systems quantified by estimating the amount of transferred tactical information and the effect to reduce the unknowns of a tactical situation was another aspect for evaluation and scoring. Improved performance over the perceived status quo was a priority for the project stakeholders and recognized as a benefit for prosecuting a SWARM scenario. Key measures of performance were defined for "Time to Detect/Classify," "Time to Identify/Decide," and "Search Rate." These measures of performance were quantified using the Excel based model and NSS.

Next, the "Effect on Engagement" key metric was chosen to evaluate the weapons employment capability of the platforms and the effect the alternatives had on determining mission success. The assessment of this key metric was supported by the project team's literature study and the application of that understanding to the operational scenarios. This key metric's specifics were based the relevance of each alternative to get reliable

targeting information to the MH-60 platform or LCS in order to successfully eliminate hostiles.

Although not a metric directly addressed by the project stakeholders, the project identified the final key metric, “Weight Impact to Air Platforms” as an important systems engineering concern. Analysis of technical and program publications identified that a key constraint to the implementation of any alternative would be the addition of equipment that added excessive weight to either the MH-60 or more critically, the Fire Scout. Additional weight on an air platform drives up cost for integration and operations and may become prohibitive from a technical and a program perspective.

The alternatives were evaluated to determine their ability to improve targeting information. In various alternatives this amounted to the difference between passing targeting data via voice channels, as in the case for Alternative 1, and passing all targeting data digitally, as in the case of Alternatives 2 and 3. Any ambiguity in targeting information could have serious safety and mission impacts. Voice communication, providing information describing what target to shoot, for example, was judged to be more prone to ambiguity, error and delay than digitally transmitted latitude and longitude coordinates or a visual image of the target. Although this determination was subjective, it was informed by an understanding of Human System Integration (HSI) and supported by stakeholder opinion.

The final preferred value used in assessing the alternatives was the “weight impact to air platforms.” This measure is as much a topic of operational concern as an area of engineering concern. Weight impacts air platform flight performance and the desire to achieve maximum onboard capability as has historically pushed every current Navy air platform to strict weight growth monitoring and management programs. Weight limits are critical design constraints for UAVs. Weight is a key cost estimating parameter. The current history of weight growth of air platforms and the effects warrant that some attention be given to this value. Absence of this value could result in an air platform having to trade fuel to incorporate the hardware, which has a negative effect on endurance and combat radius, depending on the alternative chosen. All the alternatives were evaluated based on their estimated weight risk to the MH-60 and MQ-8. This

subjective assessment was supported by program subject matter expertise and literature study.

2. Utility Scoring

The next step in the utility scoring process was evaluation of the alternatives against the key metrics. Raw scores from analysis data were used where available and a numerical value of 1, 2, or 3 points was assigned qualitatively to each alternative based on the project research and interpretation of M&S results. Using the qualitative measures, 3 points were given for the alternative demonstrating the most improvement and 1 point was given for a characteristic that was no better than a current, unmodified characteristic. Table 14 provides a summary of scoring criteria and preferred values.

Table 14: Utility Scoring System

Attribute	Least	Middle	Best
SA of ASUW Commander	1 point for no change or worse than status quo	2 points for an improvement over current configuration	3 points for movement of both air platforms information to ship digitally
Time to detect/classify	Normalized Raw score based on Table 13	Normalized Raw score based on Table 13	Normalized Raw score based on Table 13
Time to identify/decide	Normalized Raw score based on Table 13	Normalized Raw score based on Table 13	Normalized Raw score based on Table 13
Search rate	Normalized Raw score based on the Excel results	Normalized Raw score based on the Excel results	Normalized Raw score based on the Excel results
Effect for engagement	1 point for no change or worse than status quo	2 points for an improvement over current configuration but not weapons quality data	3 points for passing weapons quality targeting data
Weight impact to Air platforms	1 point if weight risk of > 50lbs	2 points if weight risk is 10lbs < risk < 50 lbs	3 points if weight risk is <10lbs

After determining the alternative raw scores using the table’s scoring rubric, a normalization of the scores was accomplished to determine a final utility score for each alternative. In normalization, raw scores were translated into a value from 0 to 1 relative to the best and worst scores and the preferred value. Normalization facilitated easier comparisons of alternatives. Finally a weighting factor was applied before aggregating the scores for each alternative and calculating the final utility value.

3. Weightings

Because the preferred alternatives represented the project stakeholder needs and derived requirements for executing the ASUW SWARM mission successfully, the preferred attributes were interpreted as priorities of value. The mass property or air platform weight attribute was not equal in importance to the SA of a warfare commander for example. To address the true priorities, a group of operational users were asked to prioritize the attributes. Priority weights were defined and applied to the normalized preferred value scores for each of the alternatives. Table 15 presents the operator-defined weightings that were applied to the final scores of the preferred attributes for all alternatives.

Table 15: Attribute Weighting

Attribute	Scoring Weight
SA of ASUW Commander	20%
Time to Identify/Decide	25%
Time to Detect/Classify	15%
Search Rate	15%
Effect on Engagement	15%
Weight Risk to Air Platforms	10%

The weighting table above shows the importance operators placed on the performance of an SOS alternative, which was confirmed over the course of the project by stakeholder comments throughout the project and mission analysis. The preferred values of Time to Identify/Decide, Time to Detect/Classify, and Search Rate represented 55% of the total weighting of a final alternative’s score. Moreover, this combined weight was supported by the M&S results. The preferred values of SA of the ASUW

CDR, Effect on Engagement, and Weight risk to air platforms were supported by the project’s literature studies and other accomplished research that provided the academic basis from which to make judgments and draw conclusions.

4. Utility Scoring Results

The following sections describe the results of the utility scoring for the SOS alternatives.

a) MH-60S and RADAR Equipped Fire Scout

Based on the scoring method described above and the normalized scores, Table 16 presents the results for the MH-60S operating with the Fire Scout equipped with RADAR. The results support the conclusion that any of the alternatives improve performance over the fielded baseline. The results favored Alternative 1 over Alternatives 3A and 3B.

Table 16: MH-60S and RADAR Equipped Fire Scout Scores

MH-60S/RADAR Fire Scout	Baseline	Alternative 1	Alternative 2	Alternative3A	Alternative 3B
Situational Awareness	0.07	0.20	0.13	0.07	0.07
Time to Detect/Classify	0.00	0.17	0.00	0.25	0.25
Time to Identify/Decide	0.00	0.15	0.00	0.00	0.00
Search Rate	0.14	0.14	0.13	0.15	0.15
Engagement Factor	0.05	0.05	0.05	0.10	0.15
Mass Properties	0.10	0.10	0.10	0.03	0.03
Weighted Final Scores/Utilities	0.35	0.81	0.41	0.60	0.65

b) MH-60R and Fire Scout without RADAR

Table 17 provides the results for the aviation mix of an MH-60R equipped with RADAR operating with Fire Scout without RADAR. These results indicated Alternatives 1 and 2 were an improvement over the fielded baseline configuration, but Alternatives 3A and 3B were not. Based on this data, Alternative 1 or 2 would be recommended before Alternative 3.

Table 11: MH-60R and Fire Scout without RADAR Scores

MH-60R/ Non RADAR Fire

Scout	Baseline	Alternative 1	Alternative 2	Alternative 3A	Alternative 3B
Situational Awareness	0.07	0.20	0.13	0.07	0.07
Time to Detect/Classify	0.00	0.25	0.00	0.00	0.00
Time to Identify/Decide	0.00	0.09	0.15	0.00	0.00
Search Rate	0.12	0.15	0.12	0.12	0.12
Engagement Factor	0.05	0.05	0.05	0.10	0.15
Mass Properties	0.10	0.10	0.10	0.03	0.03
Weighted Final Score/Utilities	0.43	0.84	0.55	0.32	0.37

It should be noted that the NSS model structure should be investigated and modified before accepting these results completely for decision-making.

c) Conclusions

The utility scoring results for the different aviation mixes indicated that either Alternative 1 or Alternative 2 provide greater potential mission improvement and may be recommended over Alternatives 3A and 3B. Alternatives 3A and 3B were predicted and expected to show a greater utility, but M&S inconsistencies could not be resolved to provide needed confidence in the results. It should be noted that the contribution of improvements to weapon employment and threat engagement were not evaluated due to limitations in project scope and modeling. It can be concluded, however, these SOS alternative architectures were all predicted to improve the preferred attributes over the current fleet proposed configurations and the utility scoring confirmed this trend.

B. CRITICAL ASSESSMENT OF ALTERNATIVES

Table 18 presents the formal definitions of UAV C2 interoperability from the Fire Scout NATOPS Manual^[18], based on the mandated international standard for UAV C2, STANAG 4586.^[21] These definitions were used as the basis for assessing the specific technical engineering details for functional and physical integration of the SOS alternatives into the design baselines of the MH-60, Fire Scout and LCS.

Over the course of the project three alternatives for MH-60 and Fire Scout interoperability were defined, modeled and evaluated. Each alternative was an independent implementation of a capability that directly impacted air asset interoperability during a combined sortie. The alternatives were technically autonomous and could be realized alone or as was later determined, in combination. Based on the findings of this research, increased mission capability is expected from an SOS alternative that improves interoperability.

This critical assessment addresses the engineering necessary to achieve the SOS alternatives. While a complete analysis would encompass the entire lifecycle of each implementation, manpower issues and logistic factors were not addressed directly by this research. Although these factors directly affect the employment and supportability of air assets on the LCS, they were not influential in the definition or analysis of alternatives and it was determined they do not impact development of the technical solutions based on these alternatives.

Table 18: Levels of Interoperability

NATOPS (A1-MQ8BA-NFM-000)/NATO Standard 4586 Edition 2 and AEP -57 Volume 1		
0	All	No air vehicle or payload actions allowed
1	Data Link	Indirect receipt and transmission of payload data from another CUCS or C4 node via the Shipboard Modular Mission Package (MMP)
2	Payload	Direct receipt of payload data from the AV
3	Payload	LOI 2 + command and control of the payload
4	Vehicle	Command and Control of an vehicle
5	Vehicle	LOI 4 + Launch and Recovery of an vehicle

This assessment describes general technical impacts and approaches to implement the alternatives. This information is provided to characterize the integration and provide technical data relevant to the engineering feasibility and to articulate the level of engineering complexity for each alternative. Moreover, the technical approach described for each alternative was recognized as only one of many ways to achieve these capabilities. The purpose of the critical assessment is to identify a technical path forward, if the decision to pursue an alternative is taken. These approaches also facilitate evaluation of where the alternatives might enter the DOD acquisition framework. ^[17]

1. Alternative-1 (A-1) Analysis

Alternative-1 for the MH-60 and Fire Scout interoperability consisted of LCS shipboard modifications. For this alternative, there was no direct interface between the MH-60 and Fire Scout. This alternative provided Level of Interoperability-1 (LOI-1) between the Fire Scout Shipboard Modular Mission Package (SMMP) and the LCS CIC. The focus was to give the LCS Tactical Watch Officer (TWO) in-flight oversight and near real-time access to Fire Scout Modular Mission Package (FMMP) payload data. Analysis of real time Fire Scout data is communicated to the MH-60 crew via voice communication. LOI-1 does not provide FMMP control to the LCS. SMMP assets are controlled by the LCS watch officer directing the SMMP Command Segment (CS) crew. The Fire Scout CS operating crew consisted of a Mission Commander (MC)/Air Vehicle Operator (AVO) and a Mission Payload Operator (MPO).

a) Shipboard Controlling Node

In this alternative the Fire Scout shipboard CS acted as the UAV controlling node and retained LOI-5 for takeoff, mission execution and landing, throughout all UAV sorties. The ship's C2 received video and acted as a second non-control shipboard node.

b) TCDL Video File Format

The Fire Scout NATOPS manual states the SMMP Tactical Control System (TCS) has the capability to publish National Imagery Transmission Format (NITF) imagery files (NTIF) data across Local Area Networks (LAN), and Tactical Communications Interface Modules (TCIM). Information about NITF data and its associated military standards can be found in Military Handbook 1300A (MII-HDBK1300A)^[23] and in Military Standard 2500B (MIL-STD 2500B)^[24]. Imagery in this format with supporting metadata will be transferred between the SMMP External Communication (EXCOMMS) equipment rack and the LCS Command, Control, Communication and Computer (C4) system.

c) Shipboard Video File Transfer

Shipboard LAN assets providing a conduit for video file information transfer and analysis will be necessary to determine if current shipboard network bandwidth supports video and data streaming throughput requirements. Figure 40 shows in red the video link between the Fire Scout SMMP and the LCS CIC.

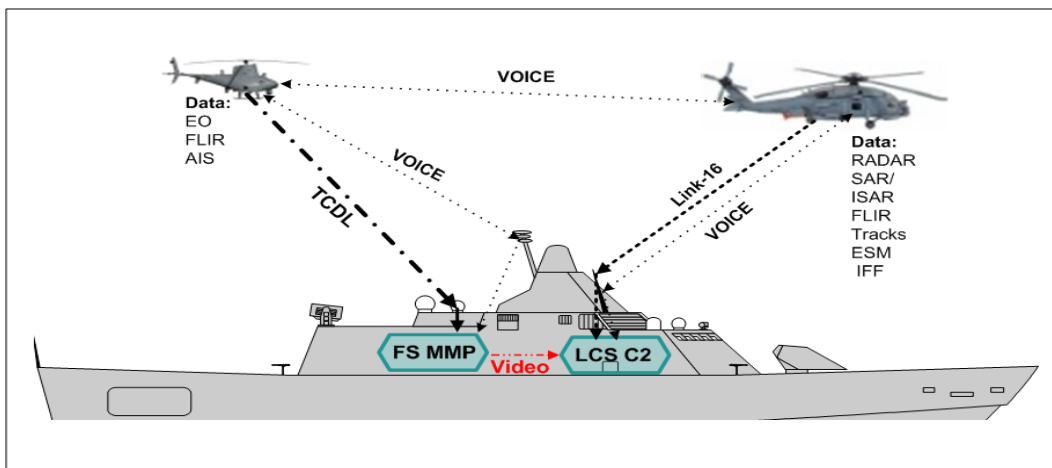

Figure 40: Alternative-1

d) General Work Required for A-1

Additional analysis, follow-on engineering, and an evaluation of HSI requirements are requisite to developing any specific shipboard engineering proposals and estimate work required to modify, qualify and install hardware and software.

Analysis of the existing LCS LAN is likely to reveal infrastructure upgrades necessary to meet throughput speeds necessary to stream certain video formats. These modifications would likely entail upgrading to faster network routers and switches. Also these upgrades may necessitate replacing existing cabling with newer higher bit-rate cabling for faster data rates. Additional upgrades to the LCS operator consoles are likely required to accommodate the new video source. These changes entail hardware enhancements for improved video buffering and switching. These hardware improvements will likely necessitate software modification to the LCS tactical C4 load in its video handling applications.

e) A-1 Conclusion

From an engineering perspective, the integration of SMMP CS video with the LCS CIC consoles should be straight forward. The scored risk for the nine factors associated with A-1 is centrally located in the risk cube, presented in a subsequent section of this report. Only one factor (Lack of Shipboard Intel Manpower) is scored red and is non-engineering related, while the rest are scored moderate to low risk. Cost will be driven by work performed on the prototype and by shipyard availability. If A-1 is accomplished stand alone, the upgrade should be scheduled during construction or in an extended work period when the ship is pier side, while other moderate upgrades are being installed. Prototyping will aid risk reduction and confirm interface definitions and installation plans, and all data rights and licensing for software and design drawings will need to be addressed in advance. Once prototype integration is achieved and material procurement is complete, shipboard installation schedules can be addressed.

2. Alternative-2 (A-2) Analysis

The focal point of Alternative-2 (A-2), shown in Figure 41, is on modifying the LCS and leveraging expected data link upgrades to the MH-60 helicopters. The Fire Scout equipment and operation are not effected in A-2. This option involves improving the existing MH-60 and LCS Link-16 tactical communication by providing the infrastructure necessary to fully utilize the follow-on H-60 Hawk Link capability. Hawk Link is a prospective CDL between the MH-60 helicopters and the LCS. Hawk link is currently being tested ^[26-28] and the higher data rate infrastructure is expected to facilitate MH-60 follow on TCDL upgrades on the MH-60 aircraft themselves and at receiving stations as well. The Hawk Link improvement facilitates increased capacity for the MH-60 to transmit data, thereby providing near-real- time sensor and video display information from MH-60 sensors to CDL and TCDL receiving stations.

a) H-60 CDL-TCDL Hawk Link

A-2 has no direct interface between the MH-60 and Fire Scout. Independent of the Hawk Link, the Fire Scout SMMP requires a TCDL antenna for communication between the LCS and UAV. CDL and TCDL data rates require dedicated Line of Sight (LOS) directional antennas. Upgrading the LCS communication arrays to include a second directional Ku Band TCDL antenna allows for reception of Hawk Link data. This provides a means for receiving MH-60 Multi-Spectral Targeting System (MTS) sensor data for display on the LCS operator consoles. By upgrading the LCS with second TCDL the LCS is given improved sensor data sharing capabilities, enhancing the tactical interaction process between the LCS C4 team and the MH-60 crew.

b) LCS Tactical Watch Officer Review of both Fire Scout and MH-60 Video

Although A-2 is an independent implementation, there is an expected synergistic increase in capability if both A-1 and A-2 are implemented on the same platform. By providing LOI-1 interoperability between the SMMP and the LCS, and near real time MH-60 sensor data to the LCS C4, it is anticipated the LCS will simultaneously display

MH-60 and Fire Scout sensor data. This combined capability provides the LCS TWO the ability to compare data and potentially, to improve asset usage while reducing confusion when identifying contacts and prosecuting targets.

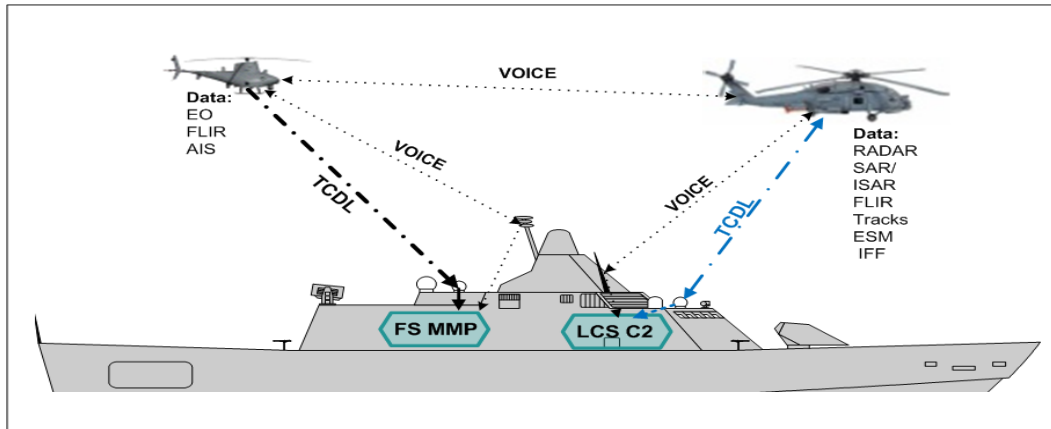

Figure 41: Alternative-2

c) Engineering for A-2

A proposal to incorporate a second TCDL aboard LCS would require an analysis of alternatives to include engineering and an evaluation of HSI needs. An assessment of where to place the new antenna in the ship's superstructure and its impact on ship stealth would be necessary. A-2 is essentially a communication suite upgrade requiring a comprehensive review of the operator console for the new source of video and sensor data. Although these upgrades seem similar in scope and capability to the improvements associated with A-1 they are from a different source and need an independent assessment of the requirements.

i. TCDL Data Transfer and Protocols

Since TCDL data transfer is based on Ethernet protocols, an analysis of the existing LCS LAN for A-2 may also reveal infrastructure upgrades are required for throughput requirements.

ii. LCS Hardware Upgrade

Upgrades to LCS operator consoles are likely. As stated above, it cannot be assumed an upgrade made to meet A-1 need will be robust enough to carry A-2 data or especially a combination of both A-1 and A-2. These changes entail hardware enhancements for improved video buffering and switching. Software modifications to the LCS tactical C4 load are likely needed to improve processing for applications associated with handling video.

iii. Fire Scout Control

Fire Scout is autonomous within A-2 so the Fire Scout SMMP will retain full LOI-5 control of the UAV throughout any combined sortie.

d) A-2 Conclusion

Like A-1, upgrading the existing LCS communication suite to include a second TCDL is expected to be straight forward. The risk factors associated with A-2 are centrally located in the risk cube for this alternative, provided later in this report. As with A-1 a lack of ship's force Intelligence manpower was the only factor scored as a high risk, while the rest are scored moderate to low risk. This is a non-engineering associated risk factor and has no impact on developing a technical solution for A-2. Analysis of the impact of adding the TCDL to the LCS RADAR profile would require a certain amount of operational test range time. The cost of LCS RADAR profile testing would need to be added to any comprehensive cost estimate for A-2. As with A-1 cost is expected to be driven by work performed on the prototype and by shipyard availability. If A-2 is accomplished stand alone, effort should be made to align maintenance schedules when the ship is pier side. The effort to modify LCS inboard infrastructure is expected to be comparable to the engineering effort required to bring the Fire Scout SMMP data into the LCS CIC consoles.

3. Alternative-3 (A-3) Analysis

The Alternative-3 (A-3) is the most challenging option to develop and involves modifications to both aircraft. A-3 involves incorporating TCDL data cross links between the Fire Scout and MH-60. This encompasses incorporating two TCDL equipment packages aboard both the Fire Scout and MH-60, or expanding the current capabilities of the Fire Scout TCDL and MH-60 Hawk Link to meet the additional work load. In either case, a second LOS directional TCDL antenna is required to be installed on both aircraft. Thought should be given and analysis performed to determine if additional airborne interoperability is fully utilized without modifications to the LCS ability to receive, process and transmit data accordingly. In A-3 the MH-60 helicopter receives FMMP payload and control data directly from the Fire Scout. A-3 currently has two variants and an analysis of alternatives to down select between LOI-2 and LOI-3, or to determine the synergistic benefits of implementing both LOI-2 and LOI-3 modifications should be conducted. Figure 42 presents A-3 communications paths.

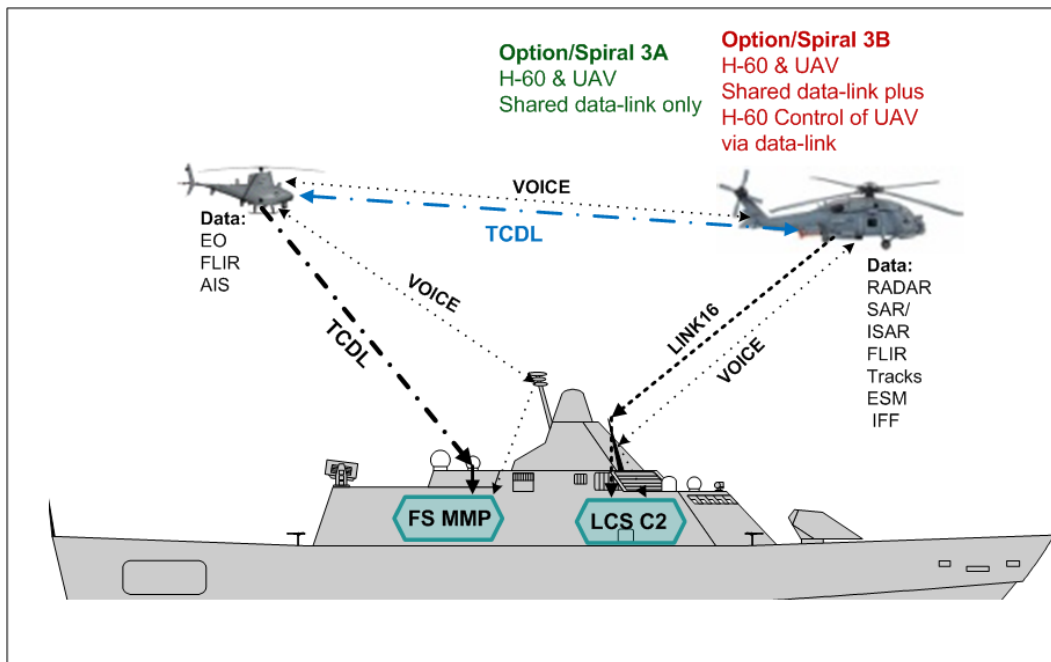

Figure 42: Alternative-3

a) COTS Alternative and UAV Control Options

A-3 moves the Primary Data Link (PDL) from the LCS SMMP and establishes TCDL control on the MH-60. An analysis of alternative equipment needs to take place, but small Commercial Off The Shelf (COTS) TCDLs such as the L3 Corporation Multi-Role Tactical Common Data Link (MR-TCDL) [26] or the L3 Corporation Mini TCDL[27] indicate technically mature products are available. These COTS equipment packages are already sized to fit aboard both the MH-60 and the Fire Scout. Although suitable products may be available, factors such as size, weight, and HSI concerns can be more challenging for aircraft integration than for shipboard applications. Additional evaluation of the suitability of these devices should be conducted.

b) Fire Scout Control during Launch and Recovery

It is expected that for A-3, the present configuration of the SMMP with redundant UHF/VHF Secondary Data Links (SDL) will be retained aboard LCS for use during UAV launch and recovery. The Fire Scout MC/AVO will remain aboard LCS and from the SMMP is expected to retain master control and continuous LOI-5 during UAV launch and recovery due to safety concerns. From the SMMP, the MC/AVO is likely to maintain responsibility for monitoring UAV point-of-safe-return and UAV general stores. Hand shake operation between the MH-60 TCDL and SMMP TCDL will move LOI-2 or LOI-3 control from the SMMP to the MH-60 TCDL during the ingress, on-station, and egress, phases of the Fire Scout flight plan.

c) Antenna Usage in A-3

Combinations of omni-directional and directional antennas on the LCS, Fire Scout and MH-60 provide a mix of data signal reception ranges. Continuous UHF/VHF SDL between the LCS and UAV is only necessary for launch and recovery operation. Within A-3 Loss of Communication (LOC) procedures and automatic functions may also shift to the MH-60 data link.

d) Link-16 Tactical Data Management Retained

Both the H-60 NATOPS (A1-H60RA-NFM-000) and NATIP (NTRP 3-22.4-MH60R) discuss the current communication suite aboard the MH-60R Helicopter. Link-16 presently provides Tactical Data Management (TDM) for presenting a Geographical Situation (GEOSIT) display using its Data Fusion (DF) capability to De-clutter (DCLT) contact and target tracks. Additionally Link-16 supplies avionics interface control and ESM system interface through its Avionics Operating Program (AOP). Due to space and weight constraints Link-16 TDM and onboard avionics interface and control is anticipated to merge into the Hawk Link system. Timing and integration should be coordinated between A-3 and Hawk Link projects for efficiency. The first order of analysis should be to determine the feasibility of using a single link solution, to include link control and loading characterization.

e) UAV TCDL Sensor Payload Management Merged with Hawk Link

Adding UAV sensor payload management to the existing Hawk Link capabilities is the principal challenge for A-3. Merging and augmenting the present MH-60 controls and indicators are both an engineering and HSI challenge.

f) Required Fire Scout Modifications

A-3 requires modifications to Fire Scout including adding hardware sustaining a second LOS antenna and software changes to provide seamless LOI-2 and LOI-3 switching between the SMMP and the MH-60 TCDL terminal. Other UAV software adaptations may be moderate since all capabilities are already developed and switching the application control source is the singular development focus. UAV hardware upgrades would be limited to stepping up the existing UAV TCDL receivers to interface with a second LOS antenna and installing the antenna.

g) Required MH-60 Modifications

A-3 modifications to the MH-60 may be extensive. The upgrades may include major software changes, including integration of UAV TCDL data control capabilities. The MH-60 crew station and HIS may be impacted, especially the control and display of information at the crew operating consoles. Providing an integrated tactically efficient MH-60 Hawk Link and Fire Scout TCDL operating interface will require extensive engineering analysis to specify impacts to the airframe, as well as mission systems. For example, a second LOS antenna and its supporting components may be essential.

h) A-3 Conclusion

A-3 is an independent development and does not need to be associated with A-1 or A-2. A-3 provides the greatest asset interaction by providing high bandwidth data directly between aircraft, potentially reducing delay and error. As with the earlier options, A-3 has the same high risk factor for lack of ship's force Intelligence manpower. Although the implementation has more pervasive and complex impacts to the existing systems, the majority of the scored risks were either moderate or low. The external modifications to Fire Scout are limited to adding another TCDL LOS antenna. Internal modifications are expected to be limited to software changes. External changes to the MH-60 are also limited, adding a second TCDL LOS antenna, but internal modifications are expected to be extensive. The degree of change may require regression testing and requalification of subsystems and system integration and flight test. Cost estimation for A-3 will encompass the full range of factors included in building or performing major modification to an aircraft based on an event driven development schedule, to include risk reduction prototyping. Because different contractors would be involved, licensing and data rights should be resolved early in the project timeline.

High bandwidth data transfer between aircraft affords tactical flexibility and improves asset usage by allowing the MH-60 aircrew direct access to Fire Scout payload data and control of onboard sensor. Although A-3 can be developed as a standalone implementation, as with previous alternatives, combining solutions may offer the greatest potential increase in the overall system effectiveness.

C. COST ANALYSIS OF ALTERNATIVES

The cost analysis was based on a high-level Work Breakdown Structure (WBS) that was created for each alternative. Table 19 provides a sample WBS. The WBS estimates were developed using market research associated with the cost of similar modifications on MH-60 variants. Subject matter experts provided the estimates for each element of the WBS based on experience with similar modifications on MH-60 and other platforms. The team relied on experienced personnel from PMA-299 who have managed and performed aircraft modifications to rotary wing platforms and other systems for the past 20 years to provide data relevant to these efforts. The subject matter experts provided a point estimate for each alternative that was based on the sum of all of the single best-cost estimates for each WBS element. Because there was not a large comparable database of cost information for similar system modifications, the decision was made to use a point estimate method supported by engineering judgment. It should be noted that a point estimate is a very precise, yet often inaccurate cost model.

Table 19: Alternative 1 WBS Excerpt

WBS	Description	Cost
1.0	Non Recurring Engineering	
1.1	Definition of requirement for TC DL data transmission	\$25,000
1.2	Definition of requirement for display of TC DL data on C2 console	\$25,000
1.3	Analysis of existing LCS databus hardware architecture	\$25,000
1.4	Architecture modification to shipboard data bus hardware	\$25,000
1.5	Analysis of existing LCS databus software architecture	\$25,000
1.6	Architecture modifications to shipboard data bus software	\$25,000
1.7	Analysis of Alternatives	\$20,000
1.8	Alternative Selection	\$5,000
1.9	Integration Design	
1.9.1	Prototyping Hardware	\$25,000
1.9.2	Prototyping Software	\$40,000

The WBS was used to accumulate costs for the materiel and work necessary to implement each alternative. Following the point estimate method, the total cost for each alternative was calculated as a roll-up value. The cost estimate for each alternative is shown in Table .

Table 20: Cost Estimate for Each Alternative

	Cost
Alternative 1	\$2,016,000.00
Alternative 2	\$2,571,000.00
Alternative 3	\$3,696,000.00

Ideally, the cost estimate would be determined using a cost estimating relationship (CER). The CER is based on distributions of input data, including average unit cost, production quantity, fiscal year, and possibly weight or other dimensional data. This cost data would be normalized to any given fiscal year dollars using a cost inflation index. Different cost estimating theories can be applied to adjust the average unit cost by considering a learning curve and to determine the Theoretical First Unit cost. The dataset of Theoretical First Unit cost and weight or other dimensional data is used to create different CER's. The CER which provides the lowest Percent Error and the highest correlation would be the equation used to predict the Theoretical First Unit cost and total production cost of the new modification. Monte Carlo simulations would be run to provide a distribution of estimates with a quantified risk. This distribution of estimates would be used to justify the budget for the modification program.

A more thorough cost analysis is recommended in the follow on work to minimize risk due to cost uncertainty. The estimate does provide a framework for use in refining cost estimates in the future.

Despite the limitations in method and available data, an important aspect of the project was to provide a framework for recommending an SOS alternative solution that was both operationally effective and programmatically achievable. To this end, the cost estimate was performed to complement the Utility Scoring assessment, building on the M&S research and analysis, in order to provide a "Bang for the Buck" recommendation. It was expected that the relative ranking of cost versus capability for the SOS alternatives would be useful information to stakeholder deliberations. The "Bang for the Buck" plots of cost versus utility are presented in Figure 43.

The plots indicated that Alternative 1 achieved the lowest cost and highest utility. This outcome confirms expectations and is consistent with the results of the project research, specifically, the Excel-based model results and to a limited extent, the NSS

finding that Alternatives 1 and 2 provided overall the most improvement in mission effectiveness as a direct result of improved data-level interoperability within the SOS.

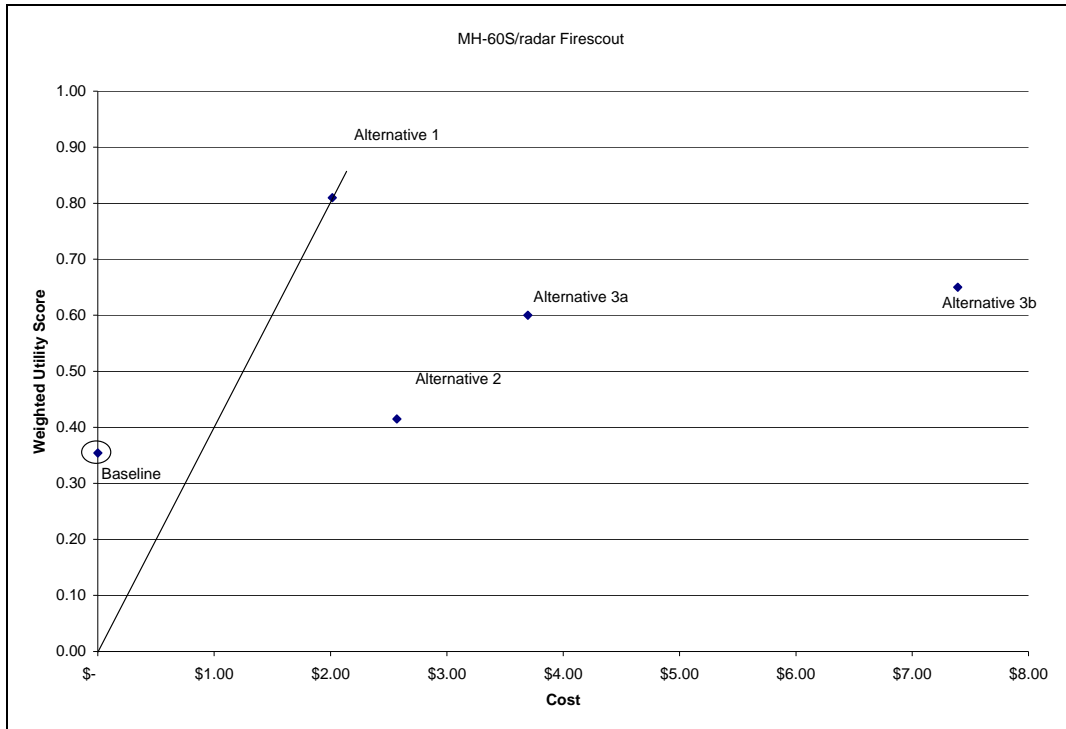

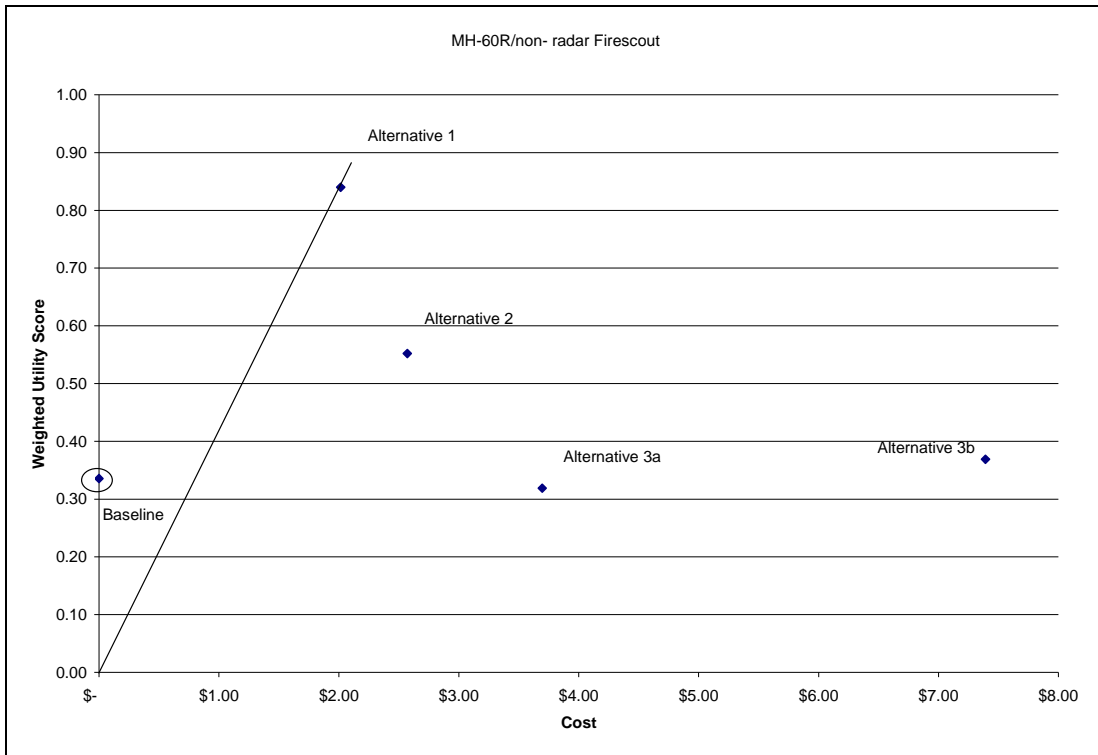

Figure 43: Cost versus Utility Plots

D. RISK ASSESSMENT

The risk assessment was performed to aid stakeholder decision-making, as well as to complement the Critical Assessment of the implementation impacts provided in the preceding section of this report. A risk assessment was conducted on each design alternative to include: identification of risk areas, analysis to determine the likelihood and consequence associated with each risk (a quantitative measure), and preliminary mitigation planning. Risk management should begin at the earliest stages of program planning, continue throughout the total life cycle of the program, and was an important factor in defining the alternative configuration and subsequently, in determining the best value system design during the Analysis of Alternatives. For this interoperability project, the impact of software development and integration efforts was addressed as part of the program’s risk management activities. Preliminary areas of risk were identified for this project as part of the initial project planning. These initial areas are

discussed in this section and refined throughout the project. These risks also provide a basis for further assessment in follow-on efforts. As the project progressed, newer more accurate risks were also identified. These are also discussed in this section.

1. Initial Risk Areas

Initially top-level, programmatic risks were identified. These risks are shown on a risk-cube in the following Figure 44 and listed below with numbers corresponding to those in the risk cube. This identification process was preliminary and provided a guide that the project team could use to steer the project for risk mitigation purposes. These risks were mostly technical in nature. It is helpful to keep in mind that these risks have been superseded by newer, more accurate risks. However, discussion of these risks is useful and will provide a history of risk identification in this project.

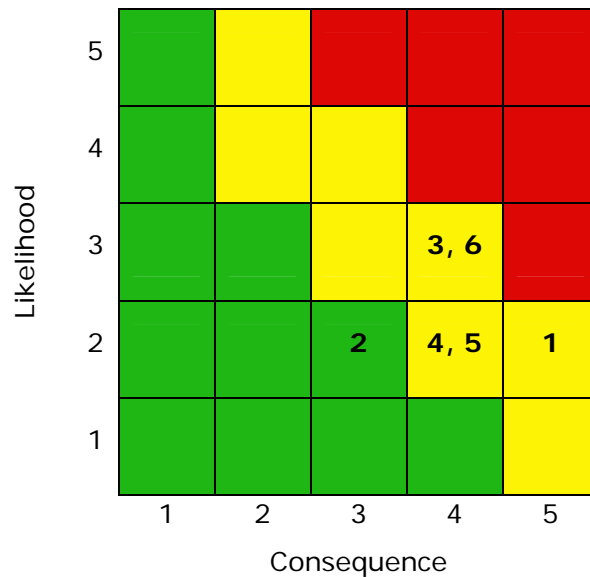

Figure 44: Initial Risk Profile

2. Listing of Initial Risks

1. System Level Requirements Definition
2. Identification of Testable Measures of Effectiveness
3. Bus Loading/Data Link Bandwidth to Accommodate Additional ISR Data
4. Mission Computer Processing Capacity
5. Fidelity of Modeling and Simulation
6. Software Modifications Required to Update Operator Displays and Integrate Data into Mission Computing Systems

a) Programmatic Risks

The initial programmatic risks are listed below. These risks were identified as items that could potentially hinder the actual systems engineering effort and not necessarily the technical design aspect of the project.

- System Level Requirements Definition
- Identification of Testable Measures of Effectiveness
- Fidelity of Modeling and Simulation

There was discussion as to whether identification of requirements could pose a problem. Identification of true stakeholders was a concern mainly because of the academic nature of this project. Without an actual JCIDS document, it was thought that gathering realistic requirements would be an issue. These risks did not materialize due to the fact that there was strong interest in this project from stakeholders, who provided valuable input.

Because actual testing was not an option for this project, the team found it difficult to confirm that MOEs proved testable. The simulation of the project's mission scenario handled the testing aspect of this project. This simulation was a proof of concept and pseudo-test event. Over time, the team was able to identify an MOE that could be proven through simulation and the risk was mitigated.

The final programmatic risk was based on the concern that the simulation of the project's mission scenario would not possess enough fidelity to provide an accurate and

stable result and conclusion. This risk has been present throughout the project and has impacted the final results to some degree, with explanation where practical.

b) Technical Risks

The initial technical risks are listed below. These risks were identified as potential issues that could affect the technical design being suggested.

- Bus Loading/Data Link Bandwidth to accommodate additional ISR data
- Mission Computer Processing Capacity
- Software Modifications required to update Operator Displays and Integrate data into Mission Computing Systems

Because the project was handling the addition of new sensor data to a pre-existing bus the risk of bus overload came to mind. Actual bus utilization needed to be assessed, once sufficient traffic characterization could be defined, as well as the bandwidth required by the new sensor data.

Much like the bus-loading risk, a risk was identified that could affect the mission computer. Because the mission computer is pre-existing it has a pre-determined processing capacity. This capacity was unknown, as was the capacity required to handle the new mission requirements.

A risk was identified for the integration of the Fire Scout operator displays and the mission computing systems aboard the LCS and MH-60. This risk focused on the potential for modifications to these systems to make them interoperable. The risk existed because the nature of these modifications was unknown and therefore, feasibility is also unknown.

Identification of risks within each alternative showed that certain risks were isolated to one alternative while other risks were present in two or three of the alternatives. The discussion in this section of the report will focus on individual risks while pointing out which alternatives are affected. A summary of each alternative will also be provided.

2. Refined Risk Areas

Once a clear vision was established and requirements took shape, more specific risks were identified. These risks were more accurate and painted a clearer risk picture through the lens of the systems engineering alternatives. Risks were addressed and discussed individually for the alternatives where they apply.

a) Lack of Shipboard Intel Manpower

- **Alternatives Affected:** 1, 2, & 3
- **Consequence & Likelihood:** (4,4)
- **Level:** High
- **Type:** Operational Suitability

This risk deals with requirements levied on the LCS crew to support the additional functionality proposed by this project. It is unknown whether there is enough manpower to handle the additional sensor data and process it in a timely manner. Especially challenging is the need to provide intelligence specialist manpower to exploit imagery in support of decision-making. This specialty area is in high demand for Naval and Joint operations and may not be available for LCS deployment. Mitigation efforts could come in the form of a manpower study and further recommendation on what resourcing modifications may be needed, if any.

b) Support for Shipboard Aviation Mission Solution

- **Alternatives Affected:** 1 & 2
- **Consequence & Likelihood:** (3,4)
- **Level:** Moderate
- **Type:** Schedule

A risk to implementation exists because the LCS is not currently tasked with supporting a full aviation mission. The success of what this project proposed was based on many individuals and groups within the Navy and DOD agreeing to an

unmanned paradigm shift. Mitigation for this risk was to provide an accurate study and assessment to the risk/reward aspect of proceeding down this path. This project takes a first steps in doing so.

c) Fire Scout Control Station and LCS CIC Interface Incompatibility

- **Alternatives Affected:** 1 & 2
- **Consequence & Likelihood:** (4,3)
- **Level:** Moderate
- **Type:** Performance

A portion of the technical solution deals with data sharing between the Fire Scout CS and the LCS CIC. A risk exists because there is currently no interoperability between these two systems. Mitigation could come in the form of performing analysis on the interfaces these two systems possess and proposing a solution to provide interoperability.

d) Software Modification required to Support Fire Scout video at LCS CIC

- **Alternatives Affected:** 1 & 2
- **Consequence & Likelihood:** (3,3)
- **Level:** Moderate
- **Type:** Performance, Schedule

This risk goes hand-in-hand with the previously discussed risk. Once an interface solution between the Fire Scout CS and LCS CIC is defined, the LCS CIC will be required to display and manipulate Fire Scout sensor data. The software modification effort to implement this is unknown. Mitigation, like the previously discussed risk, would be system analysis with software change impacts to determine a possible solution to achieve the desired results.

e) Ship Availability for Modification Install

- **Alternatives Affected:** 1 & 2

- **Consequence & Likelihood:** (3,3)
- **Level:** Moderate
- **Type:** Schedule

A risk exists because the LCS would need to be taken away from duty to implement the proposed modification. Schedule factors may affect the modification. Mitigation for this risk is to provide the most accurate schedule for the LCS availability with the greatest amount of lead-time possible.

f) Impact to Software baselines by New Software Modifications

- **Alternatives Affected:** 1, 2, & 3
- **Consequence & Likelihood:** (3,3)
- **Level:** Moderate
- **Type:** Performance, Cost

Each system that requires a software modification already possesses a software baseline with critical mission functionality. It is common that modifications to an existing software system result in unintended consequences, sometimes in the form of disruption to the software baseline. This risk exists for this project because systems related to the LCS, MH-60, and Fire Scout may require software modification. Mitigation for this risk comes in the form of rigorous software quality standards and extensive testing.

g) LCS Console Operator Workload

- **Alternatives Affected:** 1
- **Consequence & Likelihood:** (2,3)
- **Level:** Low
- **Type:** Operational Suitability

Additional mission functionality will lead to additional work-loading of those aboard the LCS, specifically, the operator of the LCS's console. Current workload

needs to be gathered and assessed with the potential additional workload proposed by this project. A human factors analysis should be performed to determine if additional manning is required for mitigation purposes.

h) Potential Inaccuracy of NSS Model Due to “Cumulative Alternatives”

- **Alternatives Affected:** 1, 2, & 3
- **Consequence & Likelihood:** (3,2)
- **Level:** Low
- **Type:** Performance

This risk is related to the potential inaccuracies associated with modeling the mission scenario. Because various alternatives can consist of cumulative functional build-ups and the modeling approach was not cumulative, additional manipulation is required to provide an assessment of the cumulative effects of incorporating multiple alternatives. The risk is that of an inaccurate result due to the model not being specific for the mission scenario. Mitigation for this risk can come in the form of additional modeling and analysis.

i) LCS Ability to Accommodate Additional Antennas

- **Alternatives Affected:** 2
- **Consequence & Likelihood:** (4,3)
- **Level:** Moderate
- **Type:** Performance, Cost

There is a risk of incorporating an additional antenna aboard the LCS to accommodate the simultaneous of the Fire Scout and MH-60 data links to the LCS. Locating a suitable integration for the antenna and supporting equipment is required to mitigate this risk.

j) Infrastructure to Support Additional TCDL

- **Alternatives Affected:** 2

- **Consequence & Likelihood:** (3,2)
- **Level:** Moderate
- **Type:** Performance, Cost

This risk is closely related to the previous antenna risk. Because the LCS will need to be able to communicate with the Fire Scout and MH-60 simultaneously an additional TCDL channel is required. It is unknown if the infrastructure to support this exists or if modifications to the LCS will be required. An engineering analysis is needed to better clarify the nature of this risk as well as identify what may be required to implement an additional TCDL.

k) Aircraft Weight Additions

- **Alternatives Affected:** 3
- **Consequence & Likelihood:** (3,3)
- **Level:** Moderate
- **Type:** Performance

With most physical upgrades comes additional equipment. This usually leads to additional mass and weight requirements. Weight is a critical factor in the aviation world. This risk exists because there is the potential for weight additions to the MH-60 and Fire Scout. These weight additions could lead to unknown mission impacts that restrict operations. This risk can be mitigated by treating weight as a KPP during the system design process or incentivizing the integrator or contractor to minimize weight growth by design.

l) Video Communication between Fire Scout and H-60

- **Alternatives Affected:** 3
- **Consequence & Likelihood:** (3,3)
- **Level:** Moderate
- **Type:** Cost, Schedule, Performance, Operational Suitability

A new communications channel is required between the MH-60 and Fire Scout to view the Fire Scout sensor data. The nature of this implementation is undefined and an engineering study into potential solutions is needed to mitigate this risk.

m) Disorientation and Motion Sickness when Viewing Sensor Data Aboard MH-60

- **Alternatives Affected:** 3
- **Consequence & Likelihood:** (3,3)
- **Level:** Moderate
- **Type:** Operational Suitability

Preliminary analysis yielded a risk to operational suitability due to a human factors concern. It is known that viewing video aboard one aircraft in flight from another aircraft's in-flight perspective can lead to motion sickness and thus degraded or null capacity to perform the mission. Additional human factors analysis is required in this area to clarify the details of this risk and present potential guidelines to reduce this potential effect before Fire Scout video aboard the MH-60 is implemented

n) Integration Complexity

- **Alternatives Affected:** 3
- **Consequence & Likelihood:** (3,3)
- **Level:** Moderate
- **Type:** Cost, Schedule, Performance

There are a variety of ways to incorporate the functionality associated with each of the alternatives. For Alternative 1, the requirement is to implement a communication channel between the FSCS and the CIC on the LCS, in order to share Fire Scout sensor data. This communication channel could take the form of an Ethernet link, Optical Fibre channel, hardwired RS-170 video line, etc. Alternative 2 requires integration of an additional TCDL Data Link channel on

the LCS to support reception of data from both the Fire Scout and MH-60 simultaneously. For one configuration of the LCS ship, two channels of TCDL and two antennas are already integrated, but the second independent channel is not enabled. On the other LCS configuration, there is only one TCDL antenna, necessitating integration of a second antenna. With two antennas and two aircraft operating TCDL simultaneously, there is the possibility of blockage of one of the antennas by ships structure, effectively blanking the video from one of the aircraft. Optimally, each TCDL channel would have full 360 degree coverage, which would necessitate multiple antennas and antenna switching. Alternative 3 requires the MH-60 to receive sensor data from the Fire Scout and also, to take control of the sensor. Integration of a communication channel for receipt of the sensor data could take a variety of forms and could impact both the MH-60 and Fire Scout. Taking control of the Fire Scout sensor would require integration of a communication system and control station on the MH-60, and would also require control negotiation between the MH-60 and the LCS-based Fire Scout control station. Complexity translates to risk.

The selection of this approach will drive the integration complexity, and thus drive Cost, Schedule, and Performance. The analysis of alternatives and selection of a recommended approach is left for follow-on work.

o) Data Latency Across Platforms

- **Alternatives Affected:** 3
- **Consequence & Likelihood:** (3,3)
- **Level:** Moderate
- **Type:** Performance

Complex communications systems consisting of data links can be plagued by data latency, especially with the implementation of multiple data links leading to compounded latency issues. Latency is a risk to the implementation of

interoperability between the Fire Scout and MH-60 platforms. Communication system tests are required to account for potential mission data flows and bandwidth. Performing tests of this nature will help shed light on the details associated with this risk.

p) Increased Range

- **Alternatives Affected:** 3
- **Consequence & Likelihood:** (2,3)
- **Level:** Low
- **Type:** Performance

Increased range is a possibility with the implementation of additional data links. Although this increased range may seem useful, increased operational time, fuel stores, and decreased MTBF are all possible impacts that may counter the benefit.

q) Data link Robustness

- **Alternatives Affected:** 3
- **Consequence & Likelihood:** (3,2)
- **Level:** Low
- **Type:** Performance

Where specific system functionality relies on the robustness of the data link for capacity, latency or other transmission attributes, there is risk to performance. Potential problems include susceptibility to jamming and/or the potential for a non-lock situation where the data link cannot initialize causing mission ineffectiveness. Analysis of the potential operating environment and potential link employment are required to mitigate this risk.

r) Fire Scout Hand-off Command to MH-60

- **Alternatives Affected:** 3
- **Consequence & Likelihood:** (3,2)

- **Level:** Low
- **Type:** Performance

This risk is addressed above as part of Section n).

s) Non-Availability of Frequency Spectrum for Operations

- **Alternatives Affected:** 3
- **Consequence & Likelihood:** (3,2)
- **Level:** Low
- **Type:** Performance

When implementing new data links with additional bandwidth requirements it is important to locate a suitable portion of the RF spectrum in which to operate. The new communications requirements proposed by this project will lead to additional RF spectrum needs. Analysis is needed to determine impacts and detailed requirements.

3. Alternative Risk Profiles

The previous portion of this section of the report detailed each individually identified risk. These various risks affect one or more different alternatives for this project. This section lays out the risk profile per alternative. The risk profiles are presented in Figure 45, Figure 46 and Figure 47. The letters in the risk cubes refer to the risks outlined in the previous section.

b) Alternative 1 Risk Profile

Alternative 1 deals with the interconnection between the Fire Scout CS and the LCS CIC, so many of the risks dealt with this integration, but also addressed the need for additional manning resources, system upgrades, software modification, and availability of the LCS for upgrade and modification. Figure 45 shows the risk profile for Alternative 1.

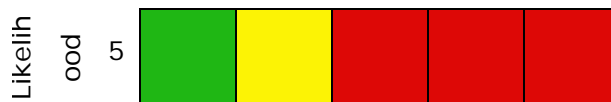

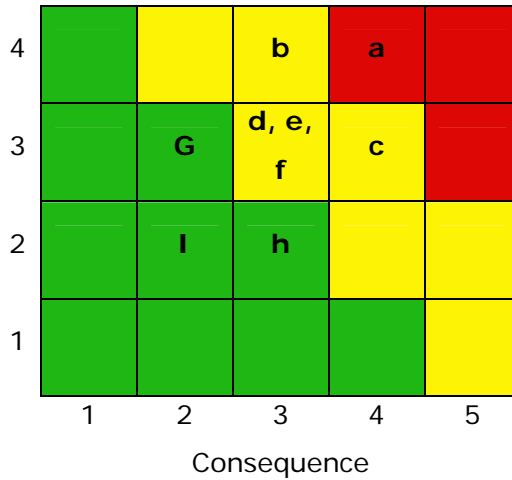

Figure 44: Alternative 1 Risk Profile

c) Alternative 2 Risk Profile

Alternative 2 handles the functional upgrade to provide simultaneous communications links from the LCS to the MH-60 and the LCS to the Fire Scout. The risk profile for Alternative 2 addresses many of the same risks as for Alternative 1, but also focuses on the physical changes required to support this functionality. Figure 46 presents the risk profile for Alternative 2.

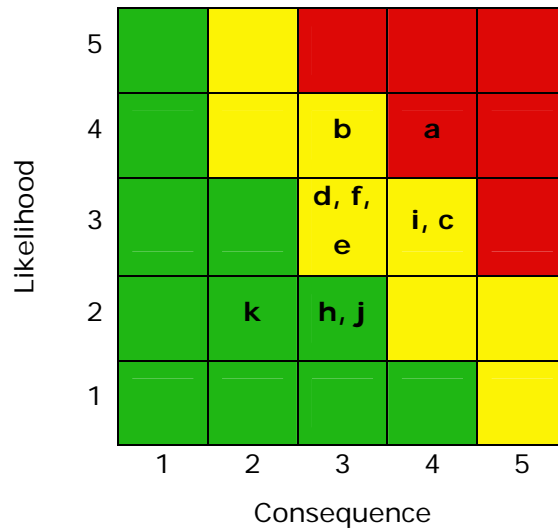

Figure 46: Alternative 2 Risk Profile

d) Alternative 3 Risk Profile

The risk profile for Alternative 3 is differentiated from the risk profiles of Alternative 1 and 2 because by emphasis on aircraft modification. Although Alternative 3 shares some risks with the other alternatives it addresses many more concerns that come with adding functionality to the air platforms and their communication systems. Figure 47 shows the risk profile for Alternative 3.

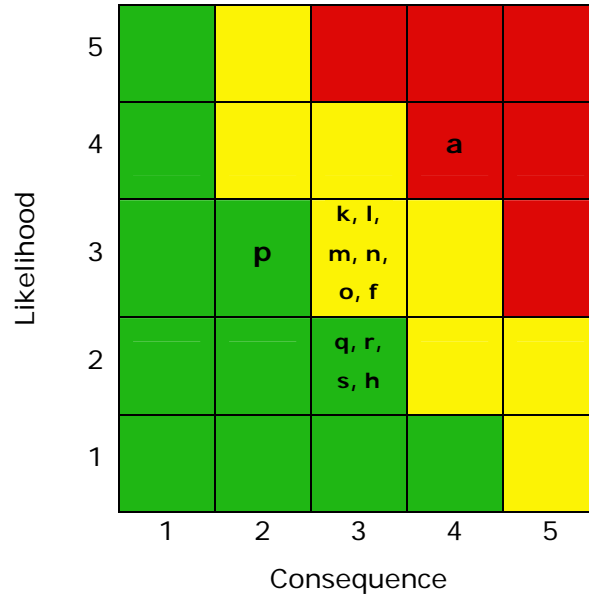

Figure 47: Alternative 3 Risk Profile

VI. CONCLUSIONS AND RECOMMENDATIONS

The goal of this research was to perform the Systems Engineering analysis required to determine whether *an integrated SOS of MH-60, Fire Scout and LCS, working on a shared COTP with enhanced data communications achieves a more effective solution defending the LCS or other HVA against SWARM threats*. The result was the development of a foundation, framework, architecture, and analysis of alternatives required to formulate a recommendation for an SOS alternative. The table below provides an overview of the results, which is described in greater detail in following paragraphs. The data below shows the comparative rank between the 3 alternatives.

Alternative	Effectiveness	Cost	Risk
1. Fire Scout Control Station to CIC link	1	1	1
2. 2 nd TCDL Channel	3	2	2
3. Sensor and Control Link between Fire Scout and MH-60	2	3	3

The research determined three separate opportunities existed to improve the decision-making time. These opportunities were subsequently defined as SOS alternatives. First, the Fire Scout sensor data (video) was data-linked to the Fire Scout CS on the LCS. The FSCS was not connected to the CIC on the LCS, so there was no convenient way to get the Fire Scout sensor data to the decision makers in CIC. Alternative 1 addressed improvements to the LCS to accommodate electronic passage and distribution of data within the LCS, providing “more” and “faster” data to the decision makers.

Another limiting factor in the communication chain was that there was only one TCDL channel in use on LCS, even though there were two channels available. The MH-60R helicopter had a Hawk Link that is compatible with the standard CDL message structure, whereas the Fire Scout was equipped with TCDL, based on the standard CDL. Currently, only one aircraft can send sensor data to the LCS down the TCDL data link. (Further, only one of the LCS ship configurations has two data link antennas. The other has only one antenna, and thus is only capable of a half-duplex link between the two aircraft.) Given the opportunity to employ existing data links, Alternative 2 addressed opening up both TCDL channels so that sensor data from both aircraft can be monitored simultaneously. Opening up both TCDL channels on the LCS again provided “more” and “faster” data to the decision makers. Also, since the MH-60R is currently the only

MH-60 in the inventory with a CDL-compatible data link and is planned to deploy from the LCS, it became a focal point for our analyses.

The third and final alternative investigated was to provide Fire Scout sensor data to the MH-60 helicopter to support sensor fusion, and to provide control of the Fire Scout sensor system by the MH-60. This approach would allow the MH-60 the capability to merge Fire Scout sensor data with on-aircraft data, and provide a more complete picture for making tactical decisions. This approach would require integration of the Fire Scout and MH-60 via data links. Potential implementation, for example may entail TCDL data link onboard the MH-60R to accommodate reception of the Fire Scout sensor data, re-transmission of that data to the LCS, or fusion of the Fire Scout data with MH-60R data for transmission to the LCS. It would also necessitate installation of FSCS components and applications on the MH-60R for control of the sensor suite. This approach provided “more”, “better”, and “faster” data to the decision makers, and also allowed the Fire Scout and MH-60 to work together when prosecuting a threat by using cooperative tactics.

The project employed both an Excel model and the Naval Simulation System (NSS) model to simulate the aforementioned alternatives, using time estimates for the steps in the decision chain. The SOS baseline performance was modeled first for comparison with each of the three alternatives. The Excel model indicated that Alternative 3 would provide the greatest improvement on the key metric, “Time to Identify.” Interestingly, the NSS model did not yield the same results. The differences in outcomes was analyzed and led to the conclusion that the NSS model was not created with the necessary fidelity to accurately capture the parameters of the mission scenario. The finding that warfare analysis models must be purpose-built for systems engineering analysis, by carefully defining the format and content of input and output parameters for the systems, scenarios and architectures, is an important lesson learned for the systems engineering process and further research. With additional time (and funding), the NSS model could be modified to better reflect the system engineering concerns and yield more informative and practical results. For example, the NSS model should be redesigned to support combining the effects of implementing more than one alternative.

To ensure the research and analysis of alternatives activities support stakeholder interests and future program decision-making, the project created a Work Breakdown Structure and defined the tasks required to implement each of the alternatives as a stand-alone effort. A parametric cost estimates was performed to create a “bang for the buck” assessment of the alternative. A high-level risk assessment was performed to categorize and quantify risks associated with each alternative. Collectively, the research addressed effectiveness of alternatives and provided a framework for assessment of cost, risk and performance impacts.

The project concluded that Alternative 1, linking the FSCS and CIC directly via data link onboard the LCS would provide the best “bang for the buck” to improve overall mission effectiveness through improved interoperability. This alternative was the least complex compared to the others, in terms of physical and functional integration. It was also, therefore, brought the least risk and cost to a solution for the original requirements.

Within the limits of the modeling assumptions and mechanics, the NSS model results indicated that Alternative 2, enabling the second TCDL channel on the LCS ship, would provide the greatest effectiveness. Taken together, the research outcomes provide an important systems engineering insight that indicates an additive, incremental approach for implementing the three leading alternatives may be feasible and the optimal way to meet the requirements while evolving manning concepts, tactics and training for SOS operations between manned and unmanned assets. Each alternative could be pursued separately, but the combination of Alternative 1 and 2 may address not only the mission in focus, LCS defense against a swarm of small boats, but also provide a robust solution for improved interoperability and effectiveness across multiple missions. Modeling and analysis of cumulative effects may confirm that it would be more beneficial to implement Alternative 1 prior to or in conjunction with Alternative 2, as opposed to only Alternative 2. The same is true for the combined effects associated with Alternatives 1 and 3. Alternative 3 presented the highest cost and technical risk, but could also ultimately achieve the greatest interoperability improvement as mission planning methods and tactics are developed. Currently, there is very little operational experience with the Fire Scout operating from a small ship such as the LCS, but as more experience is gained, greater utilization of the Fire Scout capabilities as a stand-alone aircraft, and eventually

as an interoperable asset, will be achieved. This will open the doors for development of new missions and tactics. The foundation that has been laid by this research supports development of these future capabilities.

B. FINDINGS SUMMARY

As previously indicated, several issues associated with the NSS model impacted confidence in the results of the analysis of alternatives. Below are several areas where the model could be changed to provide more information results supporting the SE approach.

- The tactical situation chosen for analysis addressed a small boat swarm attack in a choke point, such as the Straits of Hormuz. The NSS model, while showing the landmasses in its output presentation, actually simulated the scenario as if it was an open-ocean, blue-water scenario. This is a limitation of the way the model was constructed, and came about as a result of using parts of a previously developed model. This yielded a less realistic geometry for the location and distribution of targets.
- The model did not address the historical retention of targets once they had been “visited” by either the MH-60 or the Fire Scout. This allowed, and in some cases necessitated, multiple visits during the simulation run, which extended the scenario time.
- The model did not take into account either the geometry of the target layout, or a prioritization of targets other than “which one is closest to the HVA”. This led to significant “traverse time” where one air vehicle was criss-crossing over the HVA to go from one near-target to another, as opposed to designing in the assignment of a region of interest for each air vehicle to address. Additionally, the NSS model did not account for the use of a search pattern, such as a ladder search, which could optimize the effectiveness of the air vehicle when finding targets.
- The model was not designed to support the cumulative effects associated with the employment of both Alternatives 1 and 2, or 1, 2, and 3 in combination. To realize the full potential benefit of Alternative 2 (dual TCDL channels), Alternative 1 (communication link between the FSCS and CIC) may also be

required. By combining these alternatives, even greater interoperability improvements may be achieved than by incorporating either alternative as a stand-alone effort.

It is for the aforementioned reasons that the results of the NSS model simulation came into question during the analysis of alternatives. The results did not correlate with the “back of the envelope” calculations run in Excel, and did not make logical sense when the Time To Identify MOE actually increased even though more channels of communication were opened to support faster decision making. Below are listed additional changes that could be made to the model to make it more realistic in the given scenario.

- Account for AIS data from benign shipping vessels. The AIS system was mandated for shipping vessels greater than 300 metric tons, and provides data such as ship name, country and port of origin, location, speed, direction, cargo, etc. The Fire Scout has an AIS receiver system integrated into its sensor suite, which would allow the CS to coordinate with CIC to determine which of the targets could be ignored in a high-intensity situation.
- Account for RADAR return data, such as ship size, to eliminate candidate targets from consideration. The LCS, Fire Scout, and MH-60R all have advanced RADAR systems that can account for the size of a ship, and in SAR mode, could even generate a detailed scan of the structure allowing profile identification. This factor was not taken into account in the model, but surely would be during a real-world situation, again minimizing the number of targets to be prosecuted.
- When the model was programmed, 65 targets were input, 25 of which were potential threats, the remaining 40 being commercial vessels ranging in size from pleasure craft to commercial fishing to container and large shipping vessels. Had the available sensor data (RADAR and AIS) been used as a discriminator, the target population may have been significantly reduced to threats more quickly. Had this data been used to formulate a coordinated prosecution plan within the model, using target characteristics such as proximity, speed, size, etc., a more realistic and coordinated investigative approach could have been developed to classify and identify these potential threats. Threat identification is an extremely

difficult process to model, as real-world threat identification requires visual identification and observation. It is also difficult to model because the programming is complex, and generally revolves around a single threat characteristic or activity, and in the real world, variations on attack methods and concentration of assets are used which would make modeling extremely difficult, requiring substantial hardware, software, funding, and time to complete. This makes it well outside the scope of this particular project.

All of the above issues could be addressed to create a higher fidelity model, potentially providing better data to the Program Managers. Additional topics for follow-on work are provided below.

C. RECOMMENDED FOLLOW ON WORK

The following section provides summary recommendations for follow-on efforts that could leverage the research, findings and artifacts from this project to benefit future interoperability solution and UAS- fleet integration.

1. Use an Engagement Model for Mission Phase 3

An area of analysis that could not be addressed in our model was the “end game” where targets identified as threats would be prosecuted with either non-lethal or lethal means. This effort required definition of tactics, ROE, analysis of weapons (including weapon-target pairing and stand-off range), and the decision chain required to support direct action. Recommend detailed engagement modeling to explicitly assess the link between interoperability and engagement metrics, such as probability of kill.

2. Rebuild the NSS Model to Combine SOS Alternatives for Assessment of Cumulative Effectiveness

As previously stated, the model was not designed to support the cumulative effects associated with the employment of both Alternatives 1 and 2, or 1, 2, and 3. The research

findings led to the observation that it may not be beneficial to implement Alternative 2 (dual TCDL channels) without also implementing Alternative 1 (communication link between the FSCS and CIC) to integrate and exploit the airborne data. By combining these alternatives, greater interoperability improvements may be achieved than by incorporating either alternative as a stand-alone effort.

3. Use Experimentation or Live Demo to Confirm CONOPS.

Operational testing of Alternatives 1 and 2 could be performed as part of a Fleet Exercise at relatively low cost. One of the LCS ships already has two TCDL channels available, but only operates with one channel active. Providing a mini TCDL terminal to the MH-60R and doing a temporary ship alteration (SHIPALT) to open up the second TCDL channel, as well as wiring the FSCS video display into CIC could be with minimal time and cost impact to support a Fleet Exercise for the LCS ship deployed with both Fire Scout and MH-60R. This effort would require significant coordination, but could support a Fire Scout and MH-60 interoperability demonstration exercise that is currently scheduled for FY11.

4. Perform Statistical Analysis on Model Results

More detailed analysis of the model and simulation results is for an increased the level of confidence in the results that supports a resource decision. Recommend sensitivity analysis to ensure that the “Bang for the Buck” results are valid.

5. Perform Market Research to Refine the WBS for More Accurate Cost Estimation.

A WBS was developed for each alternative based on available and historical information. Additional coordination with the LCS ship community could clarify and optimize the baseline WBS, which could then lead to a more detailed cost analysis for Alternatives 1 and 2. Alternative 3 also requires optimization of the WBS, as well as market research on available communications systems that support the TCDL data formats (Alternative 3A) and subsystems that have increased number of UHF data channels to support control of the Fire Scout sensor suite (Alternative 3B). Definition of these systems (along with definition of their interface to parent aircraft systems and software) supports definition of the baseline WBS and would provide a more robust cost

estimate, one that provides an assessment of the probability of program success based on a given funding level, as opposed to a point estimate.

APPENDIX A – FUNCTIONAL DECOMPOSITION

Through the use of CORE, an EFFBD was created for specific Operational Activities and Functions. A simple, clear description of the information flows was essential to ensuring the completeness and accuracy of the system design going forward. The Operational Nodes and Operational Information needed to execute the operational activities, or functions, were identified through the development and use of an Information Exchange Requirements (IER) matrix and informal input/output trace diagrams. The functions were tied to Operational Nodes using the CORE “*performed by*” relationship, and Operational Information was related with inputs, outputs, and “*triggered by*” relationships. (An important feature of the CORE tool, when developing an architecture, is the embedded schema for defining relationships within the model.^[29] While this feature highly constrains the definition of architecture component interactions and data/information exchanges, it also ensures consistency and ease of use, stabilizing the application of architecture modeling and analysis for the SE process.) Interface definition and management concerns for this project include:

- Defining and establishing interface specifications
- Identifying preferred and discretionary interface standards
- Providing justification for selection of interface standards
- Understanding the certifications and tests applicable to each interface or standard.
- Developing functional and physical architectures
- Supporting maintenance of system requirements and specifications over the life of the intended product, including reuse for future product upgrades and enhancements.

Through the MBSE approach and use of CORE, the project team gained critical insight into the interaction of all components. Together, MBSE and CORE provide a process and

tool for the generation of a complete, consistent, and executable systems design and specification. The following 48 (activity diagram) and Figure 49 (N2 diagram) provide samples of the CORE modeling efforts in the area of the “Discriminate Contacts” function, which help define and communicate the activities and information exchange requirements for this function.

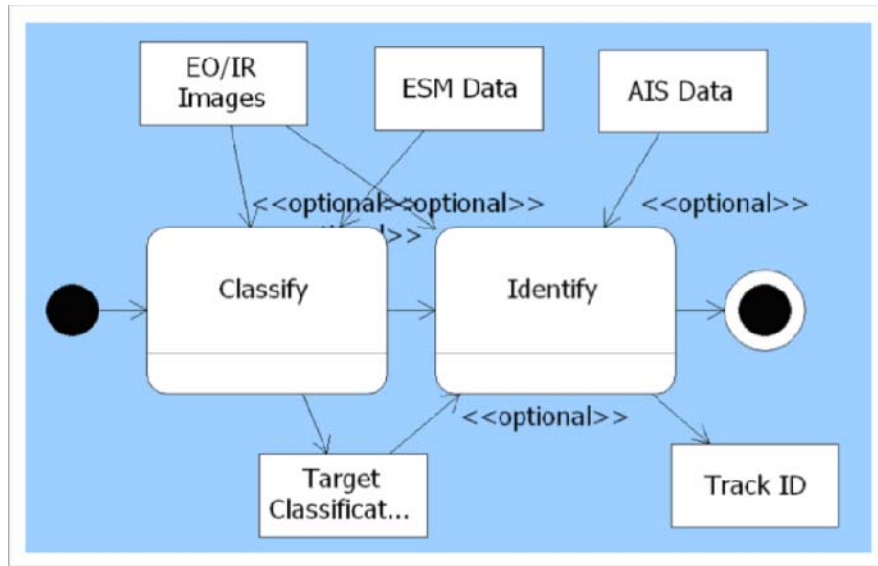

Figure 48: Activity Diagram (CORE) for 'Discriminate Contacts' Function

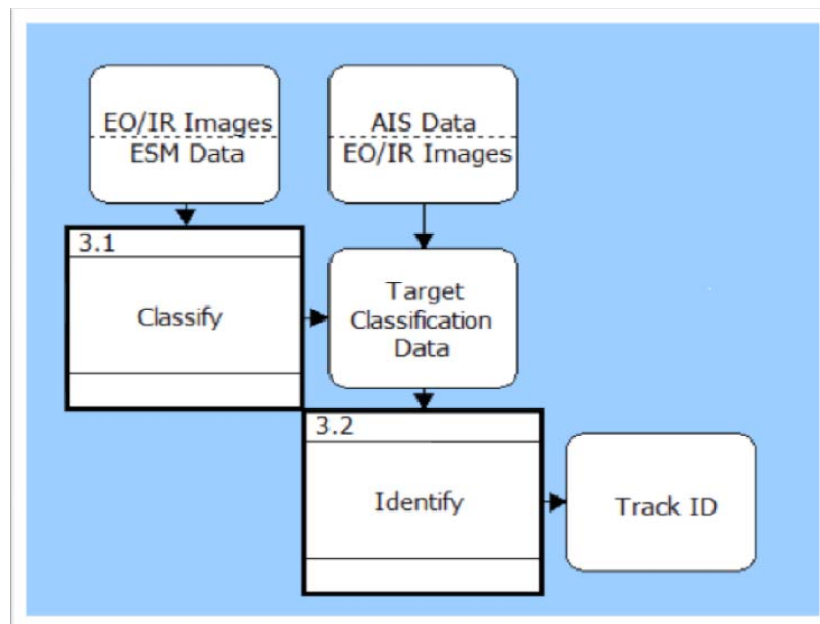

Figure 49: N2 Diagram (CORE) for 'Discriminate Contacts' Function

The functional architecture expressed the detailed functional, interface, and temporal aspects of the system that were essential to gain sufficient insight and to communicate unambiguously the behavior of the system in its intended operational environment. The development of a functional architecture and definition of system alternatives should evolve incrementally with stakeholder requirements and the physical architecture to ensure that the appropriate functions and interfaces are identified. This analysis may utilize structured or object oriented methods, or a combination thereof, along with associated and proven notations such as Integration Definition for Function Modeling (IDEF0), Enhanced Functional Flow Block Diagram (EFFBD), Department of Defense Architecture Framework (DODAF), and Systems Modeling Language (SysML) tools. It is anticipated that an automated tool such as CORE, by Vitech Corporation, will be utilized to assist in development and management of the system requirements and architecture products needed in support of the SE and acquisition processes.

For this project the Functional Architecture analysis and decomposition efforts provided the following system information:

- Description of the contributing systems' functionality, interfaces and interactions necessary to accomplish the mission scenario
- Existing and proposed system characteristics as a reference for modeling and analysis
- Entity Relationship Diagrams, Activity and Functional Flow Diagrams and N2 Diagrams used to specify integration / interoperability requirements

Artifacts produced through use of CORE and PowerPoint aided the project team in understanding the current systems configurations, capabilities (and capability gaps), as well as assisting in identification of viable alternatives for achieving increased interoperability in this mission area. Artifacts included:

- Activity diagrams
- N2 diagrams
- Sequence diagrams

- Preliminary Integrated Architecture (CORE Model)
- DoDAF views to include at minimum: OV-1, SV-5
- Information Exchange Requirements (IER) Diagrams
- Functional Flow Block Diagrams (FFBD)

A secondary objective of the project was to explore the use of architecture artifacts as direct input to the NSS modeling effort. The complexity of the two tools proved to make it difficult, and therefore prohibitive, to directly map SE artifacts into the M&S process for warfare effectiveness analysis. Regardless, the architecture developed in CORE is an artifact that can be re-used for SE follow-on work to benefit requirements engineering and management.

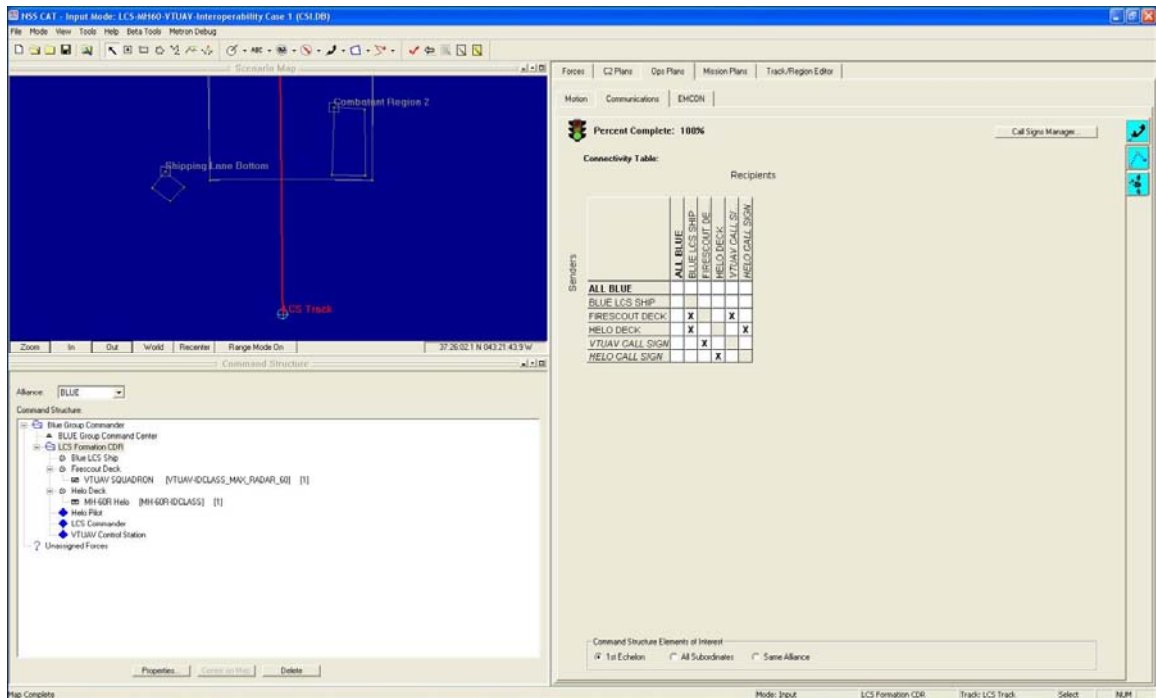

Figure B2: NSS Input Mode: Comms Passthrough

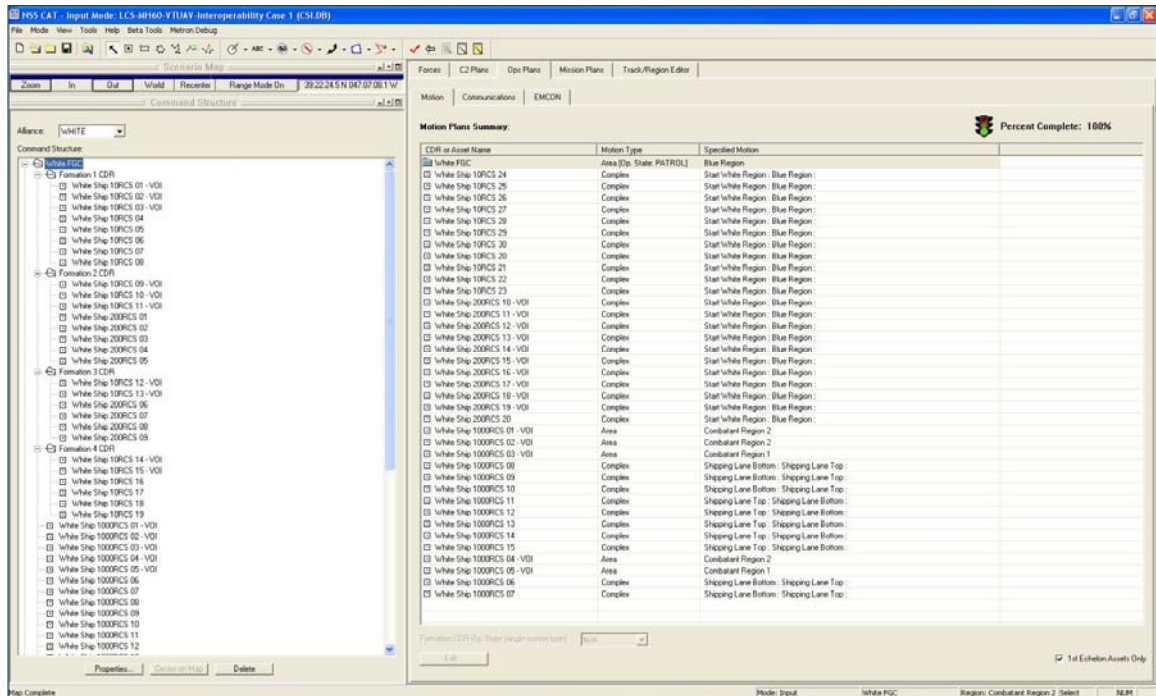

Figure B4: NSS Input Mode: Neutral Ships

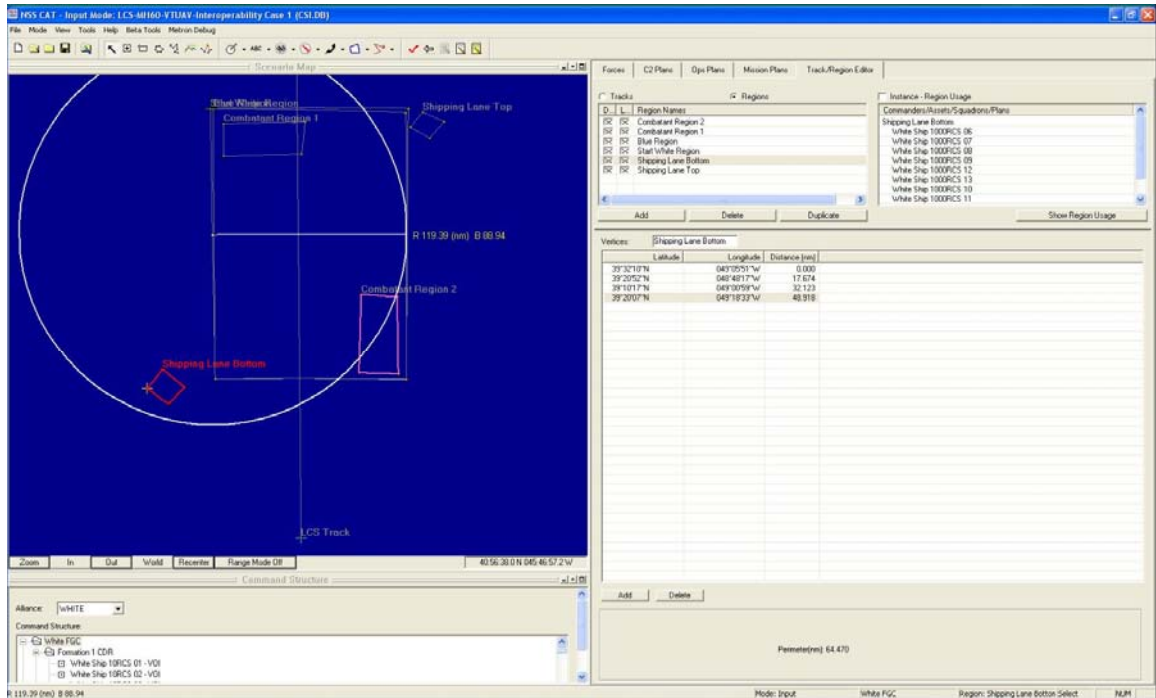

Figure B5: NSS Input Mode: Regions and Tracks

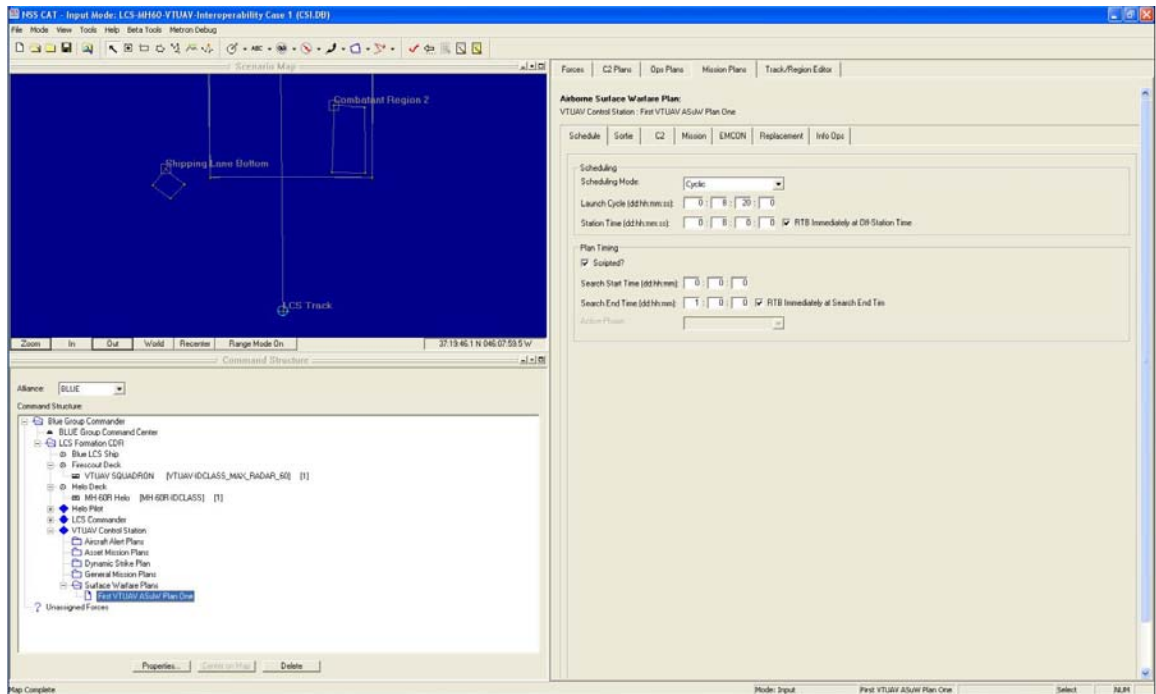

Figure B6: NSS Input Mode: Sortie Schedule

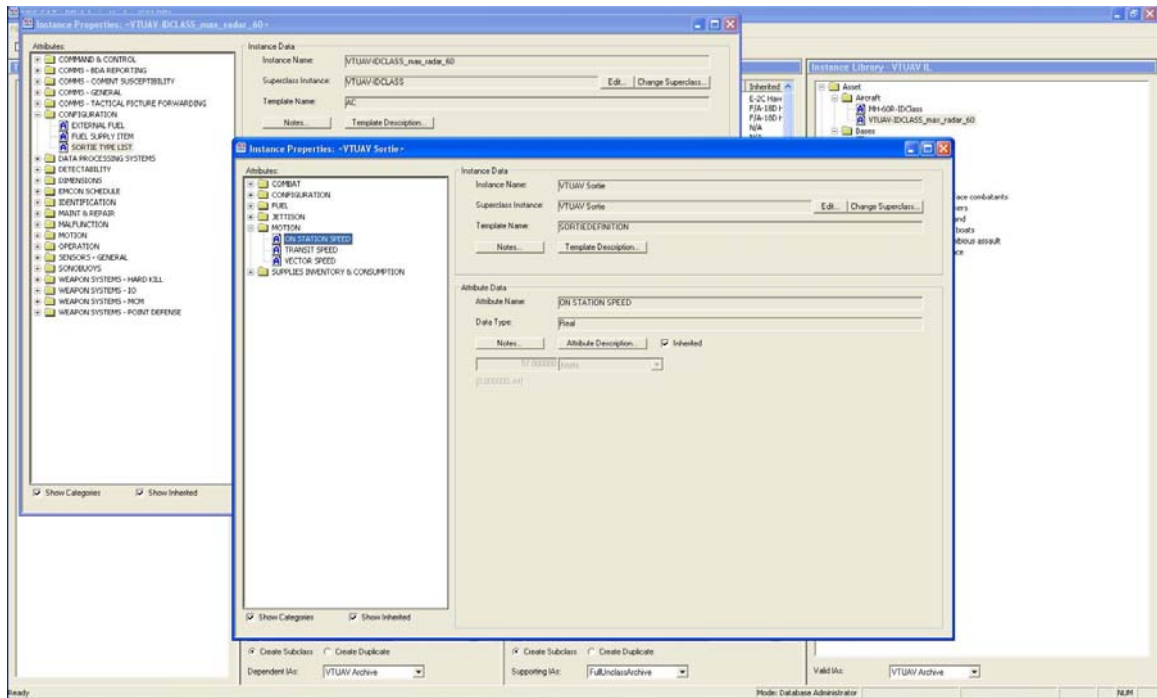

Figure B7: NSS Instance Properties: VTUAV

THIS PAGE INTENTIONALLY LEFT BLANK

REFERENCES

1. Strategic Studies Group XXVIII Way Ahead Plan: The Unmanned Opportunity, Naval War College, 9 January 2009.
2. Briefing: Naval Unmanned Air Systems Strategic Vision, Director Air Warfare (OPNAV N88) January 2009.
3. Briefing: Naval Unmanned Systems Way Ahead, RADM Bill Shannon, 11 January 2010.
4. PMA-299 Requirements Message, Robert Tourville, 2010
5. Requirements Meeting Minutes, 24 March 2010
6. Briefing: Helo CONOPS and VTUAV FFC Brief, Gary Leaman, 5 March 2010.
7. Naval Message, Naval Aviation Readiness Group POM Priorities. November 2009.
8. Joint Publication JP1-02. DOD Dictionary of Military and Associated Terms. 24 March 1994.
9. Sea Power 21: Projecting Decisive Joint Capabilities, Admiral Vern Clark, CNO, Proceedings of the Naval Institute, October 2002.
10. Universal Navy Task List (UNTL), OPNAV Instruction 3500.38A. 1 May 20012.
11. Navy Tactical Task List (NTTL) 3.0, 1 August 2004.
12. Navy Warfare Publication NWP 3-20, Navy Surface Warfare Manual, Edition January 2007.
13. The Engineering Design of Systems – Models and Methods. Dennis M. Buede. Wiley. 2009.
14. DOD Guidebook, DOD Architecture Framework, V 1.5
15. Systems Engineering and Analysis. Benjamin S. Blanchard, Wolter J. Fabrycky. Pearson Prentice Hall. 2006.
16. CJCSI 3170 Joint Capability Integration Development System
17. DOD Instruction, 5000.02. Operation of the Defense Acquisition System. 8 December 2008.

18. Briefing and Working Papers: “LCS SAG-Aviation Mix-Operations Assessment.” Systems Planning and Analysis, Inc. February 2008.
19. NATOPS Flight Manual: Navy Model MQ-8B Unmanned Air Vehicle, A1-MQ8BA-NFM-000, DRAFT, 16 July 2010.
20. NATOPS Flight Manual: Navy Model MH-60R Multi Mission Helicopter, A1-H60RA-NFM-000
21. MH-60R NATIP: NTRP3-22.4-MH-60R
22. NATOPS Flight Manual: Navy Model MH-60S Multi Mission Helicopter
23. NATO Standard for Command and Control of Unmanned Air Vehicles, STANG 4586, Edition 2
24. National Imagery Transmission Format. Military Handbook MIL-HDBK-1300A.
25. Military Display Symbology Standard. MIL-STD- 2500B.
26. L-3 Communications Adobe PDF pamphlet Multi-Role Tactical Common Data Link (MR-TCDL) – 3-Link ATE. 2007
27. L-3 Communications Adobe PDF pamphlet Mini TCDL Transceiver of 2007
28. Article: “Harris Completes Test of MMH-60R Helicopter Hawk Link Data Link.” ASD News. 1 May 2009
29. CORE 5.0 Model-Based Systems Engineering Software and User Manual. VITECH Corporation. 2009.

THIS PAGE INTENTIONALLY LEFT BLANK

INITIAL DISTRIBUTION LIST

1. Defense Technical Information Center
Ft. Belvoir, Virginia
2. Dudley Knox Library
Naval Postgraduate School
Monterey, California
3. Research and Sponsored Programs Office, Code 41
Naval Postgraduate School
Monterey, California
3. Commanding Officer
PMA-266
NAVAL AIR SYSTEMS COMMAND
22707 Cedar Point RD
Patuxent River, MD 20670
4. Department of the Navy
Office of the Chief of Naval Operations
Code N88
2000 Navy Pentagon
Washington, D.C. 20350-2000
5. Commanding Officer
PMA-299
NAVAL AIR SYSTEMS COMMAND
Patuxent River, MD 20670