



2011-09

# Evaluation of HRI payloads for rapid precision target localization to provide information to the tactical warfighter

Miller, Glenn A.

Monterey, California. Naval Postgraduate School

---

<http://hdl.handle.net/10945/5512>



Calhoun is a project of the Dudley Knox Library at NPS, furthering the precepts and goals of open government and government transparency. All information contained herein has been approved for release by the NPS Public Affairs Officer.

**Dudley Knox Library / Naval Postgraduate School**  
**411 Dyer Road / 1 University Circle**  
**Monterey, California USA 93943**

<http://www.nps.edu/library>



**NAVAL  
POSTGRADUATE  
SCHOOL**

**MONTEREY, CALIFORNIA**

**THESIS**

**EVALUATION OF HRI PAYLOADS FOR RAPID  
PRECISION TARGET LOCALIZATION TO PROVIDE  
INFORMATION TO THE TACTICAL WARFIGHTER**

by

Glenn A. Miller

September 2011

Thesis Advisor:

Kevin Jones

Second Reader:

Ray Buettner

**Approved for public release; distribution is unlimited**

THIS PAGE INTENTIONALLY LEFT BLANK

REPORT DOCUMENTATION PAGE			Form Approved OMB No. 0704-0188
Public reporting burden for this collection of information is estimated to average 1 hour per response, including the time for reviewing instruction, searching existing data sources, gathering and maintaining the data needed, and completing and reviewing the collection of information. Send comments regarding this burden estimate or any other aspect of this collection of information, including suggestions for reducing this burden, to Washington headquarters Services, Directorate for Information Operations and Reports, 1215 Jefferson Davis Highway, Suite 1204, Arlington, VA 22202-4302, and to the Office of Management and Budget, Paperwork Reduction Project (0704-0188) Washington DC 20503.			
1. AGENCY USE ONLY (Leave blank)	2. REPORT DATE September 2011	3. REPORT TYPE AND DATES COVERED Master's Thesis	
4. TITLE AND SUBTITLE Evaluation of HRI Payloads for Rapid Precision Target Localization to Provide Information to the Tactical Warfighter		5. FUNDING NUMBERS	
6. AUTHOR(S) Glenn A. Miller		8. PERFORMING ORGANIZATION REPORT NUMBER	
7. PERFORMING ORGANIZATION NAME(S) AND ADDRESS(ES) Naval Postgraduate School Monterey, CA 93943-5000		10. SPONSORING/MONITORING AGENCY REPORT NUMBER	
9. SPONSORING /MONITORING AGENCY NAME(S) AND ADDRESS(ES) N/A		11. SUPPLEMENTARY NOTES The views expressed in this thesis are those of the author and do not reflect the official policy or position of the Department of Defense or the U.S. Government. IRB Protocol number __NA__	
12a. DISTRIBUTION / AVAILABILITY STATEMENT Approved for public release; distribution unlimited		12b. DISTRIBUTION CODE A	
13. ABSTRACT (maximum 200 words) High Resolution Imagery (HRI) with precise location and targeting data for the warfighter has become an integral part in today's asymmetric warfare environment. This thesis conducted practical testing of systems and employed qualitative research methods to evaluate HRI payloads for SUAS to provide rapid precision target localization to the warfighter. The research attempted to evaluate new HRI systems integration with the current SUAS's to produce accurate or reduced error images for intelligence and targeting data. The targeting solutions were to be evaluated against those calculated solutions achieved on a manned aircraft. This part of the evaluation was not completed due to the discovery of radio frequency noise interference induced by systems modifications required to fit the small confines of the SUAS platform. Targeting solution research was conducted using archival images from a manned flight mission. Once the system and technology is modified to eliminate the radio frequency noise there is a high probability of successfully proving the desired capability.			
14. SUBJECT TERMS Unmanned Aerial Vehicles, High Resolution Payloads, Targeting, RF Noise		15. NUMBER OF PAGES 77	
		16. PRICE CODE	
17. SECURITY CLASSIFICATION OF REPORT Unclassified	18. SECURITY CLASSIFICATION OF THIS PAGE Unclassified	19. SECURITY CLASSIFICATION OF ABSTRACT Unclassified	20. LIMITATION OF ABSTRACT UU

THIS PAGE INTENTIONALLY LEFT BLANK

**Approved for public release; distribution is unlimited**

**EVALUATION OF HRI PAYLOADS FOR RAPID PRECISION TARGET  
LOCALIZATION TO PROVIDE INFORMATION TO THE TACTICAL  
WARFIGHTER**

Glenn A. Miller  
Lieutenant, United States Navy  
B.S., Information Technology, University of Phoenix, 2004

Submitted in partial fulfillment of the  
requirements for the degree of

**MASTER OF SCIENCE IN INFORMATION WARFARE SYSTEMS  
ENGINEERING**

from the

**NAVAL POSTGRADUATE SCHOOL  
September 2011**

Author: Glenn A. Miller

Approved by: Dr. Kevin Jones  
Thesis Advisor

Dr. Raymond Buettner  
Second Reader

Dr. Dan C. Boger  
Chair, Department of Information Sciences

THIS PAGE INTENTIONALLY LEFT BLANK

## **ABSTRACT**

High Resolution Imagery (HRI) with precise location and targeting data for the warfighter has become an integral part in today's asymmetric warfare environment. This thesis conducted practical testing of systems and employed qualitative research methods to evaluate HRI payloads for SUAS to provide rapid precision target localization to the warfighter. The research attempted to evaluate new HRI systems integration with the current SUAS's to produce accurate or reduced error images for intelligence and targeting data. The targeting solutions were to be evaluated against those calculated solutions achieved on a manned aircraft. This part of the evaluation was not completed due to the discovery of radio frequency noise interference induced by systems modifications required to fit the small confines of the SUAS platform. Targeting solution research was conducted using archival images from a manned flight mission. Once the system and technology is modified to eliminate the radio frequency noise there is a high probability of successfully proving the desired capability.



THIS PAGE INTENTIONALLY LEFT BLANK

# TABLE OF CONTENTS

<b>I.</b>	<b>INTRODUCTION.....</b>	<b>1</b>
<b>A.</b>	<b>PURPOSE.....</b>	<b>2</b>
<b>B.</b>	<b>THE INITIAL PROBLEM SET .....</b>	<b>2</b>
<b>C.</b>	<b>OTHER TESTS WITH SUAS TO CONDUCT HRI .....</b>	<b>3</b>
	<b>1. Naval Special Warfare Command HRI Test.....</b>	<b>3</b>
	<b>2. Pennsylvania State Electro-Optics Center Test (TNT 11–2) and         Orthorectification .....</b>	<b>4</b>
	<i>a. Orthorectification.....</i>	<i>5</i>
<b>D.</b>	<b>TYPES OF UAVS AND USE OF HRI FOR TARGET LOCALIZATION.....</b>	<b>7</b>
	<b>1. The NPS Rascal 110 SUAS.....</b>	<b>8</b>
<b>E.</b>	<b>THE NAVSYS GBO HRI PAYLOAD.....</b>	<b>9</b>
<b>F.</b>	<b>NAVSYS GBO HRI PAYLOAD MODIFIED FOR THE RASCAL SUAS .....</b>	<b>11</b>
	<b>1. The System Component Layout .....</b>	<b>12</b>
<b>G.</b>	<b>NAVSYS WEBGRIM GEO-REFERENCED IMAGE MANAGER.....</b>	<b>13</b>
	<b>1. WebGRIM Data Display .....</b>	<b>14</b>
	<b>2. WebGRIM Data Fusion .....</b>	<b>15</b>
	<b>3. WebGRIM Architecture .....</b>	<b>16</b>
<b>II.</b>	<b>TARGETING WITH IMAGES FROM MANNED AIRCRAFT TESTS OF THE NAVSYS GBO PAYLOAD AND WEBGRIM.....</b>	<b>19</b>
<b>A.</b>	<b>TARGETING OPTIONS AND MAP GEO-POSITIONING .....</b>	<b>20</b>
	<b>1. CoT/XML.....</b>	<b>21</b>
	<b>2. Imagery Combined with GBO Range.....</b>	<b>22</b>
	<b>3. UAS Imagery Combined with Precision DTED Coordinates.....</b>	<b>24</b>
	<b>4. Multiple Image Point Targeting .....</b>	<b>25</b>
<b>B.</b>	<b>TARGETING ARCHITECTURE .....</b>	<b>28</b>
	<b>1. Simulated Targeting using WebGRIM.....</b>	<b>29</b>
	<b>2. Targeting with GBO Range Coordinates and SIG .....</b>	<b>31</b>
	<b>3. Multiple Image Geo-Positioning (MIG).....</b>	<b>34</b>
<b>C.</b>	<b>FUTURE TESTING OF THE HRI PAYLOAD ON AN SUAS.....</b>	<b>37</b>
	<b>1. Advantages and Benefits .....</b>	<b>37</b>
	<b>2. Limitations.....</b>	<b>38</b>
<b>III.</b>	<b>RF NOISE INTERFERENCE ON GPS COMPONENTS.....</b>	<b>41</b>
<b>A.</b>	<b>ANTENNA NOISE INTERFERENCE ON THE GPS MODULE OBSERVATIONS.....</b>	<b>42</b>
	<b>1. Interference from Digital Coupling.....</b>	<b>44</b>
	<b>2. Electrical Noise.....</b>	<b>45</b>
	<b>3. Flicker or 1/f Noise.....</b>	<b>45</b>
<b>B.</b>	<b>GPS SIGNAL VULNERABILITIES .....</b>	<b>46</b>
<b>C.</b>	<b>SUAS GPS JAMMING VULNERABILITY .....</b>	<b>47</b>

D.	ANTI JAMMING SOLUTIONS AND TECHNIQUES.....	49
IV.	RECOMMENDATIONS AND CONCLUSION.....	53
A.	CONCLUSIONS .....	53
B.	RECOMMENDATIONS.....	54
	LIST OF REFERENCES.....	55
	INITIAL DISTRIBUTION LIST .....	57

## LIST OF FIGURES

Figure 1.	Original Image (From Bockius, 2010).....	6
Figure 2.	Orthorectified Image (From Bockius, 2010) .....	6
Figure 3.	Rascal 110 Research Aircraft (From Jones, 2011) .....	9
Figure 4.	UAS Target Location Technology for Ground Based Observers (TLGBO) Prototype Payload (From Brown, 2010).....	10
Figure 5.	NAVSYS SUAS Modified GBO Payload (right side view).....	11
Figure 6.	NAVSYS SUAS Modified GBO Payload (left side view).....	12
Figure 7.	One image/second time-sorted Imagery (From Bockius, 2010).....	14
Figure 8.	WebGRIM Architecture (From Brown, 2010) .....	17
Figure 9.	Image Footprints covering the selected target area.....	20
Figure 10.	Targeting Support Concept (From Brown, 2010).....	21
Figure 11.	Imagery and GBO Range (From Brown, 2010).....	23
Figure 12.	WebGRIM UAS Imagery + GBO Range (From Brown, 2010) .....	23
Figure 13.	Image Combined with Precision DTED (From Brown, 2010).....	24
Figure 14.	WebGRIM UAS Imagery Combined with Precision DTED .....	25
Figure 15.	Multiple Image Point Targeting (From Brown, 2010).....	26
Figure 16.	WebGRIM Multiple Image Point Targeting (From Brown, 2010).....	27
Figure 17.	Current GBO Targeting Architecture (From Brown, 2010).....	28
Figure 18.	GBO/UAS Hybrid Targeting Architecture (From Brown, 2010).....	29
Figure 19.	WebGRIM Map View.....	30
Figure 20.	Filter Layer displaying the Tour chosen for the simulation.....	31
Figure 21.	Simulated Strikelink Coordinates sent to WebGRIM.....	32
Figure 22.	Single Image Geopositioning (SIG) on the target.....	33
Figure 23.	Non-orthorectified image on WebGRIM.....	34
Figure 24.	MIG display with TLE of 4.5 meters.....	36
Figure 25.	Screenshot of GC13 Corner Gazebo with surveyed truth locations .....	38
Figure 26.	Composition of the GPS Signals .....	42
Figure 27.	NAVSYS SUAS Modified Payload (rear view).....	43
Figure 28.	GPS Gold Spreading Codes (From Sklar, 2009) .....	51

THIS PAGE INTENTIONALLY LEFT BLANK

## LIST OF TABLES

Table 1.	Data Collection Statistics (From Kiser, 2011).....	7
Table 2.	Specifications of the Stock Rascal ARF 110 .....	9
Table 3.	DTED Levels and Post Spacing Accuracy .....	16

THIS PAGE INTENTIONALLY LEFT BLANK

## LIST OF ACRONYMS AND ABBREVIATIONS

AGL	Above Ground Level
API	Applicable Programming Interface
CE	Circular Error (the two dimensional error)
COT	Cursor-on-Target
DDL	Digital Data Link
DEM	Digital Elevation Model
DGPS	Differential GPS
DoD	U.S. Department of Defense
DPPDB	Digital Point Precision Database
DPSS	Digital Precision Strike Suite
DTED	Digital Terrain Elevation Data (a DoD type of DEM)
DSMAC	Digital Scene Matching Area Correlation
EO	Electro-Optics
GBO	Ground-Based Observer
GCS	Ground Control Station
GI-Eye	A NAVSYS GPS/INS/Camera collection payload
GPS	Global Positioning System
HRI	High Resolution Imagery
IMU	Inertial Measurement Unit
INS	Inertial Navigation System
ISR	Intelligence Surveillance and Reconnaissance
LE	Linear Error (the vertical component of error)
MGRS	Military Grid Reference System
NOAA	U.S. National Oceanic and Atmospheric Administration
OGC	Open Geospatial Consortium
OTH	Over the Horizon
PSS-SOF	Precision Strike Suite for Special Operations Forces
RF	Radio Frequency
SUAS	Small Unmanned Aerial System
TERCOM	Terrain Contour Matching



TLAM	Tomahawk Land Attack Missile
TLE	Total Linear Error (CE + LE)
TLGBO	Target Location Technology for Ground Based Observers
UAS	Unmanned Aerial System
UAV	Unmanned Aerial Vehicle
WebGRIM	Web-based Geo-Referenced Image Manager
WMS	Web Map Service (an OGC standard)
XML	Extensible Markup Language

## **EXECUTIVE SUMMARY**

This thesis evaluated the NAVSYS Corporation High Resolution Imaging (HRI) Payload called “GI-Eye.” Information from a manned aircraft test of the system worked well in conjunction with their WebGRIM program. Precise location and targeting data for the warfighter was calculated that demonstrate the potential for the payload to become an invaluable asset. Furthermore when installed on a Small Unmanned Aerial System (SUAS) it can be deployed as an organic tactical asset to the warfighter.

The research demonstrated that imagery from an HRI payload such as GI-Eye can change the entire targeting architecture to improve accuracy of the targeting solutions. The captured images can be linked in real time to the WebGRIM server where a Ground Based Observer (GBO) or operator can add information from truth surveyed locations, DTED, or use multiple images to produce precise targeting data for distant fire support teams.

The GI-Eye Payload was hampered by RF noise interference resulting from modifications to fit within the small confines of a SUAS, specifically the Rascal 110. This prevented further testing of the system onboard an SUAS. Testing and research can continue when all the system noise problems are resolved. The probability of the issues being resolved is doubtful at this time.

The overall objective to determine whether an HRI payload onboard an SUAS system can be used as an organic asset and provide suitable real time over-the-horizon (OTH) intelligence and targeting information was only partially answered via the manned aircraft test. If the RF noise issue is resolved the testing on the SUAS can proceed and the technology promises dramatic improvements in the TLE for tactical units. Other issues that need to be evaluated are the image stabilization due to the higher roll rates expected on a SUAS, connectivity with the aircraft, and target location accuracy calculations.

THIS PAGE INTENTIONALLY LEFT BLANK

## **ACKNOWLEDGMENTS**

I would like to thank my wife and son for their continuous support and patience throughout my educational studies at the Naval Postgraduate School and during the process of creating this thesis.

I would also like to thank Dr. Kevin Jones and Dr. Ray Buettner for their assistance both as a professor and as a thesis advisor. This thesis would not have been completed without their guidance.

Lastly, I would like to say thanks to everyone from NAVSYS Corporation for their assistance and the system information they have shared with me. Bruce Bockius deserves a special mention, once again thank you for taking the time during several occasions and numerous hours for the training on WebGRIM program.

THIS PAGE INTENTIONALLY LEFT BLANK

## I. INTRODUCTION

The use of Unmanned Aerial Vehicles (UAVs) has been prevalent in the global war on terror and their use will only continue to increase in the foreseeable future. These UAVs have been used in military applications for intelligence surveillance, and reconnaissance missions (ISR), and more recently for target localization in armed strike missions. Research and development in the use of UAVs for targeting and its seemingly limitless possibilities for both military and commercial applications will also continue to endure. UAVs undeniably remove people from performing dangerous missions and their use for the most part is less politically sensitive than placing actual military or civilian personnel on the ground. Furthermore, the significant defense funding for UAVs proves that the research and development in these technologies including the use of UAVs for targeting purposes are very important to the Department of Defense (DoD).

One significant area with potential is the continued research into the development of payloads to provide High Resolution Imagery (HRI) for targeting, in particular reducing their sizes so that they can be utilized in an SUAS as an organic asset by the warfighter in a tactical environment. Technology maturation in this area will enable a SUAS to have the capability to acquire HRI that can provide near real-time and accurate targeting data that can be rapidly used by the warfighter or a ground based observer (GBO) as actionable intelligence for strike missions and other ISR purposes. This capability will ultimately become an essential piece for the warfighter since it can provide targeting solutions and at the same time be an organic OTH reconnaissance platform. The idea is wide-ranging since the use of HRI payloads on larger UAVs has already increased considerably in recent years due to their greater availability and due to the miniaturization of sensors (Laliberte, 2010). Reducing the size, weight, and adding the benefit of safety from a distance with HRI targeting solutions that can be applied to an organic UAV asset is the motivation for this thesis. A GBO for this research will be defined as an observer on the ground equipped with a laser range finder and a line of sight to the target.

## **A. PURPOSE**

The purpose of this thesis is to explore the potential for a small unmanned aerial system (SUAS) to provide HRI that can be used to provide accurate and near real-time targeting information to the warfighter and be utilized as a vital organic tactical asset. The research will evaluate the NAVSYS Corporation developed HRI Payload also called a GBO Payload for both a manned and small unmanned aircraft to determine if accurate targeting data can be acquired from each platform and compared between the two platforms. The experiment will also examine the web-based Geo-Referenced Image Manager (WebGRIM) to determine if it can provide real time access to the collected imagery from the SUAS and provide accurate targeting solutions. The Radio Frequency (RF) noise factor will also be analyzed since it was discovered that the noise interference become a significant factor in the overall performance of the HRI payload. During the pre-testing phase of the system the RF noise produced by the system disrupted the operation of the GPS module and prevented its testing on a SUAS.

## **B. THE INITIAL PROBLEM SET**

One of the main issues in today's battle space is getting accurate targeting data from organic assets that can be relayed for kinetic strikes to coordinate fire support from a distance. NAVSYS Corporation modified their HRI payload (GBO Payload) for use on an SUAS and together with the imagery targeting solutions calculated from their WebGRIM program is attempting to answer the challenge.

The following is a list of current issues as determined by NAVSYS Corporation on their brief that discuss some of the challenges faced by today's tactical warfighter and GBO in determining accurate coordinates for targeting (Brown, 2010).

- Ground based observers (GBOs) need enhanced ability to determine the location of targets to be engaged by air, ground, or naval surface fire support
- More precise target coordinates are needed for new Precision GPS Munitions
- Inaccuracies in magnetic azimuth devices cause large target location errors at distance from the GBOs

- High quality inertial azimuth sensors are too large and power hungry for man-portable operations
- Precision Strike Suite for Special Operations Forces (PSS-SOF) refines target using imagery but requires visible features near target to obtain new coordinates

The NAVSYS proposed solution is to produce a payload for a SUAS equipped with Target Location Technology for Ground Based Observers (TLGBO). The idea will add a UAS equipped with GI-Eye and connected wirelessly to WebGRIM, to the overall targeting architecture that provides the following benefits:

- TLGBO provides long range, non-line-of-sight precision targeting using imagery from Tier II UAS (Tier II is defined as a medium altitude and long endurance UAV such as the MQ-1 Predator and MQ-9 Reaper)
- UAS payload performs precision mensuration of real-time imagery and maintains database of registered imagery
- TLGBO web interface allows GBOs to access imagery for targeting using existing Strikelink tools
- There will be no additional equipment for the GBO to carry
- Fire support teams will have less exposure to fire and more precise targeting capability.

## **C. OTHER TESTS WITH SUAS TO CONDUCT HRI**

### **1. Naval Special Warfare Command HRI Test**

Naval Special Warfare Command (NSW) China Lake conducted a test during TNT 09-4, 10-1, 10-2, and 10-3, to stream real time HRI from their HRI Raven-B Nosecone to a laptop utilizing a Wave Relay. The images were initially downloaded after landing and later over Wave Relay or Digital Data Link (DDL). The imagery was imported into the PSS-SOF targeting tool to demonstrate the two dimensional to three dimensional terrain mapping software. The results were near perfect but depended on a



feature-rich environment. The 10 megapixel high resolution camera in the modified Raven Nose Cone worked flawlessly. The images taken were stored directly to a secure disk card and thumbnails were sent down to the laptop via Wave Relay in near real time. Several images were selected from the thumbnails for full download via the wave relay and the images were split automatically into JPEG and NITF files locally. The images were then loaded into the PSS-SOF targeting software and were scene matched against archival imagery. This was followed by determining whether the targetable coordinates can be derived from the images.

The results of the test proved successful for the future use of SUAS for HRI and targeting. The NWC Raven-B nose cone took hundreds of pictures during each flight test conducted. The Raven flew at a range of approximately 2.5 km from the ground control station and the images were downloaded from the SD card in the Raven Nose Cone to the laptop on the ground. The test was conducted to determine the actual operational range of the Raven and the laptop equipped with a single, man-portable Wave Relay node. The Wave Relay performed great but the throughput via the USB1 connection was later determined to be approximately the limiting factor with a throughput of 1 Mbps both for the upload and download.

The test also determined that the current Camp Roberts Digital Point Position Database (DPPDB) was out-of-date and caused delays during the imagery and scene matching process conducted in the PSS-SOF targeting tool. This problem can be easily remedied with a more current, up to date DPPDB for Camp Roberts, followed by another test of the system to determine if the delays continue to be a problem in providing near real time targeting information from the imagery.

## **2. Pennsylvania State Electro-Optics Center Test (TNT 11-2) and Orthorectification**

Another SUAS HRI test was conducted by the Pennsylvania State Electro-Optic Center on February 22–25, 2011. The test utilized their Phoenix Tactical Mapping System: Real-Time Geo-referencing and Orthorectified Mapping from a TigerShark UAS. A few of the goals of the test was to fly the Phoenix High Definition (HD)

mapping camera on the TigerShark UAS and collect 1 Hz images with better than a 2 meter target location error from 3000 feet above ground level (AGL) and to collect real time wide area maps of different sections of the area of operations. Other goals were to Generate Geo-referenced and Orthorectified imagery in real time on board the aircraft and to transmit the image data across the Harris Sea Lancet digital communication radios to the Ground Control Station (GCS).

*a. Orthorectification*

The topographical variations in the surface of the earth and the tilt of the satellite or aerial sensor affect the distance with which features on the satellite or aerial image are displayed. The more topographically diverse the landscape, the more distortion can be inherent in the photograph. Features such as roads, vegetation, and water can add distortion. Therefore, before this information can be gathered in a manner that is useful for a mapping or Geographic Information System (GIS), the satellite image data or aerial photographs must be prepared in a way that removes distortion from the image. This process is called orthorectification (Satellite Imaging Corporation, 2011).

Orthorectification uses precise solution information, coupled with terrain and lens models, to geometrically correct the image so the scale is uniform and North is at the top of the image. This process removes any distortion from the image caused by topographic relief, lens distortion, and camera tilt. (Bockius, 2010)

Figures 1 and 2 are an example of the same image, one is the original, and the other after it has been orthorectified. The imagery was then slated for processing with different software packages to provide intelligence products.

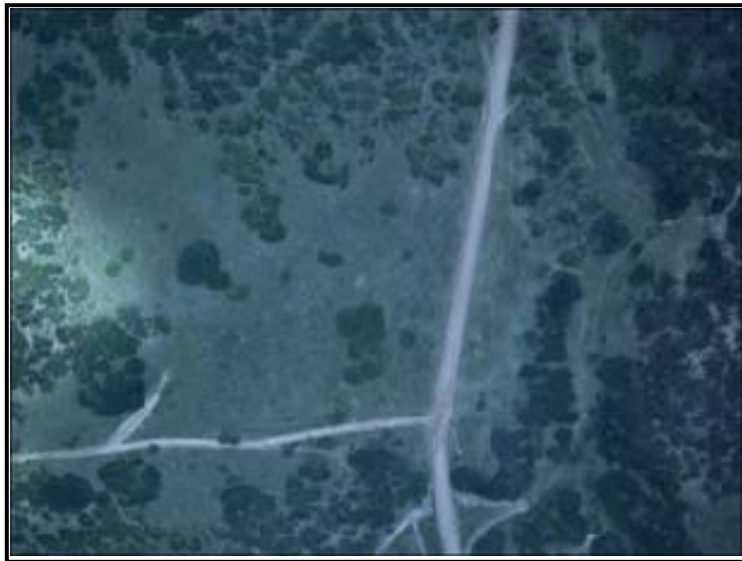

Figure 1. Original Image (From Bockius, 2010)

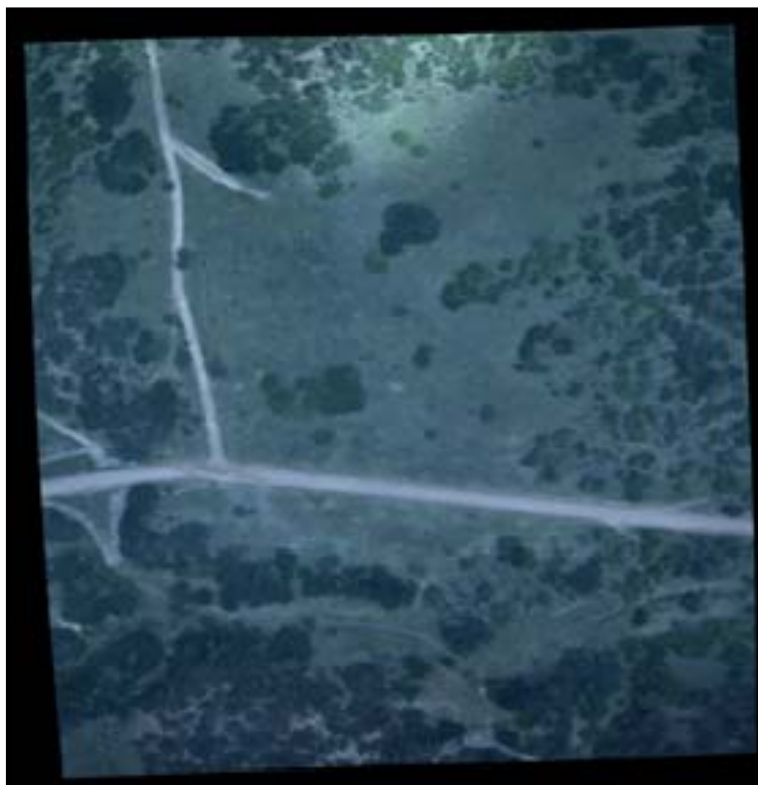

Figure 2. Orthorectified Image (From Bockius, 2010)

The results of the Pennsylvania State test were significant. The accuracy of the imagery was less than 2 meters when compared to base maps. The comparison was performed against Google Earth coordinates since surveyed ground reference points were not readily available. Therefore the results are not definitive until they are validated against surveyed truth locations. The system also successfully transmitted orthorectified image frames across the communication link and to the GCS. The drawbacks were that the data communication link did not function long enough to generate a large area mosaic of either the airfield or the area of interest. The test also experienced intermittent data link interference throughout the exercise. This was later discovered to be due to a damaged patch antenna at the ground station data link. Imagery in some frames appeared to be blurred and was believed to be due to the high cross winds, which introduced significant roll rates to the flight dynamics of the TigerShark UAS. Despite the data link communication issues, the test still managed to transmit a sufficient amount of data to the GCS for display and dissemination. Table 1 provides the statistics for the number and quality of images collected during the experiments.

Quantity of Geos Processed	730
Quantity of Orthophotos Processed	729
Average Cross Track Error (m)	0.713
Average Image to Image Pixel Offset (p)	2.5
Average Image to Image Metric Offset (m)	0.3
Average Relative Difference to Google Earth (m)	1.577

Table 1. Data Collection Statistics (From Kiser, 2011)

#### **D. TYPES OF UAVS AND USE OF HRI FOR TARGET LOCALIZATION**

The sizes and characteristics of UAVs vary greatly from those weighing a few kilograms, like the Raven, to the Boeing ScanEagle and even larger UAVs, such as the TigerShark and those currently in use for intelligence, surveillance, and reconnaissance operations (e.g., Global Hawk, Predator). An unmanned vehicle is currently defined by the U.S. Secretary of Defense’s Unmanned Systems Roadmap as a powered vehicle that does not carry a human operator, can be operated autonomously or remotely, can be

expendable or recoverable, and can carry a lethal or nonlethal payload. Ballistic or semi-ballistic vehicles, cruise missiles, artillery projectiles, torpedoes, mines, satellites, and unattended sensors (with no form of propulsion) are not considered unmanned vehicles. Unmanned vehicles are the primary component of unmanned systems (Office of the Secretary of Defense, 2007). This thesis will primarily discuss the Naval Postgraduate School (NPS) Rascal 110 SUAS and the NAVSYS Corporation HRI payload that will be modified and fitted for the smaller unmanned aircraft.

Tests of the NAVSYS HRI payload have already been conducted on a manned aircraft and the images from those tests have been loaded in WebGRIM. The targeting solutions and data resulting from those test flights will be calculated on WebGRIM and be evaluated for accuracy, ease of use and its overall effectiveness for future use by a GBO and tactical warfighter.

## **1. The NPS Rascal 110 SUAS**

The Rascal 110 SUAS fuselage is made of mostly balsa wood with a monokote plastic exterior covering. The Rascal has been a popular airframe for universities and research labs for a number of years due to its low cost, ease of use, and comfortable flight characteristics. Adapted from the radio-control hobby market, the aircraft makes use of Commercial Off-the-Shelf (COTS) hardware for propulsion and surface control. The vehicle has approximately the same dimensions, (nonfuel) payload capacity, and speed profile as ScanEagle. This makes the Rascal 110 an ideal aircraft for testing new systems that are intended for use on the ScanEagle due to its much lower operating cost and ease of use. Figure 3 is the Rascal 110 and Table 2 lists its specifications.



Figure 3. Rascal 110 Research Aircraft (From Jones, 2011)

Wingspan:	110 in	274 mm
Wing Area:	1522 in <sup>2</sup>	98.2 dm <sup>2</sup>
Length overall:	75-3/4 in	1924 mm
Flying Weight:	11-13 lbs	5000 - 5900 g (empty) with payload 10 Kg

Table 2. Specifications of the Stock Rascal ARF 110

#### E. THE NAVSYS GBO HRI PAYLOAD

NAVSYS Corporation has designed and produced a computer controlled Global Positioning System (GPS) and Inertial Navigation System (INS) composed of a camera that can be linked directly to their WebGRIM web server. The system is equipped with a GPS/inertial/video sensor called (GI-Eye) that is able to provide precision geo-registration data for collected imagery directly at the sensor. The current system weight is about 9 pounds and is about 300 cubic inches in a box form and is currently being tested on board a manned aircraft. The NAVSYS HRI Payload and components in Figure 4 will be modified to fit into the payload compartment of the Rascal SUAS for evaluation and testing to determine its performance capabilities on an unmanned aircraft.

The system modules of the GI-EYE sensor consist of the following components:

- Versallogic Leopard PC-104 high performance SBC
- Solid-state SATA hard drive
- Pixeling CCD camera PL-B954U

- Novatel OEM-5 GPS L1/L2 Receiver
- NAVSYS NIM time stamping board
- Honeywell HG1900 IMU
- switching +/- 15V power supply for the IMU
- switching 5, 12V ATX power supply for the computer and hard drive
- An L1/L2 active antenna on small back plane
- USB to serial adapter

The Web Server consists of the following components:

- Versallogic Leopard PC-104 high performance SBC
- Solid-state SATA hard drive
- switching 5, 12V ATX power supply for the computer and hard drive

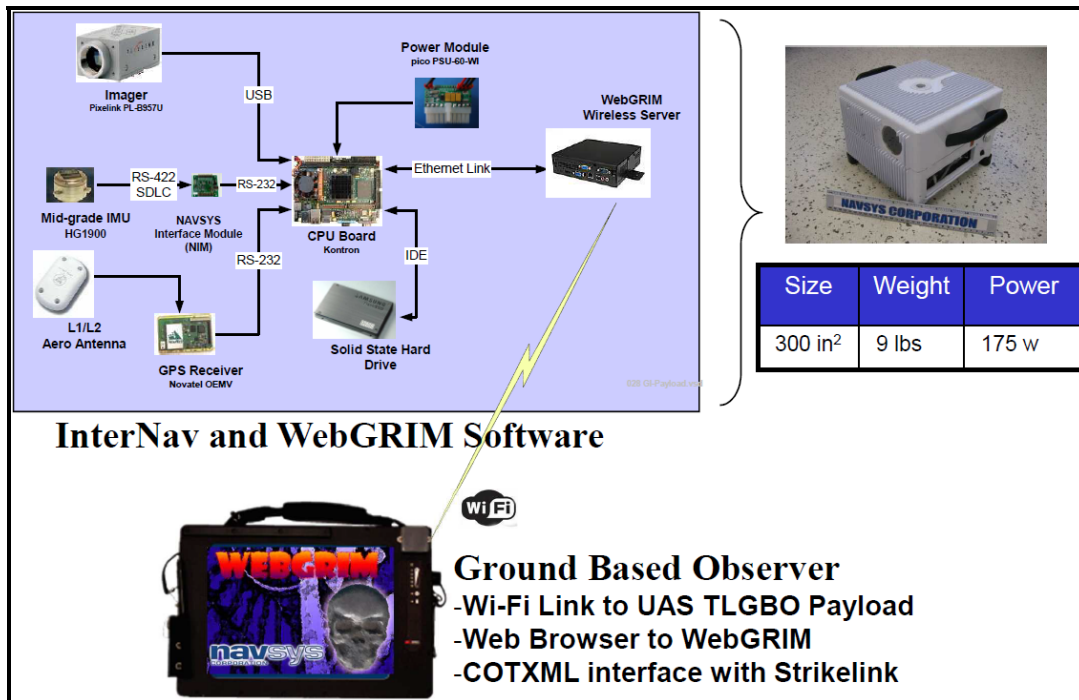

Figure 4. UAS Target Location Technology for Ground Based Observers (TLGBO) Prototype Payload (From Brown, 2010)

## F. NAVSYS GBO HRI PAYLOAD MODIFIED FOR THE RASCAL SUAS

The Rascal 110 SUAS is a considerably smaller aircraft than those utilized during the manned flights and also smaller than the TigerShark used during the Pennsylvania State test. The entire system therefore had to be modified to fit into the available payload compartments. The size, weight, and power constraints introduced several challenging limitations and restrictions for the NAVSYS GBO payload. The smaller layout of the Rascal 110 forced the designers to move components closer together and changes to the system design inevitably led to new problems and complications with the HRI Payload. The components were first arranged on a board to fit precisely in their approximate positions that they would occupy in the aircraft, as in Figure 5 and Figure 6.

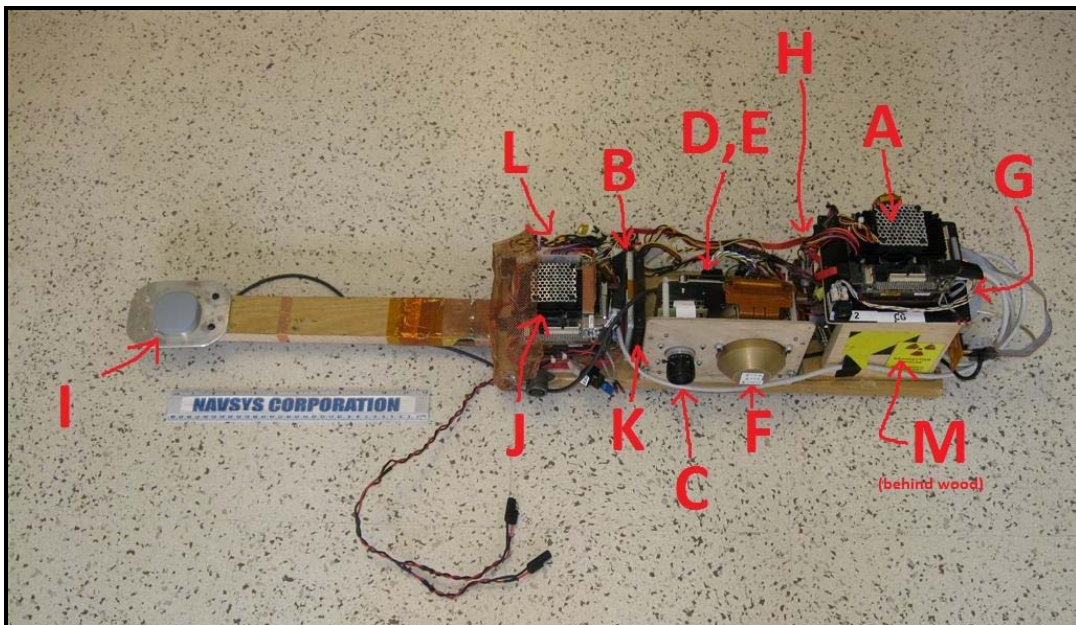

Figure 5. NAVSYS SUAS Modified GBO Payload (right side view)



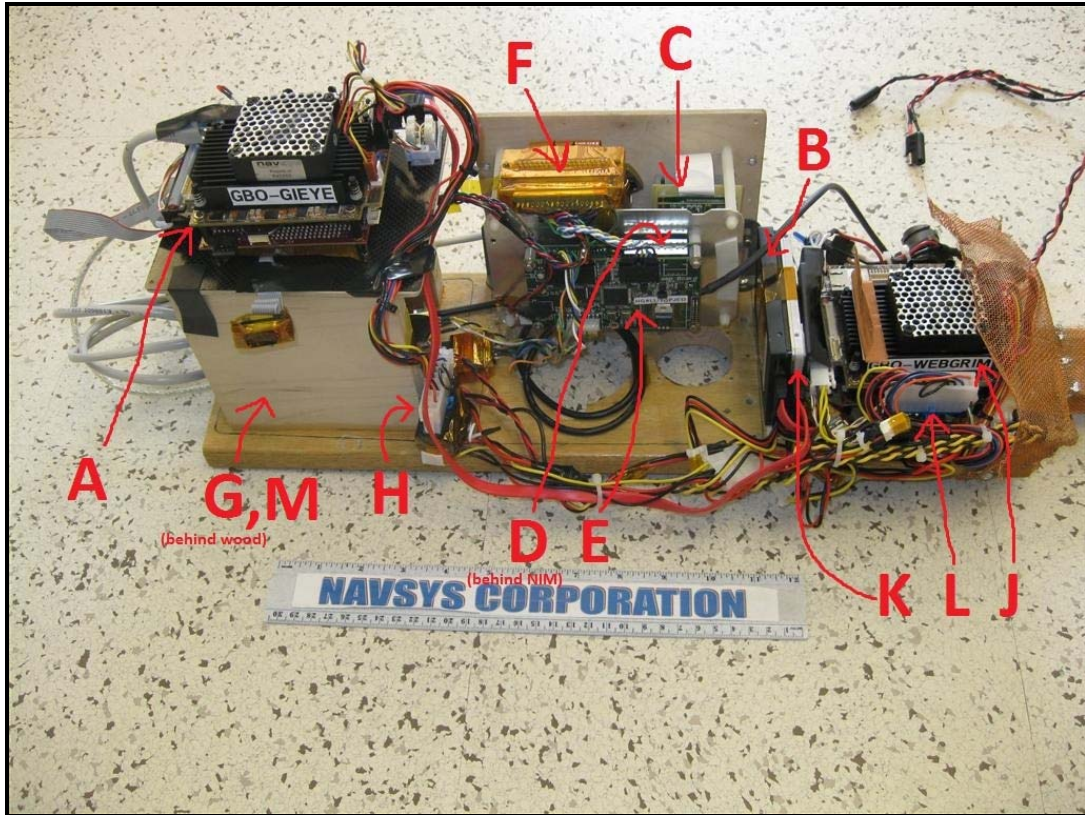

Figure 6. NAVSYS SUAS Modified GBO Payload (left side view)

### 1. The System Component Layout

- A. Versallogic Leopard PC-104 high performance SBC
- B. Solid-state SATA hard drive
- C. Pixelink CCD camera PL-B954U
- D. Novatel OEM-5 GPS L1/L2 Receiver
- E. NAVSYS NIM timestamping board (connects to Novatel, IMU & computer. Provides timestamped IMU data to the computer).
- F. Honeywell HG1900 IMU
- G. switching +/- 15V power supply for the IMU
- H. switching 5, 12V ATX power supply for the computer & hard drive
- I. An L1/L2 active antenna on a small back plane
- M. USB-to-serial adapter

## **G. NAVSYS WEBGRIM GEO-REFERENCED IMAGE MANAGER**

The NAVSYS WebGRIM is a web-based Geo-Referenced Image Manager, designed to allow web access to large sets of collected imagery and metadata, both through easy-to-use web pages for humans and programmatically through standards-based application programming interfaces (APIs) (Bockius, 2010). In today's battlespace, technological advances have made it easier and exponentially faster to collect and disseminate precise targeting information, furthermore today's modern UAVs provide a tremendous capability to collect large amount of data in the form of images very quickly. This resulted in a continuous overabundance of raw data, imagery, and information from several diverse sources. In an operational environment this overabundance of information can lead to confusion over the best course of action to undertake, and can severely hamper a leader's decision making process and reduce reaction times. The challenge is to be able to efficiently synergize these sources and databases to a single application so that the tactical warfighter or GBO can coordinate strike missions readily and easily from a distance.

NAVSYS developed WebGRIM to answer the challenge, WebGRIM is a web-based program that is able to organize and use the incoming data in an efficient manner. WebGRIM achieves this by geo-referencing all imagery data and storing it in a spatial database. This allows queries to be used to find only the relevant data through several items such as image metadata, time image was taken from oldest to most recent, or even by the platform and imaging camera used. WebGRIM has been tested with various data sets, ranging from ultra-high resolution (21 Megapixel) military imagery, to 6 megapixel data collected over Tifton, Georgia, in 2001 and the U.S. Air Force Academy (USAFA) in 2009, and to simple 0.3 megapixel imagery collected over USAFA in 2007. WebGRIM has also been deployed in ground-mobile vehicles for use by a U.S. intelligence agency, in numerous van-based mobile testing scenarios, and in manned aircraft.

## 1. WebGRIM Data Display

One important aspect of WebGRIM is the method it displays its data. The volume of images stored from a single UAV mission can be overwhelming since, “ten thousand images per hour are not unusual.” Twenty-seven seconds of imagery data collected from a UAV during a recent NAVSYS testing is shown in Figure 5. Since the aircraft was turning, the images are not all oriented in the same direction. The scale varies from image-to-image as the aircraft changes altitude or the terrain changes. Since the captured area of an individual image may be small, it is difficult to put each image in context with the large area, making it very difficult to confidently identify features. WebGRIM combats these problems by properly orientating images and displaying them against background maps, by creating new map layers from collected imagery, and by allowing spatial queries against collected data (Bockius, 2010). This will allow the operator to be able to understand and orient the images rapidly during a targeting operation while deployed or as a GBO sending coordinate information about the actual target. This will also provide the warfighter on the ground a significant advantage, since they will have the ability to produce imagery from a SUAS as an organic asset and immediately apply the real time images for targeting purposes.

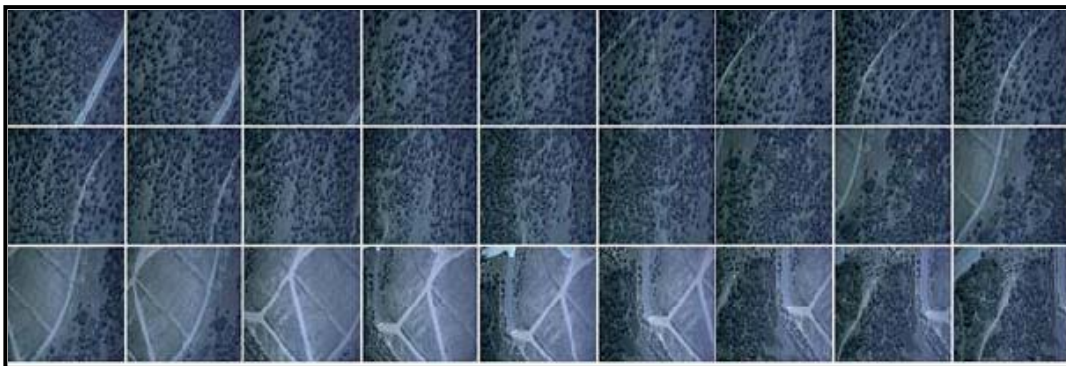

Figure 7. One image/second time-sorted Imagery (From Bockius, 2010)

## 2. WebGRIM Data Fusion

The next important step is the fusing of data from several sources. There is a lot of existing imagery, maps, and feature sets available both on public and private networks, but it is only useful if the data providers make it available to each other using standard interfaces. WebGRIM provides capabilities to both ingest network data and to publish WebGRIM data to other users—including maps, features, geo-positioning (targeting) coordinates, etc.

WebGRIM also provides several different geo-positioning modes, where users can extract precise targeting coordinates (and error estimates) from generated or shared maps and collected imagery. WebGRIM supports processing “modules,” that can provide program-specific capabilities to generate geo-referenced data from imagery, such as bathymetry generation (Bockius, 2010).

WebGRIM will initially use Digital Terrain Elevation Data (DTED) data to determine geo-positioning information and predetermined truth tables to validate the accuracy of targeting data during the simulation. DTED is a standard National Geospatial-Intelligence Agency (NGA) product that provides medium resolution, quantitative data in a digital format for military system applications that require terrain elevation. It is a uniform matrix of terrain elevation values which provides basic quantitative data for systems and applications that require terrain elevation, slope, and/or surface roughness information. If an existing digital elevation model such as DTED is already available for the location being targeted, WebGRIM can use it to perform single-image geopositioning. “WebGRIM calculates the intersection of the elevation model with a ray going from the camera to the user designated image coordinates. The accuracy of the coordinates will depend on both the accuracy of the camera’s GPS/INS solution, and the accuracy of the Digital Elevation Model (DEM).” Table 3 provides the six levels of DTED accuracy and number of points required to achieve that level of accuracy.

DTED Level	Post Spacing	Ground Distance
0	30 sec	1 kilometer
1	3 sec	100 meters
2	1 sec	30 meters
3	0.333 sec	10 meters
4	0.111 sec	3 meters
5	0.037	1 meter

Table 3. DTED Levels and Post Spacing Accuracy

Another company that produces geo-spatial imagery database products is VideoBank. VideoBank specializes in systems for gathering video and picture intelligence and can automatically extract and organize searchable data from video, audio, and other digital signals. Their products such as the Timeline Interface and Video Vault, operators can locate archived materials by date, timecode, keyword, and even geo-spatial coordinates. VideoBank’s custom-designed interfaces allow a single individual to monitor, record, and log several video feeds simultaneously, and the instant replay feature ensures that critical areas of interest can be reexamined easily or flagged for later review (VideoBank, 2011).

### 3. WebGRIM Architecture

WebGRIM is built using a combination of technologies, as shown in Figure 8. The core of the data storage system is an Oracle 11g spatial database and WebLogic applications server. Advanced image processing capabilities, such as image orthorectification, are provided by PCI Geomatics “pluggable function” libraries. MATLAB provides sophisticated processing capabilities, used both by native WebGRIM code and by WebGRIM “plug-in” modules (Bockius, 2010).

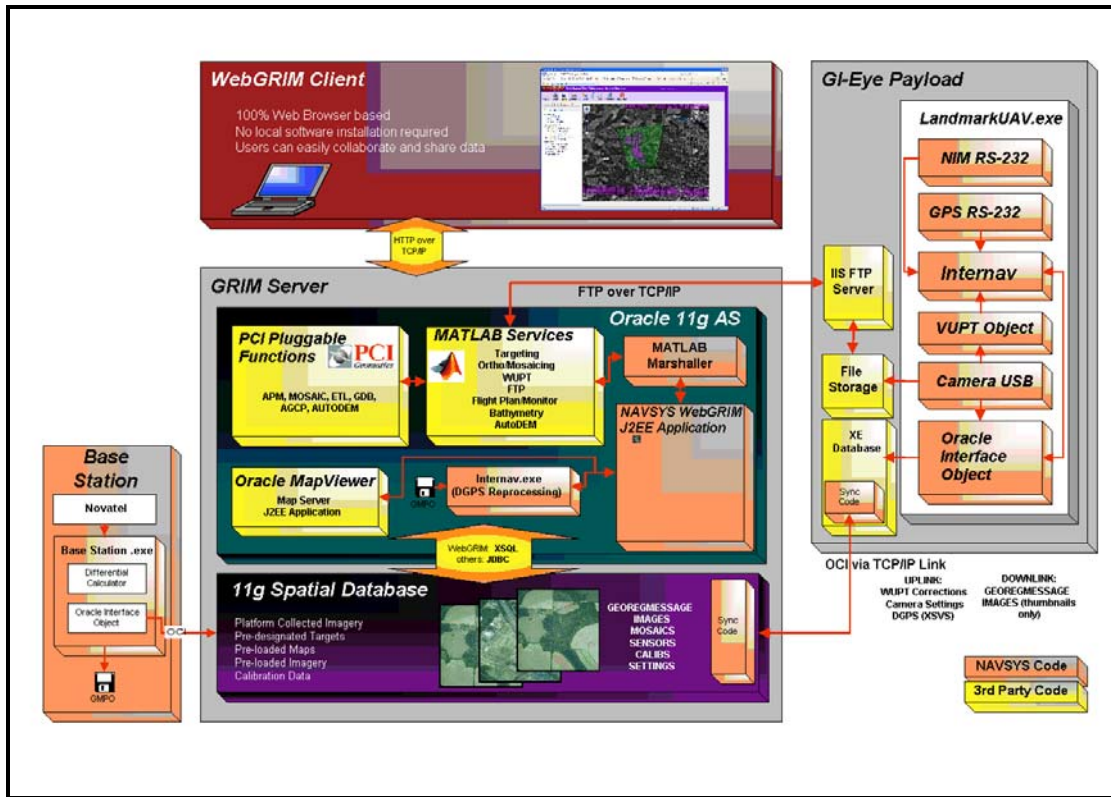

Figure 8. WebGRIM Architecture (From Brown, 2010)

The WebGRIM architecture makes it simple to access from any web browser, and therefore the database can be reached from any location with Internet connectivity. During the research for this thesis, WebGRIM was accessed using the Firefox browser since its main design was built specifically for that browser. Using the same browser also gave the added benefit of ensuring that the software engineers at NAVSYS are seeing the exact same image and page layout as the user locally to avoid confusion. The only issue during the research was the differences in screen sizes locally and remotely. The differences in screen sizes did change the layout slightly but not enough to effectively change the overall targeting simulation conducted for this thesis.

WebGRIM did take several hours of training to learn the basics of the targeting aspects of the program alone, so any operator that will use WebGRIM will have to be trained to use the program and maintain proficiency when required. There are a lot of features in WebGRIM, and this thesis will not cover every aspect of the program. The thesis will only conduct tests with the tools needed for targeting using collected imagery from an aircraft.

## **II. TARGETING WITH IMAGES FROM MANNED AIRCRAFT TESTS OF THE NAVSYS GBO PAYLOAD AND WEBGRIM**

One of the major capabilities of WebGRIM is the ability to process images for the display and generation of maps objects. Due to the large volume and resolution of images that can be accessed, presenting the information that can be useful for an operator can be an overwhelming task. WebGRIM simplifies this process by allowing the operator to easily understand where the inbound imagery fits in relation to the surroundings through the use of maps. It presents collected data in the framework of a real map and greatly enhances an operators understanding and orientation of how the imagery fits in with surrounding geography and terrain. WebGRIM is also able to obtain map data from Open Geospatial Consortium (OGC) Web Map Service (WMS) servers. WMS is a commonly used standard in both civilian and military networks to share graphical map data between machines. WMS data on the Internet includes live NOAA weather radar, USGS aerial imagery, USGS topographic maps, and many other data sets (Bockius, 2010).

In order to produce targeting information from the flight imagery WebGRIM uses Geopositioning from several images. Geopositioning is defined as any method that facilitates the location of one point relative to the surface of the Earth. In the case of WebGRIM it is the process of extracting latitude and longitude coordinates from a collection of several images from flight missions. The WebGRIM database can store all historical images and provide real time mission images when linked to the mission aircraft. The operator can choose a specific mission's images for the targeting process when required. All flight mission imagery that is stored in WebGRIM is associated with two geographic markers. The first is the point at which the camera was located at the time the image was taken and the second is the calculated "footprint" of the camera image. The footprint is the outline of the boundaries of the captured image on the surface of the Earth (Bockius, 2010).





Figure 9. Image Footprints covering the selected target area

#### A. TARGETING OPTIONS AND MAP GEO-POSITIONING

In order to gain targeting information, the operator needs a minimum of three pieces of information. The three pieces can be from sources such as an image, laser range finder, and DTED. These sources can be applied against the three targeting options which can be used to acquire coordinates for distant fire support. The first is to combine GBO range coordinates with an image. The second method is to combine an image with precision DTED information and the third is the use of multiple image point targeting. The targeting support concept with an HRI Payload onboard a SUAS provides an additional image location to the target combined with the information from the GBO location and range to the target to determine the best targeting solution. Figure 10 is the NAVSYS proposed targeting support concept.

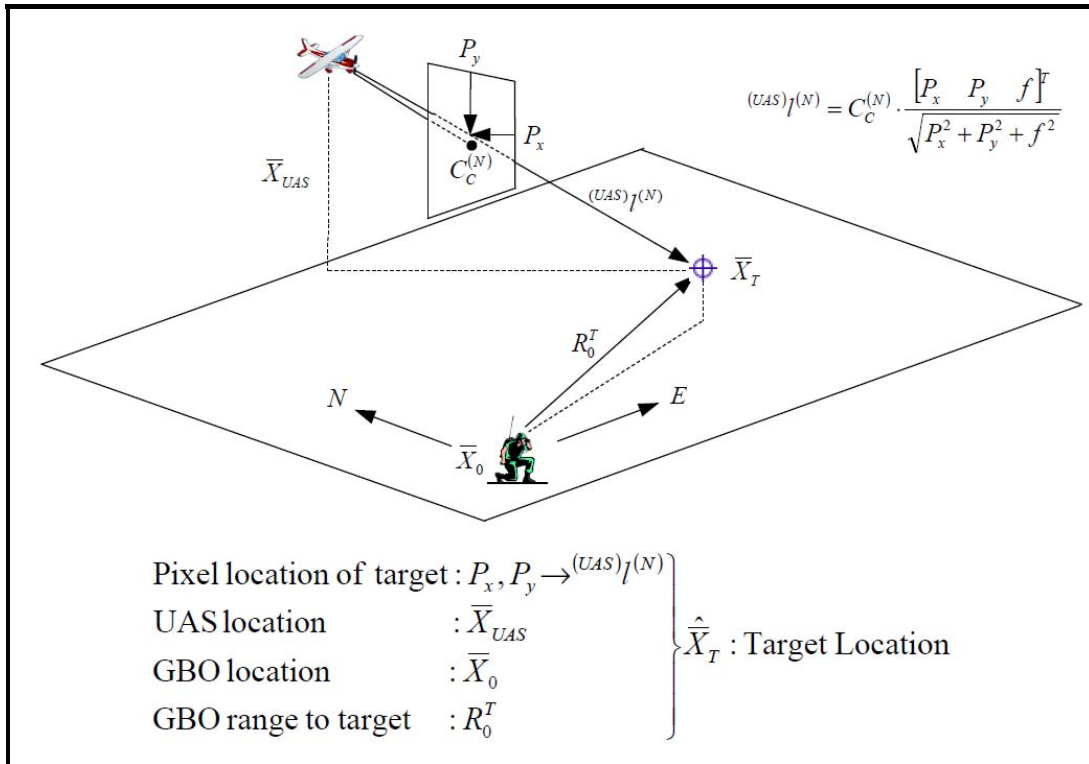

Figure 10. Targeting Support Concept (From Brown, 2010)

## 1. CoT/XML

In order for several different systems to communicate during the targeting process, protocols such as Cursor on Target Extensible Markup Language (CoT/XML) were developed. CoT/XML is a common messaging format for all the communications necessary in order to integrate several diverse systems. This was essential for system of systems approaches such as during development of an HRI Payload for a SUAS. The “Cursor On Target” terminology stems from a speech given by Gen. John Jumper during the 2002 command and control (C2) summit during which he suggested an end state for DoD systems in which they would be able to interoperate and communicate via machine to machine mechanisms much like the onboard systems on aircraft such as an F-15. CoT/XML has worked well as one standard since its deployment, and with the contributions from around the DoD, CoT/XML is now able to perform Machine-to-Machine targeting to:

- Provide a GUI for special forces giving them the ability to click on a laser rangefinder designating a hostile target
- Pass precision coordinates
- Send mensurated target coordinates to an airborne strike asset, and download these directly into GPS-guided weapons.

The result provided a 67% improvement in targeting timeline, and also a significant increase in accuracy due to the elimination of tedious manual activities. It also resulting in dramatic cost reduction and quicker data delivery time and reduces chance of operator error in data entry (CoTXML Standard for the U.S. Military, 2011).

The resulting XML schema for the exchange of information that underlies system interoperability focused on time-sensitive position exchange needs including spot reporting, blue force tracking, relocation requests, and any time sensitive position information need, to include, targeting information. Time sensitive “what,” “when,” and “where” (WWW) information availability is especially critical in asymmetric warfare arenas such as the one in Iraq, where agility and responsiveness is key to military superiority, but also to Homeland Security crisis management and response. “What” tell us if this is a friendly or hostile force; a target to be killed or a survivor to be rescued. “Where” has become synonymous with military GPS accuracy of precision coordinates that guide munitions through windows or navigate tanks through zero visibility sandstorms. “When” is becoming increasingly important as we dramatically shrink the sensor-to-shooter timeline for ‘time-sensitive-targeting’ missions. (CoTXML Standard for the U.S. Military, 2011)

## **2. Imagery Combined with GBO Range**

In this method the GBO range to target is calculated from the GBO location combined with a measured range to the target location. The use of imagery and GBO range on WebGRIM is shown on Figure 11 and Figure 12.

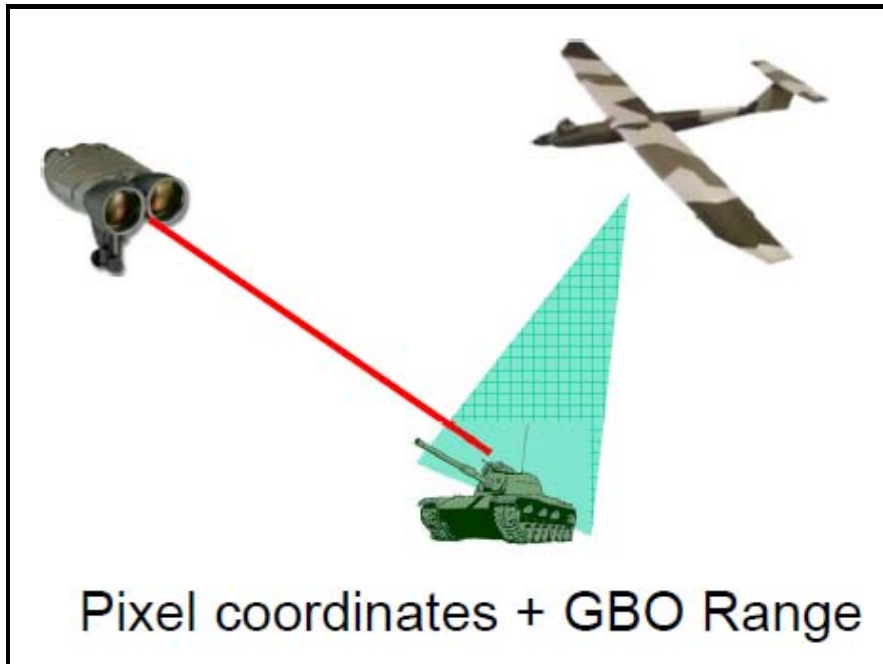

Figure 11. Imagery and GBO Range (From Brown, 2010)

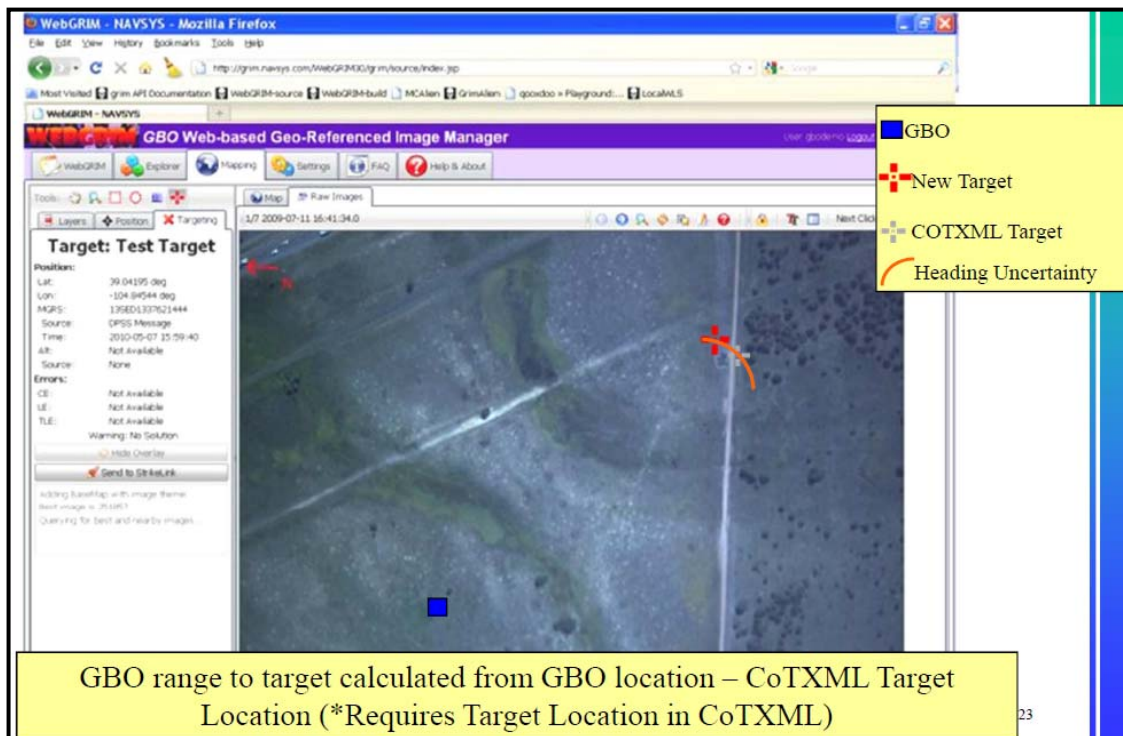

Figure 12. WebGRIM UAS Imagery + GBO Range (From Brown, 2010)

### 3. UAS Imagery Combined with Precision DTED Coordinates

In this method, the GBO or operator can directly identify a target on an image and WebGRIM will calculate targeting coordinates using the orthorectified image combined with DTED. The accuracy will solely be reliant on the precision of the DTED information and registration of the imagery. Figure 13 and Figure 14 depict the use of imagery with precision DTED information to produce targeting coordinates.

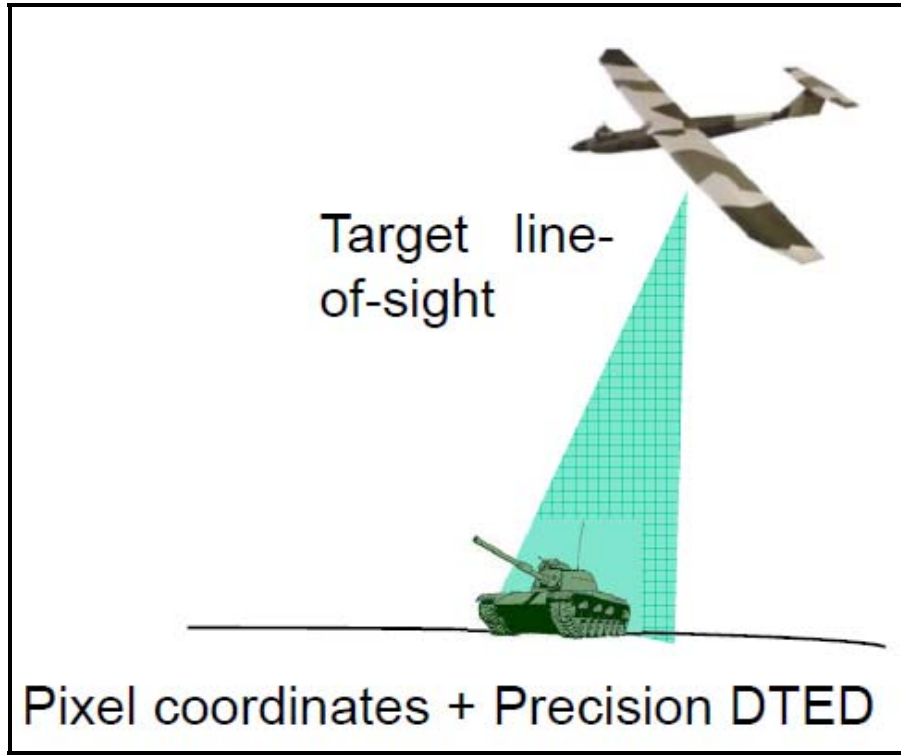

Figure 13. Image Combined with Precision DTED (From Brown, 2010)

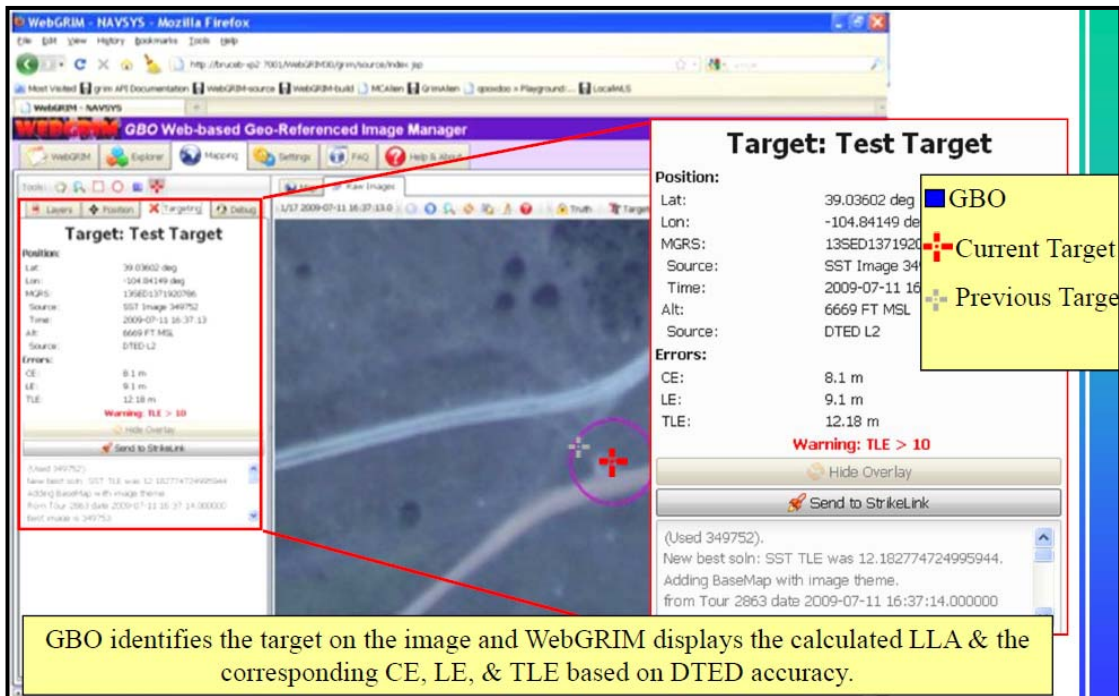

Figure 14. WebGRIM UAS Imagery Combined with Precision DTED

#### 4. Multiple Image Point Targeting

In this method, the GBO or operator can use several images to produce a targeting accuracy within the USMC standard of 10 meters. The GBO can continue to add more images if the initial accuracy is not satisfactory in order to lower the error and achieve a better targeting solution as displayed in Figure 15 and Figure 16.

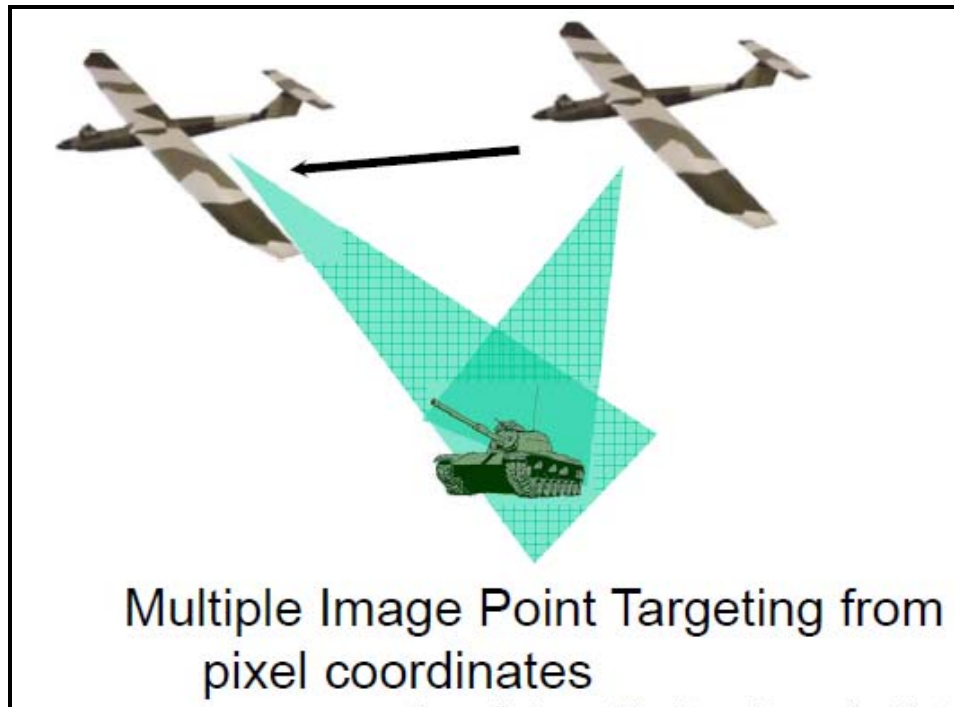

Figure 15. Multiple Image Point Targeting (From Brown, 2010)

The screenshot displays the WebGRIM web-based Geo-Referenced Image Manager interface. The central panel shows a satellite image of a coastline with a red crosshair indicating the current target location. A yellow callout box on the right identifies the symbols: a blue square for 'GBO', a red cross for 'Current Target', and a grey cross for 'Previous Target'. The interface includes a top navigation bar with 'vobGRIM', 'Explorer', 'Mapping', 'Settings', 'FAQ', and 'Help & About'. A left sidebar contains a 'Target: Test Target' panel with the following data:

Position:	
Lat:	39.03602 deg
Lon:	-104.84149 deg
MGRS:	13SED1371920
Source:	SST Image 349752
Time:	2009-07-11 16:37:13
Alt:	6669 FT MSL
Source:	DTED L2
Errors:	
CE:	8.1 m
LE:	9.1 m
TLE:	12.18 m
<b>Warning: TLE &gt; 10</b>	

The right sidebar also displays this information under the heading 'Target: Test Target'. Below the error metrics, there are buttons for 'Hide Overlay' and 'Send to StrikeLink'. A scrollable log at the bottom shows the following text:

```
(Used 349752).
New best soln: SST TLE was 12.182774724995944.
Adding BaseMap with image theme.
from Tour 2863 date 2009-07-11 16:37:14.000000
```

A yellow callout box at the bottom of the screenshot contains the text: "If resolution or accuracy not sufficient, GBO continues to click on target in provided images. WebGRIM displays LLA & the corresponding CE, LE, & TLE from MIPT calc."

Figure 16. WebGRIM Multiple Image Point Targeting (From Brown, 2010)



## B. TARGETING ARCHITECTURE

The current GBO targeting architecture (Figure 17) produces large total linear errors (TLE) during the targeting process. This is due mostly to the GBO using only a single coordinate from the Target Location and Designation Hand-off System (TLDHS). The current TLDHS uses conventional GPS and a laser range finder with a magnetic heading sensor. The system has issues with targeting hardware azimuth errors and a large probability that the heading data may not be accurate due in part to compasses being notoriously inaccurate and unreliable. The result is a large TLE that can negatively affect the final calculated targeting solutions.

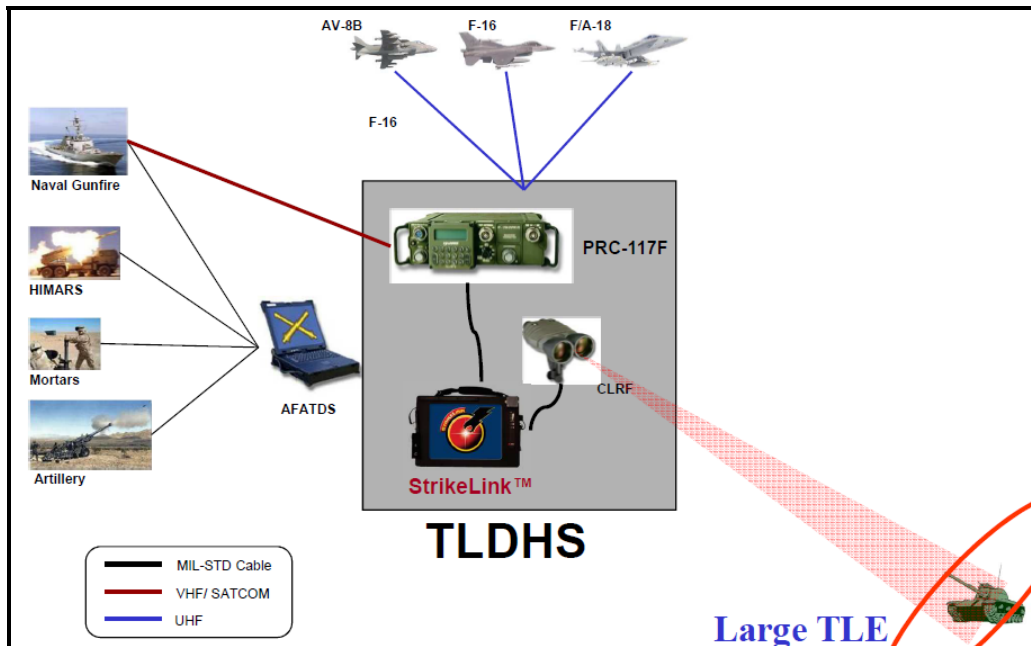

Figure 17. Current GBO Targeting Architecture (From Brown, 2010)

The NAVSYS HRI Payload working in concert with WebGRIM will improve upon the current architecture and can improve the TLE to provide more precise and accurate targeting solutions for distant fire support. The hybrid style architecture in Figure 18 improves the accuracy by adding imagery coordinate information received from a UAS to the solution, and thereby reduces the overall TLE. The SUAS TLGBO accomplishes this by producing mensurated imagery through the use of zero-age GPS

corrections from the GPS Operations Center (GPSOC) and a 3-axis inertial measurement unit (IMU) for attitude data and adding the range from the GBO laser range finder or DTED.

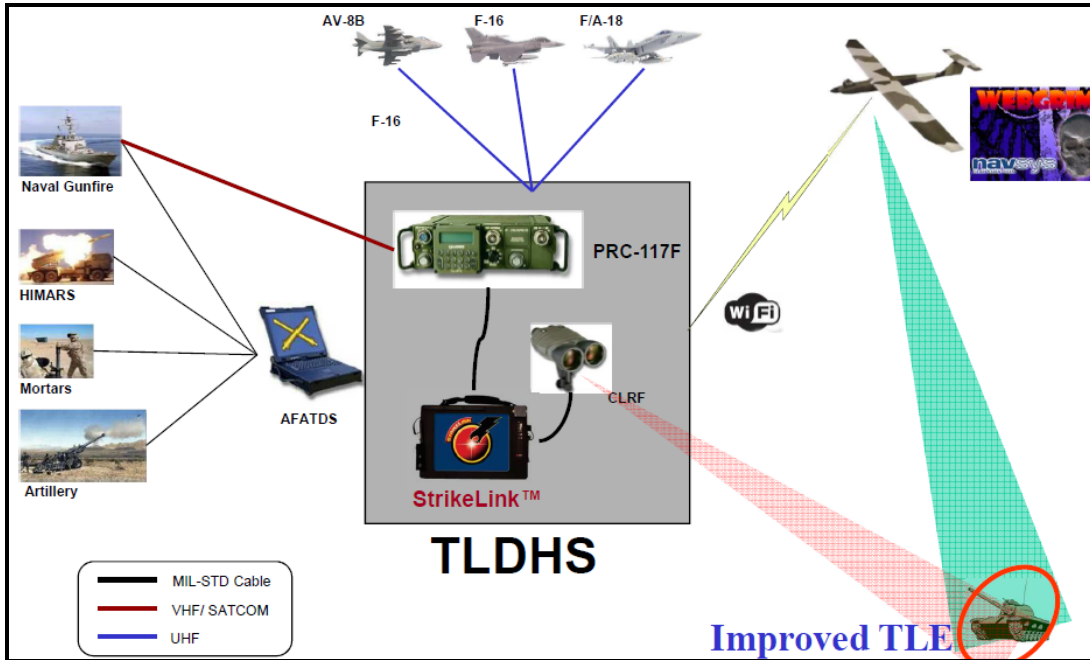

Figure 18. GBO/UAS Hybrid Targeting Architecture (From Brown, 2010)

### 1. Simulated Targeting using WebGRIM

Since real-time flight operations on an SUAS could not be performed, simulated targeting was done using archival imagery stored on the WebGRIM server. In this section simulated targeting was done with the Reprocessed Landmark Flight accomplished on July 10, 2010. WebGRIM was used to filter only those images captured from that specific flight so only those images were used during the simulation. Additional archival imagery taken from several other flights that encompass the same area for targeting could also be used if desired.

During the actual simulation conducted on WebGRIM for this research, it became necessary to remotely enter a simulated GBO coordinate via Strikelink for targeting. Originally, an engineer at the server site had to manually enter the information to simulate a Strikelink input. This became problematic due to scheduling differences and

therefore, a new button on the display that simulates a Strikelink input from a GBO was produced. This allowed targeting tests and research to be conducted remotely without the necessity of software engineers manually entering them from the site. Figure 19 is the Homepage for the Mapping tab.

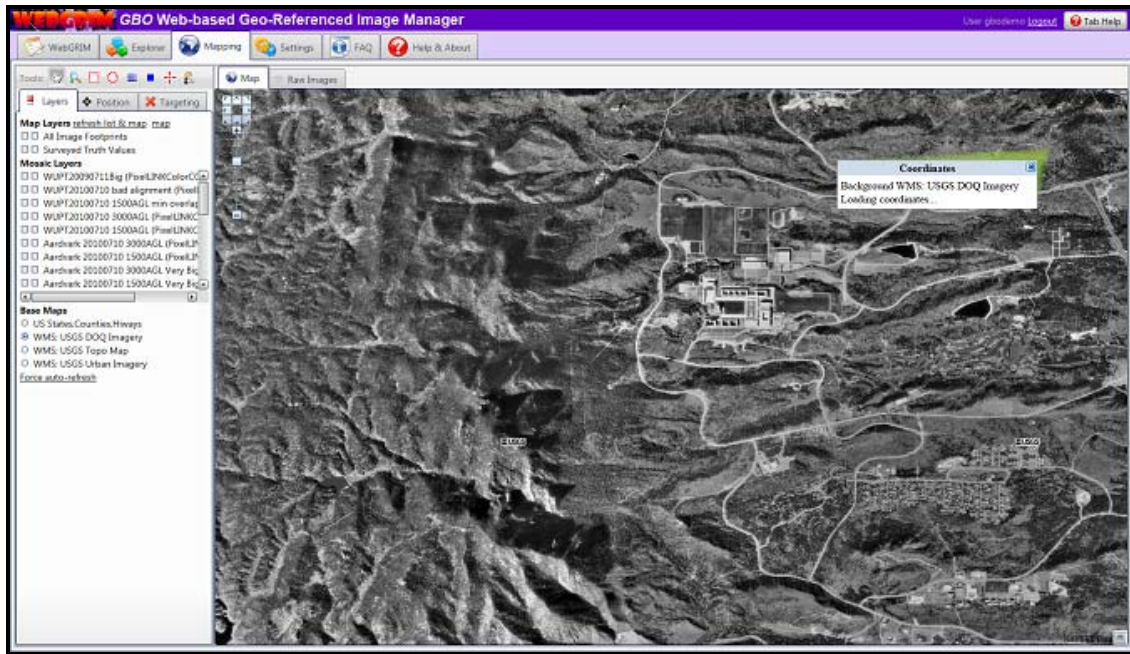

Figure 19. WebGRIM Map View

The first step is to login to WebGRIM at <http://grim.navsys.com> and once the user enters their credentials, WebGRIM will take a few seconds to start. Once WebGRIM is initialized it displays the homepage where all the necessary tabs will be located on top. During this simulation the Mapping tab is utilized and the images from the Reprocessed Landmark Flight dated July 10, 2010, were chosen as in Figure 20.

The first demonstration will be a simulation initiated by the GBO entering targeting information via Strikelink and processed with archival images stored on WebGRIM. It will first produce a targeting solution using Single Image Geopositioning (SIG) followed by a solution using Multiple Image Geopositioning (MIG).

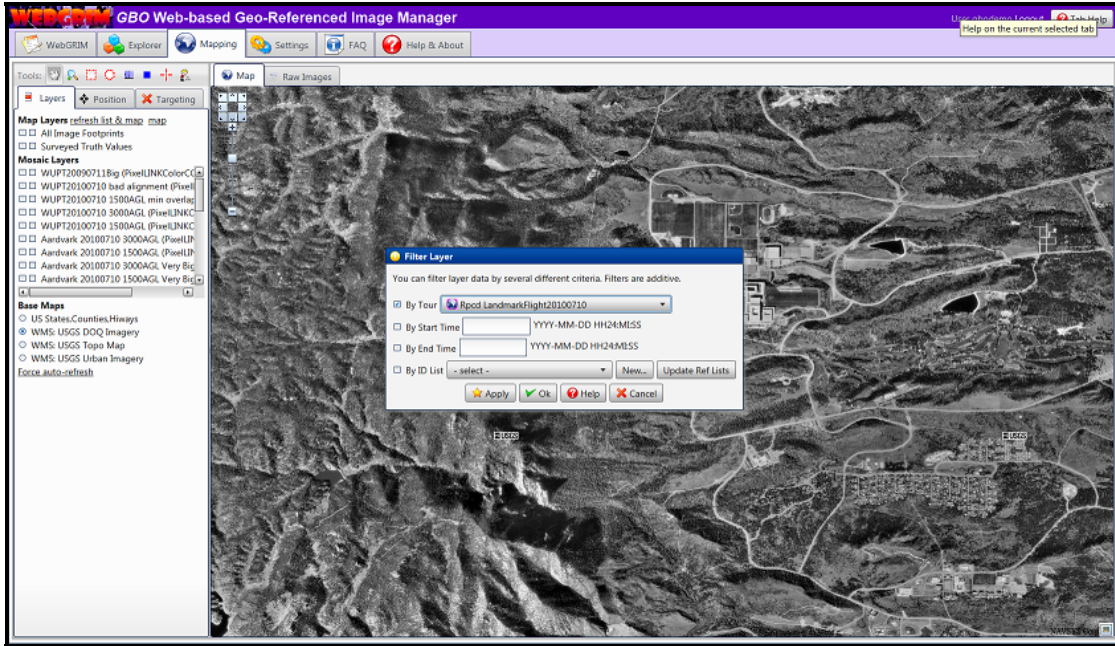

Figure 20. Filter Layer Displaying the Tour Chosen for the Simulation

## 2. Targeting with GBO Range Coordinates and SIG

The simulation initiates with a computer generated GBO sending target coordinates via Strikelink and then clicks the PSS-SOF button to send a message to WebGRIM. The information appears as an onscreen alert on WebGRIM and displays time, latitude, longitude, altitude, and some information about the target such as the one in Figure 21 simply named GC13 SE Corner Gazebo. WebGRIM will display the target coordinates on the background map with the most recent image from a UAS in this case the Landmark Flight was chosen. The image is orthorectified and overlaid on the background map. The coordinates are then layered against images from the tour chosen and in this simulation 29 raw images were discovered that had this specific coordinate location.

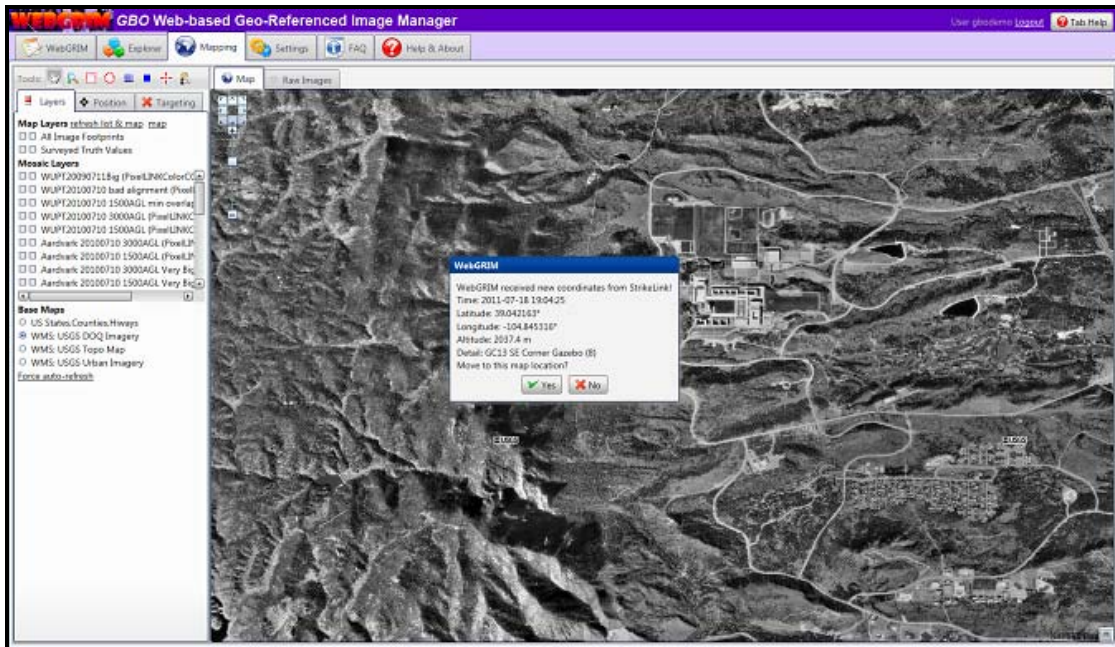

Figure 21. Simulated Strikelink Coordinates Sent to WebGRIM

Those 29 images can now be checked and used to gain targeting information if necessary. The first image of the selection was chosen immediately for the simulation since the GC13 Gazebo can readily be seen on the center of the image. The WebGRIM operator can basically use a left mouse click on or near the gazebo itself to produce Single Image Geopositioning (SIG) and attempt to gain an acceptable targeting solution. “Single-image geopositioning refers to targeting performed against a single image. The user identifies the feature he wants to target in the image and WebGRIM generates coordinates for location, including estimated accuracy information.” The SIG therefore requires information from another source such as DTED, Camera Range, or a GBO in order to generate a targeting solution.

As revealed in Figure 22, the SIG produced a circular error (CE) of 4 meters, a linear error (LE) of 29 meters, and thereby concluded a total linear error (TLE) of 29.3 meters which is greater than the 10 meter maximum required by the USMC to use for targeting. CE is defined as an accuracy figure representing the stated percentage of probability that any point expressed as a function of two linear components (e.g., horizontal position or horizontal plane) will be within the given circle. LE is defined as a

one-dimensional error (such as an error in elevation or in vertical dimension) defined by the normal distribution function. It is stated as a percentage of the probability that any point expressed as a function of a single linear component will be along the given line. In the simulation a warning presented in red is displayed to let the WebGRIM operator know that the targeting solution TLE is greater than 10. The use of only a single image geopositioning, such as in this simulation, did not generate a targeting solution within the required range for actual targeting use. Consequently, the next step is to attempt to use more images from the tour to decrease the CE in order to reduce the TLE within 10 meters. This will enable WebGRIM to provide a more accurate targeting solution that can be sent for actual fire support use.

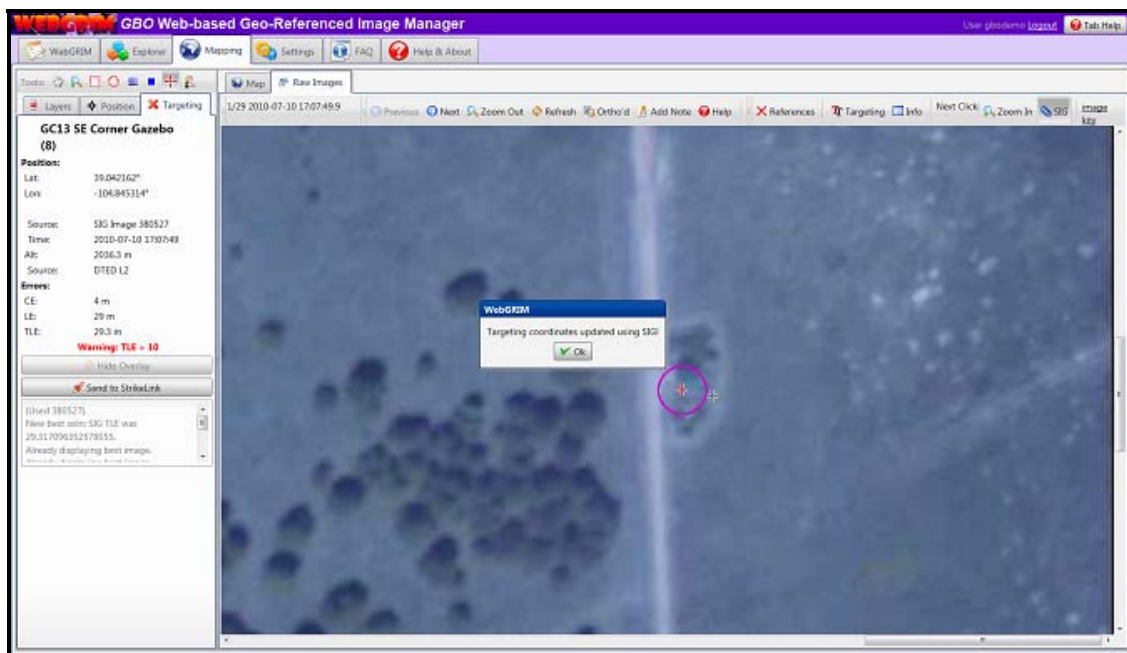

Figure 22. Single Image Geopositioning (SIG) on the target

The operator continues by clicking on the next button to view the next image in the selection and determine if it is adequate for helping attain a targeting solution. If the image is usable, the operator can again left click on the target area and that image will be selected as part of the targeting solution. The same point is then used in multiple images to decrease the TLE and the number of images can be increased as necessary until

sufficient accuracy can be achieved. This process will use several images from the collection to improve accuracy and is called Multi-Image Geopositioning (MIG).

### 3. Multiple Image Geo-Positioning (MIG)

In multi-image geopositioning the operator needs to add more images and to identify the same target point in two or more images. In this demonstration, a total of three images were used and WebGRIM was able to calculate the target coordinates without any further information from other sources such as DTED or Camera Range. During the attempt to produce a MIG, the second image from the selection was determined not to be orthorectified and therefore was not used to add information to improve the TLE. The image in Figure 23 pointed north as headed to the right of the screen while the rest of the images have north pointed directly up on the screen. The image can be orthorectified by WebGRIM if required, but if time is a constraint and the operator needed to provide accurate targeting data rapidly, the image can simply be ignored and the other images can be utilized simply by clicking next on the top of the screen.

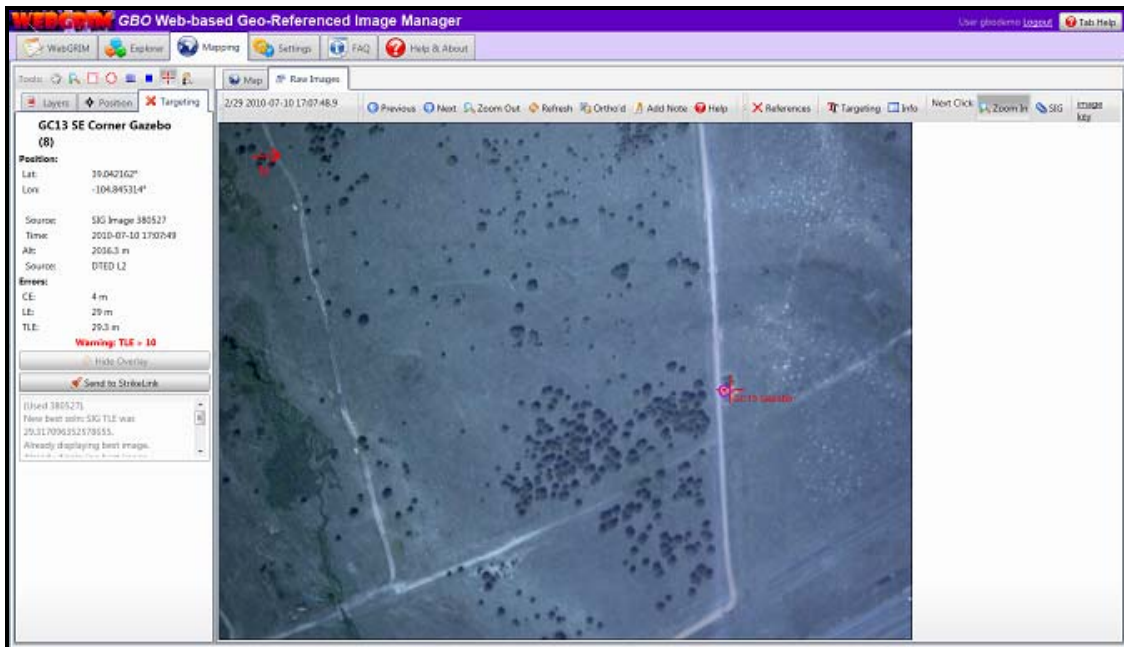

Figure 23. Non-orthorectified image on WebGRIM

The demonstration continued without orthorectification and moved to the next image in the selection. At this point the operator selects another image and adds a silhouette using the cursor over the same target located in that image, which automatically adds that image to produce a MIG. This can be repeated with as many images as required in order to produce a TLE less than 10 meters. “When desired, the user can initiate multi-image geopositioning, which will use all of the marked silhouettes to calculate a final targeting solution.” This process was repeated one more time, and a total of three images were selected during this demonstration, and this lowered the TLE to 4.5 meters, more than enough to meet the 10 meter USMC requirement that can be used for targeting information. WebGRIM operated flawlessly during the simulation and the solutions could have been sent back to Strikelink rapidly for targeting use.

The simulation only used three images to produce the MIG, but additional images can be added to provide solutions with even more accuracy to further reduce the TLE. This is especially useful if the operator is not constrained by time during an actual mission where the most accurate targeting coordinates are required for the fire support mission. This was evident during the simulation, since it merely required a few seconds to add three more images to get a MIG TLE of 4.5 meters shown in Figure 24. Hence, this will not hamper the operator in any form during a time sensitive mission. The GBO mode also proved to be a faster way for the operator to mark target locations and possibly return a target solution to WebGRIM with the use of MIG.

The compilation of several images through the use of MIG significantly enhanced the targeting information since the original GBO coordinates used alone may have inaccurate headings. The use of HRI and WebGRIM will certainly be useful for the tactical warfighter to provide better and more precise targeting solutions for distant fire support teams.





Figure 24. MIG display with TLE of 4.5 meters

There are other companies that utilize MIG such as 2d3 Sensing and Urban Robotics. 2d3 Sensing products such as their “AltiMap” software will correlate the images in “image space” and furthermore if the EXIF header contains metadata about the camera GPS position during the time the image was taken, AltiMap will also geolocate the resultant mosaic (2d3 Sensing, 2011). 2d3 Sensing also uses MIG in their terrain generation for DTED. They use structure from motion techniques to identify and track thousands of feature points on the terrain that are used to reconstruct a ‘mesh’ or model of the land. Since the same points used to create the terrain are present in the frames of video, it is also used to register parts of the imagery to the underlying DEM.

Urban Robotics products such as “TerraFlash” and “PeARL” also utilize MIG when producing aerial photogrammetry and DTED data. The products have modules for traditional geo-referencing, orthorectification, mosaicking, pyramidal tiling, and can be exported securely to web based applications such as Google Earth if necessary.

## **C. FUTURE TESTING OF THE HRI PAYLOAD ON AN SUAS**

Due to the GPS antenna attenuation from Radio Frequency (RF) noise with the modified HRI Payload, the SUAS testing on the Rascal 110 and experiment was not conducted prior to the completion of this thesis. It remains to be determined how the HRI Payload would have performed onboard the smaller Rascal 110. The Pennsylvania State test on the TigerShark did produce several blurred and unusable images due to the roll rate of the SUAS and the Rascal 110 is a much smaller aircraft than the TigerShark. Therefore, the NAVSYS HRI payload on the Rascal 110 may experience even more stability problems due to the weather.

### **1. Advantages and Benefits**

One potential performance benefit is that a SUAS will now be able to provide precise and near real-time imagery to a GBO, who would then be able to disseminate that information rapidly in order to provide accurate targeting coordinates for remote fire support teams. The GBO will also be able to send their own information via Strikelink when necessary and an operator will be able to determine targeting coordinates for fire support missions. Adding an HRI Payload to a SUAS such as the ScanEagle will also allow the tactical warfighter to have an organic asset that can be readily deployed when needed to acquire images OTH. Using a SUAS for ISR purposes will also greatly reduce personnel risk and reduce the burden on other human resources.

The performance of the HRI Payload on the Rascal 110 is expected to be similar to the Pennsylvania State test with the TigerShark and the manned test flights whose images are currently stored on WebGRIM. The only possible hindrance is that images from the HRI Payload may prove to have a greater degree of error when used for targeting due to the Rascal 110 being a much smaller and lighter aircraft and will be affected more by atmospheric turbulence. The HRI testing on the TigerShark proved that there will be some images that are blurred due to weather effects on a smaller aircraft and the result on an the even smaller and lighter Rascal 110 remains to be determined.

## 2. Limitations

One weakness of the NAVSYS HRI Payload is that it is not attached to a gimbal. A gimbal is a pivoted support that allows the rotation of an object about a single axis. This will prevent the HRI Payload from being rotated to image a target area and restricting it to only image the area directly below it. This constraint will require the SUAS to be directly above the targeted area to take images, thereby making it difficult to use for ISR purposes.

One of the main requirements in order to achieve good validation information is to have good truth surveyed locations. The images from any of the flight tests will require surveyed truth values near the location of the target area to provide good validation results of the targeting solutions. Therefore, accurate testing and results should be proven prior to sending a SUAS to a combat zone, since testing in the combat area and surveying truth locations can be extremely difficult or impossible to produce. Figure 25 is a screenshot of displaying surveyed truth locations near the chosen target area GC13.

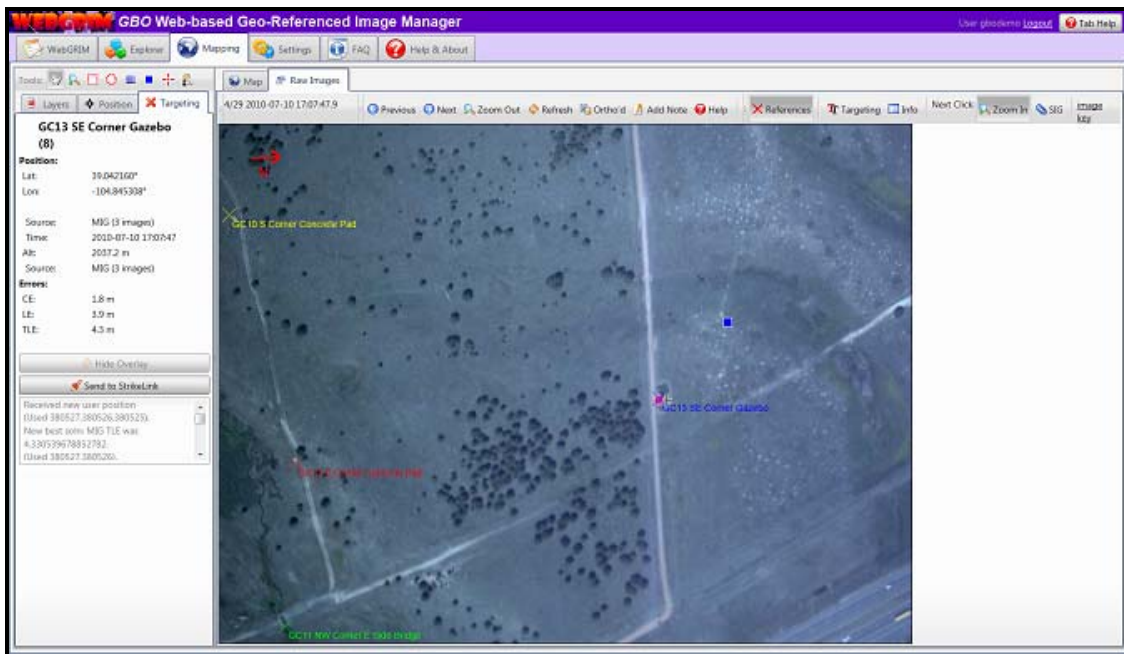

Figure 25. Screenshot of GC13 Corner Gazebo with Surveyed Truth Locations

The SUAS will inevitably be used in a combat area and be relied upon for precise targeting coordinates. Furthermore, there is no absolute way to predict when and where you may need to use the SUAS and there is no easy way to be able to gain truth surveys at every location in world. Another limitation is the weather. Inclement weather conditions can also impinge on a UASs surveillance capability, especially a SUAS equipped with only an Electro Optical (EO) camera and Forward Looking Infrared Radar (FLIR), because cloudy conditions and high humidity climates can distort the imagery produced by EO and FLIR equipment (Haddal & Gertler, 2010). The weather, therefore, may make the use of a SUAS impossible for targeting purposes depending on its severity.

Lastly, the cost of producing and operating a SUAS with all the equipment and support personnel may prove to be equivalent if not more than a manned aircraft. The SUAS may perhaps cost less to procure but can have a much greater life cycle cost than a manned aircraft that is available to perform the mission today. Admittedly though, the SUAS cost may be offset since it does give the added benefit of keeping personnel at a greater distance from danger and there can be no value placed on lives saved.

THIS PAGE INTENTIONALLY LEFT BLANK

### **III. RF NOISE INTERFERENCE ON GPS COMPONENTS**

The use of personal and portable Radio Frequency (RF) gadgets within the last few years has increased dramatically and technology has ushered in a new era of mobile communications devices. This has helped the explosive growth of communications equipment that can conform to multiple standards and gave rise to interesting challenges in terms of designing RF systems themselves. Furthermore, all the components such as the CPU's, power supplies, and other electronic systems that incorporate the system all produce RF noise. The initial testing of the modified NAVSYS Rascal SUAS payload showed that RF noise had significantly reduced the signal to noise ratio (SNR) input to the onboard GPS antenna. The RF noise factor therefore needs to be addressed for proper operation of the entire system. Understanding the impact of RF noise on the components and how it affects the overall system and its limitations is an important aspect of the project and the design process.

The radio frequency ranges in today's modern civilian and most COTS RF systems generally operate in 900 MHz to 2.4 GHz frequency range. For infrared (IR) systems the frequency ranges are much higher (Mehrotra & Sangiovanni-Vincetelli, 2010). The noise encountered by the NAVSYS GBO Payload was within this range and affected both Global Positioning System (GPS) channels L1 and L2 signals. Each GPS satellite transmits two carrier signals in the microwave range, designated as L1 and L2 (frequencies located in the L-Band between 1000 and 2000 MHz). Civil GPS receivers use the L1 frequency with 1575.42 MHz (wavelength 19.05 cm). The L1 frequency carries the navigation data as well as the standard positioning (SPS) code. The L2 frequency (1227.60 MHz, wavelength 24.45 cm) only carries the P code and is only used by receivers which are designed for precision positioning code (PPS). This can predominantly be found in military receivers. There is also the newer L5 signal transmitted at 1176 MHz's. The carriers are modulated with the binary Coarse/Acquisition Code (C/A) for civilian use which modulates the L1 carrier signal. The P code is for military use only modulates both the L1 and L2 carriers and the navigation data message. The C/A code transmits data at 1.023 million chips per second,

the P code 10.23 million chips per second. A “chip” is a measure of the speed with which encoding elements are generated in Direct Sequence Spread Spectrum (DSSS) signals. The P code can be encrypted to form P(Y) code for military equipment loaded with the decryption key. Figure 26 is the composition of the several GPS signals.

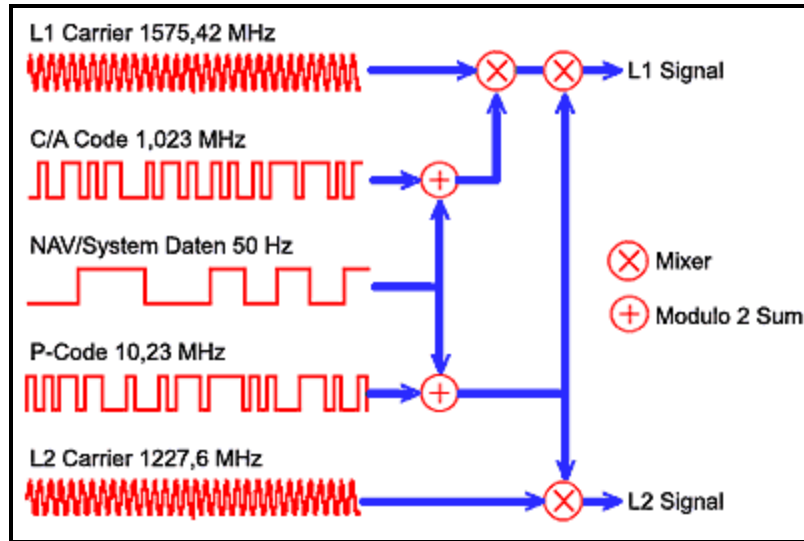

Figure 26. Composition of the GPS Signals

#### A. ANTENNA NOISE INTERFERENCE ON THE GPS MODULE OBSERVATIONS

It was discovered during the NAVSYS troubleshooting phase that disconnecting the antenna cable from the systems onboard antenna followed by connecting the cable to a remote-mounted antenna, the system quickly detects and tracks 10–12 GPS satellites on both the civil L1 and military L2 signals. If the antenna cable were connected to the onboard antenna the signal drops entirely and the module cannot detect any GPS satellite signals. The average signal-to-noise ratio was measured to be in the vicinity of 49 dB Hz on L1 while connected to an external mounted antenna but drops to 39 dB Hz when connected to the onboard antenna. This would seem to substantiate that the interference was coming from other components within the GI-Eye module itself and not from an external source. The components are now closer to each other as per Figure 27 and no longer have the same type of shielding and distance from the original configuration. The

original system worked well during the manned flight tests and therefore it can be assumed that the new layout of the components may be causing the interference between each other and affecting the antenna directly.

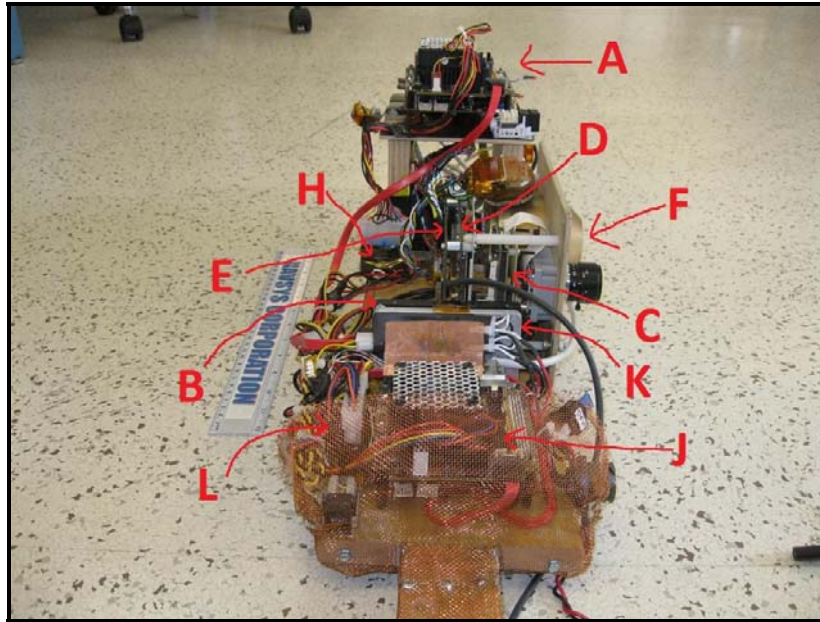

Figure 27. NAVSYS SUAS Modified Payload (rear view)

It was also noted during troubleshooting that if a hand is placed on top of the “L” Versalogic computer, there is an immediate 3 dB Hz gain in signal strength. The system is sensitive to slight movements of the magnetic field which substantiates that “in a highly integrated transceiver, switching signals from digital portions of the circuit can couple into the sensitive RF circuit nodes and directly degrade the overall signal to noise ratio (Mehrotra & Sangiovanni-Vincetelli, 2010).” It is proven that both careful design and layout techniques can minimize the effect of this noise coupling but unfortunately the limitations in size and space of the functional requirement did not allow for much tolerance in the layout design. Furthermore, it is well known in military cases that the GPS signals are absolutely vulnerable to both interference due to noise and jamming. The noise interference can be divided into three main categories of coupling, electrical, and the flicker or 1/frequency noise elements.



## **1. Interference from Digital Coupling**

The main source of noise in a vastly integrated transceiver such the GPS Module was most likely due to the switching signal from digital portions of the circuit that are coupling into sensitive RF circuit nodes and the GPS antenna. The two combined can raise the noise level, and ultimately degrade the SNR. In addition, the RF noise interference that is coupled in the system can induce unwanted currents, which may cause various unwanted disturbances. Moreover, today's modern high performance integrated circuits, such as microprocessors, have very small feature sizes and are clocked at frequencies well into the GHz range while operating at reduced voltage levels. Although this has improved the ability and performance of modern systems, it has also increased both the amount of RF noise they produce and their susceptibility to RF noise interference. The electrical charge required in transistor switching decreases with relatively smaller integrated transceiver feature sizes. Correspondingly, the energy required to make the device switch is reduced, making it easier to disrupt the circuit with lower RF noise interference signal levels. As the switching speed of the integrated transceivers increases and the supply voltage scales down, the noise margin also becomes smaller. This allows external disturbances to degrade the signal integrity more easily (Hongxia et al., 2011). This is possibly the case with the NAVSYS HRI payload, where the overall system noise went above a threshold and basically jammed the GPS antenna.

Some recommendations to reduce the RF noise interference are to move the GPS antenna away from the main components producing the majority RF noise. This may prove challenging since the design is constrained by the dimensions of the Rascal 110. This may be remedied if tested on a ScanEagle which is a larger UAV with an internal avionics bay. The avionics bay allows seamless integration of new payloads and sensors to meet emerging customer requirements, and ensures the vehicle will be able to incorporate the latest technology as it becomes available. Therefore the ScanEagle may provide better noise shielding for the components. Another is to separate the power supply and ground for the digital and RF portions of the system, and by using a large bypass capacitance to remove any unwanted high frequency signals on the supply network and by making the resistance of the power supply to the RF portions very low

(Mehrotra & Sangiovanni-Vincetelli, 2010). In addition, minor items such as offsetting the switching voltage, using Schmidt triggering devices or bus hold circuitry, increasing the signal to noise ratio, and adding input/output buffers to the circuit, could be applied to improve the noise immunity, but these techniques are not generally used in the simple digital circuit systems.

## **2. Electrical Noise**

Another type of noise that may have a detrimental effect on the system performance is electrical noise. Electrical noise is intrinsic to all electronic devices that encompass the entire system itself. The discrete nature of the charge transfer gives rise to shot noise whenever the current crosses a potential barrier (Mehrotra & Sangiovanni-Vincetelli, 2010). Electrical noise may account for some interference in the overall system performance but it is highly unlikely that the GPS antenna attenuation was caused by it.

## **3. Flicker or 1/f Noise**

The last source of noise from the system devices is the flicker or 1/f noise. This noise originates from the random capture and release of charge surface impurities. The surface impurities can differ depending on the materials used to design the device and can be difficult to isolate. Therefore, due to the noise generation method, noise power from spectral density is typically much larger for lower frequencies than higher frequencies (Mehrotra & Sangiovanni-Vincetelli, 2010). The noise power spectral density for this process is given by the equation

$$S_{\chi\chi,\text{flicker}}(\omega) \propto 1/\omega^b$$

where  $b$  is 1 for the typical flicker noise processes and  $\omega$  is the angular frequency. It is also unlikely that the GPS antenna noise stems from the flicker since the HRI Payload was already tested on a manned aircraft on a previous design where it functioned and operated normally. It is only a slight possibility since the components of the HRI system are now closer together and new materials may have been introduced that are reacting with the high frequency operations in the system.

## B. GPS SIGNAL VULNERABILITIES

The use of GPS as part of the targeting solution is an integral piece of the NAVSYS HRI payload targeting system. It also was required on the TigerShark during the Pennsylvania State test. Therefore, the continued operational signal from GPS and its accuracy is vital to proper operation of the system. This ensures that an accurate targeting solution can be achieved from the HRI imagery taken from the SUAS. Thus, another challenge in producing an SUAS that can deliver accurate targeting data for the warfighter is to ensure GPS availability or the systems proper operation in a GPS denied environment. The NAVSYS HRI Payload is completely dependent on the proper operation of its GPS module and is an example where the system failed to properly operate due to its internal RF noise interference. This example can be useful knowledge in the military case since the GPS signal can be lost due to several reasons stemming from several sources such as the operational environment, jamming, and weather, which can all lead to failure of the HRI targeting system or possible loss of the SUAS entirely.

The proliferation of GPS use has not gone unrecognized by the DoD and civilian leadership. More importantly, our reliance on GPS has not gone unrecognized by our enemies, foreign and domestic, proven by the increase in civilian and military grade GPS jammers. Commercial GPS receivers contain vulnerabilities that military GPS receivers do not. These vulnerabilities include: when they are being jammed-they die, they may report false positions, and they may broadcast their position without the user knowing which can be used to target the user. The C/A Pseudorandom codes are composed of 37 distinct “Gold Codes” which are well known and easily duplicated by someone interested in spoofing a GPS signal. The C/A P/N code repeats once every 1ms, which is extremely weak when compared to the P(Y) code which repeats once every week. Overall, the largest vulnerability in the GPS system can be attributed to the massive free space losses of the signal before it reaches the receiver. Using the free space loss equation, we can see just how much signal loss occurs from a GPS satellite to a terrestrial receiver.

$$\text{Example L1 Free space path loss} = \left( \frac{4\pi df}{c} \right)^2 = 1.77 \times 10^{18}$$

$$10\text{Log}_{10}(1.77 \times 10^{18}) = 182.5\text{dB}$$

where  $d$  = distance from transmitter to receiver (20, 186km)

$f$  = the signal frequency

$c$  = the speed of light

### **C. SUAS GPS JAMMING VULNERABILITY**

Satellites operate at extreme distances from the earth, which results in signal free space losses in excess of 160dB. This means that if a satellite using 10W of power to transmit a signal it will suffer enough free space loss by the time the signal is received at the terrestrial receiver that it is reduced down to the micro-pico watt level. This is an extraordinarily small amount of power at the GPS receiver. Terrestrial transmitters can produce much more power without the restrictions of size, weight, and power (SWaP) such as aircraft or spacecraft, i.e. an airborne jammer platform, but the jammer would have to overcome the free space losses in addition to the Direct Sequence Spread Spectrum (DSSS) coding gains in the satellite receiver to have any effect.

GPS jamming is accomplished through downlink jamming (i.e., to jam the receiver of the GPS unit). This makes it difficult to deny GPS to all users, but very easy to jam a select number of users in a geographic area such as an SUAS operating in a hostile environment. GPS receiver antennas usually face the sky and have very low gain and directivity leaving them much more vulnerable to jamming when compared to other satellite communications which incorporate directional antennas and beamforming.

The GPS signal has two levels of spectrum spreading: publicly available C/A code and high restrictive P code. The C/A code signals have about 40dB of A/J protection using open codes which still allows jamming with relatively weak signals. P code signals have an additional level of spectrum spreading and use secure codes, so they have an additional 40dB of A/J protection. Thus a jamming signal must have enough power to overcome 80 dB of A/J protection and still create adequate J/S. (Adamy, 2004)

GPS Jamming techniques will vary depending on variables such as the jammer power, operating frequencies and bandwidth, antenna design, location with respect to the target GPS receivers, and operator proficiency. The jammer operator will have to choose a technique which he/she thinks will achieve the greatest probability of disrupting the target signal. “The goals of a jammer are to deny reliable communications to his adversary and to accomplish this at minimum cost (Sklar, 2009).” In attempting to jam an SUAS GPS module the jammer will have the best effect in jamming the area of operations via spot jamming or continuous wave jamming. GPS Jamming techniques fall under denial jamming, deception jamming, and electromagnetic interference. Denial jamming includes continuous wave and broadband noise. Deception jamming includes repeater and spoof jamming.

Continuous wave (CW) jamming, otherwise known as spot jamming, or partial band jamming (PBN): consists of a jammer transmitting over a partial band (L1, L2, or L5) in an attempt to try and gain a superior Jammer to Signal (J/S) ratio at the target GPS receiver and produce a favorable anti-jam margin which results in an increased bit error rate (BER) at the GPS receiver and an useable navigation signal. Ultimately, the jammer would break all satellite locks and the receiver would fail to operate. If the jammer operator sweeps the CW signal, it falls under broadband noise (BBN) jamming. Because GPS frequencies and modulation schemes are well known, PBN jamming will have a higher success rate than using PBN to jam and unknown signal. The disadvantage to PBN jamming is that the jammer has to overcome the processing gains of spread spectrum.

Broadband noise jamming (BBN), otherwise known as barrage jamming: BBN jammers transmit Gaussian random noise over a limited broad bandwidth ( $W_{ss}$ ). Since the jammer knows the GPS satellite is using a DSSS with a P/N code, the goal is to cover the GPS spread spectrum bandwidth ( $W_{ss}$ ) with a higher power Gaussian noise to gain a superior J/S and increase the BER in the receiver resulting in an unusable signal. For a wide bandwidth the jammer chooses, there is a fixed power for the jammer. If he intends to jam the entire  $W_{ss}$  of the signal, his overall power will also be spread and essentially lowered for individual bands. The advantage of this, especially with GPS, is that the

closer he gets to the receiver with the jammer, the less free space loss and the greater J/S ratio gained- which is much closer when compared to the distance from the satellite. The disadvantage is he has to have enough jammer power to jam over the entire  $W_{ss}$  while overcoming the processing gains of the C/A code.

Repeater and spoof jamming are more complex than denial jamming. Repeater jamming takes place when a jammer is setup to receive a real GPS signal and re-transmit the same signal. The receiver would lock onto the repeater signal and result in a fully operational receiver giving false or erroneous navigation data to the user. GPS spoof jamming entails a satellite simulator that can duplicate the C/A gold codes and “appear” to be multiple legitimate satellites. Spoof jamming is extremely dangerous for a user because the jammer operator could potentially setup a simulator to intentionally lead the target receiver/user into a pre-planned geographic location or a sea or airborne asset into deadly obstacles. Deception jamming is much more complicated than denial jamming. A person would have to either design or build a satellite simulator or buy or steal one. Stealing a simulator is very possible because many organizations who design systems reliant on GPS have satellite simulators for research and evaluation purposes. Building a simulator takes much more expertise.

#### **D. ANTI JAMMING SOLUTIONS AND TECHNIQUES**

The most obvious solution to GPS jamming is to return to the older tested and proven methods that were used prior to GPS. One example is the use of the RQ-11 Raven SUAS. It does not require GPS and instead can be remotely operated using image based mensuration depending on the pilots knowledge of the terrain via an onboard EO camera. The Raven is launched by hand, thrown into the air like a free flight model airplane. The Raven lands itself by auto-piloting to a pre-defined landing point and then performing a near-vertical (1 foot down for every 1 foot forward) “Autoland” descent. The Raven can provide day or night aerial intelligence, surveillance, target acquisition, and reconnaissance with a range of approximately 10 km and a flight endurance time of 60–90 minutes.

Another solution is to produce an HRI Payload that is capable of conducting Terrain Contour Matching (TERCOM) or Digital Scene Matching Area Correlation (DSMAC) similar to the capabilities of the older Tomahawk Land Attack Missile (TLAM). In TERCOM, a digital representation of an area of terrain is mapped based on digital terrain elevation data or stereo imagery. This map is then inserted into a TLAM mission followed by loading onto the missile. When the missile is in flight it compares the stored map data with radar altimeter data collected as the missile overflies the map. Based on comparison results the missile's inertial navigation system is updated and the missile corrects its course. In DSMAC a digitized image of an area is mapped and then inserted into a TLAM mission. During the flight the missile will verify that the images that it has stored correlate with the scene it monitors below it. Based on comparison results the missile's inertial navigation system is updated and the missile corrects its course.

The most prevalent anti-jam technique is the use of DSSS. The problem with DSSS and civilian GPS use is the single L1 frequency and weak C/A code. If a more robust P/N code were available for civilian use, this would increase the gains and decrease the J/S in the case of a jamming attempt. A second or third carrier for the GPS receiver to hop between would also make it more difficult to jam by forcing the jammer to distribute his power over more frequencies. Using the satellite downlink jamming equation to calculate Processing Gain:

$$G_p = \frac{W_{ss}}{R}$$

where  $G_p$  = Processing Gain

$W_{ss}$  = Spread Spectrum Bandwidth

R = Data Rate

GPS uses two different Gold spreading codes, namely C/A code and P code with the rate of  $1.023 \times 10^6$  bit/s and  $10.23 \times 10^6$  bit/s respectively. P code is exclusive for military and does not open to the civil use. In addition, the navigation message data rate is 50 bit/s. According to the spreading gain formula, the C/A code and P code of spreading gain can be calculated [7].

For C/A code, there is

$$G_{C/A} = \frac{1.023 \times 10^6}{50} = 20460 = 43dB \quad (2)$$

For P code, there is

$$G_P = \frac{10.23 \times 10^6}{50} = 204600 = 53dB \quad (3)$$

Figure 28. GPS Gold Spreading Codes (From Sklar, 2009)

GPS receiver antennas are extremely polarization independent. The only requirement is to point the antenna to an open portion of the sky. The signal polarization is determined by how the GPS signal departs the satellite antenna. Specifically, the orientation of the electric field as it travels through space. Common polarizations include vertical, horizontal, and circular. GPS receivers are oriented in all directions so the antennas are designed to receive a signal independent of orientation other than perpendicular to the earth's surface. It is not practical to transmit GPS signals in a highly directional manner because the signal is used by so many customers spread out over enormous geographic areas. For critical systems where the risk of jamming would result in serious losses, antenna polarization would be a viable anti-jam capability but the system antenna would either have to be stationary or have a pointing capability. Array antennas could also be used to achieve higher gains collectively through multiple antennas pointed electronically or mechanically towards the transmitting satellite. Additionally, incorporating an angle of arrival (AoA) detection capability into GPS receiver antennas could help prevent deception jamming such as spoofing by alerting the receiver that the signal is coming from a different direction from the known satellite location.



Another mitigation technique is to incorporate an entirely new back-up system. eLoran is a high-powered navigation system that was proven to successfully mitigate maritime GPS jamming during the General Lighthouse Authorities maritime jamming trials. While ships only using GPS showed a position 22 km from their actual position, those using eLoran maintained precise navigational data.

## **IV. RECOMMENDATIONS AND CONCLUSION**

### **A. CONCLUSIONS**

The test of the NAVSYS HRI Payload on a manned aircraft mission demonstrated that the captured images will be beneficial in getting precise and accurate targeting solutions. Furthermore, a GBO or tactical warfighter on the ground will find it useful to incorporate the new targeting architecture proposed by NAVSYS with an SUAS and WebGRIM to help them develop better targeting solutions. The WebGRIM program was easily accessible from any computer connected to the Internet allowing for less weight to be deployed with the GBO or tactical warfighter. WebGRIM also proved that it can readily collect real time imagery from an aircraft and provide targeting solutions rather quickly. The three options for targeting SIG, MIG, and GBO Range all were utilized and each provided beneficial targeting data. The use of MIG provided the best targeting solutions amongst the three methods by quickly reducing the TLE to less than 10 meters to meet the USMC's standard for targeting requirement.

The SUAS test with the Rascal 110 was not completed due to the RF noise attenuation of the GPS antenna, therefore it remains to be seen if the HRI Payload will operate similarly to the manned aircraft test. It can be assumed that the overall TLE for the targeting solutions may be higher due to the typical movement of a SUAS vice a larger aircraft that are more stable during flight. Regardless, the TLEs that can be calculated with imagery from a SUAS can still be reduced to less than the 10 meter requirement per the USMC for targeting standard. A SUAS, due to its weight and durability, equipped with an HRI payload will undoubtedly be an important asset to the tactical warfighter. The system will give them the ability to see OTH and produce real time images that can support and produce targeting solutions for distant fire support.

Lastly, the testing of the NAVSYS HRI Payload on the Rascal 110 SUAS should commence immediately upon determination and repair of the RF noise problem in the system. The sooner the systems are tested the sooner we can determine the actual performance and feasibility of the new targeting architecture and method.

## **B. RECOMMENDATIONS**

One of the objectives of this research was to compare and determine the differences in accuracies between the targeting solutions calculated by WebGRIM with images from a manned flight versus those captured with an SUAS. Unfortunately due to the RF noise interference on the GPS module of the NAVSYS HRI Payload the test was not conducted in time for this thesis. Testing can be shifted from the Rascal 110 to the larger ScanEagle to determine if the noise issues persist with the dimensions of the larger UAV. Future testing of the HRI payload in a SUAS is recommended once the RF noise issues are resolved.

The WebGRIM program has numerous other features not mentioned in this thesis that could be of benefit to the tactical warfighter. This thesis only touched upon the targeting aspect of the program but other features such as the ability to mosaic images to produce one seamless map and using differential GPS (DGPS) data to increase the accuracy can be further researched.

To conclude, another recommendation is to determine an efficient method for gathering truth surveys worldwide. This will allow for a compilation of accurate truth tables for the use of HRI support at any moment throughout any theater of operations.

## LIST OF REFERENCES

- AltiMap geomosiacs from digital imagery*. (n.d.). Retrieved from 2d3 Sensing website: <http://www.2d3.com/product/?v=22>
- Cot/XML standard for the U.S. military*. (2011, January 8). Retrieved from Twextra website: <http://twextra.com/1qh81>
- Bockius, B. (2010). *WebGRIM 3.0 description*. Colorado Springs, CO: NAVSYS Corporation.
- Brown, A. (2010). *Target location technology for ground based observers (TLGBO)*, [Powerpoint Presentation]. NAVSYS Corporation, Colorado Springs, CO.
- Haddal, C. C., & Gertler, J. (2010, July 8). *Homeland security: Unmanned aerial vehicles and border surveillance* (Congressional Report No. RS21698). Washington, DC: Library of Congress Congressional Research Service. Retrieved from Open FAS website: [www.fas.org/sgp/crs/homesec/RS21698.pdf](http://www.fas.org/sgp/crs/homesec/RS21698.pdf)
- Jones, K. D., et al. (2011). *Cooperative autonomy for the masses fundamental steps toward enabling complex multi-asset missions with simple point-and-click tasking*. (AUVSI 2011). Washington, DC:AUVSI.
- Kiser, W. L. (2010). *Experiment C.8 Phoenix tactical mapping system: Real time geo-referencing and orthorectified mapping from a TigerShark UAS*. (QLR TNT 11-2 Report). Naval Postgraduate School, Monterey, CA.
- Laliberte, A. S. (2010). *Remote sensing of rangelands with unmanned aircraft*. Retrieved from United States Department of Agriculture website: [http://usda-ars.nmsu.edu/presentations.html#remote\\_sens](http://usda-ars.nmsu.edu/presentations.html#remote_sens)
- Mehrotra, A, & Sangiovanni-Vincentelli, A. (2010). *Noise analysis of radio frequency circuits*. Boston: Kluwer Academic Publishers.
- Satellite Imaging Corporation. (n.d.). *Orthorectification*. Retrieved July 24, 2011, from website: <http://www.satimagingcorp.com/svc/orthorectification.html>
- Sklar, B., (2009). *Digital communications fundamentals and applications*. Upper Saddle River, NJ: Prentice Hall PTR.
- VideoBank*. (n.d.). *Timeline Interface*. Retrieved September 3, 2011, from VideoBank Digital website: <http://www.videobankdigital.com/products-timeline.asp>
- Wang, H., et al. *Electromagnetic interference and digital circuits: An initial study of clock networks*. Retrieved from <http://www.ece.umd.edu-blj/papers/em26-1.pdf>

THIS PAGE INTENTIONALLY LEFT BLANK

## INITIAL DISTRIBUTION LIST

1. Defense Technical Information Center  
Ft. Belvoir, Virginia
2. Dudley Knox Library  
Naval Postgraduate School  
Monterey, California
3. Dr. Kevin Jones  
Naval Postgraduate School  
Monterey, California
4. Dr. Raymond Buettner  
Naval Postgraduate School  
Monterey, California
5. Dr. Alison Brown  
NAVSYS Corporation  
Colorado Springs, Colorado
6. Bruce Bockius  
NAVSYS Corporation  
Colorado Springs, Colorado
7. Reece Tredway  
NAVSYS Corporation  
Colorado Springs, Colorado
8. Marc Quigley  
NAVSYS Corporation  
Colorado Springs, Colorado