



**Calhoun: The NPS Institutional Archive**

---

Theses and Dissertations

Thesis Collection

---

2011-09

## Smart fires a COTS approach to tactical fire support using a smartphone

Oregon, Rogelio S.

Monterey, California. Naval Postgraduate School

---

<http://hdl.handle.net/10945/5469>



**DUDLEY  
KNOX  
LIBRARY**

Calhoun is a project of the Dudley Knox Library at NPS, furthering the precepts and goals of open government and government transparency. All information contained herein has been approved for release by the NPS Public Affairs Officer.

**Dudley Knox Library / Naval Postgraduate School  
411 Dyer Road / 1 University Circle  
Monterey, California USA 93943**

<http://www.nps.edu/library>



**NAVAL  
POSTGRADUATE  
SCHOOL**

**MONTEREY, CALIFORNIA**

**THESIS**

**SMART FIRES: A COTS APPROACH TO TACTICAL FIRE  
SUPPORT USING A SMARTPHONE**

by

Rogelio S. Oregon

September 2011

Thesis Co-Advisors: Douglas J. MacKinnon  
John H. Gibson

**Approved for public release; distribution is unlimited**

THIS PAGE INTENTIONALLY LEFT BLANK

REPORT DOCUMENTATION PAGE		Form Approved OMB No. 0704-0188	
Public reporting burden for this collection of information is estimated to average 1 hour per response, including the time for reviewing instruction, searching existing data sources, gathering and maintaining the data needed, and completing and reviewing the collection of information. Send comments regarding this burden estimate or any other aspect of this collection of information, including suggestions for reducing this burden, to Washington headquarters Services, Directorate for Information Operations and Reports, 1215 Jefferson Davis Highway, Suite 1204, Arlington, VA 22202-4302, and to the Office of Management and Budget, Paperwork Reduction Project (0704-0188) Washington DC 20503.			
1. AGENCY USE ONLY (Leave blank)	2. REPORT DATE September 2011	3. REPORT TYPE AND DATES COVERED Master's Thesis	
4. TITLE AND SUBTITLE SMART Fires: A COTS Approach to Tactical Fire Support Using a Smartphone		5. FUNDING NUMBERS	
6. AUTHOR(S) Rogelio S. Oregon		8. PERFORMING ORGANIZATION REPORT NUMBER	
7. PERFORMING ORGANIZATION NAME(S) AND ADDRESS(ES) Naval Postgraduate School Monterey, CA 93943-5000		10. SPONSORING/MONITORING AGENCY REPORT NUMBER	
9. SPONSORING /MONITORING AGENCY NAME(S) AND ADDRESS(ES) N/A		11. SUPPLEMENTARY NOTES The views expressed in this thesis are those of the author and do not reflect the official policy or position of the Department of Defense or the U.S. Government. IRB Protocol number _____NA_____.	
12a. DISTRIBUTION / AVAILABILITY STATEMENT Approved for public release; distribution is unlimited		12b. DISTRIBUTION CODE A	
13. ABSTRACT (maximum 200 words)  Communications in wartime are critical. The United States Marine Corps communicates well using a variety of radios, each for a specialized and limited purpose. However, the USMC could potentially benefit from the exploration of combining communication capabilities in a single device by leveraging commercial off-the-shelf software and expanding the existing network infrastructure. This thesis seeks to resolve this gap in capabilities by providing a fire support application prototype that serves as a proof-of-concept for rapidly developable applications that would have an immediate positive impact, providing enhanced warfighter capabilities. If successful, this application could be further developed and fielded, and thus improve warfighting capabilities and inform future efforts in an effort to accomplish improved network management and the efficient use of existing and future communication technologies.			
14. SUBJECT TERMS AFATDS, Android programming, call for fire, cellular networks, fire support coordination, Fire Support Team, forward observer, future systems, Joint Communications Battle-Platform, military wireless communication, smartphone, tactical fire support, Android development		15. NUMBER OF PAGES 149	16. PRICE CODE
17. SECURITY CLASSIFICATION OF REPORT Unclassified	18. SECURITY CLASSIFICATION OF THIS PAGE Unclassified	19. SECURITY CLASSIFICATION OF ABSTRACT Unclassified	20. LIMITATION OF ABSTRACT UU

THIS PAGE INTENTIONALLY LEFT BLANK

**Approved for public release; distribution is unlimited**

**SMART FIRES: A COTS APPROACH TO TACTICAL FIRE SUPPORT USING  
A SMARTPHONE**

Rogelio S. Oregon  
Major, United States Marine Corps  
B.S., University of California, Irvine, 1997

Submitted in partial fulfillment of the  
requirements for the degree of

**MASTER OF SCIENCE IN INFORMATION TECHNOLOGY MANAGEMENT**

from the

**NAVAL POSTGRADUATE SCHOOL  
September 2011**

Author: Rogelio S. Oregon

Approved by: Douglas J. MacKinnon  
Thesis Co-Advisor

John H. Gibson  
Thesis Co-Advisor

Dan Boger  
Dean, Graduate School of Operations and  
Information Sciences

THIS PAGE INTENTIONALLY LEFT BLANK

## **ABSTRACT**

Communications in wartime are critical. The United States Marine Corps communicates well using a variety of radios, each for a specialized and limited purpose. However, the USMC could potentially benefit from the exploration of combining communication capabilities in a single device by leveraging commercial off-the-shelf software and expanding the existing network infrastructure. This thesis seeks to resolve this gap in capabilities by providing a fire support application prototype that serves as a proof-of-concept for rapidly developable applications that would have an immediate positive impact, providing enhanced warfighter capabilities. If successful, this application could be further developed and fielded, and thus improve warfighting capabilities and inform future efforts in an effort to accomplish improved network management and the efficient use of existing and future communication technologies.



THIS PAGE INTENTIONALLY LEFT BLANK

## TABLE OF CONTENTS

I.	INTRODUCTION .....	1
A.	PROBLEM AND MOTIVATION .....	2
B.	OBJECTIVES .....	4
C.	RESEARCH QUESTIONS .....	6
D.	SCOPE AND LIMITATIONS .....	7
E.	THESIS ORGANIZATION .....	8
II.	BACKGROUND .....	11
A.	WHY SMARTPHONES .....	11
B.	MARINE CORPS FIRE SUPPORT .....	17
1.	Marine Unit Organization .....	18
2.	Marine Fire Support Organizations .....	19
a.	<i>Composition</i> .....	20
b.	<i>Communications</i> .....	21
C.	CFF PROCESS .....	28
1.	Process Flow .....	29
2.	CFF Savvion™ Model .....	32
a.	<i>As-Is Process</i> .....	32
b.	<i>To-Be Process</i> .....	34
c.	<i>Savvion™ Results</i> .....	36
III.	SMARTPHONE INTEGRATION .....	37
A.	PREVIOUS EFFORTS .....	37
1.	Commercial Integration .....	37
a.	<i>General Dynamics</i> .....	38
b.	<i>Lockheed Martin</i> .....	39
c.	<i>Raytheon</i> .....	40
2.	DoD Efforts .....	41
a.	<i>Tactical NAV</i> .....	41
b.	<i>CSDA</i> .....	43
c.	<i>FIST</i> .....	45
B.	SELECTION OF THE ANDROID PLATFORM .....	46
C.	ANDROID ARCHITECTURE .....	49
1.	Linux Kernel .....	50
2a.	Libraries .....	51
2b.	Android Runtime .....	51
3.	Application Framework .....	52
4.	Applications .....	53
D.	ANDROID-TO-USER REQUIRMENTS ANALYSIS .....	53
1.	Fire Support Man METL .....	54
2.	Smartphone Assistance for METs .....	55
a.	<i>Smartphone Features</i> .....	55
b.	<i>Evaluation of Support</i> .....	56

E.	RAPID DEVELOPMENT DEFINED .....	59
1.	User Involvement .....	59
a.	<i>Rapid Application Development</i> .....	60
b.	<i>Rapid Development for Applications</i> .....	61
c.	<i>App-boards</i> .....	63
F.	DEVELOPMENT ENVIRONMENT .....	65
1.	JDK .....	66
2.	Eclipse™ IDE .....	66
3.	Android SDK Starter .....	67
4.	ADT Plug-in for Eclipse .....	68
G.	CREATING WITH COMMONWARES REFERENCE .....	68
IV.	SMART FIRES DESIGN .....	71
A.	DESIGN PLAN .....	71
1.	Requirement to Processes .....	71
2.	User GUI Design .....	73
B.	SMART FIRES PROTOTYPE GUI .....	80
V.	RESULTS, CONCLUSIONS, AND RECOMMENDATIONS .....	83
A.	RESULTS .....	83
1.	TRANSITION TO TACTICAL CELLULAR NETWORK. ....	84
2.	ASSIST THE WARFIGHTER IN INTEGRATING COMMON TACTICAL PICTURE (CTP) .....	84
3.	EFFECTIVE COTs DEVELOPED APPLICATIONS .....	85
B.	CONCLUSIONS .....	86
C.	RECOMMENDATIONS .....	87
1.	AFTADS Integration .....	87
2.	Use of Augmented Reality .....	87
D.	FUTURE WORK. ....	88
1.	SMART Product Line Architecture .....	89
2.	SMART Range Finder .....	89
3.	SMART Simulation .....	90
APPENDIX A	.....	91
APPENDIX B	.....	93
APPENDIX C	.....	95
APPENDIX D	.....	97
APPENDIX E	.....	99
APPENDIX F	.....	101
APPENDIX G	.....	103
APPENDIX H	.....	105
APPENDIX I	.....	111
APPENDIX J	.....	113

APPENDIX K .....117  
LIST OF REFERENCES .....121  
INITIAL DISTRIBUTION LIST .....127

THIS PAGE INTENTIONALLY LEFT BLANK

## LIST OF FIGURES

Figure 1.	Commercial cellular MSC-BSC architecture (From Dixon, 2010).....	15
Figure 2.	OpenBTS architecture (From Dixon, 2010).....	16
Figure 3.	Artillery-to-maneuver tactical organization and support relationships.....	19
Figure 4.	AN/PRC-150(C) High Frequency Manpack (From Harris Corporation, 2011).....	22
Figure 5.	AN/PRC-117F (C) Multi-Band Multi-Mission Manpack Radios (From Harris Corporation, 2011)..	23
Figure 6.	AN/PRC-148 V2(C) Multi-Band Inter/Intra Team Radio, (left) and AN/PRC-152 Multi-Band Multi-Mission Handheld Radios (right) (From Harris Corporation, 2011).....	24
Figure 7.	On the left the AN/PSC-2 Digital Communications Terminal (From Ebay, 2011) and on the right the AN/PSC-13 Dismounted-Data Automated Communications Terminal (From Scott, 2006).....	27
Figure 8.	AN/GYK-47 (V) Advanced Field Artillery Tactical Data System (From PM FATDS, 2004).....	28
Figure 9.	Savvion™ Model of the As-Is voice CFF process...	33
Figure 10.	Savvion™ Model of the To-Be digital CFF process using the SMART Fires application.....	35
Figure 11.	The GD300 is a ruggedized wearable computing platform using the Android Open Operating System (From General Dynamics, 2011).....	39
Figure 12.	Handheld portion of the MONAX system with MONAX Lynx sleeve with COTS iPhone (From Lockheed Martin, 2010).....	40
Figure 13.	Raytheon's RATS™ smartphone device for military integration (From Raytheon, 2011).....	41
Figure 14.	U.S. Army Application Marketplace (From ARCIC, 2011).....	44
Figure 15.	Diagram of the FIST components and its overall architecture (From Longley, 2010).....	46
Figure 16.	U.S. Smartphone Market Share by OS from February 2010 through January 2011 (From Goldman, 2011).....	47
Figure 17.	Android operating system architecture (From Borenstein, 2008).....	50
Figure 18.	The Rapid Application Development Cycle (From Osmundson, 2011).....	61
Figure 19.	Example of App-board worksheet.....	64

Figure 20.	App-board 1 is the application start-up screen and application initialization menu.....	74
Figure 21.	App-board 2 is the main menu screen and firing agency selection screen.....	75
Figure 22.	App-board 3 is the screen to input the fire support coordination agency and the CFF menu....	76
Figure 23.	App-board 4 shows parts one and two of the four CFF screens.....	77
Figure 24.	App-board 5 shows parts three and four of the four CFF screens.....	78
Figure 25.	App-board 6 illustrates the MTO screen, and the subsequent corrections screen.....	79
Figure 26.	App-board 7 illustrates the RREMS screen, and the remaining screen element for screen #12 in Figure 25.....	80
Figure 27.	These screenshots from the SMART Fires application prototype correspond to the app-board created by the user in Figure 20.....	81
Figure 28.	The Theodolite PRO AR screen provides a variety of positional and directional information for the user (From Hunter Research & Technology, 2011).....	88

## LIST OF TABLES

Table 1.	Current and doctrinal FSCoord nets (After MCDP 3-16, 1999).....	26
Table 2.	The table presents a summary of smartphone utilization and support to the Core METs by Duty Area.....	58
Table 3.	User requirements translated into process requirements by Duty Area (After Thome, 2002)...	72



THIS PAGE INTENTIONALLY LEFT BLANK

## LIST OF ACRONYMS AND ABBREVIATIONS

A4A	Apps for the Army
ACE	Aviation Combat Element
AFATDS	Advanced Field Artillery Tactical Data System
AO	Air Officer
API	Application Programming Interface
AR	Augmented Reality
ARCIC	Army Capabilities Integration Center
Arty LNO	Artillery Liaison Officer
AVD	Android Virtual Device
BFT	Blue Force Tracker
BLT	Battalion Landing Team
C2	Command and Control
C2PC	Command and Control Personal Computer
CAC	Common Access Card
COC	Combat Operation Center
COIN	Counter-Insurgency Operations
COTS	Commercial Off-the-Shelf
CP	Command Post
CSDA	Connecting Soldiers to Digital Applications
CTP	Common Tactical Picture
DARPA	Defense Advanced Research Projects Agency
DDACT	Dismounted Data Automated Communications Terminal
DR	Disaster Relief
DS	Direct Support
FAC	Forward Air Controller
FBCB2	Force Battle21 Command Brigade and Below
FD	Fire Direction
FDC	Fire Direction Center
FDO	Fire Direction Officer

FIST	Field Information Support Tool
FiST	Fire Support Team
FO	Forward Observer
FSC	Fire Support Coordinator
FSCC	Fire Support Coordination Center
FSCOORD	Fire Support Coordination communications network
FSR	Field Service Representative
GCCS-MC	Global Command and Control System-Marine Corps
GCE	Ground Combat Element
GOTS	Government Off-the-Shelf
GPS	Global Positioning System
GS	General Support
GSM	Global Standard for Mobile Communications
GS-R	General Support-Reinforcing
GUI	Graphic User Interface
HA	Humanitarian Assistance
HA/DR	Humanitarian Assistance/Disaster Relief
HF	High Frequency
IDE	Integrated Development Environment
IEEE	Institute of Electrical and Electronics Engineers
IOS	Information-Operations Server
ISR	Intelligence, Surveillance and Reconnaissance
JVM	Java Virtual Machine
JBC-P	Joint Battle Communications-Platform
JTAC	Joint Terminal Air Controller
LAN	Local Area Network
LCE	Logistics Combat Element
MAGTF	Marine Air Ground Task Force
MAN	Metropolitan Area Network
MBITR	Multiband Inter/Intra Team Radios
MDACT	Mobile Data Automated Communications Terminal

MEDEVAC	Medical Evacuation
MET	Mission Essential Task
METL	Mission Essential Task List
MEU	Marine Expeditionary Unit
MGRS	Military Grid Reference System
MILSTD	Military Standard
MIMO	Multiple Input Multiple Output
MOS	Military Occupational Specialty
MRT	Military Ruggedized Tablet
NCO	Noncommissioned Officer
NGLO	Naval Gunfire Liaison Officer
NPS	Naval Postgraduate School
NRL	Naval Research Laboratory
OEF	OPERATION ENDURING FREEDOM
OHA	Open Handset Alliance
OIF	OPERATION IRAQI FREEDOM
OpenBTS	Open Base Transceiver Station
OS	Operating System
PAN	Personal Area Network
PKI	Public Key Infrastructure
PLA	Product Line Architecture
SA	Situational Awareness
SDK	Software development kit
SMART	Smartphone to AFATDS Prototype
TACP	Tactical Air Control Party
TAR	Tactical Air Request
TIGR	Tactical Ground Reporting application
TTPs	Tactics, Techniques and Procedures
UHF	Ultra High Frequency
UMA	Unlicensed Mobile Access
USMC	United States Marine Corps
VHF	Very High Frequency

VM	Virtual Machine
VoWifi	Voice Over Wifi
Wifi	Wireless conductivity traditionally IEEE 802.11 standard for LAN
WiMax	Worldwide Interoperability for Microwave Access, also the wireless conductivity in IEEE 802.16 standard for MAN

## ACKNOWLEDGMENTS

Above all else I would like to thank my wife, Martha, and my children, Anthony, Rogelio and Adelina, for their unconditional love and support. Next, I thank my Thesis Co-Advisors for their patience and guidance in the completion of this research. I would like to thank all the organizations that provided support in the conduct of this study; Marine Instructors Major Baughman and Major Browne from Fort Sill, 1<sup>st</sup> Battalion 11<sup>th</sup> Marines FSC, Marty Almquist and Alonzo Howard at I MEF MISTIC, and my partners in Business Process Re-engineering for helping to create the Savvion™ business model for before and after the SMART Fires application. Finally, I would like to thank my father, Salvador Oregon, for giving me a love of technology and learning.

THIS PAGE INTENTIONALLY LEFT BLANK

## I. INTRODUCTION

On March 21, 2003, during the first days of Operation Iraqi Freedom (OIF), as a member of the 15th Marine Expeditionary Unit (MEU), this researcher's position was attacked by Iraqi paramilitary forces. The attack was against the MEU's forward command post (CP) established at the Iraqi naval port in the southern Iraqi city of Umm Qasr. The attack came as the MEU's ground combat power, the Battalion Landing Team (BLT), attacked north to secure their next objective. This BLT attack left the MEU command post at its most vulnerable—and the enemy paramilitary forces seized the opportunity.

This Iraqi counter-attack was repelled by one BLT rifle company that had been left to secure the MEU CP and protect the Marines, soldiers, sailors of the CP. The attackers subsequently consolidated into a relatively isolated group of buildings previously cleared by the BLT rifle company. In the midst of the attack, the MEU commander authorized the use of the BLT's artillery battery to defend the MEU CP. The target requests were transmitted to the artillery battery by both the MEU staff officers and the BLT rifle company's Artillery Forward Observer via the traditional fire support communication network (i.e., both voice and data communication on Very High Frequency (VHF) radios, one each, voice communications on both Ultra High Frequency (UHF) and High Frequency (HF)). These requests went unanswered by the artillery battery. The situation dictated that every available means be used to communicate enemy targets to the artillery battery in defense of the MEU CP.



This researcher, as a trained Forward Observer, called the artillery battery using the Kuwaiti cellular phone issued for inter-camp coordination prior to the start of OIF. The artillery battery answered the cellular phone call and shifted to support the defense of the MEU CP. As a result, the Iraqi paramilitary force concentrations were repelled and the MEU CP remained secured.

This combat experience posed a question: "Why can the most technologically advanced country on earth not develop a communications device that simplifies the users' actions by consolidating the capabilities of the several required communications devices into one 'smart' device." In combat, the warfighter should ideally carry one *smart* device that can communicate on all required networks and formats, both voice and data, to achieve maximum effectiveness while minimizing equipment.

#### **A. PROBLEM AND MOTIVATION**

As America's Force-in-Readiness, the Marine Corps must remain a rapidly-deployable, lightweight force capable of successfully operating in a variety of contingencies, from humanitarian operations to conventional warfare. The Marine Corps conducts its operations using the Marine Air Ground Task Force (MAGTF) concept.

The goal of the MAGTF is Air-Ground coordination to maximize the effects of the available forces. In conventional combat operations, this is known as the application of combined arms. At the heart of the combined arms concept is the requirement for the Ground Combat Element (GCE) to synchronize and coordinate the available

fire support assets of the MAGTF (MCDP 1.0, 2001). The fire support coordination aspect of Command and Control (C2) is an immensely complex operation that relies heavily on both the communication and coordination skills of the fire-support Marines at the tactical level.

These tactical level warfighters are overburdened by multiple incomplete functional devices that provide single-frequency-spectrum-capable communications without providing any other warfighting functionality,<sup>1</sup> i.e., coordinate fires, track enemy locations, or show friendly maneuver in the vicinity. Instead, there is another device that must be used to display or interact with the information, and that additional device must be tethered to a communications device to retain relevant information.

These additional devices actually increase logistical requirements and decrease combat capabilities by limiting mobility. However, by reducing the communication and logistics requirement of the warfighters, an organization may allow the company and the battalion greater flexibility and mobility. If a single military communication device, modeled after a commercial smartphone, were adapted to provide combat utility with warfighting functional applications, the device could make the user more responsive and lethal in combat.

Therefore, this thesis intends to explore a smartphone application that could be used on a commercially available device that would enable the warfighter the most effective use of all available communication networks to conduct fire

---

<sup>1</sup> MCDP 1-0 defines the six warfighting functions as: command and control, intelligence, maneuver, fires, logistics and force protection.

support. This single device would be able to transmit and receive information over a variety of available networks, including tactical cellular, and could use any required network in order to accomplish the warfighter's needs at the tactical level. This thesis will only consider the use of the application at the tactical level, defined as the Infantry Battalion and below (e.g., Company through Fire Team). The secondary question is then explored: "How can the USMC develop such applications to benefit wartime communications?"

## **B. OBJECTIVES**

The USMC could benefit from improved wartime communications via the exploration of commercial off-the-shelf (COTS) software, hardware, and the existing network infrastructure to begin the development of smartphone applications. This thesis seeks to resolve a gap in capabilities by providing a prototype fire support application that serves as a proof-of-concept for rapidly developed applications that have an immediate positive impact through enhanced warfighter capabilities. This thesis will focus on USMC fire support networks, although the lessons learned will be applicable across the joint services. A wireless backbone for integration with current fire support C2 systems, specifically the Advanced Field Artillery Tactical Data System (AFATDS), will be used as the

point of departure. This will involve the prototyping of a smartphone application to request and deconflict<sup>2</sup> fire support at the tactical level.

Current Naval network research direction, as indicated by Naval Research Laboratory (NRL) Broad Agency Announcement (BAA) 55-09-07, seeks the exploration of commercial standard wireless networks, such as IEEE 802.11 and IEEE 802.16 standards, as extensions to the tactical edge network (Naval Research Laboratory, 2007). This prototype cannot succeed without progress in the adoption of all wireless communication methods to extend the tactical edge of the fire support network. This thesis will further pursue the exploration of any communications paths currently provided via commercial smartphones such as IEEE 802.11 and IEEE 802.16 resident on most devices.

More recent is the Defense Advanced Research Projects Agency (DARPA) research direction published as BAA 10-41 (DARPA, 2010). The BAA titled *Transformative Apps*, called for "innovative research in the area of tactical application development, evaluation and enhancements...to place the right mobile software applications ("apps") into the hands of the warfighter as the apps are needed" (DARPA, 2010). The announcement goes on to discuss the creation of an *Apps Marketplace Architecture* and the estimated further research areas the BAA will spawn. The NRL and DARPA BAAs provided a strong foundation for this researcher to attempt to resolve

---

<sup>2</sup> In MCWP 3-16, deconfliction is defined as the process of ensuring fire support agencies' targets, timelines and battlefield geometries are able to achieve the optimum effects in support of the ground commander's scheme of maneuver without incurring unnecessary risk to friendly personnel or equipment.

a capabilities gap in Marine Corps fire support by using a smartphone to get fires down to the tactical edge.

The Marine Corps fire support network needs to take the next logical step of adopting all relevant, existing, and foreseeable future networking technologies to fill any gaps for an enhanced network using redundant network nodes for fire support C2. The emergence of chat and chat-based services to provide notifications of changes in friendly locations, fire support plans, or fire support coordination measures, has emerged throughout the current operating environment. The chat-based services became a *de facto* standard network requirement for fire support deconfliction in the Joint and Combined<sup>3</sup> operating environments of both Operation Enduring Freedom (OEF) and Operation Iraqi Freedom (OIF) (Eovito, 2006). These chat-based services are now equally important to the tactical level warfighter from the company level to the individual Marine, as evidenced in the Capability Set 5 Urgent Needs Statement (Hastings, 2009). This evidence provides the impetus for immediate exploration of smartphone devices to provide these types of services for the warfighter.

### **C. RESEARCH QUESTIONS**

This thesis will be guided by the following questions:

- How can COTS software developmental tools be used to produce a smartphone application to aid the transition between traditional radio equipment and a tactical cellular network?

---

<sup>3</sup> Joint operations refer to operations where two or more military departments operate; combined operations involve two or more allied nations or agencies (JP 1-02, 2011).

- How does the SMART Fires application fit into existing and future Command and Control platforms in integrating information into a Common Tactical Picture (CTP) that will assist the warfighter?
- How effective will these COTS applications be in aiding the warfighter (e.g., target location precision, request latency, situational awareness increases, and efficiency)?

#### **D. SCOPE AND LIMITATIONS**

The thesis will not attempt to design the "best" fire support application, thereby requiring a rewrite of doctrine to include tactical cellular or WiFi or even WiMax networks as required. Neither will this research attempt to include communications security concerns or network security concerns that would exist for integration into the current system. This research, however, seeks to demonstrate a proof-of-concept to verify that the fire support application, Smartphone to AFATDS Prototype (SMART) Fires, is feasible. If feasible, then the SMART Fires application would be capable of leveraging a future cellular wireless technology for the military.

The Marine Corps' fire support infrastructure was chosen because of the readily available resources, including the author's background as a Marine Artillery Officer; however, the results of the research are applicable across all six warfighting functions. After further refinement of the technology, we believe the SMART Fires application can provide the basis for further application development in support of a platform hardened to Military Standards (MILSTD), capable of all wireless communication requirements for any tactical traffic. We envision that these efforts

will springboard other warfighting communities to design and implement similar supporting applications to enable those Marines to better perform their function in combat. By furthering the study of COTS Software Development Kits (SDKs) to harness these existing commercial technologies in a form that remains rapidly developable by the warfighter, our research intends to reduce the logistics required for Marines to remain America's force-in-readiness and to continue to win America's battles.

This thesis seeks to validate a proof-of-concept whereby cellular technology can provide a fire support network that is flexible and capable of rapid integration using existing wireless infrastructure in any theater of operation, and then transition back and forth to tactical radio nets as required. The research, though conducted in the narrow scope of Marine-specific fire support operations at the tactical level, can be transitioned across the Department of Defense (DoD).

#### **E. THESIS ORGANIZATION**

This first chapter provides an overview of known discrepancies within the Marine Corps' fire support network infrastructure. The chapter goes on to suggest objectives that can be achieved through the successful integration of the SMART Fires application as a part of the overall adoption of smartphone integration into military wireless communications. Finally, the chapter outlines the research questions that were evaluated and will guide the remainder of this research.

Chapter II discusses the current state of the USMC fire support networks and the current fire support software/hardware platforms. It outlines the coordination requirements for a USMC tactical fire support network, including the required communication nodes and C2 actions to successfully conduct fire support.

Chapter III provides a background for previous tactical cellular network integration. It outlines the selection of the operating system for development of the application prototype and provides a description of the Android™ environment. It provides user requirements and an evaluation of support by the fully developed application. Finally, the chapter finishes with a description of the Eclipse™ integrated development environment and the Commonsware(LLC) references used in the development of the SMART Fires application.

Chapter IV presents the SMART Fires prototype requirements and design

The results and final conclusions of the proof-of-concept are given in Chapter V. The chapter also sets forth recommendations for continued development of SMART Fires and the best way ahead for SMART applications.



THIS PAGE INTENTIONALLY LEFT BLANK

## **II. BACKGROUND**

This chapter provides the necessary background regarding previous research as to why and how smartphones and a tactical cellular network, integrated with the existing military wireless network, could help to fill existing communications gaps and extend significant network capability to the warfighter. The chapter then describes the organization of the Marine Corps fire support agencies and the composition of the tactical level agencies. The chapter elaborates on current equipment and systems implemented to conduct fire support at the tactical level. It further outlines the coordination requirements for those tactical fire support systems to successfully request and deconflict a "call for fire."

### **A. WHY SMARTPHONES**

The platform for a smartphone integrates several current standalone system capabilities into a singular device. These hardware capabilities include: accelerometer, gyroscope, compass, cameras (forward and/or rear facing) for still or video, Global Positioning System (GPS), cellular transceiver for voice and/or data, Bluetooth™ personal area network (PAN) interface, WiFi 802.11 standard Local Area Network (LAN) interface, in some cases the WiMAX 802.16 standard Metropolitan Area Network (MAN) interface, and the ability to communicate over all of these wireless networks. Both Android and iPhone application markets have applications that can initiate a pairing through the accelerometer then use the 802.11 standard or cellular data

connection to communicate using a cloud infrastructure; the BUMP™ application is one such example (BUMP, 2011). The current data rates are up to 31 Mbps per second for mobile WiMAX (Benes & Prokopec, 2011) and 45 Mbps for Long Term Evolution (LTE) (Wylie-Green & Svensson, 2010); mobile WiFi connectivity with 802.11n, still achieved data rates in excess of 15 Mbps (Lin, Tzu, Lin, & Lee, 2009), and the hardware chipsets required to conduct WiFi calling or Unlicensed Mobile Access (UWA) directly or using Voice over WiFi (VoWiFi) also exist. These current capabilities, among others, were the impetus for both the United States Army (USA) and the USMC to explore smartphone technology integrated into the tactical network.

The SMART Fires application is a prototype that will demonstrate a proof-of-concept that COTS SDKs can be used by the operating forces to implement new ideas into a rapidly deployable software application for smartphones. This type of rapid prototype development is only possible if the Marine Corps adopts the appropriate wireless infrastructure. Since there is no open developmental environment for programs of record that currently exist in the Marine Corps, Joshua S. Dixon's thesis, "Integrating Cellular Handset Capabilities with Marine Corps Tactical Communications," published in May of 2010, lays out the concepts that, if adopted, could leverage the high mobility and unique computing capability resident in most smartphones in the commercial market without having to wait through the delay of the traditional military acquisitions process. Since the commercial market is driven by the competition of other hardware and service providers to put out a cutting edge technology product, it stimulates innovation and furthers

the requirement for providers to deliver the best available product at all times. The risk associated with the commercial market is principally financial (O'Neal & Dixon, 2011). A company's failure to deliver the most current technology allows competitors to gain market share and the affected company will lose revenue. The risk of the military's failure to adopt emergent technology has much greater consequences since it could mean a weakened national defense and military advantages forfeited to nations or nonstate actors that do adopt the leading edge of technology.

Dixon proposed two solutions to integrate smartphones into military tactical communications: wired and wireless. The wired approach is referred to as the *tethered* concept. This concept adopts the integration technique used for the AN/PSC-13 Dismounted-Data Automated Communications Terminal (D-DACT). The device can be used independently of military communication systems or can be integrated directly through a wired connection to a SINCGARS radio set. Although tethering does provide solutions to security concerns, since it uses a military radio for integration, the true benefits of the highly mobile smartphone are not yet fully leveraged.

The wireless approach has two paths that provide avenues to smartphone integration in tactical communications. The first method, *indirect bridging*, requires the use of additional hardware integrated into the tactical communications networks. These networks leverage mobile base stations to provide the required small scale capabilities of larger metropolitan cellular base stations in the footprint of a single tactical vehicle. There are a

variety of hardware solutions that fulfill the needs of an *indirect bridging* solution; however, the Open Base Transceiver Station project (OpenBTS) offers the ability to connect Global System for Mobile Communications (GSM) standard smartphones on the tactical network with VoIP clients, without the hardware overhead required in commercial cellular networks.

The commercial cellular infrastructure is composed of the Base Transceiver Station (BTS), the Base Station Controller (BSC), and the Mobile Switching Center (MSC). The wireless connection between the GSM-capable cellular device and the GSM network is provided by the BTS. As a cellular device moves from one coverage area to another, the BSC provides a portion of the handover functionality that enables the transition. Finally, the MSC provides the main functionality for BTS transition and the end-to-end connections that either begin or end with a cellular device in its coverage area. This commercial GSM infrastructure is shown in Figure 1.

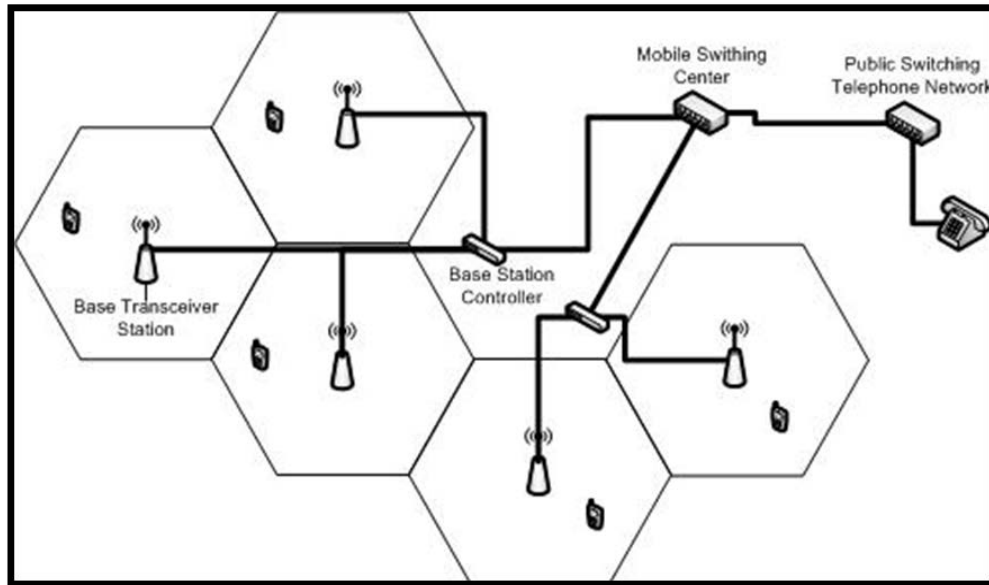

Figure 1. Commercial cellular MSC-BSC architecture (From Dixon, 2010).

In OpenBTS, the Universal Software Radio Peripheral (USRP) uses Asterix© Private Branch Exchange (PBX) to provide the required GSM functionality to make and receive VoIP calls. OpenBTS replaces the BTS, BSC and the MSC with a minimal infrastructure composed of a hardware device capable of running the open source software, OpenBTS and Asterix© PBX, and other software to enable a VoIP client on the hardware device. A comparison of Figures 1 and 2 will illustrate the reduction in equipment between a standard commercial cellular infrastructure and the minimum OpenBTS infrastructure required to complete a voice call.

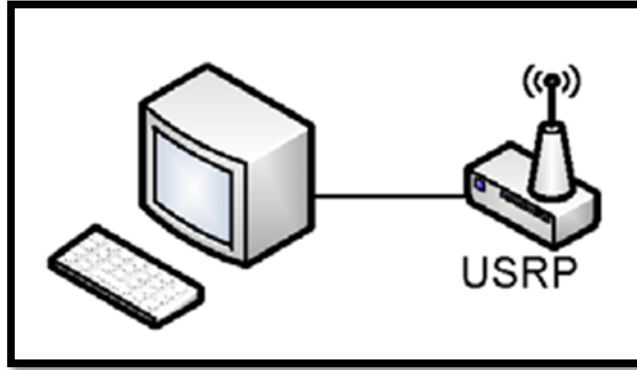

Figure 2. OpenBTS architecture (From Dixon, 2010).

The final integration method in Captain Dixon's work is *Direct Interfacing*. The work goes on to explain that by the military creating the need for marginal, military-specific (MIL-SPEC), adaptations to the commercial hardware, producers could create hardware modularity in handsets intended for dual purpose use, commercial and/or military applications. Secondly, the notion of software portability is introduced to provide a method for the smartphone and tactical handset modifications to be made to the software and firmware loaded into the handsets, both cellular and military tactical radios, for integration into one another's networks. The integration is proposed by three solutions: (i) adding a MIL-SPEC signal to smartphone, (ii) adding commercial cellular signal capability to the military radio, or (iii) modifying cellular protocol to be useable by both smartphones and military radios. Each proposal provides unique answers to integration and new areas of security concerns. All three are theoretically feasible solutions for smartphone integration into tactical military networks, though not necessarily monetarily viable. Whatever solution or integration technique is chosen, the fact remains that

this technology could provide both computing and networking capabilities that would enhance tactical operations in a form with which the individual Marine or soldier is very familiar. So, with a familiar platform, the ease of use and navigation of the new system is second nature, allowing the focus of the users to return to their warfighting task.

With respect to the scope of this research, that warfighting task is requesting fire support in the form of a Call For Fire (CFF). The CFF, however, is the critical information that must pass through a detailed and refined coordination and deconfliction<sup>4</sup> process before it is realized—when the artilleryman manning his weapon system fires a projectile at the target. The Marine Corps-specific CFF process is provided for an understanding of the current standing voice CFF procedure. It is our belief that through an examination of both the tactical organizations who conduct fire support coordination, combined with the tasks required by the entry level Marine with Military Occupational Specialty (MOS) 0861-Fire Support Man, that the proof of how an intuitive SMART Fires application will positively benefit this fire support process and may be revealed.

## **B. MARINE CORPS FIRE SUPPORT**

Fire support coordination is among the most complex processes that America's military performs during conventional wartime operations. Transient to the levels of

---

<sup>4</sup>In MCWP 3.16 deconfliction is defined as the coordination with higher and adjacent units during fire support planning. Deconfliction is facilitated through the fire support coordination measures (FSCM) and separation of the gun to target line by time or space with friendly units.



war, fire support at the strategic level directly impacts the tactical level, and vice versa. As a result of this transient nature, fire supporters executing the fire support plan must be able to coordinate with all levels of command. This communications requirement crosses geographical, service and national boundaries to maximize the effects of limited fire support assets, and to be most effective, it requires the best technology available. Without this communication, our nation risks squandering assets and, most importantly, the lives of our warfighters.

### **1. Marine Unit Organization**

A traditional Marine Corps artillery battalion is composed of three artillery firing batteries that provide fire support to the supported maneuver infantry battalions and a headquarters battery that provides the equipment and staff to enable command and control for the artillery battalion (MCWP 3-16.1, 2002). The artillery battalion provides fire support for the maneuver infantry regiment in two ways; first, through the organic artillery firing batteries providing close and continuous fires to the supported infantry battalion, and second, by providing the fire support personnel and equipment to conduct fire support planning and coordination to both the infantry regimental commander and the infantry battalion commanders. The unit organization and supporting relationships are shown in Figure 3. The tactical fire support organizations formed at the infantry battalion and down to the companies are explored further in this study.

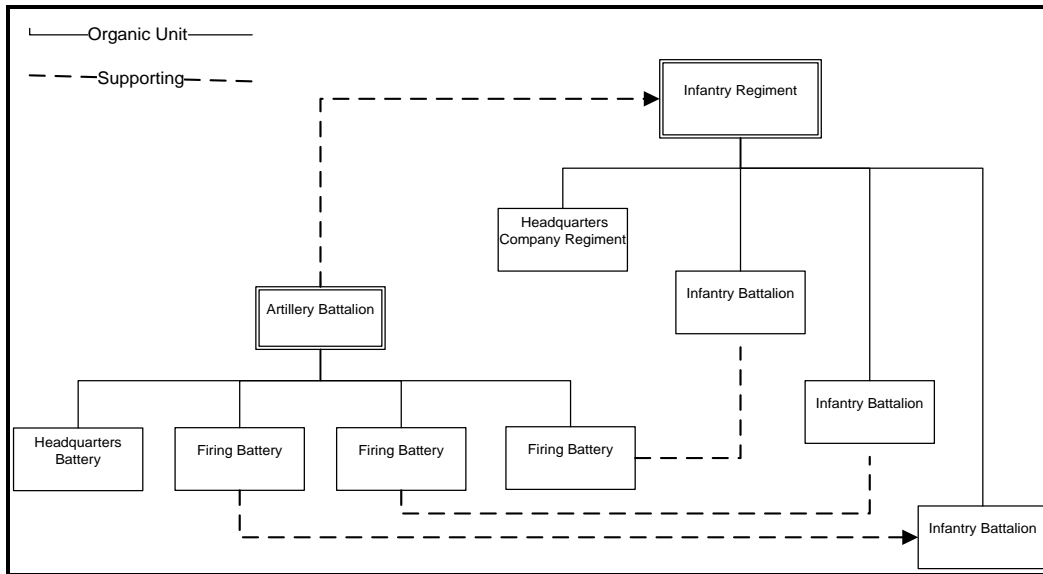

Figure 3. Artillery-to-maneuver tactical organization and support relationships.

## 2. Marine Fire Support Organizations

Tactical fire support is executed on behalf of the supported maneuver commander; therefore, the tactical fire support organizations are co-located with the maneuver commander's Combat Operations Center (COC). Tactical fire support organizations exist at every level within the infantry command structure, from the division to the company. The infantry battalion level fire support organization is the Fire Support Coordination Center (FSCC). The FSCC is a composite organization made up of both the infantry battalion personnel and the supporting artillery battery's liaison section personnel (MCWP 3-16, 1999). The next level of fire support organization at the infantry company is the Fire Support Team (FiST). The FiST is also a composite organization, with members of both the infantry company and the supporting artillery battery's Forward

Observer (FO) team. The artillery battery FO team is the first fire support organization employed in support of the infantry (FM 6-30, 1991), to advise the infantry company commander on the employment of artillery fires in support of the company's scheme-of-maneuver (MCWP 3-16.6, 1998).

**a. Composition**

Starting first at this lowest level, the FO team consists of four members:

- Forward Observer-MOS 0802
- Fire Support Man-MOS 0861
- two Radio Operators-MOS 0621

The FO Team then takes its place as part of the Fire Support Team (FiST). The company FiST and battalion FSCC have a parallel structure to facilitate simultaneous coordination and deconfliction between the FiST and their counterparts at the FSCC.

The FiST and the FSCC contain a representative from each supporting arm. At these two organizations the infantry representative also serves as the leader for the organization since he is appointed by the commander of the unit the fires are supporting. The FiST composition is:

- FiST Leader (infantryman)-MOS 0302
- FO Team (artillery)-MOS 0802
- mortarman observer-MOS 0341

- Close Air Support (CAS) representative<sup>5</sup>-MOS 7502 or 8002
- Naval Gunfire (NGF) spot team

At the FSCC, each supporting arm is represented, providing a thorough knowledge of the employment of each supporting arm to the Fire Support Coordinator (FSC). The representatives for the various supporting arms are:

- FSC (infantryman)-MOS 0302
- Artillery Liaison Officer (Arty LNO)-MOS 0802
- Senior Noncommissioned Officer (NCO) mortarman observer-MOS 0341
- Air Officer (AO)-MOS 7502
- Naval Gunfire Liaison Officer (NGLO)-MOS 0845

All representatives are assisted by more radio operators and, for the artillery and the NGLO, by an enlisted advisor that enhances the experience level in the FSCC (MCWP 3-16.6, 1998). The NGLO and the NGF spot teams are collectively known as the Shore Fire Control Party (SFCP) (MCWP 3-16.6, 1998).

#### ***b. Communications***

Many radio assets and systems are required to support the coordination of fires. Each arm of the combined-arms team has at a minimum one radio network and the associated dedicated radio assets used by that representative on the FiST. The information regarding the communications that support the fire support efforts will be

---

<sup>5</sup> Either a Naval Aviator or Naval Flight Officer with current qualifications who earned MOS 7502 serving as a Forward Air Controller (FAC) or a trained observer that has passed all certifications and qualifications and earned a secondary MOS 8002 as a Joint Terminal Air Controller (JTAC) (NAVMC 3500.42, 2008).

separated by radios and systems, which together, provide the required communications to conduct fire support.

(i) Radio Assets. Radio assets can either be vehicle-mounted or man-portable (manpack). The radio assets included in this work will be limited to those allocated to the FO Team and the rest of the FiST as this is the focus of the SMART Fires application. The FiST also, typically, requires mobility, so radios that cannot be manpack are seldom used by the majority of the FiSTs. The exceptions are FiSTs tasks organized to a particular mission set such as the Amphibious Assault Vehicle (AAV) company or a company of M1A1 Tanks in support of a maneuver unit that is required to execute a portion of the overarching fire support plan. The current doctrinal communication networks require the use of High Frequency (HF), Very High Frequency (VHF), and Ultra High Frequency (UHF). HF networks can use the AN/PRC-150(C) shown in Figure 4.



Figure 4. AN/PRC-150(C) High Frequency Manpack (From Harris Corporation, 2011).

VHF assets are more prolific. As such, a greater effort by the acquisitions community has been placed on reducing the size of the manpack VHF radio set. Three primary VHF-capable radios are currently used and they provide both VHF and UHF capability in a manpack form. The

three radios currently used for both VHF and UHF communications are the AN/PRC-117F V1(C) Multi-Band Multi-Mission Manpack Radios (MBMMR) shown in Figure 5, the AN/PRC-148 V2(C) Multi-Band Inter/Intra Team Radios (MBITR), and the AN/PRC-152 Multi-Band Multi-Mission Handheld Radios (MMHR) both shown in Figure 6.

It is not uncommon, when conducting FiST operations, to have one radio to support the 81mm mortar conduct of fire (COF) communications network and two radios for simultaneously monitoring the artillery COF voice and data, as well as the non-doctrinally-based battery fire coordination (FSCoord). The latter is used for coordination between FO and the battery Fire Direction Officer (FDO).



Figure 5. AN/PRC-117F (C) Multi-Band Multi-Mission Manpack Radios (From Harris Corporation, 2011).



Figure 6. AN/PRC-148 V2(C) Multi-Band Inter/Intra Team Radio, (left) and AN/PRC-152 Multi-Band Multi-Mission Handheld Radios (right) (From Harris Corporation, 2011).

The FAC or JTAC would have one radio for direct UHF communications to the aircraft providing CAS, and one radio for VHF communications to either the AO at the battalion FSCC, or the Air Support Element (ASE) or Direct Air Support Center (DASC) at the Regiment or Division, respectively, to request CAS sorties in support of the FiST.

The NGF spot teams would have two radios. One radio provides HF communications to the ships providing support on the Naval Ground Spot network used to coordinate surface fires from NGF ships. The other radio provides VHF communications to the NGLO at the battalion FSCC for coordination of missions on the SFCP local radio network.

As previously discussed, the FiST uses several different radios and communication networks to properly apply combined arms, maximizing the lethality of the MAGTF. Different components of the FiST are each charged

with coordinating their own fire support activity with the overall fire support plan to support the infantry maneuver. For example, the mortar FO coordinates with the battalion's 81mm Mortar platoon, the artillery FO team coordinates with the supporting artillery battery, and the FAC or JTAC coordinates with CAS assets on station. After all fire support agencies, mortars, artillery and CAS confirm they can simultaneously support the fire support plan, the FiST leader establishes a time-on-target (TOT) for the CAS and the timeline for mortars and artillery is established.

The FiSTs deconflict their requested missions by submitting them to the battalion FSCC. The battalion FSC is the battalion commander's appointed representative to approve or deny fires in support of the maneuver. The FSC is the final authority on approval of fire missions by the line companies and requires the most complicated communications support plan at the tactical level. One item that must be considered is that although many communications experts believed that the introduction of digital (data) communications would decrease the number of radios for fire support, it actually nearly doubled the requirements. It doubled the requirements for the fire supporters due to lack of trust in a digital device producing the same level of results as the traditional voice call for fire. The current and doctrinal nets for the FiST, FSCC, mortar platoon, NGF ships and the artillery battery to maintain are shown in Table 1.



Legend:																					
C - Net Control																					
X - Guard																					
R - As Required																					
	MAGTF FSCOORD (VHF)*	MAGTF Arty CMD (UHF/VHF/HF)	Infantry Regt FSCOORD (VHF)	Arty Regimental CMD (HF)	Arty Regimental FD (VHF)*	Arty Regimental TAC (VHF)	GCE Arty Air Spot (VHF)	Arty Battalion CMD (VHF)	Arty Battalion FD (VHF)*	Arty COF (VHF)*	Arty Battery FSCOOR (VHF)	TAR (HF)	TAD (VHF/UHF)	TACP Local (VHF)	GCE NGF Support (HF)	NGF Air Spot (UHF/VHF)	NGF Ground Spot (HF)	NGF Control (HF)	SFCP Local (VHF)	MAGTF NGF Spot (HF)	Bn Mortar (VHF)
Infantry Bn FSCC		X					R		R	X		X	X	C		R	C		C	R	X
DS Artillery Battery	R	R	X	X	X	X	R	C	C	C	R										
FO Team							R			X	R										
FAC							R					X	X	X							
Mortar FO																					X
NGF Spot Team																	X		X		
NGF Ships															X	R	X	X		X	
Mortar Platoon																					C
<b>Notes:</b>																					
* Data and/or Voice nets																					

Table 1. Current and doctrinal FSCOORD nets (After MCDP 3-16, 1999).<sup>6</sup>

(ii) Data Systems. For every fire support agency that could provide fire support to the line companies, internal standard operating procedures actually required redundant voice and data nets. Specifically, for artillery, when digital communications were beginning to enter the operating forces in the early 1990s, the AN/PSC-2 Digital Communications Tool (DCT), shown on the left in Figure 7, required a dedicated VHF radio to which it was tethered via cable for a digital Artillery COF net and another separate VHF asset to be used as a voice COF.

<sup>6</sup> Self-generated table from author's knowledge of internal infantry battalion and DS artillery battery operations, with doctrinal support by (MCWP 3-16, 1999).

This doubled the COF requirement for radios, since parallel communications were now required for the submission of digital CFFs with a voice confirmation of receipt or clarification. The same parallel communications networks are now required for the NGF Spot Net with the advent of the Naval Fire Control System (NFCS). This provides digital communications between the ship providing fire support and either the spotter or the firing battery with an AN/PSC-13 D-DACT, shown on the right in Figure 7, or the joint fire support system of record in the DoD, the AN/GYK-47(V) Advanced Field Artillery Tactical Data System (AFATDS), shown in Figure 8. AFATDS remains the gateway for all digital communications to enter the current FSCoord architecture in the Marine Corps for the foreseeable future.



Figure 7. On the left the AN/PSC-2 Digital Communications Terminal (From Ebay, 2011) and on the right the AN/PSC-13 Dismounted-Data Automated Communications Terminal (From Scott, 2006).



Figure 8. AN/GYK-47 (V) Advanced Field Artillery Tactical Data System (From PM FATDS, 2004).

The scope of the previous section was limited to the lowest organizational echelon to create an understanding of the CFF process at the tactical level. The tactical CFF model, however, can be traced to specific techniques, tactics, and procedures (TTP) and scenarios (more or less restrictive rules of engagement (ROE)) modeling the Fires process at any level of command or joint combined service environment. It is this organizational scope that led to the tactical CFF model and, using a restrictive method for clearance, forced numerous coordination actions amongst all of the performers at the fire support organizations.

### **C. CFF PROCESS**

The voice CFF or as-is CFF process is a result of several factors. The factors are common throughout the author's experience for newly established support relationships between the supported infantry battalion and

the supporting artillery battery. These factors facilitate increased and continuous coordination interactions between the numerous participants using centralized<sup>7</sup> clearance for the Marine infantry battalion with a Marine artillery battery providing Direct Support (DS) (MCWP 3-16, 1999). Centralized clearance is the most restrictive, requiring the highest degree of inter-level coordination. The tactics, techniques and procedures (TTPs) modeled are also very restrictive, which complement restrictive rules of engagement (ROE) and can also be attributed to the level of fire support proficiency at the battalion.

## 1. Process Flow

FO Team:

- Gathers target data for inclusion in CFF, location, relative direction & distance, target description.
- Formats target data into call for fire format.
- Initiates voice communications with FiST to pass on CFF with target data.

---

<sup>7</sup> *Centralized* is opposite of *decentralized* message clearance where the CFFs are transmitted directly to the fire support agency. The FSCC monitors CFF transmissions over the radio net and positively clears the CFF as approved or denied over the net before the fire support agency can provide fires on the target. Centralized clearance requires all CFF transmissions to be routed through the FSCC. The CFF will then be transmitted from the FSCC to the fire support agency after approval by the FSC. Any mission received by the fire support agency from the FSCC is approved and cleared to fire. After receipt of the CFF, by the agency, there are direct communications between the observer and the fire support agency, and the FSCC only monitors the net for unsafe conditions (MCWP 3-16, 1999).

FiST:

- Verifies that the CFF is safe to be fired. In order to do this he asks the question first: "Does the CFF violate any known Fire Support Coordination Measures<sup>8</sup> (FSCMs)?"
- If the answer is yes, the request is denied.
- If the answer is no, then FiST Leader proceeds with processing.
- Validates that the target data is a viable target that supports the current infantry scheme of maneuver.
- If the answer is yes, the target is approved at the Company level.
- If the answer is no, the target is denied.
- Conducts low level weaponeering<sup>9</sup>, validates whether the target can be successfully engaged with the company's organic asset,
- If the answer is yes, the CFF is transmitted to 60mm mortar platoon for prosecution.
- If the answer is no, he proceeds with processing.
- Performs another weaponeering assessment for the appropriate asset to prosecute the target.
- Formats the CFF according to the agency being requested, i.e., Naval Gunfire CFF, Close Air Support 9-line<sup>10</sup>.

FSCC:

- Verifies whether the CFF violates any FSCMs
- If the answer is yes, the request is denied.

---

<sup>8</sup> A restrictive FSCM is established in order to protect friendly maneuver units or protect locations that should not be directly engaged with fires i.e., historical/religious sites, or critical infrastructure (MCWP 3-16, 1999).

<sup>9</sup> Weaponeering is the process of matching targets to the appropriate weapon system in order to achieve the desired effects without squandering resources (MCWP 3-16, 1999).

<sup>10</sup> The formats for the standard CFF, the NGF CFF and the 9-line are provided for the reader in Appendices A, B, and C.

- If the answer is no, he proceeds with processing.
- Verifies whether the CFF is formatted properly for the agency being requested,
- If the answer is no, the CFF is denied and sent back to the FiST for reformatting.
- If the answer is yes, then the CFF request proceeds with processing.
- Conducts weaponeering, validates whether the FiST selected an appropriate fire support agency for the target.
- If the answer is yes, the CFF is forwarded to the agency as approved.
- If the answer is no, then the FSC would inform the FiST of the decision to assign the mission to a different fire support asset, then properly format the CFF for the new asset as required.
- Verifies whether the agency being assigned is capable of firing at that time.
- If the answer is yes, the CFF is forwarded as approved.
- If the answer is no, then the CFF is reformatted as required and forwarded to the next available asset as approved.

This process is rehearsed over and over to train the fire support organizations to be as efficient as possible and maximize the use of all available fire support assets. This background information provides the necessary foundation to evaluate the limitations of the current fire support systems, both the digital devices and the extensive use of stove-piped, at most, dual-banded radio assets. In order to assist this research a business model of how the SMART Fires application could increase unit efficiency was created using the Savvion™ business process modeling software.

## **2. CFF Savvion™ Model**

A low level of proficiency at the FSCC, FiST or FO team level will cause the FSC to clear all missions and not allow any missions to be sent to a fire support agency until the CFF have been approved for both content and format. In particular, a fire support team with low proficiency, operating under restrictive ROE and exercising centralized clearance is the most restrictive scenario for operations at the battalion level. This was the situation battalions faced before a deployment into OEF. It is essential then that the CFF Savvion™ model simulate this all-too-common situation to demonstrate the direct impact to the joint operating forces. The Savvion™ model follows the sequence of individual actions described in the process flow section of this chapter.

### **a. *As-Is Process***

To facilitate a deeper understanding of how the as-is CFF process can benefit from the SMART Fires application, a business model was created of the as-is process using the Savvion™ software application and is depicted in Figure 9. The model's processes and actors are shown in a simplified form representative of the actual CFF process. There is a high level of complexity in the CFF process modeled. These added complexities will attribute to a greater variance in the times associated for individual processes.

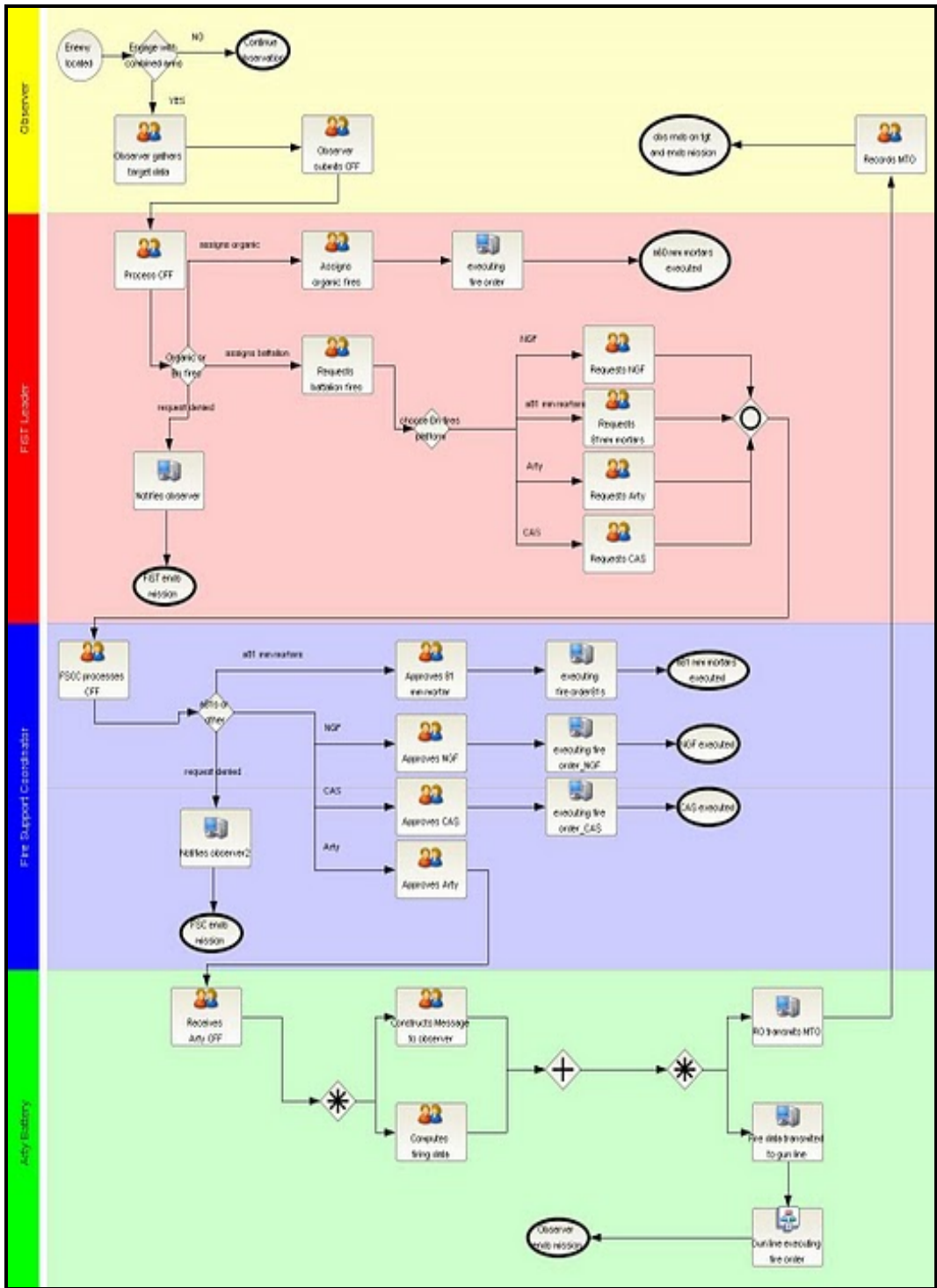

Figure 9. Savvion™ Model of the As-Is voice CFF process.



The processes represented by the model are the specific tasks and actions that must be taken by the respective coordination agent in order to provide fire support in response to a CFF. The Savvion™ model can provide information about where lag times and bottlenecks occur in the As-Is process. These bottlenecks decrease the fire support organization's efficiency and slow down the response times of the fire support agencies. The Savvion™ model is provided along with results from the simulation of the As-Is process in Appendices E and F and the To-Be process G and H.

***b. To-Be Process***

The results of the modeling effort once a SMART Fires application are implemented into the training scenario with the same group of personnel at the FO, FiST and FSCC by using a smartphone device that takes target data and converts it to any CFF format required. Process times were reduced due to the implementation of the SMART Fires application's capabilities and integration of the smartphone's positional location hardware, large display, touch or voice input capability. Increased situational awareness was also provided by the use of other C2 applications that display real-time locations for friendly units. We created a "To-Be" process model of how the ideal FO-to-FiST-to-FSCC processes might be improved by the SMART Fires application.

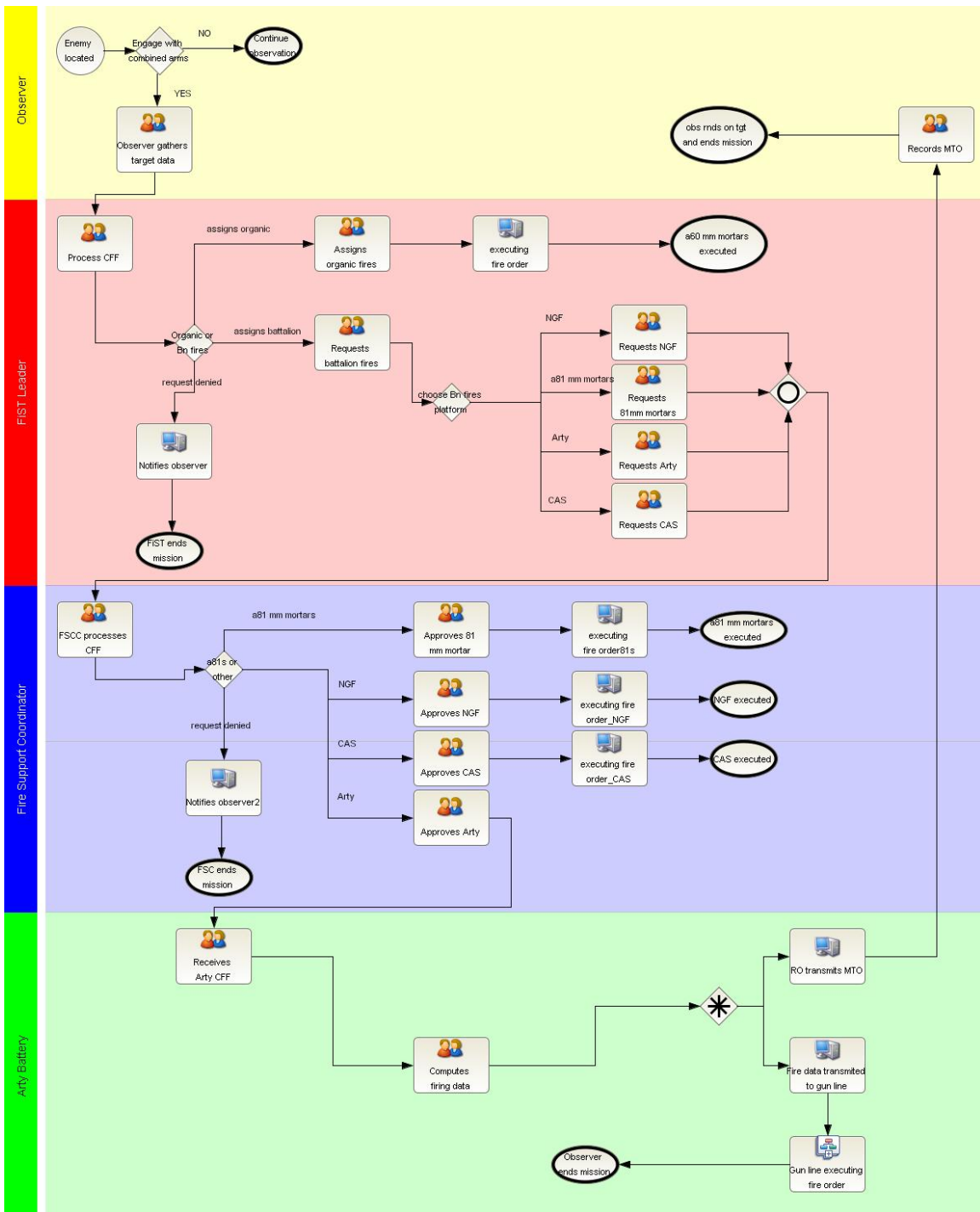

Figure 10. Savvion™ Model of the To-Be digital CFF process using the SMART Fires application.

A comparison between the "As-Is" model and the "To-Be" model demonstrates initial validation for the SMART Fires application, thus, assisted scout observers may enhance the warfighting capability of the entire fire support organization and the process resulting in more responsive fires. The Savvion™ model for the "To-Be" model is provided along with results from the simulation in Appendices G and H.

### ***c. Savvion™ Results***

The comparison of the As-Is and To-Be Savvion™ models demonstrated that a SMART Fires application capable of integrating smartphone capabilities into the existing fire support network could greatly increase efficiency and warfighting capability. The simulation replicated an eight hour training evolution for an infantry battalion conducting live fire training. The As-Is model produced ten successfully executed CFFs. The To-Be model with integration of the SMART Fires application successfully executed one hundred CFFs. The simulations resulted in a ten times increase in the efficiency of the overall CFF process modeled. These results help conclude that the FO capabilities were greatly enhanced with the smartphone running the SMART Fires application.

Next, we present the current smartphone integration efforts for military wireless communications and the benefits of the Android platform selected for the SMART Fires application. Additionally the requirements of the user are matched to the capabilities of an Android smartphone.

### **III. SMARTPHONE INTEGRATION**

This chapter provides a background for smartphone integration into military wireless communications. The chapter describes both commercial and DoD efforts to integrate smartphone technology. It further provides the reasons why the Android platform was selected for the SMART Fires application as well as a detailed explanation of how the Android OS software stack best supports the application. The chapter concludes with a solution to current fire support limitations in an analysis of how the SMART Fires application running on the Android OS assists the users' tactical mission requirements.

#### **A. PREVIOUS EFFORTS**

Prior to selecting an SDK for development, a smartphone OS had to be chosen. Research was conducted into existing smartphone integration and the operating systems used in those efforts. These previous efforts then facilitated a decision for the OS platform that best suited rapid development of the SMART Fires application. Our research revealed that efforts across DoD have favored two OS platforms over the variety of other options, namely: Apple's iPhone OS and Google's Android OS.

##### **1. Commercial Integration**

Efforts for smartphone integration and developmental exploration have come from numerous sources both within and outside of the DoD. The results and products are varied; however, the focus has been primarily on two smartphone

platforms: Apple's iPhone and Google's Android OS. Although corporate efforts are not limited to the iPhone and the Android systems, these efforts were available for public and system information.

**a. General Dynamics**

In conjunction with Itronix, General Dynamics (GD) has created the GD300, shown in Figure 11. It is advertised as a rugged, wearable computer, with an integrated GPS high gain antenna and it utilizes the Android™ open operating system (General Dynamics, 2011). The GD300 was recently tested in a simulated operational environment exercise held by the Army to test the operational feasibility of smartphone integration at the tactical level. This testing of the GD300 was conducted using the Tactical Ground Reporting (TIGR) application installed. This type of tactical application provided real-time positional location of friendly forces and suspected enemy positions.

The GD300 and the TIGR application together provide a venue for the acceptance of the SMART Fires application once fully developed. The Android based OS used for the GD300 if proven successful would be the optimum development platform for the SMART Fires application, since the existing TIGR application could provide an existing application that can provide both friendly and suspected enemy locations both of which are required to safely deconflict fires and initiate a successful CFF.



Figure 11. The GD300 is a ruggedized wearable computing platform using the Android Open Operating System (From General Dynamics, 2011).

***b. Lockheed Martin***

The MONAX© system, shown in Figure 12, is developed by Lockheed Martin Corporation and is an iPhone-based system that integrates the COTS iPhone smartphone with a MONAX Lynx sleeve that connects the smartphone to the MONAX secure network, the XG BS infrastructure. This networking infrastructure, which is proprietary to Lockheed Martin, is advertised to provide, via mobile ground stations or located onboard airborne platforms, commercial cellular infrastructure to the user. The MONAX system communicates using a non-traditional RF 4G cellular signal and is also capable of “exportable military-grade encryption” (Lockheed Martin Corp, 2010). The MONAX brochure also advertised the availability of an App Store™ twenty-four hours a day, seven

days a week for users of the MONAX system. The applications available at the time of the brochure's release were described as having the ability to assist the warfighter's situational awareness (SA) and C2. MONAX believed it achieved this by providing facial recognition software capability, ISR data access, and automated mission reports (Lockheed Martin, 2010).



Figure 12. Handheld portion of the MONAX system with MONAX Lynx sleeve with COTS iPhone (From Lockheed Martin, 2010).

### **c. Raytheon**

Raytheon's efforts into the military smartphone integration foray came in 2009 when they created the ill-fated One Force Tracker™ application for the iPhone, and the more successful Raytheon Android™ Tactical System (RATS™),

shown in Figure 13 (Raytheon, 2011). Although information on the company website was limited, the One Force Tracker™ program was later cancelled in 2011, however the RATS™ system has seen continued development. The RATS™ device is designed to assist intelligence collaboration, enable real-time full-motion video and imagery, and harness social networking functionalities to enhance situational awareness using Android™ open software architecture (Woyke, 2009). Although the RATS™ device claims to be the first device to harness the Android architecture, there have not been any further releases of information about the RATS program from Raytheon (Raytheon, 2011).



Figure 13. Raytheon's RATS™ smartphone device for military integration (From Raytheon, 2011).

## **2. DoD Efforts**

### **a. Tactical NAV**

The first public attempt to integrate smartphone technology, specifically application development, for the



iPhone OS to assist the tactical warfighter is from a fellow artillery officer in the United States Army. Captain Jonathan J. Springer privately funded the development of an iPhone application that he states "is just as accurate as some of the most expensive military GPS systems that are being issued by our soldiers today" (Thompson, 2011). The application, named Tactical NAV, included the ability to plot and plan routes for patrols, display positional location information in the Military Grid Reference System (MGRS) that is commonly printed on tactical maps issued within the military, and display direction in MILS<sup>11</sup> (Fox News, 2011).

Tactical NAV also integrated the camera resident on the iPhone with the capability to stamp photographic images with a position and time. Additional features of the Tactical NAV included: navigation to an input grid location, Go-to-Grid; ability to overlay 1 kilometer grid squares over satellite maps; a night mode for ease of view in low-light situations without the bright screen giving away one's position; and position sharing via e-mail. Recently, Tactical NAV introduced a new version, 2.0, that added improvements to the GUI and added navigational functionality to way-points. It is currently available on the iTunes App Store for \$5.99 (Tactical NAV, 2010).

---

<sup>11</sup> MILS are a unit of angular measure. 1 MIL equals 1/6400<sup>th</sup> of a circle. MILS are traditionally used in military units where the precision of angular measurement is critical to mission execution i.e., artillery and mortars. The MIL relation formula also converts angular measurement into a measured length, since at a distance of 1000m, 1 MIL = 1 meter (MCWP 3-16.6, 1998).

Tactical NAV was a private venture; however, application development by the Army has been formalized by a new program of record.

**b. CSDA**

CSDA is an ongoing effort in the ARCIC that explores the value of using smartphones to provide soldiers applications to perform everyday functions ranging from administration to combat operations(ARCIC, 2011). CSDA's approach to development has been to simultaneously develop both of what they label *Generating Force* and *Operating Force* applications.

*Generating Force* applications are targeted for the new trainee or for augmenting school training in the classroom with an application. Two respective examples are an application that provided mobile access to the Army Blue Book<sup>12</sup> and the Patriot Missile Crew Drills, which enabled soldiers' learning by use of a virtual soldier in the application. The *Operating Force* applications include position location and identification reporting, CFF (no further information was publicly available about this CFF application), and requests for medical evacuation (MEDEVAC) (ARCIC, 2011).

The most unique characteristic of the development efforts at CSDA is that the soldiers learn how to program the applications themselves. The efforts for application development at CSDA have taken place on both the iPhone and Android platforms. Most applications are available for

---

<sup>12</sup> Army Blue Book is the new recruit reference issued to all basic trainees that provides information on Army culture, history and regulations (TRADOC PAM 600-4, 2008).

download on both the iTunes App Store and the Android Marketplace. Apps for the Army (A4A) also created a repository for the applications submitted, along with instructions on development techniques, and SDK links on the Army Marketplace website, which is accessible only by DoD CAC<sup>13</sup> holders. An image of the site is shown in Figure 14. CSDA proved how effective their methods are in the recent A4A challenge sponsored by the Army CIO/G-6.

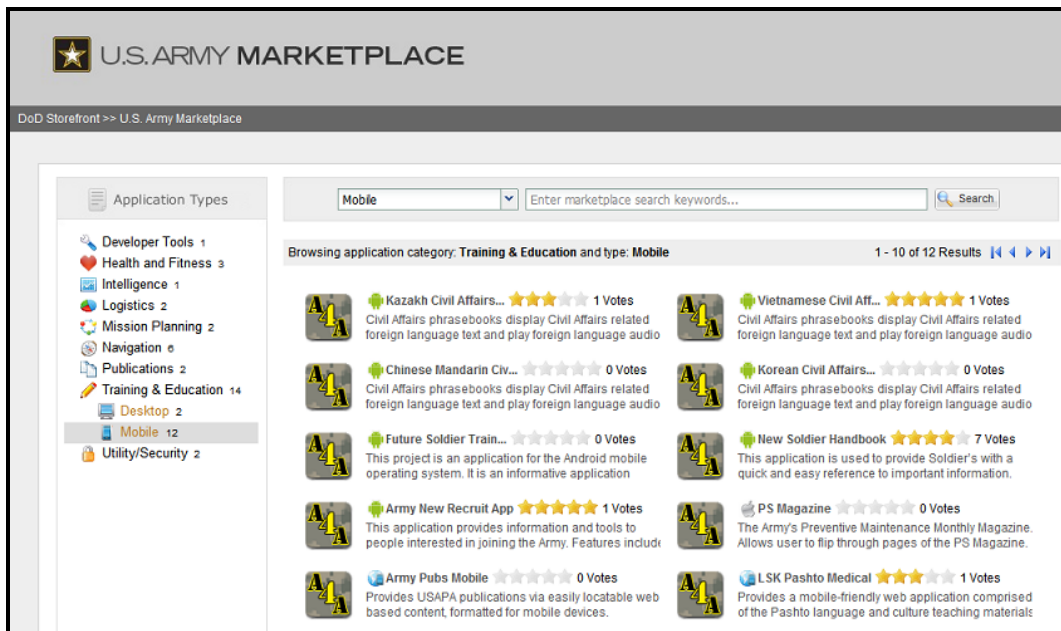

Figure 14. U.S. Army Application Marketplace (From ARCIC, 2011).

<sup>13</sup> CAC (Common Access Card) or more commonly known as the Smart Card, enables the user to encrypt and cryptographically sign e-mails, facilitating the use of Public Key Infrastructure (PKI) to establish secure online connections (CAC, 2011).

The A4A Challenge was the Army's first internal application development challenge. From March 1, 2010, to May 15, 2010, 53 applications were developed and submitted by personnel from all across the Army, both active duty and civilian. A4A demonstrated how crucial the integration of the warfighter is toward a successful rapidly developed application.

**c. FIST**

Another successful effort to develop and integrate a smartphone application came from Marine Captain Carrick T. Longley. His effort was to develop the Field Information Support Tool (FIST) system. FIST incorporated the power of a COTS smartphone and the availability of SDKs to create a software application, *Collect*, and tie the handheld device running his software application into an information management server known as *FusionPortal*. The information gathered from *Collect* and other intelligence databases was then processed and displayed in a usable form through *FusionView* software (Longley, 2010). The FIST architecture is shown in Figure 15.

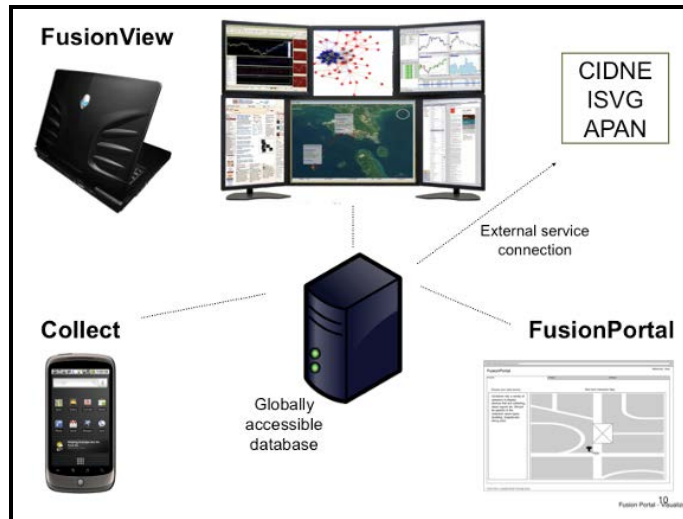

Figure 15. Diagram of the FIST components and its overall architecture (From Longley, 2010).

The FIST was designed as an intelligence collection tool that could be used in scenarios and operations varying from Counter-Insurgency Operations (COIN) to humanitarian assistance and disaster response (HA/DR) (Longley, 2010). Longley's developmental efforts were successful in the creation of the Collect application and the integration of the smartphone to address a capability gap that exists with the inherent latency involved in intelligence fusion operations. It is this tie-in to existing systems that SMART Fires must emulate to ultimately provide the functionality required to enhance a warfighting capability.

## B. SELECTION OF THE ANDROID PLATFORM

The top four current smartphones OSs are: Google's Android OS, Research In Motion (RIM) from BlackBerry, Apple's iPhone OS, and Microsoft's Windows Phone OS, as

shown in Figure 16. According to the information in the chart, only the Android platform is increasing as far as the user base. The iPhone market-share appears somewhat flat. The Android platform was selected as the target platform for this proof-of-concept. It was selected for the following reasons:

1) The growing popularity of the Android OS potentially translates to an increased user intuition toward SMART Fires usage. This increased familiarity results in decreased training requirements for the users to interact with the application on an Android device. Thus, new users will not require dedicated familiarization training on the SMART Fires platform, as is currently the case for AFTADS, due to pre-existing knowledge about the Android OS.

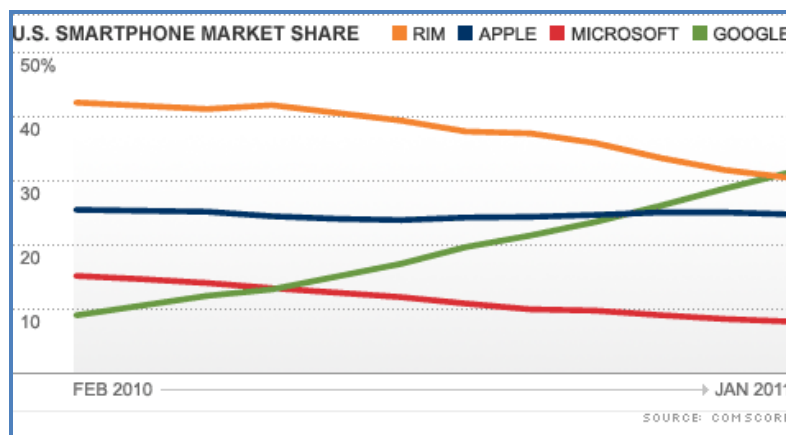

Figure 16. U.S. Smartphone Market Share by OS from February 2010 through January 2011 (From Goldman, 2011).

2) Android SDKs are available for development on any of the top three personal computing operating systems: Windows, Apple, or Linux. Android's developmental environment was

available at no cost to the user in a variety of SDKs and IDEs, all of which allowed for rapid testing and implementation on any smartphone running the Android OS without having to purchase either a new computer or learn a new computing environment.<sup>14</sup>

3) The iPhone development would require the use of the iPhone SDK that runs on MAC OS X and the Xcode integrated development environment (IDE) (Apple Inc., 2011). This would have required a relatively large time investment to learn a new computing OS and would have slowed the overall development efforts toward the SMART Fires application prototype.

4) The SMART Fires prototype was based on the primary researcher's exposure to the capabilities for Android development during the Wireless Mobile Computing<sup>15</sup> course offered at NPS. In two months, the class collectively integrated (onto a smartphone running the Android OS) an application that enabled use of all communication methods resident in the smartphone's hardware. This same type of communication hardware usage is envisioned for the future development of the SMART Fires application.

The Android architecture provides the best use of a smartphone's capabilities. Simply put, development using an

---

<sup>14</sup> The author's primary computing experience is with Windows-based computing systems.

<sup>15</sup> The wireless mobile computing class laid a foundation for understanding the inner workings of commercial GSM cellular networks. The class project required the use of a commercial cellular device that would provide emergency first responders with voice, video feed, chat, and e-mail. The prototype was meant only to demonstrate the capabilities that exist on the smartphone and how very few times they are all realized to their full potential.

Android enables greater functional use of the smartphone because of Android's open-source nature. Developers for Android routinely leverage the devices' internal components to their full capacity. These efforts seem stifled in iPhone OS. Additionally, the Android social networking for developers provides support forums for the exploration of the Android environment. These open forums serve as a venue for peer-review and enhanced collaboration, much the same as for the LINUX OS.

Linux is a key component of the Android architecture, and Android is the product of the Open Handset Alliance (OHA). The OHA is a business alliance dedicated to the open development of mobile handsets, enabling the developers to implement new technologies as they emerge and providing consumers an evolving, richer experience. OHA accomplished this by providing developers open access to the hardware and the source code in the Android architecture (Open Handset Alliance, 2011).

### **C. ANDROID ARCHITECTURE**

Shown in Figure 17 is an illustration of the Android architecture. The basic Android architecture is composed of four stacked layers. The layers are examined from the bottom-up to demonstrate the applications' interaction with the physical hardware on the smartphone that is offered uniquely by the Android OS. These layers are: the Linux Kernel, Libraries and Android Runtime, Libraries Framework, and Applications.



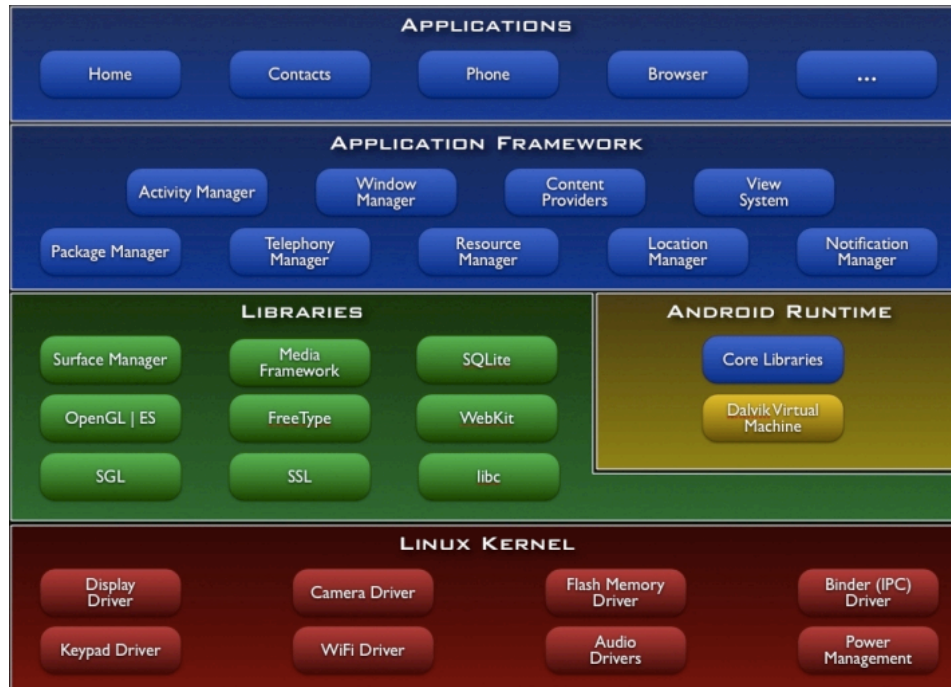

Figure 17. Android operating system architecture (From Borenstein, 2008).

## 1. Linux Kernel

The Linux Kernel<sup>16</sup> is the base stack and it is what the Android architecture uses to interface the applications to the device's hardware, i.e., the processor, memory, RAM or peripheral devices. The Linux Kernel is the base component for the rest of the Android OS and also provides core system services, including security, for memory and processor management (Android, 2011).

---

<sup>16</sup> *Linux Kernel* is an operating system released under the GNU Public License version 2 (GPLv2). Linux was created by a Finnish computer science student, Linus Torvalds, in 1991. It is a prominent example of the free and open source software development environments. (IBM, 2011).

## 2a. Libraries

The next component of the software stack is the Libraries. The Libraries component contains C/C++<sup>17</sup> compiled code libraries that provide capabilities, or systems utilities, to the application stack through Application Framework (Android, 2011). The main libraries are:

- System C Library provides support for internal C or C++ code execution
- Media Libraries support playback and recording of various audio, video, and still image formats
- Surface Manager manages the display and composites 2D and 3D layers from the applications
- LibWebCore is a modern web browser engine
- SQLite, a relational database engine

The Libraries component of the stack also contains the Android Runtime component.

## 2b. Android Runtime

Android Runtime includes libraries for the Java<sup>18</sup> programming language. In the Android architecture, every application runs in its own virtual machine<sup>19</sup> (VM). This

---

<sup>17</sup> C/C++ are both languages in the C family of programming languages, originally developed for the Unix OS. C was the original language and C++ is a more powerful general purpose subset of the C language that better facilitates ease of use by the programmer (Cprogramming.com, 2011).

<sup>18</sup> Java is the programming language developed by James Gosling at Sun Microsystems. Similar to C and C++, Java uses a simpler object model that enables Java applications to run on any Java Virtual Machine (JVM) and remain platform agnostic (Oracle, 2011). Compatible platforms provide a translation tool—an interpreter—that accepts each compiled Java statement (instruction)—or byte-code—and produces the necessary machine-level instructions to execute that statement.

<sup>19</sup> Virtual Machine, or virtual device, is an emulation of hardware or software configurations modeled on existing hardware or software (Android, 2011).

separation of software from hardware by a VM allows applications written in Java to remain platform agnostic. The instance of VM within which the application runs is not a Java VM (JVM). Java applications typically run in a JVM on a desktop or laptop computer because there is less concern for preserving power and processing consumption. In Android Runtime, the applications run in their own instance of a Dalvik VM,<sup>20</sup> This VM provides optimum performance on platforms, like a smartphone, that are constrained by limited power and processor speeds (Borenstein, 2008).

### **3. Application Framework**

The Application Framework is a set of services and systems that include:

- Views, which can be used to build applications by organizing the GUI. This includes lists, grids, text boxes, buttons, and web browser embedding;
- Content Manager to provide access to data from other applications and sharing of internal data;
- Resource Manager that enables access to non-code resources, such as strings, graphics and layouts;
- Notification Manager to enable custom display of alerts by applications; and
- Activity Manager to manage the lifecycle of running applications.

The Application Framework, an open development platform, offers the environment for developers to build rich innovative applications. These innovative applications can then take full advantage of the smartphone platform

---

<sup>20</sup> Dalvik is a process VM written by Dan Bornstein that enables Java code to run on a slow CPU with relatively little RAM, on an OS without swap space, while powered by a battery (Borenstein, 2008).

through the use of SDKs to access the full framework APIs used by the core applications (Android, 2011).

#### **4. Applications**

Applications provide the interface to the user for the platform. In this regard, the programmer develops an application with the GUI to harness the capabilities of the device that enhances the user's experience. These applications for Android are written by the developer in Java.

We next discuss our analysis in pairing smartphone capabilities to user requirements to determine how well these requirements are met.

#### **D. ANDROID-TO-USER REQUIRMENTS ANALYSIS**

To demonstrate how Android can best support the requirements of the SMART Fires application user, we must first establish the user's requirements. The SMART Fires application is envisioned for the entry level user: Fire Support Man (MOS-0861). Requirements for this user are defined in this analysis as the required tasks to be performed in combat. All artillery Marines are assigned tasks they are individually required to perform in combat according to Marine Corps Order 3501.26A, also known as the *Marine Corps Artillery Training and Readiness (T&R) Manual*. We conducted this analysis with the list of the required tasks for the E-1 Private MOS-0861 Fire Support Man according to this T&R manual.

## 1. Fire Support Man METL

The task list, known as the Mission Essential Task List (METL), is segmented into several categories referred to as duty areas.<sup>21</sup> There are seven duty areas for Fire Support, of which six apply to the proficiency of the entry level fire support man. The duty areas are numbered sequentially; however, Duty Area 06 is not within the scope of this analysis. Therefore, this research is concerned with Duty Areas 01 through 05 and Duty Area 07. The Duty Areas are as follows:

- Duty Area 01-Map Reading and M2 Compass
- Duty Area 02-Communications
- Duty Area 03-Observed Fire Procedures
- Duty Area 04-Fire Support Planning and Coordination
- Duty Area 05-Counterfire<sup>22</sup>
- Duty Area 07-Observer Digital Terminal

These duty areas comprise the Mission Essential Tasks (MET). METs are further differentiated into two types, *Core* and *Core Plus*. *Core* tasks are essential individual tasks that support the warfighting function for the unit. *Core Plus* tasks are situation dependant to the warfighting function of the unit when assigned specialized missions or duties (Goldman, 2010). An example of a *Core* versus a *Core Plus* task is:

### Duty Area 03-Observed Fire Procedures

---

<sup>21</sup> Duty areas are extracted from (MCO 3501.26A, 2000) and the excerpt of the specific tasks required for MOS 0861, Private through Lance Corporal, is provided in Appendix H.

<sup>22</sup> Counterfire is "fire intended to destroy or neutralize enemy indirect fire capability" (MCWP 3-16, 1999).

- Core Task: 0861.03.01 - Select an observation post and prepare to use it.
- Core Plus Task: 0861.03.42 - Direct a Close Air Support (CAS) strike.

## **2. Smartphone Assistance for METs**

The scope of this project was to develop and demonstrate a prototype SMART Fires application that focused on the Core Tasks for the entry level MOS 0861. A table was created to demonstrate the amount of assistance an Android device running the SMART Fires application could provide to the user to accomplish the Core METs. These Core METs became the basis of the SMART Fires application requirements.

### **a. Smartphone Features**

The standard smartphone is equipped with several hardware components that provide the *Smart* capability. These features include, but may not be limited to:

- Accelerometer
- Gyroscope
- Compass
- GPS
- Bluetooth™
- WiFi
- Telephony
- Cameras
- Large Touch Display
- Accessible Compact-Flash Storage
- Large internal Memory enabling video significant processing
- Capable Processor, most are now 1 GHz or greater

These features were used as a basis for evaluation of the functional support to the user's MET.

***b. Evaluation of Support***

The evaluation of support to the Core METs was done from two perspectives assuming a fully developed SMART Fires application. The first perspective was how many of the smartphone features were utilized in accomplishing any portion of the MET; this perspective was categorized as feature utilization. The second perspective, and most important to the study, was how well accomplishing the MET was supported; this perspective was categorized as MET support.

A determination was made as to whether or not each smartphone feature could provide support for each MET; if the answer was yes, the feature was awarded a one, if the answer was no, the feature received nothing. The total points were added together for each MET and the sum divided by the number of smartphone features. This quotient reflected the percentage of the smartphone features utilized for that MET. This process was repeated for all METs. Then the average for all Core METs was taken by Duty Area, and an average of 70 percent utilization was discovered. This demonstrated to the researchers that most of the smartphones features provide benefit to the user in enabling the performance of the Core tasks. The most important question however, is how well a fully developed SMART Fires application on a smartphone would support the user in accomplishing their Core tasks.

To determine the level of support to the METs the researchers assumed an ordinal scale that corresponded to the level of support provided by a fully developed SMART Fires application.

- If a MET was not supported in any way the SMART Fires application received a zero.
- If the MET was minimally supported the SMART Fires application received a one.
- If the MET was mostly supported the SMART Fires application received a 2.
- If the MET was fully supported, meaning the entire task could be accomplished using only the application, then it received a three.

Then the average for all Core METs was taken by Duty Area, and an average of 2.0, mostly supported, was discovered. Also key to the evaluation of support is the fact that there was no Core Task that was not at least minimally supported. The average utilization and MET Support for the Core Tasks by Duty Area is shown in Table 2.



<b>Duty Area</b>	<b>Feature Utilization Average</b>	<b>MET Support Average</b>
<b>01 Map Reading &amp; M2 Compass</b>	80%	1.8
<b>02 Communications</b>	70%	1.9
<b>03 Observed Fire Procedures</b>	88%	2.6
<b>07 Observer Digital Terminal</b>	43%	1.6
<b><u>ALL CORE METs</u></b>	<b><u>70%</u></b>	<b><u>2.0</u></b>

Table 2. The table presents a summary of smartphone utilization and support to the Core METs by Duty Area.

These figures informed the researchers that a fully developed SMART Fires application would leverage a significant portion of the platform capabilities for fire support at the tactical level and it would enhance the user's ability to perform every mission essential task in combat. In the evaluation, the utilization average was relatively low for Duty Area 07, Observer Digital Terminal (ODT), because the assumption for the evaluation was that the ODT was not the SMART Fires application. This assumption was introduced to the evaluation since the SMART Fires application was not yet developed when the T&R manual was written. This research effort considers that the best ODT would be a fully developed SMART Fires application. As proof of this belief, if the ODT were assumed to be the SMART Fires application the utilization and MET Support average would have increased from 72 percent to 76 percent

utilization and 2.0 to 2.1 MET Support. Comparison of the utilization and MET support provided by the SMART Fires application for Core Tasks is provided in Appendix I and for the Core Plus tasks in Appendix J.

#### **E. RAPID DEVELOPMENT DEFINED**

We began rapid development of the SMART Fires application prototype by establishing requirements. The underlying premise for the proof-of-concept study was that a user could aid in the rapid development of the prototype application that could then be provided to the operating forces, enhancing warfighter capability. To demonstrate this we first needed to discover what user input would be most beneficial to the developer.

##### **1. User Involvement**

Software development for mobile applications in particular is still in its infancy when contrasted with software development in general that started in the late 1960s and has been around for more than 50 years (Osmundson, 2011). Traditionally, a software developer is not in the military operating forces. The developer relies on past personal experience and/or the advice of systems engineers and software developers for how to best satisfy requirements - usually to the detriment of the user.

Often the software developer satisfies internal production requirements at a higher priority than the users' requirements. It is essential that detailed requirements be given to the developer to create software that fulfills the user's needs. Therein lies the problem with traditional

development methods: users are seldom capable of articulating the software requirements.

User requirements are difficult to articulate, in part because the user does not have an in depth knowledge of the capabilities of the system platform for which the developer will create the software application, may not exist. This is not generally the case in smartphone application development; the user and the developer both have a detailed knowledge of the platform and interface. The introduction of the user as a partner in development is what will be exploited in the SMART Fires application prototype.

We argue that that by adapting existing software development practices to the development of a smartphone application, the development time could be decreased and a fielded product provided to the warfighter sooner. An examination of current prototyping is required to understand how it was adapted.

#### ***a. Rapid Application Development***

There exists an industry accepted methodology for prototyping in software development known as Rapid Application Development (RAD) (Christensen & Thayer, 2001). The process takes place in a cycle with three steps. The cycle begins with the user's, or customer's (in the business case), provided requirements for the prototype. Next, the developer builds the prototype based on these requirements. The cycle's last step is the prototype usage by the customer. The cycle runs full course when inputs from the customer on the prototype are provided to the developer as

subsequent requirements for the prototype (Osmundson, 2011). An illustration is shown in Figure 18.

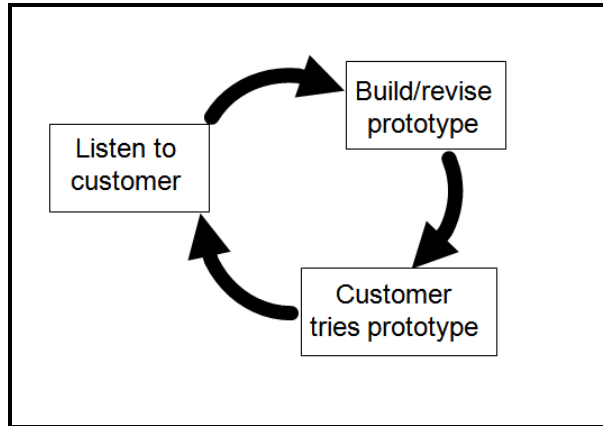

Figure 18. The Rapid Application Development Cycle (From Osmundson, 2011).

We remain convinced that the strength of user inputs to the application did not fully reveal the complete benefit to the RAD cycle until the second time the developer “listened” to the user as illustrated in Figure 18. This meant lost time to the development process. The answer to reduce this lost development time would be to introduce high value input requirements when initiating the cycle.

#### ***b. Rapid Development for Applications***

There are two key differences between the user of the current call-for-fire system and the SMART Fires user. The first difference is the previous experience with the application platform, an Android™ smartphone. The second difference is how the user expected to interact with the SMART Fires GUI. The unique benefit of the user in rapid development for applications is that the user provides a visualization of a GUI intuitive for the user that serves as a framework for the application requirements and interface.

The developer can then provide a prototype that meets user needs in one cycle with only minor changes required on any subsequent cycles. This rapid development for applications technique can result in a developer creating an application the user already knows how to employ. Unfortunately for the operating forces, this familiarity with new systems is the exception.

Fielding of fire support systems in recent history has relied on New Equipment Training Teams (NETT) to provide the users with the minimum requisite knowledge to introduce a new capability to the unit. It then is incumbent on the military commands to develop and institutionalize formal courses and recommended on-the-job training practices to gain the full benefit of a new system fielded<sup>23</sup>. Our rapid application development technique can reduce this lag in operational enhancement to the warfighter.

The user for SMART Fires needed to convey their requirements to the developer in a form that benefits the development of the application as quickly as possible. The information required to go into the application was the same as for the standard CFF. Thus, the standard CFF, provided in Appendix A, was used as the basis of information that a user would be required to input into SMART Fires.

The author's experience provided a thorough understanding of voice procedures to submit the CFF. The inputs to the CFF were known to be required inputs into the SMART Fires application before a CFF could be submitted

---

<sup>23</sup> Based on the author's experience while serving as a Battery Commander and the Regimental Logistics Officer during the fielding of two new weapon systems and the planning for the fielding of a third.

using the new application. Many inputs could be extracted directly from the Android smartphone functions and could be provided to the user: location, observer identification, and identification of the firing unit. Yet, the target location and description would change for most targets. The strength of the Android development is the ability for an application to take information from other C2 systems; information such as other friendly unit locations, suspected enemy locations, or known enemy activity helps facilitate a more informed decision by the observer.

### ***c. App-boards***

The Appboards technique was derived from how movies and animated films are first presented to the writers, cinematographers, or detailed animators, referred to commonly as story-boards. Story-board artists use roughly drawn still images of key scenes to present to the rest of the staff or development team a vision of the finished product. Story-boards have also previously been used in development of user interfaces for other software applications by IBM (IBM, 2011). This technique was adapted to the development of the SMART Fires application by creating App-boards.

App-boards are hand-drawn, roughly illustrated screen captures of the application being designed. The app-boards provide a vision of the application that makes sense to the user, and through the use of screen numbering and the notes section, the user can write down what functionality is required. The app-boards can be as detailed or as generic as the user and developer jointly determine necessary to convey the concept being depicted. The app-boards can be as

detailed as including interfaces buttons, pull down menus, settings button etc. An illustration of the app-board is shown in Figure 19.

The figure shows a worksheet template for an app-board. It contains two identical sections, one above the other. Each section starts with the text "Screen # \_\_\_\_" followed by a large empty rectangular box representing the screen layout. To the right of each screen box is a vertical column of five horizontal lines, serving as a notes section. Callout boxes with speech bubble tails provide additional information: one points to the screen box with the text "screen naming can be either a number or naming convention.", another points to the notes section with "notes section is used for explanations of item functions or clarification of layout.", and a third points to the bottom of the screen box with "screen size and layout can easily be adjusted to match the type of device that the application is developed for."

Figure 19. Example of App-board worksheet.

There are various forms of this type of product in the Android development communities and forums. These products are usually referred to as "wireframes." The *wireframe* drawing is then used to create a design for the prospective Android application. Tools that exist for *wireframing* range from hardcopy graphic-document, with a phone display silhouette like the app-board, to a downloadable software package that can be used as stand-alone software or in conjunction with an IDE, such as the Eclipse™ SDK.

In this proof-of-concept study, the user was assumed to be familiar with the use of a smartphone and not expected to be involved in actual Java programming or required to interact with the Eclipse™ IDE. For these reasons, the app-boards provided the fastest method for communication of the user's vision of the prototype. The developer could now commence work on the prototype with the user's vision communicated, moving the research efforts one step closer to the SMART Fires application.

#### **F. DEVELOPMENT ENVIRONMENT**

The Eclipse™ development tool has been mentioned as an SDK and now an IDE for Android Development but it can be used for much more. Provided is a description of Eclipse and its capabilities along with how the other required software components tie in for Android development. The first step to setup of the development computer was installing the Java Development Kit (JDK).



## **1. JDK**

On the Oracle website for Java development there are several options for download in order to begin development. All the software downloaded from the Oracle website was available at no charge. The Java Runtime Environment (JRE), required for Java applications and applets, is also required for Android development, as is the Java Development Kit (JDK). There are several open source versions of both the JRE and JDK available however this research effort selected the JRE and JDK from Oracle. Without a version of the JRE and JDK installed the IDE selected for development could not use the Java language for its software, since it is the JRE and JDK that allow for the respective running and writing of the Java programming language (Oracle, 2011).

Java does provide its own Java IDE, NetBeans™, which provides most of the same functionality as the Eclipse IDE. The Eclipse IDE, however, is widely supported in documentation and, specifically, in the Commonsware® reference library used by the researchers. The support aspect weighed heavily in the decision to begin development with the Eclipse™ IDE. Accordingly, the next step toward development was to download the Eclipse™ IDE.

## **2. Eclipse™ IDE**

The Eclipse™ integrated development environment began as a not-for-profit corporation that furthered open source software development. Eclipse is provided free of charge for public or commercial development. The infrastructure, maintained at no charge to developers, includes: code repositories, databases, mailing lists and newsgroups, and

the website front end that enables downloads of the Eclipse™ software (Eclipse Foundation, 2011). The Eclipse software supports development in a variety of programming languages in addition to Java. These other programming languages include: AspectJ, C and C++, COBOL, and PHP. Eclipse offers IDEs for these languages on the three big personal computing OS: Windows, Linux and MAC. The other main feature of using the Eclipse environment is the additional tools and builds and plug-ins available to enhance developmental efforts. The additional tools include: tester toolkits, Google plug-in (that include the Android Development Tools (ADT), and over 1000 more tools (Eclipse Foundation, 2011).

The Android Development website specifically recommends the use of the Eclipse IDE with the ADT plug-in for developers new to Android (Android, 2011). The researchers' exposure to the mobile computing application development provided exposure to the Mark Murphy CommonsWare© library of resources. The use of Eclipse is not required to follow the examples provided in the CommonsWare© tutorials and lesson examples; however, the lessons were significantly easier to understand and implement when using the same IDE as the reference. Eclipse™ was most appropriate for the development of our SMART Fires prototype. The steps to download were straight forward and simple to follow from the Eclipse website.

### **3. Android SDK Starter**

After installing JDK and the Eclipse IDE, next comes the Android SDK starter package with Android Development Tools (ADT) and an emulator, the Android Virtual Device (AVD). The AVD allows development without a physical

smartphone by use of an emulated Android smartphone to test and trouble-shoot the application being developed. Again, all software downloaded from the Android developer website was available free of charge and on the three main personal computing OS choices.

#### **4. ADT Plug-in for Eclipse**

The ADT plug-in for the Eclipse™ IDE allows access to the ADT and the AVD software directly when running Eclipse. During the setup for the plug-in the developer is required to select the platforms and APIs used in development and the ADT downloads those APIs for use. These APIs and tools allow full functionality for development and trouble-shooting directly from within the Eclipse workspace, so familiarity with a new platform is not required.

#### **G. CREATING WITH COMMONWARES REFERENCE**

The Android Development reference material written by Mark Murphy and the CommonsWare(LLC) community enabled this research effort to develop the SMART Fires Application through a paid *warescription* to the CommonsWare online library (CommonsWare, 2011). The *warescription* provides four books, viewable with any web browser in three formats, Adobe Acrobat, Amazon's Kindle, and Electronic Publication (EPUB), the latter being an open standard for electronic readers and some web browsers. The *warescription* included free version updates for the duration of the *warescription*, online office hours with Mark Murphy via a chat room connection, private consulting (at additional cost), source code for all tutorials, and access to in-person training through locally hosted workshops.

The CommonsWare materials were purchased by the researchers at a relatively minimal cost of \$40. The return on the researcher's investment was reduced time in the learning of a new programming language. The time expended the prototype development was also reduced, adding to the return-on-investment for the CommonsWare material, since the texts provide examples and tutorials using the Eclipse IDE. There were a variety of other products available, too, such as written texts and videos, the latter available at no charge via YouTube(LLC). The products however, did not include the interaction with the Eclipse IDE in the depth that was covered in the CommonsWare© reference library. The research effort was greatly assisted through the use of this resource and as such it is recommended as a reference for individual learning or augmentation to formal coursework.

With a design and development methodology and capacity established, the requirements and GUI design for the SMART Fires application prototype can be addressed. The next chapter describes the design and resulting implementation of this smartphone-based CFF tool.

THIS PAGE INTENTIONALLY LEFT BLANK

#### **IV. SMART FIRES DESIGN**

The App-boards created during the design process that consolidated user requirements and an initial GUI design are provided below. The chapter further provides the GUIs created by the researchers according to the app-boards laid out for the SMART Fires application prototype.

##### **A. DESIGN PLAN**

The design plan for the SMART Fires application prototype consisted of, first, allowing the user to create the app-boards to enable the developer to understand the user's requirements and translate them into application processes. The processes can then be programmed and integrated with an appropriate GUI design, as the user conveyed in the app-boards.

##### **1. Requirement to Processes**

The app-boards, created by the user, describe the anticipated layout, the expected interface behaviors, and the requirements for the application based on warfighting experience. The SMART Fires application prototype is aligned to the user requirements, as shown in the SMART Fires application process depicted in Table 3. Table 3 does not contain requirements for Duty Areas 04 and 05 because these areas do not contain any Core METs. This process is modeled after the Advanced Field Artillery Tactical Data System (AFATDS) process and user requirements, as documented in

research by Geoffrey Thome. His research explored the systems integration of AFATDS and the Information Operations Server (IOS) (Thome, 2002).

Duty Area	User Requirements	SMART Fires process
01 Map Reading & M2 Compass	<ul style="list-style-type: none"> <li>• Maintain current battlespace geometry</li> </ul>	<ul style="list-style-type: none"> <li>• Receive current battlefield FSCMs</li> <li>• Maintain accurate user location</li> </ul>
02 Communications	<ul style="list-style-type: none"> <li>• Digital communications</li> <li>• Voice communications</li> </ul>	<ul style="list-style-type: none"> <li>• Establish comms</li> <li>• Manage Alerts</li> <li>• Auto-Forward CFF</li> <li>• Broadcast position</li> <li>• Provide simultaneous voice and digital communications</li> </ul>
03 Observed Fire Procedures	<ul style="list-style-type: none"> <li>• Maintain accurate friendly unit information</li> <li>• Deliver Fires</li> </ul>	<ul style="list-style-type: none"> <li>• Receive friendly unit information</li> <li>• Perform FSCM checks</li> <li>• Determine recommended fires support agency</li> <li>• Format CFF info into any digital format</li> <li>• Transmit the CFF in format acceptable to any fire support agency</li> <li>• Receive MTO</li> <li>• Conduct subsequent corrections</li> <li>• Transmit RREMS</li> </ul>
07 Observer Digital Terminal	<ul style="list-style-type: none"> <li>• Maintain digital user manuals and references for special equipment or procedures (Core Plus tasks)</li> </ul>	<ul style="list-style-type: none"> <li>• Access local or cloud storage for interactive learning</li> <li>• Voice recognition searches</li> </ul>

Table 3. User requirements translated into process requirements by Duty Area (After Thome, 2002).

## 2. User GUI Design

The app-boards are reviewed to illustrate the user's inputs for GUI design. The inputs captured in app-boards 1-5 directly contribute to the observer process depicted in Savvion™ To-Be model presented in Figure 10. The MTO received from the artillery battery will populate screen 11 in app-board 6. Screen 12 on app-board 6 and all of app-board 7 are not depicted in the Savvion™ model. Specifically, we noted the following for user design:

- App-board 1, provided in Figure 20, shows the startup screen and what the application should do to facilitate the CFF.
- App-board 2, provided in Figure 21, illustrates the menu screen and selection of the firing agency when initializing the application.
- App-board 3, provided in Figure 22, is the input screen for the fire support coordination agency in the CFF process and the CFF screen to initiate a fire mission.
- App-board 4, presented in Figure 23, represents how the user expects to interact with the SMART Fires application to input the firing agency and observer identification, parts 1 and 2 of the CFF.
- App-board 5, provided in Figure 24, illustrates the description of the target screen and parts 2 and 3 of the CFF.
- App-board, 6 provided in Figure 25, illustrates the MTO screen that the user will receive when the firing agency processes their CFF, and the subsequent corrections screen for adjustments by active targets.
- App-board 7, provided in Figure 26, illustrates the user's design for the termination of the CFF known as Record as Target, Refine, End of Mission, Surveillance (RREMS), and the transmit screen for a completed CFF.



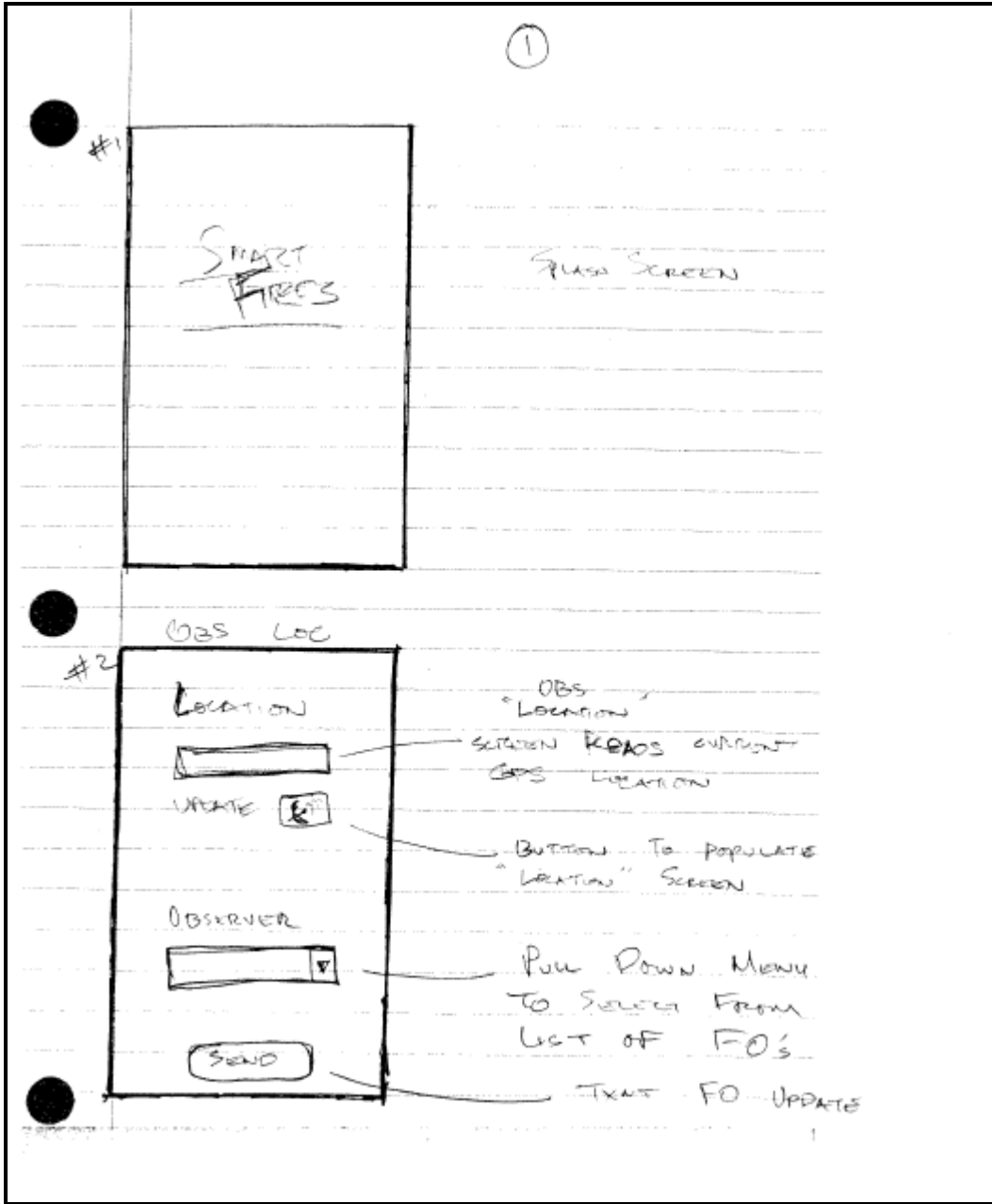

Figure 20. App-board 1 is the application start-up screen and application initialization menu.

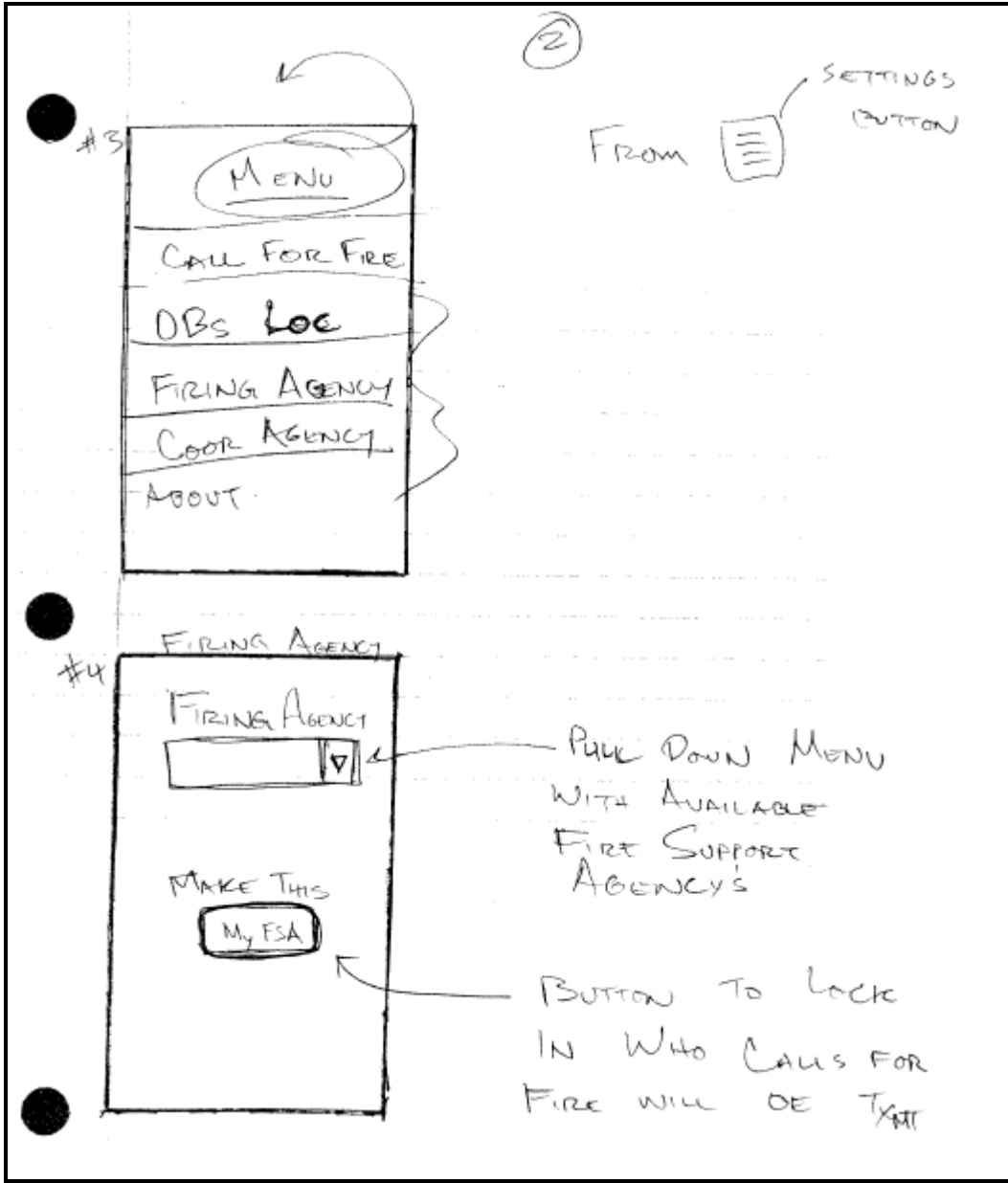

Figure 21. App-board 2 is the main menu screen and firing agency selection screen.

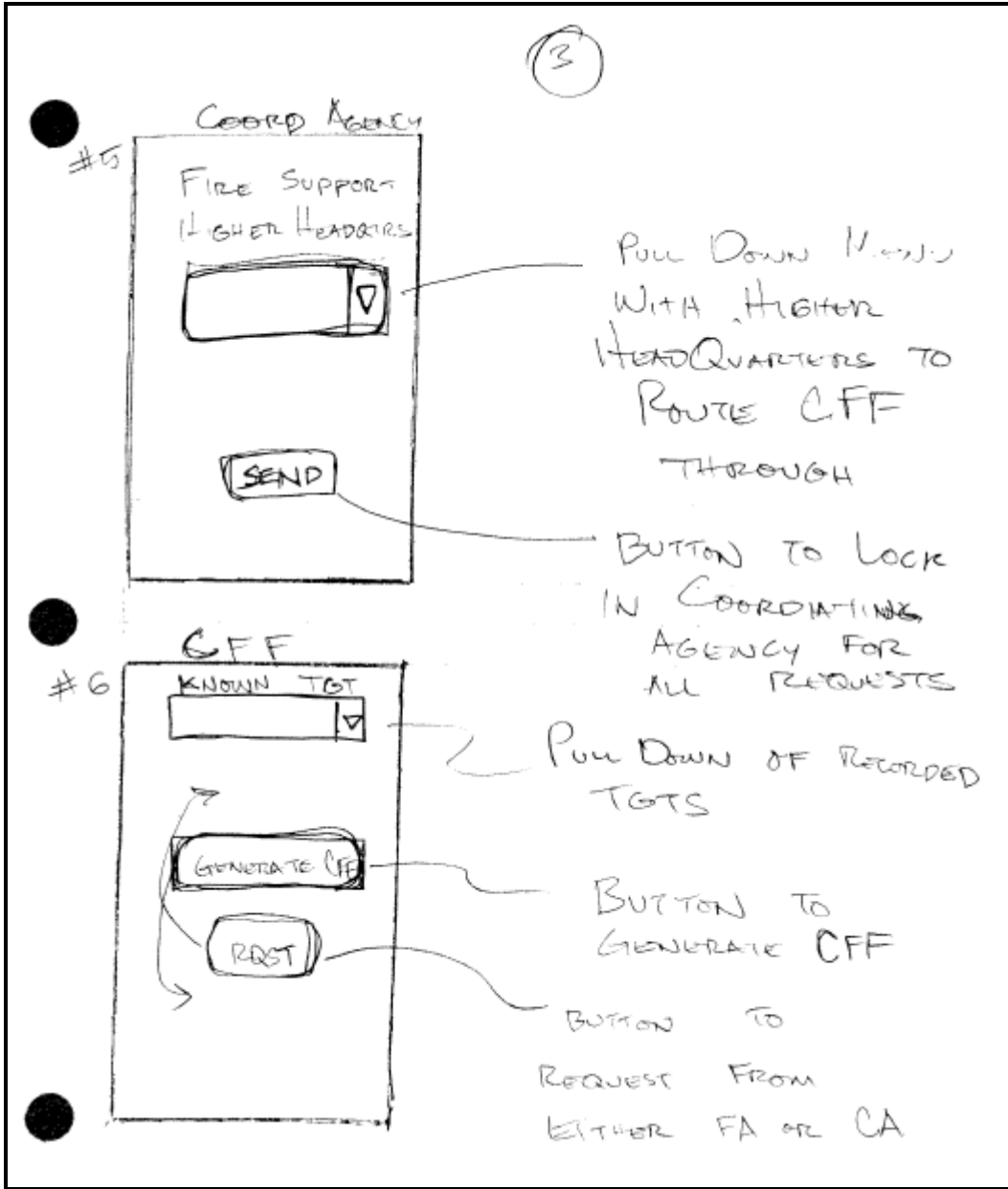

Figure 22. App-board 3 is the screen to input the fire support coordination agency and the CFF menu.

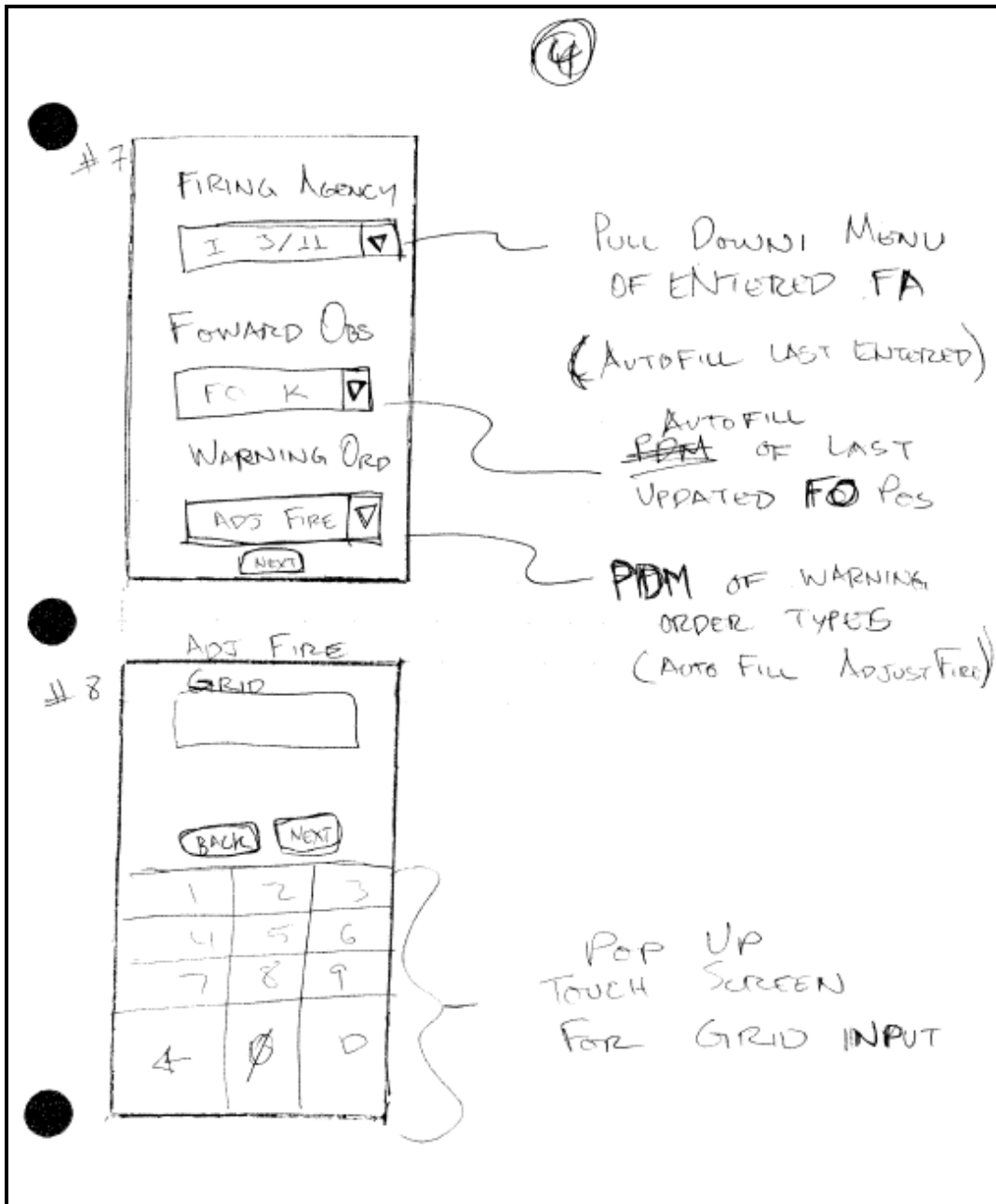

Figure 23. App-board 4 shows parts one and two of the four CFF screens.

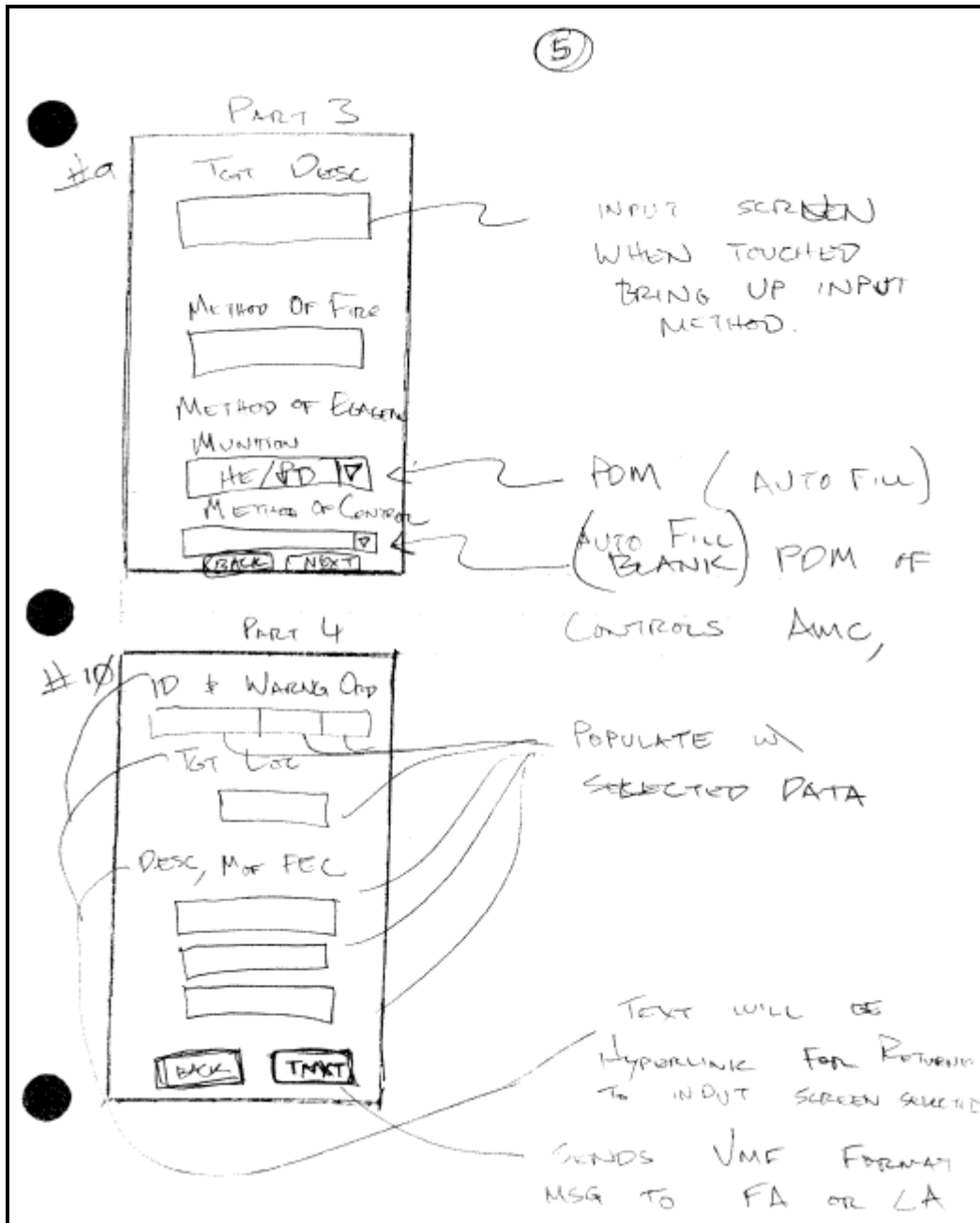

Figure 24. App-board 5 shows parts three and four of the four CFF screens.

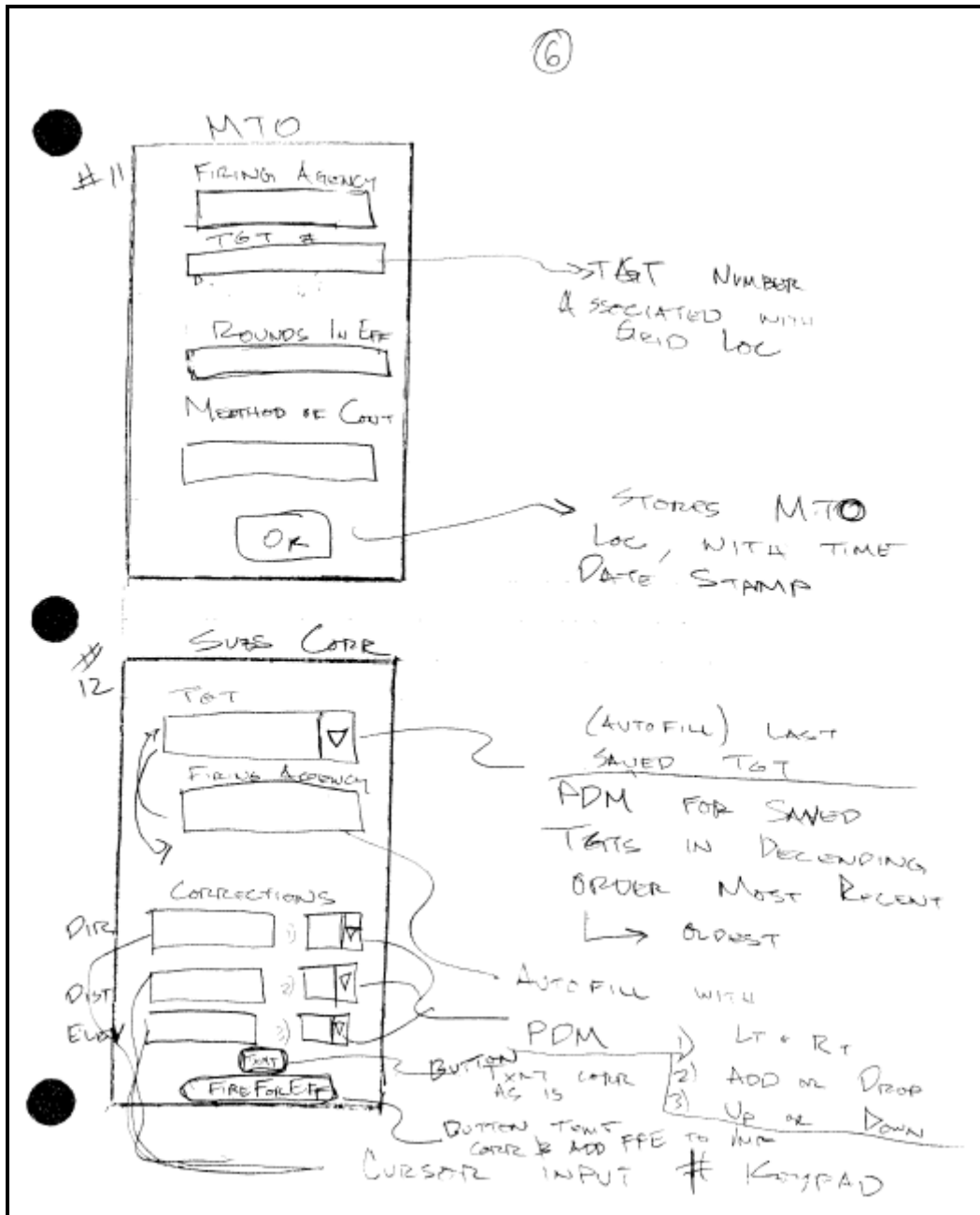

Figure 25. App-board 6 illustrates the MTO screen, and the subsequent corrections screen.

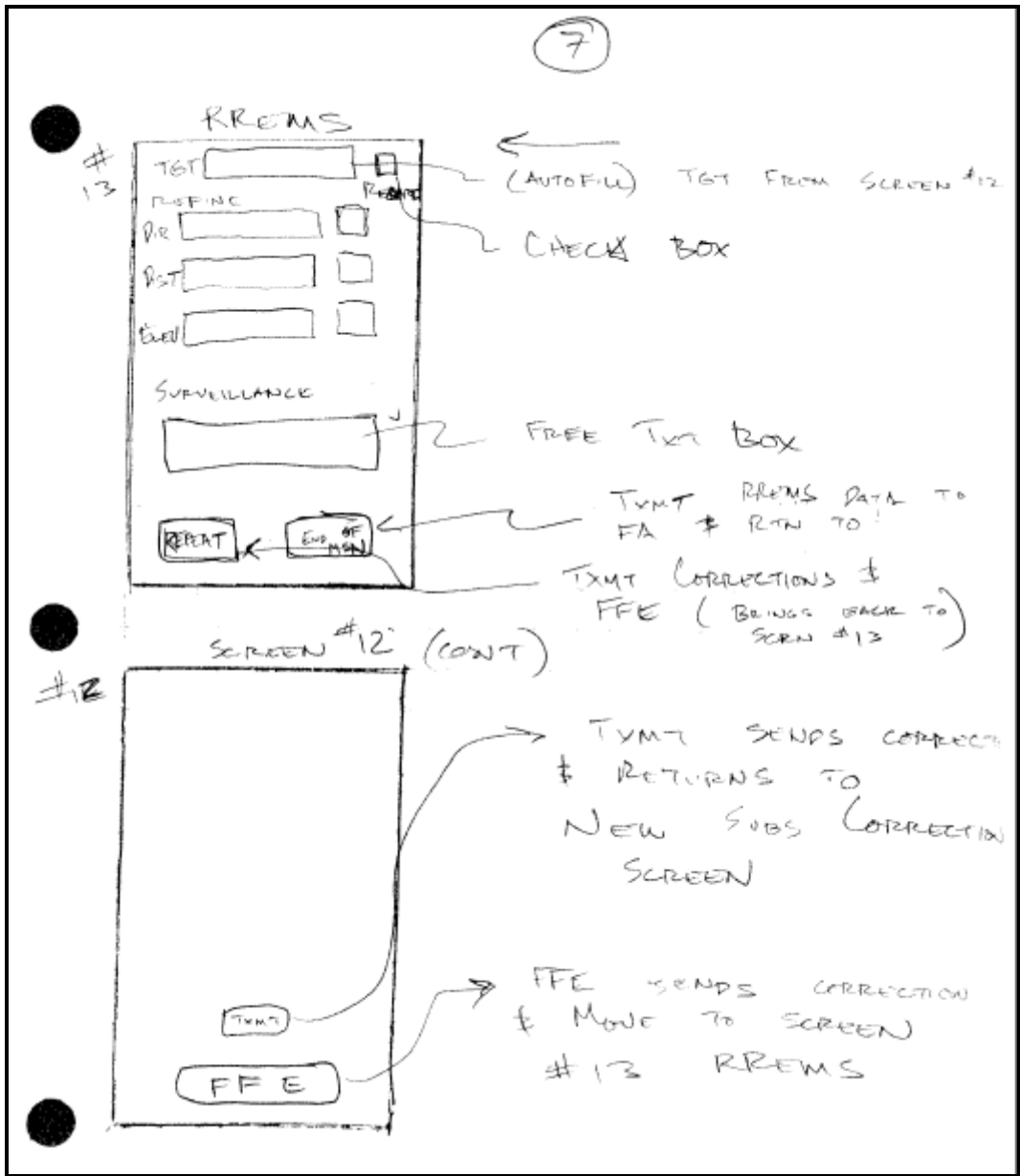

Figure 26. App-board 7 illustrates the RREMS screen, and the remaining screen element for screen #12 in Figure 25.

## B. SMART FIRES PROTOTYPE GUI

Using the development environment created as described in Chapter III, we easily translated the app-boards into

screenshots for the user to validate and provide feedback according to the rapid development for application technique.

An example of the GUI created from these app-boards is shown here in Figure 27. The final GUIs created during this development are provided in Appendix K.

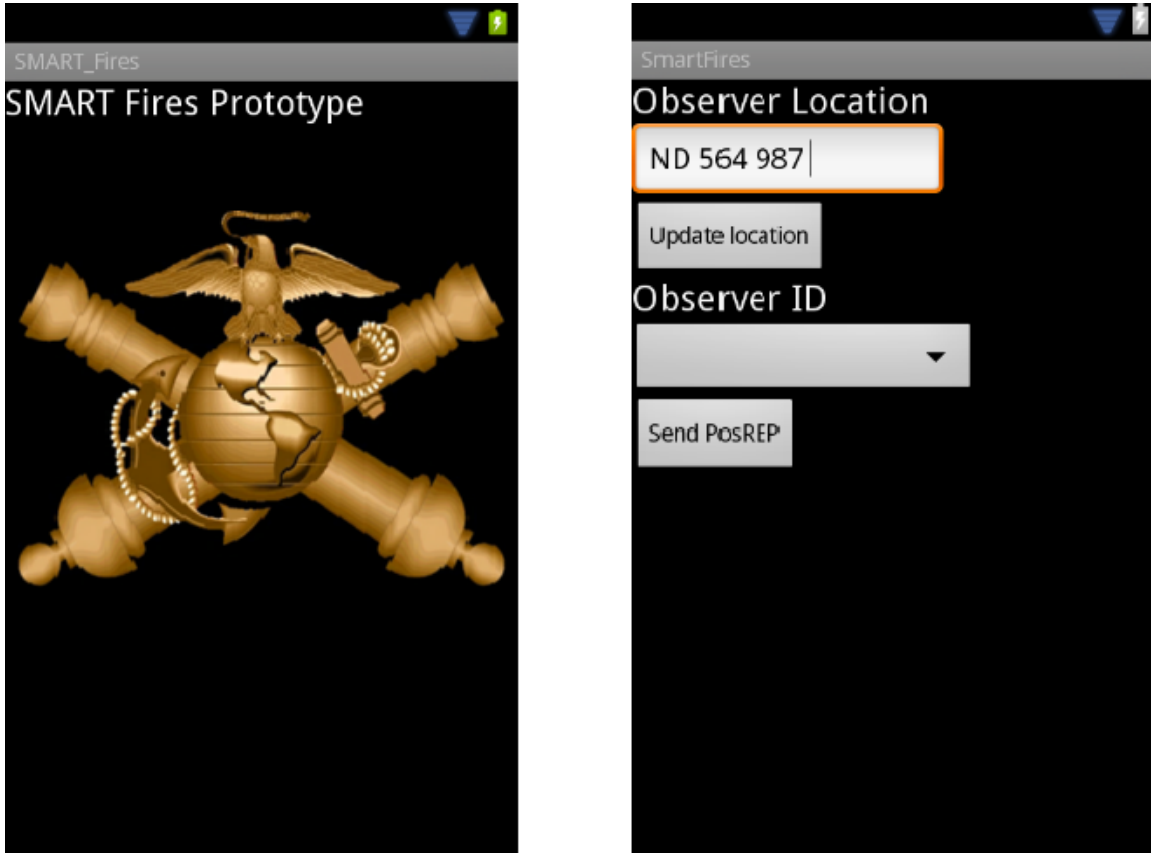

Figure 27. These screenshots from the SMART Fires application prototype correspond to the app-board created by the user in Figure 20.

The SMART Fires application developed herein demonstrated both the utility of the Android-based smartphone as a platform for hosting custom combat-relevant applications and the effectiveness of the rapid prototyping for application development methodology in generating such



applications. The final chapter will review the intent of this research effort along with its findings and conclusions, and identify areas that warrant further study and analysis.

## **V. RESULTS, CONCLUSIONS, AND RECOMMENDATIONS**

This chapter presents the answers to the questions that guided this research through analysis of the results of the proof-of-concept study. We also present the conclusions as to the validity of the SMART Fires application and the way ahead for further development of the SMART Fires application. Then, once fully developed, the chapter describes how SMART Fires can lead to a product line of SMART applications that provide warfighters with enhanced combat capability across many, and perhaps all, functional areas.

### **A. RESULTS**

The extent of the results from this proof-of-concept study is easily measured by stipulating how well the research questions were answered in the course of the effort. The questions presented in Chapter I are provided for ease of review.

- How can COTS software developmental tools be used to produce a smartphone application to aid the transition between traditional radio equipment and a tactical cellular network?
- How does the SMART Fires application fit into existing and future Command and Control platforms in integrating information into a Common Tactical Picture (CTP) that will assist the warfighter?
- How effective will these COTS applications be in aiding the warfighter (e.g., target location precision, request latency, situational awareness increases, and efficiency)?

## **1. TRANSITION TO TACTICAL CELLULAR NETWORK.**

This first research question is a two-step process addressed first by providing specific C2 functions commonly resident only at the battalion and higher levels to the company, and in some cases, to the individual Marine. In keeping with the CAPSET 5 UNS by Hastings, there exists a need now for these C2 functions by the Company-level units and below (Hastings, 2009).

By developing applications that run on the smartphone platform, we fulfill that need. This will facilitate the second part of the answer regarding transitioning to a tactical cellular network, which is the bandwidth requirement levied by providing this C2 capability down to the USMC company-level and below. This need requires an improved communications network, one previously unused by the military, namely a tactical cellular network. To gain full C2 capability at the company, smartphone systems will be required to access information resident with the legacy systems of record. This information can no longer remain stove-piped in proprietary systems. The tactical smartphone integration can be aided by demonstrating how these legacy platforms may be integrated into a tactical cellular network.

## **2. ASSIST THE WARFIGHTER IN INTEGRATING COMMON TACTICAL PICTURE (CTP)**

The Android-based GD300, tested at the Army experiment discussed in Chapter II, was tested with the Tactical Ground Reporting (TIGR) application. TIGR provides near-real time C2 at the individual soldier-level, similar to the Blue

Force Tracker (BFT) providing position of friendly vehicles and CP locations in the Army's Force Battle 21 Command for the Brigade and Below (FBCB2). The TIGR application, if loaded onto the smartphone, could provide the observer instant, accurate positions of friendly maneuver units in his area of operations. The BFT provides a near-real time position location for tactical forces. This information is an example of the integration possible by the SMART Fires application. We envision a similar functionality to that of Google Maps where information is filtered so as not to overwhelm the user as the map scale is increased. Lower level units and individuals might become visible as the map is scaled down to a focused area of responsibility. This information *feed* – focused to the area with which the user is concerned – is the best example of how, when integrated on the tactical cellular network or tethered into the C2 network, SMART Fires can enhance the user's Common Tactical Picture.

### **3. EFFECTIVE COTs DEVELOPED APPLICATIONS**

The development of a SMART product line of applications for smartphones will provide the assistance demonstrated through the Savvion™ business model in Chapter II. The results of the model indicated that the overall efficiency of a unit with integrated SMART applications could prosecute ten times the number of CFF in the same amount of time as a unit without the applications.

This efficiency in execution was directly related to the observer's ability to tie in information from the existing C2 systems like Blue Force Tracker (BFT), which is the end system for FBCB2 (Dixon, 2009). This same product

line of "SMART" applications can be designed for every warfighting function: SMART Intel, SMART Logistics, etc. A product line of SMART applications could be developed once the SMART APIs are made available for development similar to the way developers create applications to interact with open source APIs. These APIs range from Google Maps to Banking APIs. Development is constrained by the imagination of the user community with respect to how their requirements might be addressed by smartphone-based applications.

## **B. CONCLUSIONS**

This thesis explored the impact that smartphone-based applications can have on the warfighter. The focus of the proof-of-concept was to rapidly design an application, leveraging user experience with C2 programs of record systems, i.e., AFATDS, Command and Control Personal Computer (C2PC), Global Command and Control System – Marine Corps (GCCS-MC), to enhance the Call-for-Fire process executed by very junior Marines.

Such integration efforts for a military smartphone technology are ongoing. This is the time to begin development of applications that provide the warfighter enhanced warfighting capability. The SMART Fires Application can have a positive, immediate impact on the warfighter's mobility and lethality. It is in this integrated Smartphone –military tactical network environment–that the rapidly developable Smartphone applications can provide a positive impact to all warfighting functions throughout the Marine Corps and eventually the joint services.

## **C. RECOMMENDATIONS**

In the course of this research, various activities were beyond the scope established for the proof-of-concept study. Those activities should be considered as recommendations toward the completion of the SMART Fires application prototype.

### **1. AFTADS Integration**

The next step for the SMART Fires application is to complete the integration into the existing fire support network. The CFF from SMART Fires requires conversion into the Variable Message Format (VMF) for transmission to the AFATDS. This task presented a level of complication and technical expertise that was beyond the scope of this research. Through further development, however, the SMART Fires prototype could gain the required functionality and integration with existing fire support C2 systems as required by the warfighter. Such would mean SMART Fires could transmit a CFF directly to AFATDS when tethered to a COF network radio.

### **2. Use of Augmented Reality**

Some existing android market applications integrate an emerging technology known as Augmented Reality (AR). AR uses the smartphone framework of an integrated position indicator and accelerometer to provide a graphical overlay for the device's display that presents relevant information to the user, such as current position, direction, vertical angles,

altitude, etc. The closest AR application that matches the display, as envisioned by the researchers, is from Hunter Research and Technology, LLC, named Theodolite Pro, shown in Figure 28.



Figure 28. The Theodolite PRO AR screen provides a variety of positional and directional information for the user (From Hunter Research & Technology, 2011)

We envision that the primary use for AR would be in providing a visual reference of critical information in the display. AR can be used in a military application to present a known location of a target site that the user could readily distinguish on the display. This AR function could assist the user to verify the true target location very quickly, helping to avoid unnecessary collateral damage.

#### **D. FUTURE WORK.**

The SMART Fires application prototype could benefit the fire-support community immediately with increased efficiency in transmitting a CFF in any format or standard required. Future work for the SMART Fires application could establish

a SMART API for a Product Line Architecture (PLA) of applications to increase sharing of the users' CTP so that users of sister SMART applications can provide logistics, intelligence, force protection, or other information pertinent to the warfighting functionalities required for the user's success. An increase in the user's accuracy and precision in target location could also be provided. Finally, a SMART Simulator could further extend the training environment for our users.

### **1. SMART Product Line Architecture**

The Android-based operating system used on the GD300 was reported to be released to the public for developmental efforts in July 2011. The warfighter could maintain the status quo and continue to carry more equipment and systems than he should because the system providers continue to create new proprietary devices. The most advantageous aspects of smartphone integration into the military wireless network are that smartphones provide a PLA approach to tactical interfaces by standardizing the device platform. Once this framework is established, products will continue to be developed and integrated with other applications. Smartphone integration may also inform and standardize future software development because the platform has already been established.

### **2. SMART Range Finder**

The Call-for-Fire (CFF), transmitted through the SMART Fires application, is dependent upon the ability of the user to estimate the distance to the target. While the use of map APIs and overlays can enhance the user's accuracy, the human



factor remains involved in initial target location. To decrease human error, the use of a laser range-finding device as a part of the SMART Fires system may increase the likelihood of the first rounds fired having the desired effect on the target and could contribute toward conservation of ammunition. We also note that the device can either be tethered via wired or wireless communication with the smartphone or fully integrated into the hardware itself, such as a sleeve.

### **3. SMART Simulation**

The software developed by the two Naval Postgraduate School students for *The Forward Observer Personal Computer Simulator* (FOPCSIM) was created to increase CFF training effectiveness for Marines embarked aboard naval ships. The realistic training simulation increased exposure to the call for fire process and the tasks associated with accomplishing the observer core tasks (Brannon & Villandre, 2002).

Their research and creation of the this stand-alone program resulted in a system that was later tied into existing forward observer systems, to include the Training Set Forward Observer (TFSO), Closed Loop Artillery Simulation System (CLASS), Forward Observer Training Simulator (FOTS), GUARDFIST II, and eventually the DVTE where the trainer first created a virtual environment for training the forward observers. The integration of a simulation capability into the SMART Fires application, similar to FOPCSIM, might further enhance the warfighting capabilities of the user.

APPENDIX A

<b>ADJUST FIRE MISSION</b> (Grid Method)	
Observer: “ _____ this is _____ Adjust Fire, Over” (FDC’s Call Sign) (Observer’s Call Sign)	
“Grid _____, Over” (6-Digit UTM)	
Target Description “ _____ ” (Target Description, Size, Activity)	
Method of Engagement (Optional) (Danger Close, Mark, High Angle, Ammo/Fuse Type)	
Method of Fire and Control (Optional) (At My Command, Time on Target, Request Splash, Request Time of Flight, “Over”)	
FDC may challenge after they read back the above. The observer should be prepared to authenticate.	
<b>Message To Observer</b> *= Mandatory Call	
Units to Fire* (Firing Unit, Adjusting Unit)	
Changes to Call for Fire (If Any)	
Number of Rounds* (Per Tube)	
Target Number*	
Time of Flight (Seconds)	
<b>Given After Message To Observer</b>	
“Direction _____, Over” (Mils or Degrees, Magnetic)	
<b>Adjustments</b>	
“Left/Right _____ ” (Meters, from Impact to Observer Target Line)	
“Add/Drop _____ ” (Meters, Distance from Impact to Target)	
Once on target call: “Fire for Effect, Over”	
<b>Mission Completion</b>	
“End of Mission, _____, Over.” (BDA and Target Activity)	

Extracted from J-FIRE (MCRP 3-16.8B, 1997)

THIS PAGE INTENTIONALLY LEFT BLANK

**APPENDIX B**

<b>NGF CALL FOR FIRE</b> (Given in two transmission) (Grid Method)	
“_____ this is _____ Fire Mission, Target # _____, Over” (Ship Call Sign) (Observer’s Call Sign) (Assigned by observer)	
“Grid _____, Altitude _____, Direction _____ Over” (6-Digit UTM) (Meters MSL) (Mils/Grid)	
Target Description	(Target Description, Size, Activity, Cover)
Method of Engagement	(Danger Close, Ammo/Fuse Type, # Salvos, # Guns, Reduced Charge, TOT)
Method of Control	(Fire for Effect, Ship Adjust, Spotter Adjust, Cannot Observe, At My Command)
<b>Message To Observer</b>	
Gun-Target Line	(From Gun To Target)
Ready/Time of Flight/Line of Fire (if firing Illum)	(Time of Flight in Seconds)
First Salvo at Offset	(Danger-Close Missions Only)
Summit	(Max Ord in Feet for Air Spotter, Meters for Ground Spotter)
Changes to Call for Fire	

Extracted from J-FIRE (MCRP 3-16.8B, 1997)

THIS PAGE INTENTIONALLY LEFT BLANK

APPENDIX C

**CAS BRIEFING FORMAT (9-LINE)**  
(Omit data not required, do not transmit line numbers. Units of measure are standard unless otherwise specified. \*denotes minimum essential in limited communications environment. BOLD denotes readback items when requested.)

Terminal controller: " \_\_\_\_\_ this is \_\_\_\_\_ "  
(Aircraft Call Sign) (Terminal Controller)

\*1. IP/BP: " \_\_\_\_\_ "

\*2. Heading: " \_\_\_\_\_ " (Magnetic)  
(IP/BP to Target)  
Offset: " \_\_\_\_\_ " (Left/Right)

\*3. Distance: " \_\_\_\_\_ "  
(IP-to-Target in Nautical Miles/BP-to-Target in Meters)

\*4. Target Elevation: " \_\_\_\_\_ "  
(in Feet/MSL)

\*5. Target Description: " \_\_\_\_\_ "

\*6. Target Location: " \_\_\_\_\_ " (Latitude/Longitude or Grid  
Coordinates or Offsets or Visual)

\*7. Type Mark: " \_\_\_\_\_ " Code: " \_\_\_\_\_ "  
(WP, Laser, IR, Beacon) (Actual Code)  
Laser to Target Line: " \_\_\_\_\_ Degrees"

\*8. Location of Friendlies: " \_\_\_\_\_ "  
Position Marked By: " \_\_\_\_\_ "

9. Egress: " \_\_\_\_\_ "

Remarks (as appropriate): " \_\_\_\_\_ "  
(Threats, Restrictions, Danger Close,  
Attack Clearance, SEAD, Abort  
Codes, Hazards)

"Time on Target (TOT): " \_\_\_\_\_ " or Time to Target (TTT):  
"Stand by \_\_\_\_\_ plus \_\_\_\_\_, Hack."

**NOTE: When identifying position coordinates for joint operations, include the map datum data. DESERT STORM operations have shown that simple conversion to latitude/longitude is not sufficient. The location may be referenced on several different databases; for example, land-based versus sea-based data.**

Extracted from J-FIRE (MCRP 3-16.8B, 1997)

THIS PAGE INTENTIONALLY LEFT BLANK

# APPENDIX D

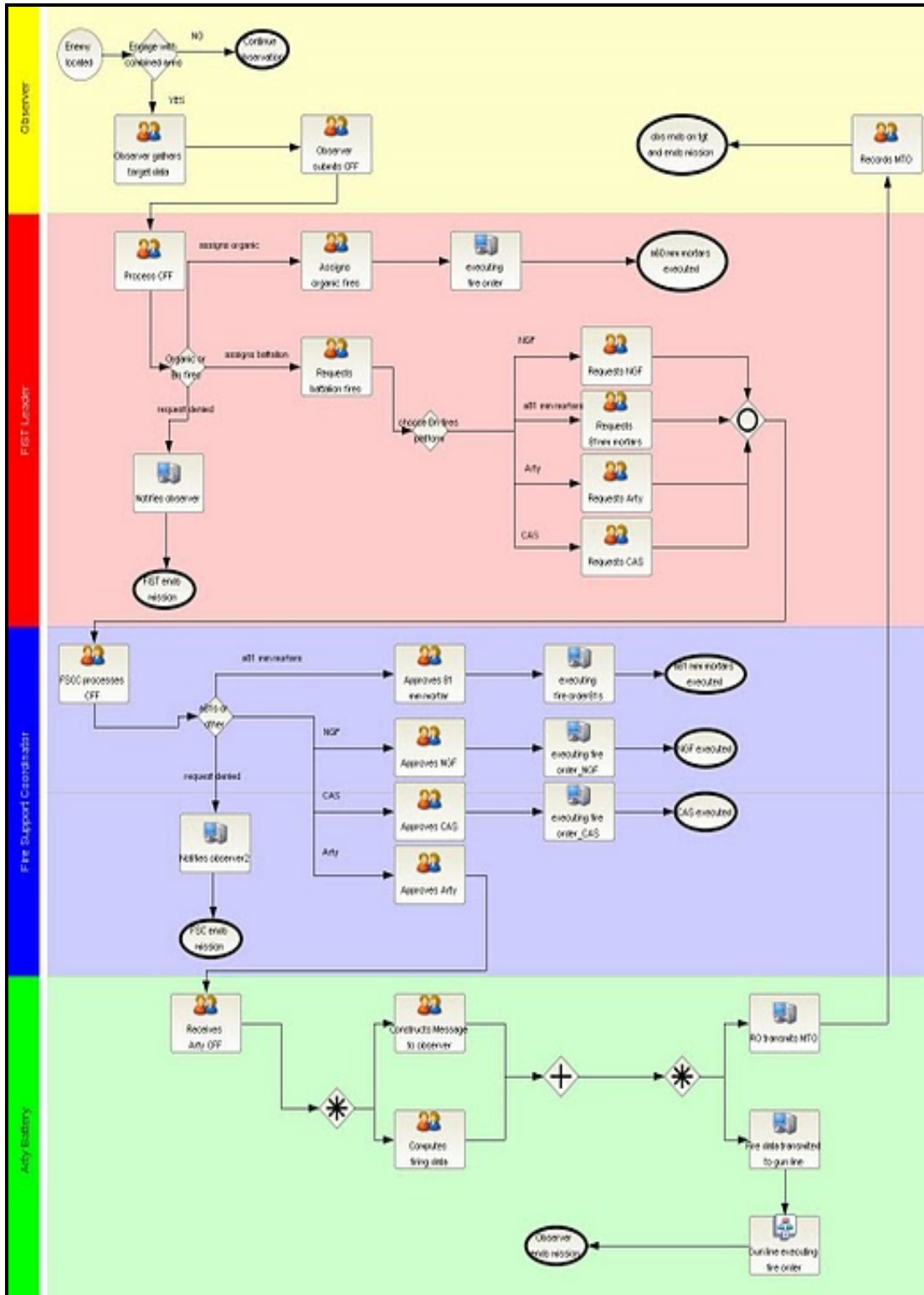



THIS PAGE INTENTIONALLY LEFT BLANK



THIS PAGE INTENTIONALLY LEFT BLANK

# APPENDIX F

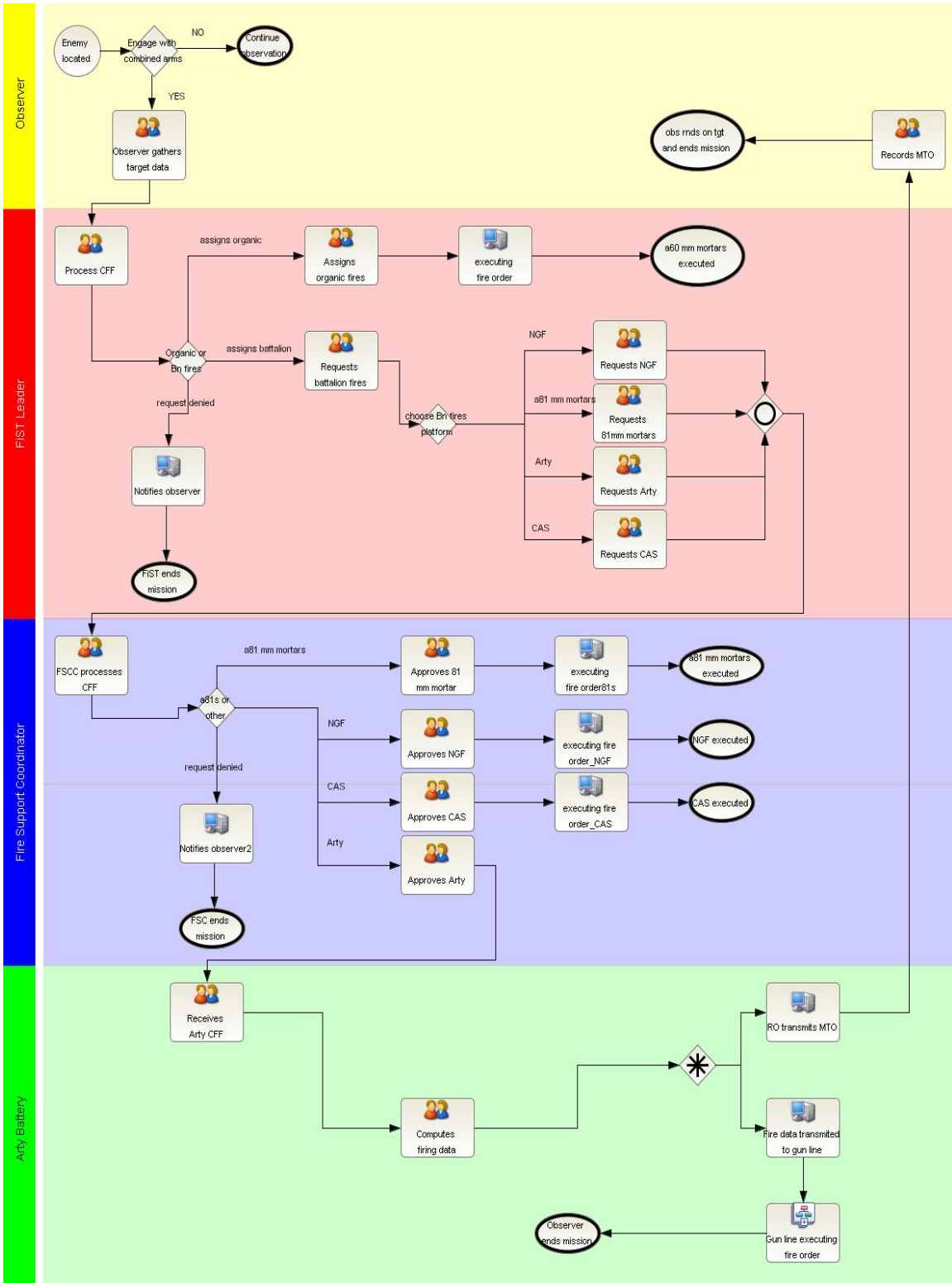

THIS PAGE INTENTIONALLY LEFT BLANK

## APPENDIX G

Simulation Results					
Duration	7:16:58 Time				
Process Time And Cost					
Process	Scenario	Instances	Total Cost	Waiting Time (Time)	Total Time (Time)
TOBE	(default)	100	3345.77	1:47:55	16:24:43
TOBE					
Scenario	(default)				
Instances	100				
Activity	Performer	Occurs	Waiting Time (Time)	Time To Complete (Time)	Total Time (Time)
Approves 81 mm mortar	FSC	16	0:00:00	0:08:00	0:08:00
Approves Arty	FSC	55	0:00:00	0:55:00	0:55:00
Approves CAS	FSC	10	0:00:00	0:20:00	0:20:00
Approves NGF	FSC	1	0:00:00	0:02:00	0:02:00
Assigns organic fires	Any member of FISTLeader	10	0:00:51	0:10:00	0:10:51
Computes firing data	All member(s) of Artillery Battery	55	0:02:10	0:09:10	0:11:20
FSCC processes CFF	FSC	83	0:00:29	0:41:30	0:41:59
Observer gathers target data	Observer	95	0:00:24	0:47:30	0:47:54
Process CFF	Any member of FISTLeader	95	0:04:08	0:47:30	0:51:38
Receives Arty CFF	All member(s) of Artillery Battery	55	0:00:21	1:50:00	1:50:21
Records MTO	Observer	55	0:02:09	0:00:55	0:03:04
Requests 81mm mortars	Any member of FISTLeader	19	0:00:00	0:38:00	0:38:00
Requests Arty	Any member of FISTLeader	48	0:00:05	1:36:00	1:36:05
Requests CAS	Any member of FISTLeader	15	0:00:00	0:30:00	0:30:00
Requests NGF	Any member of FISTLeader	1	0:00:00	0:02:00	0:02:00
Requests battalion fires	Any member of FISTLeader	83	0:00:30	4:09:00	4:09:30
Resource	Unit	Cost/Unit	Threshold	Usage	Cost
Observer	Hour	12	0	0	0
FSC	Hour	31	0	2	62
Any member of FISTLeader	Hour	20	0	7	140
All member(s) of Artillery Battery	Hour	14.25	0	218	3106.5
Performers Queue Length and Utilization					
Name	Average	Min	Max	Utilized (%)	Idle (%)
Observer	0.01	0	1	11.08	88.92
FSC	0	0	1	28.95	71.05
Any member of FISTLeader	0.01	0	1	54.07	45.93
All member(s) of Artillery Battery	0.01	0	1	27.27	72.73
Bottlenecks					
Process	Activity	Performer	Avg Queue Length	Min Queue Length	Max Queue Length
TOBE	Assigns organic fires	Any member of FISTLeader	0	0	1
TOBE	Computes firing data	All member(s) of Artillery Battery	0	0	1
TOBE	FSCC processes CFF	FSC	0	0	1
TOBE	Observer gathers target data	Observer	0	0	1
TOBE	Process CFF	Any member of FISTLeader	0.01	0	1
TOBE	Receives Arty CFF	All member(s) of Artillery Battery	0	0	1
TOBE	Records MTO	Observer	0	0	1
TOBE	Requests Arty	Any member of FISTLeader	0	0	1
TOBE	Requests battalion fires	Any member of FISTLeader	0	0	1
Note:	Red-marked Waiting Time values indicates "Activity has waiting time"				
	Red-marked Usage values indicates "Usage crossed threshold"				

THIS PAGE INTENTIONALLY LEFT BLANK

## APPENDIX H

### MOS 0861, FIRE SUPPORT MAN Mission Essential Tasks List

#### DUTY AREA 01-MAP READING AND M2 COMPASS

1. TASK: 0861.01.01 (CORE) DECLINATE AN M2 COMPASS USING THE FIELD EXPEDIENT METHOD
2. TASK: 0861.01.02 (CORE) ORIENT A MAP USING A DECLINATED M2 COMPASS
3. TASK: 0861.01.03 (CORE) LOCATE YOUR POSITION DURING A TERRAIN WALK
4. TASK: 0861.01.04 (CORE) NAVIGATE FROM ONE POINT ON THE GROUND TO ANOTHER POINT, MOUNTED
5. TASK: 0861.01.05 (CORE) LOCATE POSITIONS IN A MOBILE ENVIRONMENT
6. TASK: 0861.01.06 (CORE) DETERMINE LOCATION WITH THE AN/GVS-5 LASER RANGE FINDER
7. TASK: 0861.01.07 (CORE) DETERMINE LOCATION WITH THE AN/PAQ-3 MODULAR UNIVERSAL LASER EQUIPMENT (MULE) USING TWO KNOWN POINTS
8. TASK: 0861.01.08 (CORE PLUS) DETERMINE LOCATION WITH THE AN/PAQ-3 MODULAR UNIVERSAL LASER EQUIPMENT (MULE) USING ONE KNOWN POINT AND A BURST
9. TASK: 0861.01.09 (CORE PLUS) DETERMINE LOCATION WITH THE AN/PAQ-3 MODULAR UNIVERSAL LASER EQUIPMENT (MULE) USING TWO BURSTS
10. TASK: 0861.01.10 (CORE) DETERMINE LOCATION WITH THE AN/PAQ-3 MODULAR UNIVERSAL LASER EQUIPMENT (MULE) USING SELF-LOCATION PROCEDURE
11. TASK: 0861.01.11 (CORE) LOCATE POSITION ON A MAP OR GROUND BY RESECTION
12. TASK: 0861.01.12 (CORE) DETERMINE THE ELEVATION OF A POINT ON THE GROUND USING A MAP
13. TASK: 0861.01.13 (CORE) DETERMINE A POSITION WITH THE AN/PSN-11 PLGR IN THE AVERAGING MODE
14. TASK: 0861.01.14 (CORE) PERFORM NAVIGATION PROCEDURES WITH THE AN/PSN-11 PLGR
15. TASK: 0861.01.15 (CORE PLUS) CONDUCT BATTLEFIELD REPORTING

#### DUTY AREA 02-COMMUNICATIONS

16. TASK: 0861.02.01 (CORE) ESTABLISH/ENTER AND LEAVE A RADIO TELEPHONE NET
17. TASK: 0861.02.02 (CORE PLUS) ENCODE/DECODE/AUTHENTICATE USING THE NUMERAL CIPHER/AUTHENTICATION SYSTEM
18. TASK: 0861.02.04 (CORE) SEND AND RECEIVE RADIO TRANSMISSIONS USING PROPER RADIO TELEPHONE PROCEDURES



19. TASK: 0861.02.05 (CORE PLUS) TRANSMIT A MESSAGE UTILIZING NATO FORMAT
20. TASK: 0861.02.06 (CORE PLUS) DRAFT A MESSAGE USING NATO FORMAT
21. TASK: 0861.02.07 (CORE) OPERATE AN FM RADIO SET AN/PRC-119
22. TASK: 0861.02.08 (CORE PLUS) INSTALL AN/VRC-88 RADIO SET
23. TASK: 0861.02.09 (CORE PLUS) OPERATE A AN/VRC-88 RADIO SET
24. TASK: 0861.02.10 (CORE PLUS) INSTALL AN/MRC-145 RADIO SET
25. TASK: 0861.02.11 (CORE PLUS) OPERATE AN AN/MRC-145 RADIO SET
26. TASK: 0861.02.15 (CORE) OPERATE AN AN/PRC-104 RADIO SET
27. TASK: 0861.02.16 (CORE PLUS) INSTALL AN/MRC-138 RADIO SET
28. TASK: 0861.02.17 (CORE PLUS) OPERATE AN AN/MRC-138 RADIO SET
29. TASK: 0861.02.18 (CORE PLUS) PREPARE/OPERATE TSEC/KY-99 COMMUNICATIONS SECURITY EQUIPMENT WITH AN AM RADIO SET
30. TASK: 0861.02.19 (CORE) ERECT OE-254 ANTENNA
31. TASK: 0861.02.20 (CORE) INSTALL AND OPERATE RADIO SET CONTROL GROUP AN/GRA-39 AND/OR AN/PRC-119C FOR REMOTE OPERATION
32. TASK: 0861.02.21 (CORE PLUS) OPERATE AND MAINTAIN A FIELD PHONE
33. TASK: 0861.02.22 (CORE PLUS) EMPLOY THE AN/PPN-19 TRANSPONDER SET (RADAR BEACON)
34. TASK: 0861.02.23 (CORE) MAINTAIN COMMUNICATIONS EQUIPMENT
35. TASK: 0861.02.24 (CORE PLUS) IDENTIFY ELECTRONIC COUNTERMEASURES (ECM) AND IMPLEMENT ELECTRONIC COUNTER-COUNTERMEASURES (ECCM)
36. TASK: 0861.02.25 (CORE PLUS) PREPARE/SUBMIT OPERATOR'S MEACONING, INTRUSION, JAMMING, AND INTERFERENCE (MIJI) REPORT

DUTY AREA 03-OBSERVED FIRE PROCEDURES

37. TASK: 0861.03.01 (CORE) SELECT AN OBSERVATION POST AND PREPARE TO USE IT
38. TASK: 0861.03.02 (CORE) PREPARE AN OBSERVATION POST FOR USE WHILE AN/PAQ-3 MODULAR UNIVERSAL LASER EQUIPMENT (MULE) EQUIPPED
39. TASK: 0861.03.03 (CORE) PLACE THE OBSERVED FIRE (OF) FAN ON A MAP
40. TASK: 0861.03.04 (CORE) DETERMINE DIRECTION TO TWO TARGETS
41. TASK: 0861.03.05 (CORE) CONSTRUCT A TERRAIN SKETCH
42. TASK: 0861.03.06 (CORE PLUS) PREPARE A VISIBILITY DIAGRAM
43. TASK: 0861.03.07 (CORE) LOCATE A TARGET BY GRID COORDINATES
44. TASK: 0861.03.08 (CORE) LOCATE A TARGET BY POLAR PLOT
45. TASK: 0861.03.09 (CORE) LOCATE A TARGET BY SHIFT FROM A KNOWN POINT

46. TASK: 0861.03.10 (CORE) MEASURE ANGULAR DEVIATION WITH YOUR HAND
47. TASK: 0861.03.11 (CORE) CONDUCT AN ADJUST FIRE MISSION
48. TASK: 0861.03.12 (CORE) OPERATE THE AN/GVS-5 LASER RANGE FINDER
49. TASK: 0861.03.13 (CORE) REQUEST AND ADJUST FIRE WITH THE AN/GVS-5 LASER RANGE FINDER
50. TASK: 0861.03.14 (CORE) PERFORM PREVENTIVE MAINTENANCE CHECKS AND SERVICES ON AN/GVS-5 LASER RANGE FINDER
51. TASK: 0861.03.15 (CORE) PREPARE THE AN/PAQ-3 MODULAR UNIVERSAL LASER EQUIPMENT (MULE) FOR OPERATION
52. TASK: 0861.03.16 (CORE) CONDUCT A FIRE MISSION WITH THE AN/PAQ-3 MODULAR UNIVERSAL LASER EQUIPMENT (MULE)
53. TASK: 0861.03.17 (CORE PLUS) CONDUCT A SUPPRESSION MISSION ON A PLANNED TARGET
54. TASK: 0861.03.18 (CORE) CONDUCT AN IMMEDIATE SUPPRESSION MISSION
55. TASK: 0861.03.19 (CORE) CONDUCT A FIRE FOR EFFECT (FFE) MISSION
56. TASK: 0861.03.20 (CORE) CONDUCT AN ILLUMINATION MISSION
57. TASK: 0861.03.21 (CORE) CONDUCT A COORDINATED ILLUMINATION MISSION
58. TASK: 0861.03.22 (CORE PLUS) CONDUCT A FASCAM MISSION
59. TASK: 0861.03.23 (CORE PLUS) CONDUCT A DPICM MISSION
60. TASK: 0861.03.24 (CORE) CONDUCT A DANGER CLOSE FIRE MISSION
61. TASK: 0861.03.26 (CORE PLUS) CONDUCT TWO FIRE MISSIONS SIMULTANEOUSLY
62. TASK: 0861.03.27 (CORE PLUS) ADJUST FINAL PROTECTIVE FIRES
63. TASK: 0861.03.28 (CORE) CONDUCT AN IMMEDIATE SMOKE MISSION
64. TASK: 0861.03.29 (CORE) CONDUCT A QUICK SMOKE MISSION
65. TASK: 0861.03.30 (CORE PLUS) CONDUCT A DESTRUCTION MISSION
66. TASK: 0861.03.31 (CORE) CONDUCT A MISSION ON A MOVING TARGET
67. TASK: 0861.03.32 (CORE) SELECT AND LOCATE REGISTRATION POINTS
68. TASK: 0861.03.33 (CORE) CONDUCT A PRECISION REGISTRATION, QUICK AND TIME
69. TASK: 0861.03.34 (CORE) CONDUCT A HIGH-BURST OR MEAN-POINT-OF-IMPACT (MPI) REGISTRATION
70. TASK: 0861.03.35 (CORE) CONDUCT AN ABBREVIATED REGISTRATION
71. TASK: 0861.03.36 (CORE PLUS) CONDUCT A MEAN-POINT-OF-IMPACT (MPI) REGISTRATION WITH AN AN/PAQ-3 MODULAR UNIVERSAL LASER EQUIPMENT (MULE)
72. TASK: 0861.03.37 (CORE PLUS) CONDUCT EMERGENCY OBSERVER PROCEDURES

- 73. TASK: 0861.03.38 (CORE PLUS) CONDUCT A MORTAR PRECISION REGISTRATION
- 74. TASK: 0861.03.40 (CORE PLUS) CONDUCT FIRE MISSION ON IRREGULARLY SHAPED TARGETS
- 75. TASK: 0861.03.41 (CORE PLUS) CONDUCT A COPPERHEAD MISSION
- 76. TASK: 0861.03.42 (CORE PLUS) DIRECT A CLOSE AIR SUPPORT (CAS) STRIKE
- 77. TASK: 0861.03.43 (CORE) CONDUCT AN ARTILLERY SUPPRESSION OF ENEMY AIR DEFENSE (SEAD)
- 78. TASK: 0861.03.44 (CORE) CONDUCT A NAVAL SURFACE FIRE SUPPORT (NSFS) MISSION
- 79. TASK: 0861.03.45 (CORE) CONDUCT A NAVAL SURFACE FIRE SUPPORT (NSFS) SUPPRESSION OF ENEMY AIR DEFENSE (SEAD) MISSION
- 80. TASK: 0861.03.46 (CORE) CONDUCT A HIGH ANGLE FIRE MISSION WITH NAVAL SURFACE FIRE SUPPORT (NSFS)
- 81. TASK: 0861.03.47 (CORE) CONDUCT A DANGER CLOSE FIRE MISSION WITH NAVAL SURFACE FIRE SUPPORT (NSFS)
- 82. TASK: 0861.03.48 (CORE) REFIRE A RECORDED TARGET WITH NAVAL SURFACE FIRE SUPPORT (NSFS)
- 83. TASK: 0861.03.49 (CORE) CONDUCT AN ILLUMINATION MISSION WITH NAVAL SURFACE FIRE SUPPORT (NSFS)
- 84. TASK: 0861.03.50 (CORE) CONDUCT A FRESH TARGET SHIFT MISSION WITH NAVAL SURFACE FIRE SUPPORT (NSFS)
- 85. TASK: 0861.03.51 (CORE) CONDUCT SIMULTANEOUS MISSIONS WITH NAVAL SURFACE FIRE SUPPORT (NSFS)
- 86. TASK: 0861.03.52 (CORE) CONDUCT A NEW TARGET SHIFT MISSION WITH NAVAL SURFACE FIRE SUPPORT (NSFS)
- 87. TASK: 0861.03.53 (CORE) CONDUCT A NAVAL GUNFIRE (NGF) COORDINATED ILLUMINATION MISSION

DUTY AREA 04 - FIRE SUPPORT PLANNING AND COORDINATION

- 88. TASK: 0861.04.04 (CORE PLUS) PREPARE/SUBMIT A LIST OF TARGETS
- 89. TASK: 0861.04.27 (CORE PLUS) INTEGRATE COMPANY ORGANIC INDIRECT FIRE WEAPONS INTO FIRE PLANS

DUTY AREA 05-COUNTERFIRE

- 90. TASK: 0861.05.01 (CORE PLUS) PERFORM CRATER ANALYSIS FOR LOW-ANGLE CRATERS
- 91. TASK: 0861.05.02 (CORE PLUS) PERFORM CRATER ANALYSIS FOR LOW-ANGLE FUZE DELAY CRATERS
- 92. TASK: 0861.05.03 (CORE PLUS) PERFORM CRATER ANALYSIS FOR HIGH-ANGLE CRATERS
- 93. TASK: 0861.05.04 (CORE PLUS) PERFORM SHELL FRAGMENT ANALYSIS

94. TASK: 0861.05.05 (CORE PLUS) PREPARE/SUBMIT STANDARD SHELLING, MORTARING, AND BOMBING REPORT

DUTY AREA 07-OBSERVER DIGITAL TERMINAL (ODT)

95. TASK: 0861.07.01 (CORE) PREPARE THE OBSERVER DIGITAL TERMINAL (ODT) FOR OPERATION
96. TASK: 0861.07.02 (CORE) ESTABLISH COMMUNICATIONS PARAMETERS WITH THE OBSERVER DIGITAL TERMINAL (ODT)
97. TASK: 0861.07.03 (CORE) DETERMINE OBSERVER LOCATION WITH THE OBSERVER DIGITAL TERMINAL (ODT)
98. TASK: 0861.07.04 (CORE) REPORT OBSERVER LOCATION WITH THE OBSERVER DIGITAL TERMINAL (ODT)
99. TASK: 0861.07.05 (CORE) PROCESS AN AREA FIRE MISSION WITH THE OBSERVER DIGITAL TERMINAL (ODT)
100. TASK: 0861.07.06 (CORE) PROCESS SPECIAL FIRE MISSIONS WITH THE OBSERVER DIGITAL TERMINAL (ODT)
101. TASK: 0861.07.07 (CORE) CONDUCT A PRECISION REGISTRATION WITH THE OBSERVER DIGITAL TERMINAL (ODT)
102. TASK: 0861.07.08 (CORE) CONDUCT A HIGH-BURST (HB) OR MEAN-POINT-OF-IMPACT (MPI) REGISTRATION WITH THE OBSERVER DIGITAL TERMINAL (ODT)
103. TASK: 0861.07.09 (CORE PLUS) REPORT ENEMY ACTIVITY BY THE USE OF THE ARTILLERY TARGET INTELLIGENCE (ATI) MESSAGES WITH THE OBSERVER DIGITAL TERMINAL (ODT)
104. TASK: 0861.07.10 (CORE PLUS) TRANSMIT A TARGET FOR INCLUSION IN A LIST OF TARGETS WITH THE OBSERVER DIGITAL TERMINAL (ODT)
105. TASK: 0861.07.11 (CORE PLUS) REPORT THE FORWARD LINE OF TROOPS (FLOT) MESSAGE WITH THE OBSERVER DIGITAL TERMINAL (ODT)
106. TASK: 0861.07.12 (CORE PLUS) INPUT A TARGET IN THE KNOWN POINT FILE WITH THE OBSERVER DIGITAL TERMINAL (ODT)
107. TASK: 0861.07.13 (CORE PLUS) VERIFY OBSERVER DIGITAL TERMINAL (ODT) INITIALIZATION

THIS PAGE INTENTIONALLY LEFT BLANK

APPENDIX I

Duty Area	Smartphone Features												Utilization	MET Support	
	MET	Accelerometer	Gyroscope	Compass	Display	GPS	Wifi	Bluetooth	Telephony	Cameras	HD Storage	Computations			
01: Map Reading and M2 Compass	1	1	1	1	1	1				1	1	1	73%	1	
	2	1	1	1	1	1				1	1	1	73%	1	
	3	1	1	1	1	1	1	1	1	1	1	1	100%	3	
	4	1	1	1	1	1	1	1	1	1	1	1	100%	3	
	5	1	1	1	1	1	1	1	1	1	1	1	100%	3	
	6	1	1	1	1	1	1				1	1	1	73%	1
	7	1	1	1	1	1	1				1	1	1	73%	1
	10	1	1	1	1	1	1		1		1	1	1	82%	1
	11	1	1	1	1	1	1	1	1	1	1			82%	3
	12					1	1	1	1	1	1	1	1	73%	2
	13					1	1	1	1	1	1	1	1	73%	2
	14					1		1	1	1	1	1	1	64%	1
	02: Communications	16				1		1	1	1				36%	3
		18				1		1	1	1			1	1	55%
21		1	1	1	1	1	1	1	1	1	1	1	100%	2	
26		1	1	1	1	1	1	1	1	1	1	1	100%	2	
30					1	1	1				1	1	1	55%	1
31						1	1	1	1	1	1	1	1	73%	1
34		1	1	1	1	1	1				1	1	1	73%	1
03: Observed Fire Procedures	37	1	1	1	1	1					1	1	1	73%	2
	38	1	1	1	1	1					1	1	1	73%	2
	39	1	1	1	1	1	1				1	1	1	73%	3
	40	1	1	1	1	1	1				1	1	1	73%	3
	41	1	1	1	1	1	1					1		55%	1
	43	1	1	1	1	1	1					1		55%	3
	44	1	1	1	1	1	1					1		55%	3
	45	1	1	1	1	1	1					1		55%	3
	46	1	1	1	1	1	1				1	1	1	73%	1
	47	1	1	1	1	1	1	1	1	1	1			82%	3
	48	1	1	1	1	1	1				1	1	1	73%	1
	49	1	1	1	1	1	1				1	1	1	73%	1
	50	1	1	1	1	1	1				1	1	1	73%	1
	51	1	1	1	1	1	1				1	1	1	73%	1
	52	1	1	1	1	1	1				1	1	1	73%	1
54	1	1	1	1	1	1	1	1	1	1	1	1	100%	3	
55	1	1	1	1	1	1	1	1	1	1	1	1	100%	3	
56	1	1	1	1	1	1	1	1	1	1	1	1	100%	3	

Duty Area	MET	Smartphone Features											Utilization	MET Support	
		Accelerometer	Gyroscope	Compass	Display	GPS	Wifi	Bluetooth	Telephony	Cameras	HD Storage	Computations			
08: Observed Fire Procedures	57	1	1	1	1	1	1	1	1	1	1	1	100%	3	
	60	1	1	1	1	1	1	1	1	1	1	1	100%	3	
	63	1	1	1	1	1	1	1	1	1	1	1	100%	3	
	64	1	1	1	1	1	1	1	1	1	1	1	100%	3	
	66	1	1	1	1	1	1	1	1	1	1	1	100%	3	
	67	1	1	1	1	1	1	1	1	1	1	1	100%	3	
	68	1	1	1	1	1	1	1	1	1	1	1	100%	3	
	69	1	1	1	1	1	1	1	1	1	1	1	100%	3	
	70	1	1	1	1	1	1	1	1	1	1	1	100%	3	
	77	1	1	1	1	1	1	1	1	1	1	1	100%	3	
	78	1	1	1	1	1	1	1	1	1	1	1	100%	3	
	79	1	1	1	1	1	1	1	1	1	1	1	100%	3	
	80	1	1	1	1	1	1	1	1	1	1	1	100%	3	
	81	1	1	1	1	1	1	1	1	1	1	1	100%	3	
	82	1	1	1	1	1	1	1	1	1	1	1	100%	3	
	83	1	1	1	1	1	1	1	1	1	1	1	100%	3	
	84	1	1	1	1	1	1	1	1	1	1	1	100%	3	
85	1	1	1	1	1	1	1	1	1	1	1	100%	3		
86	1	1	1	1	1	1	1	1	1	1	1	100%	3		
87	1	1	1	1	1	1	1	1	1	1	1	100%	3		
07: Observer Digital Terminal	95				1						1	1	27%	1	
	96				1			1			1	1	36%	2	
	97	1	1	1	1						1	1	55%	2	
	98	1	1	1	1			1			1	1	64%	2	
	99	1	1	1	1						1	1	55%	2	
	100	1	1	1	1						1	1	55%	2	
	101				1						1	1	27%	1	
102				1						1	1	27%	1		
notes: *denotes Core Plus Tasks Met Support is based on the following ordinal scale 0 = not at all, 1 = minimally, 2 = mostly, 3 = fully													Total %=	72%	2.0

APPENDIX J

Duty Area	Smartphone Features												Utilization	MET Support	
	MET	Accelerometer	Gyroscope	Compass	Display	GPS	Wifi	Bluetooth	Telephony	Cameras	HD Storage	Computations			
01: Map Reading and M2 Compass	1	1	1	1	1	1				1	1	1	73%	1	
	2	1	1	1	1	1				1	1	1	73%	1	
	3	1	1	1	1	1	1	1	1	1	1	1	100%	3	
	4	1	1	1	1	1	1	1	1	1	1	1	100%	3	
	5	1	1	1	1	1	1	1	1	1	1	1	100%	3	
	6	1	1	1	1	1	1				1	1	1	73%	1
	7	1	1	1	1	1	1				1	1	1	73%	1
	8*				1						1	1	1	36%	1
	9*				1						1	1	1	36%	1
	10	1	1	1	1	1	1		1		1	1	1	82%	1
	11	1	1	1	1	1	1	1	1	1	1			82%	3
	12					1	1	1	1	1	1	1	1	73%	2
	13					1	1	1	1	1	1	1	1	73%	2
	14					1		1	1	1	1	1	1	64%	1
	15*	1	1	1	1	1	1	1	1	1	1	1	1	100%	2
02: Communications	16				1		1	1	1				36%	3	
	17*				1						1	1	1	36%	2
	18				1		1	1	1		1	1	55%	3	
	19*				1		1	1	1		1	1	55%	2	
	20*				1		1	1	1		1	1	55%	2	
	21	1	1	1	1	1	1	1	1	1	1	1	100%	2	
	22*				1						1	1	1	36%	1
	23*				1						1	1	1	36%	1
	24*				1						1	1	1	36%	1
	25*				1						1	1	1	36%	1
	26	1	1	1	1	1	1	1	1	1	1	1	1	100%	2
	27*				1						1	1	1	36%	1
	28*				1						1	1	1	36%	1
	29*				1						1	1	1	36%	1
	30				1	1	1				1	1	1	55%	1
	31				1	1	1	1	1	1	1	1	1	73%	1
32*				1						1	1	1	36%	1	
33*				1						1	1	1	36%	1	
34	1	1	1	1	1	1				1	1	1	73%	1	
35*				1						1	1	1	36%	1	
36*	1	1	1	1	1	1				1	1	1	73%	3	



Duty Area	Smartphone Features											Utilization	
	MET	Accelerometer	Gyroscope	Compass	Display	GPS	Wifi	Bluetooth	Telephony	Cameras	HD Storage		Computations
03: Observed Fire Procedures	37	1	1	1	1	1				1	1	1	73%
	38	1	1	1	1	1				1	1	1	73%
	39	1	1	1	1	1				1	1	1	73%
	40	1	1	1	1	1				1	1	1	73%
	41	1	1	1	1	1				1			55%
	42*					1				1	1	1	36%
	43	1	1	1	1	1				1			55%
	44	1	1	1	1	1				1			55%
	45	1	1	1	1	1				1			55%
	46	1	1	1	1	1				1	1	1	73%
	47	1	1	1	1	1	1	1	1	1			82%
	48	1	1	1	1	1				1	1	1	73%
	49	1	1	1	1	1				1	1	1	73%
	50	1	1	1	1	1				1	1	1	73%
	51	1	1	1	1	1				1	1	1	73%
	52	1	1	1	1	1				1	1	1	73%
	53*	1	1	1	1	1	1	1	1	1	1	1	100%
	54	1	1	1	1	1	1	1	1	1	1	1	100%
	55	1	1	1	1	1	1	1	1	1	1	1	100%
	56	1	1	1	1	1	1	1	1	1	1	1	100%
	57	1	1	1	1	1	1	1	1	1	1	1	100%
	58*	1	1	1	1	1	1	1	1	1	1	1	100%
	59*	1	1	1	1	1	1	1	1	1	1	1	100%
	60	1	1	1	1	1	1	1	1	1	1	1	100%
	61*	1	1	1	1	1	1	1	1	1	1	1	100%
	62*	1	1	1	1	1	1	1	1	1	1	1	100%
	63	1	1	1	1	1	1	1	1	1	1	1	100%

Duty Area	Smartphone Features												Utilization
	MET	Accelerometer	Gyroscope	Compass	Display	GPS	Wifi	Bluetooth	Telephony	Cameras	HD Storage	Computations	
03: Observed Fire Procedures	64	1	1	1	1	1	1	1	1	1	1	1	100%
	65*	1	1	1	1	1	1	1	1	1	1	1	100%
	66	1	1	1	1	1	1	1	1	1	1	1	100%
	67	1	1	1	1	1	1	1	1	1	1	1	100%
	68	1	1	1	1	1	1	1	1	1	1	1	100%
	69	1	1	1	1	1	1	1	1	1	1	1	100%
	70	1	1	1	1	1	1	1	1	1	1	1	100%
	71*	1	1	1	1	1	1	1	1	1	1	1	100%
	72*	1	1	1	1	1	1	1	1	1	1	1	100%
	73*	1	1	1	1	1	1	1	1	1	1	1	100%
	74*	1	1	1	1	1	1	1	1	1	1	1	100%
	75*	1	1	1	1	1	1	1	1	1	1	1	100%
	76*	1	1	1	1	1	1	1	1	1	1	1	100%
	77	1	1	1	1	1	1	1	1	1	1	1	100%
	78	1	1	1	1	1	1	1	1	1	1	1	100%
	79	1	1	1	1	1	1	1	1	1	1	1	100%
	80	1	1	1	1	1	1	1	1	1	1	1	100%
	81	1	1	1	1	1	1	1	1	1	1	1	100%
	82	1	1	1	1	1	1	1	1	1	1	1	100%
	83	1	1	1	1	1	1	1	1	1	1	1	100%
84	1	1	1	1	1	1	1	1	1	1	1	100%	
85	1	1	1	1	1	1	1	1	1	1	1	100%	
86	1	1	1	1	1	1	1	1	1	1	1	100%	
87	1	1	1	1	1	1	1	1	1	1	1	100%	

Duty Area	MET	Smartphone Features											Utilization	MET Support
		Accelerometer	Gyroscope	Compass	Display	GPS	Wifi	Bluetooth	Telephony	Cameras	HD Storage	Computations		
04: FSPC	88*	1	1	1	1	1	1	1	1	1	1	1	100%	2
	89*				1					1	1	1	36%	1
05: Counterfire	90*			1	1	1				1	1	1	55%	1
	91*			1	1	1				1	1	1	55%	1
	92*			1	1	1				1	1	1	55%	1
	93*				1					1	1	1	36%	1
	94*			1	1	1	1	1	1	1			64%	1
07: Observer Digital Terminal	95				1						1	1	27%	1
	96				1			1			1	1	36%	2
	97	1	1	1	1						1	1	55%	2
	98	1	1	1	1			1			1	1	64%	2
	99	1	1	1	1						1	1	55%	2
	100	1	1	1	1						1	1	55%	2
	101				1						1	1	27%	1
	102				1						1	1	27%	1
	103*				1						1	1	27%	1
	104*				1						1	1	27%	1
	105*				1						1	1	27%	1
106*				1						1	1	27%	1	
107*				1						1	1	27%	1	
notes: *denotes Core Plus Tasks Met Support is based on the following ordinal scale 0 = not at all, 1 = minimally, 2 = mostly, 3 = fully												<b>Total %=</b>	<b>72%</b>	<b>2.0</b>

APPENDIX K

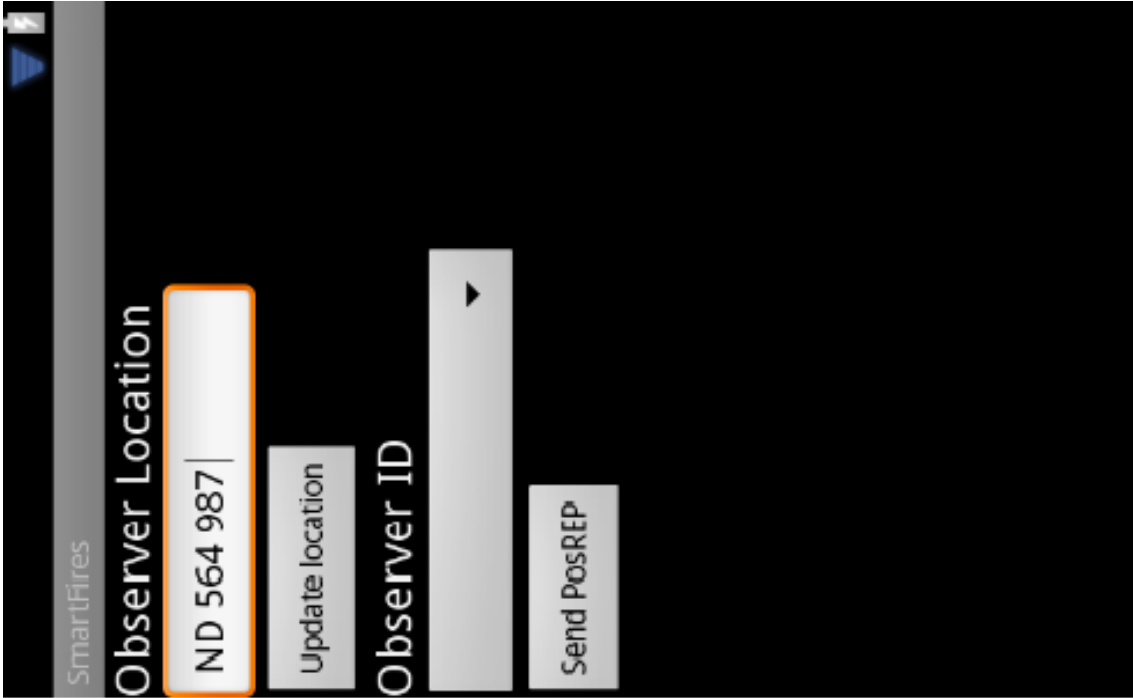

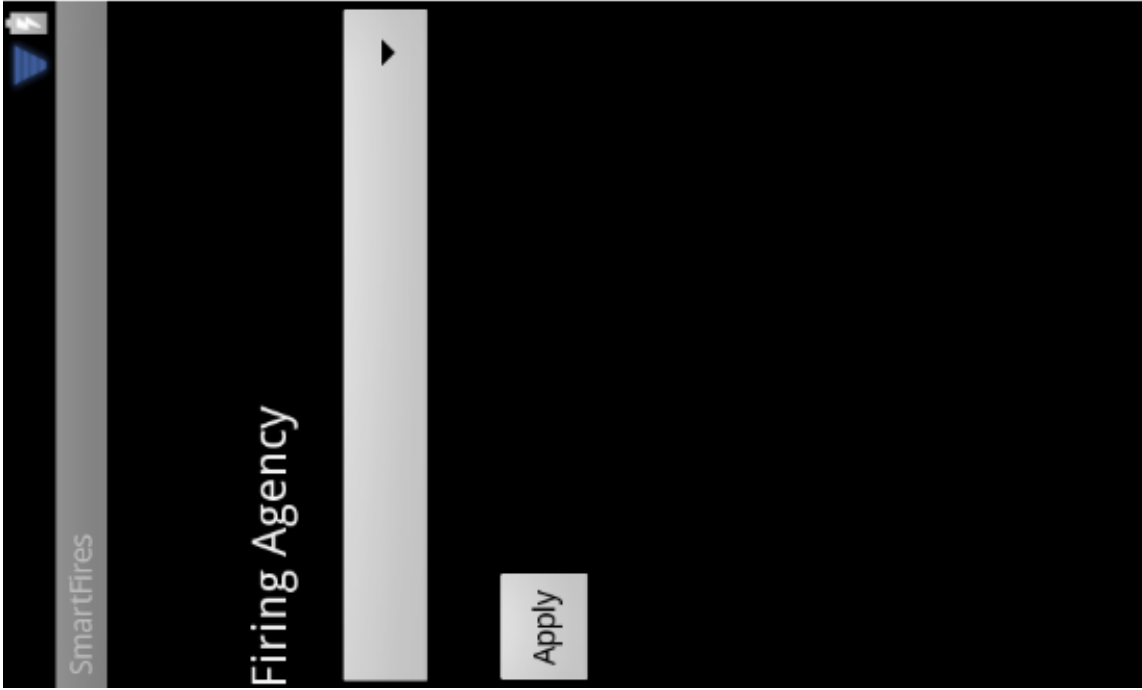
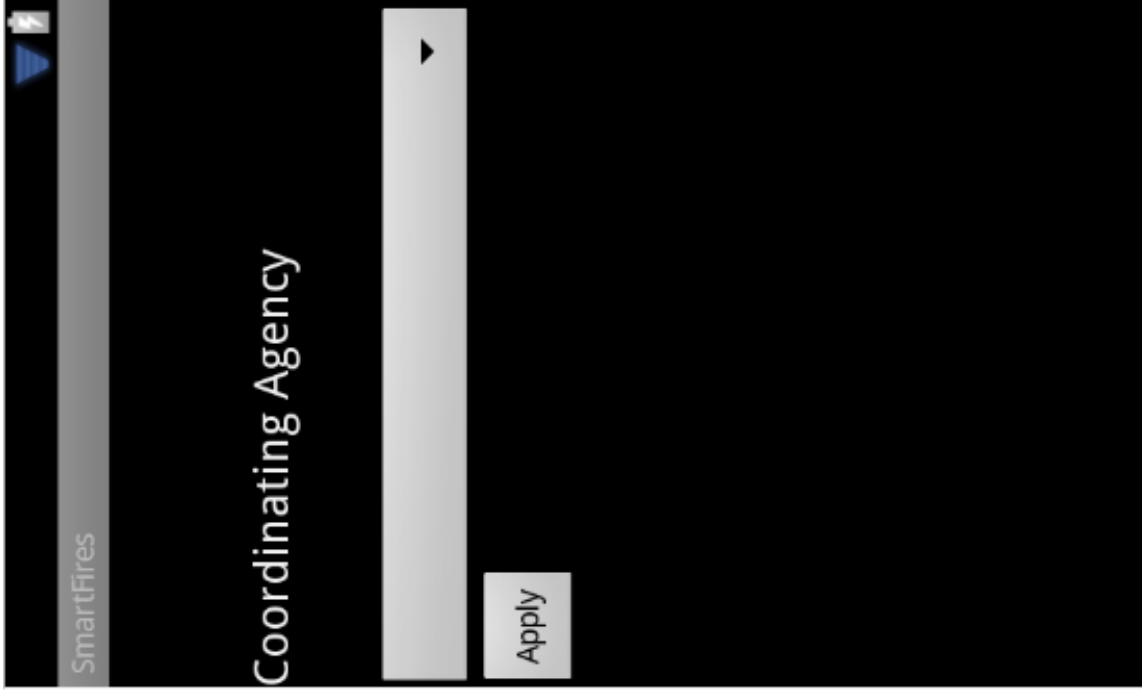

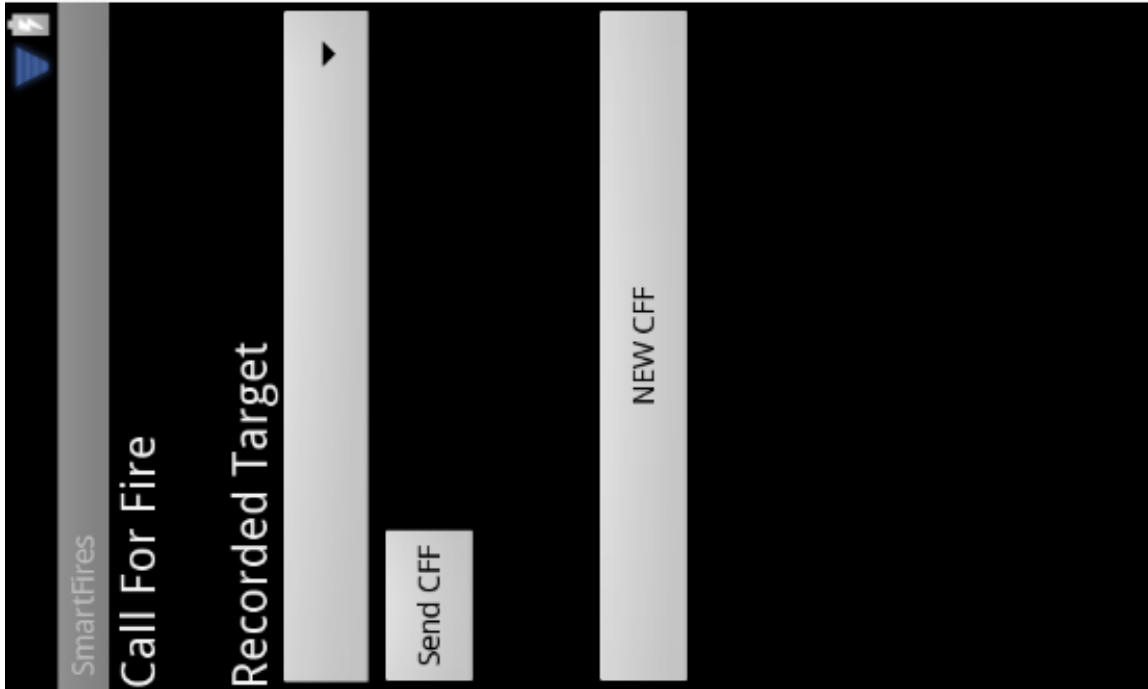
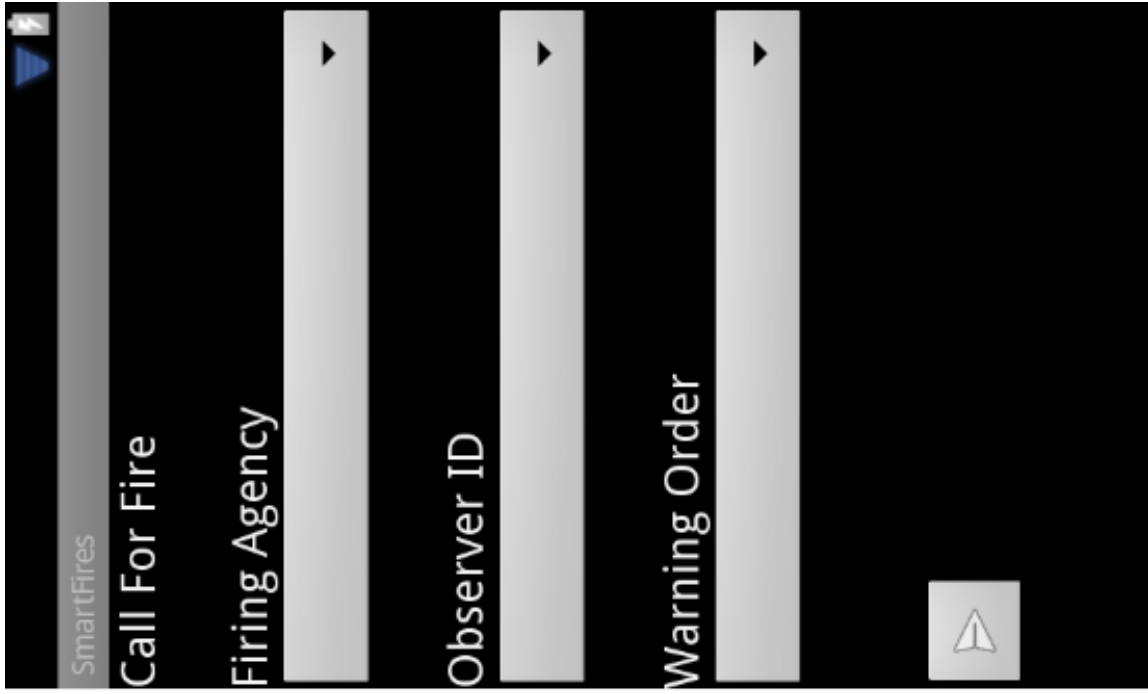

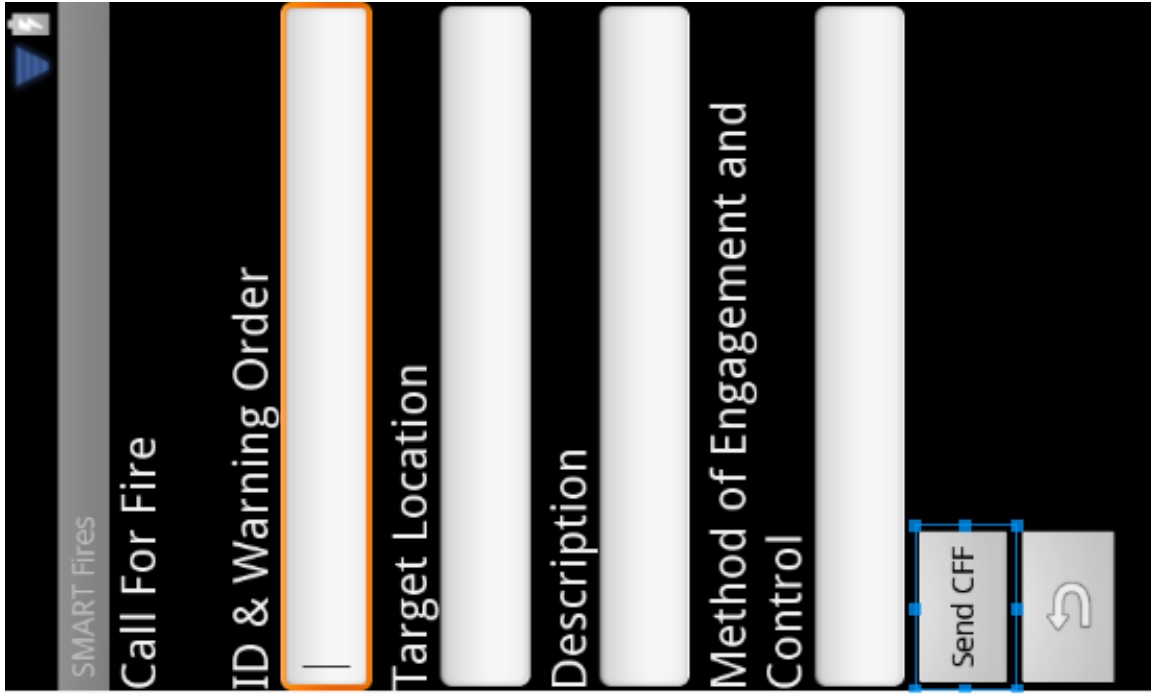
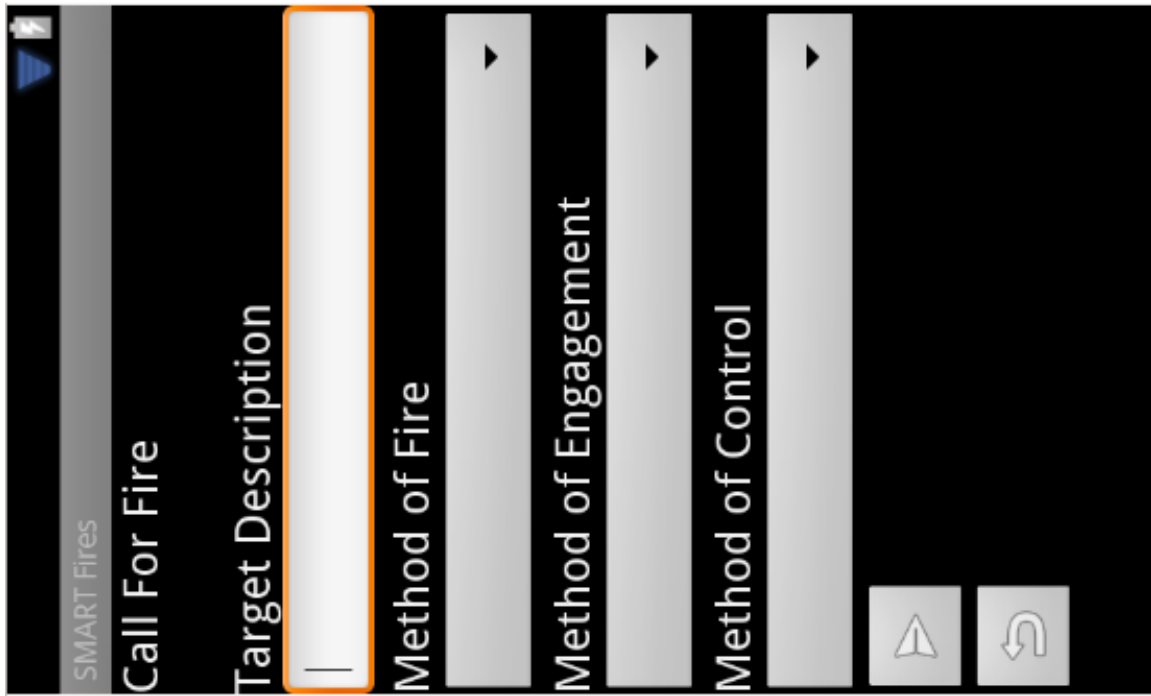

## LIST OF REFERENCES

- Android. (2011). *What is Android? | Android Developers*. Retrieved October 2010, from Android Developers: <http://developer.android.com/guide/basics/what-is-android.html>
- Apple Inc. (2011). *iOS Dev Center-Apple developer*. Retrieved July 2, 2011, from iOS Dev Center: <http://developer.apple.com/devcenter/ios/index.action>
- ARCIC. (2011). *Army Capabilities Integration Center*. Retrieved June 28, 2011, from Connecting Soldiers to Digital Applications: <http://www.arcic.army.mil/csda.html>
- Benes, J., & Prokopec, J. (2011). *Efficiency of encoding schemes in mobile WiMAX*. Brno, Czech Republic: IEEE.
- Borenstein, D. (2008). Android Dalvik VM internals. *Google 2011 IO Conference* (pp. 1-58). San Francisco, CA: Google.
- Brannon, D. A., & Villandre, M. R. (2002). *The forward observation personal computer simulator (FOPCSIM)* (master's thesis). Naval Postgraduate School.
- BUMP. (2011). *The BUMP App for iPhone and Android | Bump Technologies, Inc.* Retrieved May 28, 2011, from Bump Technologies Incorporated: <http://bu.mp/>
- CAC. (2011). *CAC Card Info*. Retrieved August 14, 2011, from CAC Common Access Card: <http://www.cac.mil/CardInfo.html>
- CIOG6. (2010). *Apps 4 Army 2010*. Retrieved July 14, 2011, from Army Chief Information Officer / G-6: <http://ciog6.army.mil/Apps4Army2010/tabid/101/Default.aspx>
- CommonsWare. (2011). *Warescription*. Retrieved October 12, 2010, from CommonsWare: <http://commonsware.com/warescription>



- CProgramming.com. (2011). *CProgramming.com: How to get started with C++*. Retrieved August 14, 2011, from CProgramming.com Your Resource for C and C++:  
<http://www.cprogramming.com/begin.html>
- DARPA. (2010, March 3). Broad Agency Announcement 10-41: Transformative Apps. *DARPA-BAA-10-41* . Arlington, VA, USA: DARPA.
- Dixon, J. S. (2010). *Integrating handset capabilities with Marine Corps tactical communications* (master's thesis). Naval Postgraduate School.
- Ebay. (2011). *Military Humvee radio comm terminal AN/PSC-2 Hummer* | eBay. Retrieved July 14, 2011, from ebay.com:  
[http://www.ebay.com/itm/MILITARY-HUMVEE-RADIO-COMM-TERMINAL-AN-PSC-2-HUMMER-/270750531820#ht\\_1002wt\\_1139](http://www.ebay.com/itm/MILITARY-HUMVEE-RADIO-COMM-TERMINAL-AN-PSC-2-HUMMER-/270750531820#ht_1002wt_1139)
- Eclipse Foundation. (2011). *Eclipse-The Eclipse Foundation open source community website*. Retrieved July 21, 2011, from Eclipse: <http://www.eclipse.org/>
- Eovito, B. A. (2006). *An assessment of joint chat requirements from current usage patterns* (master's thesis). Naval Postgraduate School.
- FM 6-30. (1991, July 16). Tactics, techniques, and procedures for observed fire. *Field Manual 6-30* . Washington, D.C., USA: Headquarters Department of the Army.
- Fox News. (2011, January 25). *Targeting the Taliban? There's an iPhone app for that* | FoxNews.com. Retrieved March 6, 2011, from Foxnews.com :  
<http://www.foxnews.com/scitech/2011/01/25/targeting-taliban-iphone-app/#ixzz1GghF8bpX>
- General Dynamics. (2011). *General Dynamics rugged wearable computer*. Retrieved August 2, 2011, from General Dynamics-Itronix: <http://www.gd-itronix.com/index.cfm?page=Products:gd300>

- Goldman, D. (2011, March 7). Android Surpasses Balckberry as No. 1 U.S. smartphone OS, Mar 7, 2011. Retrieved July 2, 2011, from *CNN Money; A service of CNN, Fortune and Money*:  
<http://money.cnn.com/2011/03/07/technology/android/index.htm>
- Goldman, M. (2010, September 1). Marine Corps task list MCTL/MET/METL life cycle. *Presentation*. Quantico, VA, USA: Marine Corps Combat Development Command.
- Harris Corporation. (2011). *AN/PRC-117F Multiband Radio | Harris RF Communications | Tactical Radios*. Retrieved June 25, 2011, from Harris Corporation:  
<http://www.rfcomm.harris.com/capabilities/tactical-radios-networking/anprc-117f.asp>
- Harris Corporation. (2011). *AN/PRC-150 Military HF Radios | Harris RF Communications | Tactical Radios*. Retrieved June 15, 2011, from Harris Corporation:  
<http://www.rfcomm.harris.com/capabilities/tactical-radios-networking/anprc-150.asp>
- Harris Corporation. (2011). *AN/PRC-152 | Harris RF Communications | Tactical Radios*. Retrieved June 24, 2011, from Harris Corporation:  
<http://www.rfcomm.harris.com/capabilities/tactical-radios-networking/an-prc-152/default.asp>
- Hastings, E. C. (2009, July 27). Universal need statement; Capability set 5-C2 requirements at the company and below. Camp Pendleton, CA, USA.
- IBM. (2011). *Anatomy of the Linux Kernel*. Retrieved August 2, 2011, from developerWorks:  
<http://www.ibm.com/developerworks/linux/library/l-linux-kernel/>
- IBM. (2011). *Form feeds function: The role of storyboards in requirements elicitation*. Retrieved September 3, 2011, from developerWorks:  
<http://www.ibm.com/developerworks/rational/library/dec05/krebs/index.html>

- JP 1-02. (2007, June 13). Department of Defense dictionary of military and associated terms. *Joint Pub 1-02* . Washington, DC, USA: Joint Staff J-7, Joint Doctrine Division, Pentagon.
- Lin, M.-F., Tzu, J.-Y., Lin, L., & Lee, H.-M. (2009). The IEEE 802.11n capability analysis model based on mobile networking architecture. *IEEE International Conference on Systems, Man, and Cybernetics* (pp. 1857-1860). San Antonio, TX: IEEE.
- Lockheed Martin. (2011). *MONAX | Lockheed Martin*. Retrieved August 12, 2011, from Lockheed Martin: <http://www.lockheedmartin.com/products/monax/>
- Longley, C. T. (2010). *Field information support tool*. Master's thesis. Naval Postgraduate School, Monterey, CA.
- MCDP 1-0. (2001, September 27). Marine Corps operations . *Marine Corps Doctrinal Publication 1-0* . Washington, DC: Headquarters United States Marine Corps.
- MCO 3501.26A. (2000, April 11). Artillery unit training and readiness manual. *Marine Corps Order 3501.26A* . Washington, DC, USA: Headquarters United States Marine Corps.
- MCRP 3-16.8B. (1997, November 6). Multi-service procedures for the joint application of firepower. *J-Fire* . Quantico, VA, USA: Marine Corps Combat Development Command.
- MCWP 3-16. (1999, May). Tactics, techniques, and procedures for fire support coordination in the ground combat element. *Marine Corps Warfighting Publication 3-16* . Washington, DC, USA: Headquarters United States Marine Corps.
- MCWP 3-16.1. (2002, May 20). Artillery operations. *Marine Corps Warfighting Publication 3-16.1* . Washington, DC, USA: Headquarters United States Marine Corps.

- MCWP 3-16.6. (1998, October 15). Supporting arms observer, spotter, and controller. *Marine Corps Warfighting Publication 3-16.6*. Washington, DC, USA: Headquarters United States Marine Corps.
- Naval Research Laboratory. (2007, September). Broad Agency Announcement 55-09-07. *NRL BAA Announcement # 55-09-07*. Washington, DC: Naval Research.
- NAVMC 3500.42. (2008, October 08). Tactical air control party training and readiness manual. *TACP T&R Manual*. Washington, DC: Headquarters United States Marine Corps.
- O'Neal, M. R., & Dixon, J. S. (2011). *Department of defense strategic and business case for commercial products in secure mobile computing* (MBA professional report). Naval Postgraduate School.
- Open Handset Alliance. (2011). *Open Handset Alliance*. Retrieved August 26, 2011, from open handset alliance: <http://www.openhandsetalliance.com/index.html>
- Oracle. (2011). *About the Java technology (The Java(TM) Tutorials > Getting Started > The Java Technology Phenomenom)*. Retrieved August 2, 2011, from The Java(TM) Tutorials: <http://download.oracle.com/javase/tutorial/getStarted/intro/definition.html>
- PM FATDS. (2004). *AFATDS operator sustainment training package*. Retrieved August 15, 2011, from ATIA Soilder Training Portal: <http://www.marines.mil/unit/marcorsyscom/Pages/NewsStories/2006/D-DACT%20empowers%20platoon%20leaders%20in%20Iraq.aspx>
- Raytheon. (2011). *Raytheon Corporation: Ratheon Android tactical system featured in Forbes*. Retrieved August 2, 2011, from Raytheon: [http://www.raytheon.com/newsroom/technology/rtn09\\_rats/](http://www.raytheon.com/newsroom/technology/rtn09_rats/)

- Scott, B. M. (2006, August 2). *D-Dact empowers platoon leaders in Iraq*. Retrieved July 14, 2011, from Marines: <http://www.marines.mil/unit/marcorsyscom/Pages/NewsStories/2006/D-DACT%20empowers%20platoon%20leaders%20in%20Iraq.aspx>
- Tactical NAV. (2010). *Available now on the App Store | TacticalNAV for the iPhone*. Retrieved March 3, 2011, from TACTICAL NAV: <http://www.tacticalnav.com/>
- Thome, G.D. (2002). *U.S. Marine specific software interoperability requirements of the AFATDS and IOS software suites* (master's thesis). Naval Postgraduate School.
- Thompson, P. (2011, January 27). *Soilder develops smartphone app to track Taliban*. Retrieved March 5, 2011, from Mail Online: <http://www.dailymail.co.uk/news/article-1350878/Soldier-develops-Smartphone-app-track-Taliban-Tactical-Nav-pinpoint-enemy-direct--fraction-cost-standard-issue-military-GPS-systems.html>
- TRADOC PAM 600-4. (2008, December 23). *www-tradoc.army.mil/tpubs/pams/p600-4.pdf*. Retrieved August 2, 2011, from IET Soldiers Handbook: <http://www-tradoc.army.mil/tpubs/pams/p600-4.pdf>
- Woyke, E. (2009, October 19). *Ratheon sends Android to battlefield. Forbes.com*. Retrieved August 14, 2011, from Forbes.com: <http://www.forbes.com/2009/10/19/android-google-military-technology-wireless-raytheon.html>
- Wyllie-Green, M. P., & Svensson, T. (2010). *Throughput, capacity, handover and latency performance in a 3GPP LTE FDD field trial*. Gothenburg, Sweden: Chalmers University of Technology.

## INITIAL DISTRIBUTION LIST

1. Defense Technical Information Center  
Fort Belvoir, Virginia
2. Dudley Knox Library  
Naval Postgraduate School  
Monterey, California
3. Dan Boger  
Naval Postgraduate School  
Monterey, California
4. Douglas J. MacKinnon  
Naval Postgraduate School  
Monterey, California
5. Marine Corps Representative  
Naval Postgraduate School  
Monterey, California
6. Director, Training and Education, MCCDC,  
Code C46  
Quantico, Virginia
7. Director, Marine Corps Research Center, MCCDC,  
Code C40RC  
Quantico, Virginia
8. Marine Corps Tactical Systems Support Activity  
(Attn: Operations Officer)  
Camp Pendleton, California