



Calhoun: The NPS Institutional Archive

Theses and Dissertations

Thesis Collection

2009-09

General use of UAS in EW environment--EW
concepts and tactics for single or multiple UAS over
the net-centric battlefield

Erdemli, Mustafa Gokhan.

Monterey, California. Naval Postgraduate School



Calhoun is a project of the Dudley Knox Library at NPS, furthering the precepts and goals of open government and government transparency. All information contained herein has been approved for release by the NPS Public Affairs Officer.

Dudley Knox Library / Naval Postgraduate School
411 Dyer Road / 1 University Circle
Monterey, California USA 93943

<http://www.nps.edu/library>



**NAVAL
POSTGRADUATE
SCHOOL**

MONTEREY, CALIFORNIA

THESIS

**GENERAL USE OF UAS IN EW ENVIRONMENT—EW
CONCEPTS AND TACTICS FOR SINGLE OR MULTIPLE
UAS OVER THE NET-CENTRIC BATTLEFIELD**

by

Mustafa Gokhan Erdemli

Thesis Co-Advisors:

Edward Fisher
Wolfgang Baer

Approved for public release; distribution is unlimited

THIS PAGE INTENTIONALLY LEFT BLANK

REPORT DOCUMENTATION PAGE			<i>Form Approved OMB No. 0704-0188</i>	
Public reporting burden for this collection of information is estimated to average 1 hour per response, including the time for reviewing instruction, searching existing data sources, gathering and maintaining the data needed, and completing and reviewing the collection of information. Send comments regarding this burden estimate or any other aspect of this collection of information, including suggestions for reducing this burden, to Washington headquarters Services, Directorate for Information Operations and Reports, 1215 Jefferson Davis Highway, Suite 1204, Arlington, VA 22202-4302, and to the Office of Management and Budget, Paperwork Reduction Project (0704-0188) Washington DC 20503.				
1. AGENCY USE ONLY (Leave blank)		2. REPORT DATE September 2009	3. REPORT TYPE AND DATES COVERED Master's Thesis	
4. TITLE AND SUBTITLE General Use of UAS in EW Environment—EW Concepts and Tactics for Single or Multiple UAS over the Net-Centric Battlefield			5. FUNDING NUMBERS	
6. AUTHOR(S) Mustafa Gokhan Erdemli			8. PERFORMING ORGANIZATION REPORT NUMBER	
7. PERFORMING ORGANIZATION NAME(S) AND ADDRESS(ES) Naval Postgraduate School Monterey, CA 93943-5000			10. SPONSORING/MONITORING AGENCY REPORT NUMBER	
9. SPONSORING /MONITORING AGENCY NAME(S) AND ADDRESS(ES) N/A			11. SUPPLEMENTARY NOTES The views expressed in this thesis are those of the author and do not reflect the official policy or position of the Department of Defense or the U.S. Government.	
12a. DISTRIBUTION / AVAILABILITY STATEMENT Approved for public release; distribution is unlimited			12b. DISTRIBUTION CODE	
13. ABSTRACT (maximum 200 words) With the development of technology, Electronic Warfare has been increasing for decades its importance in modern battles. It can even be referred to as the heart of today's net-centric battlefield. Unmanned Aerial Systems are gaining more importance every single day. Nations are working on more complex and more effective UAS in order to accomplish missions that are very difficult, or even impossible for manned aircraft. Electronic Warfare missions are often dangerous and risky. Mounting Electronic Warfare equipment on a UAS and using it to conduct the EW mission is the most rational solution, since it does not endanger human life. This thesis will examine the possible ways in which UAS can be paired with EW equipment. These two technologies can be integrated into a single mission over the net-centric battlefield. Furthermore, this thesis will try to explain the concepts and tactics required to use these integrated technologies more effectively. At the end of the thesis, a scenario will be run to help the reader understand the applicability of these tactics in the real environment.				
14. SUBJECT TERMS Unmanned Aerial Vehicle, Network Centric Warfare, Unmanned Aerial System, UAV Missions, NCW, UAS, UAV, Electronic Warfare, EW Missions, EW and UAS Tactics			15. NUMBER OF PAGES 245	
			16. PRICE CODE	
17. SECURITY CLASSIFICATION OF REPORT Unclassified	18. SECURITY CLASSIFICATION OF THIS PAGE Unclassified	19. SECURITY CLASSIFICATION OF ABSTRACT Unclassified	20. LIMITATION OF ABSTRACT UU	

THIS PAGE INTENTIONALLY LEFT BLANK

Approved for public release; distribution is unlimited

**GENERAL USE OF UAS IN EW ENVIRONMENT—EW CONCEPTS AND
TACTICS FOR SINGLE OR MULTIPLE UAS OVER THE NET-CENTRIC
BATTLEFIELD**

Mustafa Gokhan Erdemli
1st Lieutenant, Turkish Air Force
B.S., Turkish Air Force Academy, 2001

Submitted in partial fulfillment of the
requirements for the degree of

**MASTER OF SCIENCE IN ELECTRONIC WARFARE SYSTEMS
ENGINEERING**

from the

**NAVAL POSTGRADUATE SCHOOL
September 2009**

Author: Mustafa Gokhan Erdemli

Approved by: Edward Fisher
Thesis Advisor

Dr. Wolfgang Baer
Co- Thesis Advisor

Dan C. Boger
Chairman, Department of Information Sciences

THIS PAGE INTENTIONALLY LEFT BLANK

ABSTRACT

With the development of technology, Electronic Warfare has been increasing for decades its importance in modern battles. It can even be referred to as the heart of today's net-centric battlefield.

Unmanned Aerial Systems are gaining more importance every single day. Nations are working on more complex and more effective UAS in order to accomplish missions that are very difficult, or even impossible for manned aircraft.

Electronic Warfare missions are often dangerous and risky. Mounting Electronic Warfare equipment on a UAS and using it to conduct the EW mission is the most rational solution, since it does not endanger human life.

This thesis will examine the possible ways in which UAS can be paired with EW equipment. These two technologies can be integrated into a single mission over the net-centric battlefield. Furthermore this thesis will try to explain the concepts and tactics required to use these integrated technologies more effectively.

At the end of the thesis, a scenario will be run to help the reader understand the applicability of these tactics in the real environment.

THIS PAGE INTENTIONALLY LEFT BLANK

TABLE OF CONTENTS

I.	INTRODUCTION.....	1
A.	MAJOR RESEARCH QUESTIONS	1
B.	SCOPE OF THE THESIS.....	2
C.	BENEFITS OF STUDY.....	2
D.	CHAPTER OUTLINE.....	2
1.	Introduction.....	2
2.	General Description of EW	2
3.	History of EW.....	3
4.	General Information About UAS	3
5.	History of UAS	3
6.	Merging Points of EW and UAS.....	4
7.	Possible Tactics and Concepts of UAS in the Net-centric Battle Area	4
8.	Scenario.....	5
9.	Conclusions and Recommendations.....	5
II.	GENERAL DESCRIPTION OF EW.....	7
A.	MAIN DEFINITIONS RELATED TO ELECTRONIC WARFARE	7
1.	Electromagnetic Spectrum (EMS).....	7
2.	Electromagnetic Environment (EME)	7
3.	Electronic Warfare (EW)	9
4.	Electronic Attack (EA)	9
5.	Electronic Protection (EP)	10
6.	Electronic Warfare Support (ES).....	10
7.	Intelligence and Electronic Warfare Support	11
8.	Directed Energy (DE) in EW.	12
B.	EW EFFECTS.....	12
1.	Types of Electromagnetic Deception.....	13
C.	EW TENETS	15
D.	ELECTRONIC WARFARE’S RELATIONSHIP TO INFORMATION OPERATIONS (IO).....	15
E.	THE MAJOR ACTIVITIES PERFORMED IN EW	17
III.	HISTORY OF EW	21
A.	BEFORE AND DURING THE FIRST WORLD WAR.....	21
B.	FROM 1919 TO THE END OF SECOND WORLD WAR	23
C.	FROM 1946 TO THE FIRST GULF WAR	26
1.	Korean War (1950–1953) to Vietnam	26
2.	Vietnam War Era (1962–1975).....	31
3.	Yom Kippur (1973) and the Bekaa Valley (1982).....	39
<i>a.</i>	<i>Aircraft and Missiles Used in Bekaa Valley Battle.....</i>	<i>44</i>
4.	The First Gulf War (Operation DESERT STORM)	47

D.	FROM THE FIRST GULF WAR TO THE PRESENT	56
1.	Operation Allied Forces (23 March-10 June 1999)	56
2.	The War in Afghanistan (7 October 2001-Present)	59
a.	<i>Causes of Conflict [59]</i>	59
b.	<i>Description of Conflict</i>	60
3.	Operation Iraqi Freedom (2003-Present)	61
IV.	GENERAL INFORMATION ABOUT UAS	65
A.	UAV CLASSIFICATION	67
1.	Classification by Performance Characteristics	68
a.	<i>Classification by Weight</i>	68
b.	<i>Classification by Endurance and Range</i>	69
c.	<i>Classification by Maximum Altitude</i>	71
d.	<i>Classification by Wing Loading</i>	72
e.	<i>Classification by Engine Type</i>	73
B.	DOD CLASSIFICATION	74
1.	Micro UAS	75
2.	Mini UAS	75
3.	Tactical UAS	76
4.	Medium & High Altitude UAS	76
C.	U.S. MILITARY UAS CLASSIFICATIONS	76
1.	U.S. Air Force Tiers	76
2.	U.S. Marine Corps Tiers	81
3.	U.S. Army Tiers	83
D.	CURRENT AND FUTURE UAS ROLES AND APPLICATIONS:	83
1.	Current UAS Military Roles	83
2.	UAS Civilian Roles	88
E.	UAS NETWORKING	90
F.	UAS PLATFORMS	90
V.	HISTORY OF UAS	103
A.	THE ORIGINS	103
B.	WWI	104
C.	INTERWAR YEARS	105
D.	WWII	105
E.	POST-WORLD WAR II, THROUGH PRE-VIETNAM	107
1.	Surface-to-Surface Cruise Missiles	108
2.	Decoy Missiles	113
3.	Standoff Cruise Missiles	114
4.	Anti-ship Cruise Missile	115
5.	Photo Reconnaissance UAS	116
F.	VIETNAM THROUGH DESERT STORM	118
G.	DESERT STORM THROUGH PRESENT	122
VI.	MERGING POINTS OF EW AND UAS	129
A.	UAS PAYLOADS	129

1.	Generalized UAS Avionics Architecture	130
2.	Electronic Warfare Support (ES) and SIGINT Payloads	133
3.	Electronic Attack (EA) Payloads	137
B.	INTERNATIONAL PROGRAMS	140
1.	Suppression of Enemy Air Defense	148
C.	THE FUTURE OF EW PAYLOADS	149
D.	SUMMARY OF UAS INVOLVEMENT IN ELECTRONIC WARFARE	150
1.	Electromagnetic Jamming:	150
2.	Electromagnetic Deception	150
3.	Directed Energy	151
4.	Anti Radiation Missiles.....	152
5.	Expendables (Flares and Active Decoys)	152
6.	Threat Warning	152
7.	Collection Supporting EW	152
8.	Direction Finding	152
VII.	POSSIBLE TACTICS AND CONCEPTS OF MINI-UAS FOR ELECTRONIC WARFARE MISSIONS IN THE NET-CENTRIC BATTLE AREA	155
A.	LOITER.....	156
B.	JAMMING TERMS TO CONSIDER WHEN DEVELOPING NEW TACTICS.....	158
1.	Stand-Off Jamming (SOJ)	159
2.	Escort Jamming	159
3.	Mutual Support Jamming.....	160
4.	Stand-in Jamming (SIJ)	161
5.	Self-Screening/Deception Jamming.....	162
C.	ELECTRONIC JAMMING METHODS	162
D.	TACTICS FOR MINI AND MICRO UAS.....	166
1.	Tactic 1 (Single Short Range Mini UAS EA Mission)	166
2.	Tactic 2 (Double Short Range Mini UAS Emission).....	168
3.	Tactic 3 (Single or Double Short Range Mini UAS EA Mission)	170
4.	Tactic 4 (Multiple Short Range Mini UAS EA Mission)	172
5.	Tactic 5 (Decoy Tactic against SAM EA Mission)	176
6.	Tactic 6 (Decoy Tactic Against SAM and Air Interceptors EA Mission).....	177
7.	Tactic 7 (Multiple Short Range Mini UAS for Threat Warning- Unknown Threat ES Mission)	179
8.	Tactic 8 (Multiple Short Range Mini-Uas for Direction Finding-Known Threat Es Mission).....	180
9.	Tactic 9 (Multiple Short Range Mini UAS for Direction Finding-Unknown Threat ES Mission).....	181
VIII.	SCENARIO	183
A.	COUNTRIES.....	183

B.	POLITICAL STATUS.....	183
C.	FORCE SPECIFICATION.....	184
	1. Xland:.....	184
	2. Yland:.....	184
D.	WEAPON SYSTEMS.....	186
	1. Hawk Missile	186
	2. Patriot Missile.....	188
	a. Major Components.....	189
E.	MISSION	191
F.	X-DAY	195
IX.	CONCLUSION AND RECOMMENDATIONS.....	203
	A. CONCLUSION:	203
	B. RECOMMENDATIONS:	206
	LIST OF REFERENCES	209
	INITIAL DISTRIBUTION LIST	223

LIST OF FIGURES

Figure 1.	Electromagnetic Spectrum (From [2]).....	8
Figure 2.	Electromagnetic Spectrum (From [3]).....	8
Figure 3.	Electronic Warfare Subdivisions (From[4])	9
Figure 4.	Electronic Warfare’s Relationship to Information Operations (IO) (From [1]).....	16
Figure 5.	A 1941 RAF PRU photograph of the two Freyas at Auderville.....	25
Figure 6.	A Limber Freya Radar	26
Figure 7.	A Pole Freya Radar.....	26
Figure 8.	RB-36D (From [13]).....	27
Figure 9.	U-2 "Dragon Lady" (From[15]).....	28
Figure 10.	ADM-20 “QUAIL” MISSILE (From[18])	30
Figure 11.	Studies from “Operation Moonbounce” (EME path losses) (From[20]).....	31
Figure 12.	SA-2 (V-750VK Dvina) (From[22]).....	32
Figure 13.	AN/APR-25(V) Strobe Display Scope (From[24])	33
Figure 14.	F-100F (First Wild Weasel Aircraft) (From[25])	33
Figure 15.	AGM-45 (From[26]).....	34
Figure 16.	F-105 Thunderchief “THUD” (From[27]).....	35
Figure 17.	AGM-78 (From [28]).....	36
Figure 18.	“Rolling Thunder” and “Linebacker” (From[31])	37
Figure 19.	Line-abreast jamming cell formation (From [31]).....	38
Figure 20.	Different methods of chaff delivery (From [31]).....	39
Figure 21.	SA-6 GAINFUL (From [34]).....	40
Figure 22.	ZSU-23-4 Shilka 23mm Antiaircraft Gun (From[36])	41
Figure 23.	SA-7 GRAIL (From [37]).....	41
Figure 24.	F-15 “EAGLE”	44
Figure 25.	F-16 “FALCON”	45
Figure 26.	AIM-7 “SPARROW”.....	45
Figure 27.	SU-20 "FITTER"	45
Figure 28.	E-2C "HAWKEYE"	45
Figure 29.	F-4 “PHANTOM”.....	46
Figure 30.	MIG-21 "FISHBED"	46
Figure 31.	AIM-9L “SIDEWINDER”	46
Figure 32.	AA-2 "ATOLL"	46
Figure 33.	R/UGM-109C/D Tomahawk Land Attack (From [45]).....	51
Figure 34.	Tomahawk Weapon System Evaluation (From [46])	52
Figure 35.	BQM-74E (From [47]).....	52
Figure 36.	F-117A (From [47])	53
Figure 37.	AGM-88 HARM MISSILE (From [49])	53
Figure 38.	ALARM (Air Launched Anti-Radiation Missile) (From [50]).....	54
Figure 39.	E-8A "JSTARS" (From [51]).....	55
Figure 40.	E-3 AWACS (From [52])	55

Figure 41.	Wreckage of downed F-117 (From[53]).....	57
Figure 42.	Weight-All UAS	69
Figure 43.	Endurance-All UAS	70
Figure 44.	Max Altitude-All UAS.....	72
Figure 45.	Wing Loading-All UAS.....	73
Figure 46.	UAS and Engine Types (From[78]).....	74
Figure 47.	Altitude and Size Classification.....	75
Figure 48.	Notional MAE UAV (Tier II) Mission Profile (From [80])	79
Figure 49.	Notional HAE UAV (Tier II+) Mission Profile (From [80]).....	80
Figure 50.	Notional LO-HAE UAV (TIER III-) Mission Profile (From [80])	80
Figure 51.	Marine Corps FoS UAV Schedule (From [80]).....	82
Figure 52.	Marine Corps Joint UAS Program (From [83]).....	82
Figure 53.	DoD Unmanned, Present and Future Roles (From [75])	86
Figure 54.	Current and Planned UAS Programs (From [5]).....	87
Figure 55.	Joint Services Roadmap for Achieving DoD Vision for Unmanned Systems (From [75])	88
Figure 56.	German V-1 "Buzz Bomb"	107
Figure 57.	The Martin TM-1 "Matador" (From [98]).....	109
Figure 58.	The First "Matador" Launched from Cape Canaveral (From [98]).....	109
Figure 59.	The Mace (From [100])	110
Figure 60.	SM-62A "Snark" Intercontinental Surface-To-Surface Cruise Missile (From [101]).....	111
Figure 61.	SM-64 Navaho Missile (From [104])	112
Figure 62.	GAM-72 (ADM-20A) "Quail" (From [106])	114
Figure 63.	AGM-28 Hound Dog (From [107])	115
Figure 64.	SS-N-2 Styx (From [109])	116
Figure 65.	DC-130H Hercules drone control with a pair of AQM-34 (From [110]).....	117
Figure 66.	BQM- 34 on Take-off (From [110])	118
Figure 67.	BQM-74 "Chukar" (From [110]).....	121
Figure 68.	Israeli Malat Mastiff (From [117])	122
Figure 69.	IAI MALAT Scout (From [117]).....	122
Figure 70.	RQ-2 "Pioneer" (From [120]).....	123
Figure 71.	MQ-1 Predator armed with an AGM-114 Hellfire (From [126])	126
Figure 72.	RQ-4A "Global Hawk" (From [130]).....	127
Figure 73.	Evolution of Unmanned Aerial Systems.....	128
Figure 74.	Past sixty years of Northrop Grumman UAS	128
Figure 75.	Generalized UAS Avionics Architecture (From [132]).....	130
Figure 76.	Geolocation error ellipses for 0.5 deg. rms DF sensors onboard 2 platforms with stand-off range of 100km. AOI (100km x 100km) is bounded by blue line.....	134
Figure 77.	Geolocation error ellipses for 5 deg. rms DF sensors onboard 8 platforms with stand-in capability. AOI (100km x 100km) is bounded by blue line. ...	134
Figure 78.	Geolocation Error (m) versus Range for 0.1-15 degree rms DF sensors enjoying optimum geometry.....	135

Figure 79.	Relative geolocation error versus the number of DF sensors located around an emitter.	136
Figure 80.	Jammer-to-Signal Ratio versus Range for a 100Watt noise jammer against 10kW radar with 20dB antenna gain attempting to detect a target of 1m2 RCS. The red, green, and blue lines are for target ranges of 1, 10, and 100km.	138
Figure 81.	Navigation radar display showing jamming strobe due to EA payload onboard mini-UAV	139
Figure 82.	The Mucke electronic countermeasures (ECM) UAV (From [136]).....	140
Figure 83.	Eurohawk (From [137])	141
Figure 84.	ASN-206 (From [139])	142
Figure 85.	IAI-Malat Heron UAV (From [141]).....	143
Figure 86.	Hermes 450s - UAV System (From [143]).....	143
Figure 87.	Aerosonde mini-UAV (From [145]).....	145
Figure 88.	Aerosonde mini-UAV loaded with Antennas (From [144])	145
Figure 89.	The Sky-Y (From [148]).....	147
Figure 90.	Predator UAV with Hellfire-C (From [151]).....	149
Figure 91.	UCAV (From [152])	149
Figure 92.	A C-130 Carrying An Advanced Tactical Laser (From [153]).....	151
Figure 93.	Loiter Types.....	156
Figure 94.	Penetration-Stand off Sensor Coverage	157
Figure 95.	Jamming Types	158
Figure 96.	Stand-off Jamming.....	159
Figure 97.	Escort Jamming.....	159
Figure 98.	Mutual Support Jamming.....	160
Figure 99.	Stand-In Jamming (SIJ)	161
Figure 100.	Self-Screening / Deception Jamming.....	162
Figure 101.	Electronic Jamming Methods (From [4])	163
Figure 102.	Power at Radar	164
Figure 103.	Standoff Jammer Calculations	165
Figure 104.	UAS Antenna necessities for Tactic 1	167
Figure 105.	TACTIC-1	168
Figure 106.	UAS Antenna necessity for Tactic 2.....	169
Figure 107.	Tactic 2.....	170
Figure 108.	Tactic 3.....	171
Figure 109.	Tactic 3 with Relay UAS	172
Figure 110.	Radar Displays.....	173
Figure 111.	Tactic 4 Single Entry Point.....	174
Figure 112.	Tactic 4 Multiple Entry Points.....	175
Figure 113.	Decoys and Effects on Enemy Radar.....	178
Figure 114.	Effects of Using Decoy against Air Interceptor.....	179
Figure 115.	Tactic 6.....	180
Figure 116.	Xland and Yland	183
Figure 117.	Yland Defense Against Xland	185

Figure 118.	Detection And Engagement Radar Coverage for 100 Feet.....	185
Figure 119.	MIM-23 Hawk (From [161])	188
Figure 120.	MIM-104 Patriot (From [162]).....	189
Figure 121.	Attack Group.....	192
Figure 122.	Main Target and Panther’s Flight Plan	193
Figure 123.	Hawk to Be Destroyed By Tiger and Flight Plan	193
Figure 124.	Patriot to Be Destroyed By Puma and Flight Plan.....	194
Figure 125.	C-130 Loiter Pattern	195
Figure 126.	6:05 a.m.....	196
Figure 127.	6:05 a.m.....	197
Figure 128.	06:15 a.m. Flight Package.....	198
Figure 129.	EA/ES UAS Position For Radar Suppression.....	198
Figure 130.	06:18 a.m.....	199
Figure 131.	Possible A/A Engagement	200
Figure 132.	06:25 a.m. Bombs On Target-Mission Accomplished.....	201
Figure 133.	06:35 a.m. Entire Air Force Is Back In Xland Territory.....	202

LIST OF TABLES

Table 1.	The Principle Activities of Electronic Warfare (From [3])	17
Table 2.	Assets of the Coalition Forces	50
Table 3.	Select Mishap Rates	67
Table 4.	Classification by Weight.....	68
Table 5.	Range and Endurance	70
Table 6.	Classification by Maximum altitude.....	71
Table 7.	Classification by Wing Loading	73
Table 8.	Comparison of the USAF Tier II, II+ and III- (From [80])	77
Table 9.	UAS Inventory in the U.S. Services (From [85])	84
Table 10.	UAS Capabilities (From [75])	84
Table 11.	World's Unmanned Aircraft Systems List (From [90]).....	91
Table 12.	Statistics of the German V-1 Campaign (From [92])	106
Table 13.	Hawk Specification (From [160]).....	186
Table 14.	Patriot Specifications (From [165])	190
Table 15.	Future UAS Forecasts.....	205

THIS PAGE INTENTIONALLY LEFT BLANK

ACKNOWLEDGEMENTS

First of all, I would like to thank my thesis advisor, Mr. Edward “Tuna” Fisher. I would not have been able to finish this thesis without his contribution and help. Thank you for your time, support and professional guidance during this work. It was a great pleasure to work with you. And I also would like to thank Dr. Wolfgang Baer for his precious advises.

I must also acknowledge the NPS-COASTS team for creating a very friendly working environment, and for providing a great opportunity to work on Unmanned Aerial Systems and to learn about their operational side.

Lastly, and most importantly, I would like to thank my beautiful wife Eda Erdemli for always being with me and for her endless support throughout my studies and all our life. Your love is my light which enlightens my path. Thank you for your understanding, your patience and being the best thing that happened to me.

THIS PAGE INTENTIONALLY LEFT BLANK

DISCLAIMER

The views expressed in this thesis are those of the author and do not reflect the official policy or position of the Turkish Republic, the Turkish Armed Forces, the Turkish Land Forces, the Turkish Naval Forces or the Turkish Air Force.

THIS PAGE INTENTIONALLY LEFT BLANK

I. INTRODUCTION

Unmanned Aircraft Systems (UAS) are used for both defensive and offensive purposes. Different sizes and capabilities of UAS support a variety of different applications. Improved networking capabilities have enlarged the boundaries of UAS operations. We know that it is cheaper and less dangerous to use UAS in many missions formerly reserved for manned aircraft.

Electronic Warfare (EW) maintains a predominant position in today's highly technological warfare environment. We cannot even conceive of a battle without using Electronic Warfare and related tactics. Electronic Warfare has become one of the most important divisions of modern warfare.

The net-centric battlefield environment exhibits merging points between UAS and Electronic Warfare, and using this relationship we can improve the effectiveness of both. Employment of UAS for EW is not new, and in fact is becoming more common. As is clear from the title of this thesis: "General Use of UAS in an EW Environment—EW Concepts and Tactics for Single or Multiple UAS Over the Net-Centric Battlefield," this author's primary focus is to analyze the operational and strategic utility of UAS in relation to Electronic Warfare, with consideration for networking and the different types of UAS. This thesis research generally seeks to identify the concepts for employment of UAS for Electronic Warfare and examines how they have changed, and will continue to change strategies and combat tactics.

A. MAJOR RESEARCH QUESTIONS

- This study will research the answers to the following questions:
- What are the merging points between UAS and EW?
- How did Electronic Warfare evolve in the last century?
- How can we use UAS more effectively for EW purposes?
- What roles are appropriate for UAS in pre- and post-war periods?

- What are the benefits of using UAS in the net-centric battle area?
- What is the effect of networking capabilities of UAS on tactics and concepts of general use of UAS in EW?
- While running a scenario, can we determine what kind of missions can be accomplished by UAS?

B. SCOPE OF THE THESIS

This study will be a broad guide to UAS employment for EW purposes. After collecting the necessary information and data, I will close my thesis with a combat scenario that will permit readers to visualize proper employment of UAS in a net-centric EW environment. This will further illuminate possible concepts and tactics that can be applied in the future.

C. BENEFITS OF STUDY

This study can be used as a guide for interaction of UAS tactics and classic offensive and defensive aircraft tactics.

D. CHAPTER OUTLINE

The thesis research and findings will be organized in the following manner:

- 1. Introduction**
- 2. General Description of EW**

In this chapter, I discuss and describe EW and its subdivisions, according to U.S. doctrine: Electronic Attack (EA), Electronic Warfare Support (ES), and Electronic Protection (EP). I will give examples for each of these. I will also define other elements of Electronic Warfare, such as the electromagnetic spectrum, operational electromagnetic energy, directed energy, and so on. Moreover, I will discuss the EW effects and tenets. In the second part of this chapter I will define the relationship between Electronic Warfare and Information Warfare (IW), since EW is a pillar of IO. Finally I will talk about the major activities which can be achieved by EW.

3. History of EW

In Chapter III, I will research the history of EW, starting with elements of EW from before the First World War. This chapter is divided into four main categories:

1. Before and during the First World War
2. From 1919 to the end of the Second World War
3. From 1946 through the First Gulf War
4. Korean War (1950–1953)
5. Vietnam War (1959–1975)
6. Yom Kippur (1973) and the Bekaa Valley (1982)
7. The First Gulf War (Operation DESERT STORM)
8. From the First Gulf War to the present
9. Operation ALLIED FORCE (1999)
10. The War in Afghanistan (2001-Present)
11. Operation IRAQI FREEDOM (2003-Present)

4. General Information About UAS

Chapter IV will include important information and definitions about UAS, to include classification of UAS. UAS networking will be discussed. I will start this chapter by explaining why we need UAS. Current and future military and civilian roles and applications will also be discussed in this chapter.

5. History of UAS

In this chapter, I will research the history of UAS. The chapter will be divided into seven main categories starting with the origins of the UAS concept.

1. The Origins
2. WWI

3. Interwar Years
4. WWII
5. Post-World War II, Through Pre-Vietnam
 - a. Surface-to-surface Cruise Missiles
 - b. Decoy Missiles
 - c. Standoff Cruise Missiles
 - d. Anti-ship Cruise Missiles
 - e. Photo Reconnaissance UAVs
6. Vietnam Through Desert Storm
7. Desert Storm Through Present

6. Merging Points of EW and UAS

This chapter will be a synthesis of the first four chapters. This chapter also will be the main step to determine the possible EW tactics for single or multiple UAS over the net-centric battlefield.

- What are the merging points between UAS and EW?
- How can we use UAS more effectively for EW purposes?

The questions above will be thoroughly answered in this chapter. They will lead to a reasonable solution. Furthermore, I will research EW UAS payloads. At the end of this chapter I will discuss international EW UAS programs.

7. Possible Tactics and Concepts of UAS in the Net-centric Battle Area

Using the information from the Chapter VI, my experience with UAS in the COASTS program, and my knowledge as a fighter pilot, I will produce possible operational EW tactics for single or multiple UAS over the net-centric battlefield.

8. Scenario

After examining tactics in the previous chapter, I will describe and run a scenario on Falcon View.

9. Conclusions and Recommendations

In this chapter, I will conclude my thesis and discuss the possibility of using the tactics and concept that I came up with in the previous chapters. Finally, I will make recommendations for follow-up or general use.

THIS PAGE INTENTIONALLY LEFT BLANK

II. GENERAL DESCRIPTION OF EW

Control of the EM spectrum can have a major impact on the success of military operations across the levels of conflict. Proper employment of EW enhances the ability of U.S. operational commanders to achieve objectives. EW is a force multiplier. EW operates on multiple levels of a conflict, from self-protection to operational attack plans. When EW actions are properly integrated with other military operations, a synergistic effect is achieved, losses minimized, and effectiveness enhanced. [1]

A. MAIN DEFINITIONS RELATED TO ELECTRONIC WARFARE

The definitions given in this section are necessary for a thorough understanding.

1. Electromagnetic Spectrum (EMS)

EMS is the range of frequencies of EM radiation from zero to infinity [2]. “Control of the electromagnetic spectrum is an essential and critical objective in the success of today’s military operations and is applicable at all levels of conflict.” [1]

2. Electromagnetic Environment (EME)

EME is used for the resulting product of the power and time distribution, in various frequency ranges, of the radiated or conducted EM emission levels that may be encountered by a military force, system, or platform when performing its assigned mission in its intended operational environment. It is the sum of electromagnetic interference (EMI); EM pulse; hazards of EM radiation to personnel, ordnance, and volatile materials; and natural phenomena effects of lightning and precipitation static [2].

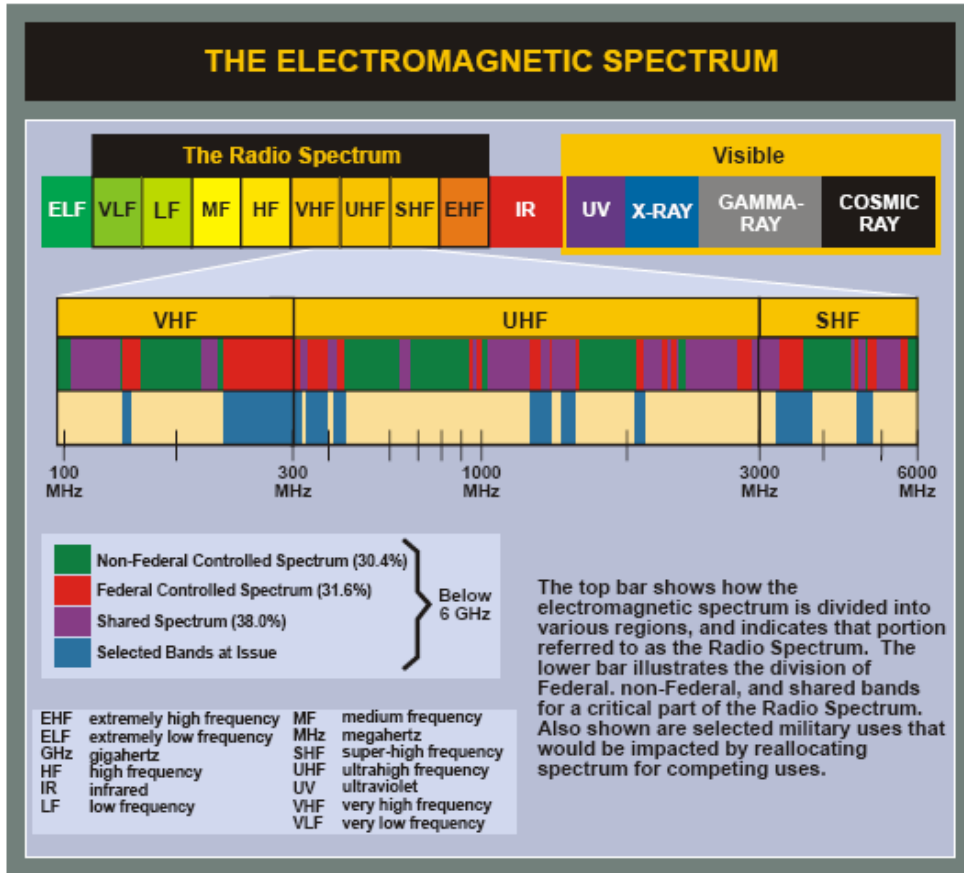

Figure 1. Electromagnetic Spectrum (From [2])

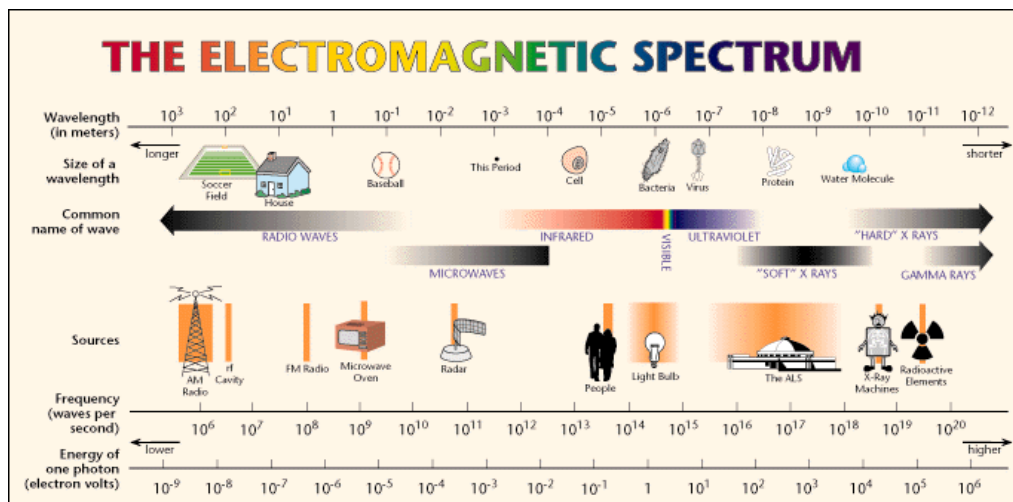

Figure 2. Electromagnetic Spectrum (From [3])

3. Electronic Warfare (EW)

EW is the use of the EMS to deny the use of this medium by an enemy, while optimizing its use by friendly forces [5]. It can be also defined as a military action whose objective is control of the EMS. The three main subdivisions are Electronic Attack (EA), Electronic Protection (EP), and Electronic Warfare Support (ES) [2].

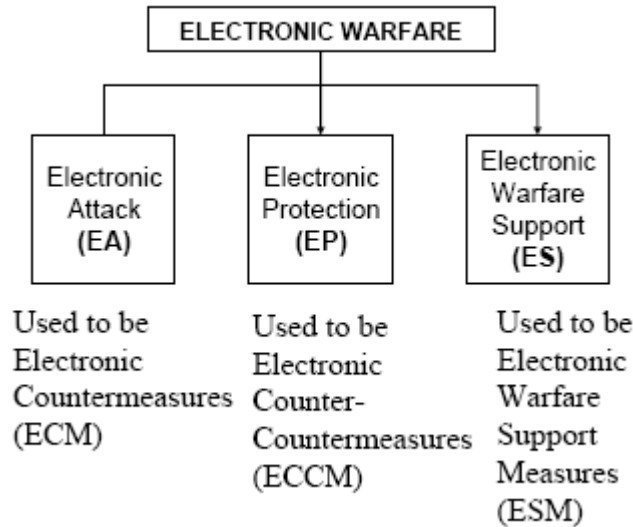

Figure 3. Electronic Warfare Subdivisions (From[4])

4. Electronic Attack (EA)

EA is the use of the EMS to attack personnel, facilities, or equipment in order to degrade, neutralize, or destroy an enemy's capabilities [2]. "EA also prevents or reduces an enemy's use of the electromagnetic spectrum. It can be accomplished through detection, denial, disruption, deception and destruction, but relies heavily on detection." [1]

EA can be either active or passive. Jamming, deception, active cancellation, and Electromagnetic pulse (EMP) are used for *Active EA*. On the other hand, *Passive EA* includes the use of chaff, towed decoys, balloons, radar reflectors, winged decoys, and stealth [5].

Hard-kill and soft-kill aspects play an important role in EA. While jamming and deception are considered soft-kill measures, anti-radiation missiles are naturally considered as hard-kill mediums due to the purpose of damaging or destroying radar antennas and equipment [4].

5. Electronic Protection (EP)

EP is the subdivision of EW that includes passive and active means to protect personnel, facilities, and equipment from any effects of friendly or enemy employment of EW that degrade, neutralize or destroy friendly combat capability [6].

Active EP includes such activities as technical modifications to radio equipment, such as the ARC-164, which is a military UHF AM radio that operates between 225-400 MHz and uses frequency-hopping spread spectrum technology. Handheld operations are widely used for EP purposes [7]. The education of operators and modified battlefield tactics or operations can be considered as *Passive EP* [5].

Examples for EP include spectrum management, EM hardening, emission control (EMCON), use of wartime reserve modes (WARM), frequency agility and changing PRF. “Integration of EP and other security measures can prevent enemy detection, denial, disruption, deception or destruction. Friendly force reliance on advanced technology demands EP safeguards.” [1]

6. Electronic Warfare Support (ES)

ES is the subdivision of EW that is used for searching for, intercepting, identifying, and locating or localizing sources of intentional and unintentional radiated EM energy for threat recognition, targeting, and planning for an immediate action. ES includes the information for decisions involving EW operations and other tactical actions such as threat avoidance, targeting, and homing (JP 3-51). ES is used to provide near real-time information to supplement information from other intelligence sources. Moreover, a more accurate picture of the battle space can be provided by correlation of ES data with other ISR information. This information is vital for situational awareness and developing new countermeasures, and affects the overall mission. “ES data can be

used to produce signals intelligence (SIGINT), which includes communications intelligence (COMINT) and electronic intelligence (ELINT).” As is obvious from the name, ES provides information required for EW planning and operational purposes. “It allows for immediate decisions involving electronic warfare operations and other tactical actions such as threat avoidance, targeting, and homing.” Because of ES’s passive nature, it may also be deployed during peacetime [1].

7. Intelligence and Electronic Warfare Support

Even though electronic forms of intelligence gathering (SIGINT, Measurement and Signature Intelligence [MASINT], and other forms) and ES seem like they are being used for the same purposes, actually there is a significant distinction between intelligence and ES, based upon who tasks or controls the intelligence assets and what they are supposed to provide, and most importantly by their purpose. Intelligence gathering comprises the main part of the day-to-day activities of the intelligence community. On the other hand, ES is a part of the intelligence process that is often referred to as combat information, which requires immediate action (i.e., Airborne Warning and Control System passive detection system). An operational commander controls or tasks the assets for the achievement of ES. These assets include efforts to search for, intercept, identify, and locate or localize sources of radiated EM energy. The most important purpose of ES tasking is immediate threat recognition for the planning and conduct of future operations, and other tactical actions such as threat avoidance, targeting, and homing. ES is intended to respond to an immediate operational requirement.

In the meantime, these assets and resources can simultaneously collect intelligence for information gathering purposes. Data collected by ES systems can be used as SIGINT, ELINT, etc. “This is not to say that data collected for intelligence cannot meet immediate operational requirements. Intelligence collected for ES purposes is normally also processed by the appropriate parts of the intelligence community for further exploitation after the operational commander’s ES requirements are met.” [6]

The radar warning receiver is the best example of ES. It provides necessary information about the enemy's radar systems, which are potentially deadly for friendly forces, and allows the pilot to take immediate action against the incoming threat. Another example may be the EP-3 monitoring of Iraqi communications networks to identify which nodes appeared to be critical, and to determine the value each node adds to its corresponding network.

8. Directed Energy (DE) in EW

DE is an umbrella term covering technologies that relate to the production of a beam of concentrated electromagnetic energy or atomic or subatomic particles. [1]

Directed-energy warfare (DEW) is military action that involves the use of DE weapons, devices, and countermeasures. It is used for causing damage or destruction of an adversary's equipment, facilities, and personnel. It may also be used to determine, exploit, reduce, or prevent hostile use of the EM spectrum. DE can be deployed to protect friendly equipment, facilities, and personnel [8].

Some applications of DE can be used in all areas of EW: laser, radio frequency, and particle beam. DE can be used as a means of EA, ES, or EP. A laser designed to blind an optical sensor is an example of DE use in EA. A warning receiver designed to detect and analyze a laser signal is considered ES. If a visor or goggle is utilized to filter out the harmful wavelength of laser light, this is obviously EP [1].

B. EW EFFECTS

Detection—"Assesses the electromagnetic environment to include radar/radio frequency, electro-optics/laser, and infrared spectrums using active and passive means." [1]. The first step in EW is detection, because effective detection of the electromagnetic environment is essential to develop an accurate electronic order of battle (EOB). EOB is critical to meet mission objectives and for decision making. There are different means of detection. On-board receivers, space-based systems, UAS, human intelligence (HUMINT), and other ISR systems are some of these means. Detection can be used in

EA, EP, and ES, and it enables the avoidance of known hostile systems when possible. When avoidance is not possible, it may be necessary to deny, deceive, disrupt, or destroy the enemy's electronic systems [1].

Denial—"Controls the information an adversary receives and prevents the adversary from gaining accurate information about friendly forces." [1]. For example, traditional noise jamming techniques, which are designed to block communications channels or radar scope presentations, can be used for denial. Advanced electronic deception techniques or destructive measures are also used for denial. The EC-130H COMPASS CALL is a very good denial example of a communications jamming weapon [1].

Deception—"Utilizes the electromagnetic spectrum to confuse or mislead an adversary." One objective of EW is to cause deception in decision-making processes through the use of the electromagnetic spectrum by the enemy, and to make it difficult to distinguish between reality and the perception of reality. Misleading and confusing the adversary's electromagnetic sensors is one of the main methods for the achievement of the mission. Multi-sensor deception can increase the adversary's confidence about the "plausibility" of the deception story.

Electromagnetic deception as it applies to EW is the deliberate radiation, re-radiation, alteration, suppression, absorption, denial, enhancement, or reflection of EM energy in a manner intended to convey misleading information to an enemy or to enemy EM-dependent weapons, thereby degrading or neutralizing the enemy's combat capability. [9]

Deception jammers/transmitters can be used to place false targets on the enemy radar's scope or cause the enemy radar to evaluate incorrectly target speed, range, or azimuth. These jammers/transmitters generally operate by receiving the pulse of energy from the radar, amplifying it, delaying or multiplying it, and reradiating the altered signal back to the enemy's transmitting radar.

1. Types of Electromagnetic Deception

- Manipulative Electromagnetic Deception

- . Simulative Electromagnetic Deception
- . Imitative Electromagnetic Deception

“Manipulative EM deception involves an action to eliminate revealing or to convey misleading EM telltale indicators that may be used by hostile forces.” [2] By transmitting a simulated unique system signature from a nonlethal platform, adversary sensors are misled to receive and catalog those systems as real threats.

Low observable technology, commonly known as “Stealth,” is a form of passive manipulative electromagnetic deception. Through stealth, the threat radar is passively manipulated or denied reception of proper return pulses, which cause a misperception of the target size or presence of the aircraft. EM deception causes the enemy to lose their EW effectiveness.

“Simulative electromagnetic deception is action to simulate friendly, notional, or actual capabilities to mislead hostile forces.” [1] The use of chaff is an excellent example of simulative electromagnetic deception. Chaff places false targets on the radar display so that the enemy thinks that a larger strike package is attacking. Deceptive techniques that mislead an adversary’s target tracking radar by using a jammer/transmitter to prevent the enemy from finding the true location of its target is another example of this type of deception.

“Imitative EM deception introduces EM energy into enemy systems that imitate enemy emissions.” [1] Repeater jamming techniques that imitate enemy radar pulses is the best example for imitative EM deception. These pulses send incorrect target information to the enemy’s radar systems [9].

Other examples of deception include IR deception involving manipulation of infrared signatures; radar deception consisting of re-radiation of signals through the use of reflectors, transponders, or repeaters; and optical deception by manipulation of the optical region of the EM spectrum through the use of aerosols, mists, etc. These techniques may be employed individually or in combination. In general, EW deception planning determines how to use EM means to mislead the adversary and create an advantage for friendly forces. [1]

Disruption—“Degrades or interferes with the enemy’s control of its forces in order to limit attacks on friendly forces.” [1] For disruption electronic jamming, electronic deception, electronic intrusion, and destruction means can be used.

Destruction—“Eliminates some or all of an adversary’s electronic defenses.” [1] Destruction is the most permanent and the most effective countermeasure. With the destruction of a system, the enemy will be unable to use this system and they will need to replace, repair or support it by moving forces in a period of time. Target tracking radars and command and control are high value targets because their destruction seriously hampers the enemy’s effectiveness. The first priority is to determine the exact location of the target that is supposed to be destroyed. ES plays an important role for precise localization. Pinpointing the location can be accomplished by onboard receivers and direction finding equipment. A variety of weapons and techniques can be used for destroying the enemy EM systems. Anti-radiation missiles are for a prime example a destruction asset.

C. EW TENETS

According to Joint Publication 3-13.1, EW has three tenets: are control, exploit and enhance.

Control. The domination of the electromagnetic spectrum, directly or indirectly, so that friendly forces may attack the adversary and protect themselves from exploitation or attack.

Exploit. Use of the electromagnetic spectrum to the advantage of friendly forces.

Enhance. Use of EW as a force multiplier

D. ELECTRONIC WARFARE’S RELATIONSHIP TO INFORMATION OPERATIONS (IO)

IO consists of EW, computer network operations (CNO), PSYOP, military deception (MILDEC), and operations security (OPSEC), in relation with specified supporting and related capabilities. IO influences, disrupts, corrupts, or usurps adversarial

human and automated decision making ability while protecting our own. Information assurance (IA), physical security, physical attack, counterintelligence (CI), and combat camera (COMCAM) are the supporting capabilities of IO. Public affairs (PA), civil military operations (CMO), and defense support to public diplomacy (DSPD) are the related capabilities of IO.

By using offensive and defensive tactics and techniques in a variety of combinations to shape, disrupt, and exploit adversarial use of the EMS while protecting friendly freedom of action in that spectrum, EW contributes to IO. While the reliance on the EMS extends for a wide range, this increases both the potential and the challenges of EW in IO. The increasing prevalence of wireless telephone and computer usage extends both the utility and threat of EW, and it should not be forgotten that the enemy has the same opportunities and EW should protect our own from similar exploitation [2].

Within the information operations (IO) construct, EW is an element of information warfare; more specifically, it is an element of offensive and defensive counter information. EW considerations must be coordinated into IO and fully integrated into operations in order to be effective. [1]

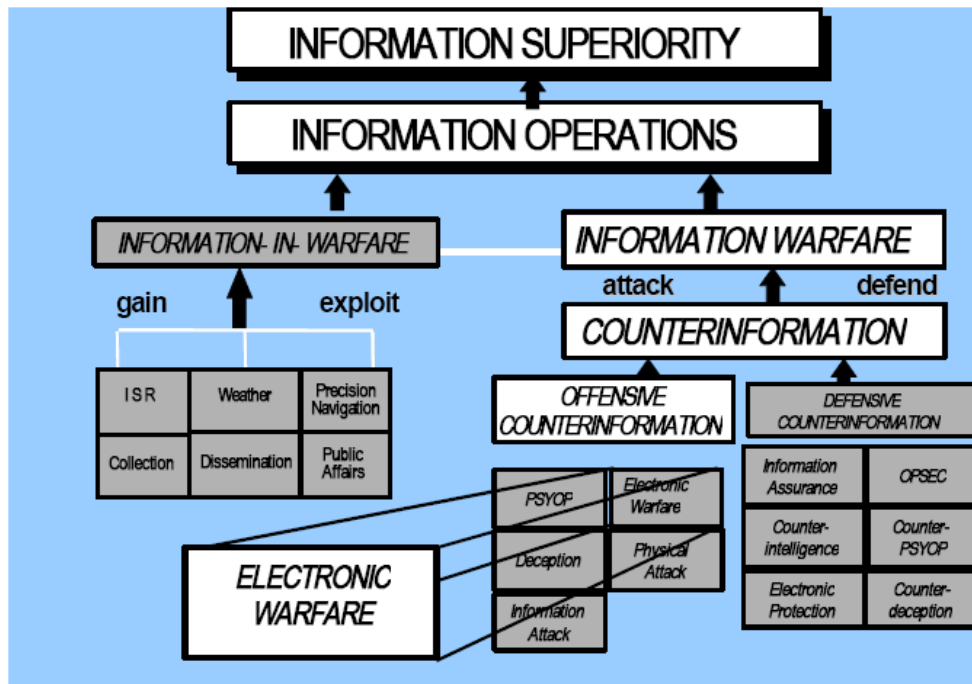

Figure 4. Electronic Warfare’s Relationship to Information Operations (IO) (From [1])

E. THE MAJOR ACTIVITIES PERFORMED IN EW

Put simply, the principal function of EW is to exploit the opportunities and vulnerabilities that the physics of electromagnetic energy dictate [6]. Table 1 shows the basic capabilities that are used in the realm of EW. To achieve the ultimate objective of the EW mission and the military campaign, these capabilities should be well-coordinated and integrated.

Table 1. The Principle Activities of Electronic Warfare (From [3])

1 EM Compatibility	9 Electronic Probing
2 EM Deception	10 Electronic Reconnaissance
3 EM Hardening	11 Electronic Intelligence
4 EM Interference	12 Electronics Security
5 EM Intrusion	13 Electronic Warfare Reprogramming
6 EM Jamming	14 Emission Control (EMCON)
7 EM Pulse	15 Spectrum Management

All of the activities above are explained in detail in Air Force Doctrine Document 2-5.1 and are summarized below.

Electromagnetic Compatibility (EMC) is the ability of systems that work throughout the EMS to operate in their intended operational environments without any degradation due to EM radiation or response. The application of sound EMS management—system, equipment, and device design configuration—ensures interference-free operation; clear concepts and doctrines that maximize operational effectiveness are considered EMC.

Electromagnetic Deception is the utilization of the electromagnetic spectrum to confuse or mislead an adversary. One objective of EW is to cause deception in decision-making processes through the use of the electromagnetic spectrum by the enemy, and to make it difficult to distinguish between reality and the perception of reality. Misleading and confusing the adversary’s electromagnetic sensors is one of the main methods for the accomplishment of the mission.

Electromagnetic Hardening. Filtering, attenuating, grounding, bonding, and shielding against undesirable effects of EM energy are the most commonly used actions taken to protect personnel, facilities, and equipment. This is considered EM hardening.

Electromagnetic Interference. Any EM disturbance that interrupts, obstructs, or degrades the effective performance of electronics or electrical equipment is considered **EMI**. This can be either induced intentionally, as in some forms of EW, or unintentionally, as a result of emissions, responses, and intermodulation products.

Electromagnetic Intrusion is the intentional insertion of EM energy into transmission paths in order to deceive operators or to confuse them.

Electromagnetic Jamming is used for reducing enemy EW capability by disrupting their use of the EMS with the intent of degrading the enemy's combat capability. Radiation, re-radiation, or reflections of EM energy for this purpose are some examples of EM Jamming.

Electromagnetic Pulse is a strong pulse, which causes damage to electrical or electronic systems by producing current and voltage surges.

Electronic Masking is a defensive measure in which radiation of EM energy on friendly frequencies is controlled in order to protect the emissions of friendly communications and electronic systems against ES measures or signals intelligence (SIGINT) of the adversary. One of the most difficult considerations in Electronic Masking is not causing any significant degradation in the operation of friendly systems.

Electronic Probing is intentional radiation applied to devices or systems of potential enemies to learn their functions and operational capabilities.

Electronic Reconnaissance is the detection, location, identification, and evaluation of foreign EM emissions.

Electronic Intelligence (ELINT) is the technical and geolocational intelligence that is collected from foreign EM emissions.

Electronics Security is used to keep unauthorized persons away from valuable information. This is a means of information protection that might be derived from the interception and study of non-communications EM radiations, e.g., radar.

Electronic Warfare Reprogramming, as the name indicates, is the deliberate alteration or modification of EW or target sensing systems (TSSs). This is done for validated changes in equipment, tactics, or the EME. Deliberate actions on the part of friendly, adversary, or third parties or may be brought about by EMI, or other inadvertent phenomena can be the reason for these modifications and alterations. The purpose of this action is to maintain the effectiveness of EW equipment according to the changing EME. Changes to self-defense systems, offensive weapons systems, and intelligence collection systems are also included in EW reprogramming.

Emission Control (EMCON) is the selective and controlled use of EM, acoustic, or other emitters by minimizing the use of the systems, to protect them from countermeasures and optimize C2 capabilities for the security of the mission. There are different types of EMCON that dictates which equipment to use throughout the operation. When the security of the operations increases, higher levels of EMCON restricts the duration and use of more equipment.

Spectrum Management involves planning, coordinating, and managing use of the EMS through operational, engineering, and administrative procedures. The main objective of spectrum management is to enable electronic systems to work in harmony without any interference with each other [1].

III. HISTORY OF EW

Contrary to common perceptions, the history of electronic warfare actually begins earlier than the Second World War. In fact, we can see the use of electronic warfare as early as 1861 in the U.S. Civil War. After the invention of the telegraph by Samuel F.B. Morse in 1837, telegraphy became the primary means of communication; overland cables became widespread. With the coming of the Civil War in 1861, therefore, telegraph wires became one of the most important targets for cavalry. Because Union forces used the telegraph extensively, they had more problems with these cavalry raids than the Confederate forces. Confederate cavalry switched military telegraph traffic to the wrong destinations, transmitted false orders to Union commanders, and cut the wires to deny information to Union forces [10]. The cavalry of both sides tried to disrupt the other side's ability to employ effective communication. These tactics are the first examples of signals intelligence, jamming, and deception [12].

Strictly speaking, the above is not an example of electronic warfare (since the telegraph does not radiate electromagnetic energy). However, it is important to understand these early counter-C3I (command, control, communications, and intelligence) tactics as they relate to modern EW techniques.

A. BEFORE AND DURING THE FIRST WORLD WAR

In 1897, Guglielmo Marconi sent and received wireless radio frequency signals over a distance of more than two miles. In 1899, Marconi increased the transmission distance to 89 miles [11]. With this increased range, radio use became practical for marine communications. EW employment followed almost immediately. Surprisingly, deliberate jamming was first used for civilian purposes during the America's Cup yacht races in 1901 in the United States. In September 1901, Marconi made a contract with Associated Press to provide radio coverage of the race. The Wireless Telegraph Company of America also secured a contract. The American Wireless Telephone and Telegraph Co. couldn't find a sponsor. They decided to exploit the situation and used a more powerful

transmitter than the other companies. John Pickard, who was one of American Wireless Telephone and Telegraph Co.'s engineers, found a way to jam signals from the other companies by overpowering them with the stronger signal, leaving AWT&T as the only company able to pass accurate reports on the races [11].

Shortly thereafter, the British initiated the first intentional use of radio jamming. This happened in 1902 during the Royal Navy's fleet exercises in the Mediterranean. The U.S. Navy first used EW in 1903 during their maneuvers [10]. In the Russo-Japanese War (1904–1905), the Russians used radio jamming to obtain tactical advantage. This war is significant for being the first war in which both sides used radio. During the Port Arthur bombardment, Russian operators heard Japanese signals and used a spark transmitter to jam. Hence, damage and casualties sustained by Russian forces were much lower than they could have been.

From 1905 to 1914, there were significant improvements in Wireless Telegraphy (WT) systems; the transmission distance was increased. Bandwidth requirements were reduced, thereby accommodating more discrete channels. Mutual interference was also reduced. Transmitter and receiver technology was advanced with improved reception capability. WT was placed into aircraft, a milestone in air-ground communications [10]. In 1906, the U.S. Navy installed the first direction finder (DF) onto a ship for testing; it had a limited capability [10].

In World War I, many nations deployed radio jamming. At the beginning of 1915, the Royal Navy built a chain of DF stations along the east coast of England for the purpose of locating ships or aircraft by their bearing [10].

Air-ground communications played a big role during World War I, primarily in support of reconnaissance. There was little deliberate jamming; most of the jamming was because of friendly aircraft flying too closely together [12].

The importance of encrypting a message was better understood after the German victory over the Russians at Tannenberg. Russian headquarters were not using encrypted communications, permitting interception by the Germans. Knowing the enemy's next

moves provided an advantage to the Germans, and contributed to a crushing Russian defeat [11]. At sea, German U-boats created difficulties for Allied ships. Allied wireless intelligence was used to counter this. However, tracking German submarines was not easy. After the U.S. Navy installed wireless DF for anti-submarine warfare, the Allied wireless intelligence service was able to track almost all German submarines around the world. The Germans minimized their communications traffic, but this proved ineffective against Allied forces [11].

B. FROM 1919 TO THE END OF SECOND WORLD WAR

Between the two world wars, significant developments took place in electronic engineering. Improvements in radio navigation aids and radar allowed them to play major roles in WWII. EW became more important because of these new technologies [11]. Scientists found new ways of reception and transmission in the higher frequencies. RT systems became smaller and lighter and began to be used in short-range communications. After World War I, the U.S. Naval Research Laboratory (NRL) worked on intercommunications between ships, aircraft, and ground units. In 1926, NRL focused on avoiding enemy detection and detecting enemy transmissions, creating interference for the enemy.

In the early 1930s, we see the initial development of Radio Detection and Ranging (RADAR) [10]. NRL developed an “interference detector” which was able to detect signals in 1932; they increased the range to 50 miles by 1934. Great Britain and Germany were working on the same technology. In 1935, the British detected an aircraft at 17 miles with pulsed radar operating at 11 MHz, and in 1936 they extended the range to 75 miles. The Germans detected an aircraft at 12 miles with radar operating at 600 MHz. The U.S. used a 200 MHz XAF radar to detect an aircraft at 100 miles and ships at 15 miles.

After noting these improvements in radar technology, experts started to try to deny or defeat radar. The first airborne jamming test was performed in London, using a continuous wave transmitter. Soon thereafter, the British placed anti-jamming technology

into the Chain Home radar systems along the coast of England. The Chain Home was the first operational air defense radar system in the world. “These anti-jamming systems were the first examples of electronic counter counter-measures (ECCM).” [10]

The first use of airborne electronic intelligence (ELINT) took place in 1939. The German Graf Zeppelin performed an ELINT mission while flying over the east coast of England. It intercepted, recorded, and assessed the potential radiation threat to the German Air Force.

The outbreak of World War II found the U.S. experimenting with and developing new equipment: radars, high frequency direction finding (HFDF) systems, and anti-jamming devices.

“1940 was the year of the ‘Battle of the Beams’ for Germany and the United Kingdom (UK). Using radio navigation systems, one of which was called Knickebein, the Germans acquired an accurate night bombing capability over ranges of up to 200 nautical miles (NM). This was a development originally generated using the German Lorenz Company’s “blind approach” navigation system.” Pilots navigated by using the dots and dashes that were created by two different transmitters. Following the overlapping dashes and dots, pilots were able to navigate accurately at night and under instrument meteorological conditions (IMC). The British made some modifications to their systems and were able to jam the Lorenz Beams, thus severely reducing German nighttime bombing accuracy. After this event, they came up with “Y” radio monitoring stations and integrated countermeasures into them. The British survived a potentially devastating German advantage through early recognition of the Lorenz system and using the correct measures against it.

Following this, the British developed the *Mandrel*. This was an airborne radar noise jammer. It was developed to counter *Freya* radars, which were used for early warning against the British by Germany. The *Freya* was used to determine formation size and range information.

Following 1944, programs in the U.S., Great Britain, Japan, Germany, and the Soviet Union placed radar on aircraft. In Europe, the frequency range of Freya radars was increased and its jamming susceptibility was reduced by spreading its power to degrade the effectiveness of *Mandrel*. “At this point, a new kind of counter-measure against radar came into play: chaff, or “window” as the British called it (the German’s referred to it as ‘duppel’).” [11] Chaff is basically narrow metallic strips of various lengths and frequency responses designed to act as tiny reflectors. Like an anti-radar smoke screen that masks a target, chaff deceives enemy radar systems. It is a half-wave dipole that causes the radar signal to reflect back to the source; thus, it creates an echo that deceives or hides the target. Chaff was extremely effective against German radars [11].

Chaff was released in bundles. When these opened in the air, they caused false target echoes. The dispersion of the chaff depended upon altitude, weather, and speed. “EW became a cat-and-mouse game as the pendulum swung from EP to EA and back to EA.” [12] It was a constant game of measures (EM), countermeasures (ECM), and counter-countermeasures (ECCM).



Figure 5. A 1941 RAF PRU photograph of the two Freyas at Auderville

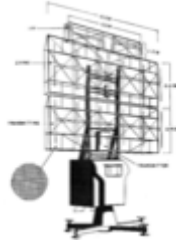

Figure 6. A Limber Freya Radar

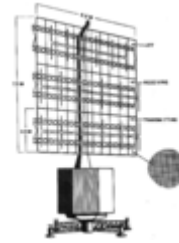

Figure 7. A Pole Freya Radar

EW was also employed in the Pacific after the end of the war in Europe, but there were no real major developments.

C. FROM 1946 TO THE FIRST GULF WAR

The most significant advances in electronic warfare occurred after the Second World War.

After World War II, development of the U.S. electronic attack slowed until the beginning of the Cold War. As the Soviet threat grew, the U.S. had to know its enemy. Americans started working on their electronic intelligence (ELINT) capabilities [12].

1. Korean War (1950–1953) to Vietnam

The U.S. flew 100 B-29 Superfortress heavy bomber aircraft during the Korean War. The North Korean Air Force had nothing to counter them with until China joined North Korea and brought MiG-15 jet fighters with them, deployed to airfields in nearby Manchuria. North Korea also used early-warning radars and radar-controlled anti-aircraft-artillery (AAA). The U.S. didn't use chaff against these systems or jam the fighter communications frequencies because they wanted to keep their EW capabilities as a secret for potential use against the Soviet Union. U.S. forces were allowed to use only spot jamming for the AAA fire-control radars. After the U.S. lost a large number of aircraft, they started deploying chaff and channel jamming [11]. After this, the U.S. understood the importance of EW-trained crew members, who began to be considered as part of operational requirements.

In the early 1950s, Russia built the first surface-to-air missile (SAM) system, the SA-1 Guild. The SA-2 Guideline quickly followed. Airborne EW systems were used to reduce the effectiveness of SAMs. More modern and capable aircraft were being used for Electronic Intelligence (ELINT) missions. The largest U.S. ELINT aircraft of the period was the Convair RB-36, pictured below, which was equipped with a comprehensive EW suite.



Figure 8. RB-36D (From [13])

The RB-36D was a reconnaissance version of the B-36D. The No. 1 (forward) bomb bay was fitted with 14 cameras. The No. 2 bay was used to carry up to 80 100-pound photo flash bombs for nighttime aerial photography. The third bay could be equipped with a variety of additional equipment, including a 3,000-gallon fuel cell for increasing the endurance of the aircraft. The last bay was equipped with electronic counter measures gear. Externally, the RB-36D was similar to the B-36D bomber version; however, the reconnaissance version had many more antennas and four large radomes. [13]

By the early 1950s, the U.S. started to use the U-2 aircraft for collecting intelligence and analyzing the Soviet threats. The Lockheed Skunkworks CL-282 aircraft was approved for production by the CIA, under the code-name AQUATONE, with Richard M. Bissell as the CIA program manager. President Dwight D. Eisenhower authorized Operation OVERFLIGHT [14].



Figure 9. U-2 "Dragon Lady" (From[15])

The Lockheed U-2, Dragon Lady, is a single-engine, high-altitude aircraft flown by the United States Air Force. It provides day and night, high-altitude (70,000 ft/21,000 m plus), all-weather surveillance. The aircraft is also used for electronic sensor research and development, satellite calibration, and satellite data validation. The U-2 made its first flight in August 1955, with famed Lockheed test pilot Tony LeVier at the controls, and began operational service in 1956.

By late 1957, Adana AB (renamed Incirlik AB on 28 February 1958) had become the main U-2 operating location, having absorbed the resources of a unit in Germany. One of the tasks the unit performed involved flying over missile sites in the Soviet Union from forward operating locations at Lahore and Peshawar in Pakistan. For every mission that penetrated Soviet airspace, there was at least one surveillance flight along the border to divert Soviet air defense attention from the intruder. These diversionary flights typically departed Adana AB traveling over Van (in eastern Turkey), Iran, and the southern Caspian Sea to the Pakistan-Afghanistan border; they returned along a similar route. These periphery missions usually collected communications and electronic signals instead of photographic imagery. The U-2 operation continued at the base for several years in the utmost secrecy, until 1 May 1960. A U-2, piloted by Gary Powers, was on a photo run at 67,000 feet when the Soviets launched an SA-2. Although the SA-2s could not achieve the same altitude as the U-2, the aircraft disintegrated in the shock waves caused by the exploding

missiles. Soviet authorities subsequently arrested Powers after he successfully ejected from the plane, and held him on espionage charges for nearly 2 years. [14]

U-2s not only photographed military and industrial installations but also collected signals intelligence (SIGINT) on operating radars. The intelligence collected by U-2s was very valuable because it could help determine characteristics of the enemy emitters and even defense system structure. U-2s collected the following intelligence [16]:

- • The frequency of the enemy emitter
- • The rate at which a radar beam can be made to scan through an aircraft.
- • The rate at which the radar pulses are transmitted.
- • Time width of the radar pulses
- • Signals

In October 1952, the Strategic Air Command issued requirements for an air-launched decoy that could be carried by its Boeing B-52 Stratofortress bombers (then under development) and released just prior to penetrating enemy airspace. This would be used to confuse an enemy's defensive radar network, providing radars with a false target that had the identical radar image of the B-52 and would fly at approximately the same speed and altitude. Enemy defensive resources would be diverted from at least some of the "real" B-52s, increasing their chances of completing their bombing missions successfully [17].



The Quail was a bomber-launched decoy missile of the USAF, designed to appear on the enemy's radar screens as additional bombers, and thus confuse and degrade the air-defense system

Figure 10. ADM-20 "QUAIL" MISSILE (From[18])

In 1955, the USAF started a major development effort for these decoy missiles. The projects included the GAM-71 Buck Duck (a rocket-powered air-launched vehicle to be carried by the B-36 Peacemaker), the SM-73 Bull Goose (a ground-launched long-range jet-powered decoy), and the GAM-72 Green Quail, a turbojet-powered air-launched decoy for internal carriage by B-52s. In February 1956, McDonnell was the prime contractor for the GAM-72, whose name was shortened to Quail. In July 1957, they started the tests, and in November 1957 they flew the first free glide flight of an XGAM-72 prototype. In August 1958, the first successful powered flight occurred. By September 1960, the USAF received its first production Quails, and in February 1961, the first B-52 squadron with Quail decoys was operational [19].

The development of EW was stimulated by the military competition between the U.S. and the Soviet Union, and served a role in maintaining a critical balance of mutual deterrence. [11]

In the late 1950s, space became the newest playground for the EW world. On October 4, 1957, the Russians jump-started the "Space Race" by launching Sputnik, the first space satellite. The U.S. Moonbounce program collected radiation from Soviet

radars after it was reflected from the surface of the moon and back to the Earth. A number of these observations were able to provide useful intelligence to the U.S. [20].

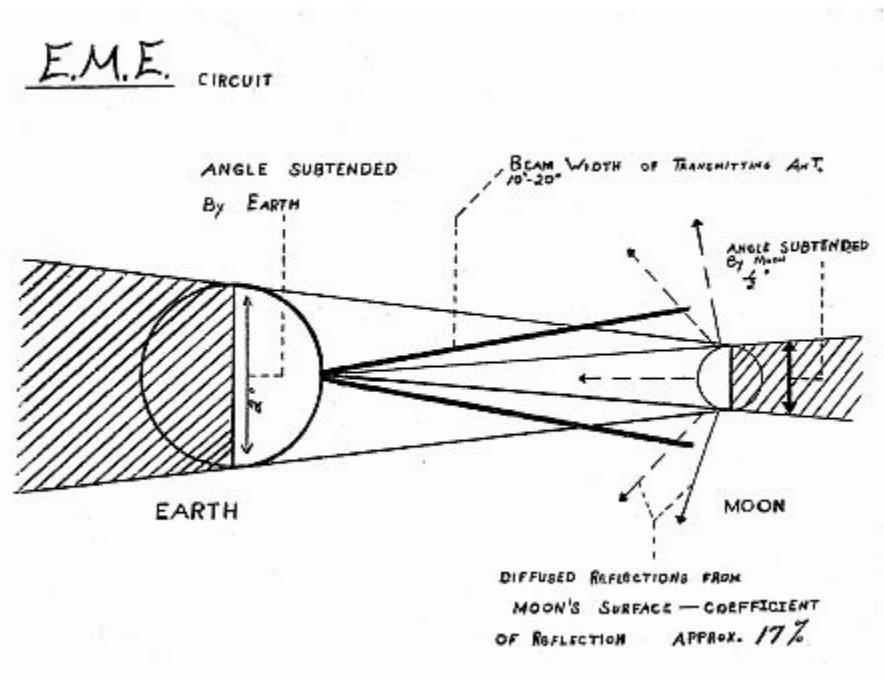

Figure 11. Studies from “Operation Moonbounce” (EME path losses) (From[20])

2. Vietnam War Era (1962–1975)

The Vietnam War was a period when many of the advances and innovations in tactics and technology took place. After the South Vietnamese military and political situation deteriorated, U.S. support and involvement in operations increased. All air operations came under U.S. control. Meanwhile, the U.S. was trying to keep the Soviet Union and China out of the conflict and at the same time to reduce any adverse public opinion.

SA-2s were the first SAMs sighted in Vietnam. This system had proven itself (after the May 1960 shutdown of Gary Powers and similar downing of Major Rudolph Anderson’s U-2 over Cuba in 1962) very effective against high flying threats. The V-75 (SA-2) surface-to-air missile system was designed for the defense of both fixed targets and field forces. The V-75 was designed to cope with the threat posed by small groups of

aircraft rather than massed raids. Flexibility and mobility are its chief advantages. It is intended for defeat of manned and pilotless air attack weapons at altitudes ranging from 300 feet to 60,000 feet, at speeds of up to 3000 km/h and ranges up to 27 nm [21].



Figure 12. SA-2 (V-750VK Dvina) (From[22])

Range: Minimum 5 miles; maximum effective range about 19 miles; maximum slant range 27miles

Ceiling: Up to 60,000 ft. **Warhead:** 288-lb. blast-fragmentation **Speed:** Mach 3.5

Due to the introduction of SA-2s into Vietnam, the U.S. changed tactics. Aircraft were forced to fly at lower altitudes where AAA was more effective. The Americans lost many aircraft due to AAA and ground fire. In addition to the SA-2s, the North Vietnamese had 200 early-warning and ground-controlled interception (GCI) radars, and around 2,000 AAA in their inventory [11]. The solution against the SAM threat was partly solved by anti-SAM aircraft missions. These aircraft, whose sole mission would be to kill the SAM sites, were equipped with radar homing and warning (RHAW) sets. The name of this project was “Project Weasel or Wild Weasel 1” [23].

The first RHAW sets, designated the AN/APR 25, were put into F-100F Super Sabre aircraft. This new equipment would allow the aircrew to get a bearing on a SAM when it turned on its radar. The equipment suite also had a launch warning detector function, which would alert the aircrew when a SAM was launched.



AN/APR-25(V) strobe display scope (Applied Technology Inc., Palo Alto, California). Part of the RHAW system. Gun tracking radar signal detecting and homing, Works in S-, X- and C-band radar

Figure 13. AN/APR-25(V) Strobe Display Scope (From[24])

There were new fighter aircrew personnel for the new "Weasel" aircraft. They were called Electronic Warfare Officers (EWOs), and were also known as "Bears," or "GIB" (Guy In the Back). The EWO was responsible for monitoring the new radar location sets and locating the SAM sites—basically acting as the eyes and ears of the aircraft for the pilot. The EWOs were chosen from among B-52 crews and the training began in October 1965 at Eglin Air Force Base in Florida. In early November 1965, they deployed to Korat Air Base in Thailand to begin their Wild Weasel missions.



Figure 14. F-100F (First Wild Weasel Aircraft) (From[25])

Wild Weasel 1 began with five F-100F aircraft and five aircrews. The Weasel crews began their missions in December 1965. The equipment and tactics were new to the pilots and EWOs. They flew in hunter/killer teams, the Weasel aircraft flying in formation with F-105D fighter/bombers. The Weasels would mark the SAM site, and the F-105D's would finish it off. They attacked with rockets, napalm, cannon and, beginning in March 1966, with Texas instruments AGM-45 *Shrike* Anti-Radiation Missiles (ARM). The Shrike missile was a short range, passive missile, which locked on to the signals emanating from the SAM's radar to guide it to its target.



Figure 15. AGM-45 (From[26])

On December 22, 1965, the Wild Weasels killed the first SAM in North Vietnam. After this success, the importance of the Weasels became evident, and from then on the Wild Weasels were in Vietnam to stay. However, despite this early success the Weasels suffered a fifty-percent casualty rate and it was clear that they needed to develop new tactics and equipment.

It became clear during the Weasel missions that the Super Sabre was not fast enough or ideally suited to the mission. The F-100F could not keep up with F-105D fighter-bombers. Therefore, the Air Force decided to use an F-105 Thunderchief variant for Wild Weasel missions. In July 1966, the F-100Fs flew their last missions. They were then replaced by the F-105 Thunderchief, which served as the primary Wild Weasel aircraft until the end of the Vietnam War.



Figure 16. F-105 Thunderchief “THUD” (From[27])

The F-105 conducted over 75% of the USAF bombing strikes during the war. The Thunderchief was faster, more agile, carried more ordnance, and was considerably more durable than the F-100F. In May 1966, the new F-105F Weasels were deployed to Vietnam. It was obvious that the F-105F was a much better aircraft for these missions.

In the beginning of 1967, the U.S. introduced a new version of the Thunderchief, the F-105G Wild Weasel. This upgraded aircraft was equipped with advanced avionics and greater weapons capabilities. The AN/APR-25 RHAW was replaced by an upgraded version, and the AGM-45 Shrike missile was augmented with the AGM-78. The AGM-78 Standard anti-radiation missile had an improved seeker head and a better range; this gave Weasel pilots much improved standoff capability. It was good news for Wild Weasels—new developments were making their jobs a little easier [23].



Figure 17. AGM-78 (From [28])

Nearing the end of the war, the U.S. conducted a series of bombing missions from 18 December to 29 December 1972. This was called Linebacker II, which was a joint U.S. Seventh Air Force and U.S. Navy Task Force 77 aerial bombardment campaign. The internal EW suites provided self protection when bombing from high altitude. During the bombardment, F-105G Wild Weasels and General Dynamics F-111s attacked the North Vietnamese SAM sites and airfields while EB-66s provided stand-off jamming. Linebacker II was proof that “a powerful barrage of electronic jamming, combined with vast quantities of chaff and carefully evolved anti-missile tactics backed by Wild Weasel attacks on the launching sites could reduce the effectiveness of the air defense system (ADS).” [16]

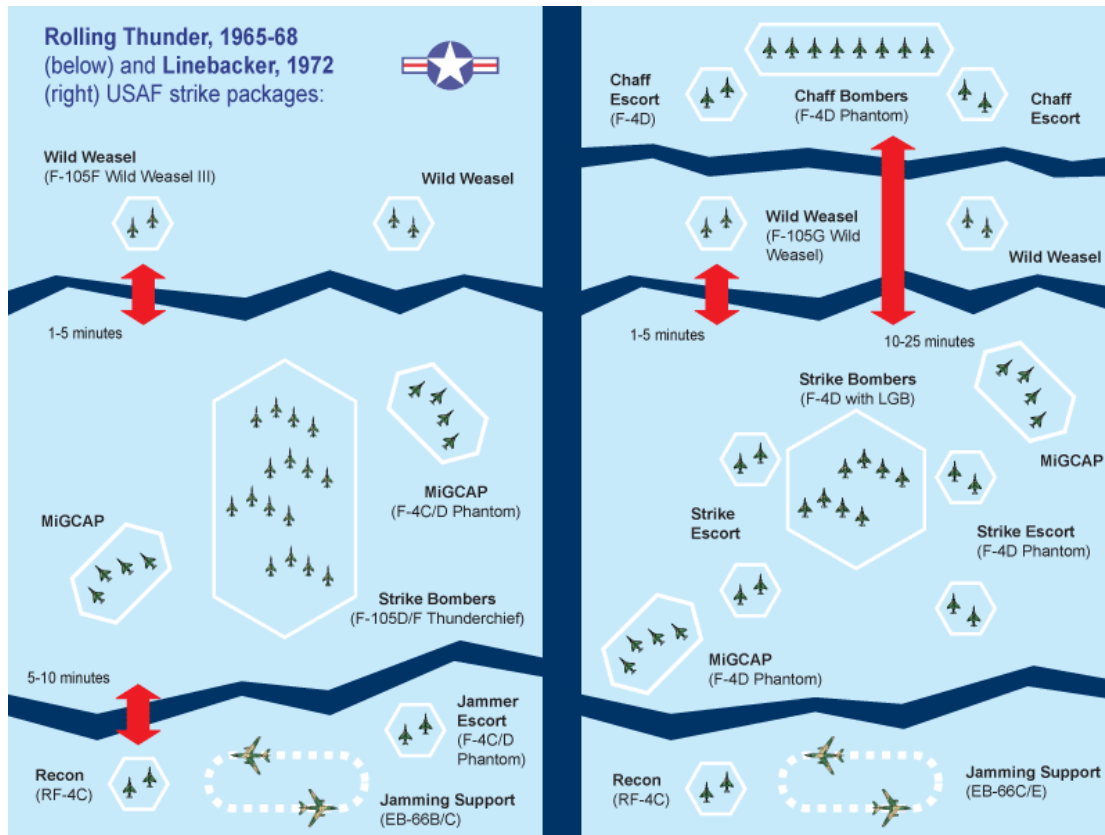

Figure 18. “Rolling Thunder” and “Linebacker” (From[31])

This graphic shows the protection for Rolling Thunder and Linebacker-era strikes. Note the increase in support forces to defend fewer bombers

The loss rate was significantly reduced by the coordination of effective tactics with electronic warfare techniques. “Along with the development of the Wild Weasels, the U.S. also introduced the first tactical jamming pods to be fitted on fighter-bomber aircraft. These new technologies, such as the Quick Reaction Capability (QRC)-160 pods, and later the AN/ALQ-87 family of communication and radar jamming pods, provided protection to tactical aircraft beginning in 1965.” [29] QRC-160 pods would fill the enemy radar scopes with strobe lines, making it very difficult to lock the targets. However, the pods had some restrictions. The pods broadcast jamming into a cone beneath the aircraft so that hard maneuvers would point the cone away from SAMs and make the plane a clear, hard target in the sky.

Placing all the bombers into a special 'jamming cell' formation made the jamming even more effective, but in this case the formation would be more vulnerable to MIG attacks [30].

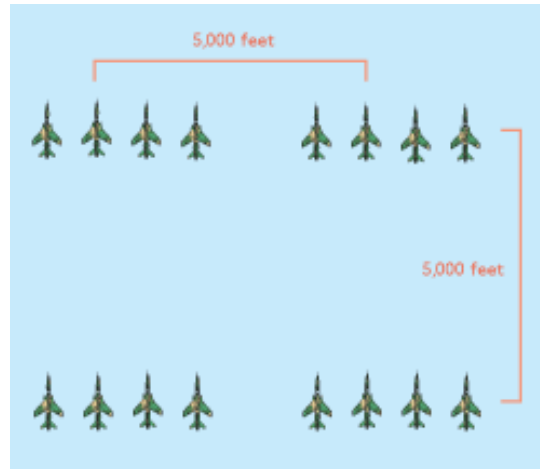

Figure 19. Line-abreast jamming cell formation (From [31])

This illustration shows a typical line-abreast jamming cell formation used by the 388th Tactical Fighter Wing in Operation Rolling Thunder. SAMs would tend to aim for the space between the four flights of aircraft and explode harmlessly

Chaff remained one of the most important protection devices for the USAF, and was widely used in the Vietnam War. For example, eight aircraft could lay a 'chaff corridor' 5 miles wide by 30 or 100 miles long, like a carpet. Aircraft flying in or just above this carpet of chaff were masked from radar beams for a fifteen-minute window. With standoff jammers, jamming pods, beacon jamming and chaff combined, raids were largely safe from the ground defenses.

Chaff was so effective that the Vietnamese MiGs started to attack the chaff-laying flights and escort protection for them became a priority. The chaffers adopted several strategies, as illustrated below [30].

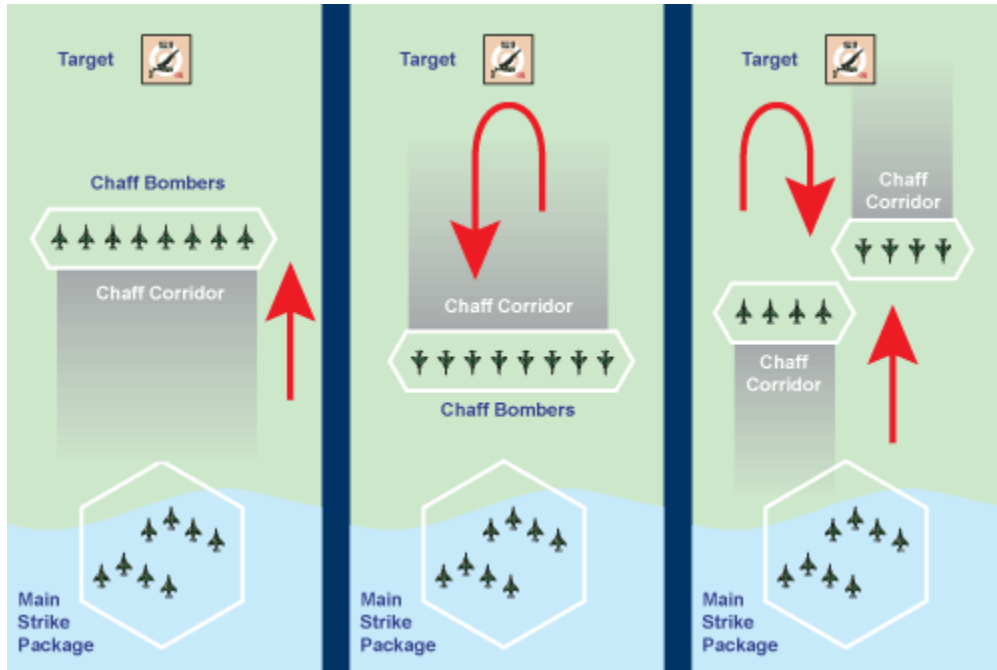

Figure 20. Different methods of chaff delivery (From [31])

There are many more lessons learned from the Vietnam War with regard to EW:

- Effective EW capability is crucial for air operations and aircraft survivability in a well-integrated and effective enemy air defense environment. Wild Weasel aircraft, RHAW systems and jamming pods provided the proof of this assertion. Combining airborne surveillance and control, air defense, attack, EW, and reconnaissance aircraft in tightly coordinated strike packages was essential to attacks on heavily defended targets in Vietnam.
- It was a clear message to the world that proliferation of airborne EW systems, realistic EW training, and an escalating air defense threat was gaining importance in battles [29].

3. Yom Kippur (1973) and the Bekaa Valley (1982)

Six years after the 1967 Six Day War, in October 1973, Syria and Egypt combined to attack Israel to recapture the territory they lost. High altitude SA-2 and SA-3 systems were known by the Israelis, but SA-6 systems, which were deployed by the Soviets to the region, were fairly new to the Israeli pilots. The SA-6 GAINFUL was a two stage, solid-fuel, low-altitude SAM. It used radio command guidance with semi-

active radar terminal homing. It was more accurate and more jam resistant than the older SAM systems. This system was extremely flexible [32]. Since the SA-6 was used in this conflict for the first time in combat, no one knew anything about this new threat and there had not been enough opportunity to properly prepare electronic warfare systems to counter it.



Figure 21. SA-6 GAINFUL (From [34])

The ZSU 23-4 anti-aircraft gun system was used to complement SA-6 systems against aircraft attacks from low altitude. The SA-7 GRAIL (Strela-2), an IR-guided MANPAD, was also used to fill the gaps in the defense system [33]. The SA-7 man-portable, shoulder-fired, low-altitude SAM system was similar to the U.S. Army REDEYE, with a high explosive warhead and passive infrared homing guidance. It was effective against helicopters and slower aircraft. Because of these new defense systems, the Israelis initially suffered heavy losses—more than 80 aircraft in the first week of the war, and more were damaged [16]. This is evidence of the importance of secrecy regarding equipment that can surprise an enemy. An adversary is then left defenseless against your new weapon, without the opportunity to develop counter measures against this new threat.



Figure 22. ZSU-23-4 Shilka 23mm Antiaircraft Gun (From[36])

The *Shilka* ZSU-23-4 [ZSU = *Zenitnaya Samokhodnaya Ustanovka* - Anti-aircraft Self-Propelled Gun] is a Self-Propelled Anti-Aircraft Gun (SPAAG) featuring a prominent radar dish that can be folded down mounted on a modified PT-76 chassis. The ZSU 23-4 Shilka is capable of acquiring, tracking and engaging low-flying aircraft (as well as mobile ground targets) while either in place or on the move. Employed in pairs 200 meters apart, 400 meters behind battalion leading elements, it is commonly used to suppress ATGM launch sites, such as TOW vehicles. The armament consists of four 23mm cannon with a maximum slant range of 3,000 meters [35].



Figure 23. SA-7 GRAIL (From [37])

The SA-7a (9K32 Strela-2) was introduced for service in 1968, but was soon replaced by the SA-7b (9K32M Strela-2M), which became the most common production model. The SA-7b differs from the SA-7a primarily by using a boosted propellant charge to increase range and speed. The SA-7a had a slant range of 3.6 km and a kill zone between 15 and 1500 meters in altitude, with a speed of about 430 meters per second (Mach 1.4). The SA-7b has a slant range of about 4.2 km, a ceiling of about 2300 meters, and a speed of about 500 meters per second (Mach 1.75). Both the SA-7a and SA-7b are tail-chase missile systems, and its effectiveness depends on its ability to lock onto the heat source of low-flying fixed- and rotary-wing aircraft targets [33].

After this painful experience, Israel invested heavily in C3I and EW systems; airborne, rocket and artillery propelled defense suppression weapons; intelligence gathering; planning; and training.

In 1982, these investments paid off during the conflict with Syria. “The Bekaa Valley (Lebanon) air battle of June 1982 is widely regarded as a significant development in modern warfare. The Israeli Air Force (IAF) achieved a remarkable military victory, and certainly there are lessons to be learned from it.” [38].

Palestinian terrorists made an assassination attempt against the Israeli ambassador in London on 3 June 1982. The next day, Israel attacked Palestine Liberation Organization bases in Lebanon with aircraft, and on 6 June ground forces started marching toward Beirut. The Syrians tried to use their air force for defense against Israeli ground and air attacks.

One of the biggest Syrian mistakes was that they hadn't changed the location of their mobile SAM (SA-6 Gainful) systems for almost one year. Israel was prepared, and executed a well-planned and pre-rehearsed attack against the Bekaa Valley integrated air defense system (IADS). Because of this error, Israel had all the information about the Syrian IADS: exact location of the SAM, radar, communications infrastructure and also their electronic fingerprints. Israel possessed thorough electronic and location intelligence. In the first attack against the Bekaa on 9 June 1982, the IAF destroyed 17 of the 19 Syrian SAM batteries and their radar sites, as well as 29 Syrian Air Force (SAF) fighter aircraft. The day after, the IAF destroyed the remaining missile batteries. By the end of July, Syria had lost at least 87 aircraft, while Israeli lost just a few helicopters, one RF-4E, and an A-4 Skyhawk [38].

IAF tactics included flying remote piloted vehicles (RPV) in simulated attack profiles and radar signatures, deceiving the Syrian IADS. While the Syrians were reloading their weapons, Israeli long-range artillery and rocket systems attacked SAM sites, and soon thereafter, aircraft attacked the early warning and fire control radars with AGM-45 Shrikes, AGM-78 Standard-ARMs, and AGM-65 Mavericks. During these

attacks, the IAF successfully employed jamming and chaff against the Syrian radar operators and air-to-ground and air-to-air communications [11].

Obviously, the IAF possessed air superiority and a qualitative advantage over the SAF. During the Lebanon War, Syrian pilots flew MiG-21s, MiG-23s and Su-20s. The Israelis, on the other hand, had the best fighters then available: McDonnell Douglas F-15s and General Dynamics F-16s, along with older, upgraded, and still effective McDonnell Douglas F-4s and Israeli Aircraft Industries Kfir. The IAF armed their aircraft with U.S.-made AIM-7F Sparrow radar-guided missiles and AIM-9L Sidewinder infrared-guided missiles. The Syrians had no comparable ordnance, relying instead on the 1960s vintage AA-2 "Atoll."

Furthermore, the Israelis had progressed in command, control, and communications (C³). The Bekaa Valley battle was the first war in which modern airborne warning and control system (AWACS) aircraft were used, specifically the U.S.-made Grumman E-2C Hawkeye. As an airborne radar platform, the Hawkeye had the capability to monitor over 200 aircraft simultaneously and control up to 130 separate air-to-air engagements at ranges up to 250 miles. In addition, the E-2C carried an ALR-59 passive detection system that could pick up radar signals from 500 miles. F-15s, with a superior planar array radar system, were also used as a "mini-AWACS" to help manage air-to-air engagements [38].

The IAF jammed Syrian C3 using modified Boeing 707s. These aircraft were equipped with standoff jammers capable of disrupting several enemy frequencies at once with very little out-of-phase disturbance, thereby minimizing self-jamming of frequencies used by the IDF. With the effective jamming of Syrian communications and radar systems, SAF aircraft found themselves in a chaotic situation.

The Israelis demonstrated a good capability of preservation of their own C3 against electronic countermeasures (ECM). For the protection of communications from Syrian interference, the IDF developed a very high frequency (VHF) FM radio system that changed radio frequencies across a 30 to 88 megahertz (MHz) band.

As mentioned earlier, RPVs also played an important role, especially in the initial phase of the war. This innovation made a strong contribution toward the Israeli victory. These drone aircraft served as cheap and survivable intelligence platforms. They also used “real-time” video intelligence systems. “Once the tactical reconnaissance and deception functions were completed and strike aircraft were directed to the SAM sites, air-launched laser-guided ordnance was guided to the target by laser designators mounted on the RPVs.” [39]

The Bekaa Valley battle clearly demonstrates the importance of electronic warfare and C3. The general concept for today’s battles is to control the air first. In order to win the air battle, one must first conquer the electromagnetic spectrum. This electronic warfare requirement was aptly demonstrated during the Bekaa Valley campaign [38].

a. Aircraft and Missiles Used in Bekaa Valley Battle



Figure 24. F-15 “EAGLE”



Figure 25. F-16 "FALCON"



Figure 26. AIM-7 "SPARROW"



Figure 27. SU-20 "FITTER"



Figure 28. E-2C "HAWKEYE"



Figure 29. F-4 "PHANTOM"



Figure 30. MIG-21 "FISHBED"



Figure 31. AIM-9L "SIDEWINDER"



Figure 32. AA-2 "ATOLL"

4. The First Gulf War (Operation DESERT STORM)

The Persian Gulf War or Gulf War (2 August 1990–28 February 1991) [40] was a conflict between Iraq and a coalition force from 34 nations authorized by the United Nations (UN). Members of the Coalition included Afghanistan, Argentina, Australia, Bahrain, Bangladesh, Belgium, Canada, Czechoslovakia, Denmark, Egypt, France, Greece, Honduras, Hungary, Italy, Kuwait, Morocco, Netherlands, New Zealand, Niger, Norway, Oman, Pakistan, Philippines, Poland, Portugal, Qatar, Romania, Saudi Arabia, Senegal, South Korea, Spain, Syria, Turkey, United Arab Emirates, United Kingdom, and the United States of America. Germany and Japan provided financial assistance. India extended military support to the United States in the form of refueling facilities situated in the Arabian Sea [40] [41].

The main aim was to return Kuwait to the control of the Emir of Kuwait after the invasion of Kuwait by Iraqi troops. The expulsion of Iraqi troops from Kuwait started in January 1991 and victory for the coalition forces came in 7 weeks.

The Gulf War has demonstrated yet again the central importance of electronic warfare to the conduct of a modern air war. So overwhelming was the weight of the initial attack, that the Iraqi IADS (integrated air defence system) collapsed in hours, never to regain anything approaching a semblance of functionality. The destruction of Iraq's IADS is a very good study of contemporary Western doctrine in the area of electronic combat, and deserves thus a close examination. [42]

First of all, it is a good idea to walk through the Iraqi air defense system. The Iraqis had 17,000 SAMs, 10,000 AAA and a wide variety of communications links [43]. During DESERT STORM “Organisationally the IADS was split into three principal elements, a national fixed site strategic system using fighters and SA-2 and SA-3 systems covering key airfields and strategic air defence sites, operated by the Iraqi air force. This system was supplemented by Republican Guard operated SAM and AAA systems

covering key nuclear, biological and chemical warfare facilities. Finally, the Iraqi army had its own mobile radar, SAM and AAA systems tasked with protecting both fixed sites and units in the field.” [42]

The SA-2 is an older system that was used during the Vietnam War. It was known to be susceptible to countermeasures and needed to be supported with some newer systems. ECCM measures were added as a priority. The fire control radar of the SA-2 was upgraded. The Fan Song E used a LORO (Lobe On Receive Only) technique, with auxiliary transmit antennas, and the Fan Song F used auxiliary optical angle tracking. The SA-2s used P-12 and P-12M Spoon Rest low PRF MTI acquisition radars.

For air defense aircraft, the Iraqis used the MiG-23, MiG-25, and the MiG-29. In total, Iraqi forces had 550 aircraft including Soviet Tu-16 and Tu-22 medium bombers, the more modern Su-25 Frogfoot attack aircraft, a core of MiG-21 fighters, and a few long-range Su-24 fighter bombers [43].

The SA-3 Goa was designed for low flying targets. There are different reports on how many Goa systems Iraq had, but it can be accepted at 25 battalions. To support the SA-3 Goa, the P-15 Flat Face, which is a low PRF MTI acquisition radar, was used. It has good ECCM performance. The Goa missile is more agile than the SA-2, and the SA-3 tracking radar has better ECCM and low altitude tracking performance [43].

Another way to analyze the Iraqi SAM defenses is to split them into two major groups: area defense SAM Systems and point defense SAM Systems [43]. Looking first at the area defense SAMs, even though they mainly originated from the Soviet Union, there were also some European weapons in use. Area defense coverage was provided mostly by the SA-2, SA-3 and SA-6. There were approximately 70 batteries. The Iraqi army's mobile SA-6/Gainful 9M9 ZRK Kub/Kvadrat was the most potent area defense SAM system. It was supported by the Straight Flush radar system. It had modified monopulse seekers for improved ECCM.

The most potent of the Iraqi point defense SAM systems were the SA-8 Gecko and the Franco-German Euromissile Roland. Both the Roland and the Gecko are accepted

as serious threats to low flying aircraft as they can be easily hidden and can operate autonomously. Both of these systems are very resistant against ECM.

IR SAMs supplemented the radar-guided SAMs in the point defense role. The Iraqi Army used 9M31 Strela 1 or SA-9 Gaskin as the most common IR system. The Gaskin is very similar to early models of the Sidewinder. It is usually operated in conjunction with the ZSU-23-4P anti-aircraft gun system. The Iraqis had also recently acquired the newer 9M37 Strela 10 or SA-13 Gopher IR SAM.

The static area defense SAMs were supplemented by AAA, The AAA was further supplemented by machine guns, hand held automatic weapons and man portable SAMs such as the SA-7B and SA-14, and the Chinese built HN-5A, a modified SA-7B with a cooled seeker.

The operational concept of the Iraqi air defense was to provide overlapping zones of coverage by various weapon types. This concept of operations is common to many nations' defensive systems. This forces adversaries to use more complex and larger ECM systems. In DESERT STORM, EW and ECM played an important role in penetrating these overlapping defensive lines.

The EW power of the Coalition Forces shouldn't be underestimated. Below is a table listing the assets of the Coalition Forces which were used during the war. [29]

Table 2. Assets of the Coalition Forces

	PLATFORM	MISSION
SUPPORT	USAF RC-135	Extensive SIGINT (ELINT/COMINT)
	USAF U-2R	Collection of COMINT
	RAF Nimrod R.2 French DC-8 Sarigue, EC-160 Gabriel, SA330 Puma Helicopter	ES purposes
	USAF EA-6B, F-4G Wild Weasel, EF-111A Tornado, B-52, Jaguar, F-16, F-111, F-117A Nighthawk, A-10	Refinement of the electronic order of battle (EOB), SEAD, hard-kill missions
	US Magnum and Vortex ELINT KH-12 imaging satellites	IMINT/ELINT purposes
ATTACK	USAF EF-111A	Escort air strikes, provide jamming support to penetrate targets
	US Marine and Navy EA-6B	Communications jamming
	USAF EC-130H Compass Call	Hard-kill mission with ALARM ARM
	RAF Tornado GR1 US Navy Tomahawk	Cruise missile (CM) for hard-kill
PROTECTION	Emission Control (EMCON)	Reduce the radiated energy that is vulnerable to hostile ES and EA
	US Army SINCGARS, USAF Have Quick radio	Had integral EP capabilities

The U.S. flew the F-14D and F-15C as interceptors, F-117A stealth fighters, B-52 strategic bombers, F-4G Wild Weasels armed with HARMs, A-10 Warthog tank killers, and Hellfire-capable Apache and Super Cobra helicopters for tactical ground support to the battlefield. The F-16, EF-111A, the EA-6B, the F/A-18, and RF-4C were also used. In addition, Tomahawk cruise missiles were widely employed during the operation. The French flew Jaguars, and the British flew the GR-1 and F-3 Tornados. Furthermore, Tomahawk cruise missiles were widely used during the operation. The F-16, EF-111A, the EA-6B, the F/A-18, and the RF-4C were also used by U.S. forces [43].

As the Coalition commenced air operations against the Iraqi forces, command posts, communication systems, airfields, air defense radars, operation centers, and the electrical generation and distribution networks were the high priority targets [11]. The first breach was made against two radar stations near the border southwest of Baghdad by

eight AH-64A attack helicopters. In the meantime, two F-117As destroyed the Iraqi air defense operations center in Nukheyb with GBU-27s. Right after the F-117 and AH-64A attacks, other F-117As and R/UGM-109C/D Tomahawk Land Attack Missiles (TLAM C/Ds) destroyed command and communications targets and elements of the electrical power network.



Figure 33. R/UGM-109C/D Tomahawk Land Attack (From [45])

During the next wave, BQM-74 drones and Tactical Air Launched Decoys (TALDs) were used. The BQM-74 was a thirteen-foot-long unmanned jet-powered drone. The Iraqis, after being decoyed and shooting these down, thought that they killed many aircraft. Following the decoys, a mass of seventy allied aircraft armed with radar-killing HARM (U.S.) and ALARM (British) missiles demolished the radar sites [44].

Tomahawk Weapon System Evolution

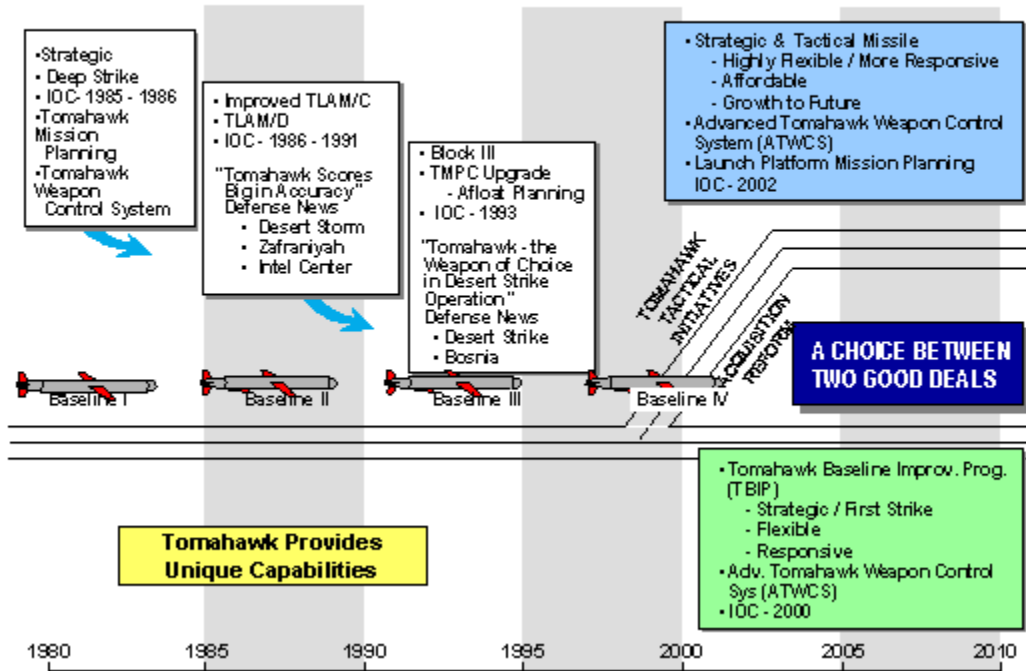

Figure 34. Tomahawk Weapon System Evolution (From [46])



BQM-74E Technical Specifications

Length.....	12.95 ft (4.0 m)
Wingspan.....	5.78 ft (1.8 m)
Range.....	> 350 nm (648.6 km)
Altitude Low.....	7 ft (2.1 m)
Altitude High.....	40,000 ft (12.2 km)
Speed.....	> 515 Knots at Sea Level
Weight.....	455 lbs (206.4 kg)
Endurance.....	78 Minutes
Navigation.....	GPS/IMU
Fuel.....	Jet Fuel (JP-5, JP-8 or Jet A-1)

(NORTHROP GRUMMAN BQM-74 FACT SHEET-PAGE 4)

Figure 35. BQM-74E (From [47])



The Lockheed F-117A Nighthawk is a stealth ground attack aircraft operated solely by the United States Air Force. The F-117A's first flight was in 1981, and it achieved Initial Operational Capability status in October 1983. The F-117A came out of secrecy and was revealed to the world in November 1988. As a product of the Skunk Works and a development of the Have Blue prototype, it became the first operational aircraft initially designed around stealth technology. The F-117A was widely publicized during the Gulf War.

[47]

Figure 36. F-117A (From [47])

Protected by fighter cover and EW support, the F-4Gs accomplished their suppression of enemy air defenses very easily with the help of the decoys. All the radar systems and anti-aircraft batteries were focused on the drones, providing the F-4Gs with numerous radar targets to strike.

The loss rate for Coalition air forces was very low. This was because they gathered accurate SIGINT on Iraqi air defense systems, conducted successful SEAD tactics, utilized effective HARM and ALARM anti-radiation missiles, employed well-developed EW systems in their aircraft, and possessed very well-trained crews [29].



Figure 37. AGM-88 HARM MISSILE (From [49])



Figure 38. ALARM (Air Launched Anti-Radiation Missile) (From [50])

ALARM (Air Launched Anti-Radiation Missile) is a British anti-radiation missile designed primarily to destroy enemy radars for the purpose of Suppression of Enemy Air Defense (SEAD). It is used by the RAF and the Royal Saudi Air Force.

Two E-8A JSTARS (Joint Surveillance and Target Attack Radar System) aircraft supported the ground war which followed the air campaign. E-8 JSTARS provided information on the movement of Iraqi ground forces, regardless of the time of day. The E-3 AWACS (Airborne Warning and Control System) aircraft was used to support air operations. The AWACS acted as the eyes for the air forces, JSTARS did the same for the ground forces, and the RC-135s were the ears for everyone. The RC-135 aircraft monitored Iraqi communications, and located and localized the source of any hostile electronic emissions [44].



Figure 39. E-8A "JSTARS" (From [51])



Figure 40. E-3 AWACS (From [52])

The ground war lasted only 100 hours, with fewer than 500 Coalition casualties [11]. This was due in large part to the excellent EW carried out by Coalition forces.

One of the most unique things about this war was the effective use of the Defense Satellite Communications Systems (DSCS). Vital communications links were supplied via military satellites. The Global Positioning System (GPS) likewise played a very important role. GPS provided the necessary land navigation data to some of the coalition forces, maintaining a higher level of situational awareness. GPS integrated systems

increased accuracy of the weapons. Special Forces made use of GPS in northeastern Iraq for targeting and destroying ground forces as well as Scud missiles [44].

The side that controls the electromagnetic spectrum has a great advantage on the battlefield. All of the studies and results of these previous wars show us the importance of the effective use of EW. The winner of future conflicts will likely be the ones who control the electromagnetic spectrum.

D. FROM THE FIRST GULF WAR TO THE PRESENT

1. Operation Allied Forces (23 March-10 June 1999)

Kosovo earned autonomous province status under the 1974 Yugoslav Constitution. More than 90% of the population was ethnic Albanians. Between 1989 and 1995, the Yugoslav constitution was changed, revoking this status and abolishing the parliament and government of Kosovo. As a result Dr. Ibrahim Rugova, President of the 'Coordinative Body of Albanian Political Parties of Kosova' started a campaign of resistance to the Serbian oppression. During 1995 and 1998, this campaign failed and negotiations were unsuccessful. As a result, the Kosovo Liberation Army (KLA/UCK) was formed with the declared goal of unifying the province with neighboring Albania. Between March and June 1998, Kosovo-Albanians asked for full independence and separation. The Yugoslavian government answered with several armed attacks and claimed to have successfully destroyed the KLA's core. In August, the UN estimated that a total of 235,000 persons had fled their homes since the conflict began. The UN ordered an immediate cessation of military activities. On October 13, a truce was established. The OSCE Kosovo Verification Mission (KVM) was given access to the whole area of Kosovo by the Government of the Federal Republic of Yugoslavia (FRY), which accepts reestablishing substantial local and regional autonomy of Kosovo, but not full independence. In December, the truce finally broke down and local fighting resumed in Kosovo. In January 1999, NATO blamed the Serb side for the massacre of at least 45 civilians in the village Racak. In February, NATO started sending soldiers to Kosovo and negotiations began. Yugoslav leader Slobodan Milosevic wanted to keep Kosovo as a part of Yugoslavia, insisted on UN leadership of foreign forces in Kosovo and rejected

quasi-NATO-occupation status for the whole of Yugoslavia. Richard Holbrooke, the U.S. negotiator, did not succeed in making Milosevic accept the plan. The Kosovo-Albanian delegation signed the peace treaty on 15 March, but the FRY delegates still wouldn't accept the implementation conditions; therefore, NATO forces prepared for offensive operations [54].

On 24 March at approximately 8 p.m., NATO started the war by launching a series of cruise missiles. The attacks against strategic military targets such as radars, aircraft, and rockets continued through the night of the following day. The NATO bombardment was aimed at Yugoslav air defense forces. On the fourth day of the war, 27 March, an American stealth F-117A was shot down near Belgrade. Yugoslav sources claimed to have downed a second stealth plane the next day, but the claim was not verified by NATO. Phase II attacks started on 29 March and involved strikes on military camps, troops, police and military installations. On 1 April, another F-117A crash-landed in Zagreb. After fourteen days of war, Milosevic on 6 April requested a cease-fire, which was rejected by NATO. Twelve days later, NATO claimed to have destroyed the Yugoslav Air Force headquarters and 29 MIGs, which was the half of the Yugoslavian air force's fighters [54].



Figure 41. Wreckage of downed F-117 (From[53])

On 3 June, Yugoslavia accepted the peace plan proposed by the G-8 Countries. The war had lasted about two-and-a-half months. The Yugoslav army's system of control

and communication was severely damaged in the campaign. Nonetheless, Yugoslav air defense did have some successes. In addition to the F-117s noted above, an American Apache-helicopter crashed on 27 April. On 2 May, an American F-16CG aircraft was shot down over western Serbia [54]. Two days later, another F-117 and an A-10 Thunderbolt II were hit by ground fire and heavily damaged, but managed to return safely.

Operation Allied Force, the 1999 NATO operation in Kosovo, is an important event in the debate over current and future U.S. EW needs. SAMs were the biggest threat to NATO aircraft even though allied forces had suppressed the enemy air defenses. After the retirement of the EF111A and the F-4G, the Air Force's EW capacity was diminished. The Air Force trusted the Navy's EA-6B to fill the EW gap [53].

During this operation, approximately 30 EA-6Bs performed EA; this is obviously a small number of aircraft for the mission with which they were tasked. They were used to protect hundreds of allied aircraft flying 37,225 combat sorties over 78 days. In theory, each Prowler would have to fly at least four sorties a day for 78 straight days [56]. These aircraft dealt with the Yugoslav (essentially, Serbian) air defense systems, which included SA-2, SA-3, SA-6, SA-9, and SA-13 batteries [55], plus numerous shoulder-fired SA-7 and SA-14 missiles. Because of the Serbian tactics, Allied forces had a hard time detecting and engaging enemy SAMs. "Serbian operators limited their radar emissions and dispersed their radar sites to avoid destruction. SAM operators took cueing data from several different radar sources and fused this information to gather accurate tracking data. Minimizing the time for this process allowed the SAM to be fired and radar shutdown before NATO aircraft could accurately engage the site." [53]

On the fourth night of the war, 28 March, an F-117 flying around Belgrade was shot down by enemy SAMs, most probably by the old SA-3 system. This SAM battery had not been located. Many factors contributed to the downing of the F-117 but the most important one was "the lack of effective EA integration with stealth operations." EA-6Bs were in the same package with the F-117s for EW support, but were orbiting too far away to provide adequate jamming; this caused a shortfall in effective EA support tactics.

More importantly, in Kosovo the issue regarding stealth reliance versus electronic attack was answered. Stealth platforms do, in fact, require support jamming to maximize their effectiveness in non-permissive, heavily defended airspace.

The shortfall in EW assets was severely felt during Operation Allied Force. Immediately after the campaign, the U.S. Air Combat command requested a three-fold increase (from 30 to 100) in the number of F-16CJ aircraft to be acquired [57]. F-16CJ will be provided by modifying the latest model F-16C/Ds (block 40) and the F-16CJs (block 50) to be used for both attack and suppression missions.

2. The War in Afghanistan (7 October 2001-Present)

The War in Afghanistan was the first major conflict of the 21st Century. Though the origins of the war involve the Afghan Civil War and the Soviet Invasion and Occupation of the 1970s and 1980s, the current war began in October, 2001 in response to the September 11, 2001 terrorist attacks on the United States. [58]

a. Causes of Conflict [59]

After the Soviets withdrew from Afghanistan in 1989, the Afghan Communist government fell in 1992. A civil war broke out between the various factions of anti-Communist Afghan fighters. During this time of chaos, some former Mujahedeen found a leader in Mullah Mohammed Omar. This member of the Pashtun ethnic group led a new armed group called the Taliban. Other former Mujahedeen leaders of Pashtun background joined with the Taliban. They also attracted the support of Osama bin Laden and his al-Qaida organization. Bin Laden provided both financial and political support to the Taliban.

In late 1994, the Taliban took control of Kandahar and obtained a large supply of modern weapons, including fighter aircraft, tanks and helicopters. The Taliban used these weapons to defeat several militias and warlords, advancing on Kabul in January 1995 and finally capturing the capital in September 1996. Several anti-Taliban leaders and their forces fled to the northern part of the country to continue the fight.

By 1997, Pakistan, Saudi Arabia and the United Arab Emirates recognized the Taliban government. Pakistan played an important role in the Taliban success. It is generally believed that several Taliban military victories are directly attributable to armed Pakistani intervention.

In 1998, the Al-Qaida group was charged with the bombing of the U.S. Embassies in Nairobi and Dar Es Salaam. After that, the United States launched a cruise missile attack on training camps belonging to bin Laden's organization in southeastern Afghanistan.

Al-Qaida took full credit for the terrorist attacks of September 11, 2001. The U.S. began plans to take the fight to al-Qaida and its Taliban sponsors, thus beginning the so-called "Global War on Terror."

Following the Taliban's repeated refusal to expel bin Laden and his group and end its support for international terrorism, the U.S. and its partners in the anti-terrorist coalition began a military campaign on October 7, 2001, targeting terrorist facilities and various Taliban military and political assets within Afghanistan. Under pressure from U.S. military and anti-Taliban forces, the Taliban disintegrated rapidly, and Kabul fell on November 13, 2001. [59]

b. Description of Conflict

The War in Afghanistan started with air strikes on Taliban and al-Qaida targets. American, British and other Allied special forces troops worked with the Northern Alliance (which included the Uzbek forces of General Dostum, the Tajik troops of former President Rabbani and the Shiite Hazaris led by Haji Mohammed Mohaqiq). This led to coordination between Allied air attacks and ground attacks by the Northern Alliance. As a result Kabul fell and the Taliban retreated from most of northern Afghanistan.

As more Allied troops entered the war and the Northern Alliance forces fought their way southwards, the Taliban and al-Qaida retreated toward the mountainous border region between Afghanistan and Pakistan.

An Afghan Interim Authority was formed and took office in Kabul on December 22, 2001 with Hamid Karzai as Chairman. The Interim Authority held power for approximately 6 months while preparing for a nationwide "Loya Jirga" (Grand Council) in mid-June 2002 that decided on the structure of a Transitional Authority. The Transitional Authority, headed by President Hamid Karzai, renamed the government as the Transitional Islamic State of Afghanistan (TISA). One of the TISA's primary achievements was the drafting of a constitution that was ratified by a Constitutional Loya Jirga on January 4, 2004. On December 7, 2004, the country was renamed the Islamic Republic of Afghanistan. [59]

From 2002 onward, the Taliban focused on survival and on rebuilding its forces. Beginning in 2005, the Taliban has increased its attacks by using suicide bombers and improvised explosive devices (IEDs). To counter part of this threat, the EA-6B Prowler has been used for the past several years in anti-IED operations, attempting to defeat these weapons by jamming remote detonation devices such as garage door openers or cellular telephones. This demonstrates that electronic warfare can be used against guerilla war. Nonetheless, it is still a new field for EW [61].

3. Operation Iraqi Freedom (2003-Present)

Operation Iraqi Freedom (OIF), also known as the Iraq War, the Second Persian Gulf War or the Occupation of Iraq, is an ongoing military campaign. It is known as Operation Telic in the United Kingdom, and Operation Falconer in Australia. OIF began with the invasion of Iraq by a multinational force (known as the Coalition) almost entirely composed of troops from the United States and United Kingdom. Smaller contingents from Australia, Poland, and other nations supported these troops [62]. The operation came about in response to continued Iraqi non-compliance with UN verification inspections mandated by the UN Security Council at the end of Operation Desert Storm [63].

On 20 March 2003, at 5:34 a.m. local time in Baghdad, Coalition forces started attacks with two F-117s supported by Navy EA-6B Prowlers, as well as 40 ship-fired Tomahawk Land Attack (TLAM) cruise missiles. [63] F/A-18 Hornets also took part in strikes. [64]

Hours before the attacks on Baghdad, a series of critical targets were destroyed. These were: communication sites near Ash Shuaybah, Mudaysis and Ruwayshid; long-range artillery near Az Zubayr; a mobile early-warning radar and an air defense command center at an Iraqi air base in western Iraq; long-range artillery on the Al Faw peninsula; a surface-to-surface missile system near Al Basrah; and an air traffic control radar near Al Basrah. As is obvious from the target selection, the Coalition struck the communications sites and the early-warning radar in order to ruin Iraq's integrated air-defense system. The air traffic control radar was used to direct Iraqi anti-aircraft artillery fire at Coalition aircraft. Destroying it removed this danger too. [64]

There were at least three surface-to-surface missiles which were launched from Iraqi sites aiming at coalition targets in Kuwait. Iraqi forces fired CSSC-3 Seersucker cruise missile which landed in the desert near Camp Commando. There were no casualties. They also used Ababil missiles, two of which were fired later in the day towards Kuwait City and U.S. targets. They were shot down by Patriot PAC-3s. "The military did not disclose how many Patriots were used, but some reports indicate that it took at least three Patriots to bring down one of the missiles." [64] According to the Asia times Iraq responded to the attack by firing at least four missiles into northern Kuwait. [65] On the other hand CBS news claimed that there were six missiles fired by Iraqis. [66] British and American marines captured Umm Qasr, a sea port, some 30 miles south of Basra, late on March 20. [64]

On the second day U.S. Air Force B-1B Lancers, B-2A Spirits, B-52H Stratofortresses, F-117 Nighthawks, F-15E Strike Eagles and F-16 Fighting Falcons, plus Navy F/A-18 Hornets and F-14 Tomcat, Marine AV-8B Harrier and coalition Tornado GR-4, Harrier GR-7 and F/A-18 aircraft flew the strike missions. [67]

A major air campaign was launched throughout the operations; several hundred military targets were struck. Coalition forces conducted more than 3,000 sorties in the air attack. "During the 24 hour period that started March 21st at 1 pm ET, the coalition flew 1,500 total sorties, 700 of which were flown by strike aircraft. The rest were jammers, planes protecting bombers, surveillance, etc." [68]

CENTCOM reported that at around 1,000 cruise missiles were launched from both naval and air assets in addition over 3,000 precision-guided munitions, were used during this war. Also the RAF's new Storm Shadow missile was successfully used for the first time on operations. [67]

On the third day, an MQ-1 Predator found and destroyed a radar-guided AAA. The Predator was carrying the AGM-114K "Hellfire II" missile to strike an Iraqi ZSU-23-4 Mobile AAA. Another Patriot firing battery successfully intercepted and destroyed an incoming Iraqi tactical ballistic missile during an attack on U.S. and Coalition Forces in Kuwait [68]. On 8 April, one A-10 aircraft was hit by a Roland SAM.

“During the fourth day a U.S. F-16 fighter engaged a U.S. Patriot battery approximately 30 miles south of An-Najaf, Iraq. The F-16 pilot executed the strike against the Patriot while en-route to a mission near Baghdad. No soldiers were injured or killed by the strike.”[69] [68]

On the fifth day U.S. forces advanced beyond An Nasiriyah. During this time aviation forces attacked Republican Guard formations near Baghdad; one U.S. helicopter was lost. Mine clearance operations in the southern waterways made good progress, with half the route to Umm Qasr made safe. [70]

On April 8 One A-10 aircraft which was executing the CAS missions was hit by a Roland SAM. The pilot ejected and he was recovered unhurt by Coalition forces. The aircraft was hit close to the Saddam International Airport. [71]

When the war came to the 21st day, three important cities Kirkuk, Mosul, and Tikrit, remained under Iraqi control. Kirkuk and Mosul are strategic cities in northern Iraq. Tikrit is the home city of the Hussein family.

On the 22nd day, Security operations in Baghdad against looting and in Basrah and other nearby towns in Southern Iraq started. In northern Iraq, Iraqi forces fled Mosul following the cease-fire arranged the day before.

On the 25th day As U.S. forces pushed towards Tikrit [68].

On the 26th day of combat operations, Tikrit was captured. Four Iraqi tanks were destroyed in the skirmishes around Tikrit. [68]

CENTCOM also announced that there was a possible F/A-18 Hornet strike fighter loss on April 2 due to friendly fire by a U.S. Patriot SAM. Also UH-60 helicopter crashed in central Iraq. [68]

“The comparative daily and total air effort as of April 11th was:

- Total sorties (today/since G-day): About 1,525/About 36,275
- Strike sorties (today/since G-day): About 375/About 14,050
- Air and space supremacy sorties (today/since G-day): About 260/About 4,900
- C2ISR sorties (today/since G-day): About 115/About 2,450
- Combat search and rescue sorties (today/since G-day): Less than 5/About 270
- Aerial refueling sorties (today/since G-day): About 380/About 7,525
- Aerial refueling offloads (through 9 Apr): 310 million pounds (46 million gals)
- Airlift sorties (today/since G-day): About 400/About 7,100
- Cargo moved (through 9 Apr): About 55,000 short tons
- Passengers moved (through 9 Apr): About 76,000
- Aeromedical evacuation sorties (today/since G-day): About 5/About 110
- AE urgent patients moved (today/since G-day): Less than 5/About 50
- AE total patients moved (today/since G-day): About 150/About 1,300
- Munitions (total guided/total unguided/percent PGM): About 17,000/About 8,500/About 65%” [68]

On the 2 May 2003, the President of the U.S. announced from the flight deck of the USS Abraham Lincoln that the major combat operations in Iraq had ended [72]. Throughout the campaign, Iraqi air defense had proven to be largely ineffective. This was due to the severe damage it had suffered in Desert Storm a decade before, and to the early Coalition attacks on the remaining command and control assets at the beginning of the current operation [73].

IV. GENERAL INFORMATION ABOUT UAS

In this chapter, the general features of unmanned aircraft systems (UAS) are discussed. This chapter will pose some questions so as to gain a broad understanding of this topic.

The first question is “What is an unmanned vehicle?”

Unmanned Vehicle: A powered vehicle that does not carry a human operator, can be operated autonomously or remotely, can be expendable or recoverable, and can carry a lethal or nonlethal payload. Ballistic or semi-ballistic vehicles, cruise missiles, artillery projectiles, torpedoes, mines, satellites, and unattended sensors (with no form of propulsion) are not considered unmanned vehicles. Unmanned vehicles are the primary component of unmanned systems. [75]

The second question would be “What is a UAS?” Unmanned Aerial Vehicles (UAVs) have been referred to in many ways: RPV (remotely piloted vehicle), drone, robot plane, and pilotless aircraft. An UAV is basically an unpiloted aircraft that can be remote controlled or can fly autonomously based on pre-programmed flight plans or more complex dynamic automation systems.

The abbreviation UAV has been expanded in some cases to UAVS (unmanned-aircraft vehicle system). The Federal Aviation Administration has adopted the generic class unmanned aircraft system (UAS) originally introduced by the U.S. Navy to reflect the fact that these are not just aircraft, but systems, including ground stations and other elements. [76]

The third and the most important question would be “Why do we need UAS?” There are a number of reasons why UAVs have only recently been given a higher priority. We try to increase the use of UAS for three main types of missions: “dull, dirty, or dangerous” [75].

For example, the longest mission in Operation Enduring Freedom was a B-2 sortie of over 44 hours, and the longest Operation Iraqi Freedom B-2 sortie was 39 hours. Fatigue management is an important factor and may cause death or serious injuries. This

is an example of a mission that could be better performed by a UAS. During “Dull” missions, UAS allow the ability to give operators normal mission cycles and crew rest.

As an example for the “dirty” missions, from 1946 to 1948 the U.S. Air Force and Navy used unmanned B-17s and F6Fs, respectively, to fly into nuclear clouds within minutes after bomb detonation to collect radioactive samples. During dirty missions, UAS increase the probability of a successful mission and minimize human exposure.

For “dangerous” missions, we can think of any situation that will put human life at excessive risk and which may cause political problems. For such missions, UAS lower the political and human cost if the aircraft is lost [75].

Conventional wisdom holds that UAS offer two main advantages over manned aircraft: they are cheaper and more cost-effective than manned aircraft, and they don’t put human life at risk. As counterpoint to the first point, however, it should be noted that the current UAS accident rate is 100 times more than that for loss or damage to manned aircraft [77]. This drives up the total cost, though the entire issue is still subject to debate:

In its recent UAV study, the Defense Science Board (DSB) notes that manned aircraft over the past five decades have moved from the relatively high mishap rate to relatively low rates through the advancement of system design, weather durability improvements and reliability upgrades [70]. It should be pointed out, however, that the UAS, with the exception of Predator, have total flight times that are significantly less than the 100,000 hours used to calculate the mishap rate. Most aircraft tend to have a much higher mishap rate in their first 50,000 hours of flight than their second 50,000 hours of flight. Further, some of the UAS in Table 3, have flown numerous missions while still under development. Predator and Global Hawk, for instance, were rushed into combat well prior to the aircrafts’ initial operational capability: 1995 for Predator, and a projected FY2006 for Global Hawk. It is unfair, some might argue, to compare the mishap rates of developmental UAS with manned aircraft that have completed development and been modernized and refined over decades of use. [77]

Table 3. Select Mishap Rates

Vehicle Type	Class A Mishaps (per 100,000 hrs)
UAV	
Predator	20
Hunter	47
Global Hawk	88
Pioneer	281
Shadow	191
Manned	
U-2	6.8
F-16	4.1

Source: DoD's UAS Roadmap 2005-2030, p. 75.

Another advantage is that unmanned aircraft can be smaller, which would increase survivability of the systems over enemy territory. Enemy radar would be less likely to detect these systems due to their relatively small radar cross sections (RCS).

A. UAV CLASSIFICATION

Classifying UAS is a problematic process. Because UAS are used in many different applications, it is not possible to talk about one classification system that covers them all. There is no commonly agreed international nomenclature, but it has been generally accepted that UAS may be classified by their performance specifications and their mission types. Weight, payload, endurance and range, speed, wing loading, cost, engine type and power are the performance specifications to conduct a proper classification. The most common mission types are Intelligence, Surveillance, Target Acquisition, and Reconnaissance (ISTAR); combat; multi-purpose; vertical take-off and landing; radar and communication relay, and aerial delivery and resupply [78].

1. Classification by Performance Characteristics

a. Classification by Weight

Weight of the unmanned systems varies greatly, from micro UAS that weigh less than a few pounds to super heavy UAS weighing more than 2000 kg.

There are five weight classes [78]:

- **Super Heavy Weight UAS:** This class includes UAS with take-off weights over 2 tons.
- **Heavy Weight UAS:** These UAS weigh between 200kg and 2000 kg.
- **Medium Weight UAS:** These are the systems that weigh between 50kg and 200 kg.
- **Light Weight UAS:** This class includes UAS from 5 kg to 50 kg.
- **Micro UAS (MAV):** UAS under 5 kg are in this class.

Table 4. Classification by Weight

Designation	Weight Range	Example
Super Heavy	>2000 kg	Global Hawk
Heavy	200-2000 kg	Predator
Medium	50-200 kg	Shadow 200
Light	5-50 kg	Aerosonde
Micro	<5 kg	Wasp

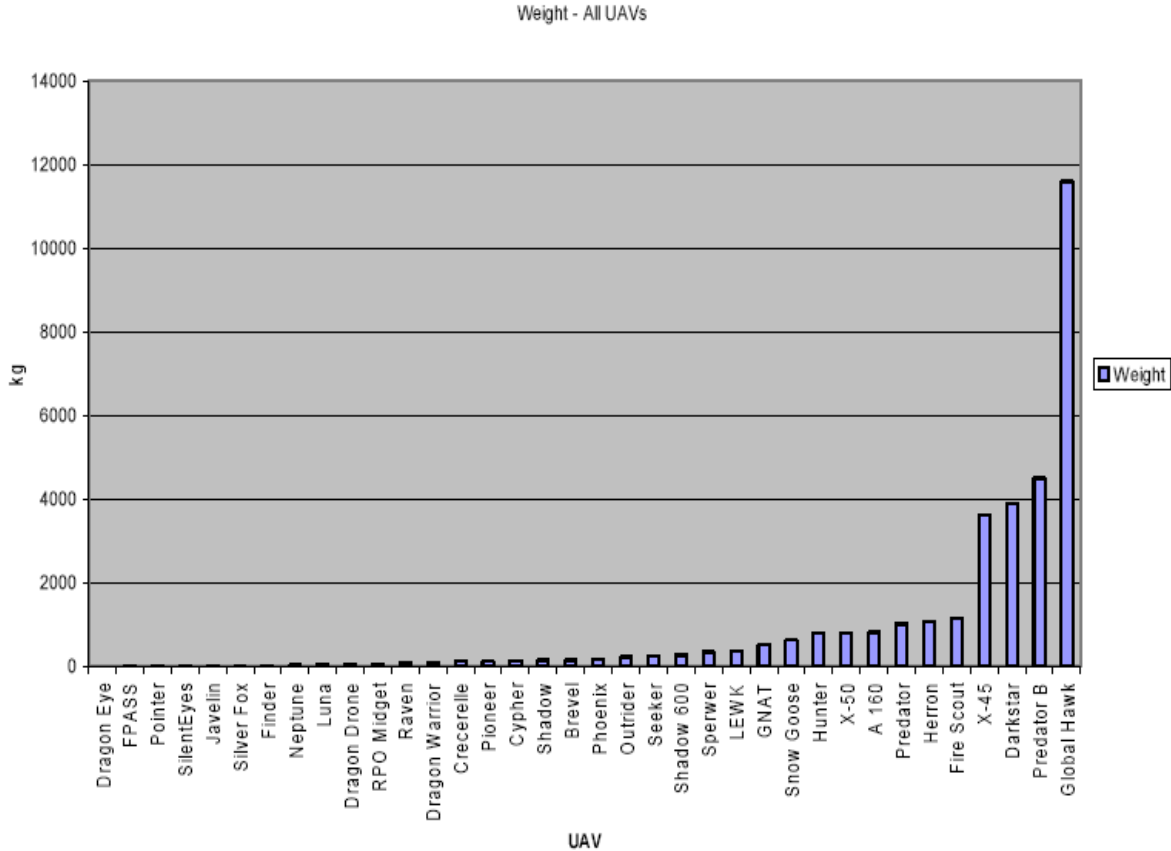

Figure 42. Weight-All UAS

b. Classification by Endurance and Range

Another classification method used for UAS is to categorize them by endurance and range, which are usually interrelated in manned aircraft systems, but often are not in UAS due to line of sight communications restrictions. These parameters are very important because they have direct impact on the mission for which a UAS is designed.

There are three classifications [78]:

- **Long Endurance UAS:** This class includes UAS that can stay airborne for 24 hours or more. The range for these UAS are correspondingly high, varying from 1500 km up to 22,000 km.

- **Medium Endurance UAS:** These have endurance between 5 and 24 hours. This is the most common type of UAS.
- **Low Endurance UAS:** UAS with less than five hours endurance are considered Low Endurance UAS. Most smaller-sized UAS fall into this category.

Table 5. Range and Endurance

Range and Endurance			
Category	Endurance	Range	Example
High	>24 hours	>1500km	Predator B
Medium	5 – 24 hours	100 – 400 km	Silver Fox
Low	< 5 hours	< 100 km	Pointer

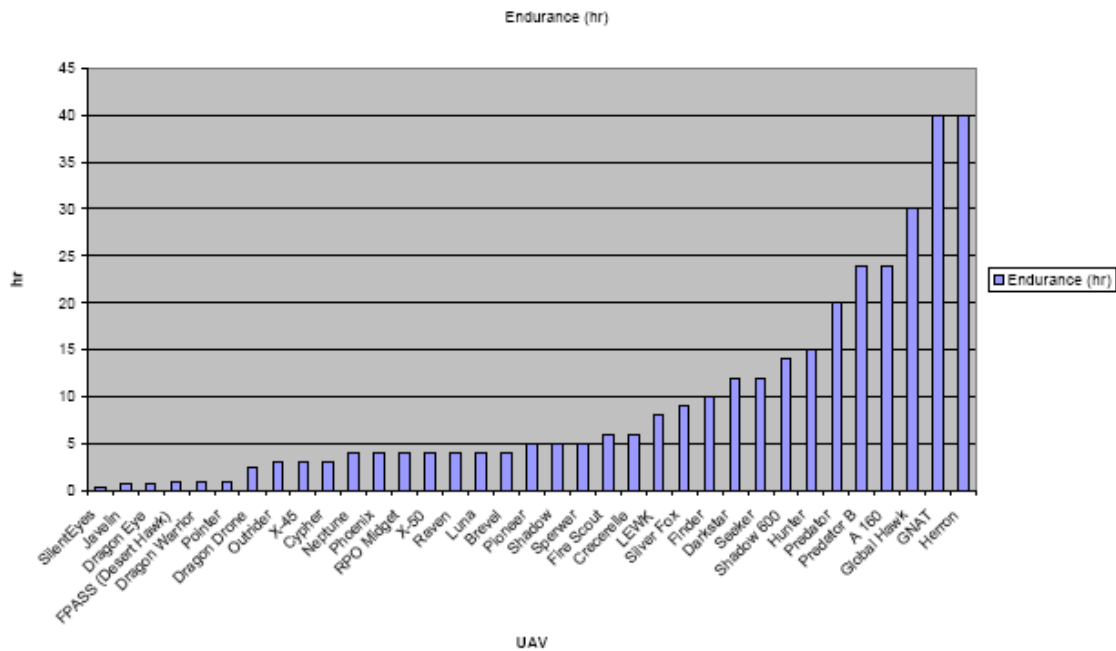

Figure 43. Endurance-All UAS

c. Classification by Maximum Altitude

The maximum operational altitude, or flight ceiling, is another performance measure by which UAS can be classified. Higher altitude capability is vital for military applications. For avoiding detection and destruction by the enemy, some UAS need to fly at high altitudes. For imaging and reconnaissance, a higher altitude is required to obtain images of the maximum amount of terrain.

There are three classes with regard to a UAV's maximum ceiling [78]:

- **Low altitude UAS:** UAS that can fly up to 1000m are considered low altitude UAS. These are typically the mini and micro UAS.
- **Medium Altitude UAS:** This category includes UAS with maximum altitude between 1000m and 10000m. The majority of UAVs fall into this category.
- **High Altitude UAS:** These unmanned aircraft can fly over 10000m.

Table 6. Classification by Maximum altitude

Category	Max Altitude	Example
Low	<1000m	Raven
Medium	1000-10000m	Predator-A
High	10000m	Global Hawk

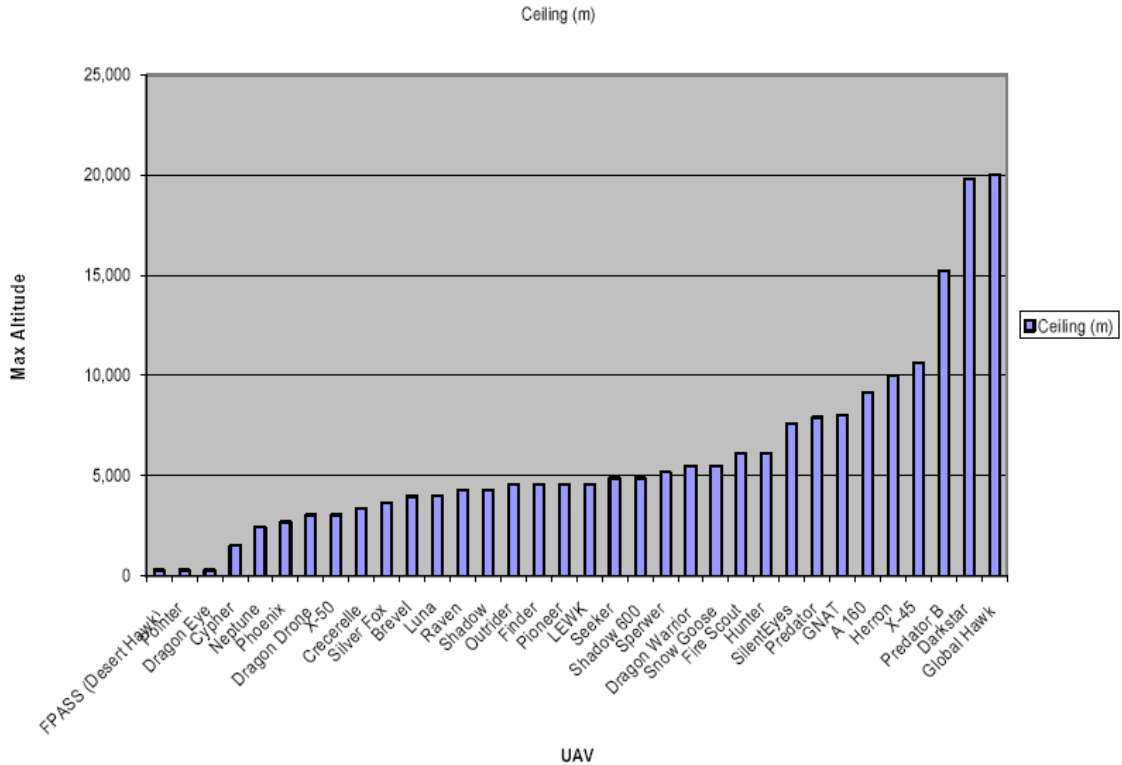

Figure 44. Max Altitude-All UAS

d. Classification by Wing Loading

Another, but less common, way of classifying UAS is by their wing loading. The wing loading of a UAS is calculated by dividing the total weight of the UAV by the wing area.

There are three classes for this classification:

- **High Loading:** UAS with a wing loading above 100kg/m² constitute this category.
- **Medium Loading:** This class includes the UAS with a wing loading between 100kg/m² and 50kg/m².
- **Low Loading:** This class includes the UAS with a wing loading of less than 50kg/m².

Table 7. Classification by Wing Loading

Category	Wing loading kg/m ²	Example
Low	<50	Seeker
Medium	50-100	X-45
High	>100	Global Hawk

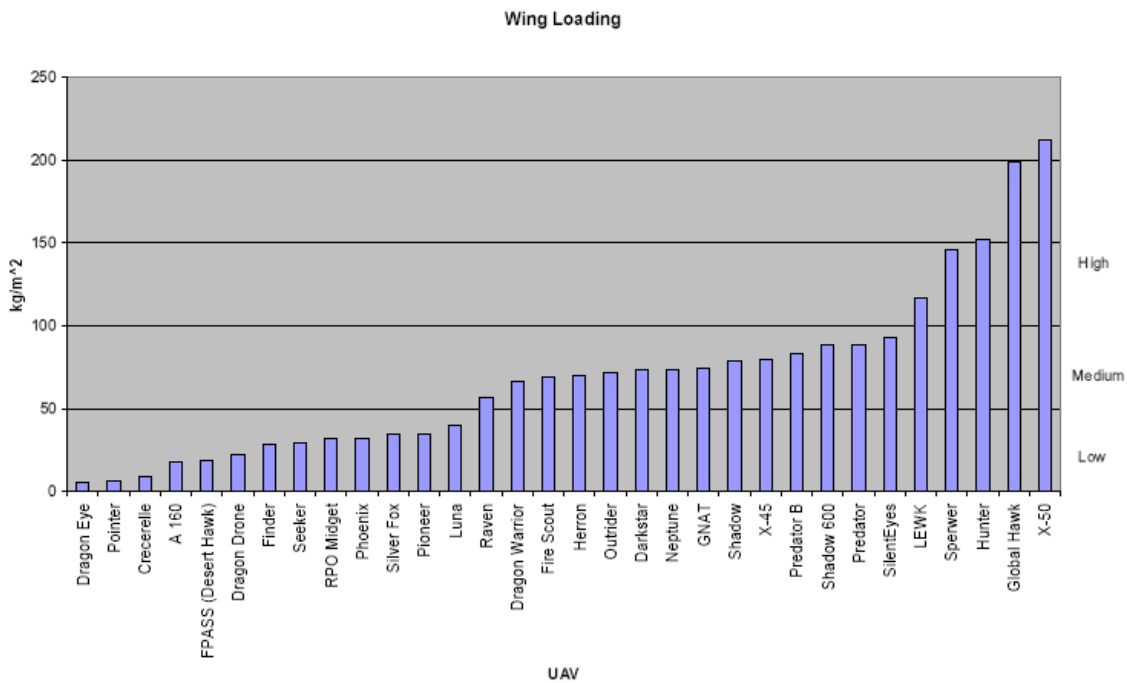

Figure 45. Wing Loading-All UAS

e. Classification by Engine Type

There are different types of engines for different types of UAS: turbofans, two stroke, piston, rotary, turboprop, push and pull, electric. The lighter, smaller UAS mostly use electric motors, while most of the heavier, battle-ready UAS tend to use piston engines.

UEL Rotary	Turbofan	Two-stroke	Piston	Turboprop	Electric	Push & Pull	Prop
Outrider	Global Hawk	Pioneer	Predator	Predator B	Dragon Eye	Hunter	LEWK
Shadow	Darkstar	RPO Midget	Neptune		FPASS		Sperwer
Shadow 600	Phoenix		Dragon Drone		Dragon Warrior		
Cypher	X-45		Finder		Pointer		
	X-50		A 160		Raven		
	Fire Scout		GNAT		Luna		
			Crececelle		Javelin		
			Seeker				
			Brevel				
			Snow Goose				
			Silver Fox				
			Heron				

Figure 46. UAS and Engine Types (From[78])

B. DOD CLASSIFICATION

According to the DoD definition, UAS can be split into four main groups by size.

These are:

- **Small.** Gross takeoff weight (GTOW) less than 55 pounds
- **Tactical.** GTOW between 55 and 1320 pounds
- **Theater.** GTOW greater than 1320 pounds
- **Combat.** An aircraft designed from inception as a strike platform with internal bomb bays or external weapons pylons, a high level of survivability, and a GTOW greater than 1320 pounds [75]

Along with the classifications above, another very commonly used classification (currently, the most common nomenclature used in informal discussions) using altitude and size is:

- Micro UAS
- Mini UAS
- Tactical UAS
- Medium Altitude Endurance UAS
- High Altitude Endurance UAS

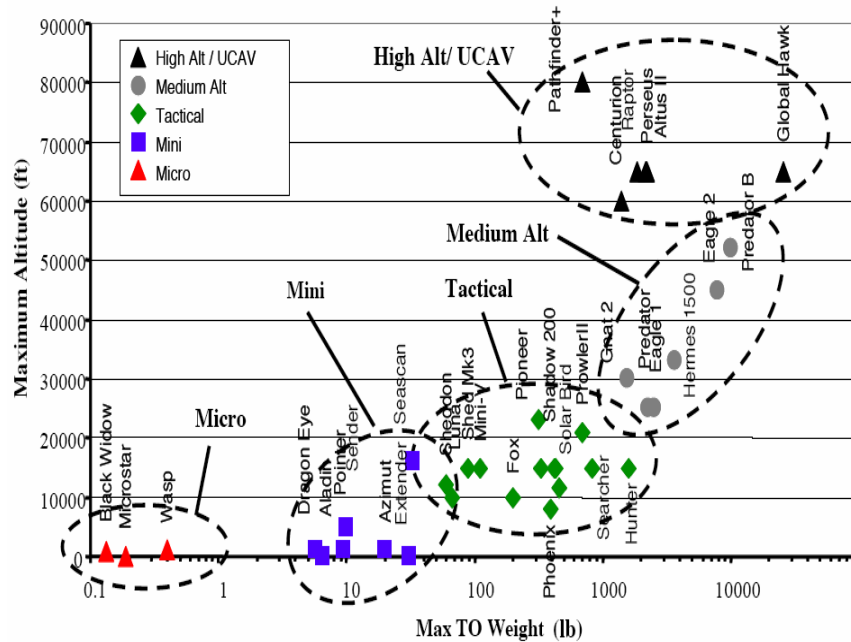

Figure 47. Altitude and Size Classification

1. Micro UAS

These UAS have a short range and limited altitude capability, and could be carried as a payload of a larger UAS. They could conduct a “perch and stare” mission in which they would place themselves in a location without the knowledge of the enemy in order to collect imagery, signals, or other types of intelligence. This intelligence could then be stored and later collected and sent back to headquarters through a second UAV. Naturally, the small size of these systems would limit the power of their transmitter and antenna gain, which in turn would limit the distance that they could transmit data [79].

2. Mini UAS

Mini UAVs typically fly between 18 and 45 knots and weigh between 1 and 40 pounds. They have wingspans between 6 inches and 10 feet. Their maximum ranges are limited by line of sight limitations. Mini UAVs must maintain line-of-sight (LOS) between the aircraft and the ground station, as they do not typically have the payload capacity to carry satellite-over-the-horizon control and communications systems. There is

some capability to extend their operational range with the use of modern power-cell technology to increase their range/endurance and the use of communications relays (such as a string of mini UAVs) to extend RF line of sight. Mini UAVs are easily supportable with a small footprint and require very little logistical support [79].

3. Tactical UAS

Tactical UAS are larger systems that require more support, maintenance and manpower. On the other hand, they provide greater range and longer loiter capabilities than smaller, less capable systems. These systems are typically between 60 to 1000 pounds and operate at low to medium altitudes. They are typically launched utilizing a runway, a catapult, or a rocket assisted launch system [79].

4. Medium & High Altitude UAS

Medium and High Altitude UAS are generally larger than 1,000 pounds. The Medium Altitude UAS operate near the altitude of commercial airliners (18,000-45,000 feet), while High Altitude UAS operate above the commercial airliner airspace, above approximately 50,000 feet [79].

As it is seen easily from the above, there is no one standard classification for the UAS.

C. U.S. MILITARY UAS CLASSIFICATIONS

There are also military classification standards designated by each branch:

1. U.S. Air Force Tiers

- Tier N/A: Small/Micro UAV. Role filled by BATMAV (Wasp Block III).
- Tier I: Low altitude, long endurance. Role filled by the Gnat 750.
- Tier II: Medium altitude, long endurance (MALE). Role currently filled by the MQ-1 Predator and MQ-9 Reaper.
- Tier II+: High altitude, long endurance conventional UAV (or HALE UAV). Altitude: 60,000 to 65,000 feet (19,800 m), less than 300 knots (560 km/h) airspeed, 3,000-nautical-mile (6,000 km) radius, 24-hour time-on-station capability. Complementary to the Tier III- aircraft. Role currently filled by the RQ-4 Global Hawk.

- Tier III-: High altitude, long endurance low-observable UAV. Same parameters as, and complementary to, the Tier II+ aircraft. The RQ-3 Dark Star was originally intended to fulfill this role before the program was cancelled. There is currently no known operational platform filling this role [94].

Table 8. Comparison of the USAF Tier II, II+ and III- (From [80])

Characteristic	MAE (Tier II)	HAE (Tier II+)	LO-HAE (Tier III-)
Gross Take-off Weight	>1873 lbs	22,914 lbs	8,600 lbs
Wingspan	48.7 feet	116.2 feet	69 feet
Mission Duration Operating Radius	24+ hours on station @ 500 NM	24 hours on station @3000 NM	> 8 hours on station @ 500 NM
Maximum Endurance	50+ hours	42+ hours	N/A
Ferry Range	N/A	15,000 NM	N/A
Payload	450 lbs	2,000 lbs	1,000 lbs
True Air Speed	60-110 knots	350 knots	>250 knots
Loiter altitude	25,000 feet max. 15,000 Feet Nominal	65,000 feet	>45,000 feet

Survivability Measures	None	Threat warning and ECM	Very low observable
Command and Control	UHF Milsat/LOS	UHF Milsat/LOS	UHF Milsat/LOS
Sensors	SAR: 1 ft IPR, Swath Width Approx. 3,300 ft EO: NIIRS 6 IR: NIIRS 6 Simultaneous Dual Carriage	SAR: 1 m search; 0.3 m spot EO: NIIRS 6 IR: NIIRS 5 Simultaneous Dual Carriage	SAR: 1 m search 0.3 m spot EO: NIIRS 6 IR: None Single Carriage
Coverage per mission	13,000 sq NM search imagery	40,000 sq. NM. search imagery, or 1,900 spot image frames	14,000 sq. NM search imagery, or 620 spot image frames
Sensor data transmission	Narrow band Comsat: 1.5 Mbits Ku Band & UHF SATCOM LOS: C-band	Wide band Comsat: 20-50 Mbits/sec LOS: X-Band Wide Band (CDL): 137-275 Mbits/sec	Narrow band Comsat: 1.5 Mbits/sec LOS: X-Band Wide band (CDLS): 137-275 Mbits/sec
Deployment	2 C-141s or Multiple C-130s	Self deployable, SE requires airlift	2 C-141s or Multiple C-130s
Ground Control	LOS & OTH	Maximum use of GOTS/COTS (LOS & OTH)	Common with Tier II Plus

Data Exploitation	Existing and Programmed: JSIPS, CARS, MIES, JIC's, NPIC	Existing and Programmed: JSIPS, CARS, MIES, JIC's, NPIC	Existing and Programmed: JSIPS, CARS, MIES, JIC's, NPIC
--------------------------	---------------------------------------------------------------	---------------------------------------------------------------	---------------------------------------------------------------

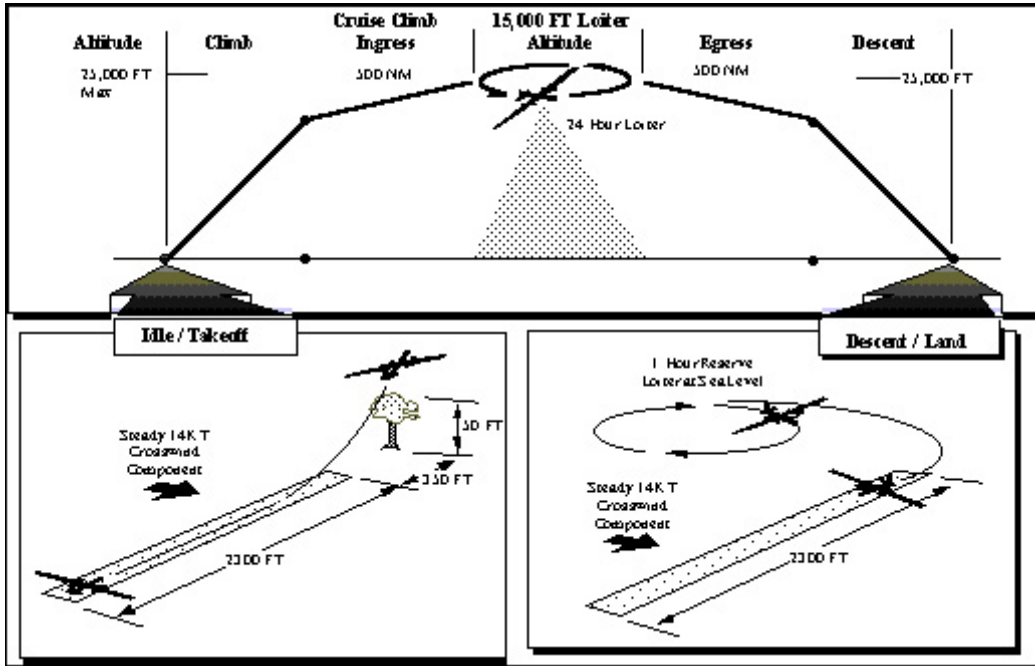

Figure 48. Notional MAE UAV (Tier II) Mission Profile (From [80])

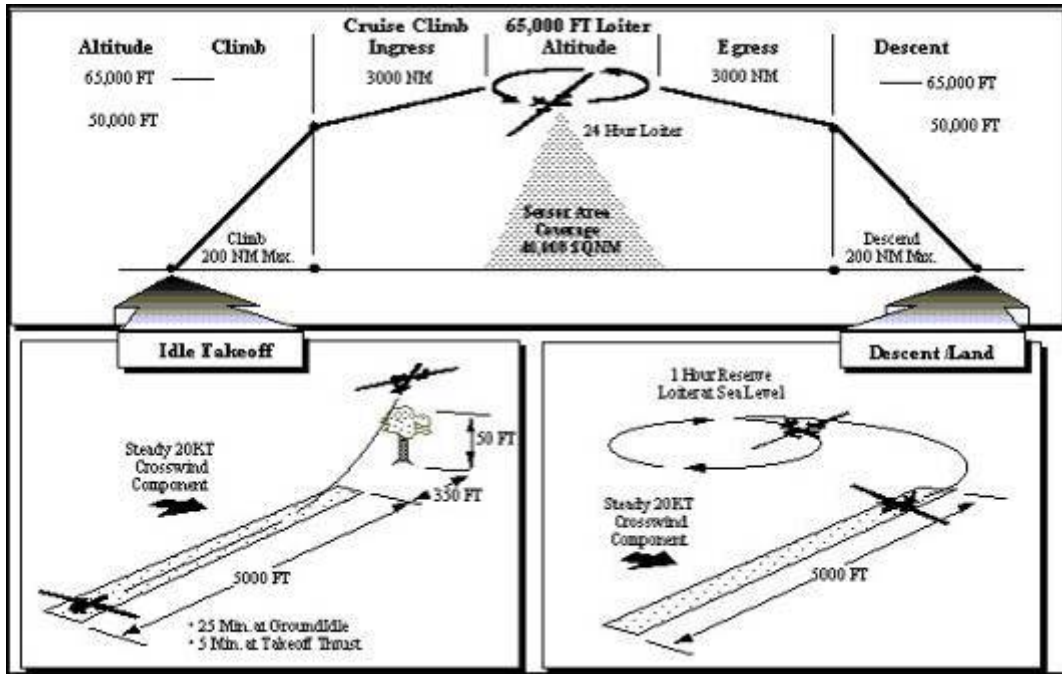

Figure 49. Notional HAE UAV (Tier II+) Mission Profile (From [80])

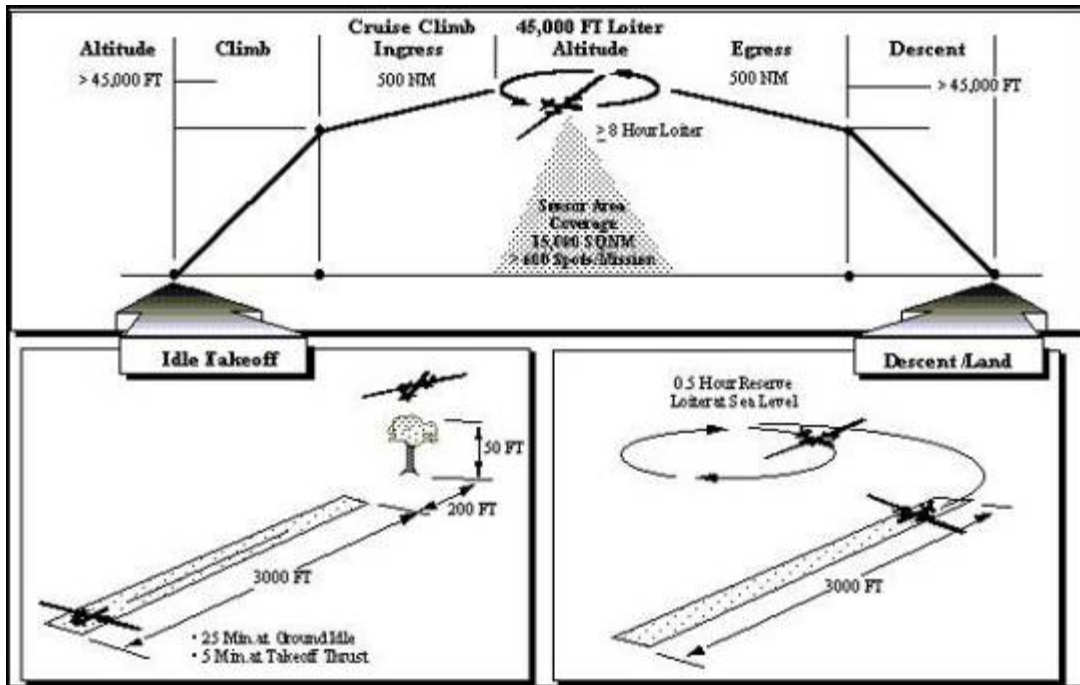

Figure 50. Notional LO-HAE UAV (TIER III-) Mission Profile (From [80])

As depicted in the pictures above, mission profiles differ depending on the class of UAV. Even though all three tiers are designed for conducting similar missions, they use different profiles.

The USAF also names UAS based on mission capability. Prior to this decade, this issue was trivial because UAS only performed surveillance roles, which is why most UAS on the books have appellations starting with 'R' for reconnaissance. Since 2001, however, General Atomics has upgraded the Predator to carry Hellfire AGMs, Stinger AAMs, and the Viper Strike guided bomb. The USAF gives attack-capable UAVs the 'M' designation; consequently, the Predator comes in RQ-1 and MQ-1 versions.” [81]

2. U.S. Marine Corps Tiers

- Tier N/A: Micro UAV. Wasp III fills this role, driven largely by the desire for commonality with the USAF BATMAV.
- Tier I: Role currently filled by the Dragon Eye but all ongoing and future procurement for the Dragon Eye program is going now to the RQ-11B Raven B.
- Tier II: Role currently filled by the ScanEagle and, to some extent, the RQ-2 Pioneer.
- Tier III: For two decades, the role of medium range tactical UAV was filled by the Pioneer UAV. In July 2007, the Marine Corps announced its intention to retire the aging Pioneer fleet and transition to the Shadow Tactical Unmanned Aircraft System [82].



Marine Corps FoS UAV Schedule

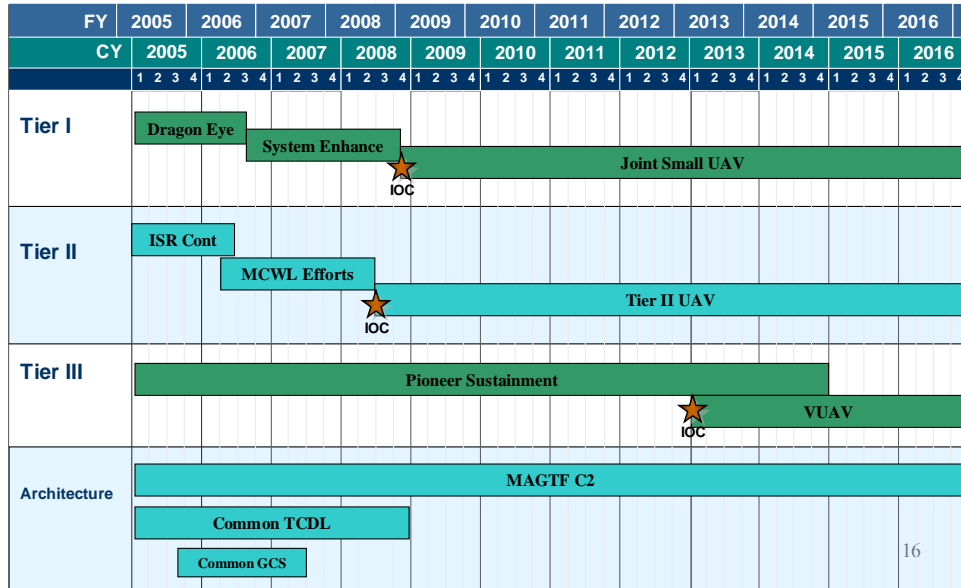

Figure 51. Marine Corps FoS UAV Schedule (From [80])

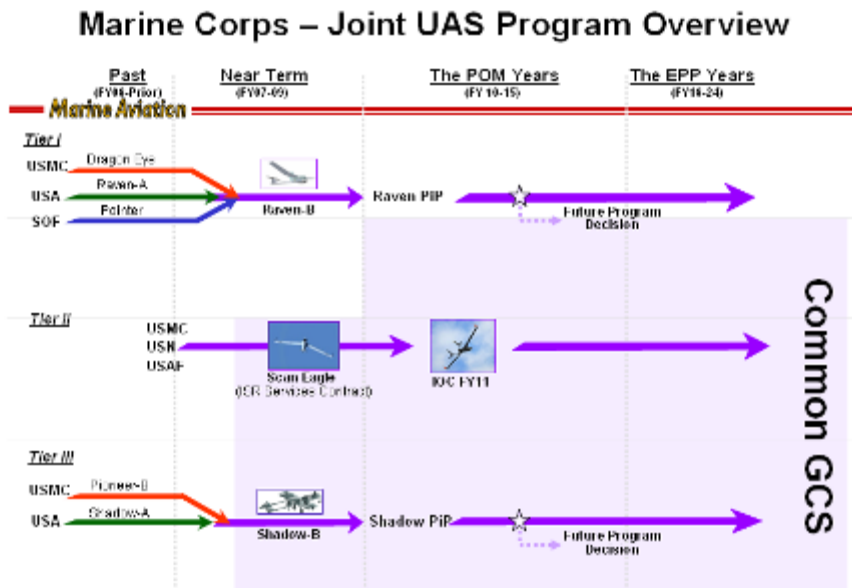

Figure 52. Marine Corps Joint UAS Program (From [83])

3. U.S. Army Tiers

- Tier I: Small UAV. Role filled by the RQ-11A/B Raven.
- Tier II: Short Range Tactical UAV. Role filled by the RQ-7A/B Shadow 200.
- Tier III: Medium Range Tactical UAV. Role currently filled by the RQ-5A/MQ-5A/B Hunter and IGNAT/IGNAT-ER, but transitioning to the Extended Range Multi-Purpose (ERMP) MQ-1C Warrior [84].

Obviously, tier definitions differ for every branch. For example, Tier III for the U.S. Army is a Medium Range Tactical UAS, but for the Air Force Tier III- is a high altitude, long endurance low-observable UAS.

D. CURRENT AND FUTURE UAS ROLES AND APPLICATIONS:

1. Current UAS Military Roles

These are some of the primary missions that UAS can perform, and are payload/technology dependant:

- Airborne surveillance
- Monitoring chemical, biological and radiation attack/spread
- Battlefield damage assessment
- Local area meteorology & mapping
- Search & rescue
- Artillery correction
- Combat:
 - Suppression of enemy air defenses (SEAD) (mobile targets)
 - Support jamming
 - Offensive air-to-air
 - Offensive air-to-ground
 - Third party targeting /designation

Many UAS are designed and used for intelligence, surveillance and reconnaissance (ISR) missions. There are different types of ISR missions, which may either be multi-intelligence, high altitude and long endurance missions conducted by the Global Hawk, or “over-the-hill” reconnaissance by the Raven UAS [85].

In 2003, 100 percent of DoD's major UAS programs were designed for conducting ISR missions.

Table 9. UAS Inventory in the U.S. Services (From [85])

UAV	Sponsoring Service	Inventory (Feb 03)
Global Hawk	Air Force	4
Predator	Air Force	48
Pioneer	Navy/Marine Corps	47
Hunter	Army	43
Shadow	Army	21
Total		163

Source: OSD UAV Planning Task Force, February 2003

In 2005, 87 percent (12 of 16) major programs were designed for ISR missions. By comparing two years, we can see the rapid growth in overall UAS programs. Most of the ISR UAS have almost the same electro-optical and infrared sensors. But they have different service levels, communications ranges, flight endurance times and landing/takeoff procedures for different types of ISR missions [75].

Table 10. UAS Capabilities (From [75])

Vehicle	Endurance (hrs)	Max Altitude (ft)	Max Speed (kt)	Range (nm)	Additional Sensor	User
Eagle Eye	5.5	20000	210	110	MMR	Coast Guard
I-Gnat-ER	30	25000	120	150	None	Army
Maverick	7	10300	118	175	None	SOCOM
MQ-1	24	25000	118	500	SAR	AF
MQ-5B	18	18000	106	144	None	Army
Neptune	4	8000	84	40	None	SOCOM
RQ-2	5	15000	110	100	None	Navy/MC
RQ-4A	32	65000	350	5400	SAR/MTI	AF
RQ-4B	28	60000	340	5400	SAR/MTI, SIGNIT	AF
RQ-5A	12	15000	106	144	None	Army
RQ-7A	5	14000	110	68	None	Army
RQ-7B	7	15000	105	68	None	Army
RQ-8	6	20000	125	150	LDFR	Army/Navy
XPN-1	2	10000	87	40	None	SOCOM
XPN-2	8.5	10000	75	40	None	SOCOM

Source: OSD. 2005-2030 UAS Roadmap. August 2005, p.4-25.

In recent years, UAS started taking active roles in the combat arena. The first public acknowledgment was when the CIA used an armed Predator with a Hellfire missile against Al-Qaeda in Yemen in 2002. Now, UAS combat capability is increasing. For example, most of the Predator A UAS have been equipped with Hellfire missiles; Predator B is able to carry more munitions; the Maverick, I-Gnat-ER, Fire Scout and Hunter UAS are undergoing armament evaluations. The J-UCAS program is being designed just for offensive applications. Using UAS for air-to-ground missions appears inherently safer due to lack of risk to human life [77].

Today's technology is not still mature enough for air-to-air missions, but in March 2003 a small step forward was made. A Predator armed with a Stinger fired a missile against an Iraqi MiG, and the MiG also fired a missile. Naturally, the MiG won the battle—for now. This was the first reported air-to-air engagement ever by a UAS. In the future, manned aircraft may not fare so well [77].

Other military missions that UAS can perform are electronic attack, in which there are some new developments, and psychological operations, such as dropping leaflets. UAS can also be used for logistic and medical applications. The Army's Shadow has been studied for its capability to deliver critical medical supplies to the battlefield.

UAS are intended also to be used for homeland defense and homeland security. The Coast Guard and U.S. Border Patrol already have plans to deploy UAS. They will use the Eagle Eye and Predator to watch coastal waters, patrol the U.S. borders, and protect major oil and gas pipelines. Congress supports use of the Predator for border security [77].

Farther in the future, large UAS will be able to perform the air refueling mission that is now performed by manned air refueling tanker aircraft. This mission in some respects appears to be well suited for unmanned aircraft. Except for the refueling boom operator, the job of the crew is to keep the aircraft flying straight, level, and at a steady speed within a constrained airspace. This can be easily accomplished by an unmanned system. Automated connection systems could easily replace the boom operator.

Additionally, future UAS can be used as communication relays to substitute for low-orbiting satellites, reducing the high cost required for space launches [77].

The Unmanned Road Map 2007-2032 provides a very detailed categorization for current and future applications for UAS. This is pictured in Figure 53.

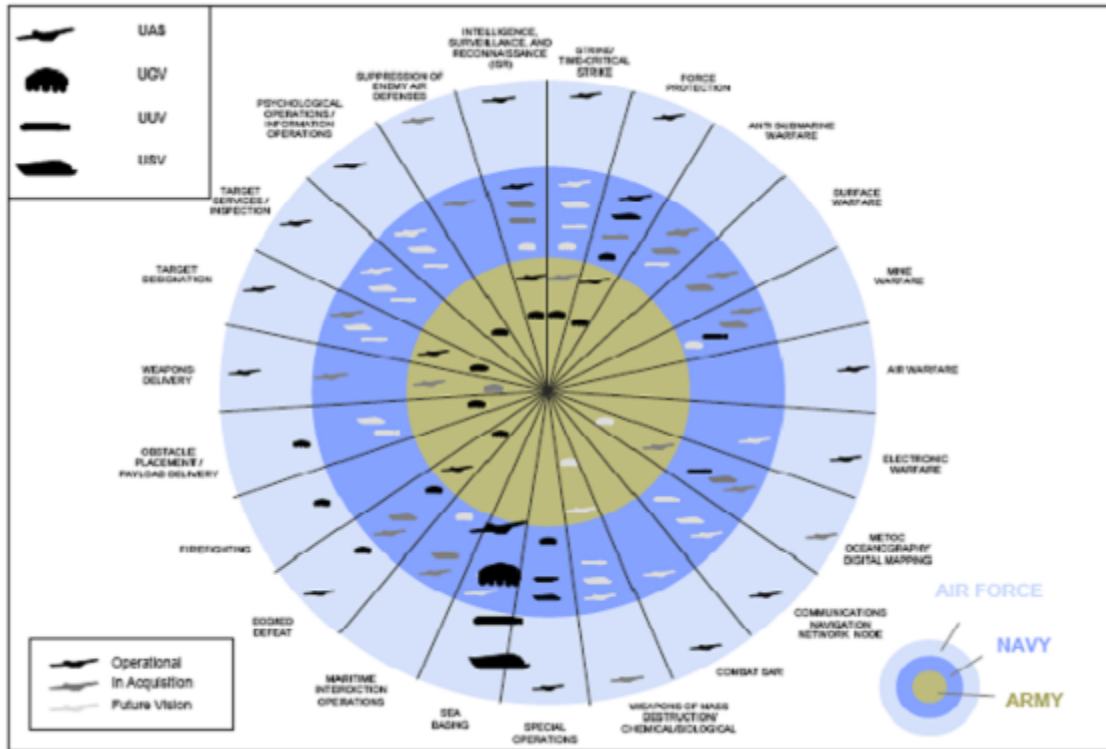

Figure 53. DoD Unmanned, Present and Future Roles (From [75])

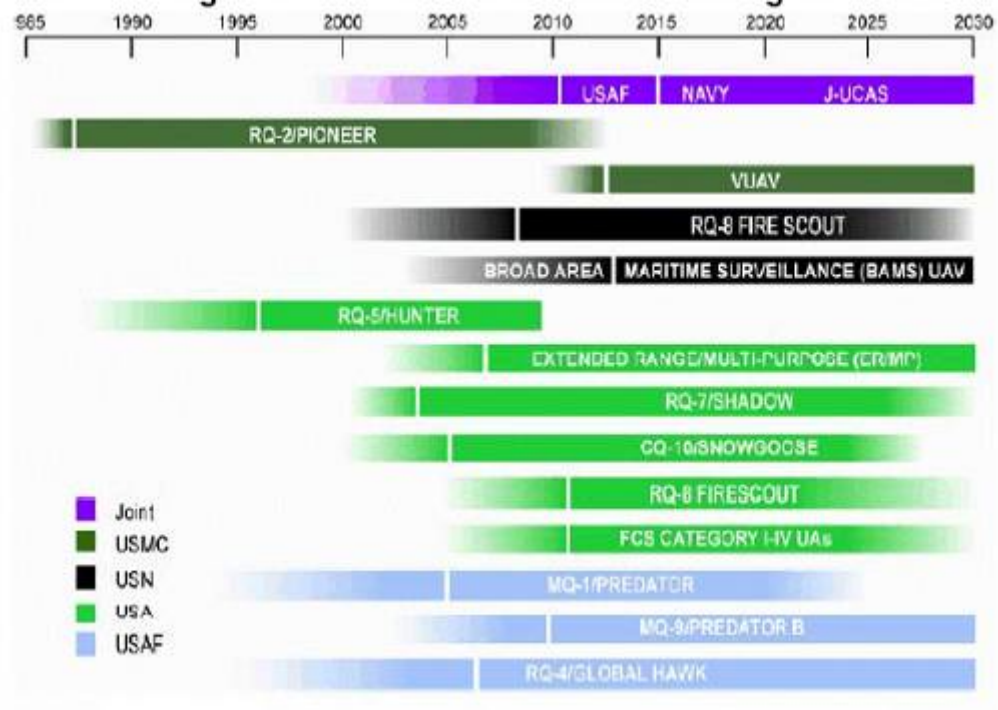

Figure 54. Current and Planned UAS Programs (From [5])

Source: OSD, UAS Roadmap 2005-2030, August 2005, Section 2, p. 3.

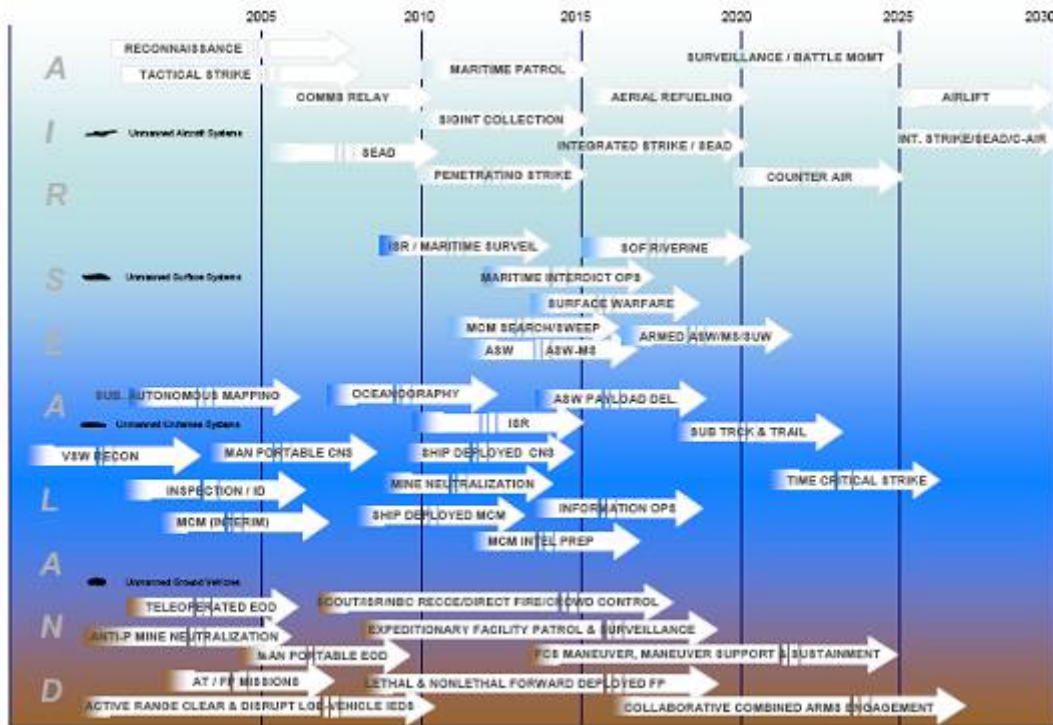

Figure 55. Joint Services Roadmap for Achieving DoD Vision for Unmanned Systems (From [75])

2. UAS Civilian Roles

When we read through the pages of UAS history, we see that until lately UAS were almost always used for military applications. Some of these capabilities could also be used in the civilian arena. Right now there is an existing demand for UAS for real-time remote sensing, both at the national and the international level. Surveillance and reconnaissance are the most demanded mission types in the civil market. But the civilian market for UAS lags behind the military. Civilian UAS applications are less than 15% of the total UAS market. This is mostly because of the certification and regulatory issues [86]. Simply stated, UAS cannot fly in the U.S. outside of very restricted areas.

There are some key challenges facing the civil UAS community: civil safety and environment certification, standards for manufacturing and operating of UAS, radio frequency spectrum management, export controls and insurance.

Small, hand-launched, fixed-wing UAS are the best candidates for various civil and commercial applications. Moreover they are not overly expensive [87].

The following are some of the areas that may benefit most from UAS in the civil arena:

- Fire-fighting
- Disaster assessment and management
- Life search and rescue
- Border surveillance
- Police surveillance
- Counter terrorism operations
- Large scale public outdoor events surveillance
- Important objects and VIP guard
- Ground and sea traffic surveillance
- Environmental control and monitoring (including air and sea pollution)
- Telecommunications
- Crop monitoring
- Animal surveillance
- Fisheries protection
- Mineral exploration
- Ground mapping and photography
- Meteorological observation
- Pipeline and power line monitoring
- Freight carrying [87]

Security of the homeland, border control & public events, maintenance/security of oil and gas pipelines, and communications are all potential missions related to counter-terrorism. Governments attempt to determine the best methods to secure their nations against terrorist attacks. In this case, UAS are the best options for continuous surveillance over these areas without overloading human operators.

Long-duration law enforcement surveillance came to the attention of the U.S. Department of Transportation in October 2002 after the sniper attacks in Washington, D.C. They have studied possible security roles for UAS, such as following trucks with hazardous cargo and security surveillance of a specific area. The Department of Energy has been developing high-altitude instruments that can be carried on a UAS in order to measure radiation in the atmosphere. Using UAS for forest fires throughout sparsely populated areas is also an option. After the devastation wrought by Hurricane Katrina, another idea is to use large UAS like Global Hawk as a “consequence management” tool. South Korea and Japan have used UAS for more than a decade for agricultural purposes like crop monitoring and dusting. This is a good example for other countries [77].

E. UAS NETWORKING

UAS control is a critical issue and has a direct effect on the use of UAS. Direct line-of-sight (LOS) or satellite link beyond-line-of-sight (BLOS) are common techniques for UAS control. Network technologies and a special branch of networks known as Mobile Ad Hoc Networks (MANET) have the potential for controlling UAS over networks via mobile network nodes. The GCS can be one of these network nodes, launching and recovering UAVs. Forward deployed teams can take over the control of the UAS for the mission in the target area. Another alternative is for manned aircraft to be used for controlling UAS from launch site to target area and flying the mission in the target area. “The technology to establish a MANET and control the UAS over the network already largely exists, which enables the military to gain BLOS capability with LOS technology.” [88]

F. UAS PLATFORMS

Recently, there has been a large amount of growth in the number and variety of UAS platforms. A conservative estimate gives around 450 individual platform types developed by international industrial, research and scientific organisations. “This number excludes target drones and also the large numbers in development in the education sector.” [89] If we include target drones and those which are still under development, this number exceeds 750 [90].

Table 11. World's Unmanned Aircraft Systems List (From [90])

Country	Producer (s) / Developer(s)	System Designation	Category	Remarks	Class	Air-frame	Status	Max. Speed (km/h)	Endurance (hours)	Range (km)	MTOW Max. (kg)	Payload Capacity
01	Argentina	Nostromo Defensa	Yarara	04-SR	M	FW	▲●	150	4	20	22	5
02	Australia	AAI Corp - Aerosonde	Aerosonde Mk III & IV	08-LALE	CC	FW	▲	150+	24+	3000+	15	Up to 5
03	Australia	ADI (Thales subsidiary)	Cybird-2	04-SR	M	FW	◆	420	1.5			
04	Australia	ADI (Thales subsidiary)	Jandru	04-SR	M	FW	◆	350	4+			35+
05	Australia	ADRO	Pelican Observer	03-CR	CC	FW	●	220	1-12		27.2	13.6
06	Australia	BAE Systems	Nulka	03-CR	M, DV	RW	▲				67.5	
07	Australia	BAE Systems & University of Sydney	Brumby Mk3	05-MR	RV	FW	▲●	185	2		45	7
08	Australia	BAE Systems & University of Sydney	Kingfisher Mk1	04-SR	RV	FW	▲●	185	3	64-185	60	12
09	Australia	BAE Systems & University of Sydney	Kingfisher Mk2	04-SR	RV	FW	▲●	185	14		115	30
10	Australia	Codarra Advanced Systems	Avatar	02-Mini	DP	FW	▲	50	1	10	6	1
11	Australia	CSIRO	Mantis	02-Mini	DP	RW	●		0.3		8	0.08
12	Australia	Entecho	Demipod	04-SR	DV	SRW	●	120(CS)	6		200	100
13	Australia	Entecho	Mupod	02-Mini	DV	SRW	●	120(CS)	2		10	5
14	Australia	Silverstone, Australia & AUVIA, USA	Flamingo	04-SR	DV	FW	●				20	
15	Australia	Sonacom & University of Sydney	Mirli	05-MR	DP	TB	▲●	370	5	1000	300	100
16	Australia	University of South Australia & Aerospace Sciences Corp.	Tandem Wing	03-CR	Twin-Wing	CC	FW	▲●				
17	Australia	V-TOL Aerospace	Hammerhead	03-CR	DV	TR	●		0.3		9	4
18	Australia	V-TOL Aerospace	i-copter Phantom	03-CR	CC	RW	●	180	2-12		250	Up to 135
19	Australia	V-TOL Aerospace	i-copter Seeker	03-CR	CC	RW	●	130	1.5-2		35-40	
20	Austria	Schiebel Elektronische Geräte	Camcopter	04-SR	DP	RW	▲	90 (CS)	6	10	68	25
21	Austria	Schiebel Elektronische Geräte	Camcopter S-100	05-MR	M	RW	▲	220	6	130	200	50
22	Belgium	Flying-Cam	FlyingCam	02-Mini	CC	RW	▲	120	0.25	0.35	15	
23	Brazil	Gyron Systemas Autonomas	Helix	04-SR	DV	RW	◆					
24	Brazil	Flight Solutions	FS-01 Watchdog	04-SR	DV	FW	●	190		70		25
25	Brazil	Flight Solutions	FS-02	03-CR	DV	FW	●				3	
26	Brazil	Flight Solutions	FS-03	05-MR	DV	RW	●				250	113
27	Bulgaria	Aviotechnica	Yastreb	03-CR	M	FW	▲?	180	1.5	50	66	4.5
28	Canada	Advanced Subsonics	Grasshopper	02-Mini	DP	FW	●	83	2		8.2	2.3
29	Canada	MicroPilot	MP-Trainer	02-Mini	DP	FW	■					0.9
30	Canada	MicroPilot	MP-Vision	02-Mini	DP	FW	■	60	0.9	4	2.7	
31	Canada	MMIST	SnowGoose	05-MR	M	Prf	▲	60		450	609	250
32	Chile	Chilean Air Force Polytechnical Academy	Vantapa X-02	05-MR	DP, DV	FW	●	150(CS)	7		150	
33	China (PR)	Beijing Strong Science & Technology Development	AW 12	02-Mini	M	FW	■					
34	China (PR)	Beijing Strong Science & Technology Development	AW 2 Sun Ying	02-Mini	M	FW	■	40-120	1.3	5	10	
35	China (PR)	Beijing Strong Science & Technology Development	AW 4 Shark	03-CR	M	FW	■					
36	China (PR)	Beijing University of Aeronautics & Astronautics	M-22	03-CR	M, DV	RW	●?		1.5		50	
37	China (PR)	Beijing University of Aeronautics & Astronautics	VT-UAV Seagull	04-SR	M	RW	▲●?					
38	China (PR)	Beijing University of Aeronautics & Astronautics	WZ-5	07-LADP	M	FW	▲	800	3	2500	1700	
39	China (PR)	Guizhou Aircraft Ind. Corp. (formerly WZ-9)	WZ-2000	10-HALE	M	FW	▲	800			1700	80
40	China (PR)	NRIST	I-Z	02-Mini	M	RW	▲	100	1		9	
41	China (PR)	NRIST	PW-1	05-MR	?	FW	?	180	6	100	210	30
42	China (PR)	NRIST	PW-2	05-MR	?	FW	?	180	7	200	210	30
43	China (PR)	NRIST	W-30	03-CR	M	FW	▲?	150	4	10	18	5
44	China (PR)	NRIST	W-50	05-MR	M	FW	▲?	180	4-6	100	95	20
45	China (PR)	NRIST	Z-2	03-CR	M	RW	■	108	1		35	10
46	China (PR)	NRIST	Z-3	04-SR	M	RW	●?		4	100	130	30
47	China (PR)	NUAA	Soar Bird	05-MR	M	RW	■	150(CS)			310	
48	China (PR)	Xi'An ASN Technology Group	ASN-104/105	05-MR	M	FW	▲	250	2	60/100	140	30/40
49	China (PR)	Xi'An ASN Technology Group	ASN-105B	05-MR	M	FW	●	200	7	150	170	40
50	China (PR)	Xi'An ASN Technology Group	ASN-15	02-Mini	M	FW	▲	80	1		6.5	
51	China (PR)	Xi'An ASN Technology Group	ASN-206	05-MR	M	FW	▲	210	4-8	150	222	50
52	China (PR)	Xi'An ASN Technology Group	ASN-207	06-MRE	M	FW	■	180	16	600	410-480	30-100
53	Colombia	EAFIT University	Colibri Project	02-Mini	RV	FW	●				8	
54	Colombia	EPiGENIA Aerospace Robotics	EJ-1B MOZART	02-Mini	DV	RW	●					
55	Croatia	Defense Research Est.	BL-50	05-MR	M	FW	●	110	5		53	

CR = Close Range	AirL = Air-Launched	M = Military	TW = Tilt Wing
SR = Short Range	B/C = Bacteriological & chemical sensing	NM = Not Motorised	UCAR = Unmanned Combat Aerial Rotorcraft
MR = Medium Range	CC = Civil/Commercial	OFF = Offensive	VSTOL = Vertical Take-Off & Landing
MRE = Medium Range Endurance	CL = Container Launched	OPA = Optionally Piloted Aircraft	VTOL = Vertical Take-Off & Landing
LADP = Low Altitude Deep Penetration	CRW = Canard Rotary Wing	Prf = Parafoil	
LALE = Low Altitude Long Endurance	CS = Cruising Speed	RATO = Rocket Assisted Take-Off	▲ = Proof-of-concept/demonstrator
MALE = Medium Altitude Long Endurance	DP = Dual Purpose - civil/military	RV = Research Vehicle	● = In inventory and/or in service
HALE = High Altitude Long Endurance	DV = Developmental Vehicle	RW = Rotary Wing	▲ = Ordered/Entering service
UCAV = Unmanned Combat Aerial Vehicle	EW = Electronic Warfare	SRW = Shrouded Rotary Wing	◆ = Ordered as test/demo system
STRA = Stratospheric	Ex = Expendable	LIA = Lighter than Air	● = Development continuing
EXO = Exo stratospheric	FLW = Flapping Wing	TB = Tilt Body	◆ = No longer in production/development
	FW = Fixed Wing	TR = Tilt Rotor	■ = Developed & market ready

Country	Producer (s) / Developer(s)	System Designation	Category	Remarks	Class	Air-frame	Status	Max. Speed (km/h)	Endurance (hours)	Range (km)	MTOW (kg)	Payload Capacity Max. (kg)
56 Croatia	Soko	B3	04-SR		DP, DV	FW	●	106 (CS)	9		220	
57 Croatia	Soko	B4	04-SR		DP, DV	FW	●	120 (CS)	12		220	
58 Czech Rep.	VTUL a PVO	Sojka III	04-SR		M	FW	▲	207	2	100	145	25
59 Finland	Patria	Mini-UAV	02-Mini	Electric	M	FW	●	120	1	20	3,5	0,5
60 France	ABS Aerolight	Maxi	03-CR		DP, DV	Prf	●	18-65	1		25	15-30
61 France	ABS Aerolight	Pky	03-CR		DP	Prf	▲	60	1		5,6(10,5)	
62 France	AeroDrones	Aerodrone	02-Mini		DV	RW	●					
63 France	Alcore Technologies	Azimat2001	03-CR		M, DV	FW	●	120	1,5	50	9	2,5
64 France	Alcore Technologies	Biodrone	03-CR		M, DV	FW	●	120	1,5	50	12	3,5
65 France	Alcore Technologies	Chacal 2	05-MR		M, DV	FW	●	280	3	700	85	10
66 France	Alcore Technologies	Drone Futura	05-MR		M, DV	FW	●	360	1	300	70	10
67 France	Alcore Technologies	Easycopter	02-Mini		M, DV	RW	●		0,15	1	1,6	
68 France	Alcore Technologies	Epsilon 1	01-Micro		M, DV	FW	●	60	0,15	1	0,45	0,1
69 France	Alcore Technologies	Maya	02-Mini		M, DV	FW	●	108	0,5	50	2,5	0,5
70 France	Bertin Technologies	Flying Ball	02-Mini		M, DV	SRW	▲	30	0,5		1,5	0,2
71 France	Bertin Technologies	FlowerEye	02-Mini		M, DV	RW	●		0,15	0,3	3,5	
72 France	Dassault Aviation	AVE C (Petit Duc C)	05-MR		DV	FW	▲				60	
73 France	Dassault Aviation	AVE D (Petit Duc)	05-MR		DV	FW	▲	M 0.5		150	60	
74 France	DSTU (Dassault Aviation & Sagem)	SlowFast UAV	05-MR		DV	FW	▲				60	
75 France	EADS Military Aircraft	EuroMALE	09-MALE	Euro partners sought	M	FW	●			24	1500	450
76 France	EADS Military Aircraft & Dyn'Aéro (airframe)	Surveyor2500	05-MR	OPA	DP	FW	●	360	12	185	450-750	100
77 France	EADS Military Aircraft & Eurocopter (airframe)	Orka 1200	05-MR		M, DV	RW	●	195	8	185	680	180
78 France	EADS Military Aircraft & IAI, Israel	Eagle 1	09-MALE		M	FW	◆	220	30	1700	1200	250
79 France	EADS Military Aircraft & IAI, Israel	Eagle 2	09-MALE		M	FW	●	460	24	2900	3600	450
80 France	EADS Military Aircraft & SurveyCopter	Scorpio 30	04-SR		DP	RW	■	50 (CS)	2	10	38	15
81 France	EADS Military Aircraft & SurveyCopter	Scorpio 6	04-SR		DP	RW	▲	35 (CS)	1	10	13	6
82 France	EADS Military Aircraft & SurveyCopter	Tracker	03-CR		M	FW	○	60 (CS)	2+	10	8,2	1
83 France	EADS Military Aircraft (former CAC Systems; ceased trading 2003)	Fox MLCS AT2	04-SR		M	FW	▲	180	3	50	90	15
84 France	ECT Industries & ISNAV	Helix M	05-MR	Naval VTOL	M, DV	RW	▲	200	5	200	550	150
85 France	EuroMC	Aero-Drone 50	02-Mini		M, DV	SRW	●	36 (CS)	0,3		1,5	
86 France	EuroMC	Aero-Drone 70	02-Mini		M, DV	SRW	●	36 (CS)	0,3		1,85	
87 France	EuroMC	Aero-Drone 120	02-Mini		M, DV	SRW	●	36 (CS)	0,3		6	
88 France	Flying Robots	FR 101	05-MR	OPA	DP	Prf	■	120	12	150	600	250
89 France	Flying Robots	FR A2	02-Mini		DP	FW	●	120	1,15	10	15	4
90 France	Flying Robots	FR E1	02-Mini		DP	FW	●	60	1	10	15	
91 France	Gates Technology	GT Aircraft	03-CR		DV	LIA	▲					
92 France	Infotron	IT 180-5 TH	02-Mini	Electric	DV	RW	●	90	1,5	5+	15	5
93 France	Infotron	IT 180-5 EL	02-Mini		DV	RW	▲	90	0,5	5	15	5
94 France	Onéra	Remanta	01-Micro		M, DV	FLW	▲				< 1	
95 France	Pix-Air & AirStar	Soulcam	02-Mini		CC	LIA	▲	20	3	1,5	90	30
96 France	Polyavionics	VULCAS	02-Mini		DV	FW	▲				20	5
97 France	PY Design	O.V.O	02-Mini		DV	LIA	▲	36	10		2	
98 France	Sagem Défense Sécurité (Safran)	Merlin	02-Mini	Twin Wing	DP	FW	●	75	1+	7+	6	0,8
99 France	Sagem Défense Sécurité (Safran)	Sperwer	05-MR		M	FW	▲	240	6+	200	350	50
100 France	Sagem Défense Sécurité (Safran)	Sperwer B	06-MRE		M	FW	●	150	12	200	350	100
101 France	Sagem Défense Sécurité (Safran)	Ugglan	05-MR		M	FW	▲	220	6		330	
102 France	Sagem Défense Sécurité (Safran) & Bertin Technologies (airframe)	Odin	02-Mini		M	SRW	●	100	0,6	1	3,2	0,2
103 France	Sagem Défense Sécurité (Safran) & Meggitt Def. Systems, UK (airframe)	Crecerelle	05-MR		M	FW	▲	240	5	200	145	35
104 France	Sagem Défense Sécurité (Safran) & Meggitt Def. Systems, UK (airframe)	Crecerelle EW	05-MR	EW	M	FW	▲	240	5		145	
105 France	Sagem Défense Sécurité (Safran) & Onéra, France & Stemma, Germany (airframe)	Busard	06-MRE	OPA	CC, RV	FW	●		20	180+	1100	
106 France	Survey-Copter	Copter 1	02-Mini		DP	RW	▲		0,5			5-7
107 France	Survey-Copter	Copter 1b	02-Mini		DP	RW	▲	70	0,75	1-8	12-15	5,5
108 France	Survey-Copter	Copter 4	03-CR	2 Engines	DP	RW	▲	70	1	1-8	25	10
109 France	Survey-Copter	DVF-2000	02-Mini	Electric	DP	FW	■	90	1,5	6	7	1
110 France	Technisolar-Seni	Bourdon	02-Mini		M, DV	FW	■	20-60	1		7	
111 France	Technisolar-Seni	Buteo	02-Mini		M, DV	SRW	■					
112 France	Technisolar-Seni	Coccinelle	01-Micro		M, DV	FW	▲					
113 France	Technisolar-Seni	D.E.R.E.	02-Mini	Solar/Electric	M	FW	▲	60 (CS)	0,5	1,5	2,5	
114 France	Technisolar-Seni	Eclairer	02-Mini		M, DV	FW	▲	120 (CS)	1	10	25	
115 France	Technisolar-Seni	Libellule	10-HALE	Solar/Electric	M, DV	FW	▲				4	
116 Germany	AirRobot	Mikado	01-Micro	4 RW	DP,DV	RW	▲		0,3+	0,5	1	

CR = Close Range	AirL = Air-Launched	M = Military	TW = Tilt Wing
SR = Short Range	B/C = Bacteriological & chemical sensing	NM = Not Motorised	UCAR = Unmanned Combat Aerial Rotorcraft
MR = Medium Range	CC = Civil/Commercial	OFF = Offensive	VSTOL = Very Short Take-Off & Landing
MRE = Medium Range Endurance	CL = Container Launched	OPA = Optionally Piloted Aircraft	VTOL = Vertical Take-Off & Landing
LADP = Low Altitude Deep Penetration	CRW = Canard Rotary Wing	Prf = Parafall	
LALE = Low Altitude Long Endurance	CS = Cruising Speed	RATO = Rocket Assisted Take-Off	▲ = Proof-of-concept/demonstrator
MALE = Medium Altitude Long Endurance	DP = Dual Purpose - civil/military	RV = Research Vehicle	▲ = In inventory and/or in service
HALE = High Altitude Long Endurance	DV = Developmental Vehicle	RW = Rotary Wing	○ = Ordered/Entering service
UCAV = Unmanned Combat Aerial Vehicle	EW = Electronic Warfare	SRW = Shrouded Rotary Wing	◆ = Ordered as test/demo system
STRA = Stratospheric	Ex = Expendable	LIA = Lighter than Air	● = Development continuing
EXO = Exo stratospheric	FLW = Flapping Wing	TB = Tilt Body	○ = No longer in production/development
	FW = Fixed Wing	TR = Tilt Rotor	■ = Developed & market ready

Country	Producer (s) / Developer(s)	System Designation	Category	Remarks	Class	Air-frame	Status	Max. Speed (km/h)	Endurance (hours)	Range (km)	MTOW (kg)	Payload Capacity Max. (kg)	
117	Germany	AirRobot	AR70	01-Micro	4 RW - Electric	DP/DV	RW	▲●		0,3	0,5	1	0,2
118	Germany	Diehl (see Microdrones, Germany)	SensoCopter	01-Micro	4 RW - Electric	DP/DV	RW	▲●					
119	Germany	EADS Military Aircraft	Barrakuda	11-UCAV		M, DV	FW	▲●					
120	Germany	EADS Military Aircraft	D0-MAV	01-Micro		M	FW	■	50	0,5	1,5	0,5	
121	Germany	EADS Military Aircraft	Midas	01-Micro		DV	FW	▲●	40	0,5		0,2	
122	Germany	EADS Military Aircraft	QuattroCopter	01-Micro		M, DV	FW	▲●	40	0,5		0,5	
123	Germany	EMT	Aladin	02-Mini		M	FW	▲	90	0,5+	5	3,2	
124	Germany	EMT	FanCopter	01-Micro		M	SRW	▲●	50	0,3+	0,5+	1,3	
125	Germany	EMT	LUNA	04-SR		M	FW	▲	70 (CS)	3+	65	40	3
126	Germany	EMT	Mikado	02-Mini		M, DV	FW	●		0,25+	0,5	0,5	
127	Germany	EMT	X13	05-MR	Heavy Fuel	M, DV	FW	●	180	6	200	130	
128	Germany	Inmar Navigation	IFF-4.5	05-MR		M, DV	RW	●	300	10		220	
129	Germany	Mavionics	Carolo C40	02-Mini	Electric	M, DV	FW	■	36	0,25	0,5	0,45	0,03
130	Germany	Mavionics	Carolo P200	02-Mini	Electric	M, DV	FW	■	55 (CS)	1		4	
131	Germany	Mavionics	Carolo P330	02-Mini	Electric	M, DV	FW	■	108	1		5	0,4
132	Germany	Mavionics	Carolo P50	02-Mini	Electric	M, DV	FW	■	90	0,33		0,53	0,05
133	Germany	Mavionics	Carolo P70	02-Mini	Electric	DP	FW	■	80	0,33		0,55	0,1
134	Germany	Mavionics	Carolo T140	02-Mini	Electric	DP	FW	■	70	0,75		1,85	0,3
135	Germany	Mavionics	Carolo T200	02-Mini	Electric	DP	FW	■	90	0,75		4,5	1
136	Germany	Microdrones (see Diehl)	Md4-1000	02-Mini	Electric	DP	RW	●					
137	Germany	Microdrones (see Diehl)	Md4-200	02-Mini	4 RW - Electric	DP	RW	●		0,3	0,5	1,1	0,2
138	Germany	Rheinmetall Defense Electronics	Fledermaus	05-MR	EW, RATO	M	FW	▲☐	120	3,5	100	161	35
139	Germany	Rheinmetall Defense Electronics	Kolibri (Hummingbird)	02-Mini		M	RW	●				1,6	
140	Germany	Rheinmetall Defense Electronics	KZO	05-MR	RATO	M	FW	▲	220	3,5+	100	161	35
141	Germany	Rheinmetall Defense Electronics	Mücke	05-MR	RATO	M	FW	▲☐	180	5	100	168	
142	Germany	Rheinmetall Defense Electronics	Opale	05-MR	Diesel, OPA	DP	FW	■		12	200	3750	
143	Germany	Rheinmetall Defense Electronics	Tares (Taifun)	05-MR	OFF	M, DV	FW	●		4	200	160	50
144	Germany	SIM Security & Electronic Systems	Air-Robot	02-Mini		M	RW	■					
145	Germany	ScaleCopter	CamClone	02-Mini		DP	RW	●	160	1,1	20	41,6	10
146	Germany	UAV Services & Systems	X-Sight	02-Mini		DP	FW	●	180	3	45	16	6
147	Greece	EADS - 3 Sigma	Nearchos	05-MR		DV,DP	FW	▲●	220	8-12	240	190	51-92
148	Hungary	HI Aero	Gabbiano	02-Mini	Electric	DP	FW	▲		2	15	4,5	
149	India	ADE Bangalore	Kapothaka	03-CR		M, DV	FW	●	180	1,5		125	
150	India	ADE Bangalore	Nishant	05-MR		M, DV	FW	▲	185	4,5	100	375	60
151	India	Speck Systems	BAAZ	02-Mini		M, DV	FW	●	60	1	10	7	
152	International	ADE Bangalore, India & IAI, Israel	Gagan	05-MR		M	?	▲▲▲			250		
153	International	ADE Bangalore, India & IAI, Israel	Pawan	05-MR		M	?	▲▲▲		5	150	120	
154	International	ADE Bangalore, India & IAI, Israel	Rustam	05-MR		M	?	▲▲▲		24+	300	1100	
155	International	Airscan Consortium (EC funded)	Airscan	04-SR		CC	LA	▲▲▲					
156	International	Aicatel, Belgium & Vito, Belgium & Verhaert, Belgium & QinetiQ, UK	Pegasus	12-STR	Solar/Electric	CC	FW	▲●				27	
157	International	Composites Technology, Malaysia & BAE Systems, USA	Eagle 150	05-MR	OPA	DP	FW	▲	246	10	250	648	60
158	International	Dassault Aviation, France & Euro Consortium	Neuron	11-UCAV		M, DV	FW	▲●●				2270	
159	International	EADS MA, France - Germany & Bombardier, Canada	CL-289	07-LADP		M	FW	▲☐	740 (CS)	0,5	180-200	240	30
160	International	EADS MA, France & Galileo Avionica, Italy	Carapas (Surveyor 600)	07-LADP	EW	M	FW	▲●●	972			330	
161	International	EADS MA, Germany & Northrop Grumman, USA	EuroHawk	10-HALE		M, DV	FW	●	555	30	3000	14000	
162	International	European Consortium	MAVDEM Project	01-Micro		M, DV	RW	▲					
163	International	Galileo Avionica, Italy & General Atomics-AS, USA	Predator-IT	09-MALE		M	FW	▲		24		1020	
164	International	IAI-Malat, Israel & Sonaca, Belgium	Hunter B	05-MR		M	FW	▲	200	8	200	727	113
165	International	IMI, Israel & Brunswick Defence, USA	Delilah	05-MR	OFF, AirL	M	FW	▲	800			185	30
166	International	IMI, Israel & Brunswick Defence, USA	Delilah AR	05-MR	OFF, CL, AirL	M	FW	▲	796			185	30
167	International	IMI, Israel & Brunswick Defence, USA	ITALD	05-MR	Decoy	M	FW	▲	925	0,6		172	
168	International	IMI, Israel & Brunswick Defence, USA	TALD	05-MR	Decoy	M	FW	▲	925	0,6		181	
169	International	Kawada, Japan & Schweizer, USA	RoboCopter 300	03-CR		CC	RW	■		1,6		794	294 Fuel Incl.
170	International	Korea Aerospace Ind., South Korea & AAI Corp, USA	Bejo	05-MR		M	FW	▲☐	150	3		130	
171	International	Northrop Grumman, USA & IAI-Malat, Israel	E-Hunter	09-MALE		M	FW	■	222	30+		998	306 Fuel Incl.
172	International	Northrop Grumman, USA & IAI-Malat, Israel	Hunter II (= Heron)	09-MALE		M	FW	●	300	30		1497	450
173	International	Northrop Grumman, USA &											

CR	= Close Range	AirL	= Air-Launched	M	= Military	TW	= Tilt Wing
SR	= Short Range	B/C	= Bacteriological & chemical sensing	NM	= Not Motorised	UCAR	= Unmanned Combat Aerial Rotorcraft
MR	= Medium Range	CC	= Civil/Commercial	OFF	= Offensive	VSTOL	= Very Short Take-Off & Landing
MRE	= Medium Range Endurance	CL	= Container Launched	OPA	= Optionally Piloted Aircraft	VTOL	= Vertical Take-Off & Landing
LADP	= Low Altitude Deep Penetration	CRW	= Canard Rotary Wing	Prf	= Parafoil	▲	= Proof-of-concept/demonstrator
LALP	= Low Altitude Long Endurance	CS	= Cruising Speed	RATO	= Rocket Assisted Take-Off	●	= In inventory and/or in service
MALE	= Medium Altitude Long Endurance	DP	= Dual Purpose - civil/military	RV	= Research Vehicle	○	= Ordered/Entering service
HALE	= High Altitude Long Endurance	DV	= Developmental Vehicle	RW	= Rotary Wing	◆	= Ordered as test/demo system
UCAV	= Unmanned Combat Aerial Vehicle	EW	= Electronic Warfare	SRW	= Shrouded Rotary Wing	●	= Development continuing
STRA	= Stratospheric	Ex	= Expendable	LIA	= Lighter than Air	☐	= No longer in production/development
EXO	= Exo stratospheric	FLW	= Flapping Wing	TB	= Tilt Body	■	= Developed & market ready
		FW	= Fixed Wing	TR	= Tilt Rotor		

Country	Producer (s) / Developer(s)	System Designation	Category	Remarks	Class	Air-frame	Status	Max. Speed (km/h)	Endurance (hours)	Range (km)	MTOW (kg)	Payload Capacity Max. (kg)
174	International IAI-Malot, Israel Northrop Grumman, USA & IAI-Malot, Israel	MQ-5B Hunter	06-MRE		M	FW	▲	222	21	100-200	816	226 Fuel Inc.
175	International NRL, USA & CybAero, Sweden	RQ-5A Hunter	05-MR		M	FW	▲	204	12	200	726	113
176	International Onéra, France & Royal Military Academy, Belgium	Apid Vantage	04-SR	Diesel	M	FW	▲	90	6		160	
177	International Politecnico Torino, Italy & Euro Consortium	Mirador	01-Micro		M, DV	FW	▲				< 1	
178	International SmartFish, Switzerland & DLR, Germany	Heliplat HyFish	12-STR 02-Mini	Solar/electric Electric	CC RV	FW FW	▲ ▲	71 (CS) 200	weeks		7200	
179	International Raytheon Systems, USA & IAI-MBT, Israel	Cutlass	05-MR	Fuel cell OFF, CL Based on Harpy	M, DV	FW	■	185 (CS)	6		135	
180	International Sagem, France & Bell, USA & Rheinmetall, Germany	Euro Eagle Eye	04-SR	Heavy Fuel	M	TR	●	400	5	1480	1350	90-135
181	International Teledyne Brown, USA & Rheinmetall DE, Germany	Prospector	05-MR	Based on KZO	M	FW	●		6		161	35
182	International Teledyne Brown, USA & Rheinmetall DE, Germany	Thunder	04-SR	OFF Based on Taifun	M	FW	●					
183	International Thales, UK & Elbit Systems, Israel	WatchKeeper 450	06-MRE		M	FW	○	176	20	200	450	150
184	International AF UAV Research & Tech Centre, UAE & CybAero, Sweden	APID 55 - UAE	04-SR		M	RW	●					
185	International AF UAV Research & Tech Centre, UAE & Schiebel, Austria	AI-Sber	05-MR		M	RW	●					
186	Iran Amirkabir University of Technology	Electric UAV	02-Mini	Electric	DV	FW	▲	120 (CS)				
187	Iran Farnas Aerospace Research Center	Sabokal	02-Mini		DV	FW	▲	55	2	5	1.3	0.35
188	Iran Iranian Aircraft Manufacturing	Ababil (-B, -T & -S)	03-CR		M	FW	▲	300-370	1.5	30-150	83	
189	Iran Iranian Aircraft Manufacturing	Mohadjer (2, 3 & 4)	03-CR		M	FW	▲	200	1.5-7	50-150	175	
190	Iran Iranian Aircraft Manufacturing	Talash (1 & 2)	02-Mini		M	FW	▲	90-120	0.5		12	
191	Iran Mechanics College of Isfahan University	Arta	05-MR		M	FW	▲	120 (CS)				
192	Israel Aero Design & Development	Heron-ADD	04-SR		M, DV	FW	●					
193	Israel Aero Design & Development	Hornet	03-CR		M, DV	RW	●	80	2	100	260	50
194	Israel Aero Design & Development	Skylark-ADD	02-Mini		M, DV	FW	●	80	1.5	10	4.6	
195	Israel Aeronautics Defense Systems	Aerolight	03-CR		M	FW	■	180	4	150	40	8
196	Israel Aeronautics Defense Systems	Aerosky	04-SR		DP	FW	▲	5	100	70	18	
197	Israel Aeronautics Defense Systems	Aerostar	04-SR	Rental Services	DP	FW	▲	200	14+	200	300	50
198	Israel Aeronautics Defense Systems	Dominator	09-MALE		M	FW	●	278	24	800	400	
199	Israel Aeronautics Defense Systems	Orbiter	03-CR		M	FW	■	138	1.5	15	6.5	1.2
200	Israel BlueBird Aero Systems	Blueye	03-CR		M	Prf	■	65	9	50	55	18
201	Israel BlueBird Aero Systems	Boomerang	02-Mini		M	FW	■	100	2	10	5	0.5
202	Israel BlueBird Aero Systems	Spyeye	03-CR		M	Prf	■	30-70	3	30	25	5
203	Israel BTA	Canard	03-CR		M, DV	FW	■	148	6	50-100	40	
204	Israel BTA	Mmi Sheddon	02-Mini		M	FW	■	130	2.5	10-50	27	
205	Israel BTA	Sheddon	03-CR		M	FW	■	130	6	50-100	40	
206	Israel Elbit - Silver Arrow	Colibri	03-CR	Trainer	M	FW	▲	161	2		36	14
207	Israel Elbit - Silver Arrow	Hermes 1500	09-MALE		M	FW	■	240	24+	200	1500	350
208	Israel Elbit - Silver Arrow	Hermes 180	05-MR		M	FW	■	194	10+	150	195	32
209	Israel Elbit - Silver Arrow	Hermes 450	06-MRE	1 or 2 Engines	M	FW	▲	176	20	200	450	150
210	Israel Elbit - Silver Arrow	Hermes 700	06-MRE		M, DV	FW	▲				700	
211	Israel Elbit - Silver Arrow	Micro-Vee	03-CR		M	FW	■	204	5	50	55	8.2
212	Israel Elbit - Silver Arrow	Seagull	02-Mini		M	FW	■	74	24	5-10	5.5	
213	Israel Elbit - Silver Arrow	Skylark I	02-Mini	Electric	M	FW	▲	72	2	5-10	5.5	
214	Israel Elbit - Silver Arrow	Skylark II	02-Mini	Electric	M	FW	●					
215	Israel Elbit - Silver Arrow	Sniper	05-MR		M	FW	■	120	6		155	
216	Israel Elbit + IAI + Urban Aerospace	Mule	04-SR		DP	SRW	▲	185	3-5		1725	
217	Israel EMIT Aviation	Blue Horizon II	05-MR	Sold to ST Aerospace	M	FW	▲	220	10	150	180	37
218	Israel EMIT Aviation	Butterfly	04-SR		M	FW	●	55	4		450	230
219	Israel EMIT Aviation	DragonFly 2000	05-MR		M	FW	●	200	14		140	16
220	Israel EMIT Aviation	Mercury 3	09-MALE		M	FW	●	260	30		550	150
221	Israel EMIT Aviation, Israel & Cradance, Singapore	Sparrow N	04-SR		M	FW	■	180	4-6	20-120	45	12
222	Israel IAI-Malot	Bird Eye 100	03-CR		M	FW	■	150	1	5	1.3	0.3
223	Israel IAI-Malot	Bird Eye 400	03-CR		M	FW	■		1.2	15	4.1	
224	Israel IAI-Malot	Bird Eye 500	03-CR		M	FW	■	110	1	10	5	0.85
225	Israel IAI-Malot	E-Hunter	09-MALE		M	FW	■	200	25	200	954	114
226	Israel IAI-Malot	Eitan	10-HALE		M	FW	▲					
227	Israel IAI-Malot	EyeView B	04-SR		DP	FW	■	111 (CS)	6		154	
228	Israel IAI-Malot	Firebird	04-SR		DP	FW	■	111 (CS)	6		154	
229	Israel IAI-Malot	Harpy	05-MR	OFF, CL	M	FW	▲	250	2	500	135	
230	Israel IAI-Malot	Heron (Mahatz)	09-MALE		M	FW	▲	231	40	1000	1100	250
231	Israel IAI-Malot	Heron TP (Heron II)	09-MALE		M	FW	●	450	30		5300	1800
232	Israel IAI-Malot	Hunter	05-MR		M	FW	▲	148 (CS)	12	100/200	727	114
233	Israel IAI-Malot	I-SEE	02-Mini		M	FW	■		0.75-1	5-10	7.5	0.8
234	Israel IAI-Malot	I-VIEW	04-SR		M	FW	○		4-6	50-80	165	20-30
235	Israel IAI-Malot	Mastiff 3	03-CR		M	FW	▲	185	7.5	135	138	37
236	Israel IAI-Malot	Mosquito 1	01-Micro		M	FW	●		Up to 1	1	0.5	

CR	= Close Range	AirL	= Air-Launched	M	= Military	TW	= Tilt Wing
SR	= Short Range	B/C	= Bacteriological & chemical sensing	NM	= Not Motorised	UCAR	= Unmanned Combat Aerial Rotorcraft
MR	= Medium Range	CC	= Civil/Commercial	OFF	= Offensive	VSTOL	= Very Short Take-Off & Landing
MRE	= Medium Range Endurance	CL	= Container Launched	OPA	= Optionally Piloted Aircraft	VTOL	= Vertical Take-Off & Landing
LADP	= Low Altitude Deep Penetration	CRW	= Canard Rotary Wing	Prf	= Parafoil		
LALE	= Low Altitude Long Endurance	CS	= Cruising Speed	RATO	= Rocket Assisted Take-Off	▲	= Proof-of-concept/demonstrator
MALE	= Medium Altitude Long Endurance	DP	= Dual Purpose - civil/military	RV	= Research Vehicle	▲	= In inventory and/or in service
HALE	= High Altitude Long Endurance	DV	= Developmental Vehicle	RW	= Rotary Wing	○	= Ordered/Entering service
UCAV	= Unmanned Combat Aerial Vehicle	EW	= Electronic Warfare	SRW	= Shrouded Rotary Wing	◆	= Ordered as test/demo system
STRA	= Stratospheric	Ex	= Expendable	LA	= Lighter than Air	●	= Development continuing
EXO	= Exo stratospheric	FW	= Fixed Wing	TB	= Tilt Body	○	= No longer in production/development
				TR	= Tilt Rotor	■	= Developed & market ready

	Country	Producer (s) / Developer(s)	System Designation	Category	Remarks	Class	Air-frame	Status	Max. Speed (km/h)	Endurance (hours)	Range (km)	MTOW (kg)	Payload Capacity Max. (kg)
237	Israel	IAI-Malot	Mosquito 1.5	01-Micro		M	FW	●		1	1.6	0.5	0.02
238	Israel	IAI-Malot	Scout	03-CR		M	FW	▲◆	176	6	100	159	38
239	Israel	IAI-Malot	Searcher I	05-MR		M	FW	▲◆	194	14	120	372	63
240	Israel	IAI-Malot	Searcher II	05-MR		M	FW	▲	230	15	200	426	100
241	Israel	IAI-Malot & Technion University	Sun Sailor	02-Mini	Solar power	DV	FW	▲					
242	Israel	Innocon	ASIS	05-MR	OPA	DV	FW	▲	235			550	150
243	Israel	Innocon	Mini Falcon I	04-SR		M	FW	■	185	5	100	100	17
244	Israel	Innocon	Mini Falcon II	05-MR	Heavy fuel	M	FW	●	200	10	200	160	25
245	Israel	Israel Military Industries	Rainbow	02-Mini		M	FW	■		2		6	
246	Israel	Israel Military Industries	Samson	04-SR	Decoy	M	FW	▲	900		70	181.5	35
247	Israel	ITL Optronics	Lightener	02-Mini	Electric	M	FW	▲	74 (CS)	2-3		5.5	
248	Israel	Rafael	SkyLite	02-Mini	CL, Electric	M	FW	■	126	1	10	6	
249	Israel	Rafael	SkyLite B	02-Mini	Electric	M	FW	■	100	1.5	10	6	1.2
250	Israel	Steadicopter	STD-5	03-CR		DP	RW	■		1-2	5		8.2
251	Israel	Topi-Vision	Casper - 200	02-Mini	Electric	M	FW	●	80	1.5	10	2.3	0.24
252	Israel	Topi-Vision	Casper - 250	02-Mini	Electric	M	FW	●					
253	Israel	Topi-Vision	Casper - 420	03-CR		DP	FW	●	110(CS)	4	50	12	
254	Italy	A2Tech	RV-02	02-Mini	Electric	CC	FW	●		0.3-0.6	2-10	2	
255	Italy	A2Tech	RV-160TD	02-Mini		CC	FW	●			10		10
256	Italy	Alenia Aeronautica	Sky-X	11-UCAV		M, DV	FW	▲●	810	1	185	1200	200
257	Italy	Alenia Aeronautica & Galileo Avionica	Molynx	10-HALE	Diesel (x2)	M	FW	▲	400	25	3700	3000	800
258	Italy	Thales Alenia Space											
258	Italy	CIRA	Castore	12-STRA		RV	FW	▲	> 1000				
259	Italy	Galileo Avionica	Falco	05-MR		M	FW	●▲	216	8-14	150	240-350	70+
260	Italy	Galileo Avionica	Mirach 150	07-LADP		M	FW	▲◆	700	1	250	340	50
261	Italy	Galileo Avionica	Mirach 26	05-MR		M	FW	▲◆	220	8	18	230	35
262	Italy	Galileo Avionica	Nibbio	07-LADP		M, DV	FW	◆	M 0,85	1.5	380	330	70
263	Italy	Galileo Avionica & U.T.R.I	ASIO	02-Mini	Electric	M	SRW	●▲	46	0.8	10		2.8
264	Italy	Galileo Avionica & U.T.R.I	Otus	02-Mini		M	FW	●				2.3	1
265	Italy	Galileo Avionica & U.T.R.I	Strix	02-Mini		M	FW	●▲			1.5	12.5	
266	Italy	International Aviation Supply	Corvo	04-SR		M	FW	●		4-8			2.3-6.8
267	Italy	International Aviation Supply	Gabbiano	03-CR		M	FW	●				4.5	0.5
268	Italy	International Aviation Supply	Sky Arrow U	04-SR		M	FW	●				450	100
269	Italy	Nautlius	NRC-Class D	02-Mini		DV	LIA	●		0.25			9
270	Italy	Nautlius	NRC-Class E	02-Mini		DV	LIA	●		0.25			7
271	Italy	U.T.R.I	MHELI	02-Mini		DV	RW	▲●	80		15	4.8	1
272	Italy	U.T.R.I	TSO-401	02-Mini		DV	SRW	▲	65		14	4.2	0.9
273	Japan	Epson & Sony	Micro VTOL	01-Micro		DV	RW	▲					
274	Japan	Fuji Heavy Industries	FFOS	03-CR		M	RW	▲	120	3	150	275	
275	Japan	Fuji Heavy Industries	HSPD	03-CR		RV	RW	◆				735	
276	Japan	Fuji Heavy Industries	RPH-1	02-Mini		DV	RW	◆	36 (CS)	1		330	
277	Japan	Fuji Heavy Industries	RPH-2A	02-Mini		CC	RW	◆	120	1	150	305	60
278	Japan	Hirobo	Sky Surveyor	03-CR		CC	RW	■				48	
279	Japan	Kavada Industries & Hitachi	Colugo	02-Mini		DP	FW	●	54	0.5		0.4	
280	Japan	Nara Institute of Science + Technology	XB-2	05-MR	Circular wing	DP	SRW	●	435	24			
281	Japan	Nara Institute of Science + Technology & TAO											
282	Japan	Yamaha Motors	Skyblade	02-Mini	Tail-sitter	CC, DV	FW	◆					
283	Japan	Yamaha Motors	Aerial RMAX	03-CR		CC	RW	▲					
284	Japan	Yamaha Motors	Agricultural RMAX Autonomous	03-CR		CC	RW	▲					
285	Japan	Yamaha Motors	RMAX II Autonomous	03-CR		DP	RW	▲	72	2.5	LOS 150m		94 10
286	Japan	Yanmar Agricultural Equipment Co.	RMAX II G	03-CR		DP	RW	▲	72	2.5	LOS 150m		94 10
287	Japan	Yanmar Heli Service & Kobe Giken	YH-300SL	02-Mini		CC	RW	▲					
288	Jordan	Jordan Aerospace Industries	KG-135	02-Mini		CC	RW	▲◆					
289	Jordan	Jordan Aerospace Industries	Falcon	04-SR		M	FW	●	180	4	30-50	60	6
290	Jordan	Jordan Aerospace Industries	I-wing	03-CR		M	FW	●			10		
291	Jordan	Jordan Aerospace Industries	Silent Eye	03-CR		M	FW	●	110	1	10	3.5	0.5
292	Malaysia	Composites Technology Research (CTRM)	Eagle ARV	05-MR	OPA	DP	FW	▲	246	10	250	648	60
293	Mexico	Hydra Technologies	S3	04-SR	2 x 30 cc	M	FW	●	300	2		40	3.2
294	Mexico	Hydra Technologies	S3E	04-SR	2 x 50 cc	M	FW	●	200	5		45	10
295	Mexico	Hydra Technologies	S4	05-MR	2 x 50 cc	M	FW	●	170	8		52	13.5
296	Netherlands	Dutch Space	MATE	04-CR		M, DV	FW	●◆			1	5	6
297	Netherlands	E-Producties	EKH-001	04-CR		DP	RW	●◆					
298	Netherlands	HighEye	HE 26	02-Mini		CC	RW	▲	110		10	15	7.5
299	Netherlands	HighEye	HE 3 6 t	02-Mini		CC	RW	▲	110		10	24	14
300	Netherlands	HighEye	HE 60	02-Mini		CC	RW	▲	110		12	25	14
301	Netherlands	HighEye	HE 80	02-Mini		CC	RW	▲	110		11	34	20
302	Netherlands	UAV-Europe	MH 23	04-SR		DP	RW	●	100	2.5	11-30	40	15
303	New Zealand	TGR Helicorp Ltd.	Snark	09-MALE	Diesel UCAV	M	RW	●	289	24+	5500	1136	686
304	New Zealand	TGR Helicorp Ltd.	Wasp	09-MALE	Diesel	CC	RW	●					
305	Norway	CE Stephansen	Recce D6	02-Mini	Electric	DP	FW	●▲	100(CS)	0.55	10	2.8	
306	Norway	Proxflyer	BladeRunner	01-Micro	Sold astoy	CC	RW	▲▲				0.05	
306	Norway	Proxflyer	MicroFlyer	01-Micro		CC	RW	▲▲			2mm	0,0078	

CR = Close Range	AiR = Air-Launched	M = Military	TW = Tilt Wing
SR = Short Range	B/C = Bacteriological & chemical sensing	NM = Not Motorised	UCAR = Unmanned Combat Aerial Rotorcraft
MR = Medium Range	CC = Civil/Commercial	OFF = Offensive	VTOL = Very Short Take-Off & Landing
MRE = Medium Range Endurance	CL = Container Launched	OPA = Optionally Piloted Aircraft	
LADP = Low Altitude Deep Penetration	CRW = Canard Rotary Wing	Pf = Paraflyer	
LALE = Low Altitude Long Endurance	CS = Cruising Speed	RATO = Rocket Assisted Take-Off	▲ = Proof-of-concept/demonstrator
MALE = Medium Altitude Long Endurance	DP = Dual Purpose - civil/military	RV = Research Vehicle	◆ = In inventory and/or in service
HALE = High Altitude Long Endurance	DV = Developmental Vehicle	RW = Rotary Wing	● = Ordered/entering service
UCAV = Unmanned Combat Aerial Vehicle	EW = Electronic Warfare	SRW = Shrouded Rotary Wing	◆ = Ordered as test/demo system
STRA = Stratospheric	Ex = Expendable	LIA = Lighter than Air	● = Development continuing
EXO = Exo stratospheric	FW = Flapping Wing	TB = Tilt Body	◆ = No longer in production/development
	FW = Fixed Wing	TR = Tilt Rotor	■ = Developed & market ready

	Country	Producer (s) / Developer(s)	System Designation	Category	Remarks	Class	Air-frame	Status	Max. Speed (km/h)	Endurance (hours)	Range (km)	MTOW (kg)	Payload Capacity Max. (kg)
307	Norway	Proxflyer	Mosquito	01-Micro		CC	RW	■▲				0,11	
308	Norway	Proxflyer	Nanoflyer	01-Micro		CC	RW	■▲		1mn		0,0027	
309	Norway	Scandicraft & CybAero, Sweden	Apid 55	04-SR		DP	RW	■	90	3-6	50	150	55
310	Norway	SiMicCon	SRC	05-MR	VTOL concept	M, DV	FW	◆◆▲	575	4		150	15
311	Pakistan	Air Weapons Complex	AWC Mk I	03-CR		M	FW	●?	175	2	30	30	14
312	Pakistan	Air Weapons Complex	AWC Mk II	04-SR		M, DV	FW	●?	175	3	50	60	34
313	Pakistan	Air Weapons Complex	Bravo	04-SR		M	FW	▲▲◆	160	4+	80	110	15-20
314	Pakistan	Air Weapons Complex	Shaspar	04-SR		M	FW	●					
315	Pakistan	Air Weapons Complex	Vision I	04-SR		M, DV	FW	●	160	5+	100	120	25
316	Pakistan	Air Weapons Complex	Vision II	04-SR		M, DV	FW	●	160	5	150	30	30
317	Pakistan	Directorate General of Munitions Prod.	HudHud I	04-SR		M, DV	FW	●	165	2,5	50	35	20
318	Pakistan	Directorate General of Munitions Prod.	HudHud II	04-SR		M, DV	FW	●	165	3,5	80	70	40
319	Pakistan	Integrated Dynamics	Border Eagle	03-CR		M	FW	●		3	30	15	4
320	Pakistan	Integrated Dynamics	Desert Hawk	03-CR		M	FW	●					
321	Pakistan	Integrated Dynamics	Firefly	01-Micro	Combustion or electric engines	M	FW	◆◆▲					
322	Pakistan	Integrated Dynamics	Hawk Mk-1	03-CR	Gun-launched; Rocket-launched	M, DV	FW	●▲		8sec			
323	Pakistan	Integrated Dynamics	Hawk Mk-2	03-CR		M	FW	●		3	50	46	12
324	Pakistan	Integrated Dynamics	Hawk Mk-5	03-CR		M	FW	●		4	50	50	15-20
325	Pakistan	Integrated Dynamics	Vision X-1	05-MR		M	FW	●		4	80	60	15
326	Pakistan	Integrated Defence Systems	Hornet Mk 2	03-CR		M	FW	▲?	277	1,5	10	46	46
327	Pakistan	Integrated Defence Systems	Hornet Mk 5	04-SR		M	FW	●	384	2,5	40-50	60	20
328	Pakistan	National Development Complex	Vector Mk 1	03-CR		M	FW	▲?	205	4,5	10	105	
329	Pakistan	National Development Complex	Vector Mk 2	05-MR		M	FW	◆◆	120 (CS)	5		120	
330	Pakistan	Satuma Research	Jassos HST	03-CR		M	FW	●	140	1,5	LOS	40	5
331	Pakistan	Satuma Research	Jassos II	04-SR		M	FW	▲?	160	4-5	100	125	20
332	Pakistan	Satuma Research	Mukhbar	03-CR		M	FW	●	220	1,5		40	5
333	Pakistan	Satuma Research	Parvaz	02-Mini	1/2 scale trainer	M	FW	▲?				40	5
334	Poland	Air Force Institute of Technology	HOB-bit	02-Mini	Electric (x2)	DP, DV	FW	▲?	90	1,5	20	3,5	
335	Poland	Research & Development Centre for Mechanical Appliances	Bee	01-Micro		M, DV	FW	●	50	0,15		0,07	
336	Poland	Research & Development Centre for Mechanical Appliances	Cambat	02-Mini		M, DV	FW	●	40	0,4		1,7	
337	Poland	WB Electronics	Sofar	02-Mini	Electric	M	FW	■	90	2	10	4,9	
338	Portugal	Faculty of Engineering - University of Porto	ASASF	02-Mini		RV	FW	▲		0,4			
339	Portugal	IST & OGMA	Armor X7	05-MR		M, DV	FW	▲	100	12-15		200	
340	Portugal	School of Engineering, Minho University	AVA	02-Mini		DV	FW	▲				15	
341	Romania	Centrul de Invetiva	Octogon	04-SR		DV	RW	▲					
342	Romania	Electromecanica Ploiesti & Politehnica Bucharest & INCAS & Romarm	Vigilent	02-Mini		DV	FW	▲					
343	Russian Fed.	Design Bureau Lutch	Tipchak	04-SR		M	FW	▲	200	2	40	50	
344	Russian Fed.	Enics Research Center	E90 (R90 system)	05-MR	AirL	M, DV	FW	■	180	0,5		45	
345	Russian Fed.	Enics Research Center	Eleron	02-Mini		DV	FW	▲	64 (CS)	1		2,9	
346	Russian Fed.	Ikut	Ikut-20	03-CR		DP	FW	●	180	3	70	20	3
347	Russian Fed.	Ikut	Ikut-2F	02-Mini		DP	FW	●	110	1	40	2,8	0,3
348	Russian Fed.	Ikut	Ikut-2T	02-Mini		DP	FW	●	110	1	40	2,8	0,3
349	Russian Fed.	Ikut & Aeronautics, Israel (airframe)	Ikut-60	03-CR		DP	FW	●	180	6	70	65	15
350	Russian Fed.	Ikut & Aeronautics, Israel (airframe)	Ikut-200	05-MR		DP	FW	●	200	12	200	200	50
351	Russian Fed.	Ikut & Stemme, Germany (airframe)	Ikut-850	05-MR	OPA	DP	FW	●	270	12	200	860	200
352	Russian Fed.	Kamov	Ka-117	05-MR		DV	RW	▲			200		
353	Russian Fed.	Kamov	Ka-137	02-Mini		M	RW	■	175	4	50	280	50
354	Russian Fed.	Kamov	Ka-226	00-MR	Mod.manned AC	DV	RW	▲		16		3600	
355	Russian Fed.	Kamov	Ka-37	04-SR		M	RW	●?					
356	Russian Fed.	Kamov	Ka-37C	04-SR		M	RW	●?					
357	Russian Fed.	KB Lutch	X01	03-CR		M	FW	▲	125	4,5		50	7
358	Russian Fed.	KB Lutch	X02	02-Mini		M	FW	▲	180	1		35	4
359	Russian Fed.	NII Kulon	BLA-06	05-MR		M	FW	▲	250	12	250	500	
360	Russian Fed.	NII Kulon	BLA-07	03-CR		M	FW	▲	190	3		35	
361	Russian Fed.	NII Kulon	Filin	07-LADP	Turbojet	M	FW	●	960	1		3000	
362	Russian Fed.	NII Kulon	Mokit (Yula)	05-MR		M	FW	●	200	1,5		250	
363	Russian Fed.	Sukhoi	Zond-1	10-HALE		CC	FW	●	M0,5	18	12000	12000	1500
364	Russian Fed.	Sukhoi	Zond-2	10-HALE		DP	FW	●	M0,6	24	12000	12000	1500
365	Russian Fed.	Sukhoi	Zond-3	09-MALE		DP	FW	●	250	12	2500	2000	500
366	Russian Fed.	Tupolev	Berkut	05-MR	With canards	DP	FW	▲	180	8		180	
367	Russian Fed.	Tupolev	Tu-143	07-LADP		M	FW	◆	875	0,2	90	1400	
368	Russian Fed.	Tupolev	Tu-243 Reys	07-LADP		M	FW	◆	850-940	0,2	180	1400	
369	Russian Fed.	Tupolev	Tu-300 Korshun	07-LADP		M	FW	●	950	1		3000	
370	Russian Fed.	Yakovlev	Albatros	02-Mini		M	TR	●?	300	7	100	450	
371	Russian Fed.	Yakovlev	Expert	02-Mini		M	FW	●?	110	6	100	40	

CR	= Close Range	AirL	= Air-Launched	M	= Military	TW	= Tilt Wing
SR	= Short Range	B/C	= Bacteriological & chemical sensing	NM	= Not Motorised	UCAR	= Unmanned Combat Aerial Rotorcraft
MR	= Medium Range	CC	= Civil/Commercial	OFF	= Offensive	VTOL	= Vertical Take-Off & Landing
MRE	= Medium Range Endurance	CL	= Container Launched	OPA	= Optionally Piloted Aircraft		
LADP	= Low Altitude Deep Penetration	CRW	= Canard Rotary Wing	Pf	= Parafoil		
LALE	= Low Altitude Long Endurance	CS	= Cruising Speed	RATO	= Rocket Assisted Take-Off	▲	= Proof-of-concept/demonstrator
MALE	= Medium Altitude Long Endurance	DP	= Dual Purpose - civil/military	RV	= Research Vehicle	▲	= In inventory and/or in service
HALE	= High Altitude Long Endurance	DV	= Developmental Vehicle	RW	= Rotary Wing	○	= Ordered/Entering service
UCAV	= Unmanned Combat Aerial Vehicle	EW	= Electronic Warfare	SRW	= Shrouded Rotary Wing	◆	= Ordered as test/demo system
STRA	= Stratospheric	Ex	= Expendable	LIA	= Lighter than Air	●	= Development continuing
EXO	= Exo stratospheric	FLW	= Flapping Wing	TB	= Tilt Body	◇	= No longer in production/development
		FW	= Fixed Wing	TR	= Tilt Rotor	■	= Developed & market ready

	Country	Producer (s) / Developer(s)	System Designation	Category	Remarks	Class	Air-frame	Status	Max. Speed (km/h)	Endurance (hours)	Range (km)	MTOW (kg)	Payload Capacity Max. (kg)
372	Russian Fed	Yakovlev	Klest	04-SR		M	FW	▲●				130	
373	Russian Fed	Yakovlev	Pchela-1T	04-SR		M	FW	▲	180	2	50	138	70
374	Russian Fed	Yakovlev	Proryv	11-UCAV	Yak-130 based	M	FW	▲●				10,000	3,000
375	Russian Fed	Yakovlev	Proryv-R	11-UCAV	Yak-130 based	M	FW	▲●		20		9,800	1,200
376	Russian Fed	Yakovlev	Strekoza	04-SR		M	FW	●?	110	6	50-100	40	
377	Russian Fed	Yakovlev	Voron	07-LADP	Study project	M	FW	▲●		2		500	140
378	Serbia	EMA	Nikola Tesla 150	02-Mini	Student project	RV	FW	▲●	70		10	40	
379	Serbia	Utva Aircraft Industry	Gavran I	02-Mini		M	FW	▲●	120(CS)	0.75	10	16	4
380	Serbia	Utva Aircraft Industry	Gavran II	02-Mini		M	FW	▲●	120	0.75	10	30	4
381	Serbia	Utva Aircraft Industry	IBL-2004	04-SR		M	FW	▲●					
382	Singapore	Cradance	Golden Eagle	02-Mini		DP	FW	●	72	2	10	0.85	0.08
383	Singapore	Singapore Technologies Aerospace	Blue Horizon	04-SR		M, DV	FW	▲	130	16		180	
384	Singapore	Singapore Technologies Aerospace	Extender	02-Mini	Foam airframe	M	FW	▲	100	0.5	5	1.6	0.25
385	Singapore	Singapore Technologies Aerospace	Fantail	02-Mini		M, DV	SRW	▲	111	0.5+	5	5.5	0.4
386	Singapore	Singapore Technologies Aerospace	LALEE	10-HALE									
387	Singapore	Singapore Technologies Aerospace	MAV-1	05-MR	Conceptual development Technology demonstrator	M, DV	FW	▲●				5000	
388	Singapore	Singapore Technologies Aerospace	Skyblade II	02-Mini		M, DV	FW	▲●	130	1-2	8	80	20
389	Singapore	Singapore Technologies Aerospace	Skyblade IV	02-Mini		DP	FW	▲	150	6-12		50	12
390	Singapore	Singapore Technologies Dynamics	Phantom Eye	02-Mini		M, DV	FW	▲	74	1		2	
391	Slovenia	Aviotech	RV/M04	04-SR		M, DV	FW	●	145	4	80	36	11
392	South Africa	ABAT	Posduif	02-Mini		DP	FW	●			60		0.7
393	South Africa	Advanced Technologies & Engineering	Civil Vulture	05-MR		CC	FW	●	120 (CS)	8-9	200	150	35
394	South Africa	Advanced Technologies & Engineering	Endurance Vulture	05-MR		M	FW	●	120 (CS)	8-9	200	150	35
395	South Africa	Advanced Technologies & Engineering	Kiwi	02-Mini	Electric	DP	FW	▲	50 (CS)	1	5	3	
396	South Africa	Advanced Technologies & Engineering	Night Vulture	05-MR		M	FW	●	120 (CS)	3-4	200	135	35
397	South Africa	Advanced Technologies & Engineering	Vulture	05-MR		M	FW	▲	120 (CS)	3-4	Up to 200	125	25
398	South Africa	Denel Aerospace Systems	Bateleur	09-MALE		M, DV	FW	▲	250	18-24	750	1000	200
399	South Africa	Denel Aerospace Systems	Seeker II	05-MR		M	FW	▲	220	10	250	275	50
400	South Africa	Denel Aerospace Systems	Seraph	07-LADP		M, DV	FW	▲	M 0.85	1.5	1300	500	80
401	South Korea	Korean Aeronautical Research Institute	Durumi	08-LALE		DP	FW	●	130	30	3300	15	2.5
402	South Korea	Korean Aeronautical Research Institute	Smart UAV	05-MR		M, DV	TR	▲	500	5	200	950	40-100
403	South Korea	Korean Aerospace Industries	Night Intruder 300	05-MR		M	FW	▲	185	6	120	300	45
404	South Korea	Korean Aerospace Industries & Daewoo	Arch-50	05-MR		CC	RW	■	150	0.6		300	50
405	South Korea	Ucon Systems	RemoEye 002	02-Mini		M	FW	■	80	1	10	2	
406	South Korea	Ucon Systems	RemoEye 006	02-Mini		M	FW	■	75	1	10	6	
407	South Korea	Ucon Systems	RemoEye 015	03-CR		M	FW	■	170	4	50	15	
408	South Korea	Ucon Systems	RemoEye H120	03-CR		M	RW	■	130	2	50	120	30
409	Spain	Aerovision	Fulmar	03-CR		DP	FW	■	150	8	50	20	8
410	Spain	Atem	Dedalo	02-Mini		CC, RV	FW	▲●					
411	Spain	Atem	Horus	02-Mini		CC, RV	RW	▲●					
412	Spain	INTA	Siva	05-MR		M, DV	FW	▲	170	6	150	300	40
413	Spain	INTA	Alo	04-SR		M	FW	▲	200	2	50	20	6
414	Spain	PLATINO Consortium	HADA	05-MR	Diesel	M	RW	▲●	420	6	200	380	100
415	Spain	Sistemas de Control Remoto (SCR)	Alba 01	02-Mini		M, DV	FW	●	216	1		18	
416	Spain	Sistemas de Control Remoto (SCR)	X-Vision	02-Mini		M, DV	FW	●	150	2		40	
417	Spain	UAV Navigation	KUAV	03-CR		DP	FW	●		5	30	30	
418	Sweden	Saab	Filur	11-UCAV		M, DV	FW	▲	300			55	
419	Sweden	Saab	Sharc	11-UCAV		M, DV	FW	▲	M0.8			60	
420	Sweden	Saab	Skeldar	04-SR		M	RW	▲	100(CS)	5	100	95	
421	Sweden	SmartPlanes	Smart-1	02-Mini	Electric	DP	FW	▲	55 (CS)	1		1	
422	Switzerland	Aeromedica	Aerocopter 1	02-Mini		CC	RW	■		0.16		2	
423	Switzerland	Aeromedica	Aerocopter 2	02-Mini		CC	RW	■		0.25		12	
424	Switzerland	Aeromedica	AeroStar 1	02-Mini	Electric	CC	FW	■		0.5		1	
425	Switzerland	Aeromedica	AeroStar 2	02-Mini	2x Electric	CC	FW	■		0.5		2	
426	Switzerland	Minizepp	Z10000Pro	02-Mini		CC	LA	■	75	2-4			4
427	Switzerland	Minizepp	Z13000	02-Mini		CC	LA	■	60	3-4			13.5
428	Switzerland	RUAG Aerospace	Ranger	05-MR		M	FW	▲	240	6	180	280	45
429	Switzerland	RUAG Aerospace	Super Ranger	06-MRE		M	FW	▲	234(CS)	20		500	
430	Switzerland	Skive	Skive	02-Mini	Helium	CC	LA	■	50	3-4			8
431	Taiwan ROC	Aero Flight Technology Enterprises	Mx-1	04-SR		DP	FW	●		5	400		
432	Taiwan ROC	AIDC-Aerospace Industrial Defence Corp	Fireant	02-Mini		M	FW	●	180	2			5-10
433	Taiwan ROC	Chung Shan Inst. of Science & Technology	Chung Shyang II	04-SR		M, DV	FW	●	150	10		450	
434	Taiwan ROC	National Cheng Kung University	Swan	02-Mini		RV	FW	▲	80(CS)	2		12	
435	Taiwan ROC	Chung Shan Inst. of Science & Technology	Kestrel II	05-MR		M	FW	▲	185	8		120	25-30
436	Taiwan ROC	YoShine Helicopters	Ezycopter Micro	01-Micro		DV	RW	▲					
437	Taiwan ROC	YoShine Helicopters	Ezycopter UAV	03-CR		M, DV	RW	▲	120			300	
438	Tunisia	Tunisia Aero Technologies	Jebelassa	04-SR		M, DV	FW	▲	140	13		228	
439	Tunisia	Tunisia Aero Technologies	NasNas	04-SR		M, DV	FW	▲	130	14		125	
440	Turkey	Global Teknik	Globiha	02-Mini		M	FW	■	83 (CS)	1.5-2	5-10	5	
441	Turkey	Kale-Baykar	Bayraktar	02-Mini	2 x Electric	DP	FW	▲	110	1	20	5	1.5
442	Turkey	METU - Departement of Aerospace Eng	Mini UAV	02-Mini	Electric	DP	FW	▲	52	1.5	10	4.5	
443	Turkey	Tusas Aerospace Industries	Baykus	03-CR		M, DV	FW	●					
444	Turkey	Tusas Aerospace Industries	Marti	03-CR		M, DV	FW	●					
445	Turkey	Tusas Aerospace Industries	Pelikan	03-CR		M, DV	FW	●					

CR	= Close Range	AirL	= Air-Launched	M	= Military	TW	= Tilt Wing
SR	= Short Range	B/C	= Bacteriological & chemical sensing	NM	= Not Motorised	UCAR	= Unmanned Combat Aerial Rotorcraft
MR	= Medium Range	CC	= Civil/Commercial	OFF	= Offensive	VSTOL	= Very Short Take-Off & Landing
MRE	= Medium Range Endurance	CL	= Container Launched	OPA	= Optionally Piloted Aircraft	VTOL	= Vertical Take-Off & Landing
LADP	= Low Altitude Deep Penetration	CRW	= Canard Rotary Wing	Prf	= Parafoil		
LALE	= Low Altitude Long Endurance	CS	= Cruising Speed	RATO	= Rocket Assisted Take-Off	▲	= Proof-of-concept/demonstrator
MALE	= Medium Altitude Long Endurance	DP	= Dual Purpose - civil/military	RV	= Research Vehicle	▲	= In inventory and/or in service
HALE	= High Altitude Long Endurance	DV	= Developmental Vehicle	RW	= Rotary Wing	○	= Ordered/Entering service
UCAV	= Unmanned Combat Aerial Vehicle	EW	= Electronic Warfare	SRW	= Shrouded Rotary Wing	◆	= Ordered as test/demo system
STRA	= Stratospheric	Ex	= Expendable	LA	= Lighter than Air	○	= Development continuing
EXO	= Exo stratospheric	FLW	= Flapping Wing	TB	= Tilt Body	○	= No longer in production/development
		FW	= Fixed Wing	TR	= Tilt Rotor	■	= Developed & market ready

	Country	Producer (s) / Developer(s)	System Designation	Category	Remarks	Class	Air-frame	Status	Max. Speed (km/h)	Endurance (hours)	Range (km)	MTOW (kg)	Payload Capacity Max. (kg)																																																																																																
446	Turkey	Tusas Aerospace Industries	UAV-X1	05-MR		M, DV	FW	●	222	7	1200	245	30																																																																																																
447	Turkey	Tusas Aerospace Industries	Tiha	09-MALE		M	FW	●	140	24	200	1500	200																																																																																																
448	U.A.E.	ATS (ADCOM Group)	Yabhon-H	03-CR		M	FW	●	175	8		62.5	5																																																																																																
449	U.A.E.	ATS (ADCOM Group)	Yabhon-M	04-SR		M	FW	●	240	12		280	30																																																																																																
450	U.A.E.	ATS (ADCOM Group)	Yabhon-R	05-MR		M	FW	●	240	30		500	50																																																																																																
451	U.A.E.	ATS (ADCOM Group)	Yabhon-RX	06-MRE		M	FW	●	310	42		535	60																																																																																																
452	U.A.E.	ATS (ADCOM Group)	Yabhon-RX-18	10-HALE	Study project	M	FW	▲●				1300																																																																																																	
453	U.A.E.	GAMCO	GRS 200	09-MALE		M, DV	FW	●																																																																																																					
454	UK	Autonomous Vehicles International	Seeker	02-Mini	Electric	M	TR	▲●		0.25	10	16	4.5																																																																																																
455	UK	BAE Systems	Corax	11-UCAV		M, DV	FW	▲●																																																																																																					
456	UK	BAE Systems	Herti-1A	06-MRE		M, DV	FW	▲●	220	30		500	145																																																																																																
457	UK	BAE Systems	Herti-1D	06-MRE	Jet-powered	M, DV	FW	▲●				350																																																																																																	
458	UK	BAE Systems	Kestrel	04-SR	Twin jet	M, DV	FW	▲●																																																																																																					
459	UK	BAE Systems	Raven	11-UCAV		M, DV	FW	▲●				8000																																																																																																	
460	UK	BAE Systems	Taranis	11-UCAV		M	FW	▲●																																																																																																					
461	UK	BAE Systems & Flight Refuelling (airframe)	Phoenix	04-SR		M	FW	▲●	157	4.5	70	180	50																																																																																																
462	UK	Cyberflight	Cyberee	03-CR		M, DV	FW	●	150(CS)	5-6		45																																																																																																	
463	UK	Cyberflight	CyberOne	02-Mini		M, DV	FW	●	160	2		12.2	6.8																																																																																																
464	UK	Cyberflight	Fat Boy	03-CR		M, DV	FW	●		5-6		70																																																																																																	
465	UK	Cyberflight	S.O.D.I	02-Mini		M, DV	FW	●	128	1	10	3	0.5																																																																																																
466	UK	Cyberflight	S.O.D.III	02-Mini		M, DV	FW	●	110	2.5	25	5.4	2																																																																																																
467	UK	Cyberflight	S.O.D.IV	02-Mini		M, DV	FW	●	110	0.25	9	0.5	0.25																																																																																																
468	UK	Cyberflight	Super Swift-Eye	02-Mini		M, DV	FW	▲●	140	1																																																																																																			
469	UK	Cyberflight	Swift-Eye	02-Mini		M, DV	FW	▲●	140	0.6	3.2	6.4																																																																																																	
470	UK	Dragonfly Air Systems	Highland Darter	02-Mini		DV	TW	●	166																																																																																																				
471	UK	Dragonfly Air Systems	Skimmer	02-Mini		DV	TR	●		1-2		20																																																																																																	
472	UK	Fanwing	STOL UAV	????	Fanwing	DV	FW	●	29 (CS)			12	2																																																																																																
473	UK	Fanwing	Fanwing	03-CR	Fanwing	DP, DV	FW	▲●	72	10		40	15																																																																																																
474	UK	GFS Projects	Flying Saucer	02-Mini		M, DV	SRW	●		0.02																																																																																																			
475	UK	GFS Projects	GFS-7	02-Mini	Coanda principal	DP	SRW	▲●				5.45																																																																																																	
476	UK	Kestrel Aerospace	Kestrel UAV	05-MR		DV	TR	▲●	340		1390	295																																																																																																	
477	UK	Kestrel Aerospace	Lancer	05-MR		DV	TR	▲●	305	12	1667		30																																																																																																
478	UK	Meggitt Defense Systems	Phantom	03-CR		M	FW	▲●	180 (CS)	4		40																																																																																																	
479	UK	Meggitt Defense Systems	Spectre (Creceulle airframe)	05-MR		M	FW	▲●	240	3-6	160	145	25																																																																																																
480	UK	Merlin Integrated Solutions Consortium	Optica	05-MR	OPA	M	FW	▲●																																																																																																					
481	UK	QinetiQ-Farnborough	Mercator	10-HALE	BLAC Airframe	DV	FW	●	8	1046		1315																																																																																																	
482	UK	QinetiQ-Farnborough & Cranfield Aerospace	MinO	02-Mini	Solar	M, DV	FW	◆				27	2																																																																																																
483	UK	QinetiQ-Farnborough & Cranfield Aerospace	Observer	03-CR		M, DV	FW	■	126	2	25	30	4																																																																																																
484	UK	Roke Manor Research	Unnamed	03-CR		M, DV	Prf	●																																																																																																					
485	UK	SkyShips	C1000	03-CR	Electric	CC	LA	▲●	55	1		30	7																																																																																																
486	UK	SkyShips	Cirrus 840	03-CR		CC	LA	▲●																																																																																																					
487	UK	Tasuma	CSV-30	02-Mini		M, DV	FW	●	175	2		22																																																																																																	
488	UK	Tasuma	Hawkeye	02-Mini		M, DV	FW	●	85	1		3.2-3.8																																																																																																	
489	UK	Tasuma	CSV-20	02-Mini		M, DV	FW	●	140	2		20																																																																																																	
490	UK	Tasuma	MinO (airframe)	02-Mini		M, DV	FW	●																																																																																																					
491	UK	Tasuma	MSV-10	02-Mini		M, DV	FW	●	55	0.5		4.2																																																																																																	
492	UK	Tasuma (Airframe) & Flight Refuelling	Raven 1	03-CR		M	FW	●	126	2	50	15																																																																																																	
493	UK	Tasuma (Airframe) & Flight Refuelling	Raven 2	03-CR		M	FW	●	180	3	50	84																																																																																																	
494	UK	Thales UK Tactical UAV Systems	T-TUAV	06-MRE		M	FW	■	176	20	200	450	150																																																																																																
495	UK	VTOL Technologies	Aerial Police Dog	03-CR		DP	SRW	?	240	1	100	5	1																																																																																																
496	UK	Warrior (Aero-Marine)	Gull 24	02-Mini	Seaplane	DV	FW	▲●	136			18	6																																																																																																
497	UK	Warrior (Aero-Marine)	Gull 44	05-MR	Seaplane	DV	FW	▲●	170			93	34																																																																																																
498	UK	Warrior (Aero-Marine)	Gull 68	05-MR	Seaplane	DV	FW	▲●	184			250	94																																																																																																
499	Ukraine	Scientific Industrial Service	Albatros 4	03-CR		M	FW	▲?	60-125	2	20	18.3	3																																																																																																
500	Ukraine	Scientific Industrial Service	Inspektor	05-MR	Twin Wing 2 Engines	M	FW	●?	160	10	1000	250	50																																																																																																
501	Ukraine	Scientific Industrial Service	Remez-3	02-Mini		M	FW	▲?	105	1	5	10	3																																																																																																
502	USA	AAI Corp	MAV	01-Micro		M	FW	○▲	90																																																																																																				
503	USA	AAI Corp	Shadow 200 TUAV	05-MR		M	FW	▲	230	5-6	125	148	25																																																																																																
504	USA	AAI Corp	Shadow 400	05-MR		M	FW	▲	185	5	185	201	30																																																																																																
505	USA	AAI Corp	Shadow 600	06-MRE		M	FW	▲	190	12-14	200	265	41																																																																																																
506	USA	AC Propulsion	So Long	03-CR	Solar powered	RV	FW	▲●	80	?	8	12.5	?																																																																																																
507	USA	Accurate Automation	LoFLYTE	02-Mini		M	FW	●	463	0.3		32																																																																																																	
508	USA	Accurate Automation	X-43A-LS	07-LADP		M	FW	●	410 (CS)	0.75		81																																																																																																	
509	USA	Advanced Ceramics Research	Coyote	?	Electric Foldable wings	M	FW	?	100	1.5	36	6.4																																																																																																	
510	USA	Advanced Ceramics Research	Manta B	04-SR		M	FW	■	200	6	24-32	23.5	6.8																																																																																																
511	USA	Advanced Ceramics Research	SilverFox	04-SR		M	FW	▲	200	8-10	37	12	2.3																																																																																																
512	USA	Advanced Hybrid Aircraft	Homet	06-MRE	4 Engines	DP	LA	■?	150		1100	3400	1134																																																																																																
<table border="0"> <tr> <td>CR</td><td>= Close Range</td> <td>AirL</td><td>= Air-Launched</td> <td>M</td><td>= Military</td> <td>TW</td><td>= Tilt Wing</td> </tr> <tr> <td>SR</td><td>= Short Range</td> <td>B/C</td><td>= Bacteriological & chemical sensing</td> <td>NM</td><td>= Not Motorised</td> <td>UCAR</td><td>= Unmanned Combat Aerial Rotorcraft</td> </tr> <tr> <td>MR</td><td>= Medium Range</td> <td>CC</td><td>= Civil/Commercial</td> <td>OFF</td><td>= Offensive</td> <td>VSTOL</td><td>= Very Short Take-Off & Landing</td> </tr> <tr> <td>MRE</td><td>= Medium Range Endurance</td> <td>CL</td><td>= Container Launched</td> <td>OPA</td><td>= Optionally Piloted Aircraft</td> <td>VTOL</td><td>= Vertical Take-Off & Landing</td> </tr> <tr> <td>LADP</td><td>= Low Altitude Deep Penetration</td> <td>CRW</td><td>= Canard Rotary Wing</td> <td>Prf</td><td>= Parafail</td> <td>▲</td><td>= Proof-of-concept/demonstrator</td> </tr> <tr> <td>LALE</td><td>= Low Altitude Long Endurance</td> <td>CS</td><td>= Cruising Speed</td> <td>RATO</td><td>= Rocket Assisted Take-Off</td> <td>▲</td><td>= In inventory and/or in service</td> </tr> <tr> <td>MALE</td><td>= Medium Altitude Long Endurance</td> <td>DP</td><td>= Dual Purpose - civil/military</td> <td>RV</td><td>= Research Vehicle</td> <td>○</td><td>= Ordered/Entering service</td> </tr> <tr> <td>HALE</td><td>= High Altitude Long Endurance</td> <td>DV</td><td>= Developmental Vehicle</td> <td>RW</td><td>= Rotary Wing</td> <td>◆</td><td>= Ordered as test/demo system</td> </tr> <tr> <td>UCAV</td><td>= Unmanned Combat Aerial Vehicle</td> <td>EW</td><td>= Electronic Warfare</td> <td>SRW</td><td>= Shrouded Rotary Wing</td> <td>●</td><td>= Development continuing</td> </tr> <tr> <td>STRA</td><td>= Stratospheric</td> <td>Ex</td><td>= Expendable</td> <td>LA</td><td>= Lighter than Air</td> <td>●</td><td>= No longer in production/development</td> </tr> <tr> <td>EXO</td><td>= Exo stratospheric</td> <td>FLW</td><td>= Flapping Wing</td> <td>TB</td><td>= Tilt Body</td> <td>■</td><td>= Developed & market ready</td> </tr> <tr> <td></td><td></td> <td>FW</td><td>= Fixed Wing</td> <td>TR</td><td>= Tilt Rotor</td> <td></td><td></td> </tr> </table>														CR	= Close Range	AirL	= Air-Launched	M	= Military	TW	= Tilt Wing	SR	= Short Range	B/C	= Bacteriological & chemical sensing	NM	= Not Motorised	UCAR	= Unmanned Combat Aerial Rotorcraft	MR	= Medium Range	CC	= Civil/Commercial	OFF	= Offensive	VSTOL	= Very Short Take-Off & Landing	MRE	= Medium Range Endurance	CL	= Container Launched	OPA	= Optionally Piloted Aircraft	VTOL	= Vertical Take-Off & Landing	LADP	= Low Altitude Deep Penetration	CRW	= Canard Rotary Wing	Prf	= Parafail	▲	= Proof-of-concept/demonstrator	LALE	= Low Altitude Long Endurance	CS	= Cruising Speed	RATO	= Rocket Assisted Take-Off	▲	= In inventory and/or in service	MALE	= Medium Altitude Long Endurance	DP	= Dual Purpose - civil/military	RV	= Research Vehicle	○	= Ordered/Entering service	HALE	= High Altitude Long Endurance	DV	= Developmental Vehicle	RW	= Rotary Wing	◆	= Ordered as test/demo system	UCAV	= Unmanned Combat Aerial Vehicle	EW	= Electronic Warfare	SRW	= Shrouded Rotary Wing	●	= Development continuing	STRA	= Stratospheric	Ex	= Expendable	LA	= Lighter than Air	●	= No longer in production/development	EXO	= Exo stratospheric	FLW	= Flapping Wing	TB	= Tilt Body	■	= Developed & market ready			FW	= Fixed Wing	TR	= Tilt Rotor		
CR	= Close Range	AirL	= Air-Launched	M	= Military	TW	= Tilt Wing																																																																																																						
SR	= Short Range	B/C	= Bacteriological & chemical sensing	NM	= Not Motorised	UCAR	= Unmanned Combat Aerial Rotorcraft																																																																																																						
MR	= Medium Range	CC	= Civil/Commercial	OFF	= Offensive	VSTOL	= Very Short Take-Off & Landing																																																																																																						
MRE	= Medium Range Endurance	CL	= Container Launched	OPA	= Optionally Piloted Aircraft	VTOL	= Vertical Take-Off & Landing																																																																																																						
LADP	= Low Altitude Deep Penetration	CRW	= Canard Rotary Wing	Prf	= Parafail	▲	= Proof-of-concept/demonstrator																																																																																																						
LALE	= Low Altitude Long Endurance	CS	= Cruising Speed	RATO	= Rocket Assisted Take-Off	▲	= In inventory and/or in service																																																																																																						
MALE	= Medium Altitude Long Endurance	DP	= Dual Purpose - civil/military	RV	= Research Vehicle	○	= Ordered/Entering service																																																																																																						
HALE	= High Altitude Long Endurance	DV	= Developmental Vehicle	RW	= Rotary Wing	◆	= Ordered as test/demo system																																																																																																						
UCAV	= Unmanned Combat Aerial Vehicle	EW	= Electronic Warfare	SRW	= Shrouded Rotary Wing	●	= Development continuing																																																																																																						
STRA	= Stratospheric	Ex	= Expendable	LA	= Lighter than Air	●	= No longer in production/development																																																																																																						
EXO	= Exo stratospheric	FLW	= Flapping Wing	TB	= Tilt Body	■	= Developed & market ready																																																																																																						
		FW	= Fixed Wing	TR	= Tilt Rotor																																																																																																								

Country	Producer (s) / Developer(s)	System Designation	Category	Remarks	Class	Air-frame	Status	Max. Speed (km/h)	Endurance (hours)	Range (km)	MTOW (kg)	Payload Capacity Max. (kg)
513 USA	Advanced Hybrid Aircraft	Wasp	05-MR	2 Engines	DP	LIA	■?			160	34	5
514 USA	Advanced Soaring Systems & NASA	Apex	10-HALE	NM (sailplane)	RV	FW	◆		5		272	
515 USA	AeroVironment	Black Widow	01-Micro		M, DV	FW	●	46	0.5		0,06	0,015
516 USA	AeroVironment	DragonEye	02-Mini		M	FW	▲	80	0.9	5	2,6	0,46
517 USA	AeroVironment	Global Observer	10-HALE	Fuel Cells	RV, DP	FW	●		1 Week		4500	450
518 USA	AeroVironment	Global Observer G0-1	10-HALE	Fuel Cells	RV, DP	FW	●				1800	160
519 USA	AeroVironment	Global Observer G0-2	10-HALE	Fuel Cells	RV, DP	FW	●			2780	4100	450
520 USA	AeroVironment	GLUAV	02-Mini	Twin Wing	M	FW	●	222	0.5	60	0,7	
521 USA	AeroVironment	Helios	10-HALE		RV	FW	▲φ	51	14		825	100
522 USA	AeroVironment	Hornet	01-Micro		RV	FW	●					
523 USA	AeroVironment	MicroBat	01-Micro		RV	FLW	●					
524 USA	AeroVironment	NAV	01-Micro	Nano UAS	DV	RW	●			0,3	0,010	0,002
525 USA	AeroVironment	OAV	02-Mini		M, DV	FW	●					
526 USA	AeroVironment	Pathfinder Plus	10-HALE	Solar	RV	FW	▲φ	57,5 (CS)	Weeks		218	11,3
527 USA	AeroVironment	Pointer	02-Mini		M	FW	▲	80	1,5	10	3,8	0,9
528 USA	AeroVironment	Puma	02-Mini		M	FW	■	96	3-4*	15	4,6	1
529 USA	AeroVironment	Raven	02-Mini		M	FW	▲	57	1,5	10	2	0,18
530 USA	AeroVironment	Raven B	02-Mini		M	FW	○▲	57	1,8	10	1,9	
531 USA	AeroVironment	SkyTote	03-CR		M, DV	RW	●	350	1,3	375	113	23
532 USA	AeroVironment	Swift	02-Mini		M	FW	■	83	1+	10	2,8	
533 USA	AeroVironment	Switchblade	02-Mini	Electric, Gun or	M	FW	●	145	0,3-0,6	7		
534 USA	AeroVironment	Wasp	01-Micro	tube launched	RV	FW	●	60	0,6-1,15	2	0,17	0,015
535 USA	AeroVironment	Wasp	02-Mini	Electric	M	FW	▲	65	0,75	5	0,430	
536 USA	Aircoscooter	Aircoscooter E70	01-Micro		CC	RW	■		0,25		14	2,25
537 USA	Aircoscooter	Aircoscooter G70	01-Micro		CC	RW	■	92	0,6		14	4,5
538 USA	Allied Aerospace Ind. (ex MicroCraft)	iStar (OAV)	02-Mini		M, DV	SRW	◆				2,27	
539 USA	Allied Aerospace Ind. (ex MicroCraft) & DARPA	Lift Augmented Ducted Fan	01-Micro	Scalable VTOL	M, DV	SRW	●	93	1	10	1,8	
540 USA	Arcturus	T-15	02-Mini		DV, DP	FW	●	166	12+		20	4,54
541 USA	Arcturus	T-16	02-Mini		DV, DP	FW	●	147	16		29	8
542 USA	Arcturus	Tracker	01-Micro		DV	RW	●					
543 USA	Atair Aerospace	LEAP I	05-MR		M	Prf	■		48-55		1620	112
544 USA	Atair Aerospace	Insect (LEAP type II)	05-MR		M	Prf	■		34		40	90
545 USA	Atair Aerospace	Micro LEAP (type III)	03-CR		M	Prf	■		4		33,7	13,5
546 USA	AUAV	Boomerang 4	02-Mini		M, DV	FW	●	157	1	130	9	2,27
547 USA	Aurora Flight Sciences	Chiron	06-MRE	OPA	RV	FW	◆	344	24		2200	180
548 USA	Aurora Flight Sciences	Excalibur	11-UCAV	STOL, STOVL	M	FW	◆	850	3		1180	180
549 USA	Aurora Flight Sciences	GoldenEye-50	02-Mini		M, DV	SRW	●	185,3	1		8,1	0,9
550 USA	Aurora Flight Sciences	GoldenEye-80	03-SR		M, DV	SRW	●		2,5	16	74,4	7,2
551 USA	Aurora Flight Sciences	GoldenEye-100	04-SR		DP, DV	SRW	●	296	4		68	9
552 USA	Aurora Flight Sciences	Marsflyer	13-EXO		RV	FW	●	111	2		108	
553 USA	Aurora Flight Sciences	Orion	10-HALE		RV	FW	●	440	30		5080	1800
554 USA	Aurora Flight Sciences	Orion HALL	10-HALE	Hydrogen	RV	FW	●	450		100	2340	180
555 USA	Aurora Flight Sciences	Perseus	10-HALE		RV	FW	■	85-128	24	3000	1000	80-150
556 USA	Aurora Flight Sciences	Theseus	10-HALE	2 Engines	RV	FW	◆	530	32+		3580	
557 USA	Aurora Flight Sciences & Athena Technologies	Unnamed	11-UCAV		M, DV	FW	●?	180 (CS)			64,4	
558 USA	Autonomous Airborne Systems	HOVTOL	05-MR		DP, DV	FW	●					
559 USA	BAE Systems	IAV1	03-CR		M	SRW	●			4,5	34	
560 USA	BAE Systems	IAV2	03-CR		M	SRW	●			4,4	56,7	
561 USA	BAE Systems	Skyagent	02-Mini	Remov. winglets	M	SRW	●		1	15	56,25	6,75
562 USA	BAE Systems	SkyEye RAE-Extended	05-MR		M	FW	▲φ	189	12	185	567	136
563 USA	BAE Systems	MAV	02-Mini		M, DV	SRW	●	150	1		7,7	0,68
564 USA	BAE Systems	MicroStar	01-Micro		M, DV	FW	●	55	0,3	5	0,14	0,015
565 USA	BAE Systems	OAV	03-CR		M, DV	SRW	●	203	1,5		63	10
566 USA	Bell Helicopter Textron	Eagle Eye	05-MR		M, DV	TR	◆◆	390	4	204	1020	136
567 USA	Boeing	Heliwing	05-MR		M, DV	RW	●				658	
568 USA	Boeing	ISIS	10-HALE		M	LIA	▲			months		
569 USA	Boeing	Little Bird	05-MR		M, DV	RW	●					
570 USA	Boeing	U-MELB	05-MR	OPA	M, DV	RW	●			4,7		
571 USA	Boeing	VARIOUS	05-MR	VTOL	M	RW	◆	300				
572 USA	Boeing	X-36	11-UCAV		M, DV	FW	▲φ	207-450			565	
573 USA	Boeing	X-45A	11-UCAV		M, DV	FW	◆◆	M 0,8	2	2400	5529	680
574 USA	Boeing	X-45B	11-UCAV		M, DV	FW	◆◆	850	2		8618	
575 USA	Boeing	X-45C	11-UCAV		M, DV	FW	◆◆	M 0,85	2	2400	16559	2000
576 USA	Boeing	X-46	11-UCAV		M, DV	FW	●					
577 USA	Boeing	X-50 Dragonfly	05-MR		M, DV	CRW	◆◆	740	3	278	645	91
578 USA	Boeing	X-48B	03-CR	3 turbojets	RV	FW	▲	220(CS)			227	
579 USA	Boeing & General Dynamics	Unnamed	09-MALE	Based on G550	M	FW	▲					
580 USA	Boeing Frontier Systems	A160 Hummingbird	09-MALE		M, DV	RW	◆◆	259	30-40	4630	1814	136
581 USA	Boeing Frontier Systems	Maverick	04-SR	OPA	M, DV	RW	◆◆		7			
582 USA	Carolina Airships	Guardian 31	04-SR		DP	LIA	●	48	3	22	37,5	6,35
583 USA	Carolina Airships	Guardian 34	04-SR		DP	LIA	●	48	3	22	56	11,3
584 USA	Carolina Unmanned Vehicles Inc.	SLURS	03-CR		M	FW	●	40	1	10	4,5	1

CR	= Close Range	AirL	= Air-Launched	M	= Military	TW	= Tilt Wing
SR	= Short Range	B/C	= Bacteriological & chemical sensing	NM	= Not Motorised	UCAR	= Unmanned Combat Aerial Rotorcraft
MR	= Medium Range	CC	= Civil/Commercial	OFF	= Offensive	VSTOL	= Very Short Take-Off & Landing
MRE	= Medium Range Endurance	CL	= Container Launched	OPA	= Optionally Piloted Aircraft	VTOL	= Vertical Take-Off & Landing
LADP	= Low Altitude Deep Penetration	CRW	= Canard Rotary Wing	Prf	= Parafoli		
LAL	= Low Altitude Long Endurance	CS	= Cruising Speed	RATO	= Rocket Assisted Take-Off	▲	= Proof-of-concept/demonstrator
MALE	= Medium Altitude Long Endurance	DP	= Dual Purpose - civil/military	RV	= Research Vehicle	◆	= In inventory and/or in service
HALE	= High Altitude Long Endurance	DV	= Developmental Vehicle	RW	= Rotary Wing	○	= Ordered/Entering service
UCAV	= Unmanned Combat Aerial Vehicle	EW	= Electronic Warfare	SRW	= Shrouded Rotary Wing	◆	= Ordered as test/demo system
STRA	= Stratospheric	Ex	= Expendable	LIA	= Lighter than Air	●	= Development continuing
EXO	= Exo stratospheric	FLW	= Flapping Wing	TB	= Tilt Body	φ	= No longer in production/development
		FW	= Fixed Wing	TR	= Tilt Rotor	■	= Developed & market ready

Country	Producer (s) / Developer(s)	System Designation	Category	Remarks	Class	Air-frame	Status	Max. Speed (km/h)	Endurance (hours)	Range (km)	MTOW (kg)	Payload Capacity Max. (kg)
585 USA	Charles Stark Draper Laboratory	NAV	01-Micro	Nano	RV	RW	●		0.3		0,010	0,002
586 USA	Charles Stark Draper Laboratory	SARD	02-Mini		RV	RW	●		0.3		15.7	
587 USA	Charles Stark Draper Laboratory	Wasp	02-Mini	Gun Launched	M,DV	FW	▲	1			3.9	
588 USA	CIRPAS (Cessna 337 based)	Pelican	05-MR		RV	FW	▲	167 (CS)	24		2086 (Nose bay)	150
589 USA	Continental Controls and Design	LOCUST MAV	01-Micro	Electric	RV	FW	▲	62 (CS)		5	0.57	
590 USA	Coptervision	CVG 2002	02-Mini		CC	FW	▲	123	0.5		23	
591 USA	CyberDefense Systems	Cyberbug	02-Mini	Triangular kite wing	M	FW	▲	32 (CS)	0.75	10	1.2 - 2.7	2,27
592 USA	Cyber Defense Systems	Cyberscout	02-Mini		DP	FW	▲	185	1	180	31.5	
593 USA	Cyber Defense Systems	M.A.R.S. HAA	10-HALE		DV	LA	●	70	10 days			675
594 USA	Cyber Defense Systems	M.A.R.S. MAA	06-MRE		DV	LA	●	57(CS)	48			450
595 USA	Cyber Defense Systems	SA 60 LAA	03-CR		DV	LA	●	57(CS)	5			
596 USA	Cyber Defense Systems	SA 90 LAA	03-CR		DV	LA	●	55	48			
597 USA	Dara Aviation	D-1 Heavy Payload	05-MR	Twin Wing	DP	FW	●	126	2	200	35	13
598 USA	Dara Aviation	D-1 Long Mission	06-MRE	Twin Wing	DP	FW	●	146	15	1500	35	4
599 USA	Dara Aviation	D-1 Short Mission	05-MR	Twin Wing	DP	FW	●	120	1.5	100	28.5	4
600 USA	DARPA	NAV	01-Micro		M	FW	●	18	0.3		0,008	0,002
601 USA	DARPA	RapidEye	10-HALE	Rocket-launched inflatable wings	M	FW	▲					
602 USA	DARPA	RUGS	01-Micro		M, DV	FW	●					
603 USA	DARPA	Vulture	10-HALE	Feasibility study	DV	FW	▲		months			
604 USA	DPR Group	SkyForce	09-MALE	OPA	DV	FW	●		20-30		1451	150-294
605 USA	Draganfly (RCToys)	DF-SAVS	02-Mini	Electric	CC	RW	▲					
606 USA	Draganfly (RCToys)	DF-TSU	02-Mini	Electric	CC	RW	▲					
607 USA	Draganfly (RCToys)	DX-PRO	02-Mini	Electric	CC	RW	▲					
608 USA	Draganfly (RCToys)	Tango	02-Mini	Electric	CC	RW	▲	100	1			2.3
609 USA	Dragonfly Pictures	DP-4X	05-MR		CC, DV	RW	■		8.1	435	63.5	16
610 USA	Dragonfly Pictures	DP-4XT	05-MR		CC, DV	RW	■		9.4	740		16
611 USA	Dragonfly Pictures	DP-5	04-SR		CC, DV	RW	■		2.5	170		16
612 USA	Dragonfly Pictures	DP-5T	03-CR		CC, DV	RW	■		1	80		68
613 USA	Dragonfly Pictures	DP-5X	04-SR		CC, DV	RW	■		1.4	100		68
614 USA	Dragonfly Pictures	DP-5XT	05-MR		CC, DV	RW	■		6.3	630		68
615 USA	DRS Unmanned Technologies	Neptune	04-SR	Amphibious	M	FW	▲	157	4	74	36.3	9
616 USA	DRS Unmanned Technologies	Sentry HP	05-SR	Delta Wing & V tail	M	FW	■	203	6	370	147	34
617 USA	DRS Unmanned Technologies	Sentry STM-5B	05-SR		M	FW	▲	130 (CS)	6		148	
618 USA	Flight Systems	Tracker UAV	02-Mini	Electric	DP	FW	▲	98	1.5	16	6.75	0.9
619 USA	Flightstar Sportplanes	FlightSpyder II	05-MR	OPA	M, DV	FW	▲					
620 USA	Freewing Aerial Robotics	Scorpion 100-60	05-MR		M	TB	●	220	6.5	75	215	27
621 USA	Freewing Aerial Robotics	Scorpion 60-25	05-MR		M	TB	●	185	4	75	45	11
622 USA	Freewing Flight Technologies Inc.	Spirit 100-800	05-MR	Tilt-boom	M, DV	FW	●	257	2.5-15		340	31-100
623 USA	Freewing Flight Technologies Inc.	Spirit 20-200	05-MR	Tilt-boom	M, DV	FW	●	192	2.2-5.6		68.2	8.4-16.7
624 USA	Freewing Flight Technologies Inc.	Spirit 400-3000	05-MR	Tilt-boom	M, DV	FW	●	270	5-24		1380	31-405
625 USA	General Atomics Aeronautical Systems	Altair	10-HALE		RV	FW	▲	400	30	9680	3266	299 Int
626 USA	General Atomics Aeronautical Systems	Altus	10-HALE		RV	FW	▲	120 (CS)	24+	5500	975	150
627 USA	General Atomics Aeronautical Systems	GNAT 750	09-MALE		M	FW	▲	269	40	2778	511	63.5
628 USA	General Atomics Aeronautical Systems	I.GNAT	09-MALE		M	FW	▲	230	40	2778	703	91 Int & 136 Ext
629 USA	General Atomics Aeronautical Systems	I.GNAT ER	09-MALE		M	FW	▲	220	40	2778	1043	204 Int & 136 Ext
630 USA	General Atomics Aeronautical Systems	lkhana	10-HALE	(Predator B)	RV	FW	▲	400 (CS)	30			900
631 USA	General Atomics Aeronautical Systems	Mariner	10-HALE		M	FW	●	440	49	15186	5000	522 Int & 907 Ext
632 USA	General Atomics Aeronautical Systems	MQ-1 Predator	09-MALE		M	FW	▲	220	40	3704	1040	204 Int & 136 Ext
633 USA	General Atomics Aeronautical Systems	Predator B - MQ-9B	10-HALE	Turbo Prop	M	FW	▲	400(CS)	32	12264	4536	363 Int & 1361 Ext
634 USA	General Atomics Aeronautical Systems	Predator C	10-HALE		M	FW	●					
635 USA	General Atomics Aeronautical Systems	Prowler II	06-MRE		M	FW	●	230	18		340	45
636 USA	General Atomics Aeronautical Systems	Sky Warrior (based on Predator MQ-1)	09-MALE		M	FW	●					
637 USA	Geneva Aerospace	Dakota	05-MR		RV	FW	▲	185	4.5	315	108	36
638 USA	Georgia Tech Research Inst.	Entomopter	01-Micro	Chemical/muscle	DV	FLW	●					
639 USA	Georgia Tech Research Institute	MarsFlyer	13-EXO		RV	FW	●					
640 USA	Georgia Tech Research Institute	UAV	02-Mini	Fuel Cells	RV	FW	▲					
641 USA	Global Aerial Surveillance	SD-06SW Sea Wraith	06-MRE	Amphibious	DV	FW	▲		12-24	926		18
642 USA	Global Aerial Surveillance	Talon L.A.S.H	06-MRE		M, DV	RW	▲	240		926		362
643 USA	Global Aerial Surveillance	XD-04E Wraith E	02-Mini		DV	FW	▲		3		2.16	
644 USA	Global Aerial Surveillance	XD-05 Wraith	06-MRE		DV	FW	▲	240	12-36	926		9
645 USA	Green Brothers Aviation	Heliplane	05-MR	Gyroplane	DV	RW	▲					
646 USA	Guided Systems Technologies	Unmanned VTOL	05-MR		DV	RW	▲		3.3		450	94.5
647 USA	Honeywell	MAV	01-Micro		DV	RW	▲	90	0.6	11	6.8	0.91
648 USA	Honeywell & AeroVironment	Kestrel (OAV)	02-Mini		M	RW	●				11.3	
649 USA	Insitu Group & Boeing	Insitu Group & Boeing	08-SR		DP	FW	▲	126	15	100	18	3.2
650 USA	Insitu Group	SeaScan	08-SR		DP	FW	▲	130	15	100	18	6 (Incl. Fuel)
651 USA	IntelliTech MicroSystems	Vector P	05-MR		RV	FW	▲			100		

CR = Close Range	AirL = Air-Launched	M = Military	TW = Tilt Wing
SR = Short Range	B/C = Bacteriological & chemical sensing	NM = Not Motorised	UCAR = Unmanned Combat Aerial Rotorcraft
MR = Medium Range	CC = Civil/Commercial	OFF = Offensive	VSTOL = Very Short Take-Off & Landing
MRE = Medium Range Endurance	CL = Container Launched	OPA = Optionally Piloted Aircraft	VTOL = Vertical Take-Off & Landing
LADP = Low Altitude Deep Penetration	CRW = Canard Rotary Wing	Prf = Parafail	
LALE = Low Altitude Long Endurance	CS = Cruising Speed	RATO = Rocket Assisted Take-Off	▲ = Proof-of-concept/demonstrator
MALE = Medium Altitude Long Endurance	DP = Dual Purpose - civil/military	RV = Research Vehicle	● = In inventory and/or in service
HALE = High Altitude Long Endurance	DV = Developmental Vehicle	RW = Rotary Wing	○ = Ordered/Entering service
UCAV = Unmanned Combat Aerial Vehicle	EW = Electronic Warfare	SRW = Shrouded Rotary Wing	◆ = Ordered as test/demo system
STRA = Stratospheric	Ex = Expendable	LA = Lighter than Air	● = Development continuing
EXO = Exo stratospheric	FLW = Flapping Wing	TB = Tilt Body	○ = No longer in production/development
	FW = Fixed Wing	TR = Tilt Rotor	■ = Developed & market ready

	Country	Producer (s) / Developer(s)	System Designation	Category	Remarks	Class	Air-frame	Status	Max. Speed (km/h)	Endurance (hours)	Range (km)	MTOW (kg)	Payload Capacity Max. (kg)
652	USA	Iron Bay	XTM	05-MR		DP	FW	▲●					
653	USA	Iron Bay	Fabcoy	03-CR	Cargo delivery	RV	RW	▲●					
654	USA	Iron Bay	Knighthawk	05-MR	Front & rear eng	RV	FW	▲●					
655	USA	Iron Bay	Sabre	02-Mini	Foam airframe	RV	FW	▲●					
656	USA	ISL Bosch Aerospace	Lears IV	08-LALE		DP, DV	FW	▲●	203	30	150	54,5	27,3
657	USA	ISL Bosch Aerospace	SASS LITE	05-MR		DP	LA	▲●	70	12-24		190	
658	USA	ISL Bosch Aerospace	WASP	02-Mini	Anhedral wing	DP	Prf	▲●	73	1		10	
659	USA	Kaman Aerospace & Lockheed Martin	K-Max Burro	05-MR		DP	RW	●	185		150	705	
660	USA	Kuchera Defence	Falcon	02-Mini		DP	RW	◆					
661	USA	L3 - BAI Aerosystems	Evolution	02-Mini		M	FW	▲	80	0,75	10	2,95	0,45
662	USA	L3 - BAI Aerosystems	Exdrome	04-SR		M	FW	▲	362	2,5	90	43	9
663	USA	L3 - BAI Aerosystems	Isis	06-MFR		M	FW	●	158	12	90	193,2	34
664	USA	L3 - BAI Aerosystems	Javelin	02-Mini		DP	FW	▲	105	2	8	6,8	1,45
665	USA	L3 - BAI Aerosystems	Neptune	04-SR	Sea-landing	M	FW	▲●					
666	USA	L3 - BAI Aerosystems	Scimitar	04-SR	Jet powered	M	FW	?					
667	USA	L3 - BAI Aerosystems	Tem	03-CR		M	FW	▲	125	2	50	59	11,3
668	USA	L3 - BAI Aerosystems	Viking 100	03-CR		M	FW	●	120	6-8	50-75	68	9
669	USA	L3 - BAI Aerosystems	Viking 300	04-SR		M	FW	●	126	8-10	50-75	143	
670	USA	L3 - BAI Aerosystems	Viking 400	05-MR		M	FW	●	145	10-12	50-75	221	27
671	USA	Lew Aerospace Inc	E-CLASS	05-MR	Blended wing	M	FW	▲●	192	16	1184	13,6	9
672	USA	Lew Aerospace Inc	Inventus E	02-Mini		DP	FW	■	157	2	166	2,7	
673	USA	Lew Aerospace Inc	Inventus S-1	03-CR		DP	FW	●	220	30	3700	22,7	22-34
674	USA	Lew Aerospace Inc	S-CLASS	05-MR	Blended wing	M	FW	▲●	233	20	3535	158	67
675	USA	Lew Aerospace Inc	SSS-CLASS	09-MALE	Blended wing	M, DV	FW	▲●	233	30	3200	824	360
676	USA	Lockheed Martin	Cormorant	11-U CAV	Sub-launched	M, DV	FW	▲●	4500	3		4500	
677	USA	Lockheed Martin	Desert Hawk	02-Mini		M	FW	▲	92	1	10	3,18	0,5
678	USA	Lockheed Martin	Desert Hawk III	02-Mini		M	FW	●	80	1,5	10+	3	0,8
679	USA	Lockheed Martin	High Altitude Airship	10-HALE		M	LA	▲●		30			250
680	USA	Lockheed Martin	LOCAAS	05-MR	Solar OFF	M	FW	●	370 (CS)	0,5	185	45,4	
681	USA	Lockheed Martin	Morphing UAV	11-UCAV		M, DV	TW	▲●					
682	USA	Lockheed Martin	NAV	01-Micro	Nano	DV	FW	◆				0,010	
683	USA	Lockheed Martin	P-175 Polecat	10-HALE	Proto crashed	M, DV	FW	▲●		4		4000	450
684	USA	Lockheed Martin	Sky Spirit	05-MR		M	FW	■?	185	10	50-90		11,34
685	USA	Lockheed Martin	Sky Spirit ER	05-MR		M	FW	●?	185	22	50-90		27,2
686	USA	Lockheed Martin & Bell Helicopter Textron	UCAR	05-MR		DV	RW	▲?					
687	USA	Lockheed Martin & Boeing	Darkstar	09-MALE	Stealth	M, DV	FW	▲●?	550	12		3901	
688	USA	Lockheed Martin & Boeing	Darkstar B	09-MALE	Stealth	M, DV	FW	▲●					
689	USA	Lutronic & DARPA	Kolibri	01 Micro		M, DV	RW	▲●?					
690	USA	Micropropulsion	NAV	01-Micro	Nano	DV	FW	◆		0,3		0,010	0,002
691	USA	Miraforte Flight Systems	Dragon Slayer	02-Mini	Electric	M, DV	FW	▲●	150	0,6	5	0,3	
692	USA	Mission Technologies (MI-TeX)	Backpack	02-Mini	Twin-wing	M	FW	▲●				4,5	
693	USA	Mission Technologies (MI-TeX)	Buster	02-Mini	Twin-wing	M	FW	▲	120	2-4	10	5,9	1,32
694	USA	Mission Technologies (MI-TeX)	Hellfox	03-CR	Twin-wing	M	FW	■	220	8		159	
695	USA	Mission Technologies (MI-TeX)	Mini-Vanguard	03-CR	Twin-wing	M	FW	▲	200	4		48	
696	USA	Mission Technologies (MI-TeX)	Vxen	03-CR	Twin-wing	M	FW	■				91	
697	USA	MLB	Bat	04-SR		DV	FW	▲?	120	4	370	11,3	1,8
698	USA	MLB	Micro Dot	01-Micro		DV	FW	●					
699	USA	MLB	Trochoid	01-Micro		DV	FW	●	98	0,3			
700	USA	NASA Dryden	I-2000	04-SR	Inflatable Wing	DV	FW	●				6,8	
701	USA	Naval Research Lab.	Alice	05-MR	AirL, EW	M	FW	▲●	120 (CS)	2			
702	USA	Naval Research Lab.	AME	03-CR	Testbed	RV	FW	▲●					
703	USA	Naval Research Lab.	BITE-Wing	01-Micro	Research	M, DV	FW	▲●				0,0195	
704	USA	Naval Research Lab.	Crystal Sun	04-SR	EW, Naval	M, DV	RW	▲●					
705	USA	Naval Research Lab.	Dragon Eye	02-Mini		M	FW	▲●	65 (CS)	0,5-1	5-10	2,95	0,225
706	USA	Naval Research Lab.	Dragon Warrior	04-SR		M	RW	▲●	185	3-5	92	154	16
707	USA	Naval Research Lab.	Duster	05-MR		M	FW	▲●		22		136	
708	USA	Naval Research Lab.	Eager	03-CR	Decoy	M, DV	RW	▲●				50	
709	USA	Naval Research Lab.	Extender	05-MR	AirL, EW	M	FW	▲●	73 (CS)	2,2		14	
710	USA	Naval Research Lab.	Finder	05-MR	AirL, B/C	M	FW	▲●	185	10	620	27	5,1
711	USA	Naval Research Lab.	Flyrt	04-SR	Decoy	M	FW	▲●		0,5		32,7	11,3
712	USA	Naval Research Lab.	Ghost/Dakota	03-CR	Testbed	RV	FW	▲●	185	2		81	
713	USA	Naval Research Lab.	Hawkeye	04-SR	AirL, EX	M, DV	FW	▲●				22,5	
714	USA	Naval Research Lab.	Laura	04-SR		M, DV	FW	▲●					
715	USA	Naval Research Lab.	MAC-1	13-EXO		M, DV	FW	▲●					
716	USA	Naval Research Lab.	Mares	04-SR		RV	FW	▲●					
717	USA	Naval Research Lab.	Mite	01-Micro		M, DV	FW	▲●				0,0095	
718	USA	Naval Research Lab.	NDM-1/2/3	03-CR		RV	FW	▲●					
719	USA	Naval Research Lab.	Pendopter	01-Micro		M, DV	FW	▲●					
720	USA	Naval Research Lab.	Samara	01-Micro		M, DV	FW	▲●					
721	USA	Naval Research Lab.	Sea ALL	02-Mini		M, DV	FW	▲●	65 (CS)	0,5-1	5-10	2,04	0,225
722	USA	Naval Research Lab.	Sender	04-SR		M, DV	FW	▲●	167	2	93	4,54	
723	USA	Naval Research Lab.	SIERRA	04-SR		M, DV	FW	▲●	101			141	
724	USA	Naval Research Lab.	Spider-Lion	01-Micro	Fuel Cells	DV	FW	▲●				2,6	

CR	= Close Range	AirL	= Air-Launched	M	= Military	TW	= Tilt Wing
SR	= Short Range	B/C	= Bacteriological & chemical sensing	NM	= Not Motorised	UCAR	= Unmanned Combat Aerial Rotorcraft
MR	= Medium Range	CC	= Civil/Commercial	OFF	= Offensive	VTOL	= Vertical Take-Off & Landing
MRE	= Medium Range Endurance	CL	= Container Launched	OPA	= Optionally Piloted Aircraft		
LADP	= Low Altitude Deep Penetration	CRW	= Canard Rotary Wing	Prf	= Parafoil		
LALE	= Low Altitude Long Endurance	CS	= Cruising Speed	RATO	= Rocket Assisted Take-Off	▲	= Proof-of-concept/demonstrator
MALE	= Medium Altitude Long Endurance	DP	= Dual Purpose - civil/military	RV	= Research Vehicle	▲	= In inventory and/or in service
HALE	= High Altitude Long Endurance	DV	= Developmental Vehicle	RW	= Rotary Wing	○	= Ordered/Entering service
UCAV	= Unmanned Combat Aerial Vehicle	EW	= Electronic Warfare	SRW	= Shrouded Rotary Wing	◆	= Ordered as test/demo system
STRA	= Stratospheric	Ex	= Expendable	LA	= Lighter than Air	●	= Development continuing
EXO	= Exo stratospheric	FW	= Flapping Wing	TB	= Tilt Body	●	= No longer in production/development
		FW	= Fixed Wing	TR	= Tilt Rotor	■	= Developed & market ready

	Country	Producer (s) / Developer(s)	System Designation	Category	Remarks	Class	Air-frame	Status	Max. Speed (km/h)	Endurance (hours)	Range (km)	MTOW (kg)	Payload Capacity Max. (kg)
725	USA	Naval Research Lab.	Sr Telemaster	02-Mini		M, DV	FW	▲●				11,36	
726	USA	Naval Research Lab.	Swallow	03-CR		M, DV	FW	▲●	110	2		28	4,54
727	USA	Naval Research Lab.	Telemaster	02-Mini		M, DV	FW	▲●				29,5	
728	USA	Naval Research Lab.	VLIIRDT	03-CR		M, DV	?	▲●					
729	USA	NAVMAR	Tiger Shark	04-SR		M	FW	▲●	120	10	32,8	128	13,5
730	USA	NAVMAR & L3 - BAI Aerosystems	XPV-2 Mako	04-SR		M	FW	▲	140	8,5	75	130	13,61
731	USA	Neany (Titan Aircraft airframe)	Arrow	05-MR	OPA	RV	FW	●	245				
732	USA	Neural Robotic Industries	AutoCopter	02-Mini		CC	RW	▲		0,8	37	22,7	6,8
733	USA	Northrop Grumman	MALD	05-MR	Decoy	M	FW	●	850	0,75		48	
734	USA	Northrop Grumman	RO-4A Global Hawk	10-HALE		M	FW	▲	630 (CS)	36	22230	12110	900
735	USA	Northrop Grumman	RO-4B Global Hawk	10-HALE		M	FW	●	570 (CS)	36	22780	14630	1360
736	USA	Northrop Grumman	RO-8A FireScout	05-MR		M	RW	●	230	6	204	1202	91 Fuel Incl.
737	USA	Northrop Grumman	RG-8B FireScout	05-MR		M	RW	●	230	8+		1429	
738	USA	Northrop Grumman	X-47A	11-UCAV		M, DV	FW	◆			2800	2678	
739	USA	Northrop Grumman	X-47B	11-UCAV		M, DV	FW	◆	320	12	2407	2500	2000
740	USA	Northrop Grumman & MD Helicopter & CarterCopter	UCAR	05-MR		M, DV	RW	▲	300	10	700		
741	USA	Octatron	SkySeer	02-Mini		DP	FW	◆	37	0,75		1,5	
742	USA	Oregon Iron Works	Sea Scout	04-SR	Seaplane	DP, DV	FW	▲●					
743	USA	Orion Aviation	Model 706 Seabat	05-MR		DP	RW	●				91	
744	USA	Piasecki Aircraft	Air Guard	05-MR		M	RW	◆					
745	USA	Piasecki Aircraft	Air Scout	05-MR		M	SRW	◆					
746	USA	Pioneer UAV Inc. (50% AAI Corp, USA & 50% IAI, Israel)	Pioneer	05-MR		M	FW	◆▲	210	5,5	185	200	45
747	USA	Procerus Technology	Unicorne 1	02-Mini	Electric	DP	FW	■	98	2		3,1	
748	USA	Procerus Technology	Unicorne 2	02-Mini	Electric	DP	FW	■	70	1		1,8	
749	USA	Procerus Technology	Unicorne 3	02-Mini	Electric	DP	FW	■	70	1		1,35	
750	USA	Proxy Aviation Systems	SkyWatcher	06-MRE	OPA	M	FW	●		15		1450	150-290
751	USA	Proxy Aviation Systems	SkyRaider	06-MRE	OPA	M	FW	▲●	320(CS)	20-30		1632	150-450
752	USA	Raspet Flight Research Laboratory	Owl	?		M, DV	FW	●		24+			
753	USA	Raytheon Missile Systems	Cobra	03-CR	COA (2006)	RV	FW	▲●	150	3		45	11
754	USA	Raytheon Missile Systems	SilentEyes	02-Mini		M	FW	●?				4,5	
755	USA	Rotomotion	SR 20	02-Mini		CC	RW	▲	50	0,2-0,4	0,8		4,5
756	USA	Rotomotion	SR 100	02-Mini		CC	RW	▲	50	0,45	0,8		8
757	USA	Rotomotion	SR 200	02-Mini		CC	RW	■	80	4	0,8		22,7
758	USA	SAIC	LEWK	06-MRE	AirL, EW	M, DV	FW	●	278	8		363	91
759	USA	SAIC	Vigilante 496	05-MR	OPA	DP	RW	●	139	5	278	500	136
760	USA	SAIC	Vigilante 502	05-MR		M	RW	●	217	9	416	500	68
761	USA	Scaled Composites	Proteus	10-HALE	OPA	RV	FW	●	500	14		5670	900
762	USA	Sikorsky Aircraft	Cypher II =										
763	USA	Sikorsky	Dragon Warrior	03-CR		M	RW	●	130	2,5		115	
764	USA	Sikorsky Aircraft & Raytheon	X-2 UAV	05-MR		M	RW	▲●	460	5	200		
765	USA	Swift Engineering	UCAR	05-MR		M, DV	RW	▲					
766	USA	Swift Engineering	KillerBee KB-2	04-SR	Stackable	M	FW	●	200	12-24	90	19,5	6,8
767	USA	Swift Engineering	KillerBee KB-3	04-SR		M	FW	●	190	12-24	90	39	13,6
768	USA	Swift Engineering	KillerBee KB-4	04-SR		M	FW	●	108(CS)	12-24		61	
769	USA	Systems Research & Development	KillerBee KB-X	04-SR		M	FW	■	195	12-24	90	163	54,4
770	USA	Systems Research & Development	Archangel	02-Mini		M, DV	FW	▲●	120	30		42,6	
771	USA	Systems Research & Development	Super Archangel	02-Mini		M, DV	FW	▲●	110	16		64	
772	USA	Systems Research & Development	Wrath	02-Mini		M, DV	FW	●					
773	USA	Tactronix-Tactical Airspace Group (TAG)	TAG-M2600	03-CR		DP, DV	RW	●	200	2		654	250
774	USA	Theiss Aviation	P.L.A.N.C	02-Mini		M	FW	●	40(CS)			2,4	
775	USA	Thorpe Seep Corp.	Super Ferret	02-Mini		M	FW	●	54(CS)			3,6	
776	USA	Thorpe Seep Corp.	P10	?		DP	FW	■					22,68
777	USA	Thorpe Seep Corp.	P10A	04-SR		DP	FW	■					22,68
778	USA	Thorpe Seep Corp.	P10B	04-SR		DP	FW	■					22,68-45
779	USA	Thorpe Seep Corp.	F40	04-SR		DP	FW	■					22,68
780	USA	Thorpe Seep Corp.	F4000	04-SR	NM	DV	FW	■					
781	USA	Thorpe Seep Corp.	F7108	04-SR	Trainer	DP	FW	■					4,5
782	USA	Thorpe Seep Corp.	RMI Spinwing	05-MR		DV	RW	■					
783	USA	Thorpe Seep Corp.	TS1000	04-SR		DP	FW	■					31,75
784	USA	Thorpe Seep Corp.	TS2000	05-MR		DP	FW	■				550	181
785	USA	Trek Aerospace	DragonFly	?		DP	TR	●	380	3		485	204
786	USA	Trek Aerospace	OVIWUN	01-Micro		DV	TR	●	75	0,3	1,6	5,4	0,5
787	USA	USAF Research Lab.	SensorCraft	10-HALE		M, DV	FW	●					
788	USA	Veratech	Phantom Sentinel	02-Mini		DV	RW	▲●				1,8	
789	USA	Veratech	X-Pro	02-Mini	4 rotors	DV	RW	▲●					
790	USA	Vought Aircraft	Kingfisher II	?	Seaplane	M	FW	●				4308	1133

CR = Close Range
 SR = Short Range
 MR = Medium Range
 MRE = Medium Range Endurance
 LADP = Low Altitude Deep Penetration
 LALE = Low Altitude Long Endurance
 MALE = Medium Altitude Long Endurance
 HALE = High Altitude Long Endurance
 UCAV = Unmanned Combat Aerial Vehicle
 STRA = Stratospheric
 EXO = Exo stratospheric
 AirL = Air-Launched
 B/C = Bacteriological & chemical sensing
 CC = Civil/Commercial
 CL = Container Launched
 CRW = Canard Rotary Wing
 CS = Cruising Speed
 DP = Dual Purpose - civil/military
 DV = Developmental Vehicle
 EW = Electronic Warfare
 Ex = Expendable
 FLW = Flapping Wing
 FW = Fixed Wing
 M = Military
 NM = Not Motorised
 OFF = Offensive
 OPA = Optionally Piloted Aircraft
 Prf = Parafoil
 RATO = Rocket Assisted Take-Off
 RV = Research Vehicle
 RW = Rotary Wing
 SRW = Shrouded Rotary Wing
 LIA = Lighter than Air
 TB = Tilt Body
 TR = Tilt Rotor
 TW = Tilt Wing
 UCAV = Unmanned Combat Aerial Rotorcraft
 VSTOL = Very Short Take-Off & Landing
 VTOL = Vertical Take-Off & Landing
 ▲ = Proof-of-concept/demonstrator
 ▲ = In inventory and/or in service
 ● = Ordered/Entering service
 ◆ = Ordered as test/demo system
 ● = Development continuing
 ◆ = No longer in production/development
 ■ = Developed & market ready

V. HISTORY OF UAS

A. THE ORIGINS

The idea of using an unmanned aircraft against enemies has been in the mind of humans since long before the Wright brothers invented the airplane. This concept is present in ancient history. Winged weapons being used by gods to gain an advantage over their enemies were illustrated in Chinese writings, which mention a warlord using large kites to carry explosives over the walls of a city and fortress nearly 2,000 years ago. This allowed him to attack his enemy while keeping his own troops out of range.

An aerial balloon that would use a time delay to float over enemies and launch rockets down on top of them was designed by a French scholar in 1818. An aerial photography system hanging from a large kite was experimented with by U.S. Army researchers as early as the 1890s during the Spanish American War. William Eddy took hundreds of photographs from kites, which may have been one of the first uses of UAS in combat [91].

From that time on, many projects were developed to build unmanned aerial vehicles for military use, but they couldn't really succeed until the development of three technologies necessary for operational use:

- First, an aerial platform that could maneuver toward an appropriate objective
- Second, a guidance system that would provide communication between an operator and the UAS
- Third, a payload able to perform a useful mission

In the following discussion of the historical development of unmanned aerial systems, I will periodically refer to the progress made in these three areas. Where numerous similar systems were being developed at the same time, I will describe how we reached the current level of UAS technology.

B. WWI

Even though the idea of building an unmanned aircraft had been around for a long time, the invention of the airplane naturally played a major role in developing this technology. The airplane provided a level of directional mobility that kites and balloons did not have: they could go up like a kite, they could move horizontally like a balloon, and they were more maneuverable and could be sent to any direction, not only the direction the wind blew in. This advance in technology solved the first problem of the three technological requirements mentioned previously.

However, it was still too early for a more sophisticated guidance system for this new technology. Without a man onboard, the airplane would have little operational success. The U.S. and Britain both attempted to develop unmanned aircraft filled with explosives.

For the U.S., Charles Kettering (of General Motors fame) developed a biplane UAV, known as "The Kettering Aerial Torpedo," "Kettering Bug" or just "Bug," for the Army Signal Corps. It took three years, could fly nearly 40 miles at 55 miles per hour, and carried 180 pounds of high explosives. These early UAS had a very simple guidance system. The UAS heading was slaved to a magnetic compass and its altitude was slaved to a barometric altimeter [92].

In 1917, the British tried to use radio control in their unmanned aircraft experiments. This was a significant advance but it did not work as expected. Thus, no unmanned aircraft successfully flew before the end of the war. Right after the war, both countries stopped nearly all work on these programs due to the budget considerations, allowing only for a modest research capability.

The Germans also tried to develop unmanned aircraft. "Among their more innovative ideas was a remote control technology for guided missiles, which used a thin copper wire that reeled out behind the vehicle and kept it in contact with a pilot on the ground—not unlike the wire-guided missiles of the 1970s...The Germans also developed

several flying bomb designs, including a glider that could carry 2,205 lb of explosive for about five miles.” German designs were not operational before the end of World War I [92].

C. INTERWAR YEARS

Between World War I and World War II, all countries cut the funding for research. Because of this decreased funding, development of unmanned aerial vehicles continued very slowly. The British stayed ahead in the game and managed to build radio controlled target drones, named Fairy Queens, many of which crashed shortly after launch. In 1933, the Fairy Queen was used for the first time as a target drone for gunfire practice [93]. In April of the following year, one survived over two hours of heavy naval gunfire for testing purposes, showing a lack of effectiveness of the fleet's anti-aircraft weapons against unmanned aircraft and the future feasibility of remotely piloted aircraft [92].

Englishman Reginald Leigh Denny and two Americans, Walter Righter and Kenneth Case, developed a series of unmanned aircraft called the RP-1, RP-2, RP-3, and RP-4. They formed the Radioplane Company in 1939, which later became part of Northrop-Ventura Division. Radioplane built thousands of target drones during World War II [95].

D. WWII

The desire to win World War II spurred countries on both sides to develop many new and more capable aircraft. The German V-1 was the most known and notorious among the unmanned aerial vehicles used during World War II. It was a self-guided monoplane that carried explosives and flew a pre-set heading and time. When it reached the desired point, the engines would shut down and the aircraft would go into a dive and explode at the point of impact. After losing the Battle of Britain, the Germans could no longer conduct strategic bombing against the British. They decided to save their remaining manned aircraft and pilots for the Russian front. Thus, it was due to a scarcity of resources that Hitler and the German high command looked to expendable unmanned

aircraft to allow them to resume a strategic bombing campaign. This was the first large-scale operational employment of unmanned aircraft. Even though the V-1 campaign did not have a large military effect, a study by the British Royal Air Ministry pointed out that the V-1 campaign cost the Allies four times more than it cost the Germans. Allied expenses included the destruction and lost civil productivity caused by the V-1's attacks, and the cost of Allied military operations against the V-1s. This campaign had a significant psychological impact too. Approximately 1.4 million people evacuated London by the second month after the V-1 campaign started. Statistics from the V-1 campaign are listed in Table 13 [92].

From June 1944 to 29 March 1945, 10,492 V-1 flying bombs were launched against England. Only 2,419 of them reached the desired targets. Of the rest, 1,847 were neutralized by Royal Air Force Spitfire pilots, who learned that placing the wing tip of their fighter plane underneath the V-1's outer wing would often cause the gyros to tumble, and send them crashing out of control before reaching their targets. Another 1,878 V-1s were shot down by anti-aircraft artillery and 232 were snagged by balloons [96].

Table 12. Statistics of the German V-1 Campaign (From [92])

Campaign Length	7.5 mo.
Total V-1s Launched	10,492
# Ground Launched	8,892
# Air Launched	1,600
# Reaching Objective	2,419
Civilians Killed	6,184
Civilians Injured	17,981
Cost to Allies	£47,635,000
Cost to Germans	£12,600,000

Shoot downs:		
By Fighters	By Balloons	By AAA Guns
1,847	232	1,878



Figure 56. German V-1 "Buzz Bomb"

In June 1944, the German army began the use of what would be a very unique, very deadly, and historical weapon called the V-1. The 'V' stood for Vergeltungswaffe which meant "vengeance weapon." Better known to Londoners as the "Buzz Bombs" or "doodlebugs," these flying bombs made a very distinctive sound as they flew overhead at low altitude, before the timing mechanisms expired, and the bomb fell to earth and exploded [96].

In the meantime, the U.S. and Britain developed better guidance technology with radio-controlled aircraft as target drones [91]. Operators had to keep the unmanned aircraft within visual range due to the lack of an over-the-horizon guidance capability. Although the electronic computer was first demonstrated by IBM in the mid-1940s, it was not small enough for use in controlling unmanned aircraft. Furthermore, electricity consumption was substantial (80 kW) for this kind of a computer [97].

E. POST-WORLD WAR II, THROUGH PRE-VIETNAM

After the WWII, there were many advances in UAS technology and tactics. The Cold War accelerated this progress. Competition between the Soviet Union and the United States played a major role for both sides. New and better platforms were developed, especially for unmanned use:

- Surface-to-surface Cruise Missiles
- Decoy Missiles
- Standoff Cruise Missiles
- Anti-ship Cruise Missiles
- Photo Reconnaissance UAVs

1. Surface-to-Surface Cruise Missiles

The German V-1 was the first and most primitive example of a cruise missile. During the post-war period, some evolutionary improvements were made with this technology, and both the U.S. and Russia developed long-range infiltration and attack systems that were able to carry nuclear payloads. These systems were not as effective as they were supposed to be because of their guidance systems. The guidance system, which was required to achieve better accuracy, was still beyond the technological capability of the day. Not only the U.S. but also Russia developed several cruise missile systems. The Matador, Mace, Snark and Navaho were the notable U.S. systems.

In August 1945, the AAF required a surface-to-surface missile that had a 175- to 500-mile range and 600 mph speed. In March 1946, the Glenn L. Martin Co. received a one year contract to study both a subsonic and supersonic version. This started under project "MX-771," and the initial test launches of the "XSSM-A-1" and "YSSM-A-1" prototypes were conducted in 1949. The prototypes "XB-61" and "YB-61" were redesigned in 1951. The "B-61A" Matador was accepted for operational service in 1954. It was redesignated "TM-61A" in 1955.

About 1,200 Matadors were built by 1957. This missile was stationed in West Germany, Florida, and Taiwan, and remained in service until 1962. The Matador-C was re-designated as "MGM-61C" in 1963 [98].



The Martin TM-61 Matador became the Air Force's first operational missile in 1951 [98].

Figure 57. The Martin TM-1 “Matador” (From [98])



In this photo of XB-61 GM-544, the first Matador launched from Cape Canaveral on 20 June 1951, the elevators on the horizontal stabilizer are readily apparent. The left finger spoilers (There is a set mounted in each wing) are seen in the far extreme reaches of the wingspan. Later versions moved the spoilers in to about mid-wing position and made more parallel to the leading edge of the wing.

Figure 58. The First “Matador” Launched from Cape Canaveral (From [98])

The "Matador-A," to simplify the issue of what to call it, was a mid-sized pilotless aircraft, with a high-mounted swept wing and a tee tail. It differed from the X/YB-61 prototypes, which had wings mounted on the midbody and a spindle-shaped fuselage. The Matador-A was launched by a single Aerojet-General solid fuel booster with 254 kN (25,850 kgp/57,000 lbf) thrust, the booster being discarded after launch. It was one of the first aircraft of any type to use such a "zero length launch" scheme. In cruise flight, it was propelled by an Allison J33-A-37 turbojet engine with 20.5 kN (2,090 kgp/4,600 lbf) thrust, with the air intake set flush into the missile's belly. [98]

To increase system mobility and because the radio guidance system of previous models was vulnerable to jamming, a new project was started in 1956. This was an improved version of the Matador. Initial test flights of "YTM-61B" prototypes started in 1956. This system had a longer wingspan and a longer blunt nose. In early 1958, it was designated as "TM-76 Mace" and entered operational service as the "TM-76A Mace-A." The Mace-A saw operational deployment with the 38th Tactical Missile Wing from 1955 to 1969.



Figure 59. The Mace (From [100])

Mace was an improved version of the Matador. Like its predecessor, the Mace was a tactical surface-launched missile designed to destroy ground targets. It was first designed as the TM-76 and later the MGM-13. It was launched from a mobile trailer or from a bomb-proof shelter by a solid-fuel rocket booster that dropped away after launch; a J33 jet engine then powered the missile to the target [99].

The Air Force installed a jam-proof inertial guidance system aboard the Mace "B." To enhance mobility, Martin designed the Mace's wings to fold for transport. Development of the "B" missiles began in 1964. The TM-76B/MGM-13C continued in operational status until December 1969 [99].

The U.S. Air Force was in need of a long-range missile and in January 1946, Northrop submitted designs for turbojet-powered long-range cruise missiles. In March

1946, Northrop's project was accepted and a development contract for project MX-775, covering the subsonic *Snark* (MX-775A) and the supersonic *Boojum* (MX-775B) was signed. In late 1947, the missile designator SSM-A-3 was assigned to the *Snark*, while *Boojum* was designated as the SSM-A-5. The first successful launch for XSSM-A-3 was in April 1951.



Figure 60. SM-62A “Snark” Intercontinental Surface-To-Surface Cruise Missile (From [101])

The severe reliability and accuracy limitations of the SM-62A, together with its significantly larger vulnerability to air defenses when compared to ballistic missiles, meant that the *Snark* could never be more than an interim emergency weapon [102].

In 1955, the Air Force introduced a new designation system for its guided missiles, and after that the XB-62 was redesignated as XSM-62. The projected XRB-62 reconnaissance version, which was later cancelled, became the XRSM-62.

The last test model was the N-69E (designated YSM-62A), which served as the prototype of the production *Snark*. The *Snark* eventually saw operational duty with the 702nd Strategic Missile Wing from May 1957 to June 1961 [102]. The *Snark* was the only intercontinental surface-to-surface cruise missile ever deployed by the U.S. Air Force, but was operational for only a very short time.

Concurrent with the Snark, another cruise missile was being built. This was the SM-64 Navaho. It was also a long-range supersonic missile that was launched vertically. However, the Navaho never become operational [103].

Despite the fact that the Navaho program was canceled before it was operational, test launches resulted in much technical advancement. The inertial guidance system developed for Navaho was used in the USS Nautilus and enabled it to be the first submarine to travel under the polar ice cap [104].

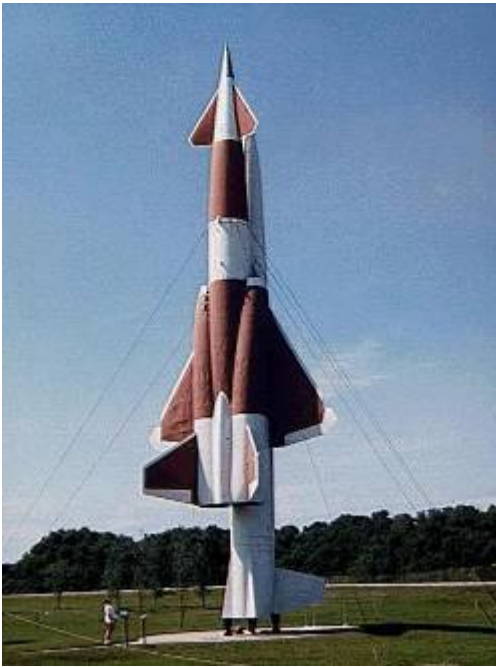

Eleven Navaho missiles were launched from the Cape between 1956 and 1958. Designed and built by North American Aviation Inc., the Navaho was being developed as a supersonic intercontinental cruise missile. The program was canceled in July 1957 when the Atlas Intercontinental Ballistic Missile was chosen over winged missile designs [104].

Figure 61. SM-64 Navaho Missile (From [104])

The best Air Force reliability rating for the Mace was 70% and it had a 500 yard CEP. The Snark was not reliable, either, and never met its required CEP of 8,000 yards. The Navaho could cruise at mach 3.25 for 5,500 miles, but it was very unreliable at the distances it was designed to travel, and very inaccurate. These three cruise missiles were not as successful as expected due to their new guidance technologies that were still not mature enough to provide the required accuracy. The Matador used LORAN, a long-range radio navigation system, and ATRAN (automatic terrain recognition and

navigation). The Snark used a combination of automated stellar navigation, and an inertial navigation system (INS). The Navaho used a variant of INS. “Because of their continued inaccuracies, these first and second generation cruise missiles were pushed aside by ICBMs (intercontinental ballistic missiles), which proved much more reliable, more accurate, and impossible to shoot down with any weapons available during that era.” [105][92]

2. Decoy Missiles

Decoy missiles are designed to confuse enemy anti-aircraft weapons into attacking the decoy while the host aircraft escapes, increasing the survivability of strategic manned bombers. A notable U.S. design was the Quail. In October 1952, the Strategic Air Command issued requirements for an air-launched decoy that could be carried by its Boeing B-52 Stratofortress bombers and released just prior to penetrating enemy airspace. This would be used to confuse an enemy's defensive radar network with false echoes. The Quail had the identical radar image of the B-52 and flew at approximately the same speed and altitude. The Quail could cruise at .9 mach for 445 nautical miles and it was preprogrammed to make two heading changes and one speed change during its flight. Quail became operational in 1960. The B-52s would carry four Quails. By 1969, Soviet radar systems became capable of distinguishing the Quail from its B-52 host, so Quails were phased out of the inventory [92].



Figure 62. GAM-72 (ADM-20A) “Quail” (From [106])

The ADM-20 was a relatively effective decoy against 1960s radars. However, in a USAF test in 1972, the Air Force radar operators were able to correctly identify the decoys in 21 out of 23 cases. Because the *Quail* was apparently no longer a useful decoy, the Air Force began its phase-out, and in 1978 the last ADM-20C had left the USAF inventory. A total of about 600 *Quail* decoys of all variants were built [106].

3. Standoff Cruise Missiles

These aerial vehicles allow strategic bombers to stay a safe distance away from heavily defended targets. This kind of missile is produced to compensate for the inaccuracy of the long-range cruise missiles such as the Snark. During this period, the most notable U.S. design was the North American Aviation Corporation AGM-28 Hound Dog, a supersonic, jet-powered, air-launched cruise missile. It had a maximum speed of mach 2.0 and a range of 675 miles. In addition, it could deliver a four-megaton nuclear weapon [92]. At first, it was designated B-77, later re-designated GAM-77, and finally designated AGM-28. Hound Dog was originally envisioned as a temporary stand off weapon for the B-52 until the AGM-48 Skybolt air launched ballistic missile could be deployed. But the Skybolt was canceled, leaving Hound Dog deployed for 13 years until replaced by newer weapons including the AGM-69 SRAM and the AGM-86 ALCM. B-52s had the ability to carry two Hound Dogs, one under each wing.



Figure 63. AGM-28 Hound Dog (From [107])

The Hound Dog was SAC's first air-launched missile. One was carried under each wing of the B-52G Stratofortress. Their mission was to attack and destroy enemy air defenses, such as fighter aircraft bases, communication centers, and anti-aircraft missile batteries, thus clearing the way for the bomber to more successfully strike its target. It was named after the popular Elvis Presley song [107].

4. Anti-ship Cruise Missile

Anti-ship cruise missiles were designed most successfully by the Russians and sold to their client states. SS-N-2 Styx is the most well known Soviet design. One of the most important operational uses of an unmanned system during this era was during the 1967 war between Egypt and Israel, when the Egyptians sank the Israeli destroyer Eilat with a single Soviet-built Styx missile [92]. The Styx was also used by India in 1971 against Pakistan, and by Iran during its 1980–1988 war with Iraq. It is still operational in many countries [108].

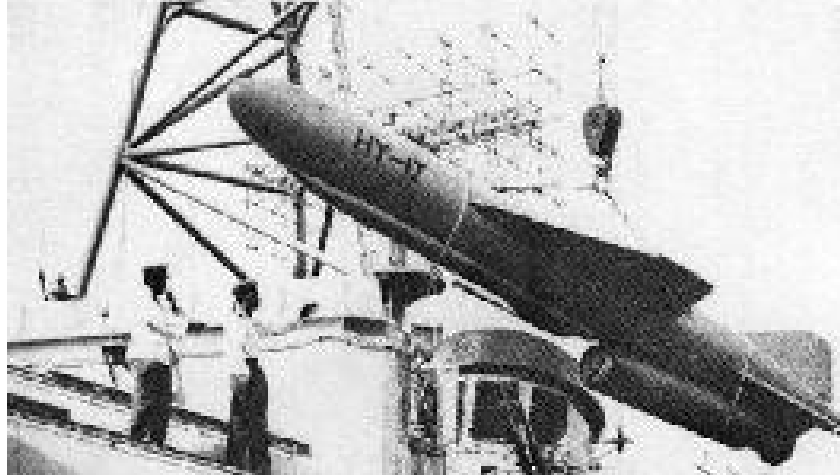

Figure 64. SS-N-2 Styx (From [109])

China acquired the Russian SS-N-2 Styx missile technology in 1959, and production began in 1974. The Russian SS-N-2 was used in 1967 against Israel by Egypt, in 1971 by India against Pakistan, and by Iran during its 1980-88 war with Iraq. Chinese copies of the Styx design (CSS-C-2 Silkworm and CSS-C-3 Seersucker) coastal defense missiles and the ship launched CSS-N-1 and CSS-N-2 were used by both sides in the Iraq-Iran War [109].

5. Photo Reconnaissance UAS

The Eastern Bloc countries were improving their military capabilities and the U.S. wanted to keep an eye on them. Photo Reconnaissance by manned aircraft was becoming more difficult due to improving anti-aircraft capabilities. After the shoot-down of the U-2 spy plane by Russia, the U.S. was under great pressure to keep the Soviets under aerial surveillance. Another U-2 was shot down during the Cuban Missile Crisis, on 27 October 1962, by a Soviet SAM over Cuba. These losses led the U.S. to adapt target drones for photoreconnaissance. The 147 family of UAS were built by the Ryan Aeronautical Company.



Figure 65. DC-130H Hercules drone control with a pair of AQM-34 (From [110])

The BQM-34 was demonstrated using existing photo reconnaissance cameras and redesignated 147A, with a high-resolution camera capable of 2-foot resolution. Later, a BQM-34 with larger wings, designed to fly at high altitude above 55,000 feet, was the first UAS designed specifically for the reconnaissance mission. Their first air launches from a C-130 proved the feasibility of the system and interceptions attempted by F-106s verified the effectiveness of the new stealth technologies in increasing the 147A's survivability against air defense radar systems [92]. After some modifications to this vehicle, the Ryan 147 B (AQM-34Q) was used operationally for intelligence collection against Cuba, and later in Vietnam [111].



Figure 66. BQM- 34 on Take-off (From [110])

The Ryan Firebee was a series of target drones or UAS developed by Ryan Aeronautical beginning in 1951. It was one of the first jet-propelled drones, and one of the most widely-used target drones ever built.

Q-2: original drone designation
BQM-34: drone capable of launching by several methods
AQM-34: air-launched variant

F. VIETNAM THROUGH DESERT STORM

Evolutionary development of UAS occurred during the period between the Vietnam War and the Gulf War. Not only were there several significant and successful operational uses of UAS during the period, but UAS were used by many different nations. The technology was maturing enough to provide the requirements for effective UAS, the three basic requirements previously discussed: “an aerial platform capable of maneuvering to an appropriate objective, a guidance system that permits over-the-horizon UAS operations and a payload that can perform a useful mission.”

New aerial platforms and advanced navigational accuracy were the main technological breakthroughs in the UAS world. The performance of UAS increased significantly: speed approached mach 4 and service ceilings reached almost to 100,000 feet [112]. “In the U.S., Teledyne Ryan developed a family of unmanned vehicles that were used in a variety of missions including reconnaissance, signals intelligence collection, radar jamming, decoy for manned or other unmanned aircraft, and leaflet dropping.” [105] Unmanned aircraft were used in flak suppression, chaff dispensing, target designation and weapons delivery roles. Some tests of unmanned drone aircraft in air-to-air combat roles were conducted. The AQM-34 demonstrated dropping 500 lb bombs, dropping the Stubby-Homing Bomb (HOBO), and deployment of anti-radiation missiles to destroy anti-aircraft radar sites [111]. They started as preprogrammed drones, but evolved to have the capability of receiving guidance while in flight.

After all these successful tests and demonstrations, the termination of the Vietnam conflict decreased the importance of the military use of UAS. The end of the Vietnam War resulted in a massive drawdown of U.S. military forces, including the elimination of Air Force UAV organizations in 1976 [113] “After the Vietnam drawdown, the Air Force appeared to lose all interest in UAVs, with little activity until the initiation of the Tier 2 (Predator), Tier 2+ (Global Hawk), and Tier 3- (DarkStar) reconnaissance-surveillance programs.” [111] In the meantime, Israel moved into the lead position in the production and operational use of mini-UAS.

During this period, long-range guidance system technology also evolved. The U.S. developed a better and more effective generation of cruise missiles with Terrain Contour Matching (TERCOM), which "sees" the terrain it is flying over using its radar system and matches this to the map stored in memory, and Digital Scene Matching Area Correlator (DSMAC) navigation systems, which are usually employed on the approach to target. A DSMAC system compares a photograph of the target with the picture provided by an onboard camera. TERCOM and DSMAC systems increased the accuracy of a missile compared to the older and simpler INS. By using these systems, CEP decreased to

100 to 600 feet after traveling intercontinental distances. These systems allowed a missile to fly lower, making it harder to be detected by ground radar [92].

In this period, there were tactical advances. Improving technology permitted the vehicles to maneuver during flight, unlike the older UAS that flew straight-line on a preprogrammed heading toward their targets or reconnaissance objectives. Some unmanned systems used a hybrid autopilot that allowed reprogrammable waypoints during the flight, or during critical phases of flight this system would allow a remote pilot to take over the control. Real-time telemetry and surveillance products could be sent back via wireless data links, allowing over-the-horizon remote guidance. This capability brought a flexibility and ability to take immediate action. Even though the unmanned vehicle was destroyed during a mission, data it transmitted before destruction would be beneficial and could be used as a valuable source of information [92].

Demand for UAS also increased worldwide. Many countries bought UAS from the world's leading producers to replace manned systems, due both to the increased relative effectiveness of anti-aircraft missiles and radar guided anti-aircraft artillery systems, and a desire to accomplish reconnaissance missions without getting recognized.

The family of 147s (147A, 147B, AQM-34, BQM-34) is the longest sustained UAS to date. It was first launched in 1951 and is still operational. It was also used in the Vietnam War for reconnaissance flights over North Vietnam. During this period, it was used over China, Cuba, and Russia as well. During the Vietnam conflict, more than 1,000 Ryan "Lightning Bug" remotely piloted vehicles flew 3435 combat missions with a 4% loss rate; this prevented many potential international incidents and the loss of many much more expensive manned aircraft and crew [113].

Israel employed UAS with innovative tactics. According to authorities, one of the keys to the success of the Israelis was the clever use of UAS during operations. During the Six-Day War, on 5 June 1967, Israel used UAVs as decoys in their air raids against Egypt. The Israelis sent numerous UAS against Egyptian facilities right before they sent their real attack forces. The Egyptian air defense forces fired on the incoming UAS,

which appeared to be Israeli aircraft on the radar display, and during the reload period manned aircraft attacked Egyptian defense systems and neutralized most of them [92].

Another significant operational use of UAS by Israel was in 1982 in the Bekaa Valley. Israel used Northrop Chukar target drones to draw fire from the Syrian's new SA-6 systems, by which they learned necessary information about the frequencies used by the missiles' search, tracking, and missile activity functions. This data was used to jam SA-6 systems during air attacks.



Figure 67. BQM-74 “Chukar” (From [110])

The BQM-74 Chukar is a series of aerial target drones produced by Northrop. The Chukar has gone through three major revisions, including the initial MQM-74A Chukar I, the MQM-74C Chukar II, and the BQM-74C Chukar III. They are recoverable, remote controlled, subsonic aerial target, capable of speeds up to Mach 0.86 and altitudes from 30 to 40,000 ft (10 to 12,000 m) [114].

Israel also used their Mastiff and Scout mini-UAS, which flew numerous reconnaissance sorties and provided real-time television images of hostile activities, such as aircraft launches and recoveries, to E2C command and control in Southern Lebanon. Because the Israelis knew from where and when and what type of air threats were coming in advance, the IAF had a aircraft kill ratio of 95:1 [115].



Three generations of the Mastiff developed by Tadiran were in operational use by the IDF performing numerous operational missions; the most well known of them was flown during the first Lebanon war when Yasser Arafat was caught by the Mastiff video camera [116].

Figure 68. Israeli Malat Mastiff (From [117])



Figure 69. IAI MALAT Scout (From [117])

The Scout remained in service with the Israeli Army until the early 1990s, when it was replaced by the IAI Searcher [116].

G. DESERT STORM THROUGH PRESENT

Increased computer processor speeds and data transfer rates have led to a new era in UAS manufacturing. Miniaturization of technology has resulted in smaller payloads and aerodynamically more efficient UAS. There has also been an increased desire for detailed, near-real-time information about the location and disposition of enemy forces. The technology has become mature enough to provide for this desire. “Gulf War after

action reports noted that intelligence gathered by national collection assets did not get to the commanders in the theater of operations that needed it. In contrast, many senior military commanders spoke high praise for the few UAS available to operational commanders during the Gulf War. The reason senior leaders praised the UAS was that they enabled decision makers in the theater of operations to have real-time or near real-time, unfiltered information about an area of interest. As a result, UAS were in big demand during the United States' operations in Bosnia and Kosovo.” [105]

The Pioneer, a joint Israel Aircraft Industries (IAI) and AAI Corporation development, was the most versatile system used in the Gulf War. The system was designed to perform unarmed battlefield surveillance and reconnaissance missions. It was launched from land or at sea via catapult or runway. Endurance and flight time varied depending on the payload but in general it could fly several hours. The Pioneer system can send real-time information through analog video by way of a line-of-sight (LOS) data link. The RQ-2 Pioneer system played a role in the Persian Gulf War of 1991, Somalia, Bosnia, Kosovo and Iraq under the U.S. Army, Navy and Marines. It also has seen service with forces sponsored by Israel and Singapore [118].



Figure 70. RQ-2 “Pioneer” (From [120])

Pioneer was procured starting in 1985 as an interim UAV capability to provide imagery intelligence (IMINT) for tactical commanders on land and at sea. In ten years, Pioneer has flown nearly 14,000 flight hours and supported every major U.S. contingency operation to date [119].

In response to earlier operations in Grenada and Libya, the Navy started the Pioneer UAV program in the late 1980s. By the time Iraq invaded Kuwait in 1990, the Navy, Marine Corps, and Army all operated UAS. With 85% of the U.S.'s manned tactical reconnaissance assets committed in Kuwait, UAS emerged as a must have military asset. Six Pioneer systems (three with the Marines, two on Navy battleships, and one with the Army) participated. They provided highly valued, near-real-time reconnaissance, surveillance, and target acquisition (RSTA) and BDA, day and night. They often worked with JSTARS, the airborne battle management and C2 platform, to confirm high-priority mobile targets. [121]

During the Gulf War, the U.S. Navy flew Pioneer for 213 hours and 64 sorties. These UAS took off from the battleships U.S.S. Missouri and U.S.S. Wisconsin and conducted target selection, naval gunfire support, battle damage assessment, maritime interception operations, and battlefield management missions. They detected many Iraqi patrol boats, and played a major role during the destruction of two high-speed boats. They were also successful in locating two Silkworm anti-ship missile sites, and were used to identify more than 320 ships. Moreover, they were used to locate AAA positions, and they were actively deployed for pre- and post-assault reconnaissance of Faylaka Island. As the war progressed, surrendering Iraqi troops and the retreat of major armored units were identified by Navy Pioneers.

The Army's Pioneers flew 155 hours and 46 sorties. They provided a quick-fire link that allowed the targets they identified to be quickly engaged by other systems. Army Pioneers were also used to increase the situational awareness of the commanders by targeting, route reconnaissance, and battle-damage assessment (BDA).

Obviously, these operations showed that Pioneers had the potential to fill the gap between manned aerial platforms and satellite-reconnaissance platforms. Furthermore, as the RF-4s were retired, one of the primary uses of Pioneer was to fill the gap created by the retirement of manned reconnaissance aircraft [122]. Marine Pioneers flew 318 hours and 138 missions during Operation Desert Shield and 185 missions and 662 hours during Operation Desert Storm [105].

During operations in the former Yugoslavia, three types of UAS were actively used. These systems were Pioneer, Hunter, and Predator and they were in action as part of U.S. operational forces. There was an evolutionary development in UAS technology: the combination of the Predator UAV; commercial satellite TV technology; and a wide bandwidth, secure tactical Internet connection through fiber-optic cables and commercial satellite transponders. This technology resulted in a much higher data transfer rate. The Predator and the Bosnia Command and Control Augmentation (BC2A) transmitted live images to theater commanders via the Joint Broadcast Service. Commanders received their 30 megabit-per-second downlinks over direct broadcast satellites. This was approximately 3,100 times more than the data rate of 9.6 kilobit-per-second allowed by the modems available during the Gulf War [124].

During the conflict in Bosnia, the main concept for targeting was dependent on UAS, which were sending data to the combined air-operations center (CAOC). This intelligence was then distributed to strike aircraft. As part of this concept, the Predator worked successfully in the Balkans to support NATO, the United Nations, and U.S. forces. Predator carried payloads of electro-optical infrared (EO/IR) and line-of-sight and ultra-high-frequency (UHF) satellite communications (SATCOM) data links. UAV/JSTARS interoperability was also demonstrated. During the conflict, the Predator UAV not only flew over 20,000 hours but also accomplished several combat missions over the Kosovo engagement zone. During Operation Allied Force, The Predator was the best evidence of the successful integration of UAS into the complex command, control, communications, computer, and intelligence (C4I) architecture [121].

Afghanistan's rough terrain was a great challenge for fighters and bombers; twenty-four hour orbiting was a must for the allied forces. Continuous coverage of the battle space with responsive reporting and engagement of time-sensitive targets was supplied by ISR platforms. Voice or data-link transmissions were used successfully for transmitting target information [125].



Figure 71. MQ-1 Predator armed with an AGM-114 Hellfire (From [126])

An MQ-1 Predator armed with an AGM-114 Hellfire missile flies a training mission. The MQ-1's primary mission is interdiction and conducting armed reconnaissance against critical, perishable targets [126].

In Afghanistan, Predators armed with Hellfire were used after some modifications. They were used against both stationary and moving targets. Both reconnaissance and strike assets were applied during the same mission without any risk to aircrew [125]. “In press releases issued on the 8th and 11th of February 2002, the Department of Defense confirmed that the CIA was using armed Predator UAS in Afghanistan, and a reference was made to a 4 February strike on a suspected Al-Qaeda complex near Zawar Kili in eastern Afghanistan.” [127] In October 2000, Predator had successfully fired the first Hellfire missile against a car that was carrying six Al-Qaeda suspects in Yemen. The Global Hawk UAS was also flown over Afghanistan, but two vehicles were lost for technical reasons. The Global Hawk generated surveillance and reconnaissance images of potential enemy targets [128].

During Operation Iraqi Freedom (OIF), UAS played a major role in intelligence gathering. The capability of sharing real time data made UAS vital for operations.

During OIF, the Predators were used to support the CAOC. In Iraq, Predators were used for ISR, and they carried Hellfire missiles [129].



RQ-4A Global Hawk is a high-altitude, long-endurance unmanned aerial reconnaissance system that provides military field commanders with high resolution, near real-time imagery of large geographic areas [130].

Figure 72. RQ-4A "Global Hawk" (From [130])

Global Hawks also played a very important role during OIF. They located thirteen surface-to-air missile (SAM) batteries, fifty SAM launchers, over seventy SAM transport vehicles and over 300 tanks in sixteen missions [130]. Even though Global Hawks flew only 5% of the OIF high-altitude missions, they accounted for 55% of the time-sensitive targeting against enemy air-defense equipment [131]. This result shows that the technology used today is at a point where we can maintain a high level of confidence in the performance of UAS.

Today, there are numerous corporations that build unmanned systems. Northrop Grumman is one of them, making many UAS that are actively used by the U.S. and its allies. Walking through the history of this company's involvement with UAS in the figure below can give us an understanding of the evolution of unmanned systems. New improvements in technology allow for better and more complex systems to be built. Tomorrow, unmanned systems will replace man in many activities.



Figure 73. Evolution of Unmanned Aerial Systems



Figure 74. Past sixty years of Northrop Grumman UAS

VI. MERGING POINTS OF EW AND UAS

This chapter is a synthesis of the first five chapters. It is also the main step to determine the possible EW tactics for single or multiple UAS over the net-centric battlefield. Two of the major research question will be answered at the end of this chapter:

- What are the merging points between UAS and EW?
- How can we use UAS more effectively for EW purposes?

In the previous chapters, I gave general information about EW and UAS, and also discussed the historical perspective in both areas. It is clear that UAS have been used in the battle area for electronic warfare purposes since the Vietnam War. With improving technology, UAS become more involved in the EW arena.

A. UAS PAYLOADS

Payloads are the determining factor for the role of UAS on the battlefield. With recent developments, EW payloads are getting smaller so that they can be inserted in mini or even micro UAS. This has a major effect on the planning process for UAS employment.

We can classify five general payload types that account for the majority of current and projected UAV applications: information collection (sensing), communications support, navigation support, weapons delivery and electronic warfare. While the first three are used for both military and civilian applications, the last two are limited mainly to military purposes [132].

1. Generalized UAS Avionics Architecture

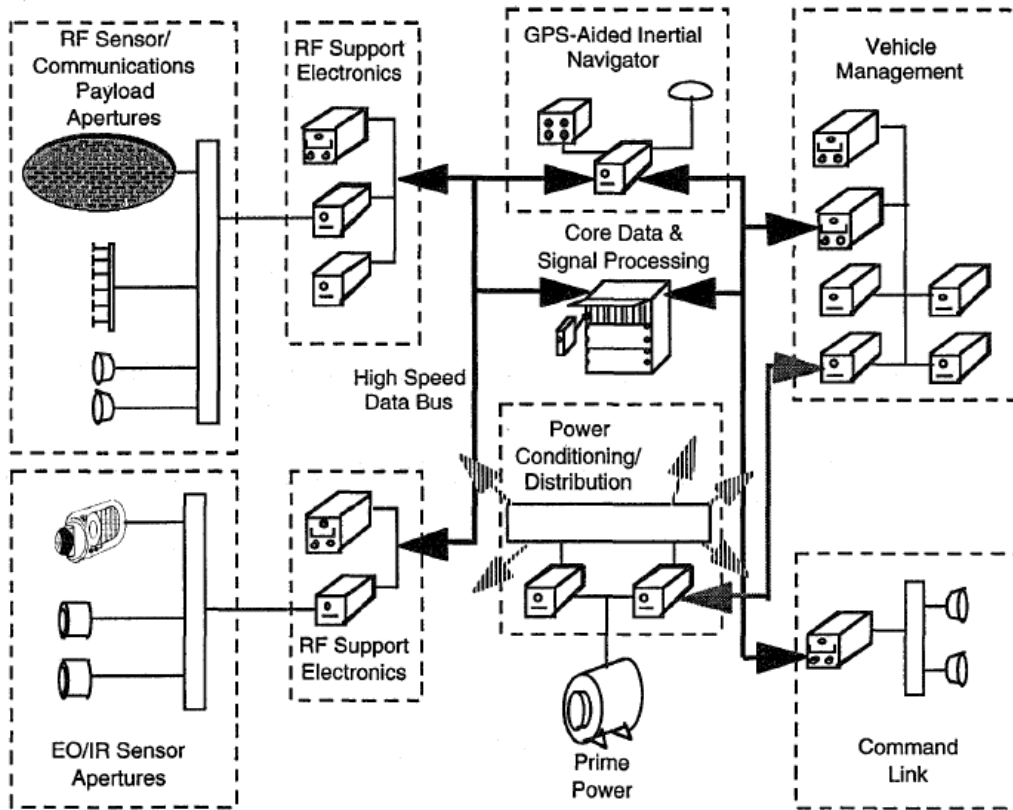

Figure 75. Generalized UAS Avionics Architecture (From [132])

In Figure 75, the elements of a modern UAS avionics suite are shown, deliberately drawn to emphasize similarity to the modular, integrated avionics of complex manned aircraft. Only the most advanced multifunction UAS will incorporate all of these avionics elements as depicted. “The basic features of modular fault tolerant hardware, high capacity fiber optic interconnects, and shared high performance digital signal and data processing are characteristic of any design that seeks to take maximum advantage of available technology to achieve high performance, reliability, and affordability.” [132]

Radio Frequency (RF) Payload Apertures: Radar, spectral surveillance functions that include RF radiometry and signal monitoring, and specialized apertures such as interferometers that are used in order to make an accurate determination of the

direction of the coming signal use payload antennas. Broadband data links for SATCOM, line of sight (LOS), or relayed data communications required by the payload are also found in this area.

RF Support Electronics: This is associated transmit and receive electronics, communicating via a high speed digital typically fiber optic network. These are placed behind the antennas.

Vehicle Management: Highly reliable flight, propulsion, and utility controls with the capacity to execute sophisticated adaptive control. Signals from flight data sensors are also processed here.

Navigation: Used for obtaining vehicle position. Accuracy of this application is vital. One highly accurate and popular solution is an Inertial navigation unit (INU) integrated with a Global Positioning System (GPS) receiver.

EO/IR Apertures: Sensors like optical or IR cameras, multi- or hyper-spectral sensors, and active devices.

EO/IR Support Electronics: Signal conditioning, preprocessing, and analog-to-digital conversion support The EO/IR apertures [132].

These are the supporting functions:

Core Processing: The heart of the payload is a high performance modular processor. This may be a fairly basic filtering, control, and data encoding computer in a simple UAV, e.g., a sensor platform that downlinks all data for processing on the ground. As the level of payload autonomy and the number of payload functions increase, the required throughput and memory can easily reach supercomputer levels.

Power Conditioning: Sophisticated payloads need high quality electrical power. Prime power from an engine-driven generator or alternator will be rectified, filtered, regulated, and distributed by the electronics in this area.

Command Link: One further RF function, usually physically separate for reliability, is the channel through which the platform exchanges control and status

information with operators. Data rates are modest, in the range of a few kbps, but high reliability, long range, and interference rejection are crucial [132].

The main focus of this chapter is the EW and EW related payloads. UAS can contribute in all aspects of Electronic Warfare, from jamming and Suppression of Enemy Air Defense (SEAD) to Electronic Warfare Support (ES), and Signals Intelligence (SIGINT). The inherent range advantages enjoyed by EW/ES payloads make them the natural sensor of choice for cross-cueing payloads with shorter ranges and/or more restricted fields of view such as SAR or EO/IR sensors. EW fits for UAS can also include SIGINT payloads, or defensive sensors that can perform a SIGINT role. For example, a radar warning receiver (RWR) can be a source of vital information, particularly when related to imagery information to form a more complete or accurate situational awareness picture or when updating the electronic order of battle. The key is the integration of the inputs from all of the vehicle's sensors, or in the case of smaller more distributed systems that use a heterogeneous mix of sensors, all of the sensors on all of the vehicles.

Studies, research and flight demonstrations prove that UAS can be utilized successfully for EW and SIGINT missions. "SIGINT sensors, for example, could be used to cue other sensors on a UAV, and they offered much longer detection ranges than EO/IR and SAR sensors." [133] UAS are an ideal platform for carrying EA payloads. The UAS can approach closer to the target emitters compared with aircraft because of their smaller RCS; therefore they need less power for effective jamming.

After the Cold War, the DOD intelligence community started showing an increased interest in UAS, and it has several mature programs to show for it. Two of today's most high-profile programs are the MQ-1/9 Predator and the RQ-4 Global Hawk. The Predator has been supporting U.S. war fighters since 1995, and the Global Hawk was flying over Afghanistan in 2001. "Both of these systems have been flying with interim SIGINT payloads for several years, and both are slated to receive new SIGINT capabilities in future years." [133]

UAS can play a very important role in the prosecution of EW campaigns. In this case EW has a vital role in the protection of UAS. To exploit this relationship, small-

sized but effective EW equipment is needed. For example, a communications jammer or an electronic surveillance (ES) receiver can be used as the main payload. A RWR can be used as a UAS payload for threat warning.

There is a great variety of payloads that can be used on UAS. Communications and electronic intelligence payloads; communications and radar jammers; electro-optic, infra-red, and MAW sensors; MTI and SAR radars; BDA sensors; communications relays; EW self-protection suites; chemical, biological, and nuclear detectors; target designators; and “horizon extenders” are some of the payloads that can be mounted on UAS for EW purposes.

2. Electronic Warfare Support (ES) and SIGINT Payloads

ES and SIGINT sensors can supply very valuable information, especially when this information is a part of or related to imagery information used for forming a trustworthy situational awareness picture or for updating the electronic order of battle. Integration of the inputs from all of the sensors is the key to success. Furthermore, these sensors require less power because they do not transmit, but just receive and process signals. ES payloads are appropriate considering the constraints of mini-UAS.

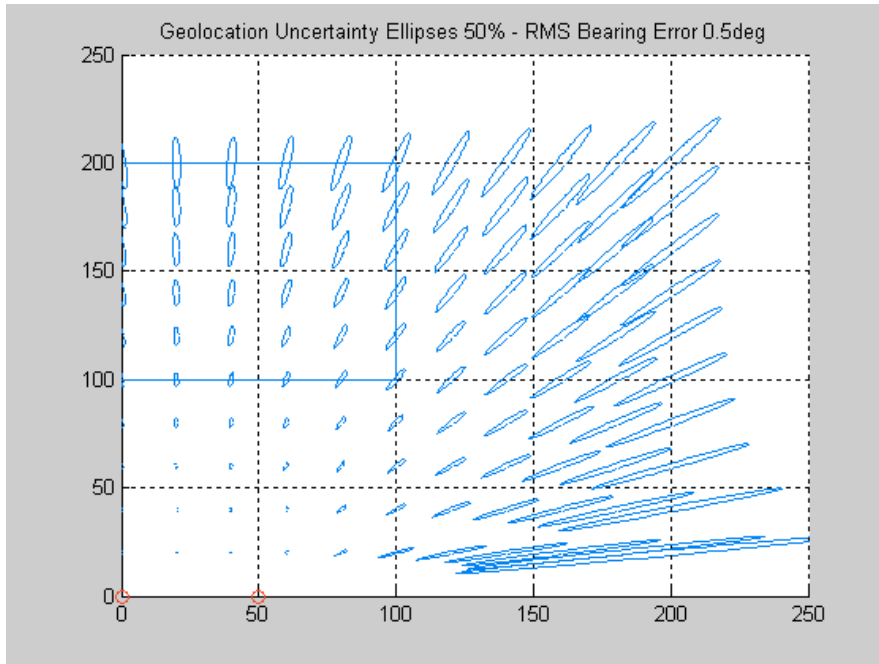

Figure 76. Geolocation error ellipses for 0.5 deg. rms DF sensors onboard 2 platforms with stand-off range of 100km. AOI (100km x 100km) is bounded by blue line.

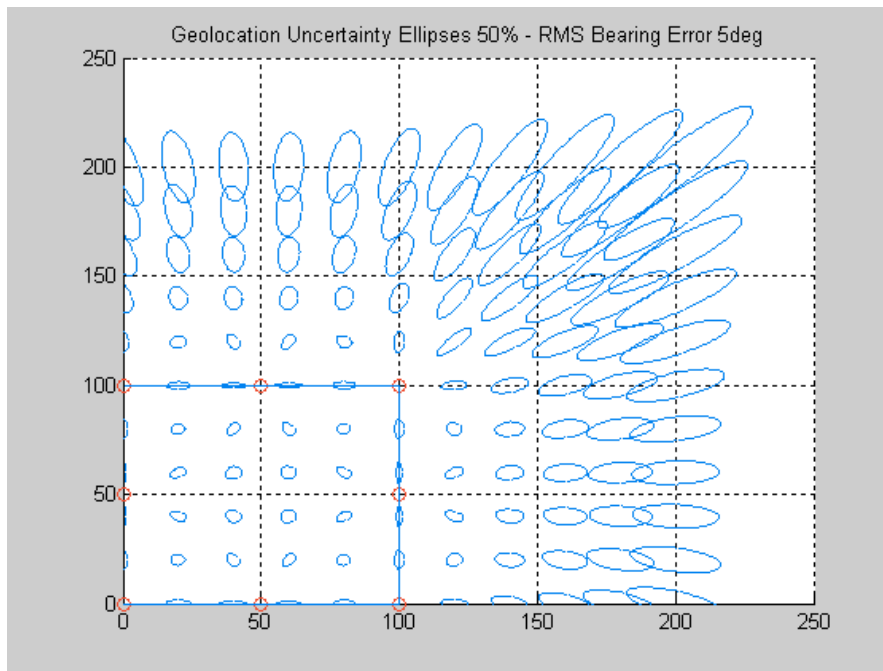

Figure 77. Geolocation error ellipses for 5 deg. rms DF sensors onboard 8 platforms with stand-in capability. AOI (100km x 100km) is bounded by blue line.

Replacing Mini-UAS with larger UAS is not reasonable and is not considered practical right now, despite that fact a greater capability can be obtained by networking these UAS sensors. Figures 76 and 77 present a comparison between the 50% uncertainty bounds for geolocating emissions of interest from two platforms with 0.5 degree rms Direction Finding (DF) capability and eight platforms with 5 degree rms DF capability. For Figure 76, more accurate sensors are used from a standoff range of 100km. For Figure 77, cheaper, smaller and less accurate sensors are used on a smaller and more affordable stand-in platform. After analyzing these two figures, we see that with a less accurate sensor at a closer range, we can obtain errors around 50% less than the ones that carry a more expensive system. The relation between geolocation error and range for a variety of Direction Finding (DF) sensor accuracies can be found in Figure 78. Depending on the range, by using ES/ELINT sensors with very modest DF capabilities, situational awareness and even targeting level accuracies can be achieved, if stand-in capability is possible.

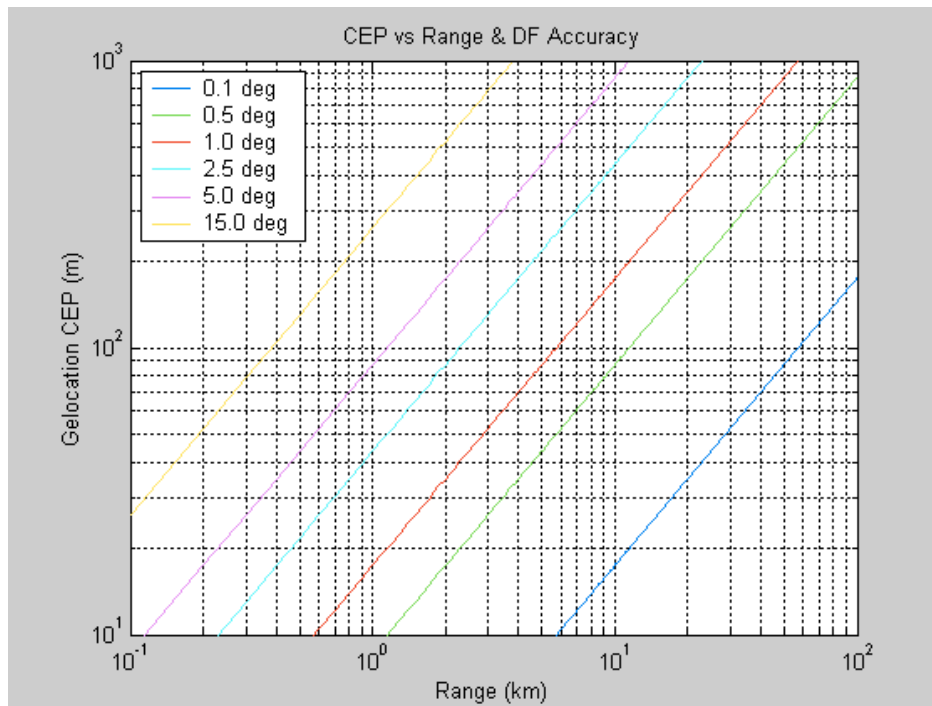

Figure 78. Geolocation Error (m) versus Range for 0.1-15 degree rms DF sensors enjoying optimum geometry.

There are several ways to determine the geolocation other than using DF techniques. Increasing the sensors around the emitter decreases the error. If there is a single platform, we need to maneuver it relative to the emitter and increase the level of accuracy by obtaining the essential geometry to overcome the geolocation problem. This means that this platform should maneuver and collect information, which is very time-consuming. If the emitter is mobile, this can cause extra complex calculation errors during these maneuvers. Using multiple platforms, geolocation can be performed in near real time. Moreover, this distribution provides a relative increase in the chances to reduce geolocation error. This provides a “double” incentive to obtain geolocation using multiple platforms [135].

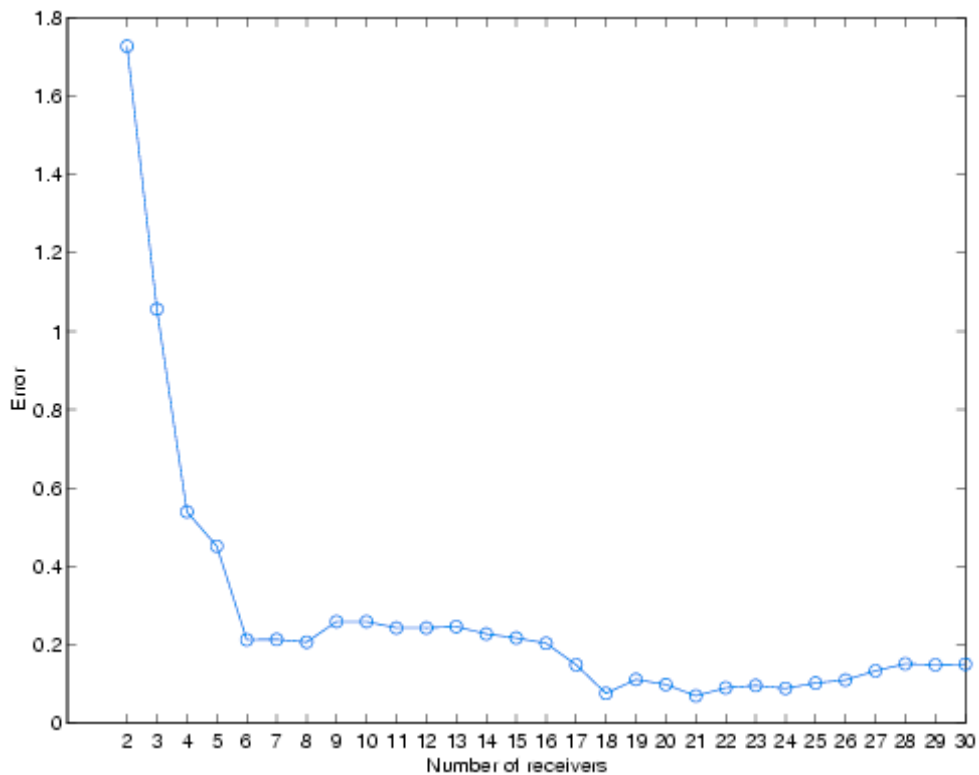

Figure 79. Relative geolocation error versus the number of DF sensors located around an emitter.

3. Electronic Attack (EA) Payloads

One payload functional area that is in advanced levels of development stage and will likely be an operational payload in the near future is electronic attack. The reason for this technological advancement is partly due to the aviation industry's successful integration of EA technologies into combat aircraft and their EA pods. For years, industry has worked to miniaturize and advance the technology needed for sophisticated EA hardware in combat aircraft. Now, several organizations are successfully integrating EA technologies into UAS payloads. It is highly possible the UAS deployed in our next military endeavor will have some EA payload on board. [134]

For self protection, jamming platforms must stand off at a considerable range from a target. Due to this fact, the jamming asset requires a large amount of power. If the size of the platform can be reduced and if it needs less or no protection, we are able to "stand in;" in this case, it would require significantly less power to jam a given target. Additionally, because the stand-in jammer is closer to its target and it transmits over a respectively smaller area, the potential for electro-magnetic fratricide is also significantly reduced. Figure 80 shows the Jammer-to-Signal Ratio (JSR) as a function of range for a 100W jammer and 10kW radar transmitting into a 20dB directional antenna. The radar return is based on the detection of a target with a radar cross-section roughly the size of a (non-stealth) strike fighter [135].

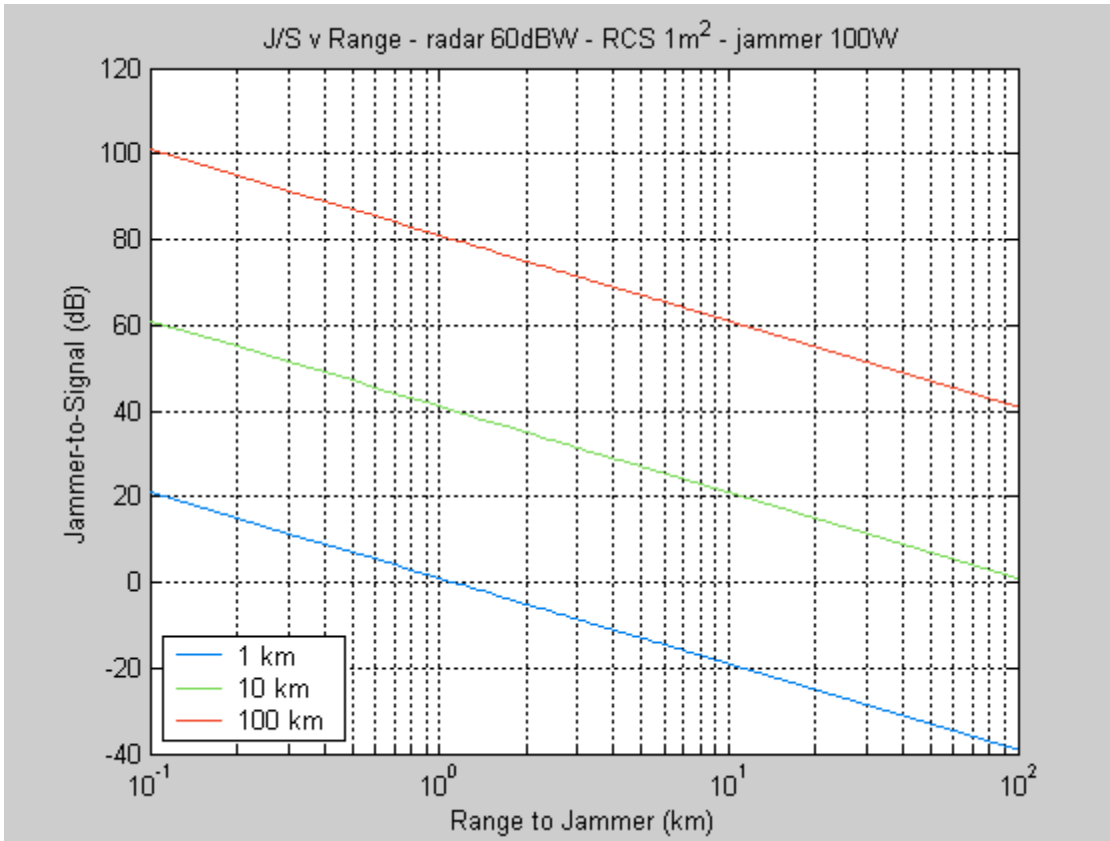

Figure 80. Jammer-to-Signal Ratio versus Range for a 100Watt noise jammer against 10kW radar with 20dB antenna gain attempting to detect a target of 1m² RCS. The red, green, and blue lines are for target ranges of 1, 10, and 100km.

As seen in the figure, achievable JSR from a 100W jammer at a range of 10km from the radar is exactly the same as a 10kW jammer located 100km from the radar attempting to protect the same target. There are many modern weapons systems with ranges over 100km; providing more power requires a bigger platform. Miniature or smaller size UAS are hard to detect. Considering these facts, it can be said that UAS are a very attractive potential alternative. Furthermore, even if the mini-UAS are detected, targeted, and engaged, because of their very small IR signatures and RCS there is still no guarantee that the weapons will fuse correctly and destroy them.

The Defence Science and Technology Organization (DSTO), which is a part of the Australian Department of Defence, conducted a series of trials to demonstrate the EW

capability of mini-UAS involved in maritime EW operations. The UAS was designed, built, and operated by Aerosonde Ltd. The payloads were designed, built, and operated by DSTO [135].

The payloads tested for EA were:

- 1. EA ~ 100MHz bandwidth noise jammer
- 2. RF repeater ~ a test target of controlled radar cross-section used with EA payload

Some of the objectives for these trials were:

- 1. To determine detectability of the UAS using the ship's radars and ES
- 2. To determine the effectiveness of the EA carried on the UAS

During these trials, a navigation radar was used as a test-radar for the EA payload. A second UAS, with an RF repeater payload, was used as a controlled radar cross-section and flown in conjunction with the UAS with the EA payload. The navigation radar was successfully jammed.



Figure 81. Navigation radar display showing jamming strobe due to EA payload onboard mini-UAV

B. INTERNATIONAL PROGRAMS

The international market for UAS is growing daily. Most of the countries are considering small and medium-sized vehicles with EW payloads.

In Germany, Rheinmetall Defence Electronics has been developing an EW version of the Kleinfluggerät Zielortung (KZO), which is used as a reconnaissance UAS. The German Army is interested in this project. The Mücke version of the KZO drone carries a VHF/UHF EA payload and also has a programmable radar jammer onboard that transmits in the 20 MHz to 110 MHz band or the 100 MHz to 500 MHz band to attack voice and data communications. Rheinmetall Defence Electronics has also developed the Fledermaus ES drone version of the KZO, which includes systems to intercept and acquire radar and radio transmissions that provide the position information and signal characteristics of the targets [136].



Figure 82. The Mücke electronic countermeasures (ECM) UAV (From [136])

The Mücke electronic countermeasures (ECM) UAV is a version of KZO for electronic warfare.

The Luftwaffe also requested that the European Aeronautic Defence and Space Company (EADS) build a SIGINT payload, 30 kHz to 30 GHz Integrated Signals Intelligence System (ISIS), for its EuroHawk UAS, which is built by Northrop Grumman [133]. An ELINT prototype was produced in 2003, and subsequent agreements between the U.S. and Germany and EADS and Northrop Grumman have been made for production of SIGINT systems in 2009.



Figure 83. Eurohawk (From [137])

Saab Avitronics has developed a 16 kg ES Payload that can be mounted into a small UAS via its business units in South Africa. This payload consist of an acquisition and analysis receiver to detect the emissions of search, track and fire-control radars and a nose-mounted antenna array that covers the 0.5 to 18 GHz frequency band. The payload is based on Avitronics' Emitter Location System (ELS).

Italy's Elettronica is working on ELT 819, a low-cost ES/ELINT payload. The focus of the payload is both passive and active radar jamming. Elettronica is also trying to develop non-military emission jamming.

In China, the People's Liberation Army (PLA) had an agreement with Xi'an ASN Technology Group Company to develop a short-range ISR and EW/EA UAS. ASN-206

UAS, with a JN-1102 EW/EA payload, was built for this purpose. Production began in 1996. This UAS can jam communications at 20-500 MHz [138].



Figure 84. ASN-206 (From [139])

ASN-206 multiple purpose UAS developed by Xi'an ASN technology group company. Design work was completed in Dec 1994. The western specialist said that the ASN-206 was developed with the help of Israel Tadiran Ltd.

Israel is one of the leading countries in the UAS industry. In September 2005, the Israeli government awarded a \$50 million order for Israel Aircraft Industry's Heron UAS, which has a payload capacity of 250kg. This provides plenty of room for SIGINT, ELINT and COMINT systems. Though no EW systems have been confirmed for the Heron, IAI's ELTA Systems Group manufactures two EW payloads: the EL/L-8385 Integrated ES/ELINT system and the EL/K-7071 Integrated COMINT system. Both of these systems are designed to perform long-range, high-endurance missions in dense radar environments, and both are intended for UAV applications and offer onboard processing [140]. Haifa-based Rafael produces the Top-Scan ES/ELINT system for UAS, which weighs no more than 15 kg and covers the 0.5 GHz-18 GHz frequency band.



Figure 85. IAI-Malat Heron UAV (From [141])

At the 2006 Farnborough Air Show, Israel's Elbit Systems unveiled a version of its Hermes 450 tactical long-endurance UAS equipped with integrated electronic intelligence gathering systems by Elisra. Hermes combined Elisra's AES-210 ES/ELINT direction-finding system (1 GHz to 18 GHz and smaller than 22kg) with a new Tadiran COMINT 30 MHz to 3 GHz SKYFIX COMINT/DF package [142].



Figure 86. Hermes 450s - UAV System (From [143])

The Hermes 450 features fully redundant avionics, fully autonomous flight, LOS and/or satellite communication data link with a fully composite structure that is highly mobile and easily deployed.

India works with Israel for its UAS needs. The state-owned Aeronautical Development Agency and IAI are working together to develop three new UAS for Indian military forces: the Rustom medium-altitude, long-endurance UAV, which features a domestically-developed EW system, the Pawan short-range drone and the Gagan tactical UAS, which also carries a domestically-developed EA system.

Australia has developed various prototypes of EW payloads for its Aerosonde mini-UAV. They have tested them against ground and shipboard radars [144]. EW payloads developed for Aerosonde Mini UAV are:

ES Superhet Receiver: This unit weighs 2.7kg and operates in the 2-18 GHz Band. A separate datalink is used to transmit pulse descriptor words out to a range of 12 km. The unit is installed in the Aerosonde with switching between two antennas, each with a beamwidth of 180 degrees.

ES IFM Receiver: The IFM receiver also operates in the 2-18 GHz band with an RF resolution of approximately 4 MHz. The unit weighs approximately 3 kg and requires 30W of payload power. This payload uses the same datalink as the ES Superhet.

EA Noise Jammer: The noise jammer operates in two bands, high-band 8-12 GHz through tunable horns mounted in shields on either side of the aircraft, and low-band 850-950 MHz through Yagi antennas mounted under the wings.

RF Repeater (Jammer Test Target): The RF Repeater is developed to provide a target of selectable Radar Cross-Section to validate the masking performance of the jammer against a number of radars. The repeater can generate an RCS of up to 10m^2 and weighs 2 kg [138].



Figure 87. Aerosonde mini-UAV (From [145])



Figure 88. Aerosonde mini-UAV loaded with Antennas (From [144])

8-12 GHz tunable horns mounted in shields either side of the aircraft, and low-band 850-950 MHz through Yagi antennas mounted under the wings

Australia has made some evaluations of EW payloads for large and small UAS. The LR-100 ES/ELINT system is one of them and was evaluated in the 2001 Tandem

Thrust exercise in Australia. The country's Defence Science Technology Organization (DSTO) has also conducted evaluations of several prototype EW payloads on an Aerosonde UAS.

Today, the LR-100 ES/ELINT system is carried by Global Hawk Block 20. Block 20s are also fitted with the Hyperwide COMINT package built by BAE systems. Neither of these systems is a long term answer to Air Force requirements. But obviously these systems make the Global Hawk more useful to the warfighters who are operating in Afghanistan and Iraq. The Air Force has disclosed few details about the SIGINT systems currently fitted on the Predator, but there are more developments anticipated in the coming years.

In the U.S. (as mentioned above) the LR-100 ES/ELINT system produced by Northrop Grumman is the main UAV SIGINT activity focus for the RQ-4A Global Hawk program. It weights 27 kg and transmits within the 2-18 GHz (baseline) range. Northrop Grumman is developing a variant of its ASIP for the Block 30 RQ-4B [142]. Advanced SIGINT Payload (ASIP) is the newest program approved for the Global Hawk and the U-2S in October 2003. Northrop Grumman started manufacturing the portions of the ASIP sensor suite that can be traced back the Joint SIGINT Avionics Family (JSAF) program's High-Band Subsystem in 1997. Other portions of ASIP were started in 1999 [133].

Four contractors have been selected to develop four low-cost, off-the-shelf, miniature EW payloads for integration into the Hunter UAS [146]. Raytheon E-Systems Melpar developed a 30-lb ES payload for the communications electronic support (ES) mission. This payload is expected to conduct precision direction finding (DF) and geolocation in the HF, VHF and UHF bands. Naval Air Warfare Center-Indianapolis (NAWC-IA) built a 47.5-lb communications jammer consisting of a receiver/exciter, power amplifier and antennas. It also has a "smart" processing subsystem that is used for autonomously recognizing and jamming the enemy VHF and UHF transmissions. Litton Amecom built an under-50-lb RWR/ES system with a 500-MHz bandwidth and VME processor as radar EW. Northrop Grumman's Electronics & Systems Integration Division started manufacturing the Tactical Radar Jammer (TRJ), which was designed to counter

pulsed, pulsed-Doppler and continuous-wave radar threats. This system is capable of finding, identifying, and electronically attacking radar emitters. This jammer offers a variety of EA techniques, including range gate pull-off, velocity gate pull-off, and multiple false targets [147].

The French arm of Thales Land and Joint Systems offers the TRC 274 VHF/UHF jamming payload for tactical to medium- or high-altitude, long-endurance (MALE/HALE) types of UAS. This is a 20-3,000 MHz, multimode communications jammer. They are also manufacturing 2-3,000 MHz TRC 6200 intercept and direction-finding (DF) equipment for UAS that range in size from tactical to strategic.

In the UK, Selex Galileo's business has been manufacturing the Passive Littoral Surveillance System (PALS), which provides geolocation of radar emitters. The PALS is scheduled for testing on Selex Galileo's Falco and Alenia Sky Y UAS in the near future. The Compact Techniques Generator, a Digital RF Memory (DRFM)-based radar jammer for UAS, is also being produced by Selex [138].



Figure 89. The Sky-Y (From [148])

The Sky-Y is the first unmanned surveillance vehicle in the Medium Altitude Long Endurance class produced by Alenia Aeronautica, a Finmeccanica company.

Pakistani contractor East West Infiniti produces the 0.5-4,000 MHz ECOM Whisper Watch SIGINT payload for UAS [146].

Despite the fact that the U.S. has a leading role in the UAV payload market for EW and SIGINT systems, many international EW and SIGINT companies are involved in this competition, and they are aiming toward a bright future and business opportunities. Israel will undoubtedly stay as another dominant force in the UAS market. Even though other international companies are presently not involved heavily, they should not be underestimated; “many are simply waiting for a better moment to push into the market.” [138]

There is an increasing demand for EW payloads all over the world. Today, few systems meet all requirements. Nevertheless, advances in the EW field are yielding impressive results that are being integrated into UAS payloads.

1. Suppression of Enemy Air Defense

The two radio calls that the leader of a strike package wants to hear during his ingress are “Viper 21, Magnum SA-3” and “Prowler 33, Music on.” They mean the SEAD F-16CJs and the EW EA-6Bs are doing their job in locating the enemy surface-to-air-missile (SAM) systems and keeping them from threatening the strike package. What isn’t reassuring is that these systems are in short supply. The availability and ability to sufficiently accomplish the mission in the near future may be jeopardized due to more capable enemy Integrated Air Defense Systems (IADS). The question is whether a UCAV should do this “dangerous and dirty but certainly not dull mission. [149]

The U.S. DoD defines the term *SEAD* as an “activity which neutralizes, destroys, or temporarily degrades surface-based enemy air defenses by destructive and/or disruptive means.” There are records of two Predator UAS strikes in Iraqi Freedom in March 2003: one against an antiaircraft vehicle another against a television satellite dish. It is also known that Predator has been used successfully as a SEAD asset in Kosovo. A new version of the Predator, Predator B, will be able to carry eight Hellfire missiles. The U.S. is also working on UCAVs that will be the newest platforms with a primary offensive mission of strike and SEAD [150].



Figure 90. Predator UAV with Hellfire-C (From [151])

C. THE FUTURE OF EW PAYLOADS

In the near future, it is expected that UAS will have a larger SEAD role. Autonomous stand-in (close-range) jamming and decoy UAS will be used against well established integrated air defense systems [138].



Figure 91. UCAV (From [152])

UCAVs are seen as future weapon systems for projection of long range, sustainable, lethal, combat power

The SEAD mission will most likely performed by a variety of SEAD UCAVs. The miniaturization of weapons that can create enough destruction is the limiting factor for this concept. With the advancing technology, there will be dedicated SEAD UAS that

will accompany counterair weapon systems into hostile territory to provide the additional SEAD protection necessary for combat operations [134].

Other authorities expect that UAV ES payloads will be used as passive detection devices to guard, as an example, shipping lanes and fisheries.

There are also some predictions that the ISR community will show even more interest in UAS to replace manned aircraft. [138]

D. SUMMARY OF UAS INVOLVEMENT IN ELECTRONIC WARFARE

As mentioned in the first chapter, EW has three subdivisions: EA, EP and ES.

The missions under the EA and possible UAS integrations are listed:

1. Electromagnetic Jamming:

Jamming payloads for UAS are being produced and integrated into a variety of UAS. Stand-in capability by UAS should be considered as a very important advantage. The closer the point of transmission, the less power required. Getting closer to the target will provide a more effective capability using the same amount of power. All kinds of jamming tactics can be used, depending on the size of the payload. Range gate pull-off, velocity gate pull-off, and multiple false targets are some of the techniques that can be offered.

Another possible EA payload might be a GPS jammer. Jamming adversary GPS systems would help protect high value targets. Considering that most of the new technology weapon systems use GPS as the primary guidance system, deceiving them can prevent friendly force losses.

2. Electromagnetic Deception

While attacking a target, deploying decoys is a way of using deception. Another technique would be sending decoys prior to the real attack force, as was done during Bekaa Valley, Operation Desert Storm and Operation Iraqi Freedom. While the adversary is reloading weapons, a very well-planned attack would bring victory with no or little loss of friendly forces.

Repeaters can be used as a means of EA. They can provide a target of selectable RCS to validate the masking performance of the jammer against a number of radars. With the false target indication on the radar, other more important assets can be protected.

3. Directed Energy

Today, there are ongoing research and test programs concerning Directed Energy Weapons (DEW). The latest known development is mounting a DEW on a C-130H aircraft. The directed-energy weapon is designed to fire through a rotating belly turret in the aircraft, known as the Advanced Tactical Laser (ATL) [157].

“First firing of the high-energy laser aboard the ATL aircraft shows that the program continues to make good progress toward giving the warfighter an ultra-precision engagement capability that will dramatically reduce collateral damage,” said Scott Fancher, vice president and general manager of Boeing Missile Defense Systems [153].



Figure 92. A C-130 Carrying An Advanced Tactical Laser (From [153])

A C-130 transport aircraft carries the Advanced Tactical Laser, which fires from a turret under the plane's belly.

Today's technology is not mature enough to integrate DEWs into small-to-medium-size UAS because of the size issues of these systems. While the research is ongoing for both DE systems and UAS, it does not seem possible to merge these systems into the even larger UAS in the near future. Nevertheless, advances may allow this to happen.

4. Anti Radiation Missiles

SEAD has already been conducted by UAS. For more effective SEAD missions, miniaturization of the weapons with the necessary destructive power, so that they fit onto the UAS, is a vital need. For example, the HARM missile, which can be deployed from a Predator B, may change the total concept of SEAD operations in the future.

5. Expendables (Flares and Active Decoys)

Even though there is no known application of UAS carrying chaff or flares, or being used as an active decoy, it seems possible. In particular, using UAS as an active decoy is very possible to provide protection for slow flying aircraft.

The missions considered as ES are:

6. Threat Warning

With the impressive advances in the manufacturing of electronic sensors, payloads became small enough to fit in the even small-sized UAS. A Radar Warning Receiver (RWR) can be used as a UAS payload for threat warning.

7. Collection Supporting EW

ES sensors can supply very valuable information for forming situational awareness and the big picture or for updating the electronic order of battle. Integration of the inputs from all of the sensors is the key to success. UAS can carry systems that intercept and acquire radar and radio transmissions and can send this information of signal characteristics of the targets in real time to operation centers.

8. Direction Finding

The accuracy of DF is increased as more platforms are available to gather data. Relative geolocation error versus the number of DF sensors located around an emitter is

shown in Figure 79 in this chapter. UAS can play a very important role for this operation, because they are cheaper and do not carry humans onboard; they can be sent and risked in enemy territory. Furthermore, because they are small and relatively insignificant, most probably enemy forces would not focus on them, instead of the real or simulated attack forces.

THIS PAGE INTENTIONALLY LEFT BLANK

VII. POSSIBLE TACTICS AND CONCEPTS OF MINI-UAS FOR ELECTRONIC WARFARE MISSIONS IN THE NET-CENTRIC BATTLE AREA

The technology that is being incorporated into the UAV systems is continually advancing. State-of-the-art technologies such as Synthetic Aperture Radars, increasingly capable microprocessors, increased data-link rates, radar-absorbing materials, the use of high bandwidth communications, and SATCOM-equipped navigation systems, are being integrated onto the platforms making them a key asset to militaries worldwide. Another key reason for UAV mission success is the UAVs' low flying altitude and slow speed that makes them difficult for traditional enemy sensors to detect or recognize. UAVs may not be limited to the operating restrictions placed on manned aircraft – they have been sent on missions over enemy territory, against sophisticated integrated air defense systems – missions that would have to be thought twice about for manned aircraft due to cost or liability. With UAV operations, loss of human life is not a consideration making the decision to perform a high-risk mission easier. [155]

In Section 220 of the Floyd D. Spence National Defense Authorization Act for Fiscal Year (FY) 2001 (Public Law 106-398; 114 Stat 1654A-38), one of the key goals stated by Congress was that by 2010, one third of the aircraft in the operational deep strike force should be unmanned. Considering that we are almost at 2010, tactics for effective UAS deployment should be generated and discussed now. It is inevitable that by the end of this century, UAS are going to replace conventional manned aircraft.

Using the information from Chapter VI and my experience with UAS in the COASTS program, in addition to my knowledge as a fighter pilot, possible operational EW tactics for single or multiple UAS over the net-centric battlefield are discussed in this chapter.

UAS operational tactics are considered classified. The tactics mentioned here are a product of this thesis and they depend on certain assumptions by the author.

UAS size, endurance, speed, maneuverability, autonomy, networking, survivability concerns, controllability, take-off and landing capabilities, sensors, and weapons carried are all pertinent factors for determining the best tactics; the operator's

level of training and type of mission must also be taken into consideration. Whether, manned or unmanned, there are two general types of missions: preplanned and on-demand [156].

- Preplanned missions are scheduled well in advance
- On-demand missions can be launched quickly (within minutes) if an aircraft is ready and a crew is on site

All of these factors are considered for determining the possible tactics in this chapter.

A. LOITER

UAS need to loiter to accomplish most of the missions. There are several types of loiter patterns that can be used with regard to the requirements of the mission. Below are some examples; many other combinations can also be used.

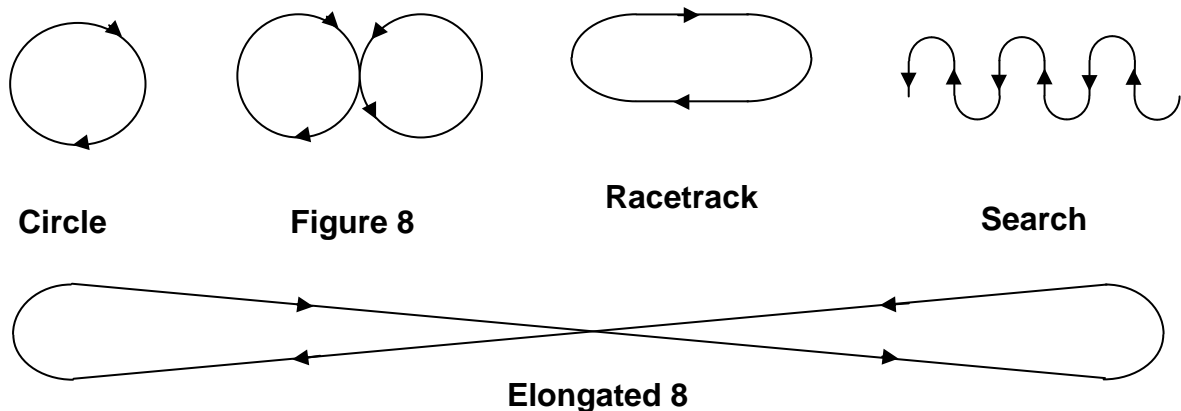

Figure 93. Loiter Types

Loiter missions can be split into two basic types: standoff and overflight (or “penetration”).

When the mission is too risky for overflight, standoff missions are flown. There can be some exceptions, but generally these are the missions flown with sensors, such as synthetic aperture radar (SAR), that do not look straight down. Sensors on penetrating platforms can look down and all around and can also cover more target area than a

standoff sensor. This is true for weapons also, and weapons on penetrating platforms have the same advantages. This can be seen in Figure 94 [156].

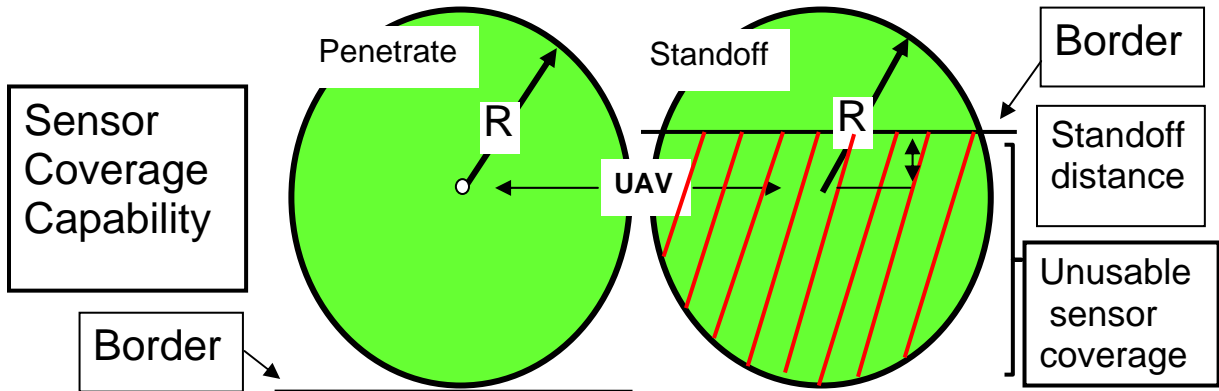

Figure 94. Penetration-Stand off Sensor Coverage

Generally, manned military missions loiter over friendly territory, allowing sensors to look into enemy territory without endangering the crew. Stealth aircraft are designed for overflight, but they seldom loiter over hostile territory. Similarly, unmanned military missions can be also flown both ways. For example, Global Hawk mostly loiters over friendly territory [156]. Because of its bigger RCS and considering the cost of this UAS, this makes perfect sense. On the other hand, “Dark Star was stealthy and designed to fly over hostile territory, UCAV will also operate this way.” [156] But loitering over hostile territory might be risky for Dark Star, as well. Even though Predator is not a stealthy design, it often loiters over hostile territory [156] after the calculating all the risks; therefore, it is sometimes lost. For micro and small UAS, these risks drop down dramatically. Survivability against threat systems of these types of UAS is increased due to their smaller RCS; they do not pop up on the display of the most of the current technology radars.

B. JAMMING TERMS TO CONSIDER WHEN DEVELOPING NEW TACTICS

We need to know some definitions about jamming in order to be able to produce tactics. As mentioned in the first chapter, jamming is a subset of EA that is conducted to degrade, neutralize, or destroy the enemy's capabilities.

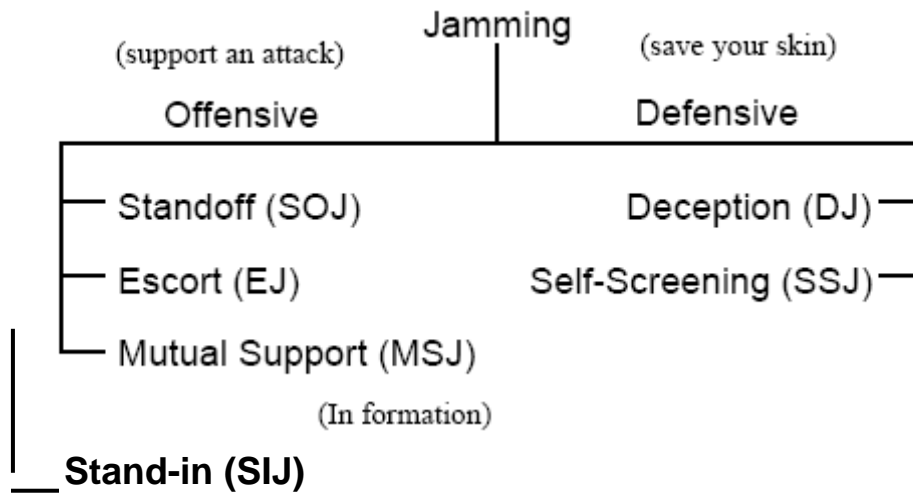

Figure 95. Jamming Types

The following are the brief explanations of the terms and figures.

1. Stand-Off Jamming (SOJ)

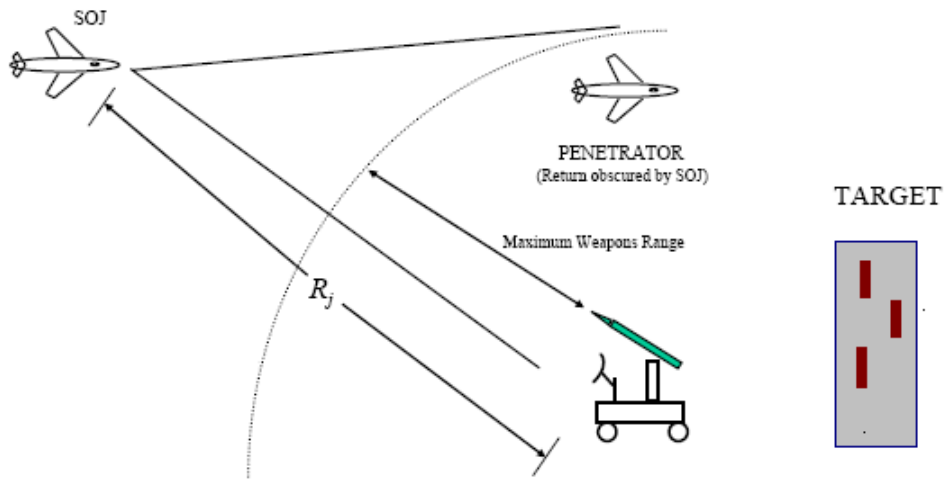

Figure 96. Stand-off Jamming

Stand-off jamming is the jamming conducted out of the range of the SAM, by which means the jamming platform does not risk being hit. During stand-off jamming, the main aim is to jam all present threat bands: SAM and AI. Stand-off jamming requires high ERP. Today, this mission is generally done by the EA-6B and EA-18G. Larger UAS can also accomplish this mission through carriage of the required jamming payload.

2. Escort Jamming

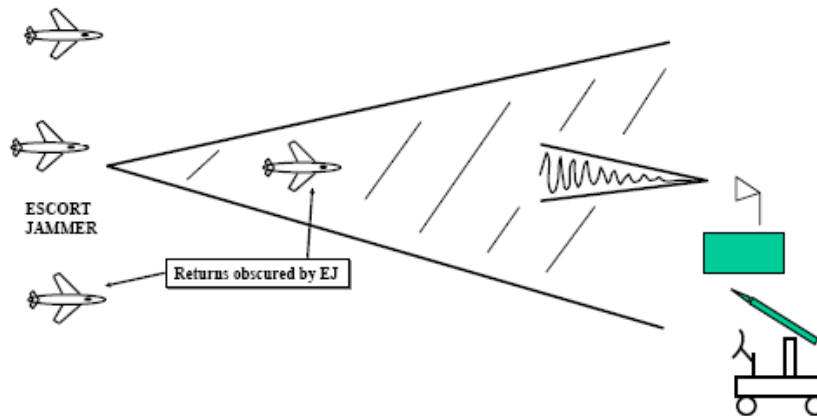

Figure 97. Escort Jamming

Escort Jamming is the protection provided by escort jamming platforms for single or multiple strike aircraft. EJ platforms escort the main attack group and cover them with more powerful jamming pods. Most stand-off jammers can also play an escort jammer role, if they are able to keep pace with the strike aircraft.

3. Mutual Support Jamming

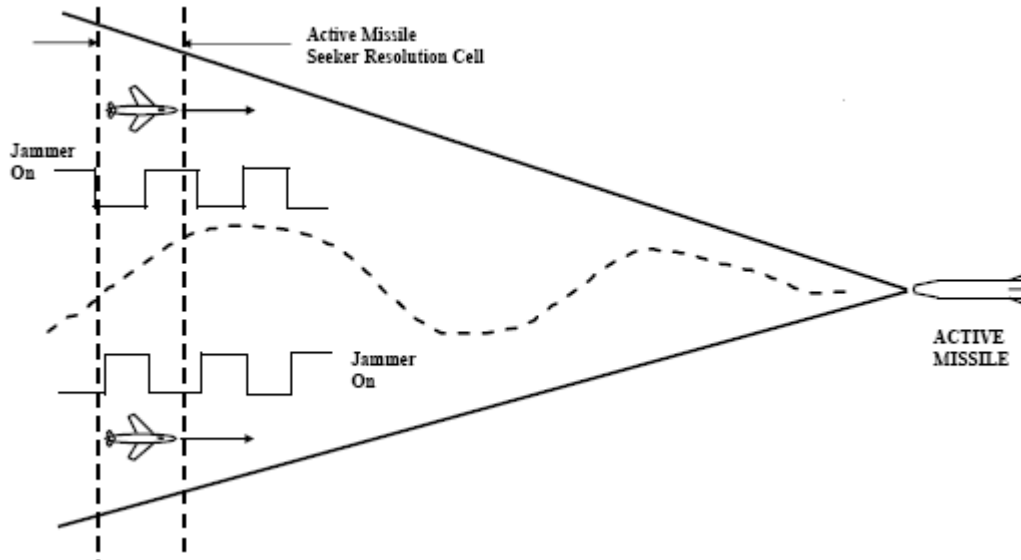

Figure 98. Mutual Support Jamming

For mutual support jamming, there should be multiple jammers in the formation. On/off blinking or swept spot noise can be used for the best result. This is effective against launched active missiles. Synchronization of a jamming program over a network makes it more effective.

4. Stand-in Jamming (SIJ)

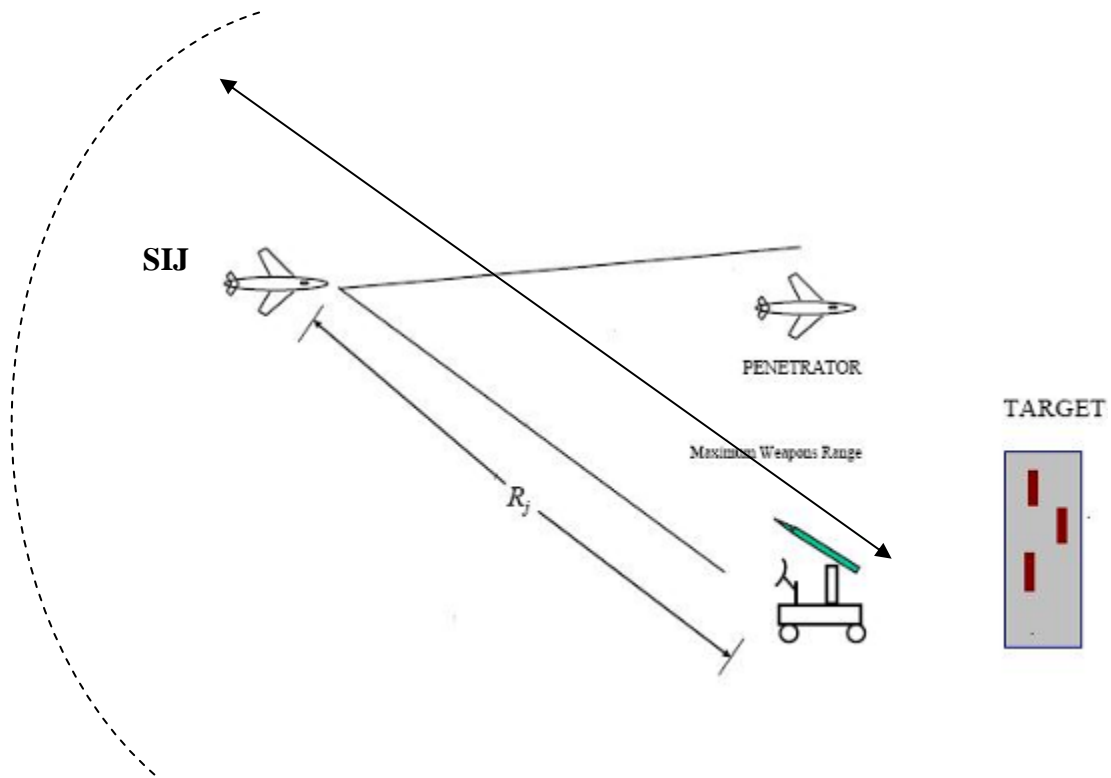

Figure 99. Stand-In Jamming (SIJ)

Stand-in jamming is a fairly new concept. It is more suitable for UAS since they have a smaller RCS and can get closer without being detected. Additionally, if a UAS is lost to the defensive systems, no personnel are lost. The main idea behind this type of jamming is to increase the effectiveness of the jamming by decreasing the range to target.

5. Self-Screening/Deception Jamming

Self protection

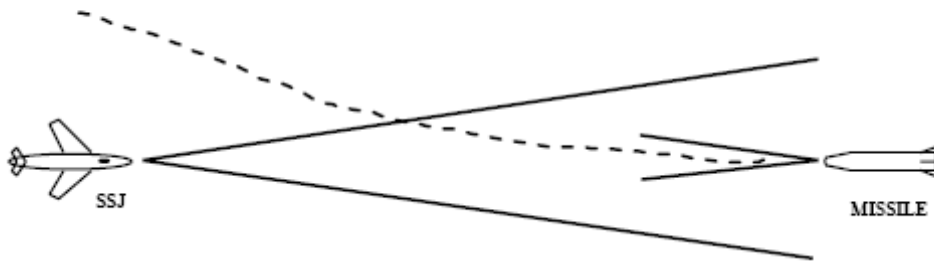

Figure 100. Self-Screening / Deception Jamming

Self protection EW/EA pods carried by fighter aircraft provide defensive action against hostile A/A and A/G missiles. These onboard pods are generally less effective than SOJ pods, and provide only partial coverage. Additionally, RWR is generally required to warn the aircrew of the threat and trigger the jamming response from the pod.

C. ELECTRONIC JAMMING METHODS

Jamming is often applied at critical times when enemy C² and weapon system voice and data communications cannot be destroyed directly. All types of emitters can be jammed and deceived.

The primary jamming methods are:

- Radar jamming by using barrage, sweep, spot, multi-spot noise pulse, chaff, and decoys
- Radio jamming of AM and FM signals using barrage, sweep, or spot noise [158]

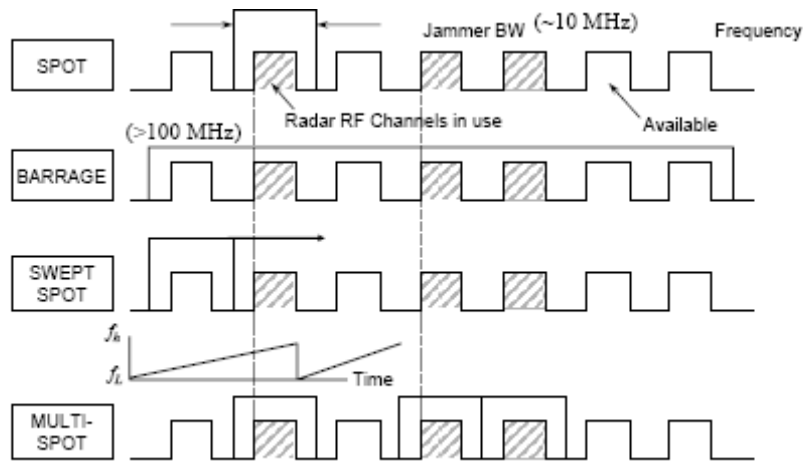

Figure 101. Electronic Jamming Methods (From [4])

Jamming effectiveness depends on some number of technical factors. These factors are:

- Target link distance (distance between the enemy transmitter and receiver)
- The distance between the jammer and the enemy receiver
- Radio LOS between the jammer and the targeted receiver
- Antenna polarization
- Effective radiated power of the jammer and the enemy transmitter
- Weather, terrain, and vegetation [158]

For a scientific approach to determining the most effective tactics, range and power calculations are essential. Below are some formulas used in jamming calculations.

POWER AT RADAR FROM JAMMER



$$P_{rT} = \underbrace{\left(\frac{P_r G_r}{4\pi R^2} \right)}_{\substack{\text{Poynting} \\ \text{Vector}}} \underbrace{\left(\frac{\sigma_T}{4\pi R^2} \right)}_{\substack{\text{Portion} \\ \text{Reflected} \\ \text{Back @ Radar}}} \underbrace{\left(\frac{G_r \lambda^2}{4\pi} \right)}_{A_e} \quad (7.1)$$

Figure 102. Power at Radar

POWER LEVEL RECEIVED FROM RADAR AT A JAMMER

$$P_{jr} = \underbrace{\left(\frac{P_r G_r}{4\pi R^2} \right)}_{\substack{\text{Poynting} \\ \text{Vector}}} \underbrace{\left(\frac{G_j \lambda^2}{4\pi} \right)}_{A_e \text{ of Jammer}} \quad (7.2)$$

SELF PROTECT J/S

$$J/S = ERPJ - ERPS + 71 + 20 \text{ Log } d - 10 \text{ Log } RCS$$

(7.3)

Self Screening Jammer Calculations:

$$\left(\frac{S}{N_j} \right)_p = \frac{P_{rT}}{P_{jr}} = \frac{\left(\frac{P_r G_r^2 \sigma_T \lambda^2}{(4\pi)^3 R^4} \right)}{\left(\frac{P_j G_j \lambda^2 G_r B_r}{(4\pi)^2 R^2 B_j} \right)} \quad (7.4)$$

SSJ BURN THROUGH RANGE

Burn through Range is the distance at which target can be detected above electronic attack. After passing this line, the jammer is no longer effective.

$$R_{BR} = \left(\frac{JSR_p ERP_r B_j \sigma_r}{ERP_j B_r 4\pi} \right)^{1/2} \quad (7.5)$$

STAND-OFF J/S

$$J/S = ERP_J - ERP_S + 71 + G_{RS} - G - 20 \text{ Log } d_j + 40 \text{ Log } d_s - 10 \text{ Log } RCS \quad (7.6)$$

Standoff Jammer Calculations – Mainlobe:

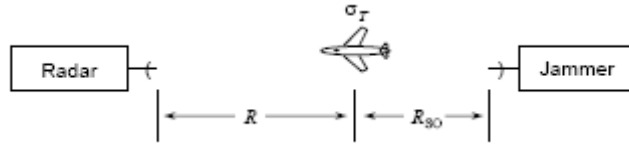

Figure 103. Standoff Jammer Calculations

$$SJR_p = \frac{P_{sr}}{P_j} = \left(\frac{P_r G_r \sigma_r B_j}{P_j G_j 4\pi B_r} \right) \frac{(R + R_{90})^2}{R^4} \quad (7.7)$$

SOJ BURN THROUGH RANGE

$$R_{BR} = \left(\frac{JSR_p ERP_r B_j \sigma_r R_{90}^2}{ERP_j B_r 4\pi} \right)^{1/4} \quad (7.8)$$

[4]

STAND-IN JAMMING

The same formulas are used for SIJ as for SOJ.

D. TACTICS FOR MINI AND MICRO UAS

Mini UAS can be very valuable for EA and ES missions. Since they are small and difficult to see with the naked eye and have a relatively small RCS, they can accomplish these missions without being detected. Another advantage is their low cost when compared to manned aircraft and larger UAS. Furthermore, there can be numerous mini UAS deployed at the same time to increase the probability of mission accomplishment. It should not be forgotten that the shorter the range to the target used by the UAV, the more jamming power that is available against an enemy radar. It is also cheaper and technically easier to design and build UAS with stealth characteristics than it is for manned aircraft.

These types of UAS can be hand launched or carried on manned aircraft as a payload; in the future, smaller (micro) UAS may potentially be carried into target area and dropped by a larger “mother-ship” UAS.

1. Tactic 1 (Single Short Range Mini UAS EA Mission)

Assumptions:

- Old technology SAM
- Mission can be either preplanned or on demand
- UAS has short range
- UAS is hand launched
- UAS is launched into the hostile territory by well trained operator
- There are two noise jammers mounted on the UAS, operating approximately 50-65 or 85-90 degree to the each side of the fuselage (or electronically adjustable)

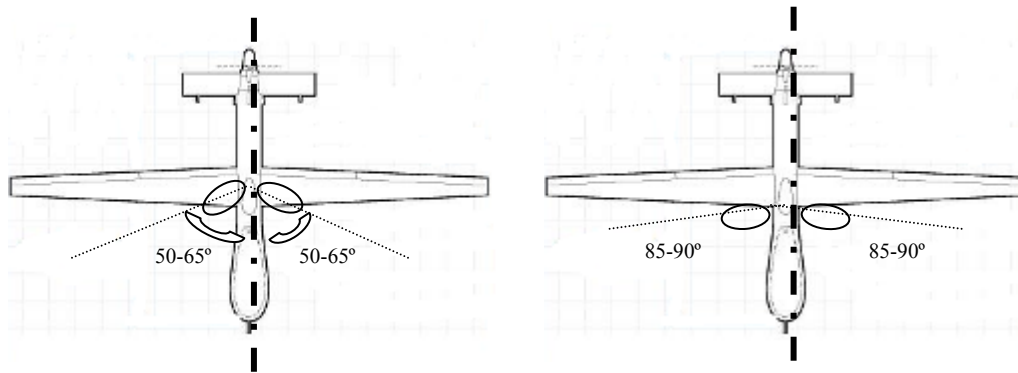

Figure 104. UAS Antenna necessities for Tactic 1

In this situation, Special Forces with UAS training can be used. Just before the attacking aircraft penetrate the SAM ring, support jamming should be started to provide extra protection and a clear penetration corridor. In this case, the strike group enters the ring from a single corridor and flies over or under the UAS conducting the EA. The UAS needs to sustain an elongated figure-8 loiter pattern to provide continuous jamming against the SAM radar. There will be a blind spot during the turns on the edges of the pattern. Search a pattern can also be used with the EA payload covering 85–90 degrees to either side of the fuselage of the UAS. In either case, blind spots are inevitable because during the turn coverage of the jammer will not cover the target for a certain amount of time without a jamming system with 180-degree-coverage. Most probably, side lobe coverage also will be insufficient. Considering that, with a 30 degree bank, a 180 degree level turn takes one minute, an aerodynamically mini UAS carrying an EA payload would not be very maneuverable; this blind time would change between 30 seconds to 60 seconds, which is a respectively long duration. Unless the EA payloads can move electronically, this tactic can be considered weak if there is a coordination gap between the strike group and UAS operator.

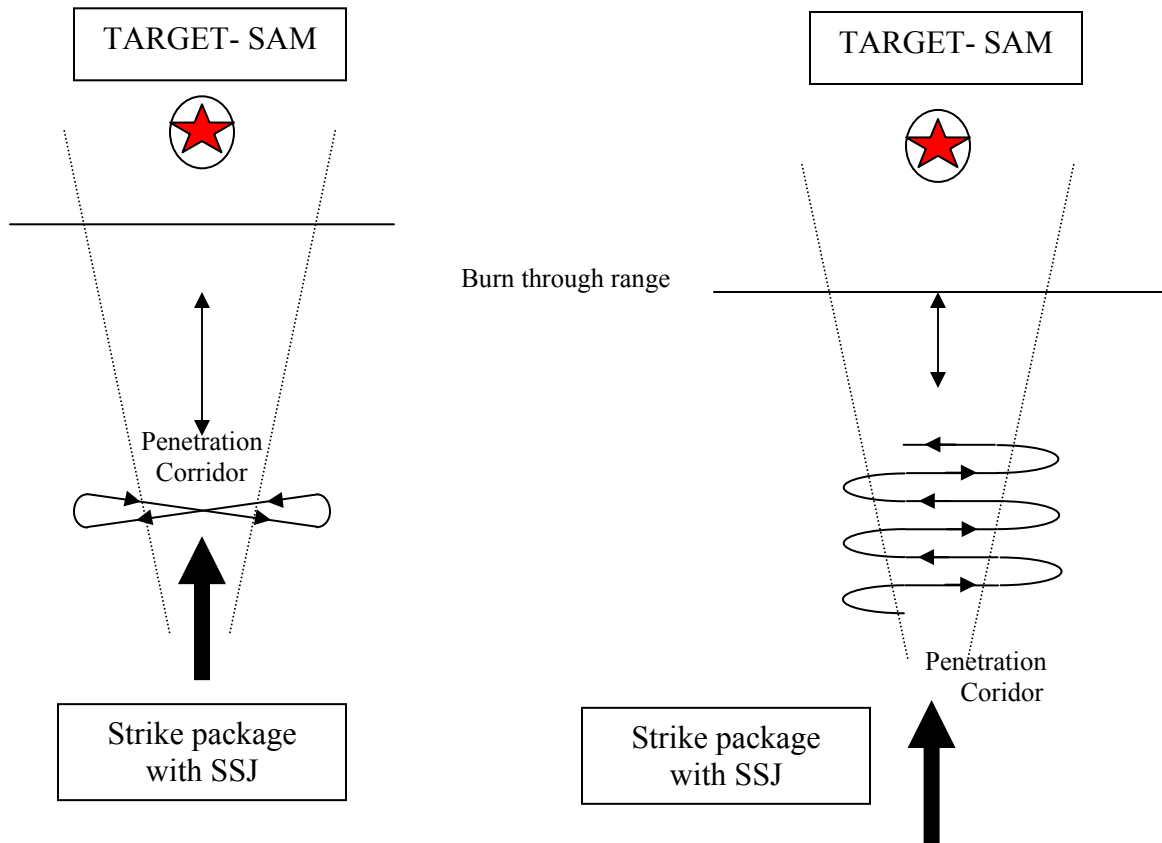

Figure 105. TACTIC-1

Additionally to succeed using this tactic, coordination of the aircraft with the UAS operator is vital. While the UAS is turning away from the radar, the attack group should not be within the range at which a SAM operator could target them; as a rule of thumb this range is two-thirds of the max range of the missile.

2. Tactic 2 (Double Short Range Mini UAS Emission)

Assumptions:

- Old technology SAM
- Mission can be either preplanned or on demand
- There are two short range UAS
- UAS are hand launched

- UAS are launched into hostile territory by well trained operator
- There may be two UAS operators, but preferably one operator control both UAS over one ground control station (GCS)
- There are one or two noise jammers mounted on the UAS, parallel to the fuselage

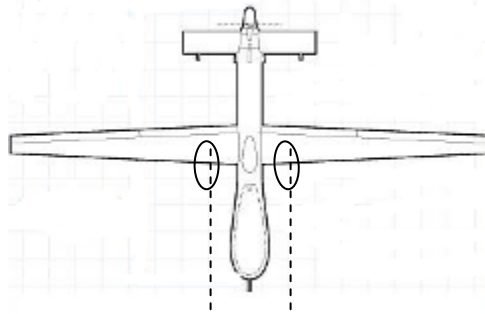

Figure 106. UAS Antenna necessity for Tactic 2

In this case also, Special Forces with UAS training can be used. Just before the attacking aircraft penetrate the SAM ring, support jamming should be started to provide extra protection and a clear penetration corridor. This tactic provides continuous jamming coverage. The strike group enters the threat ring from a single corridor and flies over or under the UAS conducting the EA; this should be coordinated beforehand. The UAS need to fly a racetrack loiter pattern and they need to follow approximately the same ground track. While one UAS is turning outbound, the other one should be inbound already. The outbound UAS can fly faster than the inbound one.

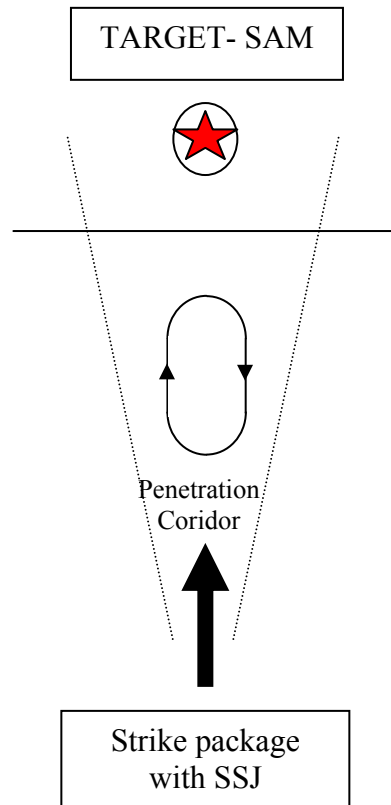

Figure 107. Tactic 2

3. Tactic 3 (Single or Double Short Range Mini UAS EA Mission)

Assumptions:

- Old technology SAM
- Mission can be either preplanned or on demand
- There are one or two short range UAS
- UAS are launched from an aircraft or a mothership UAS
- There may be either one or two UAS operators on the aircraft depending on the number of UAS deployed
- Jamming pods can be mounted on the UAS, either parallel or perpendicular to the fuselage (Figure 104/Figure 106)
- Other UAS can be used as a relay for increasing range

- If there is a mountain that can disrupt radar transmission of enemy radars, it can be used for hiding the control aircraft
- Inside of the enemy area is considered too risky to send ground personnel

In this case, the target is close to the border or Forward Edge of Battle Area. The aircraft, from which the UAS are deployed, is equipped with bigger antennas for increased transmission and receiving range.

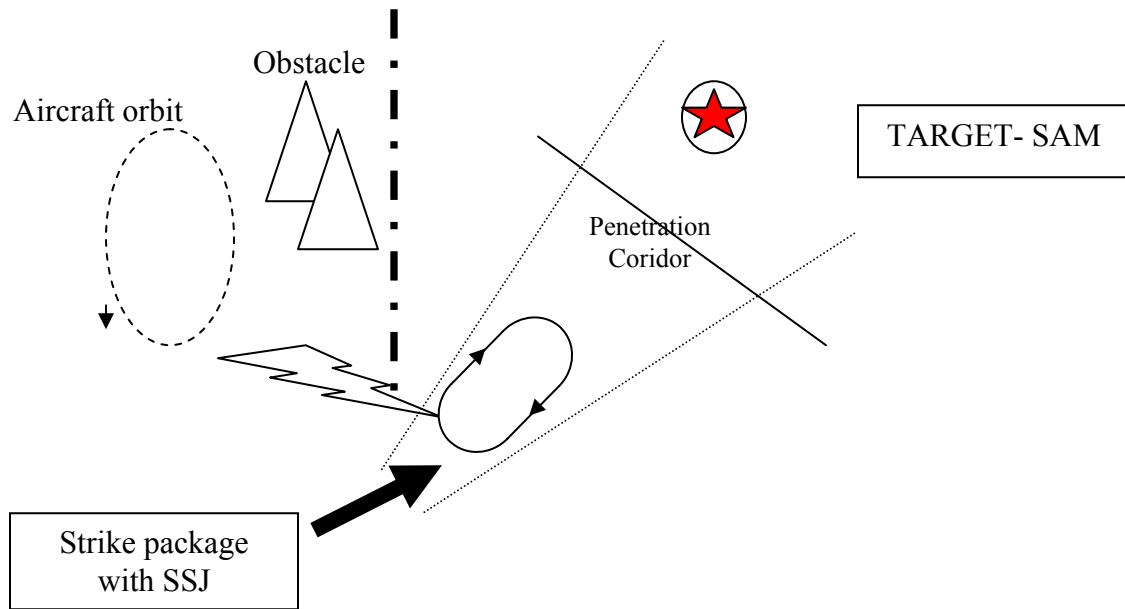

Figure 108. Tactic 3

Hiding behind the mountains, the aircraft provides line-of-sight to the UAS. It can be carried as a payload on the aircraft. It can also be thrown from the ground and the controller on the aircraft can take over the controls. For the mountain not to shadow the transmission, relay UAS should be used for effective transmission. In this case, relay UAS should be thrown first. The UAS should be thrown from a distance where it can glide up to orbiting jamming distance and reach the jamming altitude at around the same time. This would provide more battery and jamming time. While using this tactic, strike force must coordinate altitude and time before the attack. Tactic 1 or Tactic 2 can be used for effective jamming, depending on the number of UAS. The same tactic can have

an extended range using a relay UAS for transmission and receiving. After the mission, UAS should be landed in a safe territory for picking up by the ground personnel. In case the range is too great to retrieve the UAS, it can be left behind after completion of the mission.

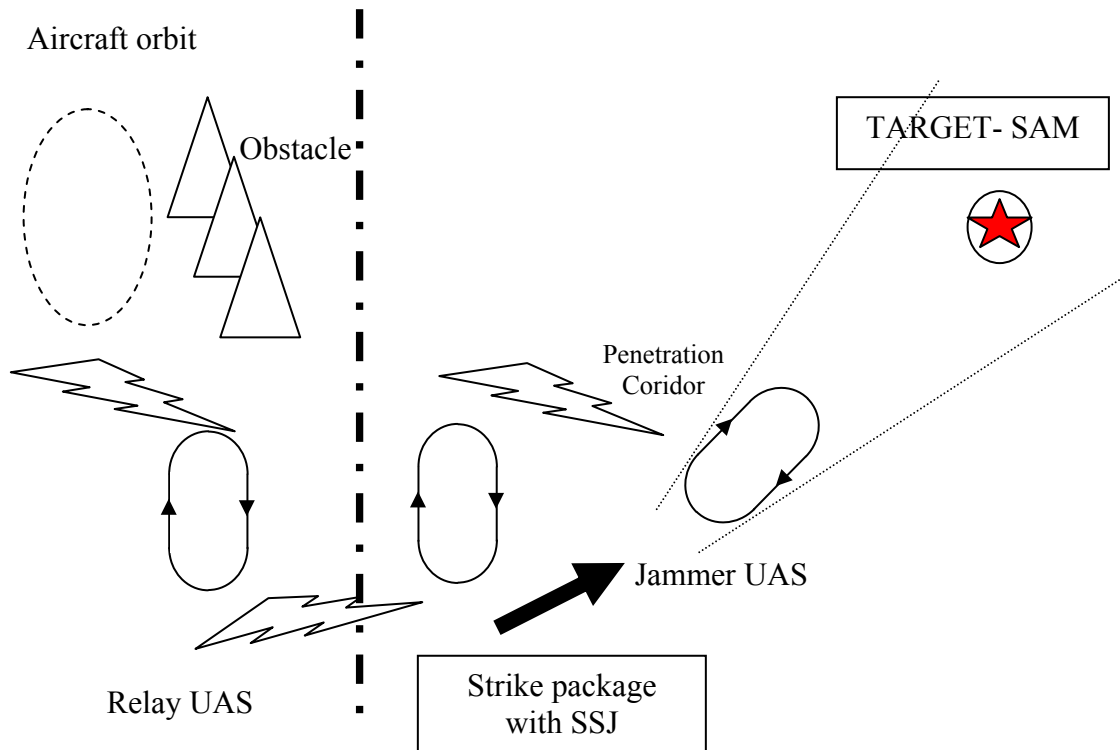

Figure 109. Tactic 3 with Relay UAS

All of the UAS can be deployed from the same aircraft or hand launched depending on the risk level over hostile territory.

4. Tactic 4 (Multiple Short Range Mini UAS EA Mission)

Assumptions:

- This tactic can be deployed against new and old technology SAMs
- Mission should be preplanned
- There are numerous short range UAS

- UAS can be launched from either an aircraft or from a mothership UAS; they can also be hand launched
- There will be numerous UAS operators

Because there will be many UAS airborne, very good coordination between UAS frequencies is needed. Altitude de-confliction should be coordinated between UAS and the strike group. Using multiple UAS increases the probability of the success of the mission. Jamming can be conducted from either a single line or from multiple angles, letting strike forces enter the missile ring from different sides, providing greater protection against enemy EP.

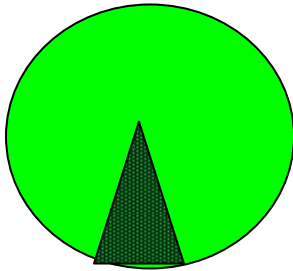

Expected Radar Display During

. Single Line Multiple EA

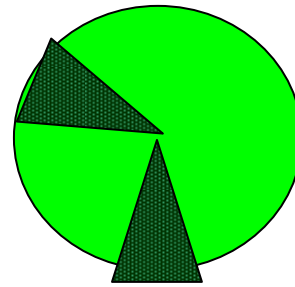

Expected Radar Display During EA

From Different Angles

Figure 110. Radar Displays

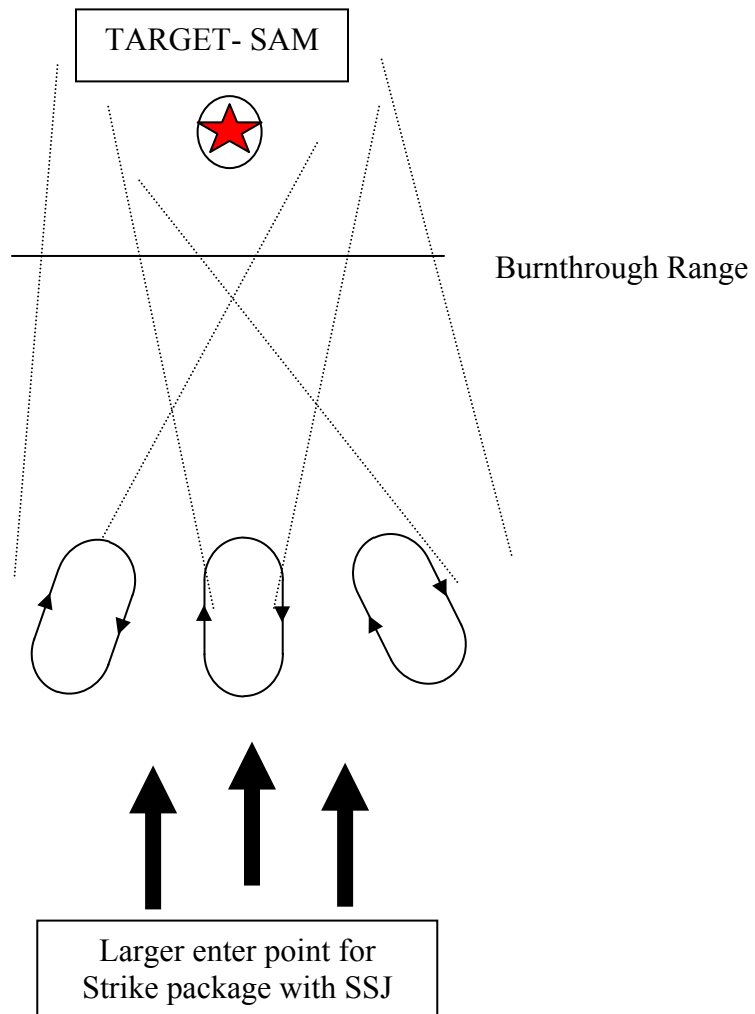

Figure 111. Tactic 4 Single Entry Point

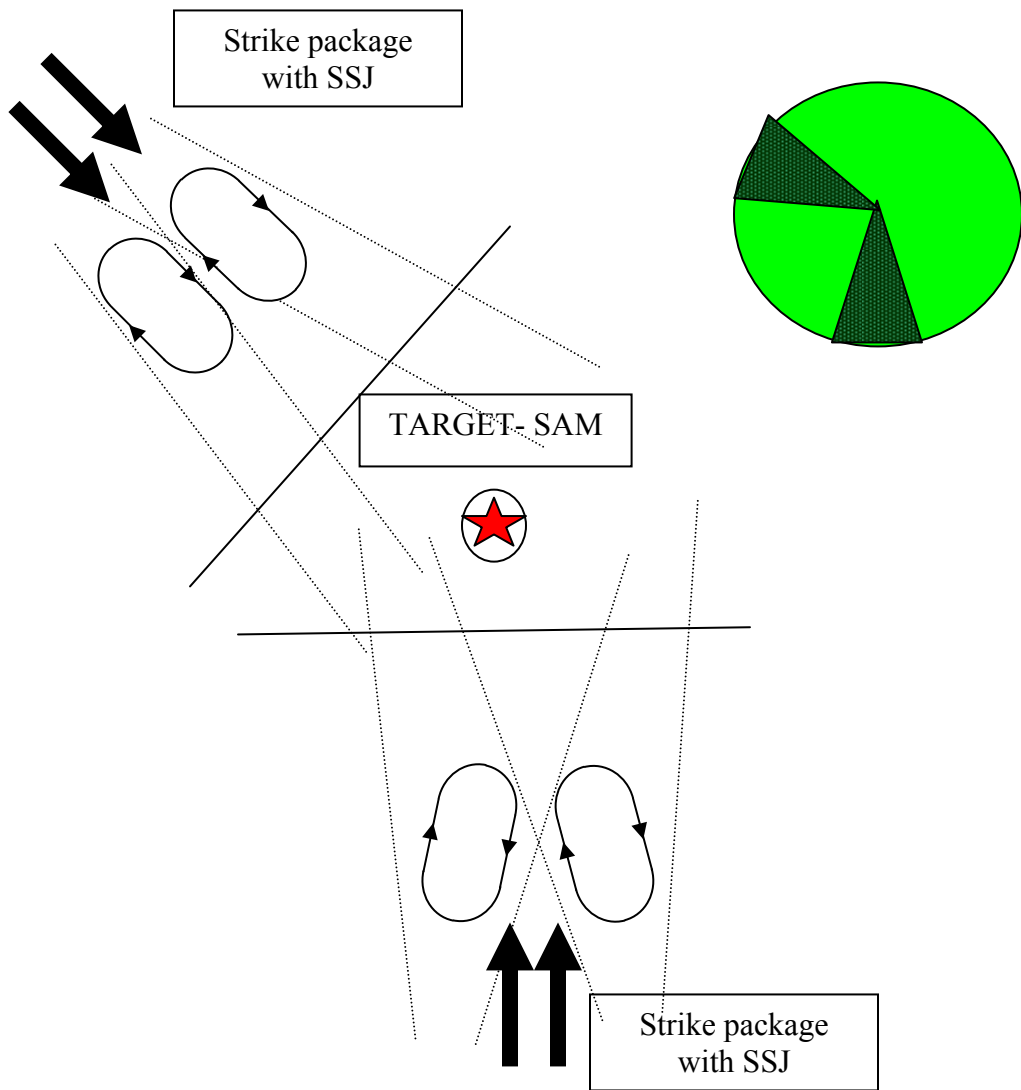

Figure 112. Tactic 4 Multiple Entry Points

5. **Tactic 5 (Decoy Tactic against SAM EA Mission)**

All warfare is based on deception

Sun Tzu

While attacking a target, deploying decoys is a way of using deception. Sending decoys in ahead of the real attack force was used to good effect in the Bekaa Valley, Operation Desert Storm and Operation Iraqi Freedom. While the adversary is reloading weapons, a very well planned attack would bring the victory without any or little loss of friendly forces. Decoy tactics have been widely used since the Vietnam War.

Assumptions:

- Against new and old technology SAMs
- Mission should be preplanned
- There are numerous UAS
- High threat environment
- UAS can be launched from either an aircraft, aircraft carrier, in front of the FEBA in friendly territory
- There will be numerous UAS operators or UAS can fly pre-programmed flight plan

Every SAM system can launch a certain number of missiles. When there are no missiles in the launcher they need to reload. This reloading period varies depending on the SAM type, experience of the personnel and equipment. Reload time ranges from 15 minutes to 40 minutes. This is more than enough time to perform a successful attack. A variation of this tactic would be to send decoys against the target until the enemy has exhausted all his ammunition, and then attack against unguarded targets.

During Desert Storm, BQM-74 drones and Tactical Air Launched Decoys (TALDs) were used. The Iraqis, after being decoyed and shooting these down, thought that they killed many aircraft. Following the decoys, a mass of seventy allied aircraft armed with radar-killing HARM (U.S.) and ALARM (British) missiles demolished the radar sites.

6. Tactic 6 (Decoy Tactic Against SAM and Air Interceptors EA Mission)

Assumptions

- Against new and old technology SAMs
- Designed for self protection of the aircraft against SAMs
- UAS are carried as a payload of an aircraft
- UAS fly a pre-programmed flight plan

This tactic can be utilized by aircraft that are supposed to attack a target inside the missile ring. Each additional decoy target return on the radar display decreases the probability that an actual attacking aircraft will be targeted by the defenders. If there is one target return on their screens, the enemy will engage this return. If we can produce multiple returns on the enemy's radar display, this will increase our chances of survival accordingly. In order to deploy this tactic, we should devote some of each aircraft's payload to carrying decoys that can imitate the carrier aircraft's RCS and characteristics. Every aircraft in the strike package should carry these decoys. Just before the package enters the interception ring, aircraft should deploy these decoys with a pre-programmed flight path in order to create more returns and decrease the probability of being locked by the radar. If a single attack aircraft carries two decoys, it will increase the chance of the enemy targeting a false echo by 66.6 %.

This tactic can also be used against air interceptors. The general concept of interception depends on the beam or stern attack (considering that both sides have similar missiles with approximately same range). Deploying the decoy as the interceptors try to build the intercepting geometry, these decoys may be used in order to corrupt this geometry and gain geometrical superiority.

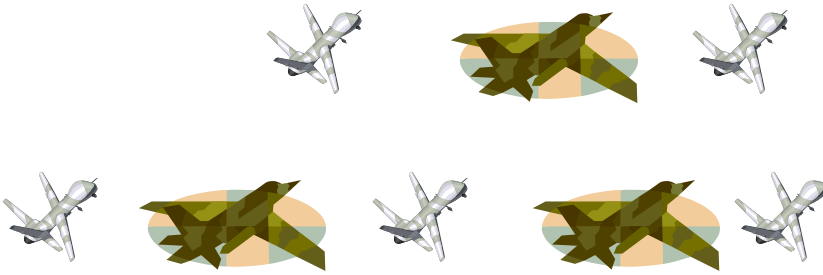
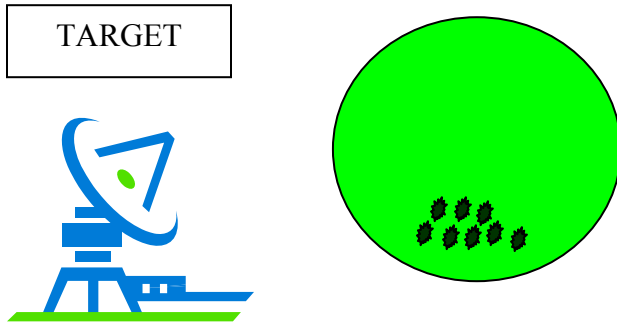

Figure 113. Decoys and Effects on Enemy Radar

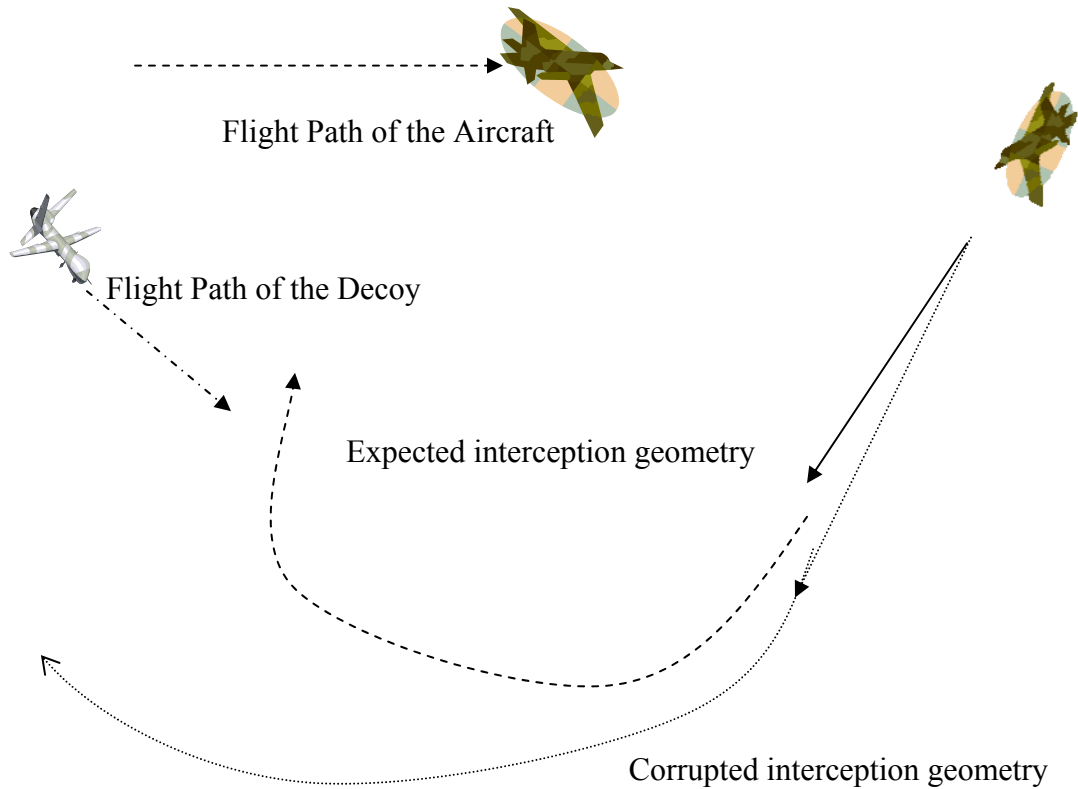

Figure 114. Effects of Using Decoy against Air Interceptor

7. Tactic 7 (Multiple Short Range Mini UAS for Threat Warning-Unknown Threat ES Mission)

With the impressive advances in the manufacturing of electronic sensors, payloads became small enough to even fit into small sized UAS. A Radar Warning Receiver (RWR) can be used as a UAS payload for threat warning.

During an operation, a UAS equipped with RWR can loiter at certain points on the path of a strike group. This UAS can give threat warning of adversary systems. The most important thing is to find the best spot for loitering. When deciding where to place the UAS, geographic conditions play a significant role. UAS should be launched from behind obstructions (mountains, hills) that block reception of the aircrafts' RWR. Also of importance is the networking and real time reporting to the Combined Air Operation Center (CAOC) or to the attacking aircraft.

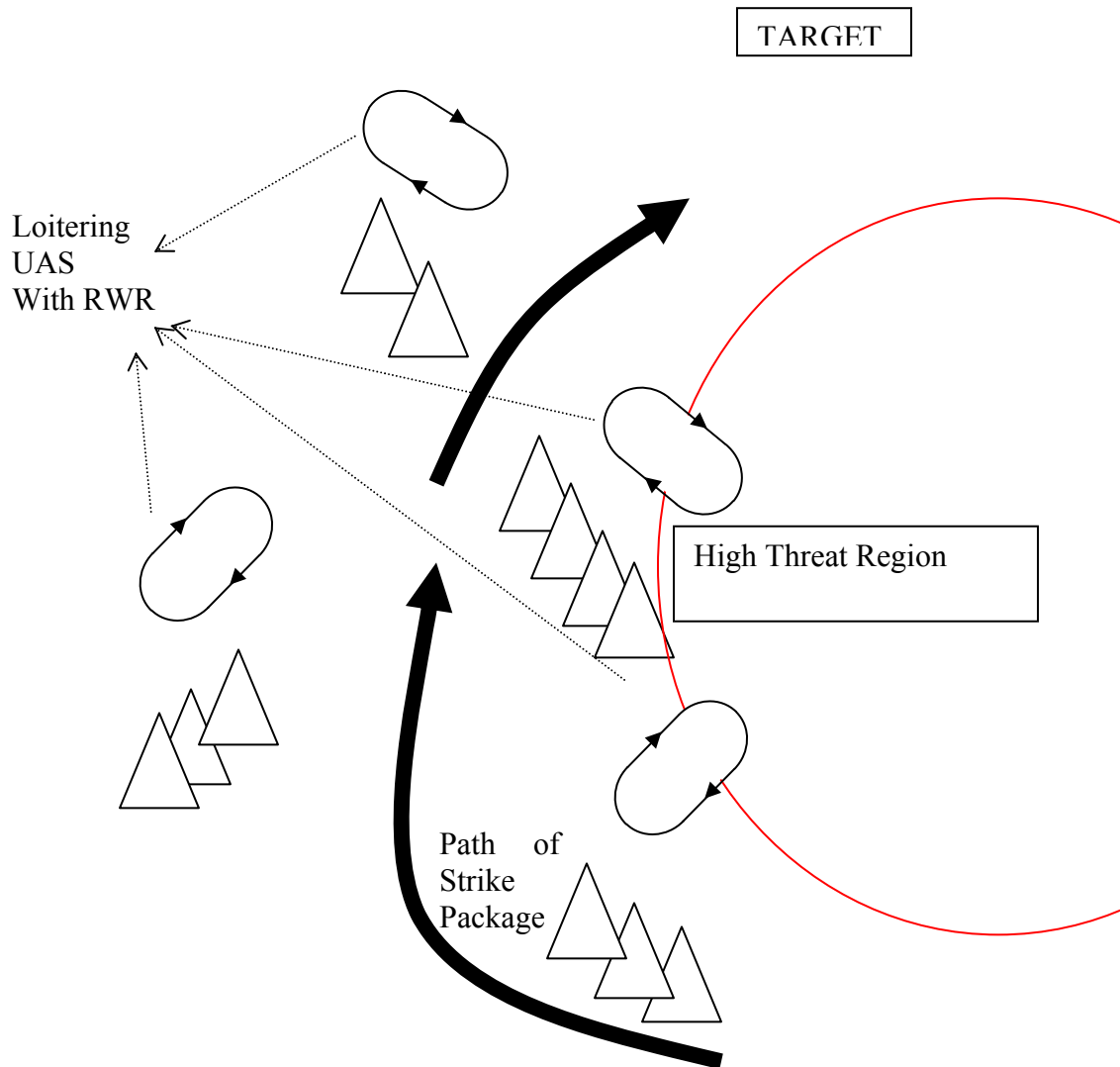

Figure 115. Tactic 6

8. Tactic 8 (Multiple Short Range Mini-Uas for Direction Finding-Known Threat Es Mission)

According to Joint Publications and DoD definitions, collateral damage means “Unintentional or incidental injury or damage to persons or objects that would not be lawful military targets in the circumstances ruling at the time. Such damage is not unlawful, so long as it is not excessive in light of the overall military advantage

anticipated from the attack.” [159] With regulations and international laws, civilian casualties need to be avoided. For reduced collateral damage and civilian casualties, more accurate weapons and systems are needed. Today, there are very accurate systems to accomplish these kinds of missions. But unless the exact location of the target is known, these weapons will be ineffective.

Assumption:

- Target location is known but exact coordinates are needed for successful destruction

To find the exact location, DF can be used. DF accuracy is increased with an increased number of platforms to gather data. UAS can play a very important role for this operation. And because they are small and relatively insignificant, enemy forces would likely not focus on them.

During the operation, UAS equipped with DF equipment should be launched and loiter around the target. The more UAS are used, the more accurate the result obtained. The method of UAS employment can be determined based upon the threat environment. UAS may be either hand launched or deployed from aircraft or bigger UAS. Near real time data transfer plays a big role and is an absolute necessity.

9. Tactic 9 (Multiple Short Range Mini UAS for Direction Finding-Unknown Threat ES Mission)

Assumption:

- Target is a mobile SAM
- Target location is changed before the operation and not known
- Target threatens the success of overall mission
- Target should be destroyed or avoided

Sometimes, intelligence assets cannot locate the mobile target. In this case, the current position should be guessed from the last known position. The speed of the SAM should be determined from available intelligence, and a circle of range should be drawn. UAS with DF equipment are sent to this circle just before the strike group enters this area. Because this is a time critical mission, UAS are deployed from an aircraft or mother

ship UAS. These UAS search the area and transfer data to the Operation Center or directly to strike group aircraft. Operation commanders can decide upon the necessary action after evaluating the data. They can either decide to attack the SAM or avoid by changing the flight path.

VIII. SCENARIO

The purpose of this chapter is to postulate a war scenario and use the tactics produced in the previous chapter. This will provide an opportunity to evaluate these tactics and determine whether they are useful.

A. COUNTRIES

Xland and Yland



Figure 116. Xland and Yland

B. POLITICAL STATUS

There are political and territorial problems between these two countries. Yland is supporting terrorist groups in order to weaken Xland's power and authority in the area. Yland lost the western part of its territory in the very beginning of the 20th century. Even though it has been more than a century since the last treaty, Yland still claims this

territory. Moreover, Yland is conducting nuclear research in order to develop a nuclear weapon, which in turn would threaten Xland's security. The new government in Yland clearly plays a hostile role, and continues to claim their lost territory. Xland has increased its defense status to the highest level. Briefly, while Xland wants to maintain the status quo, Yland wants to expand its boundary westward.

A catastrophic terrorist bomb attack, which killed over 100 civilians in an Xland government building, was overtly supported by Yland. Xland has abandoned diplomatic efforts at conciliation and given way to the increasing percentage of its population that supports war. Xland declares war against Yland.

C. FORCE SPECIFICATION

Xland and Yland are two adjacent countries. Both Xland's and Yland's army and air force have mostly western weapon systems in their inventory.

1. Xland

SAM SYSTEMS: Patriot (PAC-1), Hawk, Nike

AIRCRAFT: F-16 BLOCK 50, F/A-18F

UAS: Predator, Mini EA/ES UAS

2. Yland

SAM SYSTEMS: Patriot (PAC-1), Hawk

AIRCRAFT: F-16 BLOCK 50, Mirage 2000

UAS: Reconnaissance UAS



Figure 117. Yland Defense Against Xland

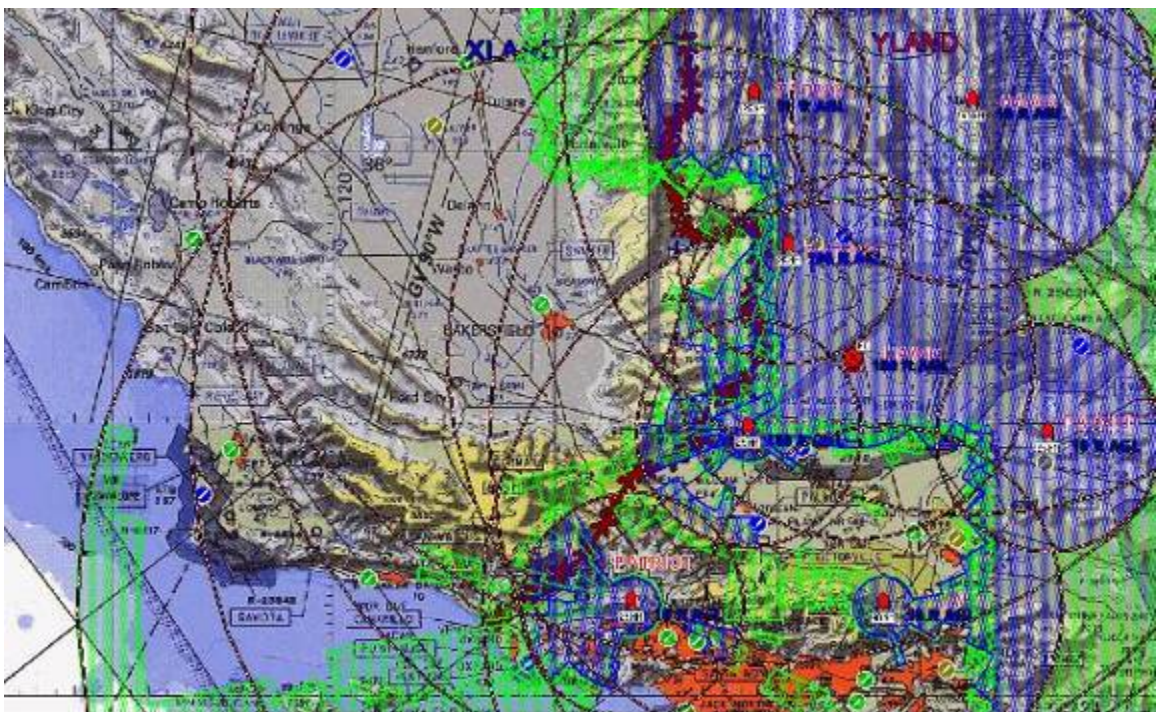

Figure 118. Detection And Engagement Radar Coverage for 100 Feet

D. WEAPON SYSTEMS

1. Hawk Missile

The HAWK surface to air missile system provides medium range, low-to-medium altitude air defense against various threats. This system can be used against aircraft and cruise missiles. It is mobile and can operate in all-weather conditions during night and day. It is highly lethal, reliable, and effective against electronic countermeasures. The Hawk was originally named for the predatory bird, but later the name was turned into an acronym for "Homing All the Way Killer." [160]

Table 13. Hawk Specification (From [160])

Contractor	Raytheon
Mission	surface-to-air missile defense
Targets	
Length	12.5 feet (3.81 meters)
Diameter	13.5 inches (3.84 centimeters)
Weight	1400 pounds (635 kilograms)
Range	Officially: 14.9 miles (24 kilometers) 40 km, in excess of 20 NM
Speed	Officially: Supersonic 800 m/sec, in excess of mach 2.4
Altitude	Officially: 30,000 feet (9.14 kilometers) in excess of 60 KFT
Propulsion	Solid propellant rocket motor
Guidance system	Radar directed semi-active homing

Warheads	One 300 pound (136.2 kg) high explosive missile
Type of fire	Operator directed/automatic modes
Magazine capacity	48 missiles/battery
Missile guidance	Semi-active homing
Target detection	Continuous wave radar and pulse acquisition radars
Target tracking	High power illuminating continuous wave radar and passive optical
Rate of fire	1 missile every 3 seconds
Basic load on vehicle	3 missile towed launcher
Reaction time, sec	35
Reload time	10 min
Emplace/displace time (min)	45 min emplacement
Sensors	High power continuous wave radar (HIPIR) Continuous wave acquisition radar (CWAR) Pulse Acquisition Radar (PAR) and passive optical scan
Detection range, km	80
Deployment	One Light Antiaircraft Missile Battalion in each Marine Air Control Group of each Marine Air Wing (two active, one Reserve). Firing Platoon: 2 Fire sections of up to 3 Launchers per (1) PAR and (1) CWAR 3 missiles per launcher
Units	2 active duty and 1 reserve Light Anti-aircraft Missile Battalion
Crew	<i>Officer:</i> 2 <i>Enlisted:</i> 49

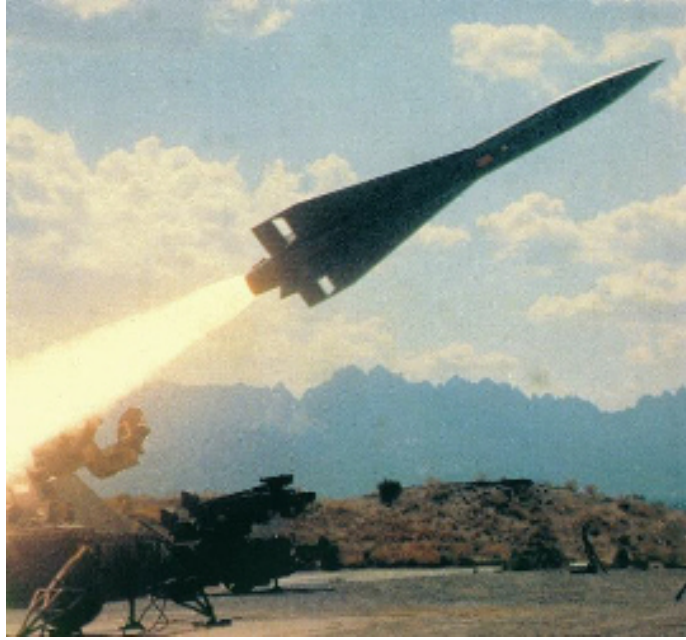

Figure 119. MIM-23 Hawk (From [161])

2. Patriot Missile

The Patriot missile is equipped with a track-via-missile (TVM) guidance system. The engagement control center (ECC), which is mobile, transmits correction data to the guidance system.

The target acquisition system in the missile acquires the target in the terminal phase of flight and transmits the data using the TVM downlink via the ground radar to the engagement control station (ECS) for final course correction calculations. The course correction commands are transmitted to the missile via the missile track command uplink.



Figure 120. MIM-104 Patriot (From [162])

a. Major Components

- Phased array radar. The radar is very difficult to jam. The AN/MPQ-53/65 Radar Set is a passive electronically scanned array radar equipped with IFF, electronic counter-countermeasure (ECCM) and track-via-missile (TVM) guidance subsystems.
- Engagement Control Station (ECS). Uses computerized decision aids. Man-machine interaction options here can range from letting the computer assist in target identification and prioritization to leaving the ECS and letting the computer fight the entire air battle itself.
- 6 to 8 missile launchers. The launcher can be located up to 1 kilometer away from the ECS/radar, receiving commands automatically via microwave data link.
- Patriot missile that can outmaneuver any manned aircraft and most missiles is controlled in flight automatically by the computer [163].

Additionally, The OE-349 Antenna Mast Group (AMG) is mounted on an M927 5-Ton Cargo Truck. It includes four 4 kW antennas in two pairs on remotely controlled masts. The antennas can be controlled in azimuth, and the masts can be

elevated up to 100 feet 11 inches above ground level. Mounted at the base of each pair of antennas are two high-power amplifiers associated with the antennas and the radios in the collocated shelter. It is through these antennas that the ECS and ICC send their respective UHF "shots" in order to create the PADIL network [164].

Table 14. Patriot Specifications (From [165])

	PAC - 1	PAC - 2	PAC - 3
Type	Land-mobile, surface-to-air guided weapon system	Single-stage, low-to-high-altitude	Single-stage, short-range, low-to-high-altitude
Length	5.3 m	5.18 m	5.2 m
Diameter	41 cm	41 cm	25 cm
Wingspan		92 cm	50 cm
Fins	four delta shaped fins		
Launch Weight	914 kg	900 kg	312 kg
Propulsion	Single-stage solid propellant rocket motor	Single-stage solid propellant rocket motor	Single-stage solid propellant rocket motor with special attitude-control mechanism for in-flight maneuvering

Guidance	Command guidance and semi-active homing, track-via-missile (TVM)	Command guidance with TVM and semi-active homing	Inertial/Active millimeter-wave radar terminal homing
Warhead	HE single 90 kg	91 kg HE blast/fragmentation with proximity fuze	hit-to-kill + lethality enhancer 73 kg HE blast/fragmentation with proximity fuze]
Max speed	Supersonic (in excess of Mach 3)	Mach 5	Mach 5
Max range	70 km	70-160km	15 km
Min range	NA	3 km	--
Max attitude	NA	24 km	15 km
Launcher	four-round Mobile trainable semi-trailer	eight-round Mobile trainable semi-trailer	

E. MISSION

There are many missions on the border between Xland and Yland but we will be interested in only one.

The main target in this mission is the nuclear plant where Yland conducts nuclear weapons research. This will be a surprise attack. Formation PANTHER will destroy the main target with LGBs, attempting to minimize collateral damage.

The second target is the Patriot SAM in the corridor, which will be destroyed by PUMA. TIGER will destroy the Hawk SAM that is in the same corridor. FALCON1 and FALCON2 are the sweep escorts, two minutes in front of the main package. EAGLE is the detached escort. FALCONS and EAGLE carry decoys, which are basically repeaters deployed to provide a target of selectable Radar Cross-Section to validate the masking performance of the jammer against enemy aircraft radar and AIM-120 AMRAAM. The main package carries the same type of repeater decoys in case something goes wrong and they need to deploy them for self defense against SAM or air-to-air interceptors. When it is necessary, they will deploy DECOY TACTIC AGAINST SAM and AIR INTERCEPTORS—EA MISSION (Tactic 6).

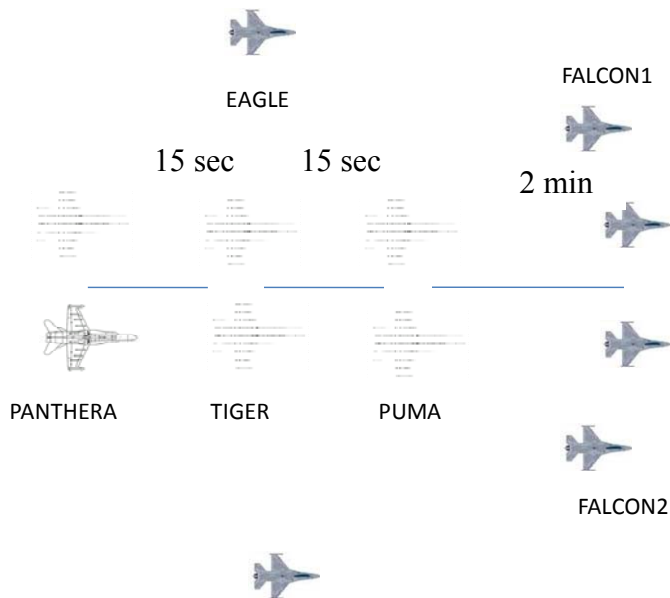

Figure 121. Attack Group



Figure 122. Main Target and Panther's Flight Plan

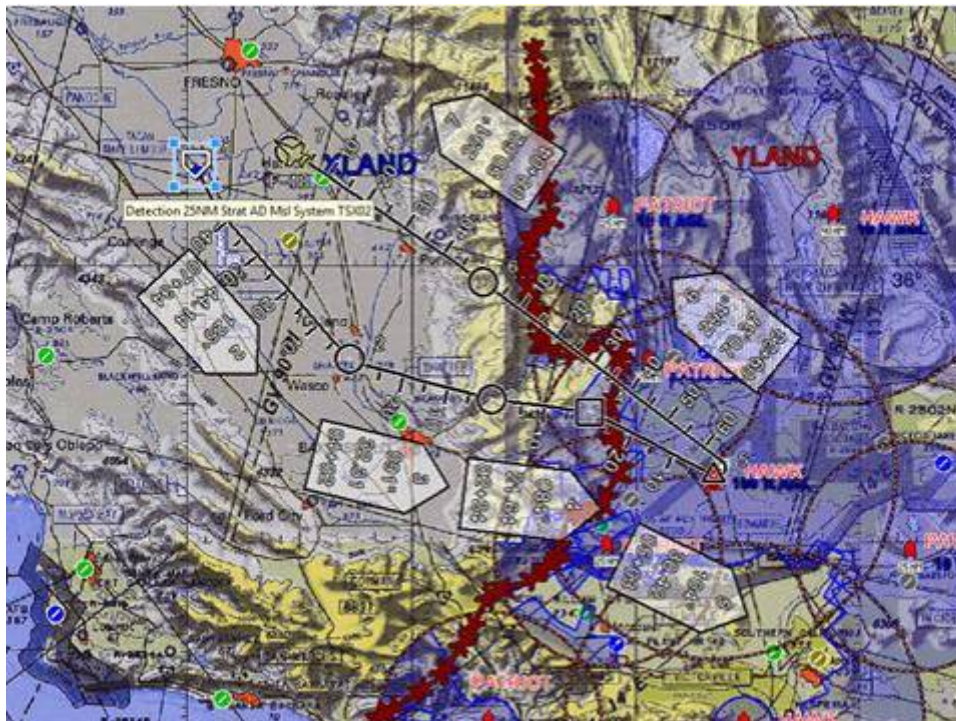

Figure 123. Hawk to Be Destroyed By Tiger and Flight Plan

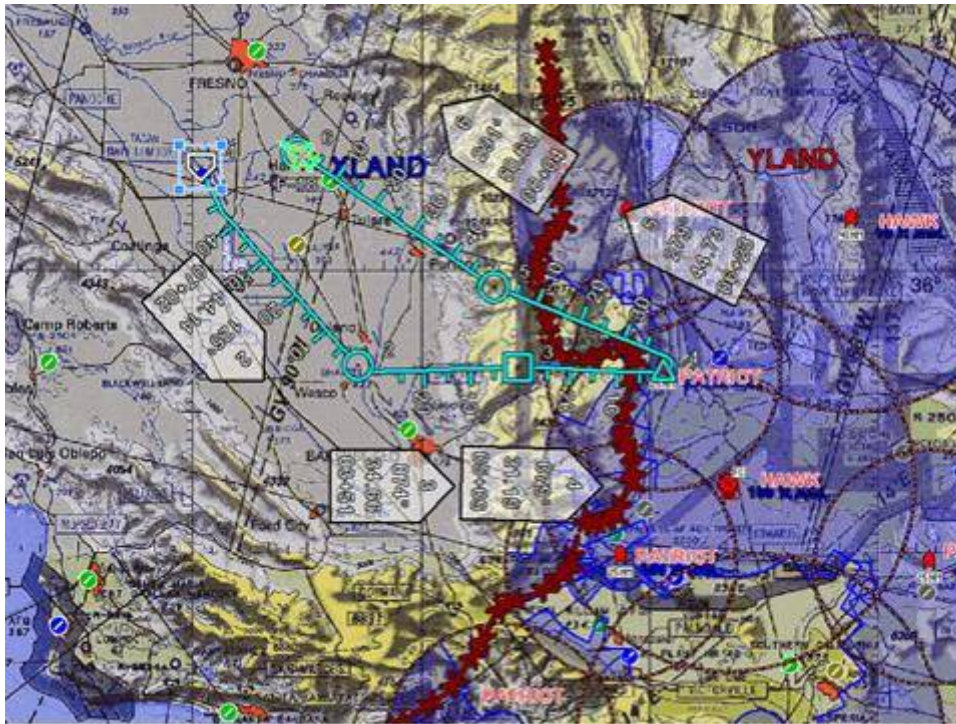

Figure 124. Patriot to Be Destroyed By Puma and Flight Plan

The package is supported by a C-130 loaded with EA, ES and a relay UAS. The UAS will be deployed from the aircraft. Operators are onboard the C-130. EA UAS are equipped with noise jammers to be used against the Hawk system. UAS are going to be in a position to deploy DOUBLE SHORT RANGE MINI-UAS—EA MISSION (Tactic 2) seven minutes before the main package gets in the SAM ring. The ES UAS are going to collect signals from the unseen area behind the mountains without being detected by enemy radar. They are going to do MULTIPLE SHORT RANGE MINI-UAS FOR THREAT WARNING-UNKNOWN THREAT—ES MISSION (Tactic 7).

From the north, special operation teams will deploy other EA UAS to use the same tactic against the Patriot SAM. They will also be in position seven minutes before the main package crosses the SAM ring. They are equipped with similar noise jammers, transmitting in a different frequency that is effective against the Patriot. Further north, special operation teams cross the border and deploy ES UAS for signal collection for

immediate action. Since the intelligence expects A/A interceptors from the north, special forces UAS operators will launch ES UAS with direction finding capability especially for interceptors that will deploy MULTIPLE SHORT RANGE MINI-UAS FOR DIRECTION FINDING-KNOWN THREAT—ES MISSION (Tactic 8).

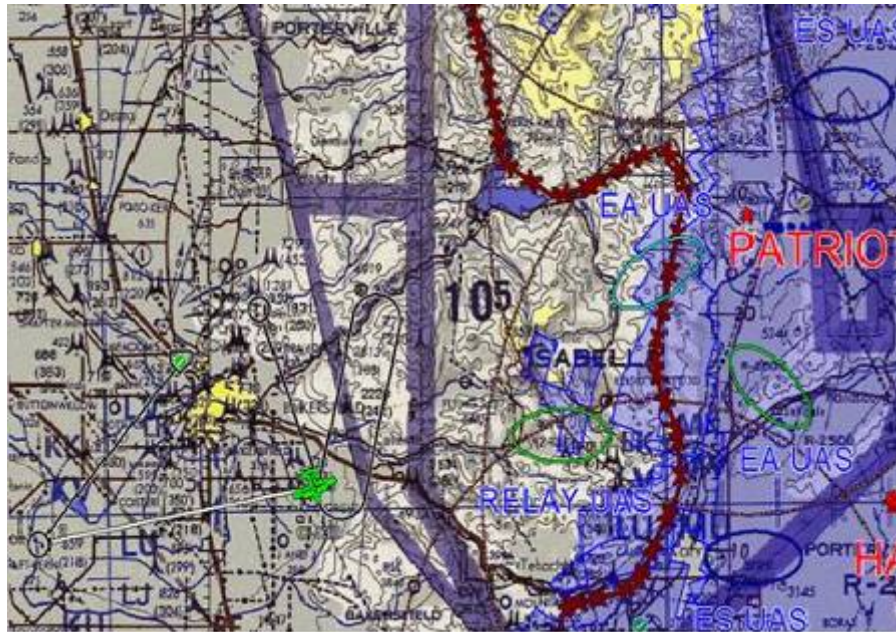

Figure 125. C-130 Loiter Pattern

Predators armed with Hellfire will be flying ready to accomplish the SEAD mission in case there is any problem with the EA missions. Predators are there as a backup force.

F. X-DAY

05:50 a.m.

Special Forces will take their place and will get ready for launching the UAS.

05:55 a.m.

C-130 takes off from the southeast base

06:00 a.m.

Falcon1, Falcon2, Tiger, Puma, Panther, and Eagle take off from the north jet base in this order.

06:05 a.m.

C-130 will have established in holding and start deploying UAS. In the meantime, attack and escort groups will be halfway through the first check point. Special Forces deploy the UAS.

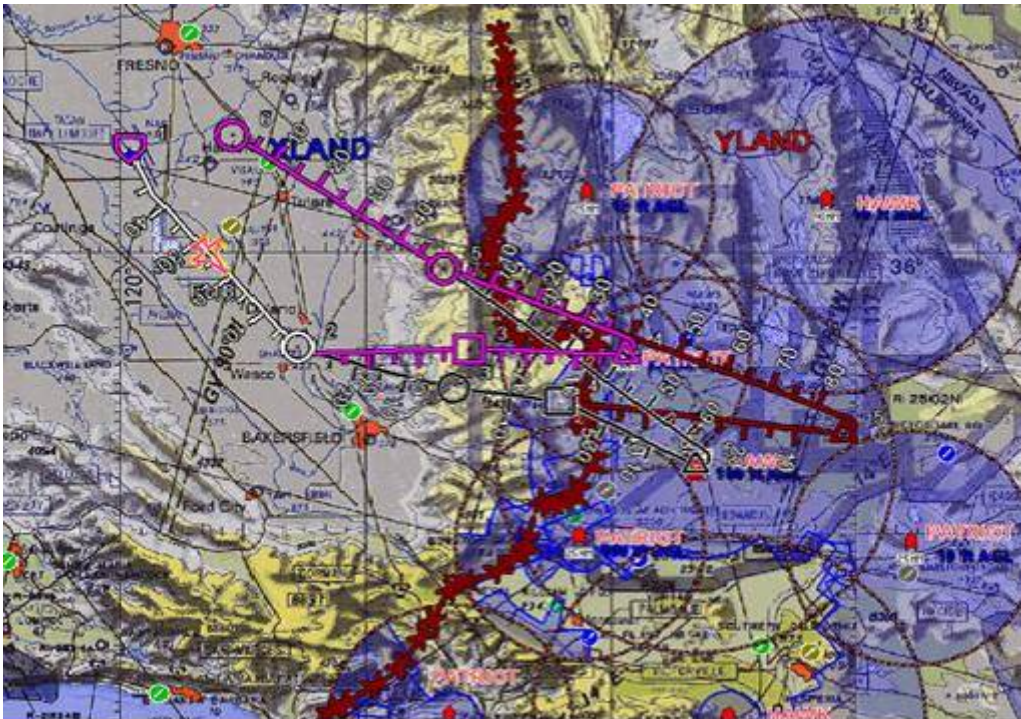

Figure 126. 6:05 a.m.

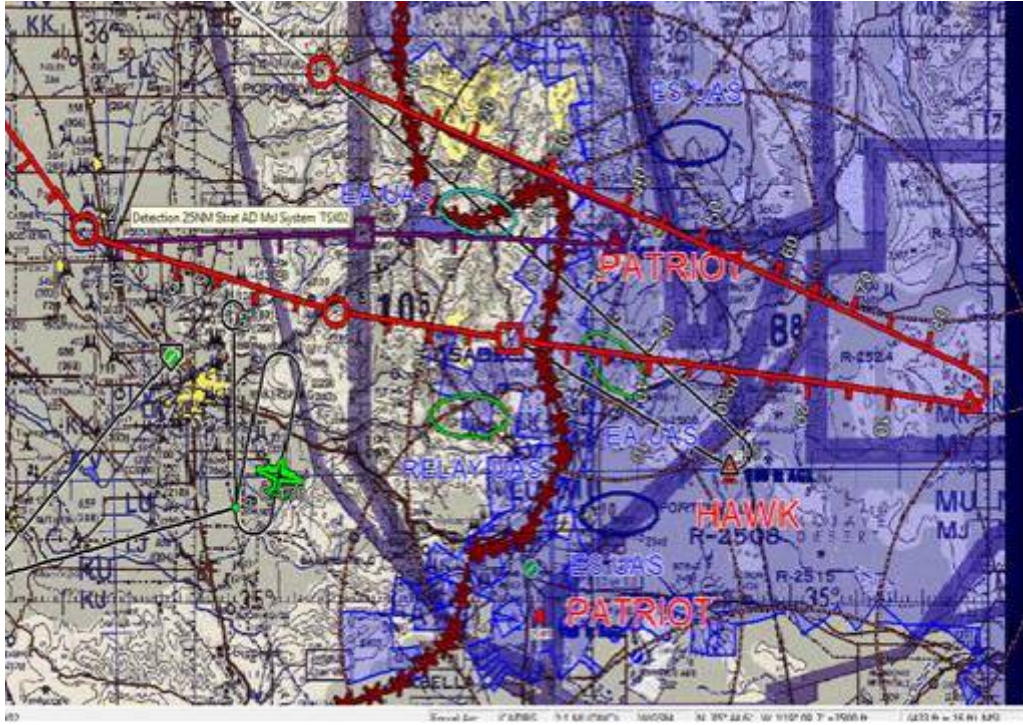

Figure 127. 6:05 a.m.

06:10 a.m.

All the UAS are in position and they start EA by jamming the radars.

06:15 a.m.

All the aircrafts cross the border and get in to the SAM ring. Since the jammer UAS successfully do their mission, main package and escort group safely penetrate the area.

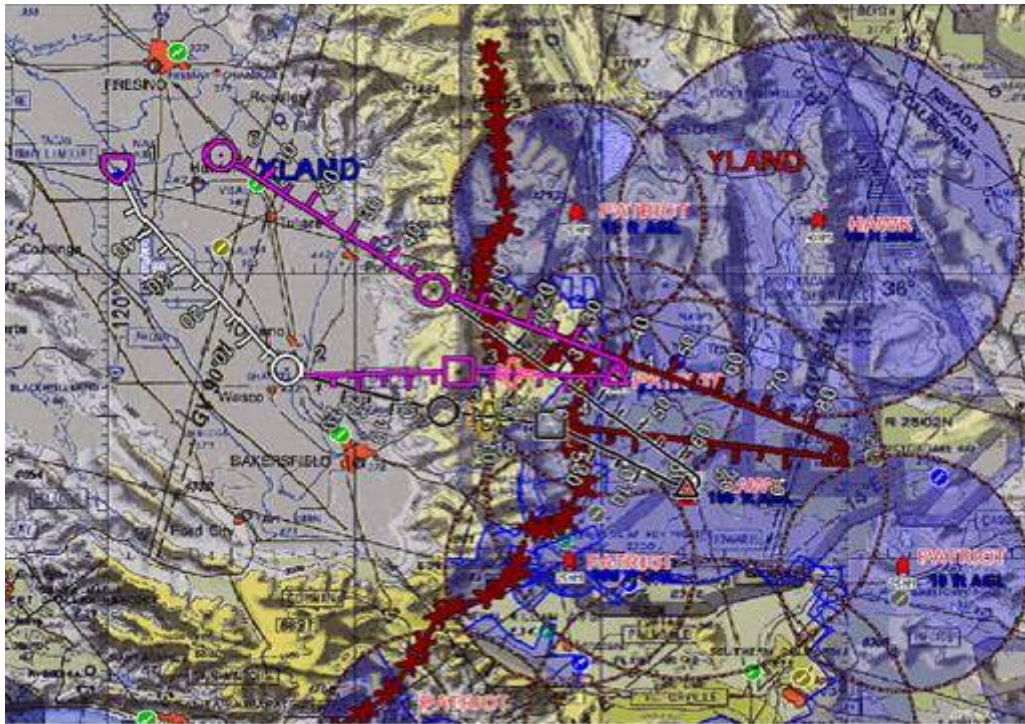

Figure 128. 06:15 a.m. Flight Package

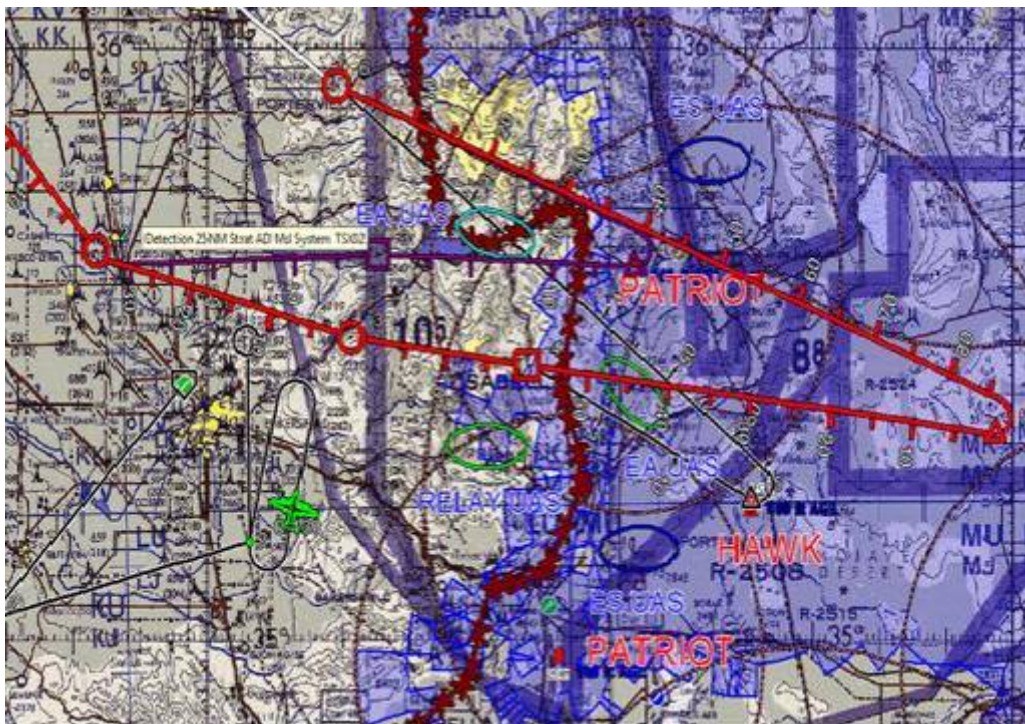

Figure 129. EA/ES UAS Position For Radar Suppression

06:18 a.m.

Each formation passes its relevant IP point. ES UAS from the north get signal for incoming four scramble interceptors coming from north. Falcon1 and Falcon2 direct toward north. Falcon leader will take the best position to defeat the A/A interceptors depending on the directives coming from CAOC, which takes the necessary information from ES UAS.

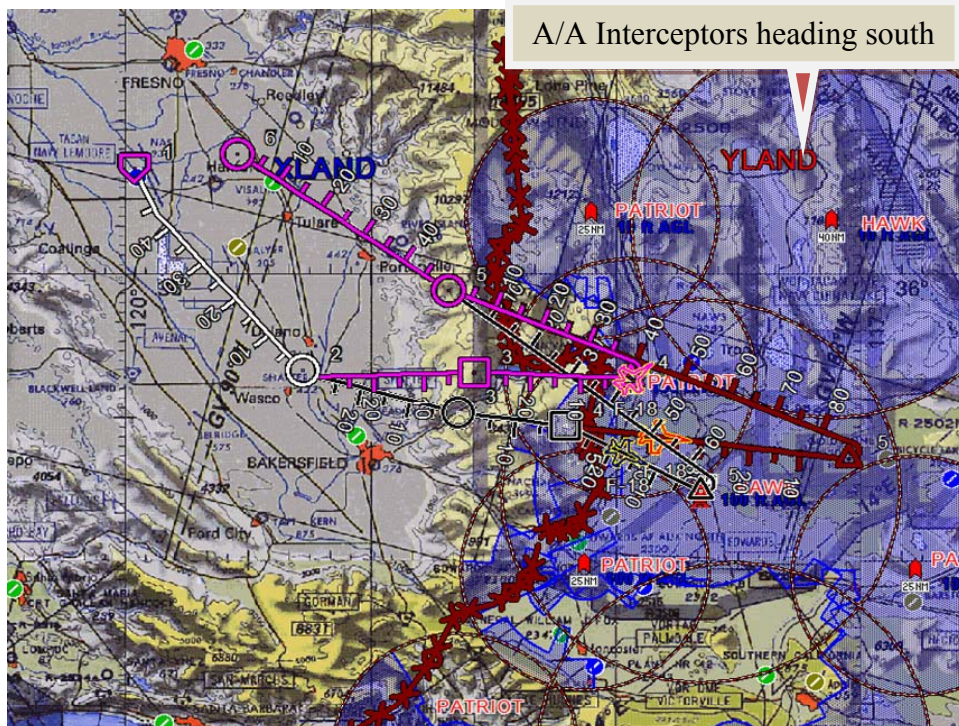

Figure 130. 06:18 a.m.

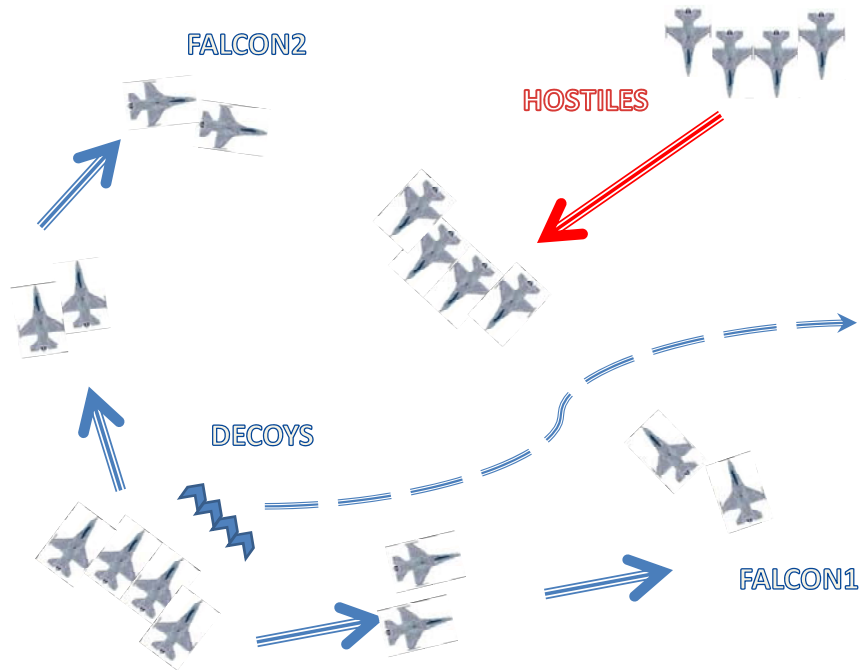

Figure 131. Possible A/A Engagement

Even though there are many possible tactics for A/A engagement, it is certain that decoys will create an advantage and spoil the scramble aircrafts' plan.

06:19 a.m.

Bombs on target. Patriot is destroyed by PUMA. After getting the confirmation, special forces bring back the EA UAS and start to pack up and get ready to leave quickly and quietly. If PUMA fails, EA UAS will stay inside the ring for protection of PANTHER and Predators will do the SEAD mission for the success of PANTHER as a backup plan.

06:22 a.m.

Bombs on target. HAWK is destroyed by TIGER. EA UAS will be brought back to the pre-determined point in Xland territory where they can be picked up. If TIGER

fails, EA UAS will stay inside the ring for protection of PANTHER and Predators will do the SEAD mission for the success of PANTHER as a backup plan.

06:25 a.m.

Bombs on target for the main target. PANTHER successfully dropped the bombs. TIGER is on the way back and PUMA has already crossed the border.

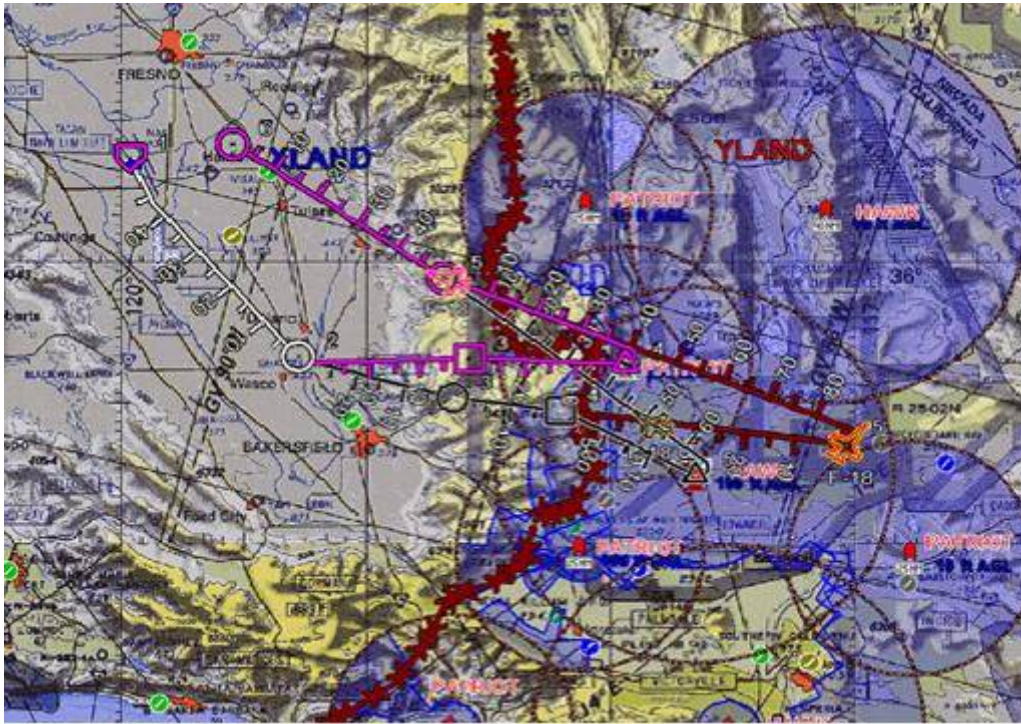

Figure 132. 06:25 a.m. Bombs On Target-Mission Accomplished

06:35 a.m.

The entire package crosses the border and they are safe. All of the UAS turn back. Special Forces head back to base. C-130 and back-up Predators are also heading back. After a successful engagement with small or no loss, escort package is turning back before the reinforcements.

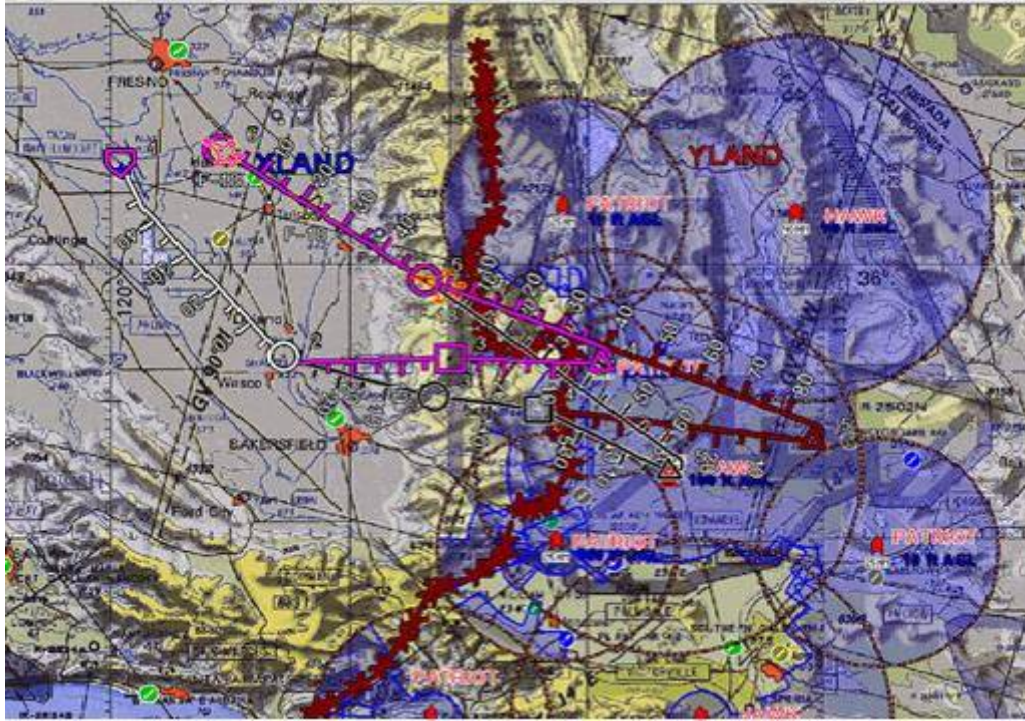

Figure 133. 06:35 a.m. Entire Air Force Is Back In Xland Territory

This scenario is clearly a transition of the UAS in the battle area in coordination with manned aircraft. In the near future, UAS will be able to accomplish all parts of this mission and there will not be any need for manned aircraft. Furthermore, there is a general belief that the F-35 Joint Strike Fighter is the last manned aircraft and will eventually be replaced by unmanned aircraft. This scenario definitely shows us how to use the possible tactics in the net-centric battlefield. Many more scenarios can be produced. Variables should be considered while developing new scenarios.

IX. CONCLUSION AND RECOMMENDATIONS

A. CONCLUSION

The recent meteoric rise of UAS development highlights the issue of the growing importance of UAS in the future and leads to the corollary issue of whether UAVs will replace manned aircraft roles and missions. UAS will allow for operations to be executed quickly, safely, and cheaply. UAS have proven their combat worth in many operations like Vietnam, Bekaa Valley, Desert Shield, Desert Storm, Kosovo and Afghanistan. UAS will continue to replace manned aircraft in many areas, but only time and technology will tell how much.

In parallel with UAS development, EW technology also is improving rapidly. With the beginning of the 20th century, EW started appearing “in-theater.” In WWI and especially in WWII this rise was drastic. After WWII, this incline increased faster. During many wars, all nations came to understand the importance of this new concept to defeat the enemy. It was a competition to gain the power. WWI, WWII, Vietnam, Korea, Bekaa Valley, Desert Shield, Desert Storm, Kosovo and Afghanistan are the major conflicts in which we can see widespread use of EW that obviously affected the results.

EW equipment can be manufactured cheaper and smaller to fit on to UAS. UAS in the EW environment are getting more important, since EW has become the heart of today’s net-centric warfare. UAS are very good platforms for EW—especially mini UAS, as they have started to play a major role because they are too small to be noticed by hostile radar systems and they are cheaper. With improving networking capabilities, these UAS can be controlled from a remote operation center and can send almost real-time data back for decision makers or field and operation commanders.

In this thesis, reviewing both the history of UAS and EW gives the reader a bigger field of view for a better understanding of the merging points of these two concepts. Historical facts may also lead to success, since the reader would see the failures and

achievements in the real world operations throughout this thesis. It must not be forgotten that if we cannot learn lessons from our past we are condemned to make similar mistakes in the future.

Obviously, this thesis has a purpose of merging UAS and EW on the same path and developing tactics for operational use. Many more tactics should be developed and run in a scenario in real or simulated operations to get the best results.

All the tactics in this thesis depend on assumptions, and they have not been field tested. There are many variables that would have an effect on which tactic should be chosen: geographical conditions, properties of the radar intended to be jammed, EW equipment mounted on the UAS, specifications of the UAS used for the mission—even the experience level of the UAS operator is a great factor while determining the proper tactics.

Furthermore, during my thesis research with the COASTS program, I had a chance to work with several types of UAS: Raven, Wasp, Puma from Aeroviroment and CyberDefense's Cyberbug. All these UAS were designed for surveillance, but whatever the mission is the platforms are almost the same; this was a good opportunity for me to evaluate UAS in a field environment. This opportunity revealed some untold facts about the UAS. Even though UAS have many advantages and there is a very rapid improvement in UAS technology, they still have some disadvantages and drawbacks. Despite being built for harsh environments and almost all weather conditions, they can be unexpectedly fragile. While working with them I learned a very important lesson: while flying a UAS one should always have a spare for every UAS part, and a spare (at least one) UAS in its entirety.

UAS have been the most dynamic growth sector of the aerospace industry this decade. Market studies estimate that the market will double over the next decade, from current worldwide UAS procurement expenditures of about \$4.4 billion to \$8.7 billion [166]. This estimate is shown in the table below.

Table 15. Future UAS Forecasts

World UAV Unit Production Forecast by Region

(Units, Air Vehicles)	2009	2010	2011	2012	2013	2014	2015	2016	2017	2018	Total
USA	2,274	1,670	1,692	778	321	1,770	1,770	1,711	1,768	1,756	15,510
Europe	348	440	394	334	338	507	487	477	549	561	4,436
Mid-East	161	274	381	167	156	165	167	109	121	115	1,816
Asia-Pacific	488	576	609	621	705	648	725	583	682	672	6,309
Africa	23	6	11	36	31	25	35	5	11	17	200
The Americas (less USA)	34	25	39	65	40	62	27	1	43	79	415
Total	3,328	2,991	3,126	2,001	1,591	3,177	3,211	2,886	3,174	3,200	28,685

(Value, \$ Millions)	2009	2010	2011	2012	2013	2014	2015	2016	2017	2018	Total
USA	1,655.0	2,060.0	2,105.0	1,935.0	2,095.0	2,195.0	2,490.0	2,170.0	2,345.0	2,985.0	22,035.0
Europe	308.5	350.8	275.0	438.8	594.8	806.8	906.6	866.1	946.9	428.3	5,922.4
Mid-East	219.8	234.7	162.6	295.2	228.8	249.0	220.2	39.0	159.0	45.0	1,853.3
Asia-Pacific	270.9	248.8	381.5	500.8	470.8	664.6	752.5	886.2	758.0	728.0	5,662.1
Africa	34.5	19.5	12.3	13.1	12.9	8.1	23.1	7.5	16.5	25.5	173.0
The Americas (less USA)	74.5	30.5	19.5	3.3	21.5	146.8	115.0	15.0	71.8	23.8	521.5
Total	2,563.2	2,944.3	2,955.9	3,186.2	3,423.8	4,070.3	4,507.4	3,983.8	4,297.2	4,235.6	36,167.7

World UAV Unit Production Forecast by Type

(Value, \$ Millions)	2009	2010	2011	2012	2013	2014	2015	2016	2017	2018	Total
Mini-UAVs	50.7	59.8	66.9	36.2	42.8	73.8	77.9	65.3	90.7	95.1	659.2
Tactical UAVs	867.5	556.5	505.0	627.0	552.0	869.5	795.5	554.5	347.5	327.5	6,002.5
Naval UAVs	40.0	55.0	147.0	201.0	227.0	369.0	346.0	364.0	406.0	268.0	2,423.0
MALE	580.0	1067.0	1072.0	1192.0	987.0	1085.0	990.0	745.0	900.0	810.0	9,428.0
HALE	715.0	930.0	650.0	675.0	1175.0	1280.0	1475.0	1530.0	1550.0	1450.0	11,430.0
UCAVs	200.0	150.0	375.0	75.0	75.0	—	375.0	300.0	475.0	800.0	2,825.0
Civil	110.0	126.0	140.0	380.0	365.0	393.0	448.0	425.0	528.0	485.0	3,400.0
Total	2,563.2	2,944.3	2,955.9	3,186.2	3,423.8	4,070.3	4,507.4	3,983.8	4,297.2	4,235.6	36,167.7

Frost & Sullivan note that defense ministries worldwide are set to allocate approximately four percent, equating to U.S. \$36 billion, of their total defense procurement and budget toward electronic warfare (EW) over the next ten years. The U.S. alone is forecast to spend U.S. \$25 billion on EW during this timeframe. Airborne countermeasures are predicted to account for 50 percent of total EW expenditure [167].

As shown in the table, there will be an increasing amount of investment on UAS in the next ten years and beyond. And it is fairly obvious that EW also will still keep its importance.

Sooner or later, operational tactics development will gain greater importance. This thesis is just a small step toward this.

EW needs UAS and UAS needs EW. This potentially synergistic relationship can provide the operators and commanders an enhanced situational awareness, a significantly superior capacity to conduct EW operations, and much more capable operational UAS.

Miniature and mini UAS are of particular interest to EW operations, as these UAS are likely to undertake some of the dullest, dirty, dangerous, and nearly impossible missions. The affordability of these smaller UAS also provides us with the opportunity to acquire or develop suitable payloads for these missions. In addition, it allows for the development, experimentation, and evaluation of operational concepts for the larger UAVs and more advanced concepts and tactics.

Finally, the future lies under the shadow of the unmanned systems. Whoever builds and controls them the best will play the biggest role in the political and military arena. This thesis can be used as a reference for future research to build more advanced tactics and concepts.

B. RECOMMENDATIONS

It is certain that, in the near future, UAS are going to be one of the major players. Likewise, EW will be holding a critical place on the battle field. Almost all nations are budgeting for UAS development and EW research. We are in the information age, and no information is unreachable. Leading nations in UAS manufacturing sell their technology on the international market. Everyone is going to take part in the game. All these facts increase the importance of operational tactics development for these technologies. It is time for doctrine, strategy, concepts of operations (CONOPs) and tactics, techniques and procedures (TTPs) to catch up to the technology that is available and ever more present.

This thesis is a starting point for developing tactics for the integration of EW into mini-UAS operations. I tried to look at the subject from a wide perspective. Follow-on research may focus on a more detailed examination of tactics while testing the equipment.

Every tactic has a weak point; follow-on research may also focus on this issue to uncover the weaknesses of the tactics displayed in this thesis.

The wide historical research accomplished in the writing of this thesis might be used as a reference for future researches, both on UAS and EW.

THIS PAGE INTENTIONALLY LEFT BLANK

LIST OF REFERENCES

- [1] Air Force Doctrine Document 2-5.1, *Electronic Warfare*. Washington, DC: Secretary of the Air Force, 5 November 2002.
- [2] Joint Publication 3-13.1, *Joint Doctrine for Electronic Warfare*. Washington, DC: Joint Staff, 25 January 2007.
- [3] NASA, "Figure," http://www.nasa.gov/audience/forstudents/5-8/features/F_The_Electromagnetic_Spectrum.html (Accessed September 2008).
- [4] P. E. Pace, "Joint Network-Enabled Electronic Warfare I," Naval Postgraduate School, Monterey, CA, 2009.
- [5] "Electronic Warfare," <http://www.nationmaster.com/encyclopedia/Electronicwarfare> (Accessed October 2008).
- [6] Joint Publication 3-51, *Joint Doctrine for Electronic Warfare*. Washington, DC: Joint Staff, 7 April 2000.
- [7] A. Parsch, "AN/ARA to AN/ARC - Equipment Listing," <http://www.designation-systems.net/usmilav/jetds/an-ara2arc.html> (Accessed October 2008).
- [8] Joint Publication 1-02, *DOD Dictionary of Military and Associated Terms*. Washington, DC: Joint Staff, amended 20 March 2006.
- [9] Joint Publication 3-13.4, *Joint Doctrine for Military Deception*. Washington, DC: Joint Staff, 13 July 2006.
- [10] A. Price, *The History of US Electronic Warfare*, 1st ed. Arlington, VA: Association of Old Crows, 1984.
- [11] J.P.R. Browne, and M.T. Thurbon, *Electronic Warfare*, Vol. 4 of *Brassey's Air Power: Aircraft Weapons Systems and Technology Series*. Washington: Brassey's, 1998.
- [12] R. Schroer, "Electronic Warfare," *IEEE Aerospace and Electronic Systems Magazine*, vol.18, issue 7. July 2003.
- [13] National Museum of the U.S. Air Force, "Figure," <http://www.nationalmuseum.af.mil/factsheets/factsheet.asp?id=2558> (Accessed July 2008).

- [14] Federation of American Scientists (FAS), “U-2 Senior Year/Aquatone/U-2/TR-1 Overview,” <http://www.fas.org/irp/program/collect/u-2.htm> (Accessed July 2008).
- [15] Air Attack, “Figure,” http://www.air-attack.com/MIL/u2/u2_3.jpg (Accessed June 2009).
- [16] A. Price, *Instruments of Darkness: The History of Electronic Warfare*. New expanded and updated ed. London: Macdonald and Jane’s, 1978.
- [17] Hill Air Force Base, “‘Quail’ Aerial Decoy,” <http://www.hill.af.mil/library/factsheets/factsheet.asp?id=5768> (Accessed June 2008).
- [18] Hound Dogs-Quails-B-52, “Figure,” http://www.ammsalumni.org/html/hound_dogs_quails_b-52_gall_7.html (Accessed June 2008).
- [19] Ammsalumni, “ADM-20 History/Data,” http://www.ammsalumni.org/html/adm-20_history_data.html (Accessed June 2008).
- [20] “Operation Moonbounce,” <http://www.sjhrc.org/moonbounce.html> (Accessed December 2008).
- [21] Global Security, “V-75 SA-2 GUIDELINE,” <http://www.globalsecurity.org/military/world/russia/v-75.htm> (Accessed June 2009).
- [22] Global Security, “Figure,” <http://www.globalsecurity.org/military/world/russia/v-75-pics.htm> (Accessed June 2009).
- [23] M. Nastasi, “The Wild Weasels ‘Daredevils of the skies’,” <http://www.militaryhistoryonline.com/vietnam/airpower/wildweasel.aspx> (Accessed September 2008).
- [24] McDonnell Douglas F-4J (F-4S) Phantom II cockpit instrument panel layouts, “Figure,” <members.chello.nl/m.waterloo/f4j-panel.html> (Accessed June 2009).
- [25] North American F-100F Super Sabre, “Figure,” <http://www.nationalmuseum.af.mil/factsheets/factsheet.asp?id=296>, (Accessed September 2008).
- [26] Texas Instruments ASM-N-10/AGM-45 Shrike, “Figure,” <http://www.designation-systems.net/dusrm/m-45.html> (Accessed December 2008).
- [27] Republic F-105 Thunderchief, “Figure,” http://www.aeroflight.co.uk/types/usa/republic/f-105/F-105_Thunderchief.htm (Accessed December 2008).

- [28] The Republic F-105 Thunderchief Over Vietnam, “Figure,” http://www.wingweb.co.uk/aircraft/Republic_F-105_Thunderchief_Vietnam (Accessed December 2008).
- [29] A. C. Kucukozyigit, “Electronic Warfare (EW) Historical Perspectives and Its Relationship to Information Operations (IO) – Considerations for Turkey,” 2006.
- [30] Airbattle, “Weapons,” http://www.airbattle.co.uk/d_weapons.html (Accessed September 2008).
- [31] H. L. Gilster, *The Air War in Southeast Asia: Case Studies of Selected Campaigns*, Air University Press, 1993.
- [32] Federation of American Scientists (FAS), “ZRK-SD Kub 3M9 SA-6 Gainful,” <http://www.fas.org/man/dod-101/sys/missile/row/sa-6.htm> (Accessed September 2009).
- [33] Federation of American Scientists (FAS), “ZRK-SD Kub 3M9 SA-6 Gainful,” <http://www.fas.org/man/dod-101/sys/missile/row/sa-7.htm> (Accessed September 2009).
- [34] SA-6 Gainful 2K12 Kub Système de missile sol-air sur blindé chenillé, “Figure,” http://www.armyrecognition.com/index.php?option=com_content&task=view&id=613&Itemid=87 (Accessed January 2009).
- [35] Global Security, “ZSU-23-4 Shilka 23MM Antiaircraft Gun,” <http://www.globalsecurity.org/military/world/russia/zsu-23-4.htm> (Accessed September 2009).
- [36] ZSU-23-4 Shilka, “Sistema de Defensa antiaérea Shilka (Rusia),” <http://desarrolloydefensa.blogspot.com/2008/08/sistema-de-defensa-antiarea-shilka.html> (Accessed June 2009).
- [37] Army Recognition, “SA-7 Grail Missile de défense antiaérien portable,” http://www.armyrecognition.com/index.php?option=com_content&task=view&id=268&Itemid=142 (Accessed September 2008).
- [38] M. M. Hurley, “The BEKAA Valley Air Battle, June 1982: Lessons Mislearned,” <http://www.airpower.maxwell.af.mil/airchronicles/apj/apj89/win89/hurley.html> (Accessed September 2008).
- [39] P. S. Cutter, “Lt. Gen. Rafael Eitan: `We Learned Both Tactical and Technical Lessons in Lebanon,’” *Military Electronics/Countermeasures*, February 1983.
- [40] R. Atkinson, *Crusade: The Untold Story Of The Persian Gulf War*, New York: Houghton Mifflin Company, 1993.

- [41] J. McIntyre, CNN Military Affairs Correspondent, "Tenth anniversary of the Gulf War: A look back," Washington, January 16, 2001.
- [42] C. Kopp, "Desert Storm-The Electronic Battle," 1995, <http://www.ausairpower.net/Analysis-ODS-EW.html> (Accessed September 2008).
- [43] B. W. Watson, *Military Lessons of the Gulf War*. Revised. London; Novato, CA: Greenhill Books; Presidio Press, 1993.
- [44] J. Adams, *The Next World War: Computers Are the Weapons and the Front Line Is Everywhere*. New York: Simon & Schuster, 1998.
- [45] First Missile Attack On Baghdad, "Figure," <http://www.war2003action.com/photostONE.html> March 21, 2003 (Accessed June 2009).
- [46] Federation of American Scientists (FAS), "BGM-109 Tomahawk," <http://www.fas.org/man/dod-101/sys/smart/bgm-109.html> (Accessed September 2009).
- [47] DoD Photo Archive, "Figure," <http://preview.defenselink.mil/transformation/images/photos/2005-02/Hi-Res/050219-N-6541W-001.jpg> (Accessed June 2009).
- [48] A Sample Feature From Aviation News, "Figure," <http://www.aviation-news.co.uk/stealthRescue.html> (Accessed June 2009).
- [49] AGM-88, "Figure," <http://www.aviation-news.co.uk/stealthRescue.html> (Accessed June 2009).
- [50] ALARM Missile, "Figure," <http://en.wikipedia.org/wiki/ALARM> (Accessed June 2009).
- [51] J. Wagner, E-8C Joint Stars, "Figure," http://www.military.cz/usa/air/in_service/aircraft/e8c/e8c_en.htm (Accessed June 2009).
- [52] E-3 AWACS, "Figure," <http://www.ausairpower.net/isr-ncw.html> (Accessed March 2009).
- [53] B. D. Parker, "Caught in a Jam: the U.S. Air Force's Electronic Attack Conundrum," Maxwell AFB, Ala. Air Command and Staff College April 2008.
- [54] R. O. Rasmussen, B. C. Jørgensen, and F. Bernhelm, "Facts And Fiction Of The Kosovo War - New Qualities Of Warfare," March 2001.
- [55] Defense Link, "NATO Operation Allied Forces," <http://www.defenselink.mil/specials/kosovo/> (Accessed February 2009).

- [56] B. Bolkcom, "Electronic Warfare: Ea-6b Aircraft Modernization and Related Issues for Congress," Washington D.C, April 2000.
- [57] V. Patney, "Air War in Kosovo," *AIR POWER Journal*, vol. 1, no.1, MONSOON 2004.
- [58] Newsonthewebnow, "The Politics of Afghanistan," <http://newsonthewebnow.net/the-politics-of-afghanistan> (Accessed April 2009).
- [59] Bureau Of South And Central Asian Affairs, "Background Note: Afghanistan, November 2008," <http://www.state.gov/r/pa/ei/bgn/5380.htm> (Accessed April 2009).
- [60] The History Guy, "The War in Afghanistan," http://www.historyguy.com/war_in_afghanistan.html (Accessed April 2009).
- [61] Military.com, "Navy Takes Aim at Roadside Bombs," *Associated Press (Military Advantage)*, 12 June 2007, <http://www.military.com/NewsContent/0,13319,138857,00.html?ESRC=dod-b.nl> (Accessed April 2009).
- [62] Vetshome, "Iraq War Page 1," http://vetshome.com/iraq_war_page_1.htm ,(Accessed April 2009).
- [63] W. Murray and R. H. Scales, Jr., "The Iraq War: A Military History (2003)," <http://www.thorntonveteransmemorial.org/memorial/iraqfree.htm> (Accessed May 2009).
- [64] Global Security, "Operation Iraqi Freedom - March 19/20 Day one," http://www.globalsecurity.org/military/ops/iraqi_freedom_d1.htm (Accessed June 2009).
- [65] *Asia Times Online*, "Confirmed military action in and around Iraq," http://www.atimes.com/atimes/Middle_East/EC22Ak02.html (Accessed June 2009).
- [66] *CBSNews*, "Follow the Action," http://www.cbsnews.com/htdocs/america_atwar/battlefield/military/flash_index.html (Accessed June 2009).
- [67] Global Security, "Operation Iraqi Freedom - March 21 Day two," http://www.globalsecurity.org/military/ops/iraqi_freedom_d2.htm (Accessed June 2009).
- [68] A. H. Cordesman and A. A. Burke, *The Iraq War: A Working Chronology*, Center for Strategic and International Studies, Washington, April 2003.
- [69] Global Security, "Operation Iraqi Freedom - March 23 Day four," http://www.globalsecurity.org/military/ops/iraqi_freedom_d4.htm (Accessed June 2009).

- [70] Global Security, "Operation Iraqi Freedom - March 24 Day five," http://www.globalsecurity.org/military/ops/iraqi_freedom_d5.htm (Accessed June 2009).
- [71] Global Security, "Operation Iraqi Freedom – April 8 Day twenty," http://www.globalsecurity.org/military/ops/iraqi_freedom_d20.htm (Accessed June 2009).
- [72] K. Penhaul, S. Malveaux, L. Schiavone and B. Starr (CNN correspondents), "Bush calls end to 'major combat'," <http://www.cnn.com/2003/WORLD/meast/05/01/sprj.iq.main/> (Accessed July 2009).
- [73] History of Nations, "History of Iraq," <http://www.historyofnations.net/asia/iraq.html> (Accessed July 2009).
- [74] Iraqi Ministry of Iraq, "State Company for Iraqi Affairs," <http://www.iraqifairs.com/aboutiraq.htm> (Accessed July 2009).
- [75] Department of Defense, "Unmanned Systems Roadmap 2007-2032," Office of the Secretary of Defense, December 10, 2007.
- [76] Trip Atlas, "Unmanned Aerial Vehicle," http://tripatlas.com/Unmanned_aerial_vehicle (Accessed February 2009).
- [77] H. Geer and C. Bolkcom, "CRS Report for Congress: Unmanned Aerial Vehicles: Background and Issues for Congress," Updated November 21, 2005.
- [78] M. Arjomandi, "Classification of Unmanned Aerial Vehicles," The University of Adelaide, Australia, March 2007.
- [79] C. C. Crouch, "Integration Of Mini-Uavs At The Tactical Operations Level: Implications Of Operations, Implementation, And Information Sharing," Naval Postgraduate School June 2005.
- [80] W. W. Bierbaum, "UAVs," *Air & Space Power Journal - Chronicles Online Journal*, <http://www.airpower.maxwell.af.mil/airchronicles/cc/uav.html> (Accessed February 2009).
- [81] R. B Gasparre, "The U.S. and Unmanned Flight – Part I," *Air Force Technology*, 25 Jan 2008, <http://www.airforce-technology.com/features/feature1528/> (Accessed January 2009).
- [82] K. Wahl, Product Group Director, Maj Jay Mullin, UAV Capabilities Officer, "Coordinated UAV Endorsement Brief," presented at UAS Symposiums, June 2005.

- [83] R. Walsh, Assistant Deputy Commandant of Aviation, "USMC UAV Operations and Program Overview," presented at 2007 AAAA UAS Symposiums, http://www.quad-a.org/Symposiums/07UAS/Presentations/uasPresentations_2007.html (Accessed February 2009).
- [84] NationMaster Encyclopedia, "U.S. Military UAV tier system," <http://www.nationmaster.com/encyclopedia/U.S.-Military-UAV-tier-system> (Accessed February 2009).
- [85] OSD, UAV Planning Task Force, February 2003, www.acq.osd.mil/dsb/reports/2008-02-ESTF.pdf (Accessed March 2008).
- [86] Cranfield University "Civilian Market for UAVs," www.dcm.t.cranfield.ac.uk/aerextra (Accessed February 2009).
- [87] A. V Koldaev, "Non-Military UAV Applications," http://www.domain-b.com/aero/technical_papers/koldaev_extract.pdf (Accessed February 2009).
- [88] I. Demirel, "Aircraft Pilot Situational Awareness Interface for Airborne Operation of Network Controlled Unmanned Systems," Naval Postgraduate School, March 2008.
- [89] UAV Survey, Flight International, 7–13 August 2007.
- [90] "Referenced All Unmanned Aircraft Systems," 2007, http://www.uvs-info.com/Yearbook2007/164_REF_All-UAS.pdf (Accessed February 2009).
- [91] S. Shaker and A. Wise, *War Without Man-Robots on the Future Battlefield*. McLean VA: Pergamon-Brassey's International Defense Publishers Inc. 1998.
- [92] M. Armitage, *Brassey's Unmanned Aircraft*. McLean VA: Brassey's Defense Publishers, 1988.
- [93] L. R. Newcome, R, "Unmanned Aviation: A Brief History of Unmanned Aerial Vehicles," American Institute of Aeronautics and Astronautics, Inc., 2004.
- [94] Edwards Air Force Base, "USAF Tier System," http://www.edwards.af.mil/articles98/docs_html/splash/may98/cover/Tier.htm (Accessed March 2009).
- [95] W. Jangwhan, "Introduction to UAV System," Park, UAV CENTER Co., Ltd. Mannyun-dong Seo-gu Daejeon-city, October 2002.
- [96] Aviation Museum of Maintenance, "German V-1 Buzz Bomb, Development of New Weapon," February 1997, <http://www.fighterfactory.com/airworthy-aircraft/buzzbomb-v1.php> (Accessed March 2009).

- [97] R. Mayne and R. Margolis, *Introduction to Engineering*. New York: McGraw-Hill, 1984.
- [98] R.T. Kent, "The Martin TM-61A Matador Missile," http://www.wingweb.co.uk/missiles/Martin_Matador_missile.html (Accessed March 2009).
- [99] Global Security, "Weapons of Mass Destruction-Mace," <http://www.globalsecurity.org/wmd/systems/mace.htm> (Accessed March 2009).
- [100] CollectAir photo, "Figure," <http://www.collectair.com/missileospace.html> (Accessed July 2009).
- [101] A. Parsch, "Figure," <http://www.designation-systems.net/dusrm/app1/sm-62.html> (Accessed March 2009).
- [102] Andreas Parsch, "Northrop SSM-A-3/B-62/SM-62 Snark," <http://www.astronautix.com/lvs/snark.htm> (Accessed March 2009).
- [103] Federation of American Scientists (FAS), "SM-64 Navaho," <http://www.fas.org/nuke/guide/usa/icbm/sm-64.htm> (Accessed April 2009).
- [104] Air Force News, "Air Force Space & Missile Museum rolls out restored Navaho missile," Released: Jul 10, 1998, http://www.fas.org/nuke/guide/usa/icbm/n19980710_981014.html (Accessed April 2009).
- [105] G. K. James, "Unmanned Aerial Vehicles and Special Operations: Future Directions," Naval Postgraduate School, Monterey, CA, December 2000.
- [106] A. Persch, "McDonnell GAM-72/ADM-20 Quail," <http://www.designation-systems.net/dusrm/m-20.html> (Accessed April 2009).
- [107] Strategic Air Command , "AGM-28 Hound Dog Missile," http://www.strategic-air-command.com/missiles/Aircraft-Launched_Missiles/agm-28_hound_dog_missile.htm (Accessed April 2009).
- [108] National Museum of U.S. Air Force, "Russian SS-N-2 STYX," <http://www.nationalmuseum.af.mil/factsheets/factsheet.asp?id=9511> (Accessed April 2008).
- [109] Federation of American Scientists (FAS) "SS-N-2 Styx," <http://www.fas.org/man/dod-101/sys/missile/row/hy-1.htm> (Accessed April 2008).
- [110] Wikipedia, "Figures," http://commons.wikimedia.org/wiki/Ryan_Firebee (Accessed April 2008).

- [111] SAF/PA 96-1204, "UAV Technologies and Combat Operations," Cleared for open publication on 6 Dec 96, <http://www.au.af.mil/au/awc/awcgate/sab-uav/> (Accessed October 2008).
- [112] J. Taylor, *Jane's All the World's Aircraft 1981-1982*. London: Jane's Publishing Company, Limited, 1981.
- [113] W. Wagner, *Lightning Bugs and Other Reconnaissance Drones*, Fallbrook, CA: Aero Publishers, 1982.
- [114] G. Goebel, "Unmanned Aerial Vehicles," <http://www.vectorsite.net/twuav.html> (Accessed June 2009).
- [115] J. Powers, "Electro-optical and Infrared Systems, Technology review and update 2000, session #2," Naval Postgraduate School, Monterey, CA, 2000.
- [116] G. Goebel, "International Battlefield UAVs," http://www.vectorsite.net/twuav_10.html (Accessed June 2009).
- [117] Israeli Air Force Museum-Wikipedia, "Figure," http://commons.wikimedia.org/wiki/Category:Israeli_Air_Force_Museum (Accessed July 2008).
- [118] Staff Writer, "IAI RQ-2 Pioneer," http://www.militaryfactory.com/aircraft/detail.asp?aircraft_id=325 (Accessed April 2009).
- [119] Global Security, "Pioneer Short Range (SR) UAV," <http://www.globalsecurity.org/intell/systems/pioneer.htm> (Accessed April 2009).
- [120] Israeli Weapons, "Figure," <http://www.israeli-weapons.com/weapons/aircraft/uav/pioneer/Pioneer.html> (Accessed June 2008).
- [121] C. A. Jones, "Unmanned Aerial Vehicles (UAVs) An Assessment of Historical Operations and Future Possibilities," Air Command and Staff College, AU/ACSC/0230D/97-03, March 1997.
- [122] C. Kurkcu and K. Oveyik, "U.S. Unmanned, Aerial Vehicles (UAVs) and Network- Centric Warfare (NCW): Impacts on Combat Aviation Tactics from Gulf War I Through 2007 Iraq," Naval Postgraduate School, Monterey, CA, March 2008.
- [123] Ammsalumni, "ADM-20 History/Data," http://www.ammsalumni.org/html/adm-20_history_data.html (Accessed June 2008).
- [124] P. G. Kaminski, "Fielding Equipment Second to None," <http://www.defenselink.mil/speeches/speech.aspx?speechid=640>, March 19, 1997, (Accessed April 2008).

- [125] R. Parker, "The Predator's War: UAVs Take Center Stage in the War on Terrorism," *Airman Magazine*, January 2002.
- [126] Official website of the USAF, "Figure," http://www.af.mil/factsheets/factsheet_media.asp?fsID=122 (Accessed April 2009).
- [127] Jane's Information Group, "Global Hawk and Predator - Operational Experience," July 2006.
- [128] A. A. Khan, "Role of UAVs/UCAVs in Air Power Employment Concept," Centre for Aerospace Power Studies, June 2005.
- [129] Department of Defense. "Defense Science Board Study on Unmanned Aerial Vehicles and Uninhabited Combat Aerial Vehicles," Office of the Under Secretary of Defense for Acquisition, Technology, and Logistics, Washington, D.C. February 2004.
- [130] Air Force Technology, "RQ-4A/B Global Hawk High-Altitude, Long-Endurance, Unmanned Reconnaissance Aircraft, USA," <http://www.airforce-technology.com/projects/global/global1.html> (Accessed April 2009).
- [131] U.S. Air Force, "The U.S. Air Force Remotely Piloted Aircraft and Unmanned Aerial Vehicle Strategic Vision," 2005.
- [132] J. M. Borky, "Payload Technologies and Applications for Uninhabited Air Vehicles (UAVs)," *Aerospace Conference, Proceedings, IEEE*, vol. 3, issue 74, 1-8 February 1997.
- [133] J. Knowles and E. Richardson, "Journal of Electronic Defense," vol. 29, iss. 8, Gainesville: August 2006.
- [134] R. L. Banks, Major, USAF, "The Integration of Unmanned Aerial Vehicles Into The Function of Counterair," Air Command And Staff College, Air University, April 2000.
- [135] A. Finn, K. Brown and T. Lindsay, "Miniature UAV's & Future Electronic Warfare," EW & Radar Division DSTO, Edinburgh, 2003.
- [136] Air Force Technology, "KZO Surveillance and Reconnaissance UAV, Germany," <http://www.army-technology.com/projects/brevel/> (Accessed December 2009).
- [137] EuroHawk, "Figure," http://eureferendum.blogspot.com/2007_02_01_archive.htm (Accessed April 2009).

- [138] M. Kunkel, "EA/SIGINT Payloads for UAVs: Assessing the International Market for EW Payloads on UAVs," *Journal of Electronic Defense*, vol. 31, iss. 6, Gainesville: June 2008.
- [139] Air Force World, "Figure," <http://www.airforceworld.com/pla/asn206.html> (Accessed December 2008).
- [140] D. Richardson and L. D. Richardson, "UAV Payload Developments," *Jane's Defence Weekly*, July 21, 2004.
- [141] Flight Daily News, "Picture: IAI-Malat Heron UAV swoops," <http://www.flightglobal.com/articles/2006/02/24/205073/picture-iai-malat-heron-uav-swoops.html> (Accessed December 2008).
- [142] Martin Streetly, "Unmanned aerial vehicle payloads - Load masters," *Jane's Defence Weekly*, June 13, 2007.
- [143] Global Security, "Figure," <http://www.globalsecurity.org/military/world/israel/images/hermes450s.jpg> (Accessed December 2008).
- [144] Aerosonde, "Electronic Warfare & UAV," http://www.aerosonde.com/downloads/electronic_warfare_ledger.doc (Accessed December 2008).
- [145] Aerosonde, "Electronic Warfare & UAV," <http://www.aerosonde.com/html/Products/gallery.html> (Accessed December 2008).
- [146] M. Streetly, "C2W Payloads for UAVs," *Journal of Electronic Defense*, January 1995.
- [147] Z.A. Lum, "Demo done, UAV EW payload players await report," *Journal of Electronic Defense*. Gainesville: vol. 20, iss. 1, January 1997.
- [148] Military Photos, "Figure," <http://www.militaryphotos.net/forums/showthread.php?t=115165> (Accessed December 2008).
- [149] J. C. Horton, "Unmanned Combat Aerial Vehicles: Sead & EW For The Future," Air War College Resident Program, Air University, Alabama, 27 February 2004.
- [150] M.S. Pardesi, "Unmanned Aerial Vehicles/Unmanned Combat Aerial Vehicles," *Air & Space Power Journal*, Fall 2005.
- [151] Maxwell AFB, "Predator UAV with Hellfire-C," <http://www.airpower.maxwell.af.mil/airchronicles/apj/apj02/sum02/lazarski.html> (Accessed December 2008).

- [152] Federation of American Scientists (FAS), "Figure," <http://www.fas.org/man/dod-101/sys/ac/ucav.htm> (Accessed December 2008).
- [153] Defense Tech, "Laser Blaster Gunships Closer to Flight Test," <http://www.defensetech.org/archives/004187.html> (Accessed January 2009).
- [154] A. Reed, "Airborne lasers to replace bombs? Boeing develops new ground-attack weapon," <http://news.medill.northwestern.edu/chicago/news.aspx?id= 101051> (Accessed January 2009).
- [155] K.L. B. Cook, "The Silent Force Multiplier: The History and Role of UAVs in Warfare," 2006.
- [156] LM Corporation, "Design of UAV Systems-Concept of Operations: (ASE.261.05.CONOPS)," 2002.
- [157] J. Skillings, "Laser gunship hits \$30 million bulls-eye," October 17, 2008 http://news.cnet.com/8300-17938_105-1-3.html?keyword=energy (Accessed December 2009).
- [158] Global Security, "Electronic Combat," <http://www.globalsecurity.org/military/library/policy/army/fm/100-61/CH132.htm> (Accessed September 2008).
- [159] Joint Publication 3-60, Joint Doctrine for Joint Targeting. Washington, DC: Joint Staff, 13 April 2007.
- [160] Global Security, "Hawk Missile," <http://www.globalsecurity.org/space/systems/hawk.htm> (Accessed May 2009).
- [161] Harpoon Head Quarters, "Figure," http://www.harpoonhq.com/encyclopedia/HTML_Files/facilites_files/sams_unitedstates.htm#hawk (Accessed May 2009).
- [162] A. Persch, "Raytheon MIM-104 Patriot," <http://www.designation-systems.net/dusrm/m-104.html> (Accessed May 2009).
- [163] Federation of American Scientists (FAS), "Patriot TMD," <http://www.fas.org/spp/starwars/program/patriot.htm> (Accessed May 2009).
- [164] Reference , "MIM-104 Patriot," <http://www.reference.com/browse/PATRIOT+Ground+to+Air+Missile> (Accessed September 2008).
- [165] Global Security, "Patriot Missile," <http://www.globalsecurity.org/space/systems/hawk.htm> (Accessed May 2009).
- [166] S. J. Zaloga, Dr. David Rockwell and Philip Finnegan, "Unmanned Aerial Vehicle Systems," 2009.

[167] S. Frost, and S. Sullivan, "Airborne countermeasure systems industry gears up for dramatic global growth," M2 Presswire, Coventry: September 8, 2003.

THIS PAGE INTENTIONALLY LEFT BLANK

INITIAL DISTRIBUTION LIST

1. Defense Technical Information Center
Ft. Belvoir, Virginia
2. Dudley Knox Library
Naval Postgraduate School
Monterey, California
3. Dan Boger
Department of Information Sciences
Monterey, California
4. Edward Fisher
Department of Information Sciences
Monterey, California
5. Dr. Wolfgang Baer
Department of Information Sciences
Monterey, California
6. 1st Lt. Mustafa Gokhan Erdemli
Turkish Air Force, 171. Filo
Malatya, Turkey
7. Hava Kuvvetleri Komutanligi
Hava Kuvvetleri Komutanligi Kutuphanesi
Bakanliklar, Ankara, Turkey
8. Hava Harp Okulu
Hava Harp Okulu Kutuphanesi
Yesilyurt, Istanbul, Turkey
9. Deniz Harp Okulu
Deniz Harp Okulu Kutuphanesi
Tuzla, Istanbul, Turkey
10. Kara Harp Okulu
Kara Harp Okulu Kutuphanesi
Bakanliklar, Ankara, Turkey