



Bus Stops Guidelines 2002

TRI  **MET**

October 2002

Acknowledgements

Bus Stop Guidelines Committee:

Ben Baldwin, Planner, Bus Stops – Project Oversight, Contributor

Myleen Richardson, Planner/Analyst – Editor, Contributor

Angie Corbin, Maintenance Supervisor, FM – Contributor, Document Review

Phil Selinger, Director of Project Planning – Contributor, Document Review

Alan Lehto, Manager Corridor Planning – Contributor, Document Review

Young Park, Manager of Capital Projects – Contributor, Document Review

Yalawnda Anderson, Engineer – Contributor, Document Review

Pete Taylor, Trainer – Document Review

Diana Anderson, Information Development Coordinator – Document Review

Elizabeth Davidson, Community Relations Specialist – Document Review

Warren Schlegel and Debbie Huntington, Graphics – Final Document Format, Production

Questions and comments pertaining to the contents of this report can be sent to:

Young Park, Manager of Capital Projects

parky@trimet.org

Copyright 2002, TriMet

All rights reserved. No part of this work covered by the copyright thereon may be reproduced or used in any form or by any means – graphic, electronic, or mechanical, including photocopying, recording, taping, or information storage or retrieval systems – without permission of TriMet

Table of Contents

Executive Summary	i
I. Introduction.....	1
II. Bus Stops Program Year 2000 Status Report.....	2
A. Bus Stop Statistics Snapshot.....	2
B. Limitations.....	3
C. Priorities.....	3
III. The Bus Stop	5
A. Stop Location and Spacing	5
B. Stop Placement.....	9
C. Stop Elements, Amenities, and Customer Information.....	10
D. Bus Stop Layouts and Design.....	17
E. Roadway Treatments.....	21
F. Bus Stop Access	23
IV. Program Partnerships	24
A. Citizen Involvement	24
B. Development Review	24
C. Public Partnerships	25
V. Bus Stop Development Projects	26
VI. Maintenance Guidelines.....	29
A. Introduction	29
B. Goal	29
C. Description of Tri-Met Maintained Amenities	29
D. Standards.....	29
E. Routine Maintenance	29
F. Emergency Cleaning.....	30
G. Waste Disposal.....	30
H. Anti-Litter and Graffiti Programs.....	30
I. Bus Stop Amenities Replacement.....	30
VII. Organizational Support.....	32
A. The Bus Stops Management Section.....	32
B. Interdepartmental Involvement.....	33
C. Bus Stops Section Development Process	34
D. Operations and Maintenance.....	35
VIII. Program Support (Funding).....	36
Attachment A.	



Executive Summary

The public's first impression of Tri-Met and its services is the bus stop. It is important that bus stops are easily identifiable, safe, accessible, and a comfortable place to wait for the bus. These guidelines provide a framework for maintaining and developing bus stops. They promote consistency for good design and the provision of bus stop amenities, making stops easier to identify and better matched to their use, location and potential for attracting riders. Through a series of development programs, Tri-Met seeks to make bus stops a positive contribution to the community streetscape and a place where riders can obtain transit related information and are encouraged to use the provided services.

The guidelines identify and encourage partnerships with the community and property owners. Tri-Met is working with communities to improve access to bus stops, including sidewalks, safe street crossings, accessible curb ramps and bicycle lanes. The quality of the streetscape is critical to the success of the bus stop development program.

The purpose of this document is to:

- 1) Identify the elements of the Tri-Met bus stop,
- 2) Set guidelines for the design of bus stops and the placement of bus stop amenities, and
- 3) Describe the process for managing and developing bus stops at Tri-Met.

This document will also act as the basis for CIP development to justify and support project goals.

The Bus Stops Guidelines document contains seven major sections, each of which is summarized below.

- **Introduction:** This section looks at the various goals that govern the development and implementation of bus stop projects within Tri-Met. The section also provides a snapshot of the current on-street inventory throughout the system and looks at some of the challenges that Tri-Met are being faced with. The section concludes by identifying the short and long term goals of the Bus Stops Section.
- **The Bus Stop:** This section looks at the guidelines maintained by Tri-Met to maximize the effectiveness of its bus service. This section defines preferred designs for bus stop location, layout, amenities and applying transit-preferential street treatments.
- **Program Partnerships:** Bus stops as public spaces are as much a part of a community as streets, pathways, parks and plazas. This section explores ways in which Tri-Met encourages jurisdictions, neighborhood associations and citizens to recognize the value bus stops play in the community and looks for ways to build partnerships with these entities to enhance bus stops.
- **Bus Stop Development Projects:** Tri-Met initiates capital projects to make significant improvements to route efficiency, on-street and bus stop safety, accessibility and comfort. This section describes some projects Tri-Met is currently implementing, which provide and / or improve amenities within existing transit services.
- **Maintenance Standards:** This section discusses the maintenance standards Tri-Met utilizes to keep the service area safe and clean.
- **Organizational Support:** Primary responsibility and accountability for bus stops – their design, placement, shelters and other amenities – lies with the Capital Projects Management section of the Project Planning Department. This nine person section works closely with other Tri-Met departments to provide for the regular maintenance and management of bus stops as well as implementation of bus stop development programs. This section provides a brief description of the Section's positions, responsibilities and the interdepartmental support needed to manage bus stops.
- **Program Support:** This section identifies ways to finance and maintain bus stop program initiatives that help offset program costs.



Bus Stops Guidelines 2002

I. Introduction

The public's first impression of TriMet and its services is the bus stop. It is important that bus stops are easily identifiable, safe, accessible, and a comfortable place to wait for the bus. These guidelines provide a framework for maintaining and developing bus stops. They promote consistency for good design and the provision of bus stop amenities, making stops easier to identify and better matched to their use, location and potential for attracting riders. Through a series of development programs, TriMet seeks to make bus stops a positive contribution to the community streetscape and a place where riders can obtain transit related information and are encouraged to use the provided services. The guidelines identify and encourage partnerships with the community and property owners. TriMet is working with communities to improve access to bus stops, including sidewalks, safe street crossings, accessible curb ramps and bicycle lanes. The quality of the streetscape is critical to the success of the bus stop development program.

The purpose of this document is threefold: 1) to identify the elements of the TriMet bus stop, 2) to set guidelines for the design of bus stops and the placement of bus stop amenities, and 3) to describe the process for managing and developing bus stops at TriMet. Through explanations and diagrams, this document provides the tools needed to plan bus stops and associated amenities within the TriMet service area.

Bus Stops Program Goals:

- A *basic bus stop* should consist of an accessible, paved area and easily identifiable signage. Bus stop shelters and other amenities shall be provided consistent with a set of bus stop development criteria.
- Bus stops should be placed to *assure customer convenience and provide for the safety* of pedestrians and vehicles. Stops shall be visible, near crosswalks and well lit.
- Bus stops should be *clearly and consistently identifiable with up-to-date information* for riders about services at the bus stop.
- TriMet should solicit *community input* for all bus stop installations and changes, and respond promptly to inquiries and complaints from customers and bus stop neighbors.
- The design of bus stops shall be *sensitive to the community setting* and may incorporate features that identify the stop with the community (such as art, bus stop naming or inclusion of a community bulletin board).
- Where reasonable, bus stops should be *accessible*. Americans with Disabilities Act (ADA) considerations will be given top priority in the siting and design of new and existing bus stops.
- Bus stops shall *be located in support of institutions* and with clients having special needs, large employers and community centers.
- Bus stops will be spaced to *maximize the efficient operation* of transit service while not requiring riders to walk more than a quarter mile to the bus stop.
- TriMet will work with local jurisdictions, communities, and land developers to *construct sidewalk connections* to bus stops. Regional planning targets, new or sustained transit service and bus stop investments will be used to encourage those improvements.
- Bus stops shall be *well maintained* and free of trash and vandalism. TriMet will seek partnerships that share responsibility for maintaining bus stops.
- Damaged or worn out bus stop features shall be *repaired or replaced* in a timely manner.
- TriMet will seek to *offset the cost of installing and maintaining bus stop amenities* through a bus shelter and bus bench advertising program.



II. Bus Stops Program Year 2001 Status Report

A. Bus Stop Statistics Snapshot

General Information

- Service Area 592 square miles
- Jurisdictions in the service area 30
- Bus Stops 8189
 - Major transit points¹ >150

Bus Stop Elements and Amenities

Poles² 8127

Shelters 888

- Ad shelters 44

Trash cans 535

Benches 1786

- Basic (used in shelters) 800
- Premium 37
- Ad 949

Informational Displays 277

- Bus Catcher Information Display 229
- BCID Transit Tubes 25
- BCID Small Pole Mounts 23

Lighting (stops with nearby lighting) 58%

Pavement³

- Curbcut near landing 46%
- Sidewalk at stop 70%
- Front landing paved 64%
- Rear landing paved 57%

An example of how to interpret the pavement data would be: 46% of stops have a curbcut nearby.

Data is current as of January 31, 2001.

¹ This includes major transit points, transit centers, and stops in the downtown bus mall.

² Currently, TriMet uses square tube poles. Previously, round, 2" poles were used. Please note that some jurisdictions also use these pole types.

³ There is not a total number presented, as stops can have any combination of the items listed. For example, the sidewalk may be the pavement for the front and back landings, and would be counted for each category.

B. Limitations

Not all TriMet bus stops are consistent with the goals listed in the preceding section. In some instances bus stops are defined by the underdeveloped corridors or roads they serve. Where roadways lack underground drainage and pedestrian systems or are constrained by natural terrain, TriMet cannot effectively improve impacted bus stops without making significant street and sidewalk enhancements, removing or reducing the number of stops or moving service. These issues may be best addressed by a coordinated effort between TriMet and the jurisdictions charged with maintaining and upgrading the roadway system.

- Approximately 32% of TriMet bus stops suffer from lack of pavement or have interrupted or no sidewalk connection to a community pedestrian network. Crosswalks may be few and far between.
- Using the boarding criteria described in Section III of this document, approximately 500 eligible stops do not have shelters, though some may have other forms of shelter from buildings, bridges or awnings.
- Not all bus stops are easily identifiable due to: 1) inconsistent placement, 2) incomplete customer information on bus stop signs, 3) signs that blend into the streetscape, and/or 4) one-sided signs.
- Only those bus stops that have a trash can and/or shelter are cleaned on a regular basis.

Bus stop inconsistencies, as measured against the guidelines contained in this report, will be identified and mapped and will be the basis for development of a capital improvement program that can be directly considered as part of the annual capital budget development process. The existing bus stop management database with its detailed bus stop descriptions together with boarding counts from the Bus Dispatch System (BDS) will facilitate identification of bus stop specific inconsistencies. TriMet will also be working with Metro and jurisdictions to map deficiencies in the pedestrian network that make it difficult and unsafe to access bus stops. Intergovernmental agreements must be developed to promote joint development of bus stops and the pedestrian network.

C. Priorities

The following are bus stop management priorities, which are either reflected in Winter 2001 programs or anticipated in future programs:

- Improve underdeveloped stops where 1) supporting infrastructure exists, 2) it is physically feasible, and 3) it is fiscally responsible. Improvements start with pavement and access upgrades, followed by shelters (100 shelters / year) and other customer amenities.
- Improve customer information through expansion of existing methods and implementation of innovative new methods. Examples include shelter and pole-mounted printed information and electronic real-time (Transit Tracker) displays.
- Replace all bus stop signage with signs that are readily distinguished, even in active streetscapes, and to be equally identified from both directions. Locate bus stops, signs and amenities consistent with guidelines and equitably among all communities served by TriMet.
- Evaluate all sites for bus stop amenities placement. Place shelters where it is feasible, where existing protection is unavailable (i.e., no awnings, etc.), and according to TriMet guidelines.
- Work with jurisdictions to identify deficiencies in the pedestrian network. Establish priorities based on pedestrian safety and existing and potential transit use. Develop strategies to work with property owners to improve the pedestrian connectivity to bus stops, where viable.



- Pursue agreements with jurisdictions and public utility agencies to facilitate placement of shelters, benches, lighting and trashcans.
- Secure resources or partnerships that target improved and consistent maintenance of *all* bus stops. This includes cleaning stops on a regular basis, not just those with bus shelters, and keeping stops free of graffiti and litter.
- Find revenue-generating opportunities through the use of ad shelters, ad benches, and similar programs.
- Maintain and expand public outreach programs and find more effective ways to solicit, process and respond to community and customer input.
- Improve operating efficiencies through bus stop spacing that is consistent with these guidelines.



III. The Bus Stop

It is impossible to force every bus stop to conform to a standard. However, TriMet maintains guidelines to maximize the effectiveness of its bus service. These guidelines define preferred designs for bus stop location, layout, amenities and applying transit-preferential street treatments. The most important of many considerations are listed in this document.

A. Stop Location and Spacing (New Stops, Moves and Consolidations)

Approach

Stop location and spacing will always depend on individual circumstances. However, one must weigh the options and choose based on well-understood criteria. Generally TriMet expects riders to walk up to a quarter-mile to reach the stop.

When determining new bus stop locations proceed as if placing stops for the first time. If an existing stop does not fit into the process listed below, there must be a very compelling reason to retain it (e.g., if significant investment has already been made at the stop, or if there is heavy use by riders who are elderly or disabled *and* a new location would clearly degrade service for those riders). A stop should remain in service as designed for at least 5-10 years.

Tools

Choices for stop location will determine access to: pedestrian crossings; transfer lines; major transit generators; and general neighborhood employment and activity areas.

What to do

Preferred bus stop locations are determined in the following sequence:

- *Transfer Locations:* All intersections with other bus lines/MAX (light rail).
- *Designated Crossings:* Stops at signalized intersections with safe pedestrian crossings (aim for spacing of 780 feet).
- *Other Major Stops:* Major transit trip generators (at closest intersection with crosswalk, where available).
- Locations based on stop spacing:
 - *Dense areas* (22 or more units/acre): Aim for 3 blocks/780 feet. Less than that is only appropriate in special circumstances on a stop-by-stop basis or for safety. For non-residential or employment areas use an equivalent 56 persons/acre. Included in “dense areas” should be regional designated centers: Regional Centers, Town Centers, and Main Streets.
 - *Medium to low density areas* (4 to 22 units/acre): 4 blocks/1,000 feet. Less than that only for special circumstances on stop-by-stop basis or for safety.

How to determine levels of density

1. The standards must be adjusted to account for the difference between net and gross acreage. Taking an average of 25% of gross acreage used for such things as right-of-way (calculated for three representative neighborhoods in Portland – Lents, Arbor Lodge, and Multnomah), 22 units/acre becomes approximately 16 units/total acre (including right-of-way).
2. Mixed use, commercial and industrial areas should also be included by using a conversion to identify the number of people per acre (employees for employment areas and residents for residential areas). Using an average of just over 2.5 persons per household (1990-97 average – Metro data), this means:
 - Dense areas = 41 or more persons/acre
 - Medium to low density = 8 to 41 persons/acre
 - Low to rural density = less than 8 persons/acre
3. Future growth needs to be accounted for as well, and can be determined by looking at zoning and regional growth projections.

For more information, please contact Metro.



- *Low to rural density areas* (below 4 units/acre or 10 persons/acre): As needed based on above considerations. No more frequent than every 1,000 feet.

Bus stop spacing will continue to be governed by a combination of density and subjective issues such as neighborhood demographics, available alternatives, safety, public input and efficient bus operations. It is intended that this process be objective, but also flexible enough to respond to unique needs and circumstances.

As programs or requests for bus stop changes call for the review of specific bus stops, these spacing criteria will be considered. Even key bus stops may require adjustment (e.g., nearside to farside placement). Long term user and operating benefits will be weighed against project costs and neighborhood/rider objections to proposed changes.

Pages 7 and 8 show examples of stop locations for areas of dense development and areas of lower density development.

What to consider

The following is a checklist of the most important considerations:

- Safety
 - Waiting, boarding and alighting must be safe
 - Access to a safe street crossing/crosswalk
 - Provide adequate sight distance, i.e., provide visibility between bus driver and waiting riders
- Service quality tradeoffs – fewer stops mean the following:
 - Faster service
 - More potential for amenities at each stop
 - May require a longer walk from/to origin/destination
- Stops must be suitable for bus operations
 - Safe access into and out of bus stop location (no parking)
 - Provide bus operators with adequate view of street and pedestrian areas
 - Provide adequate sight distance for autos before bus stop, so drivers are aware the bus is stopped
- Possible impacts on traffic safety and traffic delay
- Input and review by the public and by neighborhood and business associations
- Pedestrian safety to and from the stop and at the bus stop
- Accessible for all
 - Minimize slope
 - If necessary, construct 5' x 8' concrete pad at stop
 - Check for curb ramps at intersection and on surrounding streets
- Maximize accessibility to neighborhood or major generators
 - Preference for intersections at streets that connect into surrounding neighborhood
 - At major transit generators, locate the stop near pedestrian access to the generator, preferably at signal
 - Look at pedestrian pathways (formal and informal), not just streets
- Stops should be paired, at same intersection when possible
- Ensure compatibility with adjacent properties
- Do not move existing stops for trash, noise, and/or nuisance. Instead, seek ways to address the problem directly.



Diagram 1

Initially, plan stops at safe crossings, transfer points, and major transit generators

Preferred Stop Locations for Dense Development

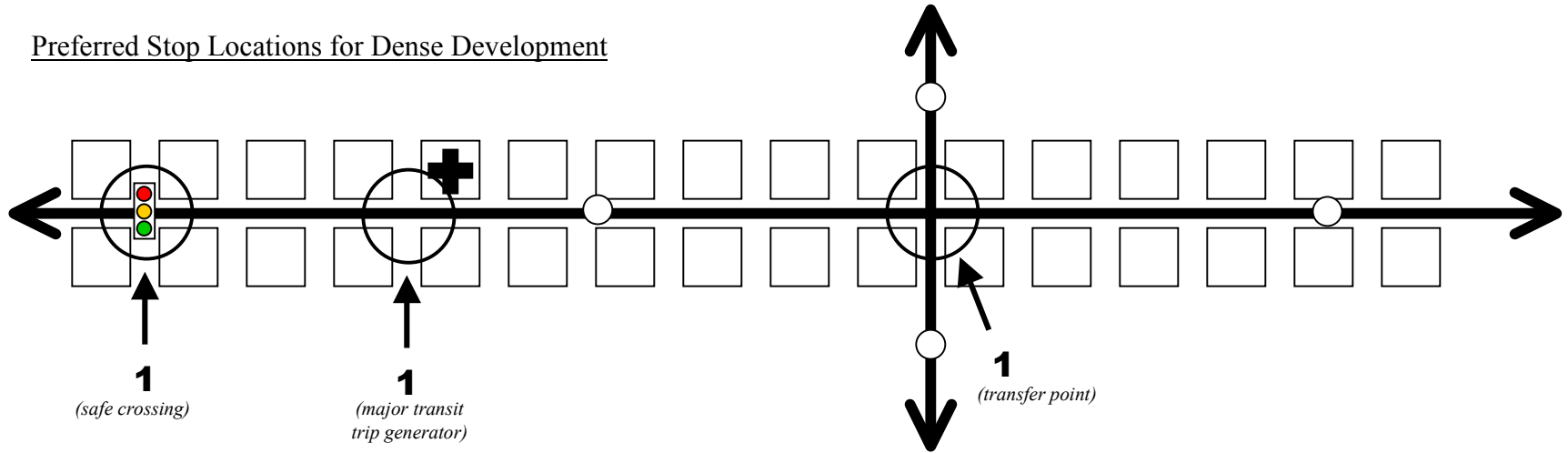

Preferred Stop Locations for Low-Mid Density Development

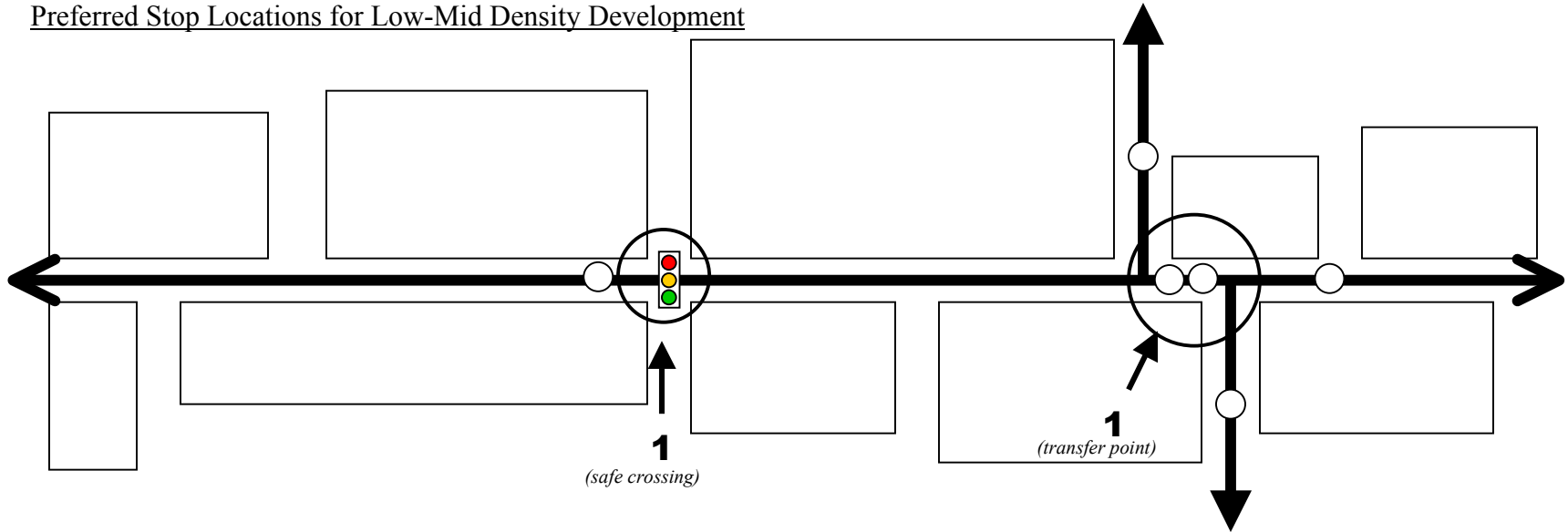
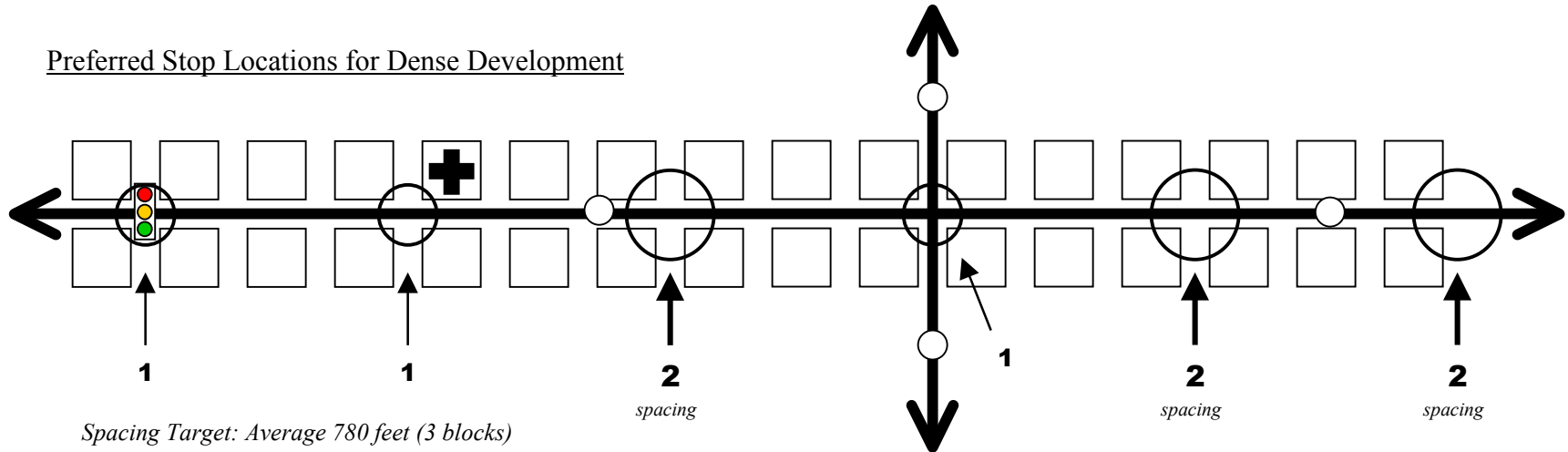

Diagram 2

Then plan stops at intersections that are spaced appropriately between the initial stops.

Preferred Stop Locations for Dense Development



Spacing Target: Average 780 feet (3 blocks)
General range from 600 - 1,000 feet

Preferred Stop Locations for Low-Mid Density Development

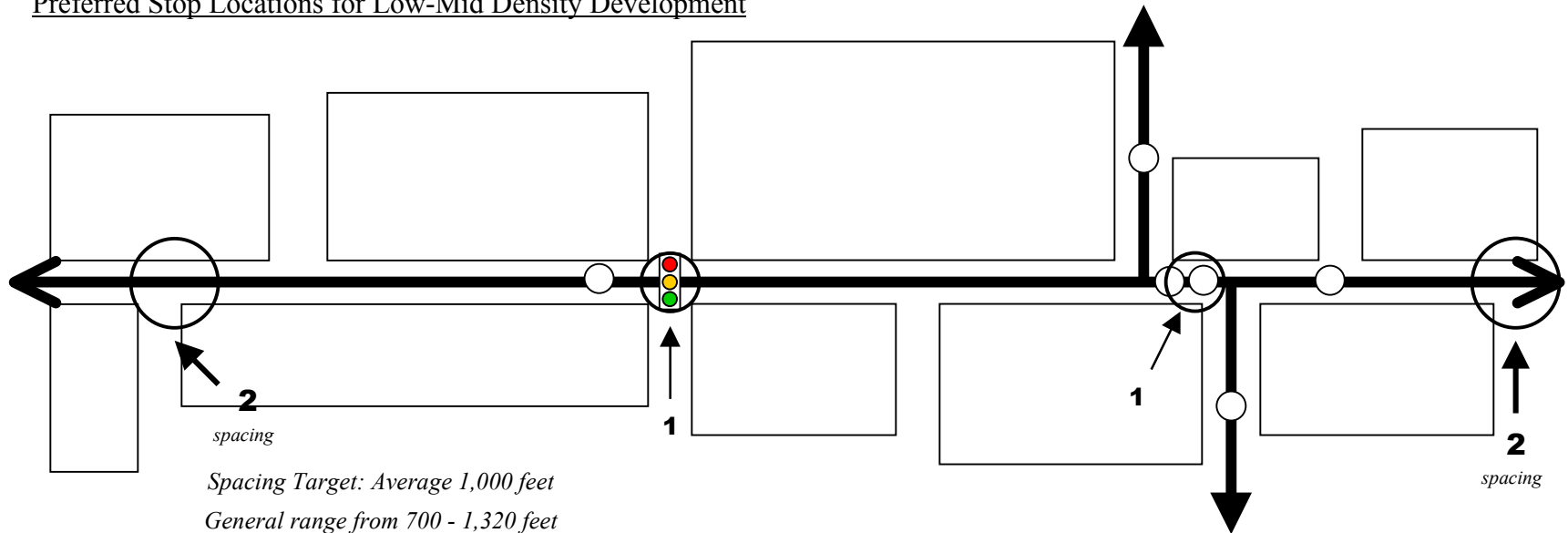

Spacing Target: Average 1,000 feet
General range from 700 - 1,320 feet



B. Stop Placement

Approach

Stops are placed at locations:

- that are safe for passengers and vehicles,
- that may be easily accessed by the surrounding neighborhood, major transit generators and/or intersecting transit services, and
- where improvements in safety, convenience and/or reduced trip times outweigh negative impacts.

Tools

The placement of the bus stop in relation to intersection: farside; nearside; midblock; off-street. Please see Appendix C. Additional Stop and Zone Materials, Diagram 1 for illustrations.

What to do

Table 1. Stop Placement

Situation	Preferred Placement
Any signalized intersection where bus can stop out of travel lane	Farside
If bus turns at intersection	Farside
Intersection with many right turns	Farside
Complex intersections with multi-phase signals or dual turn lanes	Farside
If nearside curb extension prevents autos from trying to turn right in front of bus	Nearside
If two or more consecutive stops have signals	Alternate nearside and farside (starting nearside) to maximize advantage from timed signals
If obvious, heavy single-direction transfer activity	One nearside; one farside to eliminate crossing required to transfer
If blocks are too long to have all stops at intersections	Midblock
Major transit generators not served by stops at intersections	Midblock
Midblock pedestrian-crossing combined with midblock pedestrian access into block	Midblock
Transit center	Off-street
Major transit generator that cannot be served by on-street stop, or where ridership gain will far outweigh inconvenience to passengers already on-board	Off-street

Stops are at intersections because:

- walking distances amongst origins, destinations and stops are reduced for customers,
- street crossings are legal at intersections,
- street crossings are generally safer at intersections, and
- curb ramps and other benefits of accessibility are generally located only at intersections.

Placing stops farside of the intersection is preferred in most cases for signalized intersections because they result in:

- fewer traffic delays and better safety – bus clears intersection blocking fewer movements and sight lines,
- better pedestrian and auto sight distances,



- fewer conflicts between buses and pedestrians (i.e., no pedestrians trying to cross in front of bus – where passing autos cannot see them),
- greater bus maneuvering area,
- more effective priority signal treatments,
- eliminating the danger of cars turning right in front of buses (as happens nearside), and
- minimized parking restrictions necessary to get bus to curb (shorter bus zones because buses use the intersection as part of approach to zone).

What to consider

Every site will present a unique set of issues. The following is a checklist of the most important considerations:

- ❑ Travel time delays
 - Farside allows signal treatments to work most effectively
 - Alternate placement nearside-farside if signals occur at every stop
- ❑ Safety
 - Waiting, boarding and alighting must be safe
 - Steer riders toward safe street crossings
 - Watch for other pedestrians
 - Consider impacts on other traffic
 - Provide adequate sight distance, i.e., provide visibility for bus driver and waiting riders
- ❑ Service quality tradeoffs – fewer stops mean
 - Faster and more efficient service
 - More potential for amenities at each stop
 - Longer walk distance to stops for some
- ❑ Stops must be suitable for bus operations
- ❑ Impacts on traffic
- ❑ Accessible for all
 - Slope – no more than 2% for level surfaces, 8% for ramps
 - If necessary, construct 5' x 8' concrete pad at stop
 - Check for curb ramps at intersection and on surrounding streets
- ❑ Ensure compatibility with adjacent properties

C. Stop Elements, Amenities, and Customer Information

Approach

Use elements that clearly define the bus stop for patrons, operators, pedestrians, and motorists. Provide amenities that will invite ridership by making riders comfortable and confident in the service. Do this in locations and at a level that is appropriate to the ridership and budget. Place amenities and elements of stops in configurations that maximize:

1. Safety
2. Visibility
3. Comfort

Customer information is designed to:

Show the way – Provide easy identification of every bus stop. This is achieved through colors, shapes and symbols that are consistent but unique within the streetscape.

Provide basic service information – Provide basic route information on every bus stop sign that includes the route number, direction of travel, major stops along the way and the fare zone.

Provide expanded information at targeted stops – Use visual and tactile tools, provide more detailed schedule information and maps at targeted stops.

Use artistic elements to welcome patrons and neighbors – Art can help create a sense of place, neighborhood ownership and comfort.

Tools

Bus stop elements:

- **Pole and bus stop sign** – *Required*, identifies the bus stop. TriMet bus stop signs are used at all district bus stops. Historically, these signs have been placed on any number of existing poles, columns, light standards and the occasional tree or bus shelter. This is a past practice that TriMet is attempting to phase out. At new or moved stops, TriMet signage is placed on dedicated TriMet poles; other jurisdictional signage identifying the bus stop zone may also be placed upon a TriMet bus stop pole.

Poles should be placed two feet from the curb with informational signs flag-mounted away from the street *or* poles placed behind the sidewalk and informational signs flag-mounted towards the street. In both cases the sign should be oriented towards the sidewalk for pedestrian visibility. Farside pole and sign placements should be a minimum of 50' clear of existing pedestrian crossings. Nearside pole and sign placements at signalized or controlled intersections should be setback 15' to 25' from pedestrian crossings. Nearside pole and sign placements at uncontrolled intersections may be placed as close as one foot from a crosswalk. Pole placement must be carefully planned to ensure that all bus stop elements work as designed, that all bus operators know exactly where to stop, and that all patrons know exactly where to board. *Proper placement and installation is critical to bus stop operation.* Shapes and colors of TriMet signs and poles will help identify the bus stop. Please see Appendix A. Construction Specifications, Sheet 27 for sign and pole installation specifications.

- **ADA landing pad** – *Preferred*. Required at new and existing stops, stops with moderate or better ridership (minimum 20 daily boardings) and stops with any lift activity; preferred at all bus stops.

TriMet defines an ADA landing pad as a clear, level landing area a minimum of 5' x 8' (10' x 8' is ideal) located adjacent to the TriMet bus stop sign. At new construction sites TriMet requires ADA pads to be a minimum of 8' x 8'. Construction of ADA pads is pursued at locations where a connection to a pedestrian pathway is possible. Please refer to Appendix A. Construction Specifications, Sheets 1, 5, & 16 for concrete specifications.

- **Rear landing pad** – *Preferred*. In addition to an ADA accessible landing pad to access the front door of buses, TriMet prefers to have an additional landing pad at the rear door. The rear door landing pad should be considered when more than eight (8) daily passenger alightings exist in addition to criteria that warrants an ADA landing pad.

Rear landing pads must be accompanied by a front door ADA landing area. This landing area must also be clear of obstacles and at least 4' x 6'. At new construction sites a rearlanding pad should always be pursued, but is not required.

- **Bus zone** – *When necessary*. At bus stops where accessibility improvements are planned, and parking is available, bus zones, no parking areas (NPAs) or other parking control options should be placed. TriMet cannot guarantee bus stop accessibility unless the bus has a clear path to the curb.

For additional information, please see Section III, Part E Roadway Treatments.

Bus stop amenities:

- **Shelter** – *Optional*. TriMet continues to use ridership figures as the primary criterion for determining shelter placement warrants. Yet several additional criteria are also considered when ridership figures do not support shelter placement.



- Preferred for stops with 35 or more boardings per weekday
- Infrequent service – minimum of 30 daily boardings on routes where peak headways are greater than fifteen minutes
- Lift usage – minimum of 15 weekday boardings and 4% lift usage
- Proximity to senior housing and a minimum of 20 daily boardings
- Shelters funded and maintained by others
- Development of large new activity centers adjacent to transit where ridership is projected to meet criteria
- Consolidated bus stops – combined ridership totals increase likelihood of shelter placement

If a bus stop meets TriMet’s shelter criteria it *may* be considered for bus shelter placement. Meeting these criteria *does not* guarantee shelter installation. Existing site conditions and pedestrian infrastructure, public right-of-way availability, accessibility and safety issues, and other concerns must be reviewed and addressed before future bus shelter placements are confirmed.

Bus shelter placement and orientation should follow the layout options shown in Diagrams 3 and 4. In instances where none of the suggested layouts apply or are feasible, the following must be maintained:

- Five feet of pedestrian passby, including clearance between poles, hydrants and other obstacles.
- ADA landing pad adjacent to sign and outside of shelter.
- Clear pathway from the ADA waiting area inside the shelter to the ADA landing pad.
- Clear pathway from the rear door landing area to the pedestrian path.

A variety of bus shelter shapes and sizes are available to address site restrictions and opportunities, and ridership needs. Please see Table 2 for descriptions.

Table 2. Shelter Types

Shelter Type	Dimensions (in feet)	Minimum Required Setback (from curb, in feet)	Minimum Daily Boardings	Other
B	8.5 x 4.5 x 8	11	35	Basic and most common shelter; sited in business and retail districts, residential neighborhoods, industrial and manufacturing areas, etc.
A	8.5 x 2.5 x 8	9	35	Narrow version of B shelter; pursued when a B shelter is warranted but right-of-way is limited.
BX	12 x 4.5 x 8	11	60	Longer version of B shelter; option at stops with strong usage.
AX	12 x 2.5 x 8	9	60	Rarely used; a possibility at stops with strong usage and limited setback.
BB	16 x 4.5 x 8	11	90	Double length shelter; only used at stops with significant ridership and likely only at activity centers.
AA	16 x 2.5 x 8	9	90	Rarely used; narrower version of BB.
High Capacity	Varies	Varies	>200	Special shelters for extremely high usage areas e.g., transit centers, light rail stations and high transfer points.
Awning	Varies	Not applicable	Not applicable	Protection provided by businesses...



The specifications for TriMet’s current bus shelters as well as shelter pad specifications can be found in Appendices B. Stop Amenities and C. Construction Specifications, Sheets 1-4, 17-20, & 23. Also, refer to Section VI, for shelter maintenance information.

- **Seating – Optional.** Since TriMet has several seating options, bench placement can be considered at any stop where:
 - Accessibility is provided
 - Placement does not compromise safety (it is too close to the street, causes a tripping hazard, etc.)
 - Placement does not compromise accessibility (bench partially blocks the sidewalk, infringes on the ADA or rear landing pad, etc.)
 - Ad bench placement is allowed

Benches can generally be sited like bus shelters; however, they should not be placed closer than three-and-a-half feet from the curb or six feet from the curb when a travel lane exists immediately adjacent to the curb. The same clearance requirements placed on shelters apply here. Benches should be oriented towards the street or the direction of the approaching bus. Table 3 describes current seating options.

Table 3. Seating Types

Type of Seat		Length (in feet)	Criteria for Placement	Notes
Standard	Shelter Bench	4.0	N/A	Placed in TriMet shelters.
	Premium Bench	6.5	Minimum of 25 daily boardings; appropriate surroundings	Often placed in business and retail districts where shelters are not appropriate.
	Ad Bench	~6.0	Will be considered at any stop lacking amenities if in a safe location.	Placed for ad exposure or at TriMet’s request.
Specialized	Flip Seat	N/A	Minimum of 20 daily boardings; appropriate site	Very space efficient, reserved for special situations.
	Simme Seat	N/A	Minimum of 20 daily boardings	Mounted on bus stop pole, appropriate where there are curb tight sidewalks (pole placed behind sidewalk).

- **Trash can – Optional.** Trash cans are placed in areas of high ridership, transfer locations and places where the potential for accumulating trash is apparent (near fast food restaurants, convenience stores and places where windblown trash collects). They are also placed at stops by request. Placement must not infringe upon the ADA pad or pedestrian pathway. It must not compromise direct access between the ADA waiting area and the ADA landing pad or access between either ADA area and the sidewalk.
- **Lighting – Optional.** Currently several options exist. The existing environment usually dictates which option to use. TriMet pursues both overhead lighting oriented towards the bus stop boarding area and bus shelter lighting. The current goal is to provide 1.5 – 2 foot candles of light around the bus stop area.

Customer information:

- **Printed Information – Optional.** Several choices of bus catcher information displays (BCID) are available to display schedule information at bus stops. Large (2’ x 4’) units are mounted in shelters. Transit tubes and smaller framed units are attached to TriMet bus stop poles. Braille

discs provide stop identification for visually impaired patrons. Placement criteria for these and other information tools are determined by TriMet’s Information Development Department (IDP). For specific placement criteria, please refer to Table 4.

- **Transit Tracker – Optional.** Displays in shelters that provide real time bus arrival information. The Transit Tracker siting criteria are intended to be independently applicable to:

- the entire system;
- an area of emphasis (e.g., the Interstate Corridor, or a major activity center); or
- one route.

Primary Criteria (stop-level):

- Relatively high boardings (actual or projected)
- High transfer rate
- Relatively low service frequency
- Poor on-time performance and/or poor headway adherence
- Not at end of line

Secondary Criteria (stop-level):

- A bus shelter is available
- Electricity is available
- Three or fewer routes served
- Partnership opportunities exist

Note: The idea behind the low service frequency is that TT seems more valuable in situations where transit service is less frequent. With frequent service, a passenger may not be as concerned about how long they must wait, and the value of knowing exactly when the bus will arrive may not be as great as in situations with less frequency. Also, these criteria are not intended to be applied conjunctively, but rather they have different weights, are scored in total, and are used primarily for ranking purposes. For example, a site having high boardings but low transfers scores lower than another site with the same number of boardings but with more transfers

Table 4. Customer Information Tools

Information Tools	Function	Where
Stop design consistency, unique shape and color of sign & pole	Identification	All stops
Bus stop sign	Basic service information and orientation	All stops
BCID units	Schedule, route map	Stops with bus shelters or on TriMet poles (at locations with high ridership, transfer points, transit centers, transit generators and in some cases to promote new service).
Braille discs (the status of this program needs to be reviewed)	Tactile bus stop identification for visually impaired patrons	On TriMet poles
Transit Tracker	Automated bus arrival times	Stops with bus shelters (focused at locations with high ridership, transfers)
Bus stop art	Connection to community, creating sense of place	Stops near neighborhood nodes, pedestrian activity

What TriMet wants to accomplish

TriMet places bus stop elements, amenities and customer information to:

- provide safe, level landing pads for front and rear doors (front door pad must be ADA compliant);

- make waiting customers visible to the bus operator and vice versa;
- minimize maneuvering difficulty for riders with wheelchairs and other ADA mobility devices;
- make all parts of the transit experience as comfortable and convenient as possible, given financial resources;
- keep accessible through-path on sidewalk;
- provide a clear and consistent on-street image;
- ensure that TriMet poles and signs are readily visible to patrons, pedestrians, bus operators, and motorists;
- provide basic information to orient bus patrons; and
- provide targeted information that enhances the riding experience.

Things to consider

Every site will present a unique list of issues. The following is a checklist of the most important considerations:

For elements and amenities:

- Visibility of passengers to operators, and vice versa
- Accessible for all
 - Slope
 - Minimum 5' x 8' ADA concrete pad at stop
- Safety
 - Waiting, boarding and alighting must be safe
 - Provide adequate sight distance, i.e., provide visibility between bus driver and waiting riders
- Stops must be suitable for bus operations
- Ridership and lift usage
- Elderly housing, hospitals and compelling land uses can lower minimum criteria for amenities
- Clear sight lines for pedestrians and traffic
- Ensure compatibility with adjacent properties
- Avoid private property when possible
- Consider possible partnerships with private landowners and businesses (e.g., awnings, Adopt-A-Stop, etc.) when needed
- Minimize conflict with trees and other nearby features
- Cost
 - Initial capital and installation cost
 - Long-term maintenance cost
 - Replacement cost

For customer information, also consider:

- Patron usage
- Transfer locations
- Service frequency
- Schedule reliability
- Special needs
- Labor availability
- Stop location on route



Table 5. Bus Stop Classification

Stop Type	Underdeveloped	Basic	Level 1	Level 2	Level 3
Use/Stop Type Designation Criteria	Poor, or lack of, supporting land uses; few or no boarding rides; closely spaced with another stop	All stops meeting spacing/siting criteria	High use stops (35 BR+ / day); significant employer program participant; apartments; institutions; hospitals; shopping centers; major business; minor park & ride lots (shared use); stops with significant usage by riders who are disabled or elderly	Major stops (200+ BR / day); transit mall; major park & ride lot (TriMet dedicated); all transfer points; stops with active lift or ramp usage	Bus Rapid Transit service; transit centers; high volume park & rides; major transfer hubs
TriMet Managed Bus Stop Features	No pavement; inadequate shoulder; visibility blocked; poor lighting; insufficient ADA clearances; undue exposure to weather/ traffic; shared pole; one sided visibility	Pavement meets ADA clearances; bus stop sign on dedicated pole	<i>Preceding features plus:</i> Standard (A or B) shelter (larger if justified); lighting (utility pole or shelter); BCID in shelter; trash can; free standing bench; pad for rear door, when physically possible	<i>Preceding features plus:</i> 16' or high capacity shelter; BCID or transit tracker; trash can; bike rack; public telephone (dial out only); free standing bench; art work	<i>Preceding features plus:</i> "Station" style shelter; free standing bench(s); bike lockers, lids or other long-term storage; operator building and restroom as needed; ticket vending machine; artwork element
Externally Managed Features	No clear, safe pedestrian access; no logical, safe street crossing; unsafe topography; standing water; unpleasant site conditions	Safe street crossing (corner, ADA ramps); sidewalk or safe shoulder access	<i>Preceding features plus:</i> sidewalk connections; curb extensions; crosswalks	<i>Preceding features plus:</i> art enhancements (TriMet or community); community bulletin board; newspaper vending bins	<i>Preceding features plus these possible features:</i> concession or nearby shop(s); landscaping (low maintenance); public restroom; U.S. mail box

D. Bus Stop Layouts and Design

In the past, bus stops were designed on a stop-by-stop basis leading to a wide variety of layouts and an inconsistent message to TriMet patrons and operators. Successful bus stops are designed to link to other transportation modes, existing or planned. Accommodating sidewalk systems is critical to assuring the safe and accessible transport of TriMet patrons between the origin/destination and the bus stop.

Following this section, bus stop layout diagrams are presented. They are designed to respond to existing conditions and incorporate only basic amenities. The diagrams are also intended to clearly indicate where buses stop, and where patrons wait and board. All examples assume that an accessible pedestrian system is already in place.

Stop elements and amenities covered in the diagrams:

- TriMet pole and bus stop sign – Required. The pole/sign is the cornerstone of all bus stops. Its placement must be considered carefully.
- Bus stop landing area – An ADA landing area is required by federal and state law for all new stops. Optimally, TriMet will provide a safe landing area for all bus doors. The ADA landing area must be placed adjacent to the bus stop sign whenever possible.
- Bus zone or no parking area – Required where parking might otherwise block the bus's ability to pull to the curb. The bus must get to the curb to provide accessible entry. Eliminating parking at the stop accomplishes that goal. Curb extensions and other expensive solutions are discussed in Section III, Part E Roadway Treatments.
- Bus shelter and shelter pad – Optional. Shelter from the elements makes the transit experience more pleasant. The shelter's placement, and its orientation to other elements are critical.
- Trash can – Optional. Placement is often an afterthought. When placement is planned, trash cans should be incorporated in the bus stop design.

Stop elements and amenities not covered in the diagrams:

- Curb ramps – The following layouts assume curb ramps are present. If they are missing, TriMet or the local jurisdiction will install at least one when constructing other improvements.
- Lights and other amenities – Great enhancements, but not covered in these diagrams. These are optional elements.
- Bus zone and no parking area signage – Every jurisdiction does it differently. One to four poles are possible. These are too variable to show in a diagram successfully.
- Service information – Important, but not critical to stop layout because the information is usually attached to a bus shelter or bus stop pole.
- Trees, fire hydrants, mailboxes, driveways, power poles, etc. – Continue to be accommodated on a stop-by-stop basis.

Standard clearance requirements at *all* stops:

- Sidewalk clearance – Maintain minimum five feet of sidewalk clearance
- Accessible pathway – Minimum five foot wide path between shelter and any utility objects
- Road clearance – Minimum two foot clearance between shelter and edge of curb (extra care must be taken because newer vehicles have longer tail-swing)
- Building clearance – Minimum 12" from buildings, fences, and other structures to allow room for maintenance
- ADA landing area – Minimum 5' x 8' "clear and level surface" at curb for lift or ramp operation



Requirements for *all* stops with shelters:

- ADA waiting area in shelters – Minimum 2'6" x 4' space must be kept clear for mandatory waiting area to accommodate mobility devices.
- Visibility – Shelters must not block motorists' or pedestrians' line of sight
- Relation to bus stop – Shelter should be within a compact space, close to landing area for access to bus (generally within 25').



Diagram 3

Bus stop design: Sidewalks with furnishing zones

Basic

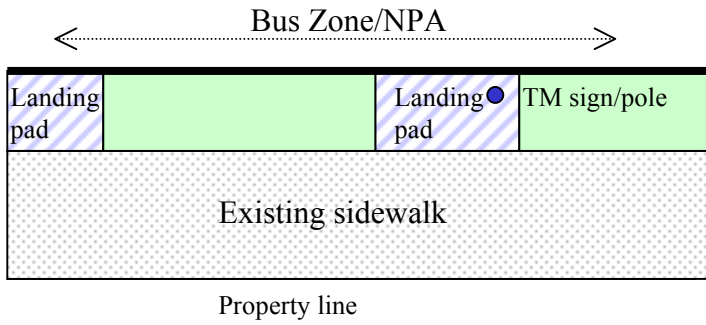

Expanded

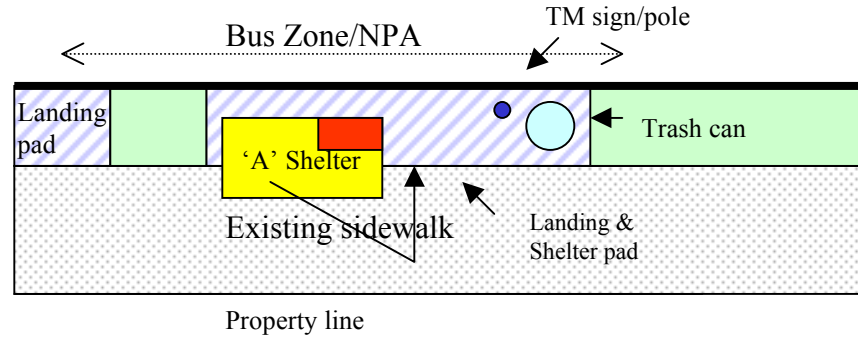
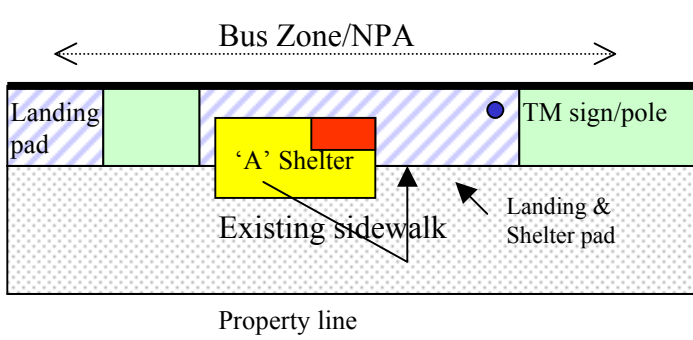
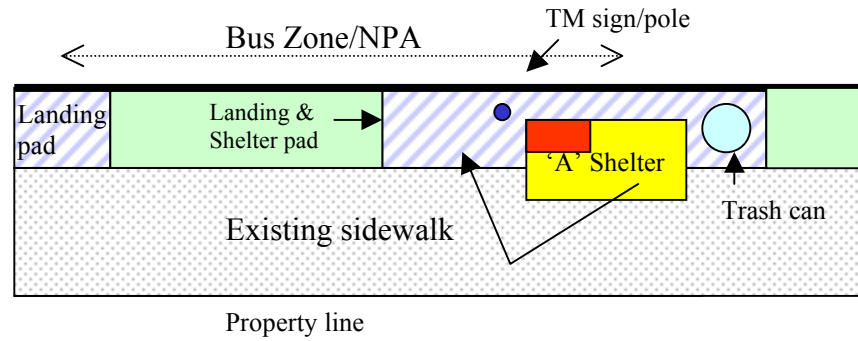
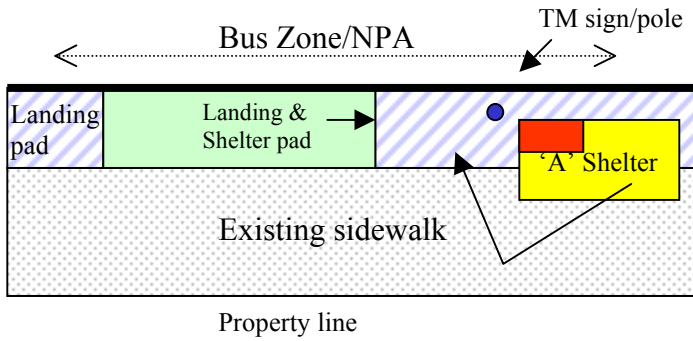
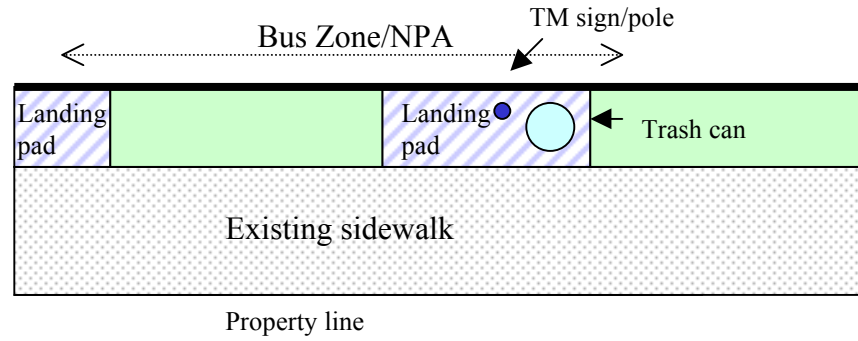
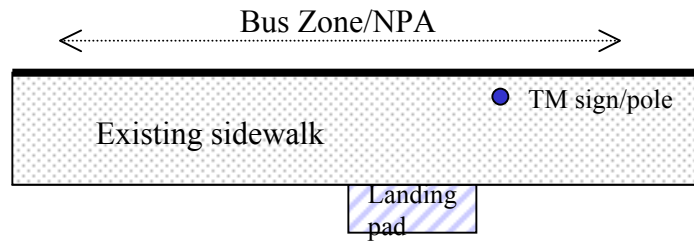

Diagram 4

Bus stop design: Sidewalks without furnishing zones

Basic



Property line

Expanded

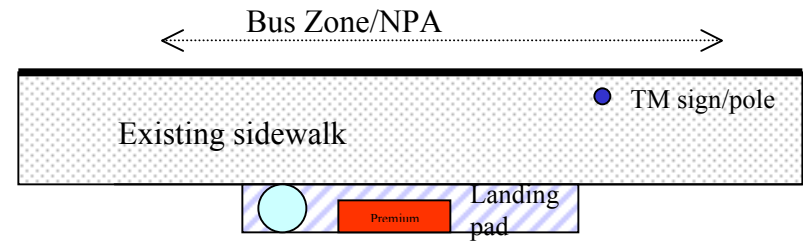

Property line

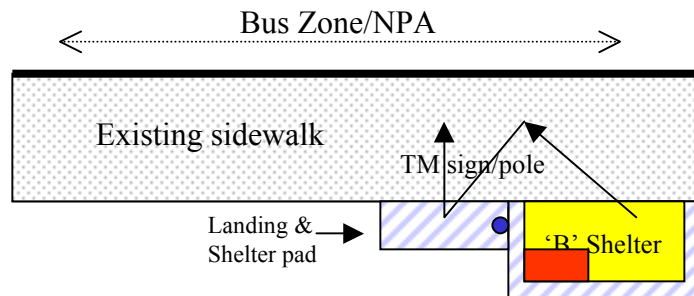

Property line

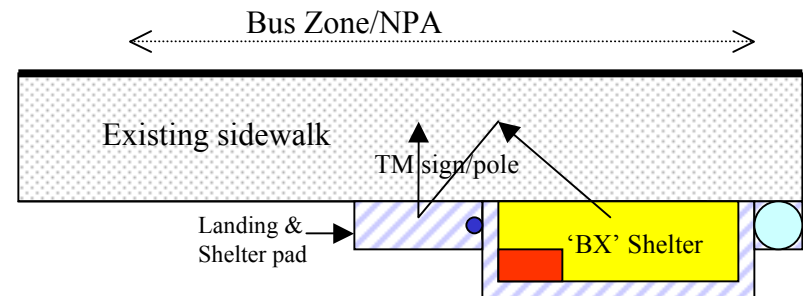

Property line

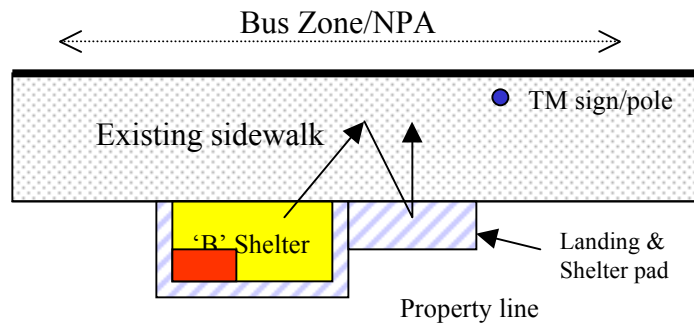

Property line

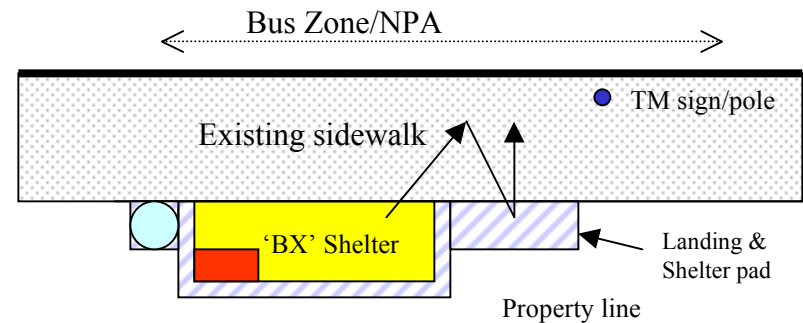

Property line

E. Roadway Treatments

Approach

Change management or structure of roadway to improve transit efficiency and accessibility. Focus on locations or corridors with the highest delays and/or those that create the most variability in on-time performance. Consider ridership and lift usage at stops.

Tools

1. Bus zones or other parking restrictions

A bus stop is not considered accessible unless the bus can reach the curb. Bus zones, no parking areas (NPAs) and other parking restrictions are often necessary to assure access. Bus zones or NPAs are required when:

- it is determined that a stop must be accessible.
- parking is allowed at the stop.
- there is not justification for a curb extension, stop move or stop deletion.
- buses lay over.

Nearside (NS) Bus Zones - preferred length is 80' measured from the bus stop sign. In extreme circumstances NS bus zones can be shortened to 60', however buses may not be able to clear the travel lane. At signalized intersections the bus should stop a minimum of 15' from the pedestrian crossing so that approaching drivers will be able to see pedestrians using the crosswalk. The area between crosswalk and bus stop must also prohibit parking.

Farside (FS) Bus Zones – preferred length is 80' measured from the crosswalk. In all instances the rear of the bus must clear the crosswalk. Farside zones can be shortened to 60', however buses may not be able to clear the travel lane.

Midblock (AT or OP) Bus Zones – preferred length is 90' measured from the bus stop sign. A minimum length for midblock zones is determined on a site-by-site basis. These zones are infrequently used, but are found on “super-blocks” often opposite of ‘T’ intersections in high-density areas and along mid- and lower density area roadways with few intersections.

Bus zones must be clearly marked – since parking control is provided by jurisdictions, so is the signage and marking requirements, resulting in several variations. Generally bus zones are marked by a front zone sign/pole, and a rear zone sign/pole. At farside zones, bus stop markers are often used to indicate where the bus should stop (to allow enough space to pullout). An NPA sign/pole may be added at the front of a bus zone to clearly define ambiguous frontage (i.e., between a zone and a driveway, or a zone and a fire hydrant). The City of Portland applies yellow tape to the curb tops in bus zones to further define the space.

Please refer to Appendix C. Additional Stop and Zone Materials, Diagrams 2 & 3 for technical specifications, incorporating driveways, etc.

2. Curb extensions incorporating transit stops

Curb extensions are a popular roadway treatment often used in streetscape improvement plans. For best effect, extensions are placed along a corridor in series of two or four to an intersection. Under this scenario the extensions improve pedestrian connections by shortening street crossing distances, and improving sight angles for pedestrians and motorists. For transit, curb extensions have several benefits. They:

- provide buses with access to the curb from the travel lane without deviation (no pulling in or merging) thereby reducing dwell time.

- can reduce nearside stop turning conflicts on two lane roads by blocking through traffic.
- provide patron waiting and boarding areas separated from pedestrian movements on sidewalks.
- provide room for stop amenities or other streetscape features.
- visually designate a street as a pedestrian friendly transit corridor.

Designing/building curb extensions that work well with transit is not an easy task. Designers must battle with the competing cross slopes of the existing roadway and sidewalks, consider drainage and relocate sewer grates. As a result, few extensions actually provide a landing area that allows low floor bus ramps to deploy at an ADA acceptable slope.

Following are the general requirements for transit stop curb extensions:

- Transit curb extensions should be paired with a pedestrian or transit curb extension across the travel street.
- Curb extensions must be clearly marked/designated to improve their visibility to motorists.
- Extensions must provide a minimum 32' of curb line free of ramps, wings and curb returns. At farside extensions, the bus must be clear of the crosswalk, requiring a minimum of 42' of clear curb line.
- A 6' x 8' clear space must be defined at front and rear door locations (door locations should be indicated by curb tape or paint).
- Bus shelters, poles, trees, benches, trash cans and other amenities must be placed a minimum of three-and-a-half feet clear of the curb face.
- Placement of curb extensions, whether nearside, farside, at signalized or non-signalized intersections must be made on a case-by-case basis. Generally, nearside curb extensions are preferred at non-signalized intersections.

Technical information for curb extensions can be found in Appendix A. Construction Specifications, Sheet 24, and Appendix C. Additional Stop and Zone Materials, Diagram 4.

3. Bus pullouts and bus pads

A bus pullout's primary function is to move buses out of travel lanes where they might impede traffic flow. Although there are scenarios where this is a valuable function, TriMet does not actively pursue the placement of bus pullouts at regular bus stops because it reduces the efficiency of transit service. TriMet will consider accepting pullouts:

- at bus layovers (where buses park for several minutes)
- at selected bus stops on roads with at least two of the following:
 - posted speed limit at or above 45 mph
 - ridership above 35 daily boardings (or six (6) daily lift boardings)
 - potential safety issues

Concrete bus pads are often incorporated in pullout designs but are also used at curbside bus stops. Bus pads are considered on a case-by-case basis but are generally found at stops with frequent service, significant ridership, or where heavy bus braking and acceleration is necessary.

Technical information for pullouts and pads can be found in Appendix A. Construction Specifications, Sheets 25 & 26, and Appendix C. Additional Stop and Zone Materials, Diagram 5.

4. "Except Bus" signage, queue jump signals and bus only lanes

These treatments should be pursued on major trunk routes, crosstown routes or any high frequency bus routes with significant traffic delays during peak periods. "Except Bus"

signage is the most common treatment where a nearside bus stop at a signalized intersection uses a right turn pocket. Queue jump signals are used in conjunction with an “except bus” queue jump lane (especially when there is no farside lane) to provide safe merging into traffic lane. Bus only lanes provide exclusive right-of-way to bypass congestion, but are only used when adequate right-of-way is available.

What to do

Each treatment has differing effectiveness based on the individual circumstances. Detailed analysis of such issues as traffic volume, ridership, safety, right-of-way, and delay to transit are required. The City of Portland’s Transit Preferential Streets Program Sourcebook (June 1997), developed with TriMet participation, and TriMet’s Streamline project guidelines contain more information on these tools.

Things to consider

Every site will present a unique list of issues. Use the following as a checklist of the most important considerations:

- Pedestrian safety
- Traffic safety
- Transit operation safety
- Schedule reliability
- Transit travel time and speeds
- Impact on traffic
- Costs/Benefits

F. Bus Stop Access

It is essential that bus riders have safe access to their bus stop. Walking on narrow roadway shoulders, through mud or puddles, or through ditches is unacceptable to most bus riders and is often unsafe. TriMet does not hold responsibility for construction or maintenance of sidewalks or curb ramps, but TriMet can leverage their construction through partnerships with jurisdictions and property owners or solicitation of regional funding for their construction. The pedestrian network is not only essential for transit access, but benefits the community and the region by encouraging walking for local travel.

TriMet must work with Metro and local jurisdictions to identify deficiencies in the pedestrian network using geographic information system (GIS) tools and then assign priorities for a pedestrian network development program. Some key considerations would include:

- Direct, paved, ADA compliant walk connections between any moderate-to-dense neighborhood or business center and transit stops. These should be on at least one side of the street.
- Pedestrian connections need to be continuous, with a safe crosswalk where sidewalks must shift from one side of the street to another. Driveways need to be limited and well lit for pedestrian safety.
- Designated and protected pedestrian crosswalks across arterial streets, no further apart than three blocks or 780 feet.
- Street lighting, particularly at street crossings.
- ADA compliant curb ramps at each intersection.
- Sidewalks need to be in good repair and free of trip hazards.
- Sidewalks and bus stops will be coordinated to provide ADA clearances and amenities of mutual benefit to both pedestrians and bus riders.

TriMet will support efforts to secure funding for pedestrian network development including Federal programs and their local allocation, designation of improvement districts or assignment of local Traffic Impact Fees (TIF) or other local tax mechanisms.

IV. Program Partnerships

A. Citizen Involvement

Bus stops as public spaces are as much a part of a community as streets, pathways, parks and plazas. TriMet encourages communities and citizens to recognize their value and to build a sense of ownership. TriMet, in partnership with Stop Oregon Litter and Vandalism (SOLV), promotes several ways for citizens to participate in the care of their local stops.

Adopt-A-Stop – A customer agrees to pick up the litter, clean the stop amenities and report any items needing repair in exchange for gloves, cleaning supplies and a steady supply of bus tickets.

Keep-A-Can – If trash is an issue at a particular stop, customers or local businesses can sponsor a trash can. Under the program, volunteers agree to empty and provide service for a trash can. In return, TriMet will provide an attractive, industrial strength can, liner, and soda can recycling container for the stop.

TriMet also offers other programs that do not relate directly to bus stops but give citizens the opportunity to support the public transit system. Details on transit, safety advocacy or any other TriMet opportunity are available through TriMet's Customer Service Department.

B. Development Review

1. **Background**

TriMet has been conducting development review on transit-adjacent development for over six years. This review process has fostered strong relationships with local jurisdictions, while helping to facilitate better designs for new development. The review process enables TriMet to be involved early enough in the process to influence the land use and infrastructure designs being proposed. Including transit improvements as part of new development helps to mitigate for transportation impacts and allows the cost of these amenities to be shared by developers. In the end, these partnerships stretch resources and create a more comprehensive transit system.

2. **Improving stop placement**

With an emphasis on bus stop improvement and support, TriMet primarily reviews development projects located directly on transit routes. For significant projects, stop spacing, location and usage along the adjacent route segment are analyzed to determine whether stop relocation or adjustment would facilitate: a) better access to transit, b) patron and pedestrian safety, c) transit operational efficiency, or d) traffic safety. If appropriate, modifications to roadway and frontage design, signalization, pedestrian pathways and street or parking lot crossings will be considered.

3. **Private sector purchasing amenities, joining SOLV, adopting stops**

Depending on the size and nature of the development or development action, TriMet may request improvements to adjacent bus stops. If frontage improvements are planned TriMet will request the addition of an ADA landing pad and a rear door landing pad at stops that lack them. If ridership potential exists, TriMet may request that a developer provide a bus shelter, a bench or other bus stop amenities as warranted. In some instances, developers may want to provide a bus shelter where only limited ridership is projected (e.g., to satisfy a condition of approval or to receive an exemption from certain conditions of approval). In this scenario, TriMet asks developers to take an active role in caring for the stop by joining SOLV, adopting the stop, sponsoring a trash can or agreeing to regularly clean the stop.

4. **Private sector designing transit stops and plazas**

Some jurisdictions are asking developers and their architects to incorporate transit stops into their projects' designs. Building and frontage themes are replicated at the bus stop, creating transit plazas that visually relate to the project. Awnings, columns, pedestals, shelters, benches and

public art provided by developers are not standard TriMet issue, therefore, their care becomes the individual property owner's responsibility (TriMet still provides and maintains signage and customer information).

C. Public Partnerships

1. **Responding to the Regional Transportation Plan (RTP)**

The 2040 Framework presents a vision for livability for the Portland metropolitan area. It defines the Portland and Vancouver city centers which are surrounded by regional centers, town centers, station areas and main streets, all of which have levels of urban density that call for concentrated transit services. The plan also calls for an extensive transit network that serves all communities with various forms of transit - from light rail transit to local neighborhood buses.

The RTP is the 5-year plan that responds to the transportation vision introduced in the 2040 Framework. The RTP, last adopted in 2000, is specific about both the levels of transit services to be provided and the mode split targets for communities to use transit and other alternative modes of travel. Jurisdictions, thus, must adopt Transportation Systems Plans (TSPs), which demonstrate the means by which they expect to achieve the mode split targets.

TriMet is a necessary partner in both the formulation and execution of these plans. Jurisdictions and TriMet must work together to define transit priority corridors, traffic management tools and streetscape improvements that will encourage reduced reliance on the single-occupant vehicle. This partnership is also critical to encourage land uses along transit corridors (Transit Oriented Development or TOD) that take advantage of the public investment in transit services.

2. **TriMet partners to improve other jurisdictions projects**

TriMet Project Planning staff is available to provide support for jurisdictional planning efforts that have transportation elements. Town center plans, corridor development, streetscape improvement plans, street-widening projects, traffic calming plans and TSP development are a few examples of planning and implementation efforts that can benefit from TriMet input. Jurisdictional plans that recognize, coordinate with or incorporate TriMet service and capital improvement plans will likely result in better transportation and transit products.

3. **Jurisdictions partner with TriMet to improve transit projects**

Project Planning also invites key jurisdictional staff to be part of TriMet project teams. Their support and input is critical to the success of TriMet projects as well. The cooperation amongst jurisdictional partners influences key planning decisions, facilitates key design elements, promotes simplified permitting and improves interagency communication.

4. **Improving coordination through IGAs and MOUs**

Intergovernmental Agreements (IGA) and Memorandums of Understanding (MOU) are documents that recognize project and program partnerships. TriMet and the City of Portland have developed several IGAs that have greatly improved TriMet's ability to provide accessibility and comfort to neighborhood bus stops. For example, a carriage walk agreement between Project Planning and the Bureau of Maintenance has allowed the agencies to coordinate bus stop accessibility improvements, like ADA landing pads and curb ramps, with the city's own efforts to upgrade the pedestrian infrastructure with curb ramps and accessible sidewalks. A bus shelter siting agreement has allowed TriMet and the City to simplify the siting and permitting process, putting amenities on the street more quickly. TriMet continues to pursue agreements like these with its regional partners to make better and more efficient use of available funding, and to provide timely, coordinated projects.



V. Bus Stop Development Projects

TriMet initiates capital projects to make significant improvements to route efficiency, on street and bus stop safety, accessibility and comfort. TriMet utilizes the tools and methodology introduced in these guidelines to provide an improved product that integrates with existing transit service.

Following are recent or current capital projects, their intent and their effect.

Low Floor Bus

Low Floor Bus 1996-2010

INITIATED: 1996 with the purchase of TriMet’s first low floor buses and the commitment to replace all high floor buses by 2010.

COMPLETED: Ongoing –will be completed when every bus line utilizing low floor buses has received low floor bus wayside improvements.

STATUS 2002: Lines 4, 8, 15, 19, 33, 54, 56, 72 and 75 have received wayside improvements.

PRIMARY GOAL: To significantly improve patron accessibility and safety at bus stops at impacted stops on appropriate routes.

TARGET: Functional accessibility at 70% of selected route’s bus stops. ADA accessibility at 50% of selected route’s bus stops.

PRIMARY TOOLS:

1. Bus stop relocation, consolidation and removal
2. Bus zones and parking restrictions
3. Curb ramps
4. ADA and rear landing pads
5. New poles and signs
6. Limited amenities (benches, shelters and trash cans)



Streamline 1999-2005

INITIATED: 1999 with the release of the 99/00 Capital budget.

COMPLETED: Ongoing – currently five lines have been selected to receive Streamline treatment.

STATUS 2002: Lines 4, 72 and 12 are in the process of receiving Streamline improvements.

PRIMARY GOAL: To improve bus service reliability and reduce travel time while also improving patron safety, accessibility and comfort on selected routes.

TARGETS: Reduce travel time to significantly impact riders’ perception of timesavings. Reduce resources necessary to operate service at current frequency.

PRIMARY TOOLS:

1. Traffic signal transit priority treatments
2. Roadway treatments (bus only lanes, queue jump and bypass lanes, curb extensions, turning radius improvements, lane adjustments etc.)
3. Bus stop relocation, consolidation and removal
4. Bus zones and parking restrictions
5. Curb ramps
6. ADA and rear door pads
7. New poles and signs
8. Amenities improvements -benches, shelters, trash cans, lighting
9. Route simplification

Streamline

Bus Shelter Expansion 2000

INITIATED: 2000 with a public announcement of the placement of 100 new bus shelters during FY 2000/2001.

COMPLETED: Ongoing – current plan to continue until 500 new shelters have been placed.

STATUS 2002: Underway–will site, permit, construct pads for and place shelters at 100 new sites by July 2002.

PRIMARY GOAL: To improve patron comfort at bus stops currently lacking shelter. Upgrading accessibility if needed.

TARGET: Meet primary goal.

PRIMARY TOOLS:

1. Bus shelters
2. Bus shelter pads
3. Curb ramps
4. ADA and rear landing pads
5. New poles and signs
6. Bus zones and parking restrictions
7. Limited additional amenities (trash cans, lighting, BCIDs)

Bus Shelter Expansion

Bus Shelter Advertising

Bus Shelter Advertising Program

INITIATED: 1999-2000 with the permitting and placement of 50 ad shelters.

COMPLETED: Ongoing

STATUS 2002: Currently approaching 100 sites, permitting and siting on hold

PRIMARY GOAL: To offset the cost of improving, upgrading and maintaining first class bus stops and amenities programs.

TARGETS: Provide accessible, safe, lighted, covered bus stops at more locations.

PRIMARY TOOLS:

1. Amenities improvements -benches, shelters, trash cans, lighting, transit tracker
2. Bus shelter electrification
3. Potential enhanced cleaning and maintenance rotation
4. Bus stop relocation, consolidation and removal
5. Bus zones and parking restrictions
6. Curb ramps
7. ADA and rear door pads
8. New poles and signs

VI. Maintenance Guidelines

A. Introduction

On-street amenities provide an opportunity for increased transit use, improved efficiency of transit operations and capital improvements that enhance the communities in which they are located. Maintenance of these amenities accommodates the needs of passengers, transit operations and adjacent property owners.

The perception, utilization and public support for public transit are in large measure predicated on the condition in which transit amenities are maintained. Over 214,000 passengers use TriMet on a daily basis. Facilities Management intends to provide passenger areas that will not only make transit a pleasurable experience for them but also increase the number of riders using these amenities.

B. Goal

The goal is to provide TriMet's service district with consistent, high-quality bus stop and passenger facilities at all times.

C. Description of TriMet Maintained Amenities

TriMet bus stops include at minimum a bus stop sign with the following potential enhancements:

- Bus stop pole (TriMet owned)
- ADA landing pad
- Bus shelter and bench
- BCID
- Premium bench
- Trash can

D. Standards

Highest consideration shall be given to the safety, comfort and convenience of transit passengers. Impacts to the adjacent property owner(s) are also given consideration. All maintenance activities shall maximize safety and minimize disruption to the community, transit passengers and transit operations. TriMet's cleaning and maintenance of amenities shall be avoided during passenger rush hours. Vehicles shall not impede passenger boarding areas or impede normal traffic flow. All employees or contractors shall be professional and courteous at all times.

E. Routine Maintenance

The following standards shall be used by TriMet in evaluating maintenance services in order to provide a safe, clean and attractive passenger environment.

Definition of a clean bus stop:

- free from debris, e.g., cigarette butts, cups, newspapers, etc.
- free from foreign substances, e.g., gum, spills, food, etc.
- free from insects and weeds
- free from graffiti (written or etched)
- free from unauthorized stickers or posters

Definition of a well-maintained bus stop:

- overall passenger facilities in good repair
- areas and improvements are in good condition and all repairs are current
- all amenities (e.g., shelters, benches, trash receptacles) are properly installed to meet the requirements of city ordinances and Americans with Disabilities Act (ADA)
- furniture surfaces are in good condition, e.g., no rust, marring, scratches, etc.
- signage, walls, seating and kiosks are in good condition

- lighting in good working order at all times
- free from overhanging trees or brush

Guideline for repair & maintenance:

- Repairs are performed by both in-house employees and contractors.

Guidelines for cleaning:

- Pick-up trash and debris within a 15' radius of bus stop areas (blowers shall not be used).
- Remove graffiti, stickers and unauthorized signs and posters.
- Power wash all amenities with water. Using a ladder, clean the shelter roof inside and outside with a soft bristled brush until all dirt has been removed. Clean and flush gutters and drain holes of all debris. Clean the shelter frame, bench and windows (inside and outside) until all dirt has been removed using soft bristled brush and pressure washer. Dry windows with a squeegee so that no smears or streaks remain visible. Wipe benches completely dry after cleaning or graffiti removal to allow immediate customer use and to prevent claims for damaged clothing.

F. Emergency Cleaning

All emergency cleanings shall be completed within four (4) hours of notification, except broken glass, which shall be replaced within two (2) hours of notification.

G. Waste Disposal

Trash in and around shelters and stops gets collected and disposed of in various ways. Whenever possible, TriMet seeks sponsors to assist with the growing trash problem.

In most cases, TriMet provides the trash receptacle at a particular shelter. The sponsor collects and disposes of the trash as needed. A plaque on the trash can denotes the sponsor's name. TriMet maintains the trash can by providing the liner insert, and repairs and repaints (due to graffiti) on an as-needed basis.

For locations without sponsors, TriMet has its own in-house trash collection crew currently consisting of two (2) employees and one (1) trash dump truck. The crew follows a regular route schedule and also assists in emergency trash pick up as needed. When a sponsor neglects a trash can due to moving, vacation, etc., the crew assists until another sponsor is found.

Trash collected by TriMet is compacted in the dump truck and taken to a Metro collection site as needed. Metro currently provides vouchers to TriMet for no-cost disposal.

H. Anti-Litter and Graffiti Programs

TriMet partners with SOLV to provide anti-litter and graffiti programs, in addition to the regular maintenance routines described above. The SOLV program consists of three major components:

- Adopt-A-Stop: Please see Section IV, Part A Citizen Involvement.
- Keep-A-Can: Please see Section IV, Part A Citizen Involvement.
- First Step Youth Program: During the summer, SOLV and TriMet organize groups of at-risk students to clean up street litter and graffiti, focusing on TriMet transit corridors. TriMet provides group payment, supervision and transportation.

I. Bus Stop Amenities Replacement

Bus stop features are replaced as a result of accidents, vandalism or general wear over time. Regular maintenance will extend the life of bus shelters and other bus stop features, but their replacement is eventually required. The Capital Improvement Program (CIP) identifies the following criteria for the replacement of bus stop shelters:

- condition compromises customer safety
- exceeds a 15-year life cycle



- customer security is in some way compromised
- parts for repair and maintenance are no longer available
- the shelter is not in compliance with the Americans with Disabilities Act

A bus shelter replacement schedule is shown in Table 4 of the CIP.

Bus stop signs are similarly replaced if they pose a safety concern for bus riders; they have been damaged or vandalized; they impede movement in conflict with ADA guidelines or exceed an 8-year life cycle. Bus stop features may be in good condition beyond their expected life in which case replacement would be deferred. Signs, shelters and other amenities may be upgraded or moved to reflect changes in bus stop use or coordination with other development projects.



VII. Organizational Support

A. Capital Projects Management Section

Primary responsibility and accountability for bus stops – their design, placement, shelters and other amenities – lies with the Capital Projects Management Section of the Project Planning Department. This nine-person section works closely with other TriMet departments to provide for the regular maintenance and management of bus stops as well as implementation of bus stop development programs. Following is a brief description of the Section’s positions and their responsibilities.

Programs Manager: Responsible for developing and implementing a 5-year Bus Stops Management and Development Plan, which includes negotiating agreements with each major jurisdiction. The Manager is also responsible for coordinating programs and managing the department and program budgets and contracts. The Capital Projects Management Section, including positions matrixed from other departments, report directly to the Programs Manager for bus stops program related activities.

Project Planner: Provides lead support for field checks and sign placement. The planner also conducts development reviews with respect to inclusion of bus stop facilities and coordinates programs with other jurisdictions, developers and other TriMet units. The planner prepares work orders, reviews Customer Service Inquiries (CSIs) and other requests associated with bus stops and shelters.

Project Planner: Works with the Programs Manager to develop and update the 5-year Bus Stops Management and Development Plan. Provides lead support for development and coordination of the Streamline Bus Improvement Program and other agency initiatives.

Project Planner: Works closely with all members of the section. This position conducts field investigations, prepares conceptual designs for bus stop improvements and identifies right-of-way and permit requirements for new or modified stops. The planner also manages the bicycle facility development program including expansion of lockers and racks.

Maintenance Supervisor: Assesses and manages the cleaning and repair needs and contracts and is responsible for quality control for these efforts. This position performs hands-on supervision of field maintenance personnel and conducts field checks for quality, accuracy and timeliness of services provided.

Engineer: Works closely with all members of the section but also reports to the Project Implementation Department within the Capital Projects and Facilities Division. Using TriMet and jurisdiction standards, the Engineer prepares design and construction drawings for all bus stop improvements. The Engineer orders utility checks, works with jurisdictions regarding joint construction or traffic management issues, establishes specifications for procurement contracts of bus stop shelters, signs and other amenities and oversees their installation.

Adopt A Stop Program Coordinator: This person monitors partnership agreements for the servicing of bus stops, shelters and trash receptacles and is a contract employee of SOLV. The coordinator develops, implements and coordinates all aspects of a special outreach program focusing on TriMet’s bus routes.

Planner/Analyst: Responsible for building and maintaining TriMet’s central bus stops database. This position is a significant resource for the planning, analysis and GIS mapping of bus stops and supporting information. The Planner/Analyst uses a Global Positioning System locator device to accurately locate bus stops within the geographic information system files. This person also prepares status and performance reports to track cleaning, repair, response to complaints and work orders.



Community Relations Specialist: Serve as a central point of contact for all external and internal communications pertaining to bus stop and P&R related inquiries. Working with the Section, this person tracks and responds to all CSI inquiries from the general public. This person also prepares mailings and notices for bus stop changes and sets up and supports community meetings pertaining to bus stop programs.

B. Interdepartmental Involvement

Overall responsibility for bus stops management resides with the Bus Stops Section. However, some issues require review and input from a broad cross-section of TriMet divisions.

- The **Service Planning Department**, in concert with the **Scheduling Department**, determines routes and the type of services to be provided along the routes. These have a direct bearing on the location and design of bus stops.
- The **Field Operations Supervisors** are in the best position to identify bus stop problems and operational concerns that influence bus stop placement. Road Supervisors request bus stop changes based on field observations and as required to accommodate construction projects or events that cause the realignment of service. They also temporarily reroute service when bus stops are affected by construction activities. Road Supervisors also receive customer comments in the course of their surveillance activities. Similarly, **Bus Operators** also pass on issues that they identify or comments from their bus riders.
- **Maintenance Technicians** in the Facilities Management Department repair and maintain stops and shelters. Maintenance technicians also receive customer comments in the course of their activities, which are managed within their group or passed to the Bus Stops Section.
- The **Information Development Department** of the Marketing and Customer Service Division prepares specifications for signage and information displays and determines locations for other customer information. The **Marketing Department** manages the shelter and bench advertising programs. Individual requests and needs for bus stop changes funnel through the **Customer Service Department** and are recorded in a Customer Service Inquiry database, which is accessed by the Bus Stops Management Section for research and response. Employer outreach efforts conducted by the **Marketing Department** provide input for program development.
- Corridor and route-specific projects, which may include bus stop improvements, are managed by the **Capital Projects Section** within the Project Planning Department.
- The **Land Development Section**, within the Project Planning Department, provides assistance with the coordination with public and private development and review of those projects.
- TriMet's **Committee on Accessible Transportation (CAT)** provides a very important consultative role in the management of bus stops. This committee comments on bus stop design guidelines and the development of standard bus stop features (e.g., bus stop shelter design). This perspective helps to assure compliance with the Americans with Disabilities Act and helps set priorities for bus stop development programs.
- In addition to the matrixed engineering support, other services are needed on a case-by-case basis from the **Project Implementation Department**. Project Implementation staff also provide information on construction and contract standards. The **CADD** section ensures drawings are properly prepared and updated.
- The **Public Art Program** also provides input for integrating art into bus stop design and in identifying opportunities for unique art projects associated with bus stops.

- Other groups are linked through the internal coordination plan and include **Safety, Training, and Real Property.**

C. Bus Stops Section Development Process

The processes for the development of bus stops may be summarized as follows:

Policy development process:

- Set vision and direction
- Establish standards and guidelines
- Establish priorities
- Identify funding needs and sources
- Determine ways to do business, e.g., partnerships

Plan development process:

- Develop Bus Stop Management Plan
 - 5-year plan (vision and needs with first year detail)
 - Include capital budget plus maintenance/operating costs
 - Include IGAs for each jurisdiction
- Perform outreach check
 - Interactive with plan development
- Solicit review - gain approvals
 - Key five inter-organizational linkages
 - Finance
 - Leadership Group
 - Board of Directors

Implementation plan process:

- Develop scope, schedule, budget for each program including outreach
- Identify resources (both funding and people)
- Determine needed contracts
- Identify and schedule needed permits
 - IGA requirements
 - Rights of way
 - Private property siting agreements/easements
- Permits centralized within the Bus Stop Section
- Coordinate and manage implementation
- Evaluate programs and processes

Construction:

- Develop field drawings for candidate sites, include digital pictures
- Prepare CADD drawings
- Consult with private property owners as required
- Determine and procure necessary permits
- Select contractor (on-call or bid)
- Inform Information Development (IDP), Facilities Management, and Marketing (advertising) of proposed changes
- Construction of site begins
 - Inspection and digital documentation is performed by the Bus Stops Engineer I
 - Notify Road Operations of completion
- Prepare and submit data updates

D. Operations and Maintenance

Road Operations and maintenance technicians provide daily information regarding bus stop and shelter conditions. Customers regularly request new bus stops and comment on bus stop conditions or issues. This information will funnel through the Customer Service group. Business and property owners identify specific issues with regard to bus stops and shelters located on or near their property. The bus stop maintenance process may be described as follows:

- Define maintenance standards per program plan
- Develop 5-year plan
 - Priorities
 - Timelines
 - Preventative/responsive budgets
 - Contract needs and other resources
- Implementation plan
 - Contract management
 - Quality control
 - Data
 - Tracking
- Evaluation
 - Inputs
 - Customer Service Inquiry (CSI) complaints [external feedback]
 - Emergency call outs
 - Standards being met
 - Internal feedback

Work order process:

- The Bus Stops Development Coordinator creates work orders based on a variety of sources/inputs:
 - Operations – Field Reports
 - Customer Service – CSIs
 - Maintenance – Field Reports
 - Other – Project Planning, other internal requests, etc.
- The work order goes directly to a single database system
 - Check the Location ID
 - Provide Road Operations notice of pending action(s)
 - Bundle work orders where possible – assign to maintenance staff or contractor
- Track work orders via the database/work order program
- Review and comments from Road Operations
- Quality control/inspection performed by Bus Stops Section
- The master data files are updated when the work order is closed

VIII. Program Support (Funding)

Approach

Identify innovative ways to finance and maintain bus stop program initiatives that help offset program costs.

Tools

Advertising—Advertising remains an effective and popular tool for offsetting various program costs. TriMet's most visible and successful advertising ventures may be the bus and MAX vehicle advertising programs; however, TriMet has also established or is pursuing advertising programs at bus stops and bus facilities:

- **Ad shelters:** An advertising component can be attached to a standard B shelter. This component allows for the placement of two 4' x 7' advertisements. Revenues accrue on a monthly basis and are directly dependent on the number of ads placed within the system.
- **Ad benches:** A basic transit bench with an advertising component attached to the back. Benches can be placed where a bus stop is located and where sufficient room exists. Revenues are dependent on the number of benches placed in the service area and are generated on a monthly basis.
- **Other ad kiosks:** There are additional advertising opportunities at bus stops and bus shelters. Advertising kiosks can be placed on telephones, sidewalks and on bus stop poles.

Partnerships—The use of non-profit or public agencies to assist in daily bus stop maintenance and graffiti removal can be an effective and cost saving tool. Current TriMet programs are:

- **Anti-litter and graffiti programs:** Please see Section IV, Part A Citizen Involvement and Section VI, Part H Anti-Litter and Graffiti Programs for more information.
- **Public volunteers:** TriMet works with local volunteers to identify safety hazards, potential improvements and maintenance deficiencies. Utilizing volunteers enables TriMet to improve the transit system with little or no cost incurred.
- **Leveraging:** The use of leveraging enables TriMet to add amenities in the system while reducing the long-term cost of project implementation. As an example, before transit improvements are made, TriMet searches for commitments from the community or local businesses to provide basic shelter maintenance and cleaning. If a commitment is made, TriMet can expedite the placement of these amenities.
- **Jurisdictional/local programs:** Grant opportunities targeting on-street or transit opportunities are available to jurisdictions. Transportation System Management grants, for example, can be used for bus stop and roadway improvements. TriMet can partner with jurisdictions to locate potential sites and provide design support for bus stop improvements.

Federal, State and local funding sources—Additional monies can be obtained through seeking out various Federal, State and local funding opportunities.

Cost efficiencies—TriMet actively looks for opportunities to save costs on the production, placement and installation of bus stops and amenities. Some useful opportunities are:

- **Standardization:** Providing consistencies in materials and supplies allows for bulk rate cost savings.
- **Less expensive materials:** Substantial cost savings can be realized by discovering less expensive materials that have similar aesthetics and durability (e.g., shelter glass).
- **Development review:** Please see Section IV, Part B Development Review.
- **Joint development/pedestrian to transit programs:** TriMet works in conjunction with local cities and jurisdictions on joint development projects. As a cost saving opportunity, TriMet and the jurisdiction assign various work responsibilities to the agency who can perform the task at a less expensive rate. For example, on several joint development projects with the City of Portland, TriMet has utilized the Bureau of Maintenance (BOM) to perform any

necessary construction work as TriMet performs other in-kind services. The BOM can perform infrastructure improvements at a much lower cost than TriMet can contract out for.

What to do

Each funding source and cost efficiency has a differing effectiveness based on individual circumstances. Therefore, each opportunity should be evaluated independently. Analysis could include:

- potential revenue gain versus capital investment
- feasibility of project implementation
- benefit to transit system

Things to consider

Every cost offsetting opportunity presents a unique list of issues. The following is a checklist of the most important considerations:

Advertising

- Placement limitations
- Capital investment (ad components, electrification) versus potential revenues gained
- Pedestrian safety
- ADA accessibility
- Aesthetic impact on environment
- Market feasibility
- Ad types

Partnerships

- Tradeoff costs
 - Contract monitoring commitments
 - Program requirements, commitments

Federal, State and local funding sources

- Local match requirements
- Project implementation and feasibility

Cost efficiencies

- Public safety
- Increase in reliability
- Tradeoff costs

Attachment A
Table of Contents

Figure 1	Shelter Pad/ADA Pad	1
Figure 2	Type "B" Shelter Pad	2
Figure 3	Type "BX" Shelter Pad	3
Figure 4	Type "A" Shelter Pad	4
Figure 5	ADA Landing Pad	5
Figure 6	Waste Receptacle Pad	6
Figure 7	Bus Stop Sign Placement	7
Figure 8	Type "A" Shelter Without Display	8
Figure 9	Type "B" Shelter With Display	9
Figure 10	Type "BX" Shelter Without Display	10
Figure 11	Pole Anchor & Sleeve	11
Figure 12	6" Curb	12
Figure 13	24" Curb & Gutter	13
Figure 14	Combination Curb & Gutter	14
Figure 15	Retaining Curb.....	15
Figure 16	Retaining Curb.....	16
Figure 17	Curb Ramp	17
Figure 18	Diagonal Curb Ramp	18
Figure 19	4" Sidewalk	19
Figure 20	Front & Rear Door Landing Pads	20
Figure 21	Leveling Pedestal	21
Figure 22	Leveling Pedestal	22
Figure 23	Bollard	23
Figure 24	Bollard Installation	24
Figure 25	Railing	25
Figure 26	Tactile Warning	26
Figure 27	Shelter Pad Conduit Location	27
Figure 28	Full Curb Extension	28
Figure 29	Bus Pull Out & Bus Pad	29
Figure 30	Bus Pad Section	30
Figure 31	Stop Locations	31
Figure 32	Driveway Locations Near Bus Stops	32
Figure 33	Recommended Bus Stop/Zone Placement	33
Figure 34	Curb Extension Treatment.....	34
Figure 35	Bus Pullout Design Options.....	35

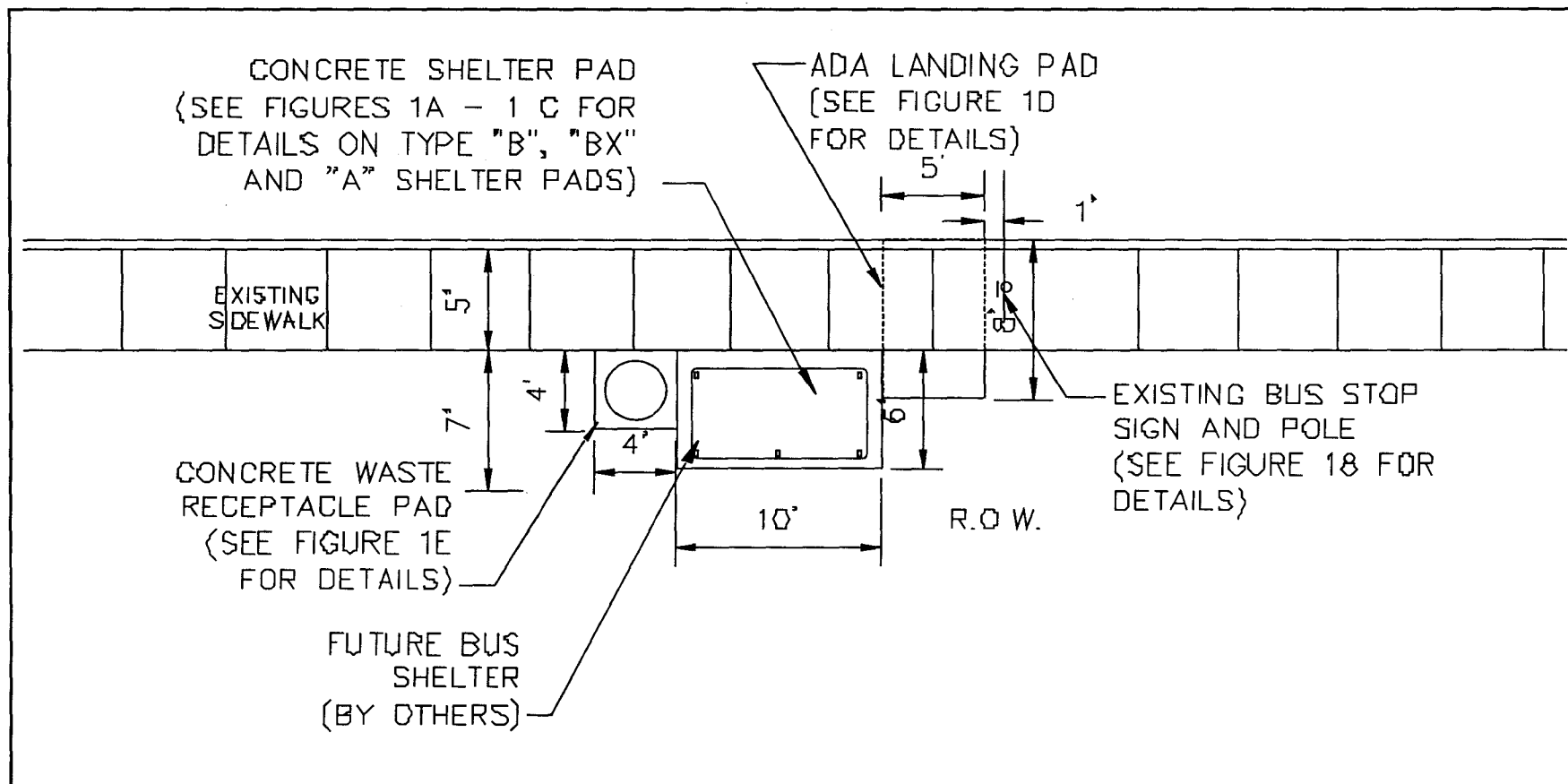

Shelter Pad/ADA Pad
Figure 1

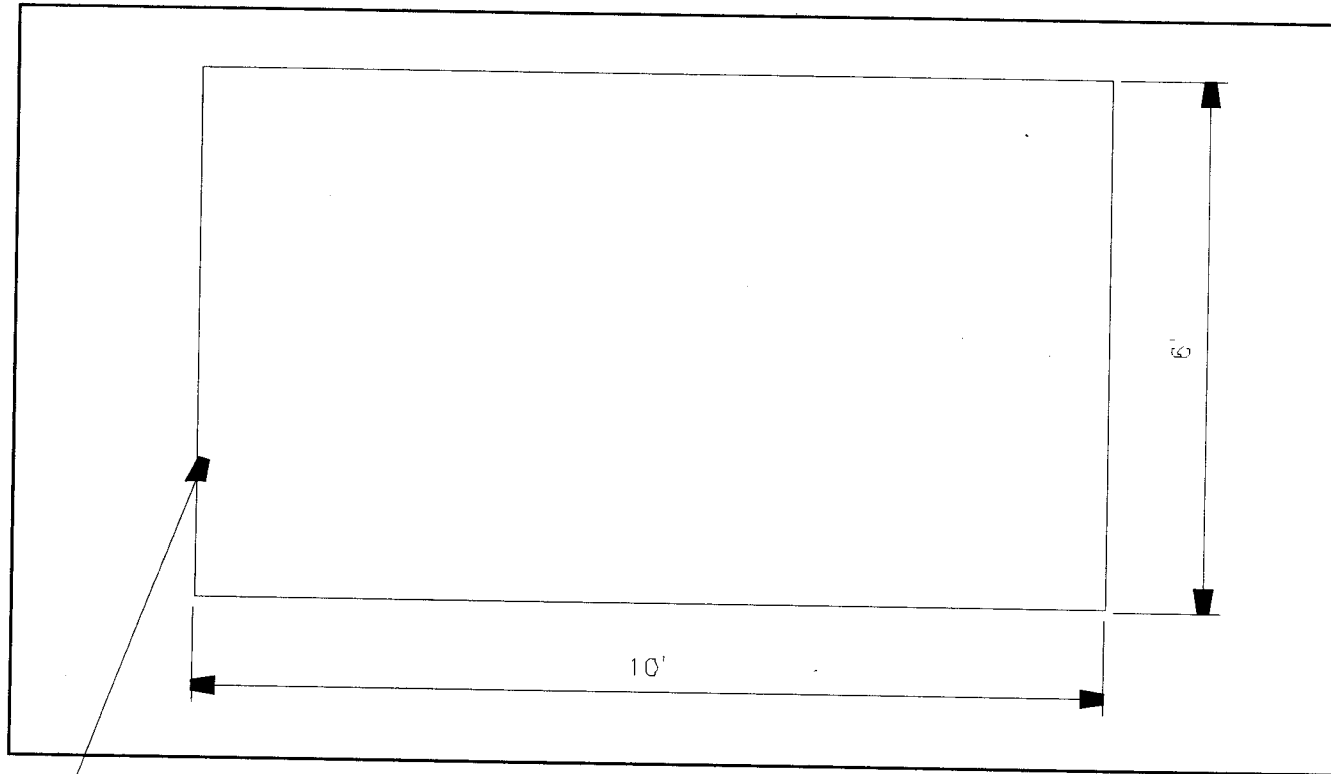

CONSTRUCT CONCRETE SHELTER PAD 5.5" MIN. THICKNESS, 3000 PSI PCC WITH 2" COMPACTED AGGREGATE BASE. SLOPE TO DRAIN TO CURB (NOT TO EXCEED 2%).

Type "B" Shelter Pad
Figure 2

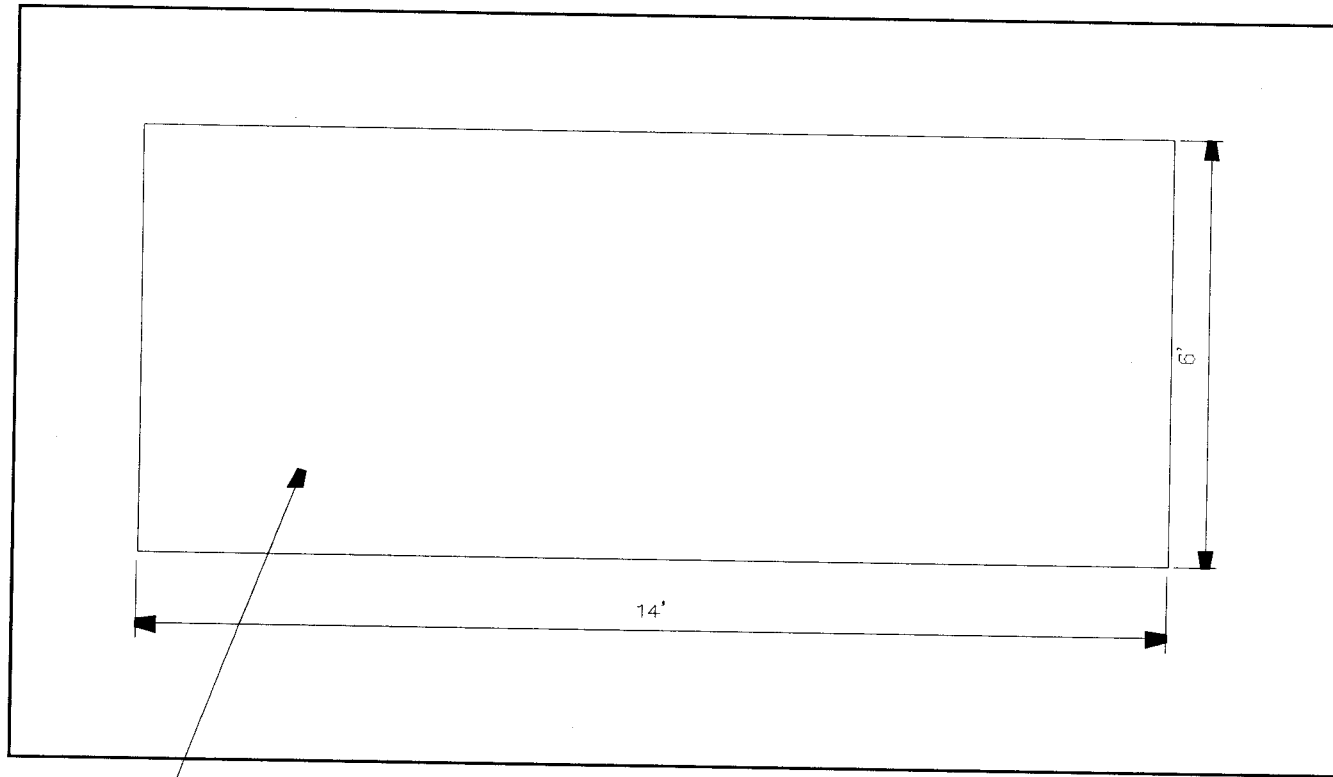

CONSTRUCT CONCRETE SHELTER PAD 8" MIN.
THICKNESS, 3000 PSI PCC WITH 2" COMPACTED
AGGRERGATE BASE. SLOPE TO DRAIN TO CURB
(NOT TO EXCEED 2%).

Type "BX" Shelter Pad
Figure 3

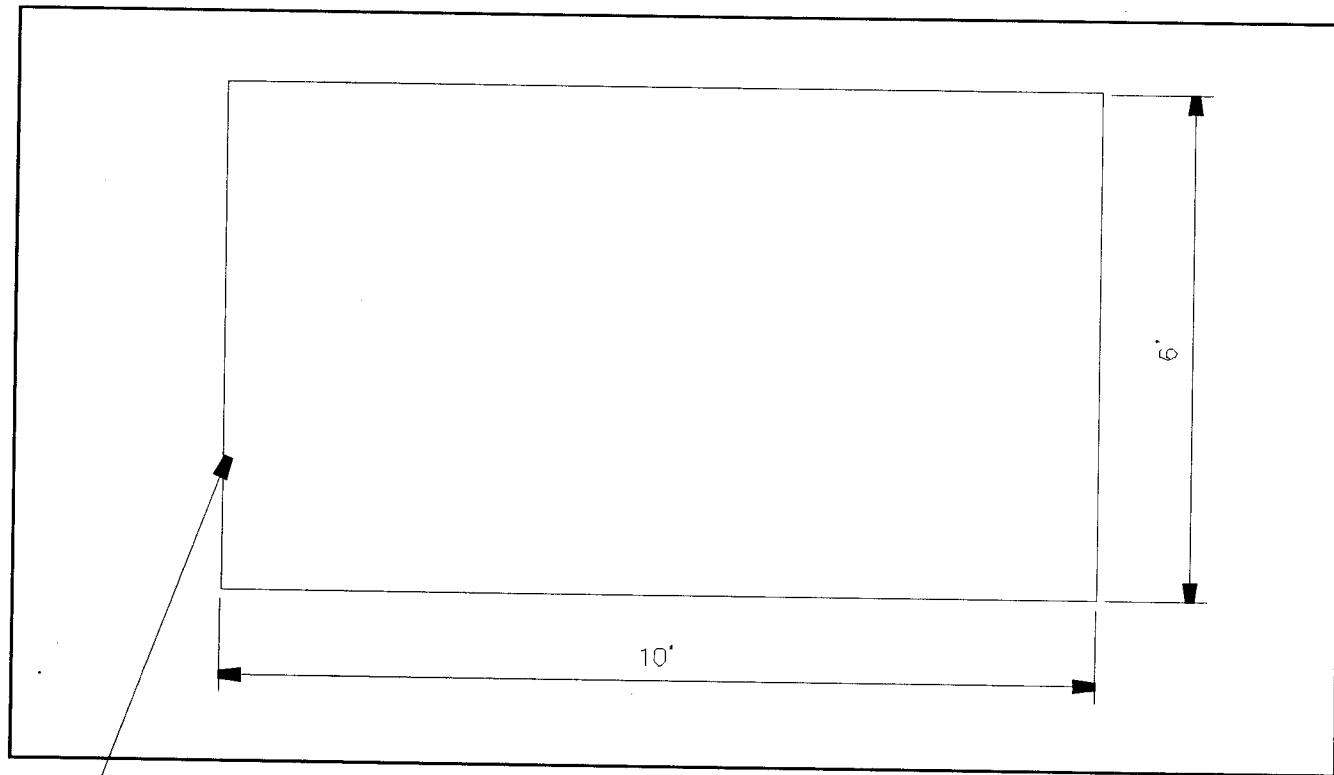

CONSTRUCT CONCRETE SHELTER PAD 5.5" MIN. THICKNESS, 3000 PSI PCC WITH 2" COMPACTED AGGRERGATE BASE. SLOPE TO DRAIN TO CURB (NOT TO EXCEED 2%).

Type "A" Shelter Pad
Figure 4

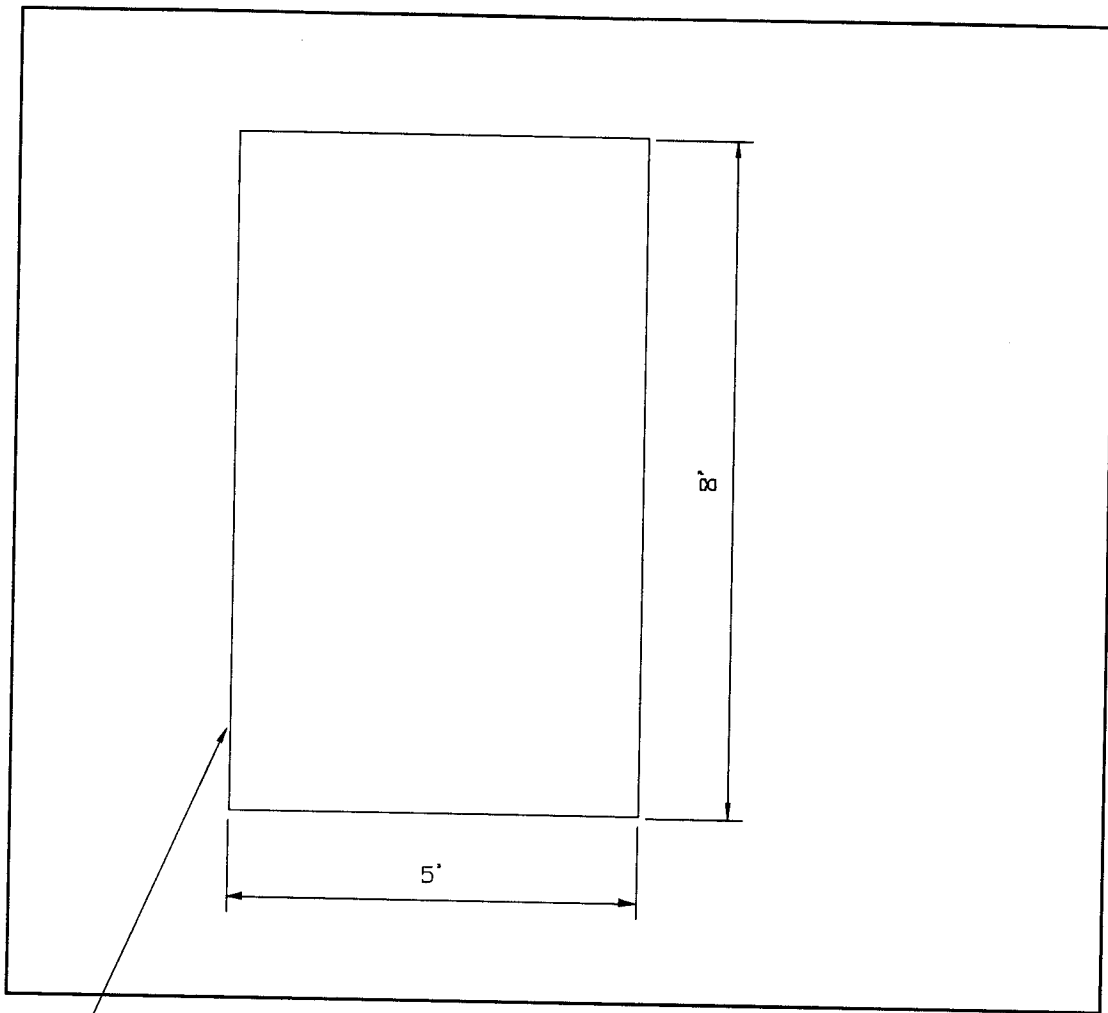

CONSTRUCT CONCRETE SHELTER PAD 4" MIN THICKNESS,
3000 PSI PCC WITH 2" COMPACTED AGGRERGATE BASE.
SLOPE TO DRAIN TO CURB (NOT TO EXCEED 2%). CROSS
SLOPE NOT TO EXCEED 1%.

ADA Landing Pad
Figure 5

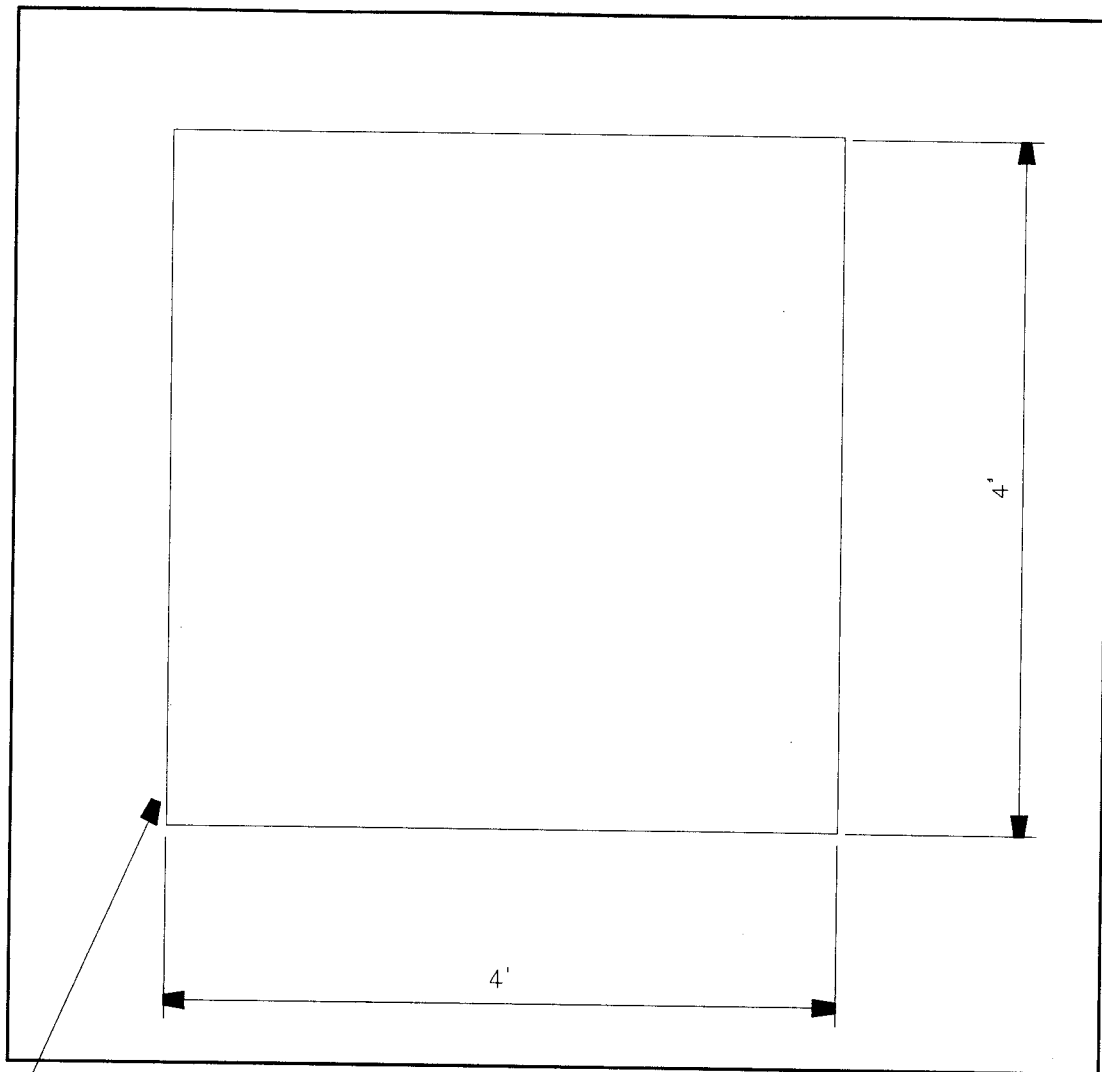

CONSTRUCT CONCRETE WASTE RECEPTACLE PAD 4" MIN. THICKNESS, 3000 PSI PCC WITH 2" COMPACTED AGGRERGATE BASE. SLOPE TO DRAIN TO CURB (NOT TO EXCEED 2%).

Waste Receptacle Pad
Figure 6

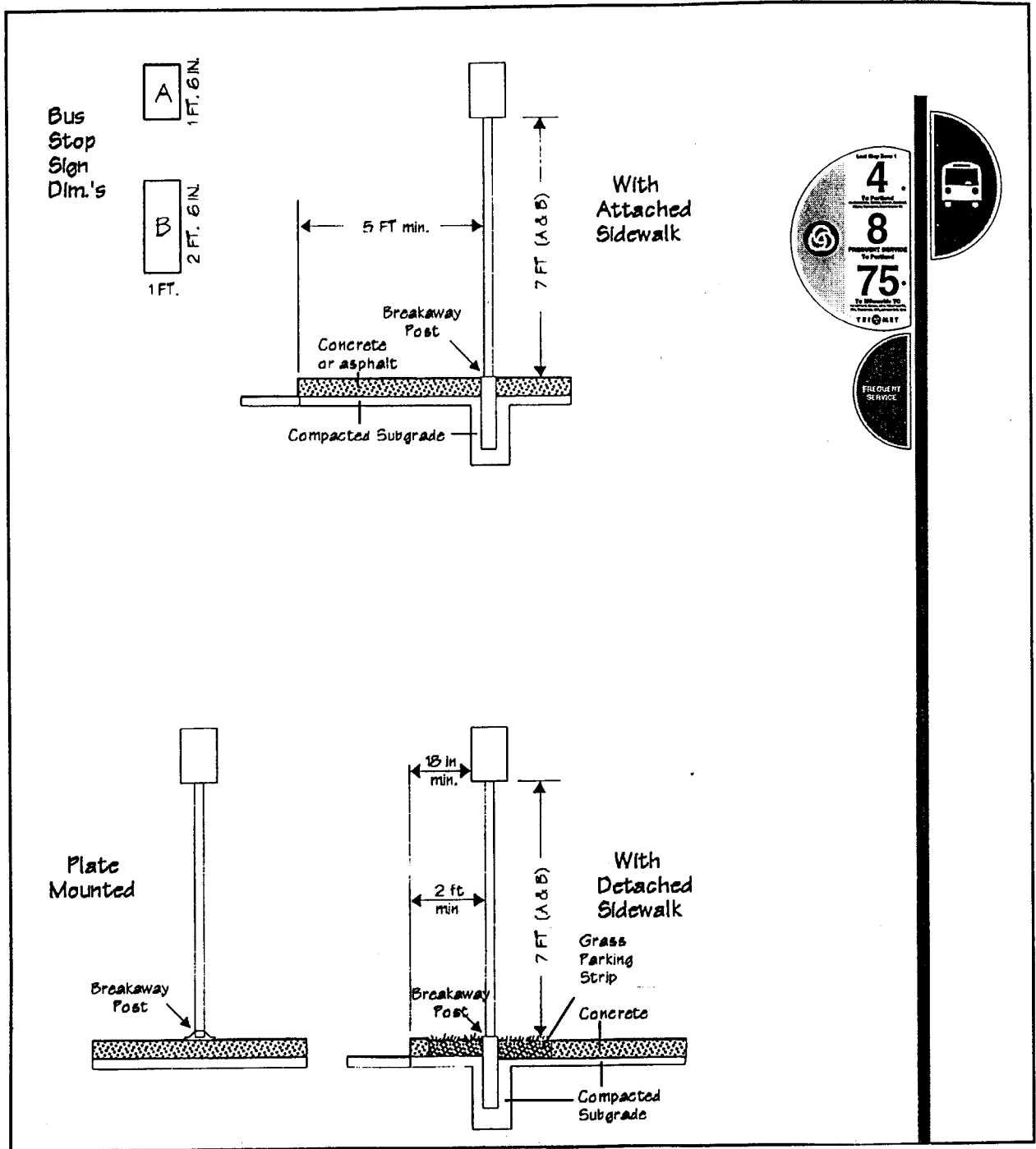

Bus Stop Sign Placement
Figure 7

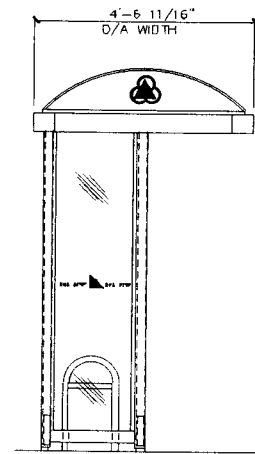

LEFT SIDE ELEVATION

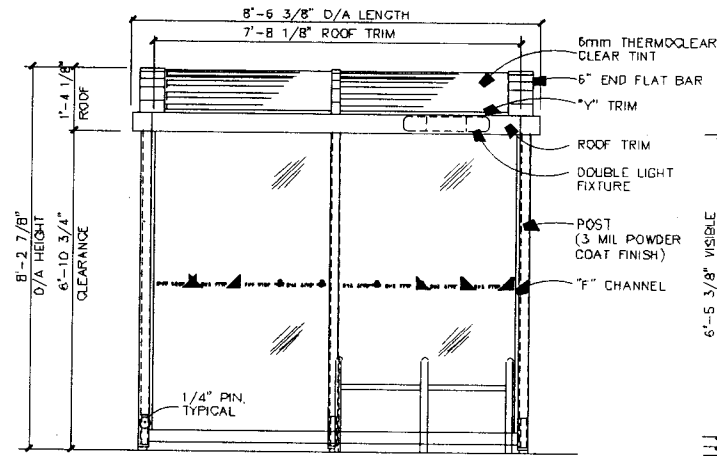

FRONT ELEVATION

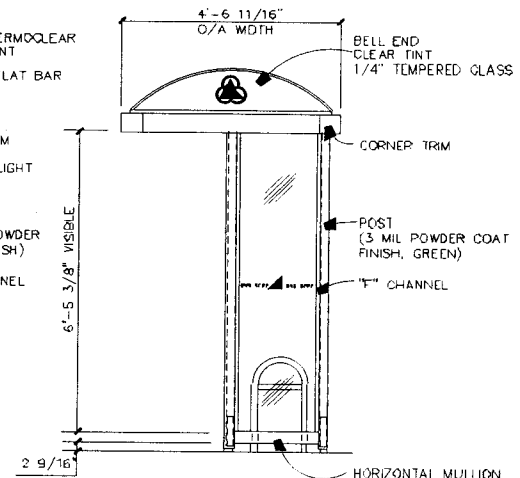

RIGHT SIDE ELEVATION

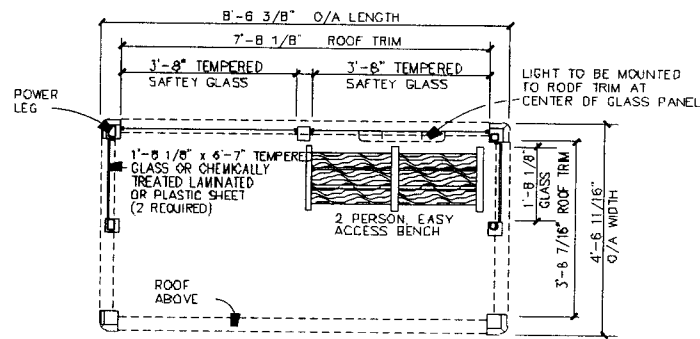

TOP VIEW - ROOF REMOVED

NOTES:
 COLOR: PER CONTRACT
 CONCRETE PAD
 5'-6" x 9'-6" x 8"

Type A Shelter Without Display
 Figure 8

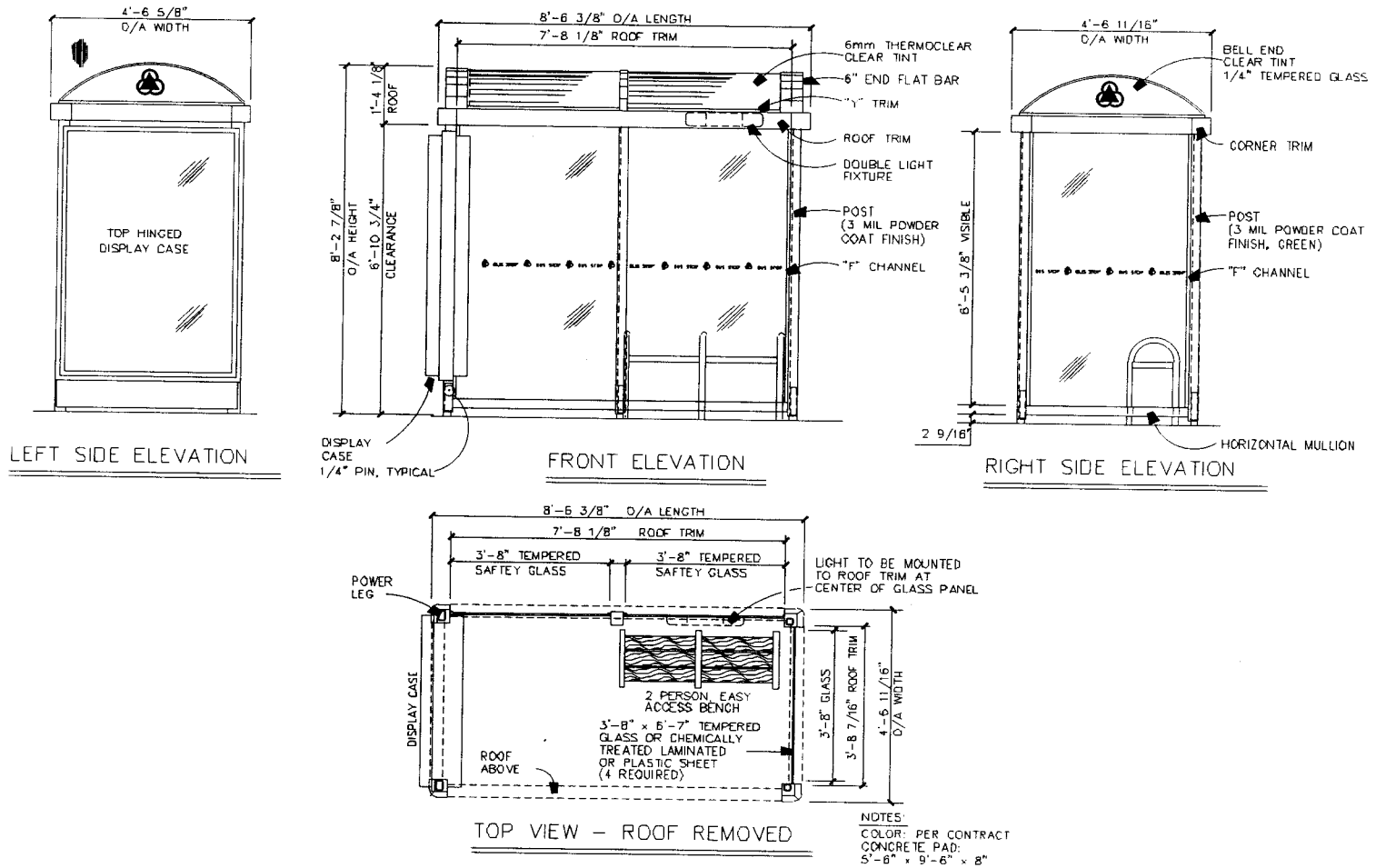

Type "B" Shelter With Display
 Figure 9

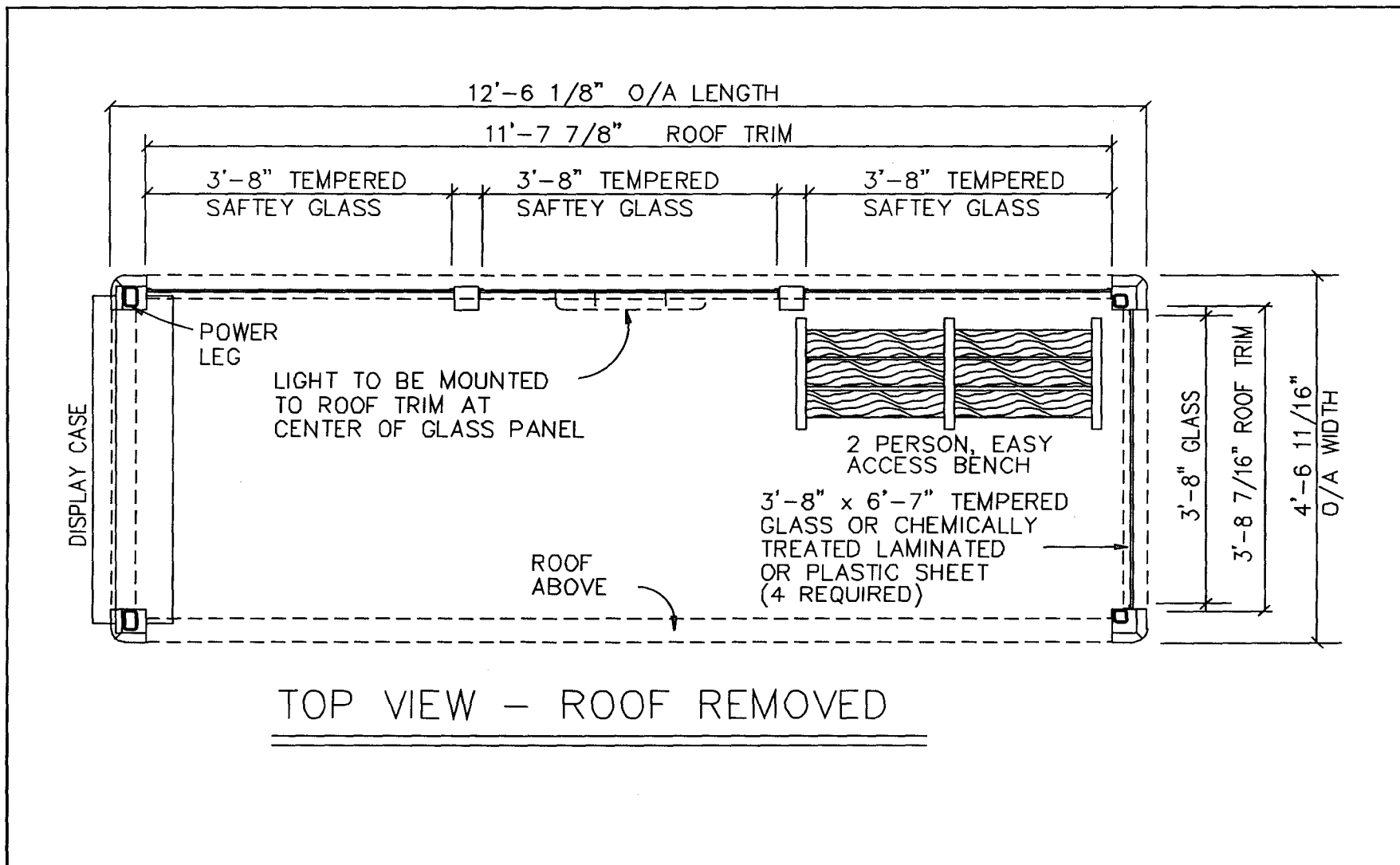

TType "BX" Shelter Without Display
Figure 10

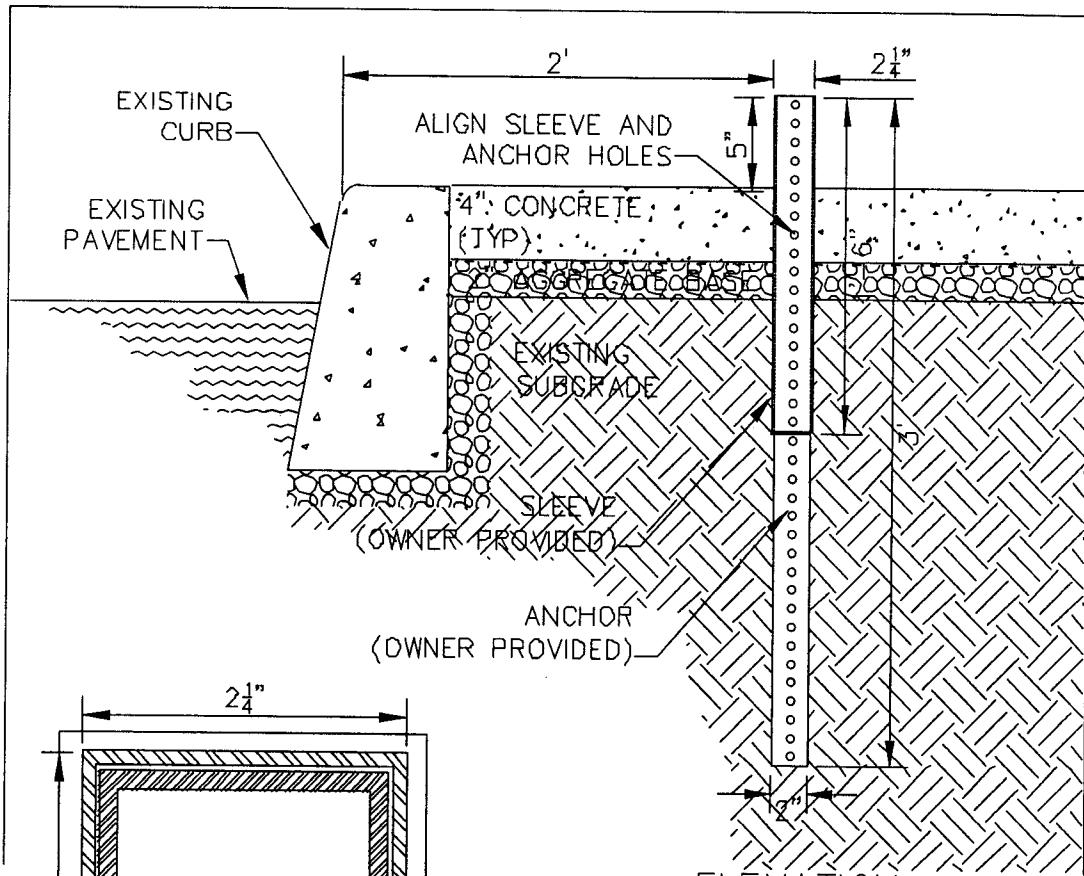

ELEVATION
SCALE: 1/2" = 1"

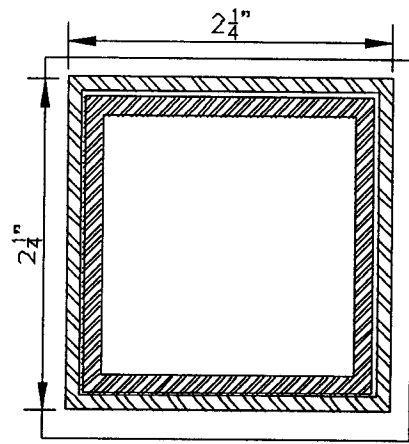

PLAN
SCALE: 1" = 1"

- NOTES:**
1. CONTACT DIANA ANDERSON AT (503) 962-4892 TO OBTAIN ANCHOR AND SLEEVE.
 2. EXCAVATE AND INSTALL ANCHOR AND SLEEVE PRIOR TO CONCRETE PLACEMENT.
 3. TIGHTLY WRAP ANCHOR AND SLEEVE WITH VISQUEEN PRIOR TO INSTALLATION.

Pole Anchor & Sleeve
Figure 11

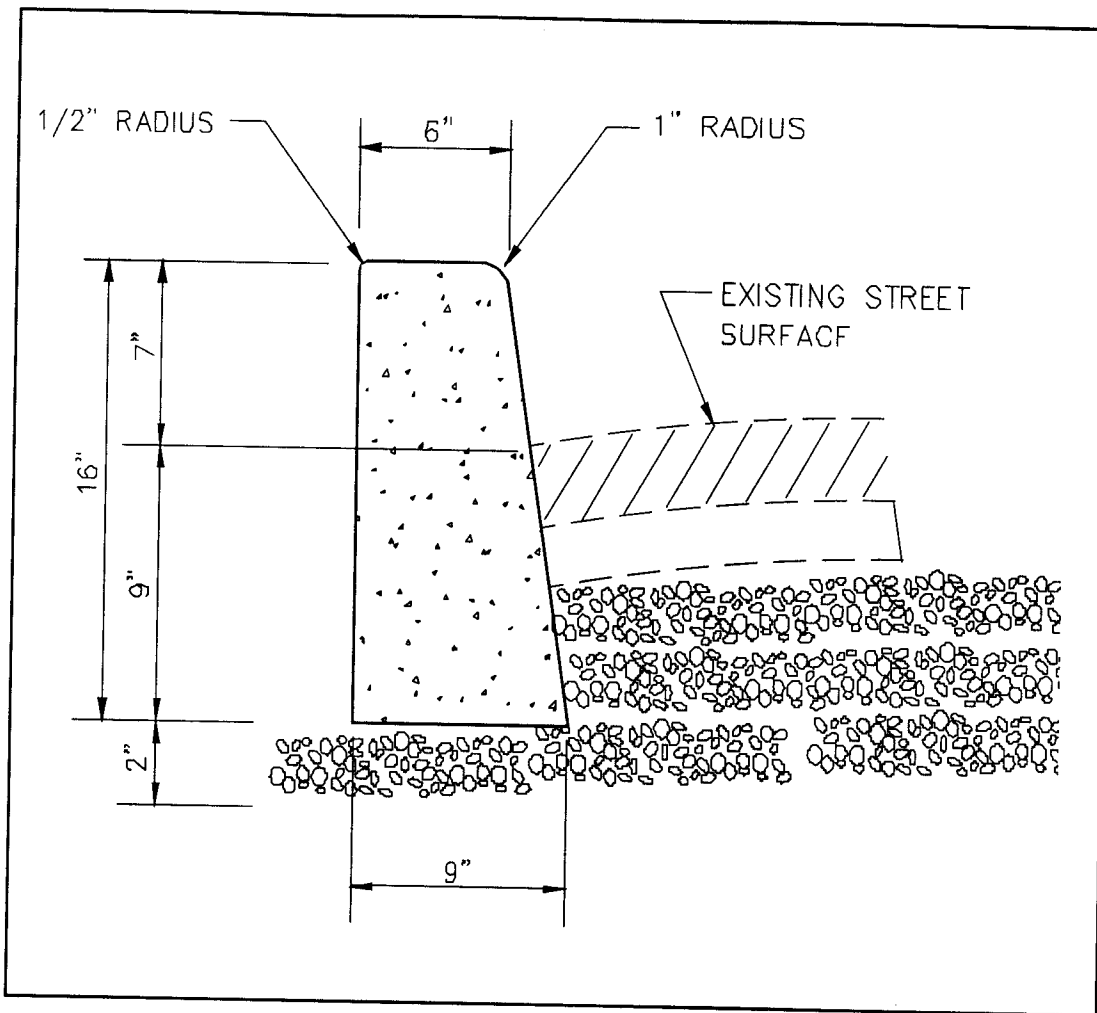

6" Curb
Figure 12

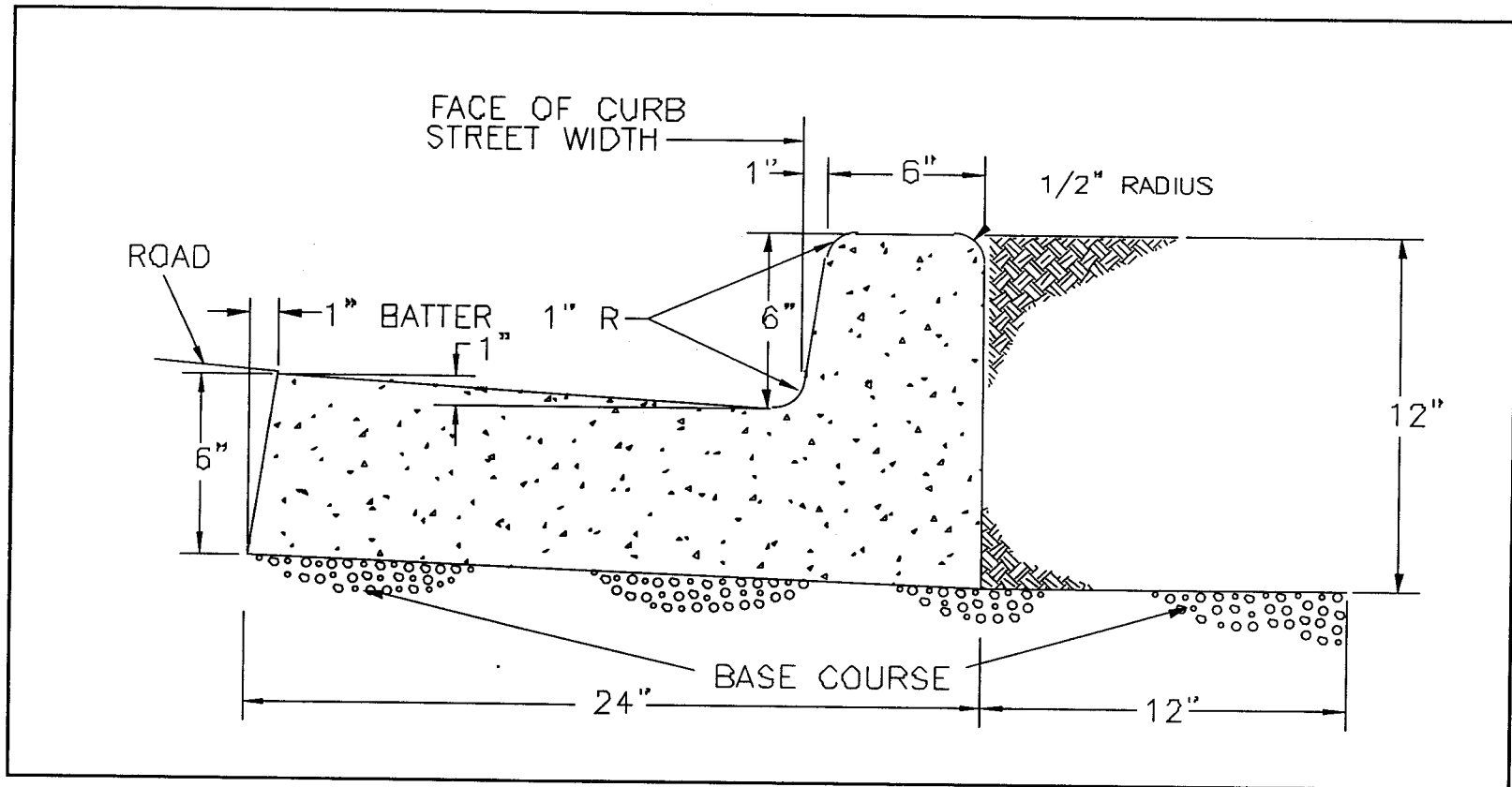

24" Curb & Gutter
 Figure 13

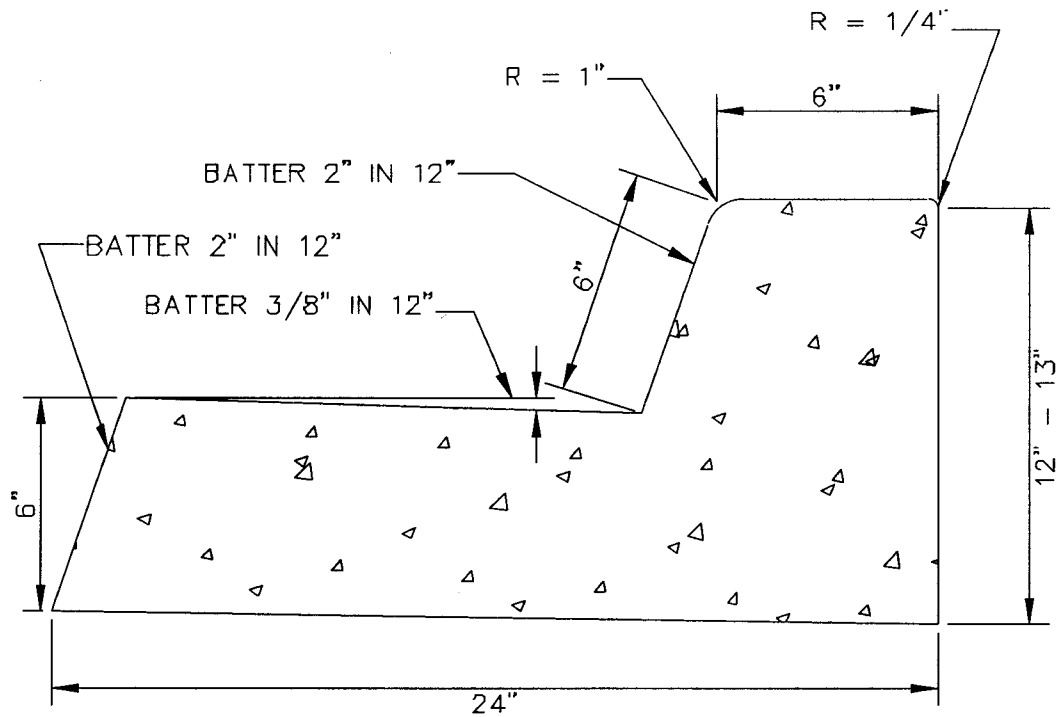

NOTES:

1. CURB TO BE CONSTRUCTED OF 3000 PSI (6.1 SACK) 2" - 4" SLUMP CONCRETE.
2. FOR COMMERCIAL/INDUSTRIAL AREAS USE 7" CURB EXPOSURE AND 13" TOTAL CURB HEIGHT.
3. TRANSVERSE CONTRACTION JOINTS TO BE CONSTRUCTED AT INTERVALS NOT TO EXCEED 12'.

24" Combination Curb & Gutter
Figure 14

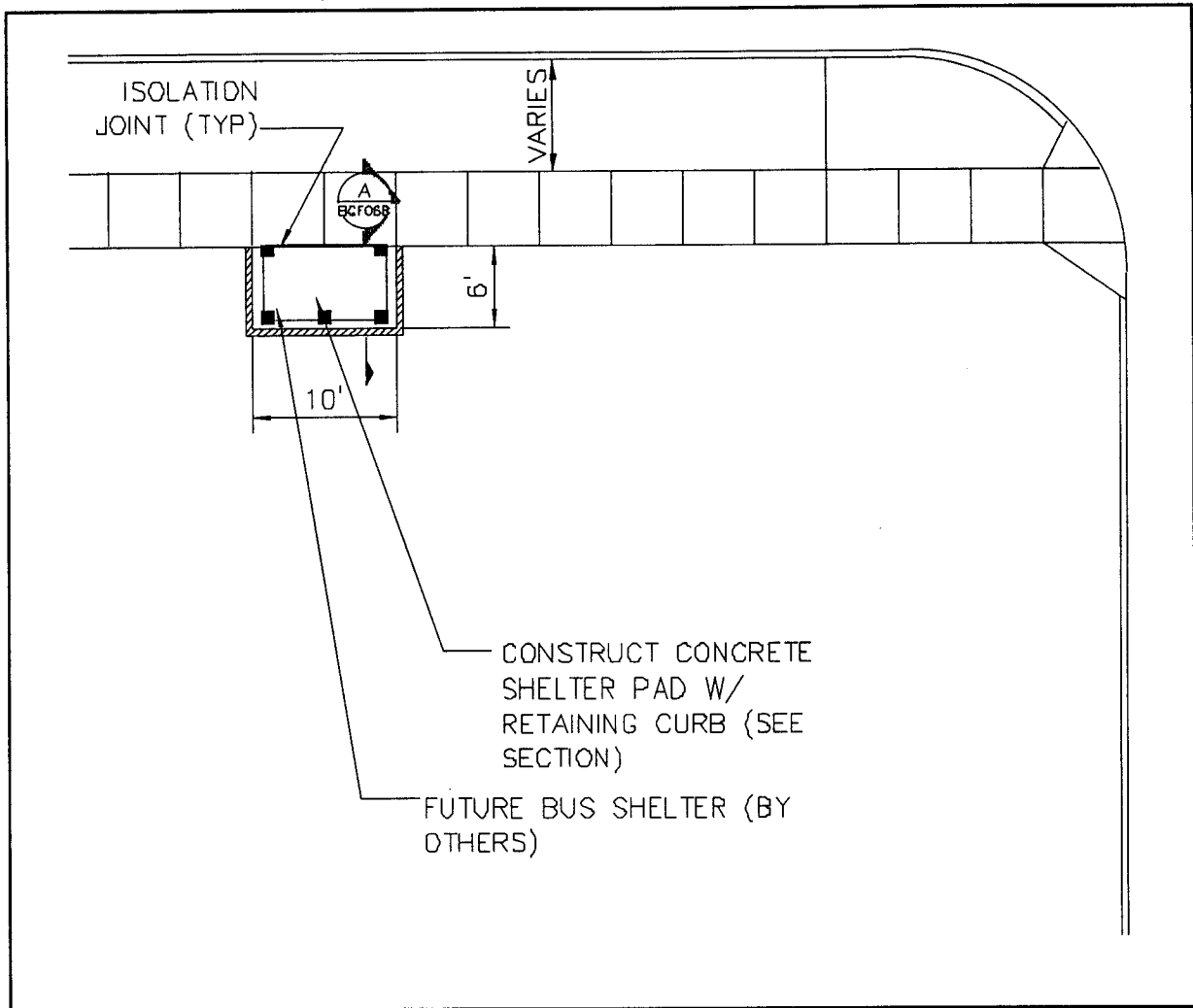

Retaining Curb
Figure 15

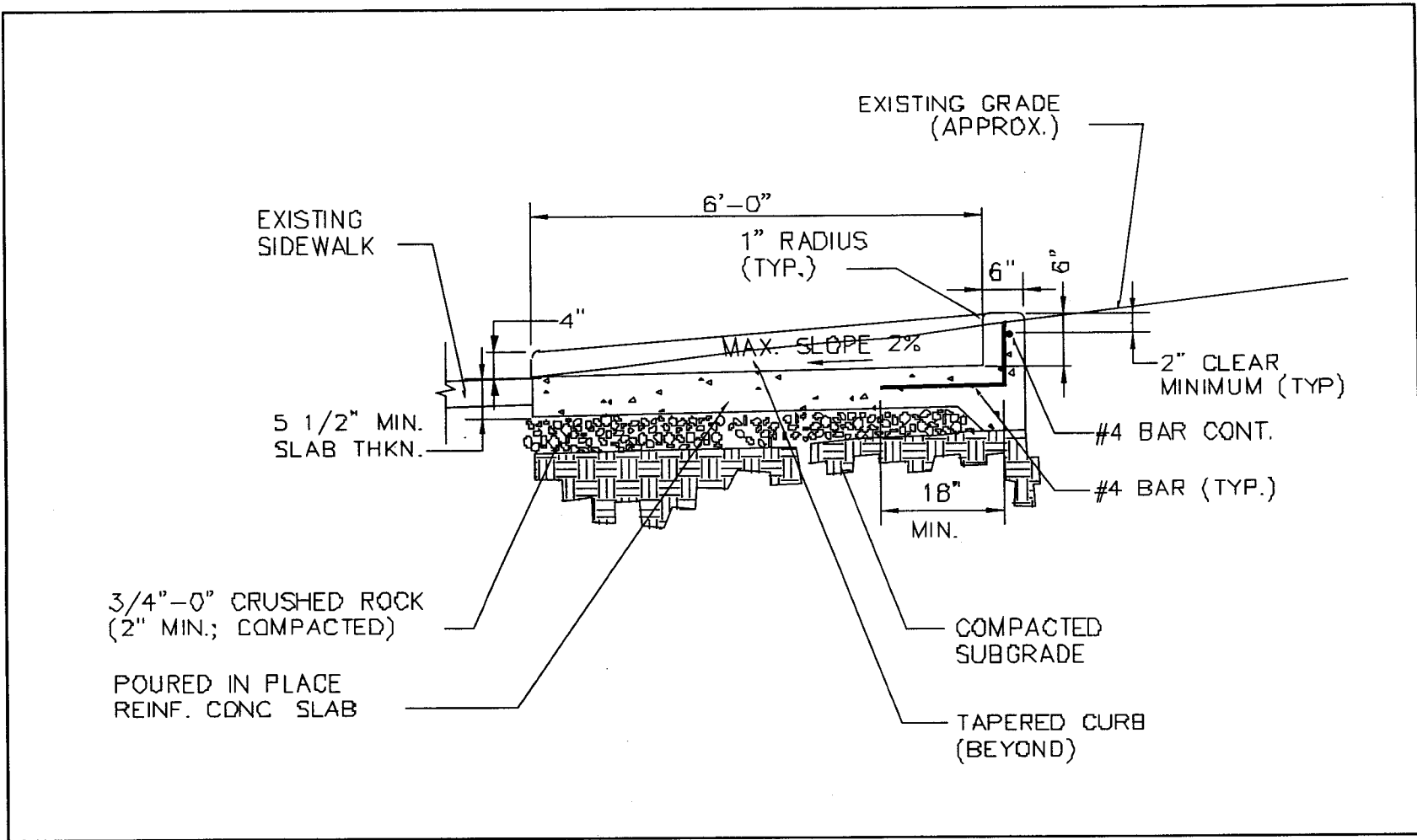

Retaining Curb
Figure 16

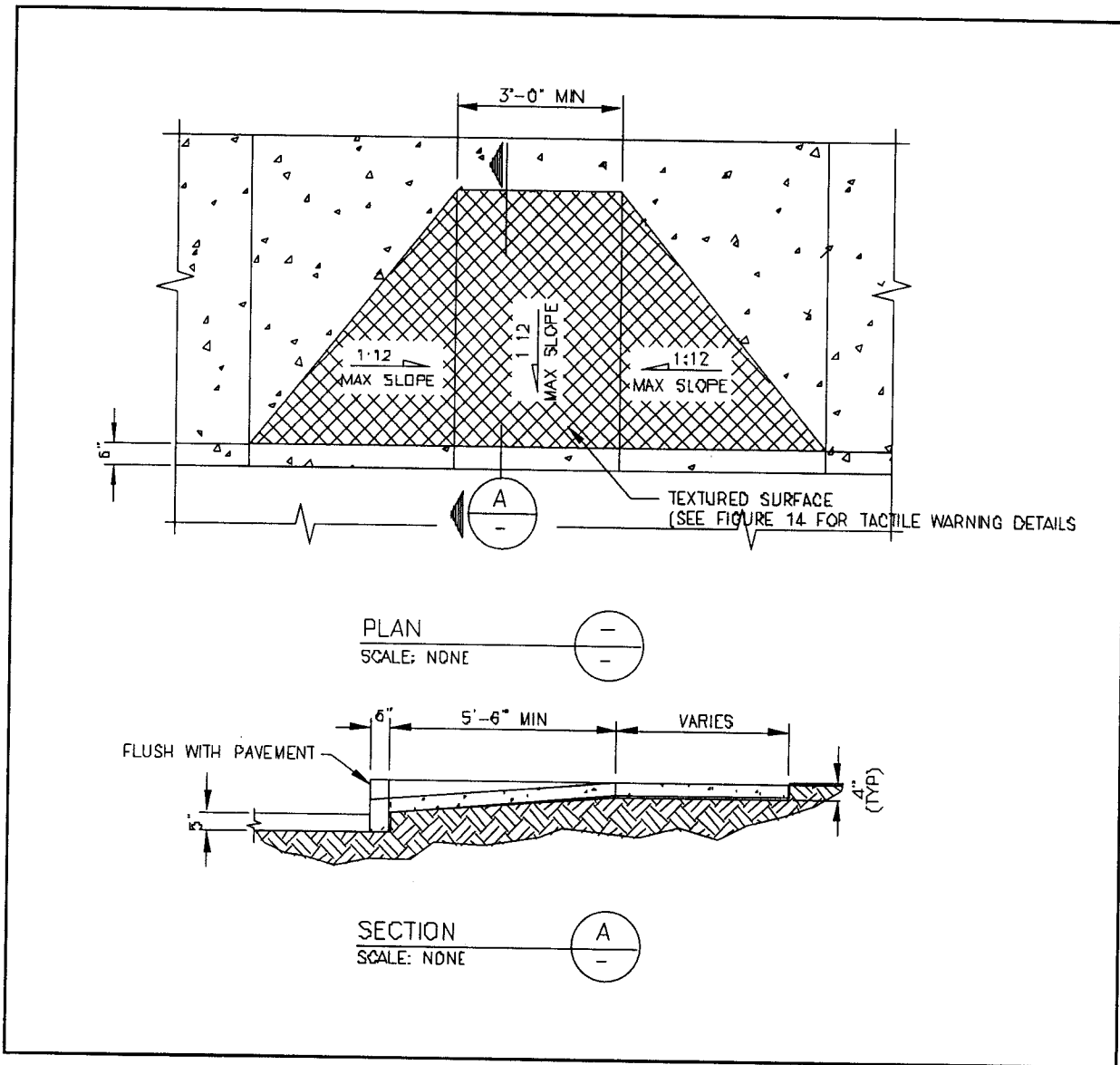

Curb Ramp
Figure 17

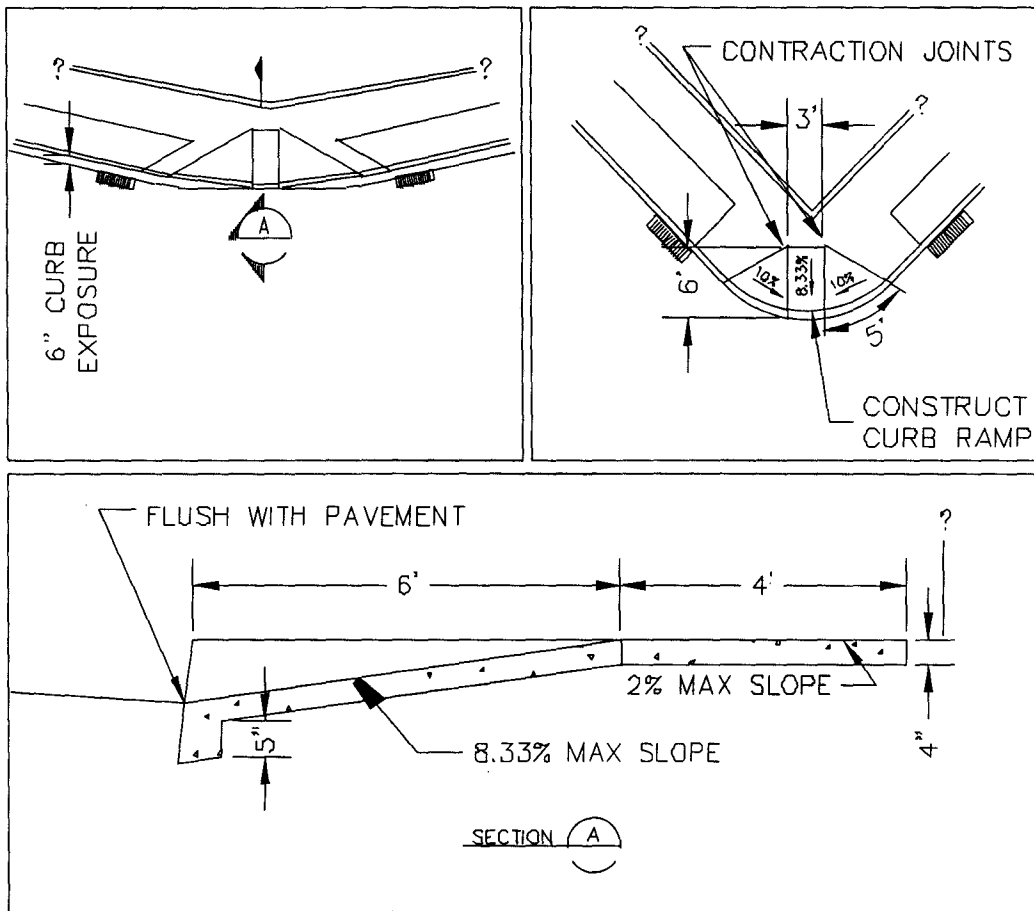

1. PROVIDE BRUSH TEXTURE AND DIAMOND TEXTURE ON RAMP AS REQUIRED BY LOCAL JURISDICTION.
2. USE 3000 PSI CONCRETE WITH 2" TO 4" SLUMP.
3. SAWCUT A MINIMUM OF 2' FROM CURBFACE AND REPLACE PAVEMENT SECTION WITH CLASS 'B' AC IN 2" LIFTS TO MATCH EXISTING.
4. PLACE CONTRACTION JOINTS AS SHOWN ABOVE

Diagonal Curb Ramp
Figure 18

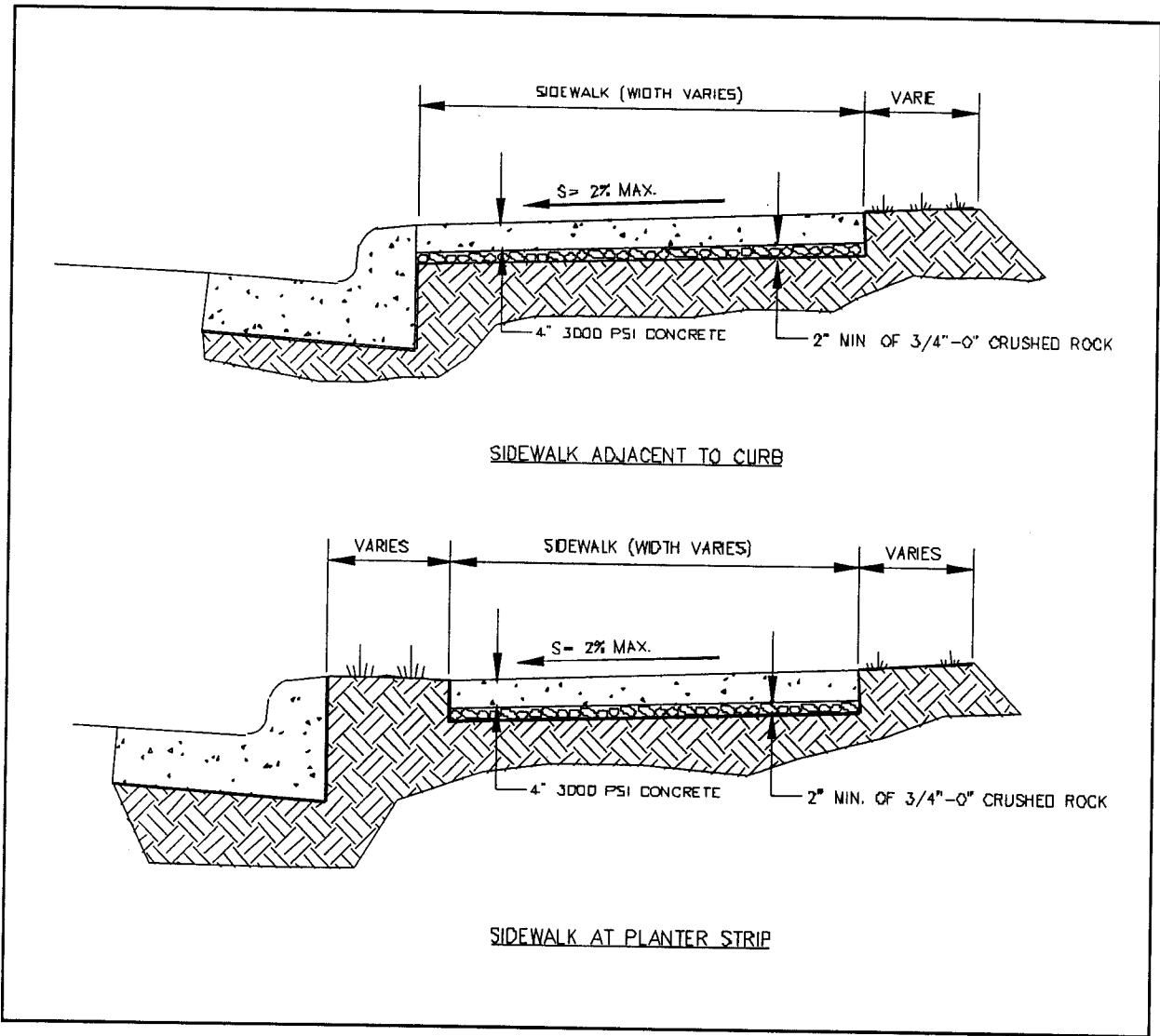

4" Sidewalk
Figure 19

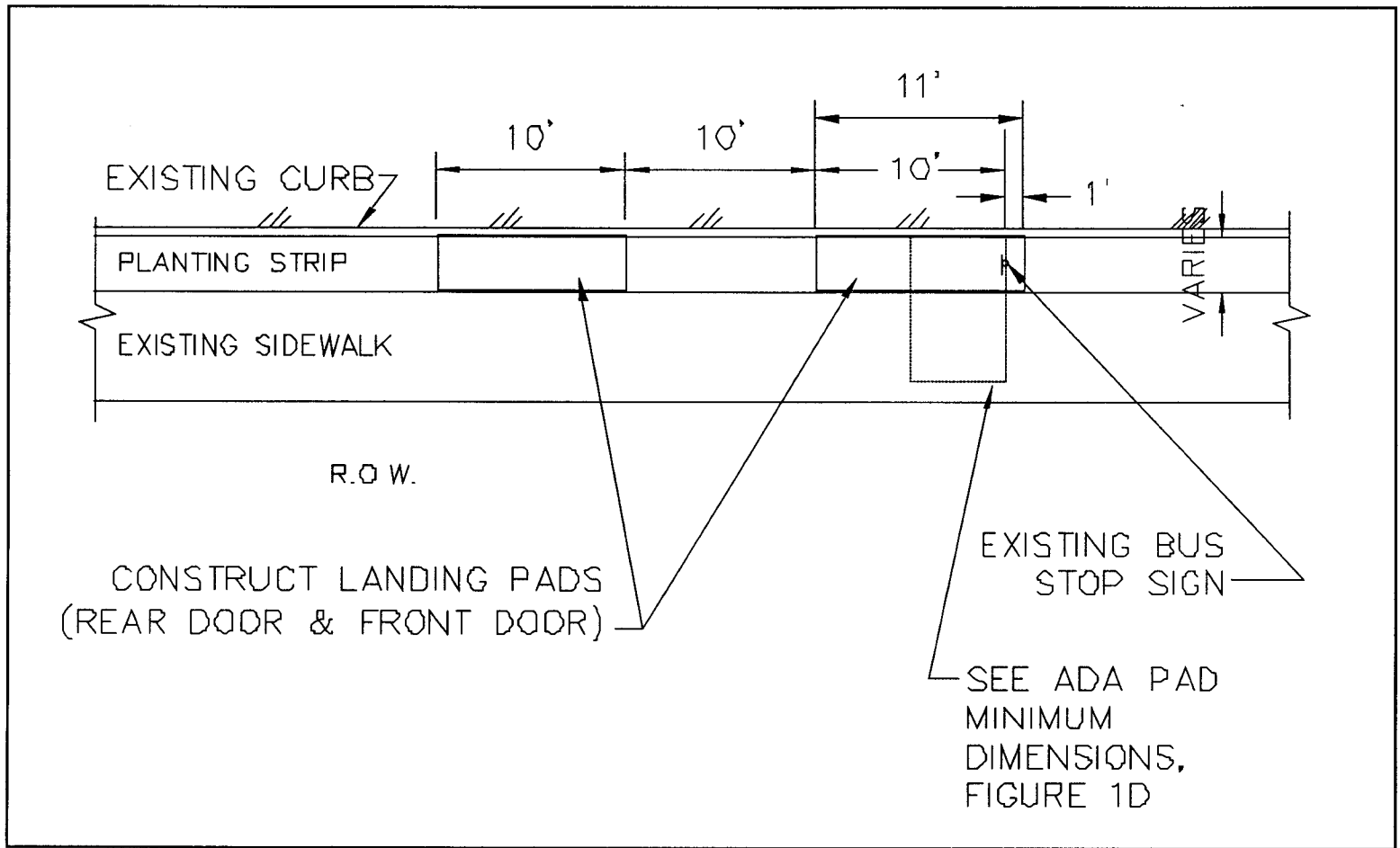

Front & Rear Door Landing Pads
Figure 20

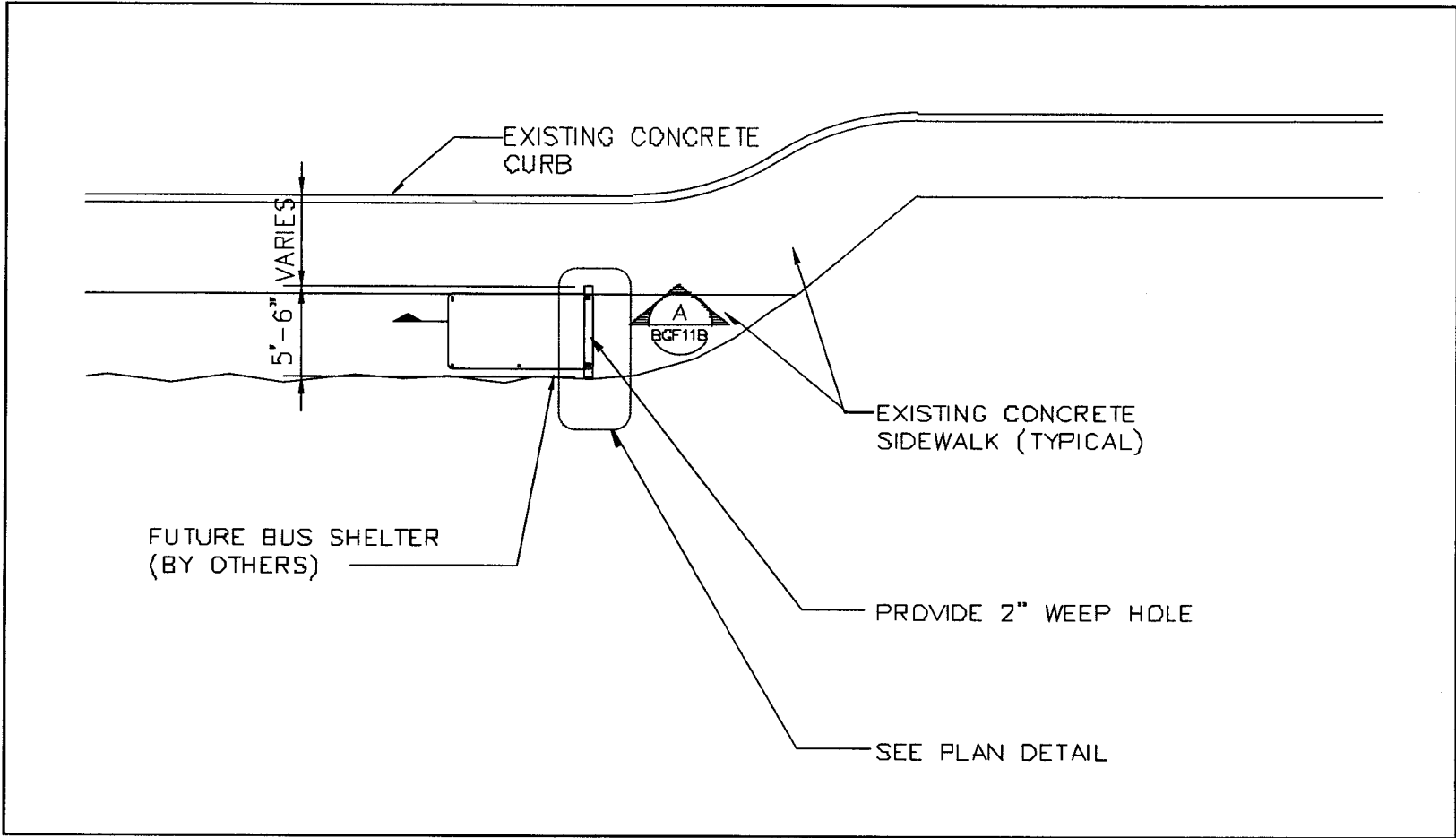

Leveling Pedestal
Figure 21

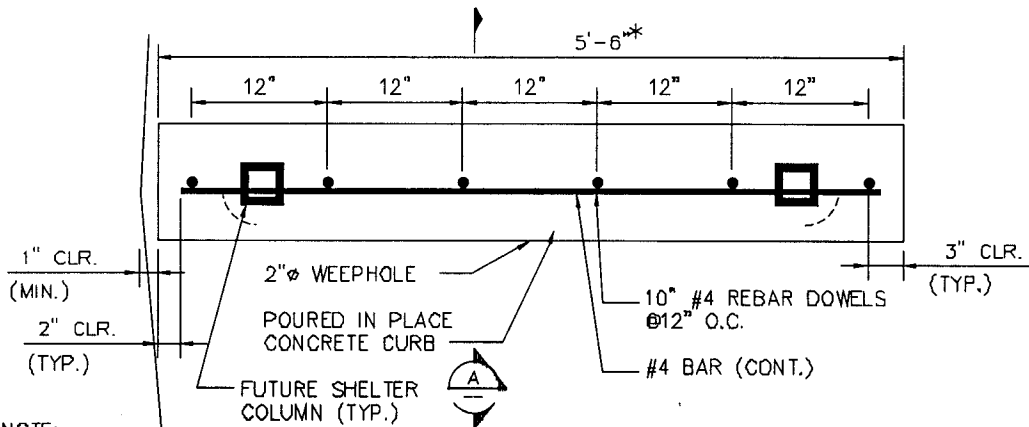
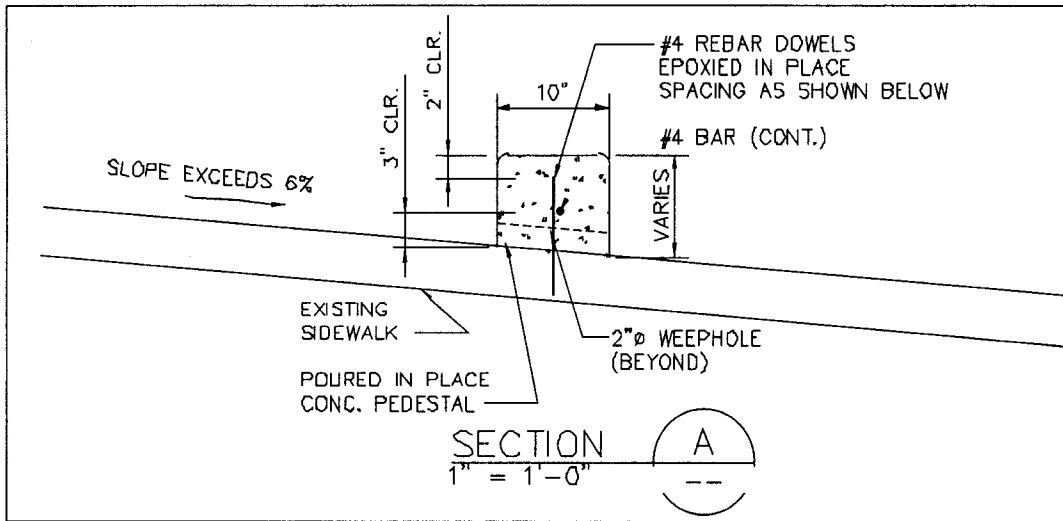

* NOTE:
 LENGTH OF PEDESTAL SHOWN IS
 FOR TYPE B & BX SHELTERS.
 PEDESTAL LENGTH FOR TYPE A IS 3'-3"

PLAN DETAIL
 SCALE: 1" = 1'-0"

Leveling Pedestal
 Figure 22

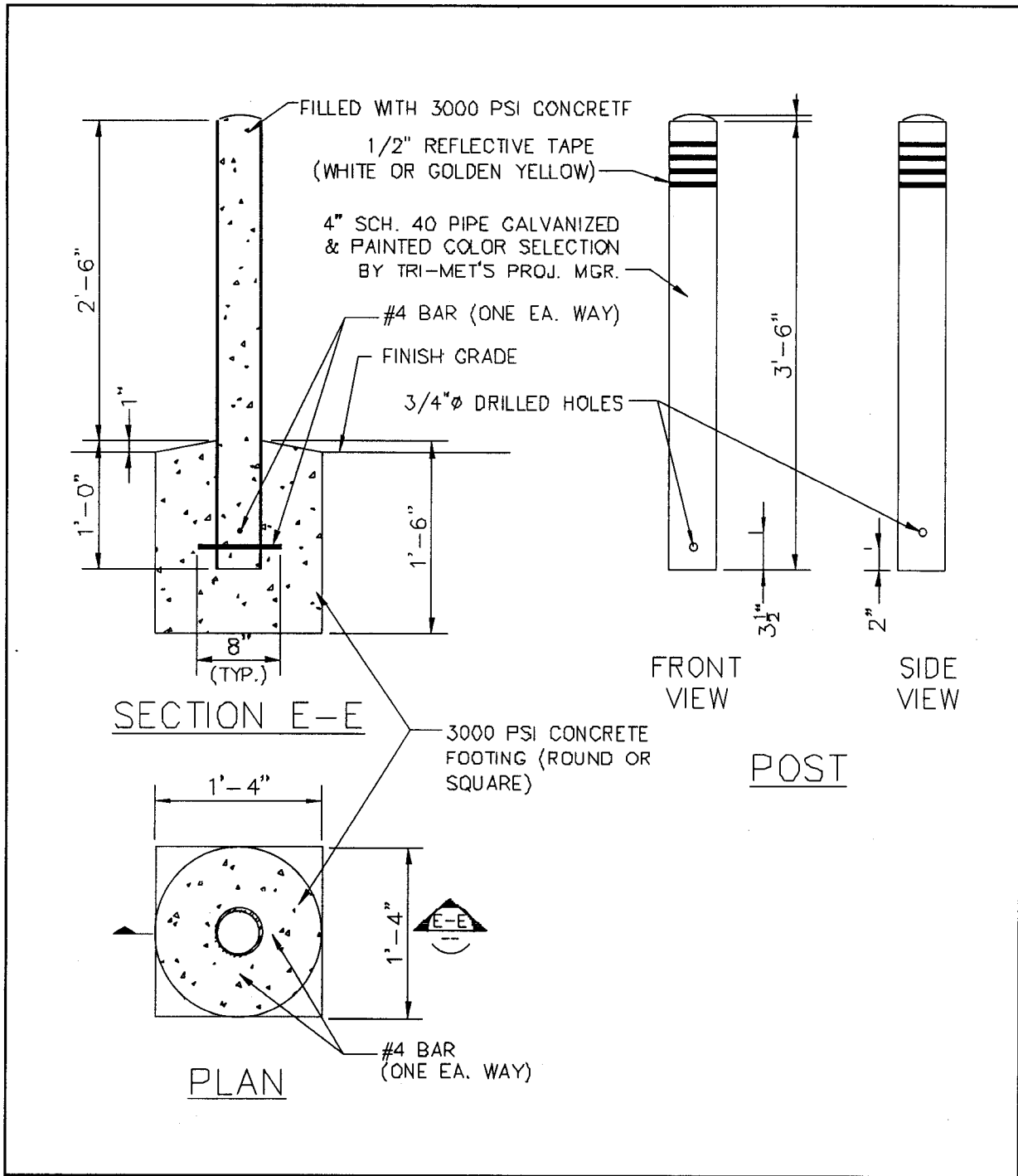

Bollard
 Figure 23

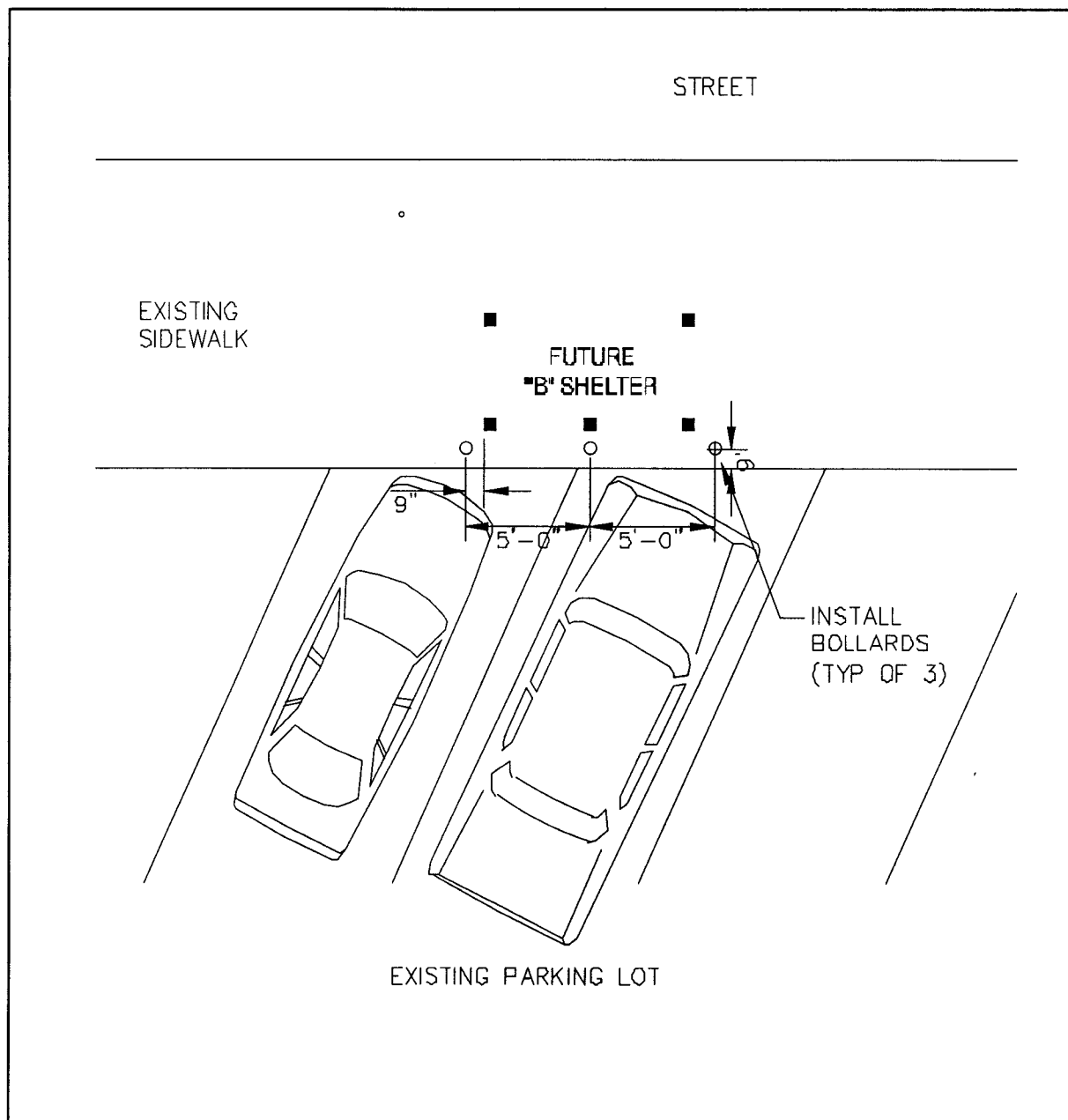

Bollard Installation
Figure 24

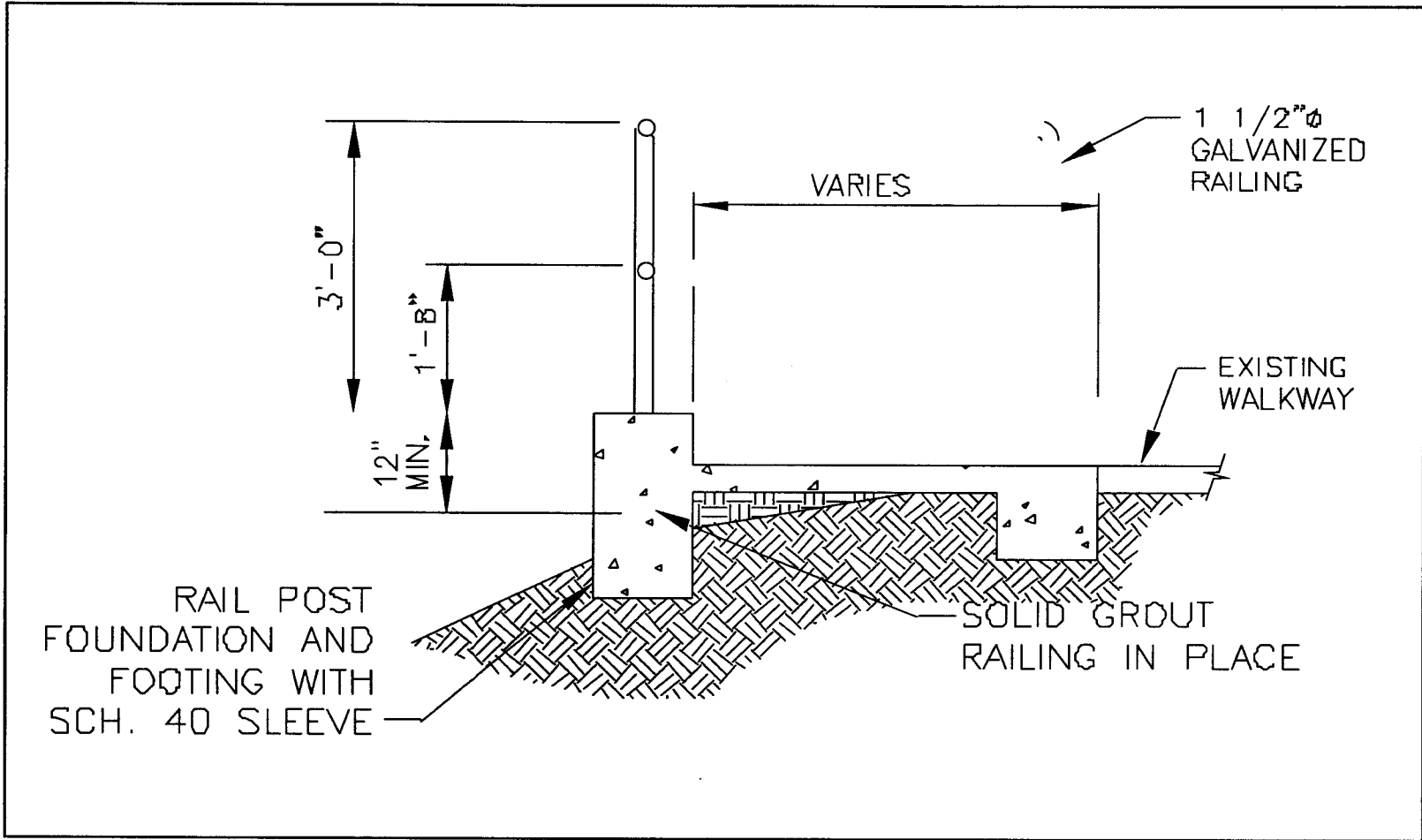

Railing
 Figure 25

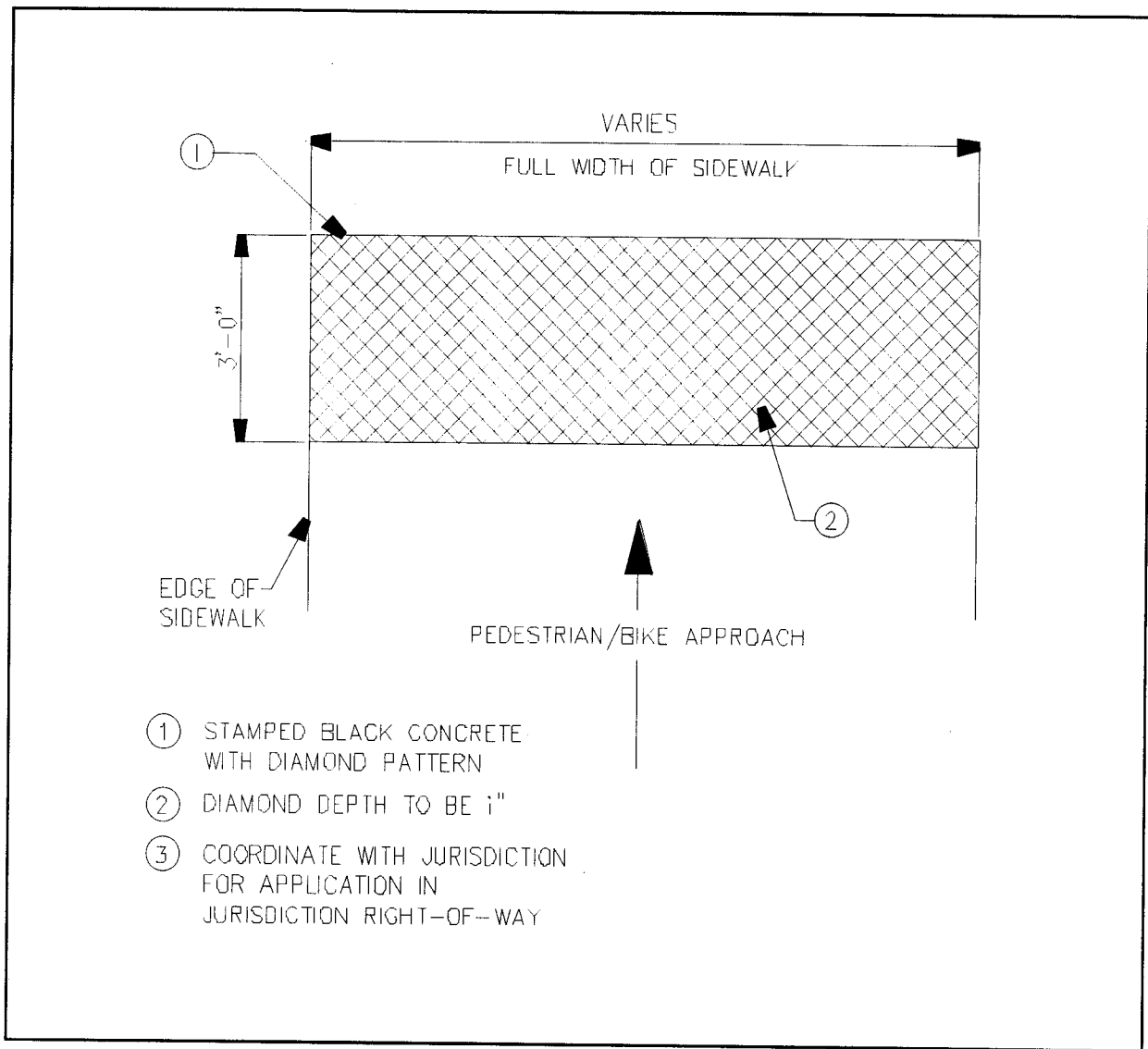

Tactile Warning
Figure 26

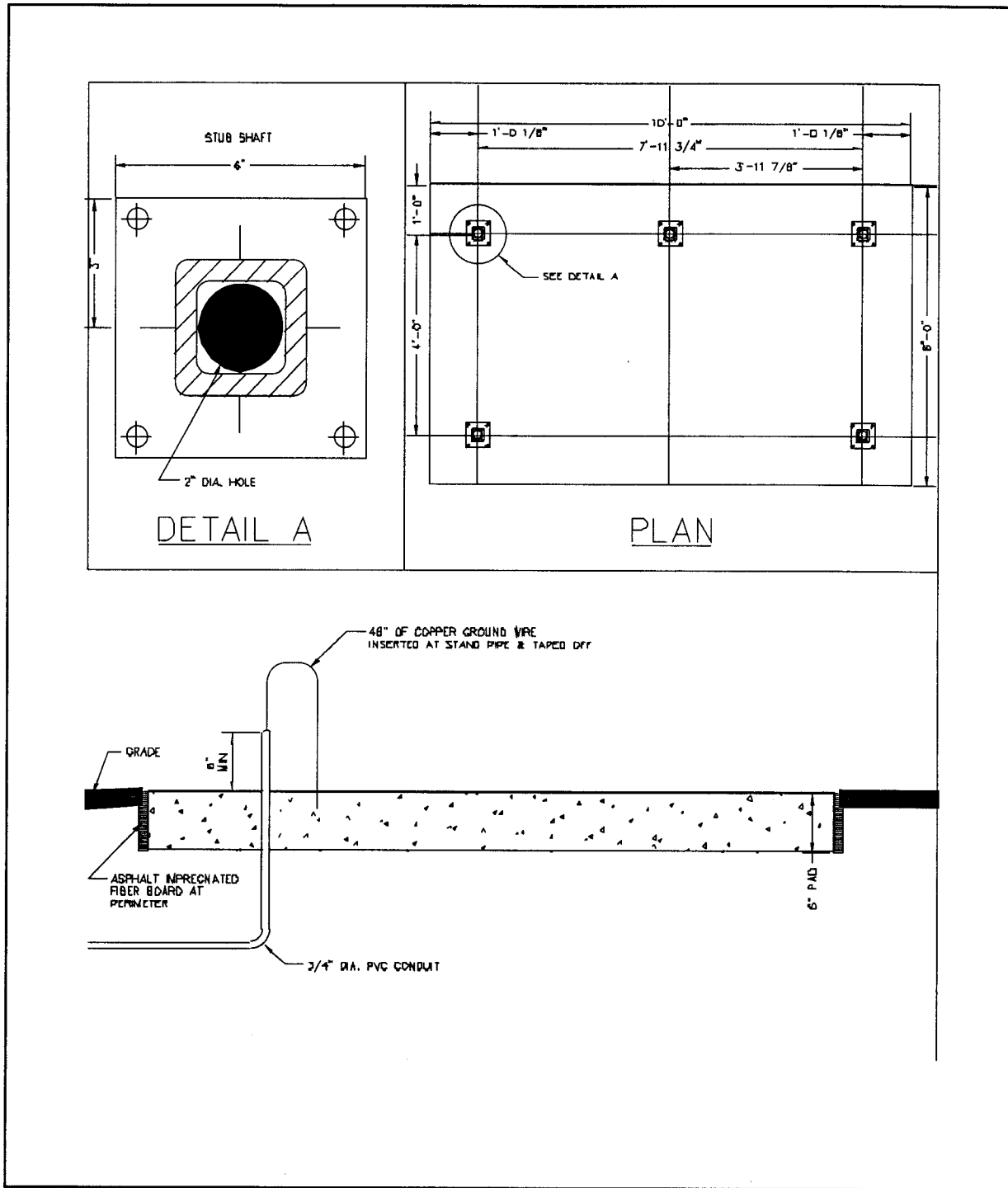

Shelter Pad Conduit Location
Figure 27

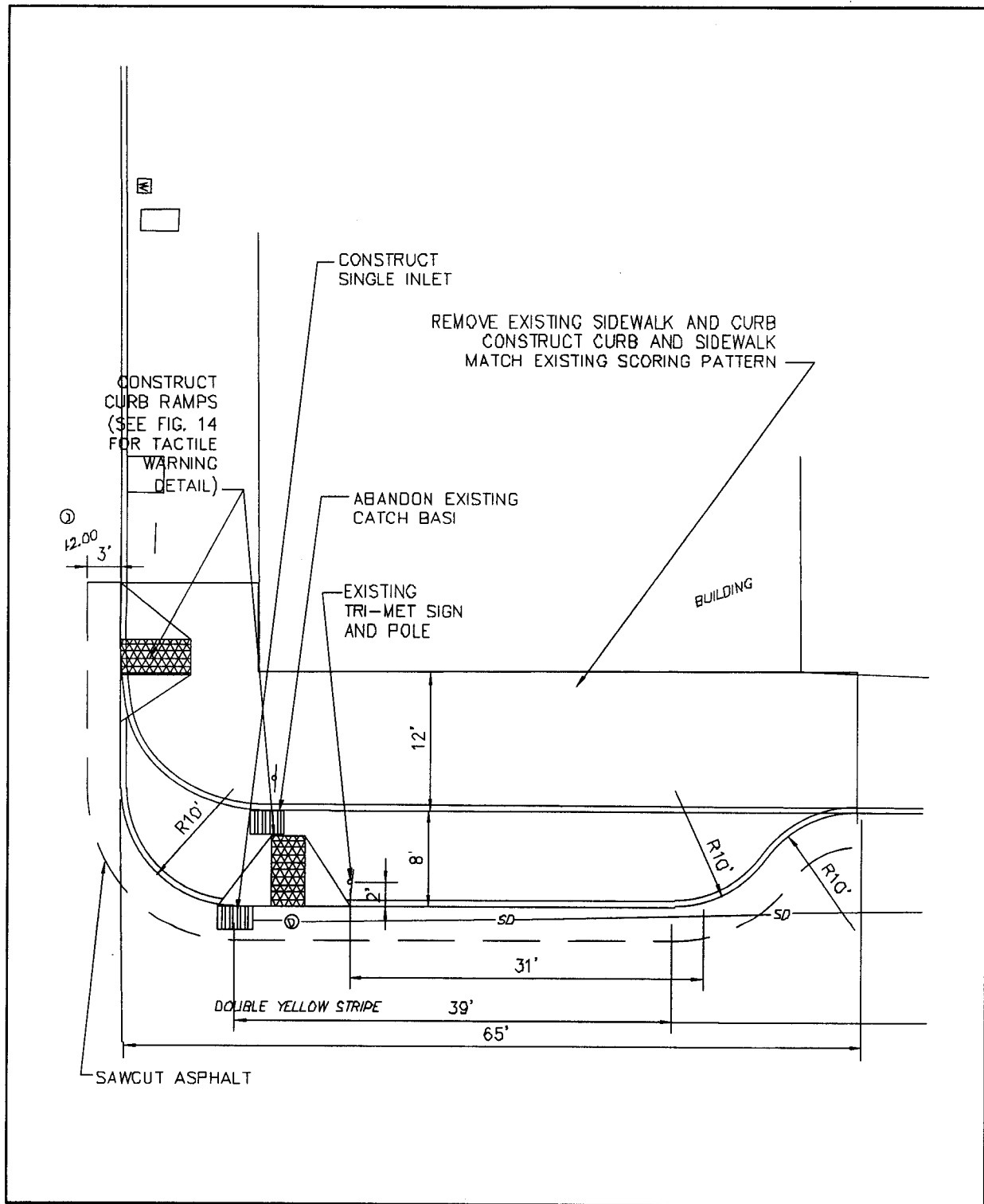

Full Curb Extension
 Figure 28

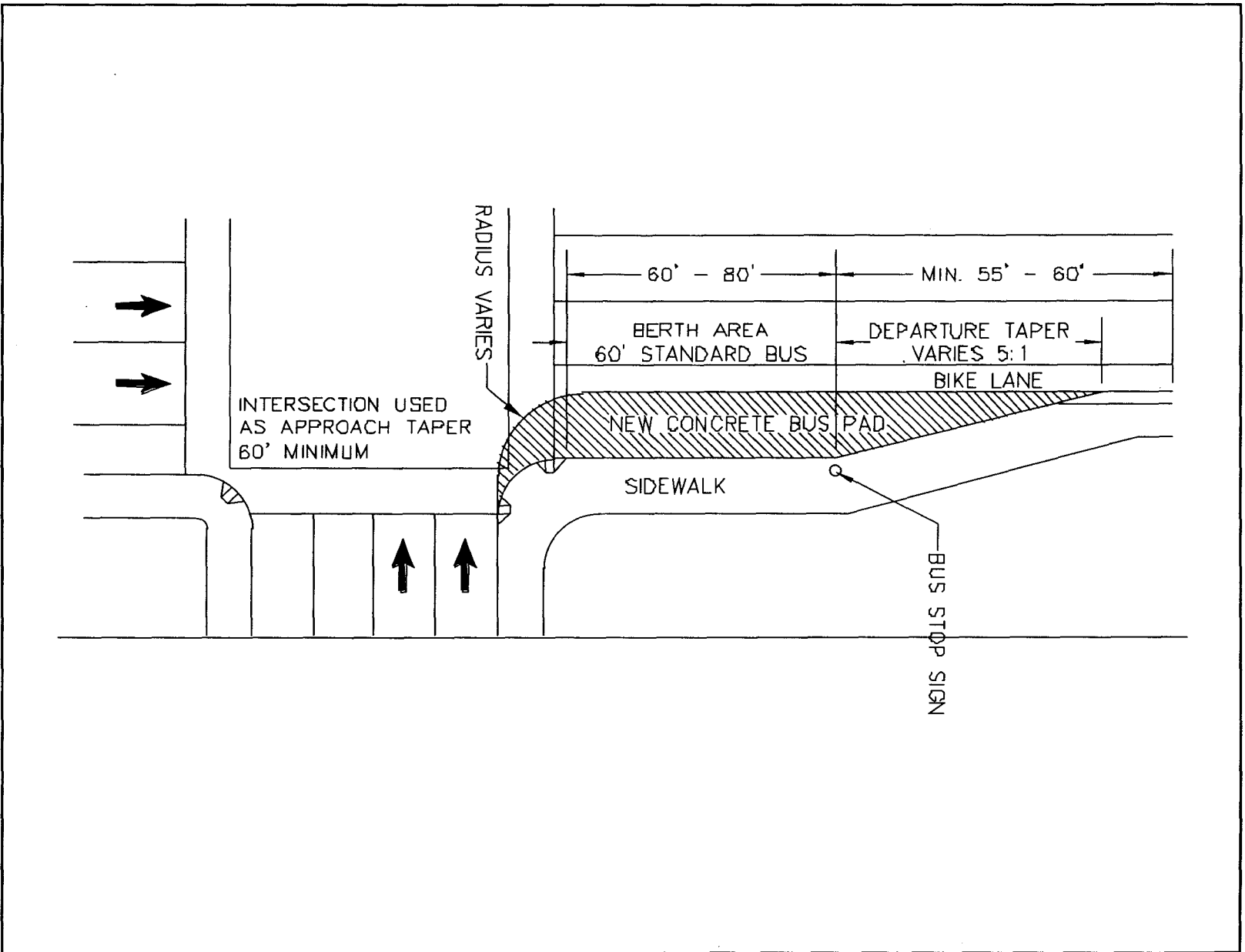

Bus Pull Out & Bus Pad
 Figure 29

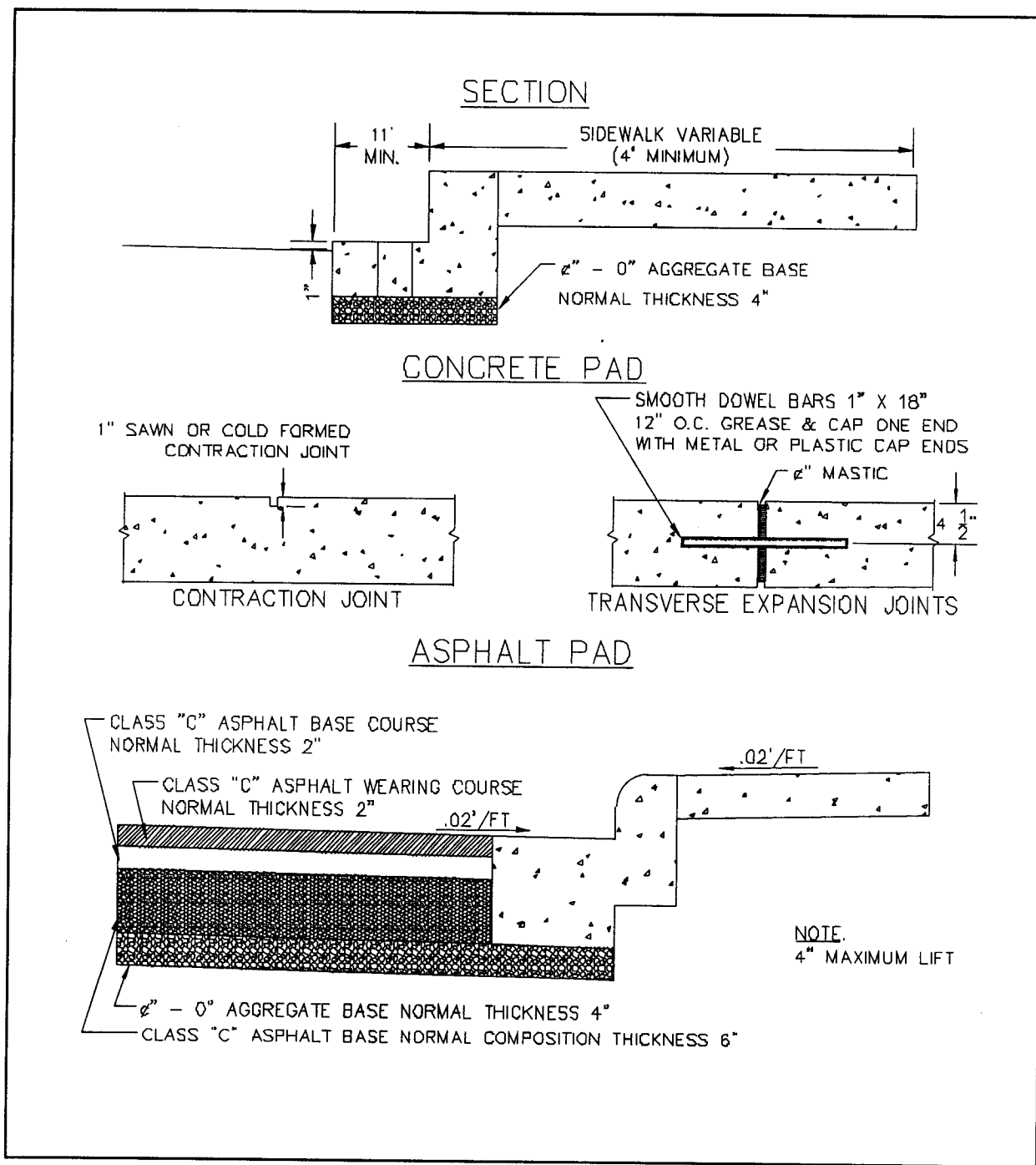

Bus Pad Section
Figure 30

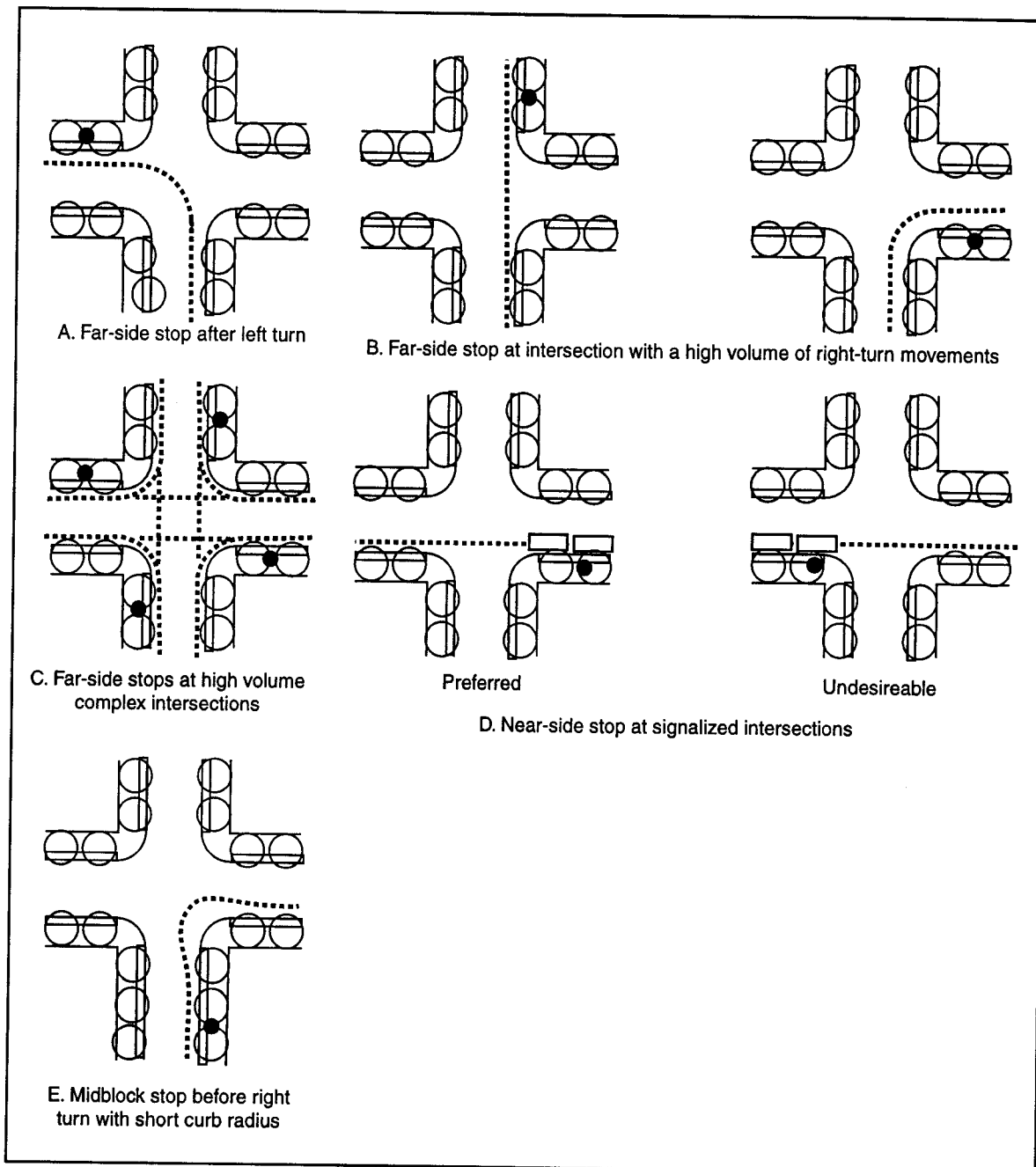

Stop Locations
Figure 31

Undesirable Driveway Arrangements

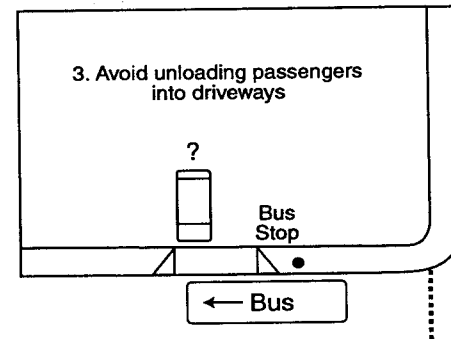
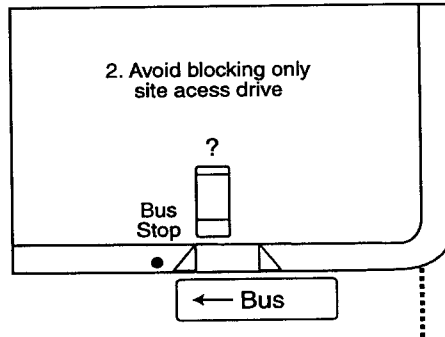
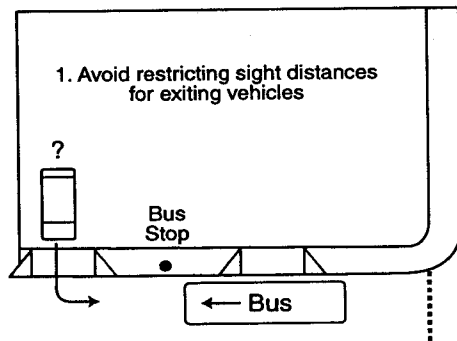

Acceptable Driveway Arrangements

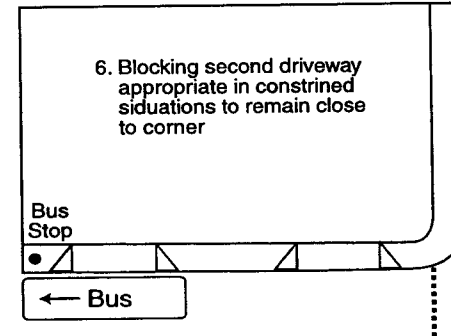
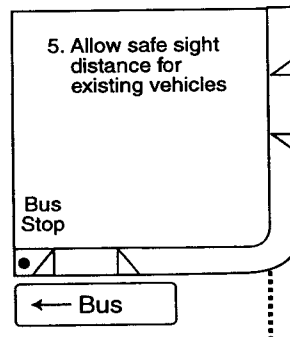
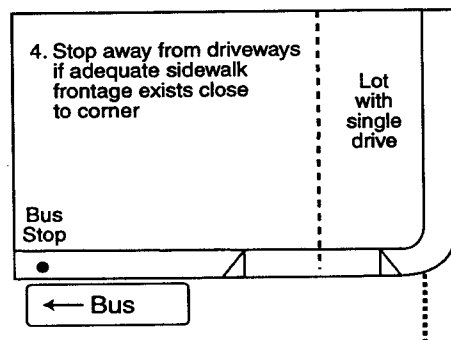

Driveway Locations near Bus Stops
Figure 32

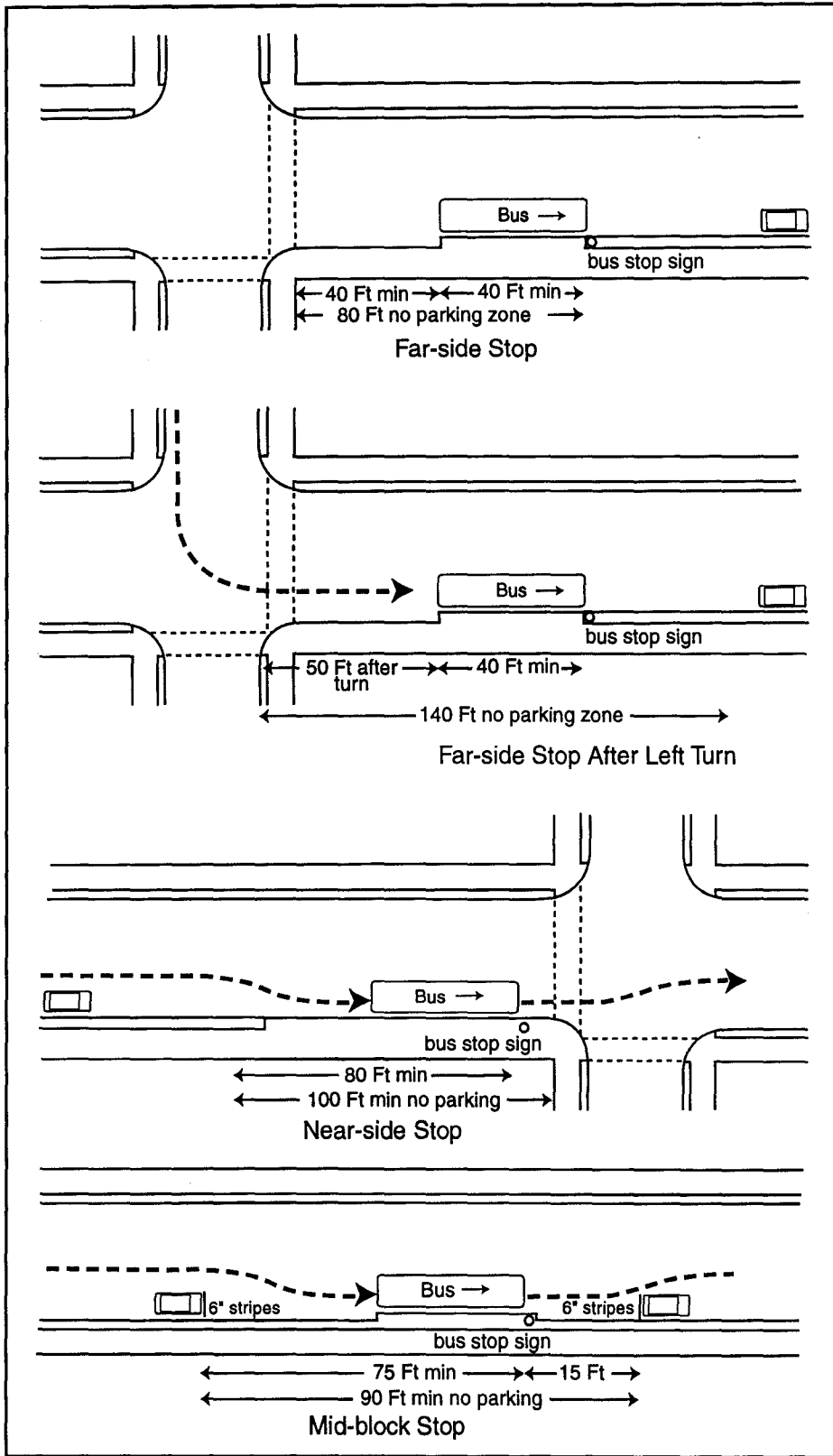

Recommended Bus Stop/Zone Placement
Figure 33

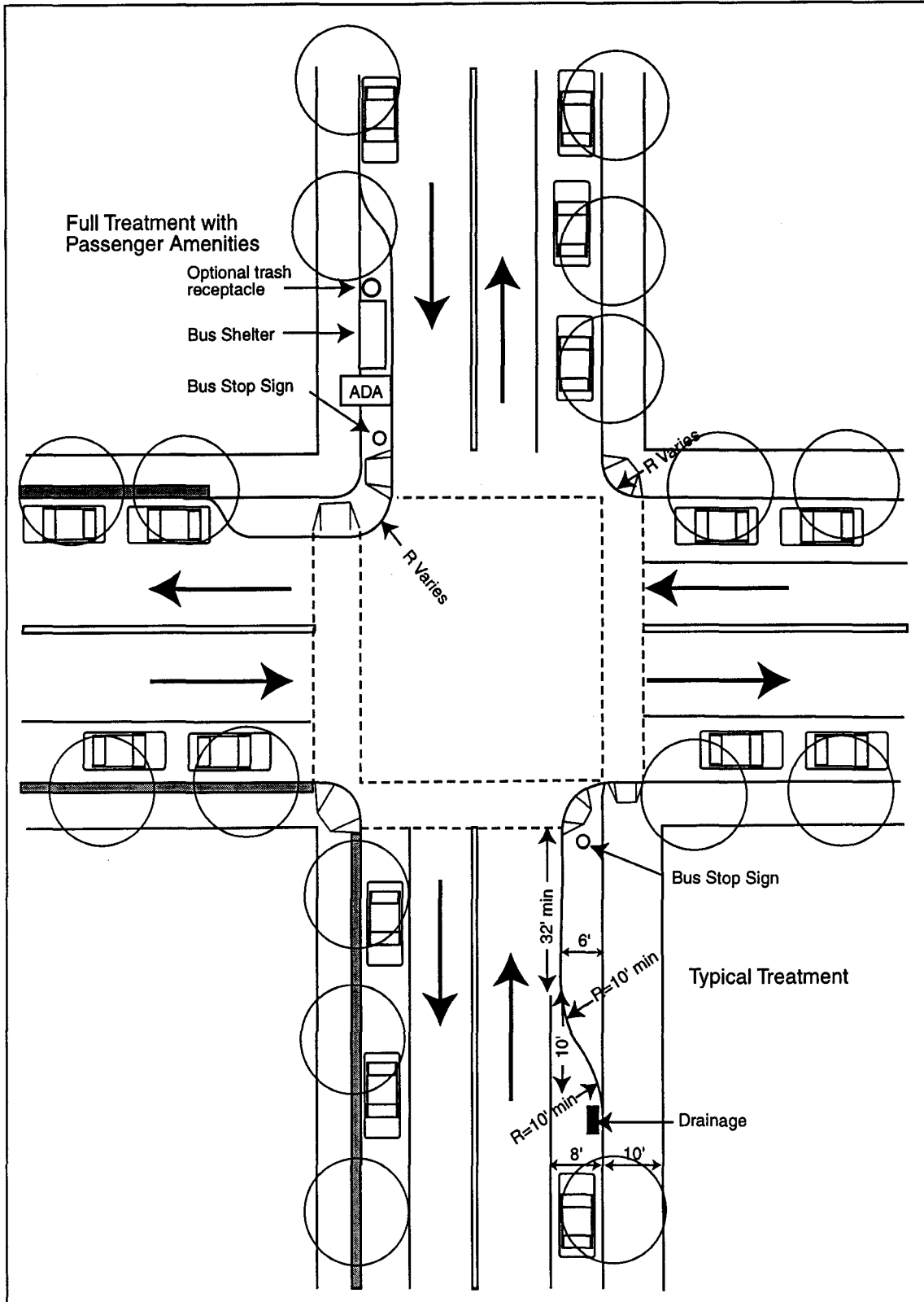

Curb Extension Treatment
Figure 34

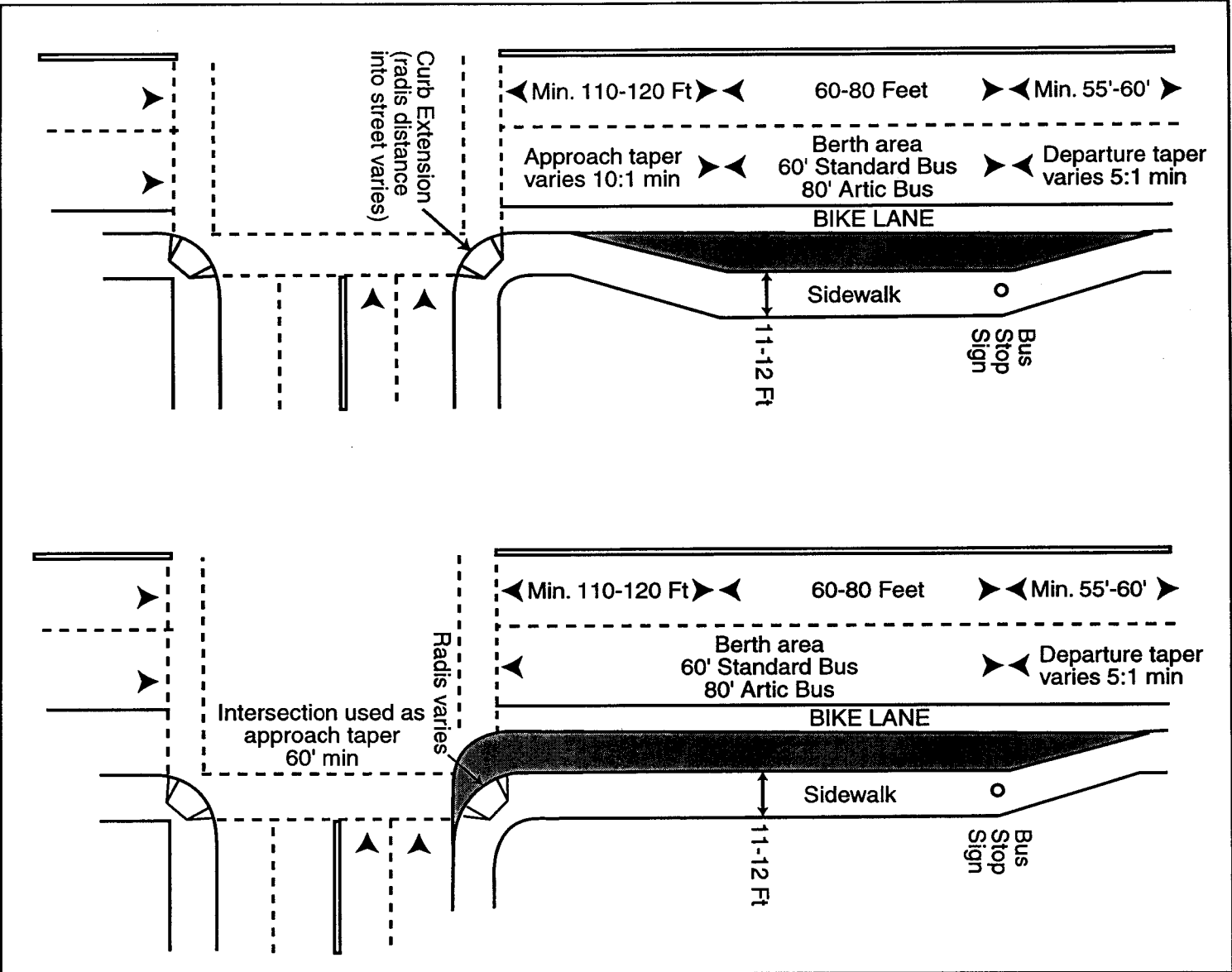

Bus Pullout Design Options
Figure 35