

# TDEs with LSST

Katja Bricman

Center for Astrophysics and Cosmology  
University of Nova Gorica

Gaia Science Alerts Workshop, Vipava, October 9<sup>th</sup>, 2018



# Tidal Disruption Events

- Disruption of a star by a supermassive black hole
  - Flares from quiescent galaxies
- To date ~ 70 candidates.



# Observational signatures

- $M_{\text{peak}} \approx -18$  to  $-20$  mag
- Blue ( $g - r \approx -1.0$ )
- Luminosity  $\propto t^{-5/3}$
- Decline: months to years

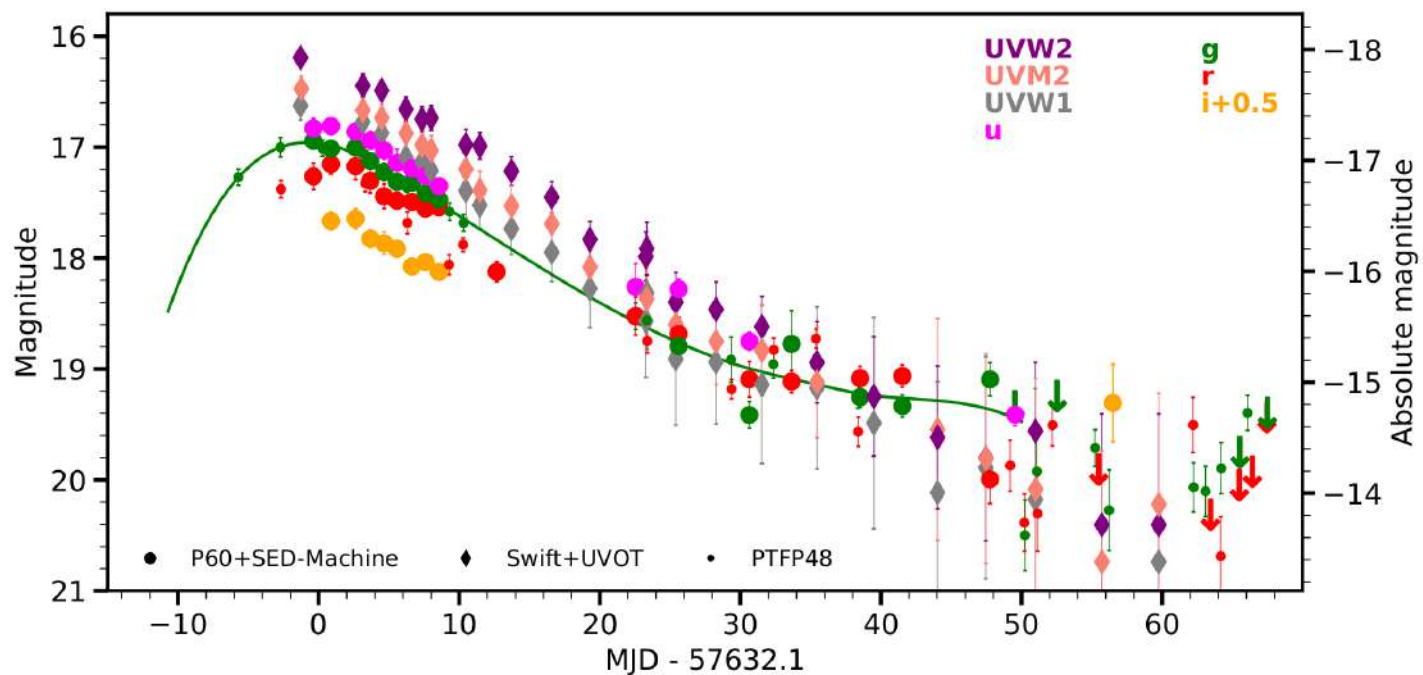
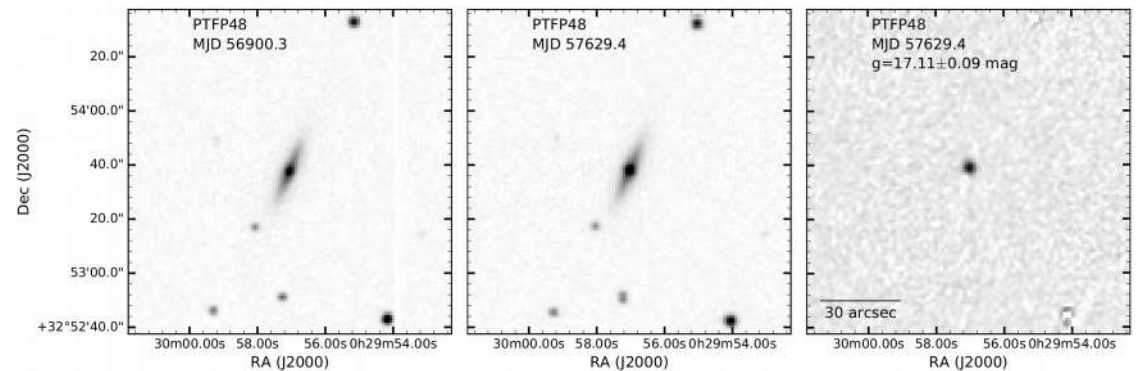

# MOSFiT

- The Modular Open Source Fitter for Transients
  - ◆ Semi-analytical model
- MCMC fitting based on hydrodynamical simulations of TDE fallback rate

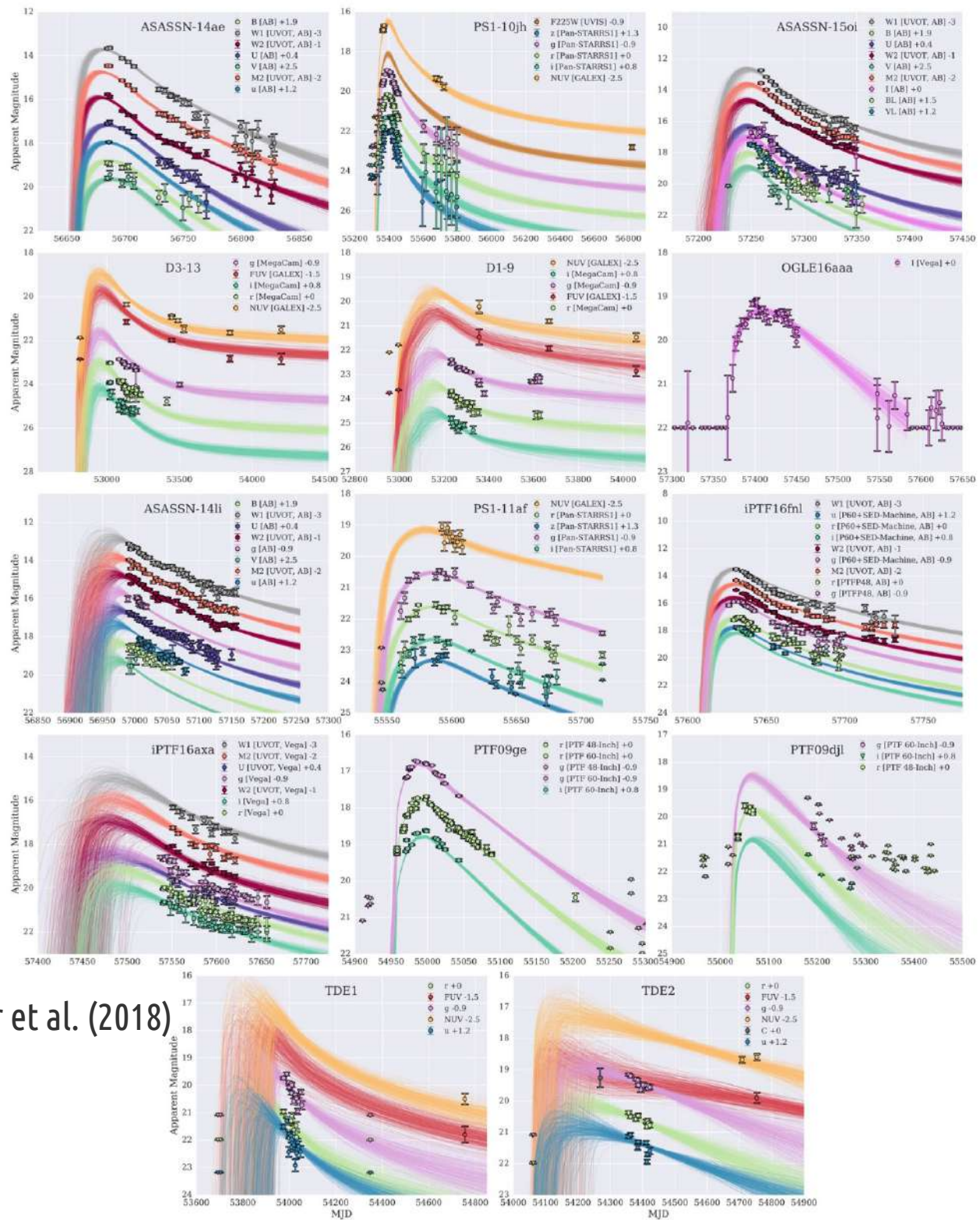

Mockler et al. (2018)

# Rare events with many impostors

- Rare events → large surveys needed (LSST)
- Main sources of contamination: Type Ia SNe

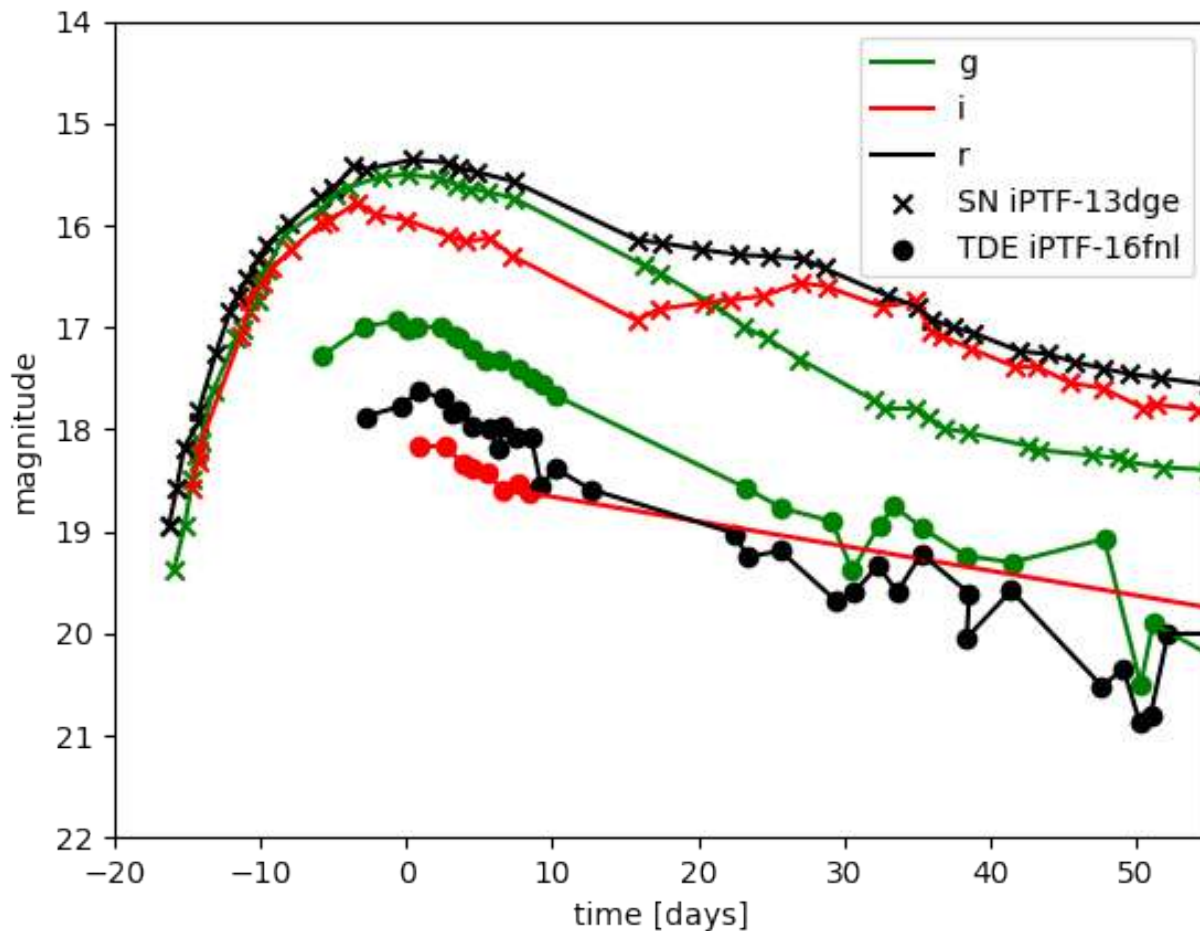

Classification ASAP  
after the first  
observation is crucial!



# Large Synoptic Survey Telescope (LSST)



Status: June 2018

# Technical details

- 10000 deg<sup>2</sup> per night
- Total observing area: 18000 deg<sup>2</sup>
- FOV 9.6 deg<sup>2</sup>
- Primary mirror 8.4 m in diameter
- 3.2 Gpx camera
- 6 optical bands (ugrizy)
- Magnitudes up to 24.5 in a single exposure, 27.5 in co-added images
- Transient classification in 60s

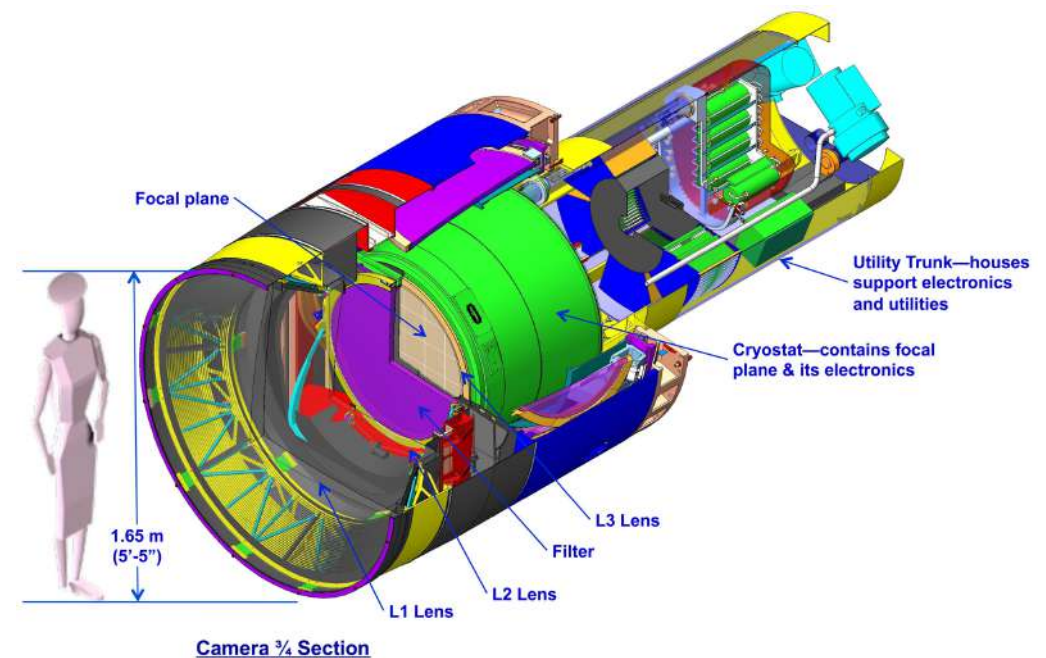
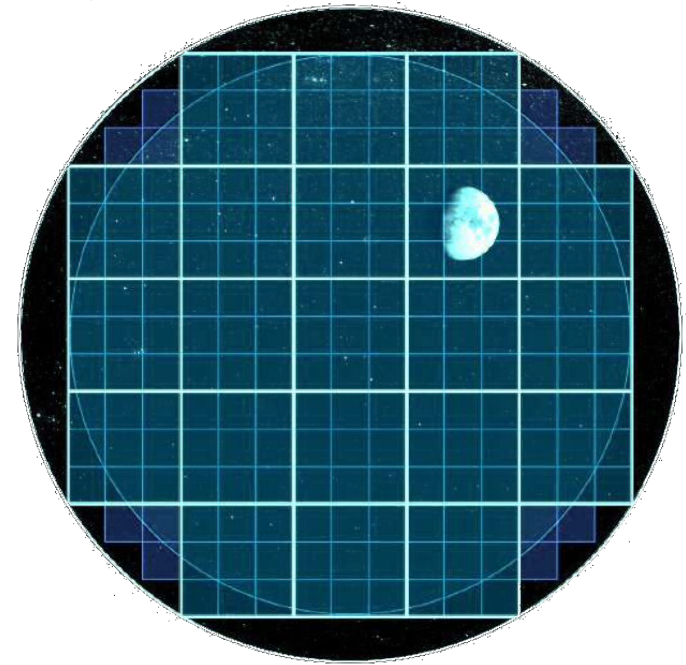



# Observing strategy

minion1016

- Wide Field Survey (90%)
  - ◆ Two 15 second exposures in one visit
  - ◆ ~ 800 visits in 10 years
  - ◆ Current observing cadence suggests the next visit in 1h – 3d
- Deep Drilling Fields (10%)
  - ◆ 4 selected DDFs
  - ◆ More frequent temporal sampling

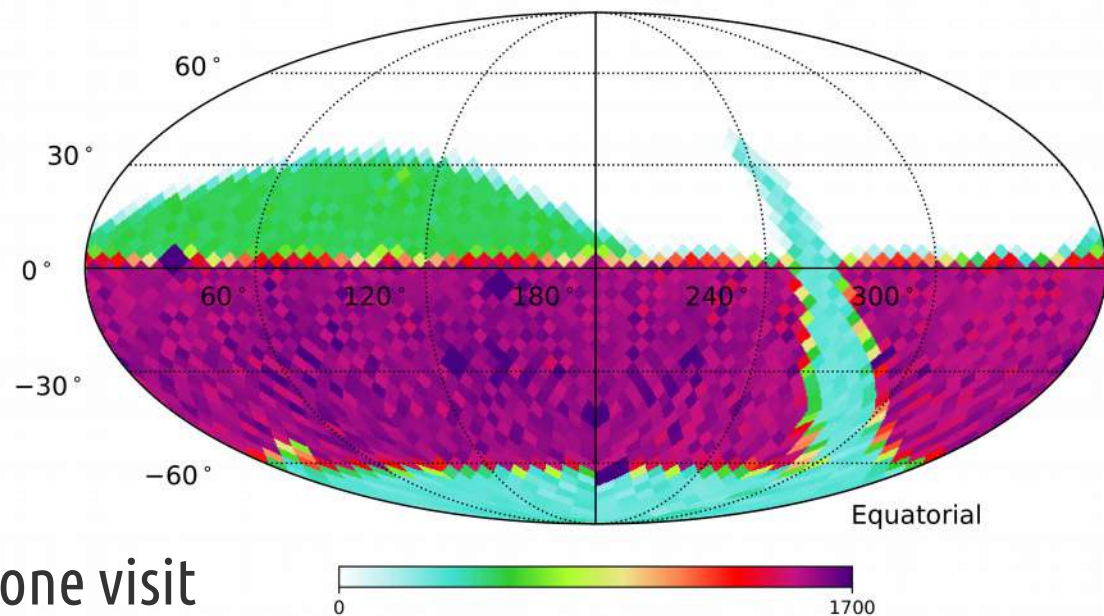

Bricman&Gomboc (in prep.)



# Where does GAIA come in?

- Previous activity of host galaxies
- Spectra of hosts (E+A postburst galaxies preferred)
- Astrometric position of the event (is the event in the center of the galaxy?)

# Why are TDEs interesting?

- What are they and what are their rates?
- Evolution of BHs, IMBHs?
- Dynamics in GCs
- SMBH mass distribution
- Accretion physics

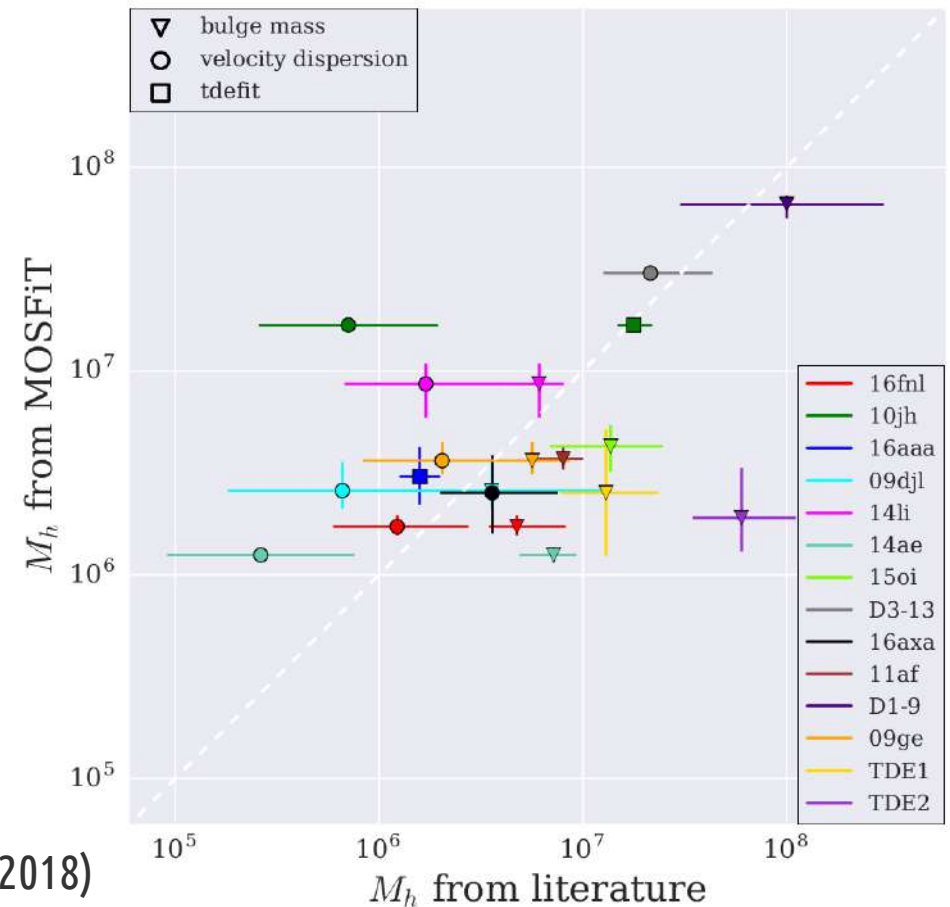

Mockler et al. (2018)