

Exploring Alternative Combustion Control Strategies for Low Load Exhaust Gas Temperature Management of a Heavy-Duty Diesel Engine

Wei Guan¹, Hua Zhao¹, Zhibo Ban², Tiejian Lin²

(¹Brunel University London, UK; ²Guangxi Yuchai Machinery Company, China)

Abstract

The employment of aftertreatment systems in modern diesel engines has become indispensable in order to meet the stringent emissions regulations. However, a minimum exhaust gas temperature (EGT) of approximately 200°C must be reached to initiate the emissions control operations. Low load engine operations usually result in relatively low EGT, which lead to reduced or no exhaust emissions conversion. In this context, this study investigated the use of different combustion control strategies to explore the trade-off between EGT, fuel efficiency and exhaust emissions.

The experiments were carried out on a single cylinder common rail heavy-duty diesel engine at a light load of 2.2 bar indicated mean effective pressure. Strategies include the late intake valve closure (LIVC) timing, intake throttling, late injection timing (T_{inj}), lower injection pressure (P_{inj}), and internal exhaust gas recirculation (iEGR) as well as external EGR (eEGR) were investigated. Results showed that the use of eEGR and lower P_{inj} were not effective in increasing EGT. Although the use of late T_{inj} could result in a higher EGT, the delayed combustion phase led to the highest fuel efficiency penalty. Intake throttling and iEGR allowed for an increase in EGT by 42°C and 52°C at the expense of 7.2% and 17% fuel consumption

23 penalties, respectively. In comparison, LIVC strategy achieved the best trade-off between EGT
24 and ISFC, increasing the EGT by 52°C and the fuel consumption penalty by 5.3% while
25 reducing NO_x and soot emissions simultaneously. When the IVC timing was delayed to after
26 -107 CAD ATDC, however, the combustion efficiency deteriorated, and hence very high HC
27 and CO emissions. This could be overcome by combining iEGR with LIVC to increase the in-
28 cylinder combustion temperature for a more complete combustion. The results demonstrated
29 that the “LIVC + iEGR” strategy can be the most effective means, increasing the EGT by 62°C
30 with small penalty in the fuel consumption of 4.6% and soot emission reduction by 85%.
31 Meanwhile, maintaining high combustion efficiency as well as low HC and CO emissions of
32 diesel engines.

33 **Keywords**

34 Heavy-duty diesel engine, variable valve actuation, late intake valve closing, internal EGR,
35 exhaust temperature, exhaust emissions

36

37 **Introduction**

38 Increasingly stringent emissions regulations and fuel prices are driving the development of
39 more efficient internal combustion engines. Diffusion combustion enables conventional diesel
40 engines to operate at a high compression ratio and high thermal efficiency and produce high
41 torque, making diesel engine the dominant powertrain in heavy duty vehicles. However, diesel
42 engines face great challenge when it comes to emissions. The mixing controlled diesel
43 combustion produces a large amount of particulate matter (PM) in the fuel rich burning region
44 and high concentration of nitrogen oxide (NO_x) in the high temperature zones [1]. In order to
45 meet the Euro VI or equivalent emission regulations of 0.4 g/kW·h NO_x and 0.010 g/kW·h PM

46 [2], significant reduction of these pollutants by in-cylinder combustion technologies and
47 emission control aftertreatment systems are required.

48

49 Advanced combustion modes such as Homogeneous Charge Compression Ignition (HCCI),
50 Pre-mixed Charge Compression Ignition (PCCI), and Low Temperature Combustion (LTC)
51 are able to achieve a reduction in NO_x and soot simultaneously, through reducing the peak in-
52 cylinder combustion temperatures and the local equivalence ratios. However, it is still
53 challenging to meet the emission regulations at all operating conditions by using these
54 combustion modes and strategies without employing aftertreatment systems. In addition, low
55 temperature combustion modes generally lead to an significant increase in Carbon Monoxide
56 (CO) and Hydrocarbon (HC) emissions [3–5].

57

58 Therefore, it is important to couple complex aftertreatment systems with the diesel engine, in
59 an effort to meet the tailpipe emission standards. Typical aftertreatment systems including
60 Selective Catalytic Reduction (SCR), Diesel Particulate Filter (DPF), and Diesel Oxidation
61 Catalyst (DOC) allow for NO_x, PM, and CO and HC emissions reduction accordingly. The
62 conversion efficiency of these aftertreatment systems is strongly dependent on the exhaust gas
63 temperature (EGT). A minimum exhaust gas temperature of approximately 200 °C is required
64 for catalyst light-off and initiate the emissions control [6,7]. This is extremely challenge at low
65 load conditions when the exhaust gas temperature is too low to provide sufficient emissions
66 reduction [8,9]. Therefore, a suitable control strategies to raise exhaust gas temperature while
67 maintaining high engine efficiency at lower loads is significantly important.

68

69 In modern diesel engines, advanced technologies, such as high injection pressure, two-stage
70 turbocharger, and multiple fuel injection strategy, have been developed to increase the engine

71 combustion efficiency which is typically accompanied with a decrease in exhaust gas
72 temperature [10]. For this reason, a number of recent studies have explored various techniques
73 to increase exhaust gas temperature. These strategies can be basically divided into three main
74 categories.

75

76 The first strategy is by means of air management, which controls the conditions of charge air
77 to increase EGTs, such as intake temperature, pressure and its composition. As the low exhaust
78 temperature at low loads is caused by the higher excess of air, the intake air throttling can be
79 applied to reduce the amount of air for exhaust gas management. Mayer et al. [11] showed that
80 a significant increase in exhaust gas temperature was achieved by throttling the air intake in a
81 turbocharged diesel engine, but with higher NO_x emission and combustion noise due to the
82 higher combustion temperature and the rate of heat release, respectively. Honardar et al. [12]
83 also analysed the impact of intake throttling on exhaust gas temperature at 2 bar BMEP under
84 both warm and cold engine operating conditions. An increase in EGTs could be obtained at the
85 expense of higher fuel consumption as well as HC and CO emissions due to a worse combustion
86 efficiency.

87

88 The second strategy for the effective exhaust thermal management is controlling the mixture
89 formation by adapting fuel injection parameters, such as main injection timing, post injection,
90 and injection pressure. Honardar et al. [12] experimentally examined the impacts of retarded
91 main injection timing and post injection on exhaust gas temperatures at low load conditions.
92 Both strategies were capable of achieving higher exhaust gas temperatures at the cost of higher
93 fuel consumption due to incomplete combustion and lower expansion work. Different fuel
94 injection strategies were explored to raise the exhaust gas temperature for active regeneration
95 of DPF by Parks et al. [13]. This experiment was performed at a 4-cylinder diesel engine with

96 two different starting DPF temperatures of 150 and 300 °C. Cavina et al. [14] analysed the
97 combined effect of air and fuel paths for thermal management by varying injection timings and
98 VGT position. It was found that a significant increase in exhaust gas temperature was achieved
99 by retarding injection timing while the resultant fuel penalty could be compensated by changing
100 the VGT position.

101

102 The last strategy for increasing the exhaust gas temperature is by using external heating
103 measures. Dosing liquid fuel or HC directly in the exhaust line upstream of the DOC device
104 [15][16] and using Electrically Heated Catalyst [17,18] have been used for exhaust thermal
105 management. However, the cost and complexity of the electrically heated catalyst limited their
106 use in large volumes.

107

108 Variable valve actuation (VVA) offers an alternative approach to increasing the exhaust gas
109 temperature as well as a number of other benefits. Ratzberger et al. [19] carried out an
110 experimental and numerical study to evaluate the ability of an early exhaust valve opening
111 (EEVO) and a late intake valve closing (LIVC) for exhaust thermal management. An increase
112 in exhaust gas temperature was realized by LIVC, however, the dropped pressure and
113 temperature at the start of combustion led to poor combustion stability and problematic unburnt
114 HC emission. Results also showed that EEVO enabled a distinct increase of exhaust enthalpy
115 at the expense of higher fuel consumption.

116

117 Garg et al. [20] investigated the influence of cylinder throttling with early and late intake valve
118 closing timings. Results showed that both delaying and advancing IVC reduced the volumetric
119 efficiency, resulting in a reduction in in-cylinder air mass flow. This contributed to an increase
120 in EGT. The reduction in piston-motion-induced compression resulted in a lower in-cylinder

121 gas temperature and higher degree of premixed combustion, which simultaneously curb NO_x
122 and soot formations. Ding et al. [21] evaluated cylinder deactivation during both loaded and
123 lightly loaded idle conditions and concluded that cylinder deactivation improved exhaust
124 thermal management. The higher exhaust gas temperature and lower unburnt HC and CO were
125 attained at low load conditions by introducing iEGR with higher exhaust back pressures [22–
126 24]. Other research into the use of a variable valve actuation to improve exhaust thermal
127 management can be found in [25–27].

128

129 The focus of this work is the exploration and direct comparison of different strategies for
130 exhaust gas temperature management and the trade-off with fuel efficiency and emissions.
131 Conventional strategies regarding air and fuel paths such as retarded injection timings, lower
132 diesel injection pressures, intake throttling as well as external EGR will be investigated here as
133 the base line results and for comparison with VVA strategies including LIVC and iEGR. The
134 experimental study was carried out in a single cylinder heavy-duty (HD) common rail fuel
135 injection diesel engine equipped with an intake VVA system. The investigation was conducted
136 at a speed of 1150 rpm and 2.2 bar net indicated mean effective pressure (IMEP) within the
137 area of World Harmonized Stationary Cycle (WHSC) test cycle [28]. The influence of various
138 strategies on the engine combustion, performance, and emissions were analysed and compared.

139

140 **Experimental setup and Methodology**

141 **Experimental setup**

142 The work was conducted on a single-cylinder four-stroke HD diesel research engine equipped
143 with a common rail injection system and coupled to an eddy current dynamometer. The
144 specifications of the engine are given in Table 1 and the schematic of the experimental setup
145 is illustrated in Figure 1.

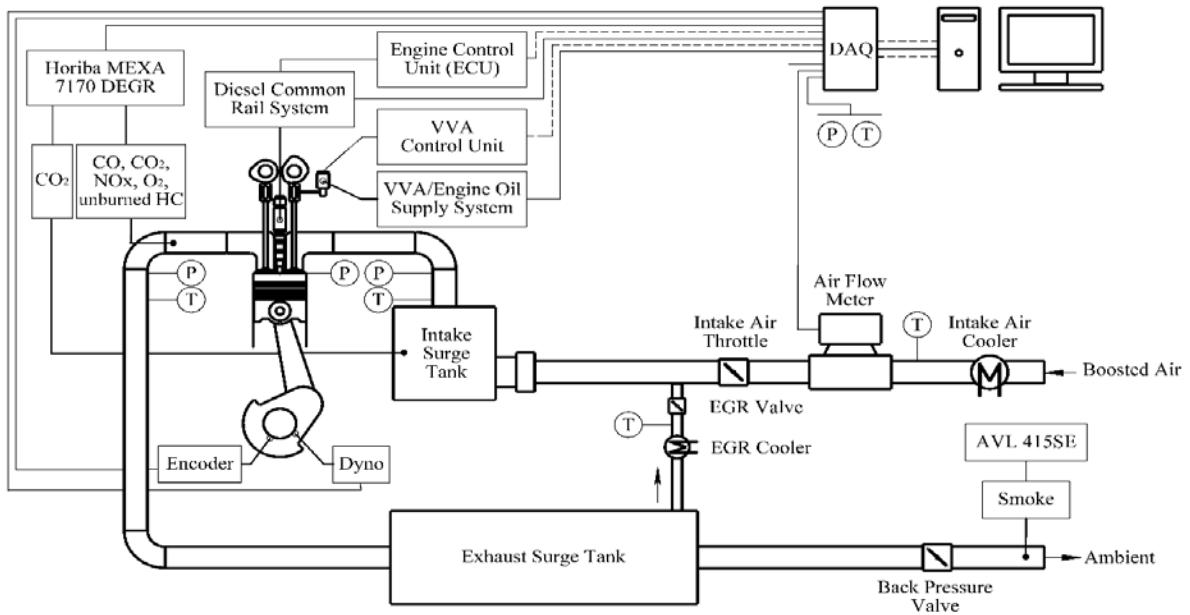

146

147

Figure 1. Layout of the engine experimental setup.

148

Table 1. Specifications of test engine.

Displaced Volume	2026 cm ³
Stroke	155 mm
Bore	129 mm
Connecting Rod Length	256 mm
Geometric Compression Ratio	16.8:1
Number of Valves	4
Piston Type	Re-entrant bowl
Diesel Injection System	Bosch common rail
Nozzle design	8 holes, included spray angle of 150°
Maximum fuel injection pressure	2200 bar
Maximum in-cylinder pressure	180 bar

149

150 Intake and Exhaust System

151 Overhead camshafts were installed on the cylinder head. The intake camshaft of the engine was
 152 equipped with a hydraulic lost motion VVA system, in which a hydraulic tappet on the valve
 153 side of the rocker arm is incorporated to realize the required valve events such as late intake
 154 valve closing and intake valve re-opening. Two large damping chambers were installed in the
 155 intake and exhaust systems to damp out the strong pressure fluctuations in the intake and

156 exhaust manifold resulted from the gas exchange dynamics of the engine. The compressed air
157 flow was supplied by an external supercharger with closed loop control. The intake mass flow
158 rate was measured by a thermal mass flow meter. The intake manifold pressure was fine
159 adjusted by means of an electronic intake throttle valve. Two piezo-resistive pressure
160 transducers were installed to measure the instantaneous intake and exhaust ports pressures. The
161 exhaust back pressure was independently controlled through a butterfly valve located
162 downstream of the exhaust surge tank. External EGR flow was achieved via an electronic EGR
163 valve. When the desired EGR rate could not be reached through using the electronic EGR valve
164 alone, higher exhaust back pressure was used to increase the EGR rate. Engine coolant and
165 lubrication oil were supplied externally and their temperature controlled via heaters and coolers.

166

167 **Fuel Delivery system**

168 In the test bench the diesel fuel was supplied by an electric motor driven high pressure pump
169 to a common rail system at pressure up to 2200 bar, and injected by a solenoid injector. The
170 fuel consumption was measured by two Coriolis flow meters. One was used for measuring the
171 total fuel supplied while the other one was used for measuring the fuel return from the high
172 pressure pump and injector. A bespoke electronic control unit (ECU) was used to control fuel
173 injection parameters such as the injection pressure, injection timing, and the number of
174 injection pulses.

175

176 **Exhaust Measurement**

177 The gaseous exhaust emissions such as NO_x, CO, CO₂, and HC were measured by an emission
178 analyzer (Horiba MEXA-7170 DEGR). With the use of the analyser system, gaseous including
179 CO and CO₂ were measured through a Non-Dispersive Infrared Absorption (NDIR) analyser,
180 HC was measured by a Flame Ionization Detector (FID), and NO_x was measured by a

181 Chemiluminescence Detector (CLD). To allow for high pressure sampling and avoid
182 condensation, a high pressure sampling module and a heated line were used between the
183 exhaust sampling point and the emission analyzer. The smoke concentration was measured
184 downstream of the back pressure valve by an AVL 415SE Smoke Meter, and thereafter
185 converted from FSN to mg/m³ [29]. All the exhaust gas components were converted to net
186 indicated specific gas emissions according to [2].

187

188 In this study, the definition of the EGR rate was defined as the ratio of the measured CO₂
189 concentration in the intake surge tank to the CO₂ concentration in the exhaust manifold as

190

$$191 \quad EGR \text{ rate} = \frac{(CO_2\%)_{intake}}{(CO_2\%)_{exhaust}} * 100\% \quad (1)$$

192 where the (CO₂%)_{intake} and (CO₂%)_{exhaust} are the CO₂ concentration in the intake and exhaust
193 manifolds, respectively.

194

195 **Experiment Data Processing**

196 A piezo-electric pressure transducer with the sampling revolution of 0.5 deg CAD was mounted
197 in the cylinder for measuring the instantaneous in-cylinder pressure recorded by an AVL
198 Amplifier. The in-cylinder pressure data was averaged over 200 engine cycles and used to
199 calculate the apparent Heat Release Rate (HRR) and combustion characteristics. According to
200 [30], the apparent HRR was calculated as

$$201 \quad HRR = \frac{\gamma}{(\gamma-1)} p \frac{dV}{dt} + \frac{1}{(\gamma-1)} V \frac{dp}{dt} \quad (2)$$

202 where γ is defined as the ratio of specific heats; V and p are the in-cylinder volume and
203 pressure, respectively; t is the time.

204

205 In this study, the CA10 and CA50 (Combustion Phasing) were defined as the crank angle when
206 the mass fraction burned reached 10% and 50%, respectively. Ignition delay was defined as the
207 crank angle between the start of injection and the start of combustion. The combustion stability
208 was measured by the coefficient of variation of the net IMEP (COV_IMEP) over the sampled
209 cycles. A displacement sensor mounted on the top of the intake valve spring retainer was used
210 to record the intake valve lift continuously.

211

212 **Methodology**

213 The study was carried out at a light load of 2.2 bar IMEP, which represents one of typical low
214 exhaust gas temperatures operating conditions of a HD drive cycle and is located within the
215 area of the WHSC test cycle, as shown in Figure 2.

216

217 During the test, the coolant and oil temperatures were kept within at 80 ± 2 °C and oil pressure
218 was maintained within 4.0 ± 0.1 bar. The average pressure rise rate and COV_IMEP were
219 limited to below 20 bar/CAD and 5%, respectively. The intake valve opening (IVO) and
220 closing (IVC) timings of baseline case were set at 367 and 545 CAD after top dead centre
221 (ATDC) while the exhaust valve timings were fixed over the experiments. The VVA system
222 also enables a second opening event of intake valve (2IVO) during the exhaust stroke to trap
223 residual gas. The maximum lifts of intake valve and 2IVO event were 14mm and 2mm,
224 respectively. Figure 3 shows the intake and exhaust valve profiles for the baseline as well as
225 the late IVC strategy and 2IVO event. All valve opening and closing events in this study were
226 considered at 1mm valve lift. Additionally, the pressure based effective compression ratio was
227 defined as

$$228 \quad ECR = \frac{V_{ivc_eff}}{V_{tdc}} \quad (3)$$

229 where V_{tdc} is the in-cylinder volume at TDC position, and V_{ivc_eff} is the effective in-cylinder
230 volume where the in-cylinder gas pressure is equivalent to the intake manifold pressure,
231 rather than the in-cylinder volume at IVC [31].

232

233 In addition, the mean in-cylinder gas temperature (T_m) was calculated using the ideal gas state
234 equation

$$PV = mRT_m \quad (4)$$

235 where P and V are the in-cylinder pressure and volume, respectively; m is the mass of charge
236 and R is the specific gas constant.

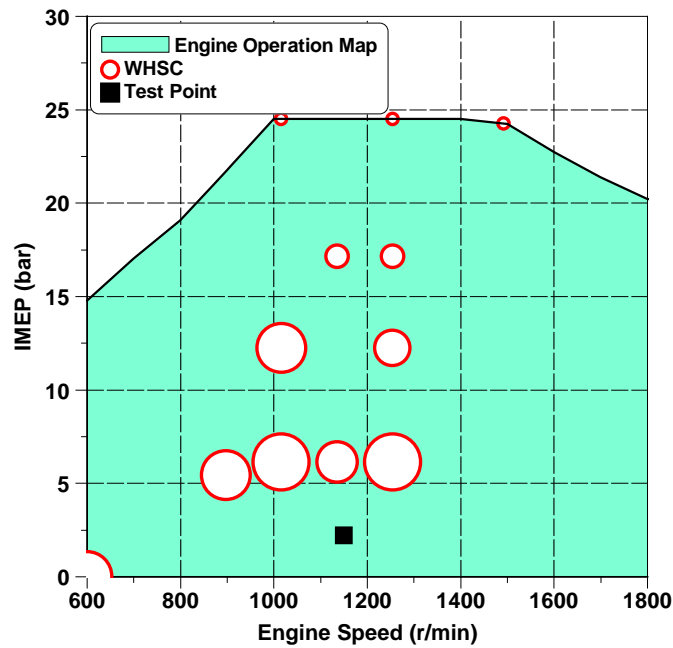

238

239 Figure 2. Test point and WHSC operation conditions.

240

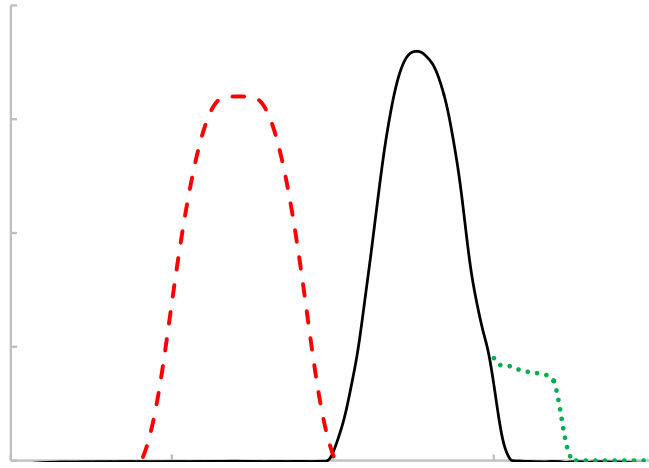

241

242 [Figure 3. Fixed exhaust camshaft timing and variable intake valve lift profiles with VVA.](#)

243

244 **Results and discussion**

245 The experimental results were divided into three subsections. In the first section, the impact
 246 of different control strategies to increasing exhaust gas temperatures, such as LIVC, intake
 247 throttling, late injection timing (T_{inj}), lower injection pressure (P_{inj}), iEGR, and eEGR are
 248 presented and analysed. This is followed by an analysis and comparison of the most effective
 249 strategies from the first section. Finally, the combined LIVC with iEGR strategy is
 250 investigated for its potential to overcoming the negative effect of LIVC strategy on CO and
 251 HC emissions.

252

253 **Evaluation of the effectiveness of various strategies for increasing EGT**

254 In this part, different strategies are explored with respect to their capability to increase EGTs
 255 and impact on the relative fuel efficiency penalty, from which the efficient EGT control
 256 strategies are selected for further analysis. Table 2 summarises the engine operating conditions
 257 and the matrix of test cases of all strategies.

258

259 Table 2. Main operation conditions of various control strategies.

Testing modes	Case number	Speed r/min	Load bar	T _{inj} CAD ATDC	P _{inj} bar	eEGR %	Int_pressure bar	Exh_pressure bar	2IVC	IVC CAD ATDC	ECR
Baseline	1	1150	2.2	-5.8	515	0	1.15	1.20	off	-178	16.8
LIVC	2			-5.8	515	0	1.15	1.20	off	-136	15.3
	3			-5.8	515	0	1.15	1.20	off	-118	13.5
	4			-5.8	515	0	1.15	1.20	off	-107	12.3
	5			-5.8	515	0	1.15	1.20	off	-100	11.4
Intake throttling	6			-5.8	515	0	1.08	1.20	off	-172	16.8
	7			-5.8	515	0	1.03	1.20	off	-172	16.8
	8			-5.8	515	0	0.98	1.20	off	-172	16.8
iEGR	9			-5.8	515	0	1.15	1.20	on	-172	16.8
	10			-5.8	515	0	1.15	1.27	on	-172	16.8
	11			-5.8	515	0	1.15	1.33	on	-172	16.8
	12			-5.8	515	0	1.15	1.42	on	-172	16.8
Late T _{inj}	13			-2	515	0	1.15	1.20	off	-178	16.8
	14			1	515	0	1.15	1.20	off	-178	16.8
	15			2	515	0	1.15	1.20	off	-178	16.8
Low P _{inj}	16			-5.8	360	0	1.15	1.20	off	-178	16.8
	17			-5.8	300	0	1.15	1.20	off	-178	16.8
eEGR	18			-5.8	515	16	1.15	1.20	off	-178	16.8
	19			-5.8	515	31	1.15	1.20	off	-178	16.8

260

261 Figure 4 shows an overview of the variations in fuel consumption versus exhaust gas
 262 temperatures when different control strategies were applied. The variation value in both ISFC
 263 and EGT is defined as the difference between the other test cases and the baseline operation
 264 depicted in Table 2. It illustrated that exhaust gas temperatures can be effectively increased by
 265 LIVC, intake throttling, or iEGR but much less affected by the injection pressure and eEGR
 266 rate. By delaying combustion phase through the late injection timings, higher EGT was
 267 observed but with highest fuel efficiency penalty. These behaviours were supported by Bai et
 268 al. [9] carrying out an experimental study at medium and low loads to investigating the effects
 269 of injection advance angle and injection pressure on exhaust thermal management. Therefore,

270 strategies including late injection timings, lower injection pressures, and increased eEGR rates
271 have been excluded from further analysis in the next subsection.

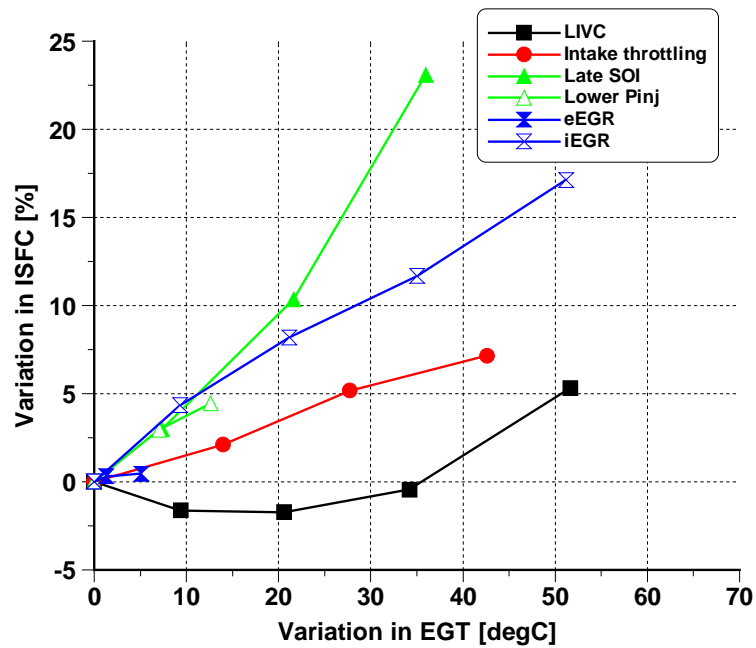

272

273

Figure 4. Potential of different strategies in increasing EGT.

274

275 Comparison of the LIVC, intake throttling, and iEGR strategies

276 In this section, the three effective EGT control strategies of LIVC, intake throttling, and iEGR
277 are further analysed and compared to the baseline case.

278

279 As shown in Figure 3 and Table 2, the original valve lift profile was used in a baseline case
280 and the corresponding IVC timing was -178 CAD ATDC. The intake manifold air pressure and
281 exhaust back pressure were set to 1.15 bar and 1.20 bar, respectively. The LIVC strategy was
282 run with four different intake valve closure timings from -178 CAD to -100 CAD ATDC. For
283 the intake throttling strategy, the intake air pressure was gradually reduced from 1.15 bar to
284 0.98 bar while keeping the exhaust pressure constant at 1.20 bar. In the case of iEGR strategy,
285 the intake air pressure was set at 1.15 bar while the exhaust back pressures of 1.27bar, 1.33 bar,

286 and 1.42 bar were performed by using the exhaust back pressure valve in order to trap higher
287 fraction of the residual exhaust gas.

288

289 **The Effect of LIVC, intake throttling, and iEGR strategies on combustion process**

290 Figure 5 shows the in-cylinder pressures of the baseline, Cases 2 and 5 of the LIVC, Cases 6
291 and 8 of the intake throttling, and Cases 9 and 12 of the iEGR strategies. It can be seen that
292 both LIVC and intake throttling strategies reduced in-cylinder pressures due to the lower
293 effective compression ratio and reduced intake air pressure respectively, especially at the
294 Case 5 of LIVC strategy and Case 8 of intake throttling strategy. The use of iEGR strategy
295 via 2IVO event showed less impact on the in-cylinder pressure, even with higher exhaust
296 back pressure of 1.42 bar in Case 12. This behaviour was the result of the hot residuals
297 trapped, which increased the in-cylinder gas temperature and hence the compression pressure
298 and temperature. The hot residuals also accelerated the fuel evaporation and combustion
299 process, resulting in a similar in-cylinder pressure curve to that of the baseline case.

300

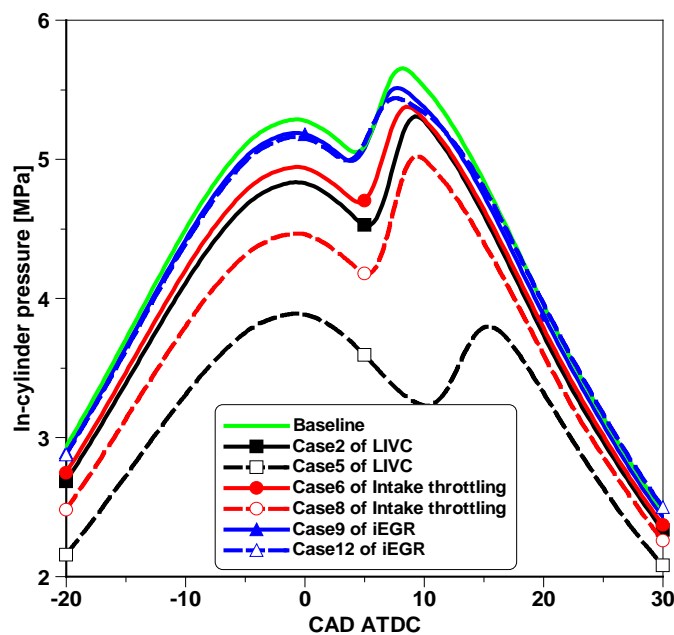

301

302

Figure 5. In-cylinder pressures for various strategies.

303 Figure 6 shows the heat release rate (HRR) of the baseline case, Cases 2 and 5 of the LIVC,
 304 Cases 6 and 8 of the intake throttling, and Cases 9 and 12 of the iEGR strategies. The LIVC
 305 strategy was characterised by longer ignition delay and higher degree of premixed
 306 combustion. The highest peak heat release rate was obtained in Case 2 of the LIVC strategy,
 307 but it declined to the same level of the baseline case when delaying IVC timing to Case 5.
 308 This was because the lower in-cylinder temperature and pressure allowed more time for
 309 mixture preparation before autoignition, and hence higher degree of premixed combustion.
 310 The longer ignition delay in Case 5 of the LIVC strategy shifted the combustion process
 311 further away from TDC, resulting in lower burned gas temperature and peak HRR. In
 312 comparison, the peak HRR increased greatly as the intake throttling strategy was employed
 313 from Case 6 to Case 8. This was a result of the reduced in-cylinder charge density caused by
 314 the lower intake air pressure, resulting in a higher peak mean in-cylinder gas temperature, as
 315 shown in the next section. Thus, the combustion rate was accelerated with hotter combustion
 316 process [24].

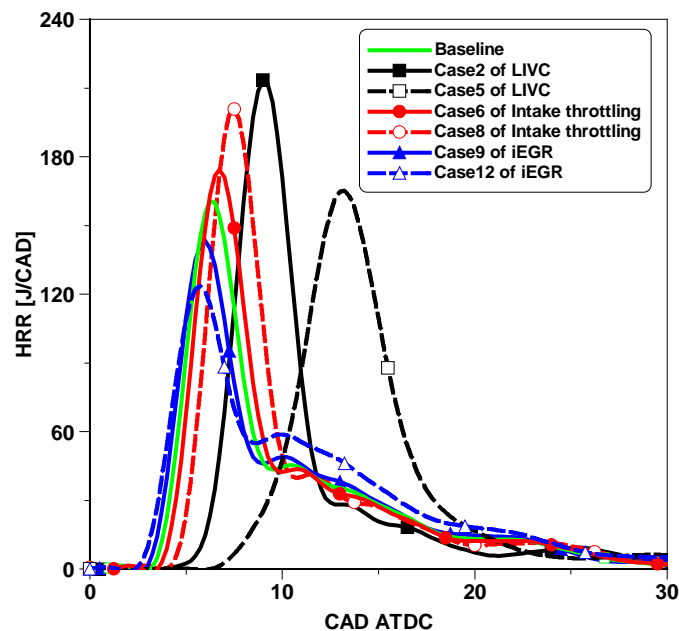

317

318

Figure 6. Heat release rate for various strategies.

319 In contrast to the LIVC and intake throttling strategies, the use of iEGR strategy decreased
 320 the peak HRR, in particular in Case 12 with higher fraction of the residuals gas. The reason
 321 could be explained by the higher in-cylinder charge temperature resulted from the hot
 322 residuals. This reduced the ignition delay and caused the combustion happened earlier than a
 323 baseline case. Figure 7 shows the in-cylinder charge temperatures (T_m) calculated by the ideal
 324 gas state equation. It can be seen that the compression temperature was reduced by using
 325 LIVC strategy due to lower effective compression ratio. However, it increased with iEGR
 326 strategy due to the hot residuals. The highest T_m was achieved in Case 12 of the iEGR
 327 strategy due to higher fraction of residuals gas.

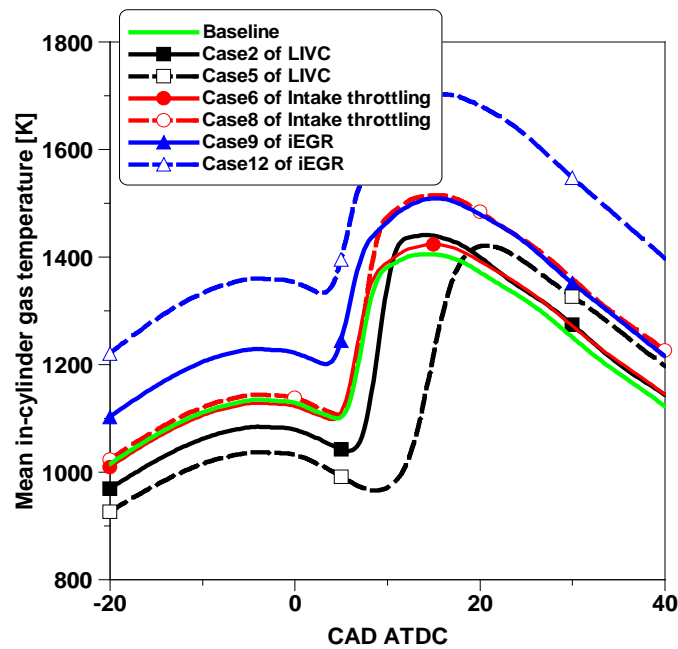

328

329 [Figure 7. Mean In-cylinder gas temperatures for various strategies.](#)

329

330 In the case of the intake throttling, the peak T_m increased as the intake air pressure was
 331 reduced via intake throttling, although the compression temperature is similar to that of the
 332 baseline case. For the LIVC strategy, however, the peak T_m increased initially with Case 2 of
 333 the LIVC strategy, but dropped as IVC timings were further retarded to Case 5 due to the
 334 aggressively reduced compression temperature and pressure and later combustion process.

335 **The effect of LIVC, intake throttling, and iEGR strategies on combustion**
336 **characteristics**

337 Figure 8 shows log P-V diagrams of the baseline case, Case 5 of the LIVC strategy, Case 8 of
338 the intake throttling strategy, and Case 12 of the iEGR strategy at the same injection timing
339 and injection pressure. There was a very small difference in the pumping loop area between
340 the baseline case and LIVC strategy as the intake and exhaust pressures were maintained.
341 However, the iEGR and intake throttling operations were characterised with significantly
342 increased pumping loop areas due to the higher exhaust back pressure and lower intake
343 manifold pressure, respectively.

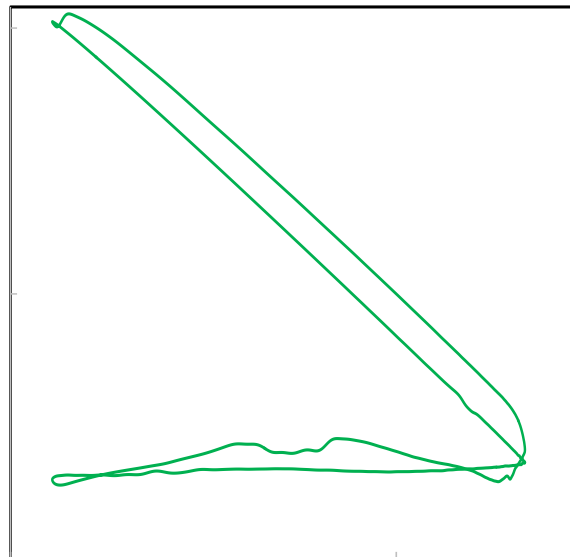

344
345 **Figure 8. Log P-V diagrams of the baseline case, Case 5 of the LIVC strategy, Case 8 of the intake throttling**
346 **strategy, and Case 12 of the iEGR strategy.**

347 Figure 9 shows the combustion characteristics of different strategies versus the variation in
348 exhaust gas temperatures. For the LIVC strategy, the reduced effective compression ratio
349 increased the ignition delay and lead to the shortest combustion duration. The iEGR strategy
350 was characterised with the shortest ignition delay due to the charge heating effect of the hot
351 residual gas but slowed down the initial heat release rate and longer combustion period

352 because of the dilution effect of residual gas. Finally, as a result of reduced air mass, the
 353 intake throttling strategy led to fastest initial combustion as measured by CA10-CA50 and
 354 slightly shorter combustion duration than the iEGR operation.

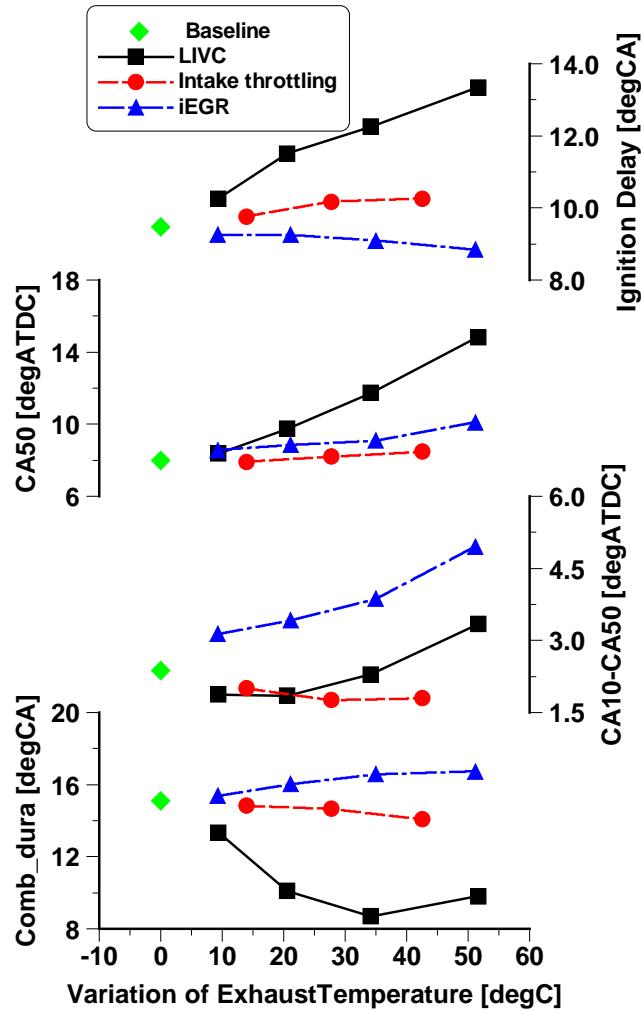

355
 356 Figure 9. Comparison of the combustion characteristics at different strategies.

357

358 **The effect of LIVC, intake throttling, and iEGR strategies on engine performance and**
 359 **emissions**

360 It is known that the exhaust gas temperature is mainly determined by the total in-cylinder
 361 charge which can be ascertained by the measured excess air ratio (λ) in the exhaust.

362 Figure 10 shows the λ of different strategies versus the variation of exhaust gas

363 temperatures for the four cases. It can be seen that the EGT increased linearly with a decrease

364 in lambda as reported by Garg et al. [9] irrespective of the strategy used. The slight deviation
 365 of the iEGR operation in the lambda value can be explained by the dilution effect of residual
 366 gas.

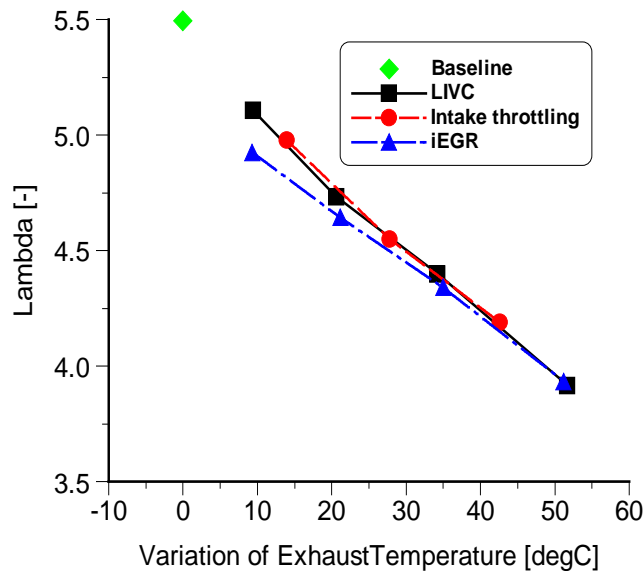

367
 368 **Figure 10. Comparison of the lambda at different strategies.**

369 Figure 11 shows the combustion efficiency, pumping mean effective pressure (PMEP), and
 370 variation of fuel consumption of different strategies. The combustion efficiency dropped
 371 significantly as the IVC timing was delayed from -178 to -100 CAD ATDC due to the lower
 372 compression pressure and the retarded combustion timing, causing the work loss during the
 373 combustion stroke. Higher PMEP was found in the strategies of intake throttling and iEGR,
 374 which can be explained by the larger pumping loop area in the log P-V diagram as shown in
 375 Figure 8, and hence higher fuel consumption. The changes in fuel consumption of LIVC
 376 strategy was different from the others. The fuel consumption increased slightly with the
 377 retarded LIVC due to the higher degree of premixed combustion and shorter combustion
 378 duration. But as the IVC timing was further retarded, the fuel consumption went up more
 379 rapidly because of the poor combustion efficiency. In order to increase the exhaust gas
 380 temperature by 52 °C, the LIVC and iEGR strategies were accompanied by 5.3% and 17%
 381 penalties in ISFC, respectively.

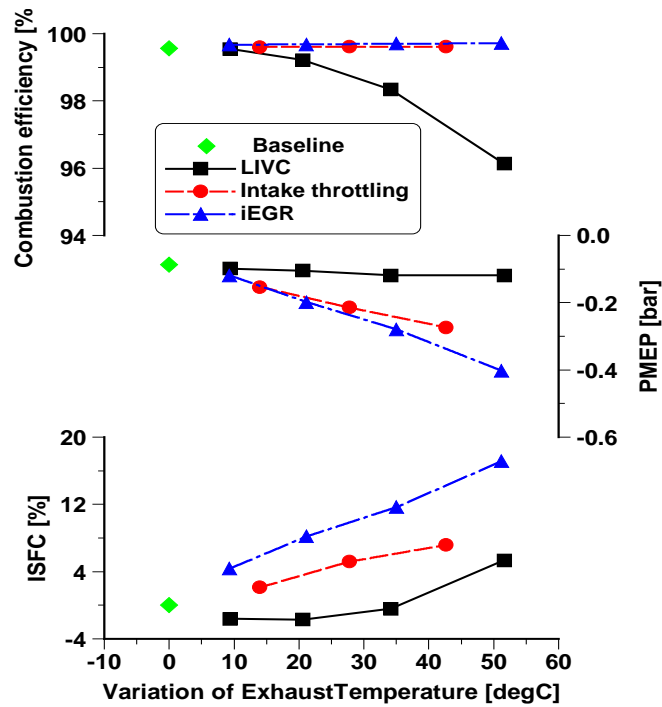

Figure 11. Comparison of the combustion efficiency, PMEP, and ISFC at different strategies.

Figure 12 shows the engine-out emissions versus the variation of exhaust gas temperatures.

The use of intake throttling and iEGR strategies had less impact on CO and HC emissions, maintaining as low as the baseline case. However, significant increases in CO and HC emissions were observed in the operation of LIVC strategy when the combustion temperature was much lower because of the lower compression ratio. This was because the CO and HC emissions are mainly affected by the local oxygen availability during combustion and the combustion temperature. The increased combustion temperature by means of intake throttling and iEGR strategies contributed to the low levels of CO and HC emissions.

The change in soot emissions showed a strong correlation with the variation of the ignition delay. The soot emissions decreased in both LIVC and intake throttling strategies because of the prolonged ignition delay, and it increased by iEGR due to the shorten ignition delay. The NOx emissions demonstrated a different trend from that of soot emissions. With the intake

397 throttling, NO_x emission increased due to the higher combustion temperature but decreased
 398 by iEGR due to the higher dilution and heat capacity of residual gas.

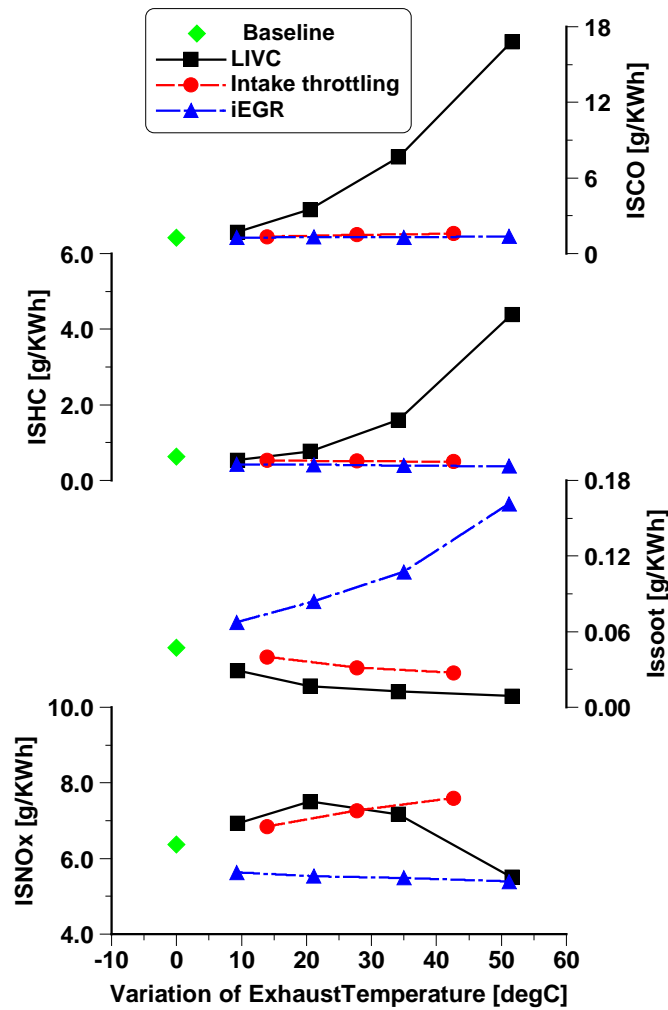

399

400 Figure 12. Comparison of the indicated specific emissions at different strategies.

401

402 Interestingly, the NO_x emission did not change linearly with LIVC strategy. It increased
 403 initially due to higher combustion temperature caused by the reduced charge mass and then
 404 decreased when the IVC timing was delayed to beyond -118 CAD ATDC when the
 405 combustion took place later and experienced lower combustion and pressure.

406

406 Combined effects of LIVC and iEGR

407 According to the discussion and analysis in the above subsection, the LIVC strategy has been
 408 demonstrated as an enabling technology for efficient increase in exhaust gas temperatures

409 while maintaining reasonable fuel consumption penalty compared to others. However, a
410 significant increase in CO and HC emissions limit the potential of LIVC strategy. Internal
411 EGR, as analysed in former section, was an effective means in curbing CO and HC
412 emissions. Therefore, the iEGR strategy was introduced when operating with LIVC strategy
413 in order to offset the negative effects of LIVC on CO and HC emissions.

414
415 Figure 13 shows that the addition of iEGR to the LIVC operation advanced the combustion
416 timing and increased the peak HRR because the in-cylinder gas temperature was increased by
417 the presence of hot residual gas as shown in Figure 14. Both “LIVC-only” and “LIVC +
418 iEGR” operations were characterised with much lower cylinder pressure than the baseline
419 operation.

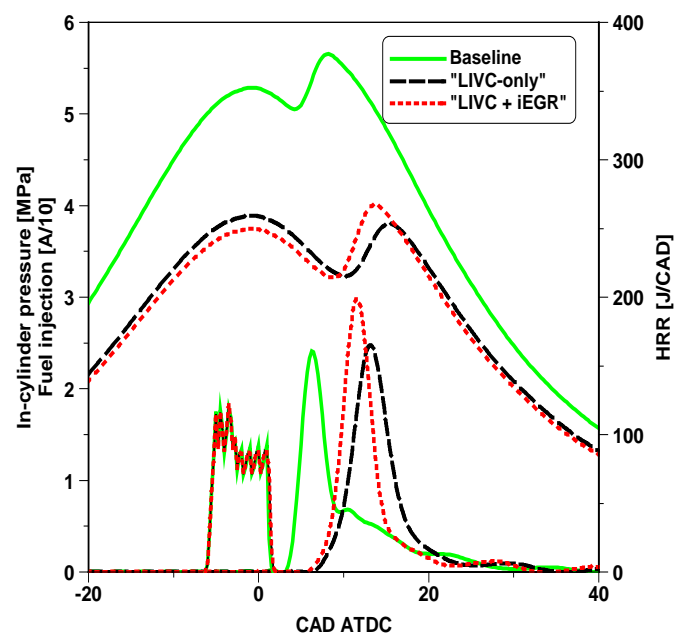

420
421 Figure 13. In-cylinder pressure, HRR, and injection signal of a baseline case, Case 5 of LIVC strategy, and Case
422 9 of “LIVC + iEGR” strategy.

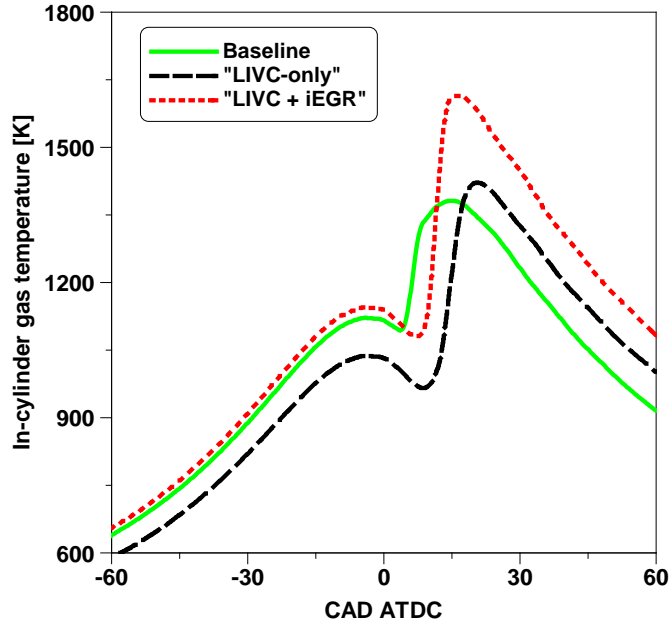

423

424 Figure 14. Mean in-cylinder gas temperature of a baseline case, Case 5 of LIVC strategy, and Case 9 of “LIVC
 425 + iEGR” strategy.

426 As shown in Figure 15, the ignition delay is slightly reduced when combining LIVC with
 427 iEGR due to the advanced combustion phasing. The combustion duration of “LIVC + iEGR”
 428 strategy was longer initially, and then reduced to a similar level of “LIVC-only” strategy
 429 when the IVC timing was further delayed.

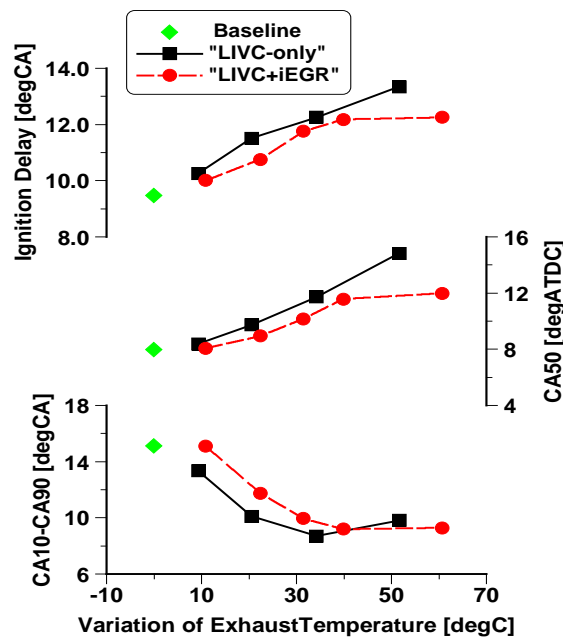

430

431 Figure 15. Combustion characteristics of a baseline case, Case 5 of LIVC strategy, and Case 9 of “LIVC +
 432 iEGR” strategy.

433 Figure 16 shows the relationship between lambda and EGT was the same for “LIVC-only”
 434 strategy and “LIVC + iEGR” strategy. The lambda was maintained at a similar level when
 435 achieving the same variation in EGT by using LIVC strategies with and without iEGR.
 436 Compare to “LIVC-only” strategy, the combustion efficiency was clearly improved in “LIVC
 437 + iEGR” strategy due to the increased combustion temperature. The higher fuel efficiency
 438 penalty of the “LIVC + iEGR” strategy with small EGT variation was due to the longer
 439 combustion duration. With further delayed IVC timings the combustion efficiency became
 440 higher and reduced the fuel consumption penalty. It is noted that an increase in EGT more
 441 than 62 °C was obtained with only 4.6% fuel penalty when operating LIVC with iEGR
 442 strategy.

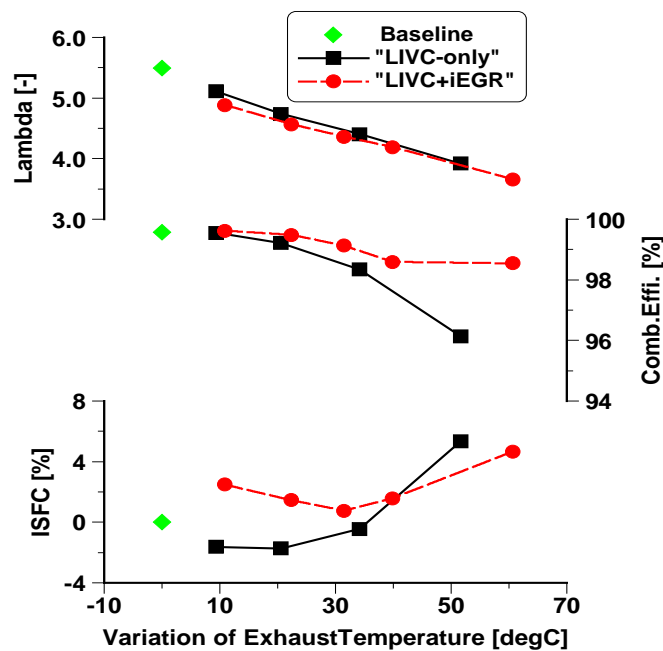

443
 444 Figure 16. Engine performance of a baseline case, Case 5 of LIVC strategy, and Case 9 of “LIVC + iEGR”
 445 strategy.

446 As shown in Figure 17, the introduction of iEGR reduced both CO and HC emissions,
 447 especially when large EGT increase was needed. This was mainly due to the higher in-
 448 cylinder combustion temperature, which helped the oxidation of CO and HC emissions. As it
 449 did not change the ignition delay clearly, the iEGR had little impact on soot emission. The

450 dilution and heat capacity effects of iEGR caused the lower NO_x emissions of “LIVC +
 451 iEGR” than those of “LIVC-only” in most cases, other than the highest EGT increase
 452 operations during which combustion temperature and hence NO_x formation were reduced
 453 due to the most retarded combustion after TDC.

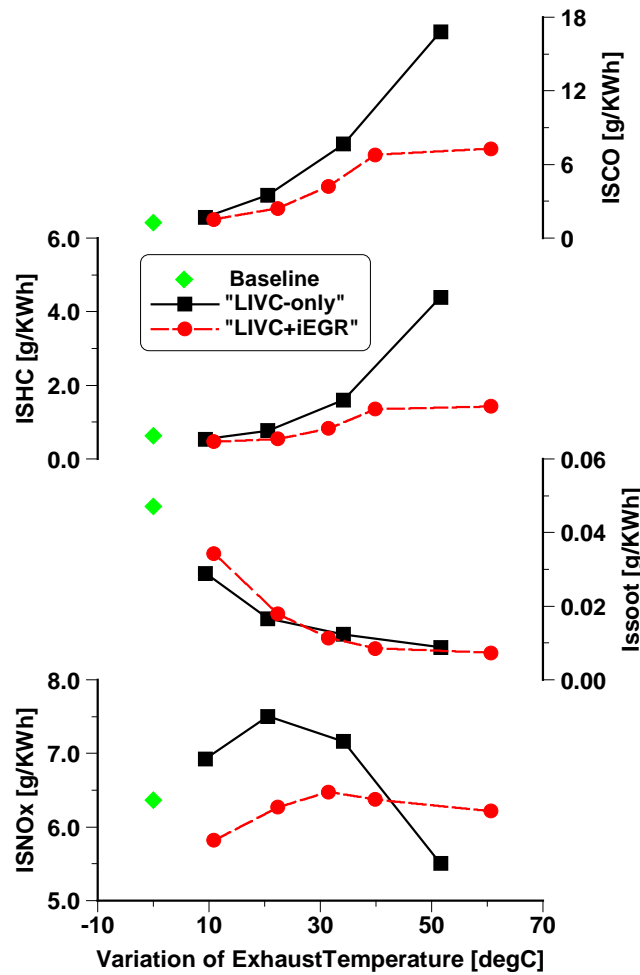

454
 455 Figure 17. Indicated specific emissions of a baseline case, Case 5 of LIVC strategy, and Case 9 of “LIVC +
 456 iEGR” strategy.

457 Figure 18 provides an overall assessment of the potential of combined LIVC and iEGR
 458 strategy to achieve the best trade-off between the EGT, fuel consumption, and emissions. As
 459 shown in Figure 18, the results of the optimum “LIVC-only” and “LIVC + iEGR” operations
 460 and baseline operation were compared.

461

462 It can be seen that “LIVC-only” strategy could increase EGT by 52 °C (31%) at the expense
 463 of a 5.3% penalty in fuel consumption. By combining LIVC and iEGR, EGT could be
 464 increased by 62 °C (37%) with 4.6% fuel efficiency penalty and much lower HC and CO
 465 emissions than the “LIVC-only” operation. Compared to the baseline operation, the soot
 466 emission was reduced substantially by LIVC operation with or without the iEGR,
 467 accompanied with a small decrease in NOx emissions.

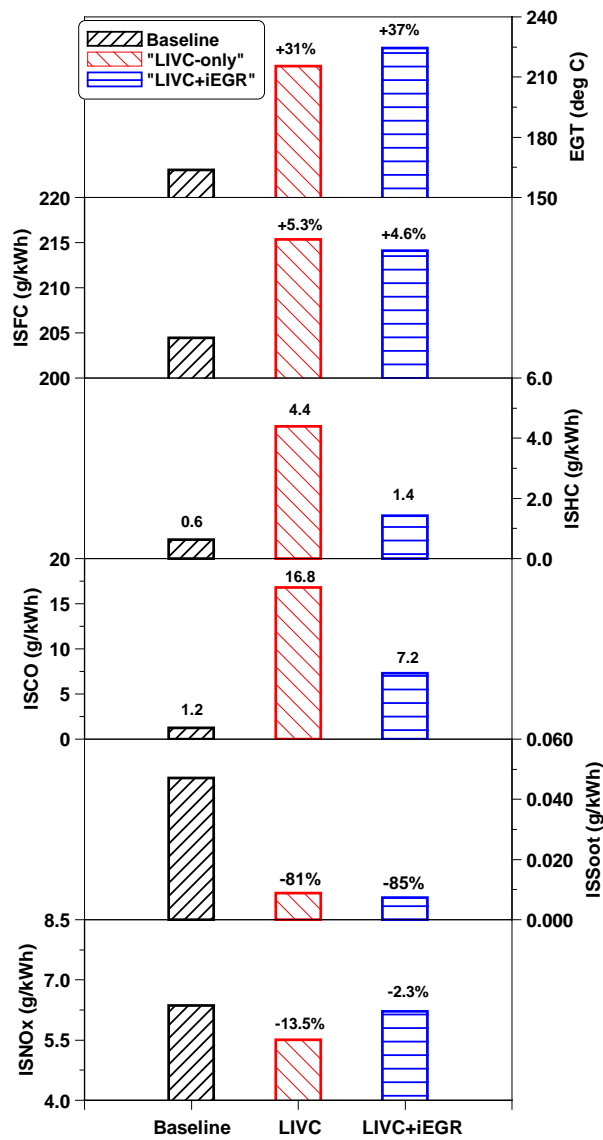

468
 469 Figure 18. Comparison between experimental results for “Case 5 of LIVC” strategy and “Case 5 of LIVC +
 470 Case 9 of iEGR” strategy.

471 Therefore, the combination of LIVC and iEGR was identified as the most effective means
472 amongst the various technologies examined in the current study to raising the exhaust gas
473 temperature with lower engine-out emissions and minimum penalty in fuel consumption.

474

475 **Conclusions**

476 Experimental studies were carried out to explore different control strategies for increasing
477 exhaust gas temperatures and analyse the impact on fuel consumption and emissions at a light
478 load condition. The experiments were performed on a single cylinder heavy-duty diesel
479 engine with a common rail fuel injection system. The engine was equipped with a VVA
480 system on the intake camshaft for the application of the LIVC strategy and the introduction of
481 iEGR. The main findings can be summarized as follows:

482

- 483 1. Sufficient high EGT could be obtained by means of the LIVC, intake throttling, and iEGR
484 strategies. Reduced diesel injection pressure and external EGR were not effective in
485 increasing EGT. Retarded diesel injection timing could be used to raise EGT but at the
486 expense of high penalty in fuel consumption.
- 487 2. The use of iEGR kept the specific emissions of NO_x, HC and CO as low as baseline case,
488 but resulted in large increase in fuel consumption and more soot emission, because of
489 higher pumping work and shorten ignition delay.
- 490 3. Throttling intake air flow was effective in increasing the exhaust gas temperature by 42°C
491 due to reduced cylinder charge but accompanied with a 7.2% fuel consumption penalty
492 and slightly higher NO_x emission.
- 493 4. The application of LIVC enabled an increase in exhaust gas temperature by 52°C and
494 lower NO_x and soot emissions with small fuel consumption penalty of 5.3%. However,

495 the lower combustion temperature led to large increase in HC and CO emissions due to a
496 lower combustion efficiency.

497 5. The combined use of LIVC and iEGR was identified as the most effective means amongst
498 the various technologies examined in the current study, increasing the exhaust gas
499 temperature by 62°C with lower engine-out emissions and minimum penalty of 4.6% in
500 fuel consumption.

501

502 **References**

- 503 1. Reitz, R.D., "Directions in internal combustion engine research," *Combust. Flame* 160(1):1–8,
504 2013, doi:10.1016/j.combustflame.2012.11.002.
- 505 2. Nations, U., "UNECE Regulation 49," (March 1958), 2013.
- 506 3. Shi, L., Zhang, L., Deng, K., Lv, X., and Fang, J., "Experimental Research on Mixture
507 Distribution of Diesel Premixed Low-Temperature Combustion," 2015.
- 508 4. Doosje, E., Willems, F., Baert, R., and Dijk, M. Van, "Experimental Study into a Hybrid PCCI
509 / CI Concept for Next-Generation Heavy-Duty Diesel Engines," *SAE Tech. Pap. 2012-01-1114*
510 (x), 2012, doi:10.4271/2012-01-1114.
- 511 5. Dev, S., Chaudhari, H.B., Gothekar, S., Juttu, S., Walke, H., and Marathe, N. V., "Review on
512 Advanced Low Temperature Combustion Approach for BS VI," 2017, doi:10.4271/2017-26-
513 0042.Copyright.
- 514 6. Buckendale, L.R., Stanton, D.W., and Stanton, D.W., "L. Ray Buckendale Lecture 2013-01-
515 2421 2013," 2013.
- 516 7. Stadlbauer, S., Waschl, H., Schilling, A., and Re, L. del, "Temperature Control for Low
517 Temperature Operating Ranges with Post and Main Injection Actuation," 2013,
518 doi:10.4271/2013-01-1580.
- 519 8. Gehrke, S., Kovács, D., Eilts, P., Rempel, A., and Eckert, P., "Investigation of VVA-Based
520 Exhaust Management Strategies by Means of a HD Single Cylinder Research Engine and

- 521 Rapid Prototyping Systems,” *SAE Tech. Pap.* 1(587):47–61, 2013, doi:10.4271/2013-01-0587.
- 522 9. Bai, S., Chen, G., Sun, Q., Wang, G., and Li, G., “Influence of active control strategies on
523 exhaust thermal management for diesel particulate filter active regeneration,” *Appl. Therm.
524 Eng.* 119:297–303, 2017, doi:10.1016/j.applthermaleng.2017.03.012.
- 525 10. Johnson, T., “Vehicular Emissions in Review,” *SAE Int. J. Engines* 6(Ld):699–715, 2016,
526 doi:10.4271/2013-01-0538.
- 527 11. Mayer, A., Lutz, T., Lämmle, C., Wyser, M., and Legerer, F., “Engine Intake Throttling for
528 Active Regeneration of Diesel particle,” *SAE Tech. Pap.* (724), 2003, doi:10.4271/2003-01-
529 0381.
- 530 12. Honardar, S., Busch, H., Schnorbus, T., Severin, C., Kolbeck, A., and Korfer, T., “Exhaust
531 Temperature Management for Diesel Engines Assessment of Engine Concepts and Calibration
532 Strategies with Regard to Fuel Penalty,” *SAE Tech. Pap.*, 2011, doi:10.4271/2011-24-0176.
- 533 13. Parks, J., Huff, S., Kass, M., and Storey, J., “DPF--Characterization of in-cylinder techniques
534 for thermal management of diesel aftertreatment,” *SAE Pap.* (724):1–3997, 2007,
535 doi:10.4271/2007-01-3997.
- 536 14. Cavina, N., Mancini, G., Corti, E., Moro, D., Cesare, M. De, and Stola, F., “Thermal
537 Management Strategies for SCR After Treatment Systems,” *SAE Int.*, 2013, doi:10.4271/2013-
538 24-0153.
- 539 15. Singh, P., Thalagavara, A.M., Naber, J.D., Johnson, J.H., and Bagley, S.T., “An Experimental
540 Study of Active Regeneration of an Advanced Catalyzed Particulate Filter by Diesel Fuel
541 Injection Upstream of an Oxidation Catalyst,” *SAE Tech. Pap.* 2006-01-0879 (724), 2006,
542 doi:10.4271/2006-01-0879.
- 543 16. Laible, T., Pischinger, S., Holderbaum, B., and Gmbh, F.E. V, “Internal and External
544 Measures for Catalyst Light-Off Support,” 2015, doi:10.4271/2015-24-2501.Copyright.
- 545 17. Pfahl, U., Schatz, A., and Konieczny, R., “Advanced Exhaust Gas Thermal Management for
546 Lowest Tailpipe Emissions - Combining Low Emission Engine and Electrically Heated
547 Catalyst,” *SAE Int.*, 2012, doi:10.4271/2012-01-1090.
- 548 18. Pace, L. and Presti, M., “An alternative way to reduce fuel consumption during cold start: The

- 549 electrically heated catalyst,” *SAE Tech. Pap.*, 2011, doi:10.4271/2011-24-0178.
- 550 19. Ratzberger, R., Kraxner, T., Pramhas, J., Hadl, K., Eichlseder, H., and Buerger, L., “Miller-
551 Evaluation of Valve Train Variability in Diesel Engines,” *SAE Int. J. Engines* 8(5):2015-24-
552 2532, 2015, doi:10.4271/2015-24-2532.
- 553 20. Garg, A., Magee, M., Ding, C., Roberts, L., Shaver, G., Koeberlein, E., Shute, R., Koeberlein,
554 D., McCarthy, J., and Nielsen, D., “Fuel-efficient exhaust thermal management using cylinder
555 throttling via intake valve closing timing modulation,” *Proc. Inst. Mech. Eng. Part D J.*
556 *Automob. Eng.* 230(4):470–478, 2016, doi:10.1177/0954407015586896.
- 557 21. Ding, C., Roberts, L., Fain, D.J., Ramesh, A.K., Shaver, G.M., McCarthy, J., Ruth, M.,
558 Koeberlein, E., Holloway, E.A., and Nielsen, D., “Fuel efficient exhaust thermal management
559 for compression ignition engines during idle via cylinder deactivation and flexible valve
560 actuation,” *Int. J. Engine Res.*, 2015, doi:10.1177/1468087415597413.
- 561 22. Fessler, H. and Genova, M., “An electro-hydraulic lost motion VVA system for a 3.0 liter
562 diesel engine,” *SAE Trans.* 113(724):1639–1649, 2004, doi:10.4271/2004-01-3018.
- 563 23. Korfer, T., Busch, H., Kolbeck, A., Severin, C., Schnorbus, T., and Honardar, S., “Advanced
564 Thermal Management for Modern Diesel Engines - Optimized Synergy between Engine
565 Hardware and Software Intelligence,” *Proc. Asme Intern. Combust. Engine Div. Spring Tech.*
566 *Conf. 2012* 415–430, 2012, doi:10.1115/ICES2012-81003.
- 567 24. Pedrozo, V.B., May, I., Lanzasova, T.D.M., and Zhao, H., “Potential of internal EGR and
568 throttled operation for low load extension of ethanol–diesel dual-fuel reactivity controlled
569 compression ignition combustion on a heavy-duty engine,” *Fuel* 179:391–405, 2016,
570 doi:10.1016/j.fuel.2016.03.090.
- 571 25. Ojeda, W. De, “Effect of variable valve timing on diesel combustion characteristics,” *SAE*
572 *Pap.*, 2010, doi:2010-01-1124.
- 573 26. Roberts, L., Magee, M., Shaver, G., Garg, A., McCarthy, J., Koeberlein, E., Holloway, E.,
574 Shute, R., Koeberlein, D., and Nielsen, D., “EEVO--Modeling the impact of early exhaust
575 valve opening on exhaust aftertreatment thermal management and efficiency for compression
576 ignition engines,” *Int. J. Engine Res.* 16(6):773–794, 2015, doi:10.1177/146808741551616.

- 577 27. Ramesh, A.K., Shaver, G.M., Allen, C.M., Nayyar, S., Gosala, D.B., Caicedo Parra, D.,
578 Koeberlein, E., McCarthy, J., and Nielsen, D., “Utilizing low airflow strategies, including
579 cylinder deactivation, to improve fuel efficiency and aftertreatment thermal management,” *Int.*
580 *J. Engine Res.* 146808741769589, 2017, doi:10.1177/1468087417695897.
- 581 28. Authorities, A., “Acts Adopted By Bodies Created By International Agreements,” *Off. J. Eur.*
582 *Union* 7–9, 2013.
- 583 29. Equipment, E.M., “AVL Smoke Meter 415SE,” 1–4.
- 584 30. Heywood J.B, “Internal Combustion Engine,” ISBN 007028637X, 1988.
- 585 31. Stricker, K., Kocher, L., Koeberlein, E., Alstine, D. Van, and Shaver, G.M., “Estimation of
586 effective compression ratio for engines utilizing flexible intake valve actuation,” *Proc. Inst.*
587 *Mech. Eng. Part D J. Automob. Eng.* 226(8):1001–1015, 2012,
588 doi:10.1177/0954407012438024.

589

590 **Contact information**

591 Wei Guan
592 Wei.guan@brunel.ac.uk
593 gwei916@163.com
594 Centre for Advanced Powertrain and Fuels Research
595 College of Engineering, Design and Physical Sciences
596 Brunel University London
597 Kingston Lane
598 Uxbridge
599 Middlesex UB8 3PH
600 United Kingdom

601

602 **Acknowledgments**

603

604 The first author, Mr W Guan, would like to acknowledge the Guangxi Yuchai Machinery Company
605 for supporting his PhD study supervised by Prof. Zhao at Brunel University London.

606

607 **Definitions/Abbreviations**

ATDC After Firing Top Dead Center.

CA10-CA90	Combustion Duration.
CAD	Crank Angle Degree.
CO	Carbon Monoxide.
CO₂	Carbon Dioxide.
DOC	Diesel Oxidation Catalyst.
DPF	Diesel Particulate Filter.
ECR	Effective Compression Ratio.
ECU	Electronic Control Unit.
EGR	Exhaust Gas Recirculation.
EGT	Exhaust Gas Temperature.
HRR	Heat Release Rate.
HC	Hydrocarbons.
IMEP	Indicated Mean Effective Pressure.
IVC	Intake Valve Closing.
IVO	Intake Valve Opening.
ISFC	Net Indicated Specific Fuel Consumption.
ISSoot	Net Indicated Specific Emissions of Soot.
ISNO_x	Net Indicated Specific Emissions of NO _x .
ISCO	Net Indicated Specific Emissions of CO.
ISHC	Net Indicated Specific Emissions of Unburned HC.
NO_x	Nitrogen Oxides.
SCR	Selective Catalytic Reduction.
TDC	Firing Top Dead Centre.
VVA	Variable Valve Actuation
WHSC	World Harmonized Stationary Cycle.

608 Dear Organizers and Reviewers,

609 Thank you for your kind comments and suggestions to the manuscript. We have modified the
610 manuscript accordingly, and detailed corrections are listed below point by point. The paragraphs in
611 black are the reviewers' comments, while our responses are listed in blue. All the modifications are
612 highlighted in red.

613 We look forward to hearing from you.

614 Sincerely,

615 Wei Guan

616 Brunel University London

617

618 **Reviewer #1:**

619 1) The biggest issue with this paper is that the experiments were completed with a single cylinder
620 engine. As a result, the authors must provide assurances that the intake and exhaust manifold
621 pressures reasonably approximate what would occur in a turbo-charged Diesel engine. They do not
622 do so. As an example, the intake and exhaust pressures implemented (per table 2) are not justified.

623

624 [Thanks for the kind suggestion. In this paper, the initial set values for intake and exhaust manifold
625 pressures are taken from Yuchai YC-6K multi-cylinder diesel engine.](#)

626

627 2) Motivation for the 2.2 bar, 1150 rpm operating point must be given.

628

629 [The motivation for testing at 1150 rpm, 2.2 bar IMEP is mainly because the exhaust gas temperature
630 of this test point is below 200 °C. This represents one of typical low exhaust gas temperatures
631 operating conditions of a heavy-duty drive cycle. However, a minimum exhaust gas temperature of
632 approximately 200°C must be reached to initiate the emissions control operations. In addition, this
633 operating point is located within the area of the world harmonized stationary cycle \(WHSC\) test
634 cycle.](#)

635

636 3) The abstract should clearly state that the experimental results are from a single cylinder engine.

637

638 [Thanks, this has been revised in the abstract on Page 1 as follows:](#)

639 ["The experiments were carried out on a single cylinder common rail heavy-duty diesel engine at a
640 light load of 2.2 bar indicated mean effective pressure."](#)

641

642 4) The abstract and conclusions should both include key quantitative findings.

643

644 [The key quantitative findings have been added in the abstract and conclusions on the pages 1, 28
645 and 29 accordingly.](#)

646

647 5) Reference(s) should be added for effective compression ratio.

648

649 [Thanks for the kind suggestion. The reference "\[31\]" for effective compression ratio has been added
650 on page 11.](#)

651 ["Estimation of effective compression ratio for engines utilizing flexible intake valve actuation."](#)