



Brunel
University
London

DOCTORAL THESIS

**Brainwave-Based Human Emotion
Estimation using Deep Neural Network
Models for Biofeedback**

*A Thesis submitted to Brunel University London
in accordance with the requirements
for award of the degree of Doctor of Philosophy*

in

the department of "Electronic and Computer Engineering"

Jingxin Liu

May 15, 2019

Declaration of Authorship

I, Jingxin Liu, declare that the work in this dissertation was carried out in accordance with the requirements of the University's Regulations and Code of Practice for Research Degree Programmes and that it has not been submitted for any other academic award. Except where indicated by specific reference in the text, the work is the candidate's own work. Work done in collaboration with, or with the assistance of, others, is indicated as such. Any views expressed in the dissertation are those of the author.

SIGNED: DATE:

(Signature of student)

Abstract

Emotion is a state that comprehensively represents human feeling, thought and behavior, thus takes an important role in interpersonal human communication. Emotion estimation aims to automatically discriminate different emotional states by using physiological and nonphysiological signals acquired from human to achieve effective communication and interaction between human and machines. Brainwaves-Based Emotion Estimation is one of the most common used and efficient methods for emotion estimation research. The technology reveals a great role for human emotional disorder treatment, brain computer interface for disabilities, entertainment and many other research areas. In this thesis, various methods, schemes and frameworks are presented for Electroencephalogram (EEG) based human emotion estimation.

Firstly, a hybrid dimension feature reduction scheme is presented using a total of 14 different features extracted from EEG recordings. The scheme combines these distinct features in the feature space using both supervised and unsupervised feature selection processes. Maximum Relevance Minimum Redundancy (mRMR) is applied to re-order the combined features into max-relevance with the emotion labels and min-redundancy of each feature. The generated features are further reduced with Principal Component Analysis (PCA) for extracting the principal components. Experimental results show that the proposed work outperforms the state-of-art methods using the same settings at the publicly available Database for Emotional Analysis using Physiological Signals (DEAP) data set.

Secondly, a disentangled adaptive noise learning β -Variational autoencoder (VAE) combine with long short term memory (LSTM) model was proposed for the emotion recognition based on EEG recordings. The experiment is also based on the EEG emotion public DEAP dataset. At first, the EEG time-series data are transformed into the Video-like EEG image data through the Azimuthal Equidistant Projection (AEP) to original EEG-sensor 3-D coordinates to perform 2-D projected locations of electrodes. Then Clough-Tocher scheme is applied for interpolating the scattered power measurements over the scalp and for estimating the values in-between the electrodes over a 32x32 mesh. After that, the β -VAE LSTM algorithm is used to estimate the accuracy of the quadratic (arousal-valence) classification. The comparison between the β VAE-LSTM model and other classic methods is conducted at the same experimental setting that shows that the proposed model is effective.

Finally, a novel real-time emotion detection system based on the EEG signals from a portable headband was presented, integrated into the interactive film 'RIOT'. At first, the requirement of the interactive film was collected and the protocol for data collection using a portable EEG sensor (Emotiv Epoc) was designed. Then, a portable EEG emotion database (PEED) is built from 10 participants with the emotion labels using both self-reporting and video annotation tools. After that, various feature extraction, feature selection, validation scheme and classification methods are explored to build a practical system for the real-time detection. In the end, the emotion detection system is trained and integrated into the interactive film for real-time implementation and fully evaluated. The experimental results demonstrate the system with satisfied emotion detection accuracy and real-time performance.

Acknowledgements

Firstly, I'd like to thank my principal supervisor, Dr. Hongying Meng, who is not only the research leader but also the spirit mentor for me. Thanks to Dr Meng's scientific research vision and predictability leading me exploring and developing at the relatively new research field. With Dr Meng's guiding and supporting helping me conquer the relatively tough research road. Moreover, he taught me how to be a good researcher with patient guidance. I also want to thank my second supervisor Prof. Asoke Nandi, who also offers me a lot of help on my research career. Although his work is very busy, he still takes time to help me with the research problems and paper modifying work. I also want to thank my research development advisor Prof Maozhen Li, who offers me great help on my research career and introduces the exchanging work at Tongji University for me. The exchanging work is really a good memory for me and train me a lot at that stage. It is an honor to have a great supervision team, and I learnt a lot from them.

I want to thank Dr. Huibin Li and his team in Xi'an Jiaotong University. He gives us a great chance to exchange to Xi'an Jiaotong University, and I learn a lot about deep learning from them, especially background subtraction used on dynamic behaviour recognition.

Then, I'd like to thank my classmates, Fan Zhang and Rui Qin, We have cooperated and finished lots of work and researches together. It is a pleasure to work with these excellent classmates and we have learnt a lot from each other.

In the end, I'd like to thank my family, who fully support me on all my decisions and researches. I appreciate their understanding and support on me.

List of Publications

- [1] **Liu, J.**, Meng, H., Liu, S., Li, H., Meng, D. 'Emotion Recognition From EEG Recording by Long Short Term Memory-Based Disentangled Adaptive Noise Learning β -Variational Autoencoder'. IEEE Transactions on Affective Computing. (To be submitted)
- [2] **Liu, J.**, Meng, H., Li, Y., Qin, R., Chen, C., 'Real-Time Interactive Film Control based on User's Emotion Detected from a Portable EEG Sensor'. IEEE Transactions on Emerging Topics in Computational Intelligence. (To be submitted)
- [3] Qin, R., **Liu, J.**, Meng, H. (2019) 'A real-time facial expression recognition system for interactive film application'. International Conference on Acoustics, Speech, and Signal Processing. (Submitted)
- [4] Liu, S., **Liu, J.**, Zhao Q., Cao X., Li H., Meng, H., Liu S., Meng, D. (2018)'Discovering Influential Factors in Variational Autoencoder'. arXiv:1809.01804.
- [5] **Liu, J.**, Meng, H., Li, M., Zhang, F., Qin, R. and Nandi, A. (2018) 'Emotion detection from EEG recordings based on supervised and unsupervised dimension reduction'. Concurrency and Computation: Practice and Experience. ISSN: 1532-0626, WILEY, (Available online since Mar 2018: <https://doi.org/10.1002/cpe.4446>)
- [6] **Liu, J.**, Meng, H. , Li, M. and Nandi, A. (2016) 'Emotion Detection from EEG Recordings'. Proceedings of 12th International Conference on Natural Computation, Fuzzy Systems and Knowledge Discovery (ICNC-FSKD). Changsha, China. 15 August, IEEE. pp. 1722 - 1727.
- [7] Gaus, YFA., Olugbade, T., Jan, A., Qin, R., **Liu, J.**, Zhang, F., et al. (2015) 'Social Touch Gesture Recognition Using Random Forest and Boosting on Distinct Feature Sets'. Proceedings of International Conference on Multimodal Interaction. Seattle, Washington, USA. 9 - 13 November ACM. pp. 399 - 406, 10.1145/2818346.2830599

Contents

1	Introduction	1
1.1	Background	1
1.2	Motivation	3
1.3	Research Question	4
1.4	Aim and Objectives	6
1.5	Thesis Contribution	7
1.6	Thesis Overview	8
2	Literature Review	10
2.1	Emotion	10
2.1.1	Physiological Basis of Emotion	10
2.1.2	Classification of Emotion	12
2.1.3	Characteristic of Emotion Evoked	13
2.1.4	Emotion Recognition Methods	13
2.2	Description of Brain and EEG Signals	15
2.2.1	Function and Structure of Brain	15
2.2.2	Electroencephalogram (EEG)	17
2.3	EEG-based Emotion Recognition	17
2.3.1	EEG Preprocessing	19
2.3.2	Features Extraction	20
2.3.3	Feature Smooth and Reduction	26
2.3.4	Classification	30
2.3.5	Challenges	34
2.3.6	Specific Methods	35
2.4	Application for Emotion Recognition Based on EEG	44
3	Emotion Detection from EEG Recordings Based on Hybrid Dimension Reduction on Distinct Features	46
3.1	Introduction	46
3.2	Related Work	48

3.3	Methodology	50
3.3.1	Overview	50
3.3.2	Set of all Features	51
3.3.3	Hybrid Dimension Features Reduction Scheme	52
3.3.4	Classification	53
3.4	Evaluation	53
3.4.1	Performance Measurement	53
3.4.2	Dataset	54
3.4.3	Experiment Settings	54
3.4.4	Feature Extraction	54
3.4.5	Results	55
3.4.6	Comparison with Existing Works	58
3.5	Summary	59
4	Exploration On Emotion Recognition From EEG Recordings by Adaptive Noise Learning β-Variational Autoencoder and Long Short Term Memory	60
4.1	Introduction	61
4.2	Related Work	62
4.3	Exploration Experiments on Variety Framework of EEG-based Emotion Detection	64
4.3.1	Overview	64
4.3.2	Dataset and Experiment Schemes	65
4.3.3	EEG Time Series to Image Transformation	66
4.3.4	β -VAE LSTM Architecture	68
4.3.5	Experiments Procedure and Performance Evaluation	71
4.4	Summary	76
5	Real-Time Interactive Film Control based on User's Emotion Detected from a Portable EEG Sensor	78
5.1	Introduction	78
5.2	Related Works	80
5.3	Interactive Film	83
5.4	Emotion Recognition System	84
5.4.1	PEED	85
5.4.2	Emotion Recognition Modeling and Evaluation	88
5.5	Real-time Implementation and Offline Testing	93
5.5.1	System Implementation	93
5.5.2	Performance Evaluation	94
5.6	Summary	96

6	Conclusion and Future Work	97
6.1	Conclusion	97
6.1.1	Feature Selection and Combination	97
6.1.2	Deep Neural Networks	98
6.1.3	Real-time System	99
6.2	Future Works	100

List of Figures

2.1	The Papez Circuit Theory of the Functional Neuroanatomical of emotion [1] (When the sensory information which related to the emotional stimuli transmitted to the thalamus, the information spread into the sensorimotor cortex (thought level) and hypothalamus (feeling level). Then the cingulate cortex integrate the information comes from hypothalamus and sensorimotor cortex, it produces the emotions or the feelings.)	11
2.2	Lange Theory of Emotion Classification [2]	12
2.3	Stimuli Distribution In the 2-D Emotional Space Formed By Arousal and Valence [3](Different part define the specific emotion categories)	14
2.4	Brain Structure Map [4]	16
2.5	Brain Function Map [4]	16
2.6	Example of 32 Channels EEG signals	19
2.7	Comparison of the EEG Signals Before and After Artifact Removal	20
2.8	Comparison of EEG Features Before and After Employ the LDS	27
2.9	The Channel Selection Based On Relief Algorithm [5]	29
2.10	Distribution of Emotional Features	30
3.1	Overview of The Proposed Method.(Multi-channel EEG signals are sent for distinct feature extraction, and the hybrid feature dimension reduction scheme is applied for emotion detection based on classification.)	50
3.2	Distinct Features Extracted from One EEG Recording with 32 Channels in DEAP Dataset.	53
3.3	Classification Accuracy on Individual Features Using RF and SVM for Arousal and Valence Emotional Dimensions.	55
3.4	Classification Accuracy (%) and Standard Deviation on Individual and Combined Features Using Different Classifiers on Arousal and Valence. (a). RF for arousal (b). RF for valence (c). SVM for arousal (d). SVM for valence.	57

4.1	Overview of Emotion Recognition from EEG Based on the β -VAE LSTM Model, 1. EEG time series from multiple locations are acquired; 2. EEG transformation work, it contains 3 frequency bands data that represents by RGB and other scheme represents by grey scale images for each time frame; 3. sequence of images are fed into the proposed VAE-LSTM network for representation learning and classification.	64
4.2	Distribution For Original ArousalValence	66
4.3	Experiments Schemes	66
4.4	3-D to 2-D Projection Example of Electrodes	67
4.5	Classification Results for Frequency Experiments	71
4.6	Architecture of Duo-LSTM	72
4.7	Classification Results for Time Experiments	74
4.8	Structure of AE+LSTM and CNN+LSTM	74
4.9	The Comparison of All Experiments' Classification Results	75
5.1	Overview of the Whole EEG-based Emotion Recognition Interactive Film.	84
5.2	The Emotive Epoc+ Sensor and Corresponding Location on Brain	85
5.3	The Experiment Protocol For the Experiment (First 15s for participants to relax, and then watch movie clips for 15s, last 15s for self-assessment, only the 15s captured for watching movie as the EEG dataset)	86
5.4	Labelling Scheme For PEED. Video-based label based on the facial recording for the participant when they watching the movie clips, Self feeling label represents the personal feelings of participants through watching the movie clips.	87
5.5	Preprocessing on EEG Raw Data Applied on ICA.	89
5.6	Performance For Individual Feature of Different Machine Learning Method. (a) stands for the results by KNN. (b) stands for the results by SVM. (c) stands for the results by RF	91
5.7	Subject Real-time System Results Plot	94
5.8	The Performance for Real-time Application (The comparison between system result and self-feeling for the participant for each level of the film, in the figure only system results shows means self-feeling is equal to system prediction.)	95

List of Tables

2.1	Comparison of Three Technologies For Emotion Recognition	14
2.2	EEG Frequency Bands	18
3.1	Features and The Number of Components Extracted from EEG Signals	51
3.2	Classification Accuracy and Its Standard Deviation on Distinct Features (% \pm Δ)	56
3.3	Average Accuracy Comparison on Emotion Dimensions between Pro- posed Fusion method with PCA and mRMR Individual Methods.	57
3.4	Average F1-score Accuracy Comparison on Emotion Dimensions between proposed fusion method with PCA and mRMR individual methods.	58
3.5	The p-value of T-test between Proposed Method with PCA and mRMR on All Features Combined.	59
3.6	Comparison on Classification Accuracy with The state-of-arts.	59
4.1	Description of Samples Setting For each Scheme	68
4.2	Detailed Architecture of Proposed Deep Network Module	70
4.3	Classification Results For Frequency-Based Experiments (%)	71
4.4	Classification Results For Time-Based Experiments (%)	73
4.5	Classification Performance For Classic Methods	75
4.6	Classification Performance Comparison For All Schemes	75
4.7	Comparison For State-of-art and my Proposed (%)	76
4.8	Comparison For Same setting as Chapter three (%)	76
5.1	Summary on Various Studies For EEG-based Emotion Rocognition	81
5.2	Description of The PEED	88
5.3	Individual Feature Self-assessment and Video Record Label Classifica- tion Performance For KNN (k=5)	90
5.4	Individual Feature Self-assessment and Video Label Classification Per- formance For SVM	90
5.5	Individual Feature Self-assessment and Video Record Label Classifica- tion Performance For RF	91

5.6	Classification Performance of MI with RF and Majority Voting Applied .	92
5.7	Binay Classification Performance For PSD, PCC AND MI With RF Applied	93
5.8	Binary Classification Performance of MI with RF and Majority Voting Applied	93

List of Acronyms

ADHD	Attention Deficit Hyperactivity Disorder
AEP	Azimuthal Equidistant Projection
AI	Artificial Intelligence
ANN	Artificial Neural Network
BCI	Brain Computer Interface
BN	Bayesian Network
CDBN	Convolutional Deep Belief Network
CNN	Convolutional Neural Network
CSP	Common Space Pattern
DA	Differential Asymmetry
DBN	Deep Belief Network
DEAP	Database for Emotional Analysis using Physiological Signals
DFT	Discrete Fourier Transform
DWT	Discrete Wavelet Transform
ECG	Electrocardiography
EEG	Electroencephalogram
EMD	Empirical Mode Decomposition
EMG	Electromyography
EOG	Electrooculography
ERP	Event-Related Potential
FCM	Fuzzy C-Means Clustering
FD	Fractal Dimension
FDA	Fisher Linear Discriminant Analysis
FFT	Fast Fourier Transform
FMRI	Functional Magnetic Resonance Imaging
GSR	Global Set/Reset
HA	High Arousal
HCI	Human Computer Interaction
HMM	Hidden Markov Model
HJO	Hjorth Feature
HOC	Higher Order Crossings
HV	High Valence
IAPS	International Affective Picture System
IADS	International Affective Digitized Sounds
ICA	Independent Component Analysis
IMFs	Intrinsic Mode Functions

KNN	K-Nearest Neighbour
LA	Low Arousal
LDA	Linear Discriminant Analysis
LDS	Linear Discriminant System
LSTM	Long Short Term Memory
LV	Low Valence
MI	Mutual Information
mRMR	Minimum Redundancy Maximum Relevance
MRI	Magnetic Resonance Imaging
MSCE	Magnitude Squared Coherence Estimate
NSI	Non-Stationarity Index
PCA	Principal Component Analysis
PCC	Pearson Correlation Coefficient
PEED	Portable EEG Emotion Database
PET	Position Emission Computed Tomography
PSD	Power Spectral Density
PSO	Particle Swarm Optimization
QDA	Quadratic Discriminant Analysis
RA	Rational Asymmetry
RF	Random Forest
RGB	Red, Green and Blue Color Model
SEED	SJTU Emotion EEG Dataset
SOM	Self Organizing Map
STA	Statistics Features
STFT	Short time Fourier Transform
SVM	Support Vector Machine
SVM-RBF	Radial Basis Function Kernel Support Vector Machine
VAE	Variational Autoencoder

Chapter 1

Introduction

1.1 Background

Brain is the most complex part of human organs, and it contains the rich physiological and psychological information of the human body. It reflects and represents the physiological and psychological changing of human beings. Electroencephalogram (EEG) is a synthesis of synaptic potential activities in all brain neurons of the cerebral cortex. The electrical activities of brain cells are extracted by the electrodes which placed on the scalp, then amplified through the EEG sensors to obtain a graph with certain waveform, amplitude, frequency and phase. It can reflect not only the activities of neurons on the surface of the cerebral cortex but also the functional state of the central nervous system. This is an important part of the human cognitive field because of brain-wave intuitively reflects biological characteristics of human beings. Specifically, it contributes to the research on psychology and medical science areas owing to the intuitive response, such as the depression diagnostics, alzheimer disease treatment, brain tumor diagnostics and so on [6] [7] [8]. Moreover, the research on brain-wave is the core technologies in Brain-computer interface (BCI) and Human-computer interaction (HCI) research areas, it appears to be the spotlight approach at engineering research area in the recent years [9] [10] [11] [12].

Emotion is a very important psychological phenomenon of human beings. The definition of emotion in general psychology is as follows: 'Emotion refers to the attitude toward the outside world along with the process of cognition and consciousness, and it is the reaction to the relationship between objective things and subject needs. The composition of emotions are complex including complex components such as emotional experience, emotional behavior, emotional awakening, and perception of stimuli' [13]. Emotion is the ba-

sis factor of human beings because it affects human's communication, learning, cognition and decision-making. Generating emotion is the instantaneous, non-spontaneous physiological and psychological process of human beings. It usually not controls by subjective consciousness but the subjective experience of perception for objective things caused by internal or external stimuli [14]. It consists of subjective feelings such as joy, anger, sadness, fear, etc [15]. Different human probably has great differences in the emotional response to the same thing or person under different times, places and other conditions [2].

Emotion estimation presents the participant's current emotional state through the processing of the collected data. Previous researches conducted that emotion recognition have been achieved through facial expressions, speech, gestures and other body movements [16] [17]. However, these external signals do not always truly reflect human emotions due to that humans may cover up their external manifestations or the disabilities cannot express their feelings. Therefore, identifying human emotions through internal physiological bio-signals is the solution. Emotion estimation through physiological signals contains the analysis on EEG, electrocardiogram (ECG), electromyography (EMG), skin resistance, skin conductance, skin temperature, photoelectric pulse, respiratory signal, etc [3] [18]. Generally, emotion is a subjective experience of whether the human brain achieves own needs for objective reality. It involves three aspects: physical, psychological and behavioral. Emotion is a high-level biofeedback function of the brain that related to not only effect organ and peripheral nerve activities but also central nervous activity. The complex neural circuit responsible for generating emotion in the brain and different location of brain play different roles in emotional components [19]. Therefore, it is meaningful to figure out the relationship between brain activities and human emotions while EEG as the direct reflection of brain activities is the optimal choice signal. Consequently researchers draw more and more attention to EEG-based emotion recognition.

EEG-based emotion estimation achieves higher recognition accuracy which compares to the other emotion recognition schemes; it is because relying on EEG's intuitive reflection of the emotional states and hardly being disguised or artificially changed. The main steps contain emotion stimulation, EEG signal acquisition, preprocessing of the EEG signal, feature extraction and selection, feature reduction and classification [20] [21]. At this stage, emotion recognition from EEG-based can be treated as a specific classification problem since the goal of the system is to predict the correct label of emotion. EEG-based emotion recognition researches conduct greater useful and practical human emotional level classification frameworks [22]. The achievements of this research area contribute to HCI and psychology areas, such as emotional disorder treatment depression treatment, Child brain development and interactive games [23] [24] [25]. The mature HCI technologies are the general tendency of scientific research and human society development.

Moreover, emotion is one of the critical and efficient communication medium between human and computer which provide lots of possibilities for the future [26].

EEG has the characteristics of non-stationaryness and randomness relying on the complexity mechanism of the brain. Simultaneously, EEG is also susceptible to other physiological signals and external disturbances. Traditional processing methods have some drawbacks [20]. With the development of Artificial Intelligence (AI) techniques, the peaks of many research areas have been updated and then demonstrate unlimited possibilities to subvert the previous achievements. Therefore, leveraging on the actively operation ability and efficient performance of deep neural networks modules in a reasonable applying way to utilize on EEG-based emotion recognition for significant achievement is imperative. This is not denying for traditional processing approaches but drawing support by advanced approaches to gain the potential improvement. Moreover, EEG-based emotion recognition acquires great scientific significance for real life as proposed above. Therefore, to exploit the advanced deep neural networks modules to obtain achievement possibly accelerating the application product forming of this research area in order to pull in the distance to the future. However, there are no specific deep neural network models for EEG processing at present. Accordingly, extending the advanced deep learning processing modules to the EEG processing research area is necessary and meaningful.

The ultimate purpose of scientific research is to solve problems of daily life for the human. Accordingly, mature scientific research technologies will eventually turn into the specific applications assimilate into corresponding fields. Therefore, the creation of applications should settle as the ultimate goal for EEG-based emotion recognition researches based on the potentially great experiment achievements. The interaction between human and machines through emotions is the unique approach to achieve AI the 'real intelligent' instead of obeying command-only programs. Overall, with the widely demand for applying the application in real life of human beings, it is feasible and maintaining great prospects for contributing to EEG-based emotion recognition application development.

1.2 Motivation

With the constant development of science and technology, the research field is increasingly expanding under the high-level demands of human reality life. However, there are many mysteries of the human body which still have not yet been solved. Particularly, the discussion on the relationship between brain signal and human emotion are turning into the researchers' spotlight issue for discussing. The exploration on human brain has never

stopped through decades, but the technical limitation of brain signal acquisition severely restrict the development speed of brain science. In recent years, the development of techniques provides the foundation of the development on brain science, such as wearable EEG sensor, magnetic resonance imaging (MRI), position emission computed tomography (PET) and functional magnetic resonance imaging (fMRI) [27] [28]. Among these techniques, EEG is relatively the easiest signal to capture and process. Therefore, it is practical for using EEG signal as the representation of brain activities to explore the relationship with human emotion.

Under the deepening of emotion researches, the research results are increasingly applied in various important areas for real life. Recently, emotion researches draw attention to the medical field for the diagnosis of mental illness and depression as the auxiliary tool to assist doctor in resolving the highly rigorous and scientific diagnosis. Acquiring the patients' emotion is particularly important in clinical for depression or emotion disorders patients. In the engineering area, emotion as the metrics of humanity is the most wanted indicator to achieve HCI with the dramatically development of AI technologies. Emotion research based on EEG is highly practical due to the EEG signal's characteristics of intuitive and reliable. Generally, the research on EEG-based emotion recognition to build the application is highly significance for the future development of scientific researches.

In summary, the main research purpose is to figure out the most suitable and effective framework to create the EEG-based emotion recognition systems with strongly performance, and then the ultimate goal is to build the applications based on the systems to solve the practical problems. Among all the emotion recognition schemes, EEG-based is one of the hardest to achieve but with potential to gain the significant achievement which gives it a high research value.

1.3 Research Question

In recent years, EEG-based emotion recognition technologies have achieved to be highly mature with the help of advanced development in bio-electric sensor technology. It is undeniable that EEG-based emotion recognition research still under the infancy stage owing to highly noise and easily disturbed compare to other relatively emotion recognition area [29]. However, the development of EEG-based emotion recognition's key technology highly influences the critical procedure of future technological development. Generally, EEG-based emotion recognition core technology's research&development and application contributes to achieve objective, accurate and effective information for emotion-level

cognition systems [30]. In order to achieve these goals there exist the following aspects of challenges.

EEG Database

Data is the foundation of machine learning [31], which reasonable data determines better features and models. The EEG signal collection procedure is relatively complex and slow since 32 or more channels EEG acquisition sensors applied in current researches. The main issue is because the preparation process of the experiment last a relatively long time by wearing the sensors for experiments' participants, injecting the saline (or brain electric paste into each electrode) and detecting the contact for each electrode. The highly cost on human resource and time resulting in that it is difficult to complete the acquisition for larger amount samples. The less amount of samples likely to cause over-fitting of data models during data analysis and can not reflect the actual accuracy for specific task. Another important issue is that there is no universal guideline for defining sources of stimuli to generate emotions, which lead to relatively hard to stimulate participants' specific emotion. It is impossible to formulate the generally common principle for the emotion stimuli based on different background, gender, nationality, age and religion of participants. Public EEG databases are normally practical and reliable, but the experiment protocol and labeling pattern are different which resulting in hardly implementing the generic model. Therefore, research questions contain how to build effective generic EEG-based emotion classification models through public database and how to build the reliable and practical EEG-based emotion database.

Feature Selection

What are the effective features for EEG-based emotion recognition to distinguish the emotional states accurately and clearly? Although EEG processing contains various feature extraction methods based on different processing background. Specifically, traditional EEG processing contains frequency domain features and time domain features under the consideration of time series sequential data processing mechanism, and more recent channel-based EEG uniquely features. However, numerous previous approaches have presented that the models which achieve the ultimate higher classification accuracy required to be implemented by different combinations of features but no single feature applied. Therefore, how to extract the relevant information and discard redundancy information through various features to achieve the best accuracy worth to be discussed.

Deep Neural Networks

Is deep neural network modules maintain reaching efficient and accurate in EEG-based emotion recognition tasks? Leveraging on deep learning neural networks various research areas' achievements have been significantly updated [32] [33] [34], however, for the relatively newer and developing EEG-based emotion recognition research area there is lack of researches with employing deep neural networks. Therefore, how to promote the advanced deep neural networks modules into EEG-based emotion recognition area and how to build the specific EEG-processing deep modules with strong generalization are the great issues.

Applications

For every research area, the ultimate goal is to produce the real application to provide the better services for real life based on the mature technologies. Moreover, EEG-based emotion recognition is a strongly recommended discipline because it is the key technology of HCI through previous researches. If the mature EEG-based emotion recognition systems and technology turning into the applications, many key problems will be solved in various specific researches areas, such as the current existence AI will turn into truly intelligent with emotion. Therefore this will be the focus of future research circles.

1.4 Aim and Objectives

The main aim of this research is to develop the effective and practical automatic emotion recognition systems through brain-waves. Based on the mainly issues that research questions presented above, the approaches are achieving this aim following the progressive relationship. Firstly, to explore the key technologies of EEG-based emotion recognition and produce the best performance framework based on the various features. Secondly, to promote and model the efficient and accurate emotion recognition systems based on the advanced deep neural network modules from EEG. Finally, to establish the highly reliable and accurate EEG emotional database and further explore various schemes to build the practical and effective system based on the database and previous approaches, which contribute for proposing the EEG-based emotion HCI applications. Therefore, the objectives are:

- To extract and combine relevant and discard the redundancy information for the emotion detection to achieve accurate and reliable classification results in an efficient way. The high levels of noise which resulting in that single feature alone

cannot achieve good performance. A combination of distinct features is the key for automatic emotion detection. Simultaneously, the exploration for choosing the reasonable classification and validation experiment schemes is necessary.

- To achieve more accurate and practical EEG-based emotion classification performance based on deep neural network modules. To figure out the EEG data processing pattern and select the reasonable deep learning networks to achieve significant improvement and verify the improvement between proposed model and other processing schemes.
- To create the EEG-based emotional HCI systems and its application. Especially, to achieve this goal, the emotional EEG database establishment is necessary relying on the task of brain function is relatively unique. The key technologies that exploring the best model on the proposed EEG database acquire from the previous proposed researches.

1.5 Thesis Contribution

The contributions for this thesis are mainly about elaborating the research works for EEG-based emotion estimation. There is a progressive relationship between each researches, therefore, the following presented these contributions under the mutual relationship.

- A new emotion detection system is proposed. Firstly, multiple feature extraction methods are used to produce different types of features from different domains. Secondly, I applied a new hybrid dimension features reduction scheme which used the combination of supervised and unsupervised reduction method to fuse the different features in order to get the best feature. Advanced machine learning methods are used and evaluated on a public available dataset DEAP (Database for Emotional Analysis using Physiological Signals) [3]. Experimental results are given on all different features and different feature selection methods for the emotion information extraction from EEG signals. The classification results for emotional states label as $77.2\pm 8.6\%$ on valence and $74.3\pm 8.4\%$ on arousal based on proposed experiment schemes. It is compared with other state-of-the-art methods at the same setting up on the public DEAP database.
- An exploration experiments on EEG-based emotion recognition were presented with the proposed disentangle adaptive noise learning β -VAE and LSTM deep neural network schemes. Firstly, all EEG activities were transferred into a sequence of multi-channel image based on the different domain's experiment schemes. Furthermore, the proposed β -VAE and LSTM modules was applied to learn robust

representations from the sequence of images under the different frequency-based and time-based experiment schemes. Specifically, we proposed the β -VAE and double-LSTM modules serving to the time-based experiment with consideration on large amount of data and obviously sequence characteristic. Finally, the evaluation and comparison were presented with traditional EEG methods, similar deep neural network modules and state-of-art. The experiments were on DEAP of quadratic (arousal-valence) classification and achieved $63.3\pm 2.4\%$ accuracy for frequency-based, $66.4\pm 4.2\%$ accuracy for time-based experiment.

- The requirement of the interactive film and design the protocol for data collection using a portable EEG sensor (Emotiv EPOC) were studied. Then a portable EEG emotion database (PEED) of 15 participants is built for emotion analysis from portable EEG sensors with the emotion labels using both self-reporting and video annotation tools. Further, I explore the various combination schemes of feature extraction, and classification methods with majority voting under the subject independent validation to build a practical system for real-time emotion detection. Finally, the emotion detection system is trained and integrated into the interactive film for real-time implementation and evaluation.

1.6 Thesis Overview

According to the interrelationship of research works, the main contents of the specific chapters of this thesis are as follows:

- The first chapter presents a brief introduction to the background, research questions, motivations and significance of this thesis's research.
- The second chapter presents the literature review. It covered the description of human emotions and the bio-significance of generating the brain-wave theoretical basis. The general EEG-based emotion recognition analysis methods and the existing EEG-based emotion recognition researches were reviewed which present the research status for this thesis work. Simultaneously EEG-based emotion recognition system's methods were addressed in terms of feature extraction, feature selection and classification. The review on existing EEG-based emotion recognition applications were presented at last.
- In chapter three, a hybrid dimension feature reduction scheme was presented by using a total of 14 different features extracted from EEG recordings. The main contribution is proposed the feature reduction scheme which combines these distinct features in the feature space using both supervised and unsupervised feature selection

processes. Maximum Relevance Minimum Redundancy (mRMR) is applied to reorder the combined features into max-relevance with the labels and min-redundancy of each feature. The generated features are further reduced with Principal Component Analysis (PCA) for extracting the principal components. Experimental results show that the proposed work outperforms the state-of-art methods using the same settings in the publicly available DEAP data set.

- In chapter four, leveraging on the proposed disentangled adaptive noise learning β -VAE combine with LSTM model to produce the exploration experiments schemes of emotion recognition based on EEG recording. The time series EEG data transferred into the 32x32 EEG-images database based on Azimuthal Equidistant Projection and Clough-Tocher scheme under different setting of frequency and time domains firstly. Then the exploration experiments are divided into frequency-based (three bands used or four bands used) and time-based (single-LSTM or double-LSTM) four different schemes for producing the classification results.
- In chapter five, a novel real-time emotion detection system based on the brainwave signals from a portable EEG headband, integrated into the interactive film 'RIOT'. Firstly, I study the requirement of the interactive film and design the protocol for data collection using a portable EEG sensor (Emotiv Epoc). Secondly, I build a portable EEG emotion database (PEED) from 10 participants and produce the emotion labels using both self-reporting and video annotation tools. Thirdly, I explore the various combination schemes of feature extraction and classification methods with majority voting under subject independent validation to build a practical system for the real-time detection. Finally, the emotion detection system is trained and integrated into the interactive film for real-time implementation and fully evaluated.
- Finally, the chapter six is the conclusion and future work of this thesis.

Chapter 2

Literature Review

2.1 Emotion

2.1.1 Physiological Basis of Emotion

Human emotion is a complex phenomenon which lacks clear definition. It is relatively associated with phenomena such as human's state of mind, mood and feelings and consists of physical, psychological and social factors [35]. The research of emotion has been pursued since ancient times and currently spans a multitude of disciplines such as philosophy, psychology, neuro-science, sociology, economics, medicine, history, the arts and computer science [36]. James [15] is called as the father of the psychology proposed the earliest definition for emotion, he believed that 'emotion is the feeling for the diversification inside human's body', the emotional perception comes after the changes in the body. Every emotion produced by the certain physical changes on the body, such as facial expressions, muscle tension, visceral activities. Lange [2] proposed the similar point in 1885. Therefore, later generation called their work as the James-Lange theory, also been called as emotional outer periphery theory [37]. James-Lange theory confirms the intrinsic link between physiological and emotion, but the theory of emotion generating only based on the outer periphery physiological changes is one-sidedness.

Cannon [37] proposed the production of emotion decided by the thalamus. He believed that the cerebral cortex activated the thalamus when the external stimuli delivered into the vertebral cortex, and then brought out different emotions. One of Cannon's colleague, Bard, also proposed that the emotion is decided by the thalamus, so their work called as

the Cannon-Bard theory [38]. Cannon-Bard theory affirmed that the important role of thalamus of the emotion, but the theory completely denial the relationship between the outer periphery physiological and emotion, so this theory also is one-sidedness. Paperz [39] once again draw the relationship between the human emotion and the physiological activities, and proposed the limbic system mechanism of the emotion, also been known as the Papez circuit, as shown in 2.1. When the sensory information which related to the emotional stimuli transmitted to the thalamus, the information spread into the sensorimotor cortex (thought level) and hypothalamus (feeling level). Then the cingulate cortex integrate the information comes from hypothalamus and sensorimotor cortex, it produces the emotions or the feelings. After decades, Maclean [40] proposed the concept of visceral brain, 'visceral brain made responsible for mediating all the relevant organs with emotion, and it had the corresponding response on visceral and skeletal through the hypothalamus'. Papez-Maclean theory integrates all the previous studies on emotion and makes a foundation for further research.

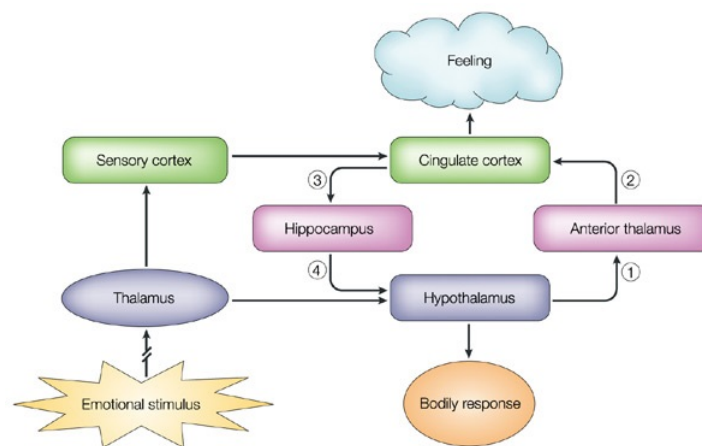

Figure 2.1: The Papez Circuit Theory of the Functional Neuroanatomical of emotion [1] (When the sensory information which related to the emotional stimuli transmitted to the thalamus, the information spread into the sensorimotor cortex (thought level) and hypothalamus (feeling level). Then the cingulate cortex integrate the information comes from hypothalamus and sensorimotor cortex, it produces the emotions or the feelings.)

Although the definition of emotion has not yet unified, but the results of neuroscience and cognitive science shows that emotion is highly related to the activity of the cerebral cortex which provides a theoretical basis for the research of brain cortex activity analysis and identification of human emotional state [13].

2.1.2 Classification of Emotion

Human emotion is very complex. Researchers are still trying to figure out the result about regrading each emotion as the individual and independent existence or there is correlation between different emotions. Modern researchers have proposed different kinds of basic emotion sets through the research [41]. James's emotion set contains anger, fear, sad, love [15]. Ekman's [35] emotion set contains anger, fear, sad, happy, hate and surprise. Clynes's [42] emotion set contains anger, hate, sad, happy, love, romantic, and no mood. Izard's [43] emotion set contains anger, fear, sad, happy, surprise, kindness, disgust de-spise, shame and guilty. They all believed all the emotion of human expanded by the basic emotion set.

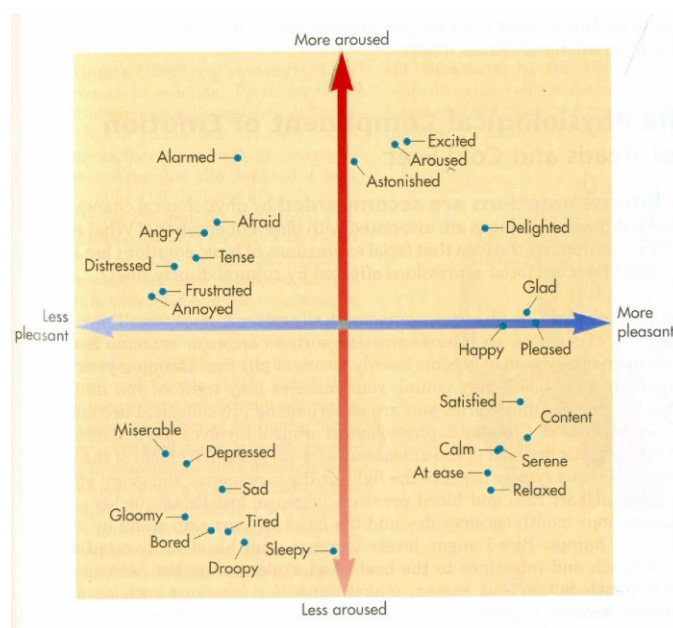

Figure 2.2: Lange Theory of Emotion Classification [2]

However, it is found that there is some correlation between some emotions, such as anger and disgust simultaneously occur sometimes. Therefore, researchers begin use different dimension to express emotions according to the association between emotions. Lange's two-dimensional mood classification model is the most common classification method [44], as shown in Figure 2.2. The model uses ordinate to represent the degree of aroused and abscissa to represent the degree of pleasure, a gradual transition from doldrums to excitement. Different emotions can be divided into this two-dimensions and mapped to the coordinate system.

2.1.3 Characteristic of Emotion Evoked

Eliciting different human emotions is one of the most important preconditions for emotion research. Emotion stimulation can be achieved by external stimuli and internal stimuli. The following three methods are the most widely used ways for emotion evoked currently.

1. The most commonly used method for modern researchers is using images, music, video or other external stimuli to evoke different emotions. To induce the different emotions objectively and effectively then mark score for different emotional states, Lang and his team built the International Affective Picture System [44] and the International Digital Sound System [45]. They chose different ages, different genders, different ethnic participants scoring for the materials of the system, and finally got the three-dimension scores of every materials for valance, arousal and dominance.

2. To ask participants to make corresponding facial expressions to the different emotions. Ekman [46] proposed a set of facial behavior coding system by researching the relationship between facial muscle movement and facial expressions. 'Emotion of human will manifest through facial expressions', they believed facials are honest and reliable. Therefore, some researchers ask participants to make different facial expressions due to analysis the corresponding emotion [47]. However, this method is unreliable, mainly because if human wants to cover up their emotions, it is hard to detect the change of their facial expressions.

3. To ask participants to recall their own memory segment with corresponding emotion. This is the entirely internal emotion evoked by the participants, and some researchers treat this method as the basic way of researching [48] [49]. However, this method can not guarantee that participants can find out the memory segment with corresponding emotion, and it is hard to calculate the retention time for the emotion.

These three methods have their own advantages and disadvantages. Therefore, researchers need to choose the suitable method depend on the different research background and purpose.

2.1.4 Emotion Recognition Methods

Emotion recognition methods are entirely different which corresponding to the different emotion evoked methods. Emotion recognition based on non-physiological signal and physiological signals are the two common methods, as shown in Table 2.1. Non-physiological methods contain the recognition based on facial expression and audio. Fa-

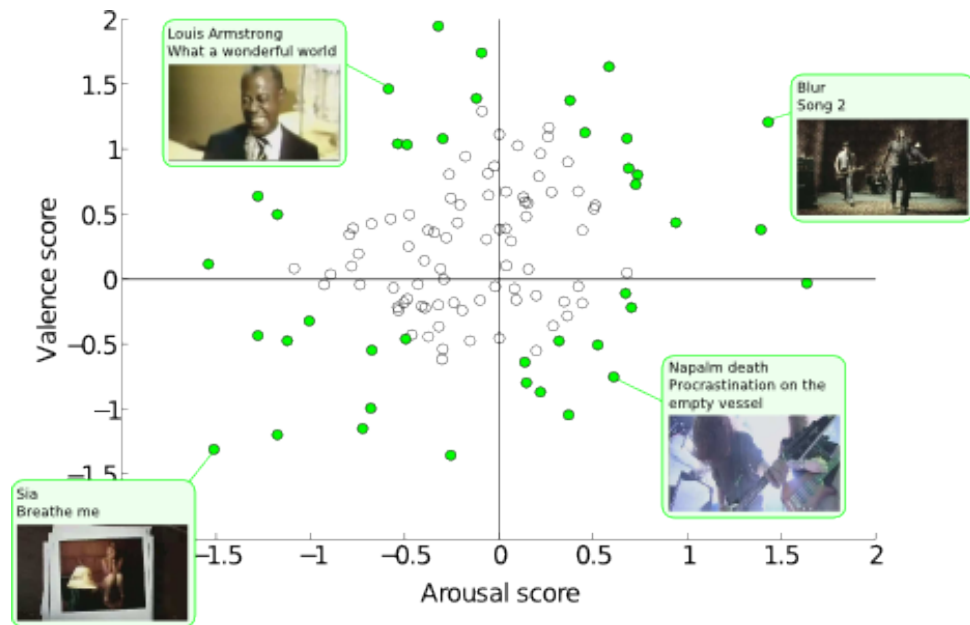

Figure 2.3: Stimuli Distribution In the 2-D Emotional Space Formed By Arousal and Valence [3](Different part define the specific emotion categories)

cial expression recognition is mainly based on the corresponding relationship between facial expression and emotion, human will bring up certain facial muscle movement and facial expression pattern under the specific emotion state. For example, human will upturn mouth and appear endless wrinkles when they feeling great; and if they are angry, mostly they will frown or eyes widely open. Currently, facial expression recognition always uses image recognition method to be achieved [50]. Audio and tone recognition method is depending on the different language expression by human under the different emotional states [51]. For example, human will talk by a cheerful tone of voice under the pleasure, and they will speak more boring under the fretful. The advantages for non-physiological methods are relatively simple and no specific equipment required. However, the weakness of these methods is that they can not guarantee the reliability of the emotion recognition, because human could cover up their true feeling by camouflaging facial expressions and tone of voice. Secondly, non-physiological methods are not suitable for the disabilities.

Table 2.1: Comparison of Three Technologies For Emotion Recognition

	Non-Physiological	Autonomic nervous	EEG
Difficulty on signal Acquisition	Low	Medium	High
Signal quality (SNR)	High	Medium	Low
Accuracy	Low	Medium	High

Physiological methods contain emotion recognition based on autonomic nervous system and central nervous system. Recognition based on autonomic nervous system is mainly

measuring the heart rate, GSR, respiration and other physiological signals to identify the corresponding emotion. Picard [52] recognized calm, anger, hate, sad, pleasure, romantic, happy and fear through the measurement and analysis on the autonomic nervous system. These autonomic nervous signals can not fake, but due to the low accuracy and lack of reasonable evaluation criteria, this method is not suitable for practical applying at present.

Recognition based on central nervous system is recognizing the corresponding emotion through the analysis of the different brain signals under the different emotional states. EEG and fMRI are the two commonly used methods, but fMRI need the specific equipment and it's very expensive, by contrast EEG signal acquisition equipment is very simple and it has high accuracy [53]. Therefore, EEG-based emotion recognition is the commonly chosen research method.

2.2 Description of Brain and EEG Signals

2.2.1 Function and Structure of Brain

Human brain is the most complex part of all organs and the terminal of all nervous systems. It consists of the left, right hemispheres and the endplate at the front of the third ventricle which connects the two hemispheres. The thin layer on the surface of the brain is called the cerebral cortex. Collaboration between the left and right hemispheres is achieved by the connected giant fibers between the left and right hemispheres [54]. The surface of the cerebral hemisphere is uneven and covered with different sulcus. There is oblique sulcus on the dorsal side of each cerebral hemisphere which called the lateral fissure. These sulcus and fissures divide each hemisphere into four lobes. The frontal lobe locates at above of the central sulcus and the lateral fissure, it is the largest of the four lobes which occupying for about one-third of the cerebral hemisphere. Below of the lateral fissure is the temporal lobe. The parietal lobe locates at the part after the central sulcus and above the lateral fissure. After the parietal lobe and temporal lobe, above the cerebellum is called the occipital lobe [55]. There are abundant neurons and various nerve centers in each brain region. Therefore, each brain region controls different functions for the tasks which forming a divisional functional structure of the cerebral cortex. The brief details of structure and function in the following, as shown in Figure 2.4 and Figure 2.5.

1. Frontal lobe: Also called the prefrontal lobe. As the most important part of the brain, it plays an extremely important role. The front of the frontal lobe is the frontal pole, and the frontal lobe is located between the frontal pole and the central sulcus. The frontal lobe is

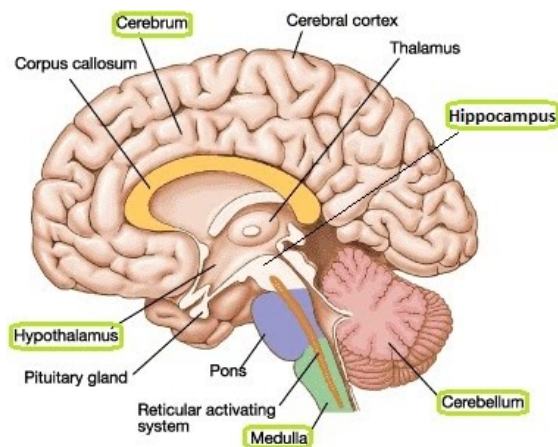

Figure 2.4: Brain Structure Map [4]

divided into the primary motor area, the frontal motion area and the prefrontal lobe. The frontal lobe is primarily related to thinking, planning and emotions [55].

2. Parietal lobe: It located at the part which after the central sulcus above the lateral fissure. The parietal lobe is primarily responsible for pain, touch, taste, temperature, and stress, moreover, the area is related to mathematics and logic [55].

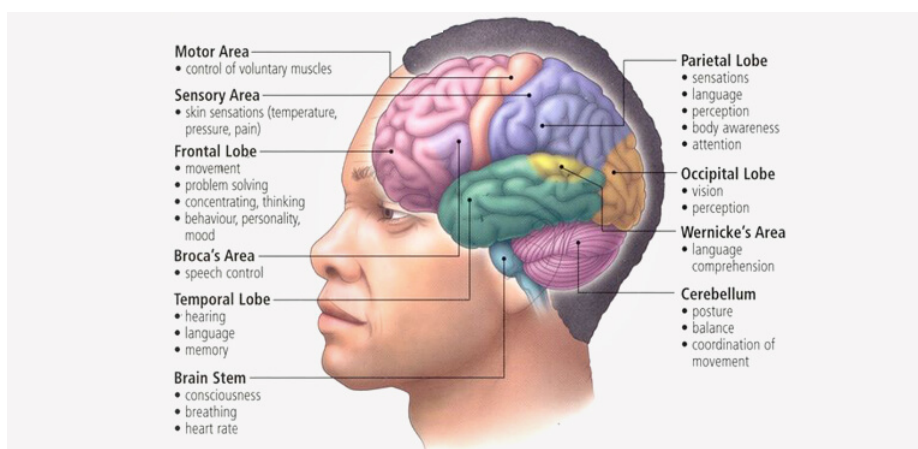

Figure 2.5: Brain Function Map [4]

3. Temporal lobe: It located at below of the lateral fissure, connecting from the bungee of the lateral side of the brain to the occipital. The upper part of the area is responsible for processing the auditory information. The front part of the temporal lobe is a mental cortex, which is strongly related to human memory and emotion [55].

4. Occipital lobe: It is located at the back of the hemisphere, behind the occipital sulcus.

The occipital lobe is small on the outer side and the sulcus is indefinite. The occipital lobe is responsible for the visual information as the visual cortical center, it also relates to language and movement perception [55].

5. Insular lobe: It is in the shape of a triangular island, located in the deep side of the outer sulcus which covered by the forehead, top, and temporal lobe. According to the existing research, the Insular lobe is highly related to emotional regulation and human internal organs activities [55].

6. Limbic System: It relates to the memory and emotion processing [55].

2.2.2 Electroencephalogram (EEG)

EEG refers to the recording of the potential which occurred by the spontaneity and rhythmic movement of the brain neurons under the chronological order. Neuroscience, psychology and cognitive science present that many mental activities and cognitive behaviors can be reflected by EEG [56]. Therefore, EEG is more and more widely used in the emotion recognition area. Generally, human's different mental states or even subtle changes of emotion will be directly reflected in EEG signals. It mainly has the following two characteristics [57].

1. EEG is the weakness signal resulting in it is not only difficult to collect but also easily interfered by physiological electric signals during the acquisition process. The commonly noise physiological electric signals contains EMG, ECG and EOG [58]. Therefore, original EEG signals acquire to go through the denoising procedure.

2. Human emotions, thinking and even physiological factors directly affect EEG signals because it is the intuitive reflection of brain activities. Since they are relatively independent for the emotional states, and time and space factors reflect from brain for each moment, therefore, EEG signals acquire strongly nonlinear characteristic [59].

2.3 EEG-based Emotion Recognition

The main steps contains emotion evoked, EEG signal acquisition, preprocessing of the EEG signal, feature extraction and selection, feature reduction and classification. Typically EEG acquisition always applies for extracting and amplifying the signal. Since EEG signal is very weak, it needs to be amplified first. Then, the signal must remove the artifact

Table 2.2: EEG Frequency Bands

Bands	Frequency	Amplitude	Cognitive Characteristics
δ	0.5-4	20-200	It belongs to the slow wave and often appears in the occipital lobe and temporal lobe. Normal people are less measured, more common in fatigue or anesthesia. Do not participate in the processing of information.
θ	4-8	100-150	It belongs to the medium and low amplitude slow wave, which appears when the person calmly relaxes and turns to sleep. It is the expression of the central nervous system inhibition state and is related to the working memory load.
α	8-13	20-100	It is a low-amplitude sync wave, which is the main waveform recorded in a waking quiet state, and is generally considered to be related to the preparation activity of the brain.
β	13-30	5-30	It is a high-frequency, low-amplitude, unsynchronized fast wave that reflects the alert state of the brain. It is visible when emotions are excited or excited, indicating that the human cerebral cortex is in an excited state.
γ	>30	<2	Belonging to the high-frequency part of brain waves, gamma waves play an important role in the high-level functions of information reception, transmission, processing, synthesis, feedback, etc. in the brainstem and the cognitive activities of the human brain, and are related to activities requiring attention and sensory stimulation.

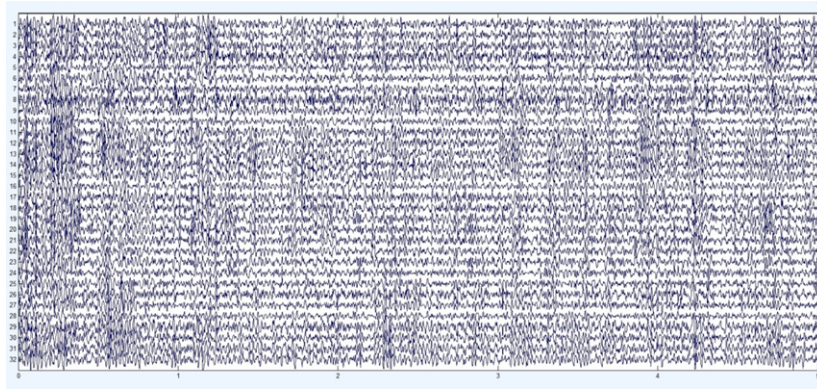

Figure 2.6: Example of 32 Channels EEG signals

through the preprocessing algorithm. But different researchers have different opinions on these step, it depends on the specific project. The following present the specific procedure of EEG-based emotion recognition research.

2.3.1 EEG Preprocessing

Since EEG signal is very weak, so the acquisition processes are highly influenced by other noise signals. Preprocessing of EEG largely includes a number of processes, such as line noise removal, adjustment of referencing, elimination of bad EEG channels, and artifact removal [60]. The procedure mainly refers to the removal of the artifacts the collected EEG signal. The artifact includes EOG, EMG, ECG, frequency interference, electromagnetic interference and some other signals not related to the task [61] [62]. The comparison of artifact removal before and after as shown in Figure 2.7. Numerous techniques have been developed to identify and remove EMG and EOG related artifacts [63] [64] [65]. Since frequency interference and electromagnetic interference often occurs at high frequencies, it is possible use band pass filter or low-pass filtering to filter out interference bands and only retain the effective EEG bands.

Recently common artifact removal methods include matching pursuit (MP) [66] and independent component analysis (ICA) [67] [68]. These methods are applied to identify the interference signals, then separated from the EEG signal for the artifacts which hardly removal by filtering [69] [70] [71]. Basically, ICA is proved to be the most common used EEG artifact removal method, it is the mathematical method to decompose the fuzzy mixed signals into the relatively independent components. Therefore, ICA can effectively divide the signals into EEG and other noise signals [68].

Bartels [72] proposed a highly effective method on removal artifact, it combines blind

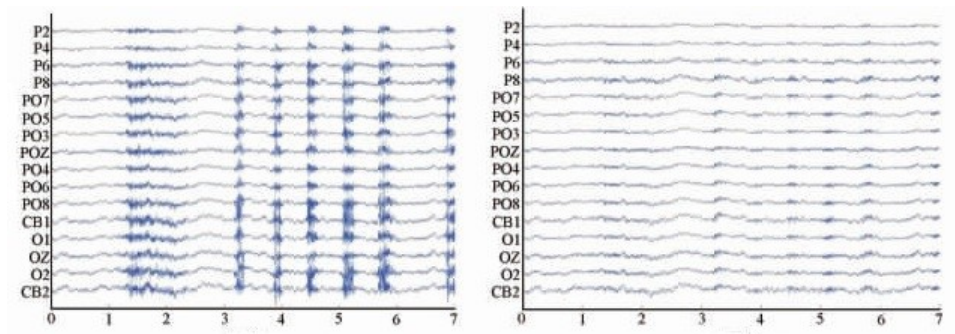

Figure 2.7: Comparison of the EEG Signals Before and After Artifact Removal

signal separation, ICA and SVM. Specifically, the Amuse algorithm of blind separation signal usually employed for removal EOG and the Infomax algorithm of ICA used for removal EMG [72]. Yang et al. [73] proposed the hybrid two stage de-noising methods to enhance the signal preprocessing based on wavelet-based noise removal methods. Rao et al.[71] compared the different performance of MP and ICA under the advanced Time-delay neural network to achieve that ICA is more effective than MP. Most recent research conduct the combination schemes of ICA and other signal processing methods to achieve the highly artifact removal [74] [75] [76]. Zhou [77]proposed to combine the ICA and the EEG dipole model to discard the specific eye movement artifacts through EEG. Santilln-Guzmn et al. proposed the combination of ICA and empirical mode decomposition (EMD) to eliminate muscle and ocular artifacts, EMD further applied to discard the components by ICA which still containing physiological information [78].

EEG preprocessing procedure is the basic of EEG-based processing approaches. Generally, the artifact removal avoids the suppression of the interference for other human physiological signals. Discarding the noise signals leads to the more effective and reliable EEG-based experiments [22]. It will provide pure and smooth EEG signals to the further processing procedures.

2.3.2 Features Extraction

Feature Extraction refers to extract the specific feature from EEG which suitable for the project. It is a vital part for emotion recognition based on EEG, only extract the reliable feature which corresponding to the emotion so that it can provide the guarantee for the classification result. Kim proposed a brief view for the field of emotion recognition from EEG. [22]. The reliable features represent the corresponding useful information for the specific requirement to the tasks. Generally, perfect features contributes to the effective and practical performance for the classifying the emotional states, it relatively determine

the specific capability for the EEG-based recognition system [20]. Typically, traditional EEG feature extraction based on the time domain [79] [80], frequency domain [81] [82] and time-frequency domain [83] [84]. Recently, there are numerous new type of EEG feature extraction methods have been proposed based on the different domain with the development of EEG-based researches. Channel-based and deep neural network based achieves the significant improvement [85] [86] [87].

Although the new type feature extraction methods are shown to be effective, traditional methods also contribute to this research area. Therefore, it is meaningful to review the contributions of these feature extraction approaches. In the following of this section, we review a widely range of related feature extraction relevant approaches for EEG-based emotion recognition under each domain separately. We generally distinguish features in time domain, frequency domain, time-frequency domain and other new-type methods.

Time Domain

Time domain feature refers to use the EEG signal to extract the time domain information or statistics as the feature to achieve the further approach [79]. Basically, EEG is the classic continuous time-series data, it acquires the most intuitive information to reflect the changing of human states. Time-domain features extraction methods are the relatively simple, straightforward and basic of EEG-based research [88]. Time-domain feature extraction methods typically using the original after artifact removal time-series EEG data which means there is no any transformation procedure compare to other kind of feature extraction background. Therefore, time-domain based EEG researches continuously are the representation of fundamental and highly yield of EEG processing technologies. In the following content will list out numerous outstanding approaches.

Event-related potentials (ERP) refers to when giving or canceling the stimuli on the particular part of the brain or some kind of mental factors arising, the potentials changes at specific part of the brain [89]. Normally the ERP researcher always uses different emotional color pictures or pictures with different facial expressions as stimuli, then identify different emotion through the analysis on the evoked potentials at related brain part. Frantzidis et al. used amplitude and latency of ERPs (P100, N100, N200, P200 and P300) as features in their study [90]. Eimer uses human face images with scared or neutral expressions as stimuli, then use ERP to find out the difference between scared and neutral emotion [91]. In their studies, it proposed that when the upright position of panic emoticons appears, the participants will produce a positive potential inherent in the frontal part in 120ms, and if image is placed upside down, the related potentials will delay. Further, they found that the emotional face images will positive increase ERP with respect to the

neutral emotional face images. Besides, N170 phenomenon will not affect the identification of the emotion, it shows that emotional expression analysis and face structure encoded are the two parallel systems for the processing of the information in the brain. There are numerous studies about using ERP to achieve BCI because it is relatively simple to extract [92][93]. However, there are lack of EEG-based emotion rely on ERP, the potentially issue is the lower correlation between emotion and ERP information.

The most common and simple feature of time domain feature methods is the extraction on statistics of the EEG signals [20], such as the mean, peak, absolute value, standard deviation and so on. Barr et al.[94] applied the peak algorithm which calculated and discarded the registration of low-voltage activity riding on EEG waves through the amplitude threshold. Further, Khalili proposed the mean, standard deviation, peak value, 1st difference mean absolute value of the original data and 1st difference mean absolute value of the normalized data as the EEG feature [95]. Zhang proposed the amplitude difference between symmetrical electrodes in time domain as the EEG feature [96]. Yuen et al.[97] proposed using the mean, standard deviation, first difference and second difference as the input to the back-propagation neural network for emotion classification.

High order crossing (HOC) is one of the classic time-domain EEG feature extraction method. It is applied the zero-crossing counting filter to the sequence of time series EEG data [98]. HOC applied to extract the feature from the intrinsic mode functions (IMFs) through EMD to achieve the EEG-based emotion classification by Petrantonak et al. [99] Further, he proposed to use HOC to test four different classifiers, discriminant analysis (QDA), KNN, Mahalanobis distance and SVM to achieve the most effective accuracy for emotion classification [100]. Liu. [101] proposed to use the combination of HOC and statistics as the features for emotion recognition tasks. My previous approaches also applied HOC as one of the feature to achieve the emotion recognition and obtain relatively great results [102].

Fractal Dimension (FD) is commonly mathematics method regarded as the extraction method for calculating the time-series features [103]. Various studies proves that FD is effective for EEG time domain feature extraction procedure as EEG signal is nonlinear and chaotic [104] [105]. Aftanas et al.[106] proposed to use FD as the EEG feature to distinguish positive and negative emotions. FD contributed to EEG-based concentration detection by Wang et al.'s work [107]. Sourina et al. proposed the FD as the feature to analysis the emotion through EEG when music stimuli applied [108] [109]. Liu et al. proposed FD as the on-line feature extraction methods to build the real-time EEG emotion recognition systems [25].

Despite of the above studies on specific time-domain EEG feature extraction methods, there are various time-based EEG-processing researches. Hjorth [79] proposed the Hjorth Features to given the three time domain statistics as the features, the following researchers contribute various achievement by this method [20] [110] [111]. Kroupi et al. firstly proposed to employ the non-stationary index (NSI) as the features to analyze the variation of the local average based on time to achieve emotion classification [112], NSI is normally used for other EEG-based researches [113] [114]. Delorme et al. [115] proposed the famous EEG-processing tools EEGLAB which provide the fast-preprocessing and time-based feature extraction, EEGLAB is the commonly auxiliary tool for EEG-based researches.

Frequency Domain

Frequency Domain Features refers to transform the original EEG signal from time domain to frequency domain, and then extract the relevant frequency characteristics as EEG features. Previous researches present that, the five commonly used frequency bands (delta (1 4Hz), theta (4 8Hz), alpha (8 13Hz), beta (13 30Hz), gamma (36 44Hz)) of EEG have relationships with every physiological and psychological activities of human. The different EEG frequency bands represent the various functions of the human brain by single or collaboration of each frequency bands, such as emotion, memory, decision making, mediation and so on [116]. The first step for frequency-based EEG research is transforming time-series data into frequency domain, there are numerous methods can be employed, such as fast fourier transform (FFT) and discrete fourier transform [117] [118] [119] [120] [121].

Band power [122] [123] [124], Power spectrum [125] [126] and Power density spectrum [127] [128] are the common features for frequency domain [20]. Extraction of frequency domain features are generally built on the basis of the power spectra density (PSD) estimation. The classic PSD estimation based on the FFT of a certain period of time-series EEG data. PSD estimation is the ratio between the mean of overall squared amplitude-frequency characteristic and time. The frequency domain characteristics of band power, power spectrum and PSD are presented based on the PSD estimation [20] [22].

Frequency domain features are widely used for EEG-based researches, especially at emotion recognition area. Zouridakis proposed that raw EEG signal can be mapped to five frequency bands after the band pass filtering, and then calculated the corresponding band power for these 5 bands as the feature for emotion recognition [129]. Aftanas proposed that raw EEG signal can be mapped to theta, alpha and beta bands after FFT, and then calculated the PSD of each electrode as the feature for emotion recognition [106]. Kothe

proposed a complete spectrum method for studying the relationship between EEG and cognition. They used an adaptive mixed ICA method to achieve directly mapping the signal to another signal representation. And then selected a series of sparse features by linear or nonlinear sparse learning method to obtain the PSD as the feature for emotion classification. [130].

As EEG signal contain five specific frequency bands, many researchers draw the research points on the relationship between each specific band and human emotions. Li et al. [131] proposed the research on the relationship between EEG gamma band and two specific emotions (happiness and sadness). Jauovec et al.[132] proposed the human emotional intelligence related to theta and alpha EEG frequency band. Zhang et al. proposed [133] the comparison of representation level for five frequency bands separately under the same frequency-based features and classification method. Li et al. [134] employed the graph theoretical analysis to demonstrate the gamma out of five frequency bands represent the patient with depression perfectly.

Time-Frequency Domain

If the signal is non-stationary, time-frequency methods can produce effective information with considering the dynamical changes [20]. Due to the instability of the EEG, simply consider the time domain or frequency domain characteristic features are not comprehensive, many EEG time-frequency domain researches appear in order to figure out the feature can represent characteristics of both time and frequency domain in recent years. Moreover, the focus point of time-frequency domain is the dynamic change through time-series data which correspond to the key issue of emotion research. Because the physiological interpretation of human emotion is a variable based on time, after the specific emotion being generated, it will last for a period of time then recover to calm [35]. From this perspective, the time-frequency domain features are more competitive. Short-time fourier transform (STFT) [135] [136] [137] and discrete wavelet transform (DWT) [138] [139] are the two commonly methods.

STFT added the window function with constantly moving to determine the locally sinusoidal signal's frequency and phase compare to the traditional fourier transform [140]. Lin proposed that used music as the stimuli and used 32-channel EEG electrode cap to collect EEG signal from participants. And then use STFT which mapped EEG to five frequency bands, then calculated the corresponding PSD for each electrode, and integrated 4 groups features based on the symmetrical relationship between each electrode. The difference of symmetric electrode, the quotient of symmetric electrode, the PSD without the middle electrode and the PSD of all the electrodes. The group features were employed to achieve

the emotion recognition. [141]. Zheng et al. [142] proposed to figure out the critical frequency bands for EEG-based emotion recognition, STFT applied to transfer EEG to five frequency bands and then send to train the deep belief network for emotion classification. Lan et al. proposed to employ STFT to extract the band power and PSD features of 5 frequency bands to test the stability of each feature, and then select the feature to build the real-time emotion recognition for pleasant, happy, frightened, and angry [143].

Another commonly used technique from signal processing is DWT, which decomposes the signal in different approximation and detail levels corresponding to different frequency ranges, while conserving the time information of the signal [20]. Murugappan et al. [144] proposed that used videos as the stimuli, and then applied DWT to indicate the wavelet coefficients. Through these coefficients the power for each wavelet can be calculated. They selected the rate between sub-bands and whole bands power, alpha band wavelet coefficient's root mean squared value and band power as the feature for emotion classification. Mohammadi et al. [145] proposed that employed DWT to address the EEG to corresponding frequency bands and extract features, and then applied SVM and KNN for a recorded 10-channel EEG-based emotion classification. More recently, Ang et al.[146] combined the DWT with deep neural network, they firstly applied DWT as the feature extraction method and then employed artificial neural network to address the representation of emotion.

More recent empirical mode decomposition (EMD) appears to be the highlight data-driven signal processing technique for EEG-based researches[147] [148] [149]. EMD mainly is decomposing the non-linear and non-stationary signal into many intrinsic mode functions (IMFs) on various frequency scales [150]. Shahnaz et al. [151] proposed that EMD decomposed EEG signals to IMFs firstly, then DWT applied on IMFs to produce the wavelet coefficients as the features to achieve emotion classification. Mert et al. [152] employed multivariate EMD on multichannel EEG signals to decompose for the IMFs, and then analyzed the power ratio, PSD, entropy, Hjorth parameters and correlation as features for the emotion classification.

Channel-Based and Other methods

Besides of these three common features, there are many other kinds of domain can be employed for EEG feature extraction, channel-based [20] is the most commonly used for recent. Basically, the channel-based feature extraction methods mainly calculate the various relationship based on each electrodes, such as mutual information, correlation coefficients, band power difference and PSD difference. Khosrowabadi et al. [153] proposed to employ magnitude squared coherence estimate (MSCE) as the feature extraction

method and combine with KNN to classify emotions. Chen et al. [154] proposed to use mutual information, person correlation coefficients between each EEG channel as the features to achieve the emotion recognition and presented significant improvement. These researches lead to a new-level of considering EEG-based emotion recognition which the existence of interconnections between different parts of the brain is important.

There are numerous studies employed the different combination of mathematics model to produce the EEG features. Khosrowabadi [155] proposed that used filter for the raw EEG signal in order to get the 4 13Hz bands data, and then used kernel density estimation and Gaussian mixture model to extract the features from EEG separately to calculate the correlation between EEG and emotions. Aftanas et al. [156] proposed that used nonlinear K-entropy and Lyapunov coefficients as the EEG features to classify emotions. Most recent, Zhang et al. [157] proposed that decomposed EEG signals in to band-limited IMFs by variational mode decomposition (VMD), and then extract autoregression based features to achieve seizure detection through EEG. Yang et al. [158] proposed to employ the convolutional neural network (CNN) combine with entropy feature extraction methods to address the representation of emotion based on EEG and got significant result.

In many cases, EEG features can be combined with other physiological features or non-physiological features to achieve emotion recognition. Scotti et al. proposed that used EEG combine with GSR, blood pressure and ECG as the feature for emotion estimation [159]. Zhang et al. proposed that used EEG time-frequency domain features combine with the facial expression as the feature for emotion recognition [96]. McDonald et al selected the effective information from the combination of EEG features with non-EEG features, these features contain traditional EEG PSD, the mapping value of theta, alpha and gamma, EOG, EMG and ECG in Cognitive Status Assessment match which held by Air force in 2011 [160]. Soleymani et al. [161] proposed that combined with EEG signals and facial expressions, and employed recurrent neural network to contribute the sequence processing for emotion recognition.

2.3.3 Feature Smooth and Reduction

Normally emotion changing is the gradual process, but there are some dramatic changes in EEG. In order to minimize the noise of these dramatic changes, the smooth procedure for EEG features is needed. Moving average is the commonly method. However, this method always contain a certain time delay [162]. linear dynamics system (LDS) is more recent feature smooth method [163], it is employed to smooth the features since the original EEG features always have strong fluctuations and contain some unrelated information

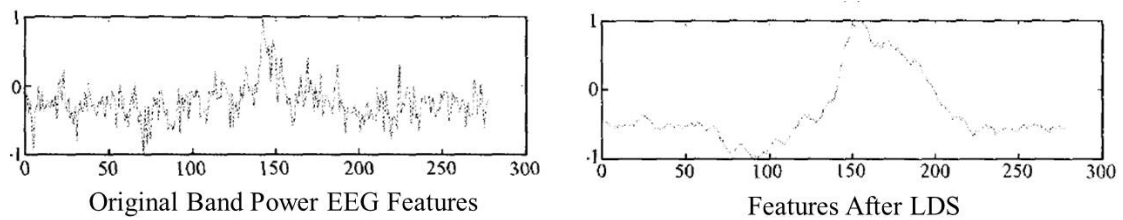

Figure 2.8: Comparison of EEG Features Before and After Employ the LDS

for specific task. Shi et al. [163] proposed linear dynamics system (LDS) to smooth the EEG feature, and get a low influence by the non-related signal, the comparison as shown in figure 2.8. Nie et al. [119] employed LDS as the feature smooth method to discard the non-related information from the log band energy of each channel features and then achieve the emotion classification task. Duan et al. [164] proposed applied LDS on the combination feature of differential entropy, differential asymmetry and rational asymmetry to compare with the traditional energy spectrum feature for EEG-based emotion classification.

Researchers always employ 32, 64 or 128 channels electrode cap for EEG acquisition. The EEG features are normally corresponding to each electrode which lead to high dimensional features. However, the higher EEG features' dimension means the more information to be processed which is clearly not conducive to the practical application of emotion recognition. Therefore, it is necessary to select the small amount of existing EEG features which acquire characteristics highly relate to emotion. It is the task that feature dimension reduction to be accomplished [165] [166]. The information of feature that after feature smooth procedure is not the ultimate data I use for classification, although smooth procedure discard most noise information but the after processing features do not represent the highly-related information for specific task. Smoothing procedure do not conflict with the feature reduction, both procedure contribute to improve the quality of features.

Feature reduction can be divided into two categories, one is the feature selection, it refers to select the corresponding feature for the task from the feature set. Another idea is doing the linear or nonlinear transform for the original features, and then mapped these to the dimensions which can highly reflect the emotional state. EEG-based feature reduction commonly used methods contain principal component analysis (PCA) [167] [168] [169], minimal-Redundancy-Maximal-Relevance (mRMR) [170] [102] [171] and common space pattern (CSP) [172]. Feature Selection methods can generally be divided into filter and wrapper methods [173] [174]. Filter methods are model-independent while wrapper methods select features based on the inter-relationship under a classifier [20]. Filter methods acquire less calculation resource than wrapper methods, but wrapper methods produce

more effective information.

Numerous researches employed the above commonly methods as the feature reduction schemes. Li et al. [131] proposed that used CSP to achieve feature reduction due to figure out the best corresponding frequency band for each participant. Firstly, the raw EEG signal transform to frequency domain through FFT, and set up the dynamic bandwidth in order to guarantee the best found out frequency band fit for each participant. On each dynamics band, CSP was applied for mapping all the feature into the maximum class different projection direction in order to find out the best 2,4, 20 and 40 dimensions. And then select the most suitable frequency band and dimension for each participant by the classification performance corresponding to each feature. Zhang et al. [96] proposed that employed amplitude difference between the electrodes as EEG feature. Based on the sampling frequency and time, he got 600 dimension features. In order to reduce the feature dimension the unsupervised PCA applied to do the feature selection. The core idea of this approach is to identify a set of best coordinate system which reflect the characteristics of high-dimensional, and then mapping the original high-dimensional feature to the set of coordinates by the linear transformation. In this way they extract a relatively better top 100 dimensional feature for subsequent analysis of emotion recognition.

There are many other feature selection methods based on the different way of thinking of selection. Lin et al. [141] proposed that used F integral indexing method to achieve the selection, the main idea of this method is calculate the F value for each feature, this value represents the ratio of inter class variance and intra-class variance. The bigger of the value shows this feature is more reliable for representing the difference. Then select the feature which with bigger F value. Firpi et al. [175] proposed that used particle swarm optimization to do the selection for the features. The main idea of this method is abstracting all the features into weightless particles, and then find out the best position for each particles through the iterations.

Channel Selection

Basically, EEG signals contains the distribution around the head. Different location of the EEG signals represent the different brain functional zone which causing not all channels for EEG signals contribute to generate the emotions. There is a certain area that is correlated with emotions in the brain, which makes channels from other areas unrelated to emotion classification [176]. Channel selection is based on the feature selection, as similar to feature selection, it can be divided into filter methods and wrapper methods. Moreover, the filter and wrapper will combine for specific task [177].

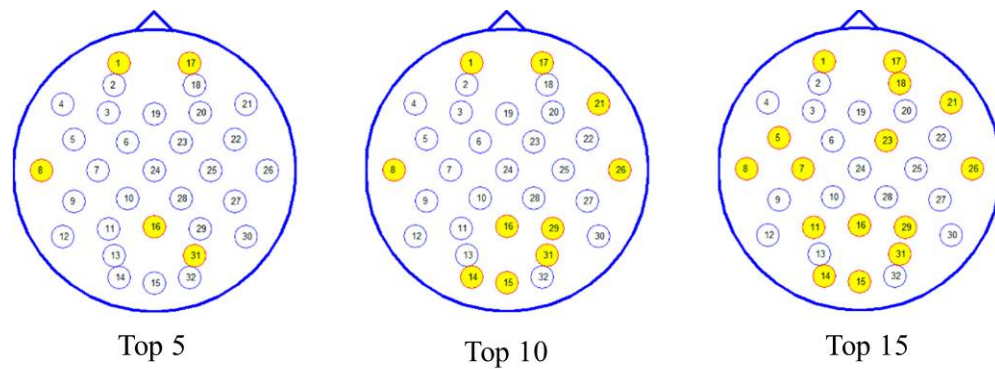

Figure 2.9: The Channel Selection Based On Relief Algorithm [5]

Karim et al. [178] proposed that using synchronization likelihood as a channel selection method to select the effective channel to achieve feature reduction. Zheng et al. [142] applied the four selected channel with the deep belief network for emotion classification presented that selected data performance is significantly better than the complete data for same experiment setting. Zhang et al. [5] proposed the relief-algorithm based channel selection scheme to select the best channels in classifying four emotional states (joy, fear, sadness and relaxation), 19 out of 32 channels were chosen to achieve the emotion recognition, as shown in figure 2.9.

Considering the symmetrical electrode for left-right hemisphere of brain is also a highlight issue for channel selection. The symmetrical electrodes represent the different functional part of brain which manage the different human behaviour representations. Rizon et al. [179] proposed the to use the ratio asymmetry of the symmetrical electrode to achieve the channel selection. The ratio of variances between hemisphere symmetrical channels was used as an indicator for representing the functional space of brain and the channels associated with emotion detection. They picked 28 pairs out of 63 channels with five emotions (disgust, happy, surprise, sad, and fear), the results conducted great performance when pairs channel applied.

The goal of EEG-based emotion recognition research is to choose the features highly represent the emotional state to improve the classification accuracy as higher as possible by optimizing the emotional state model, and provide a reliable theoretical guarantee for the EEG applications in the field of emotion recognition. Another goal is to find the emotional state associated with the different brain regions and the frequency band, provided the physiological basis for EEG applications in the field of emotion recognition.

Schmidt et al. [180] proposed that used music as the stimuli to evoke the happy, pleasure, sad and fear four emotions of participant. They found that when listening to positive

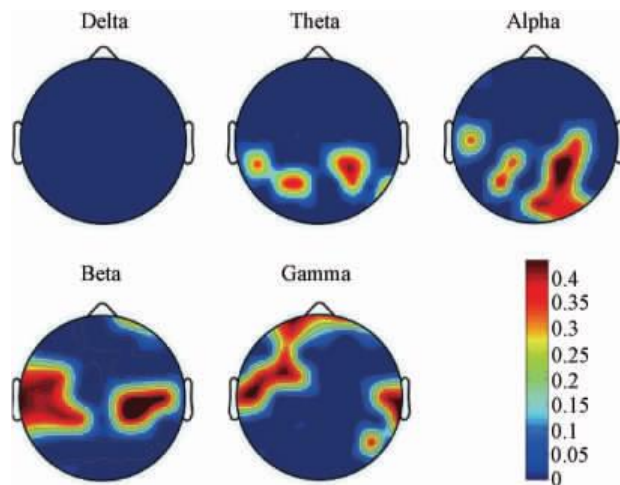

Figure 2.10: Distribution of Emotional Features

emotions music, left front brain will have a strong electrical activity, when listening to music negative emotions. It will produce a strong electrical activity at right front brain . Sarlo et al. [181] proposed that used surgery scene, cockroaches, human fights and natural view four videos as the stimuli to evoke the neutral and negative emotion. They found that alpha band make the great role in emotion changing, and when negative emotion had been evoked, right behind brain will have a strong electrical activity . Petranonakis et al. [100] proposed asymmetry index concept in order to represent the degree of difference between left and right brain. They used International Picture System's source as the stimuli, and then use high order-crossing and cross-correlation as the features, and found that asymmetry index closely related to emotion.

2.3.4 Classification

EEG classification means providing the observations from which specific emotion state can be inferred for the existing EEG features [22]. Generally, the features are feeding into the classifiers for training the rules of the corresponding emotion with highly possibility under different algorithms. The two mainly tasks for EEG-based emotion classification are: 1. How to determine the EEG patterns of various emotional states through EEG features? 2.How to classify the untrained feature samples by corresponding EEG patterns? To achieve emotional state recognition can be divided into two categories: unsupervised learning method and supervised learning method.

Unsupervised Learning

Unsupervised Learning refers to not identify the category information when doing the training on the samples, and make the similar characteristics samples get closer, simultaneously keep away from characteristics dissimilar samples. Thereby, it will achieve the classification under the similar samples gather together and dissimilar samples separate to each other [182]. For EEG-based emotion area, the unsupervised learning is commonly used. Mainly because that human emotion is quite complex and independent, there is no common rules for justify the emotions through experiments. Only various reference methods for labelling the emotional states based on physiology area make it even harder for the reliable labeled emotion EEG data [183]. However, unsupervised learning relatively provide the possibility solution with the self-learning the different category. The commonly used unsupervised learning methods are fuzzy clustering and K-means [184] [185] [186].

Traditional clustering method is based on the euclidean distance [187] to determine the sample's class attribute and determine the boundaries between different categories by controlling the size of sampling or the distance. Murugappan et al. [179] proposed that employed fuzzy C-means clustering to find out the inherent characteristics of the category and then identify the similar samples for the mixed participants' emotions (happy, fear, anger and surprise). Thus the samples can be divided into 4 emotional categories. Khosrowabadi [153] proposed that used pictures as stimuli to evoke the participants to produce calm, happy, sad and fear four emotions. In addition that the emotion which produced by participants can be different with the expected which means the supervised learning potentially demonstrate the unreliable results. Therefore, they used self-organizing map to divide the samples and achieve great results. Li et al. [188] proposed to employ the unsupervised deep belief network automatically extract EEG features to achieve the emotion classification.

Supervised Learning

Supervised learning needs labeled the samples' categories and constantly revise the parameters of the model under the guidance of the categories information. Then classify the test sample by the training model. It is opposite to unsupervised learning, the label for each category is the core factor through supervised learning. Generally, there are two labelling schemes for EEG-based emotion recognition data. Firstly, the emotions can be justified by the arousal-valence two-dimension based on psychology area [35]. These two factors determine the different emotional states with the corresponding combination of different level on both arousal and valence separately [3] [189] [102] [190]. Another way of labelling emotion is settling the specific emotional state of the participant when

stimuli applied as the label through the experiment. There are some assistant measurements to help label the reliable emotion for participant, such as facial expressions, body movements, heart rate, pulse and the emotional attributes of the stimuli resource [191]. SVM, decision tree, random forest (RF), Bayesnet, KNN and the most recent deep neural networks are the commonly used methods for supervised learning [22].

SVM is the most widely used classification method, its core idea is mapping the non-divide-low-dimensional set to the high-dimensional space in order to identify the maximum marginal hyperplane edges of different categories to achieve the low-dimensional space classification. There are numerous EEG-based emotion recognition researches using SVM [96][141][119]. Mehmood et al. [192] proposed the Hjorth parameter as the EEG features to feed into SVM classifiers, they compare the different classifiers' performance which SVM achieves the best for the 5 emotion recognition task. Liu et al. [193] proposed a three-layer EEG-based emotion recognition system, the first layer is the extraction of spectrum power of each channel, and then send the data into second layer for kernel fisher's discriminant analysis method for feature extraction. Finally, the imbalanced quasiconformal kernel SVM was proposed for emotion classification. Bajaj et al.[194] proposed to employ ratio of the norms based measure, Shannon entropy measure, and normalized Renyi entropy measure ratio of the norms based measure, Shannon entropy measure, and normalized Renyi entropy measure as the EEG features, and then fed into the multi-class least squares SVM to achieve the emotion detection. They also compared the multi-class least square SVM with the other SVM schemes to show the best performance of proposed through all similar methods. With the appearance of advanced methods, SVM always is the most reliable and practical baseline methods for comparison.

K-nearest neighbour (KNN) is a simple classification method and often regarded as the baseline for measuring the classification method's performance [195]. The core idea is to find the nearest K samples of the unknown category sample point, and then determine the category of the unknown sample by the majority categories of K samples. There are various studies applied KNN as the basic comparison methods for EEG-based emotion recognition tasks [100] [102] [196] [197]. Similar to KNN, Mahalanobis distance [198] is the distance between sample's covariance and used to measure the similarity between samples. The advantages of Mahalanobis distance is not influence by the different dimensions of features, but the drawback is easily magnify small changes [199]. Frantzidis et al. [90] proposed that employed Mahalanobis distance to do the two emotional factors classification, they divide the emotions into high arousal or low arousal, high valence or low valence by large two-dimension graph [2].

Bayesian network (BN) is a reasoning model based on probability. Leveraging on prior

distribution representing the uncertainty of sample before the classification and applying posterior distribution as the classification of samples. Ko et al. [200] proposed employed BN as the emotion classification method for classifying the PSD features of EEG. Wang et al. [117] proposed that used high restriction hidden Bayesian model for training and classification, and got the classification performance almost close to single trail experiment. Similar to NB, hidden Markov model (HMM) is also a probabilistic model, its core idea is determining the hidden parameters in markov process by observable parameters, and then use these parameters to do the classification. HMM is typically used for EEG-based recognition area recently [201] [202] [203].

Deep learning Methods

Artificial neural network (ANN) is also a common classification methods, it is the mathematical model that simulating human real neural network architecture. Multilayer perceptron is a common neural network model, it uses the category information of samples as a guide to constantly revise parameters weights from intermediate layer to the output layer until it reaches the certain criteria, and then using the trained perception to classify samples [204]. Estep et al. proposed that employed ANN to do the classification for the unstable cognition level and achieve great results [205]. Zheng et al.[142] proposed the deep belief network (DBN) to extract the EEG feature for emotion recognition. Ren et al.[206] proposed to employ convolutional deep belief network (CDBN) as the feature extraction methods, they believed the CDBN occurred the strongly ability of feature learning and understanding. These approaches belong to the EEG feature level deep learning applications.

With the techniques development of deep neural network modules, many significant achievements have been obtained in many areas, such as image processing [32] and sequential data processing [207]. There are numerous studies presented that deep learning based approaches have achieved competitive achievements in EEG-based recognition research. The idea of applying deep learning methods divide into three parts, image-processing only, sequential processing only or image-sequential processing [208]. Yanagimoto et al. [209] proposed to employ the supervised pre-trained CNN to achieve the emotion recognition based on the EEG frequency domain features and gain relatively perfect results. Tripathi et al. [210] proposed to seek the most effective schemes of a simple Deep Neural Network and a CNN for emotion classification. Song et al. [211] proposed the dynamic graph CNN to achieve the emotion recognition, it built a dynamically graph model to model the multichannel EEG features and address the emotion states representations through the neural network. The results conducted significant improvement on two public EEG-emotion datasets. Moon et al. [212] proposed that CNN had the capability to con-

sider the spatial information with the two-dimensional filters at the convolutional layers, therefore, the EEG connectivity features as the input to CNN and perform the emotion classification results. Mei et al.[213] proposed to employ CNN to extract the feature from the multi-channel EEG electrodes' pair correlation matrices and gain relatively great result for emotion recognition. For sequential processing, Alhagry et al. [214] proposed that employed the long short term memory (LSTM) as the time series data processing method to achieve the emotion recognition, the EEG data cut into amount of sequence firstly and then fed into LSTM, the result achieved significant improvement compare to state-of-art. Nakisa et al. [215] proposed the similar scheme for applying the LSTM for EEG emotion recognition, the input of LSTM is the differential entropy for EEG signals, they compared the proposed with other hyperparameter optimization methods and achieved best.

2.3.5 Challenges

Although emotion recognition has been improving in recent years, most research is still in the laboratory stage and there is a considerable distance away from practical application, mainly in the following issues to be resolved.

EEG Signal Acquisition

Traditional signal acquisition usually use wet electrode technology, participants must apply for conductive medium before the acquisition in order to overcome the effect from the stratum. This procedure requires others to help and it not only will take a long time but also the conductive will change with the time. If the acquisition last long time, the conductivity of medium will decrease or even disappear. The signals will distortion which will affect the quality of the whole process. Currently, a new type of dry electrode for EEG acquisition has emerged [216]. Dry EEG acquisition technology can solve these problems to some extent. However, the current dry EEG acquisition with long hair area is not very stable and needs further improvement.

Further, since the EEG is very weak, so the collection process must apply high magnification EEG amplifiers for signal amplification. Currently the volume of commercial EEG amplifiers is generally large, which makes it not conducive for portable usage. Recently there is the new type chip of EEG amplifies but occurs the high cost, which hardly makes it practical.

The impact on the real environment

Since the EEG acquisition is very susceptible to interference from external environment, the existing artifacts are often directed to the certain removing for specific kinds of noise effectively. In practical applications, the existing artifact removal method is difficult to remove EEG artifact effectively due to the complexity of reality environment and the various kinds of source interference. In addition, EEG-based emotion recognition normally acquire processing on-line, which requires not only the higher effectiveness artifact removal algorithm, but also a lower time cost through the removal procedure. Therefore, the development of more effective method of removing artifacts online is needed.

Individual Differences

EEG signal acquires individual differences through the certain representations, and the current study is still basically in the laboratory stage. There will have different responses for the same emotion stimuli between each participant. How to find the stable corresponding relationship between each EEG features to discard the individual differences is a challenging problem for EEG researchers to be solved at present.

2.3.6 Specific Methods

Preprocessing

Preprocessing of EEG largely includes a number of processes, such as line noise removal, adjustment of referencing, elimination of bad EEG channels, and artifact removal [60]. ICA is the commonly used method for artifact removal, specifically for EMG and EOG removal [70].

- ICA

ICA is normally used for decomposing the mixed signal into statistically independent components [217]. For multi channel EEG signals decomposing, ICA assume that signal is a linear mixture of several independent sources. Centering and Whitening are two important steps in ICA. Centring is mainly calculating the mean of the signal and subtracting until the signal have zero mean. Whitening is calculating for the uncorrelated signals with unit variance by the linear transformation [218], normally the ICA for EEG evoked removal is done by EEGLAB [115].

Feature Extraction Methods

A wide range of features used for emotion recognition from EEG that have been proposed in the past. We generally distinguish the features extraction methods into time domain, frequency domain, time-frequency domain, multi-electrode features and connectivity features. Overall, 14 different features have been used.

- Statistics features (STA)

There are 7 different features proposed in this method. They are straightforward to be calculated according to the formulas given in [20], for the signal $S(t), t = 1, 2, 3, \dots, T$ as shown below:

Power:

$$P_S = \frac{1}{T} \sum_{t=1}^T |S(t)|^2 \quad (2.1)$$

Mean:

$$\mu_S = \frac{1}{T} \sum_{t=1}^T S(t) \quad (2.2)$$

Standard deviation:

$$\sigma_S = \sqrt{\frac{1}{T} \sum_{t=1}^T (S(t) - \mu_S)^2} \quad (2.3)$$

First difference:

$$\delta_S = \frac{1}{T-1} \sum_{t=1}^{T-1} |S(t+1) - S(t)| \quad (2.4)$$

Normalized first difference:

$$\bar{\delta} = \frac{\delta_S}{\sigma_S} \quad (2.5)$$

Second difference:

$$\gamma_S = \frac{1}{T-2} \sum_{t=1}^{T-2} |S(t+2) - S(t)| \quad (2.6)$$

Normalized second difference:

$$\bar{\gamma} = \frac{\gamma_S}{\sigma_S} \quad (2.7)$$

- Higher Order Crossings

The aim of the HOC feature is to try to capture the oscillatory pattern of the EEG waveform. The crossings are calculated by subtracting from the mean from the time series and then counting the number of sign changes. It is calculated only for the alpha and beta range, so the signal is first filtered through a tenth order Butterworth band-pass filter. The highest order for which the number of crossings was calculated was 10. The first order

is the original signal. For subsequent orders, the new signal is obtained by taking the difference between consecutive points of the previous signal and the number of crossings is then computed for this signal. When taking a difference, one point is lost so in order to retain the same number of points at each level, it is necessary to start (in this case) 10 points from the beginning of the signal [100].

- Fractal Dimension

This feature is also used to capture information about the shape of the signal. The formal way of defining dimension is to consider the scaling relationship between units of measurement and the number of such units required to measure a shape, as shown in the following equation:

$$N \propto \varepsilon^{-D} \quad (2.8)$$

In the above, ε denotes the amount by which the unit of measurement is increased or reduced, N denotes the number of the newly scaled units of measurement required to measure the same shape and D is the fractal dimension. For an ordinary line, reducing a unit of measurement by ε would mean that $N = 1/\varepsilon$ so that $D = 1$. On the other hand, a fractal line reveals a higher degree of complexity at a higher resolution, so that more than $1/\varepsilon$ units would be required every time the unit of measurement is reduced by ε . This complexity is quantified in the fractal dimension, which, for a line, is greater than 1.

The method used in [20] was the Higuchi algorithm that is described in more detail in [219]. To use the method for the signal $S(t)$, a new time series is constructed as follows:

$$S_k^m = S(m), S(m+k), \dots, S\left(m + \frac{\text{floor}[(N-m)]}{k} * k\right) \quad (2.9)$$

$m = 1, \dots, K$

where the function $\text{floor}[\cdot]$ rounds down the value of the argument to the nearest integer. The length of the curve is then given by

$$L_m(k) = \left(\sum_{i=1}^{\text{floor}[\frac{N-m}{k}]} |S(m+i*k) - S(m+(i-1)*k)| \right) \frac{N-1}{\text{floor}[\frac{N-m}{k}] * k} \quad (2.10)$$

In the above, the term $\frac{N-1}{\text{floor}[\frac{N-m}{k}] * k}$ is a normalization factor for the curve length of subset time series. For each time interval k , the value of the length of the curve is averaged

over all values of m to obtain the value ($L(k) \propto k^{-D}$), which is analogous to $N \propto \varepsilon^{-D}$ above. We can estimate the fractal dimension D by calculating $L(k)$ for different values of k plotting it against k and fitting a line to the points. The magnitude of the gradient of this line is the estimate for D .

- Hjorth

These are simple statistical features computed using the following expressions, for the signal $S(t)$, where $\mu(S(t))$ is its gradient:

Mobility:

$$\sqrt{\frac{\sigma(\dot{S}(t))}{\sigma(S(t))}} \quad (2.11)$$

Complexity:

$$\sqrt{\frac{\mu(\dot{S}(t))}{\mu(S(t))}} \quad (2.12)$$

As in [20], an additional feature, Activity omitted because it is just square of the standard deviation (i.e. the variance) and the standard deviation is already included among the statistical features above.

- Non-Stationary Index

NSI is a measure of fluctuation dynamics that is used to evaluate the change in time of the local average [220], independent of the magnitude of the fluctuation.

- Differential Asymmetry and Rational Asymmetry

DA and RA are the difference and ratio of power bands of corresponding pairs of electrodes:

$$DA = X_R - X_L \quad (2.13)$$

$$RA = \frac{X_R}{X_L} \quad (2.14)$$

X_R and X_L represent the power spectral density feature for right and left brain hemisphere symmetric pairs electrodes of the scalp [20].

- Magnitude Squared Coherence Estimate

This feature represents the two signals $S1$ and $S2$ correspondence of each other [153]. It takes into account the cross-PSD between pairs of electrodes according to the equation [221]:

$$C_{ij}(f) = \frac{|P_{ij}(f)|^2}{P_i(f)P_j(f)} \quad (2.15)$$

Only magnitude of the cross-power spectral density is required and since $P_{ij} = P_{ij}^*$, $|P_{ji}| = |P_{ij}|$, so that $C_{ij} = C_{ji}$. Also the value of C_{ij} for $i = j$ is simply P_i , the power spectral density, which is considered separately, so that is also neglected from this set of features.

- Power Spectra Density

As an initial choice of feature, the power spectral density was used. It is a commonly used frequency domain feature in studies on emotion recognition from EEG. It is usually computed for a number of frequency bands and used as an indicator of the extent of brain activity within each of these bands. The downloaded data already been down-sampled to 128 Hz and low-pass filtered to remove frequencies above the desired range [222].

- Discrete Wavelet Transform

The discrete wavelet transform (DWT) is an alternative method to power spectral density for measuring the prominence of different frequencies in the EEG. An important difference is that it preserves time domain information which is lost in the power spectral density. The wavelet transform is an alternative to the Fourier transform which decomposes a signal according to certain wavelet functions rather than sine and cosine functions as in the case of Fourier transforms. In this case the Daubechies 4 wavelet was used. as in [223] [224], Using the detailed coefficients, three feature vectors were created comprising values related to the energy, root mean square (RMS) and entropy, for signal $S(t)$:
Band energy:

$$E_{band} = \sum_{-\infty}^{\infty} |S(t)|^2 \quad (2.16)$$

Total band energy across alpha, beta and gamma bands:

$$E_{total} = E_{alpha} + E_{beta} + E_{gamma} \quad (2.17)$$

From the energy values, the Recursive Energy Efficiency (REE) was obtained for each of the alpha, beta and gamma bands:

$$REE = \frac{E_{band}}{E_{total}} \quad (2.18)$$

Two further values, $\log(REE)$ and the absolute value of $\log(REE)$ were also computed from the above. These three values were included together in a single feature vector.

RMS can be calculated from the decompositions $D_i(n)$ of the DWT in different layers as the following:

$$RMS(j) = \sqrt{\frac{\sum_{i=1}^j \sum_{n_i} D_i(n)^2}{\sum_{i=1}^j n_i}} \quad (2.19)$$

The REE, RMS and entropy features were obtained as three feature vectors to be used separately in the classifiers.

It is important that the existence of interconnections between different parts of the brain is also considered.

- Mutual Information

Mutual information [154] is a measurement of how informative a random variable is for another random variable. It is calculated on the basis of entropy, given the random X defined as:

$$I(X) = - \sum_{t=1}^n P_t \log(P_t) \quad (2.20)$$

Then the Mutual Entropy between two random variables X and Y is defined as:

$$MI_{XY} = \sum_{ij=1}^n P_{XY}^{ij} \log\left(\frac{P_{XY}^{ij}}{P_X^i P_Y^j}\right) \quad (2.21)$$

where P_{XY}^{ij} is the joint probability. Two random variables X and Y are regarded as statistically independent if the mutual information MI_{XY} is zero [225].

- Pearson Correlation Coefficients

Pearson correlation [226][154] measures the linear correlation between two variables, and the range is between -1 and 1 which represent negative or positive correlation. The Pearson correlation coefficient between two random variables X and Y is shown as:

$$\rho_{xy} = \frac{\sigma_{xy}}{\sigma_x \sigma_y} \quad (2.22)$$

where σ_{xy} stands for the covariance of two random variables X and Y . We consider the temporal sampling points which proposed by Chen [154]. The PCC is calculated as below:

$$\rho_{xy} = \frac{\sum_{i=1}^t (x_i - \bar{x})(y_j - \bar{y})}{\sqrt{\sum_{i=1}^t (x_i - \bar{x})^2} \sqrt{\sum_{i=j}^t (y_j - \bar{y})^2}} \quad (2.23)$$

Machine Learning Methods

- Bayes Network

BN is a set of directed acyclic graphical and conditional probability table. Each node in directed acyclic graphical can represent a directly observable variable or a hidden variable. If there is a directed edge between the two nodes, it means that the corresponding two random variables are probability dependent. The data stored in conditional probability table corresponds to the unique node in the directed acyclic graphical, this table stores the joint conditional probability of this node for all its direct precursor nodes [227] [228]. Bayesian networks have special properties, that is, each node is independent of all its indirect precursors after the value of its immediate precursor node is established. Therefore, the joint conditional probability distribution of any random variable combination can be simplified.

$$P(x_1, \dots, x_n) = \prod_{i=1}^n [P(x_i | P(y_i))] \quad (2.24)$$

$P(x_1, \dots, x_n)$ is the probability for the specific combination of x values. And the value of $P(x_i | P(y_i))$ corresponds to the table of y_i 's conditional probability table [229]. The use of bayesian network classification mainly involves two steps. The first step is the construction of the bayesian classifier, which is mainly to learn the structure and conditional probability distribution; the second step is to calculate the conditional probability of the class nodes in the Bayesian network to achieve data classification. NB usually provides the baseline result for comparing to advanced methods.

- K-Nearest Neighbour

Dasarathy [230] proposed KNN in 1991. KNN is an extension of the minimum distance classifier, the specific principle is as follows: Firstly, the train set is given. The distance between each sample and the training sample is calculated when classifying unknown new samples. Next, it selects the nearest K samples and votes on the label of the sample, the latest sample is the one with the most votes. KNN calculates the distance is Euclidean distance or Manhattan distance:

$$d(x,y) = \sqrt{\sum_{k=1}^n (x_k - y_k)^2} \quad (2.25)$$

$$d(x,y) = \sqrt{\sum_{k=1}^n |x_k - y_k|} \quad (2.26)$$

KNN is one of the classic classification algorithm and widely applied in text Categorization [231] [232] [233], pattern recognition [234], image processing [235] and other research areas. Specifically, KNN is widely used in EEG-based emotion recognition area [224] [117] [102], however, the results for KNN always regarded as the comparison methods due to the relatively low accuracy than other classifiers.

- Support Vector Machine

SVM is a binary classification model [236]. It establishes a classification model by seeking the hyperplane with the largest distance of eigenvector in the feature space. Compared with other traditional machine learning algorithms, it has many advantages in solving small sample data, nonlinear data and high-dimensional pattern recognition [237]. SVM is seeking the maximum marginal hyperplane (MMH) to reach the best hyperplane. MMH-related edges can give maximum separation between classes and improve generalization performance [238]. SVM contains two commonly used methods, for multi-category considering, it will treat the same category samples as one kind and the remaining samples as another kind. Then, repeat the above binary problem for the remaining samples. For single-category considering, it will only consider two category samples and build the SVM model.

The principle is: firstly, construct a reasonable hyperplane:

$$w^T X + b = 0 \quad (2.27)$$

Use this hyperplane to separate different types of data and pick the best hyperplane model with high robustness and excellent generalization. For linearly separable data, linear de-

cision boundaries can usually be used to solve the SVM optimization model:

$$\max_{w,b} \frac{1}{2} \|w\|^2 \quad (2.28)$$

$$s.t. y^i X(w^T x^i + b) \geq 1, i = 1, 2, \dots, m \quad (2.29)$$

Data linearly separable and data nonlinearly separable are the two commonly issues for SVM [239]. For nonlinearly separable data, SVM uses a kernel function to find nonlinear decision boundaries in the input space to create a nonlinear SVM for nonlinearly separable data classification. The commonly used kenerl functions are linear Kernel, polynomial Kernel and radial basis function, as shown in equation 2.30, equation 2.31 and equation 2.32.

$$k(x, y) = x^T + c \quad (2.30)$$

$$k(x, y) = (x^T y + c)^d \quad (2.31)$$

$$k(x, y) = \exp(-(x - y)^2 / 2\sigma^2) \quad (2.32)$$

Linear SVM is the commonly used method in EEG-based emotion recognition research area. Because normally the amount of samples are less than the features for EEG experiment and EEG datasets are all relatively small compare to other datasets. Various studies presented that linear SVM is more robust than other kernel SVM [240].

- Random Forest (RF)

Random Forest is based on decision tree. The tree consists of nodes and branches. Each node corresponds to a feature and each branch to a value taken by the feature. For continuous valued features, as here, the features need to be divided into discrete ranges. At each branch the feature having the highest information gain is selected for the next node. The information gain is calculated as follows:

$$Gain(S, A) = Entropy(S) - \sum_{v \in (Values(A))} \frac{|S_v|}{|S|} Entropy(S_v) \quad (2.33)$$

S denotes the set of all training example, A denotes the feature for which the gain is being calculated, S_v denotes the subset of training examples for which the feature A takes on

the value of v . The entropy term is calculated as follows:

$$Entropy(S) = \sum_{i=1}^c -p_i \log(p_i) \quad (2.34)$$

Here p_i denotes the proportion of training examples belonging to the i_{th} class out of c classes. The tree starts off with a root node which is the feature that has the highest information gain out of all the features based on all the training examples. Random Forest method generates a number of decision trees. Each tree is trained on a subset of the training examples generated by sampling with replacement so there tends to be overlap between the subsets for each tree. During classification, each tree assigns a label and the final classification is given as:

$$(c|v) = \frac{1}{T} \sum_{t=1}^T P_t(c|v) \quad (2.35)$$

Averaging the decision boundaries that result from each tree can produce a superior result to that generated by single trees [241].

2.4 Application for Emotion Recognition Based on EEG

With the rapid development of the in-depth study of neuroscience and cognitive science of emotions and dry electrode technology, EEG-based emotion recognition technology will be widely used in the near future. Emotion detection through EEG has a wide variety of practical applications [141][117][242]. Possibilities that have been proposed for the use of these machine learning systems include multimedia environments that detect the users' emotional state, such as recommendation and tagging systems, interactive games and films [119] that respond to the user emotions, and biofeedback devices that can be worn in the manner of headsets and might help users gain control over their emotional states.

Currently, there are many effective applications based on BCI, such as the wheelchair control based on motor imagery [243], the cursor control based on event evoked potential [24] and driving simulation under 3-D virtual environment [244]. However, the current BCI still remains in the realization of the basic needs of persons with disabilities, and for more advanced needs are still unable to achieve. EEG-based Emotion Recognition technology provide the possibility for further meet the demands of disabilities human, such as people with a particular emotional disorder disease. It can be analyzed by EEG level preferences degree, such as the choice of meals, TV programs and music selection

choices, so as to design a more friendly and intelligent BCI application to achieve better care effect, and improve the quality of life of the disabled.

Traffic safety is an important issue of public concern. For high-speed railway and bus drivers, emotional stability is very important. When the driver is in tension, excitement, anger or anxiety and other emotions, the probability of accidents will be significantly increased. If the use of the emotional state of the driver's real-time monitoring by EEG, and alerts the driver when negative emotions arise, the accidents can be prevented or reduced to a certain extent.

On the battlefield, the commander needs to know the mental state of the soldier in time. Mattews et al. [245] developed a mobile system that can monitor the working pressure of soldiers in real time by placing electrodes in the soldier's helmet. The commander can better understand the status of the soldiers through the system and distribute the soldiers' tasks more rationally.

Chapter 3

Emotion Detection from EEG

Recordings Based on Hybrid Dimension

Reduction on Distinct Features

3.1 Introduction

Human emotion is a complex phenomenon that comes from human brain, but there is no clear knowledge on its generation mechanism. Physiologists and computer scientists have been studying it for decades. For example, Ekman et al. [35] proposed the notion of 6 basic emotions that were universal and found across cultures. Posner et al. [246] proposed a two-dimensional model in which emotions were given co-ordinates denoting the degree of valence (the positive or negative quality of emotion) and arousal (how responsive or energetic the subject is). Other models include Plutchik wheel of emotions [247], a tree of emotions [248], etc.

In relation to engineering applications, the definition and classification of emotions are of importance in deciding what variables should be considered and what measurements are required during the design of a system. A person's emotions can be gauged from external features such as facial expressions and tone of voice. These can be captured via photographs, video and audio recordings. However, emotion also results in other bodily changes such as variation in heart rate, muscle tension, respiration and skin conductance,

and, of course, brain activity.

Emotion detection through EEG signals has a wide variety of practical applications, evidenced by medicine and scientific research, and the field of affective computing [52]. The latter refers to the incorporation of emotions in human-computer interaction giving machines a degree of emotional intelligence. It has been proposed for the use of these machine learning systems include multimedia environments that recognize the emotions of the users, such as recommendation and tagging systems, games and films that respond to the user emotions, and biofeedback devices that can be worn in the manner of headsets and might help users gain control over their emotional states. This echoes objections made at a much earlier stage by Picard et al. [52] to emotion recognition based on external displays. Among these are that emotions are frequently concealed or masked or even unknown to the subjects themselves, the disparity between posed and spontaneous emotion, the practical and ethical obstacles to recording spontaneous emotion, as well as matters that can limit applications such as privacy in relation to video-based detection. They recorded a variety of peripheral physiological signals including heart rate, respiration, skin conductance, blood volume pressure and facial muscle tension and achieved 81% accuracy which was amongst the highest at that time.

In this chapter, a new emotion detection system is proposed. Firstly, multiple feature extraction methods are used to produce different types of features from different domains. Secondly, a new hybrid dimension features reduction scheme is applied which used the combination of supervised and unsupervised reduction method to fuse the different features in order to get the best feature. Advanced machine learning methods are used and evaluated on a public available dataset DEAP (Database for Emotional Analysis using Physiological Signals) [3]. Experimental results are given on all different features and different feature selection methods for the emotion information extraction from EEG signals. It is compared with other state-of-the-art methods at the same setting up on the public DEAP dataset.

The rest of the chapter is organized as the following. Section 3.2 gives a review on related work. The proposed method is introduced in details in section 3.3. Section 3.4 presents the experimental results and section 3.5 gives the conclusion.

3.2 Related Work

Emotion detection system from EEG signals can be treated as a classification problem since the goal of the system is to predict the correct label of emotion. It is thus often a supervised learning task since labels are already assigned to the data by humans, although clustering methods have also been employed [249]. Detailed information about the current research in this area can be found in [250].

An important part of the study of emotion via machine learning involves the choice of features. Researchers have made use of a variety of features from EEG recordings. Jenke et al. [20] made a survey on feature selection and extraction across a variety of studies and classified these as time-domain, frequency-domain, time-frequency domain, and multi-electrode features. Time-domain features include event related potentials, signal statistics, Hjorth features, non-stationary index, fractal dimension, and higher-order crossings. Frequency-domain features include band power and higher order spectra; time-frequency domain features include the Hilbert-Huang spectrum and discrete wavelet transforms; multi-electrode features include magnitude squared coherence estimate and differential and rational asymmetries. Frequency domain features are prevalent and appear in the majority of the studies surveyed in the chapter, in particular spectral power, but it was also found that its performance scores is lower compared to other features.

A very high level of performance was achieved in the study by Valenzi et al. [249] who analyzed EEG data from nine participants in response to video stimuli intended to induce the emotional states of amused, disgusted, sad and neutral. A key difference in the use of video stimuli in this study was that between stimuli, a distraction task rather than a relaxation task was used to neutralize the emotional state of the participant and considered to be more effective than a relaxation task. Data was recorded from 32 electrodes. The features extracted from the EEG were spectral power in delta (0.16-4 Hz), alpha (8-13 Hz), lower beta (14-21 Hz), upper beta (21- 30 Hz), and gamma (30-40 Hz) bands. Linear discriminant analysis was used to reduce dimensionality of the feature space. Both supervised and unsupervised learning methods were used. Supervised learning methods were Error Back Propagation and Support Vector Machine (SVM). Unsupervised learning algorithms used were Vector Quantization, Fuzzy C-Means Clustering (FCM), K-Means, and K-Medians. A maximum average accuracy of 97.2% was achieved for supervised learning (for SVM) and a maximum average accuracy of 95.2% for unsupervised learning (for FCM). Average EEG power was computed across the stimuli for the different electrodes and showed larger frontal right symmetry for negative emotions. Electrode reduction was attempted, using only 8 electrodes (6 frontal and 2 temporal) yielding a best rate (using SVM) of 92.5% for individual classification and an average classification rate of 87.5%. It was

noted however that the method in its current state was designed only to work offline.

Using all the features, an average classification accuracy of 87.5% was achieved when features from all the bands were used. For individual bands, higher frequency alpha, beta and gamma bands yielded better results compared to lower frequency bands. After feature reduction, classification accuracy in fact increased slightly when using the top one hundred subject-independent features and was at 89.2%. It was noted the selected subject independent features were mainly in the higher frequency bands and this was consistent with studies relating human emotional response to these bands.

Noticed by Othmana et al. [251], one possible application for this area is intervention in cases of brain developmental disorders such as ADHD and autism. Their study involved 5 child participants, who were shown emotional faces whilst EEG recordings were made. Two different dimensional models were used for the classification of the emotions known as rSASM and 12-PAC. Recordings were taken only from the F3 and F4 frontal electrodes, and only the theta and alpha bands were considered. For the purposes of feature extraction, Mel-Frequency Cepstral Coefficients and Kernel Density Estimation were used and multi-layer perception was used for classification. The best performance achieved was for the 12-PAC with Kernel Density Estimation, at a mean squared error range (among the participants) of 0.07 to 0.09.

Another study used the connectivity between the EEG channels. Chen et al. [154] considered the relationship between each channel, and calculated the mutual information, person correlation coefficient [226] and phase coherence connectivity [252] between each channels and use these information as the extracted features and then use the Fisher linear Discriminant method as the feature selection method which is at the same setting with the one in the DEAP dataset [3]. They use a SVM as the classification method, and obtained 76% on valence and 73% on arousal.

Meanwhile, Gupta et al. [253] also applied connectivity features for DEAP dataset [3]. This method is inspired by the work of Pablo et al. [254]. For their work, Welch's t-test and PCA used the two step feature reduction methods which applied for the fusion of spectral power and mutual information. At the DEAP dataset, a total of 880 features were extracted from 32 channels. For Welch's t-test, they used 0.01 increase step as the threshold and best features were selected. Then they applied PCA for the second step reduction. In order to reduce the effect of different classifiers, they used SVM-RBF, SVM-Sigmoid and BN as the classification methods. The presented results show that arousal reaches $67.7 \pm 11.3\%$ and valence reaches $69.6 \pm 9.3\%$ for the best classification accuracy.

Inspired by Pablo's work [254], we make the further improvements: 1) we produce more different types of features which potentially contains more information for different domain and 2) The mRMR method is used not only to consider the features significantly different from each other, but also the relationship between features and the labels to keep the most useful information for the classification.

3.3 Methodology

This section presents the overview, details about the applied features and the description of proposed two-steps hybrid dimension features reduction scheme.

3.3.1 Overview

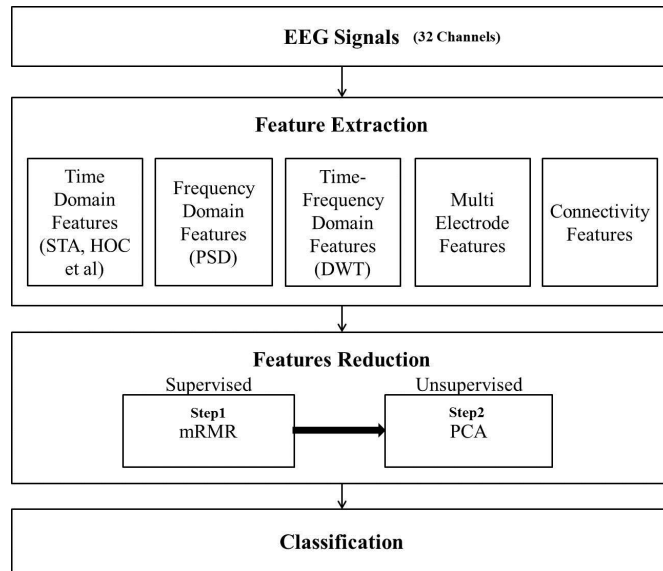

Figure 3.1: Overview of The Proposed Method.(Multi-channel EEG signals are sent for distinct feature extraction, and the hybrid feature dimension reduction scheme is applied for emotion detection based on classification.)

One of the most important factors that influence the performance of classification is the selection from different type highly dimensional features of different classes. Certainly the original features contain more information that can be fed into the classification. However, it will potentially decrease the positive impact when all types of features are used simultaneously. In this case, the fusion work is applied on the different type of features combine which fused all types features with the combination of supervised and unsupervised feature reduction method to achieve the best performance. As shown in Figure 3.1,

14 different kinds of features are employed as extraction methods from different domain in order to produce more information from the EEG data, and then, as described above, the feature reduction method are applied for these features combine in order to keep the most value information for further work. After the reduction work, the valuable features are fed into the different classifiers to do the binary classification work. The feature extraction methods and reduction methods are shown below.

3.3.2 Set of all Features

EEG signals with whole duration except the 3 seconds prior to recording are used for extracting connectivity features. In order to settle the same set up with the dataset paper [3], Last 30 seconds data is applied for extracting features and further steps.

The consideration of the time domain feature, frequency domain feature, time frequency domain and the connectivity feature are the same experiment setting with DEAP paper [3] when doing the feature extraction. Each feature is extracted from each participant [3]. Table 3.1 shows the dimension and type for each feature.

Table 3.1: Features and The Number of Components Extracted from EEG Signals

Types	Features	
	Feature name	No. of components
Time Domain	Statistical features	224
	Higher order crossing	320
	Fractal Dimension	32
	Hjorth features	64
	Non-stainarity Index	32
Frequency Domain	Power Spectral Density	128
Time-frequency Domain	REE	288
	RMS	128
	entropy	128
Multi Electrode features	Differential Asymmetry	56
	Rational Asymmetry	56
	MSCE	496
Connectivity features	Mutual Information	496
	Pearson correlation	496

3.3.3 Hybrid Dimension Features Reduction Scheme

Two steps of multiple highly dimensional features reduction was proposed in this scheme. The highly dimensional features were fused by the combination of mRMR and PCA in a classification perspective.

- mRMR

mRMR is proposed as the first step for feature reduction method for the combination feature of all these 14 kinds of features. This method use mutual information to characterize the suitability of features proposed by Ding and Peng [255]. Mutual information between two variables is shown above. The mRMR method is used to optimize two criteria simultaneously: Maximal-relevance criterion D , which aims to maximize average mutual information between each feature and the specific label. The Minimum-redundancy criterion R means to minimize the average mutual information between two features [170]. The algorithm finds near-optimal features using forward selection. Given an already chosen set S_k of k features, the next feature is selected by maximizing the combined criterion $D - R$, as shown in equation 3.1:

$$\max_{x_j \in (X - S_k)} [MI(x_j; y) - \frac{1}{k} \sum_{x_i \in (S_k)} MI(x_j; x_i)] \quad (3.1)$$

At this stage, mRMR is applied to reorder the combined features based on the specific arousal and valence label for each subject. The new order is based on the mRMR theory that shown above that maximum the feature's relevance with the labels and minimum the redundancy between each features.

- PCA

After the supervised step is the unsupervised stage in which PCA converts the new order features produced by mRMR into the next linearly uncorrelated set. From the first step, the features that have maximum relevance with the labels but minimum redundancy with each other were kept so that in this stage all the features which applied for PCA are the max relevance label features. It potentially keeps main information for all different types of features. The PCA step further reduces the new high relevance dimensional features and retain most of its variance.

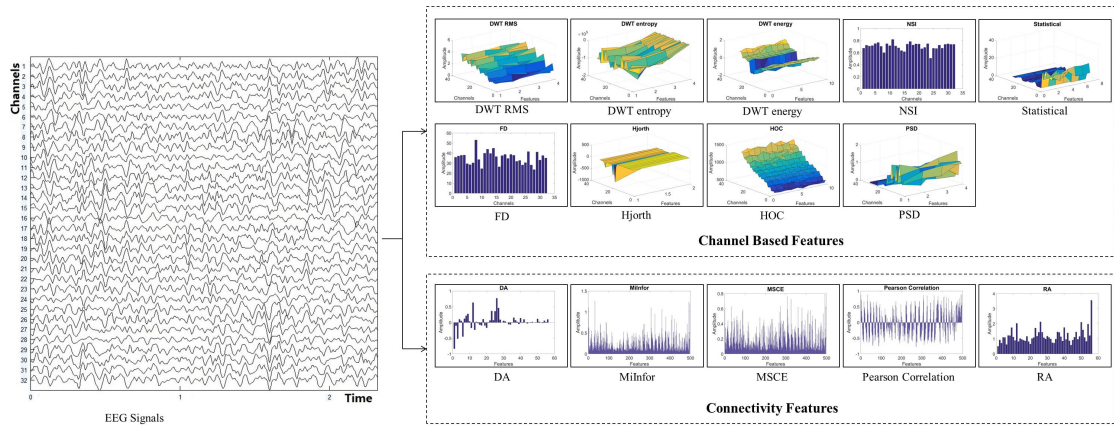

Figure 3.2: Distinct Features Extracted from One EEG Recording with 32 Channels in DEAP Dataset.

3.3.4 Classification

The emotion information was represented by emotional dimensions such as arousal and valence. For the classification, the values are divided into two classes based whether the value was higher or lower than the midpoint value. For Arousal, there are two classes: high arousal (HA) and low arousal (LA). For valence, they are high valence (HV) and low valence (LV).

For this binary classification problem, many methods can be used for the classification such as K-Nearest Neighbour (kNN), Support Vector Machine (SVM), Naive Bayes classifier, and Random Forest (RF) [256] [257][258]. In this study, SVM was chosen as it has achieved best performance in many binary classification tasks. The RF classifier was added due to its super ability to automatically select best features in the classification process.

3.4 Evaluation

The proposed method is evaluated on a public dataset and compared to the state-of-the-art performance achieved by other researchers in the same experimental setting condition.

3.4.1 Performance Measurement

For classification performance measurement, accuracy is the most popular one that can identify how many samples are classified correctly. It was used here for all the binary classification tasks. In addition, another accuracy measure F1-score is also provided for

summarizing the results of each method in considering the balance of single number class. Further, the paired t-test is carried out to evaluate the significance of the proposed method against other methods.

3.4.2 Dataset

DEAP dataset [3] is a multi-modality dataset for the analysis of human affective states. EEG recordings from 32 channels, peripheral physiological signals and frontal face videos were obtained from 32 participants whilst watching 40 music videos. The videos were selected to evoke one of the four of the following categories of emotion: 1). HV&HA; 2). HV&LA; 3). LA&HA; 4). LV&LA. The EEG data was processed by average referencing, down-sampling to 256 Hz and high-pass filtering to 2 Hz cut-off frequency. Changes in power relative to the pre-stimulus period was computed and averaged over the Theta (3-7 Hz), Alpha (8-13 Hz), Beta (14-29 Hz) and Gamma (30-47 Hz) bands.

3.4.3 Experiment Settings

For DEAP dataset, the binary classification problem was addressed after thresholding the self-assessments following the protocol in [3]. The affective label will be set to high if the rating is above 5. If the rating is equal or lower than 5, the corresponding affective label will be set to low. Thus for each trial, binary labels were generated. high valence (HV) or low valence (LV) was to describe the affective level in valence space, and high arousal (HA) or low arousal (LA) was to describe the affective level in arousal space. Identification of valence and arousal levels are treated as two independent binary classification tasks in this chapter.

3.4.4 Feature Extraction

For DEAP dataset, the time domain feature, frequency domain feature, time frequency domain and the connectivity feature from each EEG recording are extracted. Overall, 14 distinct features were extracted from each recording. Figure 3.2 shows an example of the features from one recording.

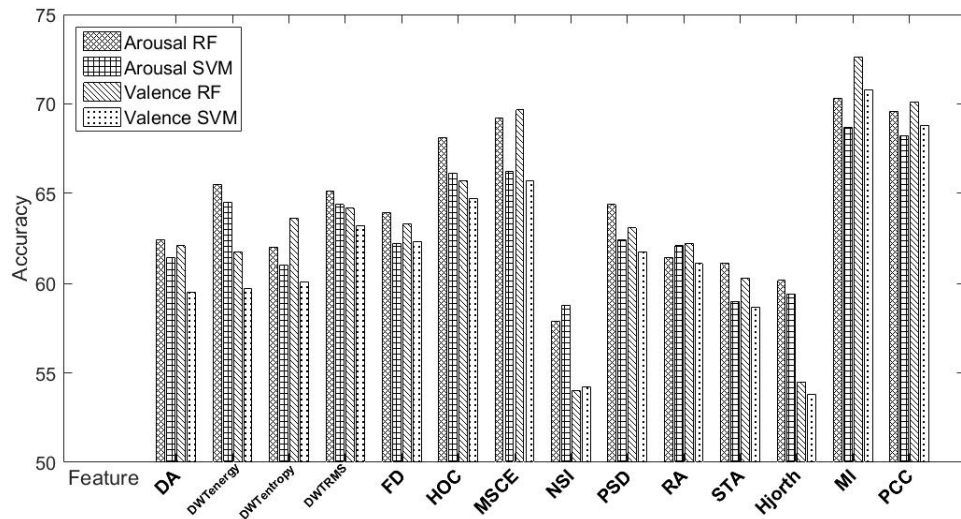

Figure 3.3: Classification Accuracy on Individual Features Using RF and SVM for Arousal and Valence Emotional Dimensions.

3.4.5 Results

Investigate Classification on Individual Features and Combination Features

The following results are obtained on the DEAP database under the same settings as the benchmark paper [3]. As in [3], the leave-one-out validation method is applied for each subject to evaluate the performance for each method. It means at each step of the validation, one video is treated as the test and the rest 39 videos of the same subject are treated as training. For RF method, form the published work [102] indicated the parameter 1000 trees is more reasonable and practical for this experiment. For linear SVM classifier, default parameter is used. Table 3.2 shows the average classification accuracy and its standard deviation over 32 subjects on 14 distinct under the same validation setting. As expected results from [154], the connectivity features conduct better performance than other feature extraction methods, thus, it potentially indicates that the strength of connectivity between two electrodes is the better representations for the interaction between these two cortical areas which just is the changing of EEG signals. Simultaneously, the combination of 14 distinct features are not significant as the expected compare to the connectivity features for both arousal and valence.

From Figure 3.3, it can be seen that MI feature reaches the highest performance for both arousal and valence as 70.3% and 72.6% respectively. All the connectivity features are significantly greater than other domain features. It indicates that the further performance improvement might be achieved by applying optimal work on connectivity features. Si-

Table 3.2: Classification Accuracy and Its Standard Deviation on Distinct Features ($\% \pm \Delta$)

Features	RF ($\% \pm \Delta$)		SVM ($\% \pm \Delta$)	
	Arousal	Valence	Arousal	Valence
DA	62.4±7.2	62.1±7.1	61.4±7.5	59.5±6.8
DWTenergy	65.5±7.3	61.7±6.9	64.5±5.9	59.7±6.4
DWTentropy	62.0±7.4	63.6±7.1	61.0±5.2	60.1±7.6
DWTRMS	65.1±7.4	64.2±7.2	64.4±8.1	63.2±4.8
FD	63.9±6.8	63.3±7.5	62.2±6.7	62.3±7.5
HOC	68.1±5.9	65.7±7.6	66.1±6.3	64.7±6.0
MSCE	69.2±6.9	69.7±7.5	66.2±5.5	65.7±7.4
NSI	57.9±8.0	54.0±6.1	58.8±8.8	54.2±7.9
PSD	64.4±7.4	63.1±6.0	62.4±5.8	61.7±7.3
RA	61.4±7.4	62.2±7.0	62.1±6.8	61.1±5.7
Statistical	61.1±5.5	60.3±6.9	59.0±8.6	58.7±9.4
Hjorth	60.2±6.3	54.5±7.1	59.4±8.5	53.8±7.7
MI	70.3±6.8	72.6±8.9	68.7±7.7	70.8±6.6
PCC	69.6±5.9	70.1±8.7	68.2±7.5	68.8±8.4
Combine	68.3±6.3	68.7±8.1	67.8±4.5	68.1±6.4

multaneously, all types of features show potentially and relatively stable based on the classification methods. Additionally, it could be seen from Table 3.2 that accuracy of valence levels identification is higher than that of arousal. This is consistent with the results presented in [259]. This Table 3.2 presents the performance for different types of features and obviously illustrate the best performance for individual feature extraction method for the further comparison.

Investigate the Proposed Two-Steps Feature Reduction Scheme on Top Rank Individual Feature and Combination Feature

The next step is the proposed method applied on the combination of all 14 types features. As the same setting with [3], the reduction scheme will applied to each validation step. After mRMR method re-order the features and gain the max-relevance min-redundancy attributes, the next is to reduce the features. However, the amount of features to choose cannot determine. In this case, the full-range analysis is applied which means the mRMR will reduce from the last of the new order features and step by 0.01 until the number of dimensions that remained is strictly best performance. Additionally, this last means at last of the new order features which means lowest relevance between features and the label and high redundancy of other features. The following presents the comparison between proposed method and best performance of other methods. At this stage, two classification methods SVM and RF are employed to do the comparison which possibility decrease

the effect of different classifiers. Simultaneously, the standard deviation and F1-score are presented to represent the balance capability of each algorithm.

Table 3.3: Average Accuracy Comparison on Emotion Dimensions between Proposed Fusion method with PCA and mRMR Individual Methods.

	Features	RF (% $\pm \Delta$)			SVM (% $\pm \Delta$)		
		PCA	mRMR	Proposed	PCA	mRMR	Proposed
Arousal	PCC	68.4 \pm 7.1	69.8 \pm 8.3	71.4 \pm 6.2	65.8 \pm 8.9	69.6 \pm 9.4	70.5 \pm 8.4
	MI	68.4 \pm 8.7	71.6 \pm 7.1	73.6 \pm 5.8	66.2 \pm 8.8	71.9 \pm 7.9	72.1 \pm 6.7
	All combine	67.5 \pm 9.6	72.7 \pm 7.7	74.3\pm8.4	67.2 \pm 9.4	71.6 \pm 6.5	72.4\pm8.8
Valence	PCC	68.6 \pm 9.2	71.3 \pm 8.5	73.5 \pm 7.8	65.9 \pm 9.7	71.0 \pm 8.4	71.4 \pm 8.9
	MI	69.8 \pm 9.3	73.3 \pm 6.4	74.8 \pm 7.5	68.1 \pm 9.4	72.7 \pm 8.8	73.6 \pm 6.9
	All combine	67.9 \pm 9.9	74.2 \pm 8.1	77.2\pm8.6	67.2 \pm 9.6	73.8 \pm 8.3	76.1\pm7.4

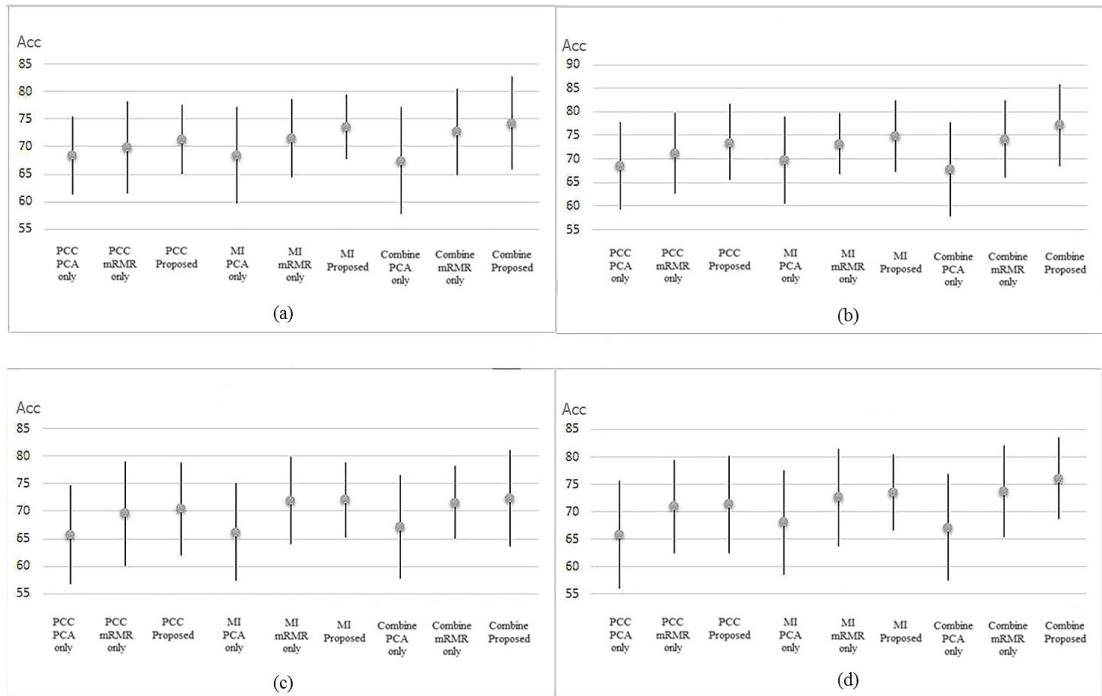

Figure 3.4: Classification Accuracy (%) and Standard Deviation on Individual and Combined Features Using Different Classifiers on Arousal and Valence. (a). RF for arousal (b). RF for valence (c). SVM for arousal (d). SVM for valence.

Table 3.3 presents the observation of the relatively higher performance achieved by proposed method in comparison with the PCA only and mRMR only on best individual feature extraction algorithm and all feature combine. In arousal, the proposal presents the highest average accuracy which reach 74.3% by RF. Figure 3.4 also presents the results in the more specific form. Therefore, the proposal performance are significant higher than other individual features selection method on both single feature or all feature combine.

In valence, similarly to the previous result, RF achieved the best performance for 77.2%. Simultaneously, if only PCA is applied, for both individual or combined feature, the performance decrease. Moreover that if only mRMR is applied, the performance shows great than original but not significant. The proposed method reached both highest for arousal and valence.

Table 3.4 provides the F1-score for PCA-only, mRMR-only and proposed method on combined feature. The results support that a consequence of variety features combination and the proposed hybrid feature reduction method achieved the improvement. In addition, the paired t-test was conducted to check whether the proposed highlighted results are significantly better than the rest of methods in Table 3.3 for the combined feature. Both in arousal and valence terms, the p-value are presented in Table 3.5 which indicated that the results of proposed method are statistically significant with PCA only and mRMR only methods.

Table 3.4: Average F1-score Accuracy Comparison on Emotion Dimensions between proposed fusion method with PCA and mRMR individual methods.

Emotion	Method	RF(% \pm Δ)	SVM(% \pm Δ)
Arousal	PCA	58.1 \pm 11.3	57.1 \pm 10.9
	mRMR	62.5 \pm 12.1	58.9 \pm 9.6
	Proposed Method	71.0 \pm 10.2	66.7 \pm 8.9
Valence	PCA	59.1 \pm 16.2	68.2 \pm 11.9
	mRMR	62.9 \pm 9.9	71.1 \pm 10.1
	Proposed Method	78.9 \pm 10.4	77.3 \pm 9.8

3.4.6 Comparison with Existing Works

Finally, the comparison of the results with other existing work on DEAP dataset for vary purpose which includes emotional state recognition [118] [101], EEG-based feature extraction [20] [260] and also emotion detection system modeling [261][262] [263]. The comparison only presents for same binary affective levels identification in valence and arousal spaces using EEG signals as shown below in Table 3.6. The proposed method reaches highest performance for both arousal and valence.

Table 3.5: The p-value of T-test between Proposed Method with PCA and mRMR on All Features Combined.

Emotion	Method	RF	SVM
Arousal	PCA	0.011	0.013
	mRMR	0.032	0.043
Valence	PCA	0.001	0.019
	mRMR	0.024	0.038

Table 3.6: Comparison on Classification Accuracy with The state-of-arts.

Methods	Arousal (% $\pm \Delta$)	Valence (% $\pm \Delta$)
Koelstra et al. [3]	62.0	57.6
Chung et al. [264]	66.4	66.6
Naser and Saha [265]	66.2	64.3
Zhuang X. et al. [266]	67.1 \pm 14.1	70.9 \pm 11.4
Bahari and Janghorbani [197]	64.6 \pm 10.7	58.1 \pm 9.3
Pablo and Miguel [254]	67.7 \pm 11.3	69.6 \pm 9.3
Zhuang N. et al. [263]	72.0 \pm 7.8	69.1 \pm 7.0
Chen et al. [154]	73.6 \pm 7.9	76.2 \pm 6.8
Liu et al. [102]	71.2	69.9
Proposed Method	74.3\pm8.4	77.2\pm8.6

3.5 Summary

Emotion detection based on EEG signals is a comparatively new and developing research area. The key contribution of this chapter is to extract more useful information for the emotion detection based on variety features' fusion under an efficient way. From this work, a total of 14 features have been extracted from different domains of EEG recordings and investigated the classification individually. And then, since the combination of 14 features' performances are not that significant, in order to combine more useful information for different feature methods, further, the two step feature reduction method was used for the dimension reduction of the combine feature vectors. From the experimental results, it can be seen that firstly, connectivity features achieve best compare to other feature extraction methods, secondly the combination of supervised and unsupervised feature dimension reduction method can improve the performance by removing some irrelevant feature vectors and better than individually use. The final feature produces the best results within all the existing results in the same DEAP EEG emotional dataset under the same experiment settings.

Chapter 4

Exploration On Emotion Recognition

From EEG Recordings by Adaptive

Noise Learning β -Variational

Autoencoder and Long Short Term

Memory

From previous chapter three, the selection on various features combine produced relatively significant improvement. However, the features and classification methods which employed from previous approach are relatively traditional and classic. In chapter two the review presents AI technologies have been achieved many significant improvements in many areas, such as image processing [32] and sequential data processing [207]. Therefore, with the development of AI techniques inspired me to try various deep neural network modules to produce the feature extraction and dynamic modelling system for EEG-based emotion recognition.

4.1 Introduction

Researches on human brain have widely improved in recent decades, especially with the development of the actual demands for human normal life, for instance that the treatment for disabilities, industrial intelligence and entertainment. HCI and BCI developing in a rapid speed, specially, the research on emotion recognition from EEG continuous achieve the hot topic and increasingly important. EEG is the time series signals, previous researches indicates that the consideration on the continuous change potentially increase the performance. Various features extraction methods have been proposed for EEG-based emotion recognition, containing time domain, frequency domain, Channel-based analysis and other strategies.

For feature level, the statistics of EEG time series, fractal dimension, high order crossing and Hjorth are utilized for emotion recognition [267] [189] [268] [79] [100]. Recently, the features extracted from relationship information between electrodes are widely utilized, such as coherence, asymmetry, correlation coefficients and mutual information of electrodes [269] [270] [271] [154]. Jenke et al. summarized the variety feature extraction and selection methods on different domain [20] and presented the comparison between each method.

With the development of AI, many deep neural network strategies applied for increasing the performance for the emotion classification tasks. Zheng and Lu proposed deep neural network to investigate critical frequency bands for emotion recognition [142]. Mukesh et al. conducts the 4 steps deep neural network based on different ratio amount of training and testing samples for emotion recognition [272]. Hierarchical network via subnetwork nodes was proposed by Yang et al. [273] for EEG-Based emotion recognition. Miku and Chika [209] presented using convolutional neural network to do the emotion recognition which achieve the greater progress for this research area.

The significant achievements verified that the improvement on the deep neural calculation methods inflict their effective. Pouya et al. [274] proposed the transfer model which implicitly implement the conversion EEG time-series signals to 3-channels RGB images, the detailed of their contribution is presented in section 4.2. Considerably, this work framed the newly background for EEG signal-processing. The strongly mature processing technology in image-processing area which provided the possibility that the transform work potentially commence another platform for EEG-emotion recognition. Their work inspired us about proposing the following model.

In this chapter the exploration emotion recognition based on EEG through the noise learn-

ing β -VAE and LSTM deep module is presented. Firstly, all EEG time-series signals are transferred into multi-channel EEG images by 1 second per image based on different domain. The proposed β -VAE then processed the image data and provide the adaptive output features. These temporal sequence information ultimately utilized by LSTM and produce the emotion classification results. The comparison of each experiment schemes are presented.

The remainder of this chapter is as following: Section 4.2 presents the brief literature review on EEG-emotion recognition works and their methods attempting to provide the preliminary understanding and most recently achievements. Section 4.3 presents the exploration experiments on variety framework of EEG-based emotion detection, and detailed introduces the β -VAE LSTM deep neural module. And then the performance and achievement are conducted. Section 4.4 draws the conclusions.

4.2 Related Work

There are numerous studies about automatic emotion recognition in recent years, which show that EEG signals have strong correlation with the actual emotion. Some of these studies will be presented further in this section. Liu [268] proposed that Real-time EEG-based Human Emotion Recognition, they use the fractal dimension model to train the offline EEG dataset, First, they designed and implemented emotion induction experiments using two-dimensional model to describe emotions. And use the silde window for online emotion recognition. also they build the 3D visualization system for participant to visualize the emotion in real-time.

Recently, VAEs [275][276] are used to obtain the factor representation underlying the data through casual modeling and to reconstruct/generate though/decode original signal. The advancements induced by VAE are introduced to EEG signal-to-image decoding [277] and to EEG emotion recognition by enabling the joint modular and label-efficient learning [278]. However, the latter recognition results are not as promising as expected and one potential cause might be the entangled factor representation.

Disentanglement contributes to the most efficient representation thus to its latter tasks, and β -VAE [279] attains the disentangled representation by enhancing the constraints on the channel capacity induced by the encoder network and is found effective in few short learning [280] and transfer learning [281][282]. Both of them alleviates the learning problems caused by insufficiency in data scale. My model adopts the adaptive noise learning

β -VAE, which was shown boosting on the disentanglement by enabling the model to adapt to the unknown noise. Besides, the disentangled representation would also boost the memory of subsequent LSTM in the model due to its relatively low dimension representation. The adoption of LSTM in the model also enables the immediate recognition in stream data.

Pouya et al. [274] proposed the model with the combination of CNN and LSTM for processing the EEG-working memory classification task. They transferred all EEG-time series signals into images area by applying short Fourier transform to estimate the power spectrum of the signal. They defined the working memory related to three specific frequency bands theta (4-7Hz), alpha (8-13Hz), and beta (13-30Hz). The standard method didn't consider the space information for EEG signals, they proposed two step transformation method to produce the 2-D 32x32 images which contain the space information about the EEG sensor. Firstly, the Azimuthal Equidistant Projection (AEP) applied to original EEG-sensor 3-D coordinates to perform 2-D projected locations of electrodes. And then Clough-Tocher scheme applying for interpolating the scattered power measurements over the scalp and for estimating the values in-between the electrodes over a 32x32 mesh. The three-channel (RGB) image is represented by theta, alpha and beta which then merged together to form an image with three(color) channels. The final step is applying recurrent-convolutional network architecture on processing the EEG video. The experiment was set on their own EEG-working memory dataset and the performance represent that their model achievement great.

Du et al. [278] proposed a multi-view extension for VAE by imposing a mixture of Gaussians assumption on the posterior approximation of the latent variables and provided the model on the semi-supervised multi-modality framework on EEG-emotion recognition. The proposed combines the advantages of deep multi-view representation learning and Bayesian modeling. They produced the experiments on both SEED and DEAP emotion EEG dataset, the performance achieve great on both dataset. For SEED dataset, the best emotion classification accuracy performance nearly 0.968. For DEAP dataset, they produce the quadratic-label for two binary indexes arousal and valence simultaneously, and they discarded the original dataset which labeled between 3 and 6. The classification for EEG-only is 0.407 and for multi-modality is 0.451. The great achievement verified the significance on applying VAE to regenerate the features.

These researches present both a number of advantages and disadvantages between each other respectively. Pouya et al's work provided the transformation framework which transferring time-series EEG data to images and furthermore they consider the sequence information in the temporal EEG-video. Du et al proposed executing the experiment on

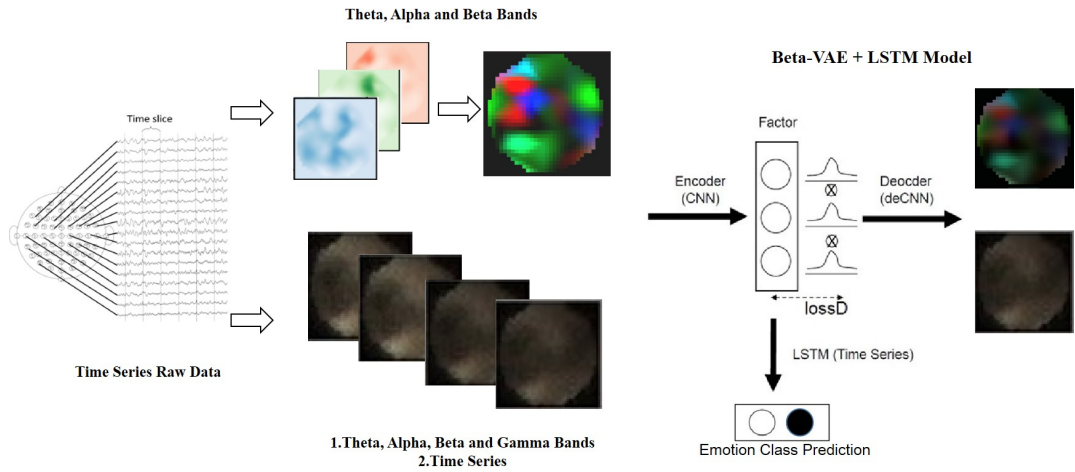

Figure 4.1: Overview of Emotion Recognition from EEG Based on the β -VAE LSTM Model, 1. EEG time series from multiple locations are acquired; 2. EEG transformation work, it contains 3 frequency bands data that represents by RGB and other scheme represents by grey scale images for each time frame; 3. sequence of images are fed into the proposed VAE-LSTM network for representation learning and classification.

original pre-processing EEG data by the multi-view VAE with the mixture of Gaussians assumption. Both their work inspired us about creating the model. Judging to their work, the proposes improvement conduct the consideration on applying VAE on EEG-video, meanwhile, the advantage of disentangled β -VAE combine with the LSTM is indicated which potentially maximum degree of premeditating and integrating the multi-aspects specialty.

4.3 Exploration Experiments on Variety Framework of EEG-based Emotion Detection

4.3.1 Overview

Figure 4.1 presents the overview of the main experiment based on the proposed model. The EEG time series data transferred to EEG-images based on frequency domain and time domain firstly. There are two kinds of EEG images, the three bands frequency data merged into 3 channel RGB (color) images, simultaneously other schemes' data were regarded as the multi-channel images. Furthermore, the EEG video-like data for each experiment scheme is given as the input to feed into the β -VAE LSTM model. The data send to β -VAE for representing learning the factors of EEG-images. Meanwhile, LSTM is employed to process the sequence characteristics for classification. Finally different

experiment parameters are conducted to achieve the best performance.

4.3.2 Dataset and Experiment Schemes

DEAP Dataset

DEAP is a publicly famous multi-modalities emotion recognition dataset proposed by Koelstra et al. [3] and available online, which recording the EEG signals from 32 channels, peripheral physiological signals and frontal face videos for 32 participants whilst watching 40 music videos. All video clips last for 63 seconds which represent the different specific visual emotion stimuli. Each electrode record for 63 seconds with 3s baseline signal before the trail, and each participant took 40 trails respectively. The EEG data was first preprocessed which down-sampling into 128Hz and band range 4-45 Hz.

The two indexes to evaluate these stimuli are arousal and valence, which were labeled from the scale 1-9. For arousal and valence separately, 5 is applied as the boundary for measuring amplitude for both arousal and valence that the label were generated into high-arousal (HA),high-valence (HV),low-arousal (LA) and low-valence(LV). This chapter performs the identification task for arousal and valence simultaneously which the new label reshaped as HA-HV, HA-LV, LA-HV and LA-LV quadratic task. The distribution map for arousal and valence labels is shown in Figure 4.2. The DEAP experiment provided 32 participants data with 40 trails each which the amount of samples for the experiment are 1280.

Experiments Schemes

Figure 4.3 presents the main structure of the experiment schemes. Generally, the exploration experiments contain three parts. Firstly, the experiment is similar as that Pouya [274] proposed for three frequency bands EEG data which are merged into the RGB images after transformation work, moreover, this work expand the transfer work into four frequency bands to produce the multi channel images. Secondly, the experiments on time domain are demonstrated with consideration on utilizing more information. The difference of the two experiments schemes are the LSTM part, single-LSTM which is the original proposed model. Furthermore, consider the specific sequential data characteristic and large data amount, the double-LSTM is applied. Double LSTM consist of first 'sequence to sequence' LSTM and then second 'Sequence to one' LSTM, the detailed architecture will presents in the following. Finally, the baseline methods are conducted to demonstrate the results for this experiment setting, therefore, the comparison of performance for

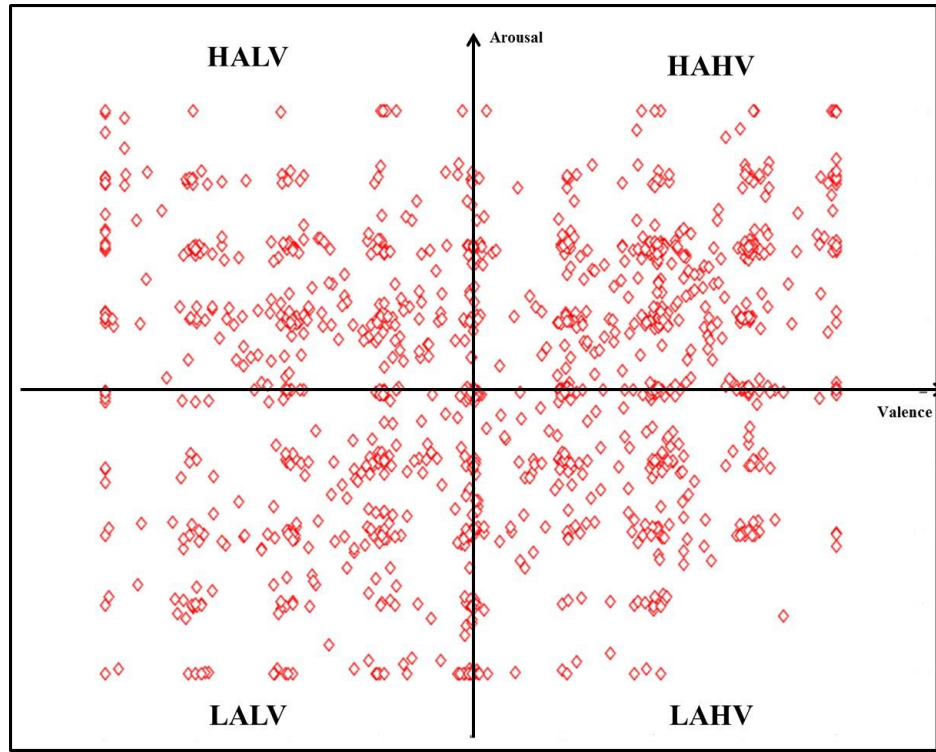

Figure 4.2: Distribution For Original ArousalValence

each scheme and will indicate the conclusion for exploration's result. The following will present each experiment scheme and performance evaluation in detail.

4.3.3 EEG Time Series to Image Transformation

The EEG transformation works were inspired by Pouya et al.'s [274] approach proposed. The EEG electrodes are distributed over the scalp in a 3-D space. In order to transform the spatially distributed activity maps as 2-D images. First step is to project the loca-

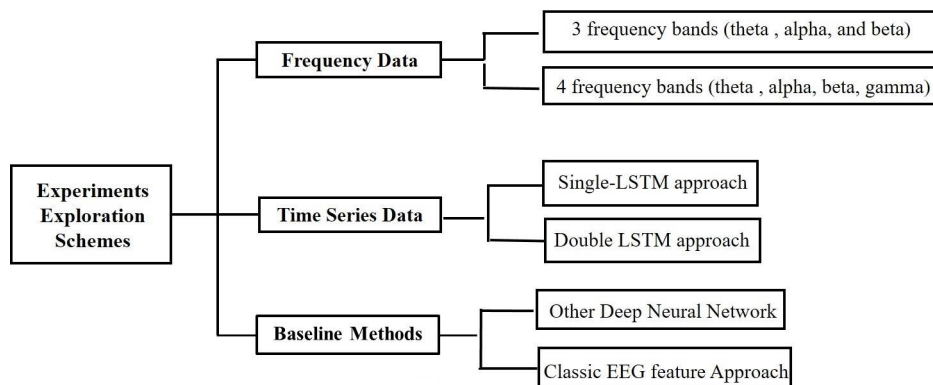

Figure 4.3: Experiments Schemes

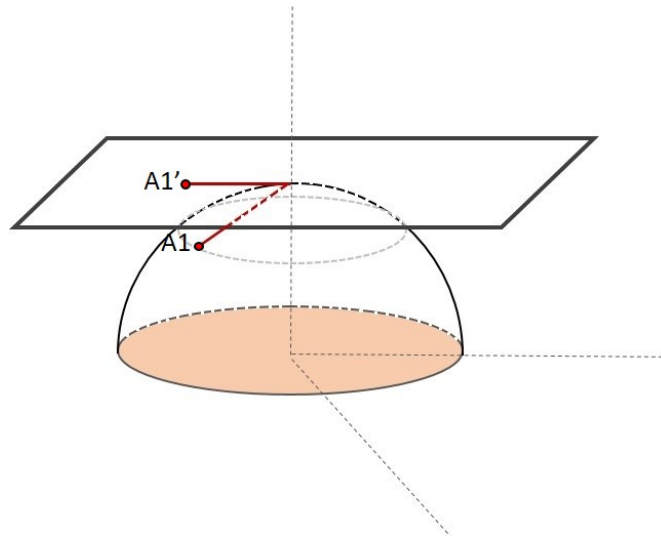

Figure 4.4: 3-D to 2-D Projection Example of Electrodes

tion of electrodes from a 3-D space onto a 2-D surface. However, such transformation should also preserve the relative distance between neighbouring electrodes. Azimuthal Equidistant Projection (AEP) is applied, the EEG wearable sensor can be approximated by a sphere for participant's head, simultaneously, AEP compute the projection of each electrode locations on a 2D tangent to the top point of the head surface. Figure 4.4 conducts the example of project work. The next step is Clough-Tocher scheme applied for interpolating the scattered to estimate the values between electrodes over a 32x32 mesh. Basically, it is achieved by Pouya's work which mentioned in related work, but the work based on the two different domain, the following will present the specific details about each domain transformation separately.

For frequency domain, first FFT is employed for each 32-channel respectively which estimate the power spectrum of the time series signal for each trail. The transformation is basically on two schemes. Both Three bands (θ , α , β) and four bands (θ , α , β , γ), the detailed procedure is applying the above methods on each frequency band separately, thus, the EEG time series data transferred into three or four channel image data corresponding to each frequency band. Three bands images can be processed as the color (RGB) image and four bands images conducted directly into the proposed model as a 4-channel image database. The DEAP dataset EEG last for 63 seconds, therefore, this experiment performed 1 image per second which integrated 63 images for each trail per participant. For time domain, the instruction procedure is basically similar as frequency domain. Among the processing the unlike section is the sampling rate for DEAP dataset is 128Hz, which leads to 128 images per second for one trail per participant. Table 4.1 conduct the details of samples for each schemes.

Table 4.1: Description of Samples Setting For each Scheme

	Schemes	Subject	Time	Trail	Sample(Per Second)
Frequency	3 bands	32	63	40	3
	4 bands	32	63	40	4
Time	Time series	32	63	40	128

4.3.4 β -VAE LSTM Architecture

The model takes a sequence of input frames $X = \{x^1, \dots, x^M\}$. Each frame of X is D dimensional vector derived by reshaping the converted RGB image. Let x denote a frame in general.

Adaptive Noise Learning β -VAE

We assume that x is generated by several independent factors $z = (z_1, \dots, z_H)$ following the multivariate Gaussian $(0, I_H)$. Besides We assume the conditional independence $p(z|x) = p(z_1|x) \cdots p(z_H|x)$. Those two assumptions, proved in [283], lead to the separation of mutual information regarding frame and the factors in dimension, that is

$$(x; z) = (x; z_1) + \cdots + (x; z_H). \quad (4.1)$$

Those assumptions are achieved with a VAE framework. VAE takes the input x^i frame by frame and encodes them into a posterior distribution

$$q_\phi(z|x^i) = (\mu(x), \sigma_z^2(x)), \quad (4.2)$$

through an encoder network where $\mu(x)$ is the network parameterized mean and $\sigma_z^2(x) = (\sigma_{z_1}^2(x), \dots, \sigma_{z_H}^2(x))$ is a network parameterized diagonal covariance matrix. ϕ represents the parameter involved in the distribution.

The sample z of $q_\phi(z|x^i)$ is fed to the decoder network of the VAE to recover the original signal through the generation process

$$p_\theta(x|z) = (G(z), \sigma^2 I) \quad (4.3)$$

where $G(z)$ is the network parameterized mean and σ is the pixel wise sharing noise variance and is set adaptively to learn and θ represents all the parameters involved in the generation process.

The objective of VAE part derived from the variational lower bound of the log likelihood and can be formulated as the following,

$$\mathcal{L}_{VAE} =_{z \sim q_\phi(z|x)} \ln p_\theta(x|z) - D_{KL}(q_\phi(z|x) || p_\theta(z)). \quad (4.4)$$

β -VAE introduces a tunable parameter β into the original objective which constraints the channel capacity induced by the encoder network and can be formulated as the following,

$$\mathcal{L}_{\beta-VAE} =_{z \sim q_\phi(z|x)} \ln p_\theta(x|z) - \beta D_{KL}(q_\phi(z|x) || p_\theta(z)). \quad (4.5)$$

Long Short Term Memory

We introduce $Z = \{z^1, \dots, z^M\}$ to represent the sequence of produced factor for

$$i^t = \sigma(W_{iz}z^t + W_{ih}h^{t-1} + b_i), \quad (4.6)$$

$$f^t = \sigma(W_{fz}z^t + W_{fh}h^{t-1} + b_f), \quad (4.7)$$

$$o^t = \sigma(W_{oz}z^t + W_{oh}h^{t-1} + b_o), \quad (4.8)$$

$$g^t = \tanh(W_{gz}z^t + W_{gh}h^{t-1} + b_g), \quad (4.9)$$

$$c^t = f^t \odot c^{t-1} + i^t \odot g^t, \quad (4.10)$$

$$h_t = o_t \odot \tanh(c_t), \quad (4.11)$$

$$a = \text{softmax}(W_{ah}h_M + b_a), \quad (4.12)$$

$$p_\psi(y|Z) = \prod_{i=1}^c a_i (h_M)^{y_i}, \quad (4.13)$$

where σ is the sigmoid function, \tanh is the hyperbolic tangent function, \odot denotes element-wise product, W_{*x} is the transform from the input to LSTM states, W_{*h} is the recurrent transformation matrix between the hidden states and b_* is the bias.

The following objective for the LSTM part is applied.

$$\mathcal{L}_{LSTM} =_{Z \sim q_\phi(z|x^1) \dots q_\phi(z|x^M)} \ln p_\psi(y|Z) \quad (4.14)$$

$$\mathcal{L}_{LSTM} + \sum_{i=1}^M \mathcal{L}_{\beta-VAE} \leq \log p_{\theta, \psi}(X, y) \quad (4.15)$$

Table 4.2: Detailed Architecture of Proposed Deep Network Module

	Architecture	Model Parameters
β -VAE	Encoder	Conv 32x4x4,32x4x4,64x4x4,64x4x4 (stride 2).FC 256. ReLU.
	Latent	128/32
	Decoder	FC 256. Linear. Deconv reverse of encoder. ReLU.Gaussian.
Predictor	Recurrent	LSTM dim128. Time-Step 60.
	Predict	FC 4. ReLU

$$\log p_{\theta,\psi}(X, y) \quad (4.16)$$

$$\geq_{Z \sim q_{\phi}(z|x^1) \cdots q_{\phi}(z|x^M)} \log p_{\theta,\psi}(X, y|Z) \quad (4.17)$$

$$-D_{KL}(q_{\phi}(z|x^1) \cdots q_{\phi}(z|x^M) || p_{\theta}(Z)) \quad (4.18)$$

Since

$$\begin{aligned} \log p_{\theta,\psi}(X, y|Z) &= \\ \log p_{\theta}(X|Z) + \log p_{\psi}(y|Z). \end{aligned} \quad (4.19)$$

$$\begin{aligned} &Z \sim q_{\phi}(z|x^1) \cdots q_{\phi}(z|x^M) \log p_{\theta}(X|Z) \\ &- \beta D_{KL}(q_{\phi}(z|x^1) \cdots q_{\phi}(z|x^M) || p_{\theta}(Z)) \\ &= \sum_{i=1}^M \sum_{z \sim q_{\phi}(z|x^i)} \ln p_{\theta}(x^i|z) - \beta D_{KL}(q_{\phi}(z|x^i) || p_{\theta}(z)) \\ &= \sum_{i=1}^M \mathcal{L}_{\beta\text{-VAE}}(x^i, z^i). \end{aligned} \quad (4.20)$$

We adopted LSTM to capture temporal evolution in sequences of EEG Images. Since brain activity is a temporally dynamic process, variations between frames may contain additional information about the underlying mental state. Table 4.2 presents the detailed architecture of above β -VAE LSTM module.

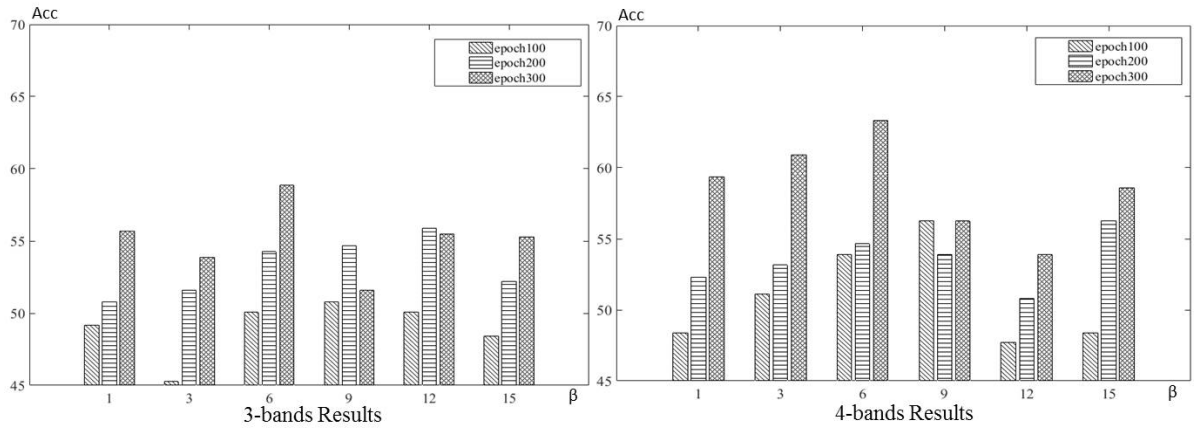

Figure 4.5: Classification Results for Frequency Experiments

4.3.5 Experiments Procedure and Performance Evaluation

Exploration on Frequency Domain

Firstly, different parameter settings are applied on the β for VAE and amount of hidden layer cell for LSTM respectively to figure out the effective by differential parameter setting for frequency domain. The samples are split randomly roughly by ratio [0.8: 0.1: 0.1] into training, validation, testing set. β is applied [1,3,6,9,12,15]. β -VAE is trained on each frame and LSTM was used to combine all the frames together for each video. The number of epoch is from [100,200,300].

Table 4.3: Classification Results For Frequency-Based Experiments (%)

Frequency	β	Epoch		
		100	200	300
3-bands	1	49.2±3.8	50.8±3.7	55.7±2.2
	3	45.3±4.5	51.6±5.9	53.9±3.5
	6	50.1±1.1	54.3±2.5	58.9±3.2
	9	50.8±1.4	54.7±7.7	51.6±3.1
	12	50.1±1.6	55.9±3.5	55.5±2.3
	15	48.4±3.7	52.2±1.7	55.3±2.9
4-bands	1	48.4±1.4	52.3±1.8	59.4±4.2
	3	51.1±1.9	53.2±3.1	60.9±3.5
	6	53.9±2.3	54.7±3.2	63.3±2.4
	9	56.3±2.1	53.9±2.8	56.3±1.7
	12	47.7±3.3	50.8±2.4	53.9±3.3
	15	48.4±3.5	56.3±1.9	58.6±3.2

Table 4.3 conduct the emotion classification performance for both 3-bands and 4-bands experiment scheme. Overall, Epoch 300 achieves best average performance for both

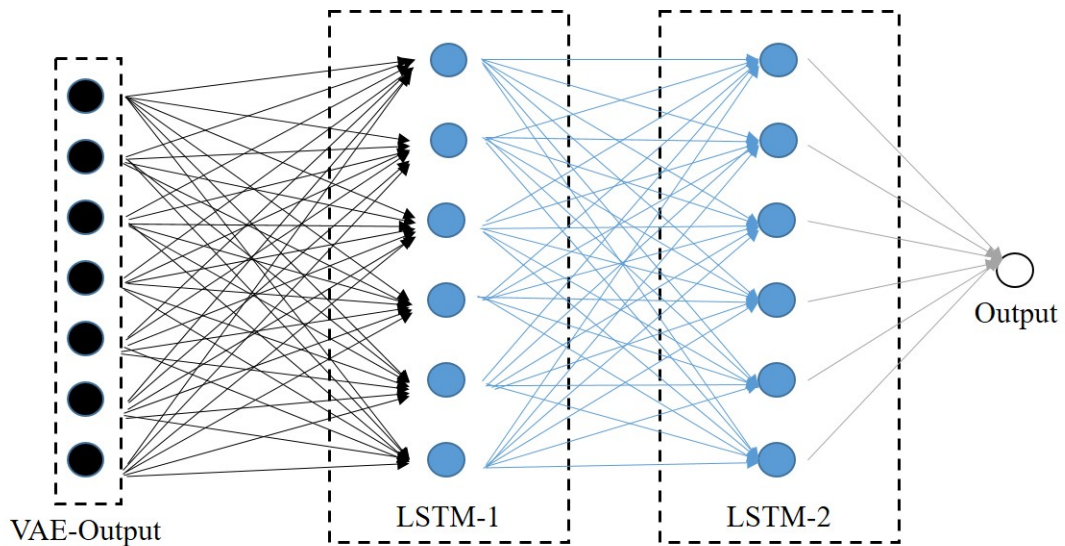

Figure 4.6: Architecture of Duo-LSTM

schemes which approves that the 300 epoch settled better through all experiments. Generally, when β settled to 6 achieve best performance for both two schemes. Considering the classification performance demonstrates that latent factor appeared greater influence on the processing of EEG-images at frequency domain. Integrated considering different scheme, 4-bands average performances are greater than 3-bands which approves the assumption that more information resulting in better performance on emotion classification.

For frequency bands level, 4-bands scheme classification accuracy better than 3-bands scheme in general. This presents that θ , α , β and γ bands are all contribute to generate the human emotion. The four frequency bands contain the related emotional information. Moreover, leveraging on VAE to figure out the influential factors representation of the variants of data [284], it provides the potentially opportunity for drawing the connections between frequency bands or channels with emotions specifically.

Exploration on Time Domain

Basically, the framework settle for exploration experiment on time domain is slimier as frequency domain. However, the time-based data possess a specific character that there are larger amount of data flows than frequency level for every second, therefore, it leads highly complex calculation and pressure for the system. Consequently, the double-LSTM scheme at predict procedure proposed draw support time series (like audio data) processing experience of LSTM model.

The double-LSTM scheme is inspired by [214], it consists of two LSTM, firstly, the EEG

images data segmented into 7 segments for 9 seconds each. Furthermore, the data as the input are given into the β -VAE to produce the factors. As Figure 4.5 presents, the first LSTM is applied as the sequence to sequence part, the time step is 9 seconds same as the length of each EEG segments, it contains LSTM layer and a dropout layer with a probability of 0.2 which used to reduce the overfitting by preventing units from co-adapting. The second LSTM is sequence to one that used for integrating the sequence result into one output; it contains LSTM layer and a dense layer. The whole model implemented by Tensorflow backend. Different from the frequency bands, as the EEG-images data for time domain is 128 per second leads to a large scale input and hardest for training with the limited calculation resources. Hence, there only pick the first 10 images as the representation from 128 images as the input because the generating procedure of human emotion is not a transiently changing. The data split randomly roughly samples by ratio [0.8: 0.1: 0.1] into training, validation, testing set. β is applied [1,3,6,9,12,15]. β -VAE is trained on each frame and LSTM was used to combine all the frames together for each video. The number of epoch is from [100,200,300].

Table 4.4: Classification Results For Time-Based Experiments (%)

Time	β	Epoch		
		100	200	300
OneLSTM	1	43.2±1.7	47.4±2.2	50.5±2.8
	3	46.1±1.1	48.3±3.5	50.7±3.2
	6	52.2±2.4	52.8±2.5	54.7±3.4
	9	51.8±5.1	52.4±3.6	53.9±1.9
	12	45.3±1.8	48.3±2.7	49.7±2.4
	15	48.7±3.1	50.4±2.8	52.2±2.4
DoubleLSTM	1	51.2±1.8	54.6±3.7	60.6±3.2
	3	52.6±2.6	52.1±2.8	59.3±1.7
	6	55.7±1.9	57.4±2.6	66.4±4.2
	9	52.3±3.7	53.2±3.5	53.6±3.1
	12	50.8±2.8	51.7±2.5	52.4±2.4
	15	54.7±1.7	53.8±1.8	57.7±2.2

Table 4.4 conducts that the best performance for similar experiment module still when $\beta=6$, achieves 54.7%, however, it indicate that potentially more information contain doesn't achieve significant performance compared to frequency result. Consequently, it demonstrates best performance 66.4% through all experiment scheme while draw back to the double-LSTM scheme. Apparently the double-LSTM improve the emotion classification task's performance which proves the LSTM's capacity on the sequence processing with consideration on the particularity of continuous signal is meaningful.

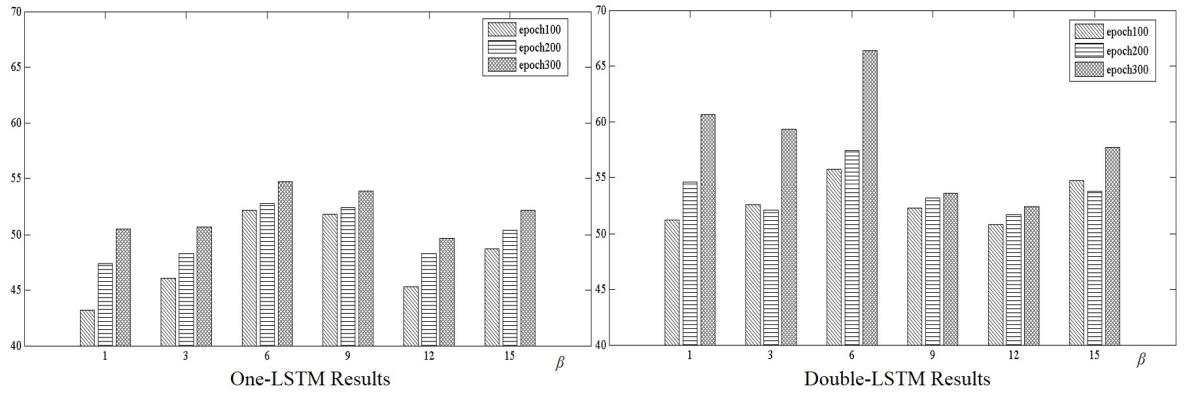

Figure 4.7: Classification Results for Time Experiments

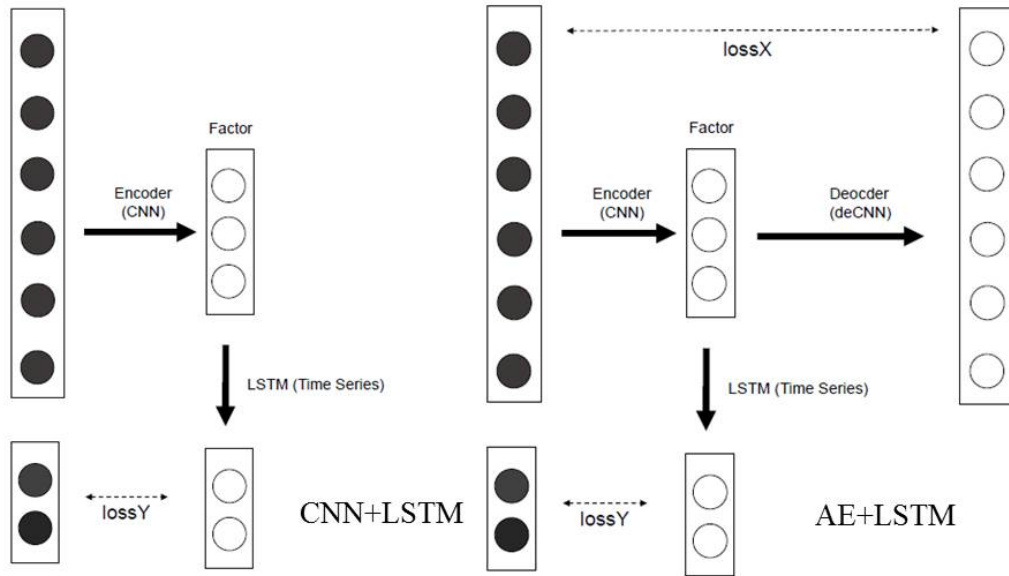

Figure 4.8: Structure of AE+LSTM and CNN+LSTM

Comparison with Baseline Methods

The following will present the experiments for baseline result producing. The main purpose is comparing with the approach schemes and prompting the exploration task completely and strictly. Basically, the baseline methods divided into two main area, other similar deep learning modules and classic EEG feature extraction and classification schemes. Therefore, the similar deep learning modules are employed to consider as the ablation study, simultaneously the classic methods enrich the exploration framework and provides the relatively EEG-processing based results causing my approach more persuasive and meaningful.

The deep modules are AE+LSTM and CNN+LSTM (as shown in Figure 4.8), The comparison is under the consistent settings with the proposed exploration experiments. VAE+LSTM

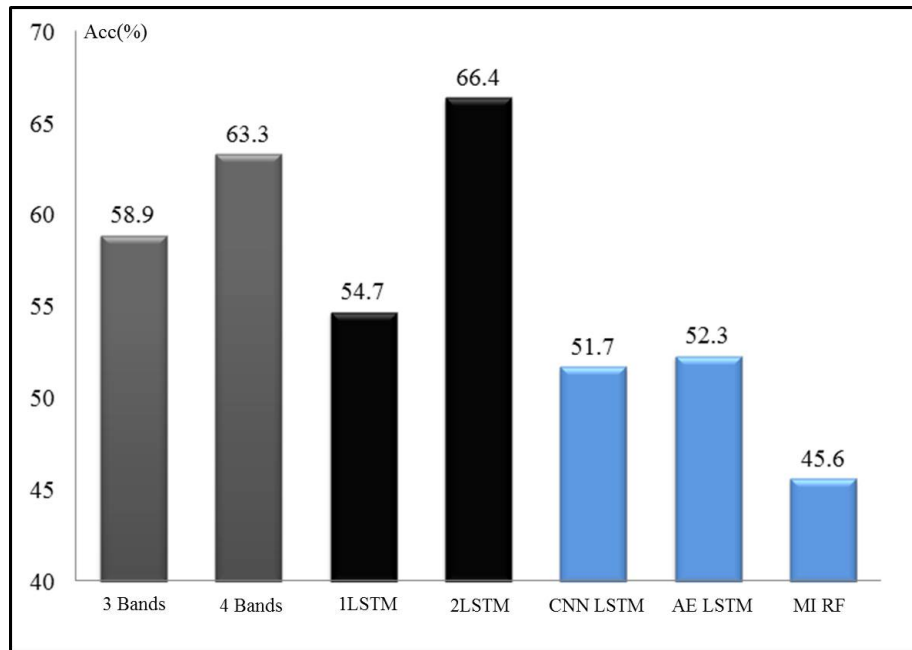

Figure 4.9: The Comparison of All Experiments' Classification Results

is just my approach when β equal to 1. Based on my previous research approach, for classic methods, the listed feature extraction methods from different domain are the recently widely accepted and relatively obvious effect on EEG-based emotion classification. PSD, HOC, FD, PCC and MI are conducted for producing the comparison baseline results. KNN, SVM and RF are chosen to be the classification methods on these features with the relatively great performance from previous approach. Generally, the comparison is based on the best average classification result for each methods.

Table 4.5: Classification Performance For Classic Methods

Methods	KNN	SVM	RF
PSD	40.1±2.6	39.2±1.5	41.7±3.1
HOC	38.6±1.7	41.6±4.1	43.2±1.8
FD	39.6±2.9	41.5±3.1	41.8±2.3
PCC	38.4±2.5	39.7±2.5	40.7±1.7
MI	41.1±3.6	42.5±3.3	45.6±2.1

Table 4.6: Classification Performance Comparison For All Schemes

Frequency		Time		Baseline		
3bands	4bands	1LSTM	2LSTM	CNN+LSTM	AE+LSTM	MI+RF
58.9±3.2	63.3±2.4	54.7±3.4	66.4±4.2	51.7±3.3	52.3±2.8	45.6±2.1

Generally, the comparison results conduct that my approach for time domain β -VAE double LSTM module reaches the best classification performance through all the experiments

schemes. Overall, the proposed frameworks' EEG-based emotion classification accuracy is significantly improved on both experiment schemes compare to the baseline and other state-of-art. Draw back to deep neural modules comparison, obviously, the proposed methods is more practical and accurate. There are not many studies draw attention on the quadratic classification for DEAP dataset in state-of-art, Zheng et al. [86] proposed that employed the discriminative graph regularized extreme Learning Machine with differential entropy features achieves the 69.97% for arousal-valence quadratic classification, the experiment under the data with discarding the labeling from 4.8 to 5.2 for arousal and valence as they believed the fuzzy part.

Table 4.7: Comparison For State-of-art and my Proposed (%)

Zheng et al. [86]	69.7(Discard data arousal and valence rating between 4.8 and 5.2.)
Du et al. [278]	45.1 \pm 2.2 (Discard data arousal and valence rating between 3 and 6)
The proposed	58.9 \pm 3.2 (θ , α , β bands Applied)
The proposed	63.3 \pm 2.4 (θ , α , β , γ bands applied)
The proposed	66.4\pm4.2 (Time series with double-LSTM applied)

In order to produce more evidence for the better performance of the proposed deep neural module, the proposed method also apply to the binary arousal and valence classification experiments as the same experiments settings for chapter three. From above experiments the best settings for the parameters have been conducted, hence the experiment are for β setting as 6 for 3 frequency bands, 4 frequency bands, one-LSTM time domain and double-LSTM time domain schemes.

Table 4.8: Comparison For Same setting as Chapter three (%)

	3-Fre	4-Fre	One-LSTM	Double-LSTM
Arousal	75.8	80.6	71.1	82.7
Valence	74.1	79.2	70.6	81.1

4.4 Summary

This chapter proposes a exploration for multi-view experiment frameworks on EEG-based emotion classification leverage on a novel deep neural modules scheme β -VAE LSTM. The work is motivated by finding the relationship between human emotion and EEG-data which conducts the representation for the inner feelings. The approach explores the different processing schemes concentrate on the experience of EEG-processing research area. Firstly, leverage on the previous transformation idea the time-series EEG data transferred

into EEG images database, compare to the previous transformation work the improvement is that the expand the method into multi-view of EEG data and produced the multi-channel EEG images. Specifically, the duo-channel EEG images potentially contain more valuable information for emotion classification, which the experiments results proved. For frequency based, 4 bands result significantly better than the 3 bands results approved that all EEG bands contribute for the representation of human emotions. Simultaneously, the time-based results demonstrates that more information do not mean better performance, time series required the appropriate processing scheme which double-LSTM's best classification results prove that. Moreover, the experiments based on the different β values demonstrates that the factors is certain number to control the specific task, which not means more factors equal to better results. At this point, the factors indicates the important element for generating human emotion. The best classification results demonstrates my approach is effective.

Chapter 5

Real-Time Interactive Film Control

based on User's Emotion Detected from a Portable EEG Sensor

The creation of the EEG-based emotion recognition application is the highly research value issue for this area. Simultaneously, building the reliable EEG emotion database is another big issue for the area. Because the EEG-based emotion recognition research area is relatively getting started in recent years resulting in there are lack of public database. Moreover, human emotion is very complex and sensitive [16], the different EEG emotion experiment protocol and purpose may cause some unknown errors. Therefore, it is necessary to build the reliable EEG emotion database for my future research work. In addition, the previous chapter three and four present many robust EEG-based emotion recognition methods and frameworks on different processing background. This provide the technique basis to develop a EEG-based emotion recognition HCI application.

5.1 Introduction

Brain conducts the the most mysterious black box of human body, the research on the working mechanism of human brain has attracted more attention nowadays due to fast development of deep learning neural network models. Among in this research, the human emotion detection from EEG signals is a very interesting area for the researchers

[141][119].

Emotion-based HCI is another significant research area, to draw the connection between HCI and EEG analysis is significant for researching area. Simultaneously, modern human draw more and more attention on the pursuit of personalized life demand under the development of high-tech, with considering the combine researching area between HCI and EEG-based emotion recognition analysis provide the possibility that participant control the trend of the film story by their personal feeling which indicates 'There are a thousand Hamlets in a thousand people's eyes'.

The increasingly development of human-centric-driven interaction is going along with digital media potentially revolutionizing entertainment, brain development education, medical brain rehabilitation learning and many other areas of life. Since emotion-driven interactive become the hot spot of research area, the need and importance of automatic emotion detection has grown with an increasing role of HCI applications [285]. Recently, the EEG-based emotion detection work has been done [286] [287] [287] [288]. Automatic emotion detection from EEG signals attracts more attention with the development of new forms of human-centric and human-driven interaction with digital media. The development of Wireless portable and wearable EEG headsets makes it available at a reasonable price, excellent detection accuracy and compact instruction make it possible that popularize EEG-based emotion detection researching technology to applications for the markets. The advanced and adaptability of the development for the portable EEG sensors will benefit many areas such as medical rehabilitation, psychotherapy, entertainment, gaming and virtual reality.

Emotion detection through EEG has a wide variety of practical applications [117][242]. The techniques achieved great performance at medical and psychology filed. In recent, HCI appears to be the research spotlight within the highly demand of real life. Possibilities that have been proposed for the use of these machine learning systems include multimedia environments that detect the emotions of the users, such as recommendation and tagging systems, games and films [119] that respond to the user emotions, and biofeedback devices that can be worn in the manner of headsets and might help users gain control over their emotional states.

In this chapter, the requirement of the interactive film and design the protocol for data collection using a portable EEG sensor (Emotiv Epoc) are reviewed. Then a portable EEG emotion database (PEED) is established from 15 participants and produce the two emotion labels using both self-reporting and video annotation tools. Further, the exploration of the various feature extraction and classification methods under the subject indepen-

dent for both labelling schme are presented to select a practical framework for real-time emotion detection. Finally, the emotion detection system is trained and integrated into the interactive film for real-time implementation and evaluation. The emotion detection system consist of OFFLINE training and ONLINE detection.

The main contributions can be summarized as follows:

- A portable EEG emotion database (PEED) is built for emotion analysis from portable EEG sensors with full emotion annotations;
- Exploring multiple features and pattern recognition methods to build a real-time emotion detection system;
- Real-time emotion detection system is implemented and integrated in an interactive film that has been demoed in many occasions with satisfied performance.

The remainder of this chapter is as following: section 5.2 provides the literature review on the recent EEG-based real time emotion detection works and their methods. Section 5.3 describes the interactive film and its requirement for user's emotion detection. Section 5.4 is the proposed emotion detection system including data acquisition, emotion label annotation, feature extraction and machine learning, and then presents the system evaluation and experimental results. Section 5.5 demonstrates the framework of EEG-based real time emotion interactive film. Section 5.6 draws a summary of the approach.

5.2 Related Works

Emotion is a intense expression which represent the specific feeling of human that occur by different types and patterns of stimuli. Ekman [35] distinguished the notion of basic emotions and other affective states of human being. Russell [246] proposed a two-dimensional model in which emotions were given co-ordinates denoting the degree of valence (the positive or negative quality of emotion) and arousal (how responsive or energetic the subject is). International Affective Picture System (IAPS) [44] and International Affective Digitized Sounds [293] are two famous images and sound emotion stimuli datasets respectively, moreover, emotion also can be evoked by the working memory [294] or videos in real laboratory experiments [3][142]. There are numerous studies about automatic emotion detection in recent years, which show that EEG signals have strong correlation with the actual emotion. Based on my project, the listed review on various algorithms on emotion detection from EEG signal are presented. Firstly, the review conduct the possibility for us to explore the best performance algorithm for offline training model, and draw the review on several schemes for building the emotion detection EEG dataset which benefit and evidential my work on building the dataset. Finally

Table 5.1: Summary on Various Studies For EEG-based Emotion Recognition

Ref	Ch.	Subjects	Stimuli	Methods	Emotion Pattern	Performance
D.O.Bos[21]	3	5	IAPS, IADS	α β two frequency bands power, FDA	Valence and Arousal	92.3% for both valence and arousal
Heraz et al.[289]	2	17	IAPS	Four frequency bands amplitude, KNN and bagging	Valence,arousal, dominance	74% for both valence and arousal, 75% for dominance
Murugappan et al.[224]	62	20	Video	Four bands wavelet features, KNN and LDA	Disgust, happy, surprise, fear and neutral	83.26%
Lin et al.[141]	24	26	Music	PSD for five frequency bands, SVM	Joy,anger,sadness and pleasure	82.29%
Brown et al.[270]	8	11	IAPS	Spectral power for five frequency bands, KNN	Positive,negative and neutral	85%
Petrantonakis et al.[290]	4	16	IAPS	Asmmetry index of α and β power,SVM	Valence-arousal quadrants	62.58%
Koelstra et al.[3]	32	32	Music Video	spectral power, Gaussian naive Bayes	Valence,arousal and dominance	57.6% for valence,62%for arousal
Soleymani et al[291]	32	24	Video	PSD and fusion with eye track, SVM	Valence and arousal	68.5% for valence and 76.4% for arousal
Wang et al.[292]	62	6	Video	Power spectrum, wavelet and non-linear dynamical features, SVM	Positive and negative	87.53%
Jenke et al[20]	64	16	IAPS	Higher order crossing, higher order spectra and Hibert-Huang Spectrum, QDA	Happy, curious, angry, sad, quiet	36.8%
Zheng et al.[142]	64	15	Movie Clips	Differential Entropy, differential asymmetry and rational asymmetry and mRMR for feature selection,	Positive, Negative and neutral	

the specific review on some real-time EEG-based emotion states recognition works are conducted which correspond to the theme.

There are various studies has been conducted attempt to build computational intelligence model to estimate human emotion states from different EEG features. Kim et al. [22] draw the review on EEG-based emotion detection by different computational models and Jenke et al. [20] presented the review on vast number of feature extraction and feature selection methods on estimating the emotion from EEG signals. The brief summary of EEG-based emotion detection studies in Table 5.1 is shown. In short, it can draw the first view of detailed different experiment configuration and evidently the feasibility on building the computational model for EEG-based emotion detection. The different types of stimuli can affective and evoked human emotions as shown in Table 5.1. Simultaneously, various feature extraction, selection and classification methods also influence the performance of the EEG-based emotion detection computational model. It also indicates that the different pattern of emotion detection tasks is meaningful and testify labeling the corresponding specific emotions directly is feasible and efficient.

Facing the seriously lack of public available emotional EEG datasets which deferring the progress for investigating the various problems of the exploration of computational intelligence model researching on EEG-based emotion detection. This urgent problem to be solved leads us to plan to build a emotion detection EEG dataset. Consequently, the two famous public emotional EEG dataset DEAP [3] and SEED [142] were consulted. The DEAP dataset recorded the EEG and peripheral physiological signals of 32 participants when watching 40 one-minute music videos. It also contains the participants' rate for each video in terms of the levels of arousal, valence, like/dislike, dominance, and familiarity. The scale is from 1-9. The SEED dataset recorded 15 participants EEG signals when watching the 15 four minutes Chinese film clips (positive, neutral and negative emotions). For the feedback, participants were told to report their emotional reactions to each film clip by completing the questionnaire immediately after watching each clip and each subject was required to perform the experiments for three sessions.

With the rapid development of updating the computational for EEG-based emotion detection lead to the urgent demand for the market under the high performance and achievement. A vast number of studies has been conducted the staged achievements and future prospects. Liu et al. [25] proposed the fractal dimension model combine with the 3D visualization system to conduct the emotion in real-time. Further Sourina and Liu [295] proposed the same Fractal dimension model embedded with music therapy. Jatiplai-boon et al. [296] conducted the pattern correlation between recognition between different EEG frequency bands and specific emotions. Simultaneously, the promotion of brain

imagine affect many studies, real-time Functional Magnetic Resonance Imaging (fMRI) [297][298][299][300], Kavasidis et al [277] proposed the computational model with variational autoencoder (VAE) to achieve the generative model about the brain images when participants watching the real images.

The attributes chosen in the studies above is more detailed indicate the reflection and explanation of the research step for building the EEG-based emotion detection computational intelligence model. The significant attribution of these studies provided amount of consultation and evidential theory. Furthermore, these various schemes for offline training demonstrates the precious opportunity to explore the best performance and practical algorithms for specific tasks.

5.3 Interactive Film

HCI accomplish the hot spot for human-centric interaction research field. Interactive film is relatively one of the practical, advanced and entertaining application among this area. It is the core exemplification of the Human Computer Interaction research field, the main theme is that the audience can participate in the development of the film's story-line and interact instantly by body-movement, speech, wink, gesture or human physical signals. Basically, interactive film is liberating the audience from the single-linear narrative mode of traditional films, moreover, the audience is no longer just passively watching the film but determine the different story trends. Normally, interactive film is widely used in entertainment, like video-games, music-videos. Generally, interactive film designer setting up amount of the alternative points through the entire film story. Different choices lead to different process and ending.

The 'RIOT' film is filming for facing police enforcement, it contains 4 chapters and 3 checkpoints as shown in figure 5.1. Each chapter has three different result scenes which corresponding to the emotion anger, fear and calm. The check points are settled before proceeding to the next stage. It tests the current emotion of the participant for the chapter and output the result in real-time. Only if the result is calm which means the participant keep steady, the film will jump into next stage. However, the film ends immediately when the participant failed to keep calm.

In fact, many specific identity of human physical signals can represent the emotion such as EMG, Heart Rate, pulse, blood pressure, EEG, facial expression and so on. EEG is the relatively reasonable and accurate among vast number of signals due to that EEG signal

comparatively authentic demonstrate and transport the diversification of human emotion. In order to achieve the destination, the exploration for indicating the best performance is proposed to figure out the stable and practical EEG emotion detection system for implementing into the film.

5.4 Emotion Recognition System

Figure 5.1 shows the overview structure of the real-time portable EEG-based emotion recognition interactive film. Before developing the real-time system, the classification model has to be trained with off-line EEG signals. 14 channels Emotiv Epoch EEG sensor was employed to collect the EEG RAW data from the participants. Since disadvantage of EEG data is noisy, the raw data is pre-processed (i.e. filtering) in order to remove the noise and artifact which are caused by the poor electrode contact and muscular activity. After then, the salient features are extracted adopting several well-known algorithms, including HOC, PSD, MI, PCC and MSCE. Next, the comparison of the 5 kinds of features with the KNN, SVM and RF as the classification methods to figure out the best performance scheme. Finally, the majority voting is applied for simulating the real-time working mechanism to improve the classification accuracy. All experiment on subject independent as the simulation and preparation for the on-line system build. By comparing the performances of classification models, the most appropriate feature extraction algorithm and classifier are selected to allocate the class of emotion for ONLINE-EEG signal.

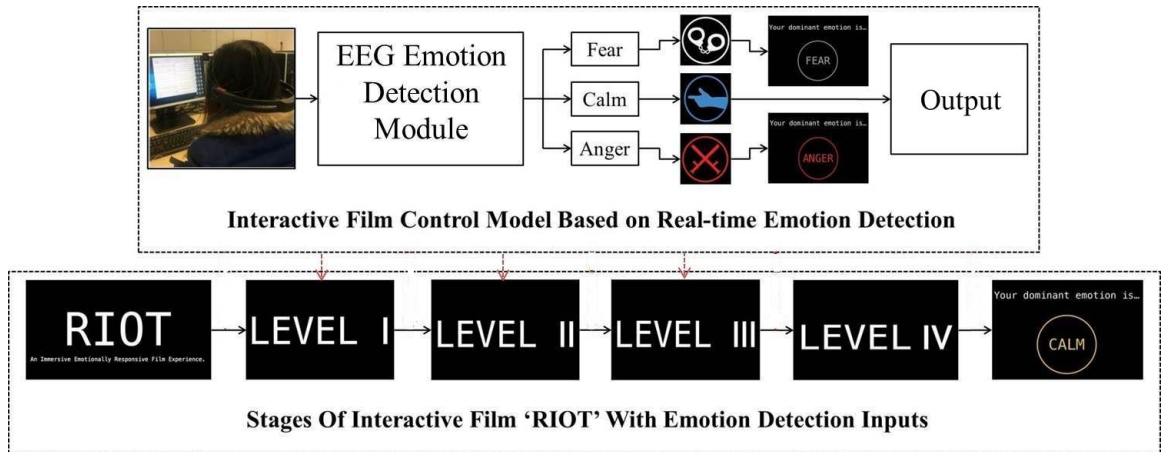

Figure 5.1: Overview of the Whole EEG-based Emotion Recognition Interactive Film.

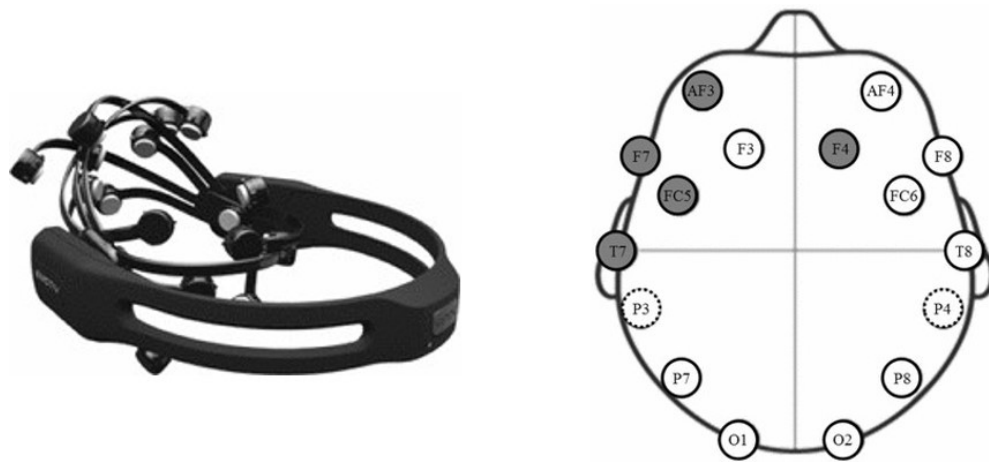

Figure 5.2: The Emotive Epoc+ Sensor and Corresponding Location on Brain

5.4.1 PEED

Materials and Stimuli

In this chapter a 14-channel sensor is applied to collect the EEG signals, the brain signal acquisition is done with the use of Emotiv Epoc neuroheadset released from Emotiv Systems Inc [301]. As shown in Figure 5.2, it has 16 electrodes. There are 14 electrodes (AF3, F7, F3, FC5, T7, P7, O1, O2, P8, T8, FC6, F4, F8, and AF42) which are channels to capture EEG signal, while two electrodes in P3 and P4 location are used as reference. Besides, it is sequential sampling with single ADC, and the sample rate of the headset is 128 samples per second. The signal transfers from the headset to computer with wireless via a dedicated dongle. So it is easy to use and flexible. However, because it is designed for games originally, it is sensitive to noise. EEG signal is hardly detected with high reliability although the accuracy of headset is sufficient to present participants brainwave.

Many different kinds of stimuli can be used for EEG-based emotion recognition. Some researcher proposed to use images [100], other researchers employed music [302] [303], however, video clips [112] [304] [3] [291] [305] are the most widely used stimuli for researchers. As stimuli several kinds of movie clips, including musical, romantic, war, disaster and horrible films were chosen. The reason for choosing movies as stimuli is that audiovisual stimuli is highly benefit for arousing human emotion [306]. Firstly the stimuli library is built, 60 initial stimuli have been selected, each emotion have 20 initial stimuli. Eliciting emotion for participants is the difficult work so the select effective stimuli is necessary. Refer to the method that proposed in DEAP EEG dataset [3] The final 10 video stimuli were chosen for calm, anger and fear each. Among these stimuli also considered the influence of different culture, racial and religion. Especially for anger and fear, in

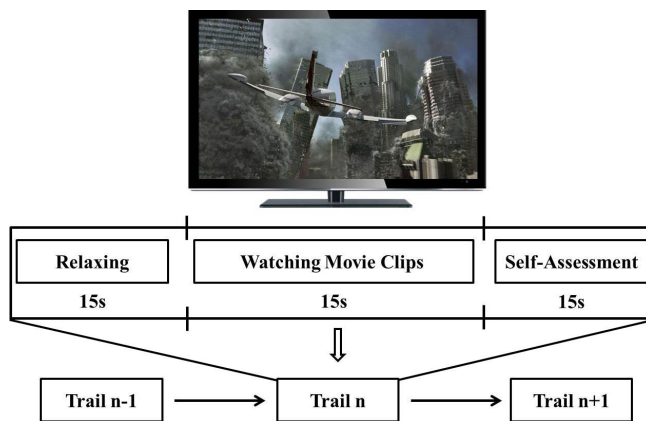

Figure 5.3: The Experiment Protocol For the Experiment (First 15s for participants to relax, and then watch movie clips for 15s, last 15s for self-assessment, only the 15s captured for watching movie as the EEG dataset)

order to reduce the error as low as possible. The facial expression of participants were recorded to label the emotions. In the interactive film, three emotions were mentioned as the the control variable for the interactive film. So the use three emotions as the three categories for the classification.

Participants and Experiment protocol

There are 15 healthy participants (10 male and 5 female), whom age between 18 and 25, took part in this experiment. Each participant signed the consent form. Next, the introduction of experiment protocol given to the participants, once they were clear about the instructions, the experiment will begin. After all the sensors were placed, a practice trial will prepared for the participant firstly for understanding well of the experiment. The experiment starts with a 15 second recording without stimuli in order to let participant relax. Then the 6 videos were presented in 10 trials. As shown in Figure 5.3, the video followed by the self-assessment. They will be asked about the feeling through they watch the video. At the meantime, the front face for each participant recorded. The whole experiments have already achieved the ethics and guaranteed the personal safety of participants. The ethics form is submitted with the final thesis as the sub-file.

Annotation

a. Self-assessment: Although the specific emotions about the stimuli videos are defined, however, actually different factors about the participants determine the different feelings about each video. At this point the self-assessment label is meaningful for the experiment.

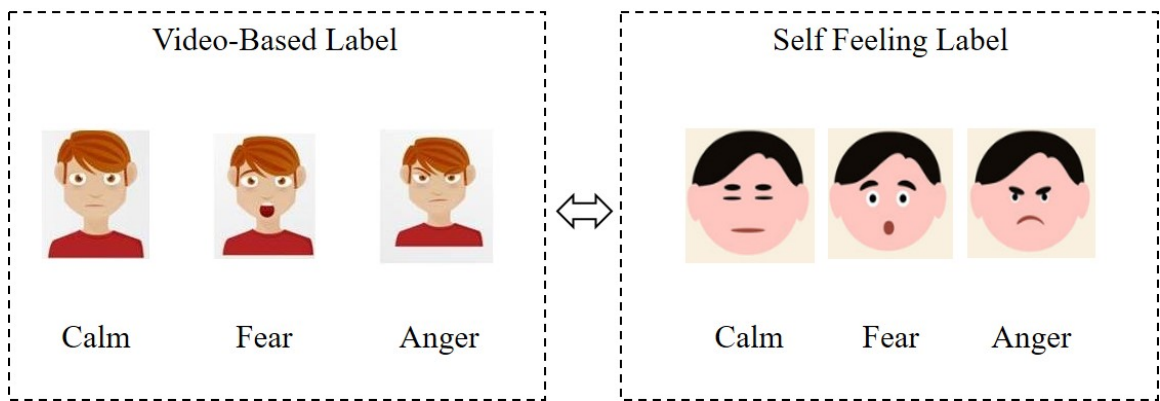

Figure 5.4: Labelling Scheme For PEED. Video-based label based on the facial recording for the participant when they watching the movie clips, Self feeling label represents the personal feelings of participants through watching the movie clips.

At the end of each trail, the participants performed the personal feeling after watching 6 videos separately. The specific emotions are represented by the scale 1, 2 and 3, which represent calm, anger and fear separately. This measure inquires about the participant's personal feelings. Each video last for 15 seconds, the participants were asked to perform the inner feeling about the whole video 15 seconds once.

b. Video-Record: Another angel of this labeling work is that the personal feelings has possibility that possess error, which means personal feelings can't represent the actual feelings of the participants when they watching the films. The facial expression video about the participants were recorded through the completely experiment stage to perform the actual and accurate personal reaction and status of the stimuli videos. As the same with self-assessment label scheme, participants' reaction about the videos was labelled for 15 seconds once.

Figure 5.4 presents the two labelling schemes for PEED dataset. The self-assessment mainly gather the participants' self-feeling about each movies they watched. Every participants' self-assessment accomplished after the watching movie stage in order to maintain the most effective and realistic feeling for them. However, the timely personal feedback exists the incorrect possibility, therefore, the facial videos of the participants were collected in order to indicate the accurate and reliable evaluation results. The facial video actually not the strong credible evidence for the representation of human emotion because sometimes emotion only are the inner feeling and not react that obviously by facial expression, but the facial results assist the evaluation progress for this experiment. Generally, these schemes were worth to be explored.

Data Evaluation and Selection

15 participants data were collected, considering the self-assessment result and recorder front-face video result led us to produce the data selection procedure. It is meaningful to do this selection progress to decrease the meaningless and distortion data which based-on the difference of two labels. The self-assessment label and video label are mutually made up shortage, so the Kappa-coefficient of each participant’s self-assessment label and video label were calculated and applied as the criterion of data selection work. Therefore, 5 lowest kappa-coefficient subjects’ data were discarded. The description of PEED dataset as shown in Table 5.2.

Table 5.2: Description of The PEED

Detail About EEG OFFLINE Dataset	
Number of Participants	10
Stimuli Videos	6 videos labeled as 2 calm, 2 anger and 2 fear, each lasts for 15 seconds
Trail on Each Video	2
Emotion Pattern	Calm, Fear, Anger
Recorded Signal	14-Channel 128Hz EEG signals, 10 participants facial videos,
Label Schemes	Self-assessment label and Video record label

5.4.2 Emotion Recognition Modeling and Evaluation

Signal Pre-Processing

From the discussion before, it is clear that EOG correction and EMG correction are of great significance. And Independent Component Analysis (ICA)[115] a powerful technique which can separate out artifacts embedded in data. It assumes that recorded EEG is a linear combination of temporal, independent and spatially fixed signals. And it estimates the weight of each independent component[307]. First of all, the data is whitened by removing the correlations within the data. That means different channels are forced to be uncorrelated. Then, the signal is decomposed into statistically independent components. By analyzing the weight of components, artifacts components are obviously identify by visual inspection since the artifacts are usually independent of each other. Last, the artifact components are removed. And cleaned EEG data is obtained by recombining the remaining components. Hence, ICA is an effective approach to remove EOG and EMG artifacts from EEG signal. As the human emotion has the Instantaneous and will last for short period of time, so we separate the 15 seconds to per seconds which contribute to establish the real-time system.

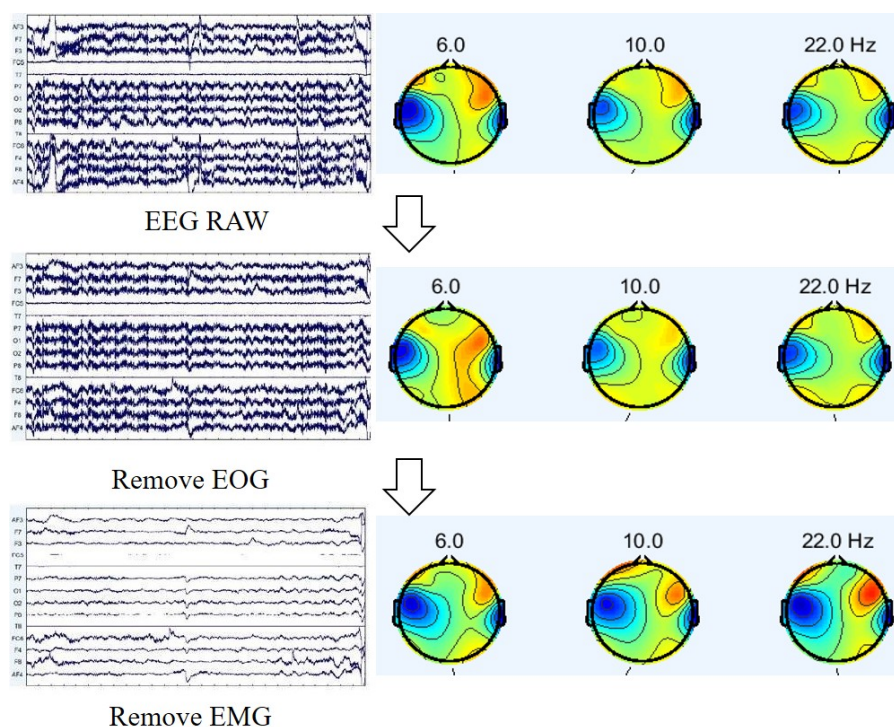

Figure 5.5: Preprocessing on EEG Raw Data Applied on ICA.

Feature Extraction Algorithms

The previous published paper's conclusions [308] conducted the multi-feature extraction methods on DEAP dataset. Based on the relatively better performance for various feature extraction methods of previous chapter, generally five features extraction methods are applied from time domain, frequency domain and Multi-electrode features on my dataset. The purpose is to explore the best performance and practical feature extraction method for the EEG-based emotion detection computational model. The brief description of each method is shown in chapter two. Here the feature extraction methods are the HOC, PCC, MI, MSCE and PSD five kinds of features based on different domain.

Evaluation

As the statement above, the two labeling schemes for the dataset were conducted, which both meaningful for the emotion interactive area. Self-assessment indicates the participants' personal feeling about the stimuli, and the facial expression video in order to indicate the accurate and reliable results under the psychology area. In the following, the exploration schemes based on the performance of various feature extraction methods for different pattern recognition methods are presented. Firstly, different machine learning methods were applied for the experiment on both labelling scheme to judge which way

achieve better performance and more practical. Furthermore, based on the result the great performance individual feature extraction method was chosen, and applied the majority voting to figure out whether the mechanism of human emotion affected to achieve better performance. KNN, RF and SVM [257] are employed as the classification methods. (For KNN, K=5, for RF, tree=100) The validation method was chosen to subject independent because it will always be new data when different participant test the system.

Table 5.3: Individual Feature Self-assessment and Video Record Label Classification Performance For KNN (k=5)

Subject	Self(%)					Video(%)				
	HOC	MI	PCC	PSD	MSCE	HOC	MI	PCC	PSD	MSCE
1	35.3	38.1	30.2	40.0	39.6	32.2	33.3	39.4	41.2	32.5
2	33.7	34.1	50.1	43.2	42.5	40.5	47.1	44.2	37.1	31.6
3	41.2	46.5	50.2	49.3	42.5	44.0	42.2	47.1	47.2	40.6
4	42.1	54.3	52.2	40.1	41.8	40.0	60.7	52.5	47.3	46.6
5	40.8	48.2	41.8	37.7	36.6	37.4	44.5	39.2	33.1	32.6
6	36.4	46.2	41.8	37.6	35.4	33.1	42.2	38.7	32.8	31.2
7	36.4	38.5	53.2	31.7	34.4	30.8	41.2	58.0	32.4	32.2
8	41.4	44.5	37.4	46.5	39.4	40.1	39.7	39.1	41.8	38.7
9	41.2	43.4	38.5	50.1	37.2	42.6	41.4	40.7	51.2	40.4
10	42.5	53.1	40.4	51.4	44.5	44.6	56.2	41.4	49.8	41.2
Avg.	39.1	44.7	43.6	42.8	39.4	38.5	44.9	44.0	41.4	36.8

Table 5.4: Individual Feature Self-assessment and Video Label Classification Performance For SVM

Subject	Self(%)					Video(%)				
	HOC	MI	PCC	PSD	MSCE	HOC	MI	PCC	PSD	MSCE
1	38.2	39.6	37.4	50.6	36.2	33.3	32.4	39.5	41.2	30.7
2	32.4	43.6	43.2	33.4	30.2	38.1	40.8	31.7	39.8	32.5
3	41.5	47.4	33.1	49.4	42.8	41.6	40.4	47.6	50.2	43.4
4	42.5	47.1	48.6	43.7	41.7	44.5	64.2	39.1	57.8	45.6
5	36.2	51.9	37.6	40.4	30.6	35.2	39.6	30.4	38.2	31.6
6	34.4	51.2	48.6	39.1	33.2	30.1	46.2	49.5	30.1	34.4
7	34.2	43.4	48.2	42.8	33.1	34.5	49.2	62.8	43.4	31.2
8	33.2	41.2	48.7	36.3	39.4	32.4	33.1	38.6	36.5	34.2
9	40.4	42.1	36.5	52.8	41.6	40.4	39.8	31.8	60.4	34.6
10	45.1	51.8	31.6	37.2	42.6	39.1	49.8	46.4	47.2	38.6
Avg.	37.8	45.9	41.4	42.6	37.1	36.9	43.6	41.7	44.5	35.7

Table 5.3, Table 5.4 and Table 5.5 indicate all of the multi-dimensional individual features affecting the classification task in the experiments, chief among two label schemes, all features performed relatively stable through all experiments. Basically, there are two

Table 5.5: Individual Feature Self-assessment and Video Record Label Classification Performance For RF

Subject	Self(%)					Video(%)				
	HOC	MI	PCC	PSD	MSCE	HOC	MI	PCC	PSD	MSCE
1	31.4	47.6	37.9	42.8	35.6	30.2	43.6	41.5	39.2	32.8
2	39.2	46.5	46.6	51.9	33.4	38.5	53.5	41.6	37.2	32.8
3	44.5	60.9	51.8	62.3	48.5	41.1	54.5	36.8	57.2	44.4
4	42.1	53.2	50.8	56.6	44.2	52.6	68.4	62.6	64.2	51.7
5	44.2	56.5	34.1	66.6	42.5	48.4	53.2	43.7	51.5	50.1
6	41.8	47.9	48.4	56.1	44.2	40.6	53.7	44.8	40.2	41.9
7	31.6	52.9	48.5	44.1	33.2	32.0	48.7	63.5	46.2	37.6
8	37.1	57.5	53.6	51.1	44.2	41.7	54.5	49.8	43.4	46.8
9	41.2	57.9	44.0	56.2	32.1	42.8	61.5	46.7	51.2	34.6
10	40.2	59.8	43.5	51.1	33.3	44.5	51.1	47.7	47.2	36.5
Avg.	39.3	54.1	45.9	53.9	39.1	41.2	54.3	47.9	47.8	39.9

metrics of selection for online system, considering both performance and running time. Above all, feature MI achieves best results of various features. Besides, for all classification methods, self-assessment label scheme's average results are better than video record label scheme's. Simultaneously, RF demonstrates best performance among all of the classification methods. Overall, MI is selected as the feature extraction method and RF as the classification method.

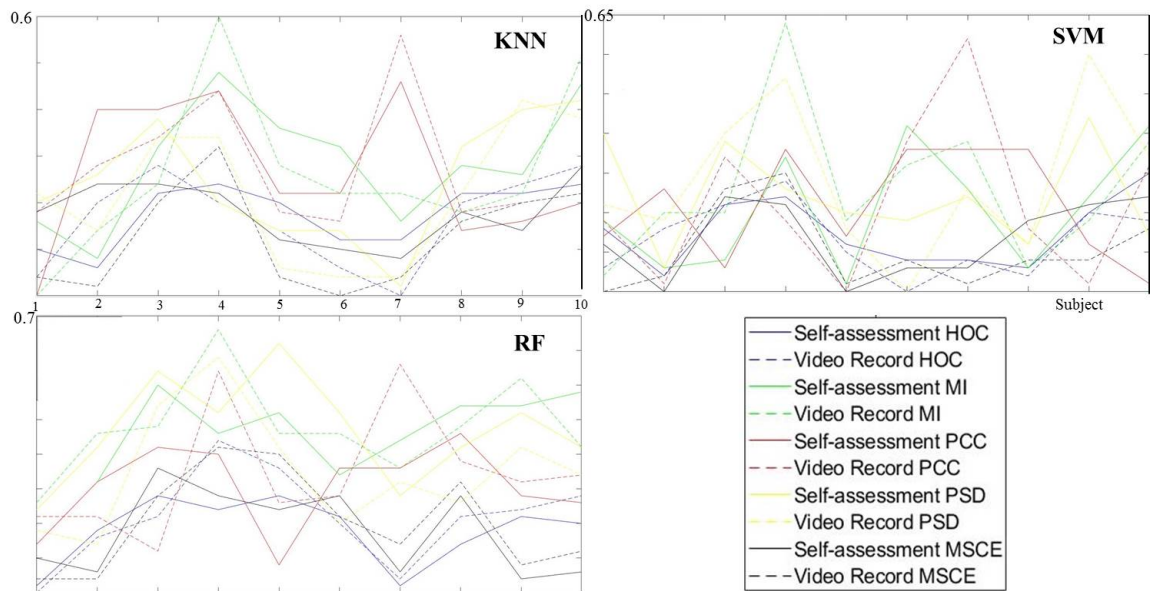

Figure 5.6: Performance For Individual Feature of Different Machine Learning Method. (a) stands for the results by KNN. (b) stands for the results by SVM. (c) stands for the results by RF

Human emotions will be triggered at one point and then last for period of time. Simultaneously, the participant's data will be recorded and processed every second for online system. Considering both emotion's continuous and ephemeral and the simulation work for online system, majority voting is applied. The specific approach is cutting the testing subject's data into 1 second each, and then do the majority voting 15 seconds once, then compare with the emotion label. This procedure is the simulation work for real-time system. Real-time systems requires the constantly output to achieve the timely control, moreover, since emotion is a continuous variable and last for a period of time. In summary, the majority voting is necessary and practical as the simulation of real-time process.

Table 5.6: Classification Performance of MI with RF and Majority Voting Applied

Subject	1	2	3	4	5	6	7	8	9	10	Avg.
Self(%)	66.7	66.7	83.3	66.7	66.7	83.3	66.7	66.7	50	100	71.7
Video(%)	33.3	50	50	66.7	66.7	50	50	33.3	83.3	66.7	55

As Table 5.6 presented, the performance obtain great improved for all subject based on the identical feature and classification scheme. That achievements conduct the strong evidence for my assumption, therefore, the simulation experiments are necessary and meaningful. Both self label scheme and video label scheme average performance reach better performance compare to the same scheme without majority voting applied. Among the results, self-label scheme is significantly better than the video-label scheme, simultaneously the performance 71.7% verify the model is suitable and practical.

Furthermore, the experiment on binary classification that represented calm and not calm to figure out whether it will achieve more accurate and stable performance. In the mean time, this mechanism is the simulation of on-line film project. Basically, the film's content is about keeping calm when the participate facing different situation. Thus, this is meaningful and more practical to attempt.

Table 5.7 and Table 5.8 indicate that all subject's results are significant improved when binary classification applied as expected. Overall, the results demonstrate that this framework achieves best and stable performance for both two label schemes. Moreover, it verified the assumption of emotion triggering mechanism. Furthermore, it approves the settings for real-time systems is meaningful and practical.

Table 5.7: Binay Classification Performance For PSD, PCC AND MI With RF Applied

Subject	Self(%)			Video(%)		
	PSD	PCC	MI	PSD	PCC	MI
1	51.2	54.5	76.4	52.3	55.7	63.9
2	68.5	66.4	79.1	51.8	48.6	56.2
3	58.4	50.2	77.6	66.8	49.5	88.9
4	67.2	61.3	69.1	77.5	78.4	82.5
5	66.1	47.5	75.2	64.4	57.8	64.4
6	58.1	51.5	63.4	55.5	52.3	57.5
7	48.2	55.6	51.4	52.8	54.5	73.4
8	56.5	54.2	65.1	52.8	54.5	68.5
9	58.2	47.6	69.1	62.5	54.7	79.6
10	58.2	52.2	76.3	55.4	59.6	61.8
Avg.	59.1	54.1	70.3	59.2	56.6	69.7

Table 5.8: Binary Classification Performance of MI with RF and Majority Voting Applied

Subject	1	2	3	4	5	6	7	8	9	10	Avg.
Self(%)	83.3	66.7	100	50.0	66.7	83.3	66.7	83.3	66.7	100	76.7
Video(%)	50.0	66.7	66.7	83.3	66.7	83.3	66.7	50.0	100	66.7	70.1

5.5 Real-time Implementation and Offline Testing

The real-time EEG emotion detection can be applied to many different fields such as entertainment, education and medicine. As mentioned above, this work is based on controlling the interactive film. Therefore, considering that human emotion will continue for a short period of time so the multi-feature emotion detection model is employed into the real-time system. The total structure as Figure 5.7 shows that the system working between every two nearly chapter for the film and control whether the story moving to next level or failed.

5.5.1 System Implementation

All of the implementation work are based on the MATLAB2017b's GUI. The EEG-based Emotion Model algorithm is packaged by MATLAB. The following are the specific parts of the model, the system consists of three parts.

1. Data Collection. The model is based on the Emotiv Development Kit for acquiring EEG RAW data from the device. The EEG RAW data are collected by using Emotiv headset at 128Hz.
2. Data Processing. The data stream from the Emotiv device is stored in a buffer. Each

second the read command triggered and it will clear the buffer and feeding the data into filtering and ICA. The feature extraction requires data to be fed as 128 samples for each channel every 3 seconds. Therefore, the loop for all 14 channels is built to run the feature MI out in the fixed order and output the fixed feature matrix. Then the offline trained model receive the feature and do the prediction, the new loop is refreshed when all the previous prediction is done. The prediction result will output immediately.

3. Interactive Film. The prediction result will feed into the buffer for the film. The result in the buffer will be updated once new prediction feeding. Only if the film goes to the checkpoint it will judge the current emotion to decide the tendency of the film. Figure 5.7 presents the on-line system's working mechanism, the detection occur in each level, only if the participate keep calm then will going to next level as the figure shown.

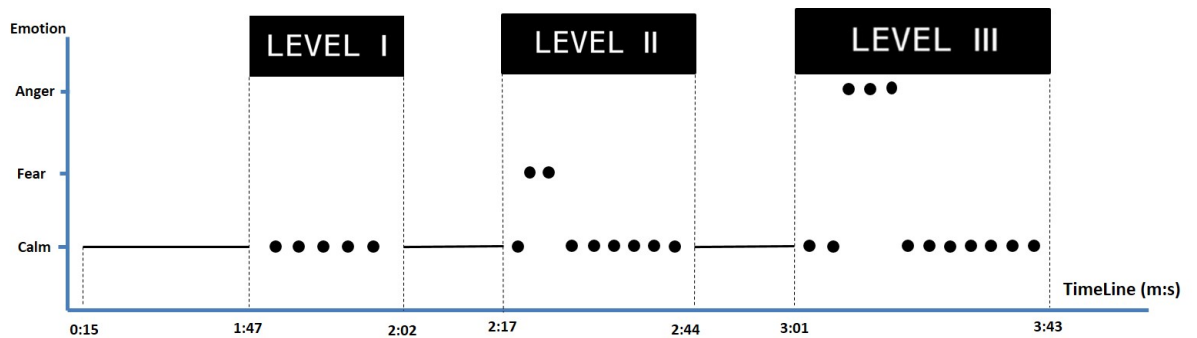

Figure 5.7: Subject Real-time System Results Plot

5.5.2 Performance Evaluation

In order to test the performance of the real-time application, from many tester's results, 10 participants results for each level were recorded and selected. Based on their testing result, the comparison of the self-feeling about each level, the recording of the participant during the film and testing result to indicate the performance for whole system. Figure 5.8 demonstrates that the testing result relatively anastomosis with the self-feeling of the participants.

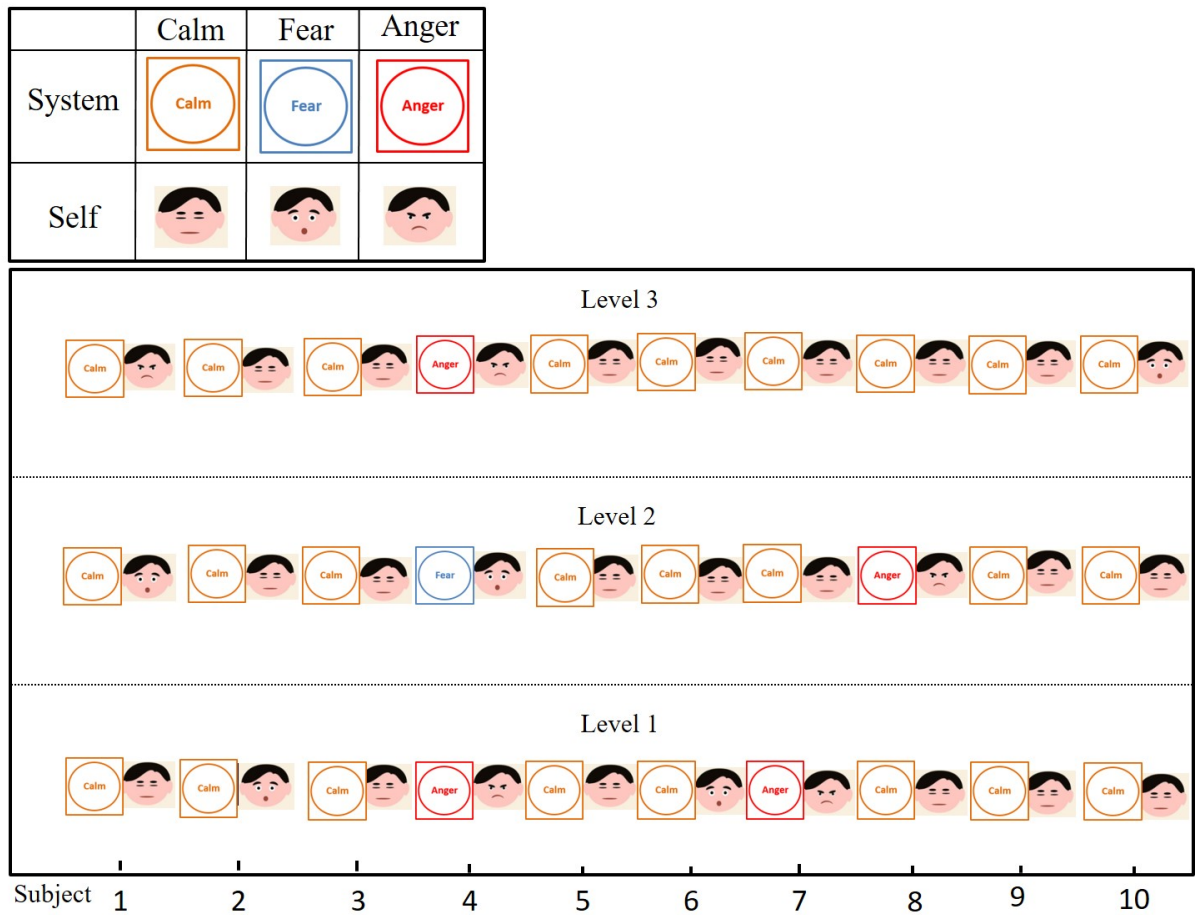

Figure 5.8: The Performance for Real-time Application (The comparison between system result and self-feeling for the participant for each level of the film, in the figure only system results shows means self-feeling is equal to system prediction.)

5.6 Summary

This chapter presents the development of a real-time brainwave controller system, which controls the interactive film depending on the emotional state via brainwaves. The data collection system is built for EEG signal, produced stimuli based on the common protocol. In this project, there was a crucial problem about getting the classification model with high accuracy, which means it should be able to classify three emotion classes correctly. To achieve the best model before implement with the film, the exploration of the multi-feature extraction methods, and classification methods on two labels under the subject independent schemes. Comparing the performance of classification models which were obtained from the experiments indicates that the size of dataset had great influence on the accuracy of models. Compare the performance for using different schemes on each feature MI feature and RF classifier are decided. After all, the majority voting is applied as the simulation of the real-time system working mechanism, the result justify that proposed scheme reach the highest performance.

Then I build the real time emotion detection system for controlling the interactive film. The interactive film has three checkpoints which triggering by three emotion anger, fear and calm. The offline training model is used in the online system and the prediction for emotions is used as the trigger for the film. The processing part has slightly delay and feeding the data every 3 seconds.

Chapter 6

Conclusion and Future Work

6.1 Conclusion

Emotion is a state that comprehensively represents human feeling, thought and behavior, thus takes an important role in interpersonal human communication. Emotion estimation aims to automatically discriminate different emotional states by using physiological and nonphysiological signals acquired from human to achieve effective communication and interaction between human and machines. Brainwaves-Based Emotion Estimation is one of the most common used and efficient methods for emotion estimation research area. The technology reveals great role for human emotional disorder treatment, brain computer interface for disabilities, entertainment and many other research areas. In this thesis, various methods, schemes and frameworks are presented for Electroencephalogram (EEG) based human emotion estimation.

6.1.1 Feature Selection and Combination

The key idea of Chapter Emotion Detection from EEG Recordings Based on Hybrid Dimension Reduction on Distinct Features is to extract more useful information for the emotion detection from variety features and fusion them in an efficient way. From this work, a total of 14 features have been extracted from different domains of EEG recordings, these features basically included the most commonly used methods for each domain. Then, the two step feature reduction method was used for the dimension reduction of the combine feature vectors. From the experimental results, it can be found that the proposed method was useful to detect the emotion information from EEG recordings with a good

accuracy. From the experimental results, it can be seen that combination of supervised and unsupervised feature dimension reduction method can improve the performance by removing some irrelevant feature vectors and better than individually use. The final feature produces the best results within all the existing results in the DEAP dataset. The proposed work conduct a effectively reasonable solution scheme for the selection of related information through various features for specific task as research question presented.

The significance of this proposed work achieves that variety features represent multi-view processing point is meaningful of producing more valuable information for the EEG-based human emotion estimation, simultaneously, multi-angle information not equivalent to greater results which the information selection scheme is necessary and effective as the chapter proposed. Basically, the proposed conduct the highly rare cogitation for the EEG-based emotion classification research area, it provide a specific view for EEG-processing, multi-distinct feature create more valuable information for respectively tasks and supply the basic pattern of thinking for further research.

The approach framework relatively perform the effective solution for one of the research questions which is how to selection the effective information through multi-view features to combine for achieving improvement on classification. Moreover, the multi-features basically provide the every possible angle of EEG feature extraction. As the approach is the first research work of my PhD career, this work provides the techniques and ideas supporting for my future research work.

6.1.2 Deep Neural Networks

The significant achievements verified that the improvement on the deep neural calculation methods inflict their effective. Obviously, leveraging on deep-learning methods that the achievements on many research areas exceeded constantly. This chapter proposes a exploration for multi-view experiment frameworks on EEG-based emotion classification leverage on a novel deep neural modules scheme β -VAE LSTM. The work is motivated by finding the relationship between human emotion and EEG-data which conduct the representation for the inner feelings. The approach explore the different processing schemes draw back on the experience of EEG-processing research area. Firstly, leverage on the previous transformation idea the time-series EEG data transferred into EEG images database, compare to the previous transformation work the improvement is I applied on multi-view of EEG data and produced the multi-channel EEG images. Specifically, the duo-channel EEG images potentially contain more valuable information for emotion classification, which the experiments results proved. For frequency based, 4 bands result

significantly better than the 3 bands results approved that all EEG bands contribute for the representation of human emotions. Simultaneously, the time-based results demonstrates that more information do not mean better performance, time series required the appropriate processing scheme which double-LSTM's best classification results prove that. Moreover, the experiments based on the different β values demonstrates that the factors is certain number to control the specific task, which not means more factors equal to better results. At this point, the factors indicates the important element for generating human emotion. The best classification results demonstrates the approach is effective.

The significance of this proposed work achieves that I build the deep neural network EEG processing scheme, the approach is general enough to be used in any EEG-based classification task. Deep learning obtain strongly achievements at images processing area in recent years, therefore, the approach provides the relatively a platform to process the time-series EEG signals at images-level. Simultaneously, the approach make the consideration on sequential factors accordingly retain the characteristics of sequence data in continuous-image (video-like) level. Moreover, leveraging on the VAE to analysis the relationship between factors and emotion-related information presents opportunity to identify if the specific emotion corresponding to the specific type of EEG signals.

The approach framework conduct the exploration on EEG-based emotion recognition with employing the advanced deep learning modules. The experiment scheme is a comprehensive expansion from AI to EEG-based research area with considering both feature extraction and sequential characteristics for EEG signal.

6.1.3 Real-time System

With new development on human-centric-emotion-driven technologies in the affective computing, high accurate emotion detection systems have been built based on humans' facial expression, speech, body movements and bio-sensors such as Electroencephalogram (EEG) and Galvanic Skin Response (GSR). This makes it possible to integrate real-time emotion detection system into potential high level Human Computer Interaction (HCI) applications like interactive films. presents the development of a real-time brainwave controller system, which controls the interactive film depending on the emotional state via brainwaves. I build the data collection system for EEG signal, produced stimuli based on the common protocol. In this project, there was a crucial problem about getting the classification model with high accuracy, which means it should be able to classify three emotion classes correctly. To achieve the best model before implement with the film, I explore the multi-feature extraction methods, classification methods and selec-

tion schemes under the subject independent. Comparing the performance of classification models which were obtained from the experiments indicates that the size of dataset had great influence on the accuracy of models. Compare the performance for using different validation method and classifiers on each feature that I decide to use random forest classifier. After all, I conduct the MI and applied majority voting for advanced experiments, the result justify that combined feature reach the highest performance. Then I build the real time emotion detection system for controlling the interactive film. The interactive film has three checkpoints which triggering by three emotion anger, fear and calm. The offline training model is used in the online system and the prediction for emotions is used as the trigger for the film. After first 15 seconds the processing part has slightly delay and feeding the data every 3 seconds.

The significance of this proposed work is building the emotion EEG-database and the real-time application of emotion recognition. The PEED dataset provides the possibilities to produce more achievements. Although PEED's size is not that large, but the relatively great experiment results proves it is reliable and can be commonly used for different research. Moreover, there is quite a few public EEG-based emotion dataset around this research area so PEED potentially contributes to the further research. The real-time interactive film application is a milestone of my research career, the technologies that I explored on this research area ultimately embedded into the real product. Meanwhile, the emotion interactive film through EEG provides a high level platform to be developed and contain the widely application prospects. In the future, different people may get different story or different plot trend while watching the same film.

Based on the previous two approaches, the third approach presents the research work on creating the EEG-based emotion recognition application. Simultaneously, the PEED dataset provide opportunities for further research work.

6.2 Future Works

For future improvements of feature selection level, specifically, the first proposed provides the based thinking of processing EEG-based issues on feature level which maintain the most related and discard the redundancy information. At this stage, further work should acquire more features can be added into the system and the performance might be improved further. Especially, various deep learning models can be used for feature extraction and dynamic modelling, that will improve performance. In addition, based on different kinds of features, more advanced fusion method might be used in the future.

Furthermore, the contribution of each channel can be further analyzed and channel selection might make further improvement.

For future improvements of deep learning level, firstly, the exploration experiments results demonstrate that the β -VAE with double-LSTM attribute the best performance, however, this deep neural network module only applied to time series image transfer data. Therefore, further work should promote the module to frequency image transfer data that potentially moving forward to improve the modules' capability at emotion classification. Secondly, the original DEAP EEG is lasting for 63 seconds each trail and I build the EEG-image database based on 1 second as per frame, however, the emotion label for DEAP is every 63 seconds once which hardly to indicate the sequence characteristics analysis of generating the emotion. Consequently the further work should acquire the experiments on semi-supervised learning which will take fully consideration on sequence-processing that potentially improve the performance. Owing to the strongly self-learning particularity for deep learning neural network modules, this thinking possess highly capacity to achieve greater results. Finally, the experiments results verify the proposed system is effective on the EEG-based emotion classification work on DEAP dataset, probably the further I should apply the integrated scheme on more EEG public dataset to produce the generalization on widely dataset.

For future improvements of EEG-based emotion application, firstly, the amount of participants and experiments trail of PEED database that I build possibly to increase based on the relatively simply cognitive experiment setup. More abundant experiment information potentially produce variety experiments. Secondly, the method that I applied in this experiments is relatively classic methods (feature extraction, classification), as the previous research approve that deep neural networks achieves significant performance through the relatively consistent classification task which provide the possibility that embed more advanced deep learning neural network modules to achieve better performance. However, the operation speed and machine performance is the hardly challenge for settling this idea. Finally, the real-time system that I build consist of three level, and the challenging game is only if the participant keep calm the story line of the interactive film will go through. In the future, the system should acquire more entertainment elements, consequently, the story line of the film should contain different tendency rely on the different feelings of participant based on the main theme of the system represent the human-machine interactive. Simultaneously, it provide the possibility to implement on the mobile terminal to result in likely to be accepted and spread around the reality human life.

Bibliography

- [1] Tim Dalgleish. The emotional brain. *Nature Reviews Neuroscience*, 5(7):583, 2004.
- [2] Carl Georg Lange. The mechanism of the emotions. *The classical psychologists*, pages 672–684, 1885.
- [3] Sander Koelstra, Christian Muhl, Mohammad Soleymani, Jong-Seok Lee, Ashkan Yazdani, Touradj Ebrahimi, Thierry Pun, Anton Nijholt, and Ioannis Patras. DEAP: A database for emotion analysis; using physiological signals. *IEEE Transactions on Affective Computing*, 3(1):18–31, 2012.
- [4] Marcus E Raichle, Ann Mary MacLeod, Abraham Z Snyder, William J Powers, Debra A Gusnard, and Gordon L Shulman. A default mode of brain function. *Proceedings of the National Academy of Sciences*, 98(2):676–682, 2001.
- [5] Jianhai Zhang, Ming Chen, Shaokai Zhao, Sanqing Hu, Zhiguo Shi, and Yu Cao. Relief-based EEG sensor selection methods for emotion recognition. *Sensors*, 16(10):1558, 2016.
- [6] Gorm Greisen, Lena Hellström-Westas, H Lou, Ingmar Rosén, and NW Svenningsen. EEG depression and germinal layer haemorrhage in the newborn. *Acta Paediatrica*, 76(3):519–525, 1987.
- [7] Christoph Besthorn, Hans Förstl, Claudia Geiger-Kabisch, Heribert Sattel, Theo Gasser, and Ursula Schreiter-Gasser. EEG coherence in alzheimer disease. *Clinical Neurophysiology*, 90(3):242–245, 1994.
- [8] Fadi N Karameh and Munther A Dahleh. Automated classification of EEG signals in brain tumor diagnostics. In *Proceedings of the American Conference on Control*, volume 6, pages 4169–4173. IEEE, 2000.
- [9] Christoph Guger, Alois Schlogl, Christa Neuper, Dirk Walterspacher, Thomas Strein, and Gert Pfurtscheller. Rapid prototyping of an EEG-based brain-computer

- interface (BCI). *IEEE Transactions on Neural Systems and Rehabilitation Engineering*, 9(1):49–58, 2001.
- [10] Yuanqing Li, Jinyi Long, Tianyou Yu, Zhuliang Yu, Chuanchu Wang, Haihong Zhang, and Cuntai Guan. An EEG-based BCI system for 2-D cursor control by combining Mu/Beta rhythm and P300 potential. *IEEE Transactions on Biomedical Engineering*, 57(10):2495–2505, 2010.
- [11] Kohei Arai and Ronny Mardiyanto. Evaluation of users' impact for using the proposed eye based HCI with moving and fixed keyboard by using EEG signals. *International Journal of Research and Reviews in Computer Science*, 2(6):1228, 2011.
- [12] Jyotish Kumar et al. Affective modelling of users in HCI using EEG. *Procedia Computer Science*, 84:107–114, 2016.
- [13] Paul Ekman, Tim Dalgleish, and Michael Power. Basic emotions. in *handbook of cognition and emotion*.
- [14] Klaus R Scherer, Angela Schorr, and Tom Johnstone. *Appraisal processes in emotion: Theory, methods, research*. Oxford University Press, 2001.
- [15] William James. What is an emotion? *Mind*, 9(34):188–205, 1884.
- [16] Paul Ekman. Facial expression and emotion. *American psychologist*, 48(4):384, 1993.
- [17] Erte Xiao and Daniel Houser. Emotion expression in human punishment behavior. *Proceedings of the National Academy of Sciences*, 102(20):7398–7401, 2005.
- [18] Joey Benedek and R Hazlett. Incorporating facial emg emotion measures as feedback in the software design process. *Proceeding of Human Computer Interaction Consortium*, 2005.
- [19] Joseph E LeDoux. Emotion circuits in the brain. *Annual review of neuroscience*, 23(1):155–184, 2000.
- [20] Robert Jenke, Angelika Peer, and Martin Buss. Feature extraction and selection for emotion recognition from EEG. *IEEE Transactions on Affective Computing*, 5(3):327–339, 2014.
- [21] Danny Oude Bos et al. EEG-based emotion recognition. *The Influence of Visual and Auditory Stimuli*, 56(3):1–17, 2006.

- [22] Min-Ki Kim, Miyoung Kim, Eunmi Oh, and Sung-Phil Kim. A review on the computational methods for emotional state estimation from the human EEG. *Computational and mathematical methods in medicine*, 2013, 2013.
- [23] Ryan Thibodeau, Randall S Jorgensen, and Sangmoon Kim. Depression, anxiety, and resting frontal EEG asymmetry: a meta-analytic review. *Journal of abnormal psychology*, 115(4):715, 2006.
- [24] Tao Liu, Leslie Goldberg, Shangkai Gao, and Bo Hong. An online brain–computer interface using non-flashing visual evoked potentials. *Journal of neural engineering*, 7(3):036003, 2010.
- [25] Yisi Liu, Olga Sourina, and Minh Khoa Nguyen. Real-time EEG-based human emotion recognition and visualization. In *International Conference on Cyberworlds (CW)*, pages 262–269. IEEE, 2010.
- [26] Vasileios Charisis, Stelios Hadjidimitriou, Leontios Hadjileontiadis, Deniz Uğurca, and Erdal Yilmaz. Emoactivity-An EEG-based gamified emotion HCI for augmented artistic expression: The i-treasures paradigm. In *International Conference on Universal Access in Human-Computer Interaction*, pages 29–40. Springer, 2015.
- [27] Peter J Lang, Margaret M Bradley, Jeffrey R Fitzsimmons, Bruce N Cuthbert, James D Scott, Bradley Moulder, and Vijay Nangia. Emotional arousal and activation of the visual cortex: an fMRI analysis. *Psychophysiology*, 35(2):199–210, 1998.
- [28] Turhan Canli, John E Desmond, Zuo Zhao, Gary Glover, and John DE Gabrieli. Hemispheric asymmetry for emotional stimuli detected with fMRI. *Neuroreport*, 9(14):3233–3239, 1998.
- [29] Toshimitsu Musha, Yuniko Terasaki, Hasnine A Haque, and George A Ivamitsky. Feature extraction from EEGs associated with emotions. *Artificial Life and Robotics*, 1(1):15–19, 1997.
- [30] Yixiang Dai, Xue Wang, Pengbo Zhang, Weihang Zhang, and Junfeng Chen. Sparsity constrained differential evolution enabled feature-channel-sample hybrid selection for daily-life EEG emotion recognition. *Multimedia Tools and Applications*, pages 1–28, 2018.
- [31] Nasser M Nasrabadi. Pattern recognition and machine learning. *Journal of electronic imaging*, 16(4):049901, 2007.

- [32] Yann LeCun, Yoshua Bengio, and Geoffrey Hinton. Deep learning. *nature*, 521(7553):436, 2015.
- [33] Wojciech Zaremba, Ilya Sutskever, and Oriol Vinyals. Recurrent neural network regularization. *arXiv preprint arXiv:1409.2329*, 2014.
- [34] Kaiming He, Xiangyu Zhang, Shaoqing Ren, and Jian Sun. Deep residual learning for image recognition. In *Proceedings of the IEEE conference on computer vision and pattern recognition*, pages 770–778, 2016.
- [35] Paul Ekman, Wallace V Friesen, Maureen O’Sullivan, Anthony Chan, Irene Diacoyanni-Tarlatzis, Karl Heider, Rainer Krause, William Ayhan LeCompte, Tom Pitcairn, Pio E Ricci-Bitti, et al. Universals and cultural differences in the judgments of facial expressions of emotion. *Journal of personality and social psychology*, 53(4):712, 1987.
- [36] Robert W Levenson. Human emotion: A functional view. *The nature of emotion: Fundamental questions*, 1:123–126, 1994.
- [37] Walter B Cannon. The james-lange theory of emotions: A critical examination and an alternative theory. *The American journal of psychology*, 39(1/4):106–124, 1927.
- [38] Otniel E Dror. The Cannon–Bard thalamic theory of emotions: A brief genealogy and reappraisal. *Emotion Review*, 6(1):13–20, 2014.
- [39] James W Papez. A proposed mechanism of emotion. *Archives of Neurology & Psychiatry*, 38(4):725–743, 1937.
- [40] Paul D MacLean. Psychosomatic disease and the” visceral brain”; recent developments bearing on the Papez theory of emotion. *Psychosomatic medicine*, 1949.
- [41] Jennifer Anne Healey. *Wearable and automotive systems for affect recognition from physiology*. PhD thesis, Massachusetts Institute of Technology, 2000.
- [42] Manfred Clynes. Generalised emotion how it may be produced, and sentic cycle therapy. In *Emotions and psychopathology*, pages 107–170. Springer, 1988.
- [43] Carroll E Izard. *Human emotions*. Springer Science & Business Media, 2013.
- [44] Peter J Lang, Margaret M Bradley, and Bruce N Cuthbert. International affective picture system (IAPS): Technical manual and affective ratings. *NIMH Center for the Study of Emotion and Attention*, pages 39–58, 1997.

- [45] Peter Lang and Margaret M Bradley. The international affective picture system (IAPS) in the study of emotion and attention. *Handbook of emotion elicitation and assessment*, 29, 2007.
- [46] Jeffrey F Cohn, Zara Ambadar, and Paul Ekman. Observer-based measurement of facial expression with the facial action coding system. *The handbook of emotion elicitation and assessment*, pages 203–221, 2007.
- [47] James A Coan, John JB Allen, and Patrick E McKnight. A capability model of individual differences in frontal eeg asymmetry. *Biological psychology*, 72(2):198–207, 2006.
- [48] Helen J Crawford, Steven W Clarke, and Melissa Kitner-Triolo. Self-generated happy and sad emotions in low and highly hypnotizable persons during waking and hypnosis: laterality and regional EEG activity differences. *International Journal of Psychophysiology*, 24(3):239–266, 1996.
- [49] Antonio R Damasio, Thomas J Grabowski, Antoine Bechara, Hanna Damasio, Laura LB Ponto, Josef Parvizi, and Richard D Hichwa. Subcortical and cortical brain activity during the feeling of self-generated emotions. *Nature neuroscience*, 3(10):1049, 2000.
- [50] Keith Anderson and Peter W McOwan. A real-time automated system for the recognition of human facial expressions. *IEEE Transactions on Systems, Man, and Cybernetics, Part B (Cybernetics)*, 36(1):96–105, 2006.
- [51] Jeremy Ang, Rajdip Dhillon, Ashley Krupski, Elizabeth Shriberg, and Andreas Stolcke. Prosody-based automatic detection of annoyance and frustration in human-computer dialog. In *Seventh International Conference on Spoken Language Processing*, 2002.
- [52] Rosalind W. Picard, Elias Vyzas, and Jennifer Healey. Toward machine emotional intelligence: Analysis of affective physiological state. *IEEE transactions on pattern analysis and machine intelligence*, 23(10):1175–1191, 2001.
- [53] Helmut Laufs, Andreas Kleinschmidt, Astrid Beyerle, Evelyn Eger, Afraim Salek-Haddadi, Christine Preibisch, and Karsten Krakow. EEG-correlated fMRI of human alpha activity. *Neuroimage*, 19(4):1463–1476, 2003.
- [54] Richard SJ Frackowiak. *Human brain function*. Elsevier, 2004.
- [55] David A Sousa. *How the brain learns*. Corwin Press, 2016.

- [56] Pascal Ackermann, Christian Kohlschein, J6 Ágila Bitsch, Klaus Wehrle, and Sabina Jeschke. EEG-based automatic emotion recognition: Feature extraction, selection and classification methods. In *The 18th International Conference on E-Health Networking, Applications and Services (Healthcom)*, pages 1–6. IEEE, 2016.
- [57] Arne Dietrich and Riam Kanso. A review of EEG, ERP, and neuroimaging studies of creativity and insight. *Psychological bulletin*, 136(5):822, 2010.
- [58] D Puthankattil Subha, Paul K Joseph, Rajendra Acharya, and Choo Min Lim. EEG signal analysis: a survey. *Journal of medical systems*, 34(2):195–212, 2010.
- [59] Deon Garrett, David A Peterson, Charles W Anderson, and Michael H Thaut. Comparison of linear, nonlinear, and feature selection methods for EEG signal classification. *IEEE Transactions on neural systems and rehabilitation engineering*, 11(2):141–144, 2003.
- [60] Sung-Phil Kim. Preprocessing of EEG. In *Computational EEG Analysis*, pages 15–33. Springer, 2018.
- [61] Metin Akay and J Andrew Daubenspeck. Investigating the contamination of electroencephalograms by facial muscle electromyographic activity using matching pursuit. *Brain and language*, 66(1):184–200, 1999.
- [62] Gabriele Gratton. Dealing with artifacts: The EOG contamination of the event-related brain potential. *Behavior Research Methods, Instruments, & Computers*, 30(1):44–53, 1998.
- [63] Cornelis H Brunia, Joachim Möcks, Van den Berg-Lenssen, M Margaretha, Michael Coelho, et al. Correcting ocular artifacts in the EEG: A comparison of several models. *Journal of Psychophysiology*, 1989.
- [64] Garrick L Wallstrom, Robert E Kass, Anita Miller, Jeffrey F Cohn, and Nathan A Fox. Automatic correction of ocular artifacts in the EEG: a comparison of regression-based and component-based methods. *International Journal of psychophysiology*, 53(2):105–119, 2004.
- [65] Gabriele Gratton, Michael GH Coles, and Emanuel Donchin. A new method for off-line removal of ocular artifact. *Electroencephalography and clinical neurophysiology*, 55(4):468–484, 1983.
- [66] Piotr J Durka, Dobieslaw Ircha, and Katarzyna J Blinowska. Stochastic time-frequency dictionaries for matching pursuit. *IEEE Transactions on Signal Processing*, 49(3):507–510, 2001.

- [67] Erkki Oja and Aapo Hyvarinen. Independent component analysis: a tutorial. *Helsinki University of Technology, Helsinki*, 2004.
- [68] Michael Vinther. Independent component analysis of evoked potentials in EEG. *Orsted, DTU. December*, 2002.
- [69] Weidong Zhou. Removal of ECG artifacts from EEG using ICA. In *Proceedings of the Second Joint of the Biomedical Engineering Society Conference on Engineering in Medicine and Biology*, volume 1, pages 206–207. IEEE, 2002.
- [70] Gaurav Srivastava, Sonia Crottaz-Herbette, K.M. Lau, Gary H Glover, and Vinod Menon. ICA-based procedures for removing ballistocardiogram artifacts from EEG data acquired in the mri scanner. *Neuroimage*, 24(1):50–60, 2005.
- [71] Rakendu Rao and Reza Derakhshani. A comparison of EEG preprocessing methods using time delay neural networks. In *Proceeding of 2nd International Conference on Neural Engineering*, pages 262–264. Citeseer, 2005.
- [72] Georg Bartels, Li-Chen Shi, and Bao-Liang Lu. Automatic artifact removal from EEG—a mixed approach based on double blind source separation and support vector machine. In *International Conference on Engineering in Medicine and Biology Society (EMBC)*, pages 5383–5386. IEEE, 2010.
- [73] Su Yang and Farzin Deravi. Wavelet-based EEG preprocessing for biometric applications. In *Fourth International Conference on Emerging Security Technologies (EST)*, pages 43–46. IEEE, 2013.
- [74] Miro Zima, Peter Tichavský, Karel Paul, and Vladmir Krajča. Robust removal of short-duration artifacts in long neonatal EEG recordings using wavelet-enhanced ICA and adaptive combining of tentative reconstructions. *Physiological measurement*, 33(8):N39, 2012.
- [75] Abdulhamit Subasi and M Ismail Gursoy. EEG signal classification using PCA, ICA, LDA and support vector machines. *Expert systems with applications*, 37(12):8659–8666, 2010.
- [76] Brahmantya Aji Pramudita, Yabes Dwi Nugroho, Igi Ardiyanto, Mohd Ibrahim Shapiai, and Noor Akhmad Setiawan. Removing ocular artefacts in eeg signals by using combination of complete EEMD (CEEMD) independent component analysis (ICA) based outlier data. In *International Conference on Robotics, Automation and Sciences (ICORAS)*, pages=1–5, year=2017, organization=IEEE.

- [77] Weidong Zhou and Jean Gotman. Automatic removal of eye movement artifacts from the EEG using ICA and the dipole model. *Progress in Natural Science*, 19(9):1165–1170, 2009.
- [78] A Santillán-Guzmán, JJ Oliveros-Oliveros, and MM Morín-Castillo. Introducing a combination of ICA-EMD to suppress muscle and ocular artifacts in EEG signals. In *2018 40th Annual International Conference on Engineering in Medicine and Biology Society (EMBC)*, pages 1250–1253. IEEE, 2018.
- [79] Bo Hjorth. EEG analysis based on time domain properties. *Electroencephalography and clinical neurophysiology*, 29(3):306–310, 1970.
- [80] Bernard Saltzberg and Neil R Burch. Period analytic estimates of moments of the power spectrum: A simplified EEG time domain procedure. *Clinical Neurophysiology*, 30(6):568–570, 1971.
- [81] Pedro Valdés, J Bosch, R Grave, J Hernandez, J Riera, R Pascual, and R Biscay. Frequency domain models of the EEG. *Brain topography*, 4(4):309–319, 1992.
- [82] Istvan Kondakor, Daniel Brandeis, Jiri Wackermann, Kieko Kochi, Thomas König, Edi Frei, Roberto.D Pascual-Marqui, Takami Yagyu, and Dietrich Lehmann. Multichannel EEG fields during and without visual input: frequency domain model source locations and dimensional complexities. *Neuroscience letters*, 226(1):49–52, 1997.
- [83] Brian J Roach and Daniel H Mathalon. Event-related eeg time-frequency analysis: an overview of measures and an analysis of early gamma band phase locking in schizophrenia. *Schizophrenia bulletin*, 34(5):907–926, 2008.
- [84] Rodrigo Quian Quiroga and Osvaldo.A Rosso. Time-frequency analysis of electroencephalogram series. III. wavelet packets and information cost function. *Physical Review E*, 57(1):932, 1998.
- [85] U Rajendra Acharya, Shu Lih Oh, Yuki Hagiwara, Jen Hong Tan, and Hojjat Adeli. Deep convolutional neural network for the automated detection and diagnosis of seizure using EEG signals. *Computers in biology and medicine*, 100:270–278, 2018.
- [86] Wei-Long Zheng, Jia-Yi Zhu, and Bao-Liang Lu. Identifying stable patterns over time for emotion recognition from EEG. *IEEE Transactions on Affective Computing*, 2017.

- [87] Wei-Long Zheng, Jia-Yi Zhu, Yong Peng, and Bao-Liang Lu. EEG-based emotion classification using deep belief networks. In *International Conference on Multimedia and Expo (ICME)*, pages 1–6. IEEE, 2014.
- [88] Joseph L. Goldstein. Time domain analysis of the EEG. the integrative method. In *CEAN-Computerized EEG Analysis*, pages 251–270. Gustav Fischer Verlag Stuttgart, 1975.
- [89] Steven J Luck. Event-related potentials. *APA handbook of research methods in psychology*, 1:523–546, 2012.
- [90] Christos A Frantzidis, Charalampos Bratsas, Manousos A Klados, Evdokimos Konstantinidis, Chrysa D Lithari, Ana B Vivas, Christos L Papadelis, Eleni Kaldoudi, Costas Pappas, and Panagiotis D Bamidis. On the classification of emotional biosignals evoked while viewing affective pictures: an integrated data-mining-based approach for healthcare applications. *IEEE Transactions on Information Technology in Biomedicine*, 14(2):309–318, 2010.
- [91] Martin Eimer and Amanda Holmes. An ERP study on the time course of emotional face processing. *Neuroreport*, 13(4):427–431, 2002.
- [92] Michael Tangermann, Martijn Schreuder, Sven Dähne, Johannes Höhne, Sebastian Regler, Andrew Ramsay, Melissa Quek, John Williamson, and Roderick Murray-Smith. Optimized stimulation events for a visual ERP BCI. *Int J Bioelectromagnetism Volume*, 13(3):119–120, 2011.
- [93] Thilo Hinterberger, Andrea Kübler, Jochen Kaiser, Nicola Neumann, and Niels Birbaumer. A brain–computer interface (BCI) for the locked-in: comparison of different eeg classifications for the thought translation device. *Clinical Neurophysiology*, 114(3):416–425, 2003.
- [94] Ronald E Barr, James J Ackmann, and Joseph Sonnenfeld. Peak-detection algorithm for EEG analysis. *International Journal of bio-medical computing*, 9(6):465–476, 1978.
- [95] Zahra Khalili and Mohammad Hasan Moradi. Emotion recognition system using brain and peripheral signals: using correlation dimension to improve the results of EEG. In *International Joint Conference on Neural Networks (IJCNN)*, pages 1571–1575. IEEE, 2009.
- [96] Qing Zhang and Minhoo Lee. A hierarchical positive and negative emotion understanding system based on integrated analysis of visual and brain signals. *Neurocomputing*, 73(16-18):3264–3272, 2010.

- [97] Tong Yuen Chai, San San Woo, Mohamed Rizon, and Ching Seong Tan. Classification of human emotions from EEG signals using statistical features and neural network. In *International*, volume 1, pages 1–6. Penerbit UTHM, 2010.
- [98] Benjamin Kedem and Sidney Yakowitz. *Time series analysis by higher order crossings*. IEEE press New York, 1994.
- [99] Panagiotis C Petrantonakis and Leontios J Hadjileontiadis. EEG-based emotion recognition using hybrid filtering and higher order crossings. In *3rd International Conference on Affective Computing and Intelligent Interaction and Workshops (ACII)*, pages 1–6. IEEE, 2009.
- [100] Panagiotis C Petrantonakis and Leontios J Hadjileontiadis. Emotion recognition from EEG using higher order crossings. *IEEE Transactions on Information Technology in Biomedicine*, 14(2):186–197, 2010.
- [101] Yisi Liu and Olga Sourina. EEG databases for emotion recognition. In *International Conference on Cyberworlds (CW)*, pages 302–309. IEEE, 2013.
- [102] Jingxin Liu, Hongying Meng, Asoke Nandi, and Maozhen Li. Emotion detection from EEG recordings. In *The 12th International Conference on Natural Computation, Fuzzy Systems and Knowledge Discovery (ICNC-FSKD)*, pages 1722–1727. IEEE, 2016.
- [103] Nithyananda Pradhan and D.Narayana Dutt. Use of running fractal dimension for the analysis of changing patterns in electroencephalograms. *Computers in biology and medicine*, 23(5):381–388, 1993.
- [104] Werner Lutzenberger, Thomas Elbert, Niels Birbaumer, William J Ray, and H Schupp. The scalp distribution of the fractal dimension of the EEG and its variation with mental tasks. *Brain topography*, 5(1):27–34, 1992.
- [105] Vladimir Kulish, Alexei Sourin, and Olga Sourina. Analysis and visualization of human electroencephalograms seen as fractal time series. *Journal of Mechanics in Medicine and Biology*, 6(02):175–188, 2006.
- [106] Ljubomir I Aftanas, Natalia V Lotova, Vladimir I Koshkarov, Victor P Makhnev, Yuri N Mordvintsev, and Serguei A Popov. Non-linear dynamic complexity of the human EEG during evoked emotions. *International Journal of Psychophysiology*, 28(1):63–76, 1998.
- [107] Qiang Wang, Olga Sourina, and Minh Khoa Nguyen. EEG-based” serious” games design for medical applications. In *International Conference on Cyberworlds (CW)*, pages 270–276. IEEE, 2010.

- [108] Olga Sourina, Vladimir Kulish, and Alexei Sourin. Novel tools for quantification of brain responses to music stimuli. In *13th International Conference on Biomedical Engineering*, pages 411–414. Springer, 2009.
- [109] Olga Sourina, Alexei Sourin, and Vladimir Kulish. EEG data driven animation and its application. In *International Conference on Computer Vision/Computer Graphics Collaboration Techniques and Applications*, pages 380–388. Springer, 2009.
- [110] Anita Patil, Chinmayee Deshmukh, and AR Panat. Feature extraction of EEG for emotion recognition using hjorth features and higher order crossings. In *Conference on Advances in Signal Processing (CASP)*, pages 429–434. IEEE, 2016.
- [111] Seung-Hyeon Oh, Yu-Ri Lee, and Hyoung-Nam Kim. A novel EEG feature extraction method using hjorth parameter. *International Journal of Electronics and Electrical Engineering*, 2(2):106–110, 2014.
- [112] Eleni Kroupi, Ashkan Yazdani, and Touradj Ebrahimi. EEG correlates of different emotional states elicited during watching music videos. *Affective Computing and Intelligent Interaction*, pages 457–466, 2011.
- [113] Kin Foon Kevin Wong, Andreas Galka, Okito Yamashita, and Tohru Ozaki. Modelling non-stationary variance in EEG time series by state space garch model. *Computers in biology and medicine*, 36(12):1327–1335, 2006.
- [114] Alexandre Gramfort, Daniel Strohmeier, Jens Haueisen, Matti S Hämäläinen, and Matthieu Kowalski. Time-frequency mixed-norm estimates: Sparse M/EEG imaging with non-stationary source activations. *NeuroImage*, 70:410–422, 2013.
- [115] Arnaud Delorme and Scott Makeig. EEGLAB: an open source toolbox for analysis of single-trial EEG dynamics including independent component analysis. *Journal of neuroscience methods*, 134(1):9–21, 2004.
- [116] Wolfgang Klimesch. EEG alpha and theta oscillations reflect cognitive and memory performance: a review and analysis. *Brain research reviews*, 29(2-3):169–195, 1999.
- [117] Xiao-Wei Wang, Dan Nie, and Bao-Liang Lu. EEG-based emotion recognition using frequency domain features and support vector machines. In *International Conference on Neural Information Processing*, pages 734–743. Springer, 2011.
- [118] Yisi Liu and Olga Sourina. EEG-based valence level recognition for real-time applications. In *International Conference on Cyberworlds (CW)*, pages 53–60. IEEE, 2012.

- [119] Dan Nie, Xiao-Wei Wang, Li-Chen Shi, and Bao-Liang Lu. EEG-based emotion recognition during watching movies. In *Neural Engineering (NER), 2011 5th International IEEE/EMBS Conference on*, pages 667–670. IEEE, 2011.
- [120] Majid Aljalal, Ridha Djemal, Khalil AlSharabi, and Sutrisno Ibrahim. Feature extraction of EEG based motor imagery using CSP based on logarithmic band power, entropy and energy. In *2018 1st International Conference on Computer Applications & Information Security (ICCAIS)*, pages 1–6. IEEE, 2018.
- [121] Tahereh Nezam, Reza Boostani, Vahid Abootalebi, and Karim Rastegar. A novel classification strategy to distinguish five levels of pain using the EEG signal features. *IEEE Transactions on Affective Computing*, 2018.
- [122] Leonhardt Unruh, Rick Adams, Alan Anticevic, and L Elliot Hong. Resting EEG changes in schizophrenia. *Schizophrenia Bulletin*, 44(Suppl 1):S327, 2018.
- [123] Katsuya Ogata, Hisato Nakazono, Ryutaro Hayashi, and Shozo Tobimatsu. Alpha band power can predict MEP amplitudes: An online EEG-TMS study. *Clinical Neurophysiology*, 129(5):e39–e40, 2018.
- [124] Kavitha P Thomas and A Prasad Vinod. EEG-based biometric authentication using gamma band power during rest state. *Circuits, Systems, and Signal Processing*, 37(1):277–289, 2018.
- [125] Emily Cohen, Flora Y Wong, Euan M Wallace, Joanne C Mockler, Alexsandria Odoi, Samantha Hollis, Rosemary SC Horne, and Stephanie R Yiallourou. EEG power spectrum maturation in preterm fetal growth restricted infants. *Brain research*, 1678:180–186, 2018.
- [126] Meysam Hashemi, Axel Hutt, Laure Buhry, and Jamie Sleigh. Optimal model parameter estimation from EEG power spectrum features observed during general anesthesia. *Neuroinformatics*, 16(2):231–251, 2018.
- [127] Brianne A Kent, Stephen M Strittmatter, and Haakon Nygaard. Sleep and EEG power spectral analysis in three transgenic mouse models of alzheimers disease: APP/PS1, 3xTgad, and Tg2576. *Journal of Alzheimer’s Disease*, (Preprint):1–12, 2018.
- [128] Patrizio Sale. Use of EEG signal information to optimize training and promote plasticity. In *International Conference on NeuroRehabilitation*, pages 218–220. Springer, 2018.

- [129] George Zouridakis, Udit Patidar, Nikhil S Padhye, Luca Pollonini, Antony Passaro, and Andrew C Papanicolaou. Spectral power of brain activity associated with emotiona pilot MEG study. In *The 17th International Conference on Biomagnetism Advances in Biomagnetism–Biomag*, pages 354–357. Springer, 2010.
- [130] Christian A Kothe and Scott Makeig. Estimation of task workload from EEG data: new and current tools and perspectives. In *The Annual International Conference on Engineering in Medicine and Biology Society, (EMBC)*, pages 6547–6551. IEEE, 2011.
- [131] Mu Li and Bao-Liang Lu. Emotion classification based on gamma-band EEG. In *The Annual International Conference on Engineering in medicine and biology society (EMBC)*, pages 1223–1226. IEEE, 2009.
- [132] Norbert Jaušovec, Ksenija Jaušovec, and Ivan Gerlič. Differences in event-related and induced EEG patterns in the theta and alpha frequency bands related to human emotional intelligence. *Neuroscience Letters*, 311(2):93–96, 2001.
- [133] Qing Zhang and Minhoo Lee. Emotion recognition in natural scene images based on brain activity and gist. In *2008 IEEE International Joint Conference on Neural Networks (IEEE World Congress on Computational Intelligence)*, pages 3050–3057. IEEE, 2008.
- [134] Yingjie Li, Dan Cao, Ling Wei, Yingying Tang, and Jijun Wang. Abnormal functional connectivity of EEG gamma band in patients with depression during emotional face processing. *Clinical neurophysiology*, 126(11):2078–2089, 2015.
- [135] Vaclav Gerla, Elizaveta Saifutdinova, Macas Macas, Jan Mladek, and Lenka Lhotska. Comparison of short-time fourier transform and continuous wavelet transform for frequency analysis of sleep EEG. *Clinical Neurophysiology*, 129(4):e14, 2018.
- [136] Soheil Rayatdoost and Mohammad Soleymani. Cross-corpus EEG-based emotion recognition. In *2018 IEEE 28th International Workshop on Machine Learning for Signal Processing (MLSP)*, pages 1–6. IEEE, 2018.
- [137] Guozhen Zhao, Yan Ge, Biying Shen, Xingjie Wei, and Hao Wang. Emotion analysis for personality inference from EEG signals. *IEEE Transactions on Affective Computing*, 9(3):362–371, 2018.
- [138] Abhijit Bhattacharyya, Manish Sharma, Ram Bilas Pachori, Pradip Sircar, and U Rajendra Acharya. A novel approach for automated detection of focal EEG signals using empirical wavelet transform. *Neural Computing and Applications*, 29(8):47–57, 2018.

- [139] Noor Kamal Al-Qazzaz, Sawal Hamid Md Ali, S Islam, SA Ahmad, and Javier Escudero. EEG wavelet spectral analysis during a working memory tasks in stroke-related mild cognitive impairment patients. In *International Conference for Innovation in Biomedical Engineering and Life Sciences*, pages 82–85. Springer, 2015.
- [140] M Murugappan and Subbulakshmi Murugappan. Human emotion recognition through short time electroencephalogram (EEG) signals using fast fourier transform (FFT). In *9th International Colloquium on Signal Processing and its Applications (CSPA)*, pages 289–294. IEEE, 2013.
- [141] Yuan-Pin Lin, Chi-Hong Wang, Tzyy-Ping Jung, Tien-Lin Wu, Shyh-Kang Jeng, Jeng-Ren Duann, and Jyh-Horng Chen. EEG-based emotion recognition in music listening. *IEEE Transactions on Biomedical Engineering*, 57(7):1798–1806, 2010.
- [142] Wei-Long Zheng and Bao-Liang Lu. Investigating critical frequency bands and channels for EEG-based emotion recognition with deep neural networks. *IEEE Transactions on Autonomous Mental Development*, 7(3):162–175, 2015.
- [143] Zirui Lan, Olga Sourina, Lipo Wang, and Yisi Liu. Stability of features in real-time EEG-based emotion recognition algorithm. In *International Conference on Cyberworlds (CW)*, pages 137–144. IEEE, 2014.
- [144] Muthusamy Murugappan, M Rizon, R Nagarajan, S Yaacob, D Hazry, and I Zunaiddi. Time-frequency analysis of EEG signals for human emotion detection. In *4th Kuala Lumpur International Conference on Biomedical Engineering 2008*, pages 262–265. Springer, 2008.
- [145] Zeynab Mohammadi, Javad Frounchi, and Mahmood Amiri. Wavelet-based emotion recognition system using EEG signal. *Neural Computing and Applications*, 28(8):1985–1990, 2017.
- [146] Adrian Qi-Xiang Ang, Yi Qi Yeong, and Wee Wee. Emotion classification from EEG signals using time-frequency-DWT features and ANN. *Journal of Computer and Communications*, 5(03):75, 2017.
- [147] Ning Zhuang, Ying Zeng, Li Tong, Chi Zhang, Hanming Zhang, and Bin Yan. Emotion recognition from EEG signals using multidimensional information in EMD domain. *BioMed research international*, 2017, 2017.
- [148] Yong Zhang, Xiaomin Ji, and Suhua Zhang. An approach to EEG-based emotion recognition using combined feature extraction method. *Neuroscience letters*, 633:152–157, 2016.

- [149] Farhan Riaz, Ali Hassan, Saad Rehman, Imran Khan Niazi, and Kim Dremstrup. EMD-based temporal and spectral features for the classification of EEG signals using supervised learning. *IEEE Transactions on Neural Systems and Rehabilitation Engineering*, 24(1):28–35, 2016.
- [150] Norden E Huang, Zheng Shen, Steven R Long, Manli C Wu, Hsing H Shih, Quanan Zheng, Nai-Chyuan Yen, Chi Chao Tung, and Henry H Liu. The empirical mode decomposition and the hilbert spectrum for nonlinear and non-stationary time series analysis. In *Proceedings of the Royal Society of London A: mathematical, physical and engineering sciences*, volume 454, pages 903–995. The Royal Society, 1998.
- [151] Celia Shahnaz, SM Shafiu Hasan, et al. Emotion recognition based on wavelet analysis of empirical mode decomposed EEG signals responsive to music videos. In *Region 10 Conference (TENCON), 2016 IEEE*, pages 424–427. IEEE, 2016.
- [152] Ahmet Mert and Aydin Akan. Emotion recognition from EEG signals by using multivariate empirical mode decomposition. *Pattern Analysis and Applications*, 21(1):81–89, 2018.
- [153] Reza Khosrowabadi, Hiok Chai Quek, Abdul Wahab, and Kai Keng Ang. EEG-based emotion recognition using self-organizing map for boundary detection. In *The 20th International Conference on Pattern Recognition (ICPR)*, pages 4242–4245. IEEE, 2010.
- [154] Mo Chen, Junwei Han, Lei Guo, Jiahui Wang, and Ioannis Patras. Identifying valence and arousal levels via connectivity between EEG channels. In *International Conference on Affective Computing and Intelligent Interaction (ACII)*, pages 63–69. IEEE, 2015.
- [155] Reza Khosrowabadi, Abdul Wahab, Kai Keng Ang, and Mohammad H Baniasad. Affective computation on EEG correlates of emotion from musical and vocal stimuli. In *International Joint Conference on Neural Networks (IJCNN)*, pages 1590–1594. IEEE, 2009.
- [156] Ljubomir I Aftanas, Natalia V Lotova, Vladimir I Koshkarov, Vera L Pokrovskaja, Serguei A Popov, and Victor P Makhnev. Non-linear analysis of emotion EEG: calculation of kolmogorov entropy and the principal lyapunov exponent. *Neuroscience letters*, 226(1):13–16, 1997.
- [157] Tao Zhang, Wanzhong Chen, and Mingyang Li. AR based quadratic feature extraction in the VMD domain for the automated seizure detection of eeg using random forest classifier. *Biomedical Signal Processing and Control*, 31:550–559, 2017.

- [158] Yu-Xuan Yang, Zhong-Ke Gao, Xin-Min Wang, Yan-Li Li, Jing-Wei Han, Norbert Marwan, and Jürgen Kurths. A recurrence quantification analysis-based channel-frequency convolutional neural network for emotion recognition from EEG. *Chaos: An Interdisciplinary Journal of Nonlinear Science*, 28(8):085724, 2018.
- [159] Stefano Scotti, Maurizio Mauri, Riccardo Barbieri, Bassam Jawad, Sergio Cerutti, Luca Mainardi, Emery N Brown, and Marco A Villamira. Automatic quantitative evaluation of emotions in E-learning applications. In *The 28th Annual International Conference on Engineering in Medicine and Biology Society*, pages 1359–1362. IEEE, 2006.
- [160] Neil J McDonald and Walid Soussou. Quasar’s qstates cognitive gauge performance in the cognitive state assessment competition 2011. In *The Annual International Conference on Engineering in Medicine and Biology Society*, pages 6542–6546. IEEE, 2011.
- [161] Mohammad Soleymani, Sadjad Asghari-Esfeden, Yun Fu, and Maja Pantic. Analysis of EEG signals and facial expressions for continuous emotion detection. *IEEE Transactions on Affective Computing*, (1):17–28, 2016.
- [162] Philip J Allen, Giovanni Polizzi, Karsten Krakow, David R Fish, and Louis Lemieux. Identification of EEG events in the MR scanner: the problem of pulse artifact and a method for its subtraction. *Neuroimage*, 8(3):229–239, 1998.
- [163] Li-Chen Shi and Bao-Liang Lu. Off-line and on-line vigilance estimation based on linear dynamical system and manifold learning. In *The Annual International Conference on Engineering in Medicine and Biology Society (EMBC)*, pages 6587–6590. IEEE, 2010.
- [164] Ruo-Nan Duan, Jia-Yi Zhu, and Bao-Liang Lu. Differential entropy feature for EEG-based emotion classification. In *The 6th International Conference on Neural Engineering (NER)*, pages 81–84. IEEE, 2013.
- [165] Zhong Yin and Jianhua Zhang. Identification of temporal variations in mental workload using locally-linear-embedding-based EEG feature reduction and support-vector-machine-based clustering and classification techniques. *Computer methods and programs in biomedicine*, 115(3):119–134, 2014.
- [166] John Atkinson and Daniel Campos. Improving BCI-based emotion recognition by combining EEG feature selection and kernel classifiers. *Expert Systems with Applications*, 47:35–41, 2016.

- [167] Xinyang Yu, Pharino Chum, and Kwee-Bo Sim. Analysis the effect of PCA for feature reduction in non-stationary EEG based motor imagery of BCI system. *Optik-International Journal for Light and Electron Optics*, 125(3):1498–1502, 2014.
- [168] Laxmi Shaw and Aurobinda Routray. Statistical features extraction for multivariate pattern analysis in meditation EEG using PCA. In *Student Conference (ISC), 2016 IEEE EMBS International*, pages 1–4. IEEE, 2016.
- [169] S.S. Lekshmi, V.Salai Selvam, and M.Pallikonda Rajasekaran. EEG signal classification using principal component analysis and wavelet transform with neural network. In *International Conference on Communications and Signal Processing (ICCSP)*, pages 687–690. IEEE, 2014.
- [170] Chris Ding and Hanchuan Peng. Minimum redundancy feature selection from microarray gene expression data. *Journal of bioinformatics and computational biology*, 3(02):185–205, 2005.
- [171] Ankita Mazumder, Poulami Ghosh, Anwesa Khasnobish, Saugat Bhattacharyya, and DN Tibarewala. Selection of relevant features from cognitive EEG signals using relief and MRMR algorithm. In *Advancements of Medical Electronics*, pages 125–136. Springer, 2015.
- [172] Xiaoping Bai, Xiangzhou Wang, Shuhua Zheng, and Mingxin Yu. The offline feature extraction of four-class motor imagery EEG based on ICA and wavelet-CSP. In *Control Conference (CCC), 2014 33rd Chinese*, pages 7189–7194. IEEE, 2014.
- [173] Petr Somol, Jana Novovicová, and Pavel Pudil. Efficient feature subset selection and subset size optimization. In *Pattern recognition recent advances*. InTech, 2010.
- [174] Yvan Saeys, Iñaki Inza, and Pedro Larrañaga. A review of feature selection techniques in bioinformatics. *bioinformatics*, 23(19):2507–2517, 2007.
- [175] H Alexer Firpi and R Jacob Vogelstein. Particle swarm optimization-based feature selection for cognitive state detection. In *The Annual International Conference on Engineering in Medicine and Biology Society (EMBC)*, pages 6556–6559. IEEE, 2011.
- [176] Turkey Alotaiby, Fathi E Abd El-Samie, Saleh A Alshebeili, and Ishtiaq Ahmad. A review of channel selection algorithms for EEG signal processing. *EURASIP Journal on Advances in Signal Processing*, 2015(1):66, 2015.
- [177] D.Asir Antony Gnana, S. Appavu, and E.Jebamalar Leavline. Literature review on feature selection methods for high-dimensional data. *methods*, 136(1), 2016.

- [178] Karim Ansari Asl, Guillaume Chanel, and Thierry Pun. A channel selection method for EEG classification in emotion assessment based on synchronization likelihood. 2007.
- [179] M Murugappan and Sazali Yaacob. Asymmetric ratio and FCM based salient channel selection for human emotion detection using EEG. 2008.
- [180] Louis A Schmidt and Laurel J Trainor. Frontal brain electrical activity EEG distinguishes valence and intensity of musical emotions. *Cognition & Emotion*, 15(4):487–500, 2001.
- [181] Michela Sarlo, Giulia Buodo, Silvia Poli, and Daniela Palomba. Changes in EEG alpha power to different disgust elicitors: the specificity of mutilations. *Neuroscience letters*, 382(3):291–296, 2005.
- [182] Isak Gath and Amir B. Geva. Unsupervised optimal fuzzy clustering. *IEEE Transactions on pattern analysis and machine intelligence*, 11(7):773–780, 1989.
- [183] Ruhi Mahajan and Bashir I Morshed. Unsupervised eye blink artifact denoising of EEG data with modified multiscale sample entropy, kurtosis, and wavelet-ICA. *IEEE journal of Biomedical and Health Informatics*, 19(1):158–165, 2015.
- [184] Dan H Kerem and Amir B Geva. Brain state identification and forecasting of acute pathology using unsupervised fuzzy clustering of EEG temporal patterns. In *Fuzzy and neuro-fuzzy systems in medicine*, pages 19–68. CRC Press, 2017.
- [185] Khushnandan Rai, Varun Bajaj, and Anil Kumar. Novel feature for identification of focal EEG signals with K-means and fuzzy C-means algorithms. In *International Conference on Digital Signal Processing (DSP)*, pages 412–416. IEEE, 2015.
- [186] Nikita Gurudath and H Bryan Riley. Drowsy driving detection by EEG analysis using wavelet transform and K-means clustering. *Procedia Computer Science*, 34:400–409, 2014.
- [187] Per-Erik Danielsson. Euclidean distance mapping. *Computer Graphics and image processing*, 14(3):227–248, 1980.
- [188] Xiang Li, Peng Zhang, Dawei Song, Guangliang Yu, Yuexian Hou, and Bin Hu. EEG based emotion identification using unsupervised deep feature learning. 2015.
- [189] Olga Sourina and Yisi Liu. A fractal-based algorithm of emotion recognition from EEG using arousal-valence model. In *BIOSIGNALS*, pages 209–214, 2011.

- [190] Nazmi Sofian Suhaimi, Chrystalle Tan Bih Yuan, Jason Teo, and James Mountstephens. Modeling the affective space of 360 virtual reality videos based on arousal and valence for wearable EEG-based VR emotion classification. In *The International Colloquium on Signal Processing & Its Applications (CSPA)*, pages 167–172. IEEE, 2018.
- [191] Wei-Long Zheng and Bao-Liang Lu. A multimodal approach to estimating vigilance using EEG and forehead EOG. *Journal of neural engineering*, 14(2):026017, 2017.
- [192] Raja Majid Mehmood and Hyo Jong Lee. EEG based emotion recognition from human brain using hjorth parameters and SVM. *Int. J. Bio-Sci. Bio-Technol*, 7(3):23–32, 2015.
- [193] Yi-Hung Liu, Chien-Te Wu, Wei-Teng Cheng, Yu-Tsung Hsiao, Po-Ming Chen, and Jyh-Tong Teng. Emotion recognition from single-trial EEG based on kernel fishers emotion pattern and imbalanced quasiconformal kernel support vector machine. *Sensors*, 14(8):13361–13388, 2014.
- [194] Varun Bajaj and Ram Bilas Pachori. Detection of human emotions using features based on the multiwavelet transform of EEG signals. In *Brain-Computer Interfaces*, pages 215–240. Springer, 2015.
- [195] Omar AlZoubi, Rafael A Calvo, and Ronald H Stevens. Classification of EEG for affect recognition: an adaptive approach. In *Australasian Joint Conference on Artificial Intelligence*, pages 52–61. Springer, 2009.
- [196] M Murugappan. Human emotion classification using wavelet transform and KNN. In *International Conference on Pattern analysis and intelligent robotics (ICPAIR)*, volume 1, pages 148–153. IEEE, 2011.
- [197] Fatemeh Bahari and Amin Janghorbani. EEG-based emotion recognition using recurrence plot analysis and k-nearest neighbor classifier. In *The 20th Iranian Conference on Biomedical Engineering (ICBME)*, pages 228–233. IEEE, 2013.
- [198] Prasanta Chandra Mahalanobis. On the generalized distance in statistics. National Institute of Science of India, 1936.
- [199] Fabio Babiloni, Luigi Bianchi, Francesco Semeraro, J del R Millan, Josep Mouriño, Angela Cattini, Serenella Salinari, Maria Grazia Marciani, and Febo Cincotti. Mahalanobis distance-based classifiers are able to recognize EEG patterns by

- using few EEG electrodes. In *Proceedings of the 23rd Annual International Conference on Engineering in Medicine and Biology Society*, volume 1, pages 651–654. IEEE, 2001.
- [200] Kwang-Eun Ko, Hyun-Chang Yang, and Kwee-Bo Sim. Emotion recognition using EEG signals with relative power values and bayesian network. *International Journal of Control, Automation and Systems*, 7(5):865, 2009.
- [201] Enrique M Albornoz, Diego H Milone, and Hugo L Rufiner. Multiple feature extraction and hierarchical classifiers for emotions recognition. In *Development of Multimodal Interfaces: Active Listening and Synchrony*, pages 242–254. Springer, 2010.
- [202] Miran Lee, Inchan Youn, Jaehwan Ryu, and Deok-Hwan Kim. Classification of both seizure and non-seizure based on EEG signals using hidden markov model. In *International Conference on Big Data and Smart Computing (BigComp)*, pages 469–474. IEEE, 2018.
- [203] Min Wang, Sherif Abdelfattah, Nour Moustafa, and Jiankun Hu. Deep gaussian mixture-hidden markov model for classification of EEG signals. *IEEE Transactions on Emerging Topics in Computational Intelligence*, 2(4):278–287, 2018.
- [204] Dennis W Ruck, Steven K Rogers, Matthew Kabrisky, Mark E Oxley, and Bruce W Suter. The multilayer perceptron as an approximation to a bayes optimal discriminant function. *IEEE Transactions on Neural Networks*, 1(4):296–298, 1990.
- [205] Justin R Estep, Samantha L Klosterman, and James C Christensen. An assessment of non-stationarity in physiological cognitive state assessment using artificial neural networks. In *The Annual International Conference on Engineering in Medicine and Biology Society (EMBC)*, pages 6552–6555. IEEE, 2011.
- [206] Yuanfang Ren and Yan Wu. Convolutional deep belief networks for feature extraction of EEG signal. In *International Joint Conference on Neural Networks (IJCNN)*, pages 2850–2853. IEEE, 2014.
- [207] Sepp Hochreiter and Jürgen Schmidhuber. Long short-term memory. *Neural computation*, 9(8):1735–1780, 1997.
- [208] Yilong Yang, Qingfeng Wu, Ming Qiu, Yingdong Wang, and Xiaowei Chen. Emotion recognition from multi-channel EEG through parallel convolutional recurrent neural network. In *2018 International Joint Conference on Neural Networks (IJCNN)*, pages 1–7. IEEE, 2018.

- [209] Miku Yanagimoto and Chika Sugimoto. Convolutional neural networks using supervised pre-training for EEG-based emotion recognition. In *8th International Workshop on Biosignal Interpretation (BSI)*, 2016.
- [210] Samarth Tripathi, Shrinivas Acharya, Ranti Dev Sharma, Sudhanshu Mittal, and Samit Bhattacharya. Using deep and convolutional neural networks for accurate emotion classification on DEAP dataset. In *AAAI*, pages 4746–4752, 2017.
- [211] Tengfei Song, Wenming Zheng, Peng Song, and Zhen Cui. EEG emotion recognition using dynamical graph convolutional neural networks. *IEEE Transactions on Affective Computing*, 2018.
- [212] Seong-Eun Moon, Soobeom Jang, and Jong-Seok Lee. Convolutional neural network approach for EEG-based emotion recognition using brain connectivity and its spatial information. In *International Conference on Acoustics, Speech and Signal Processing (ICASSP)*, pages 2556–2560. IEEE, 2018.
- [213] Han Mei and Xiangmin Xu. EEG-based emotion classification using convolutional neural network. In *International Conference on Security, Pattern Analysis, and Cybernetics (SPAC)*, pages 130–135. IEEE, 2017.
- [214] Salma Alhagry, Aly Aly Fahmy, and Reda A El-Khoribi. Emotion recognition based on EEG using LSTM recurrent neural network. *Emotion*, 8(10), 2017.
- [215] Bahareh Nakisa, Mohammad Naim Rastgoo, Andry Rakotonirainy, Frederic Maire, and Vinod Chandran. Long short term memory hyperparameter optimization for a neural network based emotion recognition framework. *IEEE Access*, 6:49325–49338, 2018.
- [216] Babak A Taheri, Robert T Knight, and Rosemary L Smith. A dry electrode for EEG recording. *Electroencephalography and clinical neurophysiology*, 90(5):376–383, 1994.
- [217] Scott Makeig, Anthony J Bell, Tzyy-Ping Jung, and Terrence J Sejnowski. Independent component analysis of electroencephalographic data. In *Advances in neural information processing systems*, pages 145–151, 1996.
- [218] DTU Ørsted. Independent component analysis of evoked potentials in EEG. 2002.
- [219] Tomoyuki Higuchi. Approach to an irregular time series on the basis of the fractal theory. *Physica D: Nonlinear Phenomena*, 31(2):277–283, 1988.
- [220] Philip Hans Franses. Seasonality, non-stationarity and the forecasting of monthly time series. *International Journal of Forecasting*, 7(2):199–208, 1991.

- [221] G Carter, C Knapp, and A Nuttall. Estimation of the magnitude-squared coherence function via overlapped fast fourier transform processing. *IEEE transactions on audio and electroacoustics*, 21(4):337–344, 1973.
- [222] Christian Cajochen, Daniel P Brunner, Kurt Krauchi, Peter Graw, and Anna Wirz-Justice. Power density in theta/alpha frequencies of the waking EEG progressively increases during sustained wakefulness. *Sleep*, 18(10):890–894, 1995.
- [223] M Murugappan, M Rizon, R Nagarajan, S Yaacob, I Zunaidi, and D Hazry. EEG feature extraction for classifying emotions using FCM and FKM. *International Journal of Computers and Communications*, 1(2):21–25, 2007.
- [224] Murugappan Murugappan, Nagarajan Ramachandran, Yaacob Sazali, et al. Classification of human emotion from EEG using discrete wavelet transform. *Journal of Biomedical Science and Engineering*, 3(04):390, 2010.
- [225] Gavin Brown, Adam Pocock, Ming-Jie Zhao, and Mikel Luján. Conditional likelihood maximisation: a unifying framework for information theoretic feature selection. *Journal of Machine Learning Research*, 13(Jan):27–66, 2012.
- [226] Karl Pearson. Note on regression and inheritance in the case of two parents. *Proceedings of the Royal Society of London*, 58:240–242, 1895.
- [227] Judea Pearl. Bayesian networks: A model of self-activated memory for evidential reasoning. In *Proceedings of the 7th Conference of the Cognitive Science Society, 1985*, pages 329–334, 1985.
- [228] Jie Cheng and Russell Greiner. Learning bayesian belief network classifiers: Algorithms and system. In *Conference of the Canadian Society for Computational Studies of Intelligence*, pages 141–151. Springer, 2001.
- [229] Saed Sayad. Bayesian belief network. *University of Toronto*, 2010.
- [230] Belur V Dasarathy. Nearest neighbor ($\{NN\}$) norms: $\{NN\}$ pattern classification techniques. 1991.
- [231] Songbo Tan. An effective refinement strategy for KNN text classifier. *Expert Systems with Applications*, 30(2):290–298, 2006.
- [232] Pascal Soucy and Guy W Mineau. A simple KNN algorithm for text categorization. In *Proceedings IEEE International Conference on Data Mining (ICDM)*, pages 647–648. IEEE, 2001.

- [233] Monica Rogati and Yiming Yang. High-performing feature selection for text classification. In *Proceedings of the eleventh international conference on Information and knowledge management*, pages 659–661. ACM, 2002.
- [234] Luis A Berrueta, Rosa M Alonso-Salces, and Károly Héberger. Supervised pattern recognition in food analysis. *Journal of chromatography A*, 1158(1-2):196–214, 2007.
- [235] Giuseppe Amato and Fabrizio Falchi. KNN based image classification relying on local feature similarity. In *Proceedings of the Third International Conference on Similarity Search and Applications*, pages 101–108. ACM, 2010.
- [236] Marti A. Hearst, Susan T Dumais, Edgar Osuna, John Platt, and Bernhard Scholkopf. Support vector machines. *IEEE Intelligent Systems and their applications*, 13(4):18–28, 1998.
- [237] Armin Shmilovici. Support vector machines. In *Data mining and knowledge discovery handbook*, pages 231–247. Springer, 2009.
- [238] Shan Suthaharan. Support vector machine. In *Machine learning models and algorithms for big data classification*, pages 207–235. Springer, 2016.
- [239] Jason Weston. Support vector machine. *Tutorial*, http://www.cs.columbia.edu/~kathy/cs4701/documents/jason_svm_tutorial.pdf, accessed, 10(0):0–5, 2014.
- [240] Bernhard Scholkopf and Alexander J Smola. *Learning with kernels: support vector machines, regularization, optimization, and beyond*. MIT press, 2001.
- [241] Jamie Shotton, Tae-Kyun Kim, and Bjorn Stenger. Boosting and randomized forests for visual recognition. In *Tutorial at International Conference on Computer Vision*, 2009.
- [242] Binh T Nguyen, Minh H Trinh, Tan V Phan, and Hien D Nguyen. An efficient real-time emotion detection using camera and facial landmarks. In *The Seventh International Conference on Information Science and Technology (ICIST)*, pages 251–255. IEEE, 2017.
- [243] Ferran Galán, Marnix Nuttin, Eileen Lew, Pierre W Ferrez, Gerolf Vanacker, Johan Philips, and J del R Millán. A brain-actuated wheelchair: asynchronous and non-invasive brain–computer interfaces for continuous control of robots. *Clinical neurophysiology*, 119(9):2159–2169, 2008.

- [244] QiBin Zhao, LiQing Zhang, and Andrzej Cichocki. EEG-based asynchronous bci control of a car in 3D virtual reality environments. *Chinese Science Bulletin*, 54(1):78–87, 2009.
- [245] R Matthews, PJ Turner, NJ McDonald, K Ermolaev, T Mc Manus, RA Shelby, and M Steindorf. Real time workload classification from an ambulatory wireless EEG system using hybrid EEG electrodes. In *The 30th Annual International Conference on Engineering in Medicine and Biology Society (EMBS)*, pages 5871–5875. IEEE, 2008.
- [246] Jonathan Posner, James A Russell, and Bradley Peterson . The circumplex model of affect: An integrative approach to affective neuroscience, cognitive development, and psychopathology. *Development and psychopathology*, 17(03):715–734, 2005.
- [247] Robert Plutchik. The nature of emotions human emotions have deep evolutionary roots, a fact that may explain their complexity and provide tools for clinical practice. *American Scientist*, 89(4):344–350, 2001.
- [248] Phillip Shaver, Judith Schwartz, Donald Kirson, and Cary O’connor. Emotion knowledge: further exploration of a prototype approach. *Journal of personality and social psychology*, 52(6):1061, 1987.
- [249] Stefano Valenzi, Tanvir Islam, Peter Jurica, and Andrezj Cichocki. Individual classification of emotions using EEG. *Journal of Biomedical Science and Engineering*, 7(8):604, 2014.
- [250] S. M. Alarcao and M. J. Fonseca. Emotions recognition using EEG signals: A survey. *IEEE Transactions on Affective Computing*, PP(99):1–1, 2017. doi:10.1109/TAFFC.2017.2714671.
- [251] Marini Othman, Abdul Wahab, Izzah Karim, Mariam Adawiah Dzulkifli, and Imad Fakhri Taha Alshaikli. EEG emotion recognition based on the dimensional models of emotions. *Procedia-Social and Behavioral Sciences*, 97:30–37, 2013.
- [252] Mahmoud Hassan, Olivier Dufor, Isabelle Merlet, Claude Berrou, and Fabrice Wendling. EEG source connectivity analysis: from dense array recordings to brain networks. *PloS one*, 9(8):e105041, 2014.
- [253] Rishabh Gupta, Tiago H Falk, et al. Relevance vector classifier decision fusion and EEG graph-theoretic features for automatic affective state characterization. *Neuro-computing*, 174:875–884, 2016.

- [254] Pablo Arnau-González, Miguel Arevalillo-Herráez, and Naeem Ramzan. Fusing highly dimensional energy and connectivity features to identify affective states from EEG signals. *Neurocomputing*, 244:81–89, 2017.
- [255] Hanchuan Peng, Fuhui Long, and Chris Ding. Feature selection based on mutual information criteria of max-dependency, max-relevance, and min-redundancy. *IEEE Transactions on pattern analysis and machine intelligence*, 27(8):1226–1238, 2005.
- [256] Naomi S Altman. An introduction to kernel and nearest-neighbor nonparametric regression. *The American Statistician*, 46(3):175–185, 1992.
- [257] Chih-Chung Chang and Chih-Jen Lin. LIBSVM: a library for support vector machines. *ACM Transactions on Intelligent Systems and Technology (TIST)*, 2(3):27, 2011.
- [258] Tin Kam Ho. Random decision forests. In *Proceedings of the Third International Conference on Document Analysis and Recognition*, volume 1, pages 278–282. IEEE, 1995.
- [259] C Lithari, MA Klados, and PD Bamidis. Graph analysis on functional connectivity networks during an emotional paradigm. In *The XII Mediterranean Conference on Medical and Biological Engineering and Computing*, pages 115–118. Springer, 2010.
- [260] Teodiano Freire Bastos-Filho, André Ferreira, Anibal Cotrina Atencio, Sridhar Arjunan, and Dinesh Kumar. Evaluation of feature extraction techniques in emotional state recognition. In *The 4th International Conference on Intelligent human computer interaction (IHCI)*, pages 1–6. IEEE, 2012.
- [261] Hasan Murat Akinci and Engin Yesil. Emotion modeling using fuzzy cognitive maps. In *The 14th International Symposium on Computational Intelligence and Informatics (CINTI)*, pages 49–55. IEEE, 2013.
- [262] Aravind E Vijayan, Deepak Sen, and AP Sudheer. EEG-based emotion recognition using statistical measures and auto-regressive modeling. In *International Conference on Computational Intelligence & Communication Technology (CICT)*, pages 587–591. IEEE, 2015.
- [263] Ning Zhuang, Ying Zeng, Chi Zhang Li Tong, Hanming Zhang, and Bin Yan. Emotion recognition from EEG signals using multidimensional information in EMD domain. *BioMed Research International*, 2017:1–1, 2017. [doi:10.1155/2017/8317357](https://doi.org/10.1155/2017/8317357).

- [264] Seong Youb Chung and Hyun Joong Yoon. Affective classification using bayesian classifier and supervised learning. In *The 12th International Conference on Control, Automation and Systems (ICCAS)*, pages 1768–1771. IEEE, 2012.
- [265] Daimi Syed Naser and Goutam Saha. Recognition of emotions induced by music videos using DT-CWPT. In *Indian Conference on Medical Informatics and Telemedicine (ICMIT)*, pages 53–57. IEEE, 2013.
- [266] Xiaodan Zhuang, Viktor Rozgic, and Michael Crystal. Compact unsupervised EEG response representation for emotion recognition. In *International Conference on Biomedical and Health Informatics (BHI)*, pages 736–739. IEEE, 2014.
- [267] Kazuhiko Takahashi and Akinori Tsukaguchi. Remarks on emotion recognition from multi-modal bio-potential signals. In *International Conference on Systems, Man and Cybernetics*, volume 2, pages 1654–1659. IEEE, 2003.
- [268] Yisi Liu and Olga Sourina. Real-time subject-dependent EEG-based emotion recognition algorithm. In *Transactions on Computational Science XXIII*, pages 199–223. Springer, 2014.
- [269] Boris Reuderink, Christian Mühl, and Mannes Poel. Valence, arousal and dominance in the EEG during game play. *International journal of autonomous and adaptive communications systems*, 6(1):45–62, 2013.
- [270] Lindsay Brown, Bernard Grundlehner, and Julien Penders. Towards wireless emotional valence detection from EEG. In *International Conference on Engineering in Medicine and Biology Society*, pages 2188–2191. IEEE, 2011.
- [271] Viktor Rozgić, Shiv N Vitaladevuni, and Rohit Prasad. Robust EEG emotion classification using segment level decision fusion. In *International Conference on Acoustics, Speech and Signal Processing (ICASSP)*, pages 1286–1290. IEEE, 2013.
- [272] Mukesh Kumar Choudhary. Facial emotion classification from EEG signal using deep neural network. 2017.
- [273] Yimin Yang, QM Jonathan Wu, Wei-Long Zheng, and Bao-Liang Lu. EEG-based emotion recognition using hierarchical network with subnetwork nodes. *IEEE Transactions on Cognitive and Developmental Systems*, 2017.
- [274] Pouya Bashivan, Irina Rish, Mohammed Yeasin, and Noel Codella. Learning representations from EEG with deep recurrent-convolutional neural networks. *arXiv preprint arXiv:1511.06448*, 2015.

- [275] Diederik P Kingma and Max Welling. Auto-encoding variational bayes. *arXiv preprint arXiv:1312.6114*, 2013.
- [276] Danilo Jimenez Rezende, Shakir Mohamed, and Daan Wierstra. Stochastic back-propagation and approximate inference in deep generative models. *arXiv preprint arXiv:1401.4082*, 2014.
- [277] Isaak Kavasidis, Simone Palazzo, Concetto Spampinato, Daniela Giordano, and Mubarak Shah. Brain2image: Converting brain signals into images. In *Proceedings of the 2017 ACM on Multimedia Conference*, pages 1809–1817. ACM, 2017.
- [278] Changde Du, Changying Du, Jinpeng Li, Wei-long Zheng, Bao-liang Lu, and Huiguang He. Semi-supervised bayesian deep multi-modal emotion recognition. *arXiv preprint arXiv:1704.07548*, 2017.
- [279] Irina Higgins, Loic Matthey, Arka Pal, Christopher Burgess, Xavier Glorot, Matthew Botvinick, Shakir Mohamed, and Alexander Lerchner. Beta-VAE: Learning basic visual concepts with a constrained variational framework. 2016.
- [280] Irina Higgins, Nicolas Sonnerat, Loic Matthey, Arka Pal, Christopher P Burgess, Matthew Botvinick, Demis Hassabis, and Alexander Lerchner. SCAN: learning abstract hierarchical compositional visual concepts. *arXiv preprint arXiv:1707.03389*, 2017.
- [281] Irina Higgins, Arka Pal, Andrei A Rusu, Loic Matthey, Christopher P Burgess, Alexander Pritzel, Matthew Botvinick, Charles Blundell, and Alexander Lerchner. DARLA: Improving zero-shot transfer in reinforcement learning. *arXiv preprint arXiv:1707.08475*, 2017.
- [282] Wei-Ning Hsu, Yu Zhang, and James Glass. Unsupervised learning of disentangled and interpretable representations from sequential data. *arXiv preprint arXiv:1709.07902*, 2017.
- [283] Anonymous. Fitting data noise in variational autoencoder. *International Conference on Learning Representations*, 2018. URL: <https://openreview.net/forum?id=SkERSm-0->.
- [284] Shiqi Liu, Jingxin Liu, Qian Zhao, Xiangyong Cao, Huibin Li, Hongying Meng, Sheng Liu, and Deyu Meng. Discovering influential factors in variational autoencoder. *arXiv preprint arXiv:1809.01804*, 2018.
- [285] Yisi Liu, Olga Sourina, and Minh Khoa Nguyen. Real-time EEG-based emotion recognition and its applications. In *Transactions on computational science XII*, pages 256–277. Springer, 2011.

- [286] Robert Horlings, Dragos Datcu, and Leon JM Rothkrantz. Emotion recognition using brain activity. In *Proceedings of the 9th International Conference on Computer Systems and Technologies*, page 6. ACM, 2008.
- [287] Yuan-Pin Lin, Chi-Hong Wang, Tien-Lin Wu, Shyh-Kang Jeng, and Jyh-Horng Chen. EEG-based emotion recognition in music listening: A comparison of schemes for multiclass support vector machine. In *2009 IEEE International Conference on Acoustics, Speech and Signal Processing*, pages 489–492. IEEE, 2009.
- [288] M Murugappan, M Rizon, Ramachandran Nagarajan, S Yaacob, I Zunaidi, and Desa Hazry. Lifting scheme for human emotion recognition using EEG. In *International Symposium on Information Technology, ITSIm.*, volume 2, pages 1–7. IEEE, 2008.
- [289] Alicia Heraz and Claude Frasson. Predicting the three major dimensions of the learners emotions from brainwaves. *International Journal of Computer Science*, 2(3):187–193, 2007.
- [290] Panagiotis C Petrantonakis and Leontios J Hadjileontiadis. A novel emotion elicitation index using frontal brain asymmetry for enhanced EEG-based emotion recognition. *IEEE Transactions on information technology in biomedicine*, 15(5):737–746, 2011.
- [291] Mohammad Soleymani, Jeroen Lichtenauer, Thierry Pun, and Maja Pantic. A multimodal database for affect recognition and implicit tagging. *IEEE Transactions on Affective Computing*, 3(1):42–55, 2012.
- [292] Xiao-Wei Wang, Dan Nie, and Bao-Liang Lu. Emotional state classification from EEG data using machine learning approach. *Neurocomputing*, 129:94–106, 2014.
- [293] Ryan A Stevenson and Thomas W James. Affective auditory stimuli: Characterization of the international affective digitized sounds (IADS) by discrete emotional categories. *Behavior Research Methods*, 40(1):315–321, 2008.
- [294] Pouya Bashivan, Gavin M Bidelman, and Mohammed Yeasin. Spectrotemporal dynamics of the EEG during working memory encoding and maintenance predicts individual behavioral capacity. *European Journal of Neuroscience*, 40(12):3774–3784, 2014.
- [295] Olga Sourina, Yisi Liu, and Minh Khoa Nguyen. Real-time EEG-based emotion recognition for music therapy. *Journal on Multimodal User Interfaces*, 5(1):27–35, 2012.

- [296] Noppadon Jatupaiboon, Setha Pan-ngum, and Pasin Israsena. Real-time EEG-based happiness detection system. *The Scientific World Journal*, 2013, 2013.
- [297] Vadim Zotev, Raquel Phillips, Han Yuan, Masaya Misaki, and Jerzy Bodurka. Self-regulation of human brain activity using simultaneous real-time fMRI and EEG neurofeedback. *Neuroimage*, 85:985–995, 2014.
- [298] R Christopher deCharms. Applications of real-time fMRI. *Nature Reviews Neuroscience*, 9(9):720–729, 2008.
- [299] Andrea Caria, Ralf Veit, Ranganatha Sitaram, Martin Lotze, Nikolaus Weiskopf, Wolfgang Grodd, and Niels Birbaumer. Regulation of anterior insular cortex activity using real-time fMRI. *Neuroimage*, 35(3):1238–1246, 2007.
- [300] Giuseppina Rota, Ranganatha Sitaram, Ralf Veit, Michael Erb, Nikolaus Weiskopf, Grzegorz Dogil, and Niels Birbaumer. Self-regulation of regional cortical activity using real-time fMRI: The right inferior frontal gyrus and linguistic processing. *Human brain mapping*, 30(5):1605–1614, 2009.
- [301] Nicholas A Badcock, Petroula Mousikou, Yatin Mahajan, Peter De Lissa, Johnson Thie, and Genevieve McArthur. Validation of the Emotiv EPOC® EEG gaming system for measuring research quality auditory ERPs. *PeerJ*, 1:e38, 2013.
- [302] Yi-Hsuan Yang and Homer H Chen. Prediction of the distribution of perceived music emotions using discrete samples. *IEEE Transactions on Audio, Speech, and Language Processing*, 19(7):2184–2196, 2011.
- [303] Mohsen Naji, Mohammad Firoozabadi, and Parviz Azadfallah. Emotion classification during music listening from forehead biosignals. *Signal, Image and Video Processing*, 9(6):1365–1375, 2015.
- [304] Shangfei Wang, Yachen Zhu, Guobing Wu, and Qiang Ji. Hybrid video emotional tagging using users EEG and video content. *Multimedia tools and applications*, 72(2):1257–1283, 2014.
- [305] Sander Koelstra and Ioannis Patras. Fusion of facial expressions and EEG for implicit affective tagging. *Image and Vision Computing*, 31(2):164–174, 2013.
- [306] Zhihong Zeng, Maja Pantic, Glenn I Roisman, and Thomas S Huang. A survey of affect recognition methods: Audio, visual, and spontaneous expressions. *IEEE transactions on pattern analysis and machine intelligence*, 31(1):39–58, 2009.

- [307] Alain D. Bigirimana, Nazmul Siddique, and David Coyle. A hybrid ICA-wavelet transform for automated artefact removal in EEG-based emotion recognition. In *International Conference on Systems, Man, and Cybernetics (SMC)*, pages 004429–004434. IEEE, 2016.
- [308] Jingxin Liu, Hongying Meng, Maozhen Li, Fan Zhang, Rui Qin, and Asoke K Nandi. Emotion detection from EEG recordings based on supervised and unsupervised dimension reduction. *Concurrency and Computation: Practice and Experience*, page e4446.