

Feature Article

A Novel Instrument for Simultaneous In Situ NO_x and O₂ Measurement Applied to Coal-fired Power Plant Applications

Peter A. DeBarber, Hiroshi Mizutani

HORIBA has developed the INM-700, a low cost, low-maintenance, in situ instrument for simultaneously monitoring NO_x and O₂ concentrations aimed at industrial applications. The INM-700 is based on a novel use of a solid-state zirconium oxide sensor strategy. Using this new configuration, the instrument eliminates the drawbacks such as sample handling and conditioning and time lags associated with more conventional extractive sampling methods. In this paper, we review the development and testing of the HORIBA INM-700 in preparation for deployment on selective catalytic reduction (SCR) units on coal-fired power plants. We describe the sensor technology developments and modifications implemented to integrate the instrument to the SCR application. We show data to track NO_x and O₂ concentrations at a typical power plant and compare that data to conventional extractive methods. The HORIBA INM-700 data tracks plant history data sets and demonstrates this innovative and affordable approach to industrial process monitoring.

INTRODUCTION

The combustion of coal provides more than 50% of the energy needed to generate electricity in the US. One of the unwanted byproducts of coal combustion is nitrogen oxides, NO_x. To maintain compliance with Title IV of the Clean Air Act Amendments of 1990 criteria for NO_x reduction, most US coal-fired power plants use combustion modification methods and/or SCR NO_x reduction systems. For the various combustion modification techniques, the methods rely on NO_x monitoring from the CEMS at the stack or in the duct leading to the stack. Such measurements are distant from the combustion process and are frequently a composite reading of multiple units feeding into a single stack. This situation points to a need for an inexpensive, reliable, and accurate in situ unit analyzer.

Such an analyzer would also benefit SCR operations. The SCR process controls emissions of nitrogen oxides through catalytic reduction of NO_x by reaction with ammonia, NH₃, to produce nitrogen, N₂, and water, H₂O. In general, the SCR consists of a reactor chamber with a catalyst bed, and an ammonia handling and injection system. The ammonia is injected into the flue gas

upstream of the catalyst. In commercial operations, SCR systems provide reductions in NO_x emissions on the order of 90%. More efficient management and use of SCR systems may be enabled using in situ NO_x monitors at the inlet and outlet to the catalytic beds. The real time NO_x data may be used to better control the ammonia injection over the beds and also allow better catalyst health management. Most existing SCR systems on coal-fired units operating in the US make use of a limited number of NO_x measurement points using extractive sampling probes mated to chemiluminescence analyzers. The limited number of sampling points often will not provide an accurate measurement of SCR inlet and outlet NO_x levels since stratification or spatial variations of NO_x within the SCR are not accounted for. The relatively lower cost of the INM-700 in situ analyzer makes deployment of multiple sampling points economical. This will lead to improvements in SCR operation by striking a tighter balance between minimizing NH₃ slip and reducing NO_x emissions. At the same time, planned unit outages for catalyst maintenance activities may be better managed by monitoring in real time catalyst health.

In the remainder of this paper we discuss the development of the INM-700 in situ NO_x and O₂ analyzer and its

application to SCRs. We first describe the theory behind the zirconium oxide sensor. Then we discuss field testing on an SCR at a major coal-fired plant in the US. Finally we present a few concluding remarks.

THEORY: ZIRCONIUM OXIDE NO_x SENSOR

At the heart of the INM-700 is a sensor technology based on zirconium oxide, ZrO₂. This sensing strategy is an adaptation of an analogous measurement strategy used for automotive applications. In general, the ZrO₂ for sensor applications is typically processed as a zirconia-ceramic. The ceramic can have various transition metals added to enhance certain characteristics. One property that enables ceramic ZrO₂ to be used as a sensor is its porosity to oxygen ions and other molecules at temperatures above 650 °C. As we show shortly, an O₂ sensor takes advantage of this porosity. The sensor is basically an electrochemical cell and is constructed by applying a thin film of porous platinum, Pt, to two opposing surfaces of a ZrO₂ ceramic. This element divides the reference side of the cell from the sample side. The Pt films serve as the electrodes and the heated ZrO₂ serves as the electrolyte. Differences in

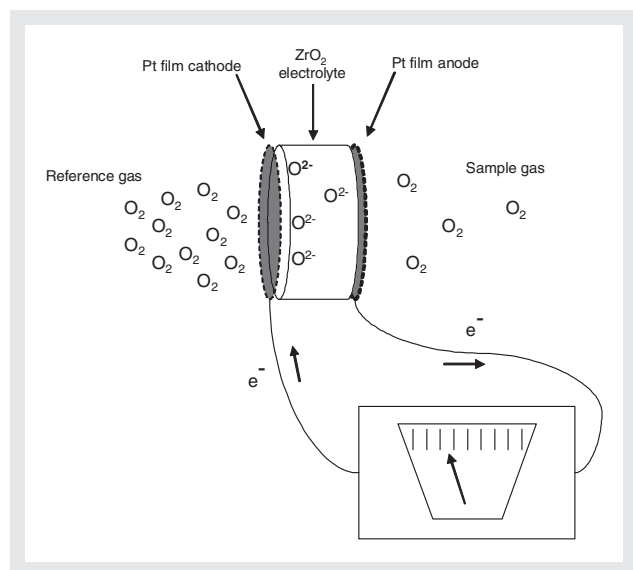

Figure 1 The zirconium oxide sensor operates as an electrochemical cell.

the partial pressure of O₂ from one side of the electrochemical cell to the other create an electromotive force. Oxygen ions, O²⁻ are able to migrate across the ZrO₂ electrolyte in a direction to restore the potential equilibrium. As long as there is a difference in the partial pressures between the reference and sample sides of the electrochemical cell, ions will migrate, and current will flow. This is illustrated in Figure 1. The electromotive force to restore the imbalance may be used to yield an

accurate measurement of the partial pressure difference between the reference and sample. Knowledge of the partial pressure within the reference gas allows calculation of the partial pressure in the sample gas.

HORIBA scientists and engineers have taken this technology a step further by incorporating a novel zirconium oxide sensor into an analyzer that is capable of simultaneously measuring O₂ and NO_x. This sensing approach was first developed by HORIBA's Engine Measurement Division for their MEXA-720NO_x product. The MEXA-720NO_x is a direct-installation gas analyzer for real-time, on-board vehicle emissions. It is used to measure NO_x and air fuel ratios in engine exhausts. HORIBA has now adapted this sensor for industrial applications in the INM-700 product (Figure 2).



Figure 2 HORIBA's INM-700 for simultaneous NO_x and O₂ industrial process applications.

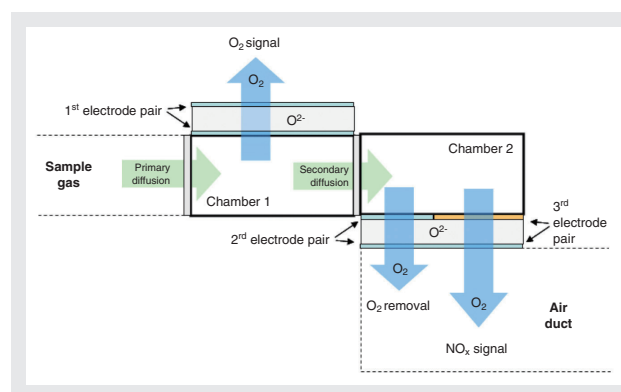

Figure 3 The two chambers of a zirconium oxide sensor may be configured for simultaneously measuring NO_x and O₂.

The underlying idea behind the sensor used in the INM-700 is schematically shown in Figure 3. The sensor is comprised of an internal heater, and two internal chambers. The chambers house three pairs of electrodes: one electrode pair in the first chamber and two electrode pairs in the second chamber. Sample gas enters the first chamber through a primary diffusion element. Within the first chamber, a Pt electrode pair is used as an

Feature Article

A Novel Instrument for Simultaneous In Situ NO_x and O₂ Measurement Applied to Coal-fired Power Plant Applications

electrochemical pump to reduce oxygen levels in the sampled gas to below 10 ppm and yield a measurement of the oxygen concentration in the sampled gas. The oxygen depleted sample gas then diffuses into the second chamber. Within the second chamber, oxygen levels are further lowered to less than 0.01 ppm by a second oxygen pumping Pt electrode pair. This also provides a feedback signal of the oxygen levels to the electrochemical pump in the first chamber to effect consistent pumping conditions with respect to the changing ambient and reference oxygen levels. The third electrode pair made of Rh is used to infer the NO_x concentration from the oxygen signal. The oxygen signal is generated as a result of the electrochemical reduction of NO in the sampled gas.

TESTING ON SCRs

Tests were conducted on the inlets and outlets of SCRs on 200 MW coal-fired units. Stream temperatures approached 370 °C. These locations are ideal for the in situ NO_x analyzer for controlling the rate and distribution of the injected ammonia over the catalyst bed. For initial testing only single probes were placed at the inlet and outlet to the SCR. Subsequent field testing (ongoing) uses

four INM-700 analyzers installed on the inlet and four INM-700 analyzers on the outlet. Such multiple probe configurations ensure adequate spatial coverage for control purposes as well as catalyst health monitoring.

Figure 4 shows the mounting locations for two of the INM-700 probes. The analyzer control boxes were located approximately 10 meters away. In practice, the control units may be located up to 50 meters from the probes. The probes were mounted adjacent to the existing extractive sampling chemiluminescence analyzer (CLA) and paramagnetic (PM) oxygen analyzer ports. The INM-700 probes were separated from the CLA by approximately 2 meters. This separation caused some bias between observed INM-700 and CLA values and is a result of stratification within the flow stream. In the next section we show a typical data trace.

RESULTS AND DISCUSSION

The power plant data traces of Figure 5 show the plant output was operating at approximately 150 MW. The NO_x measurements from the INM-700 and the plant's chemiluminescence analyzer are indicated as ppm, and

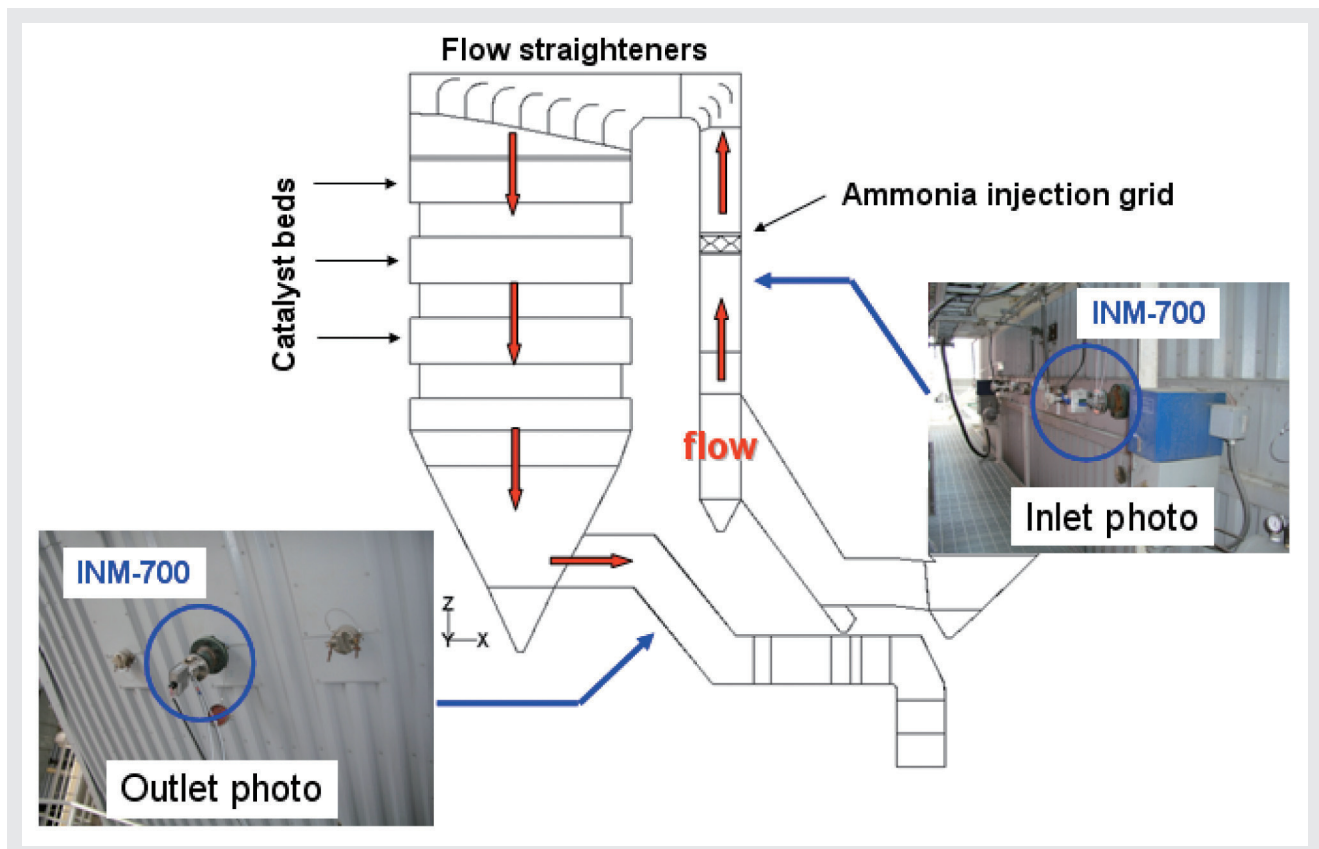

Figure 4 Simple installation and placement of the INM-700. The simplicity of the INM-700 contributes to low installation and maintenance costs.

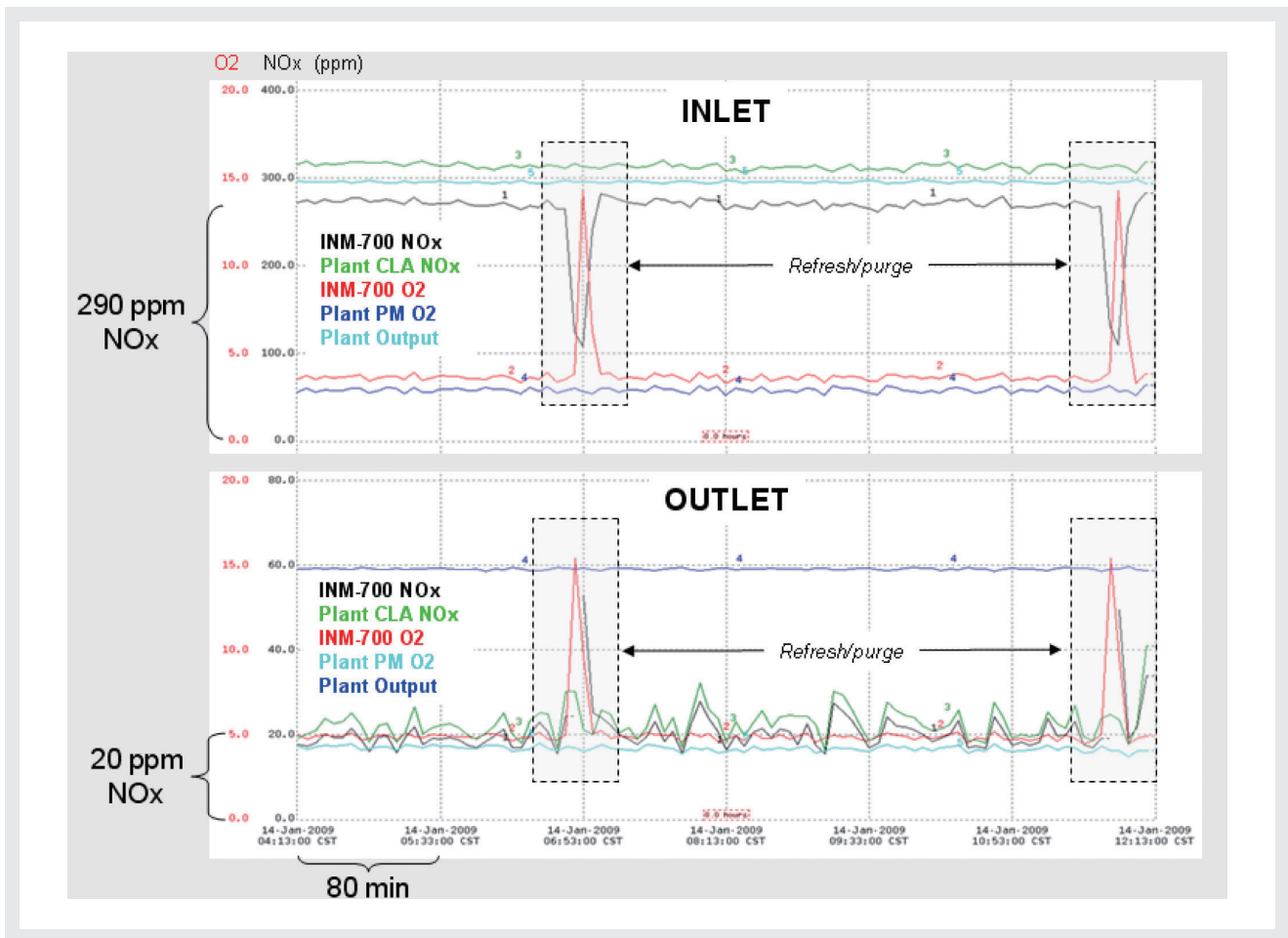

Figure 5 Data traces comparing inlet SCR measurements to outlet measurements.

the O₂ measurements from the INM-700 and the plants O₂ analyzer are labeled as percent. The data is presented as a function of time with 80 minutes between major divisions on the graph. The top half of the graph shows the data for the inlet measurements and the bottom half of the graph shows the data for the outlet. In both panels, the HORIBA INM-700 analyzers closely track the plant's NO_x and O₂ analyzers. The slight offset bias observed between the INM-700 and the CLA is due to stratification within the flow. The NO_x data for the inlet indicates that NO_x levels were steady at 290 ppm. After SCR treatment, at the outlet, the data shows that NO_x has been considerably reduced to 20 ppm. Such data show that this SCR was operating at 90% efficiency.

The regions of data outlined by the dashed boxes show INM-700 operation during sensor refresh/purge periods. The sensor refresh/purge mode is a feature that increases sensor stability and longevity. Periodically a high voltage is applied to the sensor element that aids desorption of any contaminants that may rest on the surface of the sensor. After the refresh voltage, the sensor is purged using instrument air. The purge air removes the desorbed contaminants. The frequency and period of the refresh/

purge cycle is on the order of 5 hours for approximately 10 minutes. In practice, the frequency is increased as the sensor ages. For example, a new sensor may only need a refresh/purge cycle every 12 hours. An older sensor may require refresh/purge twice as often.

In addition to data recorded during SCR operation, we also used x-ray fluorescence to analyze the accumulated dust and fly ash both inside and outside the probe tip (see Figure 6). Our initial concerns were related to the formation of NH₄SO₄ ammonium bisulfate (ABS) on the sensor. Figure 6 shows the results of this analysis. The samples were mostly two types of particles: a lighter colored, 200 micron-sized (average) particle predominantly consisting of oxygen, aluminum, and silicon and a darker, 300 micron particle of mostly carbon. Both these particles are characteristic of normal fly ash and unburned coal particles. Based on the x-ray fluorescence spectra, there was no evidence of ABS formation on and within the probe. Regardless, a redesign of the probe tip has now eliminated the possibility of dust and ash accumulating inside the probe tip.

To access the relative health of a used zirconium oxide

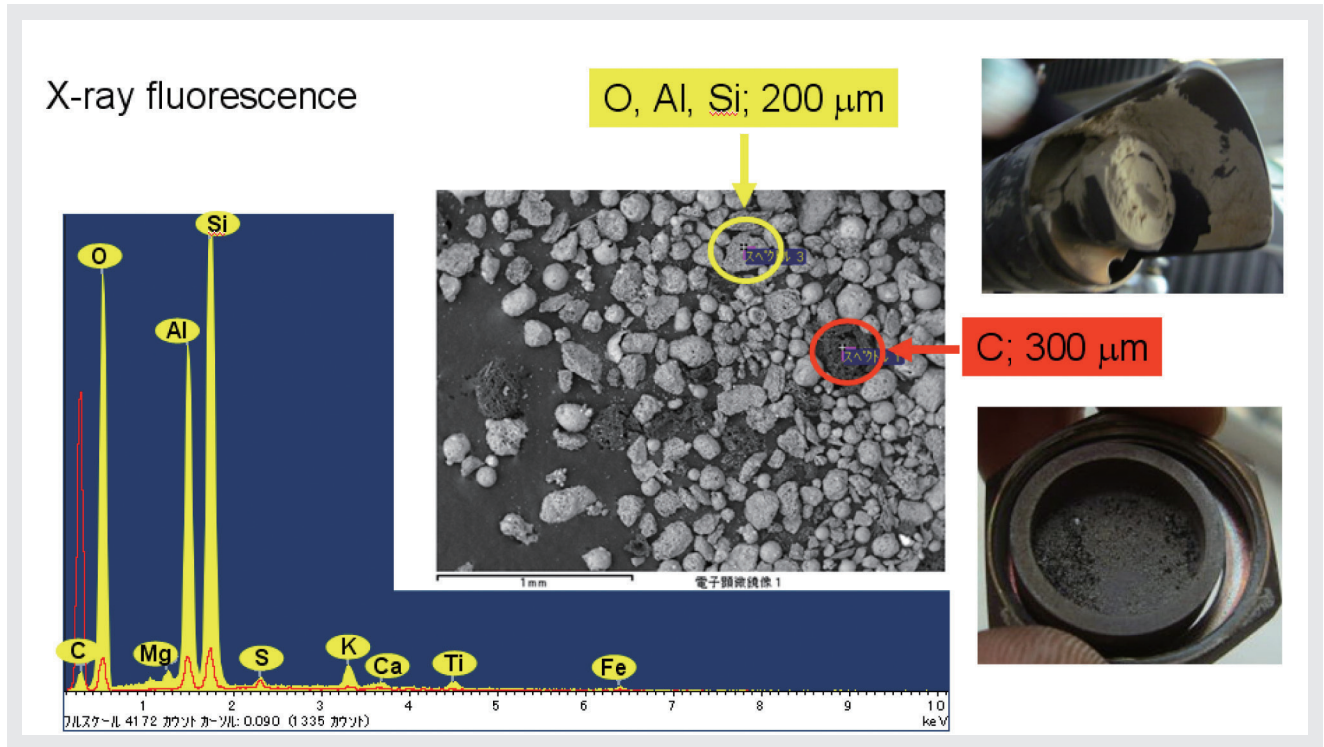

Figure 6 X-ray fluorescence analysis of dust and fly ash on and in the probe tip indicated no ammonium bisulfate formation.

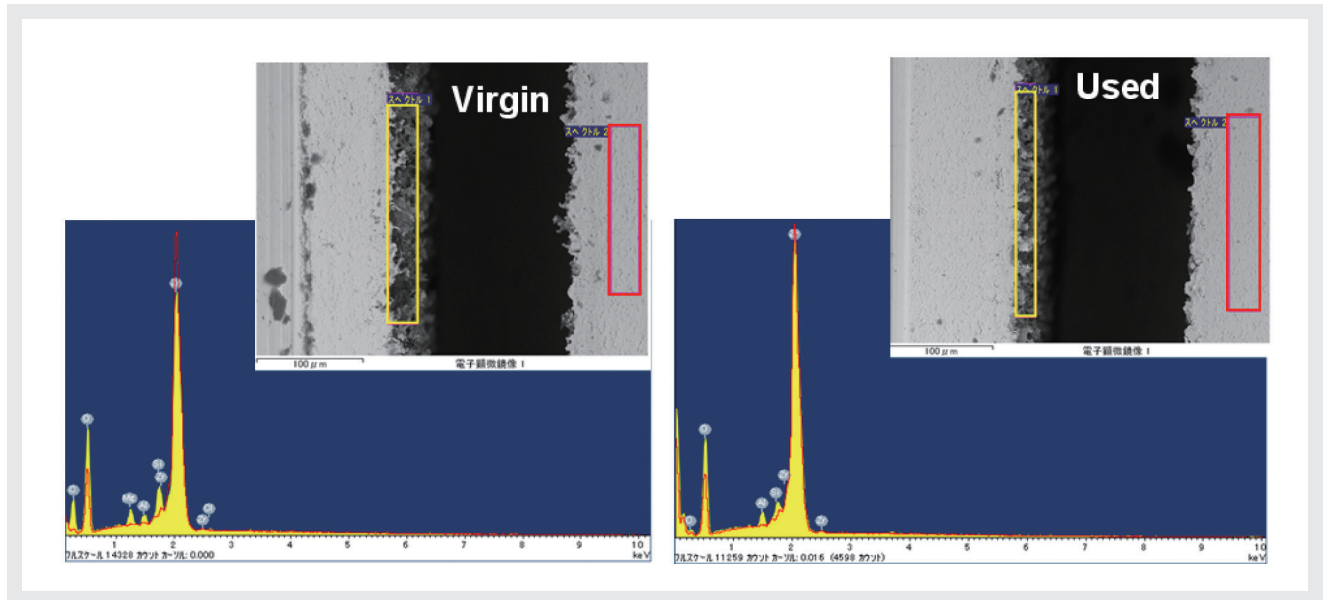

Figure 7 Comparison x-ray fluorescence analysis between a one year old sensor and a virgin, unused sensor. There was no significant contamination observed on the used sensor.

sensor, we also recorded x-ray fluorescence spectra of a sensor that had been in operation for one year and a fresh, unused (virgin) sensor. Figure 7 shows the results of this comparison analysis. The results indicated no significant contaminants on the used sensor.

CONCLUSIONS

This paper reviewed the general operating principles behind zirconia-ceramic based sensors and introduced a new approach for the in situ, simultaneous measurement of NO_x and O₂. The benefits of this new approach are in the area of improved time response and lower life cycle

costs in comparison to existing extractive sampling methods. The zirconium oxide sensor technology is well-established and reliable. The refresh feature of the analyzer ensures steady and accurate data. Test results on a 200 MW coal-fired power plant on an operating SCR inlet and outlet were presented and demonstrate viability for this application. The real-time measurements verified that the SCR catalyst was performing to specification of 90% NO_x reduction. Post test analysis on dust and fly ash indicated no problems with ABS or sensor contamination. Field tests continue on an ammonia injection grid controls project. Preliminary results look promising. For more up to date information, please contact the authors.

ACKNOWLEDGMENTS

The authors wish to thank many individuals including fellow Horibarians, Dick Bates, Shigeyuki Hokamura, Dave Horstman, and Satoshi Inoue.

References

- [1] Institute of Clean Air Companies, White Paper Report “Selective Catalytic Reduction (SCR) Control of NO_x Emissions from Fossil Fuel-fired Electric Power Plants,” May 2009.
- [2] A. Kunimoto, Y. Yan; Yongtie, M. Hasei, H. Kurosawa, Y. Nakanouchi; Yukio, NO_x Sensor, US Patent 6126902, October 2000.



Peter A. DeBarber

Business Development
Process & Environmental
HORIBA Instruments, Inc.
Ph.D.

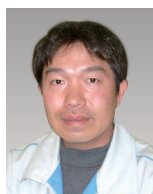

Hiroshi Mizutani

Quality Management Center
HORIBA, Ltd.