



# INTERNATIONAL JOURNAL OF ADVANCE RESEARCH, IDEAS AND INNOVATIONS IN TECHNOLOGY

ISSN: 2454-132X

(Volume2, Issue3)

Available online at: [www.ljariit.com](http://www.ljariit.com)

## Optimise the Gain of Optical Signal by SOA with Saturated ASE and Unsaturated ASE

**Shilpa Thakur**

*Student (E.C.E)*

*Rayat Bahra University, Mohali*

[st3793@gmail.com](mailto:st3793@gmail.com)

**Er.Vivek Gupta**

*Astt.Professor (E.C.E)*

*,Rayat Bahra University, Mohali*

[vivekgupta@rayatbahra.com](mailto:vivekgupta@rayatbahra.com)

---

**Abstract**— *Optical Amplifiers are essentials components in long haul fibre optic system. An amplifier is a electronic device that can increase the power of signal. An Optical Amplifier is effectively the opposite of attenuator while Optical Amplifiers provide gain and attenuator provides loss. When a signal travels in a optical fibre medium the signal suffer from various losses such as fibre losses, attenuation losses, fibre splice losses, reduce these loses use the Semiconductor method with saturated and unsaturated Amplified Spontaneous Emission. It reduces the phase shift and recover original signal.*

**Keywords**— *Optical fibre communication, Optical Amplifiers, SOA, Self-Phase Modulation, Amplified Spontaneous Emission.*

---

### I. INTRODUCTION

The transmission of message is old as life on earth. The transformation of electrical signal in which data can be send and receive began in 19th century by the appearance of telegram framework. Telegram uses a beat electrical signal which is decoded at collector end. After telegram framework, cellular telephone comes in existence in 1970. The first simple utilize portable telephone frame work is AMPS and that was used in Tokyo Japan in 1970. After cellular telephone, optical fibre comes in existence. Optical fibre is a fast transmission medium for transferring information between urban communities, nation and continents. The transmission distance of any fibre optic communication is eventually limited by fibre losses. The regenerator and optoelectronic repeater are used to overcome the losses in long haul system. Regenerator are quite complex and expensive for wavelength division multiplexed (WDM) light wave system. An optical amplifier is a alternative approach for loss management which amplify the optical signal directly. Optical amplifier amplifies the light through stimulated emission having laser without feedback. Optical gain is the main ingredient of the optical amplifier and it is realized when amplifier is pumped (optically or electrically) to achieve population inversion. In general optical gain depends on the frequency of the incident signal but also on the local beam intensity at any point

inside the optical amplifier [1]. Semiconductor optical amplifier is used to amplify optical signals. It is based on a semiconductor gain medium [2]. Semiconductor Optical Amplifier has ultra band spectrum and provide better result when no. of channel are increases. In semiconductor optical amplifier the gain saturation problem arises due to cross gain modulation, cross phase modulation and four wave mixing [3]. If power can be transfer from one channel to another when therefore cross talk occur and it degrades the system performance. Such a transfer can occur because of nonlinear effects in optical fibbers [1]. Self phase modulation is a fundamental non linear effect that leads to spectral broadening of optical pulses. The main idea behind Self phase modulation in Semiconductor Optical Amplifier was found the gain saturation which leads to the intensity dependent changes in the refractive index in response to variation in carrier density [4]. The noise can be generated by active medium of an optical amplifier is called Amplified Spontaneous Emission. The spontaneously emitted photons which follow the direction of the information signal that are amplified by an active medium [5].

Drew N. May war [6] proposed that the self-phase modulation (SPM) induced by gain dynamics on picoseconds pulses in semiconductor optical amplifier and the gain recovery of semiconductor optical amplifier is effected by amplified spontaneous emission (ASE) is investigated. They observed that the pulse spectra which are highly asymmetric at low drive currents but they showing more asymmetric with increasing current, owing to the ASE-induced reduction in the gain recovery.

R. Bonk [7] proposed that the input power dynamic range (IPDR) of a semiconductor optical amplifier (SOA) gives the input power range within which an SOA can be operated error free. These parameters are favourable, especially for the upper IPDR limit, by providing a large saturation power. Further, a high bias current is preferable for a large IPDR.

Naohide Kamitani [8] proposed that the pattern effect in semiconductor optical amplifier (SOA) is experimentally investigated in 40Gbps coherent 16QAM transmissions. The input pattern dependent gain fluctuations due to the slow carrier recovery time.

Jesper Mørk [9] analyses the noise spectrum of a semiconductor optical amplifier excited by an amplitude-modulated input signal is presented. The well-established theory for the case of continuous-wave input signals and is relevant for various applications within optical signal processing. Therefore, the analysis of noise in microwave photonic elements based on slow-light propagation in semiconductor optical amplifiers.

Ibrahim A. Murdas [10] proposed that the nonlinear effects in optical fibres such as self- phase modulation (SPM) and cross phase modulation (XPM) that lead to impairments of the optical signal transmitted in wavelength division multiplexing (WDM) systems in single mode optical fibres.

## II. OPTICAL AMPLIFIERS

Optical Amplifiers are essential components in long haul fibre optic system. An amplifier is a electronic device that can increase the power of signal. An Optical Amplifiers is effectively the opposite of attenuator while optical amplifiers provide gain and attenuator provides loss [2]. When a signal travels in a optical fibre medium then signal suffer from various losses such as fibre losses, attenuation losses, fibre splice losses. The signal can be detected at receiver side is very difficult due to these losses. Therefore, the signal can be transmitted over a long distances in a fibre and it is also important to boost up the signal within the fibre. The block diagram of optical Amplifier as shown below:

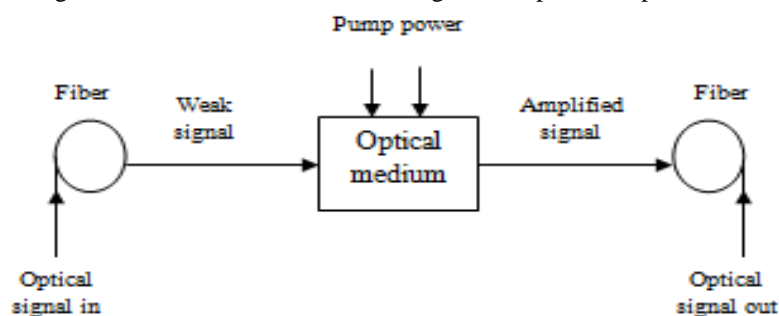

Figure 2.1 Block diagram of optical Amplifier.

Optical Signal are converted into electrical signal then amplification and then it is reconverted into optical signal. This is a quite complex and costly procedure. Three main classes of optical amplifier are: Raman Amplifier, Erbium-Doped fibre Amplifier, Semiconductor optical Amplifier [11].

### III. SEMICONDUCTOR OPTICAL AMPLIFIER

Semiconductor Optical amplifier have been widely used to perform variety of all optical function such as wavelength conversion, signal regeneration and pulse reshaping [5]. Semiconductor optical amplifier work on the principle of stimulated emission. It is used for amplify the optical information signal. The optical input signal enters in the active region with the help of coupling optics. Two same type of coupling optics are used. Coupling is required in single mode fibre. At conduction band the external energy is necessary to pump the electron. The transition of electron down to the valence band is stimulated by input signal and emission of photon having same energy and same wavelength. Therefore, the output in amplified optical signal is obtained [12].

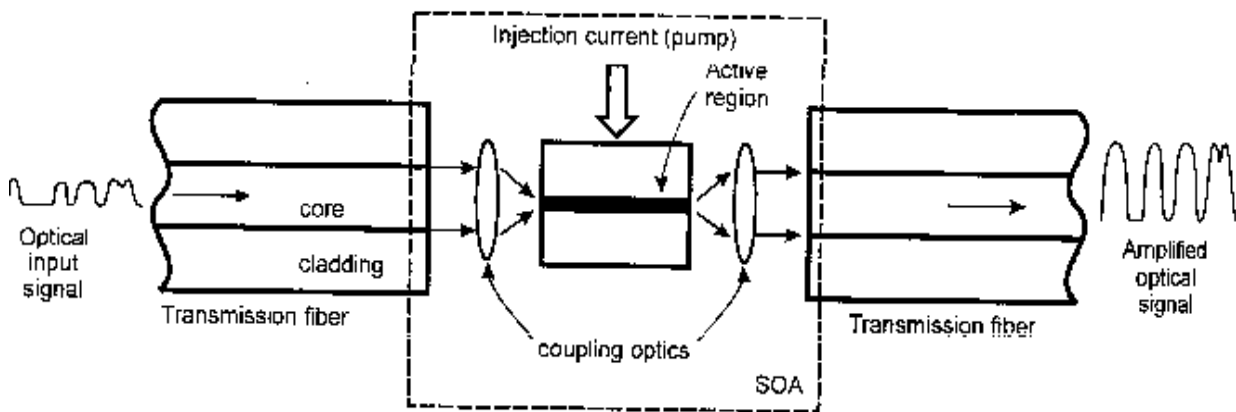

Figure 3.1 Semiconductor Optical Amplifier [12].

Semiconductor Optical Amplifier may also reduce the carrier recovery time and can be used for patterning reduced application. Semiconductor Optical Amplifier are also introduce higher amount of noise due to amplified spontaneous emission [13].

### IV. SELF-PHASE MODULATION

Self phase modulation is a non linear it occur when nonlinear phase modulation of optical pulse is caused by its own intensity in an optical medium. Optical pulse travel down the fibre, the leading edge of pulse causes the refractive index of the fibre to increase causing a blue shift while the falling edge of the pulse decreases the refractive causing a red shift. These shifts introduce a frequency chirp on each edge and signal is broadened in the frequency domain by an amount given as:

$$\Delta B = \gamma L_{eff} \frac{dP}{dt}$$

Where  $dP/dt$  is the time derivative of the pulse power,  $\lambda$  is the non-linear coefficient and  $L_{eff}$  is the effective length [14].

### V. AMPLIFIED SPONTANEOUS EMISSION

The impact of Amplified Spontaneous Emission induced gain saturation on signal amplification in SOA with emphasis on the self phase phenomenon in the pulsed case. The total Amplified Spontaneous Emission Power is long the length of the amplifier and increases with the current injected into the SOA [4].

## VI. SIMULATION

### I. Input Pulse Graph:

The values for parameter Time and Amplitude are represented in Table 6.1

Table 6.1 Input Table

Parameter	Value
Time (ps)	3070 – 4050
Amplitude (hz)	0.025

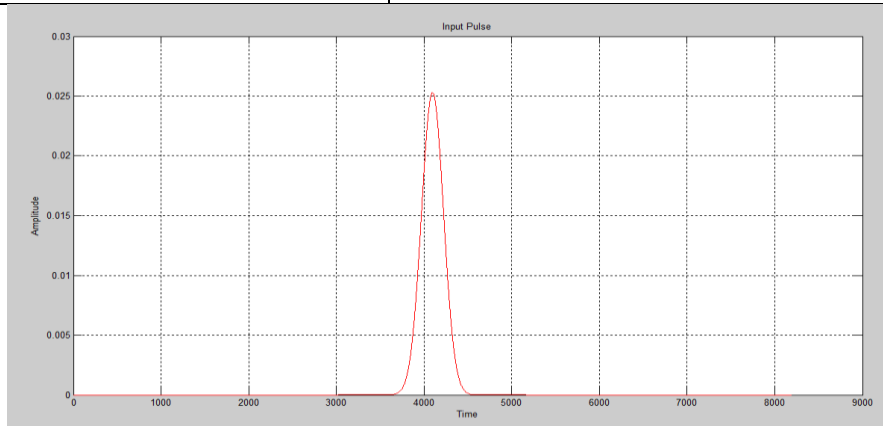

Figure 6.1 Input Pulse

In figure 6.1, x label is used for Time (ps) and y label is used for Amplitude (Hz). Input pulse lies between Time and Amplitude. This is a simple input pulse graph using two parameters.

### II. Pulse Evolution Graph:

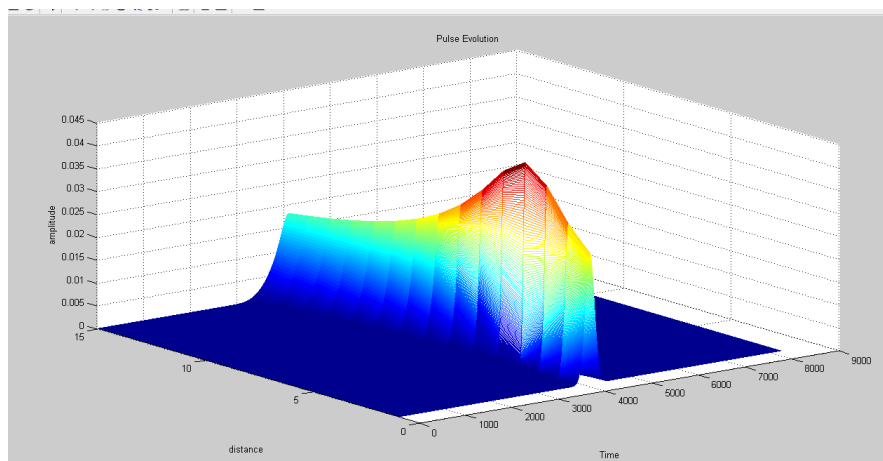

Figure 6.2 Pulse Evolution

In figure 6.2, x label represents Time (ps) and y label represents Distance and z label represents Amplitude (Hz). Input pulse lies between Time, Distance and Amplitude. It uses three parameters for representation. This is a 3D representation of input signal

### III. Pulse Broadening Ratio Graph:

The values for number of steps and pulse broadening ratio are represent in table6.2:

Table 6.2 Pulse ratio increased table

Parameter	Value
Pulse broadening Ratio	Max.2
No. of steps	0-15

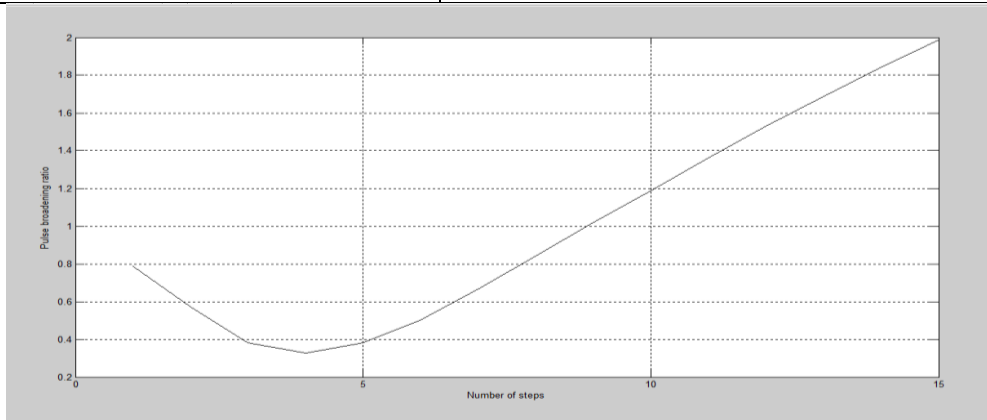

Figure 6.3 Pulse Broadening Ratio

In figure 6.3, x label represents number of steps used by each input pulse and y label represents pulse broadening ratio. If pulse ratio is increased means step size of each input pulse is increased and gain is also increased. This means that gain of Semiconductor Optical Amplifier is increased.

IV. Achieving Gain without ASE Graph:

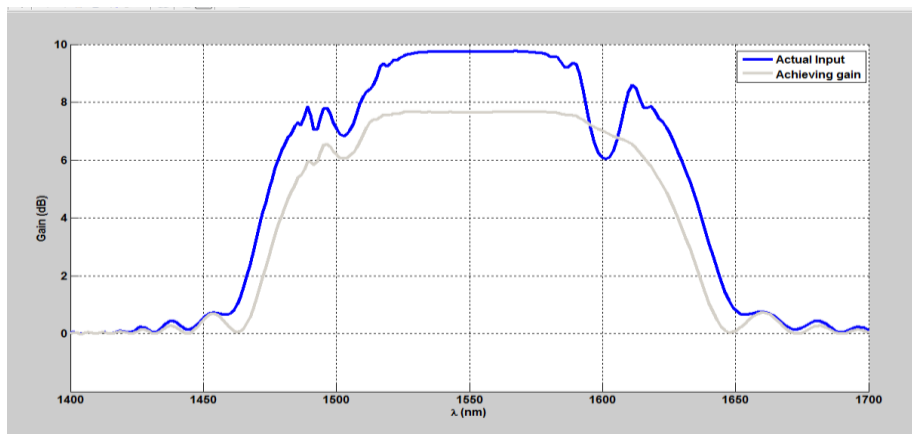

Figure 6.4 Achieving gain without ASE

In figure 6.4, gain is represented without ASE and  $\lambda$  represent wavelength (nm) and its values lies between 1400- 1700. Gain is measured in terms of dB. Noise is introduced without ASE. White line represents how much gain is achieved. Blue line represents actual condition. This is phase shifting graph. Maximum value of gain is achieved 79 percent. White line is Achieving gain line it does not follow the actual input. When ASE is negligible gain is flat. Without ASE gain is decreased as compared to actual input. When ASE is negligible then gain recovery time for SOA is much longer then input pulse. This method does not achieve good improvement in gain. It has a maximum noise.

V. Achieving Gain with ASE Graph:

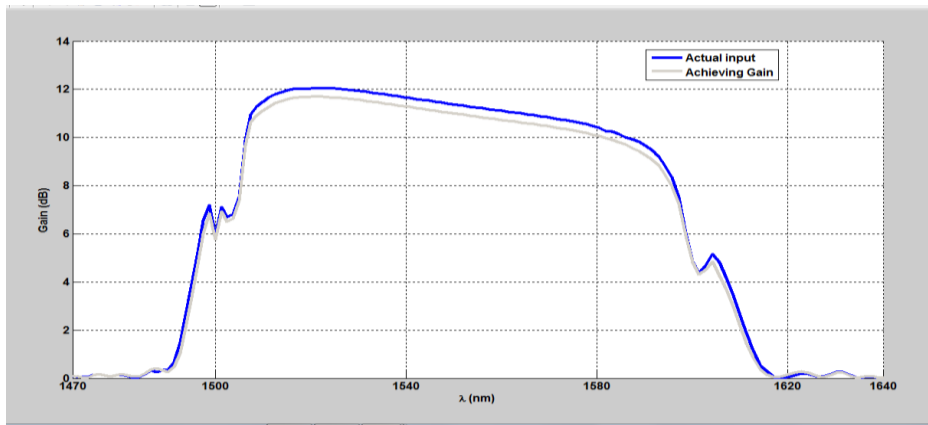

Figure 6.5 Achieving Gain with ASE

In figure 6.5, gain is represented with ASE and  $\lambda$  represent Wavelength (nm). Gain is measured in terms of dB. White line represents how much gain is achieved. Blue line represents actual condition. This is a phase shifting graph. In this figure, maximum value of gain is achieved 100 percent. White line is achieving gain and it follows the actual input. Therefore, gain is overlap with actual input. When ASE is present in SOA it saturates the gain and reduce the gain recovery time. In this figure, when ASE is present then gain is improved and it shows gain improvement in SOA amplifier.

VI. Gain is minimized without ASE:

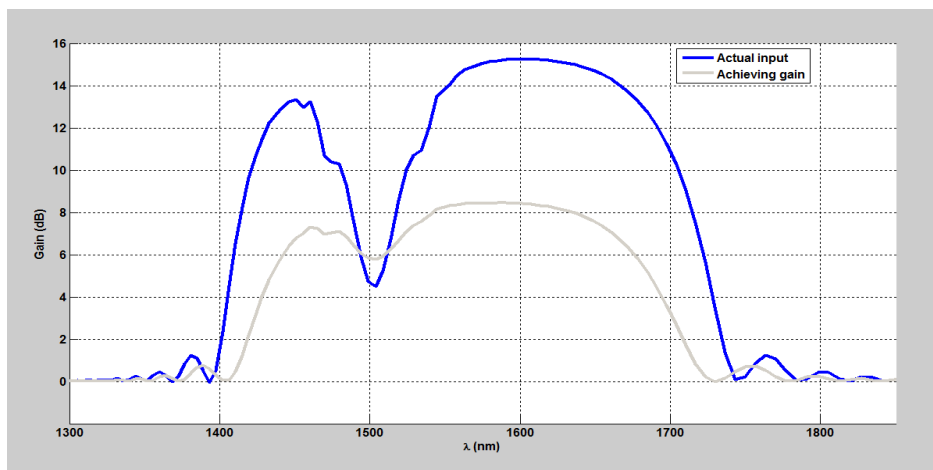

Figure 6.6 Gain is minimize without ASE

In figure 6.6, gain is represented without ASE effect and  $\lambda$  represent wavelength and values lies between 1300- 1700. Gain is measured in terms of dB. Noise is introduced without ASE. White line represents how much gain is achieved. Blue line represents actual condition. Gain is increased at first level 65 percent and then it slightly decreases at value 60 percent then it also increases about 80 percent. In the above figure, pulse width is very small and ASE is not present so it take a longer time for gain recovery. Therefore, gain is minimized and noise is maximum in this method.

VI. CONCLUSIONS

Semiconductor Optical Amplifier have been widely used to perform variety of all optical function such as wavelength conversion, signal regeneration and pulse reshaping. Semiconductor Optical Amplifier work on the principle of stimulated emission. It is used for amplify the optical information signal. The optical input signal enters in the active region with the help of coupling optics. Two same type of coupling optics are used. Coupling is required in single mode

fiber. At conduction band the external energy is necessary to pump the electron which mathematical optimized with ASE and unsaturated ASE, so we can gain according to show in graph of ASE better results.

#### REFERENCES

- [1] Govind P. Agarwal, Optical Amplifier, Fiber-Optic Communication Systems, Third Edition, New York: John Wiley & Sons, 2002.
- [2] Prince Jain and Neena Gupta “Comparative study of all Optical Amplifiers,” International Journal of Scientific & Engineering Research (IJSER), Volume 5, Issue 11, November 2014.
- [3] Simranjit Singh and R.S. Kaler “Performance evaluation of EDFA, RAMAN and SOA optical amplifier for WDM systems,” Science direct ELSEVIER, June 2010.
- [5] Prashant P. Bavega and Drew N. Maywar “Self Phase modulation in semiconductor optical amplifier: Impact of Amplified Spontaneous Emission,” IEEE journal of quantum electronics, vol. 46, no. 9, September 2010.
- [6] Drew N. Maywar Aaron M. Kaplan “Spectral broadening in ultrafast semiconductor optical amplifier induced by gain dynamic and Self phase modulation” OPTICS LETTER, vol. 35, no. 3, February 2010.
- [7] R.Bonk and C.Meuer “The Input Power Dynamic Range of a Semiconductor Optical Amplifier and Its Relevance for Access Network Applications” IEEE Photonics journal, vol. 3, no. 6, December 2011.
- [8] Naohide Kamitani and Suita “Experimental Study on Impact of SOA Nonlinear Phase Noise in 40Gbps Coherent 16QAM Transmissions” ECOC Technical Digest, 2012.
- [9] Jesper Mørk and Soren Blaaberg “Noise Spectrum of a Semiconductor Optical Amplifier Excited by a Modulated Signal” IEEE journal of quantum electronics, vol. 50, no. 4, April 2014.
- [10] Ibrahim A.Murdas and Talib M.Abbas “Numerical simulation for self phase modulation and cross phase modulation in optical fibre” IJSR, volume 3, issue 11, November 2014
- [11] Shivani Radha Sharma and Tanvi sood “Gain Flattening of EDFA using Hybrid EDFA/ Raman Amplifier with Reduced Channel Spacing,” IJEDR, volume 3, issue 3, 2015.
- [12] Djafar K. Mynbaev, Components of fibre- optic network, Fiber- Optic Communications Technology, Pearson education, 2001.
- [13] Kamal Hussain and Satya Pratap Singh “Effect of input signal and filter parameters on patterning effect in a semiconductor optical amplifier” Science Direct ELSEVIER, June 2013.