

NANO MANIPULATION WITH RECTANGULAR CANTILEVER OF ATOMIC FORCE MICROSCOPE (AFM) IN A VIRTUAL REALITY ENVIRONMENT

M. H. KORAYEM^{a*}, S. ESMAEILZADEHHA^a, N. RAHMANT^b,
M. SHAHKARAMI^b

^aScience and Research Branch, Islamic Azad University, Tehran, Iran

^bIslamic Azad University of Qazvin, Qazvin, Iran

One of the problems of working with AFM in nano environment is lack of simultaneous image feedback. For solving this problem, a virtual reality environment (VR) is designed. For this purpose, a nano manipulation environment is implemented and then, through examining and analyzing the forces existing between probe tips and nanoparticle, the process of nanoparticle driving is added to this environment. In the first step of nano manipulation operations, the dimensions of the base plan as well as the exact place of nanoparticles on that plan needs to be defined so that the user can identify the place of the origin and nanoparticles' destination. The second step in simulation is driving the nanoparticle. In this process, the AFM probe tip starts moving toward nanoparticle with a constant speed of V_{afm} and after touching it and applying F_T resultant force from probe tip side on nanoparticles and increasing up to critical value (F_{cr}), it overcomes contract and frictional forces existing between the particle and base plane. In this moment, the probe tip starts moving along with nanoparticle and as a result the nanoparticle is transferred to the pre-determined place by the user. Thus the user may observe the manipulation process.

(Received February 6, 2012; Accepted March 20, 2012)

Keywords: AFM, Rectangular Cantilever, Virtual Reality Environment, Manipulation of Nanoparticle.

Nomenclature

R_p	radius of nanoparticle
R_{tip}	tip radius
V_{sub}	substrate velocity
L	length of cantilever
t	thickness of cantilever
H	probe height
D	tip distance from free end of cantilever
ρ	density
m	mass
I_p	moment of inertia
E	Young's module
G	shear modulus
ϑ	Poisson's ratio
K_y	lateral spring constant of the cantilever
K_z	normal spring constant of the cantilever
K_θ	torsional spring constant of the cantilever
K_x	longitudinal spring constant of the cantilever
K_α	bending spring constant of the cantilever
ω	work of adhesion (energy per unit area of two flat surfaces)

* Corresponding author: hkorayem@iust.ac.ir

φ_0	initial deformation of cantilever
φ	probe/nanoparticle contact angle
z_{p0}	initial normal deflection
τ_s, τ_t	shear strength of the particle/substrate or tip/ particle sliding in contact area
τ_{rs}, τ_{rt}	shear strength of the particle/substrate or tip/ particle rolling in contact area
μ_d	friction coefficient of nano particle sliding on substrate (stationary state)
μ_s	friction coefficient of nano particle sliding on substrate
μ_r	friction coefficients of nano particle rolling on substrate
μ_t	friction coefficient of tip sliding on nanoparticle
τ_r, τ_s	shear strength of contact in sliding or rolling
A_t, A_s	tip/nanoparticle or contact area
$\delta_{sub}, \delta_{tip}$	tip/nanoparticle or substrate/nanoparticle indentation depth
θ	torsion angle of cantilever
y_p	horizontal deformation of probe cantilever
z_p	vertical deformation of probe cantilever
y_T	horizontal displacement of probe tip
y_T	vertical displacement of probe tip
y_{sub}	horizontal displacement of substrate
z_{sub}	vertical displacement of substrate
F_y, F_z	the cantilever bending forces
M_θ	torsional torque of cantilever
V	shear force
f_t, f_s	tip–particle and particle–substrate friction
F_t, F_s	tip–particle and particle–substrate normal forces in contact area
F_Y, F_Z	vertical and horizontal forces of the probe tip
F_T	pushing force
F_s^*	critical forces for sliding on substrate
F_r^*	critical forces for rolling on substrate
F_{cr}	critical force (tip forces on the particle to overcome adhesion forces)
t_{cr}	critical time(beginning time of nanoparticle motion on substrate)

1. Introduction

Nanomanipulation of nanoparticles has been widespread of interest for the last years, and dynamic modeling is a basic tool for understanding the pushing procedure at real time. Nanoparticles can be traced every moment and it makes possible to locate nanoparticles at desired positions for nanoassembly. The initial model for pushing was provided by Falvo [1], but in this model, the forces due to the scale changing were not considered. The first model that considers surface forces and contact deformations is proposed by Sitti [2]. It uses Johnson–Kendall–Roberts (JKR) theory of contact mechanics in which a discrete system model is used to design teleoperating control of pushing. Kim et al. have studied modeling of nanoscale mechanics for pushing and picking/placing purposes but they have not modeled the pushing procedure completely [3]. Tafazzoli and Sitti have presented a more complete model for the nanoparticles pushing. They have tried to simulate a real-time nanomanipulation [4, 5]. Using this model, Korayem and Zakeri have studied pushing of nanoparticles and developed the model to obtain the sensitivity of pushing critical force and critical time due to variations of geometrical and material parameters [6, 7].

The reason for designing a virtual reality environment is the fact that one probe has been used for two functions: scanning and nanomanipulation; in a physical dimension these two functions cannot be done simultaneously. Generally, the limitation of this method is that while manipulating the sample the graphical representation is fixed and hence more additional scanning is needed for observing manipulation results.

As it was mentioned before, some researchers like Sitti has been mostly focused on remote control nanomanipulation and they have nanomanipulated the nanoparticle with AFM. But, in this

study, for reducing the costs designing a virtual reality nanomanipulation environment has been attempted so that the nanomanipulation could be tested in this environment and in case its results were ratified then it could be done in real world environment. According to validation trials the obtained results from nanomanipulation environment is quite the same as the results that Sitti has attained in his real world nanomanipulation.

The experiment done in this article is very close to what Guangyong Li and Ning Xi have done. Both works indicate nanoparticle nanomanipulation in a virtual reality environment [8]. But, the difference between this study and the above works is the fact that the designed virtual reality environment in this study is more extended. In this environment one can also investigate the effects of different geometries of cantilevers in nanomanipulating nanoparticles and hence it can be concluded that which cantilever will minimize the needed level of exerted force for nanomanipulation and also nanoparticle's start time movement.

In this paper, a virtual reality environment that goes with that nanoparticle is designed. First stage is to create a primary working environment in nano-environment for nanoparticles to be placed in. Position of nanoparticles is chosen randomly so that in every operation the position of the particles changes. This is a capability of this program that shows the nanoparticles in two ways; another advantage is that the user can enter the number of nanoparticles to be shown. In the second stage of operation, the user can choose one of the nanoparticles for nanomanipulation operation—it is driving of the selected nanoparticle. Finally the user can observe the step by step process of manipulation by choosing the position into which the particle should move.

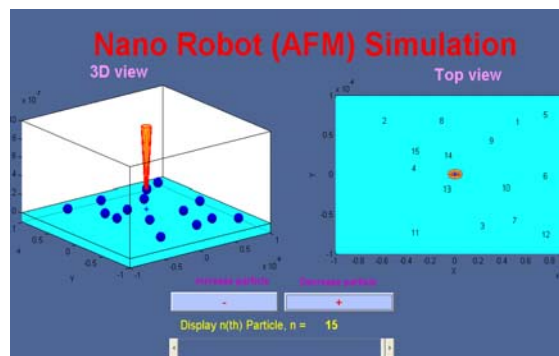

Fig.1: Nano particle positioning.

A. Nanoparticle Positioning

As you see in Figure 1, nanoparticles are seen as blue globes with default radius of $R_p=50\text{nm}$. These are placed on the base plate in a one-layered form by a series of chemical operations so that the minimum specified distance between each globe is observed. The tip of the cantilever probe, also, is seen as red cone with radius $R_{tip}=20\text{nm}$. In the designed software, after seeing the position of the nanoparticles, the user should mark the specified nano particle he wants to manipulate for the system. To do so, each nano particle is given a number for the user to see. The two keys + and – in the figure is to reduce or increase the number of nanoparticles.

B. Choosing the end nano particle and specifying destination coordinates

After finishing above stages, and specifying the desired nanoparticle, the user should enter the desired number in the software. After this the final coordinates for manipulation should be defined. This can be done through a slippery band in the program. With the aid of this band X or Y coordinates can be specified separately so that the other one does not change. While the user is working with the window in Figure 2, he can simultaneously see the final result as well as stages of manipulation whose information changes dynamically. As you can see in Figure 2, the tip of AFM probe has a safe height by name of h_{safe} . This safe height is designed for preventing the tip of the probe of being hit and damaged by nanoparticles or other physical obstacles when it moves toward the aimed nanoparticle. In this program, it is assumed that the only particle that the user

has chosen for manipulation is on the base plate or at least there is no other nanoparticle or physical obstacle on the chosen way of manipulation by the user.

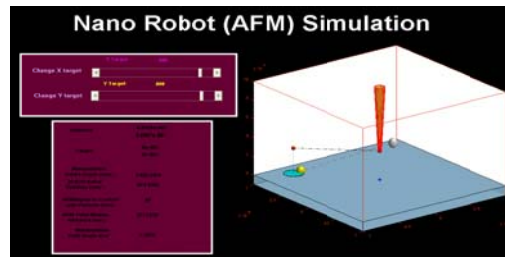

Fig.2: Specifying final coordinates of manipulate by the user and observing the information of the manipulation path while changing coordinates.

2.1 Modelling of nano manipulation

The spring constants are calculated by considering the forces along an Euler–Bernoulli beam when a load is placed at its free end. AFM probe, as a nano manipulation tool, consists of a tip connected to a cantilever. The geometry and dimensions of the nano manipulator are shown in Fig.3. Stiffness coefficients of the cantilever are function of geometry (L , w , t) and mechanical properties (E , G) of AFM cantilever.

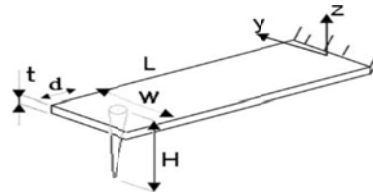

Fig. 3 Schematic diagram of RC AFM probe with off-end tip with distance, d , from free end of cantilever [9]

Normal spring constant of RC is:

$$K_z = \frac{EWt^3}{4L^3} \quad (1)$$

Torsional and lateral bending stiffness is achieved for a RC by the following equations:

$$K_\theta = \frac{Gwt^3}{3L} \quad (2)$$

$$K_y = \frac{EtW^3}{4L^3} \quad (3)$$

Longitudinal spring constant and bending stiffness of rectangular cantilever is:

$$K_x = \frac{L^2}{3H^2} K_z \quad (4)$$

$$K_\alpha = \frac{2L^2}{3(1+\nu)} K_z \quad (5)$$

A. Dynamic modeling

Free body diagram of the particle pushed by the tip of AFM is shown in Fig. 4. The following kinematical equations are obtained for cantilever deformation based on geometrical features of Fig. 4b.

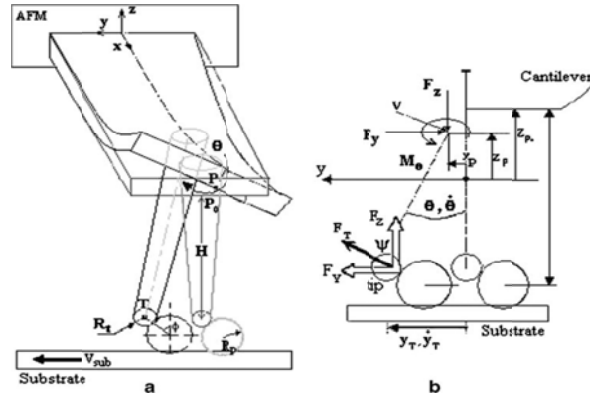

Fig. 4 Schematic diagrams of nanoparticle pushing: a Cantilever deformation in lateral motion. b Free-body diagram of the particle displacement [9].

$$z_p = z_{afm} + H \cos(\theta) \cos(\alpha) + (R_p - \delta_s) + (R_t + R_p \delta_t) \cos(\Phi) \quad (6)$$

$$x_p = x_{afm} - (R_t + R_p - \delta_t) \sin(\Phi) - H \sin(\alpha) \quad (7)$$

$$y_p = y_{afm} - (R_t + R_p - \delta_t) \sin(\Phi) - H \sin(\theta) \quad (8)$$

\ddot{y}_p and \ddot{z}_p are achieved by derivation from Eqs. 6, 7 and 8. The force equations of tip are achieved in terms of z_p , y_p, x_p and θ as follow:

$$F_Y = F_y + V \cos \theta + m \left(\frac{\dot{y}_T + \dot{y}_p}{2} \right) \quad (9)$$

$$F_X = F_x + V \cos \alpha + m \left(\frac{\dot{x}_T + \dot{x}_p}{2} \right) \quad (10)$$

$$F_Z = F_z + V \sin \alpha + V \sin \theta + m \left(\frac{\dot{z}_T + \dot{z}_p}{2} \right) \quad (11)$$

$$-M_\theta + F_Z H \sin \alpha \sin \theta - F_Y H \cos \theta - M_\alpha - F_X H \cos \alpha = I_p (\ddot{\theta} + \ddot{\alpha}) \quad (12)$$

Finally pushing force, F_T , can be calculated from the following equations:

$$F_{XY} = \sqrt{F_X^2 + F_Y^2} \quad (13)$$

$$F_T = \sqrt{F_{XY}^2 + F_Z^2} \quad (14)$$

$$\psi = \tan^{-1} \left(\frac{F_{XY}}{F_Z} \right) \quad (15)$$

Dynamics of nanoparticle motion has been modeled [4–10]. Friction models for sliding and rolling are then achieved by considering nanoparticle adhesion model as shown in Fig. 5. According to previous studies, critical conditions are obtained as the following equations [10] for critical situation of nanoparticle sliding on substrate:

$$F_T > \frac{\tau_s A_s}{\sin \psi - \mu_s \cos \psi} \quad (16)$$

tip sliding on nano particle:

$$1. F_T > \frac{\tau_t A_t}{\cos \zeta - \mu_t \sin \zeta} \quad (17)$$

and nano particle rolling on substrate:

$$F_T > \frac{\tau_{rs}A_s + \tau_{rt}A_t}{R_p(\sin \psi + \cos \zeta) + \mu_{rt} \sin \zeta - \mu_{rs} \cos \psi} \quad (18)$$

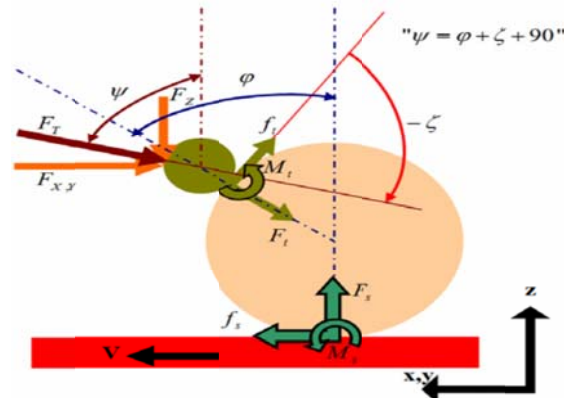

Fig. 5 Schematic diagrams of interaction forces and the resultant deformations between tip/particle and particle/substrate [9]

where $\psi = \varphi + \zeta + 90$. According to Eqs. 16–18, F_{cr} is a function of pushing force and angle ψ , probe/nanoparticle contact angle φ , friction constants μ and τ , and contact area A . Now, it is possible to determine the exact value of critical force and time for nanoparticles pushing as well as dynamic behavior of nanoparticles by solving and plotting the critical values. For this purpose, all of the equations have to be analyzed, simultaneously.

A. Problem primary data

In this simulation, gold particle with $R_p=50$ nm has been pushed on the silicon oxide substrate that moves with constant velocity. Geometrical and mechanical properties of the RC are summarized in Tables 1, 2, and 3 [11].

Table 1 The AFM geometric constants

$L(\mu\text{m})$	$W(\mu\text{m})$	$t(\mu\text{m})$	$H(\mu\text{m})$	$R_p(\mu\text{m})$
225	48	1	12	20

Table 2 Tribological parameters between tip/nano particle and nano particle/ substrate [4, 7]

μ_s	μ_d	μ_r	τ	τ_r
0.8	0.7	80nm	28MPa	28Pa.m

Table 3 AFM mechanical properties

$E(\text{GPa})$	ν	$G(\text{GPa})$	$\rho(\text{Kg/m}^3)$
169	0.27	66.54	2.330

2.2 Theory of manipulating nanoparticle

For manipulating nanoparticles in contact mode of AFM and driving them, the whole operation should be divided into some distinct sections, and each section should be studied separately. In Figure 6 different stages of pushing the nanoparticle is shown [10].

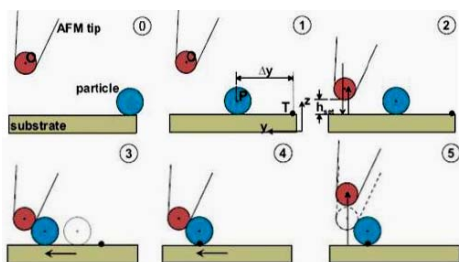

Fig. 6 Strategy of pushing the nano particle in contact mode.[10]

A) Stage 0 to 1:

Before AFM begins to work, its probe tip is located right in the middle of base plate according to assumed origin and with height h_{safe} . After choosing the desired nanoparticle for manipulation by the user and extracting information about trajectory of probe's tip—first stage—the next stage is the moving of the probe's tip with V_{afm} velocity from the primary point toward the specified nanoparticle and its stopping near the nanoparticle by distance of R_{ini} . This stage is illustrated in Figure 7. Since there is a smooth touch between the tip of the probe and the nanoparticle, and the nanoparticle is not supposed to have any undesirable motion, the core of the nanoparticles should have the minimum distance of $2R_{ini}$ from each other, so that:

$$R_{ini} = 3R_{tip} + R_p \quad (19)$$

Where R_p is the radius of nanoparticle and R_{tip} is the radius of the tip of the probe.

In this stage, the tip of the probe moves just along (X, Y) axes, and since in this stage it has a constant height of h_{safe} , so the changes along Zs axis will be zero.

In the current designed VR, moving velocity for the tip of the trope is assumed to be constant 100nm/s, but since there is a probability that its trajectory on the base plate might be angular—i.e. it moves along both X and Y—so, sum of the velocity of motion for both axes should be 100nm/s.

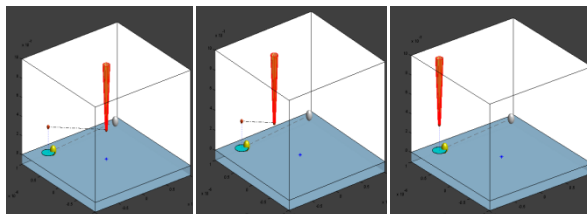

Fig.7: Display of user interface for the stage 0 to 1 of nanomanipulation in which the tip of the probe moves toward nanoparticle.

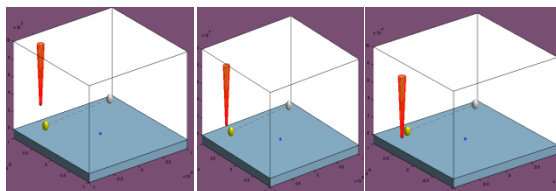

Fig.8: Display of 1→substrate stage from strategy of pushing the particle in which the tip of the probe moves toward the base plate

B) Stage 1 to 2:

In this stage, probe's tip should adjust its height. Since the primary height of probe's tip is not reachable, a reference point is defined for the system. This reference point can be the surface of the base plate in a way that the probe's tip can be moved downward to the point that it reaches the base plate. In this way, the zero point of the height of the probe can be found. After illustrating

the contact, the tip of the probe goes upward to the point that it makes the designed angle (ϕ) with particle's horizon radius. So this section is divided into two subsections:

Stage 1 substrate: in this subsection, the tip of the probe moves toward the base plate along Z axis. Since there is a probability that the tip of the probe would collide into the base plate and get damaged, horizontal motion velocity of AFM reduces to 30nm/s. (Fig. 8)

Stage 2 substrate: in this subsection, after hitting the base plate in the previous stage, the tip of the probe goes back to height h_{set} (Fig.9).

Some points to be considered in h_{set} computation:

A. After final computation of h_{set} in which the tip of the probe should recede from base plate, δtip should be added to the total sum of the motion of probe's tip so that it can make the tip to penetrate into the base plate.

B. h_{set} is connected with the angle between tip of the probe and particle's horizon radius (ϕ), and also the distance between the tip and the particle in a contact situation. So, the following equation for h_{set} can be used:

$$h_{set} = R_p - \delta sub_0 + (R_p + R_{tip} - \delta tip_0) \cos(\phi^\circ) \quad (20)$$

Where δsub_0 and δtip_0 are the depth of first contact of the particle with the base plate and the depth of first contact of the particle with the tip of the probe respectively. And R_p is the radius of the particle and R_{tip} is the radius of the probe's tip.

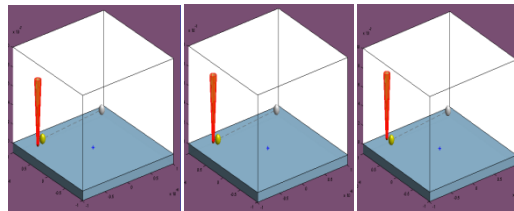

Fig. 9 Display of the user interface of substrate \rightarrow 2 stage of nano manipulation in which the tip of the probe moves from the base plate to h_{set} .

C) Stage 2 to 3:

When the tip of the probe was placed in a safe distance from the particle in the defined height and the angle of contact, then the stage of making contact with the particle is ready. AFM's movement is just along X and Y axes (Fig.10).

In this stage, since a high velocity of the contact might damage either the probe's tip or the particle or both, or it might cause the particle to move while making contact hence we lose the location of the particle, so we must reduce the sum velocity of the tip of the probe to 10nm/s in order to make the contact slower. In this stage, before making contact, there is no force from the tip of the probe on the particle, but after making contact, which is the aim of this stage too, there is a F_{z0} force on the particle along Z axis.

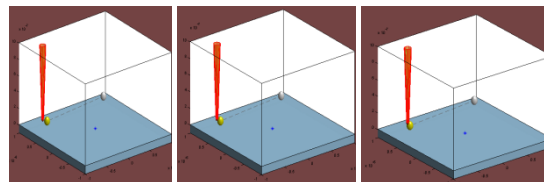

Fig. 10 Display of 2 to 3 stage of the nanomanipulation in which the tip of the probe moves toward the particle.

D) Stage 3 to 4:

This stage is one of the most critical ones in nano manipulation because, after the probe's tip contact with the particle, the force for driving the nanoparticle along the way of manipulation will begin with a specific angle (Figure 11). In this stage, like macro-world, the applied forces by the tip of the probe should overcome movement-resistant forces so that it can move the nanoparti-

cle in the specified direction. In modeling this stage, the primary criteria which have been created in the previous stage should be considered, like:

1. Primary force of F_{z0} along Z axis from the probe's tip on the particle
2. Angle of contact with the particle
3. Depth of contact between the tip of the probe and the particle because of their transformation.
4. Depth of contact between nanoparticle and the base plate because of nanoparticle's transformation.
5. Coordinates and the current location of the tip of the probe regarding to the movement of probe's tip by small load along Z-axis.

After calculating these conditions, the dynamical equations of pushing the particle's in contact mode should be solved; surely, the resistant-to-movement equations are involved in these equations. After doing all above and solving equations, our simulation would be like that in Figure 8.

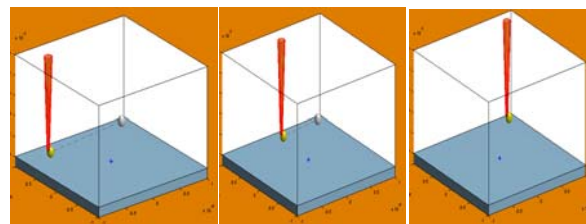

Fig.11 Display of user interface of 3 to 4 stage in which, after touching the particle, probe's tip pushes it toward its destination (white globe).

E) Stage 4 to 5:

When pushing the particle to its specified final destination is finished, AFM's tip should return to the primary point in order to get ready for next operation. This stage is divided into two substages:

A. Ascending up to the height: since in the stages1 and 2 the height of the probe's tip for making contact with the particle and pushing it was reduced from h_{safe} to h_{set} , so if the probe's tip stays at the same height, in case that the AFM's tip returns to the primary point it might collide into the nanoparticles and with a high probability it will get damaged. For preventing this, first the tip of the probe ascends upward along Z-axis till it reaches a safe height h_{safe} (Fig.12).

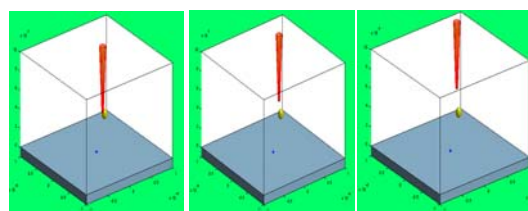

Fig. 12 Ascending to h_{safe} height by 30nm/s velocity

B. Returning to the start point: after AFM's tip reached a safe height, it starts moving along X and Y axes to the point that it reaches the primary point of operation (Fig. 13).

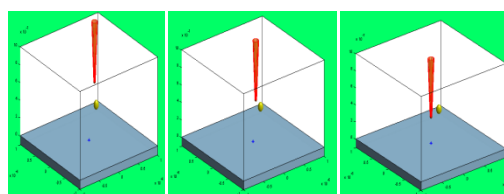

Fig.13 Returning to the primary point by 100nm/s velocity in h_{safe} height

3. Simulation and results

Diagrams of F_T , F_S^* and F_r^* are shown in Figs. 14 and 15. Figures 14 and 15 are obtained for nano manipulation based on AFM with rectangular cantilever where the tip is put at the end of the cantilever.

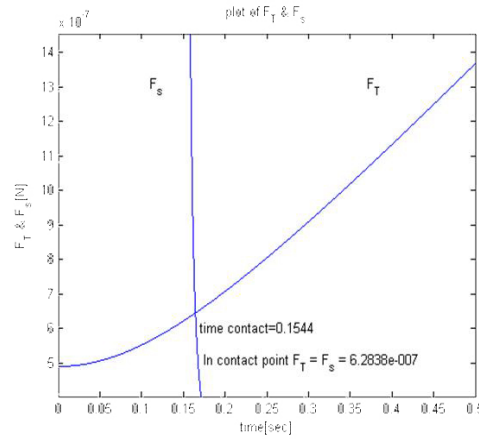

Fig.14 Force diagrams of nano manipulation F_T, F_S^* based on rectangular cantilever of AFM

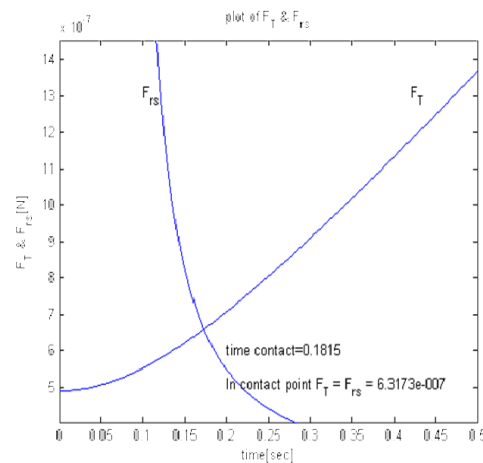

Fig.15 Force diagrams of nano manipulation F_T, F_r^* based on rectangular cantilever of AFM

In Fig. 14 the intersection of F_T and F_S^* diagram the critical time for rectangular cantilever with a tip at the apex is $t_{cr}=0.1544$ s with a force equal to $F_{cr}=0.628 \mu N$. In Fig. 15 is $t_{cr}=0.1815$ s and $F_{cr}=0.631 \mu N$.

This results means, the nanoparticle starts sliding before rolling which is in agreement with the previously published results [11, 12].

4. Conclusion

Using the dynamic modeling of the nano manipulation process, it is possible to understand the events that occur during pushing, by which it is possible to track the nanoparticle during the pushing process. This makes us able to displace the nanoparticle and put it in desired situations for manufacturing and assembly in nanoscale.

On the other hand, Virtual Reality method is one of the newest methods which create a virtual and multimedia environment similar to actual environment so that the user can feel the sense of being placed in the actual environment by just watching it. Using VR method, the user can eliminate the distance he feels between the nano-world and himself; he can also understand all the stages happening when nanoparticle is pushed. In this study, by using cantilever dynamic modeling and free diagram of nanoparticle and also specifying modeling of various friction forces in

the exact time of nanoparticle's movement, the exact place of nanoparticle and probe's tip while pushing are defined; the exact location of nanoparticle in the virtual environment can also be defined by entering this information to VR environment.

References

- [1] MR. Falvo, RM. Taylor, A. Helsen, V. Chi, Nanometer-scale rolling and sliding of carbon nanotubes. *Nature* **397**, 236 (1999).
- [2] M. Sitti, H. Hashimoto, Force controlled pushing of nanoparticles: modeling and experiments. *IEEE/ASME Trans on Mechatronics* 5:199–211, (2000).
- [3] DH. Kim, J. Park B. Kim, K. Kim Modeling and simulation of nanorobotic nanomanipulation with an AFM probe. ICCAS, Muju Resort, Jeonbuk, (2002).
- [4] A. Tafazzoli, M. Sitti Dynamic behavior and simulation of nanoparticles sliding during nanoprobe-based positioning. Proceedings of IMECE'04 2004 ASME International Mechanical Engineering Congress, Anaheim, CA, (2004).
- [5] A. Tafazzoli, M. Sitti, Dynamic modes of nano-particle motion during nanoprobe based nanomanipulation. Proceedings of 4th IEEE Conference in Nanotechnology, Munich, Germany. (2004).
- [6] MH. Korayem, M. Zakeri, Dynamic simulation of nanoparticle nanomanipulation based on AFM nano-robot, 15th. Annual (International) Conference on Mechanical Engineering-ISME, (2007).
- [7] MH. Korayem, M. Zakeri, Sensitivity analysis of nanoparticles pushing critical conditions in 2-D controlled nanomanipulation based on AFM. *Journal of Advanced Manufacturing Technology* **41**, 714 (2009).
- [8] Liu. Lianqing, Xi. Ning, Luo. Yilun, Wang. Yuechao, Zhang. Jiangbo, Li. Guangyong, Detection and Real-time Correction of Faulty Visual Feedback in Atomic Force Microscopy Based Nanorobotic Manipulation, IEEE International Conference on Robotics and Automation Pasadena, CA, USA, May 19-23, (2008).
- [9] MH. Korayem, M. Zakeri, The effect of off-end tip distance on the nanomanipulation based on rectangular and V-shape cantilevered AFMs, . *Journal of Advanced Manufacturing Technology* **41**, 714–726, (2010).
- [10] W. Vogl, M. Sitti, Nanomanipulation With 3D Visual And Force Feedback Using Atomic Force Microscopes, IEEE Int. Conference On Nanotechnology, (2004).
- [11] JE. Sader, Parallel beam approximation for V-shaped atomic force, microscope cantilevers. *Rev Sci Instrum* **66**(9), 4583 (1995).
- [12] JI. Hazel, VV Tsukruk, Spring constants of composite ceramic/gold cantilevers for scanning probe microscopy. *Thin Solid Films* **339**, 249 (1999).