

---

# Dynamic Modelling of Advanced Battery Energy Storage System for Grid-Tied AC Microgrid Applications

---

Antonio Ernesto Sarasua,  
Marcelo Gustavo Molina and Pedro Enrique Mercado

Additional information is available at the end of the chapter

<http://dx.doi.org/10.5772/52219>

---

## 1. Introduction

In the last decade, power generation technology innovations and a changing economic, financial, and regulatory environment of the power markets have resulted in a renewed interest in on-site small-scale electricity generation, also called distributed, dispersed or decentralized generation (DG) (Abdollahi Sofla & Gharehpetian, 2011). Other major factors that have contributed to this evolution are the constraints on the construction of new transmission lines, the increased customer demand for highly reliable electricity and concerns about climate change (Guerrero et al, 2010). Along with DG, local storage directly coupled to the grid (aka distributed energy storage or DES) is also assuming a major role for balancing supply and demand, as was done in the early days of the power industry. All these distributed energy resources (DERs), i.e. DG and DES, are presently increasing their penetration in developed countries as a means to produce in-situ highly reliable and good quality electrical power (Kroposki et al, 2008).

Incorporating advanced technologies, sophisticated control strategies and integrated digital communications into the existing electricity grid results in Smart Grids (SGs), which are presently seen as the energy infrastructure of the future intelligent cities (Wissner, 2011). Smart grids allow delivering electricity to consumers using two-way (full-duplex) digital technology that enable the efficient management of consumers and the efficient use of the grid to identify and correct supply-demand imbalances. Smartness in integrated energy systems (IESs) which are called microgrids (MG) refers to the ability to control and manage energy consumption and production in the distribution level. In such IES systems, the grid-interactive AC microgrid is a novel network structure that allows obtaining the better use of

DERs by operating a cluster of loads, DG and DES as a single controllable system with predictable generation and demand that provides both power and heat to its local area by using advanced equipments and control methods (Hatziaegyriou et al, 2007). This grid, which usually operates connected to the main power network but can be autonomously isolated (island operation) during an unacceptable power quality condition, is a new concept developed to cope with the integration of renewable energy sources (RESs) (Katiraei et al, 2008).

Grid connection of RESs, such as wind and solar (photovoltaic and thermal), is becoming today an important form of DG (Mathiesen et al, 2011). The penetration of these DG units into microgrids is growing rapidly, enabling reaching high percentage of the installed generating capacity. However, the fluctuating and intermittent nature of this renewable generation causes variations of power flow that can significantly affect the operation of the electrical grid (Tiwaria et al, 2011; Kanekoa, 2011). This situation can lead to severe problems that dramatically jeopardize the microgrid security, such as system frequency oscillations, and/or violations of power lines capability margin, among others (Serban & Marinescu 2008). This condition is worsened by the low inertia present in the microgrid; thus requiring having available sufficient fast-acting spinning reserve, which is activated through the MG primary frequency control (Vachirasricirikul & Ngamroo, 2011).

To overcome these problems, DES systems based on emerging technologies, such as advanced battery energy storage systems (ABESSs), arise as a potential alternative in order to balance any instantaneous mismatch between generation and load in the microgrid (Molina, 2011). With proper controllers, these advanced DESs are capable of supplying the microgrid with both active and reactive power simultaneously and very fast, and thus are able to provide the required security level. The most important advantages of these advanced DESs devices include: high power and energy density with outstanding conversion efficiency, and fast and independent power response in four quadrants (Molina & Zobaa, 2011).

Much work has been done, especially over the last decades, to assess the overall benefits of incorporating energy storage systems into power systems (Hewitt, 2012; Schroeder, 2011; Maharjan et al, 2011; Qian, 2011). However, much less has been done particularly on advanced distributed energy storage and its utilization in emerging electrical microgrid, although major benefits apply (Molina, 2011; Vazquez et al, 2010). Moreover, no studies have been conducted regarding a comparative analysis of the modeling and controlling of these modern DES technologies and its dynamic response in promising grid-interactive AC microgrids applications.

In this chapter, a unique assessment of the dynamic performance of novel BESS technologies for the stabilization of the power flow of emerging grid-interactive AC microgrids with RESs is presented. Generally, electrochemical batteries include the classic and well-known lead-acid type as well as the modern advanced battery energy storage systems. ABESSs comprise new alkaline batteries, nickel chemistry (nickel-metal hydride–NiMH, and nickel-cadmium–NiCd), lithium chemistry (lithium-ion–Li-Ion, and lithium-polymer–Li-po), and

sodium chemistry (sodium-sulfur–NaS, and sodium-salt–NaNiCl) (Molina & Zobaa, 2011; Molina & Mercado, 2006; Iba et al. 2008). In this work, of the various advanced BESSs nowadays existing, the foremost ones are evaluated. In this sense, the design and implementation of the proposed ABESSs systems are described, including the power conditioning system (PCS) used as interface with the grid. Moreover, the document provides a comprehensive analysis of both the dynamic modeling and the control design of the leading ABESSs aiming at enhancing the operation security of the AC microgrid in both grid-independent (autonomous island) and grid-interactive (connected) modes.

Section 2 details the general considerations for selecting batteries. Section 3 summarizes the key features of selected batteries. Section 4 defines the parameters to be considered in each type of battery and reviews some of the existing models for batteries. Finally, section 5 proposes a general model of batteries developed in MATLAB/Simulink and implemented in a test power system.

## 2. Selection criteria of BESS technologies

Unlike other commodities, there are not significant stocks or inventories of electricity to mitigate differences in supply and demand. Electricity must be produced at the level of demand at any given moment, and demand changes continually. Without stored electricity to call on, electric power system operators must increase or decrease generation to meet the changing demand in order to maintain acceptable levels of power quality (PQ) and reliability.

Electricity markets are structured around this reality. Presently, generating capacity is set aside as reserve capacity every hour of every day to provide a buffer against fluctuations in demand. In this way, if the reserve capacity is needed, it can be dispatched or sent to the grid without delay. There are costs, at times considerable, for requiring the availability of generating capacity to provide reserves and regulation of power quality. However, economic storage of electricity could decrease or even eliminate the need for generating capacity to fill that role.

For the selection of a specific energy storage technology in order to participate in the power reserve of a grid-tied AC microgrid, storage capacity must be defined in terms of the time that the nominal energy capacity is intended to cover the load at rated power. All storage technologies are designed to respond to changes in the demand for electricity, but on varying timescales. Thus, various types of existing storage technologies are adapted for different uses. Then, the power reserve range can be divided into two kinds:

- Power quality management (shorter timescales): Demand fluctuations on shorter timescales—sub-hourly, from a few minutes down to fractions of a second—require rapidly-responding technologies which are often of smaller capacity. Responding to these short-timescale fluctuations keeps the voltage and frequency characteristics of the grid electricity consistent within narrow bounds, providing an expected level of power quality. PQ is an important attribute of microgrid electricity, as poor quality electricity—momentary spikes, surges, sags (dips), or severe contingencies like outages—can harm electronic devices.

- Energy management (long timescales). Daily, weekly, and seasonal variations in electricity demand are fairly predictable. Higher-capacity technologies capable of outputting electricity for extended periods of time (up to some hours) moderate the extremes of demand over these longer timescales. These technologies aid in energy management, reducing the need for generating capacity as well as the ongoing expenses of operating that capacity. This is the case of serious failures of generation or disconnection of the MG from bulk power system. Variations in demand are accompanied by price changes, which lead to arbitrage opportunities, where storage operators can buy power when prices are low (hours of low consumption) and sell when prices are high (peak hours).

As a result, the permanent participation of the storage system in the AC microgrid is required for both situations: to control severe contingencies and to balance the demand and continuous changes of minor contingencies. In the first case the level of storage system performance is lower than in the second, but the power requirements and dynamic response are significantly higher. Conversely, in the case of energy management events it requires more energy, but less rapidly.

Based on the previous considerations and taking into account the considered grid-tied AC microgrid applications the following criteria for selection of battery energy storage systems are proposed:

- The possibility of build medium-scale units (MW), according to the size of the MG.
- Commercially available technology with applications in electric power systems. It is required that the technology has been proven by industry to ensure a real solution.
- High reliability. It is necessary that the equipment incorporated into the MG ensures high availability when required.
- Minimum requirements to allow the location of the storage systems next to the loads as a distributed energy storage device.
- Competitive costs (Installation and Operation-Maintenance). Storage devices should hold costs competitive with the benefit incorporated into the operation of the MGs.
- Long lifetime, exceeding 2000 cycles. Studies on the efficient use of new storage devices show that it takes more than 2000 cycles of charge/discharge to consider possible implementation in MGs.
- High electrical efficiency, defined as the ratio of the energy used to fully charge the storage device and the maximum extractable energy from it. This requirement requires maximum use of the device electrical storage, which will improve operating costs.
- Minimal environmental impact.
- Discharge time (bridging time) greater than a minute. According to the size and operation of the microgrid can be extended to several minutes or hours.
- Very short time response (less than a second), to improve the response of other alternatives.

- High discharge rate, which allows quickly cover large imbalances of power. This action will significantly improve regulation and reduce the impact of any disturbances in the main power system.
- High re-charge rate, to quickly restore the lost reserve from the BESS units and to allow quickly absorb large excesses of energy. For this particular case, it must maintain a state of optimal storage load to ensure a minimum level of storage when required by the control system.

These general guidelines serve as a basis for the selection of the storage device, but it should be taken into consideration that the final evaluation of the BESS device should be carried out conjointly with the power system with it is to interact and taking into account the policies of control-economy established.

### 3. Overview of BESS technologies

The term Battery contains the classic and well-known lead-acid (Pb-acid) type as well as the redox flow types batteries, and also include the so called advanced battery energy storage systems (ABESSs). ABESSs comprise new alkaline batteries, nickel chemistry (nickel metal hydride–NiMH, and nickel cadmium–NiCd), lithium chemistry (lithium polymer–Li-po, and lithium-ion–Li-Ion), and sodium chemistry (sodium sulfur–NaS, and sodium salt–NaNiCl). Based on the selection criteria previously described, the following batteries are studied:

- Lead-acid batteries
- Nickel cadmium and nickel metal hydride batteries
- Lithium ion and lithium polymer batteries
- Sodium sulfur batteries

#### 3.1. Lead acid batteries

Each cell of a lead-acid battery comprises a positive electrode of lead dioxide and a negative electrode of sponge lead, separated by a micro-porous material and immersed in an aqueous sulphuric acid electrolyte. In flooded type batteries (with an aqueous sulphuric acid solution) during discharge, the lead dioxide on the positive electrode is reduced to lead oxide, which reacts with sulphuric acid to form lead sulphate; and the sponge lead on the negative electrode is oxidized to lead ions, that reacts with sulphuric acid to form lead sulphate. In this manner, electricity is generated and during charging this reaction is reversed. Valve regulated (VRLA) type uses the same basic electrochemical technology as flooded lead-acid batteries, except that these batteries are closed with a pressure regulating valve, so that they are sealed. In addition, the acid electrolyte is immobilized (Divya & Østergaard 2009).

Pb-acid batteries are the most commonly used batteries in various applications worldwide. They are within the category of less physical efficiency battery. They have also the lower energy densities and power per weight and volume (20 to 40 kWh/ton and 40 to 100 kWh/m<sup>3</sup>) (Nourai 2002). For this reason, Pb-acid batteries require more space and have

greater weight than any other type of batteries. However, they have significant advantages that positions best suited for applications requiring high power and speed. The units are robust and secure, and allow extremely fast downloads, in periods of about 5 ms. The most important features are its low cost and high electrical efficiency. The cost of these batteries is in the order of \$ 300 to \$ 600 per kWh and performance can reach 90% (Chen 2009).

Another problem with these batteries is their relatively short lifetime measured in charge-discharge cycles, which reaches 500 cycles for the batteries most basic to 1000 cycles for the latest models (Chen 2009). The low amount of charge-discharge cycles is due to the high volumetric density of lead. Another major problem they have is the charging time of around three hours to the total load of batteries.

Despite these disadvantages, Pb-acid batteries have been used in many storage systems. Among them are the system built at the plant of 8.5MWh/1h BEWAG in Berlin, Germany, the system of 14 MWh/1.5h at the plant PREPA (Puerto Rico) and the greatest of all in Chinese (California, U.S.) of 10MWh/4h (Chen 2009). The earliest transportable battery system of lead-acid is located at the Phoenix distribution system is a multi-mode battery. The battery switches between power quality (2MW up to 15 s) and energy management (200 kW for 45min) mode (Divya & Østergaard 2009).

### 3.2. Nickel cadmium and nickel metal hydride batteries

Batteries of Ni-Cd type have a cadmium electrode (positive) and a nickel hydroxide (negative). The two electrodes are separated by nylon and potassium hydroxide. With sealed cells and half the weight of conventional lead acid batteries, these batteries have been used in a wide range of portable devices. Today, due to environmental problems and memory effect, Ni-Cd batteries are being replaced by Ni-MH or Li-Ion. Ni-Cd battery types are affected by the so-called memory effect. Memory effect, also known as battery effect or battery memory, is an effect that describes a specific situation in which Ni-Cd batteries gradually lose their maximum energy capacity if they are repeatedly recharged after being only partially discharged. The battery appears to remember the smaller capacity. The source of the effect is changes in the characteristics of the underused active materials of the cell.

Ni-Cd batteries have the advantage of a long life (up to 2000 charge-discharge cycles) and if they are charged and discharged properly maintain their properties to the end of its life. Each Ni-Cd cell can provide a voltage of 1.2 V and have a capacity between 0.5 and 2.3 Ah.

ABB and SAFT companies have developed a system based on Ni-Cd batteries for supporting the interconnected system of Alaska. The system is capable of delivering up to 40 MW during 15 minutes and is designed to act as a dumping reserve before activation of turbo-gas plants. So far, this battery system is the largest in the world.

Ni-HM batteries share several characteristics with Ni-Cd batteries. Each Ni-MH cell can also provide a voltage of 1.2 V and have a capacity between 0.8 and 2.7 Ah. Its energy density reaches 80 Wh/kg. They improve Ni-Cd batteries by changing the nickel hydroxide electrode and the other by a metal hydride alloy. Another advantage is that they have no

memory effect. Their disadvantages are that they have less ability to release high peak power. They have also high self-discharge rate and are more susceptible to damage from overcharging.

### 3.3. Lithium ion, lithium polymer and lithium sulphur batteries

These batteries are built with alternating layers of electrodes, among which cyclically circulate lithium ions. The Li-Ion batteries have no memory effect and support recharge before being fully discharged. This is called the topping charge capacity. They have high energy density of the order of 115 Wh/kg.

The first lithium batteries were developed in 1979 and had a great attraction due to its high energy density, but low commercial development because of the risks of explosion. Subsequently, thanks to improvements developed by Sony with the Li-Ion batteries in 1990 were popularized in electronic equipment such as laptops or mobile phones. In addition, the flat design of the containers, the high energy density and the topping charge characteristic make them ideal for automotive applications.

This type of battery has a ratio of energy density three times greater than Pb-acid batteries. This difference is due to the characteristics of low atomic weight of lithium, about 30 times lighter than lead. In addition to having a higher voltage than lead-acid cells, this means fewer cells in series to achieve the desired voltage and lower manufacturing costs.

In addition to the strict selection of batteries with same voltage and internal resistance for connection in parallel or in series, it is also necessary that each battery cell should be charged to the same value as the other cells permanently. The voltage in the cell during discharge should not be less than 2.6V. The self-discharge of the lithium battery is approximately 5% per month. After a year unused, the capacity can be significantly reduced as well as the voltage level.

The big drawback with Lithium-ion type batteries is that they are not adaptable to permanent deep discharge duty cycles even in cases in which its nominal capacity is respected. Even more, this type of battery does not accept overloads.

The lithium polymer batteries are a variation of the Li-Ion. Their characteristics are very similar, but allow a higher energy density and a significantly higher discharge rate. The high initial costs are the main drawbacks. It is expected that once the mass production of Li-po is reached it will be priced lower than those of Li-Ion due to its simpler manufacturing.

Lithium sulphur batteries operate quite differently from Li-Ion batteries. The overall reaction between lithium and sulphur can be expressed as:



Based on the above complete reaction, sulphur cathode can offer a theoretical specific capacity of 1675 mAh/g and a theoretical energy density of 2600 Wh/Kg (Li et al 2010). Although investigated by many workers for several decades the practical development of

the lithium/sulphur battery has been so far hindered by a series of shortcomings. A major issue is the high solubility in the liquid organic electrolyte of the polysulfides that forms as intermediates during both charge and discharge processes (Scrosati & Garche 2010)

The US the Department of Energy has sponsored a project by SAFT and SatCon Power Systems to design and construct two 100 kW/1 min Li-ion battery energy storage systems for use in providing power quality for grid connected micro-turbines (Naish 2008). Sanyo has developed a lithium-ion mega battery system with one of the world's largest capacities by installing approximately 1000 units of 1.6 kWh standard battery systems (a total of 1.5 MWh). This installation in the Kasai Green Energy Park, a massive testing site for large-scale, renewable power storage systems is located near Osaka (Japan). In the power storage building, economical late-night power is mainly used to charge batteries, which is then consumed during the day, while in the administration building, unconverted DC electricity from photovoltaic modules is the main source of power for charging batteries and direct consumption. The Standard Battery System for power storage is a storage battery unit with a capacity of approximately 1.6 kWh; containing 312 cylindrical lithium-ion battery cells often used in laptop PCs. Multiple systems can be connected to provide larger capacity. Batteries have a charge/discharge efficiency of 98% and are designed to last at least 10 years using the same rechargeable batteries (Panasonic).

### 3.4. Sodium sulphur batteries

Sodium sulphur batteries are one of the most favourable energy storage candidates for applications in electric power systems. They consist of an anode and a cathode of sodium and sulphur, respectively and a beta alumina ceramic material (beta-Al<sub>2</sub>O<sub>3</sub>) that is used as electrolyte and separator simultaneously. The tubular configuration of these batteries allows the change of state of the electrodes during charge and discharge cycles and minimizes the sealing area favouring the overall design of the cell (Wen 2008). Figure 1 shows the tubular design of each cell of sodium sulphur batteries.

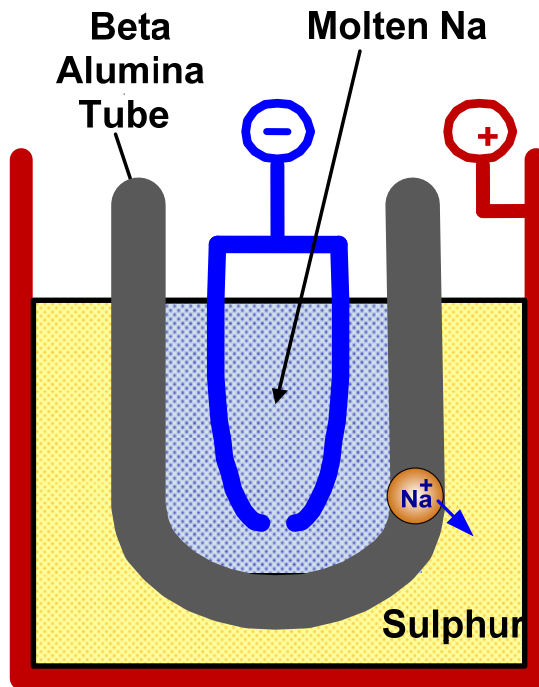
The greatest advance in this type of battery has achieved very rapidly during the past two decades as a result of the collaboration between the Tokyo Power Company (TEPCO) and the NGK Insulators Company. TEPCO and NGK developed these batteries aiming at displacing the use of pumping stations.

Sodium sulphur batteries, usually work at temperatures between 300 and 350°C. At these temperatures, both sodium and sulphur and the reaction products are in liquid form, which facilitates the high reactivity of the electrodes. In this characteristic lies the high power density and energy of these batteries, nearly three times the density of lead acid batteries. They are environmentally safe because of the seal system with which they are constructed, thus not allowing any emissions during operation. Additionally over 99% of the battery materials can be recycled. They have a high efficiency in charge and discharge and a lifespan of approximately 15 years. The cells also have high efficiency (around 89%) and minimal degradation, which contributes to the life cycle, much larger than other cells (Baxter 2005). This type of battery has no self-discharge problems if they are kept at nominal operating

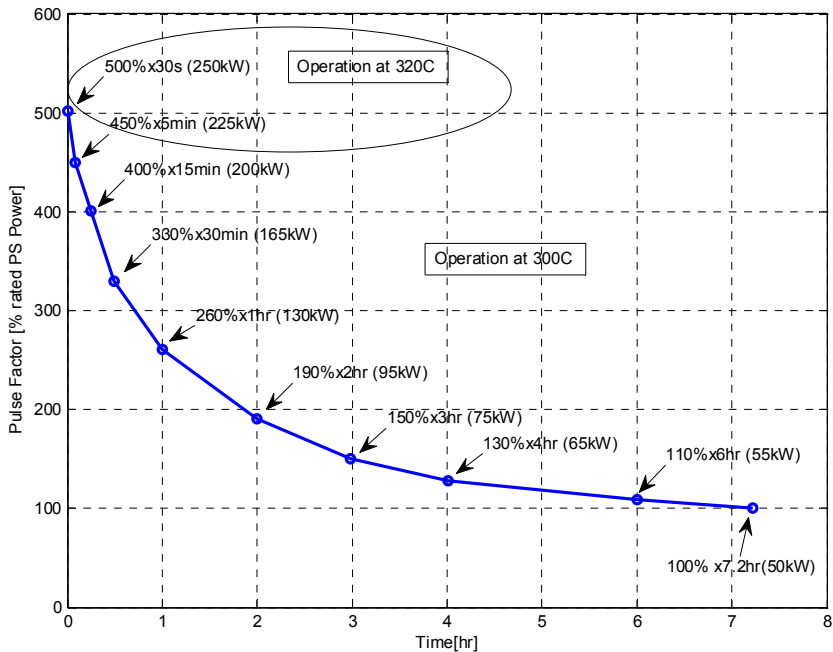


temperature, which leads to having a high efficiency. For this purpose, the built containers have embedded heaters capable of maintaining the temperature with low energy consumption.

One of the most important characteristics of the sodium batteries is their ability to deliver power pulses of up to five times of its rated capacity over a period of time up to 30 seconds continuously. This is the fundamental reason because these batteries are considered economically viable for both power quality and energy managements applications. The pulse power capability is also available even if the unit is currently in the middle of a discharge process (Nourai 2002). The module of sodium batteries offered by TEPCO/NGK for power quality events have a nominal capacity of 50 kW, but the module can discharge up to 250 kW for 30 seconds or more, and comply with lower power levels for longer periods of time. Figure 2 shows the power vs. pulse duration of the discharge of a standard module with a capacity of 50 kW nominal power (Bito 2005).



**Figure 1.** Schematic representation of a sodium-sulphur cell



**Figure 2.** Pulsed power vs. discharge time of a NaS battery module

At 100% depth of discharge, sodium batteries last approximately 2500 cycles. Like other electrochemical batteries lower discharges extend its duration. At 90% depth of discharge, the cell has a lifespan of 4500 cycles, while 65% have a life of 6500 cycles and 20% a lifespan of 40 000 cycles. In practice, sodium battery discharge is limited to less than 100% of its theoretical capacity due to the corrosive properties of sodium polysulfide (Na<sub>2</sub>S<sub>3</sub>). This is the reason why the cells typically deliver 85-90% of its theoretical capacity. At 90% capacity of sodium polysulfide composition corresponds approximately to 1.82 V per cell. At this point, the main obstacles to large-scale applications of the sodium battery are its high cost of production which depends largely on the quantity of batteries produced. The approximate cost of these batteries, including the power electronic converters is \$ 2500 to 3000 per kW (Iba et al 2006). According to (Gyuk 2003), the total system cost for a typical multifunctional NaS battery is \$ 810 per kW, with 60% of this value attributable to the battery module.

Another obstacle in NaS batteries is given by the fact that the ceramic electrolyte is presently only commercially manufactured by one company, i.e. NGK. Moreover, the protection of intellectual property the company holds over the electrolyte difficult to study and implement appropriate models to simulate their dynamic behaviour (Hussien 2007).

The greatest sodium BESS installed is about 34 MW in Aomori, Japan, forming a hybrid system with a 51 MW wind farm. TEPCO/NGK commercializes sodium batteries under the trademark NaS in Japan and USA. So far the batteries TEPCO/NGK were the only ones available in the market for BESS, but POSCO, General Electric and Fiamm Sonick also

develop sodium batteries. POSCO succeeded in developing a sodium sulfur battery for the first time in Korea, with the goal of commercializing by 2015 with RIST (a research institute wholly owned by POSCO). General Electric commercializes its Durathon battery which uses sodium metal halide chemistry and Fiamm Sonick battery is made up of salt (NaCl) and nickel (Ni). In China, research works began in the 70's and since 1980 the Chinese Institute SICCA has become the only institution outside of Japan with research in the area of sodium sulphur batteries.

#### 4. Dynamic model of advanced BESS

The most important characteristics of a battery are determined by the voltage of their cells, the current capable of supplying over a given time (measured in Ah), the time constants and its internal resistance (Sorensen 2003). The two electrodes that supply or receive power are called positive electrodes ( $e_p$ ) and negative ( $e_n$ ), respectively. Inside the battery, the ions are transported between the negative and positive electrodes through an electrolyte. The electrolyte can be liquid, solid or gaseous. The electromotive force  $E_0$  is the voltage difference between the electrode potentials for an open external circuit or at no load, defined as:

$$E_0 = Ee_p - Ee_n \quad (2)$$

The above description of the behaviour of the battery is in open circuit and the value of  $E_0$  depends on the reduction potential of redox couple used (see Appendix for more details). During the initial discharge of the battery the battery voltage can be parameterized as:

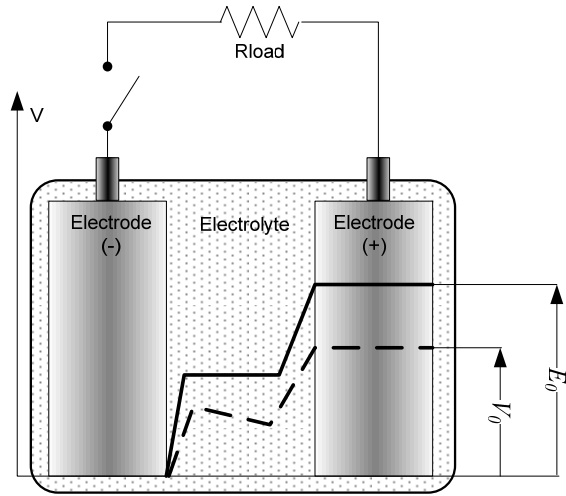
$$V_0 = E_0 - \eta IR_0, \quad (3)$$

where  $I$  is the current consumption of the connected load,  $R_0$  is the internal resistance of the cell and  $\eta$  the polarization factor. The polarization factor synthesizes or summarizes the contribution of complex chemical processes that can take part inside the cell between the electrodes through the electrolyte and are dependent of the battery type. Figure 3 shows an schematic with the potential difference across the cell with and without load.

Both the voltage  $V_0$  and the resistance  $R_0$  generally have a variable behaviour depending on the state of charge, the depth of discharge and also according to whether is charging or discharging the battery. That is why a more general and complete expression of equation (3) is the equation proposed in equation (4).

$$V_i = E_0 - \eta IR_i, \quad (4)$$

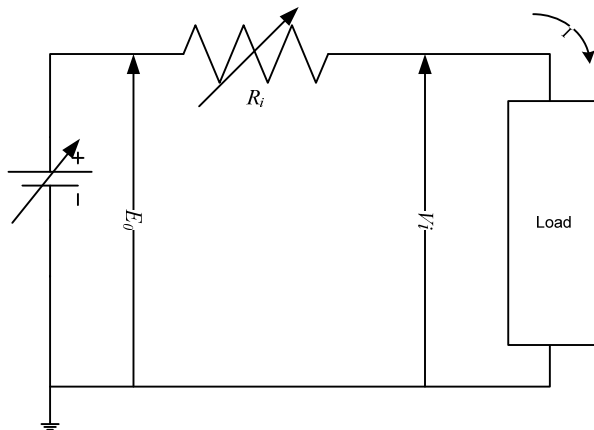
being  $V_i = V_0 - K_v Q_d$  and  $R_i = R_0 + K_R Q_d$ . The voltage  $V_i$  in open circuit decreases linearly with the discharge  $Q_d$  in Ah, and the internal resistance  $R_i$  increases linearly with  $Q_d$ . That is, the open circuit voltage is lower and the internal resistance is higher in a state of partial discharge compared to the initial values  $V_0$  and  $R_0$  for fully charged battery. The constants  $K_v$  and  $K_R$  are constants that can be determined by battery testing and reflect the characteristics of the analyzed battery (Mukund 1999).



**Figure 3.** Potential distribution in an electrochemical cell. Solid line: unloaded cell, dashed line: loaded cell

The battery model taking into account equation (4) is very useful for steady-state studies, where the parameters  $K_v$  and  $K_R$  are constant. Figure 4 shows this battery model in schematic form.

In studies where it is necessary to study the dynamic behaviour of the battery system, possible variations of values of  $K_v$  and  $K_R$  should be taken into account. In these cases, the voltage and internal resistance of the battery does not have a linear behaviour as the one proposed in equation (4). The following sub-section briefly describes some characteristics of different types of batteries required for proposing a general model of the advanced BESSs.



**Figure 4.** Equivalent electrical circuit of a steady-state battery

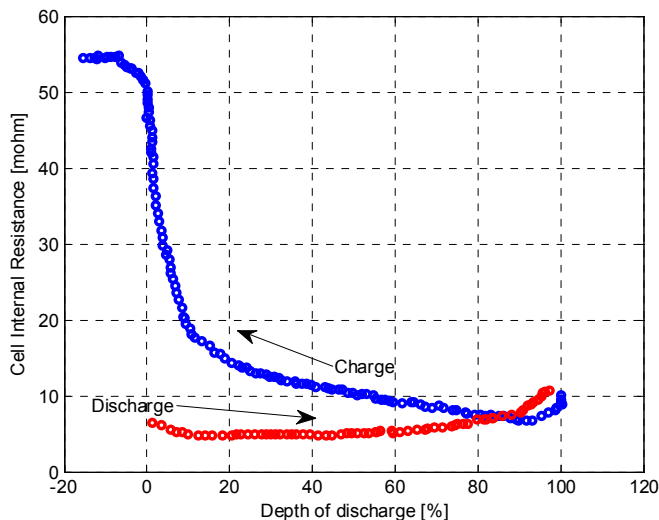
#### 4.1. Analysis of performance characteristics

This sub-section discusses major performance characteristics curves of advanced BESS devices, obtained from the literature and by own experimental set-ups. These curves show indistinct of variations in voltage and/or internal resistance depending on the state of charge (SOC). In some of these curves instead of SOC they indicate the state of discharge (SOD). The relationship between these two states is given by equation (5).

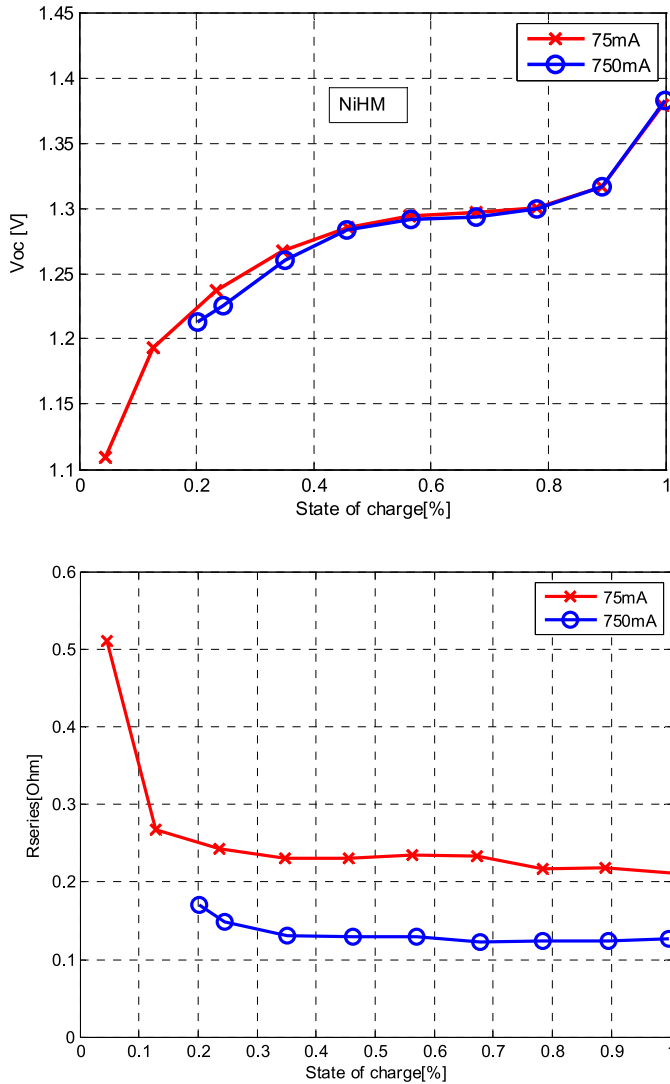
$$SOC = 1 - SOD \quad (5)$$

Batteries of Pb-acid type are characterized by an internal resistance which varies depending on the state of discharge. Figure 5 shows the variation of the internal resistance per cell vs. depth of discharge (CIEMAT 1992). This figure shows not only a nonlinear variation but also a hysteresis loop that clearly differentiates the broad difference that has the internal resistance in charging or discharging state.

In the case of Ni-MH batteries, Figure 6 shows the variation of open circuit voltage ( $V_{oc}$ ) and the internal resistance ( $R_{series}$ ) for different states of charge. This figure was constructed from testing a 750 mAh Ni-MH cell with discharge pulsed current from 75 mAh up to 750 mAh (Chen & Rincon-Mora 2006). As shown, the open circuit voltage varies with the SOC, but is almost independent of the depth of discharge. The internal resistance however, depends largely on the current drawn from the battery.

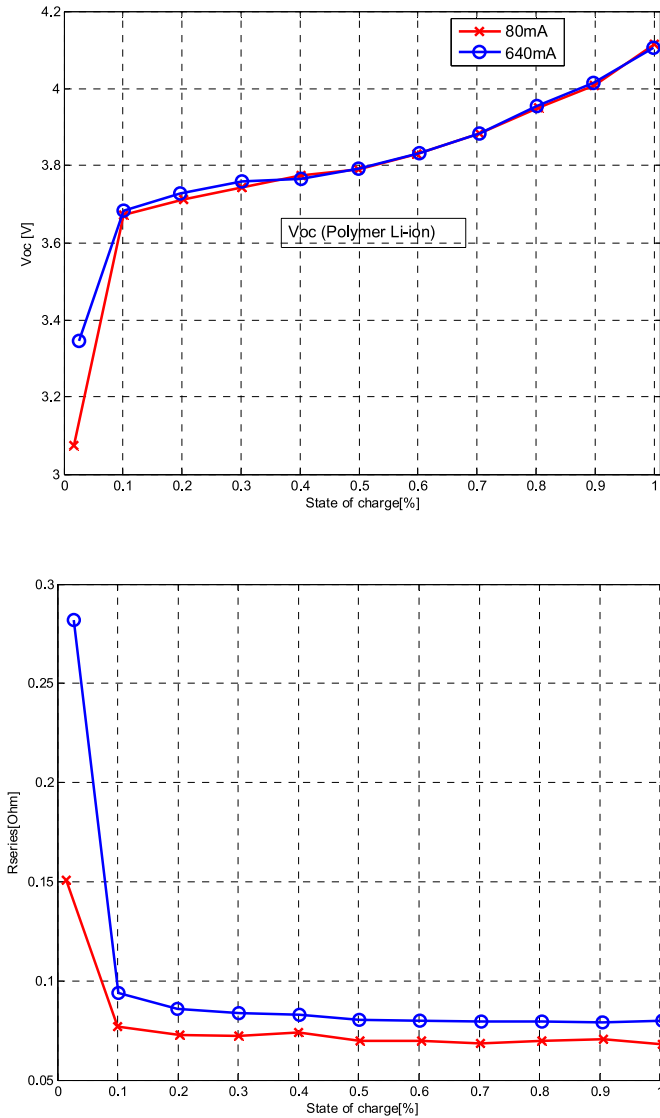


**Figure 5.** Internal resistance in charging or discharging state as a function of SOD for a Pb-acid battery at 25°C.



**Figure 6.** Variation of internal resistance (a) and voltage (b) depending on the state of charge for Ni-MH battery at room temperature.

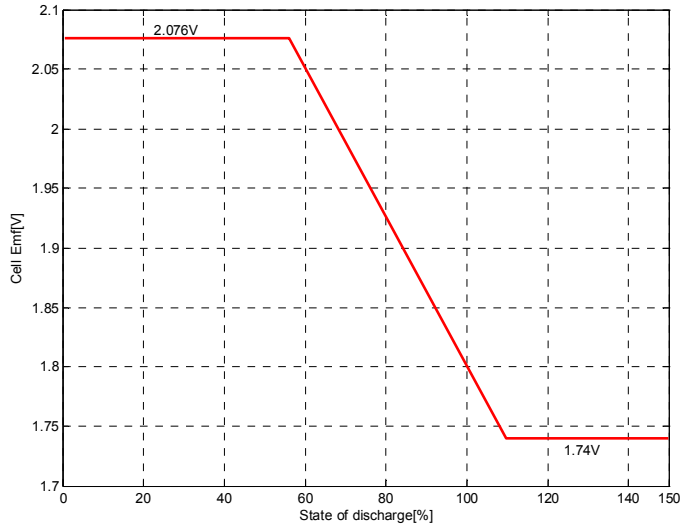
Figure 7 was built from a test of a 850 mAh Li-Ion Polymer battery with discharge pulses from 80 mA to 640 mA (Chen & Rincon-Mora 2006). This figure shows the variation of open circuit voltage ( $V_{oc}$ ) and the internal resistance ( $R_{series}$ ) for different charge states. As shown, the open circuit voltage varies with SOC but is almost independent of the depth of discharge. On the other hand, in such batteries it can be seen that the internal resistance is not only independent of the state of charge, but also of the depth of discharge. The internal resistance remains almost constant from 20% SOC.



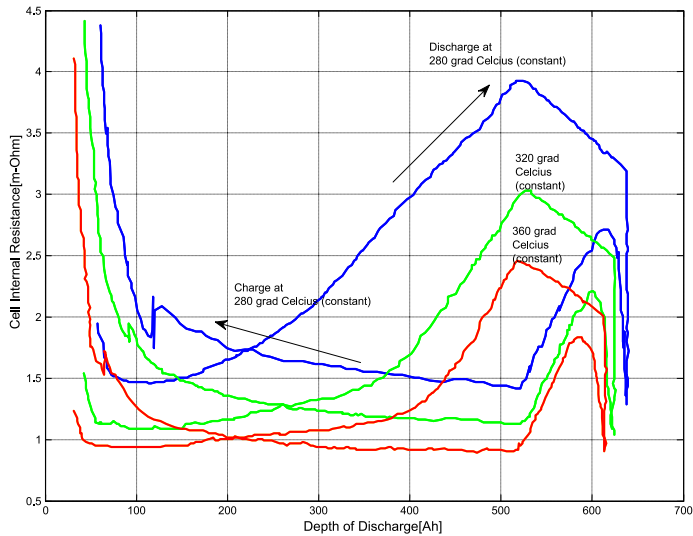
**Figure 7.** Variation of internal resistance (a) and voltage (b) depending on the state of charge for Li-ion polymer at room temperature

Figure 8 shows that for the case of NaS battery type, voltage changes with the depth of discharge of the battery (Hussien 2007). Due to their internal reactions, the electromotive force of the sodium battery is relatively constant, but decreases linearly after 60 to 75% depth of discharge (Van der Bosche 2006). Figure 9 also shows that depending on the state of charge, charge direction and the temperature at which the battery is operated, the internal resistance can vary up to four times its base value (Hussien 2007). It also clearly

shows a hysteresis loop similar to that observed for lead acid batteries (Figure 5), in which the internal resistance value varies not only with temperature and SOD, but also with the direction of current flow.



**Figure 8.** Voltage variation as a function of SOD for NAS-type battery cell



**Figure 9.** Internal resistance variation depending on the state of charge/discharge for various temperatures in a NAS-type battery cell



## 4.2. Proposed general model of BESS

Figures 5 through 9 shows a large nonlinearity in the behaviour of the most important batteries parameters. These features should be included in a model that wants to accurately represent the behaviour of batteries in power quality or energy management events.

Based on the analysis in the previous section, it can be seen that both, the battery voltage and the current capable of being delivered at any given time, generally depends on several factors. Among the most important ones are the following:

- The room temperature
- The amount of charge/discharge cycles the battery has been subjected to (cycles)
- The depth of charge/discharge
- The state of charge/discharge

If the aim of the battery model, for a given operating state, is to observe its behaviour in power quality or energy management events, this action sets a time within which the temperature can be considered constant for power quality-like events. While for energy management events lasting over an hour it should be considered a change of temperature; it may nevertheless be considered constant or studied to typical and/or extreme temperatures which would be the battery subjected to. In this way, for both cases (power quality or energy management events) the value of the parameters depends on the operating temperature of the battery.

It has been considered for the realization of the model that the battery is in a state of charge such that the characteristics curves are for the unit fully charged or discharged. This also sets the initial conditions of the model regarding the influence of the numbers of charge/discharge cycles that is capable of delivering the battery.

The depth of charge/discharge cycles influences not only the ability to the power or energy that the battery can deliver, but also its lifespan. In this sense, the depth of discharge must be taken into account in the maximum simulation time and the limitations recommended by the manufacturer.

The state of charge of the battery is the most important factor of all the above and should be taken into account directly in the model. This factor directly influences the value of power/energy that the battery can deliver in time of occurrence of events.

From the graphs shown above (Figures 5 through 9) it can be inferred a general model to simulate the battery considered. A model that includes all the batteries tested should consider that the open circuit voltage and internal resistance varies with the state and direction of the charge. The values of  $K_v$  and  $K_R$  can not be considered constant. The most convenient solution is to use directly the curves described in Figures 5 through 9 with the value of SOC.

Given the battery type, operating temperature and the depth of discharge, a model that takes into account these factors is shown in Figure 10. This figure shows the outline of a general battery model, depicted as an example for a NaS-type battery.

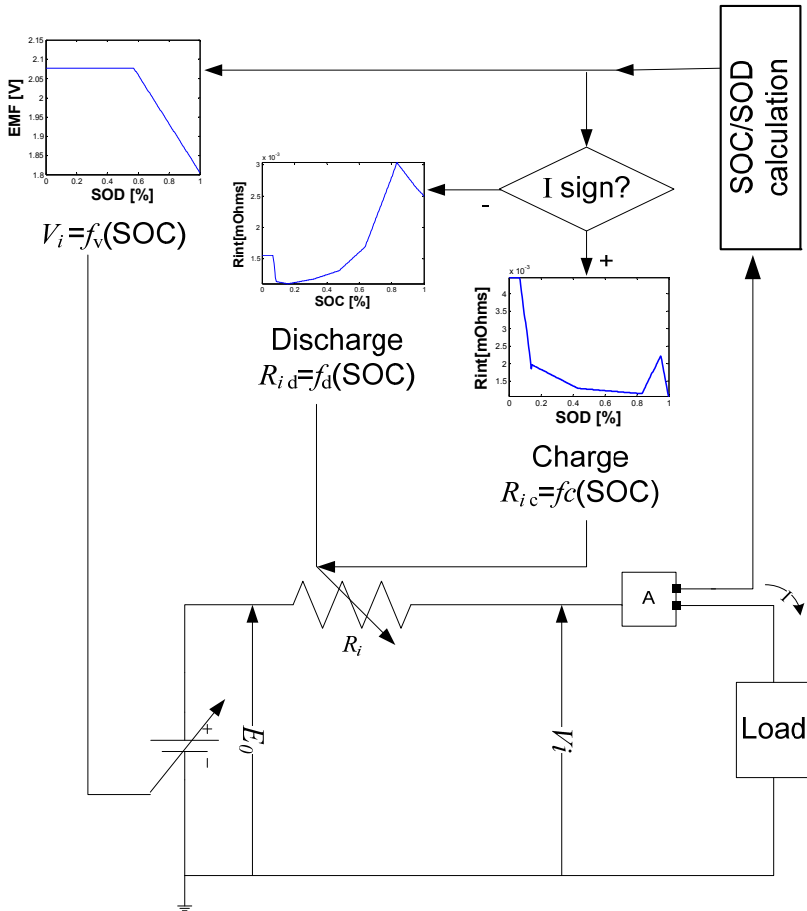


Figure 10. Proposed general model of the BESS

### 4.3. Test of proposed BESS model

The developed model of the BESS was tested using a single cell in order to validate the model. Figures 11 and 12 show the variation of internal resistance to changes of SOD for discharging and charging, respectively, in a NaS T5 type cell at 320°C. Figure 13 shows the electromotive force variation vs. SOD. Finally, Figure 14 shows a test system where a NaS PQ-G50 module (Hussien 2007) is connected through an IGBT DC/AC Inverter to an infinite bus. This module is a 50 kW pack consisting of 320 cells connected in series for obtaining a higher capacity storage device with higher voltage.

The module is simulated to perform a power quality event. From the simulation carried out up to 10s, the NAS battery delivers 50 kW. At 10s (around 10% SOD), the battery is commanded to deliver its maximum capacity (1 p.u. of 250 kW). Figure 15 shows the variation of the output active and reactive power,  $P$  and  $Q$ , on the AC side of the battery module throughout the duration of the simulation.

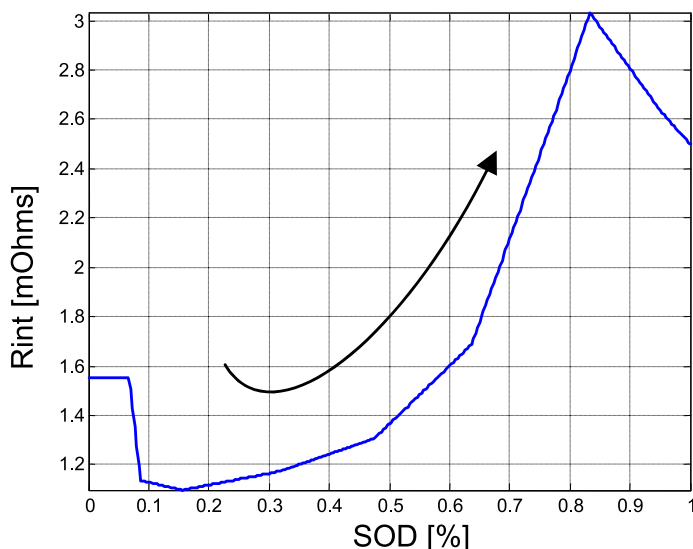


Figure 11. Simulation of cell resistance vs. SOD at 320°C for a discharge situation

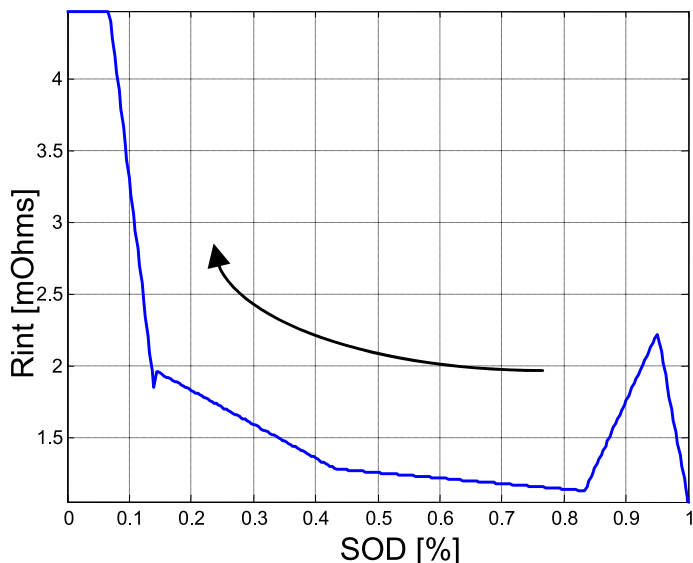
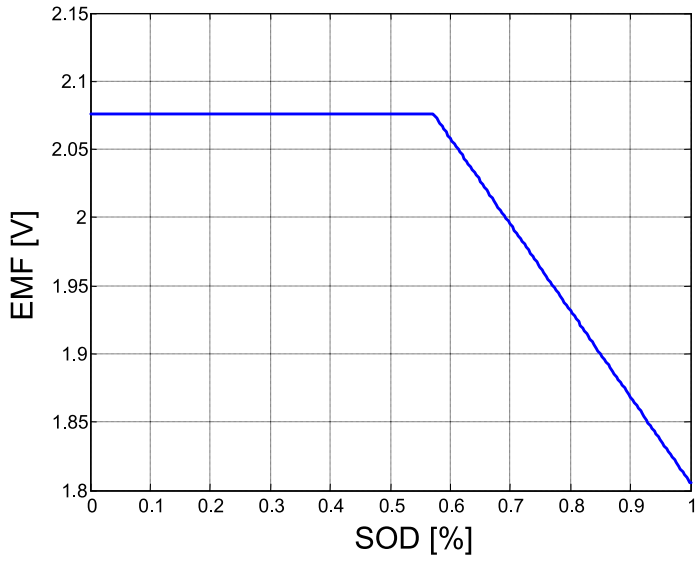
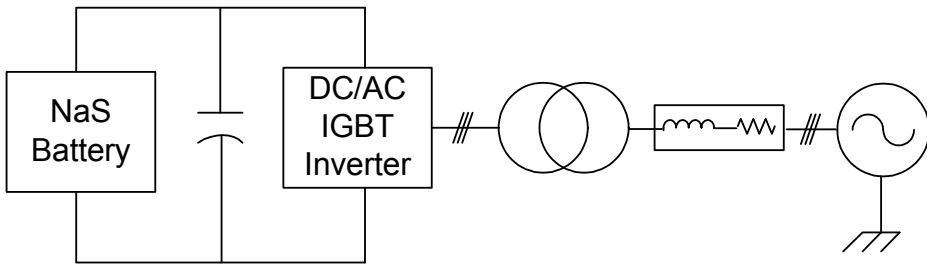


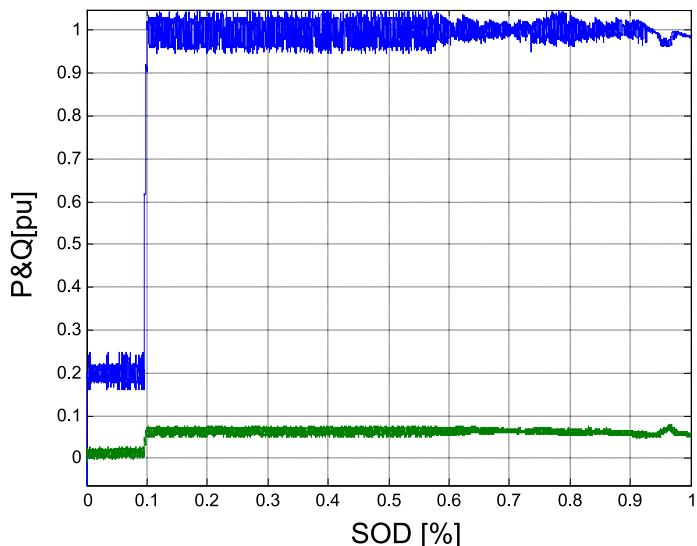
Figure 12. Simulation of cell resistance vs. SOD at 320°C for a charge situation



**Figure 13.** Simulation of cell electromotive force vs. SOD



**Figure 14.** NAS module connected to a test power system



**Figure 15.** Variation of active and reactive power from the Battery module (AC side)

This model can be easily modified to operate also in energy management mode. Because of methodology of modelling used, the model can be easily modified to simulate the temperature variation.

## 5. Conclusion

With the exception of conventional lead-acid batteries, advanced batteries analyzed in this chapter represent the cutting edge technology in high power density BESS applications. Li-Ion batteries have the greatest potential for future development and optimization. In addition to small size and low weight of the Li-Ion, they offer higher energy density and high storage efficiency, making them ideal for portable devices and flexible grid-connected distributed generation applications in microgrids. However, some of the biggest drawbacks of Li-Ion technology are its high costs (due to the complexity arising from the manufacture of special circuits to protect the battery) and the detrimental effect of deep discharge in its lifespan (Divya & Østergaard 2009). Although the Ni-Cd and Pb-acid batteries can provide large peak power, they contain toxic heavy metals and suffer from high self-discharge.

Sodium sulfur-type BESS devices are best suited to the requirements set by modern microgrid applications. These batteries can act in contingencies where rapid action is required to maintain the adequate levels of the grid frequency, but also in the case of high penetration of renewable generation, such as wind or solar photovoltaic, since the NaS battery can operate as the perfect complement in valley hours. In this case, the excess energy can be stored for delivery in peak hours. They are environmentally safe and have low maintenance while operate at high temperatures; it does not represent a major drawback. The biggest drawbacks are the cost and the limited information about these type of batteries

which difficult the development of experimental prototypes and computer models. It is expected however that the appearance of other vendors reduces costs and facilitate the modelling.

### **Appendix: Oxidation reduction (Redox) reaction**

The oxidation-reduction reactions (also known as redox reaction) refer to all chemical reactions in which atoms have their oxidation state changed. Fundamentally, redox reactions are a family of reactions that are concerned with the transfer of electrons between species. Thus, in order to produce a redox reaction in the system, an element to yield electrons and one that will accept them must exist. This transfer occurs between a set of chemical elements, an oxidant and a reductant.

Oxidation involves an increase in oxidation number, while reduction involves a decrease in oxidation number. Usually the change in oxidation number is associated with a gain or loss of electrons, but there are some redox reactions (e.g., covalent bonding) that do not involve electron transfer. Depending on the chemical reaction, oxidation and reduction may involve any of the following for a given atom, ion, or molecule:

- Oxidation - involves the loss of electrons or hydrogen or gain of oxygen or increase in oxidation state
- Reduction - involves the gain of electrons or hydrogen or loss of oxygen or decrease in oxidation state

Oxidants are usually chemical substances with elements in high oxidation states (e.g.,  $\text{H}_2\text{O}_2$ ,  $\text{CrO}_3$ ,  $\text{OsO}_4$ ), or else highly electronegative elements ( $\text{O}_2$ ,  $\text{F}_2$ ,  $\text{Cl}_2$ ,  $\text{Br}_2$ ) that can gain extra electrons by oxidizing another substance. Reductants in chemistry are very diverse. Electropositive elemental metals, such as lithium, sodium, magnesium, iron, zinc, and aluminum, are good reducing agents. These metals donate or give away electrons readily.

In redox processes, the reductant transfers electrons to the oxidant. Thus, in the reaction, the reductant or reducing agent loses electrons and is oxidized, and the oxidant or oxidizing agent gains electrons and is reduced. The pair of an oxidizing and reducing agent that are involved in a particular reaction is called a redox pair or couple.

When a net reaction proceeds in an electrochemical cell, oxidation occurs at one electrode, the anode, and reduction takes place at the other electrode, the cathode. The cell consists of two half-cells joined together by an external circuit through which electrons flow and an internal pathway that allows ions to migrate between them. Since the oxidation potential of a half-reaction is the negative of the reduction potential in a redox reaction, it is sufficient to calculate either one of the potentials. Therefore, standard electrode potential is commonly written as standard reduction potential.

The sign of the potential depends on the direction in which the electrode reaction has elapsed. By convention, the electrode potentials refer to the semi-reduction reaction. The potential is then positive, when the reaction occurs in the electrode (facing the reference) is

the reduction, and is negative when oxidation. The most common electrode as a reference electrode is called the reference or normal hydrogen, which has zero volts.

Finally, the voltage of a cell is determined by the reduction potential of redox couple used and is usually between 1 V and 4 V per cell. A complete table of the type of potential constituent of the electrode can be seen in (Linden & Reddy 2001).

Batteries in which the redox process is not reversible are called primary (non-rechargeable). For this work, are of interest only secondary batteries (rechargeable) which are based on some kind of reversible process and can be repetitively charged and discharged. In this way, only this type of batteries are considered here when batteries are referred.

## Author details

Antonio Ernesto Sarasua

*Instituto de Energía Eléctrica, Universidad Nacional de San Juan, Argentina*

Marcelo Gustavo Molina and Pedro Enrique Mercado

*CONICET, Instituto de Energía Eléctrica, Universidad Nacional de San Juan, Argentina*

## Acknowledgement

The authors wish to thank the CONICET (Argentinean National Council for Science and Technology Research), the UNSJ (National University of San Juan), and the ANPCyT (National Agency for Scientific and Technological Promotion) under grant FONCYT PICTO UNSJ 2009 – Cod. No. 0162, for the financial support of this work.

## 6. References

- Abdollahi Sofla M. & Gharehpetian G.B. (2011). Dynamic performance enhancement of microgrids by advanced sliding mode controller. *Electrical Power and Energy Systems*; Vol. 33, No. 1, pp. 1–7.
- Baxter, R. (2005). *Energy Storage: A Nontechnical Guide*, Issue 1, Pennwell Books. 978-1593700270. New York
- Bito, A. (2005). Overview of the Sodium-Sulfur (NAS) Battery for the IEEE Stationary Battery Committee. Special Presentation from Sodium-Sulfur Battery Division, NGK Insulators, Ltd. Nagoya, Japan. June 15
- Chen, H.; Cong, T.N.; Yang, W.; Tan, Ch.; Li, Y. and Ding, Y. (2009). Progress in electrical energy storage system: A critical review. *Progress in Natural Science*, Vol. 19, pp. 291-312.
- Chen, M. & Rincón-Mora, G.A. (2006). Accurate Electrical Battery Model Capable of Predicting Runtime and I-V Performance. *IEEE Transactions on Energy Conversion*, Vol 21, No. 2, pp. 504-511.

- CIEMAT (1992). *Fundamentos, dimensionado, y aplicaciones de la energía solar fotovoltaica*. CIEMAT: Centro de Investigaciones Energéticas, medioambientales y tecnológicas. Universidad Politécnica de Madrid. 8478341684. Madrid
- Divya, K.C. & Østergaard, J. (2009). Battery energy storage technology for power systems - An overview. *Electric Power Systems Research*, Vol. 79, pp.511-520.
- Guerrero, J.M.; Blaabjerg, F.; Zhelev, T.; Hemmes, K.; Monmasson, E.; Jemei, S.; Comech, M.P.; Granadino, R. & Frau, J.I. (2010) Distributed generation: toward a new energy paradigm. *IEEE Industrial Electronics Magazine*; Vol. 4, No. 1, pp. 52–64.
- Gyuk, I. (2003). EPRI-DOE Handbook of Energy Storage for Transmission and Distribution Applications. *Electric Power Research Institute (EPRI) and U.S. Department of Energy Inc.*, Final Report: 1001834, December 2003.
- Hatziargyriou, N.; Asano, H.; Iravani, R. & Marnay, C. (2007). Microgrids. *IEEE Power & Energy Magazine*; Vol. 5, No. 4, pp. 78–94.
- Hewitt, N.J. (2012). Heat pumps and energy storage – The challenges of implementation. *Applied Energy*; Vol. 89, No. 1, pp. 37-44.
- Hussien, Z.F.; Cheung, L. W.; Siam, M.F. M. & Ismail, A. B. (2007). Modelling of Sodium Sulphur Battery for Power System Applications. *Elektrika*, Vol. 9, No. 2, pp. 66-72.
- Iba, K.; Ideta, R. & Suzuki, K. (2006). Analysis and Operational records of a NAS battery. *Proceedings of the 41st International Universities Power Engineering Conference, UPEC 2006*, Vol. 2, pp. 491-495.
- Iba, K.; Tanaka, K. & Yabe, K. (2008). Operation and Control of NaS Batteries on a University Campus. *16<sup>th</sup> PSCC*, Glasgow, Scotland, July 14-18, 2008. ISBN of Conference Proceedings: 978-0-947649-28-9
- Kaneko, T.; Uehara, A.; Senjyua, T.; Yona, A. & Urasaki, N. (2011). An integrated control method for a wind farm to reduce frequency deviations in a small power system. *Applied Energy*; Vol. 88, No. 4, pp. 1049–1058.
- Katiraei, F.; Iravani, R.; Hatziargyriou, N. & Dimeas, A. (2008). Microgrids management: Controls and operation aspects of Microgrids, *IEEE Power & Energy Magazine*; Vol. 6. No. 3, pp. 54–65.
- Kroposki, B.; Lasseter, R.; Ise, T.; Morozumi, .S; Papatlianassiou, S. & Hatziargyriou, N. (2008) Making microgrids work. *IEEE Power & Energy Magazine*; Vol. 6, No. 3, pp. 40–53.
- Li, K.; Wang, B.; Su, D.; Park, J.; Ahn, H. & Wang, G. (2010). Enhance electrochemical performance of lithium sulphur battery through a solution-based processing technique. *Journal of Power Sources*
- Linden, D. & Reddy, T.B. (Ed(s.)) (2002). *Handbook of Batteries*. Mac Graw Hill. 0071359788. New York
- Maharjan, L.; Tsukasa, Y. & Akagi, H. (2010). Active-power control of individual converter cells for a battery energy storage system based on a multilevel cascade PWM converter. *IEEE Trans. Power Electronics*; Vol. PP, No. 99,. ISSN: 0885-8993
- Mathiesen, B.V.; Lunda, H. & Karlsson, K. (2011). 100% Renewable energy systems, climate mitigation and economic growth. *Applied Energy*; Vol. 88, No. 2, pp. 488–501.



- Molina, M. G. & Mercado, P. E. (2006). New Energy storage devices for applications on frequency control of the power system using FACTS controllers. *Proceedings of X Latin-American Regional Meeting of CIGRÉ (ERLAC), CIGRÉ*, pp. 222-226, May 2006 Iguazú, Argentina.
- Molina, M. G. & Zobaa, A.F. (2011). Improving the performance of grid-tied AC microgrids including renewable generation by distributed energy storage. *3<sup>rd</sup> Latin American Conference on Hydrogen and Sustainable Energy Sources (HYFUSEN 2011)*, June 6–9, Mar del Plata, Argentina.
- Molina, M. G. (2011). Enhancement of power system security level using FACTS controllers and emerging energy storage technologies. In: Acosta, M. J., editor. *Advances in Energy Research – Vol. 6*. New York: Nova Science Publishers Inc; pp. 1–65.
- Mukund, R. P. (1999). *Wind and Solar Power Systems*. CRC Press.
- Naish, C.; McCubbin, I.; Edberg, O. & Harfoot, M. (2008). Outlook of Energy Storage Technologies. *Study of the European Parliament - Policy Department of Economic and Scientific Policy*, Info: IP/A/ITRE/FWC/2006-087/Lot 4/C1/SC2.
- Nourai, A. (2002). Large-Scale Electricity Storage Technologies for Energy Management. *Proc. 2002 IEEE Power Engineering Society Summer Meeting*, Vol. 1, pp. 310-315.
- Panasonic (n.d.). 1.5MWh Lithium-ion Mega Battery System. Available from: <http://panasonic.net/sanyo/gep/guide/04.html>
- Qian, H.; Zhang, J.; Lai, J. & Yu, W. (2011). A high-efficiency grid-tie battery energy storage system. *IEEE Trans. Power Electronics*; Vol. 26, No. 3, pp. 886–896.
- Schroeder, A. (2011). Modeling storage and demand management in power distribution grids. *Applied Energy*; Vol. 88, pp. 4700-4712..
- Scrosati, B. & Garce, J. (2010) Lithium batteries: Status, prospects and future. *Journal of Power Sources*. Vol. 195, pp 2419–2430.
- Serban, I. & Marinescu, C. (2008). Power Quality Issues in a Stand-Alone Microgrid Based on Renewable Energy. *Revue Roumaine des Sciences Techniques, Série Électrotechnique et Énergétique*; Vol. 53, No. 3, pp. 285–293.
- Sørensen, B. (2003) "Renewable Energy". Elsevier Science. Third Edition.
- Tiwari, G.N.; Mishra, R.K. & Solanki, S.C. (2011). Photovoltaic modules and their applications: A review on thermal modeling. *Applied Energy*. Vol. 88, No. 7, pp. 2287–2304.
- Vachirasricirikul, S. & Ngamroo, I. (2011). Robust controller design of heat pump and plug-in hybrid electric vehicle for frequency control in a smart microgrid based on specified-structure mixed H<sub>2</sub>/H<sub>∞</sub> control technique. *Applied Energy*. Vol. 88, No. 11, pp. 3860–3868.
- Van den Bossche, P.; Vergels, F.; Van Mierlo, J.; Matheys, J. & Van Autenboer, W. (2006). SUBAT: An assessment of Sustainable battery technology. *Journal of Power Sources*, Vol. 162, No. 2, pp. 913-919.
- Vazquez, S.; Lukic, S.M.; Galvan, E.; Franquelo, L.G. & Carrasco, J.M. (2010). Energy storage systems for transport and grid applications. *IEEE Trans. Power Electronics*; Vol. 57, No. 12, pp 3881–3895.

Wen, Z.; Cao, J.; Gu, Z.; Xu, X.; Zhang, F. & Lin, Z. (2008). Research on sodium sulfur battery for energy storage. *Solid State Ionics*. Vol. 179, pp.1697-1701.

Wissner M. (2011). The Smart Grid – A saucerful of secrets? *Applied Energy*; Vol. 88, No. 7, pp. 2509–2518.