

portant difference in chemical reactivity between Fe-(TMM) L_3 complexes ($L = PR_3$ (**3**) and $L = CO$): a one-electron transfer easily occurs from **3** on attempts of alkylation and the resulting 17-electron intermediate is stabilized by the basic phosphines L , whereas Fe-(TMM)(CO) $_3$ is the site of electrophilic substitutions,¹⁵ but its one-electron abstraction is difficult to perform and immediately undergoes decomposition, presumably via initial cleavage of an Fe-CO bond. This illustrates the deciding role of the nature of the ligands to modulate the behavior of complexes within the same family.

Cyclic voltammetry of **6a-c** showed a reversible one-electron oxidation at negative potential corresponding to the formation of Fe(*o*-xylylene) L_3^+ (**6⁺**), and an irreversible wave between 0.50 and 0.70 V was observed (Table VI). The latter oxidation can be attributed to the **6⁺**/**6²⁺** couple which may decompose with phosphine dissociation. The ease of the first oxidation of **6** confirms their electron-rich character. The lowering of the corresponding potential follows the expected increase in electron-donor ability of phosphorus derivatives L according to the sequence P(OMe) $_3 < PMe_2Ph < PMe_3$. Of special interest is the comparison of the first oxidation potentials for **3** and **6** and for the same ligand L . It shows a greater reducing power for **6** vs **3** of more than 0.2 V. This is consistent with a lower oxidation state of the iron center in **6** than in **3**. It confirms the nature of an (η^4 -diene)Fe⁰ complex of type IV for derivatives **6**.

Conclusion

Our results present an easy access to electron-rich (η^4 -hydrocarbon)iron complexes via FeCl $_2$ (PR $_3$) $_n$ interme-

diates, magnesium, and halogenated substrates. This method avoids the preliminary preparation of unstable Grignard reagents and should offer a potential for organometallic syntheses. The nature and the number of ancillary PR $_3$ groups play a determining role for the reactivity of FeCl $_2$ (PR $_3$) with *o*-BrMgCH $_2$ C $_6$ H $_4$ CH $_3$, which leads to either a C-H activation or a C-C coupling reaction. The studied Fe(η^4 -TMM) L_3 and Fe(η^4 -*o*-xylylene) L_3 complexes show at the same time a high tendency to give an electron transfer and an unexpected stability of the resulting paramagnetic species. These two characteristics, which are indicative of the electron-rich nature of the complexes, appear to be modulated by the electron-donor capability of the phosphorus groups and also by the type of interaction between the hydrocarbon ligand and the metal.

Acknowledgment. We are grateful to C. Mountassir and Dr. S. Sinbandhit for helpful assistance and discussions.

Registry No. **1a**, 55853-16-2; **1b**, 95911-92-5; **1d**, 55059-43-3; **2**, 1871-57-4; **3a**, 95911-86-7; **3a⁺**(CF $_3$ SO $_3^-$), 95911-88-9; **3a⁺**(NO $_3^-$), 111409-19-9; **3b**, 95911-83-4; **3b⁺**(CF $_3$ SO $_3^-$), 95911-85-6; **3c**, 111409-15-5; **3c⁺**(CF $_3$ SO $_3^-$), 111409-17-7; **4a**, 612-12-4; **5**, 56812-61-4; **6a**, 111409-13-3; **6a⁺**, 111409-14-4; **6b**, 95911-91-4; **6d**, 95911-89-0; **7**, 952-80-7; **8b**, 111409-18-8; **9b**, 110074-88-9; MeC(CH $_2$ PMe $_2$) $_3$, 77609-83-7; CH $_3$ C(CH $_2$ Cl) $_3$, 1067-09-0.

Supplementary Material Available: Tables of bond lengths, bond angles, and anisotropic temperature factors and an ORTEP of the structure including the anion (Figure S1) for **3a⁺**(CF $_3$ SO $_3^-$) (4 pages); a listing of calculated and observed structure factors (10 pages). Ordering information is given on any current masthead page.

Metallacyclobutadiene versus Metallatetrahedrane Structures for Cl $_3$ MoC $_3$ H $_3$ Complexes

Eric V. Anslyn, Mark J. Brusich, and William A. Goddard III*

Arthur Amos Noyes Laboratory of Chemical Physics, [†] California Institute of Technology, Pasadena, California 91125

Received May 13, 1987

The bonding and energetics in the Cl $_3$ MoC $_3$ H $_3$ metallacyclobutadiene are contrasted with those in the metallatetrahedrane. The complexes are found to be within 20 kcal/mol of one another, with the metallatetrahedrane being the lower in energy. The Mo-C bonds are essentially covalent in both structures, and the metallacyclobutadiene possesses resonance stabilization. Charge distribution in the carbon fragments reveals no cyclopropenium character in the C $_3$ H $_3$ ring of the metallatetrahedrane. Bonding, energetics, and charge distributions are all discussed with an emphasis on structure and reactivity.

I. Introduction

Metallacyclobutadienes **A** are believed to play the same role in acetylene metathesis¹ (eq 1) as metallacyclobutanes **B** play in olefin metathesis² (eq 2). Strong evidence for

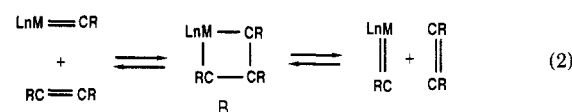
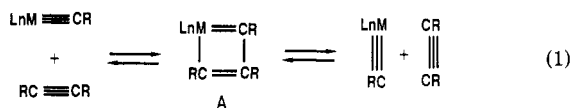

the role of **A** in acetylene metathesis is provided by the isolation and crystal structures of the following complexes: **1**, W[C(CMe $_3$)(CMe) $_2$]Cl $_3$;³ **2**, W(C $_3$ Et $_3$)[O-2,6-C $_6$ H $_3$ (*i*-Pr) $_2$] $_3$;⁴ **3**, W(C $_3$ Et $_3$)[OCH(CF $_3$) $_2$] $_3$.⁵ Unfortunately, not all

(1) (a) Wengrovius, J. H.; Sancho, J.; Schrock, R. R. *J. Am. Chem. Soc.* **1981**, *103*, 3932. (b) Sancho, J.; Schrock, R. R. *J. Mol. Catal.* **1982**, *15*, 75.

(2) (a) Dragutan, V.; Balaban, A. T.; Dimone, M. *Olefin Metathesis and Ring Opening Polymerizations of Cyclo-Olefins*; Wiley-Interscience: Chichester, 1985. (b) Ivin, K. J. *Olefin Metathesis*; Academic: London, 1983. (c) Mol, J. C. *CHEMTECH* **1983**, *13*, 250. (d) Grubbs, R. H. In *Comprehensive Organometallic Chemistry*; Wilkinson, G., Ed.; Pergamon: Oxford, 1982; Vol. 8, pp 499-551. (e) Banks, R. L. *Catalysis (London)* **1981**, *4*, 100.

(3) Pedersen, S. F.; Schrock, R. R.; Churchill, M. R.; Wasserman, H. *J. Am. Chem. Soc.* **1982**, *104*, 6808.

(4) Churchill, M. R.; Ziller, J. W.; Freudenberger, J. H.; Schrock, R. R. *Organometallics* **1984**, *3*, 1554.

* Contribution no. 7586.

of the metallacyclobutadienes isolated are active catalysts.⁵⁻⁷ Species 2 and 3 are, however, isolated as end products from catalytically active systems.^{4,5} Despite the experimental observation of these species, there remain a number of questions concerning the bonding in these complexes. Are the complexes best viewed as metallacyclobutadienes, and, if so, is there resonance stabilization or destabilization in the π system? The X-ray structures of 1, 2, and 3 reveal a particularly short W- β -C distance ranging from 2.093 to 2.159 Å—only about 0.2 Å longer than the W- α -C bond.³⁻⁵ This naturally led to speculation that there might be a bonding interaction between W and the β -carbon and that 1, 2, and 3 might be structurally or electronically different from the metallacycles presumed to form in the catalytically active systems. Further studies of dialkylacetylene metathesis involved varying the steric bulk of the alkyl groups on the metallacycle carbons and of the axial-equatorial ligands. The conclusion reached was that sterics are the overriding factor influencing the rate of metathesis and thus the stability of the metallacycle.⁴⁻⁷

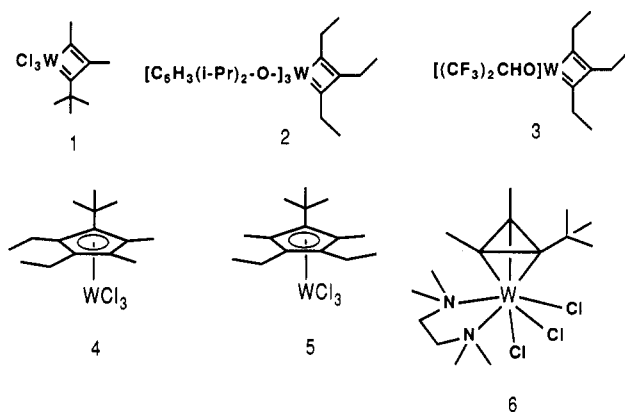

The fate of 1 in the presence of excess diethylacetylene is not that of metathesis but of cyclopentadienyl formation. Surprisingly, two cyclopentadienyl complexes (4 and 5) are formed.⁷ The simplest mechanism which would give rise to a cyclopentadienyl complex is one in which the alkyne coordinates and then inserts into a W- α -C bond to yield a tungstabenzen intermediate, which then collapses to a cyclopentadienyl complex. Such a route should yield only 4. A possible answer to this problem⁷ was suggested following the isolation of 6, $W[C_3Me_2(CMe_3)][TMEDA]Cl_3$, from the reaction of 1 and TMEDA (tetramethylethylenediamine). The complex is pseudooctahedral and contains a *symmetrically bound* η^3 -cyclopropenyl ligand. This interconversion between a metallacyclobutadiene and a metallatetrahedrane allows for the formation of the two cyclopentadienyl complexes by rotation of the η^3 ring and, thus, isomerization of the alkyl groups in the metallacyclobutadiene.

The structure of 6 revealed that the ring substituents all bend up out of the plane of the carbon ring.⁷ The original investigators⁷ explain this in terms of steric interactions between the ring groups and the W ligands. The origin of this interaction is presumably due to the carbon ring being drawn close to the metal due to the latter's

electron deficiency. These investigators⁷ proposed W(IV) and $(C_3R_3)^-$ but did not rule out that the tungstenate-tetrahedrane is W(VI) with a $(C_3R_3)^{3-}$ ligand. They suggested that $(C_3R_3)^+$ with W(II) seemed least satisfactory.

The interconversion between metallatetrahedrane and metallacyclobutadiene has been treated theoretically for the general case where an ML_n fragment cleaves a C-C bond of the metallatetrahedrane to give a metallacyclobutadiene.⁸ Equilibrium geometries for several ML_n and C_3R_3 fragments were predicted, but detailed analyses of bonding and energetics were not presented. Therefore we undertook to study in detail a specific system of considerable current experimental interest.

The experimental studies suggest several questions which lend themselves to detailed theoretical analysis. What is the nature of the W-C bonding interaction in the metallacyclobutadiene and the metallatetrahedrane; is it mostly covalent or ionic? What are the charges on the carbon fragments and how large is the electron deficiency of each species? Is there any W- β C bonding interaction in the metallacyclobutadiene? What are the relative energetics between the two structures and why do they interconvert so readily? Is there any barrier to rotation of the C_3R_3 ring in the metallatetrahedrane species? What role do the electron-withdrawing ligands play in the energetics of the species?

II. Computational Details

A. Basis Sets and Effective Potentials. All electrons were considered explicitly for C and H but effective potentials were used to replace core electrons of Cl and Mo. For Cl, the Ne core was replaced with the SHC effective potential⁹ (treating neutral Cl with seven explicit electrons) and for Mo, a relativistic effective potential¹⁰ was used for the Zn core (treating neutral Mo with 12 explicit electrons). All calculations used Cartesian Gaussian basis sets. For carbon,⁹ the 9s, 5p primitive Gaussian basis was contracted to valence-double ζ 3s, 2p.¹¹ For hydrogen,⁹ the 3s primitive basis was scaled ($\zeta = 1.2$) and contracted to 2s.¹¹ For Mo,¹⁰ the basis set was contracted to 3s, 4p, 2d from the primitive 3s, 5p, 3d. For Cl,⁹ the 3s, 2p primitive basis was contracted to 1s, 1p based on $TiCl_4$.

B. Wave Functions. Wave functions were calculated at the Hartree-Fock (HF), generalized valence bond (GVB), and generalized valence bond configuration interaction (GVB-CI) levels. For HF, the singlet state has all orbitals doubly occupied

$$\Phi^{HF} = \phi(1)\phi(2)(\alpha\beta - \beta\alpha) \quad (3)$$

but optimized self-consistently. This leads to a good description of bonds constructed from highly overlapping orbitals but a poor description of bonds involving low overlap (e.g., M-C π bonds). The GVB wave function introduces electron correlation effects by allowing each electron to have its own orbital, which is then optimized self-consistently. For a typical two-electron bond, the GVB wave function has the form

$$\Phi^{GVB} = [\phi_1(1)\phi_r(2) + \phi_r(1)\phi_1(2)](\alpha\beta - \beta\alpha) \quad (4)$$

where ϕ_r and ϕ_1 are, in general, fairly localized on opposite atoms in the bond.

Because some electron pairs are well treated in HF (as in 1), while others require correlation (as in 3), GVB cal-

(5) Freudenberger, J. H.; Schrock, R. R.; Churchill, R. M.; Rheingold, A. L.; Ziller, J. W. *Organometallics* 1984, 3, 1563.

(6) (a) Schrock, R. R.; Clark, D. N.; Sancho, J.; Wengrovius, J. H.; Rocklage, S. M.; Pedersen, S. F. *Organometallics* 1982, 1, 1645. (b) Schrock, R. R.; Listermann, M. L.; Sturgeoff, L. G. *J. Am. Chem. Soc.* 1982, 104, 4291.

(7) Schrock, R. R.; Pedersen, S. F.; Churchill, M. R.; Ziller, J. S. *Organometallics* 1984, 3, 1574.

(8) Jemmis, E. D.; Hoffmann, R. *J. Am. Chem. Soc.* 1980, 102, 2570.

(9) Huzinaga, S. *J. Chem. Phys.* 1965, 42, 1293.

(10) Hay, P. J., personal communication to Goddard, W. A., III.

(11) Dunning, T. H., Jr. *J. Chem. Phys.* 1970, 53, 2823.

culations often correlate only a portion of the bond pairs.¹² Generally, we correlated the pairs that change significantly during a reaction sequence and those that have large correlation errors. To indicate the level of correlation, the GVB wave function is denoted as GVB (n/m), where n is the number of electron pairs being correlated and m is the number of orbitals used for the correlated pairs (generally $2n$). In the various $\text{Cl}_3\text{Mo}(\text{C}_3\text{H}_3)$ complexes, the 12 electrons involved in Mo-C and C-C bonding are correlated since these electrons change dramatically as the structure is changed from 7 to 8. Thus we carry out GVB (6/12)

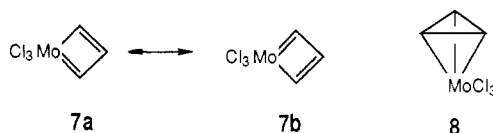

level calculations. The shape of the self-consistent GVB orbitals is used to interpret the bonding characteristics of the wave function. We find that these six bond pairs have the following character: the metallacyclobutadiene 7 has two metallacycle π bonds, two Mo-C σ bonds, and two C-C σ bonds (leaving the other orbitals as self-consistent doubly occupied orbitals). The metallatetrahedrane involves three Mo-C bonds and three C-C bonds.

The self-consistent GVB calculations were restricted (perfect pairing) such that each correlated pair is constrained to have the form in eq 4. This leads to an excellent description of systems that are well-described in terms of one bonding structure (e.g., 8) but not of systems involving strong resonance effects (as in 7). One approach to handling resonance in the GVB description is to optimize the orbitals for the resonating structures (7a and 7b) self-consistently, while allowing different orbitals for the two structures.¹³ This is termed GRVB (generalized resonating valence bond) and has been applied to similar systems (e.g., cyclobutadiene).¹⁴ An alternative approach is to start with the GVB orbitals for one bonding structure, say 7a, and then to carry out a configuration interaction calculation in which the occupation of the orbitals is allowed to change, permitting the orbitals to describe other resonance structures (e.g., 7b). For the metallacyclobutadiene, we used the latter approach. Thus for 7a, the Mo-C and C-C σ bonds were allowed to have all spin pairings within each set of natural orbitals in a given bond pair (not just the one in eq 4); this is termed GVB-RCI. We allowed all excitations within the four natural orbitals representing the GVB π bonds (GVB-CI). In addition, to allow readjustments in the shapes of the various orbitals in the presence of resonance, we allowed all excitations out of the dominant configurations into the entire valence space (GVB-RCI-S) for the Mo-C bonds in order to allow resonance. For the metallatetrahedrane, the C-C bonds were described with GVB-RCI and the Mo-C bonds with GVB-CI.

III. Results and Discussion

First, we will examine the GVB description of the bonding in both the metallacyclobutadiene and the metallatetrahedrane with an emphasis on qualitative aspects. Next, we examine charge distribution, and finally we will compare relative energetics between the two complexes.

(12) Bobrowicz, F. W.; Goddard, W. A., III In *Modern Theoretical Chemistry, Methods of Electronic Structure Theory*; Schaefer, H. F., III, Ed.; Plenum: New York, 1977; Vol. 3, Chapter 4, pp 79-127.

(13) Voter, A. F.; Goddard, W. A., III *Chem. Phys.* 1977, 57, 3, 253.

(14) Voter, A. F.; Goddard, W. A., III *J. Am. Chem. Soc.* 1986, 108, 2830.

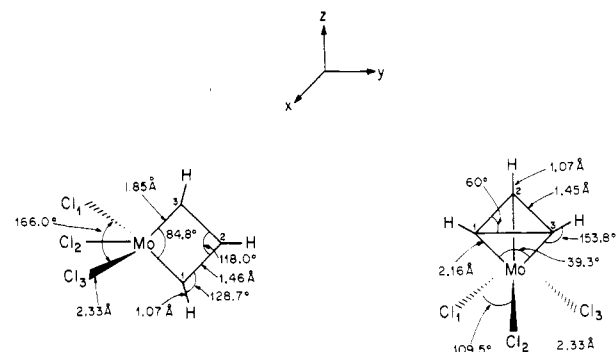

Figure 1. Calculated structures for the metallatetrahedrane and the metallacyclobutadiene.

This will all be done with an emphasis on reactivity.

A. Geometries. The structures for the two geometries are presented schematically in Figure 1. Mo was used in place of W for calculational convenience. It is felt that, because of the close correspondence of reactivity and structures for W and Mo, this substitution will not significantly affect the trends calculated. In fact, similar alkylidyne,¹⁵ metallatetrahedrane,¹⁶ and metallacyclobutadiene^{15d} chemistry for Mo is already emerging and exhibits acetylene metathesis and polymerization activity. In addition, several acetylene metathesis systems based on Mo are known.¹⁷ Furthermore, the covalent and ionic radii for Mo and W are similar,¹⁸ so that no adjustment of the bond lengths and angles from the W crystal structure are expected.

In support of this assumption, a recent crystal structure of a less oxidized metallatetrahedrane, $\text{CpMo}(\text{CO})_2(\text{C}_3\text{Ph}_3)$, showed bond lengths of approximately 0.1 Å longer than those used in our calculation. This is as would be expected for a less oxidized species where the electron-rich C_3R_3 fragment is not held as close to the metal.

The goal of this study is to extract a conceptual understanding of 7 and 8 and of the relative bonding characteristics and relative energetics. Consequently, we based the geometries solely on crystal structure information. In cases where the crystal structure information could not be used to place the atoms, several geometries were calculated. For complex 7, we constrained the system to have equal Mo-C distances and equal C-C distances, leading to C_{2v} symmetry in the $\text{Cl}_3\text{Mo}(\text{C}_3\text{H}_3)$ complex. In complex 8, however, the chlorines are not totally placed from crystal structure information and the TMEDA ligand was omitted. The Mo-Cl bond distances were derived from the crystal structure but the Cl positions relative to the cyclopropenyl fragment were placed in several arrangements, always retaining C_{3v} symmetry. The TMEDA ligand was deleted so that the two complexes have the same number of ligands and electrons, allowing a fair comparison of the relative energetics for these bonding types.

(15) (a) Fischer, E. O.; Kreis, G.; Kreiter, C. G.; Müller, J.; Huttner, G.; Lorentz, H. *Angew. Chem., Int. Ed. Engl.* 1973, 12, 564. (b) Clark, D. N.; Schrock, R. R. *J. Am. Chem. Soc.* 1978, 100, 6774. (c) Schrock, R. R.; Clark, D. N.; Sancho, J.; Wengrovius, J. H.; Rocklage, S. M.; Pedersen, S. F. *Organometallics* 1982, 1, 1645. (d) McCullough, L. G.; Schrock, R. R.; Dewan, J. C.; Murdyck, J. C. *J. Am. Chem. Soc.* 1985, 107, 5987.

(16) Drew, M. G. B.; Bresdon, B. J.; Day, A. J. *J. Chem. Soc., Dalton Trans.* 1981, 1310, and references therein.

(17) (a) Mortreux, A.; Delgrange, J. C.; Blanchard, M.; Lubochinsky, B. *J. Mol. Catal.* 1977, 2, 73. (b) Devarajan, S.; Wlaton, O. R. M.; Leigh, G. J. *J. Organomet. Chem.* 1979, 181, 99. (c) Bencheick, A.; Petit, M.; Mortreux, A.; Petit, F. *J. Mol. Catal.* 1982, 15, 93. (d) Villemin, D.; Cachiot, P. *Tetrahedron Lett.* 1982, 23, 5139. (e) Petit, M.; Mortreux, A.; Petit, F. *J. Chem. Soc., Chem. Commun.* 1982, 1385.

(18) Weast, R. C. *CRC Handbook of Chemistry and Physics*; CRC Press: Boca Raton, FL, 1980.

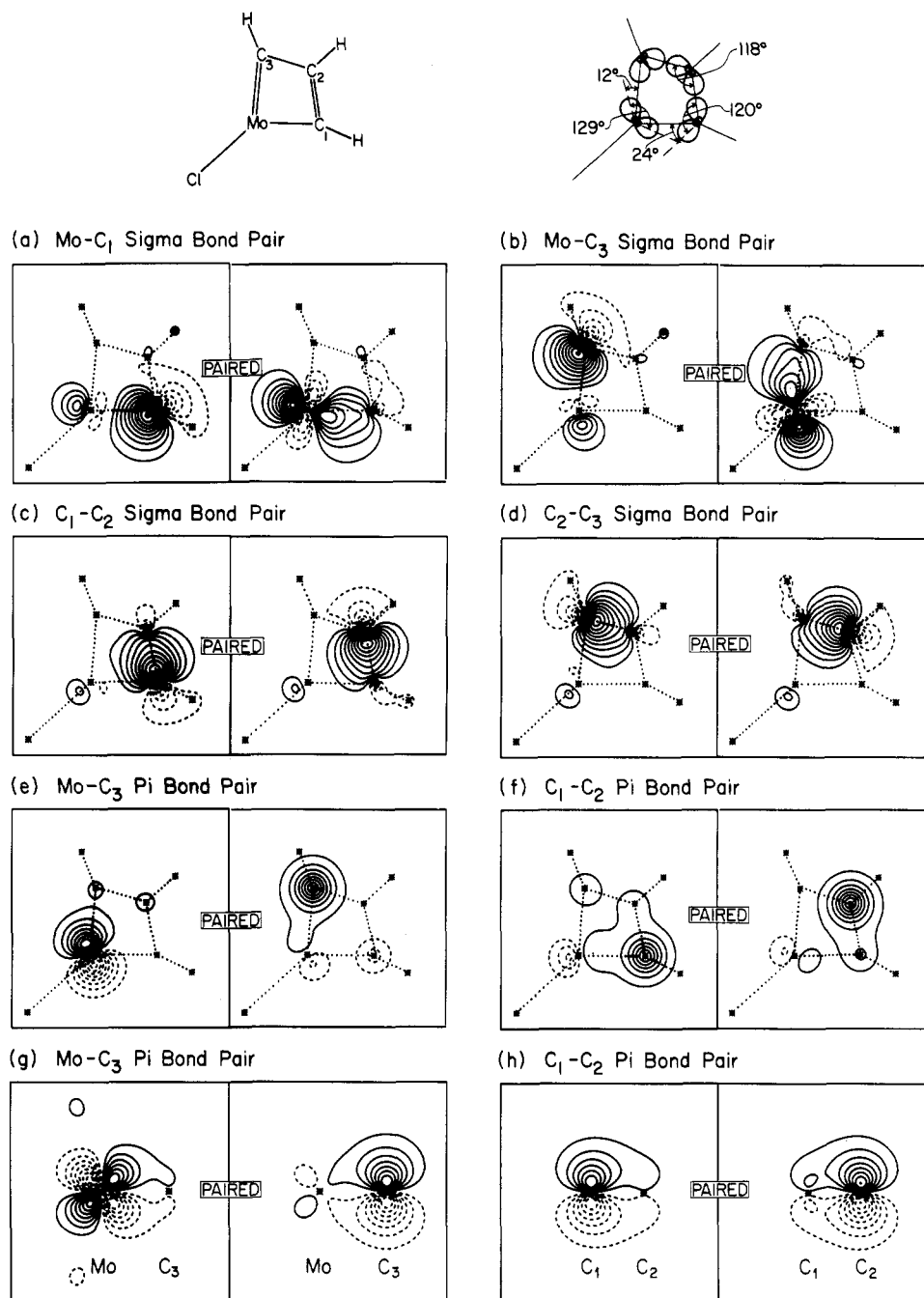

Figure 2. Contour plots for the GVB-PP orbital of metallacyclobutadiene. Spacing between contours is 0.05 au; solid lines are positive and dashed lines are negative.

B. Orbitals. The contour plots of the GVB orbitals for the metallacyclobutadiene are presented in Figure 2 and the GVB orbitals for a metallatetrahedrane in Figure 3. As discussed in section II.B, each GVB orbital has one electron, but the two orbitals of a bond pair are allowed to overlap, forming a wave function as presented in eq 2.

1. Bonding in the Metallacyclobutadiene. As indicated in Figure 2, the metallacyclobutadiene has covalent Mo-C₁, C₁-C₂, C₂-C₃, and Mo-C₃ σ bonds and covalent C₁-C₂ and Mo-C₃ π bonds. Thus, the name metallacyclobutadiene is appropriate. Considering both resonance structures (7a and 7b), the bond order is 1 $\frac{1}{2}$ for each Mo-C and C-C bond. The result is that three d orbitals on the Mo are involved in the bond to the C₃H₃ fragment. The other three valence electrons initially on Mo are involved in partially ionic bonds to the three Cl atoms.

The C₃H₃ framework has a central bond angle of 118.1°, and the C-C bond pairs are well directed along the bond

axes (unstrained). However, parts a and b of Figure 2 show that the Mo-C single bonds are strained. The center of the C lobe of the GVB bond is at an angle of 120° with respect to the C₁-C₂ axis (as if it were going to point at the H of planar allyl), leading to an angle of 42° off the line joining Mo and C₁. Similarly, the d-like bonding orbital on the Mo points about 22° off of the Mo-C₁ vector, leading to a bent bond. The net result is that the two Mo d-like orbitals form Mo-C bonds lying at an angle of 129° with each other. This is quite consistent with the prediction of Rappé and Goddard¹⁹ who showed that in order for two pure d orbitals to each be symmetric about their respective bond axes, the angle must be 125.3°.

The C-C π bond (Figure 2h) is conventional, involving p_x orbitals on each carbon. The Mo-C π bond (Figure 2g)

(19) Rappé, A. K.; Goddard, W. A., III *J. Am. Chem. Soc.* 1982, 104, 297.

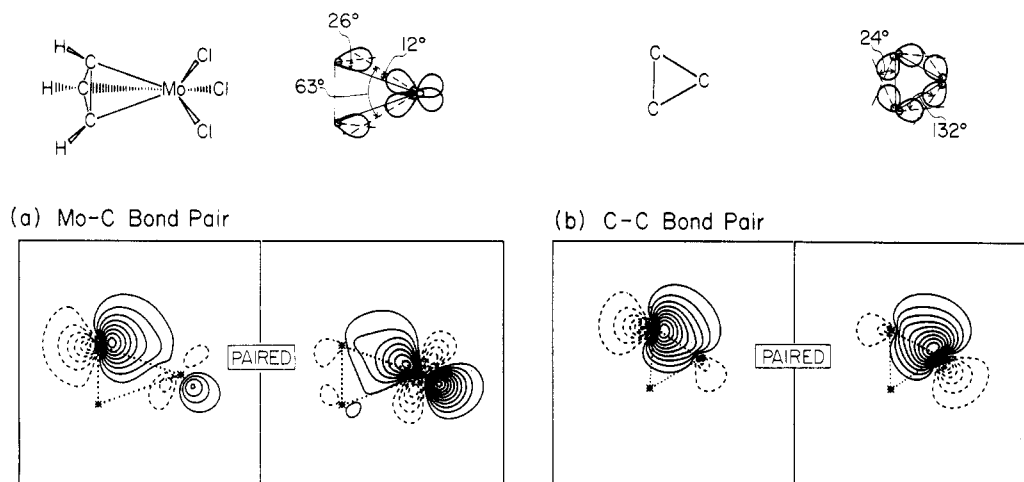

Figure 3. Contour plots for the metallatetrahedrane.

is quite covalent, involving one orbital that is Mo d -like ($d_{xy} + d_{xz}$) and one that is Cp_x . A cross section through these π bonds in a plane parallel to the MoC_3H_3 plane (yz) but displaced 0.5 \AA (in the x direction) reveals some bonding delocalization of the C-C π bond onto the Mo-C π bond (in Figure 2, parts e and f) and some delocalization of the Mo-C π bond onto the C-C π bond. In fact, this delocalization from the Mo-C π bond to the C-C π bond is about equal on each carbon. In addition, the delocalization of the C-C π bond to the Mo-C π bond is about equal on both the C and the Mo. Thus, *neither of these bonds has any significant interaction between Mo and the βC but only delocalization stemming from a resonance contribution.* The contour plots (Figure 2) show that there is no significant bonding interaction between the Mo and the βC . The C-C σ framework is sp^2 (Figure 2c,d) with a C-C-C and H-C-C bond angle of $\sim 120^\circ$. The combination of a C-C-C bond angle of 118° with bent Mo-C single bond leads to a short Mo- β -C distance. The geometry thus is a balance struck between the small C-Mo-C angle and the restraint of forming two good C-C bonds with a bond order of 1.5. There is no Mo- β -C bonding interaction.

A contrasting view is presented by Bursten,²⁰ who performed Fenske-Hall²¹ molecular orbital calculations and found a significant W- β -carbon interaction in the butadienoid core $[WC_3H_3]^{3+}$. Bursten's results are best portrayed by using perturbational molecular orbital theory (PMOT). The interactions of the two occupied orbitals (A_2 , B_2) of allyl radical with the two $d\pi$ orbitals on W produce the two bonding orbitals b_2 and a_2 . As is seen in the b_2 orbital, there is considerable W- β -carbon bonding. Linear combinations of these orbitals do not produce localized π bonds as described in our GVB calculations.

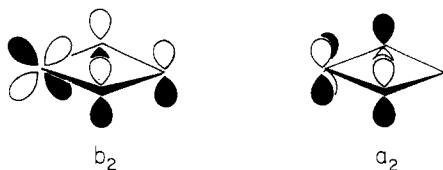
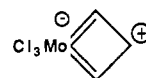

Figure 4. Mulliken populations for each atom in the metallatetrahedrane and metallacyclobutadiene.

between the carbons and also includes electron correlation in the bond pairs. This metalloaromatic system is thus stable because of the two $d\pi$ symmetry orbitals that allow the metal to form two π bonds simultaneously (by resonance) with bond orders each less than 1. In contrast, cyclobutadiene, uses a *single* carbon p orbital to form the π interaction with *both* adjacent carbon p orbitals.¹⁴

There is also an additional resonance structure which could arise from the PMOT approach by second-order mixing of the antibonding allyl orbital and the b_2 orbital. This would yield the valence bond structure shown.



There is no significant mixing of this state in our *ab initio* calculations, as indicated by the positive charge of 0.86 found on the Mo and the small charge (-0.03) on the β -C (see section C and Figure 4).

To form the two Mo- α -C bonds and two resonating π bonds, the Mo uses four of its five available orbitals. The empty orbital is of d_{z^2} character and leads to a coordination of a ligand along the x axis. An acetylene coordinated along this axis could then insert into an Mo- α -C bond to form a metallacyclohexatriene complex. With this insertion product formed, resonance is initially lost from the metallacyclobutadiene but is reintroduced in a hypothetical planar metallacyclohexatriene complex.

While the C-Mo-C angle is preferred to be 125° to form the optimum directional $d\sigma$ bonds, the axial Cl-Mo-Cl angle is expected to be large (166° in this case) due to high sd character (180° is optimal for two such bonds). Due to the high electronegativity of Cl, the Mo-Cl bonds are highly polarized toward Cl. These polar Mo-Cl bonds use Mo s orbitals since the ionization potential of the $5s$ electrons is less than for the $4d$ electrons. As a result of the charge transfer to the chlorines, the metal is positive,

(20) Bursten, B. E. *J. Am. Chem. Soc.* **1983**, *105*, 121.

(21) Hall, M. B.; Fenske, R. F. *Inorg. Chem.* **1972**, *11*, 768.

leading to covalent bonds to the carbons that are 4d-like and highly directed. This is the case in both the metallacyclobutadiene and the metallatetrahedrane.

2. Bonding in the Metallatetrahedrane. For the metallatetrahedrane, all GVB wave functions led to three covalent Mo-C bonds. All attempts to force another description such as a π allyl complex only resulted in reversion to the three covalent bond description. A typical Mo-C σ bond is in Figure 3a.

Each Mo-C bond involves a Mo d σ orbital pointing at an sp^3 -like orbital of the C_3H_3 fragment to form a σ bond. The metallatetrahedrane Mo-C σ bonds are less directional (more spatially diffuse) than in the metallacyclobutadiene because the metal now is forced to make three σ bonds rather than two. The bond is slightly bent ($\sim 12^\circ$) from the bond axis, leading to an angle of 63° between ends of the Mo d orbitals involved in each Mo-C bond. This small angle is created by the short C-C distance compared with the Mo-C distance. Rappé and Goddard²² showed that three equivalent orthogonal d orbitals, each rotationally symmetric about its bond axis, must be at an angle of 54.7° , in reasonable agreement with the calculated results. A contour map of the C-C bond is shown in Figure 3b. It involves typical sp^3 orbitals localized on each carbon with no interaction with the metal.

C. Charges. Reactivity in transition-metal complexes is controlled by the charge distributions between the metal and its ligands and by the nature of the metal-ligand bonds. The proposed reactivity of the metallacyclobutadiene in coordinating an acetylene requires that the metal center have an empty orbital and be electrophilic. The metallacyclobutadiene is a 12-electron species and therefore has empty orbitals. It is also calculated to be electrophilic, with the metal having a high positive charge of 0.86. In this complex, each chlorine takes approximately 0.34 electrons (see Figure 4 for all Mulliken populations). The α carbons are slightly negative and the β carbon is neutral. This charge distribution of the organic ligand is basically covalent, with no large charge polarization between the Mo and the C's. This is also apparent by viewing the contour maps in Figure 2, parts a and b. Each one-electron orbital is essentially centered on the individual atoms.

The chlorine-to-molybdenum bonds behave the same in both complexes. The chlorines serve to remove s electron density from the metal. In each case, the chlorines take about 1.1 electrons and leave the positive charge to be dispersed among the Mo and the organic fragment.

The metallatetrahedrane has a similar charge distribution as the metallacyclobutadiene. Each chlorine takes about 0.36 of an electron and leaves the Mo with a positive 0.74 charge and the ring with a positive 0.34 charge (0.34 for the tetrahedrane, 0.19 for the butadiene). Again, the carbons have a slight negative charge, reflecting a higher electronegativity than Mo or H. This is as expected for a covalent Mo-C interaction.

In order to explore how charge transfer is affected by geometry of the C_3H_3 ring, we recalculated the wave function with a flat C_3H_3 ring (the original geometry had the H's bent back by 44°). Since $C_3H_3^-$ is "antiaromatic", this might lead to a propensity for $C_3H_3^+$ and hence charge transfer to the metal. Indeed, the carbons lose 0.18 electron to obtain a net charge of +0.52, while the metal gains 0.12 electron to obtain a net charge of 0.62. Basically, the strong tendency for the Mo and the C's to form covalent Mo-C bonds prevents charge flow from the ring in either

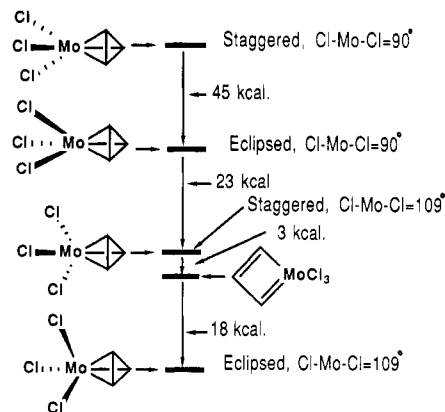

Figure 5. Ground-state energy difference of several metallatetrahedranes and the metallacyclobutadiene at the GVB (6/12) level.

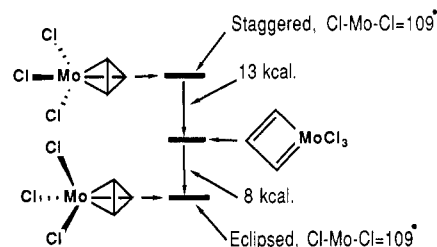

Figure 6. Ground-state energy differences of the metallatetrahedrane and the metallacyclobutadiene at the CI level.

Table I. Orbital Overlaps for the GVB Pair Orbitals

metallacyclobutadiene		metallatetrahedrane	
bond	overlap	bond	overlap
Mo-C α	0.74	Mo-C	0.67
Mo-C α	0.74	Mo-C	0.67
Mo-C π	0.53	Mo-C	0.67
C-C π	0.71	C-C	0.83
C-C σ	0.87	C-C	0.83
C-C σ	0.87	C-C	0.83
total	4.46	total	4.50

the flat or bent up hydrogen geometry. Furthermore, metallatetrahedrane with the flat C_3H_3 geometry is 6 kcal/mol (GVB (6/12)) above the system with a nonplanar C_3H_3 geometry. Although this bent back geometry is favored by steric interactions with the metal ligands, we believe that the dominant factor is the covalent metal-carbon bonding. Hence, the "bend-back angle" is a guide to the true metallatetrahedrane character in the bonding. Every metallatetrahedrane may have different bend-back angles depending on the charge distribution between the metal and the carbon ring, the oxidation state of the metal, and the steric requirements of the ligands on the metal and the alkyl groups on the carbon ring. In summary, the charge transfer is dominated by the nature of the M-C bonds. Because of the greater polarity in its Mo-C σ bond, the Mo in the metallacycle is more electrophilic than in the metallatetrahedrane.

D. Geometries and Energies. A dominant factor in the interconversion of the metallacyclobutadiene and metallatetrahedrane is the difference in ground-state energies. In Figures 5 and 6, the energy separations between the metallacycle and the metallatetrahedrane are shown for various levels of theoretical treatments.

The metallacycle has four σ bonds, two of which are Mo-C and two are C-C. It also has one Mo-C π bond and one C-C bond. The metallatetrahedrane also has six covalent bonds, three of which are Mo-C and three are C-C. Taking GVB overlaps as a rough guide to relative bond

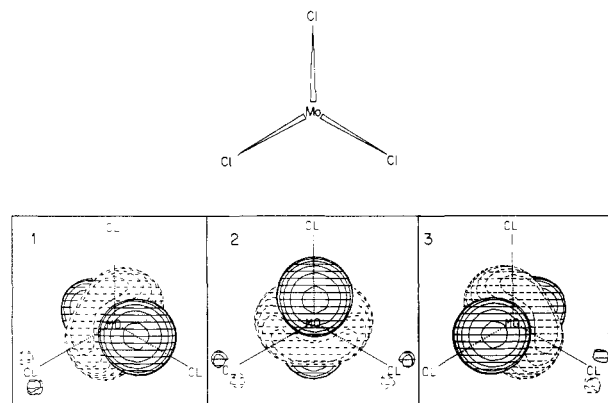

Figure 7. Singly occupied orbitals localized over the Cl's of the quartet state of MoCl_3 .

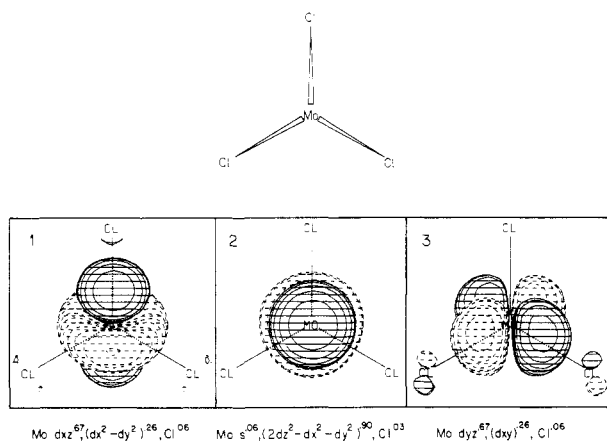

Figure 8. Singly occupied orbitals of the quartet state of MoCl_3 .

strengths, the total bond strength would be approximately the same since the sums of the overlaps are approximately the same (Table I). This neglects strain effects and resonance, which favors the metallacycle and also neglects the energetics associated with the chlorine ligand geometries.

The placement of the chlorine ligands in the metallatetrahedrane was calculated in several geometries. Calculations were done at both 109° and 90° for the angle between the Cl's (the Cl–Mo–Cl angle). The 109° geometry is lower in energy by 44.0 kcal (for MoCl_3 high-spin quartet, the 109° geometry is favored by 24.8 kcal). These energy differences are due to the decreased steric interaction between the chlorines in the 109° geometry.

The second geometry change was to stagger or eclipse the Cl's with the carbons of the C_3H_3 ring. The various geometries and their relative energies are presented in Figures 5 and 6. From calculations of the staggered and eclipsed geometries of the metallatetrahedrane with respect to the Cl's, we found that the *eclipsed* conformation is significantly lower than the staggered (by 18–45 kcal). In order to investigate the origin of this effect, we calculated the quartet state of free MoCl_3 , arriving at the localized orbitals for the MoCl_3 fragment presented in Figure 7. These orbitals are the ones used to bond the C_3H_3 fragments and are linear combinations of the orbitals in Figure 8. These localized high-spin orbitals are *eclipsed* with respect to the chlorines. Thus, the origin of the eclipsed preference for the tetrahedrane is in the MoCl_3 fragment. Since the free MoCl_3 quartet state is preferred to have an eclipsed geometry. The staggered geometry requires rehybridization of MoCl_3 orbitals in order to bond to the C_3H_3 fragment.

The high-spin orbitals for the MoCl_3 fragment are presented in Figure 8. Mixing these frontier orbitals with

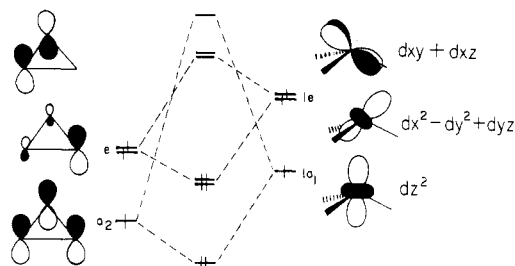

Figure 9. Orbital interaction diagram showing the preference for the eclipsed geometry arises from the ground-state high-spin orbitals of MoCl_3 .

the frontier orbitals of the cyclopropenium quartet state lead to the orbital interaction diagram of Figure 9 (no energy scale intended). The $1e$ and $1a_1$ orbitals on the metal are of the correct symmetry to mix with the equivalent symmetry orbitals of the cyclopropenium fragment *only* in an eclipsed geometry. Thus, covalent three-coordinate early-transition-metal systems (where the $1a_1$ and $1e$ set of orbitals is only singly filled) prefer to make covalent bonds to three other substituents in an eclipsed geometry. As these orbitals fill, the preference for a staggered (octahedral) geometry becomes stronger. Steric interactions could also lead to a preference for staggered and are probably the dominant interactions in most experimental systems. Thus, in group VIII (group 8)³¹, metal systems where these orbitals are filled (e.g., $\text{Cl}_3\text{Fe}^0\text{Me}_3$ ²³), the geometry would be staggered due to the symmetry of the high-lying $2e$ and $2a_1$ orbitals.²³

Literature structures related to these conclusions are limited to the trigonal prism complexes of early transition metals with dithiolato bidentate ligands.²⁴ It has been suggested that these complexes are eclipsed due to S–S bonding interactions.²⁵ Since this suggestion, dithiolato complexes have been isolated with S–S distances greater than the sum of the covalent radii.²⁶ We propose that the eclipsed preference is instead due to the electronic effects presented above.

The preference for eclipsed geometries derives from the high-spin MoCl_3 fragment. This fragment has been calculated previously, and our calculations confirm the past results.^{27,28} The $1e_1$ orbitals are tilted from the axis due to mixing of d_{xy} with d_{yz} and $d_{x^2-y^2}$ with d_{xz} . The question of bonding then reduces to why the $1e_1$ orbitals mix in such a fashion so as to prefer eclipsing. Calculations on MoCl_3 at several Cl–Mo–Cl angles reveal the preference for the high-spin orbitals to lie in the nodal planes of the Mo–Cl bonds. This allows for the least repulsion due to orthogonality between various occupied orbitals. It can be seen in Figure 8 that the $d_{x^2-y^2}$ and d_{xz} combination lies with the positive lobe directly between two Mo–Cl bonds. Conversely, the d_{xy} and d_{yz} combination has an angular node placed directly along a Mo–Cl bond. In this manner

(23) Albright, T. A.; Hofmann, P.; Hoffmann, R. *J. Am. Chem. Soc.* 1977, 99, 7546.

(24) (a) Brown, G. F.; Stiefel, E. I. *Chem. Commun.* 1970, 728. (b) Brown, G. F.; Stiefel, E. I. *Inorg. Chem.* 1973, 12, 2140. (c) Eisenberg, R.; Ibers, J. A. *J. Am. Chem. Soc.* 1965, 87, 3776. (d) Smith, A. E.; Schraner, G. N.; Mayweg, V. P.; Heinrich, W. *J. Am. Chem. Soc.* 1965, 87, 5798.

(25) Gray, H. B.; Eisenberg, R.; Stiefel, E. I. *Adv. Chem. Ser.* 1966, No. 62, 641.

(26) (a) Bennett, M. J.; Cowie, M.; Martin, J. L.; Takats, J. *J. Am. Chem. Soc.* 1973, 95, 7504. (b) Cowie, M.; Bennett, M. J. *Inorg. Chem.* 1976, 15, 1584, 1589.

(27) (a) Elian, M.; Hoffmann, R. *Inorg. Chem.* 1975, 14, 1058. (b) Elian, M.; Chen, M. M. L.; Minges, D. M. P.; Hoffmann, R. *Inorg. Chem.* 1976, 15, 1148. (c) Burdett, J. K. *Inorg. Chem.* 1975, 14, 375.

(28) Orgel, L. E. *An Introduction to Transition Metal Chemistry*; Wiley: New York, 1960; p 174.

the high-spin orbitals prefer to make bonds directly over the Mo-Cl bonds.

E. Electron Correlation. The above calculations used the simple GVB-PP wave function where the orbitals are optimized for a single bonding structure (for spin coupling). Thus these calculations are biased *against* this fully delocalized metallacycle, which requires two configurations.

In order to elucidate further the energetic differences between the metallatetrahedrane and the metallacyclobutadiene, we undertook several calculations designed to allow resonance in the metallacyclobutadiene.

An Mo atom with three unpaired d orbitals prefers the high-spin state (Hund's rule) in which all three d electrons have the same spin, say α . However, bonding these electrons to ligands requires that the two electrons in the bond have opposite spins and that each electron has both α and β .

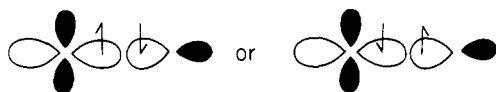

As a result, the d electrons on the metal can no longer all have the same spin. Thus the high-spin coupling of the metal tends to inhibit full bonding to the ligands and vice versa. A proper description of these spin-coupling effects requires bonding structures in which the two electrons of a given pair are allowed to be coupled either low spin (bonding) or high spin (antibonding). Such configurations are included in the GVB-RCI wave function, and we find that the metallacycle energy drops 6.28 kcal/mol more in the RCI than does the tetrahedrane. The contribution from such excitations within each GVB π bond pair resulted in a 19.8 kcal/mol lowering (half the total RCI lowering). Comparison to the analogous excitations from the C-C σ bonds of the metallatetrahedrane shows only a 7.63 kcal/mol lowering.

In order to allow resonance to build into the metallacycle, a full GVB-CI in the π space was allowed, with simultaneous σ relaxations (single excitations out of the σ bonds). This gave a further lowering of 9.86 kcal/mol. The tetrahedrane was then subjected to a comparable calculation. It consisted of a full GVB-CI in the Mo-C space while leaving the RCI in the C-C space. This gave a further lowering of 6.56 kcal/mol. The final separation between the two geometries is 8 kcal/mol, favoring the metallatetrahedrane. Due to the incorporation of resonance into the π system, these final CI's introduced a greater lowering for the metallacyclobutadiene than for the metallatetrahedrane.

The long Mo-C bond distances (in comparison to C-C bond distances) places the π bonds much further from one another than in cyclobutadiene.¹⁴ This means that the repulsion from orthogonality that is so destabilizing in cyclobutadiene is much less evident in the metallacyclobutadiene and therefore the metallacycle takes advantage of some resonance stabilization.¹⁴ Analysis of the resonance configurations shows a resonance stabilization of 8.68 kcal/mol.

F. Implications for Chemistry. This study allows us to speculate about the mechanism of metathesis performed by metallacyclobutadienes. It is viewed as decomposition of the metallacycle to an acetylene-alkylidyne adduct which then loses the initial acetylene before or after coordinating a second acetylene. This reaction thus involves the slipping of an acetylene from a metallacycle to π co-

ordination at the metal. The initial metallacyclobutadiene is a 12-electron species whereas the acetylene-alkylidyne complex is a 14-electron species. The movement of the acetylene thus increases the electron richness of the metal. A strong π electron donor ligand should slow this reaction. This is a direct consequence of filling the orbitals the acetylene is moving into and thus making them less accessible. This logic is supported by the calculation of Rappé and Upton²⁹ for titanium metallacyclobutane olefin metathesis. In the titanium case, electron-donating substituents on the titanium slow the metathesis reaction.³⁰ This is in direct contrast to the tungsten-acetylene metathesis reaction where electron-withdrawing groups are indicated by Schrock et al. to slow the metathesis reaction.⁵ Thus, there is a contradiction and it would seem that the major effect operating in the tungsten metathesis systems is the steric environment imposed by the axial-equatorial ligands.

IV. Summary

The Mo-C bonding in both the metallacyclobutadiene and the metallatetrahedrane is covalent with no large polarization toward either Mo or C. The Cl's remove 5s electron density from the Mo, leaving the d electrons to form hybrids that bond to the carbon fragments. The positive charge induced by the large electronegative chlorines is dispersed among the metal and the organic fragments. The metallacyclobutadiene is more electrophilic than the metallatetrahedrane. This supports the notion that the metallacycle can coordinate an acetylene. The electrophilicity of the Mo in the metallacycle argues in favor of accepting electron density from the axial-equatorial ligands. However, in contrast to the proposal by the original investigators,⁵ this acceptance would (on an electronic basis) slow the metallacycle decomposition to an acetylene-alkylidyne. The energy difference between the metallacycle and metallatetrahedrane shows that the two geometries are very close in energy (within 20 kcal/mol by all calculational procedures). This is due to covalent bonds in the metallatetrahedrane that make up for the increased strain energy. In contrast to cyclobutadiene, the metallacyclobutadiene shows resonance stabilization. There is no bonding interaction between the Mo and the β carbon in the metallacycle ring. The bending of the ring substituents out of the plane of the carbons in the metallatetrahedrane is due to bonding effects (hybridization at the carbons forming covalent bonds to the Mo) not steric interactions with the axial-equatorial ligands. There is a considerable barrier to rotation of the C_3H_3 ring in the metallatetrahedrane due to strong electronic preference for the eclipsed geometry.

Acknowledgment. Partial support from the National Science Foundation (Grant No. CHE83-18041) is gratefully acknowledged.

Registry No. 7a, 110661-53-5; 8, 110661-54-6.

(29) Upton, T. H.; Rappé, A. K. *J. Am. Chem. Soc.* 1981, 103, 5582.

(30) Finch, W. C.; Anslyn, E. V.; Grubbs, R. H., unpublished results.

(31) In this paper the periodic group notation is in accord with recent actions by IUPAC and ACS nomenclature committees. A and B notation is eliminated because of wide confusion. Groups IA and IIA become groups 1 and 2. The d-transition elements comprise groups 3 through 12, and the p-block elements comprise groups 13 through 18. (note that the former Roman number designation is preserved in the last digit of the new numbering: e.g., III \rightarrow 3 and 13.)