

Improvement of Corrosion Resistance of Aluminium Alloy by Natural Products

R. Rosliza

*TATI University College, Jalan Panchor, Teluk Kalong,
Kemaman, Terengganu,
Malaysia*

1. Introduction

Protection of metals from ever progressing corrosion presents one of the topical issues of this century. The increasing industrialization of our life is accompanied with the ever-growing number of metals that corrode and become devalued. Corrosion is a chemical or electrochemical reaction process against certain material, usually metal and its environment which produce the deterioration of the material and its properties. The corrosion reaction produces a less desirable material from the original metal and resulted in the reduced function of a component or system, a significant problem encountered everyday.

Corrosion is a problem that impacts every industry. The serious consequences of the corrosion process have become a problem of worldwide significance. It is estimated that annual loss and damage due to corrosion in the United Kingdom costs about £5000 million; and approximately one tone of steel is lost through corrosion every 90 seconds. Further, it is estimated that 25% of this loss could be avoided by correct design, correct material selection and proper preventive processes (Barbara and Robert, 2006).

Even with the proper application of available countermeasures, the estimated cost by National Association of Corrosion Engineers (NACE) for replacing corroded piping systems in the United States alone stands well in excess of \$70 billion annually, which was 4.2% of the gross national product (GNP)-making corrosion one of the most potentially damaging losses to any commercial, private, or industrial property (Barbara and Robert, 2006).

Even though the term of corrosion is usually applied to metals; all materials including ceramics, plastics, rubber and wood deteriorate at the surface to some extent as a result of being exposed to certain combinations of liquids and/or gases. Few practical examples are the rusting of tools and automobiles over many years of use; the failure of pipelines delivering volatile components such as natural gases and environmentally harmful chemicals such as crude oil and hydrochloric acid; bridge failure, ship failure (due to pumps, fuel tanks, boiler and sensors) and aircraft crashes; for example, Aloha Airlines flight 737 jet landing gear failure in 1988 (Radia, 2004). Therefore, the importance of understanding corrosion is clear, especially in the analysis and the design systems that incorporate metal as a major component material which exposed to corrosive environments.

Although much progress has been made in understanding the thermodynamics and kinetics of the corrosion process, the mechanisms of localized corrosion are not well understood, nor are those for imparting resistance or protection against aqueous or gases corrosion. With knowledge of the types of and a better understanding of the mechanism and causes of corrosion, it is possible to make measures to prevent them from occurring. For examples, we may change the nature of the environment by selecting a material that is relatively non reactive and/or protect the material from corrosion. Controlling corrosion in the infrastructure can prevent premature failure and lengthen useful service life, both of which save money and natural resources, promote public safety and protect the environment.

Due to the various industrial applications and economic importance of aluminium and its alloys, its protection against corrosion has attracted much attention (Aballe *et al.*, 2001; Cheng *et al.*, 2004; Hintze and Calle, 2006). Most aluminium alloys have good corrosion resistance towards natural atmospheres and other environments, because aluminium alloy surfaces are covered with a natural oxide film of thickness about 5 nm (Klickic *et al.*, 2000). However, in the presence of aggressive ions, like chloride, the protective layer can be locally destroyed and corrosive attack takes place (Kliskic *et al.*, 2000). Yet, if correctly protected, applications of aluminium alloy may be more reliable and have long service life.

One of the methods to protect metals or alloys against corrosion is addition of species to the solution in contact with the surface in order to inhibit the corrosion reaction and reduce the corrosion rate (Trabenelli *et al.*, 2005) known as corrosion inhibitor. A number of corrosion inhibitors for aluminium alloys have been developed for this purpose such as lanthanide chloride, tolytriazole, bitter leaf, Schiff base compounds and polyacrylic acid (Benthencourt *et al.*, 1997; Onal and Aksut, 2000; Avwiri and Igho, 2003; Yurt *et al.*, 2006; Amin *et al.*, 2009).

Owing to the growing interest and attention of the world towards environmental problems and towards the protection of environment and the hazardous effects of the use of chemicals on ecological balance, the traditional approach on the choice of corrosion inhibitors has gradually changed. Researches are mainly focusing on non-toxic "green" corrosion inhibitors. Therefore, there is a great task to search for suitable natural source to be used as corrosion inhibitor as an alternative for the existing inhibitors.

2. Literature review on corrosion resistance

Corrosion can be controlled by suitable modifications of the environment which in turn stifle, retard or completely stop the anodic or cathodic reactions or both. This can be achieved by the use of inhibitors (Blustein *et al.*, 2005; Emregul *et al.*, 2005; Goa *et al.*, 2008). Corrosion inhibitors are substances which when added in small concentrations to corrosive media decrease or prevent the reaction of the metal with the media. Inhibitors are added to many systems, *e.g.* cooling systems, refinery units, acids, pipelines, chemicals, oil and gas production units, boiler and process waters etc. (Raja and Sethuraman, 2009).

A number of corrosion inhibitors have been developed to mitigate aluminium corrosion for the last two decades. A variety of inhibitors have been tested such as chromates, dichromates, molybdates, nitrate, nitrite and sulfate. Their high efficiency/cost ratio has made them standard corrosion inhibitors for a wide range of metals and alloys (Benthencourt *et al.*, 1997).

Although chromates, dichromates, molybdates, nitrate, nitrite and sulfate were found to be the effective inhibitor for the corrosion processes taking place at the electrode/electrolyte interface of aluminium and some of its alloys in acidic and basic solutions (El-Sobki *et al.*, 1981; Kassab *et al.*, 1987; Badawy *et al.*, 1999), unluckily a major disadvantage is their toxicity and such as their use has come under severe criticism (Bethencourt *et al.*, 1997; Song-mei *et al.*, 2007).

In recent days many alternative eco-friendly corrosion inhibitors have been developed, the range from rare earth elements (Neil and Garrard, 1994; Mishra and Balasubramaniam, 2007), and inorganic (Salem *et al.*, 1978) to organic compounds (Onal and Aksut, 2000; Branzoi *et al.*, 2002; Maayta and Al-Rawashdeh, 2004). Owing to the growing interest and attention of the world towards environmental problems and towards the protection of environment and the hazardous effects of the use of chemicals on ecological balance, the traditional approach on the choice of corrosion inhibitors has gradually changed. Researches are mainly focusing on non-toxic "green" corrosion.

El-Etre and Abdallah (2000) study the natural honey as corrosion inhibitor for carbon steel in high saline water. It was found that natural honey exhibited a very good performance as inhibitor for steel corrosion in high saline water. The effect of fungi on the inhibition efficiency of natural honey is markedly decreased in high saline water. This is due to the high concentration of NaCl that retard the growth of fungi. This finding attracts the author to carry out further investigation on the effect of natural honey in seawater which contains NaCl.

One of the aromatic groups that showed good inhibitive effect is vanillin. The inhibition effects of vanillin on the corrosion of steel in HCl and H₂SO₄ solutions were investigated by Emregul and Hayvali (2002) and Li *et al.* (2008), meanwhile El-Etre (2001) studied the effect of vanillin against acid corrosion of aluminium. They were explored that an aromatic aldehyde containing carbonyl, methoxy and hydroxyl groups arranged around the aromatic ring in vanillin contributed to the inhibition mechanism process. Lack of research on the effect of this inhibitor on the corrosion of aluminium alloy in seawater has motivated the author to explore this research area as contribution to the current interest on environmental-friendly and green corrosion inhibitors.

3. Research methodology

3.1 Materials

The material employed was Al-Mg-Si alloy (AA6061). The chemical composition (weight %) of Al-Mg-Si is listed in Table 1 and the validity of composition was determined by EDS. Extruded shape of Al-Mg-Si alloy was selected in this study because of its well-proven medium strength structural alloy that satisfies the requirements of a number of specifications and most applicable alloy used in marine applications.

The samples were cut into 25 x 25 x 3 mm coupons and mechanically polished using #400, 500 and 600 silicone carbide emery papers (ASTM G 1) and lubricated using distilled water. The polished samples were cleaned with acetone (Merck, 99.8% purity) washed using distilled water, dried in air and stored in moisture-free desiccators prior to use.

Alloys		% Weight
Silicon	Si	0.40–0.80
Iron	Fe	0.7
Copper	Cu	0.15–0.40
Manganese	Mn	0.15
Magnesium	Mg	0.80–1.20
Chromium	Cr	0.04–0.35
Zinc	Zn	0.25
Titanium	Ti	0.15
Others (each)		0.05
Others (total)		0.15
Aluminium	Al	Remainder

Table 1. The chemical-composition of Al-Mg-Si alloy

3.2 Test solution

The study test solution was tropical seawater collected approximately 100 m from the shoreline of Pantai Teluk Kalong, Kemaman, Terengganu. Pantai Teluk Kalong is located near Teluk Kalong Industrial Estate (oil and gas industrial area) and Kemaman Supply Base port which is about 6.78 km from Chukai, Terengganu, Malaysia.

Pantai Teluk Kalong was selected in this research due to widely application of Al-Mg-Si alloy in the shipping, marine, oil and gas industrials surrounding the area. The values of physicochemical properties of seawater such as salinity, dissolved oxygen, pH and temperature were monitored during the immersion test. Average selected physicochemical data of the seawater used are reported in Table 2.

pH	Temperature (°C)	Salinity (g/L)	Dissolved oxygen (mg/L)
7.63	28.3	34.8	7.66

Table 2. Physicochemical properties of seawater

3.3 Corrosion inhibitors

The corrosion inhibitors tested in this study were natural honey, vanillin and tapioca starch. The choice of natural honey (NH), vanillin (VL) and tapioca starch (TS) as corrosion inhibitors for the study were based on the following:

- i. the selected natural products contained the possible adsorption functional groups
- ii. these natural products are commercially available at low cost
- iii. good solubility in water and non-toxic

The Nicolet 380 Fourier transform infrared (FTIR) spectrometer was used to determine the function group for each inhibitor.

3.4 Electrochemical measurements

All electrochemical measurements (PP, LPR and EIS) were accomplished with Autolab frequency response analyzer (FRA) and general purpose electrochemical system (GPES) for

Windows-version 4.9.005 coupled to an Autolab potentiostat connected to a computer. The cell used consists of conventional three electrodes with a platinum wire counter electrode (CE), a working electrode (WE) and a saturated calomel electrode (SCE) as reference to which all potentials are referred.

The WE was in the form of a square cut so that the flat surface was the only surface in the electrode. The exposed area to the test solution was 3.75 cm². The WE was first immersed in the test solution and after establishing a steady state open circuit potential, the electrochemical measurements were performed. The cell was exposed to air and the measurement was conducted at room temperature (25.0 ± 0.1 °C). Triplicate experiments were performed in each case of the same conditions to test the validity and reproducibility of the measurements. All procedures for electrochemical measurements were performed in accordance with the Standard Practice for Calculation of Corrosion Rates and Related Information from Electrochemical measurements (ASTM G 102).

4. Results and discussion

Many corrosion phenomena can be explained in terms of electrochemical reactions. Therefore, electrochemical techniques can be used to study these phenomena. Measurements of current-potential relations under carefully controlled conditions can yield information on corrosion rates, coatings and films, pitting tendencies and other important data.

4.1 Electrochemical measurements

The corresponding corrosion potential (E_{corr}), corrosion current density (i_{corr}), anodic Tafel slope (b_a), cathodic Tafel slope (b_c) and CR for uninhibited and inhibited systems from PP measurement are listed in Table 3. The data demonstrates that the E_{corr} values shift to more positive values as the concentration of added studied inhibitors are increased. On the other hand, the corrosion current densities are markedly declined upon addition of the studied corrosion inhibitors. The extent of its decline increases with increasing of the corrosion inhibitor concentration. Moreover, the numerical values of both anodic and cathodic Tafel slopes decreased as the concentration of inhibitors were increased. This means that the three natural products have significant effects on retarding the anodic dissolution of aluminium alloy and inhibiting the cathodic hydrogen evolution reaction.

Anodic and cathodic processes of aluminium corrosion in seawater are dissolution of aluminium and reduction of dissolved oxygen, respectively, as



Hence, Al^{3+} reacts with OH^- to form aluminum hydroxide near the aluminium surface as below

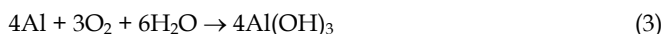

Inhibitor	C_{inh} (ppm)	PP				CR ($10^{-2}mm\text{yr}^{-1}$)	LPR R_p ($k\Omega\text{ cm}^2$)
		E_{corr} (mV)	i_{corr} ($\mu\text{A cm}^{-2}$)	b_a (mV dec $^{-1}$)	b_c (mV dec $^{-1}$)		
Blank		-796	1.622	101	274	1.078	11.71
NH	200	-554	0.593	65	93	0.381	34.78
	400	-546	0.551	69	85	0.354	37.15
	600	-553	0.434	75	89	0.289	55.06
	800	-550	0.258	67	92	0.166	79.23
	1000	-556	0.137	48	59	0.088	112.72
VL	200	-693	0.538	56	66	0.349	35.28
	400	-642	0.346	83	61	0.230	52.48
	600	-590	0.330	32	67	0.215	57.13
	800	-545	0.198	80	76	0.129	90.98
	1000	-530	0.122	40	43	0.079	145.05
TS	200	-578	0.483	65	133	0.315	41.29
	400	-565	0.237	82	86	0.155	78.43
	600	-577	0.199	65	128	0.130	81.67
	800	-567	0.173	44	57	0.113	102.89
	1000	-514	0.103	43	49	0.064	177.00

Table 3. The electrochemical parameters of Al-Mg-Si alloy in absence and presence of different concentrations of NH, VL and TS

and the hydroxide precipitates on the surface due to its low solubility product. Aluminium hydroxide changes gradually to aluminium oxide, resulting in the formation of passive film (Aramaki, 2001):



However, this nature oxide film does not offer sufficient protection against aggressive anions and dissolution of aluminium substrate occurs when exposed to corrosive solution.

Seawater predominantly consists of about 3.5% of sodium chloride (NaCl) and many other ions. Chloride ions are very strong and could easily penetrate the passive film. Thus, dissolution of the aluminium substrate occurs and results in corrosion. The adsorption of the corrosion inhibitor competes with anions such as chloride. By assuming that the corrosion inhibitor molecules preferentially react with Al^{3+} to form a precipitate of salt or complex on the surface of the aluminum substrate, the anodic and cathodic processes subsequently suppressed by inhibitor molecules. Thus, this result suggests that the protective film that was formed comprise aluminium hydroxide, oxide and salts or complexes of the corrosion inhibitor anions.

Polarization resistance, R_p values for Al-Mg-Si alloy in seawater in the presence and absence of corrosion inhibitor were determined using linear polarization method. The values of R_p are tabulated in Table 3. Generally, the value of R_p increased with increasing inhibitor concentration for all studied inhibitor. The highest R_p values for Al-Mg-Si alloy obtained at

1000 ppm of NH, VL and TS i.e. 112.72, 145.05 and 177.00 $\text{k}\Omega \text{cm}^2$, respectively. A higher of R_p indicates the lower of the corrosion rate. The corrosion resistance obtained by LPR measurement was compared between the studied inhibitors. The inhibitor concentration was plotted against the values of R_p for each studied inhibitor (Figure 1). The results show that the values of R_p after addition of inhibitor increase with the following sequence: $\text{NH} < \text{VL} < \text{TS}$.

The values of R_{ct} and double layer capacitance, C_{dl} for Al-Mg-Si alloy at various concentrations of NH, VL and TS are presented in Table 4. The results show that the R_{ct} values increase with the addition of corrosion inhibitors when compared with those without corrosion inhibitor. Furthermore, the values of R_{ct} are observed to increase with the increasing corrosion inhibitor concentration, which can be attributed to the formation of a protective over-layer at the metal surface. It becomes a barrier for the charge transfers.

The values of R_{ct} for the alloy in inhibited solution with NH were enhanced up to 10 times higher as compared to that of the value of R_{ct} in uninhibited solution. Meanwhile, VL and TS shown better performance in improving the value of R_{ct} for Al-Mg-Si alloy in studied aggressive solution, where they were increased the values up to 13 and 14 times higher, respectively.

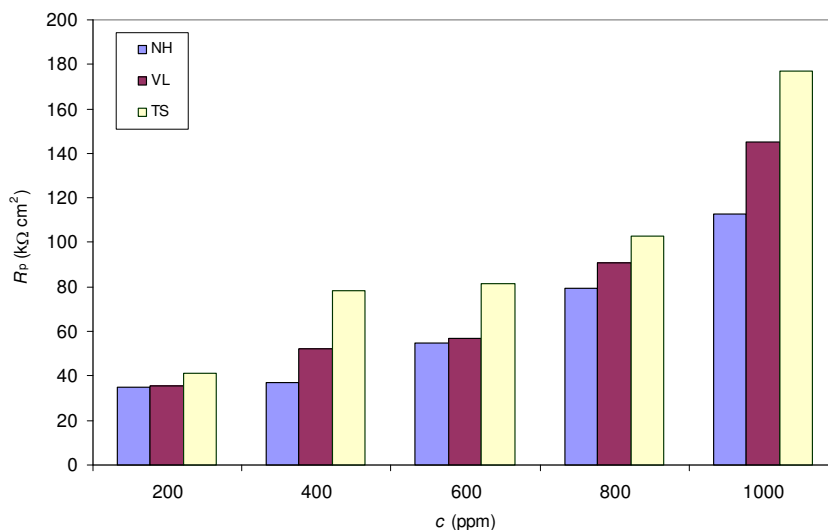

Fig. 1. R_p versus concentration of the studied inhibitors

It should be noted that while R_{ct} values increase with the addition of corrosion inhibitor, the capacitance, C_{dl} values decrease indicating the formation of a surface film. Thus, effective corrosion resistance is associated with high R_{ct} and low C_{dl} values (Yagan *et al.*, 2006). Increase in R_{ct} values and decrease in C_{dl} values by NH, VL and TS indicated that the studied inhibitors inhibit the corrosion of Al-Mg-Si alloy in seawater by adsorption mechanism (Noor, 2009) and the thickness of the adsorbed layer increases with the increase of inhibitor concentration.

The equivalent circuit fitting for these experimental data is a Randles circuit. The Randles equivalent circuit is one of the simplest and most common circuit models of electrochemical impedance. It includes a solution resistance, R_s in series to a parallel combination of resistor, R_{ct} , representing the charge transfer (corrosion) resistance and a double layer capacitor, C_{dl} , representing the electrode capacitance (Badawy *et al.*, 1999). In this case, the value of R_s can be neglected because the value is too small as compared to that of the value of R_{ct} . The equivalent circuit for the Randles cell is shown in Figure 2.

Inhibitor	c (ppm)	R_{ct} ($k\Omega\text{ cm}^2$)	C_{dl} ($\mu\text{F cm}^2$)
Blank		11.76	23.98
NH	200	33.10	8.11
	400	36.06	7.79
	600	57.12	5.16
	800	76.39	3.81
	1000	119.84	2.31
VL	200	39.04	7.06
	400	51.63	5.43
	600	60.27	4.39
	800	98.05	3.16
	1000	155.84	1.95
TS	200	40.73	7.30
	400	69.72	3.86
	600	79.23	3.37
	800	107.45	2.79
	1000	166.09	0.99

Table 4. R_{ct} and C_{dl} of Al-Mg-Si alloy in seawater obtained using impedance method

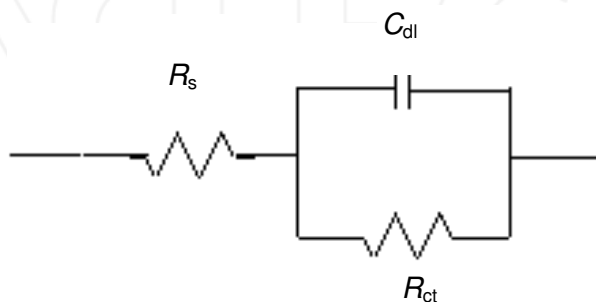

Fig. 2. The equivalent circuit for the Randles cell

4.2 Inhibition Efficiency (IE)

Owing to the adsorption of the corrosion inhibitor molecules onto the surface of Al-Mg-Si alloy, a thin film is formed on the aluminium alloy to retard the corrosion. Thus, in this case, all studied inhibitors worked as the film-forming corrosion inhibitor to control the corrosion rate. Instead of reacting with or removing an active corrosive species, the film-forming corrosion inhibitor function by strong adsorption and decrease the attack by creating a barrier between the metal and their environment (Al-Juhni and Newby, 2006).

The values of IE (%) from the PP, LPR and EIS measurements obtained by using following equation:

$$IE_{PP} (\%) = 100 \left(\frac{i_{corr} - i'_{corr}}{i_{corr}} \right) \quad (5)$$

$$IE_{PP} (\%) = 100 \left(\frac{CR - CR'}{CR} \right) \quad (6)$$

$$E_{RP} (\%) = 100 \left(\frac{R'_p - R_p}{R_p} \right) \quad (7)$$

$$IE_{EIS} (\%) = 100 \left(\frac{R'_{ct} - R_{ct}}{R_{ct}} \right) \quad (8)$$

The values of the result are presented in Table 5. All these parameters showed a similar trend. In all cases, increasing the inhibitors concentration is accompanied by an increase in the IE (%) and maximum for 1000 ppm. The IE (%) for all the measurements obtained from three different methods; PP, LPR and EIS are in good agreement. The inhibitive properties of the studied natural products can be given by the following order: NH < VL < TS.

4.3 Inhibition mechanism

The protection action of inhibitor substances during metal corrosion is based on the adsorption ability of their molecule where the resulting adsorption film isolates the metal surface from the corrosive medium. Consequently, in inhibited solutions, the corrosion rate is indicative of the number of the free corrosion sites remaining after some sites have been blocked by inhibitor adsorption.

The adsorption of NH, VL and TS compounds on the aluminium alloy surface reduces the surface area available for corrosion. Increases in inhibitor concentration results in amplify the degree of metal protection due to higher degree of surface coverage, θ ($\theta = IE\%/100$). This is resulting from enhanced inhibitor adsorption. The higher θ were acquired at 1000 ppm of NH, VL and TS i.e. 0.9036, 0.9185 and 0.9587, respectively. Further investigation using surface analytical technique i.e. FTIR and SEM-EDS enable to characterize the active materials in the adsorbed layer and identify the most active molecule of the studied inhibitors.

Inhibitor	c (ppm)	IE (%)			
		PP		LPR	EIS
		CR	i_{corr}	R_p	R_{ct}
Honey	200	64.66	63.43	66.34	64.48
	400	67.16	66.04	68.48	67.39
	600	73.21	73.24	78.73	79.42
	800	84.63	84.12	85.22	84.61
	1000	91.85	91.58	89.61	90.19
Vanillin	200	66.84	67.62	66.81	69.88
	400	78.70	78.68	77.69	77.23
	600	79.66	80.02	79.50	80.49
	800	87.81	88.01	87.13	88.01
	1000	92.50	92.67	91.93	92.46
Tapioca	200	70.27	71.84	71.64	71.13
	400	85.42	86.19	85.07	83.14
	600	87.75	88.40	85.66	85.16
	800	89.34	89.90	88.62	89.06
	1000	93.98	93.98	93.38	92.92

Table 5. Values of IE (%) for Al-Mg-Si alloy at various concentrations of NH, VL and TS

4.3.1 Inhibition mechanism of NH

The inhibition performances of honey could be explained as follows: Fourier transform infrared (FTIR) spectrum in Figure 3 demonstrates that honey is a mixture of various compounds containing carbon (C), oxygen (polyphenols), nitrogen and sulphur (glucosinolates) which all can be adsorbed on the corroded metal (Radojicic *et al.*, 2008). The bands at about 1055.3 and 1418.1 cm^{-1} are consists of C, O, H and N atoms, meanwhile the peak at 1255.6 cm^{-1} is due to sulphur (S). A band appearing near 2935.7 cm^{-1} proves the existence of C, O and H atoms in NH. A band located at 3355.1 cm^{-1} corresponds to O, N and H atoms.

The adsorption of NH onto the surface of Al-Mg-Si alloy may take place through all these functional groups. The simultaneous adsorption of the four functional groups forces the natural honey molecule to be horizontally oriented on the surface of Al-Mg-Si alloy (Gao *et al.*, 2008). As the corrosion resistant concentration increases, the area of the metal surface covered by the corrosion resistant molecule also increases, leading to an increase in the IE.

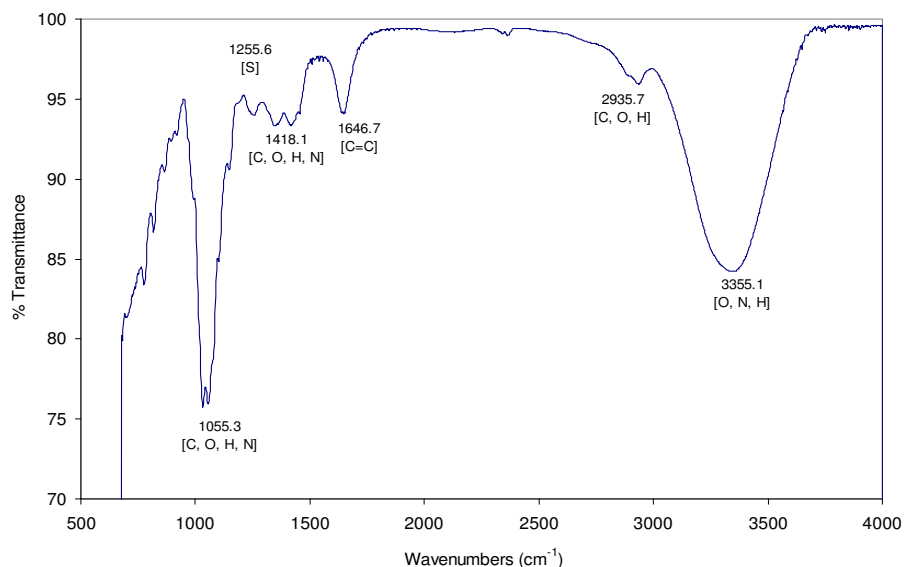

Fig. 3. FTIR spectrum of NH.

4.3.2 Inhibition mechanism of VL

The inhibition process of vanillin could be explained as follows: FTIR spectrum illustrate that vanillin is an aromatic aldehyde containing carbonyl, methoxy, and hydroxyl groups arranged around the aromatic ring (Figure 4). The bands at about 1153.7 to 1199.9 cm⁻¹ and 2362.3 cm⁻¹ in the spectrum are assigned to carbonyl group, meanwhile the bands located between 1429.8 to 1664.9 cm⁻¹ are refers to hydroxyl group and aromatic compound (benzene ring).

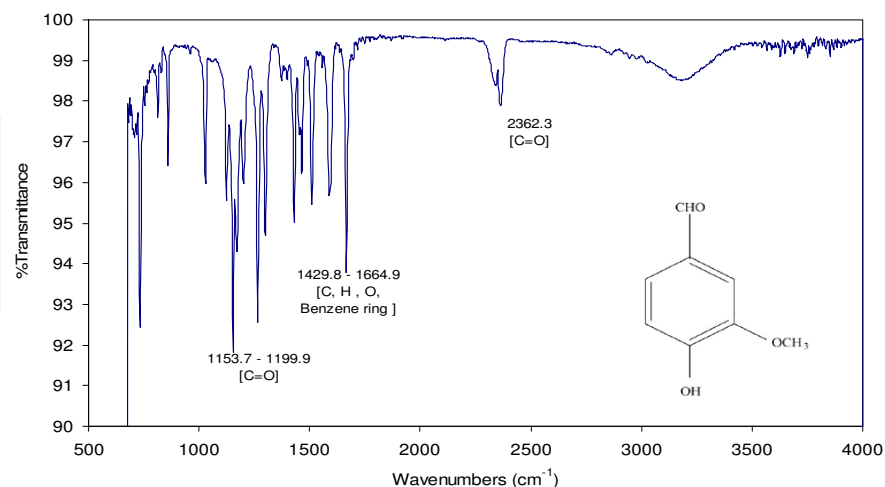

Fig. 4. FTIR spectrum of VL.

The adsorption of vanillin onto the surface of the aluminium alloy may take place through all these functional groups. The simultaneous adsorption of the three functional groups forces the vanillin molecule to be horizontally oriented at the surface of the aluminium alloy (Li *et al.*, 2008). As the inhibitor concentration increases, the area of the metal surface covered by the inhibitor molecule also increases, leading to an increase in the IE.

Similar to the findings reported previously (El-Etre, 2001; Emregul and Hayvali, 2002; Li *et al.*, 2008) the adsorption of vanillin mechanism is related to the presence of carbonyl, methoxy, and hydroxyl groups arranged around the aromatic ring in their molecular structures.

4.3.3 Inhibition mechanism of TS

The inhibition process of tapioca starch can be explained as follows: FTIR spectrum shows that TS is composed of mixture of two molecular entities (polysaccharides), a linear fraction, amylose and highly branched fraction, amylopectin (Figure 5). Both of them are polymers of glucose.

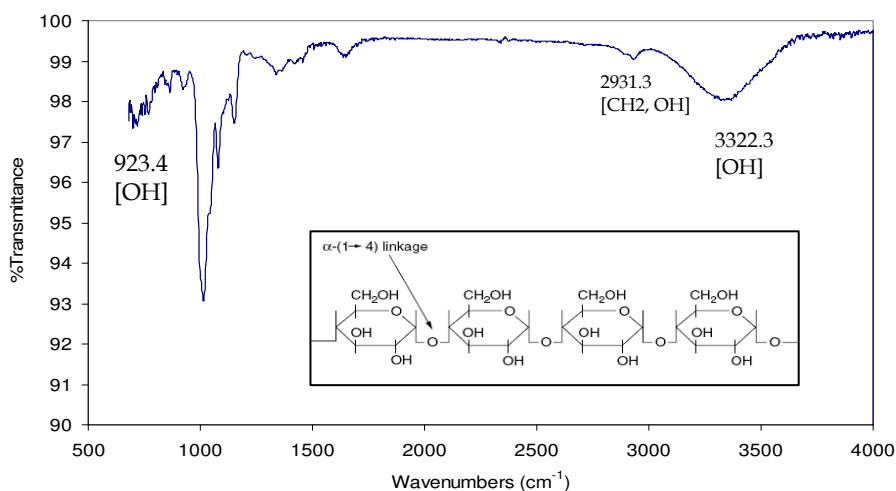

Fig. 5. FTIR spectrum of TS.

Amylose is constituted by glucose monomer units joined to one another head to tail forming alpha-1, 4 linkages; these are linked with the ring oxygen atoms all on the same side. Amylopectin differs from amylose in that branching occurs, with an alpha-1, 6 linkages every 24–30 glucose monomer units. Amylopectin has phosphate groups attached to some hydroxyl group (Wu *et al.*, 2009).

The peak at 923.4, 2931.3 and 3322.3 cm⁻¹ in the FTIR spectrum are characteristic of hydroxyl group (OH). The adsorption of TS on Al-Mg-Si alloy surface would take place through all these functional groups. As the concentration of corrosion inhibitor increases, the part of the metal surface covered by the corrosion inhibitor molecule also increases, leading to an increase in the IE.

4.4 Surface morphology studies

Uninhibited and inhibited samples were analyzed by SEM and EDS in order to identify the morphology and composition of the corrosion products before and after immersion in seawater at 25°C.

4.4.1 Unexposed specimen

The SEM micrograph of the unexposed Al-Mg-Si alloy is shown in Figure 6. It shows that the surface of the metal is absolutely free from any pits and cracks. Polishing scratches are also visible.

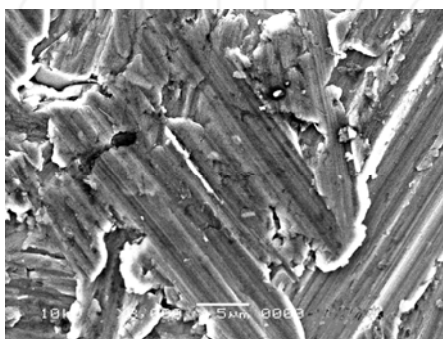

Fig. 6. SEM analysis of the unexposed Al-Mg-Si alloy surface.

4.4.2 Unexposed specimen

Figure 7 corresponds to the SEM of the specimen surface after 60 days of immersion in seawater. Flakes showing corrosion products like metal hydroxides and its oxides can be observed, however no pits or cracks were noticed (Gao *et al.*, 2008). The figures also show the presence of micro organisms (plankton) on the surface of the specimen which contributes to the corrosion process. The corrosion process in deep seawaters occurs under very specific conditions and is characterized mainly by high chloride contents, the presence of CO₂ and H₂S and micro organisms (Yagan *et al.*, 2006).

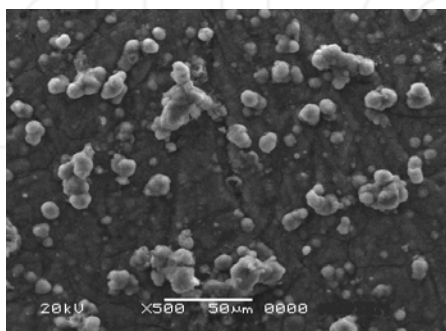

Fig. 7. SEM of Al-Mg-Si alloy surface after 60 days of immersion

The EDS spectrum in Figure 8 presents the elements exist in Al-Mg-Si alloy after immersion test. It shows the presence of sodium (Na) and chlorine (Cl) in the specimen surface. Seawater predominantly consists about 3.5% of sodium chloride (NaCl) and many other ions. Chloride ions are very strong, and could easily penetrate the passive film, and dissolution of the aluminium substrate occurs and results in corrosion.

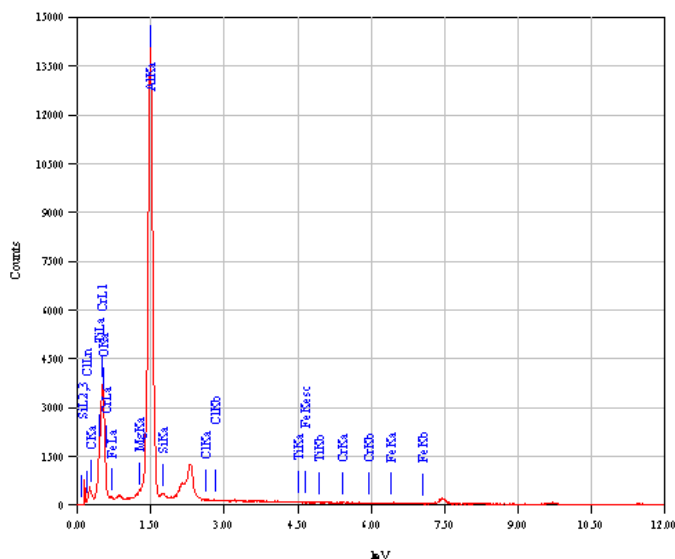

Fig. 8. EDS analysis of Al-Mg-Si alloy surface after 60 days of immersion.

4.4.3 Inhibited specimen with NH

Figure 9 depicts the SEM of the specimen surface after 60 days of immersion in seawater with the addition of 1000 ppm of NH. It can be seen that the flakes in the surface of the specimens decreased as compared to that of the micrograph in Figure 8. The specimen is covered with the inhibitor molecules giving a protection against corrosion, where a thin layer developed on the specimen surfaces.

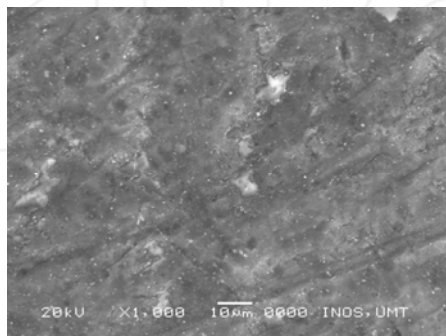

Fig. 9. SEM of specimen surface after immersion in seawater containing 1000 ppm of NH.

The EDS spectrum in Figure 10 shows the existence of carbon (C), oxygen (O) and sulphur (S); due to the carbon, oxygen and sulphur atoms of the NH. These data show that carbonaceous material containing O and S atoms has covered the specimen surface. This layer is absolutely due to the inhibitor, because the carbon signal and the high contribution of the oxygen signal are absent on the specimen surface exposed to uninhibited seawater. It can be seen obviously from the spectra, the Al peaks are dramatically suppressed relative to the samples in uninhibited seawater (Figure 8). This is due to the overlying inhibitor film on the specimen surface area (Amin *et al.*, 2009).

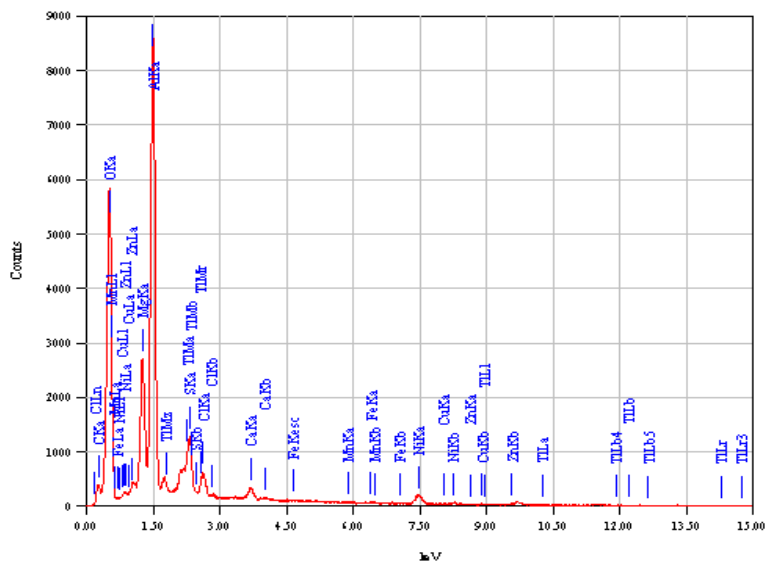

Fig. 10. EDS analysis of Al-Mg-Si alloy immersed in seawater containing 1000 ppm of NH.

4.4.4 Inhibited specimen with VL

Figure 11 portrays the SEM micrograph of Al-Mg-Si alloy immersed in seawater with the presence of 1000 ppm of VL. It was observed that compounds of VL were precipitated on the alloy surface.

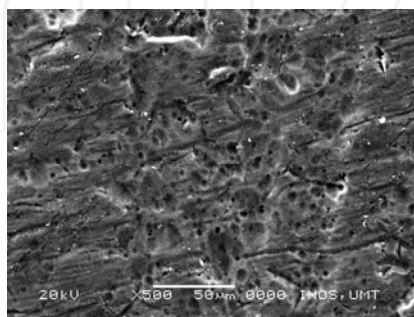

Fig. 11. SEM of specimen surface after immersion in seawater with presence of 1000 ppm VL

The observations mentioned above were confirmed by EDS analysis (Figure 12). The EDS spectra showed an additional line characteristic for the existence of C (due to the carbon atoms of the VL). These data show that carbonaceous material has covered the specimen surface. This layer is absolutely due to the VL compound, because the carbon signal is absent on the specimen surface exposed to uninhibited seawater.

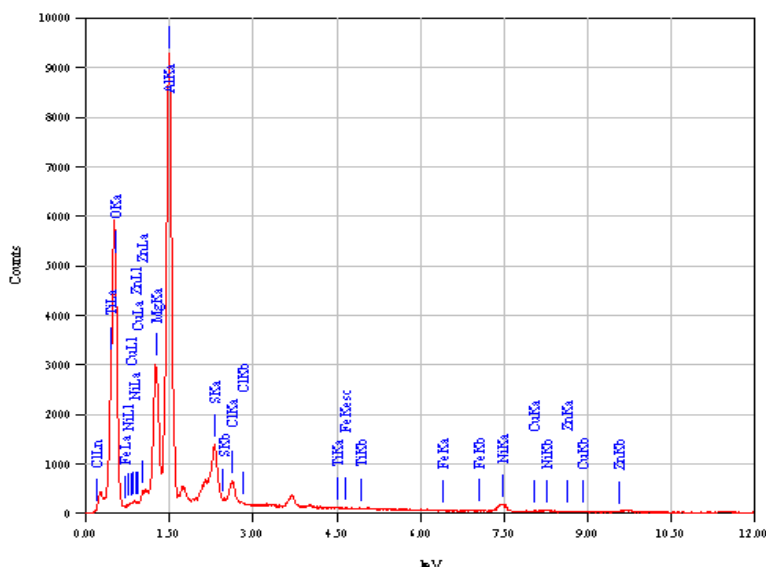

Fig. 12. EDS analysis of Al-Mg-Si alloy immersed in seawater containing 1000 ppm of VL.

4.4.5 Inhibited specimen with TS

Figure 13 depicts the SEM of specimen surface after 60 days of immersion in seawater with the addition of 600 ppm of tapioca starch. TS had shown similar characterization as NH and VL. From the micrograph, it can be seen that the flakes in the surface of the specimen are lessen when compared with that of the micrograph of uninhibited specimen.

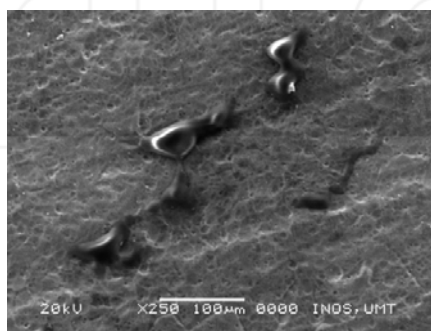

Fig. 13. SEM of specimen surface after immersion in seawater with presence of 1000 ppm TS

The EDS spectrum proved the existence of carbon (due to the carbon atoms of the tapioca starch) and these molecules covered the surface of specimen. These data show that the carbonaceous material has covered the specimen surface (Figure 14).

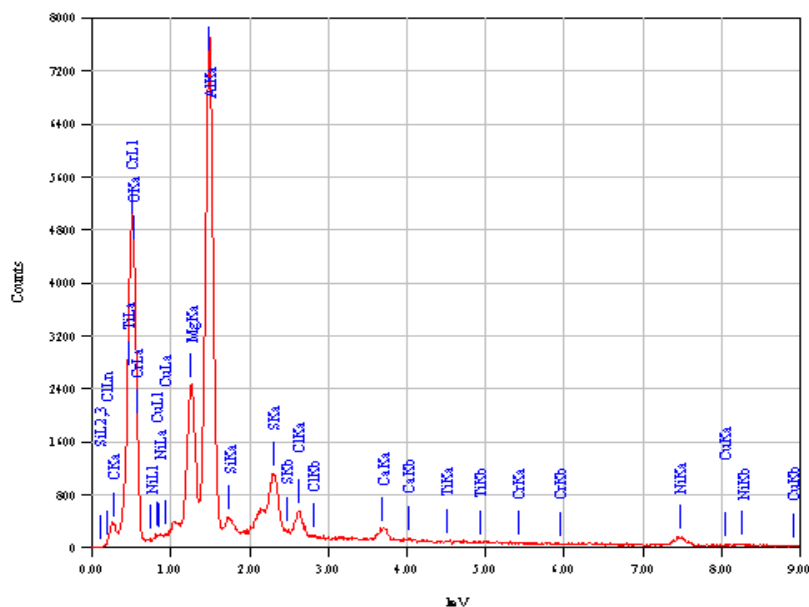

Fig. 14. EDS analysis of Al-Mg-Si alloy immersed in seawater containing 1000 ppm of TS

5. Conclusions

The corrosion inhibition studies of the aluminium alloy were carried out at room temperature using seawater and the results indicate that NH, VL and TS are an effective corrosion inhibitor of aluminium alloy in that particular solution.

The electrochemical studies of the corrosion inhibition process of Al-Mg-Si alloy in seawater using three selected natural products as corrosion inhibitors show that the corrosion rate of the alloy significantly reduced upon the addition of studied inhibitors. PP measurement reveals that the studied inhibitors can be classified as mixed-type inhibitors without changing the anodic and cathodic reaction mechanisms. The inhibitors inhibit both anodic metal dissolution and also cathodic hydrogen evolution reactions.

EIS measurements clarifying that the corrosion process is mainly charge-transfer controlled and no change in the corrosion mechanism occurred due to the inhibitor addition to seawater. It also indicates that the R_{ct} values increase with addition of inhibitor whilst, the capacitance values decrease indicating the formation of a surface film. The EIS measurement also confirms the similar corrosion process and mechanism occurs in PP measurements. According to LPR data, the values of R_p of Al-Mg-Si after addition of the studied inhibitors increase with the following order: NH < VL < TS.

It can be concluded that the corrosion parameters result obtained from PP, LPR and EIS measurements show the inhibitive effect on the corrosion behaviour of aluminium alloy in seawater by the studied inhibitors. The performance of natural products as corrosion inhibitors was evaluated by inhibition mechanism. The results reveal that inhibition efficiency increases with the increase in concentration of the studied inhibitors. Similar to the findings reported previously (Yurt *et al.*, 2006; Bhrara and Singh, 2006; El-Etre and Abdallah, 2000) the adsorption corrosion inhibitor mechanism is related to the presence of heteroatom such as nitrogen, oxygen, phosphorous, sulphur and long carbon chain length, as well as triple bond or aromatic ring in their molecular structures.

The studied natural products give above 90% of inhibition efficiency in their tested solutions. The comparison of present results with the results of reviewed paper by the other researchers on the same studied inhibitors proves that NH, VL and TS are comparable to the other natural products as corrosion inhibitor for aluminum alloy.

The use of SEM-EDS techniques provide good insight into the surface corrosion products grown on Al-Mg-Si alloy during the immersion test in seawater with and without the natural products as corrosion inhibitors. The SEM results indicate that the natural products (NH, VL and TS) absolutely minimized the corrosion products on the specimen surfaces. They also protect the passive film from dissolution in aggressive solution like seawater.

The EDS spectrums reveal that the presence of C, O, and S for NH as elements which take place in the inhibition mechanism. The carbonyl, methoxy and hydroxyl groups arranged around the aromatic ring are determined as functional groups of VL in inhibition process. The C atoms in TS are recognized by the EDS analysis, where these atoms involve in the adsorption process in alloy surface. The formation of precipitates of oxides/hydroxides of these inhibitors results in improved corrosion resistance.

Based on the results from SEM and EDS studies, it can be concluded that the TS gave the best protection of Al-Mg-Si alloy from the corrosion attack in seawater, following by VL and NH. The protection of passive film is increased with the increasing in inhibitor concentrations.

It is explored and proven in this research that NH, VL and TS carry tremendous potential for industrial usage. Unlike the pure synthetic product that requires enormous investment scale; NH, VL and TS can be produced at any type of industrial scale, which is potentially capable of eradicating the disparity among the communities, especially in the third world. Furthermore, the potential usages of these natural products discussed in this research are in line with the recent trend of the environment-friendly concept. However, resolution of the problem of whether the origin of these effects is associated with an application of aluminium alloys must await the results of further experimental studies.

6. References

- Aballe, A., Bethencourt, M., Botana, F.J. & Marcos, M. (2001). CeCl₃ and LaCl₃ binary solutions as environment-friendly corrosion inhibitors of AA5083 Al-Mg alloy in NaCl solutions. *Journal of Alloys and Compounds* 323:855–858.
- Al-Juhni, A.A. & Newby, B.Z. (2006). Incorporation of benzoic acid and sodium benzoate into silicone coatings and subsequent leaching of the compound from the incorporated coatings. *Progress in Organic Coatings* 56:135–145.

- Amin, M.A., Abd El-Rehim, S.S., El-Sherbini, E.E.F., Hazzazi, O.A. & Abbas, M.N. (2009). Polyacrylic acid as a corrosion inhibitor for aluminium in weakly alkaline solutions. Part I: Weight loss, polarization, impedance EFM and EDX studies. *Corrosion Science* 51:658–667.
- Avwiri, G.O. & Igho, F.O. (2003). Inhibitive action of *Vernonia amygdalina* on the corrosion of aluminium alloys in acidic media. *Materials Letters* 57:3705–3711.
- Badawy, W.A., Al-Kharafi, F.M. & El-Azab, A.S. (1999). Electrochemical behaviour and corrosion inhibition of Al, Al-6061 and Al-Cu in neutral aqueous solutions. *Corrosion Science* 41:709–727.
- Barbara, S. & Robert, K. (2006). What is corrosion? *The electrochemical Society Interface* 6:24–26.
- Bethencourt, M., Botana, F.J., Cauqui, M.A., Marcos, M., Rodriguez, M.A. & Rodriguez-Izquierdo, J.M. (1997). Protection against corrosion in marine environments of AA5083 Al-Mg alloy by lanthanide chlorides. *Alloys and Compounds* 250:455–460.
- Bhrara, K. & Singh, G. (2006). The inhibition of corrosion of mild steel in 0.5 M sulfuric acid solution in the presence of benzyl triphenyl phosphonium bromide. *Applied Surface Science* 253:846–853.
- Blustein, G., Rodriguez, J., Romanogli R. & Zinola, C.F. (2005). Inhibition of steel corrosion by calcium benzoate adsorption in nitrate solutions. *Corrosion Science* 47:369–383.
- Branzoi, V., Branzoi, F. & Golgovici, F. (2002). A comparative electrodisolution and localized corrosion study of pure aluminium in acidic solutions with different aggressive anions and organic inhibitors. *Revue Roumaine de Chimie* 47:131–137.
- Cheng, Y.L., Zhang, Z., Cao, F. H., Li, J.F., Zhang, J.Q., Wang, J.M. & Cao, C.N. (2004). A study of the corrosion of aluminum alloy 2024-T3 under thin electrolyte layers. *Corrosion Science* 46:1649–1667.
- El-Etre, A.Y. (2001). Inhibition of acid corrosion of aluminum using vanillin. *Corrosion Science* 43:1031–1039.
- El-Etre, A.Y. & Abdallah, M. (2000). Natural honey as corrosion inhibitor for metals and alloys. II. C-steel in high saline water. *Corrosion Science* 42: 731–738.
- El-Sobki, K.M., Ismail, A.A., Ashour, S., Khedr, A.A. & Shalaby, L.A. (1981). Corrosion behaviour of aluminium in neutral and alkaline chloride solution containing some anions. *Corrosion Prevention and Control* 28:7–12.
- Emregul, K.C., Akay, A.A. & Atakol, O. (2005). The corrosion inhibition of steel with Schiff base compounds in 2 M HCl. *Materials Chemistry and Physics* 93:325–329.
- Emregul, K.C. & Hayvali, M. (2002). Studies on the effect of vanillin and photocatechualdehyde on the corrosion of steel in hydrochloric acid. *Materials Chemistry Physics* 83:209–216.
- Gao, B., Zhang, X. & Sheng, Y. (2008). Studies on preparing and corrosion inhibition behaviour of quaternized polyethyleneimine for low carbon steel in sulfuric acid. *Materials Chemistry and Physics* 108:375–381.
- Hintze, P.E. & Calle, L.M. (2006). Electrochemical properties and corrosion protection of organosilane self-assembled monolayers on aluminum 2024-T3. *Electrochimica Acta* 51:1761–1766.
- Kassab, A., Kamel, K.M., Abdel Hamid, E. (1987). Effect of molybdate ion on the corrosion behaviour of aluminium in NaOH solutions. *J. Electrochemical Society of India* 36:27–30.

- Kliskic, M., Radosevic, J., Gudic, S., & Katalinic, V. (2000). Aqueous extract of *Rosmarinus officinalis* L. as inhibitor of Al-Mg alloy corrosion in chloride solution. *Journal of Applied Electrochemistry* 30:823–830.
- Li, X., Deng, S., Fu, H. & Mu, G. (2008). Synergism between rare earth cerium (IV) ion and vanillin on the corrosion of steel in 1.0 M HCl solution. *Corrosion Science* 50:3599–3609.
- Maayta, A.K. & Al-Rawashdeh, N.A.F. (2004). Inhibition of acidic corrosion of pure aluminum by some organic compounds. *Corrosion Science* 46:1129–1140.
- Mishra, A.K. & Balasubramaniam, R. (2007). Corrosion inhibition of aluminium by rare earth chlorides. *Materials, Chemistry and Physics* 103:385–393.
- Neil, W. & Garrard, C. (1994). The corrosion behaviour of aluminium-silicon carbide composites in aerated 3.5% sodium chloride. *Corrosion Science* 36:837–851.
- Noor, E.A. (2009). Evaluation of inhibitive action of some quaternary N-heterocyclic compounds on the corrosion of Al-Cu alloy in hydrochloric acid. *Materials Chemistry Physics* 114:533–541.
- Onal, A.N. & Aksut, A.A. (2000). Corrosion inhibition of aluminium alloys by tolyltriazole in chloride solutions. *Anti-Corrosion Methods and Materials* 47:339–348.
- Radia, A. (2004). Examination of the corrosion mechanism and corrosion control of metals in saltwater environments. Department of Chemical Engineering, University of Toronto.
- Radojicic, I., Berkovic, K., Kovac, S. & Vorkapic-Furac, J. (2008). Natural honey and black radish juice as tin corrosion inhibitors. *Corrosion Science* 50:1498–1504.
- Salem, T.M. Horvath, J. & Sidky, P.S. (1978). The use of soluble corrosion inhibitors for aluminium alloys. *Corrosion Science* 18:363–369.
- Song-mei, L., Hong-rui, Z. & Jian-hua, L. (2007). Corrosion behavior of aluminum alloy 2024-T3 by 8-hydroxy-quinoline and its derivative in 3.5% chloride solution. *Transactions of Nonferrous Metals Society of China* 17:318–325.
- Raja, P.B. & Sethuraman, M.G. (2008). Natural products as corrosion inhibitor for metals in corrosive media – A review. *Materials Letters* 62:113–116.
- Reis, F.M., de Melo, H.G. & Costa, I. (2006). EIS investigation on Al 5052 alloy surface preparation for self-assembling monolayer. *Electrochimica Acta* 51:1780–1788.
- Wu, Y., Geng, F., Chang, P.R., Yu, J. & Ma, X. (2009). Effect of agar on the microstructure and performance of potato starch film, *Carbohydr. Polymers* 76:299–304.
- Yagan, A., Pekmez, N.O. & Yildiz, A. (2006). Corrosion inhibition by poly (*N*-ethylaniline) coatings of mild steel in aqueous acidic solutions. *Progress in Organic Coatings* 57:314–318.
- Yurt, A., Ulutas, S. & Dal, H. (2006). Electrochemical and theoretical investigation on the corrosion of aluminum in acidic solution containing some Schiff bases. *Applied Surface Science* 253:919–925.



Corrosion Resistance

Edited by Dr Shih

ISBN 978-953-51-0467-4

Hard cover, 472 pages

Publisher InTech

Published online 30, March, 2012

Published in print edition March, 2012

The book has covered the state-of-the-art technologies, development, and research progress of corrosion studies in a wide range of research and application fields. The authors have contributed their chapters on corrosion characterization and corrosion resistance. The applications of corrosion resistance materials will also bring great values to reader's work at different fields. In addition to traditional corrosion study, the book also contains chapters dealing with energy, fuel cell, daily life materials, corrosion study in green materials, and in semiconductor industry.

How to reference

In order to correctly reference this scholarly work, feel free to copy and paste the following:

R. Rosliza (2012). Improvement of Corrosion Resistance of Aluminium Alloy by Natural Products, Corrosion Resistance, Dr Shih (Ed.), ISBN: 978-953-51-0467-4, InTech, Available from:

<http://www.intechopen.com/books/corrosion-resistance/improvement-of-corrosion-resistance-of-aluminium-alloy-by-natural-products>

INTECH

open science | open minds

InTech Europe

University Campus STeP Ri
Slavka Krautzeka 83/A
51000 Rijeka, Croatia
Phone: +385 (51) 770 447
Fax: +385 (51) 686 166
www.intechopen.com

InTech China

Unit 405, Office Block, Hotel Equatorial Shanghai
No.65, Yan An Road (West), Shanghai, 200040, China
中国上海市延安西路65号上海国际贵都大饭店办公楼405单元
Phone: +86-21-62489820
Fax: +86-21-62489821