

EXPERIMENTAL AND NUMERICAL INVESTIGATION OF HYDROGEN GAS AUTO-IGNITION

**Golub, V.V., Baklanov, D.I., Bazhenova, T.V., Golovastov, S.V., Ivanov, M.F.,
Laskin, I.N., Semin, N.V. and Volodin, V.V.**

Department of Physical Gasdynamics, Associated Institute for High Temperatures RAS, Izhorskaya st.
13/19, Moscow, 125412, Russia
golub@ihed.ras.ru

ABSTRACT

This paper describes hydrogen self-ignition as a result of the formation of a shock wave in front of a high-pressure hydrogen gas propagating in the tube and the semi-confined space, for which the numerical and experimental investigation was done. An increase in the temperature behind the shock wave leads to the ignition on the contact surface of the mixture of combustible gas with air. The required condition of combustible self-ignition is to maintain the high temperature in the mixture for a time long enough for inflammation to take place. Experimental technique was based on a high-pressure chamber inflating with hydrogen, burst disk failure and pressurized hydrogen discharge into tube of round or rectangular cross section filled with air. A physicochemical model involving the gas-dynamic transport of a viscous gas, the detailed kinetics of hydrogen oxidation, $k-\omega$ differential turbulence model, and the heat exchange was used for calculations of the self-ignition of high-pressure hydrogen. The results of our experiments and model calculations show that self-ignition in the emitted jet takes place. The stable development of self-ignition naturally depends on the orifice size and the pressure in the vessel, a decrease in which leads to the collapse of the ignition process. The critical conditions are obtained.

1.0 INTRODUCTION

The promising developments of hydrogen power engineering pose the problems of the explosion-proof at storage and use of hydrogen. The large number of cases of ignition with the leakage of hydrogen without the visible reasons was fixed in the previous century. Five mechanisms of the ignition were proposed: the inverse effect of Joule-Thompson, electrostatic discharge, diffusion ignition, sudden adiabatic compression, ignition by hot surface [1].

The mechanism of diffusion ignition on the boundary of cold combustible and hot oxidizer was for the first time proposed in the paper [2]. Hydrogen under the high pressure was given into the region, which contains oxygen or air. It was discovered, that the ignition is possible even if the temperature of hydrogen is less than ignition temperature. Ignition appears due to the rise in temperature of the combustible mixture, which is formed due to the diffusion of hydrogen on the contact surface with the oxidizer, heated by shock wave. This phenomenon was called diffusion ignition.

The study of the possibility of ignition with the outflow of combustible gas into the oxidizing medium is task of importance. The processes of the outflow of combustible gas are encountered in the heat engines, where mixing fuel-air mixture, ignition and combustion efficiency of fuel and, consequently, the effectiveness of combustion depend on the flow pattern of gas. Expiration also can occur with the ejection of gas from the reservoirs or the gas pipes. Special topical character of the problem of ignition

acquired in connection with the development of hydrogen power engineering, when the need for ensuring safe storage of hydrogen in the reservoirs under the high pressure arose. In 2005 almost simultaneously appeared the works [3, 4, 5], in which by numerical methods is analyzed the possibility of the diffusion ignition of hydrogen for the isolated special cases. Bazhenova et al. [6] and Liu et al. [7] made numerical analysis of auto-ignition in high-pressure hydrogen jets coming into contact with air, and proved that it was possible. In the paper [8], the burst disk was used in the rapid discharge of high-pressure hydrogen into a tube of $5 \cdot 10^{-3}$ - 10^{-2} m in diameter, $3 \cdot 10^{-3}$ - $1.85 \cdot 10^{-1}$ m in length, and with an open end. The failure pressure was changed from $4 \cdot 10^6$ to $4 \cdot 10^7$ Pa. Ignition of the hydrogen jet was observed in the extension tube. Recent publication of Golub et al. [9] demonstrates the numerical solution of the hydrogen self-ignition task when the hydrogen releases into the semi-confined space. The paper includes experimental investigation of impulse jet structure, numerical simulations of hydrogen mixing with air and hydrogen jet initiation. Diffusion self-ignition mechanism occurs to be responsible for hydrogen jet discharging into the air initiation. The paper of Dryer et al. [10] reports the similar mechanism of hydrogen and natural gas self-ignition at the burst disk failure and combustible gas release into the tube filled with air. Also the transverse shocks that forming at the burst disk failure lead the gas on the contact surface heating.

In this paper the reservoir pressure range, when a shock wave formed in the air, has sufficient intensity to produce self-ignition of the hydrogen-air mixture formed at the front of compressed hydrogen is found. An analysis of governing physical phenomena, which based on the experimental and numerical results, of the initial conditions (the hydrogen pressure inside the vessel, and the shape of the tube in which the hydrogen was emitted) and physical mechanisms, which lead to combustion is presented.

2.0 THE STRUCTURE OF PULSE JET

It is known that with the jet emergence into the space with the counterpressure in front of the emerging gas in the environment appears the shock wave, in which the mechanical kinetic energy of gas is converted into the thermal by nonisentropic means. In this case in the region of that filled with oxidizer, appears strong shock wave even if the flow of subsonic. For example, hydrogen escaping into air with the speed of sound generates shock wave with the Mach number 5. The temperature jump and density appears on the contact surface, which separates the escaping gas from the gas, heated by shock wave. Contact surface is strongly created turbulence, which contributes to the mixing of the escaping cold gas with the hot gas behind the shock wave.

The development of pulse jet was simulated on the shock tube, in end of which was established the slotted nozzle. Fig. 1 presents the schlieren photographs of the formation of the pulse jet of nitrogen on discharge from the slit nozzle [11]. Hydrogen pulse jet structure is the same like the nitrogen one with negligible differences.

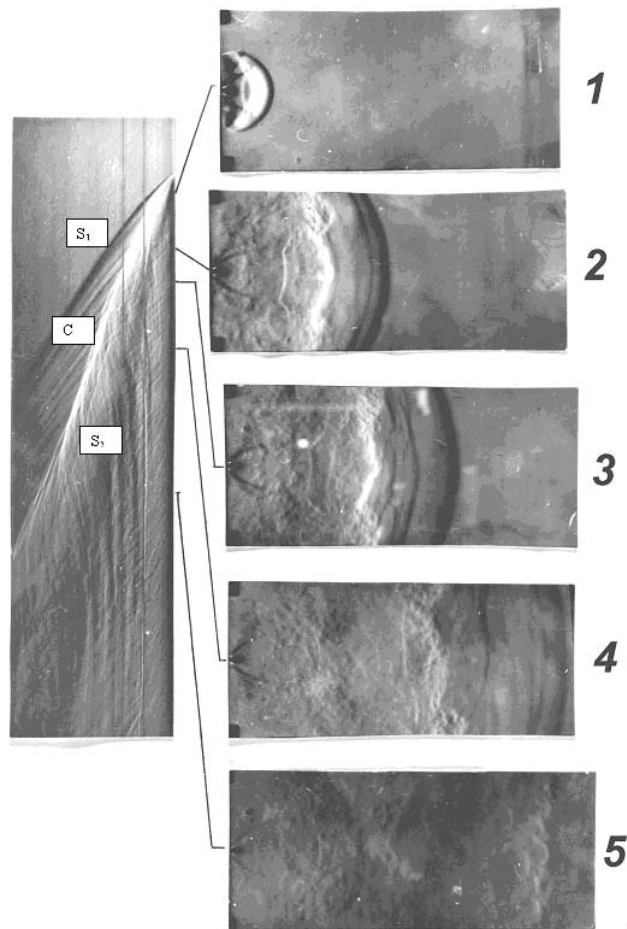

Figure 1. Schlieren pictures and streak record of pulse jet formation on discharge from the slit nozzle.

As can be seen from photograph, there are following basic elements of pulse jet: the starting shock wave S_1 , which is extended in the surrounding gas, the contact surface C , the second shock wave S_2 . The development of instabilities on the contact surface leads to the mixing of the escaping gas and gas behind the starting shock wave.

3.0 NUMERICAL SIMULATION SELF-IGNITION OF THE HYDROGEN DISCHARGE INTO SEMI-CONFINED SPACE

Calculation is based on the model, which includes the gas-dynamic transfer of viscous gas, the kinetics of the oxidation of hydrogen, multicomponent diffusion and thermal conductivity. The process of expiration and of igniting the jet of hydrogen was calculated by the two-dimensional hydrodynamic code taking into account of viscosity, thermal conductivity and diffusion in the axially symmetric setting.

The numerical simulation of mixing and burning of the mixture of the hydrogen jet with hot air behind the primary shock wave was conducted at initial air and hydrogen temperature $T = 300\text{ K}$, hydrogen pressures $P = 1.5 \cdot 10^7 - 4 \cdot 10^7\text{ Pa}$ and diameter of orifice, through which the jet of hydrogen emerging, $d = 10^{-3} - 8 \cdot 10^{-3}\text{ m}$. With the storage pressure on the order of $1.5 \cdot 10^7 - 4 \cdot 10^7\text{ Pa}$ and the diameter of orifice exceeding $3 \cdot 10^{-3}\text{ m}$ the shock wave forming in air has intensity, sufficient for the ignition of hydrogen-air mixture behind the front of the expanding hydrogen jet (solid line in fig.2).

Temperature at the front of combustion in this case locally exceeds 2500 K that is in 2 times exceeds the temperature in the shock wave in air (under otherwise equivalent conditions of injection of a inert gas).

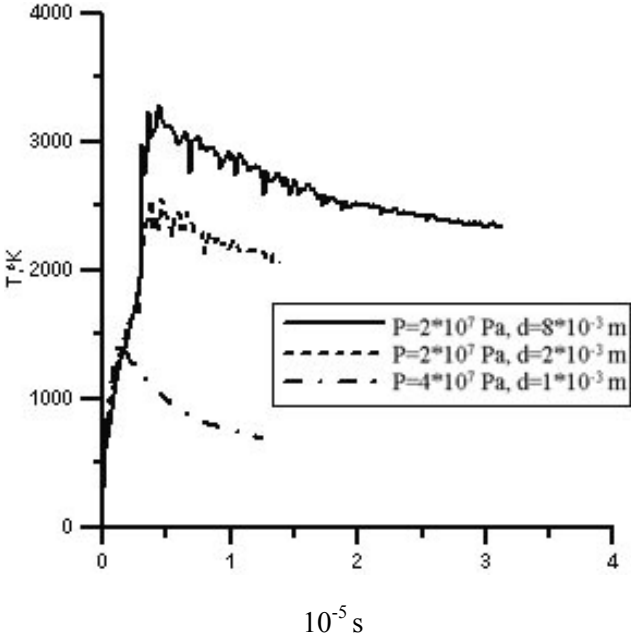

Figure 2. Maximum temperature in the jet vs time.

It is evident from the given results that on front jet boundary is formed the steady front of combustion, even without the developed mechanisms of turbulent mixing. It should be noted that the solution is not simulated in the coordinates of similarity to the scale of orifice diameter, since the induction period of ignition is dimensional value. In the case, when the diameter of orifice is less than $2.6 \cdot 10^{-3}\text{ m}$, the disruption of ignition even at a pressure $4 \cdot 10^7\text{ Pa}$ occurs, which is reflected in Fig. 2 with dash-dotted line. Dashed line in figure 2 demonstrates the situation, when the ignition occurs; however, the maximum temperature in the jet lower than the temperature of the stable burning of hydrogen-air mixture, which leads to damping of the combustion

The exposition time of the arising mixture at a high temperature is insufficient for the stable burning at pressures of below $1.5 \cdot 10^7\text{ Pa}$ and the diameters of opening it is less than $3 \cdot 10^{-3}\text{ m}$. At the same time investigated process depends substantially on the initial temperature of hydrogen and air. Thus, at the initial temperature of medium 400 K and a pressure of compressed hydrogen $2 \cdot 10^7\text{ Pa}$ the jet emerging from the bottle ignites even with the diameter of the orifice only of $2 \cdot 10^{-3}\text{ m}$.

4.0 EXPERIMENTAL INVESTIGATION OF HYDROGEN SELF-IGNITION IN ROUND AND RECTANGULAR TUBES

Experimental investigation of hydrogen self-ignition in extension tube filled with air was carried out in round and rectangular tubes of $6.5 \cdot 10^{-2}$ - $1.85 \cdot 10^{-1}$ m in length and the cross section area of $2 \cdot 10^{-5}$ m². Experimental setups are presented in fig.3.

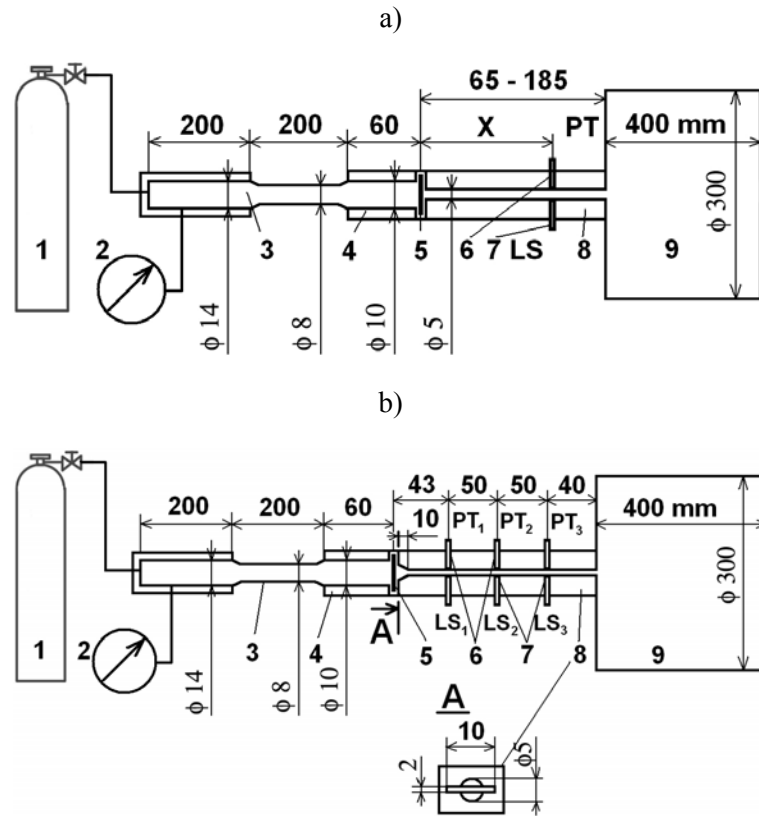

Figure 3. Schematic of experimental setups. a) low pressure tube of round cross section; b) low pressure tube of rectangular cross section. 1 – hydrogen bottle, 2 – manometer, 3 – high pressure chamber, 4 – diaphragm block, 5 – copper diaphragm (burst disk), 6 – pressure transducers (PT), 7 – light sensors (LS), 8 – low pressure chamber; 9 – buster chamber. X – distance between diaphragm and pressure transducer.

It consists of a hydrogen supply system (1) equipped with a valve and a manometer (2) for feeding and measuring the pressure in the hydrogen reservoir (3) of high pressure, a diaphragm block (4,5) connected to the reservoir by one side and a low-pressure chamber (8) by the other side. Low-pressure chamber is connected to the buster chamber (9). The hydrogen reservoir is feeding with hydrogen from the bottle (1). The high-pressure and low-pressure chambers are separated with the copper diaphragm (burst disk) of 10^{-4} - $2 \cdot 10^{-4}$ m thickness. As the pressure in the reservoir reaches the critical value of the burst disk failure it opens and hydrogen discharges to the low-pressure chamber (8) forming the leading shock wave. Three pressure sensors PCB 113A24 (6) and light gauges FD-256 (7)

are installed in the low-pressure chamber to detect shock wave propagation and the ignition. Oscillograms of pressure and light gauges readings, when hydrogen self-ignition occurs in front of the first pair of gauges in rectangular chamber and at the distance of 6-8 tube diameters in round chamber, are presented in figure 4 (curves 1,2,7,8). The distance between the first pair of gauges and cooper diaphragm is equal to $3.3 \cdot 10^{-3}$ and $4.3 \cdot 10^{-3}$ m in round and rectangular chambers respectively. The self-ignition occurs at $5.6 \cdot 10^6$ Pa of initial pressure in high-pressure chamber at the hydrogen discharge in rectangular chamber. Delay between the shock wave and flame front was equal to $2.4 \cdot 10^{-5}$ s at first pairs of gauges and $1.3 \cdot 10^{-5}$ s at second pairs of gauges. Velocity of flame decreases from 1894 m/s between LS1 and LS2 to 1389 m/s between LS1 and LS2. The velocity of shock wave is equal to 1316 m/s between PT1 and PT2, pressure value in shock front is equal to $1.8 \cdot 10^6$ Pa. At the same initial pressure in high pressure chamber the self-ignition didn't occur in round tube. Moreover the self-ignition didn't occur up to $9.4 \cdot 10^6$ Pa of P_0 . At the same time the intensity of shock wave in round tube was less than one in the rectangular tube. With increasing of initial pressure the intensity of shock wave increases too and achieves the intensity that is sufficient for the self-ignition. The self-ignition was observed at $P_0=9.6 \cdot 10^6$ Pa and higher. Time difference between the shock wave and flame front is equal to $2.4 \cdot 10^{-5}$ s at the distance of $3.3 \cdot 10^{-2}$ m along the tube from the burst disk, the pressure of shock wave is equal to $2.3 \cdot 10^6$ Pa.

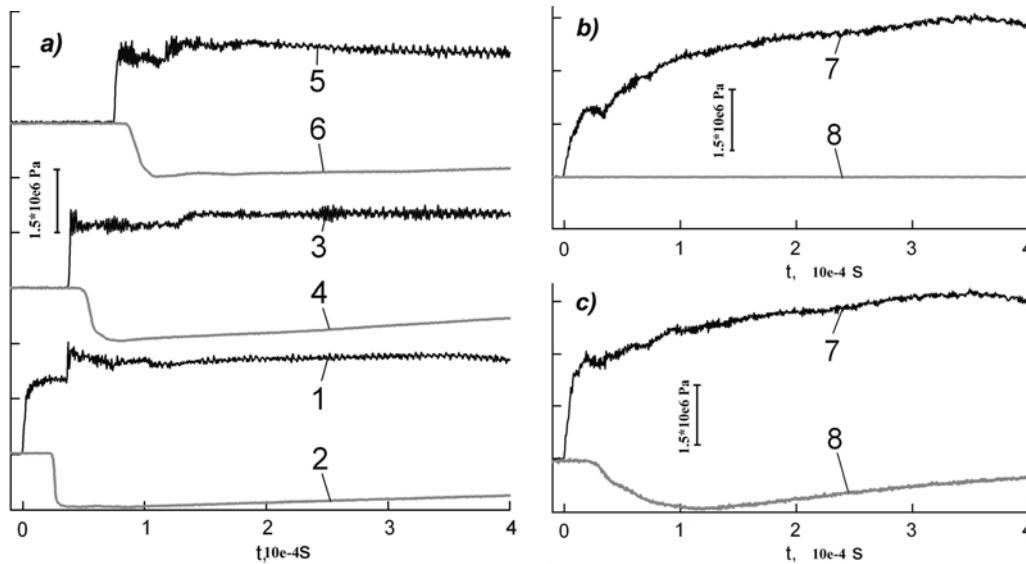

Figure 4. Oscilloscope readings of the pressure transducers and light sensors signals in the low-pressure chamber: a) of rectangular cross section at $P_0=5.6 \cdot 10^6$ Pa, b) of round cross section at $P_0=9.4 \cdot 10^6$ Pa, c) of round cross section at $P_0=96$ atm.

- 1 – pressure signal from PT1, $X=4.3 \cdot 10^{-2}$ m, 2 – light signal from LS1, $X=4.3 \cdot 10^{-2}$ m,
- 3 – pressure signal from PT2, $X=9.3 \cdot 10^{-2}$ m, 4 – light signal from LS2, $X=9.3 \cdot 10^{-2}$ m,
- 5 – pressure signal from PT3, $X=1.43 \cdot 10^{-1}$ m, 6 – light signal from LS3, $X=1.43 \cdot 10^{-1}$ m,
- 7 – pressure signal from PT in round low-pressure tube, $X=3.3 \cdot 10^{-2}$ m,
- 8 – light signal from LS in round low-pressure tube, $X=3.3 \cdot 10^{-2}$ m.

In all experiments the self-ignition of hydrogen in round and rectangular chambers occurred in the measuring section ($1.33 \cdot 10^{-1}$ - $1.43 \cdot 10^{-1}$ m) at the pressure in front of shock wave equal to $9 \cdot 10^5$ Pa

and higher. With the increase of shock wave pressure the distance between the burst disk and hydrogen self-ignition location decreases. This may be explained with the increase of atmospheric air temperature behind the shock wave near the contact surface of air with hydrogen. Therefore an induction time of mixture self-ignition decreases sufficiently.

The shock wave pressure at which the hydrogen self-ignition occurs in rectangular chamber is less than one in round chamber. The difference equals $5 \cdot 10^5$ Pa for hydrogen self-ignition at the distance of $4 \cdot 10^{-2}$ m from the burst disk along the chamber axis. But in the case of self-ignition at the distance from the burst disk of $1.4 \cdot 10^{-1}$ m this difference reduces to $2 \cdot 10^5$ Pa. It can be explained with the significant influence of boundary layer on mixing and ignition of hydrogen-air mixture behind the shock wave. In the rectangular chamber boundary layer compresses the flow behind the shock wave and therefore the hydrogen- air mixture behind the shock wave gets the additional heating.

5.0 NUMERICAL SIMULATION SELF-IGNITION OF THE HYDROGEN DISCHARGE INTO TUBE

Numerical simulation of the self-ignition of a hydrogen jet is based on a system of the full Navier-Stokes equations with the Reynold's averaging for the multicomponent mixture of gases. The physicochemical model involves the gasdynamic transport of a viscous gas, the detailed kinetics of hydrogen oxidation (ChemKin – II package), k- ω differential turbulence model, multi-component diffusion and heat exchange.

The system of the partial differential equations discretized and solved numerically using the upwind, finite volume procedure. The Roe flux vector splitting scheme with a MINMOD limiter is used for the discretization of the fluxes in the equations. In the all cases considered here, the solid surface is assumed as non-catalytic and adiabatic. Calculations were performed in a two-dimensional (axisymmetric) geometry with the use of an explicit scheme of the second order accuracy on the time and space.

The dimensions of tube (diameter of $5 \cdot 10^{-3}$ m, the length of $L = 6.5 \cdot 10^{-2} - 1.8 \cdot 10^{-1}$ m, the position of pressure sensor and the light of $S = 3.5 \cdot 10^{-2} - 1.35 \cdot 10^{-1}$ m) and the volume of high-pressure chamber with hydrogen correspond to experimental setup ones. The typical grid was: for the low-pressure chamber $5 \times (30 \div 50)$ cells with the refining to the diaphragm and to the outlet with growth factor of 1.03; for high-pressure chamber 30×30 with the refining to the diaphragm with growth factor of 1.02, calculation was performed with the step of the time equal to $10^{-6} - 1.5 \cdot 10^{-6}$ s. Total number of steps was equal to 70 -150. The initial conditions were:

- Low-pressure chamber: air (mass fraction of $O_2 = 0.23$, mass fraction of $N_2 = 0.77$), pressure $P = 10^5$ Pa, temperature $T = 300$ K.
- High-pressure chamber: hydrogen (mass fraction of $H_2 = 1$), pressure $P = 2 \cdot 10^6 - 10^7$ Pa, temperature $T = 300$ K.

Figure 5 shows typical computational grid and the dimensions of computational region are presented.

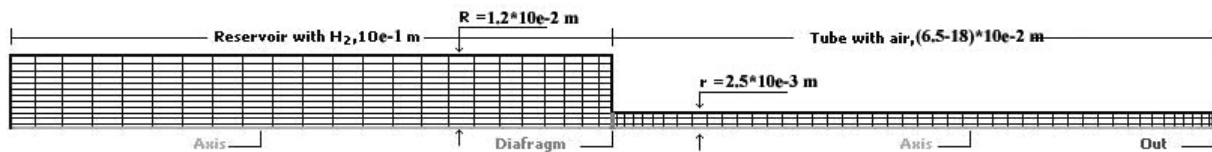

Figure 5. Calculation region and grid.

In the calculation series about 50 computational experiments were carried out. The parameters under variation were: the initial pressure of hydrogen in the reservoir and the length of tube. The distributions of pressure, temperature, mass fraction of water, and the velocities of flow in the tube were calculated. The temperature of mixture higher than 1500 K with the appearance of water mass fraction $\sim 10^{-4}$ is assumed as the criterion of the hydrogen ignition.

It should be noted that the results of calculations must converge with the grid refining. In this connection the additional check calculation was carried out with the use of the more detailed grid (8 times more detailed than typical grid). An example with the initial pressure in the chamber of $4 \cdot 10^6$ Pa and the length of the tube 10^{-1} m was examined. The same distributions of basic parameters as in the calculations with the typical grid were recorded. It should be noted that in the calculation of this regime the combustion practically does not appear. It is possible to make a conclusion about the acceptability of calculation with typical grids.

In this task the quantitative assessment of boundary layer effect is necessary. Taking into account the short time scale of the task, boundary layer influence is not obvious. In order to reveal this influence, a series of calculations were carried out. The task with the initial pressure in the high-pressure chamber of $9 \cdot 10^6$ Pa is examined as an example. As the calculations show, ignition without taking into account the boundary layer occurs at the axis of the chamber, while with taking into account the boundary layer it occurs on the wall. If in the case when the boundary layer neglected it is possible to tell only about the "origins" of ignition, then in the case taking into account friction on the wall combustion occurs.

Thus, the calculations show, that boundary layer makes a noticeable contribution to the temperature of mixture. Furthermore, upon its consideration the distance, at which the combustion of hydrogen arises, decreases a little and the intensity of shock wave, which provides hydrogen self-ignition, also decreases. Boundary layer effect is sufficiently obvious to be accelerating the ignition process; however, its role is not obvious in the "short" tubes. Typical x-t diagram of hydrogen self-ignition (length of tube $1.8 \cdot 10^{-1}$ m, hydrogen pressure $8 \cdot 10^6$ Pa) is presented in figure 6. The shock wave and the regions of air, hydrogen and water are drawn.

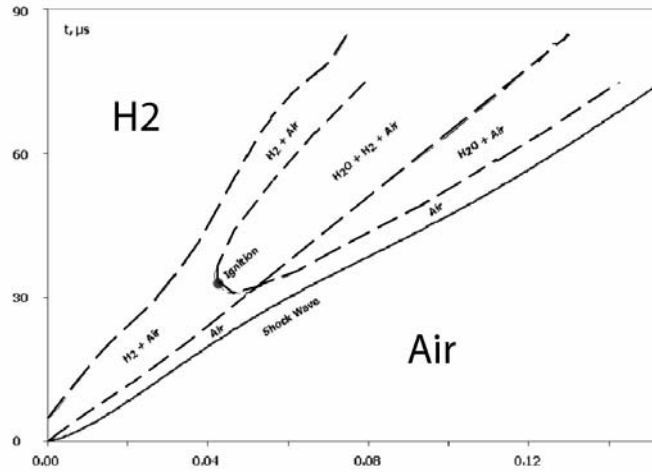

Figure 6. X-T diagram of hydrogen self-ignition (calculation, hydrogen pressure $8 \cdot 10^6$ Pa)

6.0 COMPARISON OF EXPERIMENTAL AND NUMERICAL RESULTS

Maps of self-ignition limits in round and rectangular chambers are presented in figure 7 in the parameters of initial pressure in high-pressure chamber (P_0) and shock wave pressure (P_{sw}).

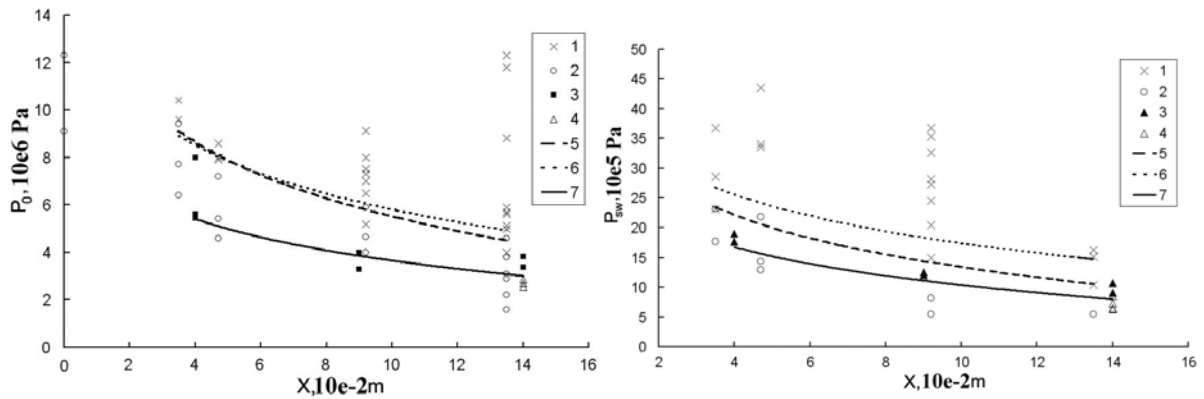

Figure 7. Self-ignition limits of hydrogen in round (5, 6) and rectangular (7) chambers. X – distance from the diaphragm along the axis of the tube, P_0 – initial pressure in high-pressure chamber, P_{sw} – pressure in front of shock wave in the chamber.

1 – ignition in round tube, experiment; 2 – no ignition in round tube, experiment; 3 – ignition in rectangular tube, experiment; 4 – no ignition in rectangular tube, experiment; 5 – self-ignition limit in round tube, experiment; 6 – self-ignition limit in round tube, numerical simulation; 7 – self-ignition limit in rectangular tube, experiment.

Basing on the results of the calculations and the experiments the dependence of hydrogen self-ignition minimum pressure in the high-pressure chamber on the distance from burst disk to the hydrogen self-ignition location was obtained. This dependence separates the zone where the hydrogen ignites from the zone where the hydrogen discharges without self-ignition (fig.7). One can see that the calculated dependence of the self-ignition distance on the pressure in the shock wave lies higher than that obtained experimentally ($\Delta p \sim 2 \cdot 10^5 - 4 \cdot 10^5$ Pa) while the dependences of the self-ignition distance on the pressure in the high-pressure chamber coincide. This may be explained with some untaken into account physical mechanism that to be determined in the next investigation.

8.0 CONCLUSIONS

1. The possible reason for self-ignition of hydrogen with the pulse expiration into the oxidizing medium can be the ignition of hydrogen on the contact surface, which separates the escaping gas from the gas, heated by starting shock wave in the oxidizing medium.
2. Numerically showed that the self-ignition of hydrogen discharge into semi-confined space takes place at a normal temperature of oxidizing medium and hydrogen, pressure in the tank is more than $1.5 \cdot 10^7$ Pa and the diameter of the hole is more than $3 \cdot 10^{-3}$ m.
3. Experiments have shown that the self-ignition in the tubes of $2 \cdot 10^{-5}$ m² in cross section (round and rectangular) area is possible at the burst of the hydrogen from the high-pressure chamber at initial pressure of $4 \cdot 10^6$ Pa and higher.
4. The cross section shape of the tube is of importance because it affects the flow boundary layer. It is shown experimentally that at the same cross section area the self-ignition in narrow rectangular tube occurred at lower pressure than that in round tube. At the initial pressure in high pressure chamber lower on $1.5 \cdot 10^6 - 2 \cdot 10^6$ Pa (shock wave pressure lower on $2 \cdot 10^5 - 5 \cdot 10^5$ Pa) self-ignition occurs at the same distance.
5. Experimentally and numerically shown that as the initial pressure in the high-pressure chamber increases the distance from the burst location to the hydrogen flash on the contact surface reduces.

9.0 ACKNOWLEDGEMENTS

The authors would like to thank Russian Federal Agency on the Science and Innovations for the support of investigation.

10.0 REFERENCES

1. Astbury G.R., Hawksworth S.J. Spontaneous Ignition of Hydrogen Leaks: A Review of Postulated Mechanisms, CD Proc. Int. Conference on Hydrogen Safety. Pisa. Italy. September 8-10, 2005. P. 11.
2. Wolanski P., Wojcicki S. Investigation into the mechanism of the diffusion ignition of a combustible gas flowing into an oxidizing atmosphere, 14th Int. Symp. on Combustion. Pennsylvania The Combustion Institute. Pennsylvania. Pennsylvania State University. 1973. P. 1217.

3. Bazhenova T.V., Bragin M.V., Golub V.V., Scherbak S.B., & Volodin V.V., Self ignition of the impulse hydrogen sonic jet emerging in the air semiconfined space. In Abstracts of the 25th International Symposium on Shock Waves, Bangalore, 11-16 July 2005, p. 229.
4. Bityurin V.A., Bocharov A.N., & Filimonova E.A. Effects of arc discharge products on ignition of non-premixed system, In Proc of The 15 Int. Conference on MGD Energy Conversion and 6 Int. Workshop on Magnetoplasma Aerodynamics, Moscow, May 24-27 2005, p. 359.
5. Liu Y.-F., Tsuboi N., Sato H., Higashino F., Hayashi A.K., Direct numerical simulation on hydrogen fuel jetting from high pressure tank, In Proc. of the 20th International Colloquium on the Dynamics of Explosions and Reacting Systems, Montreal, Canada, 31 July – 5 August 2005.
6. Bazhenova T.V., Bragin M.V., Golub V.V., & Ivanov M.F., Self ignition of a fuel gas upon pulsed efflux into an oxidative medium. *Technical Physics Letters*, 32(3), 269-271.
7. Liu Y.-F., Tsuboi N., Sato H., Higashino F., Hayashi A.K., Numerical analysis of auto-ignition in high pressure hydrogen jetting into air, In Proc. of The 31st International Symposium on Combustion, Heidelberg, Germany, 6-11 August 2006.
8. Mogi T., Shiina H., Kim. D., Horigushi S., Ignition of high pressure hydrogen by a rapid discharge, In Proc. of the 31st International Symposium on Combustion, Heidelberg, Germany, 6-11 August 2006.
9. Golub V.V., Baklanov D.I., Bazhenova T.V., Bragin M.V., Golovastov S.V., Ivanov M.F., & Volodin V.V. Shock-Induced Ignition of Hydrogen Gas During Accidental or Technical Opening of High Pressure Tanks // *Journal of Loss Prevention in Process Industries*. In print.
10. Dryer F., Chaos M., Zhao Zh., Stein J., Alpert J., & Homer Ch., Spontaneous ignition of pressurized release of hydrogen and natural gas into air. *Combust. Sci. and Tech.*, 179, 2007, pp. 663-694.
11. Belavin V.A., Golub V.V., Naboko I.M. Struktura impul'snyh struj gazov, istekajuschih cherez sverhzhukovye sopla (Structure of pulse gas jets, emerging through the supersonic nozzles) in Russian // *PMTF*. 1979. # 1. p. 56.