Nonholonomic Mobile Robot Trajectory Tracking using Hybrid Controller

MUHAMMAD SAFWAN*, VALI UDDIN**, AND MUHAMMAD ASIF***

RECEIVED ON 02.03.2015 ACCEPTED ON 28.05.2015

ABSTRACT

A control scheme is being presented for the trajectory tracking of a nonholonomic kinematic model of mobile robots. As a kinematic model of mobile robots is nonlinear in nature, therefore, it is controlling is always being a difficult task. Thus, a control hybrid scheme comprises of fuzzy logic and PID (Proportional Integral Derivative) is being proposed, in which adaptive gains of PID controller is being tuned by a fuzzy logic controller. Moreover, the effectiveness of this innovative technique is also proved using the simulations by adding model uncertainties and external disturbances in the system. Besides, the fuzzy logic control system is also being compared by the proposed control system. Results attained shows that the fuzzy based PID controller drives improved results than fuzzy logic controller.

Key Words: PID Controller, Fuzzy Logic, Kinematic Robot, Trajectory Tracking.

1. INTRODUCTION

In recent era, WMR (Wheeled Mobile Robot) has gained attention of the robotic community as it is suitable for a variety of applications including transportation, security and exploration. WMR can be divided into holonomic and non holonomic robot with respect to their mechanical design. Robots whose controllable degree of freedom is equivalent to number of controllable inputs is known as holonomic robot [1]. Whereas, non holonomic robots comprise of less number of controllable inputs, as compare to holonomic robot causing restriction in mobility, therefore it is considered as more challenging problem [2]. Therefore, many researchers

have worked in this field and proposed various controllers that includes fuzzy logic [3], adaptive feedback [4], back-stepping [5], feedback linearization [6], neural network [7], sliding mode control [8] and many more.

Trajectory tracking can be done by taking information either from leader robot or reference path. When a robot takes a reference path from leader robot this phenomena is called multi-robot formation control [9-10]. Whereas, if the trajectory is being inputted then the phenomena is called trajectory tracking [11]. Most of the proposed schemes for trajectory tracking shows theoretical approaches using computer simulations by neglecting

* Post-Graduate Student, Faculty of Engineering Science & Technology, Hamdard University, Karachi, and Sir Syed University of Engineering & Technology, Karachi.

** Professor, Faculty of Engineering Science & Technology, Hamdard University, Karachi.

*** Department of Electronic Engineering, Sir Syed University of Engineering & Technology, Karachi.

disturbances and model uncertainties in the Practical aspects [12-14]. The neglecting of disturbances and model uncertainties leads to poor transient and steady state characteristics. In this paper, an innovative and computationally effective approach is proposed for WMR trajectory tracking by using the feedback and feedforward controllers.

The purpose of this paper is to provide an innovative controller technique for the feedback controller of the kinematic model of mobile robot. This innovative technique is a hybrid technique comprising of fuzzy Logic and PID known as fuzzy PID controller (F-PID). Moreover, in this technique fuzzy logic is being used as gains tuner of PID. Whereas, Feed forward controller is being designed taking feed forward mechanism from [15]. Indeed, feed forward control mechanism requires reference trajectory.

The remaining organization of the paper is described as: Section 2 elaborates the system model of WMR. Section 3 presents the designing of control model. Section 4 shows the simulation result and covers the area of discussion. Finally, paper is concluded in Section 5.

2. SYSTEM MODELLING

The kinematic model of two wheel differential drive shown in Fig. 1 can be written as [16]:

$$\dot{\zeta}(t) = \begin{bmatrix} \dot{x}(t) \\ \dot{y}(t) \\ \dot{\phi}(t) \end{bmatrix} = \begin{bmatrix} \cos \phi(t) & 0 \\ \sin \phi(t) & 0 \\ 0 & 1 \end{bmatrix} \begin{bmatrix} v(t) \\ w(t) \end{bmatrix} + \begin{bmatrix} d_1(t) \\ d_2(t) \end{bmatrix} \quad (1)$$

$$\dot{\zeta}(t) = S(\zeta)v(t) \quad t \geq 0$$

Where $x(t)$ and $y(t)$ are translations and $\phi(t)$ is the orientation of the robot at time t , $v(t)$ defines the linear velocity, angular velocity is being shown by $w(t)$, $S(\zeta)$ represent Jacobian matrix that transforms input velocities to robotic velocities, $\mathbf{d}(t)=[d_1(t)d_2(t)]^T$ are the disturbances

produce by random noise and model uncertainties, defined as:

$$\sup \|d_i(t)\| \leq \epsilon, \forall t \geq 0, i = 1,2$$

and finally, $\zeta(t)$ is a configuration vector defined as:

$$\zeta(t) = [x(t) y(t) \phi(t)]^T \quad (2)$$

The time varying reference trajectory is being followed by kinematic control design, which is defined as:

$$\zeta_r(t) = [x_r(t) y_r(t) \phi_r(t)]^T \quad (3)$$

To bring orientation and position error to zero kinematic control is being designed as $t \rightarrow \infty$. Therefore, the trajectory tracking error of the mobile robot $\zeta_e(t)$ is defined as follows:

$$\dot{\zeta}_e(t) = T(\phi(t))[v_r(t)] - v(t) = \begin{bmatrix} e_x(t) \\ e_y(t) \\ e_\phi(t) \end{bmatrix} = \begin{bmatrix} \cos \phi(t) & \sin \phi(t) & 0 \\ -\sin \phi(t) & \cos \phi(t) & 0 \\ 0 & 0 & 1 \end{bmatrix} \begin{bmatrix} x_r(t-x(t)) \\ y_r(t-y(t)) \\ \phi_r(t)-\phi(t) \end{bmatrix} \quad (4)$$

Where $T(\phi(t))$ is the transformation matrix use to make orientation error, independent of $\phi(t)$ The derivative of Equation (1) gives the trajectory tracking error as:

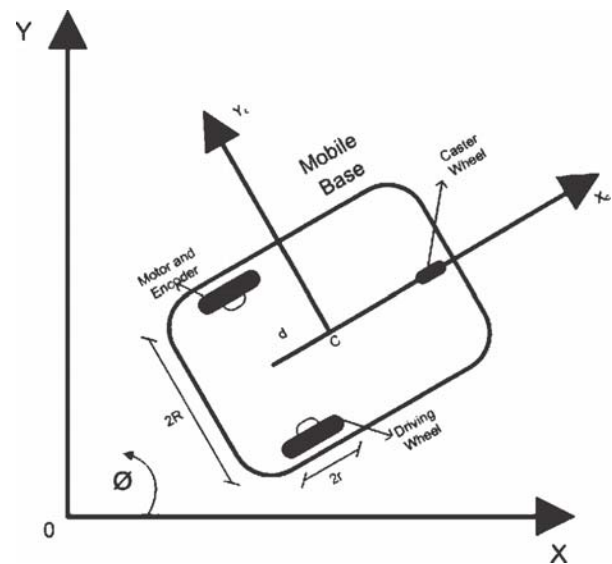

FIG. 1. NONHOLONOMIC KINEMATIC MODEL OF MOBILE ROBOT DESIGN

$$\dot{\zeta}_e(t) = \begin{bmatrix} \dot{e}_x(t) \\ \dot{e}_y(t) \\ \dot{e}_\phi(t) \end{bmatrix} = \begin{bmatrix} -v(t) + w(t)e_y(t) + v_r(t)\cos e_\phi(t) \\ -w(t)e_x(t) + v_r(t)\sin e_\phi(t) \\ -w(t) + w_r(t) \end{bmatrix} \quad (5)$$

Where $v_r(t)$ is reference linear and $w_r(t)$ reference angular velocity defined as [17]:

$$\begin{aligned} v_r(t) &= \sqrt{\dot{x}_r^2(t) + \dot{y}_r^2(t)} \\ w_r(t) &= \frac{\dot{x}_r(t) - \ddot{y}_r(t)\ddot{x}_r(t)}{\dot{x}_r^2(t) + \dot{y}_r^2(t)} \end{aligned} \quad (6)$$

3. CONTROLLER DESIGN

Controller design $v(t)$ is further divided into two parts that include feed-forward controller and feedback controller. The generalized controller can be written as:

$$v_r(t) = \begin{bmatrix} v(t) \\ w(t) \end{bmatrix} = \begin{bmatrix} v_{ff}(t) \\ w_{ff}(t) \end{bmatrix} + \begin{bmatrix} v_{fb}(t) \\ w_{fb}(t) \end{bmatrix} \quad (7)$$

Where $V_{fb}(t)$ and $W_{fb}(t)$ is feed backward linear and angular velocities, respectively and $V_{ff}(t)$ and $W_{ff}(t)$ is the feedforward linear and angular velocities.

3.1 Feedforward Controller

Reference trajectory and error propagation mechanism is used to generate the feedforward velocities. The given expression defines how the feedforward control action is being generated [15].

$$v_{ff}(t) = \begin{bmatrix} v_{ff}(t) \\ w_{ff}(t) \end{bmatrix} = \begin{bmatrix} v_r(t)\cos e_\phi(t) \\ w_r(t) \end{bmatrix} \quad (8)$$

Here $v_{ff}(t)$ and $w_{ff}(t)$ are the feed forward linear and angular velocities respectively.

3.2 Feedback Controller

In this section, the kinematic feedback controller based on Fuzzy PID is discussed. The kinematic controller is designed using PID mechanism and the gains of PID controller are adaptively tuned by using fuzzy logic. This hybrid controller is being designed for each input for fine tuning. The proposed scheme is being discussed in detail block diagram shown in Fig. 2.

Fig. 2 comprises of transformation block T, which is used to make orientation error independent and the proposed controller algorithm shown in Equation (4). The inputs of fuzzy logic controllers are positioned and orientation errors along with their derivatives. The range of the input error signals is defined for range -1 to 1 and their linguistic levels are defined as PB (Positive Big), PS (Positive Small), Centre, NS (Negative Small), and NB (Negative Big). Figs. 3-4 shows the input triangular MFs (Membership Functions).

The control decision is being made with the help of if-then rule bases shown in Tables 1-3 for K_p , K_I and K_D respectively.

The outputs of fuzzy controllers are Fuzzy proportional gain (F_{KP}), Fuzzy Integral gain (F_{KI}) and Fuzzy differential gain (F_{KD}). Whereas, their linguistic levels are assigned as ZE (Zero), PS and PB, and that are being normalized between the ranges of 0-1. The outputs of fuzzy logic controllers are transformed to a crisp output by de-fuzzification. Figs. 5-7 shows the output triangular MFs.

The results obtained from fuzzy logic is used as an adaptive gain for the PID controller. Moreover, the output of the fuzzy PID controller is given as:

$$x_{FPID}(t) = x_{FP}(t) + x_{FI}(t) + x_{FD}(t) \quad (9)$$

Where,

$$\begin{aligned} x_{FP}(t) &= f_P\left(e_x, \frac{de_x}{dt}\right) G_p e_x(t) \\ x_{FI}(t) &= f_I\left(e_x, \frac{de_x}{dt}\right) G_I \int_0^T e_x(t) \\ x_{FD}(t) &= f_D\left(e_x, \frac{de_x}{dt}\right) G_D \frac{de_x(t)}{dt} \end{aligned} \quad (10)$$

Where G_p is Proportional gain, G_I is Integrator gain and G_D is derivative gain are the respectively of the PID controller. The values of G_p , G_I and G_D are being tuned manually whereas, fine tuning of the system is being performed by F_{KP} , F_{KI} and F_{KD} .

and,

$$F_{KP} = f_P\left(e_x, \frac{de_x}{dt}\right); F_{KI} = f_I\left(e_x, \frac{de_x}{dt}\right); F_{KD} = f_D\left(e_x, \frac{de_x}{dt}\right) \quad (11)$$

Finally, overall equation for the F-PID of nonholonomic kinematic model of mobile robot is written as:

$$x_{FPID}(t) = F_{KP} \cdot G_p e_y(t) + F_{KI} \cdot G_I \int_0^T e_y(t) + F_{KD} \cdot G_D \frac{de_y(t)}{dt} \quad (12)$$

with $t = 0, 1, 2, 3 \dots$

Similarly,

$$\begin{aligned} y_{FPID}(t) &= F_{KP} \cdot G_p e_y(t) + F_{KI} \cdot G_I \int_0^T e_y(t) + F_{KD} \cdot G_D \frac{de_y(t)}{dt} \\ \phi_{FPID}(t) &= F_{KP} \cdot G_p e_\phi(t) + F_{KI} \cdot G_I \int_0^T e_\phi(t) + F_{KD} \cdot G_D \frac{de_\phi(t)}{dt} \end{aligned} \quad (13)$$

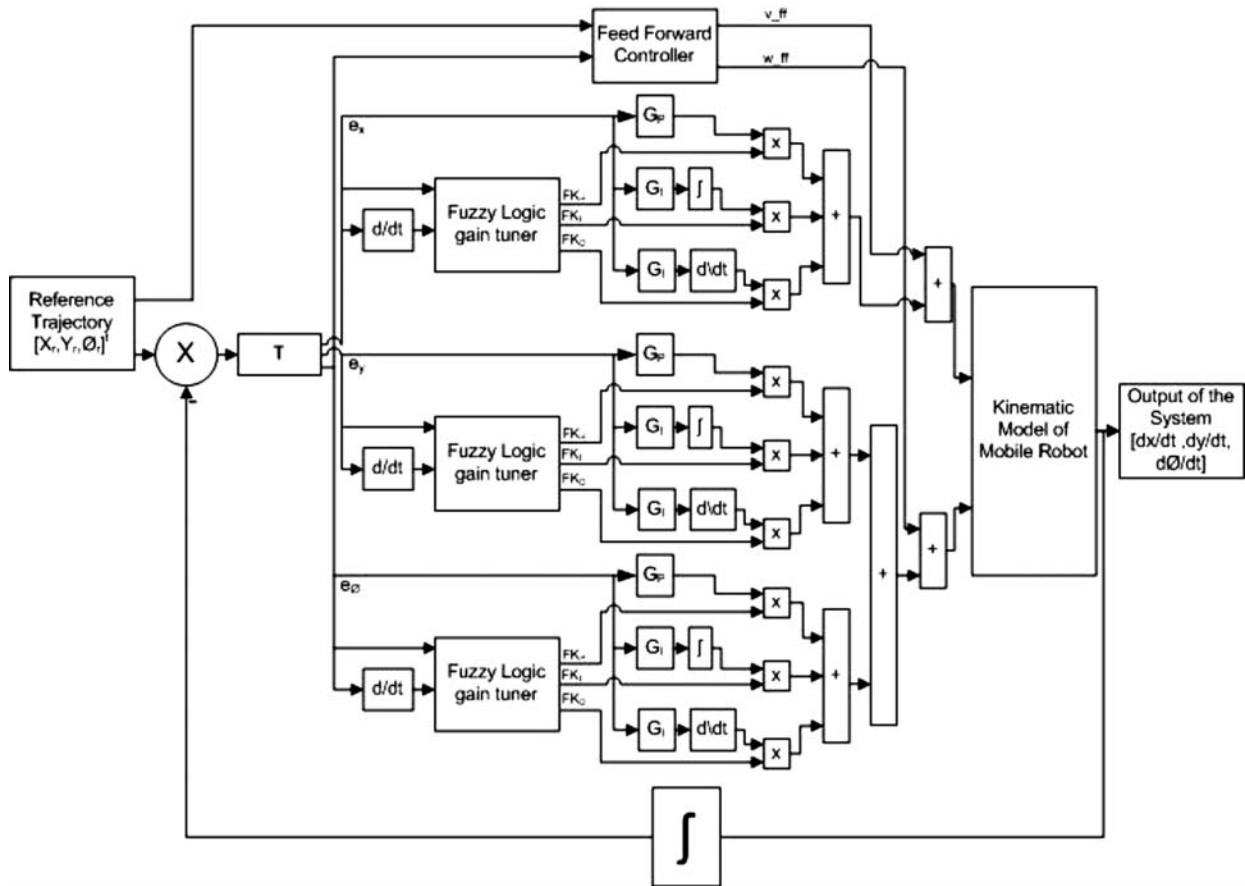

FIG. 2. BLOCK DIAGRAM OF OVERALL SYSTEM USING FUZZY BASED PID CONTROLLER

4. SIMULATIONS RESULTS AND DISCUSSION

The control scheme for Nonholonomic Mobile Robot Trajectory Tracking using Fuzzy PID controller is being projected. Simulink is being used for the simulation of the proposed model which is being compared by the conventional fuzzy logic controller. The lemniscate curve trajectory is used as input for the simulation of the system. This curve trajectory is used to avoid constant, linear and angular velocities. Moreover, the simulation is done in the presence of external disturbances and model uncertainties. Indeed, Fig. 8 explains the trajectory tracking comparison between the fuzzy based PID controller with the conventional fuzzy logic controller in which external noise is also added to the system. Fig. 9 shows the external noise.

TABLE 1. IF-THEN FUZZY LOGIC RULE BASE FOR K_p

Error (de/dt)	NB	NS	Z	PS	PB
NB	ZE	PS	PS	PS	ZE
NS	PS	PS	PM	PS	PS
Z	PM	PS	PM	PM	PM
PS	PM	PM	PM	PS	PL
PB	PL	PM	PM	PS	PL

TABLE 2. IF-THEN FUZZY LOGIC RULE BASE FOR K_i

Error (de/dt)	NB	NS	Z	PS	PB
NB	ZE	ZE	ZE	ZE	ZE
NS	ZE	PS	PS	PS	ZE
Z	PS	PS	PS	PS	PS
PS	PB	PS	PS	PS	PS
PB	PB	PB	PB	PB	PB

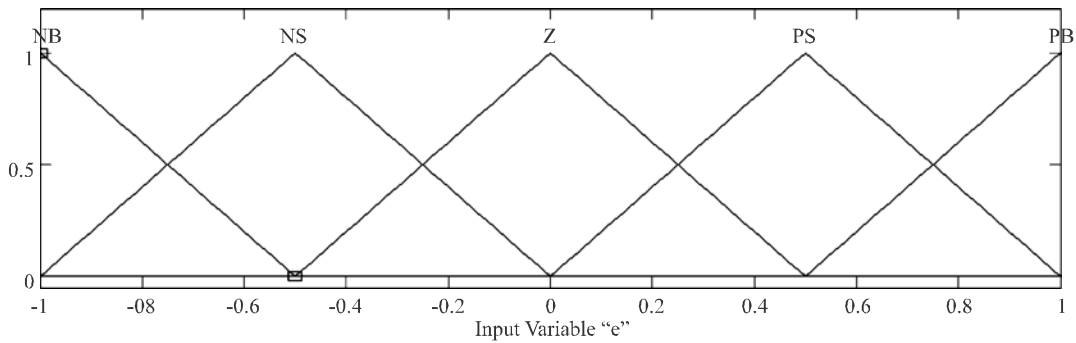

FIG. 3. INPUT TRIANGULAR MF OF ERROR (E)

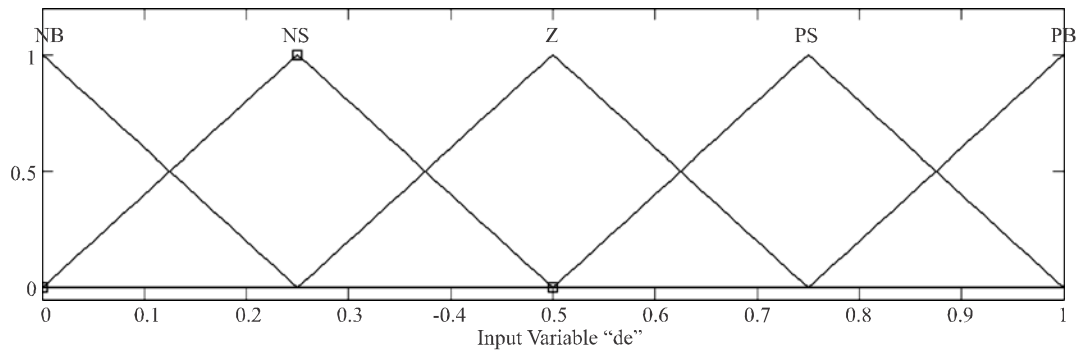

FIG. 4. INPUT TRIANGULAR MF OF CHANGE IN ERROR (DE/DT)

TABLE 3. IF-THEN FUZZY LOGIC RULE BASE FOR K_D

Error (de/dt)	NB	NS	Z	PS	PB
NB	PS	PB	PB	PB	PB
NS	PS	PS	PS	PS	PB
Z	ZE	PS	PS	PS	PB
PS	ZE	PS	PS	PS	PS
PB	ZE	PB	PB	PB	PS

From the simulation results it's being observed that the proposed controller scheme is more effective than the conventional fuzzy logic controller. Furthermore, Figs. 10-12 shows the error plots of the all the coordinates, which shows that the proposed controller comprises of better performance in regards of chattering, steady state response and settling time along x,y and ϕ coordinate for the nonholonomic wheeled mobile robots.

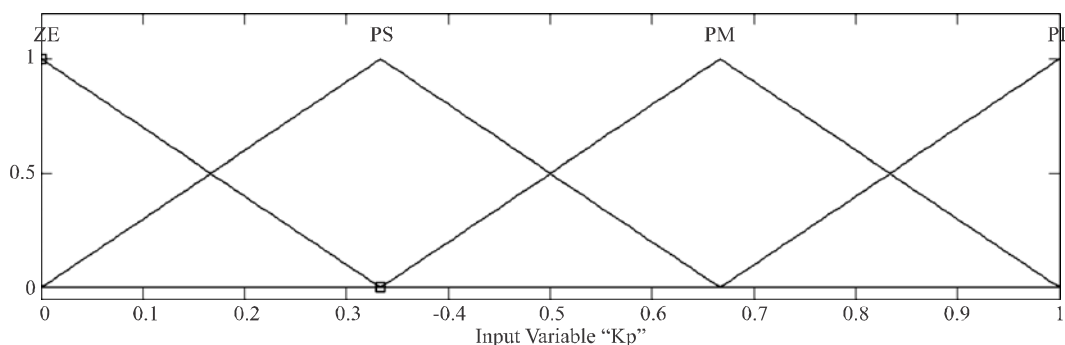

FIG. 5. OUTPUT TRIANGULAR MF OF PROPORTIONAL GAIN (K_p)

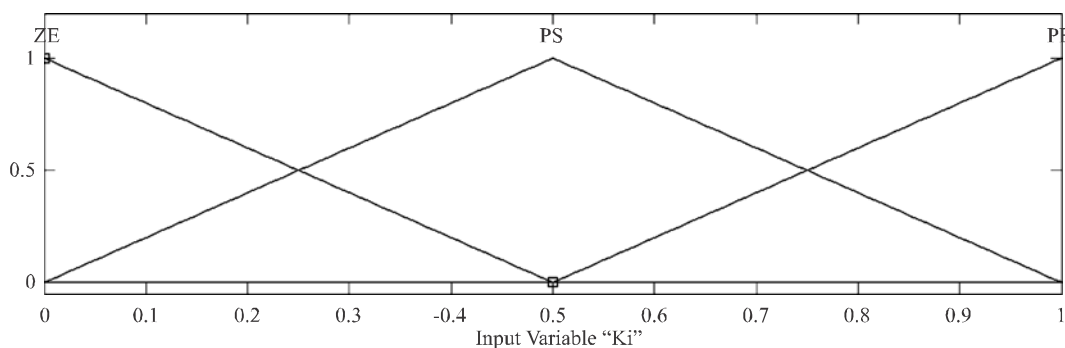

FIG. 6. OUTPUT TRIANGULAR MF OF FUZZY LOGIC, INTEGRAL GAIN (K_i)

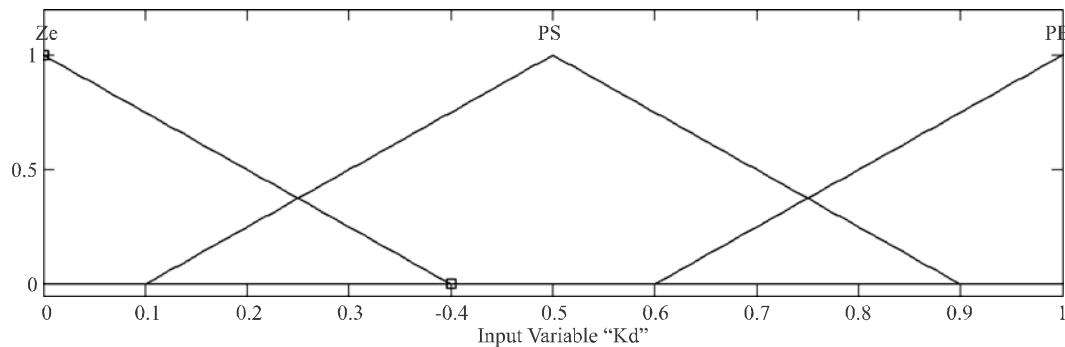

FIG. 7. OUTPUT TRIANGULAR MF OF DERIVATIVE GAIN (K_d)

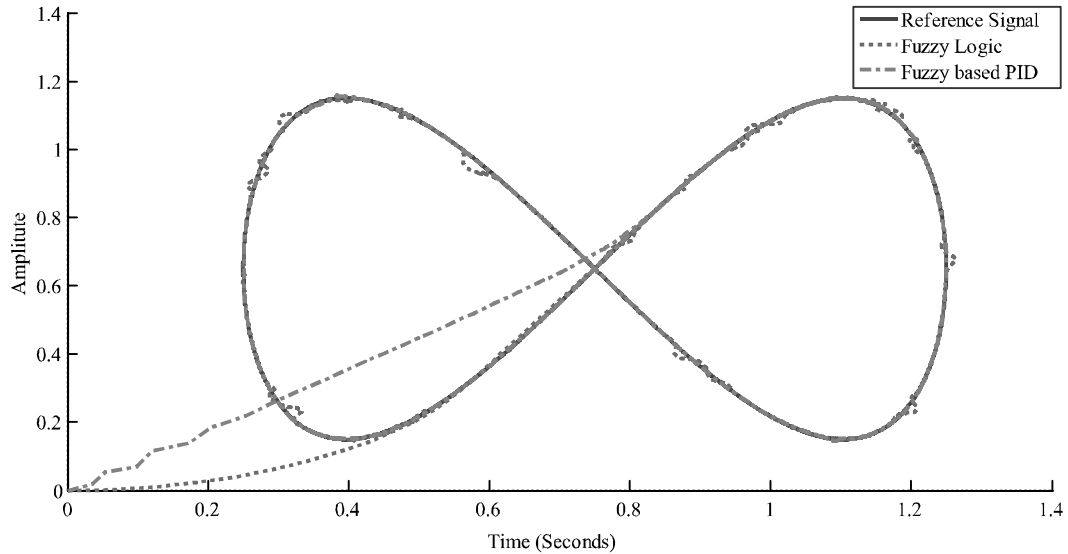

FIG. 8. COMPARATIVE RESULTS BETWEEN REFERENCE MODEL, FUZZY AND FUZZY BASED PID

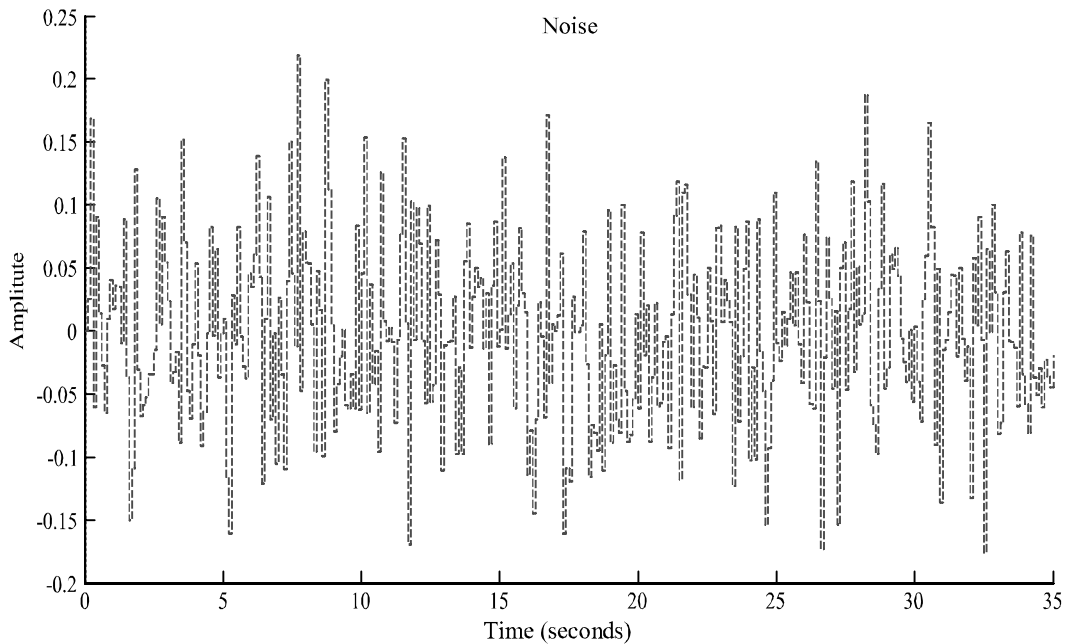

FIG. 9. NOISE SIGNAL

5. CONCLUSION

In this paper, feed-back and feed-forward kinematic controller for unicycle differential type mobile robot trajectory tracking is presented. Feedforward control velocities are calculated using error propagation mechanism and reference velocities. The desired feedforward control action is made using feedforward control action with delayed velocity error. Moreover,

proposed fuzzy based PID controller is used to calculate the feedback velocities. The performance of the Fuzzy based PID controller is compared with Conventional Fuzzy Controller. Simulated results demonstrate that the proposed controller provides efficient result by tracking precisely the given trajectory in comparison with conventional fuzzy logic controller with zero steady state error.

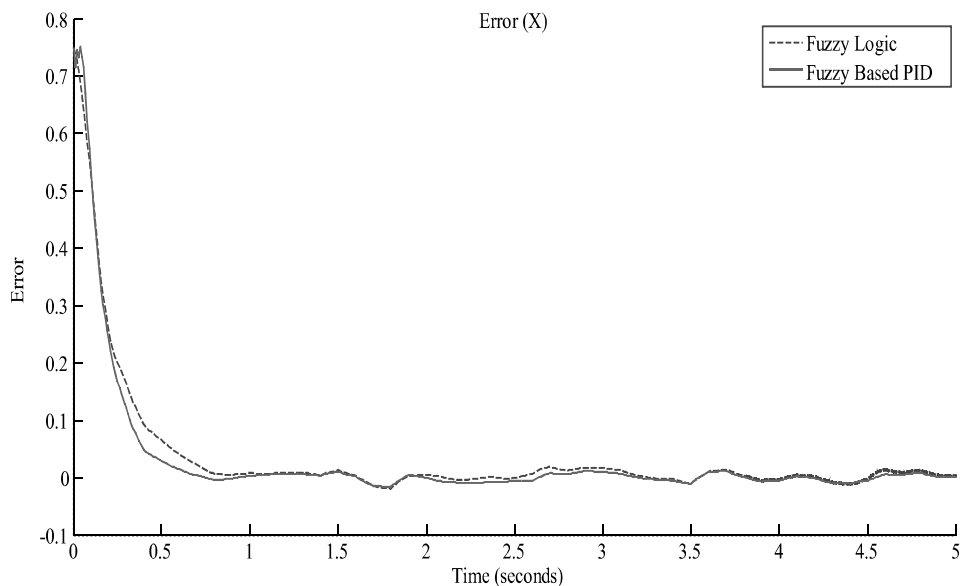

FIG. 10. ERROR PLOT OF "X" WITH FUZZY LOGIC COMPARATIVE WITH FUZZY BASED PID

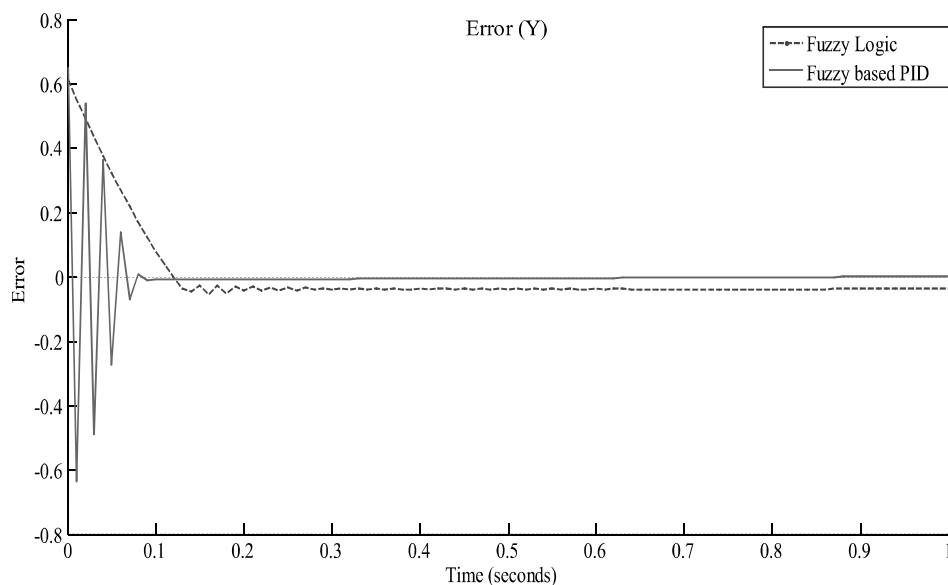

FIG. 11. ERROR PLOT OF "Y" WITH FUZZY LOGIC COMPARATIVE WITH FUZZY BASED PID

ACKNOWLEDGEMENT

For the valuable comments and suggestions author would like to thank the Anonymous Reviewers and Editorial Board, for upgrading the quality of the original manuscript.

REFERENCES

- [1] Chang, Y.C., and Chen, B.S., "Robust Tracking Designs for Both Holonomic and Nonholonomic Constrained Mechanical Systems: Adaptive Fuzzy Approach", IEEE Transactions on Fuzzy Systems, Volume 8, No. 1, pp. 46-66, 2000.

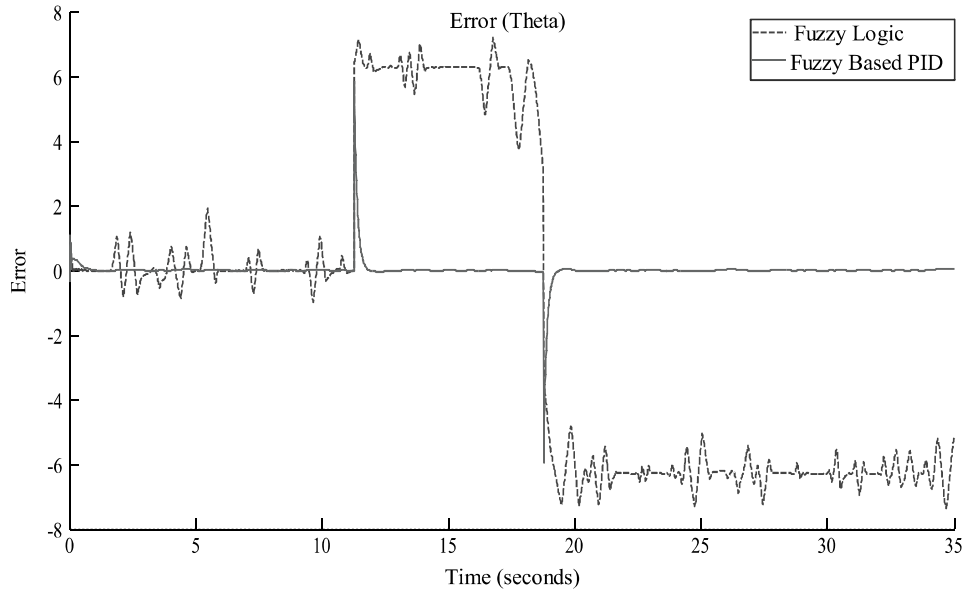

FIG. 12. ERROR PLOT OF "THETA" WITH FUZZY LOGIC COMPARATIVE WITH FUZZY BASED PID

- | | |
|--|---|
| <p>[2] Webster, R.J., Kim, J.S., Cowan, N.J., Chirikjian, G.S., and Okamura, A.M., "The International Journal of Robotics Research, Volume 25, No. 5-6, pp. 509-525, 2006.</p> <p>[3] Antonelli, G., Chiaverini, S., and Fusco, G., "A Fuzzy-Logic-Based Approach for Mobile Robot Path Tracking", IEEE Transactions on Fuzzy Systems, Volume 15, No. 2, pp. 211-221, 2007.</p> <p>[4] Cao, Z., Zhao, Y., and Wu, Q., "Adaptive Trajectory Tracking Control for a Nonholonomic Mobile Robot", Chinese Journal of Mechanical Engineering, Volume 24, No. 4, pp. 546, 2011.</p> <p>[5] Hou, Z.G., Zou, A.M., Cheng, L., and Tan, M., "Adaptive Control of an Electrically Driven Nonholonomic Mobile Robot via Backstepping and Fuzzy Approach", IEEE Transactions on Control Systems Technology, Volume 17, No. 4, pp. 803-815, 2009.</p> <p>[6] Khooban, M.H., "Design an Intelligent Proportional-Derivative (PD) Feedback Linearization Control for Nonholonomic-Wheeled Mobile Robot", Journal of Intelligent and Fuzzy Systems, Volume 26, No. 4, pp. 1833-1843, 2014.</p> | <p>[7] Xuan, H., and Zeng, W., "Design of Visual Feedback Tracking Algorithm for Nonholonomic Mobile Robots Based on Neural Network", 2013.</p> <p>[8] Wang, G., Wang, C., Song, X., and Du, Q., "Trajectory Tracking of Nonholonomic Mobile Robots via Discrete-Time Sliding Mode Controller Based on Uncalibrated Visual Servoing", Computational Intelligence, Networked Systems and Their Applications, pp. 342-350: Springer, 2014.</p> <p>[9] Aguiar, A.P., Atassi, A.N., and Pascoal, A.M., "Regulation of a Nonholonomic Dynamic Wheeled Mobile Robot with Parametric Modeling Uncertainty Using Lyapunov Functions", pp. 2995-3000.</p> <p>[10] Burgard, W., Moors, M., Fox, D., Simmons, R., and Thrun, S., "Collaborative Multi-Robot Exploration", pp. 476-481.</p> <p>[11] Yang, J.M., and Kim, J.H., "Sliding Mode Control for Trajectory Tracking of Nonholonomic Wheeled Mobile Robots", IEEE Transactions on Robotics and Automation, Volume 15, No. 3, pp. 578-587, 1999.</p> |
|--|---|

- [12] Jiangdagger, Z.P., and Nijmeijer, H., "Tracking Control of Mobile Robots: A Case Study in Backstepping", *Automatica*, Volume 33, No. 7, pp. 1393-1399, 1997.
- [13] Klanèar, G., and Škrjanc, I., "Tracking-Error Model-Based Predictive Control for Mobile Robots in Real Time", *Robotics and Autonomous Systems*, Volume 55, No. 6, pp. 460-469, 2007.
- [14] Fukao, T., Nakagawa, H., and Adachi, N., "Adaptive Tracking Control of a Nonholonomic Mobile Robot", *IEEE Transactions on Robotics and Automation*, Volume 16, No. 5, pp. 609-615, 2000.
- [15] Fierro, R., and Lewis, F.L., "Control of a Nonholonomic Mobile Robot Using Neural Networks", *IEEE Transactions on Neural Networks*, Volume 9, No. 4, pp. 589-600, 1998.
- [16] Fierro, R., and Lewis, F.L., "Control of a Nonholonomic Mobile Robot: Backstepping Kinematics into Dynamics", pp. 3805-3810.
- [17] Freund, E., and Mayr, R., "Nonlinear Path Control in Automated Vehicle Guidance", *IEEE Transactions on Robotics and Automation*, Volume 13, No. 1, pp. 49-60, 1997.