

An Evaluation of the Assessment of Graphical Education at Junior Cycle in the Irish System

Thomas Delahunty, Dr. Niall Seery and Dr. Raymond Lynch, University of Limerick

Abstract

Junior Certificate Technical Graphics was introduced in Ireland in 1991 and aimed to develop innovative problem solving aptitudes and knowledge of plane and descriptive geometry (NCCA 1991). Despite the philosophy of breadth and balance (NCCA 2004) associated with educational outcomes in the Junior Certificate curriculum, many subjects, Technical Graphics included, employ a summative assessment strategy (Griffin 1998). The summative measurement model portrays a limited view of student learning (Lin and Dwyer 2006, Williams 2011) and has been found to exert significant influence on teaching and learning throughout the course of study (Bloxham and Boyd 2007).

This research study aims to evaluate the types of approach to assessment of two different year groups at different stages of the Junior Cycle. The core hypothesis being investigated is whether there is a more sophisticated approach to the assessment evident among the older year groups. In order to achieve this aim a visual protocol similar to Middleton (2008) and Lane et al. (2010) was employed to capture the approach in solving a prescribed graphical task among first and second year students in the Technical Graphics classroom.

Findings indicate that the use of a traditional summative approach to assessment has significant limitations within the subject of Technical Graphics. There are also notable trends occurring in students' approach to the assessment, which seem to rely on a low level of graphical knowledge and problem solving skills.

The findings confirm that the older year group adopted a more efficient approach to the assessment but displayed unsophisticated approaches to the application of graphical principles. Some limitations of the summative measurement model are supported by the results of this paper.

Key words

graphical education, technical graphics, assessment, problem solving

Introduction

The research presented in this paper is concerned with examining the current performance indicators employed to validate students' attainment in Junior Certificate Technical Graphics. The primary objective of the study is to examine students' responses to assessment tasks when focusing on the dynamic application of graphical principles as opposed to a measure of representation. In order to achieve this, a review of the literature surrounding assessment of learning at Junior Cycle in Ireland was undertaken, which informed the method. The findings are then discussed in relation to the intended philosophy of Junior Certificate Technical Graphics.

Context

The Junior Certificate is a three-year course of study, which was introduced in 1989 and is taken by students in Ireland generally between 12 and 15 years of age. In 1991, the Junior Certificate Technical Graphics course replaced Mechanical Drawing, which was primarily focused on the development of skills relating to craft-focused outcomes. The Technical Graphics course introduced a broader conception of graphical education. The rationale underpinning Technical Graphics was to develop students' *creative imagination by encouraging pupils to reason in two and three-dimensions and by applying these abilities to the solution of graphical and spatial problems of an abstract and practical nature* (NCCA 1991). The development of these cognitive abilities aims to better develop students' ability to view their environment with a critical awareness. Freehand drawing is given distinct recognition in the syllabus's rationale as a key skill in communicating through the universal language of design and technology (NCCA 1991). Figure 1 illustrates a flow chart of the course content taken from the syllabus.

Despite the Junior Certificate course, having been introduced in 1989 it was not until 1991 that Technical Graphics was examined as Junior Certificate subject. Seery et al. (2010) discuss this offset of implementation and cite this along with a lack of professional development for practicing teachers as one of the core reasons for the prevalence of traditional practices resembling the delivery

An Evaluation of the Assessment of Graphical Education at Junior Cycle in the Irish System

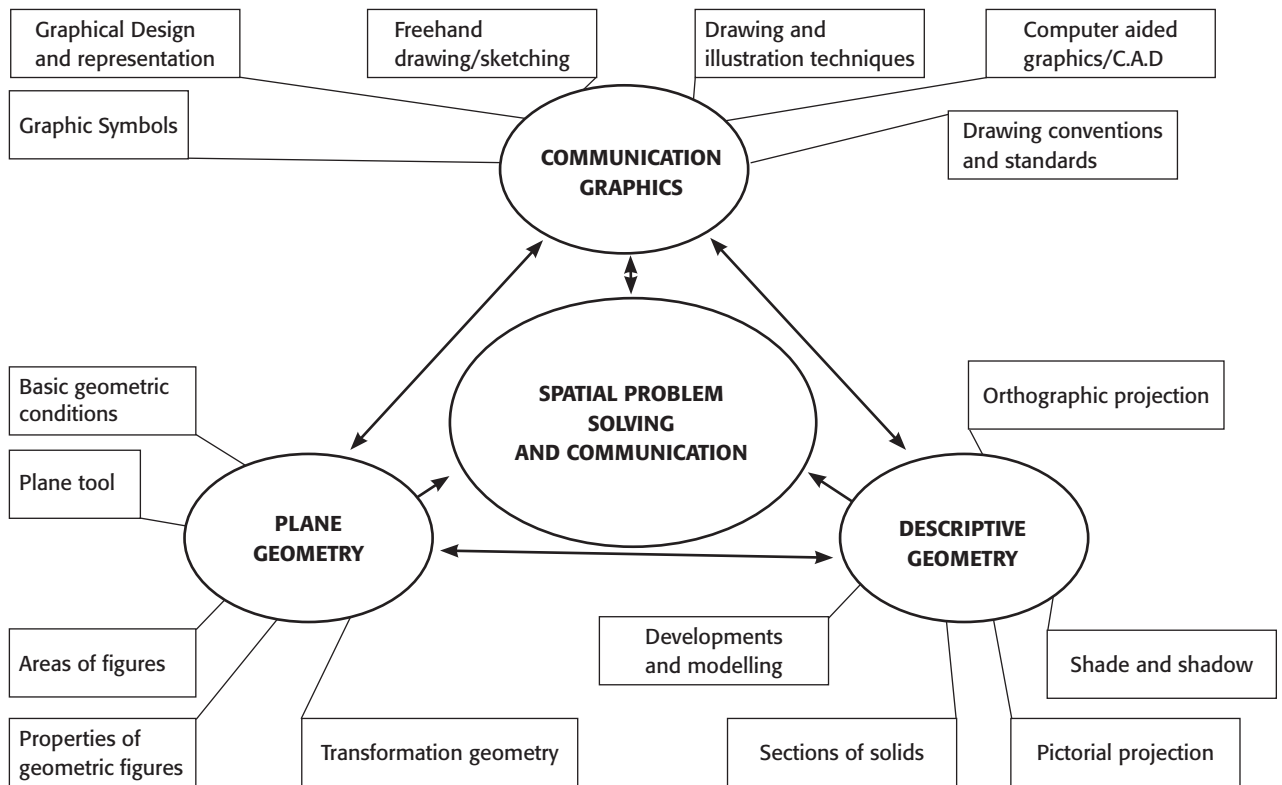

Figure 1: Flow Chart of Course Content (NCCA 1991)

of Mechanical Drawing. This offset implementation results in what Dakers (2005) describes as the 'hegemonic behaviourist cycle'. As this subject evolved directly from the vocational system much of the traditional vocational direction still remains (McGarr 2010).

Technical Graphics is assessed through a terminal summative assessment at the conclusion of the three-year

cycle. The assessment is a board drawing examination incorporating mechanical-based graphical tasks and elements of freehand sketching and is offered at higher and ordinary levels. Both examinations are presented in two sections. Section, A which incorporates short questions where students have the option to complete 10 out of 15 problems. Section B is based on longer abstract graphical activities, which are completed as full

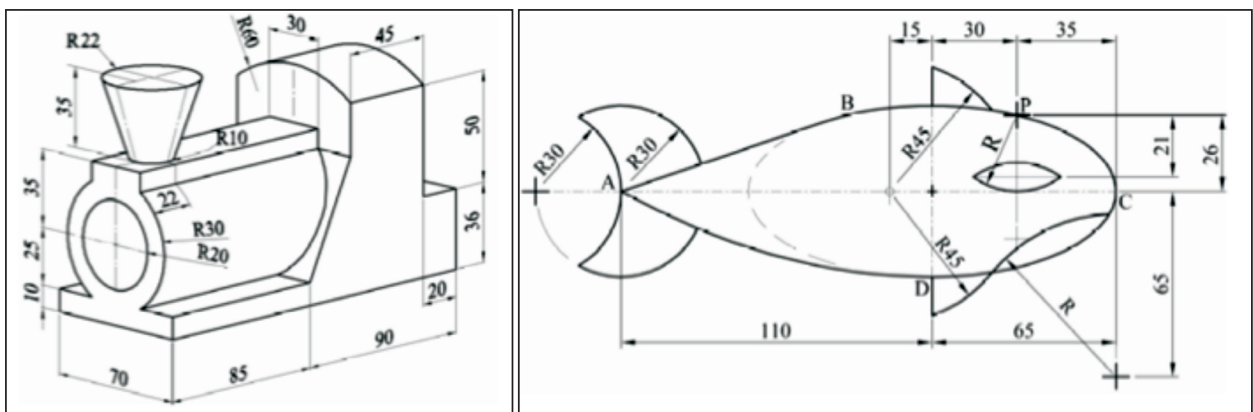

Figure 2: Orthographic and Ellipse/Parabola Problems from Section B of Higher Level Paper 2008

An Evaluation of the Assessment of Graphical Education at Junior Cycle in the Irish System

mechanical-based pencil drawings. The candidate must answer four out of a possible six questions during this section of the examination. A sample of these problems can be seen in figure 2.

Assessment at Junior Certificate Level

The original intention within the Junior Certificate curriculum was to employ a wide variety of assessment strategies to match the philosophy of delivering a broad and balanced educational experience (NCCA 2004). Despite this initial philosophy, the majority of subjects at Junior Certificate level are assessed predominantly by summative means of assessment for certification purposes (Griffin 1998). The (NCCA 2010) discusses the misalignment between assessment and learning at Junior Certificate level. This report claims that most students view the Junior Certificate as a 'practice run' for the Leaving Certificate examinations, which are taken by students at the end of their Second Level education. The results of these examinations are used to award places in Third Level courses. Subject choice at senior cycle is also shown to be one of the influences stemming from Junior Certificate examination performance. The most notable view presented in this document is that students see little relationship between the examination and the learning that occurs throughout the three years at Junior Certificate level.

The views of teachers were also presented by the NCCA (2010) and highlighted the belief that students who seem to do well in the current assessment format are those who are capable of memorising great quantities of facts and this influences the teaching style in many classrooms. The dominance of terminal written examinations is at odds with the principle of breadth and balance, and disenfranchises students whose strengths lie outside the formal written context and influences a style of pedagogy, which is narrow in focus with excessive emphasis on the product (NCCA 2004).

The Summative Model of Assessment

By now it is well established that the use of assessment for formative purposes has significant benefits to student learning (Biggs and Tang 2007, Bloxham and Boyd 2007, Black et al. 2002, Hattie 2012, Petty 2009).

The work by Black et al. (2002) provides extensive evidence of the benefits of assessment for learning and when implemented correctly in the educational setting can

achieve significant positive gains in learning performance (Hattie 2012). The research in this paper is concerned with the assessment of learning within graphical education and hence the literature review will remain focused on summative aspects.

Bloxham and Boyd (2007) discuss the influences that varying forms of assessment have on student learning, either surface or deep, and the approach they take. Most students only engage with the types of knowledge and illustrate the cognitive abilities that they perceive as critical in an examination setting (Scouller 1998). The strategy of teaching to the exam will ultimately impel students to engage with a surface approach to learning and the summative assessment model often influences this style of teaching (Rust 2002). Students who adopt a surface approach to learning focus on the memorisation of facts and procedures as opposed to understanding and applying concepts and principles (Bloxham & Boyd 2007). This surface approach acts as a barrier to lifelong learning and personal understanding (Entwistle 2000). This results in students having significant difficulty in applying what they have learned to new types of problems (Boud and Falchikov 2006). Engagement with a deep approach to learning is often associated with the higher levels of academic achievement (Entwistle, 2000) where the goal to construct meaning engages active learning processes and encourages reflection on one's own understanding (Entwistle, McCune and Walker 2000 cited in Entwistle 2000).

Another limitation of an entirely summative assessment methodology is the limited amount of learning styles that are catered for. Having one summative examination limits the success of a number of pupils given the wide range of diversity that exists within the modern classroom setting. Jordan (2010) states that not all the traits of schools or students can, or should be, measured by a simple pencil and paper examination. Being aware of our own learning styles and considering these different traits in course design will aid in achieving a fairer assessment model that caters for a wider variety of students (Sadowski et al. 2005).

The summative measurement model of assessment remains popular in many education systems today. Biggs and Tang (2007) present some convincing reasons for its

An Evaluation of the Assessment of Graphical Education at Junior Cycle in the Irish System

sustained popularity including bureaucratic convenience and tradition. In other words why question what has always seemed to work? Teaching convenience is also cited as a strong reason for the prevalence of summative assessment in educational contexts as it may be seen as expedient for some to teach to the exam (Biggs and Tang 2007).

Summary and Research Questions

The paper so far, has elaborated on the intended philosophy of the Junior Certificate curriculum in Ireland and presented some of the key arguments relating to summative assessment both within Junior Cycle and within broader educational contexts. The responses of students of Technical Graphics to the current measurement strategy employed for the subject is evident in many of the chief examiners' reports for the subject. A notable trend among all the reports is the popularity of the first question based on principles of orthographic projection in section B of the paper (see example in figure 2). This is normally the most popular of problems attempted by candidates (State Examinations Commission 2008). The problem in figure 2, which was from the 2008 Examination paper, was correctly drawn by most candidates but the majority of students had difficulty completing the elliptical curve in plan. The second most popular question from the paper tends to be the problem involving principles of the ellipse and parabola (State Examinations Commission 2008), which are treated as plane geometry. The 2008 question (figure 2) was well answered by most but there was a significant amount of guesswork evident in many candidates' solutions (State Examinations Commission 2008).

Despite the perceived shortcomings of assessment in the Junior Cycle curriculum (NCCA 2010), the graphical activities designed for evaluating student knowledge, in Technical Graphics, seem to focus on an authentic application of key principles. These include principles relating to plane and descriptive geometry and spatial problem solving.

On analysis of the Chief Examiners' report for the subject, the occurrence of a procedural response to the measurement system, in the solutions of many candidates becomes apparent. If this is the case, then there is a direct misalignment with the intended learning outcomes for Junior Certificate Technical Graphics, which aims to

promote creative problem solving and reasoning aptitudes. Previous research contends that traditional assessment strategies fail to assess true measures of the learning process and high order cognitive skills (Lane 2004, Lin and Dwyer 2006, Williams 2011). This contention informs the current research study where the aim is to ascertain the type of approach taken to typical graphical activities and by inference the type of learning.

The following research questions will guide this study:

- Are pupils' responses to national assessment instruments appropriate for the intent of that instrument?
- Does the response to the assessment strategy vary depending on the acquisition of more knowledge and skill? Will an older year group demonstrate a more sophisticated application of graphical principles and problem solving ability than a younger year group, when solving the same problem?

Method

The aim of the research work presented in this paper is to examine the approach that students, of Junior Certificate Technical Graphics, adopt in solving prescribed problems. The aim is to establish the type of knowledge (strategic, declarative, and procedural) that is predominant in student solutions for typical Junior Certificate graphical problems and to ascertain whether there is an increased sophistication or efficiency in approach among a more advance year group.

Approach

The research employs a qualitative and quantitative case study approach to examine students' problem solving process with a prescribed graphical problem adopted from the Junior Certificate Technical Graphics Syllabus. The objective of the problem was to elicit the capacity of Junior Cycle pupils to apply graphical principles. The study was conducted within a second level school in the south of the country. The graphical activity was administered within the Technical Graphics/Design and Communications Graphics classroom in the school. The class teachers graciously agreed to administer the activities and recording of solutions (with a webcam similar to Lane et al. 2010) throughout an entire week in the spring term of the school year. After the study was conducted, visual data from a sample of student solutions was collected as well as all hard copy results.

An Evaluation of the Assessment of Graphical Education at Junior Cycle in the Irish System

The visual data was analysed using a visual protocol similar to Middleton (2008) and (Lane et al. 2010). Middleton (2008) discusses the significance of pauses and changes in rate of problem solving when analysing visual data and suggested dividing the sample in tentiles (ten equal sections). The use of tentiles was deemed inappropriate for this study as most collected videos were in excess of 15 minutes and this would have resulted in tentiles, which exceed one minute in length. The concern here was that too much significant activity would occur in each tentile and the observer would therefore ignore a great deal of significant data. It was deemed appropriate to utilise ten second intervals to code the cognitive behaviour during observation.

The data was then coded in three distinct steps. Firstly, the active time was divided into two sections, pertinent activity relating to the completion of a solution and other activity that was deemed unrelated to the achievement of a solution. The second step involved breaking down and analysing the pertinent activity into a general approach, which was based on either exploration or mechanical drafting of a solution. The third step involved analysing the pertinent activity under the heading of application. Either this included the application of a graphics principle, such as the addition/subtraction of radii to locate centres for tangential arcs, or a procedural strategy concerned with achievement of a representational outcome. All three areas were graphed for visual representation and will be discussed in the findings section. In addition, a graph for strategic approach was produced for each student to observe the application of strategic knowledge to the prescribed problems.

As well as observing problem solving approaches, an alternative measurement strategy was implemented for comparison purposes. Student solutions were first graded in hard copy and then graded through observation of the visual data. Both grading sessions utilised a scale of professional judgement (ranging from 1-10) in order to efficiently and justly grade the work. The aim of this was to compare the performance evident from the current style of measurement mechanism employed in Junior Certificate Technical Graphics to a real-time performance.

Second Level Students

It was decided to administer the graphical problems to

Year One and Year Two pupils in the selected post-primary school. These pupils were selected as they have varying levels of experience with Technical Graphics activities and the completion of the proposed case study problem would fit into the schemes of work for the class groups' course of study. Both class groups had an equal amount of exposure to the subject content and prerequisite knowledge to be able to complete the graphical task required of them for this study.

The groups for this study were chosen as they have not entered the examination (3rd year) of the Junior Certificate course. At the time of this research study, the third years would have been involved in examination preparation and may have had a certain amount of conditioning influencing their approaches. This coupled with added personal pressure due to upcoming examinations made the third years an unsuitable year group for the purpose for this study.

Graphical Activity

In order to examine students' ability to apply graphical principles it was decided to base the problem on a typical Junior Certificate topic which students were known to have covered during the course of study to date. This would allow the researcher to observe the ability of students to apply graphical principles to a posed problem and to observe the strategic approach students adopted in formulating a solution. The topic that was selected was based on the principle of tangential arcs known as Circles in Contact within the Junior Certificate Technical Graphics Syllabus (NCCA 1991). The problem was adopted from O' Sullivan and O' Sullivan (2006) which is a popular Technical Graphics textbook at second level. The problem focused on the construction of a guitar (See figure 3).

Implementing the Graphical Activity

The activity (figure 3) was administered during the normal class periods for the first and second year groups over the period of one week in order to suit the teachers' schedules. The activities were administered online on the Technology Education Research Group website and allowed each student to have an individual log in for data collection purposes. The online problems were accompanied by a student workbook in which the activities were already set-up to allow students to engage fully with the problem solving process and not be concerned with the procedural work of setting up the

An Evaluation of the Assessment of Graphical Education at Junior Cycle in the Irish System

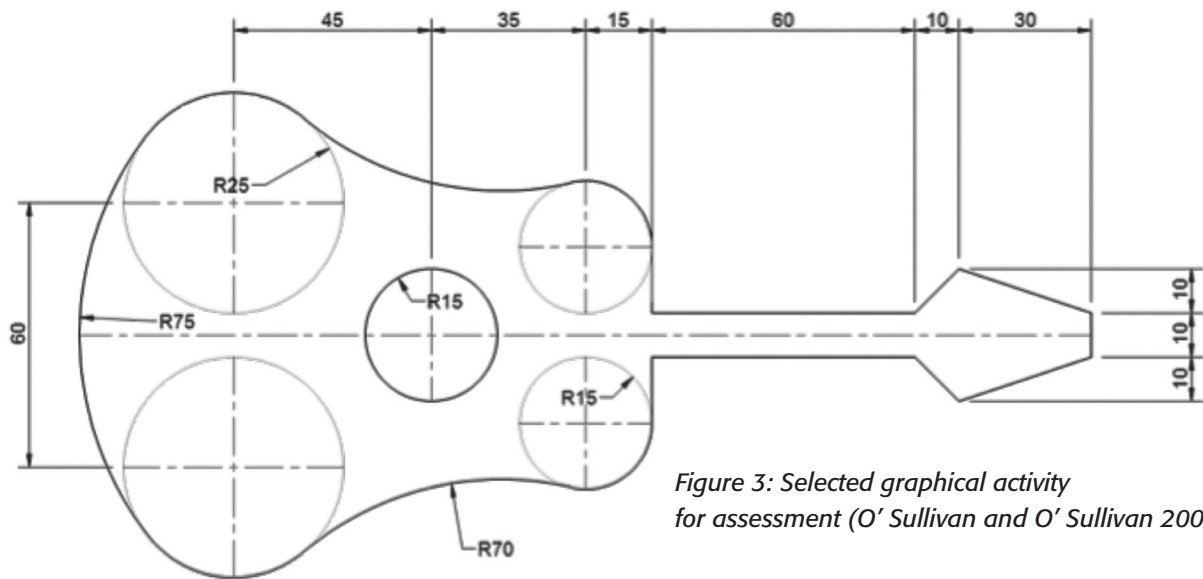

Figure 3: Selected graphical activity for assessment (O' Sullivan and O' Sullivan 2006)

question. The total number of Year One Pupils was 23, with 22 in Year Two.

Due to equipment constraints, it was only possible to utilise the visual protocol with six students from each group. In order to gain a broader picture of responses to the measurement mechanism across diverse ability levels, the class teacher selected the six students from each group to participate in the visual protocol. This ensured that the ethical considerations of the study were not breached and that a suitable range of candidates participated. These students' solutions were then uploaded to the Technology Education Research Group web portal (www.tech-ed.ie/moodle). The visual data for the entire week was available for observation on the Moodle website and all hard copy graphical solutions were collected for grading along with the visual observations.

Findings

This section presents the findings established from the observation of visual data recorded during the completion of the graphical activity and during the grading of student solutions utilising both measurement mechanisms.

Visual Observation of Student Solutions

The average time of each solution recorded for the first year group was 988 seconds (approximately 16.5 minutes) and 878 seconds (approximately 15 minutes) for the second year group. A significant portion of the time in each recording contained inactive or off-camera periods, which have been omitted for the purpose of this study.

The breakdown of the active time the first year students spent on the solution is presented in figure 4 as per the codification system outlined in the previous section. The analysis of second year data can be seen in figure 5. As can be seen in figure 4, the Year One pupils spent the majority of pertinent activity applying a procedural strategy to the completion of a solution and many did not display a correct understanding of the principles underpinning tangential circles. The Year Two spent a slightly higher percentage of pertinent activity applying principles (24%) and the majority of hard copy solutions observed would indicate a better understanding of the underlying principles. It is also notable that the Year Two pupils displayed less trivial activity (shuffling, tapping desk, playing with computer etc.) than the first year group which accounted for 30% of activity observed. The second year group spent 22% of activity observed on task engaging in trivial activity. The Year One pupils observed spent a higher percentage of the time actively exploring during their approach than the Year Two pupils, but did not produce as many correct solutions to the problem when hard copy solutions were observed.

The strategic approach evidenced by students from each group also varied. The first years applied a more sporadic approach alternating between working on elements of the body or handle of the guitar, which they were required to complete. It was believed that students would work on the body, which was the primary focus of the assessment based on principles of tangential arcs, first and then move onto the handle portion of the problem which was a

An Evaluation of the Assessment of Graphical Education at Junior Cycle in the Irish System

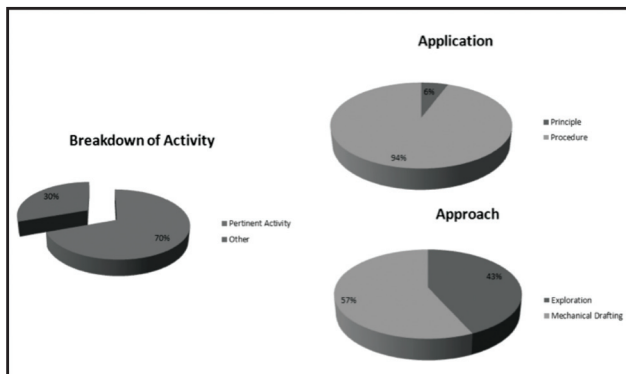

Figure 4: Analysis of First Years' Assessment Task

more procedural construction and not the core focus of the assessment. Of course, the opposite would also be a possible strategy where students would complete the handle portion initially and then progress to the body. Either way one would expect to see a uniform transition from the body to the handle of the guitar should the student have a robust strategy for solving the problem. Many of the second year students presented a clearer application of strategic knowledge in their solutions and the majority of hard copy solutions collected appeared to display the correct solution. Figure 6 presents examples of the strategic approach taken by both groups. For the purpose of clarity, only two students from each year group were selected.

As can be seen in figure 6, the first year students displayed a more erratic approach to solving the problem than the second year students. A clear trend is noticeable among the strategy employed by the second years that started with the body of the guitar, which contained the tangential arcs, and progressed to the handle, which was based on more procedural elements. The existence of this trend would indicate that the second years had a much clearer idea of how to engage with the problem posed compared with the overall approach observed with the first year students.

Notable Behaviour Observed

Throughout the observation of the visual data a number of incidences of notable behaviour occurred while students were engaging with the task. Frustration was a common behaviour noted throughout all activities and manifested itself in various ways. The most dominant form was the uncomfortable shuffling evident in many recorded

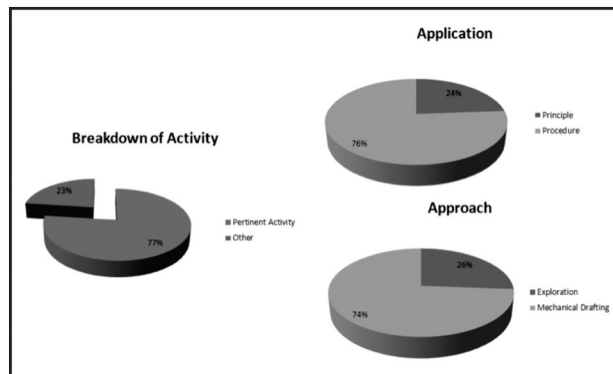

Figure 5: Analysis of Second Years' Assessment Task

solutions. The levels of frustration appeared to be higher in the first year students' recorded solutions.

First Year Participant 13

- 160: Aggressively tapping set-square on the desk
- 170: Begins turning the sheet and set-squares randomly around the desk
- 210: Aggressively banging his pencil off the worktop
- 270: Again resumes turning his worksheet around the desk
- 330: Resumes shuffling drawing instruments around the workspace in an aggressive manner

Frustration was also apparent in some of the second year processes of arriving at a solution even though the occurrences were of a lesser nature.

Second Year Participant 04

- 160: After a good deal of inactive and purposeless periods the student starts exploring the principle of adding radii for the arc constructions.
- 220: After taking a measurement on compass relating to the external tangential arc, the student stops the process and starts tapping the compass on the desk repeatedly

Another notable behaviour witnessed during the visual solutions was hesitation in committing to the problem and resorting to guesswork when it was clear the candidate did not understand the principle. Many of the first years began with long periods of inactivity or trivial activity and were then observed to try to fit a recalled procedure to an unfamiliar problem.

An Evaluation of the Assessment of Graphical Education at Junior Cycle in the Irish System

First Year Participant 03

- 250: Draws line at the top of his drawing sheet
- 260: Seems to be exploring some principle but cannot see how it is related to the guitar
- 440: After much inactivity resorts to taking random radii on his compass
- 580: Starts drawing a series of arcs using random centre points...appears as if the student is attempting to fit a curve that appears correct

Hesitation was also observed in the second year group where it was apparent that the student was having difficulty applying the principle of tangential arcs. There were a few instances of trivial activity witnessed among the second year solutions.

Second Year Participant 09

- 50/60: Has created two arcs outside the position of the internal arc. Why? Seems to be confused as to the principle required...
- 100: There is a great deal of inactive time initially but the activity that is occurring by this point is pertinent to the solution
- 180: Great deal of impertinent shuffling by the student and at 180 the student re-marks the centre of the middle (black) circle which was already given on the worksheet
- 220: It can be seen that the student is trying to recall

the procedure for drawing the internal arc. He has two points on the centre line and is unsure which the centre of the required arc is. By observing this instance and taking into account the fact that there are numerous inactive periods it may be possible that the student is attempting to recall procedure but having difficulty.

240: Again re-marks the centre point of the circle.

340: Scribes a set of arcs for the required centre point of one of the external arcs but it is unclear where the radius for these arcs has come from. Possible guess work?

Erratic behaviour was also indicative of this hesitancy. A prime example of this occurred during the activity. First year participant 12 ceased all work at 740 seconds into the activity and wrote his name in the box provided in the sheet. This incident was, as would be expected, preceded by much behaviour indicating uncertainty with the problem posed.

First Year Participant 12

- 120: Begins by joining centres of given circles...possibly exploring principle of tangent line to a circle
- 200: Draws a random line at the bottom of the worksheet
- 480: Takes measurement related to the radius of the large circle on the guitar body

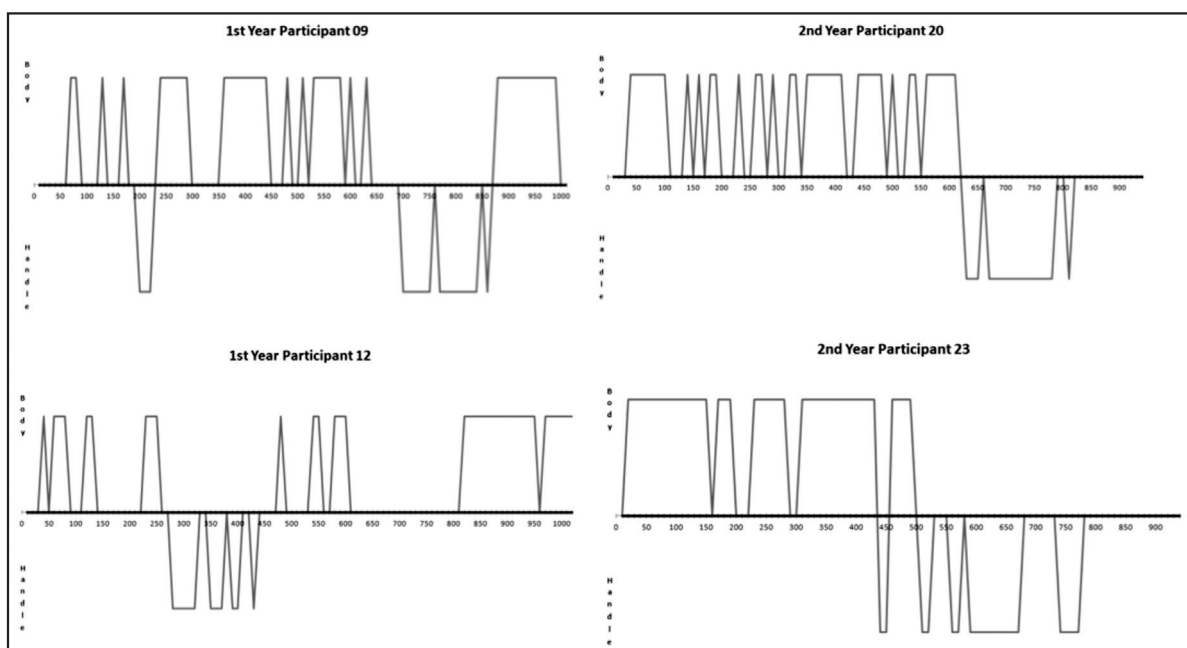

Figure 6: Sample of Strategic Approaches from Both Year Groups

An Evaluation of the Assessment of Graphical Education at Junior Cycle in the Irish System

740: After a long period of inactivity, student writes his name in the space provided at the bottom right of the sheet

First year participant 13 began using his compass, for the first time, at 750 seconds into the problem indicating high levels of hesitation and further erratic activity.

First Year Participant 13

560: Starts joining the centres of all circles...possibly a tangential line to circle?

750: Takes out his compass for the first time during the activity

This is a fascinating incident of behaviour as the graphical problem posed to the students was predominantly based on tangential arcs, which had to be mechanically constructed with a compass.

Performance in the Measurement Mechanisms

In order to evaluate the traditional measurement methodology currently employed as the principle form of assessment at Junior Certificate level, an alternative strategy was used for comparison, which was achieved using the visual data. The students' hard copy solutions were graded using a scale of professional judgement. The results of the traditional summative grading process can be seen in figures 7 and 8. The highlighted columns indicate pupils who took part in the visual protocol and alternative assessment strategy.

There is a notable difference in performance scores when the visual recordings, for the six pupils in each group are analysed. Figures 9 and 10 illustrate a comparison between performances in the two

measurement strategies. Students were generally deducted marks for applying principles incorrectly and for obvious guesswork. The incorrect application of principles was much more evident in the visual recordings than in the hard copy solution alone. Participant 09 in the first year group was awarded 90% (an A grade) with the traditional measurement strategy but was demoted by the alternative strategy. It was clear that the student did not understand the principles of tangential arcs and opted to employ a guesswork strategy. The alternative measurement strategy provided a much clearer measure of the students' capability.

Discussion

There is a strong contention that the summative model of assessment does not portray an accurate account of student learning (Lane 2004, Lin and Dwyer 2006, Williams 2011). The discrepancy in performance scores (figures 9 and 10) recorded in this study certainly confirm this contention for this particular educational context. The alternative strategy of assessment of learning in this study captured a truer measure of students' graphical capability and highlighted a significant focus on procedural approaches during the problem solving process. This finding is at odds with the intended outcomes of the Junior Certificate Technical Graphics syllabus, which aims to promote creative problem solving (NCCA 1991). The traditional strategy of assessment alone portrays an obscured view of student learning where it seemed that students achieved a high level of learning relating to the principles of tangential arcs. The poor application of principles and the sporadic approach noted among the two year groups seems to somewhat

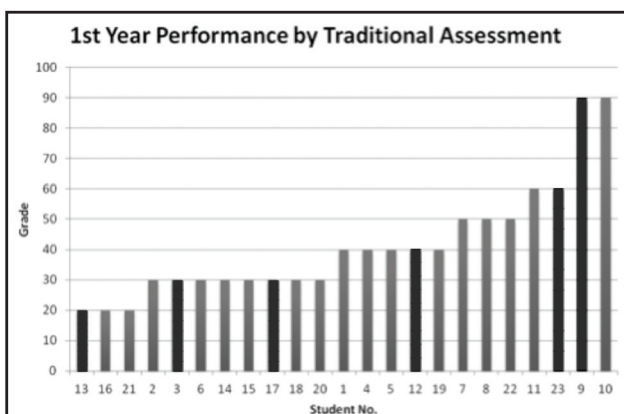

Figure 7: Results of Traditional Assessment Process (1st Years)

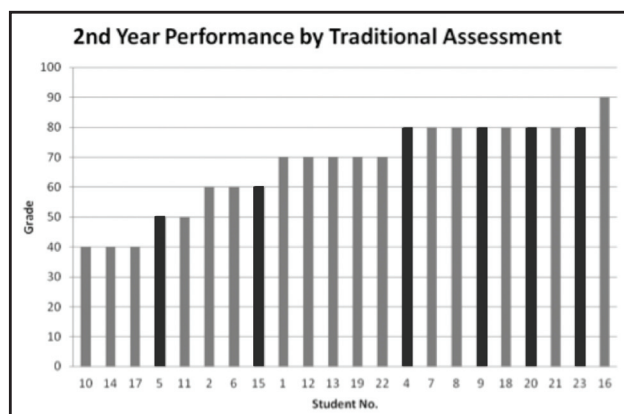

Figure 8: Results of the Traditional Assessment Process (2nd Years)

An Evaluation of the Assessment of Graphical Education at Junior Cycle in the Irish System

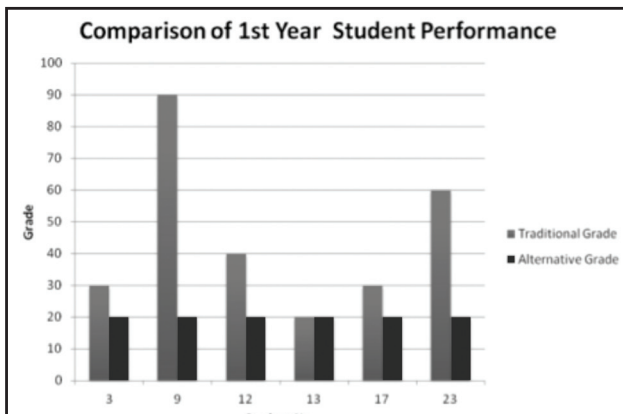

Figure 9: First Year Performances in Measurement Mechanisms

confirm some of the trends, relating to guesswork, occurring in the Chief Examiners' report for the subject (State Examinations Commission 2008). The most dominant type of knowledge observed among the two class groups was procedural in nature. One of the core aims of the study was to observe the sophistication of response to the assessment strategy and the findings illustrate more of efficiency in exam strategy than in problem solving sophistication. Students were seen to attempt to fit a recalled procedure to the problem and when this could not be accomplished, the solution was based on guesswork. The strategic approach displayed by the first years was erratic in nature and it was clear that the problem solving approach of these students was quite weak. On the other hand, the second year students had a stronger application of strategic knowledge indicating a more focused approach. Despite this more efficient approach, the application of graphical principles, in general, was quite unsophisticated. When students did not understand the problem, they resorted to completing an answer that appeared correct for this purposes of measurement. The problem in this study was administered under typical summative conditions and was convergent in nature. Convergent assessment typically aims to ascertain if a student knows or can do a predetermined thing (Torrance and Pryor 2001) and what was determined in this study is that second year students were more efficient in converging on a method of completing the measurement task disregarding the application of graphical principles. The original expectation would be for more sophisticated application of graphical principles among the second years but the findings simply

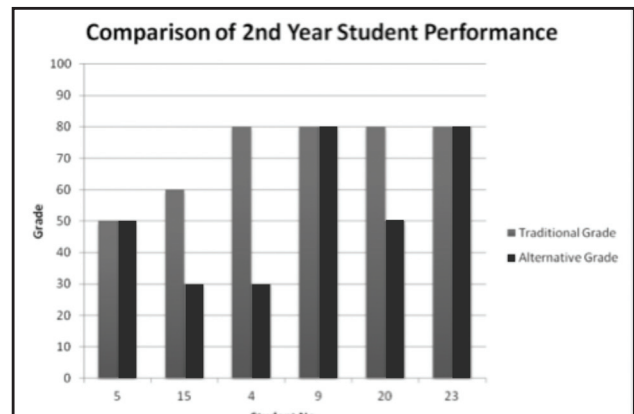

Figure 10: Second Year Performances in Measurement Mechanisms

illustrate a more efficient exam strategy, where the focus was not on application of graphical knowledge but on achievement of correct looking solutions. The higher levels of exploration observed in the first year solutions may indicate a group that are not as conditioned to examination conditions.

Bloxham and Boyd (2007) and Lin and Dwyer (2006) state that many teachers teach to the summative examination and the type of convergence evident here may be indicative of this trend. What is clear from observing the visual recordings is that students did not understand why they were utilising that particular method to attain the solution. Participant 20 from the second year class group was a clear example as he took four attempts to achieve the correct position for the arc centres and was quite clearly utilising a procedural method. This student could recall the method but showed no evidence of comprehension.

Conclusion

This study proposed to answer a number of research questions relating to assessment of learning in Junior Certificate Technical Graphics. The findings indicate that the level of problem solving performance displayed by the two year groups was in general poor. This was indicated by the erratic approach evident in many of the strategic graphs (figure 6) and the poor application of graphical principles observed during the visual analysis of data. The original intention of the Technical Graphics syllabus was to develop creative problem solving aptitudes and knowledge of plane and descriptive geometry. These

An Evaluation of the Assessment of Graphical Education at Junior Cycle in the Irish System

learning outcomes are measured by a terminal summative examination. As the findings in this study suggest, the approach taken to the assessment instrument misaligns with the intent of the instrument. Arriving at an end solution appears to be the objective, with the process and application of knowledge incidental.

The differences in approaches to the measurement task between the two year groups are noteworthy and may be indicative of a conditioning culture in the teaching and learning of this subject. Aligning with the intended learning outcomes and philosophy of the Technical Graphics Syllabus, one would expect the second year group to display a more sophisticated or efficient problem solving approach. However, the findings indicate that the second years were simply capable of converging on representational outcome devoid of meaning. There is evidence in the current findings relating to the measurement capacity of the traditional strategy (see figures 9 and 10) that may indicate a lack of what Biggs and Tang (2007) coined 'constructive alignment' between the intended course outcomes and the way in which pupils' behaviour in response to the measurement strategies. The empirical evidence presented in this study highlights an issue regarding pupils' responses to the measurement model currently employed within the system. The responses observed completely neglected the application of graphical principles and opted for a solution that appeared correct in the context of the measurement task prescribed. This misalignment may present significant misconceptions in relation to the purpose, definition and ultimately the value of graphical education.

References

- Biggs, J. and Tang, C. (2007) *Teaching for Quality Learning at University*, 3rd ed., Berkshire: McGraw-Hill.
- Black, P., Harrison, C., Lee, C., Marshall, B. and William, D. (2002) *Working inside the black box*, London, UK: King's College London Department of Education and Professional Studies.
- Bloxham, S. and Boyd, P. (2007) *Developing Effective Assessment in Higher Education*, Birkshire: Open University Press.
- Boud, D. and Falchikov, N. (2006) 'Aligning Assessment with Long Term Learning', *Assessment and Evaluation in Higher Education*, 31(4), 399-413.
- Commission, S. E. (2008) *Technical Graphics Chief Examiners Report: Higher and Ordinary Levels*, Available at http://www.examinations.ie/archive/examiners_reports/cer_2008/JC_Technical_Graphics_2008.pdf
- Dakers, J. R. (2005) 'The Hegemonic Behaviorist Cycle', *International Journal of Technology and Design Education*, 15(2), 111-126.
- Entwistle, N. J. (2000) 'Promoting deep learning through teaching and assessment: conceptual frameworks and educational contexts', in *Teaching and Learning Research Paper Conference*, Leicester, England, November 2000,
- Griffin, R. (1998) 'The junior certificate assessment system: Assessment incorporating the theory of multiple intelligences with particular reference to "civic, social and political education"', *Irish Educational Studies*, 17(1), 175-182.
- Hattie, J. (2012) *Visible Learning for Teachers: Maximizing Impact on Learning*, UK: Routledge.
- Jordan, W. J. (2010) 'Defining Equity: Multiple Perspectives to Analysing the Performance of Diverse Learners', *Review of Research in Education*, 34(142), 142-178.
- Lane, D., Seery, N. and Gordon, S. (2010) 'Examining sketching ability within initial technology teacher education' in Norman, E. and Seery, N., eds., *Graphicacy and Modelling*, Loughborough: UK.
- McGarr, O. (2010) 'Education for sustainable development in technology education in Irish Schools: a curriculum analysis', *International Journal of Technology and Design Education*, 20(3), 230-241.
- Middleton, H. (2008) 'Examining Design Thinking: Visual and Verbal Protocol Analysis' in Middleton, H., ed. *Researching Technology Education: Methods and Techniques*, Netherlands: Sense.

An Evaluation of the Assessment of Graphical Education at Junior Cycle in the Irish System

NCCA (1991) *Junior Certificate Technical Graphics Syllabus*, Dublin: Department of Education and Science

NCCA (2004) *Update on the Junior Cycle Review*, Dublin: Department of Education and Science.

NCCA (2010) *Innovation and Identity: Ideas for a New Junior Cycle*, Dublin: Department of Education and Science.

Petty, G. (2009) *Teaching Today: A Practical Guide*, Cheltenham: Nelson Thornes Limited.

Rust, C. (2002) 'The Impact of Assessment on Student Learning', *Active Learning in Higher Education*, 3(2), 145-158.

Sadowski, M., Birchman, J. and Harris, L. V. (2005) 'An Assessment of Graphics Faculty and Student Learning Styles', in *ASEE Annual Conference and Exposition*, Portland, Oregon, June 12-15,

Scouller, K. (1998) 'The Influence of Assessment Method on Students' Learning Approaches: Multiple Choice Question Examination versus Assignment Essay', *Higher Education*, 35(4), 453-472.

Seery, N., Lynch, R. and Dunbar, R. (2010) 'A review of the nature, provision and progression of graphical education in Ireland' in Norman, E. and Seery, N., eds., *Graphicacy and Modelling*, Loughborough: UK Available: <http://hdl.handle.net/2134/9051>.

Sullivan, J. O. and Sullivan, T. O. (2006) *Understanding Technical Graphics*, Dublin: Gill and Macmillan.

Torrance, H. and Pryor, J. (2001) 'Developing Formative Assessment in the Classroom: using action research to explore and modify theory', *British Educational Research Journal*, 27(5), 615-631.