

# HIGH PERFORMANCE ELECTRICALLY EXPLODED FOIL OPENING SWITCHES

J.C. Bueck and R.E. Reinovsky

Air Force Weapons Laboratory  
Kirtland AFB, NM 87117-6008

## Abstract

Electrically exploded foil fuses have been employed as high energy opening switches for several years (Ref 1,2). As stored energies evolve into the tens of megajoules and currents rise to near one hundred megamperes, small improvements in fuse performance could have significant effects on the amount of energy transferred to a load. In this paper we examine changes in the parameters of aluminum fuses that produce improved fuse performance when operated without a load. The factors of fuse thickness and fuse quench are seen to affect fuse performance as well as alteration of the fuse mass, length, and width. Those fuses that performed the "best" were examined and their results analyzed in both the time domain and the specific energy domain.

## Introduction

Opening switch technology is one of the key issues in the effective use of inductive energy storage. One opening switch that has been successfully operated in very high energy environments is the electrically exploded foil fuse. Thin foil fuses have been used for several years at the Air Force Weapons Laboratory's SHIVA-STAR fast capacitor bank (Ref 1,2). They have successfully interrupted tens of megamperes and held off inductive overvoltages of hundreds of kilovolts. The behavior of foil fuses is dependent on the circuit in which they are used. In the case of inductive energy storage and transfer where the load is primarily a fixed inductance, the fuse must absorb at least 50 percent of the available energy (Ref 3). Foil fuses require a significant amount of energy to vaporize the metal conductor and, therefore, have an intrinsic mechanism to absorb the energy inevitably lost in the switching of inductive circuits. The foil fuses discussed here are being developed for use with an imploding load that is both inductive and resistive. The optimization characteristics of such a fuse are, therefore, not obvious and must be discovered by computer simulation or experimentation. Simulation is the least expensive and most rapid optimization method but requires a good model of the nonlinear fuse impedance.

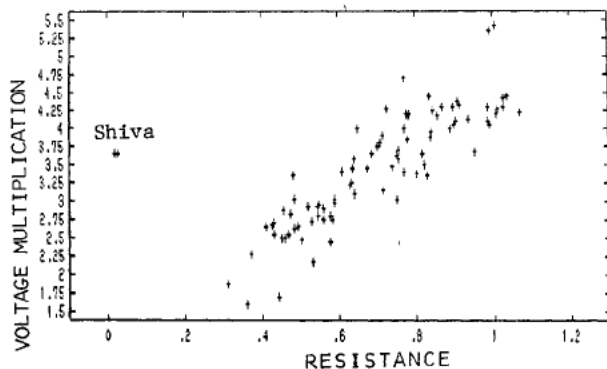

Figure 1

In fuse models used to date at the Air Force Weapons Laboratory experimental fuse data in the form of the resistivity vs the specific energy of the fuse has been the primary simulation tool. One of the purposes of this experiment was to improve the model by providing more complete and accurate data about the specific energy characteristics of the various fuse combinations.

Conceptually, a fuse consists of two elements. The first element is the foil conductor which may be divided into many separate strips, adjusted in width or length, configured for low inductance, varied in thickness, and varied with fuse material used. The second element is the medium surrounding the fuse, which may be free atmosphere, a granular quench, deionized water, or some other quench whose purpose includes suppressing the arc as the fuse explodes. For the purpose of this experiment the cross section was held within a small variation while the length was allowed to vary depending upon the fuse configuration for those fuses that were tested at room temperatures.

The data base for this study is comprised of more than 100 successful (where useable data was collected) experiments in which fuse and quench parameters were varied. Figure 1 is a scattergram showing many of these experiments in terms of the voltage multiplication which is the ratio of maximum voltage across the fuse to the initial charge voltage. Voltage multiplication is related to pulse compression (Ref 4) and, therefore, to the performance of a fuse as a current interruptor. This report will deal with high performance fuses which are those fuses in the upper several percent of voltage multiplication.

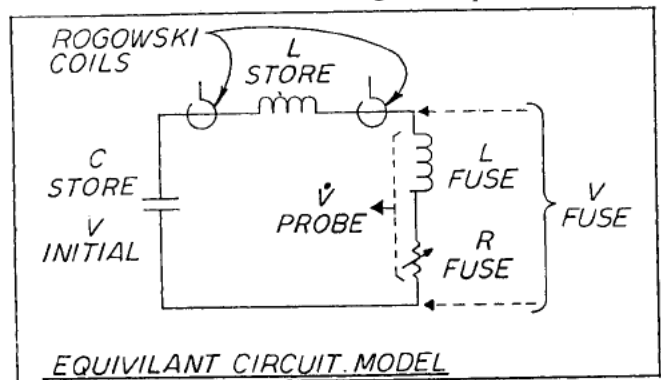

Figure 2 Test Circuit

## The Experiment

Figure 2 shows the circuit model used to test the fuses. The 36.25 microfarad capacitors provided over 36 kilojoules of energy with the 300 nanohenry inductive store providing the bulk of the system inductance. Current data was recorded using Rogowski coils and voltage data was acquired using a capacitive V-dot probe whose output was passively integrated. The data recording system was a Tektronix digitizing system which allowed quick processing and display of resistivity and other related fuse performance data.

## Report Documentation Page

*Form Approved*  
*OMB No. 0704-0188*

Public reporting burden for the collection of information is estimated to average 1 hour per response, including the time for reviewing instructions, searching existing data sources, gathering and maintaining the data needed, and completing and reviewing the collection of information. Send comments regarding this burden estimate or any other aspect of this collection of information, including suggestions for reducing this burden, to Washington Headquarters Services, Directorate for Information Operations and Reports, 1215 Jefferson Davis Highway, Suite 1204, Arlington VA 22202-4302. Respondents should be aware that notwithstanding any other provision of law, no person shall be subject to a penalty for failing to comply with a collection of information if it does not display a currently valid OMB control number.

1. REPORT DATE <b>JUN 1985</b>	2. REPORT TYPE <b>N/A</b>	3. DATES COVERED <b>-</b>			
4. TITLE AND SUBTITLE <b>High Performance Electrically Exploded Foil Opening Switches</b>		5a. CONTRACT NUMBER			
		5b. GRANT NUMBER			
		5c. PROGRAM ELEMENT NUMBER			
6. AUTHOR(S)		5d. PROJECT NUMBER			
		5e. TASK NUMBER			
		5f. WORK UNIT NUMBER			
7. PERFORMING ORGANIZATION NAME(S) AND ADDRESS(ES) <b>Air Force Weapons Laboratory Kirtland AFB, NM 87117-6008</b>		8. PERFORMING ORGANIZATION REPORT NUMBER			
9. SPONSORING/MONITORING AGENCY NAME(S) AND ADDRESS(ES)		10. SPONSOR/MONITOR'S ACRONYM(S)			
		11. SPONSOR/MONITOR'S REPORT NUMBER(S)			
12. DISTRIBUTION/AVAILABILITY STATEMENT <b>Approved for public release, distribution unlimited</b>					
13. SUPPLEMENTARY NOTES <b>See also ADM002371. 2013 IEEE Pulsed Power Conference, Digest of Technical Papers 1976-2013, and Abstracts of the 2013 IEEE International Conference on Plasma Science. Held in San Francisco, CA on 16-21 June 2013. U.S. Government or Federal Purpose Rights License</b>					
14. ABSTRACT <b>Electrically exploded foil fuses have been employed as high energy opening switches for several years (Ref 1,2). As stored energies evolve into the tens of megajoules and currents rise to near one hundred megamperes, small improvements in fuse performance could have significant effects on the amount of energy transferred to a load. In this paper we examine changes in the parameters of aluminum fuses that produce improved fuse performance when operated without a load. The factors of fuse thickness and fuse quench are seen to affect fuse performance as well as alteration of the fuse mass, length, and width. Those fuses that performed the "best" were examined and their results analyzed in both the time domain and the specific energy domain.</b>					
15. SUBJECT TERMS					
16. SECURITY CLASSIFICATION OF:			17. LIMITATION OF ABSTRACT	18. NUMBER OF PAGES	19a. NAME OF RESPONSIBLE PERSON
a REPORT <b>unclassified</b>	b ABSTRACT <b>unclassified</b>	c THIS PAGE <b>unclassified</b>	<b>SAR</b>	<b>4</b>	

The fuse was sized so as to produce a voltage maximum at about eight tenths of the quarter period when exploded in BT-12 glass beads. This fuse geometry was the same as in previous experiments (ref 7) to allow comparisons with previously acquired data. Figure 3 shows the fuse geometry when mounted and typical fuse dimensions. The quench was placed in a mylar envelope surrounding the fuse so that at least several millimeters of quench totally surrounded the active portion of the fuse. The fuse was banded as shown in Figure 3 to allow the effective portion of the fuse to be totally surrounded by quench and to reduce field enhancement effects found at attachment points to the fuse. After the experiment the banded sections of the fuse were found to be intact and suffered little heating during the experiment.

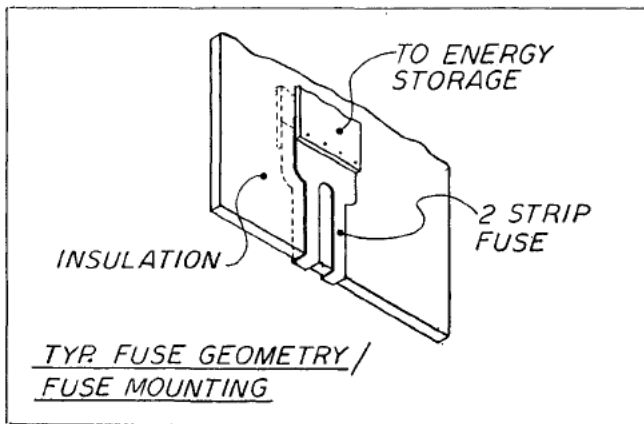

Figure 3 Fuse Construction

The data was processed by using a self consistent, single loop circuit model described by Eq (1) and shown in Figure 2. I-dot and voltage diagnostics were repeatedly calibrated using an RLC ringing circuit for current probes and a calibrated pulse generator for voltage probes. Small differences in assembly of a particular experiment can result in minor changes in probe sensitivity. Since details of fuse performance are the essence of these experiments, calibrations were further refined by invoking energy conservation and Kierchoff's circuit laws assuming time independence of the known circuit elements and allowing small scale factor changes around the calibrated values of the voltage and current data. The small scale factor changes were iteratively accomplished until the voltage demanded by the known circuit elements and the voltage measured at the fuse were in close agreement. While perfect agreement was generally not possible, close agreement at the peak values and over the initial several microseconds was routinely achieved. To correct the measured voltage for the inductive drop, the fuse inductance (Lf) is computed by the inductive division at t=0+ using the self consistently calibrated voltage. To verify the analysis process, small, arbitrary changes were made to both the voltage and current data. The calibration consistently removed the artificial perturbations and returned the original data.

$$V_f = -L_o \left( \frac{dI}{dt} \right) - \frac{1}{C} \int I dt - R I + V_o \quad (1)$$

### Results

For aluminum fuses at room temperature, thickness and the nature of the quench media represent the primary parameters readily accessible to change. We may then discuss this set of experiments in three categories. First there are one mil thick fuses in granular quenches. Next there are one third mil fuses in granular quenches, and finally there are one third

mil fuses in deionized water. The granular quenches used for the high performance fuses can be considered as silica based (either high purity quartz or soda-lime glass) granules typically less than 50 microns in diameter but generally greater than 10 micrometers. Quenches finer than ten micrometers have been tested but the powdery consistency of the quench degrades the performance of the fuse unless the quench is compressed (Ref 5).

RESISTIVITY VS SPECIFIC ENERGY

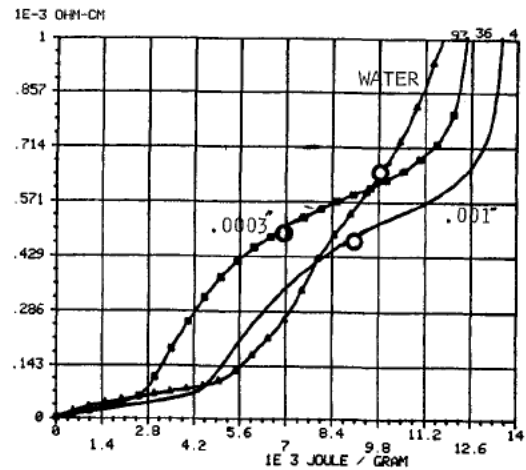

Figure 4 Three Classes of Fuse Experiments

One of the models useful in circuit simulation codes involving fuse elements is the resistivity vs specific energy relationship. Figure 4 shows representative resistivity curves for each of the three general groups displayed as a function of specific energy (actually change in specific energy). There are clearly differences in the appearance of these curves. The energy corresponding to the occurrence of peak voltage at the fuse is marked on Figure 4 for each of the experimental curves.

Other differences in the performance of the three sets of experiments can be shown by examining the voltage, current, and resistivity plots. Figures 5, 6, and 7 show the voltage, current and resistivity data as a function of time. A first examination of Figure 5 shows an obvious timing difference between the one mil fuse and the one third mil fuses of the same cross-section in either granular or water quenches. Part of this difference can be attributed to the difference in the circuit caused by the much larger inductance of the narrower one mil fuse. As seen in Figure 6, the differences in the initial slope where the fuse is of negligible resistance shows that the inductance of the one mil fuse is greater than that of the one third mil fuses since the system

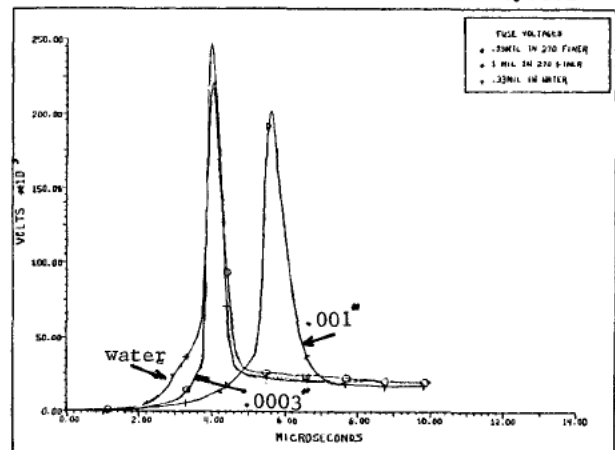

Figure 5 Voltage Data for Thin, Thick and Water Quenched Fuses

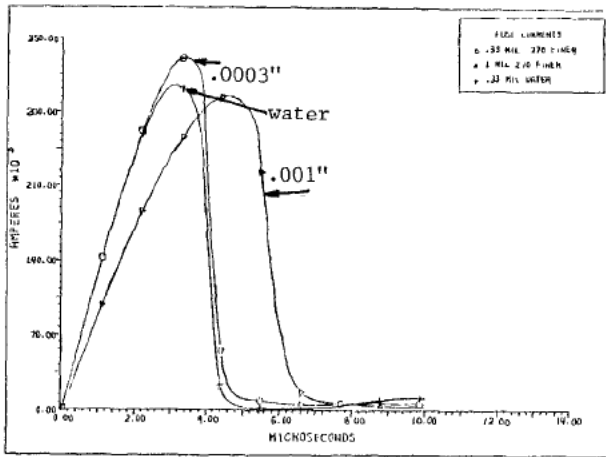

Figure 6 Current Data for Thin, Thick and Water Quenched Fuses

inductance did not change. This inductance change is due primarily to the three fold increase in fuse package width using the thin fuse which reduces the inductance of the fuse. With respect to the quarter period of the circuit, however, the one mill fuse is found to open later than the one third mil fuses.

Returning to Figure 5, one can detect a difference in the early voltage rise for each of the shots. The deionized water bath is seen to have an early and rather constant slope to the point where the very rapid rise to peak voltage occurs. The other one third mil fuse displays a much more abrupt transition from its very low voltage to the steep rise to peak voltage. The one mil fuse shows a transition somewhere between the other two as far as shape and duration of the initial rising voltage are concerned. The effects of the early resistance rise on the third mil water quenched fuse are easily seen in Figure 6. Here the current traces of both the one third mil fuses are identical until near the peak value. The early resistance rise (which is seen as a voltage rise) leads to a reduction in the peak value of the current. This reduction is seen as a 15 percent reduction in the maximum energy stored in the external inductor while at the time of voltage maximum, there is a 50 percent reduction in the energy stored in the inductor. Figure 7 displays the resistivity of the fuses. The early rise of the water quenched fuse is

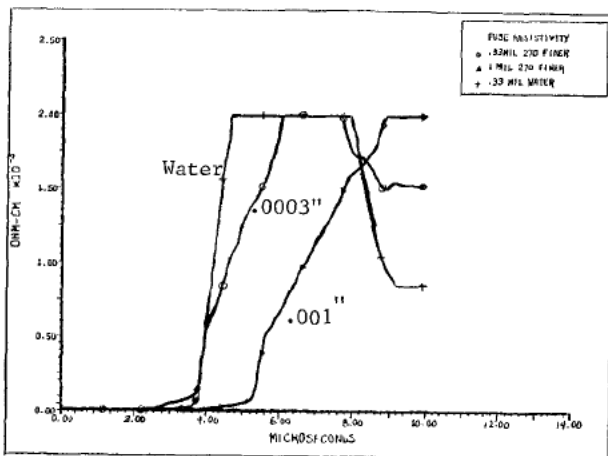

Figure 7 Resistance Data for Thin, Thick and Water Quenched Fuses

clearly shown. The step like change in the one third mil granular quenched fuse compares to the less dramatic change in the 1 mil granular quenched fuse. Fuse resistivities are cutoff at 2000 micro-ohm-cm to preserve detail.

TABLE 1  
EXPERIMENTAL FUSE LIST

SHOT NUMBER	NAME
04	1 MIL FUSE IN 270 FINER
05	1 MIL FUSE IN #16 GLASS BEADS
21	1 MIL FUSE IN 170-325 GLASS BEADS
23	1 MIL FUSE IN SILICA FLOUR
36	.33 MIL FUSE 3 STRIP 10IN WIDE
44	.33MIL FUSE 3 STRIP 10 IN WIDE
45	.33MIL FUSE S STRIP 13 IN WIDE
46	.33MIL FUSE 2 STACK TOTAL 10IN WIDE
72	1 MIL FUSE IN 280 NOVACULITE
75	1 MIL FUSE IN DAPER NOVACULITE
92	.33MIL FUSE IN H2O #92)
93	.33MIL FUSE IN H2O #93
95	.33MIL FUSE (24X30)
96	.33MIL (30X30)
97	.33MIL 3 STACK (9X30) 27 WIDE TOTAL

Next we turn our attention to other variations of fuse configuration. Table I describes and identifies by shot number 15 different experiments which are compared in Figures 8-10. Figure 8 shows three one third mil fuses each 40 cm long along with three other fuses also 40 cm long which were among the poorest fuse performers observed during this series of experiments. The poorly performing fuses are characterized by low voltage peaks and resistivities that are relatively slow to change and do not reach high values. They are included to give the reader an opportunity to observe the wide variation in the resistivity vs specific energy behavior for some special cases of fuse configuration which are not pursued in other analysis. On the other hand, little variation can be noted in the one third mil fuses grouped near the top of Figure 8. The similarity between the shapes of the resistivity vs specific energy curves is clear for one third-mil fuses and this observation gives encouragement for the use of the resistivity vs specific energy models.

Figure 9 shows similar data for high performance one mil fuses. For these thicker fuses much greater variation is evident. Shots 72 and 75 used very fine (less than ten micron) quartz powder as their quenches. Previous experimental work has shown that external pressure is necessary when using very fine quartz as a quench in order to improve (up to 50 percent) overall fuse performance (Ref 3). These fuse were under no external pressure.

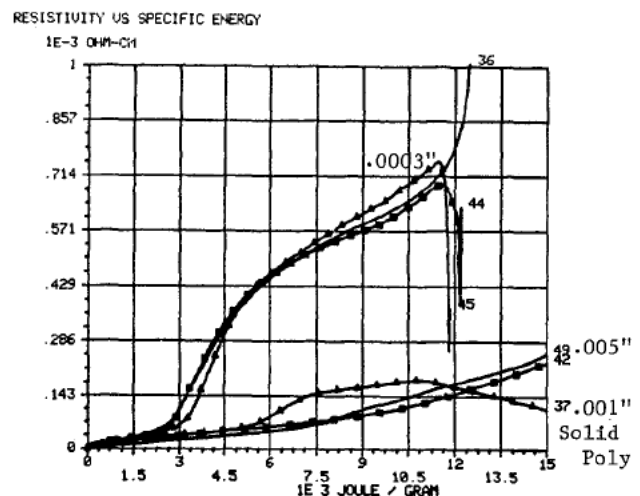

Figure 8 Thin Fuse Performance & Representative Poor Performers

## RESISTIVITY VS SPECIFIC ENERGY

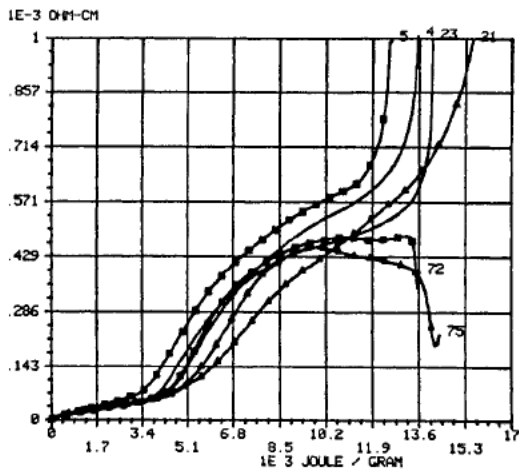

Figure 9 Thick (.001") Fuse Performance

For practical applications, energy must be transferred to a load, therefore the fuse must be lower in mass to absorb less energy during its operation. Therefore, fuses were tested with reduced length in order to assess the performance with higher ratios of driving power to fuse mass that are encountered when operating with a load. Figure 10 graphically shows this data which was taken without the benefit of the parallel load, but with shorter fuses.

## RESISTIVITY VS SPECIFIC ENERGY

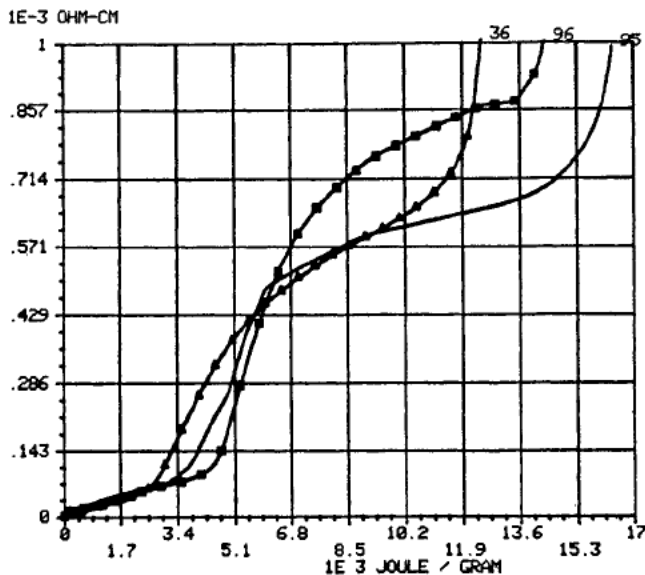

Figure 10 Shorter Fuse Data

Summary

The performance of the fuse opening switch is affected by several external parameters. Variations in the thickness of the fuse foil and modification of the arc suppressing quench surrounding the fuse both have significant effects on fuse performance. There are a wide variety of granular silica based quenches in the range of 20 to 100 micron diameters that give comparably good performance. Quenches both larger and smaller seem to perform in an inferior manner with the large quenches not providing enough suppression and the finer quenches not performing well unless compressed. In general the thinnest (one third mil) fuse behaved much better in a variety of quenches than did comparable one mill fuses. The use of deionized

water was seen to produce significantly different resistivity vs specific energy curves which was probably related to the pressure around the fuse.

In general there is no great increase in the performance of fuses to be had by changing the environment or the fuse material. However, proper selection of the thickness of the fuse and the quench surrounding it can result in improved opening switch operation.

References

1. Reinovsky, R. E. et. al. "Inductive Store Pulse Compression System for Driving High Speed Plasma Implosions", IEEE Transactions on Plasma Science, PS-10 (2), Jun 82.
2. Reinovsky, R. E. et. al. "Shiva Star Inductive Pulse Compression System", 4th IEEE Pulse Power Conference, Albuquerque NM, Jun 83.
3. Maisonnier, C. et. al. "Rapid Transfer of Magnetic Energy by Means of Exploding Foil", Review of Scientific Instruments, 30(11): p1032-1037 (Oct 66).
4. Benford, J. et. al. "High-Power Pulse Generation Using Exploding Fuses", Energy Storage, Compression, and Switching, edited by H. W. Bostic, V. Nardi, and O. S. F. Fueks, New York and London: Plenum Press, 1976.
5. Andrezen, A. B., et. al. "Investigation of a Fast Foil Current Breaker, 1. Electrical Foil Explosion in Pulverized Quartz", Leningrad NIIIEFA Preprint, 1975, AD B-045219L.
6. DiMarco, J. N., and Burkhardt, L. C. "Characteristics of a Magnetic Energy Storage System Using Exploding Foils", Journal of Applied Physics, 41(9):3894-3899, (Aug 70).
7. Bueck, J. C. and Reinovsky, R. E., "The Effects of Cryogenic Initial Temperatures on Aluminum and Copper Electrically Exploded Foil Fuses", 4th IEEE International Pulse Power Conference, Albuquerque NM, Jun 83.
8. Bueck, J. C., "Comparison of Aluminum and Copper Fuse Opening Switches Under Room and Cryogenic Temperature Conditions", Thesis, Air Force Institute of Technology (Dec 82), (AFIT/GE/EE/82D-22).