

We are IntechOpen, the world's leading publisher of Open Access books Built by scientists, for scientists

5,300

Open access books available

130,000

International authors and editors

155M

Downloads

Our authors are among the

154

Countries delivered to

TOP 1%

most cited scientists

12.2%

Contributors from top 500 universities



WEB OF SCIENCE™

Selection of our books indexed in the Book Citation Index
in Web of Science™ Core Collection (BKCI)

Interested in publishing with us?
Contact book.department@intechopen.com

Numbers displayed above are based on latest data collected.
For more information visit www.intechopen.com



Chapter

Biom mineralization of Magnetosomes: Billion-Year Evolution Shaping Modern Nanotools

Tarcisio Nascimento Correa, Igor Nunes Taveira, Rogerio Presciliano de Souza Filho and Fernanda de Avila Abreu

Abstract

Biom mineralization in the microbial realm usually gives origin to finely structured inorganic nanomaterials. Perhaps, one of the most elegant bioinorganic processes found in nature is the iron biom mineralization into magnetosomes, which is performed by magnetotactic bacteria. A magnetosome gene cluster within the bacterial genome precisely regulates the mineral synthesis. The spread and evolution of this ability among bacteria are thought to be a 2,7-billion-year process mediated by horizontal gene transfers. The produced magnetite or greigite nanocrystals coated by a biological membrane have a narrow diameter dispersibility, a highly precise morphology, and a permanent magnetic dipole due to the molecular level control. Approaches inspired by this bacterial biom mineralization mechanism can imitate some of the biogenic nanomagnets characteristics in the chemical synthesis of iron oxide nanoparticles. Thus, this chapter will give a concise overview of magnetosome synthesis's main steps, some hypotheses about the evolution of magnetosomes' biom mineralization, and approaches used to mimic this biological phenomenon *in vitro*.

Keywords: magnetotactic bacteria, magnetosomes, magnetic nanoparticles, magnetite, magnetosome gene cluster, horizontal gene transfer, biomimetics

1. Introduction

Among everything that is known in Microbiology, magnetotactic bacteria (MTB) are known to perform one of the finest examples of a controlled biom mineralization process. MTB were first observed in the late 1950s, by the medical Doctor Salvatore Bellini in the Italian city of Pavia and later described in Massachusetts by Richard Blakemore in the 1970s [1, 2]. MTB are known to align its motility axis to the geomagnetic field and use it for orientation. When observed under the light microscope, MTB present unidirectional swimming to the North or South Magnetic Poles from an applied external magnetic field (a magnet); this behavior is called magnetotaxis [3]. This behavior occurs due to the presence of magnetic

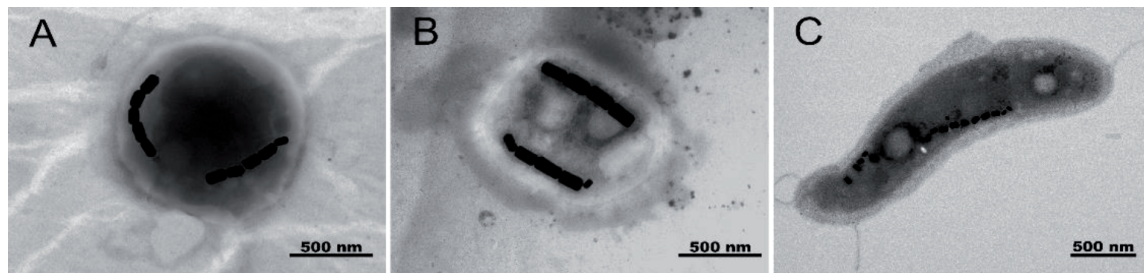

Figure 1. Transmission electron microscopy of: (A) uncultured coccoid magnetotactic bacteria from Monsimet Cove, Antarctica. (B) Uncultured coccoid magnetotactic bacteria from Punta Ullman, Antarctica. (C) *Magnetovibrio blakemorei* strain MV-1^T.

nanocrystals—the magnetosomes—, usually aligned in single or multiple chains within the bacterial cytoplasm (**Figure 1**), and flagellar propulsion guided by chemotaxis [3]. In a simple way, chemotaxis in MTB is assisted by bacterial orientation along Earth’s magnetic field (magnetotaxis). Therefore, magnetotaxis allows MTB to find the optimum position for survival and growth in a chemically stratified water column, seeking for an optimum environment where proton motive driving force reaches maximum potential. For MTB, which are frequently microaerophilic or anaerobic microorganisms, this environment is near the oxic/anoxic interface [4].

Magnetosomes are composed of a magnetic nanoparticle in most cases composed of magnetite (Fe₃O₄) and sometimes greigite (Fe₃S₄) with species specific shapes and sizes, and enveloped by a phospholipid bilayer with associated proteins, which constitutes the magnetosome membrane (MM) [3]. The gene regulation of magnetosome biomineralization (MB) and organization within the cell will be discussed in more detail in the sections ahead. Based on the total iron amount within a magnetotactic bacterium cell, MTB appear to play a major role in the biogeochemical cycling of iron [5]. MTB through magnetosome synthesis,

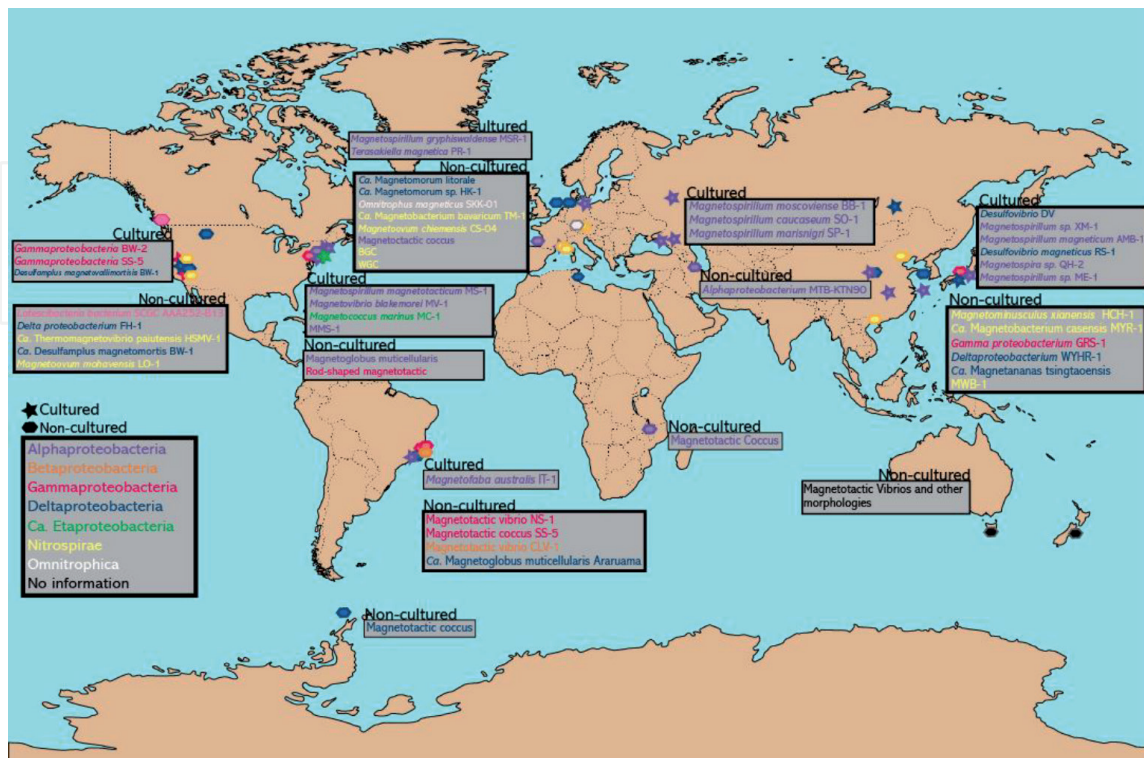

Figure 2. Map of the distribution of known cultured and non-cultured magnetotactic bacteria across de world by phylogenetic group (see the correspondence between taxa and colors on the bottom left corner of the image).

assimilate the iron solubilized in the environment to an inorganic crystal. After cell lysis, the magnetosome is deposited in the sediment, forming what is known as magnetofossils [6]. Besides, MTB can be ingested by protozoans, and the iron from magnetosomes is, then, incorporated in the food chain [7]. Apart from iron and based on their physiology, MTB seem to have relevant roles in other biogeochemical cycles of sulfur, nitrogen, and carbon [8].

MTB are an extremely diverse group of Gram-negative bacteria with a variety of morphotypes (i.e., rods, vibrios, spirilla, coccoid, and ovoid) and species affiliated to Proteobacteria (Alpha-, Beta-, Gamma-, Delta-, and *Ca. Etaproteobacteria* class), Omnitrophica and Nitrospirae phyla [9]. MTB affiliation to other taxa have been proposed based on metagenomics studies, but observation of the magnetosomes was not performed to confirm this matter. This great diversity is reflected in MTB ubiquity in almost all aquatic habitats across the Earth (**Figure 2**), including extreme environments such as thermal trenches and saline-alkaline lakes [6, 10]. More than being interesting species for their unique evolutionary process and ecological importance, MTB are also proving to be of interest for biotechnological applications. Their unique physiology makes MTB potential bioremediators of heavy metals and magnetosomes can be extracted and used as nanotools for magnetic controlled drug targeting, contrast agents for magnetic resonance imaging, enzyme immobilization and many more industrial and biomedical applications [11].

2. Steps of magnetosome biomineralization in MTB

MB is highly regulated at the genetic level [12]. Magnetosome gene clusters (MGCs) [13], structured as *operons*, are responsible for MB in MTB. MTB genomes contain: (i) conserved *mam* genes, encountered in all MTB; and (ii) restricted genes encountered in some phylogenetic groups of MTB [14]. Examples of genes restricted to certain MTB are: (i) *mms* (from magnetosome membrane specific) genes found in magnetotactic Proteobacteria; (ii) *mad* (from magnetosome associated Deltaproteobacteria), which were first reported in magnetotactic deltaproteobacteria [15] and recently encountered in MTB affiliated to Omnitrophica and Nitrospirae phyla [9]; and (iii) *man* (from magnetosome genes in Nitrospirae), which are genes reported in MTB affiliated to Nitrospirae phylum [16]. Comprehension of MB were inferred by *mam* and *mms* genes deletion in the cultured magnetotactic alphaproteobacteria *Magnetospirillum magneticum* strain AMB-1 and *Magnetospirillum gryphiswaldense* strain MSR-1 [14]. Precise *man* and *mad* genes roles in MB remain unclear as they were studied in uncultured MTB [16], thus genetic systems to test gene function is not available.

As previously described, MTB are capable of biomineralizing magnetosomes, an organelle with a ferrimagnetic mineral core surrounded by a biological membrane [3]. A series of complex mechanisms occur in order to transform the environmental bioavailable iron into a complete and fully functional magnetic organelle. MB process involves different steps such as iron uptake, magnetosome vesicle formation, specific protein recruiting, crystal nucleation, redox balance, and pH control in magnetosome vesicle, size and crystalline morphology control and magnetosome vesicle docking in the bacterial cytoskeleton [3].

Mam and Mms proteins involved in MB belong to different protein families including: TPR proteins (from Tetratricopeptide Repeat; MamA) [17], CDF transporters (Cation Diffusion Facilitators: MamB and MamM) [14, 18], serine proteases HtrA-like (MamE, MamP, and MamO) [14], actin-like proteins (MamK) [19], liposome tubulation protein (MamY) [20], generic transporters (MamH and MamN) [14, 21] and MTB specific proteins without prior homology in other non-magnetotactic microorganisms

(MamG, MamF, MamD, MamC, MamJ, MamW, MamX, MamY, Mms6, MtxA) [3]. MB involves four major steps as they are: (i) MM formation (participation of MamI, MamL and MamAB proteins) [3, 14]; (ii) crystal nucleation (which include MamE, Mms6, MamB and MamM) [3, 14]; (iii) crystal maturation (participation of MamE, MmsF, MamGFDC and Mam P, S, T) [3, 14]; and (iv) magnetosome chain alignment within cell body (participation of MamJ, MamK and MamY) [14, 20]. Mam and Mms protein functions involved in MB are described in **Table 1** and **Figure 3**.

Protein	Operon	Function	MTB strain	Reference
MamA	<i>mamAB</i>	Protein recruitment	AMB-1	[23]
MamB	<i>mamAB</i>	Membrane invagination and iron uptake	AMB-1/ MSR-1	[14, 18]
MamC	<i>mamGFDC</i>	Size and morphology control	AMB-1	[24]
MamD	<i>mamGFDC</i>	Size and morphology control	AMB-1	[24]
MamE	<i>mamAB</i>	Protein targeting and redox control	AMB-1	[14]
MamF	<i>mamGFDC</i>	Size control	AMB-1	[24]
MamG	<i>mamGFDC</i>	Size and morphology control	AMB-1	[24]
MamH	<i>mamAB</i>	Iron uptake	AMB-1/ MSR-1	[14, 21]
MamI	<i>mamAB</i>	Membrane invagination	AMB-1	[14]
MamJ	<i>mamAB</i>	Magnetosome alignment	MSR-1	[25]
MamK	<i>mamAB</i>	Magnetosome alignment	MSR-1	[19]
MamL	<i>mamAB</i>	Membrane invagination	AMB-1	[14]
MamM	<i>mamAB</i>	Iron uptake	AMB-1/ MSR-1	[14, 18]
MamN	<i>mamAB</i>	pH control	AMB-1	[14]
MamO	<i>mamAB</i>	Crystal nucleation	AMB-1/ MSR-1	[14, 26]
MamP	<i>mamAB</i>	Redox control	AMB-1	[14]
MamQ	<i>mamAB</i>	Membrane invagination	AMB-1	[14]
MamR	<i>mamAB</i>	Size and morphology control	AMB-1	[14]
MamS	<i>mamAB</i>	Size and morphology control	AMB-1	[14]
MamT	<i>mamAB</i>	Size e morphology control and redox control	AMB-1	[27]
MamU	<i>mamAB</i>	Not defined	AMB-1	[14]
MamV	<i>mamAB</i>	Not defined	MSR-1	[18]
MamW	<i>mamAB</i>	Magnetosome alignment	MSR-1	[28]
MamX	<i>mamXY</i>	Redox control	MSR-1	[21]
MamY	<i>mamXY</i>	Membrane invagination and magnetosome alignment	AMB-1/ MSR-1	[20, 29]
MamZ	<i>mamXY</i>	Iron uptake and redox control	MSR-1	[21]
Mms6	<i>mms6</i>	Size and morphology control	AMB-1	[30]
MmsF	<i>mms6</i>	Size and morphology control	AMB-1	[31]

Table 1.

Mam and *Mms* protein functions inferred by mutant construction in the cultured magnetotactic alphaproteobacteria *Ms. magneticum* strain AMB-1 and *Ms. gryphiswaldense* strain MSR-1.

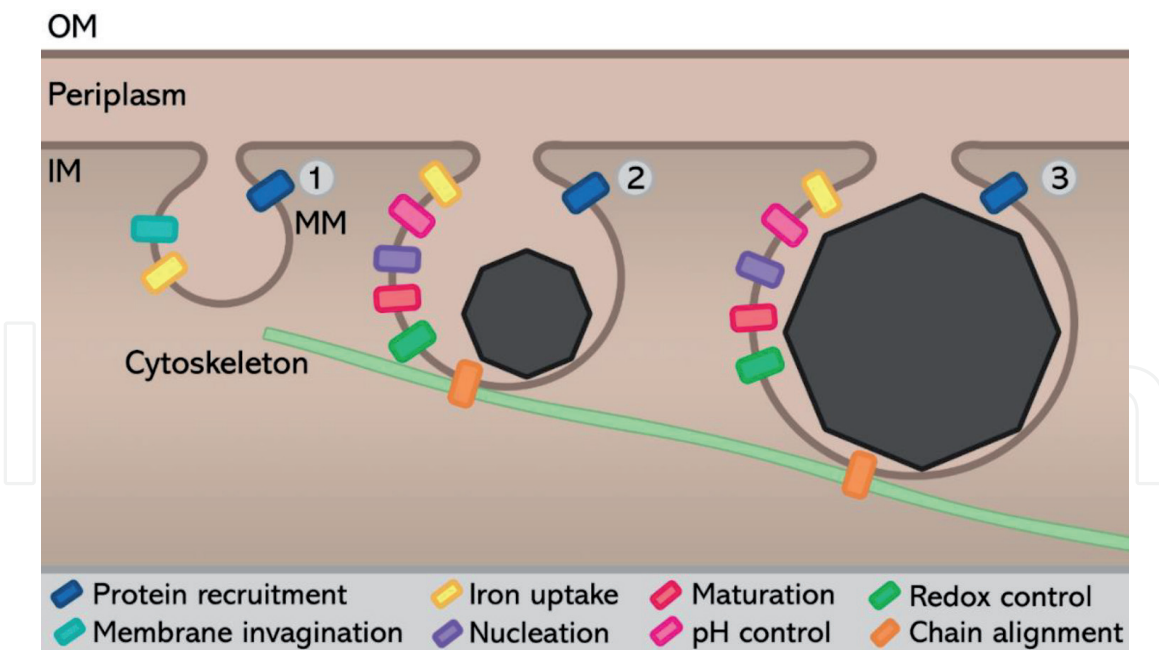

Figure 3.

Three major steps of MB in MTB. 1st step: protein recruitment initiating the biomineralization process while forming the invagination of the magnetosome membrane (MM) and iron uptake. 2nd step: Crystal nucleation, characterized by the incorporation of iron and oxygen for magnetite biomineralization. Interestingly, oxygen for the synthesis of magnetite is derived from water [22]. So far, the sulfur source for the synthesis of greigite has not been clarified. Magnetosome begins to grow in size while morphology, pH and redox balance are strictly regulated. Magnetosomes are aligned in chains within the cell's cytoskeleton. 3rd step: Magnetosomes continue to grow under strict regulation until de crystal maturation is complete. OM: outer membrane; IM: inner membrane, meaning the cytoplasmic membrane.

The advances of molecular biology techniques provided a much greater understanding of the MB mechanism over the last years as cultured and environmental MTB had their genomes sequenced. Magnetite MGCs and magnetite magnetosomes were studied in magnetotactic proteobacteria affiliated to the classes Alpha- [32–36], Beta- [37], Gamma- [38, 39], Delta- [40–43], *Ca.* Eta- [9, 32, 44, 45], *Ca.* Lambda- [9] and Zetaproteobacteria [9] and MTB affiliated to Nitrospirae [13, 16, 46–50] and Omnitrophica [49] phyla. Greigite MGC and greigite magnetosomes were characterized in magnetotactic deltaproteobacteria [51, 52] and MTB affiliated to *Ca.* Latescibacteria [8] and Planctomycetes [9] phyla. Culturing environmental MTB and mutant constructs different from the already known magnetotactic alphaproteobacteria *Ms. magneticum* strain AMB-1 and *Ms. gryphiswaldense* strain MSR-1 may provide a greater comprehension of the MB mechanism.

3. Evolutionary history of MGCs within Bacteria domain

MGC origin and evolution within the Bacteria domain is a constantly discussed topic in the literature. The scattering of MGCs and the magnetotactic behavior raises questions as MTB encompasses high diversity regarding their ecology, metabolism, and phylogeny. The first proposed hypothesis was the polyphyletic origin of magnetite and greigite MB [53]. According to this hypothesis, biomineralization of greigite and magnetite magnetosomes would have evolved without sharing a last universal common ancestor of magnetotactic bacteria (LUCA MTB). At that time MGCs were not discovered. Thus, this assumption relied on the information that the biochemical and nutritional parameters for greigite and magnetite biomineralization are different. Likewise, all known MTB affiliated to Alphaproteobacteria synthesized magnetite magnetosomes, while the ones affiliated to Deltaproteobacteria

synthesized greigite magnetosomes, thus permitting the inference the polyphyletic hypothesis. Years later, after the discovery of MGCs, similarities between *mam* genes of magnetite and greigite MTB showed a common ancestor for both minerals synthesis in MTB [54]. It is speculated that greigite MGCs originated after events of duplication and divergence from magnetite MGCs in sulfate-reducing bacteria like the multicellular magnetotactic prokaryote (MMP) *Ca. Magnetoglobus multicellularis* strain Araruama affiliated to Deltaproteobacteria [54].

On behalf of that, Lefèvre and colleges [55] hypothesized a monophyletic origin of MGCs concerning magnetotactic proteobacteria. The comparison of 16S rRNA gene and conserved Mam proteins evolution showed a convergence of both phylogenetic inferences. It was suggested that MTB affiliated to Proteobacteria phyla shared a LUCA MTB and over time, some proteobacteria would have lost the MGC, resulting in the inability of biomineralizing magnetosomes [55].

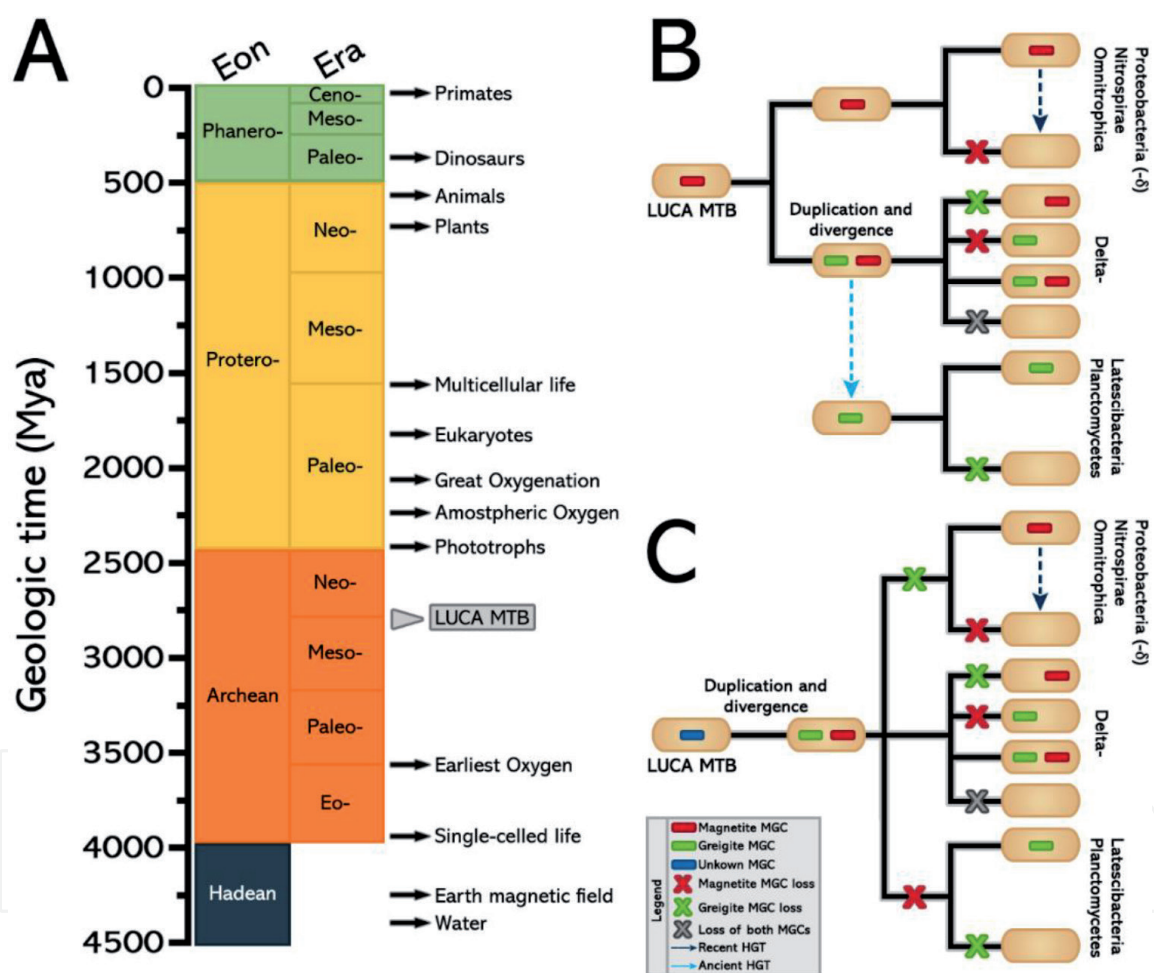

Figure 4.

*Geologic time and evolution model proposed for MGC and magnetotaxis evolution. (A) Geologic time in million years ago (Mya). LUCA MTB origin (gray arrowhead) is estimated 2.7 billion years ago during the Archean eon. The first single-celled form of life originated ~4 billion years ago and the origin of phototrophs, that permitted great oxygenation in earth, only happened ~2.4 billion years ago. (B and C) Two models for MGC and magnetotaxis evolution adapted from [9]. (B) LUCA MTB containing magnetite MGC branched two MTB lineages: (i) MTB affiliated to Proteobacteria (without Delta-), Nitrospirae and Omnitrophica phyla with recent HGT events responsible for MGC scattering; and (ii) MTB affiliated to Deltaproteobacteria class that after events of duplication and divergence hosted microbes with magnetite, greigite or both MGCs. Ancient HGT events would have been responsible for greigite MGC acquaintance in Planctomycetes and *Ca. Lastescibacteria* phyla. Adapted from [9]. (C) LUCA MTB containing an unknown MGC after events of duplication and divergence gave origin for both magnetite and greigite MGC. A monophyletic origin is proposed for MTB affiliated to Proteobacteria (without Delta- class), Nitrospirae, Omnitrophica, Planctomycetes and *Ca. Lastescibacteria* phyla and Deltaproteobacteria class. Recent HGT events originating from MTB affiliated to Proteobacteria (without Delta- class), Nitrospirae, Omnitrophica could have been responsible for the scattering of MGC and magnetotactic behavior. Adapted from [9].*

Opposing all previous statements, a considerable number of authors proposed the importance and influence of horizontal gene transfer (HGT) events on the evolution and scatter of MGC in Bacteria domain [9, 13, 56–59]. In light of these events, different non-MTB would have received MGCs by HGT, granting them the capacity of biomineralizing magnetosomes [9].

The origin of MB was dated, by molecular Bayesian clock, before the divergence of the Nitrospirae and Proteobacteria phyla during the Archean eon [13]. The divergence happened 2.7 billion years ago before the appearance of phototrophs and Great Oxygenation at the time of Paleoproterozoic on the Proterozoic eon (**Figure 4**). This hypothesis is supported by: (i) low pressure or absence of O₂ in the atmosphere and anoxic oceans in Archean [60]; (ii) abundant dissolved Fe²⁺ as concentrations of 40 to 120 μmol/L [61]; (iii) presence of primary electron donors of Earth early ecosystems such as H₂, H₂S, S⁰, Fe²⁺, CH₄, NH₄⁺ and CH₂O [62]; and (iv) presence of primary electron acceptors of Earth early ecosystems such as CO₂, CO, SO₄²⁻, NO, NO₂⁻ and NO₃⁻ [62]. These conditions favored the survival and growth of MTB [13]. Known examples of such conditions that are in accordance with available resources of primitive Earth are: (i) microaerophilic or anaerobic respiration in all known MTB; (ii) chemolithoautotrophy as MTB are capable of CO₂ fixation by Calvin–Benson–Bassham cycle, the reverse tricarboxylic acid cycle, or the reductive acetyl-CoA pathway [63]; (iii) capacity of denitrification of NO, NO₂⁻ and NO₃⁻ [16, 49]; (iv) capacity of oxidizing H₂S via sulfur oxidation pathway [16, 49]; (v) water temperature ranging from 26 to 85°C [64, 65] compatible with MTB growth as there are psychrophilic [66], mesophilic [8] and moderately thermophilic MTB [47]. Alongside these conditions, Earth's magnetic field originated 4.2 billion years ago enduring several inversions until the present time [67]. Considering this panorama, it is plausible that MTB and the geomagnetic fields have coevolved selecting the ones capable of undergoing all the continuous biotic and abiotic variations [13].

Large scale metagenome approach of MTB diversity demonstrated two possible routes concerning MGC evolution over time [9]. It is hypothesized that a LUCA MTB contained magnetite or an unknown MGC followed by events of MGC duplication, divergence, and loss combined with ancient and recent HGT events could explain the scattering of the magnetotactic behavior in the Bacteria domain [9] (**Figure 4**). The unending studies regarding MTB diversity and ecology are indispensable for an accurate decipherment of MGC evolution in the Bacteria domain.

4. Influence of the medium on biomineralization

The fact that related magnetotactic strains synthesize magnetosomes with significant differences in sizes and elongation is a clue that, despite a rigorous genetic control, environmental factors may influence the characteristics of the biomineralized nanocrystals [68]. Extensive experiments performed in cultures of MTB have pointed out temperature, pH, iron concentration, oxygen concentration, external magnetic fields, and nutrient concentrations as important factors driving physical changes in magnetosomes [69].

Ferric iron concentrations exert an important influence on the magnetic properties of *Magnetospirillum magnetotacticum* strain MS-1 cells due to alterations within biogenic magnetite [70]. The coercive force (H_C), probably the most important criterion in the selection of magnetic nanoparticles for technological applications, is significantly affected [70]. The H_C was increased from 216 Oe when cells were cultured at 12 μM Fe³⁺ to 238 Oe at 68 μM [70].

In another study, it was shown that reducing conditions leads to an increase in magnetosomes crystals of *Ms. magneticum* strain AMB-1 in culture [71]. An oxidoreduction

potential of 0 mV (neutral condition) led to a crystal diameter of 31.5 ± 1.3 nm, which augmented to 37.2 ± 0.6 nm when the culture was carried out at -500 mV (reducing condition) [71]. The reducing condition also caused an increase in the total magnetite mass per cell as 9.1 ± 1.9 magnetosomes were observed per μm (cell length), in contrast to 5.48 ± 1.3 in neutral condition.

The evidence that characteristics of biogenic magnetite can be modified is of great interest for practical applications because certain purposes may require specific particle properties. Therefore, the knowledge of the interplay between environmental conditions and process regulation by biomolecules in biom mineralization can help develop methods for the *in vitro* biomimetic preparation of magnetic nanoparticles with tunable properties.

5. Microbes inspire chemistry: biomimetic synthesis of artificial nanoparticles

Understanding MB is key not only for the in-depth learning of microbial physiological phenomena, but it can teach us valuable insights for the fabrication of technological materials. Magnetic nanoparticles have emerged as functional materials since the 1940s, when iron oxide powders, with crystals ranging from 60 nm to 1 μm , were used to impregnate recording tapes [72]. In that media, recorded information was engraved through changes in magnetization of the impregnated nanoparticles. Similarly, the biogenic magnetosomes can carry paleomagnetic signals, which can be detected, for instance, through the measurement of their magnetic properties in marine sediments [73]. The roles of bacterial magnetite as magnetofossils is only possible due to their stable single magnetic domain, caused by their controlled size range (20–100 nm) [73, 74]. This magnetic property also permits the utilization of biogenic nanomagnets in research on anticancer and antimicrobial therapy—as drug carriers, contrast agents, and hyperthermal agents—, enzyme immobilization—as recyclable supports—, cell labeling and other applications [11].

Biological materials are precisely arranged at the nanoscale. Hence, biomimetics, which is the art of imitating biological process to architecture novel materials, is proving profitable for nanotechnology industries [75]. One of the foundations of biomimetics is the biodiscovery and bioengineering of surface-binding proteins and peptides [76]. The regular structures present in such biomolecules enables the recognition and the interaction with atomic patterns on the surface of synthetic polymers, semiconductors, and metal oxide crystals [76]. In the case of metal oxides, these interactions occur basically via non-covalent weak bindings like hydrogen bonds and electrostatic dipoles.

In chemical syntheses, the shape- and size-controlled nanoparticles generally are obtained with high temperatures and organic solvents [74]. These consumptions are related to high production costs and environmental impacts during the life cycle of the nanoparticles [74]. One of the simplest and widely utilized techniques for making iron oxide nanoparticles is coprecipitation [74]. In this technique, ferrous and ferric salts are dissolved, and the cations are precipitated in an alkaline aqueous medium. For the synthesis of magnetite, a fixed molar proportion of 2:1 ($\text{Fe}^{3+}/\text{Fe}^{2+}$), is precipitated, following the stoichiometry:

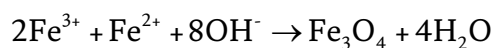

This molar proportion is mandatory because it is the same ferrous/ferric ratio within magnetite [77]. In MTB, iron is accumulated inside the magnetosome vesicle

in its ferrous form before being oxidized to ferric ion by magnetochromes—oxidizing domains of MamP, MamX, MamT and MamE [77]. This is an example of naturally occurring partial oxidation of ferrous ion. Partial oxidation is also used to obtain artificial, biomimetic magnetite [78]. In this case, the ferrous cation is precipitated to form ferrous hydroxide ($\text{Fe}(\text{OH})_2$). After that, a strong oxidizing agent, usually nitrate, partially transforms Fe^{2+} to Fe^{3+} , leading to magnetite:

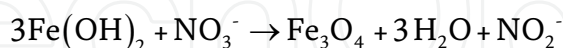
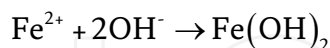

While coprecipitation leads to nanoparticles of an irregular shape, partial oxidation magnetite has a well-defined faceted morphology and a larger size [78]. Due to its low solubility, $\text{Fe}(\text{OH})_2$ tends to form larger precipitates. This is not the case for the coprecipitation of Fe^{3+} and Fe^{2+} , which tends to form multiple, smaller precipitates [78].

Complementary to oxidation control, the surface interaction of the forming magnetic crystal with biomolecules is the main strategy for synthesizing magnetosome-like nanoparticles. A summary of biomolecule-supplemented chemical syntheses of magnetic nanoparticles is in **Table 2**.

MamC protein from *Magnetococcus marinus* strain MC-1 has an effect of enlarging magnetite precipitates [79, 84]. Due to its effect over synthesis, this protein has been expressed for use in different biomimetics studies (**Figure 5**). Different coprecipitation experiments have shown an increase from ~10-25 nm, in control synthesis, to ~30-40 nm, when recombinant MamC from strain MC-1 is added in concentrations over 10 $\mu\text{g}/\text{mL}$ [79, 84].

In another study, *Ms. magneticum* strain AMB-1-derived Mms6 displays a negative effect on average particle size – 20 nm length down from 32 nm in the control experiment – in partial oxidation and coprecipitation-derived magnetite [80]. Instead, its addition to the reactional medium narrows size distribution regardless of the chemical route. The presence of recombinant Mms6 derived from strain AMB-1 imprints the cubo-octahedral morphology of the naturally occurring magnetosomes onto chemically precipitated crystals. From experiments using mutant clones of strain AMB-1, it has been demonstrated that the anionic residues Asp123, Glu124, and Glu125 effectively participate as key residues of Mms6 for defining crystal morphology in the protein binding to magnetite [88]. The interactions between these C-terminal side-groups and the magnetite surface ultimately respond for the strong morphology and size controlling character of Mms6 either in biologic or biomimetic mineralization [89].

To modulate/improve magnetite chemical synthesis by the use of MB proteins, magnetite-interacting components (MICs) of three magnetite-associated proteins (MamC, Mms6, and Mms7) have been subjected to NMR studies to investigate their affinity and binding to the ferrous ion during coprecipitation [81]. In all cases, it has been a clear role of aspartate and glutamate residues to the affinity to the cation [81]. The strong binding of ferrous cation to four anionic residues is related to confinement of iron by Mms6- and Mms7- MICs and, consequently, to the initiation of magnetite nucleation by these proteins. Besides ferrous ion, Mms6 glutamate residues positions 44, 50, and 55 at C-terminal region shows a strong binding affinity to ferric ion [90]. MamC-MIC, in turn, displays a weaker iron-binding but a stronger effect on magnetite size [81]. Thus, the ionotropic (i.e. iron-affinity) effect of MamC does not give sufficient ground for the role of this protein in

Additive(s)	Synthesis	Size (nm)	Shape	Ms (emu/g)	References
Magnetosomal proteins					
MamC	CP	30–40	Rhomboid	—	[79]
Mms6	PO	20.2 ± 4.0	Cubo- octahedral	—	[80]
MamC-MIC	CP	26.1 ± 0.61	Cuboid	—	[81]
Mms6-MIC		19.9 ± 0.36	Rhomboid	—	
Mms7-MIC		18.54 ± 0.29	Cuboid	—	
MmsF	CP	36	Rounded	129	[82]
MamF		25	Irregular	44	
Active loop of MmsF	CP	50 ± 13	Cuboidal	90	[83]
Active loop of Mms13		34 ± 12	Irregular	93	
MamC + Mms6	CP	30 ± 10	Rhomboid	—	[84]
Aminoacids					
Lysine (0.1 to 10 mM)	CP	21 ± 7 to 29 ± 7	Rhomboid	67 (for 10 mM Lys)	[85]
Arginine (0.1 to 10 mM)		16 ± 7 to 19 ± 6	—	36 (for 10 mM Arg)	
Polyaminoacids and polypeptides					
Polyarginine	CP	35 ± 5	Irregular	—	[86]
Polyaspartate	PO	7.6 ± 1.5	Rounded	78	[78]
14-mer peptide (magnetite- binding domain + ovarian cancer target) + ginger extract	CP	7.35 ± 3.7	Irregular	48.9	[87]

M_s = magnetization saturation at 300 K; CP = coprecipitation; PO = partial oxidation; MIC = magnetite-interacting component.

Table 2.

Summary of methods for chemical synthesis of biomimetic magnetic nanoparticles.

biomineralization [84, 91, 92]. MamC must exert a template effect in magnetite formation [84]. In the MM, MamC is constituted by two transmembrane domains connected by alpha-helical looping, which contacts the forming magnetite within the magnetosome vesicle lumen [92]. The distance between iron-interacting residues Glu66 and Asp70 of the alpha-helical looping matches the iron interatomic distance within the magnetite surface plane. The alpha-helical conformation of the MamC-MIC ensures the proper positioning of the points of interaction with iron [91]. The complementary roles of MamC and Mms6 can be combined in a biomimetic synthesis, yielding large magnetosomes (30 ± 10 nm) with well-defined crystal faces [84].

Other MM proteins are also good candidates for use in biomimetics. MamF controls the size monodispersity of nanocrystals. In aqueous solution, this protein forms a self-aggregative proteinosome of approximately 36 nm [82]. When used as an additive in coprecipitation, homogeneously sized nanocrystals are obtained. As in MamC, Mms13 and MmsF have their active loops located between the two transmembrane domains [83]. These active loops were expressed in a chimeric coiled-coil scaffold protein, which was called Mms13cc and MmsFcc. The MmsFcc construct regulated the cuboidal morphology of the produced nanocrystals.

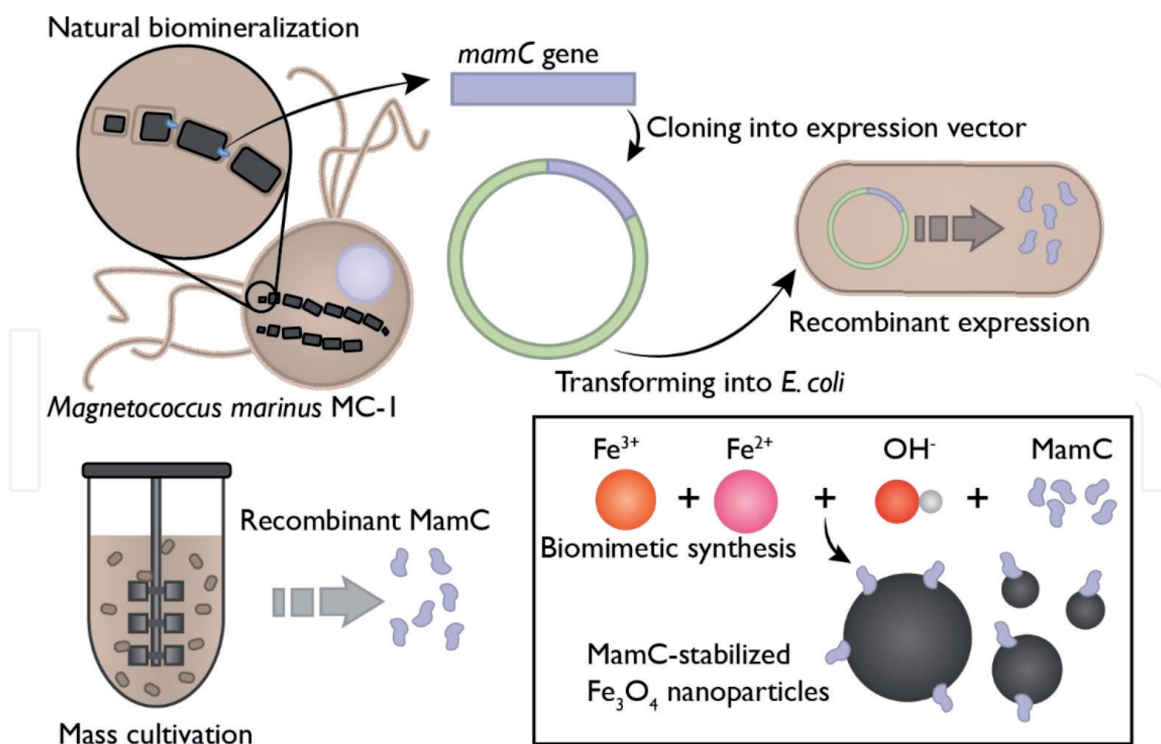

Figure 5. Biomimetic route for making size- and shape-controlled magnetite nanoparticles [79]. MamC is a 12.4 kDa magnetite-interacting transmembrane protein found in different species of MTB. The gene encoding this protein in *Mc. marinus* strain MC-1 (*mamC*) was cloned in a pTrcHis-TOPO plasmidial expression vector. It was, then, transformed into *Escherichia coli* TOP10. The transforming *E. coli* can be cultivated in a large-volume (1–10 L) bioreactor and express the recombinant MamC. After mass-cultivation, expressed MamC, which is found in intracellular inclusion bodies, is recovered and then purified. MamC can be used as an additive for the coprecipitation of iron to synthesize nanometric magnetite. In this synthesis, MamC binds and stabilizes crescent magnetite nuclei. This interaction ultimately results in nanocrystals of narrowly distributed size and uniform morphology.

Taking the inspiration of the interaction between anionic residues and nascent magnetite, the addition of acidic polypeptides is an alternative to recombinant proteins [78]. In the presence of poly-aspartate, partial oxidation synthesis resulted in narrower size distribution of nanocrystals [78]. Using a classical partial oxidation synthesis, 65% of magnetite nanoparticles assumed a faceted shape with a size distribution between 20 and 60 nm. When the synthesis was supplemented with poly-aspartate, a drastic change of the morphology occurred, with 85% of the nanoparticles showing a more rounded shape. However, the size distribution became significantly narrower, with most particles ranging 15–30 nm.

As discussed, biomimetic synthesis of magnetite with recombinant magnetosome proteins involves electrostatic interaction between anionic aminoacids with iron cations. Nevertheless, the use of cationic polymers and aminoacids also has been proven successful in imitating characteristics of magnetosomes into artificial magnetite. In those cases, the one accepted chemical mechanism is the dipole stabilization of the negatively charged surface of magnetite crystals by positive side groups, namely amino and guanidine, present in alkaline aminoacids [85, 86]. This phenomenon is supported by the phosphatidylethanolamine composition of the magnetosome vesicle, which exposed positively charged amino groups to the nucleation sites [86, 93].

In one experiment performed at the Max Planck Institute of Colloids and Interfaces, Germany, a wide array of randomly-generated peptides was expressed in phage display and had their binding capacity tested against a magnetite powder [86]. The primary structure of magnetite adhering peptides was then compared to the proteomes of several MTB species, but no significant similarity was spotted.

However, of the five magnetite-interacting peptides identified in that study, three had arginine as half the residues in the sequence. The cationic poly-arginine was used as an additive to the iron precipitation. The resulting nanoparticles possessed a fine size distribution (30-40 nm), reproducible – despite irregular – morphologies and colloidal stability. These characteristics were not achieved in the control of conventional precipitation. Poly-arginine also improves the tuneability of the biomimetic synthesis. In the presence of the additive, the average diameters of the magnetite precipitates could be adjusted from 10 to 40 nm when the reaction occurred in pHs from 9 to 11, respectively [94].

As polyaminoacids, single aminoacids can promote control over magnetic nanoparticle syntheses [85]. When arginine and lysine were tested for that purpose, the latter was able to control the particle size according to its concentration (**Table 2**) [85]. The side-chain amino group in lysine can perform a steadier stabilization of the anionic oxyhydroxide precursor of magnetite. Then, further growth of lysine-stabilized nuclei enables a larger crystal size with a better-defined hexahedral shape. The control over size and shape also reflects in the magnetic properties of the nanomaterial. The obtained nanoparticles displayed a superparamagnetic behavior, with a large magnetic moment and magnetization saturation (67 emu/g).

Not only is the size dispersity and morphology better controlled in biomimetic synthesis, but the colloidal stability of bioinspired nanomagnets is generally improved. The magnetic core of bare nanomagnets exerts an attractive force, possibly leading to instability to the colloidal suspension [78, 85]. When peptides are added to the precipitation media, functional groups of the same charge become exposed on the nanoparticle surface and counterbalance the attractive force with electrostatic repulsion [78, 85]. Due to the interaction of cationic amino groups with magnetite, carboxyl groups become exposed during coprecipitation with lysine [85]. Thus, the zeta-potential of those nanoparticles was -31 mV at physiological pH, while the control nanoparticles showed a 0 value. The synthesis of magnetite supplemented with poly-aspartate led to nanoparticles with surface-exposed carboxyl groups [78]. Therefore, the measured zeta potential was approximately -30 mV. Because suspension stability in aqueous media is crucial for biomedical applications, the colloidal stability obtained in biomimetic nanoparticles is a fundamental property.

The knowledge gained from biomimetic approaches was used to construct a double-stimuli-responsive nanoformulation consisting of a nanomagnet bound to the antiproliferative drug oxaliplatin [95]. The nanocrystal was synthesized by co-precipitation of iron ions in the presence of recombinant MamC. The magnetite-oxaliplatin bond was stable at pH 7.2. In acidic pH, the release of oxaliplatin was triggered. This release was further boosted by the application of an alternating magnetic field and the cytotoxicity against colorectal cancer cells was improved [95]. The responsive to alternating magnetic fields also enables MamC-derived magnetic nanoparticles to be used in hyperthermia treatments [96]. A 25 mg/mL suspension of the biomimetic nanoparticles exposed to an alternating field of 226 Oe at a 280 kHz frequency can cause a temperature increase of 16.7 °C (specific absorption rate = 47 W/g).

Another functional magnetic nanoparticle was coprecipitated in the presence of a bifunctional polypeptide and ginger extract [87]. The fourteen-residue-long polypeptide was designed from two heptapeptides: a magnetite binding domain and a cell-targeting domain with specificity to ovarian carcinoma cells. The metal-reducing and chelating activity of the ginger extract leads to nanoparticles averaging 10 nm in length and 48.9 emu/g of magnetization saturation. When different cell lines – A2780 (ovarian carcinoma) and L929 (mouse fibroblast) – were treated with the functional nanoparticle, the first group exhibited a particle uptake almost 5 times more intense.

6. Conclusion

In this chapter, we have summarized how the basic-science knowledge gained through molecular biology, phylogenetics, and metagenomics of MTB can be translated into tools of technological interest. Although the authors had not the pretentiousness of gathering extensive information available on the topic, the chapter evidences how cross-disciplinary research is crucial for understanding and applying such a complex biological phenomenon. This is especially true in a field in which intriguing discoveries are made at a fast pace.

Acknowledgements

We thank Unidade de Microscopia Multiusuário Souto-Padrón & Lins (UniMicro, UFRJ, Brazil) for the use of their microscopy facility.

This research was funded by Brazilian agencies CNPq, CAPES and FAPERJ.

Conflict of interest

The authors declare no conflicts of interest.

Author details

Tarcisio Nascimento Correa, Igor Nunes Taveira, Rogerio Presciliano de Souza Filho and Fernanda de Avila Abreu*

Universidade Federal do Rio de Janeiro, Rio de Janeiro, Brazil

*Address all correspondence to: fernandaabreu@micro.ufrj.br

IntechOpen

© 2020 The Author(s). Licensee IntechOpen. This chapter is distributed under the terms of the Creative Commons Attribution License (<http://creativecommons.org/licenses/by/3.0>), which permits unrestricted use, distribution, and reproduction in any medium, provided the original work is properly cited. 

References

- [1] Blakemore R. Magnetotactic bacteria. *Science*. 1975;**190**(4212):377-379. DOI: 10.1126/science.170679
- [2] Bellini S. On a unique behavior of freshwater bacteria. *Chinese Journal of Oceanology and Limnology*. 2009;**27**(1):3-5. DOI: 10.1007/s00343-009-0003-5
- [3] Uebe R, Schüler D. Magnetosome biogenesis in magnetotactic bacteria. *Nature Reviews Microbiology*. 2016;**14**(10):621-637. DOI: 10.1038/nrmicro.2016.99
- [4] Lefèvre CT, Bazylinski DA. Ecology, diversity, and evolution of magnetotactic bacteria. *Microbiology and Molecular Biology Reviews*. 2013;**77**(3):497-526. DOI: 10.1128/MMBR.00021-13
- [5] Amor M, Tharaud M, Gélabert A, Komeili A. Single-cell determination of iron content in magnetotactic bacteria: Implications for the iron biogeochemical cycle. *Environmental Microbiology*. 2020;**22**(3):823-831. DOI: 10.1111/1462-2920.14708
- [6] Lin W, Bazylinski DA, Xiao T, Wu LF, Pan Y. Life with compass: Diversity and biogeography of magnetotactic bacteria. *Environmental Microbiology*. 2014;**16**(9):2646-2658. DOI: 10.1111/1462-2920.12313
- [7] Martins JL, Silveira TS, Abreu F, Silva KT, da Silva-Neto ID, Lins U. Grazing protozoa and magnetosome dissolution in magnetotactic bacteria. *Environmental Microbiology*. 2007;**9**(11):2775-2781. DOI: 10.1111/j.1462-2920.2007.01389.x
- [8] Lin W, Pan Y, Bazylinski DA. Diversity and ecology of and biomineralization by magnetotactic bacteria. *Environmental Microbiology Reports*. 2017;**9**(4):345-356. DOI: 10.1111/1758-2229.12550
- [9] Lin W, Zhang W, Zhao X, Roberts AP, Paterson GA, Bazylinski DA, et al. Genomic expansion of magnetotactic bacteria reveals an early common origin of magnetotaxis with lineage-specific evolution. *ISME Journal*. 2018;**12**(6):1508-1519. DOI: 10.1038/s41396-018-0098-9
- [10] Bazylinski D, Lefèvre C. Magnetotactic bacteria from extreme environments. *Life*. 2013;**3**(2):295-307. DOI: 10.3390/life3020295
- [11] Vargas G, Cypriano J, Correa T, Leão P, Bazylinski D, Abreu F. Applications of magnetotactic bacteria, magnetosomes and magnetosome crystals in biotechnology and nanotechnology: Mini-review. *Molecules*. 2018;**23**(10):1-25. DOI: 10.3390/molecules23102438
- [12] Bazylinski DA, Frankel RB. Magnetosome formation in prokaryotes. *Nature Reviews Microbiology*. 2004;**2**(3):217-230. DOI: 10.1038/nrmicro842
- [13] Lin W, Paterson GA, Zhu Q, Wang Y, Kopylova E, Li Y, et al. Origin of microbial biomineralization and magnetotaxis during the Archean. *Proceedings of the National Academy of Sciences of the United States of America*. 2017;**114**(9):2171-2176. DOI: 10.1073/pnas.1614654114
- [14] Murat D, Quinlan A, Vali H, Komeili A. Comprehensive genetic dissection of the magnetosome gene island reveals the step-wise assembly of a prokaryotic organelle. *Proceedings of the National Academy of Sciences of the United States of America*. 2010;**107**(12):5593-5598. DOI: 10.1073/pnas.0914439107

- [15] Lefèvre CT, Trubitsyn D, Abreu F, Kolinko S, Jogler C, de Almeida LGP, et al. Comparative genomic analysis of magnetotactic bacteria from the Deltaproteobacteria provides new insights into magnetite and greigite magnetosome genes required for magnetotaxis. *Environmental Microbiology*. 2013;**15**(10):2712-2735. DOI: 10.1111/1462-2920.12128
- [16] Lin W, Deng A, Wang Z, Li Y, Wen T, Wu LF, et al. Genomic insights into the uncultured genus "Candidatus Magnetobacterium" in the phylum Nitrospirae. *ISME Journal*. 2014;**8**(12):2463-2477. DOI: 10.1038/ismej.2014.94
- [17] Zeytuni N, Ozyamak E, Ben-Harush K, Davidov G, Levin M, Gat Y, et al. Self-recognition mechanism of mamA, a magnetosome-associated TPR-containing protein. promotes complex assembly. *Proceedings of the National Academy of Sciences of the United States of America*. 2011;**108**(33):480-487. DOI: 10.1073/pnas.1103367108
- [18] Uebe R, Junge K, Henn V, Poxleitner G, Katzmann E, Plitzko JM, et al. The cation diffusion facilitator proteins MamB and MamM of *Magnetospirillum gryphiswaldense* have distinct and complex functions, and are involved in magnetite biomineralization and magnetosome membrane assembly. *Molecular Microbiology*. 2011;**82**(4):818-835. DOI: 10.1111/j.1365-2958.2011.07863.x
- [19] Komeili A, Li Z, Newman DK, Jensen GJ. Magnetosomes are cell membrane invaginations organized by the actin-like protein MamK. *Science*. 2006 Jan 13 [cited 2012 Nov 15];**311**(5758):242-5. DOI: 10.1126/science.1123231
- [20] Toro-Nahuelpan M, Giacomelli G, Raschdorf O, Borg S, Plitzko JM, Bramkamp M, et al. MamY is a membrane-bound protein that aligns magnetosomes and the motility axis of helical magnetotactic bacteria. *Nature Microbiology*. 2019;**4**(11):1978-1989. DOI: 10.1038/s41564-019-0512-8
- [21] Raschdorf O, Müller FD, Pósfai M, Plitzko JM, Schüler D. The magnetosome proteins MamX, MamZ and MamH are involved in redox control of magnetite biomineralization in *Magnetospirillum gryphiswaldense*. *Molecular Microbiology*. 2013;**89**(5):872-886. DOI: 10.1111/mmi.12317
- [22] Mandernack KW, Bazylinski DA, Shanks WC, Bullen TD. Oxygen and iron isotope studies of magnetite produced by magnetotactic bacteria. *Science*. 1999;**285**(5435):1892-1896. DOI: 10.1126/science.285.5435.1892
- [23] Komeili A, Vali H, Beveridge TJ, Newman DK. Magnetosome vesicles are present before magnetite formation, and MamA is required for their activation. *Proceedings of the National Academy of Sciences of the United States of America*. 2004;**101**(11):3839-3844. DOI: 10.1073/pnas.0400391101
- [24] Scheffel A, Gärdes A, Grünberg K, Wanner G, Schüler D. The major magnetosome proteins MamGFDC are not essential for magnetite biomineralization in *Magnetospirillum gryphiswaldense* but regulate the size of magnetosome crystals. *Journal of Bacteriology*. 2008;**190**(1):377-386. DOI: 10.1128/JB.01371-07
- [25] Scheffel A, Gruska M, Faivre D, Linaroudis A, Plitzko JM, Schüler D. An acidic protein aligns magnetosomes along a filamentous structure in magnetotactic bacteria. *Nature*. 2006;**440**(7080):110-114. DOI: 10.1038/nature04382
- [26] Yang W, Li R, Peng T, Zhang Y, Jiang W, Li Y, et al. mamO and mamE genes are essential for magnetosome

- crystal biomineralization in *Magnetospirillum gryphiswaldense* MSR-1. *Research in Microbiology*. 2010;**161**(8):701-705. DOI: 10.1016/j.resmic.2010.07.002
- [27] Siponen MI, Adryanczyk G, Ginet N, Arnoux P, Pignol D. Magnetochrome: A c-type cytochrome domain specific to magnetotactic bacteria. *Biochemical Society Transactions*. 2012;**40**(6):1319-1323. DOI: 10.1042/BST20120104
- [28] Lohsse A, Ullrich S, Katzmann E, Borg S, Wanner G, Richter M, et al. Functional analysis of the magnetosome island in *Magnetospirillum gryphiswaldense*: The mamAB operon is sufficient for magnetite biomineralization. *PLoS One*. 2011;**6**(10):e25561. DOI: 10.1371/journal.pone.0025561
- [29] Tanaka M, Arakaki A, Matsunaga T. Identification and functional characterization of liposome tubulation protein from magnetotactic bacteria. *Molecular Microbiology*. 2010;**76**(2):480-488. DOI: 10.1111/j.1365-2958.2010.07117.x
- [30] Tanaka M, Mazuyama E, Arakaki A, Matsunaga T. Mmm6 protein regulates crystal morphology during nano-sized magnetite biomineralization in vivo. *Journal of Biological Chemistry*. 2011;**286**(8):6386-6392. DOI: 10.1074/jbc.M110.183434
- [31] Murat D, Falahati V, Bertinetti L, Csencsits R, Körnig A, Downing K, et al. The magnetosome membrane protein, MmsF, is a major regulator of magnetite biomineralization in *Magnetospirillum magneticum* AMB-1. *Molecular Microbiology*. 2012;**85**(4):684-699. DOI: 10.1111/j.1365-2958.2012.08132.x
- [32] Bazylinski DA, Williams TJ, Lefèvre CT, Berg RJ, Zhang CL, Bowser SS, et al. *Magnetococcus marinus* gen. nov., sp. nov., a marine, magnetotactic bacterium that represents a novel lineage (Magnetococcaceae fam. nov., Magnetococcales ord. nov.) at the base of the Alphaproteobacteria. *International Journal of Systematic and Evolutionary Microbiology*. 2013;**63**(3):801-808. DOI: 10.1099/ijs.0.038927-0
- [33] Matsunaga T, Okamura Y, Fukuda Y, Wahyudi AT, Murase Y, Takeyama H. Complete genome sequence of the facultative anaerobic magnetotactic bacterium *Magnetospirillum* sp. strain AMB-1. *DNA Research*. 2005;**12**(3):157-166. DOI: 10.1093/dnares/dsi002
- [34] Wang Y, Lin W, Pana Y. High diversity of magnetotactic Deltaproteobacteria in a freshwater Niche. *Applied Environmental Microbiology*. 2013;**79**(8):2813-2817. DOI: 10.1128/AEM.03635-12
- [35] Ji B, Da ZS, Arnoux P, Rouy Z, Alberto F, Philippe N, et al. Comparative genomic analysis provides insights into the evolution and niche adaptation of marine *Magnetospira* sp. QH-2 strain. *Environmental Microbiology*. 2014;**16**(2):525-544. DOI: 10.1111/1462-2920.12180
- [36] Monteil CL, Perrière G, Menguy N, Ginet N, Alonso B, Waisbord N, et al. Genomic study of a novel magnetotactic Alphaproteobacteria uncovers the multiple ancestry of magnetotaxis. *Environmental Microbiology*. 2018;**20**(12):4415-4430. DOI: 10.1111/1462-2920.14364
- [37] Abreu F, Leão P, Vargas G, Cypriano J, Figueiredo V, Enrich-Prast A, et al. Culture-independent characterization of a novel magnetotactic member affiliated to the Beta class of the Proteobacteria phylum from an acidic lagoon. *Environmental Microbiology*. 2018;**20**(7):2615-2624. DOI: 10.1111/1462-2920.14286
- [38] Lefèvre CT, Vilorio N, Schmidt ML, Pósfai M, Frankel RB, Bazylinski DA.

Novel magnetite-producing magnetotactic bacteria belonging to the Gammaproteobacteria. *ISME Journal*. 2012;**6**(2):440-450. DOI: 10.1038/ismej.2011.97

[39] Leão P, Teixeira LCRS, Cypriano J, Farina M, Abreu F, Bazylinski DA, et al. North-seeking magnetotactic gammaproteobacteria in the southern hemisphere. *Appl Environmental Microbiology*. 2016;**82**(18):5595-5602. DOI: 10.1128/AEM.01545-16

[40] Nakazawa H, Arakaki A, Narita-Yamada S, Yashiro I, Jinno K, Aoki N, et al. Whole genome sequence of *Desulfovibrio magneticus* strain RS-1 revealed common gene clusters in magnetotactic bacteria. *Genome Research*. 2009;**19**(10):1801-1808. DOI: 10.1101/gr.088906.108

[41] Lefèvre CT, Frankel RB, Pósfai M, Prozorov T, Bazylinski DA. Isolation of obligately alkaliphilic magnetotactic bacteria from extremely alkaline environments. *Environmental Microbiology*. 2011;**13**(8):2342-2350. DOI: 10.1111/j.1462-2920.2011.02505.x

[42] Zhou K, Zhang WY, Yu-Zhang K, Pan HM, Da ZS, Zhang WJ, et al. A novel genus of multicellular magnetotactic prokaryotes from the Yellow Sea. *Environmental Microbiology*. 2012;**14**(2):405-413. DOI: 10.1111/j.1462-2920.2011.02590.x

[43] Abreu F, Morillo V, Nascimento FF, Werneck C, Cantão ME, Ciapina LP, et al. Deciphering unusual uncultured magnetotactic multicellular prokaryotes through genomics. *ISME Journal*. 2014;**8**(5):1055-1068. DOI: 10.1038/ismej.2013.203

[44] Lefèvre CT, Bernadac A, Yu-Zhang K, Pradel N, Wu LF. Isolation and characterization of a magnetotactic bacterial culture from the Mediterranean Sea. *Environmental Microbiology*. 2009;**11**(7):1646-1657. DOI: 10.1111/j.1462-2920.2009.01887.x

[45] Morillo V, Abreu F, Araujo AC, De Almeida LGP, Enrich-Prast A, Farina M, et al. Isolation, cultivation and genomic analysis of magnetosome biomineralization genes of a new genus of south-seeking magnetotactic cocci within the Alphaproteobacteria. *Frontiers in Microbiology*. 2014;**5**(72):1-12. DOI: 10.3389/fmicb.2014.00072

[46] Jogler C, Wanner G, Kolinko S, Niebler M, Amann R, Petersen N, et al. Conservation of proteobacterial magnetosome genes and structures in an uncultivated member of the deep-branching Nitrospira phylum. *Proceedings of the National Academy of Sciences of the United States of America*. 2011;**108**(3):1134-1139. DOI: 10.1073/pnas.1012694108

[47] Lefèvre CT, Abreu F, Schmidt ML, Lins U, Frankel RB, Hedlund BP, et al. Moderately thermophilic magnetotactic bacteria from hot springs in Nevada. *Applied Environmental Microbiology*. 2010;**76**(11):3740-3743. DOI: 10.1128/AEM.03018-09

[48] Lefèvre CT, Frankel RB, Abreu F, Lins U, Bazylinski DA. Culture-independent characterization of a novel, uncultivated magnetotactic member of the Nitrospirae phylum. *Environmental Microbiology*. 2011;**13**(2):538-549. DOI: 10.1111/j.1462-2920.2010.02361.x

[49] Kolinko S, Richter M, Glöckner FO, Brachmann A, Schüler D. Single-cell genomics of uncultivated deep-branching magnetotactic bacteria reveals a conserved set of magnetosome genes. *Environmental Microbiology*. 2016;**18**(1):21-37. DOI: 10.1111/1462-2920.12907

[50] Qian XX, Liu J, Menguy N, Li J, Alberto F, Teng Z, et al. Identification of novel species of marine magnetotactic bacteria affiliated with Nitrospirae phylum. *Environmental Microbiology Reports*. 2019;**11**(3):330-337. DOI: 10.1111/1758-2229.12755

- [51] Lins U, Keim C, Evans F, Farina M, Buseck P. Magnetite (Fe₃O₄) and greigite (Fe₃S₄) crystals in multicellular magnetotactic prokaryotes. *Geomicrobiology Journal*. 2007;**24**(1):43-50. DOI: 10.1080/01490450601134317
- [52] Lefèvre CT, Menguy N, Abreu F, Lins U, Pósfai M, Prozorov T, et al. A cultured greigite-producing magnetotactic bacterium in a novel group of sulfate-reducing bacteria. *Science*. 2011;**334**(6063):1720-1723. DOI: 10.1126/science.1212596
- [53] DeLong EF, Frankel RB, Bazylinski DA. Multiple evolutionary origins of magnetotaxis in bacteria. *Science*. 1993;**259**(5096):803-806. DOI: 10.1126/science.259.5096.803
- [54] Abreu F, Cantão ME, Nicolás MF, Barcellos FG, Morillo V, Almeida LGP, et al. Common ancestry of iron oxide- and iron-sulfide-based biomineralization in magnetotactic bacteria. *ISME Journal*. 2011;**5**(10):1634-1640. DOI: 10.1038/ismej.2011.35
- [55] Lefèvre CT, Trubitsyn D, Abreu F, Kolinko S, de Almeida LGP, de Vasconcelos ATR, et al. Monophyletic origin of magnetotaxis and the first magnetosomes. *Environmental Microbiology*. 2013;**15**(8):2267-2274. DOI: 10.1111/1462-2920.12097
- [56] Schübbe S, Kube M, Wawer C, Heyen U, Meyerdierks A, Madkour MH, et al. Characterization of a spontaneous nonmagnetic mutant of *Magnetospirillum gryphiswaldense* reveals a large deletion comprising a putative magnetosome island. *Journal of Bacteriology*. 2003;**185**(19):5779-5790. DOI: 10.1128/JB.185.19
- [57] Richter M, Kube M, Bazylinski DA, Lombardot T, Glöckner FO, Reinhardt R, et al. Comparative genome analysis of four magnetotactic bacteria reveals a complex set of group-specific genes implicated in magnetosome biomineralization and function. *Journal of Bacteriology*. 2007;**189**(13):4899-4910. DOI: 10.1128/JB.00119-07
- [58] Jogler C, Kube M, Schübbe S, Ullrich S, Teeling H, Bazylinski DA, et al. Comparative analysis of magnetosome gene clusters in magnetotactic bacteria provides further evidence for horizontal gene transfer. *Environmental Microbiology*. 2009;**11**(5):1267-1277. DOI: 10.1111/j.1462-2920.2009.01854.x
- [59] Jogler C, Schüler D. Genomics, genetics, and cell biology of magnetosome formation. *Annual Reviews of Microbiology*. 2009;**63**:501-521. DOI: 10.1146/annurev.micro.62.081307.162908
- [60] Canfield DE. The early history of atmospheric oxygen: Homage to Robert M. Garrels. *Annual Reviews of Earth and Planetary Sciences*. 2005;**33**:1-36. DOI: 10.1146/annurev.earth.33.092203.122711
- [61] Rouxel OJ, Bekker A, Edwards KJ. Iron isotope constraints on the Archean and Paleoproterozoic Ocean redox state. *Science*. 2005;**307**(5712):1088-1091. DOI: 10.1126/science.1105692
- [62] Canfield DE, Rosing MT, Bjerrum C. Early anaerobic metabolisms. *Philosophical Transactions of the Royal Society B: Biological Sciences*. 2006;**361**(1474):1819-1834. DOI: 10.1098/rstb.2006.1906
- [63] Williams TJ, Zhang CL, Scott JH, Bazylinski DA. Evidence for autotrophy via the reverse tricarboxylic acid cycle in the marine magnetotactic coccus strain MC-1. *Applied Environmental Microbiology*. 2006;**72**(2):1322-1329. DOI: 10.1128/AEM.72.2.1322

- [64] Blake RE, Chang SJ, Lepland A. Phosphate oxygen isotopic evidence for a temperate and biologically active Archaean Ocean. *Nature*. 2010;**464**(7291):1029-1032. DOI: 10.1038/nature08952
- [65] Knauth LP. Temperature and salinity history of the Precambrian Ocean: Implications for the course of microbial evolution. *Palaeogeography, Palaeoclimatology, Palaeoecology*. 2005;**219**(1-2):53-69. DOI: 10.1016/j.palaeo.2004.10.014
- [66] Abreu F, Carolina A, Araujo V, Leão P, Silva KT, de CFM, et al. Culture-independent characterization of novel psychrophilic magnetotactic cocci from Antarctic marine sediments. *Environmental Microbiology*. 2016;**18**(12):4426-4441. DOI: 10.1111/1462-2920.13388
- [67] Tarduno JA, Cottrell RD, Davis WJ, Nimmo F, Bono RK. A hadean to Paleoproterozoic geodynamo recorded by single zircon crystals. *Science*. 2015;**349**(6247):521-524. DOI: 10.1126/science.aaa9114
- [68] Pósfai M, Lefèvre CT, Trubitsyn D, Bazylinski DA, Frankel RB. Phylogenetic significance of composition and crystal morphology of magnetosome minerals. *Frontiers in Microbiology*. 2013;**4**:1-15. DOI: 10.3389/fmicb.2013.00344
- [69] Moisescu C, Ardelean II, Benning LG. The effect and role of environmental conditions on magnetosome synthesis. *Frontiers in Microbiology*. 2014;**5**:1-12. DOI: 10.3389/fmicb.2014.00049
- [70] Yiriletu IT. Magnetic properties of magnetite synthesized by *Magnetospirillum magnetotacticum* MS-1 cultured with different concentrations of ferric iron. *Biotechnology Letters*. 2015;**37**(12):2427-2433. DOI: 10.1007/s10529-015-1928-8
- [71] Olszewska-Widdrat A, Schiro G, Reichel VE, Faivre D. Reducing conditions favor magnetosome production in magnetospirillum magneticum AMB-1. *Frontiers in Microbiology*. 2019;**10**(582):1-10. DOI: 10.3389/fmicb.2019.00582
- [72] Mee CD. Magnetic tape recording materials. *IEEE Transactions on Communication and Electronics*. 1964;**83**(73):399-408. DOI: 10.1109/tcome.1964.6541245
- [73] Amor M, Busigny V, Durand-Dubief M, Tharaud M, Ona-Nguema G, Gélabert A, et al. Chemical signature of magnetotactic bacteria. *Proceedings of the National Academy of Sciences of the United States of America*. 2015;**112**(6):1699-1703. DOI: 10.1073/pnas.1414112112
- [74] Mirabello G, Lenders JJM, Sommerdijk NAJM. Bioinspired synthesis of magnetite nanoparticles. *Chemical Society Reviews*. 2016;**45**(18):5085-5106. DOI: 10.1039/C6CS00432F
- [75] Bhushan B. Bioinspired materials and surfaces for green science and technology (part 3). *Philosophical Transactions of the Royal Society A: Mathematical, Physical and Engineering Sciences*. 2020;**378**(2167):2-3. DOI: 10.1098/rsta.2019.0439
- [76] Sawada T, Serizawa T. Peptides as smart biomolecular tools: Utilization of their molecular recognition for materials engineering. In: Ito Y, Chen X, Kang I-K, editors. *Advances in Bioinspired and Biomedical Materials*. Washington, D.C.: American Chemical Society; 2017. pp. 31-48. DOI: 10.1021/bk-2017-1252.ch003

- [77] Barber-Zucker S, Zarivach R. A look into the biochemistry of magnetosome biosynthesis in magnetotactic bacteria. *ACS Chemical Biology*. 2017;**12**(1):13-22. DOI: 10.1021/acscchembio.6b01000
- [78] Altan CL, Lenders JJM, Bomans PHH, De With G, Friedrich H, Bucak S, et al. Partial oxidation as a rational approach to kinetic control in bioinspired magnetite synthesis. *Chemistry - A European Journal*. 2015;**21**(16):6150-6156. DOI: 10.1002/chem.201405973
- [79] Valverde-Tercedor C, Montalbán-López M, Perez-Gonzalez T, Sanchez-Quesada MS, Prozorov T, Pineda-Molina E, et al. Size control of in vitro synthesized magnetite crystals by the MamC protein of *Magnetococcus marinus* strain MC-1. *Applied Microbiology and Biotechnology*. 2015;**99**(12):5109-5121. DOI: 10.1007/s00253-014-6326-y
- [80] Amemiya Y, Arakaki A, Staniland SS, Tanaka T, Matsunaga T. Controlled formation of magnetite crystal by partial oxidation of ferrous hydroxide in the presence of recombinant magnetotactic bacterial protein Mms6. *Biomaterials*. 2007;**28**(35):5381-5389. DOI: 10.1016/j.biomaterials.2007.07.051
- [81] Nudelman H, Lee YZ, Hung YL, Kolusheva S, Upcher A, Chen YC, et al. Understanding the biomineralization role of magnetite-interacting components (MICs) from magnetotactic bacteria. *Frontiers in Microbiology*. 2018;**9**(2480):1-14. DOI: 10.3389/fmicb.2018.02480
- [82] Rawlings AE, Bramble JP, Walker R, Bain J, Galloway JM, Staniland SS. Self-assembled MmsF proteinosomes control magnetite nanoparticle formation in vitro. *Proceedings of the National Academy of Sciences of the United States of America*. 2014;**111**(45):19094-19099. DOI: 10.1073/pnas.1409256111
- [83] Rawlings AE, Somner LA, Fitzpatrick-Milton M, Roebuck TP, Gwyn C, Liravi P, et al. Artificial coiled coil biomineralisation protein for the synthesis of magnetic nanoparticles. *Nature Communications*. 2019;**10**(1):1-9. DOI: 10.1038/s41467-019-10578-2
- [84] Peigneux A, Jabalera Y, Vivas MAF, Casares S, Azuaga AI, Jimenez-Lopez C. Tuning properties of biomimetic magnetic nanoparticles by combining magnetosome associated proteins. *Scientific Reports*. 2019;**9**(1):1-11. DOI: 10.1038/s41598-019-45219-7
- [85] Contreras-Montoya R, Jabalera Y, Blanco V, Cuerva JM, Jimenez-Lopez C, Alvarez de Cienfuegos L. Lysine as size-control additive in a bioinspired synthesis of pure superparamagnetic magnetite nanoparticles. *Crystal Growth & Design*. 2020;**20**(2):533-542. DOI: 10.1021/acs.cgd.9b00169
- [86] Baumgartner J, Antonietta Carillo M, Eckes KM, Werner P, Faivre D. Biomimetic magnetite formation: From biocombinatorial approaches to mineralization effects. *Langmuir*. 2014;**30**(8):2129-2136. DOI: 10.1021/la404290c
- [87] Liu L, Pu X, Yin G, Chen X, Yin J, Wu Y. Biomimetic mineralization of magnetic iron oxide nanoparticles mediated by bi-functional copolypeptides. *Molecules*. 2019;**24**(7):16. DOI: 10.3390/molecules24071401
- [88] Yamagishi A, Narumiya K, Tanaka M, Matsunaga T, Arakaki A. Core amino acid residues in the morphology-regulating protein, Mms6, for intracellular magnetite biomineralization. *Scientific Reports*. 2016;**6**(35670):1-10. DOI: 10.1038/srep35670
- [89] Yamagishi A, Tanaka M, Lenders JJM, Thiesbrummel J, Sommerdijk NAJM, Matsunaga T,

et al. Control of magnetite nanocrystal morphology in magnetotactic bacteria by regulation of *mms7* gene expression. *Scientific Reports*. 2016;**6**:1-11. DOI: 10.1038/srep29785

[90] Rawlings AE, Liravi P, Corbett S, Holehouse AS, Staniland SS. Investigating the ferric ion binding site of magnetite biomineralisation protein Mms6. *PLoS One*. 2020;**15**(2):1-16. DOI: 10.1371/journal.pone.0228708

[91] Nudelman H, Perez Gonzalez T, Kolushiva S, Widdrat M, Reichel V, Peigneux A, et al. The importance of the helical structure of a MamC-derived magnetite-interacting peptide for its function in magnetite formation. *Acta Crystallographica Section D: Structural Biology*. 2018;**74**:10-20. DOI: 10.1107/S2059798317017491

[92] Ubago-Rodríguez A, Casares Atienza S, Fernández-Vivas A, Peigneux A, Jabalera Y, De La Cuesta-Rivero M, et al. Structure-function of MamC loop and its effect on the in vitro precipitation of biomimetic magnetite nanoparticles. *Crystal Growth & Design*. 2019;**19**(5):2927-2935. DOI: 10.1021/acs.cgd.9b00150

[93] Grünberg K, Müller E-C, Otto A, Reszka R, Linder D, Kube M, et al. Biochemical and proteomic analysis of the magnetosome membrane in *Magnetospirillum gryphiswaldense*. *Applied Environmental Microbiology*. 2004;**70**(2):1040-1050. DOI: 10.1128/AEM.70.2.1040-1050.2004

[94] Kuhrts L, Macías-Sánchez E, Tarakina NV, Hirt AM, Faivre D. Shaping magnetite with poly-l-arginine and pH: From small single crystals to large mesocrystals. *Journal of Physical Chemistry Letters*. 2019;**10**(18):5514-5518. DOI: 10.1021/acs.jpcllett.9b01771

[95] Jabalera Y, Garcia-Pinel B, Ortiz R, Iglesias G, Cabeza L, Prados J, et al. Oxaliplatin–biomimetic magnetic

nanoparticle assemblies for colon cancer-targeted chemotherapy: An in vitro study. *Pharmaceutics*. 2019;**11**(8):4-6. DOI: 10.3390/pharmaceutics11080395

[96] Iglesias GR, Jabalera Y, Peigneux A, Fernández BLC, Delgado ÁV, Jimenez-Lopez C. Enhancement of magnetic hyperthermia by mixing synthetic inorganic and biomimetic magnetic nanoparticles. *Pharmaceutics*. 2019;**11**(6):16. DOI: 10.3390/pharmaceutics11060273