

OLEO
47
6
ER-66-38
P. 2

COLLEGE STATE UNIVERSITY
FORT COLLINS, COLORADO

THE USE OF TRACERS IN MAKING ACCURATE
DISCHARGE MEASUREMENT IN PIPELINES

by

R. W. Filmer and V. M. Yevdjevich

October 1966

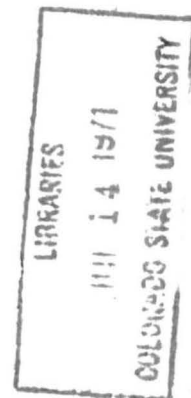

THE USE OF TRACERS IN MAKING ACCURATE
DISCHARGE MEASUREMENT IN PIPELINES

By

R. W. FILMER and V. M. YEVDJEVICH

Prepared under

U. S. Bureau of Reclamation Contract D-293

Denver Federal Center,

Denver, Colorado

ENGINEERING RESEARCH CENTER

COLORADO STATE UNIVERSITY

FORT COLLINS, COLORADO

October 1966

CER66RWF-VMY 38

ABSTRACT

The purpose of this investigation was to provide some field data for the diffusion of a soluble tracer (Rhodamine W-T) in pipes. Nine parameters were selected and their effect on tracer concentration distribution was studied. The most important parameters varied were: water discharge through the pipe, mixing distance and the injection probe geometry.

The experiments were conducted in a 36-inch pipe line where it was possible to vary the rate of flow and mixing distance. Uniformity of the rate of dye injection was insured by the use of a Chemcon Model 1110 chemical proportioning pump which could be manually adjusted while a radial arm, some distance downstream from the injection point, could sample the solution at different positions in a cross-section. A Turner model 111 fluorometer constituted the detection device which combined the advantages of high sensitivity in dye detection, ruggedness and nearly complete independence from the power supply voltage.

The degree of uniformity of mixing of the soluble tracer is represented by C_v , which is the coefficient of variation of the tracer concentration distribution. Values of C_v , calculated from the observed concentration data for each flow rate, were fitted by the function $C_v = Ke^{\alpha z}$ by the method of least squares, where z is the mixing distance and K and α are constants.

ACKNOWLEDGMENT

The investigation of this report was sponsored by the U. S. Bureau of Reclamation. The following students are recognized for having participated in the experiments carried out under this project: Messrs., A. KandaTa, J. Safai and S. Su. Appreciation is also extended to Miss Beryl Olson for typing the final report.

TABLE OF CONTENTS

Chapter		Page
I.	INTRODUCTION	1
II.	PROJECT OBJECTIVES AND VARYING PARAMETERS	3
	A. Objectives	3
	B. Varying Parameters	3
	C. Procedure in the Investigations	4
III.	RESEARCH FACILITIES, EQUIPMENT AND INSTRUMENTATION	6
IV.	EXPERIMENTAL PROCEDURE	31
V.	ANALYSIS AND PRESENTATION OF DATA	34
	Analysis of accuracy in distribution of dye concentration	50
APPENDIX A	PLANS FOR THE RADIAL ARM AND SAMPLING PROBE	59
APPENDIX B	TABULATION OF TRACER CONCENTRATION DATA	66
APPENDIX C	METERING DEVICE TESTS	87

Remark:

References related to the study, "The Use of Tracers in Making Accurate Discharge Measurements in Pipelines," are included in the bibliography report on dilution discharge measurement methods. Therefore, no references are included in this report.

THE USE OF TRACERS IN MAKING ACCURATE DISCHARGE MEASUREMENT IN PIPELINES

By

R. W. Filmer and V. M. Yevdjovich

I. INTRODUCTION

In 1863, Schloesing injected an ammonium sulphate solution into a river in France and computed its flow rate by determining the amount of dilution that took place. Since then, this indirect method of flow measurement has been used countless times all over the world. Modern techniques have greatly improved the overall accuracy of the method and have made very precise measurements of streamflow and pipeflow possible.

Crude discharge measurements can be inexpensively and easily obtained by the tracer-dilution method. Greater precision calls for greater expense and more time; it also requires more sophisticated techniques. However, these are often warranted, particularly when no other method can be utilized which will procure the desired accuracy. For instance, such techniques may be necessary in modern hydroelectric plants where the energy of flowing water is converted into mechanical energy by hydraulic turbines, or in modern pumping plants where the electric energy is converted by pumps into the energy of flowing water. The discharge or flow of water through the turbine or pump is used to calculate turbine or pump efficiency, to schedule releases of water, to determine the amount of water diverted into various irrigation systems and sometimes to determine total streamflow. The desired measurements can be made by injecting a soluble substance into the penstock (pipe) leading from the reservoir to the turbine or from the pump to the reservoir or canal and subsequently by measuring its concentration at a location where it is well mixed. The discharge

may then be calculated by determining the amount of dilution that has occurred. Several modifications of this procedure (e.g., total count method) are described in the literature and are commonly used. The fundamental requirement, regardless of which method is used, seems to be that the soluble substance be very well mixed with the water. The overall accuracy can be no better than the accuracy with which the diluted concentration is determined. If the soluble substance is well-mixed, perhaps one sample taken from the pipe is sufficient. However, if variations across the pipe section occur with time because of poor mixing, more samples are required and the accuracy of the determination suffers.

The purpose of this project was to determine the effectiveness of natural turbulence in large pipes in producing a high degree of uniformity in the concentration of solute in a cross-section downstream from the point of injection. Such information is vital in estimating the feasibility of the tracer-dilution discharge measurement method where high accuracy is needed.

II. PROJECT OBJECTIVES AND VARYING PARAMETERS

A. Objectives

The objectives of the investigations described in this report were:

1. To characterize the time and space distribution of the soluble tracer in a full flowing pipe.
2. To determine what statistics of this space-time distribution best describe the degree of uniformity of mixing. (The following statistics were investigated as indices of diffusion: C_v , s^2 , skewness, kurtosis, $\frac{C_{\max}}{C}$, and statistics of space-time correlations.)
3. To determine the optimum injection system, in terms of the uniformity criteria selected above, including the optimum location(s) of the injection probe(s) and to obtain a given degree of mixing in a given length of pipe.
4. To relate the uniformity of mixing to the head loss for the length of pipeline traveled by the diffusing tracer.

B. Varying Parameters

In order to determine the optimum injection system, nine parameters or variations were selected and their effect on dye dilution was studied. These parameters or variations were:

1. The method of tracer injection. The method was changed and varied so that the effect of each method could be determined.
2. Injection probe geometry. Injection locations were varied to locate the optimum point of injection for a single probe, simulating a point source.

3. Water discharge through pipe. This was an important parameter.
4. Mixing distance. The distance between the injection and sampling points was another important parameter.

The following parameters were considered for potential variation, but were assumed as constants during experimentation:

5. Slope of the pipeline. For a fully developed pipe flow, the slope of the pipe was not a factor that affected the turbulence of the mixing process.

6. Water temperature. Temperature was almost constant, because all the water supplied to the pipeline was taken from Horsetooth Reservoir.

7. Tracer discharge. This flow rate was negligible compared to the flow rate of water and was eliminated as a variable parameter. However, the flow was slightly varied to accommodate different flow rates and tracer concentrations, the only restriction being that the flow be a precisely controlled "constant."

8. Tracer temperature. It could be assumed as constant for all practical purposes.

9. Tracer concentration. It was kept constant for each run of the experiment.

C. Procedure in the Investigations

Distribution of the soluble tracer in time and space is described below. The mean of time variation is given for each coordinate (r, θ, z) to describe the concentration distribution at any given pipe cross-section (where, z is fixed). The coordinates are: r = radial distance of a point in a cross-section from the center of the pipeline, θ = the angle from the vertical axis, and z = position of the cross-section along the pipe, measured from the tracer injection point.

Anyone of the previously mentioned indices of concentration distribution -- namely, s/\bar{c} (standard deviation of concentration distribution over a cross-section divided by the mean concentration), c_{\max}/\bar{c} (the maximum concentration divided by the average concentration), or others -- are the mean indices in characterizing the non-uniformity of concentration distribution over a given cross-section.

Using these criteria for uniformity of mixing, the procedure was to determine the optimum location for a single injection probe by varying the flow rate and the injection position while sampling at just one cross-section. Once this optimum point had been determined, data was obtained for uniformity of mixing as a function of head loss and mixing distance.

III. RESEARCH FACILITIES, EQUIPMENT AND INSTRUMENTATION

The tests were conducted in a 36-inch pipeline, 800 feet in length, located in the Outdoor Hydraulics Laboratory of Colorado State University, Fort Collins, Colorado, (see figure 1). Large quantities of water were available from Horsetooth Reservoir above the laboratory. The water was subsequently discharged into College Lake which was a small storage reservoir making up part of the laboratory complex. The 36" experimental pipe facility was connected to a 24" pipe at its upstream end and the control valve was located in this 24" line. Downstream from the control valve there was an orifice position. Three orifices (small, medium, and large) were used. They were gravimetrically calibrated accurate to 1 percent. Immediately downstream from the enlargement to the 36" pipe were a series of straightening vanes and a set of turbulence grids. The first dye injection station was located 38 diameters downstream from the turbulence grids. Because of the constant head available from Horsetooth Reservoir, it was possible to maintain a constant discharge of water through the pipe and to measure this discharge quite accurately with the calibrated orifices. Dilution discharge measurements made during the course of the investigation showed excellent agreement with orifice measurements.

As a result of the injection of a soluble tracer of uniform concentration into the pipe at a constant rate for a constant flow rate through the pipe, the downstream concentration of the diffused tracer became a function of time, mixing distance, position in the cross-section, and the turbulence occurring in the pipe. Uniform turbulence was assured by a series of straightening vanes and a set of turbulence grids installed at the upstream end of the pipe.

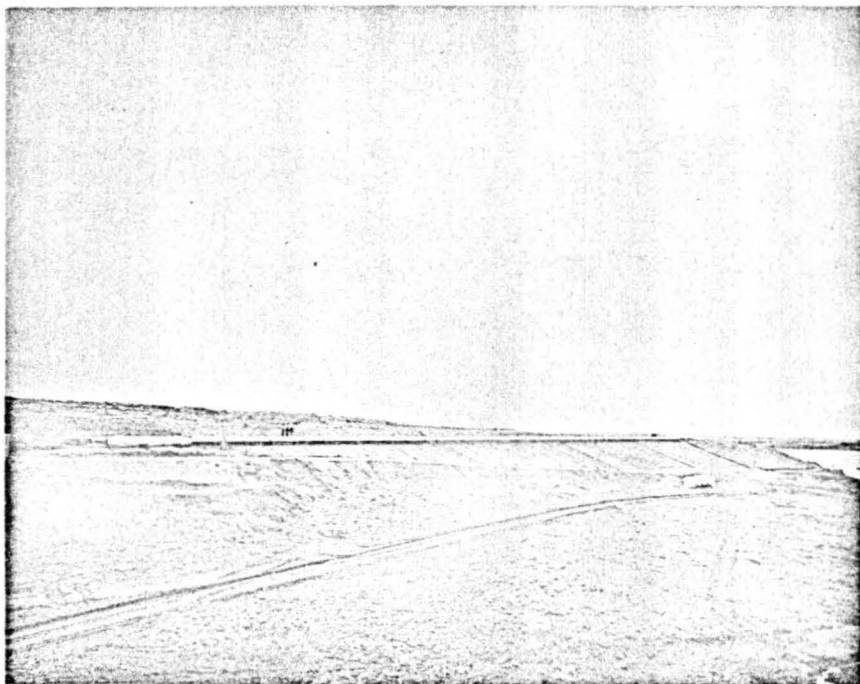

Fig. 1. 36-inch pipeline

A relatively constant injection rate of dye was achieved by the use of a Chemcon¹ model 1110 chemical proportioning pump equipped with a back pressure valve and a polyvinyl chloride head. No metering device delivers an absolutely constant flow rate and in this case the flow rate varied over a range of about ± 1 percent although the variance about the mean was quite small. The dye injection pump is shown in figure 2. The provision for adjustment by means of a control dial located on the right hand side of the pump should be noted. This made it possible to change the injection rate while the pump was in operation.

The Chemcon pump combined the advantages of a diaphragm pump and a piston pump. Its diaphragm is mechanically activated by a variable stroke cam which can be adjusted by a vernier dial. The pump cannot short stroke, air bind, or lock; and consistent displacement is maintained by the use of a rigid backing plate attached to the cam follower. Ball type automatic valving is used to insure precise metering. The manufacturer's claims of instrument-like accuracy of ± 0.5 percent from 5 to 100 percent of rated capacity seem to be somewhat exaggerated, but the pump did perform far better than did any other device tested (see appendix C) and proved satisfactory for this study.

In order to be sure that the pump was operating properly and to determine if any corrections were necessary, the dye flow rate was measured by means of a Brooks² ELF turbine flowmeter shown in the center of the instrument board in figure 3. The output of the turbine flowmeter

¹Chemcon In., 8 Industrial Park, Medfield, Mass.

²Brooks Instrument Division, Emerson Electric Company, 407 Vine, Hatfield, Pa.

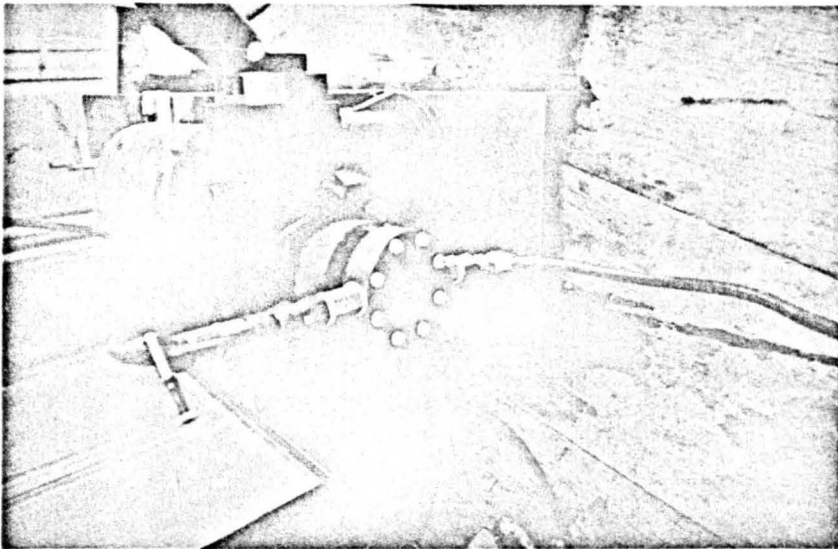

Fig. 2. Dye injection pump

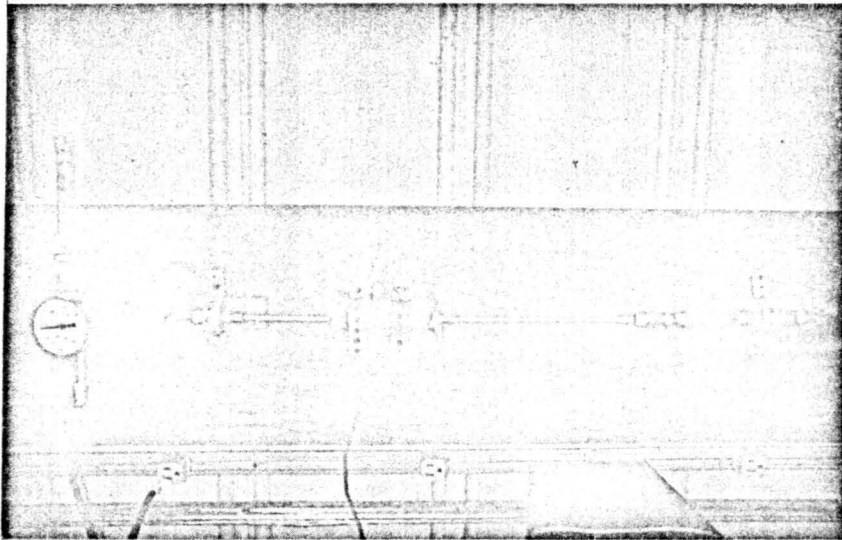

Fig. 3. Brooks ELF turbine flowmeter

was in the form of a pulsating D.C. signal which was fed into a Brooks model 4753 frequency to D.C. analog converter. The D.C. output from this converter was directly proportional to the flow rate and was fed into a Mosely 680 recording voltmeter, making it possible to monitor the dye flow rate continuously. Any necessary corrections were made by adjusting the pump and observing the effect of the induced change in order to avoid the possibility of overcorrection.

The entire system is shown in figure 4. The converter and recording voltmeter are on the table facing the operator. At the left are two water cans for storing dye and water. A manifold with a 3-way valve made it possible to switch from water to dye or from one dye concentration to another with comparative ease. The manifold was connected to the inlet side of the pump which appears underneath the table in that same figure. The discharge from the pump led to a pair of in-line filters shown on the right with a pore size in the range of 150-200 microns and 50-129 microns, respectively. This precaution was necessary because of the small size of the passageways in the turbine flowmeter. Immediately to the left of the turbine meter is a thermometer well for the determination of dye temperature.

After temperature determination, the dye then passed through a short length of PVC tubing to a stainless steel injection probe mounted in the pipeline immediately behind the instrument shack, as shown in figure 5. The injection probe was $\frac{3}{4}$ of an inch in diameter with a $\frac{1}{4}$ inch wall, an adapter at one end for connection to the plastic tubing and a specially constructed orifice at the other end, as shown in figure 6. The orifice simulated a point source condition and was used to introduce

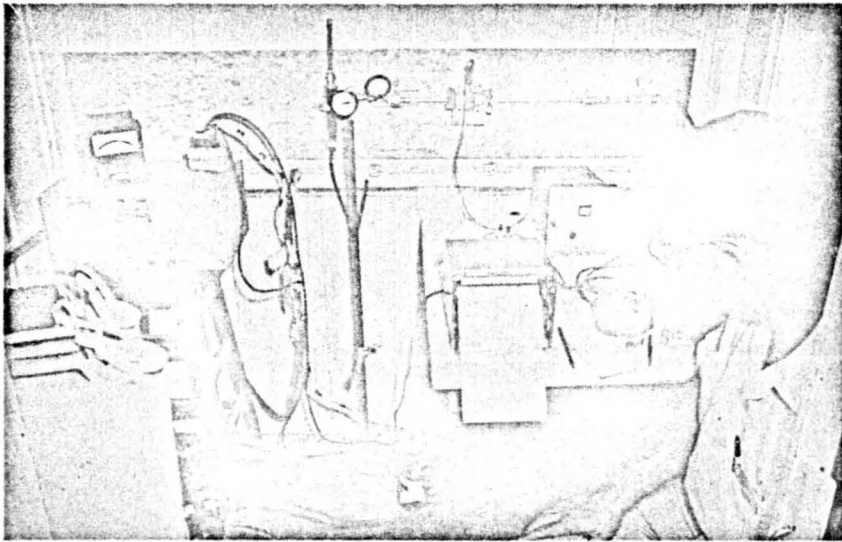

Fig. 4. Dye injection system

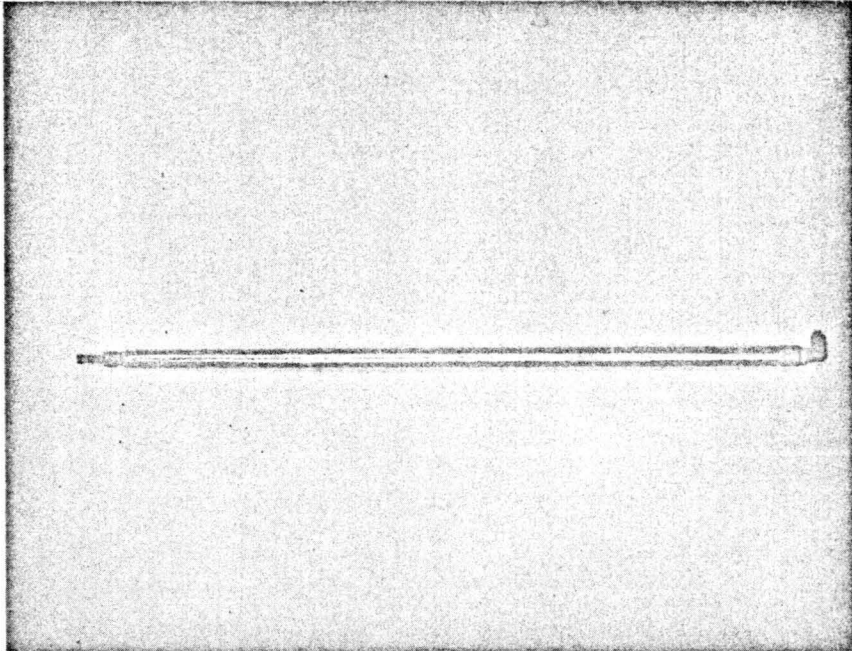

Fig. 5. Injection probe

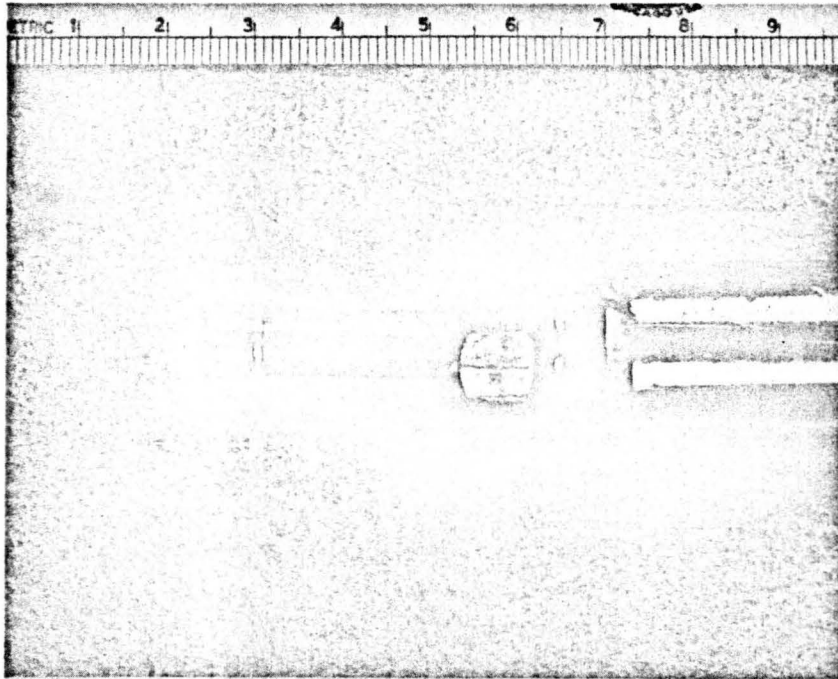

Fig. 6. Orifice detail

the dye into the pipe at pipeline velocities or at higher velocities. Several different orifice configurations were tested and this one proved the simplest to fabricate and the easiest to use. A 3/8 inch copper-tubing-to-pipe adapter was threaded into the stainless steel probe. A short piece of thin wall brass tubing was drilled out on one side with a 3/16 inch drill about 1 inch from the end. This provided an access and observation hole which enabled the watchmaker to drill a sharp, clean hole on the opposite wall using a no. 78 drill (.016 inch). This hole was cleaned and polished to produce a sharp edged orifice, and the access hole was then closed with silver solder and one end of the brass tubing was capped. The tubing was then inserted into the adapter, resulting in a leakproof orifice assembly with the dye jet issuing at right angles to the axis of the probe. The whole assembly was such that it could be inserted into the pipe through a compression gland while the water in the pipe was flowing. The compression glands which held the probe were 3/4 inch copper-tubing-to-pipe compression adapters, drilled through to a full 3/4 inch diameter with the brass ferrules replaced by O-rings. These glands, or injection ports as referred to herein, were installed at strategic points along the length of the pipe and could be used either for dye injection or piezometric measurements.

A constant source of voltage was maintained in the dye shack by a Sorensen 115V, 1 KVA voltage regulator and all instruments including the pump were connected to this power source. The Brooks flowmeter was calibrated by means of a 2000 gram Mettler automatic balance shown at the left of figure 17.

Shown in figure 7 is a perspective view of the pipe facility which operates on the gravity flow principle. The flow was controlled by a large valve on the upstream end and virtually all of the head loss occurred there. The gate at the downstream end of the pipe, figures 7 and 8, was used to adjust the water elevation so that the pipe would flow full at any given flow rate.

Visible in figure 7 in the background is a dark colored storage building. Immediately to the left is a small instrument shack where the dye injection equipment just described was housed. To the left of this building and centered over the pipe is a second white building which was used to house the concentration sampling device and related instrumentation.

The interior of this building is presented in figure 9 which shows 7 plastic tubes issuing from a circular hole in the floor in the right foreground. These tubes lead from the sampling device located in the pipe to a valve manifold mounted on a board at the right of the building. Each tube terminates at a 3-way valve so that the flow of water may go to a waste-line or it may pass through the concentration detection device, in this case a Turner³ Model 111 fluorometer immediately to the right of the technician at about chest height.

The Turner fluorometer utilizes an optical bridge, analogous to a Wheatstone Bridge, which measures the difference between light emitted by an excited sample of fluorescent material and a calibrated light path. A mechanical chopper permits a photocell to receive light alternately from the sample and from the calibrated light path. First,

³G. K. Turner Associates, 2524 Pulgas Avenue, Palo Alto, California

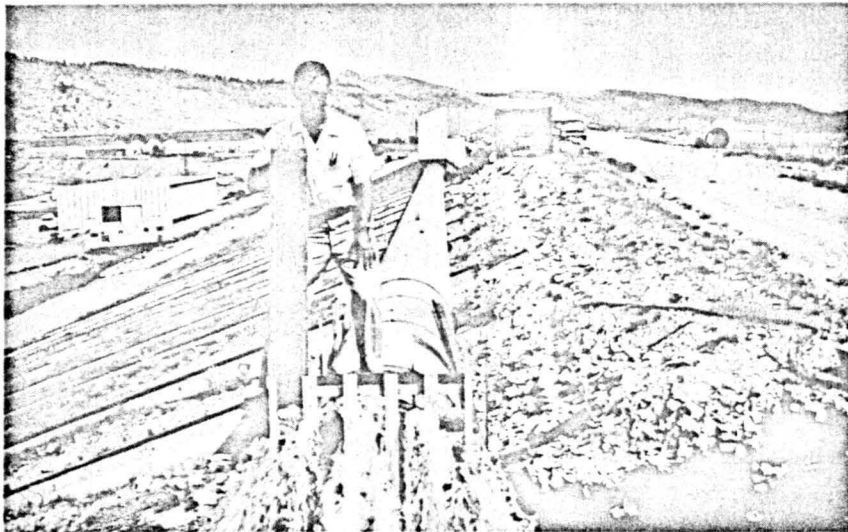

Fig. 7. Perspective view of the pipe facility and downstream pipe gate



Fig. 8. Downstream pipe gate

the output of the photomultiplier is amplified and received by a phase sensitive detector, the polarity of the output of which depends upon which light path has an excess of light. Then, the output of the phase detector operates a servo-mechanism which rotates a diffusion screen thereby balancing the amount of light in both light paths. The quantity of light required in the rear path to balance that from the sample is indicated by a fluorescent dial attached to the servomotor. Variations in the light source caused by aging of the ultra violet light source (used to excite the fluorescent material) and by line voltage and frequency changes do not affect the light balance since they affect the light on the sample and in the calibrated path proportionately; also changes in the photomultiplier cancel similarly. This instrument is equipped with a standard door opening into a chamber where a test tube containing the sample may be inserted. The door is then closed and the reading taken. When it is desirable to continuously monitor a concentration, as was done in this study, the door can be removed and replaced with a continuous-flow door equipped with a closed test tube or "cuvette" and fittings for attaching pipe or tubing. The latter combination is shown in figure 9. Then the water can be pumped from the manifold into the fluorometer and then through the variable area flowmeter shown to the left of the fluorometer.

The sampling device which was mounted inside the 36" pipe directly under the building is shown in figures 10 and 11. The so-called fluorometer shack was mounted over a square junction box in the pipe and the sampler was attached to this box or manhole. In figure 10, the view shown from inside the manhole directly under the shack and looking upstream. The plastic tubes shown connected the manifold with the



Fig. 9. Interior of white building

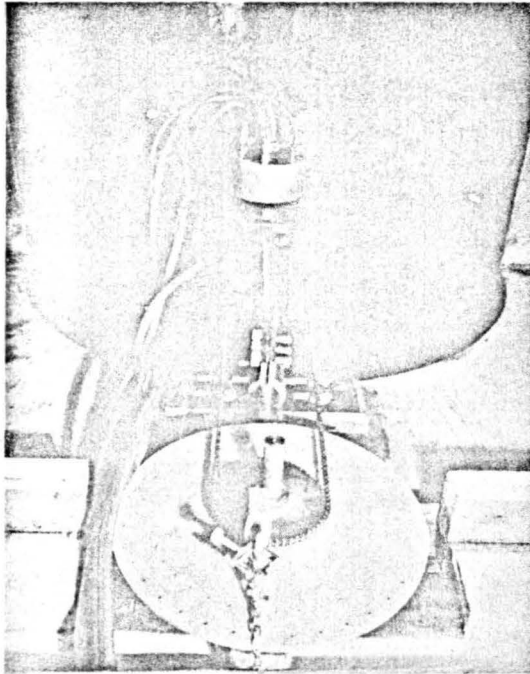

Fig. 10. Sampling device

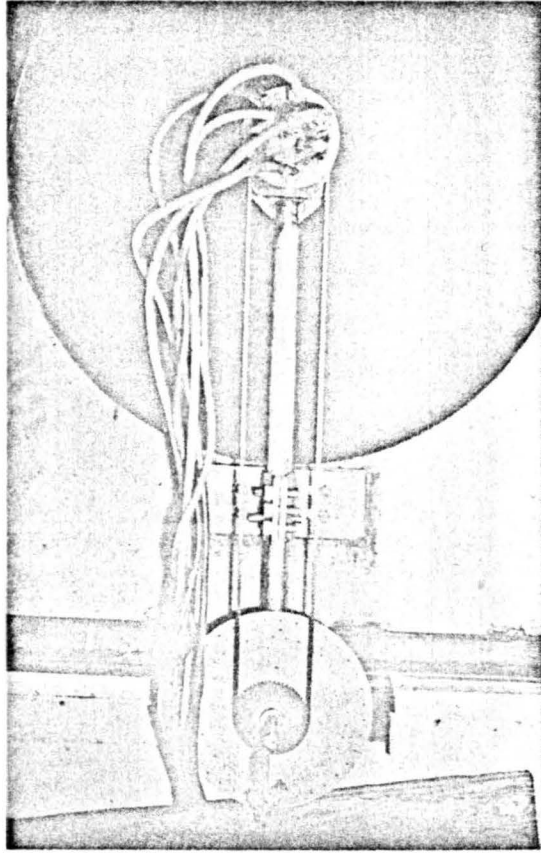

Fig. 11. Sampling device

concentration samplers, (a series of brass tubes which led through a hollow rotating shaft to a rotating radial arm, and then projected into the flow at various radial positions). Figure 12 shows the sampler as seen from inside the pipe looking downstream toward the manhole. The sampler tubes were located in such a way as to sample equal areas of the cross-section of the flowing fluid. The rotating arm was adjusted by means of the handwheel and chain drive shown in figures 10 and 11 and could be positioned at 5° intervals. Plans for this device may be found in appendix A.

Piezometric head was measured by inserting lengths of 3/4" acrylic tubing into the injection ports, as shown in figure 13.

A considerable amount of laboratory work was necessary in order to calibrate the fluorometer and to determine the concentration of the fluorescent dye and, occasionally, of the diluted samples taken from the pipe. High concentrations of dye cannot be measured accurately in the fluorometer and it is necessary to dilute it first by a factor of about 10^{-6} to 10^{-8} . Samples in this range were also used for calibration of the standard and continuous-flow doors. These were calibrated up to a concentration of about 50 ppb.

A UV green lamp T-5⁴ envelope was used with the fluorometer for excitation of fluorescent material. This lamp had a continuous emission from 520 millimicrons to over 560 millimicrons. Two primary filters⁵ were used: First, a narrow pass filter, color specification #58 which

⁴Turner #110-854

⁵Turner #110-822 and #110-814 respectively

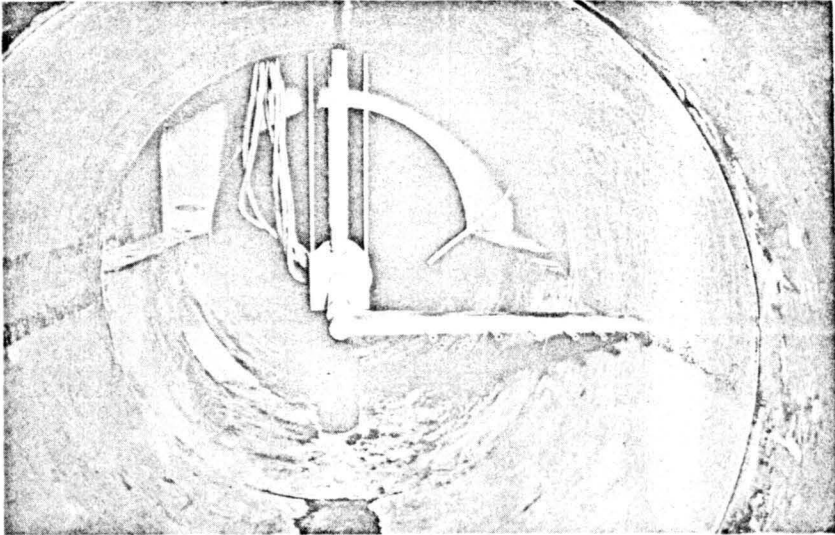

Fig. 12. Sampler

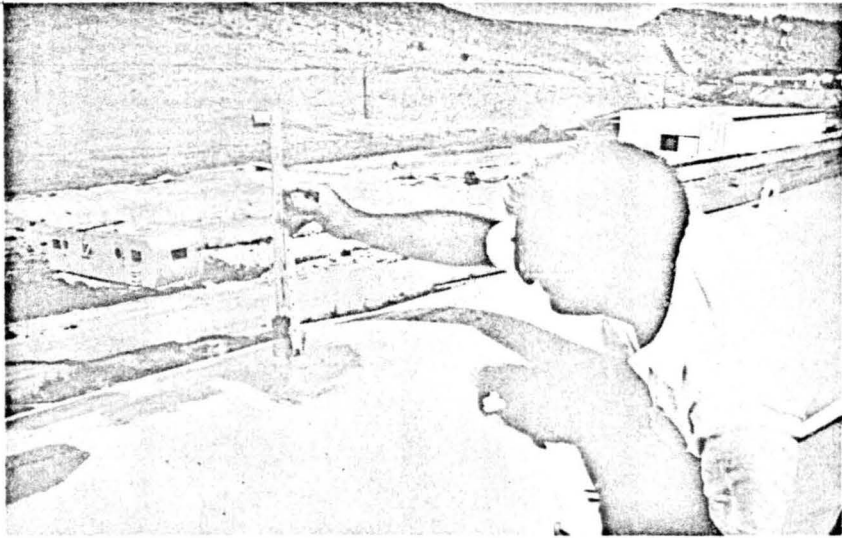

Fig. 13. Piezometer

peaks at 525 millimicrons together with a narrow pass filter, color specification #1-60, the two forming a narrow pass filter at 546 millimicrons; second,⁶ a sharply cut filter, color specification #23 A, which passes wave lengths longer than 570 millimicrons. These filters gave a very high sensitivity at the expense of some selectivity. However, the water used in the experiments was reservoir water relatively free from impurities, and therefore selectivity was not an important factor.

The fluorometer is shown in figure 14 with the continuous-flow door. The continuous-flow door was a Turner Model 110-870 with a 20 cc cuvette. In order to achieve maximum accuracy in the serial dilutions (see fig. 15), gravimetric rather than volumetric techniques were utilized. Since no satisfactory weighing pipettes were available commercially, it was necessary to develop the CSU weighing pipette as shown in figure 16. Dye was sucked up into the sphere and held there by a ball-tube seal attached to the glass tubulature. The entire pipette was held in a 50 ml. pyrex Erlenmeyer flask to permit precise weighing without having to contend with evaporation problems. Figure 17 shows the weighing procedure utilizing a Mettler precision balance. The automatic Mettler balance shown on the left in figure 17 is a 2000 gram capacity model used to calibrate the dye-injection equipment.

Other equipment used included numerous containers, barrels, buckets, and transfer pumps for mixing and storing the fluorescent material. The fluorescent material used was Rhodamine W-T red fluorescent dye available from the E.I. Du Pont Co. This has a high fluorescence and is not readily absorbed on surfaces.

⁶Turner #110-824

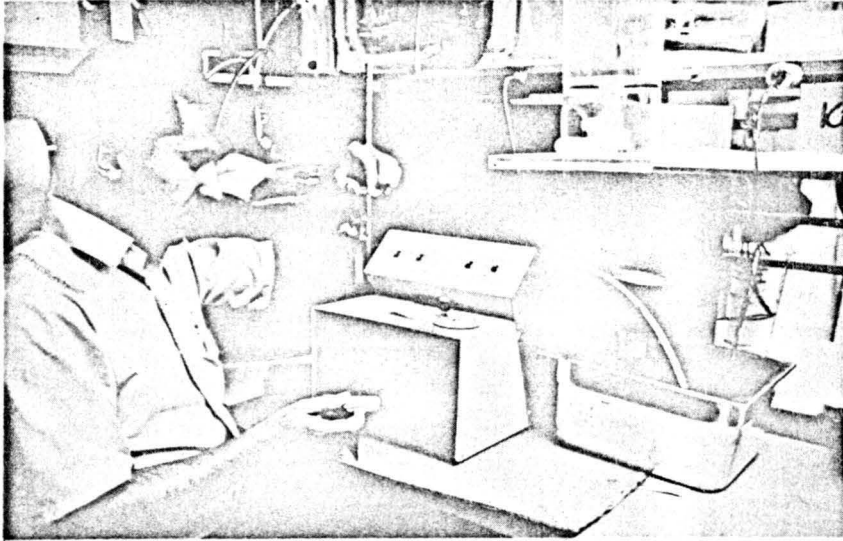

Fig. 14. Fluorometer

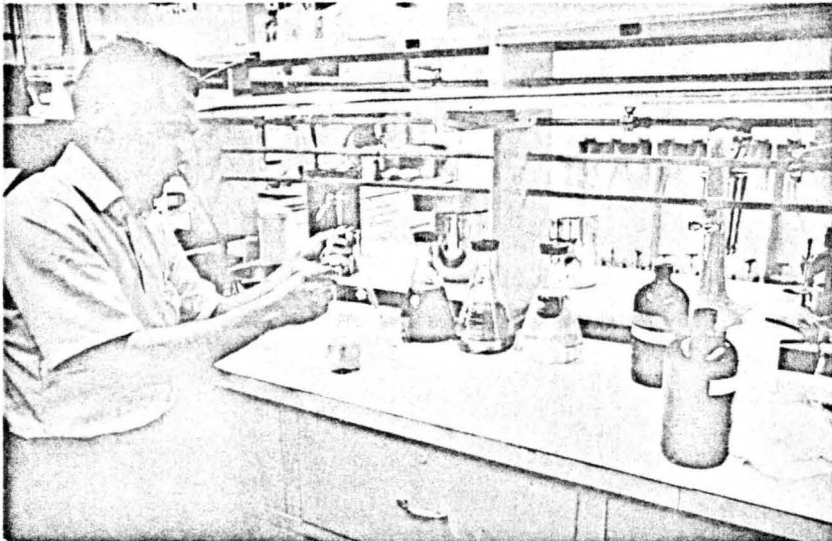

Fig. 15. Gravimetric dilution

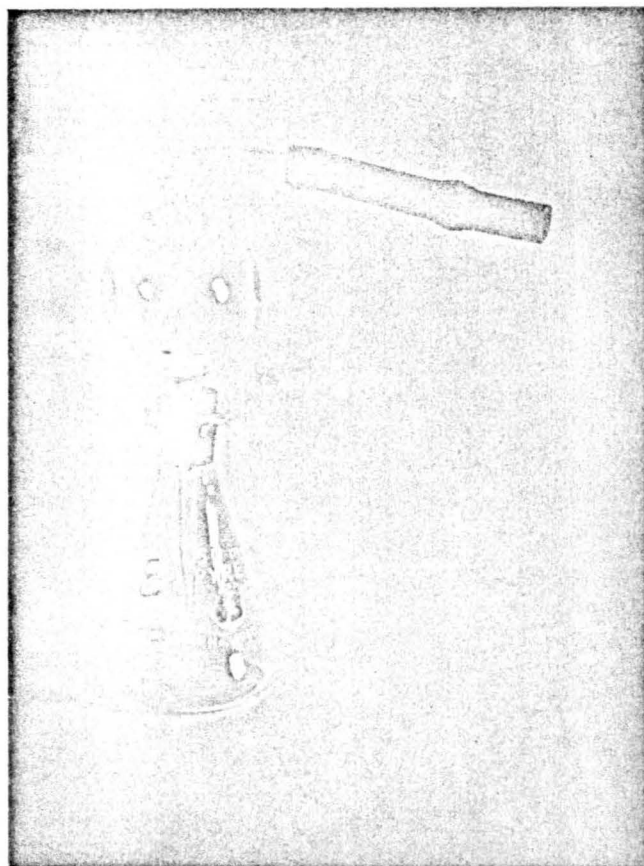

Fig. 16. C. S. U. weighing pipette

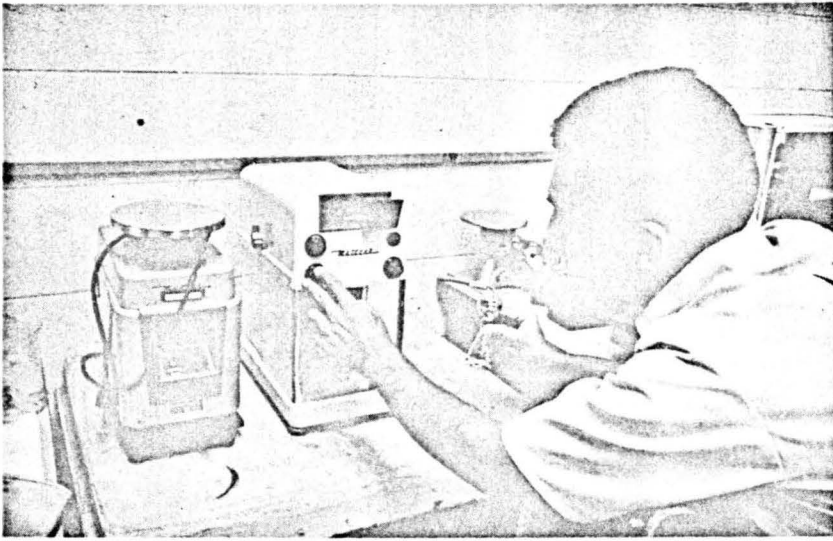

Fig. 17. Mettler precision balance

IV. EXPERIMENTAL PROCEDURE

The sampling station was permanently located in a manhole approximately 200 feet or about 65 pipe diameters from the outlet of the pipe. Injection points were taken at 27.1, 47.3, 74.5, 139.3, and 183.7 diameters upstream from the sampling station.

A series of runs were made at the 74.5 diameter station to determine the optimum probe position. The flow rate was held at 7.7 and 42 cfs and the outlet of the injection probe was placed at the centerline ($r = 0$) and at $r = 0.5 R$, $0.8 R$, and $0.9 R$ above the centerline on the vertical diameter (R refers to the radius of the pipe). The data were subsequently analyzed and it was found as per speculation that the optimum probe position was at the centerline.

All subsequent runs were made using the centerline injection. Run 21 was made under the same conditions as run 20 but using a foot-long extension at the bottom of the probe to keep the injected stream of dye out of the main wake turbulence zone of the probe. There was no substantial difference in mixing, and all subsequent runs were made using the orifice shown in figure 6.

At each injection station runs were made at 7.8, 33, 42, 54, and 61 cfs while injecting at the centerline. Sampling was done at the 7 radial positions which give equal areas, i.e., 4.688, 8.125, 10.438, 18.375, 14.000, 15.000, and 16.875 inches from the centerline. The runs at 7.8, 33, 42, and 61 cfs were made utilizing 4 angular positions, namely 0° , 90° , 180° , and 270° , i.e. along the horizontal and vertical diameters

giving a total of 28 points in space. The runs made at 54 cfs utilized angular positions taken every 30° for a total of 84 points in space.

At the 74.5 diameter station, a 35 minute run was made on a single sampler to determine the degree of stationarity of concentration as a function of time. This was analyzed and it was determined that a two minute sampling time would be reliable for most conditions. Subsequently the sampling time was reduced to one minute for the larger mixing distances, where the time fluctuations were smaller.

Piezometer measurements were also taken so that the mixing could be correlated with the head loss or the Darcy-Weisbach friction factor. Figure 18 shows a sketch of the location of the piezometers, as well as the pipe line profile and the location of various dye injection periods and the sampling cross-section.

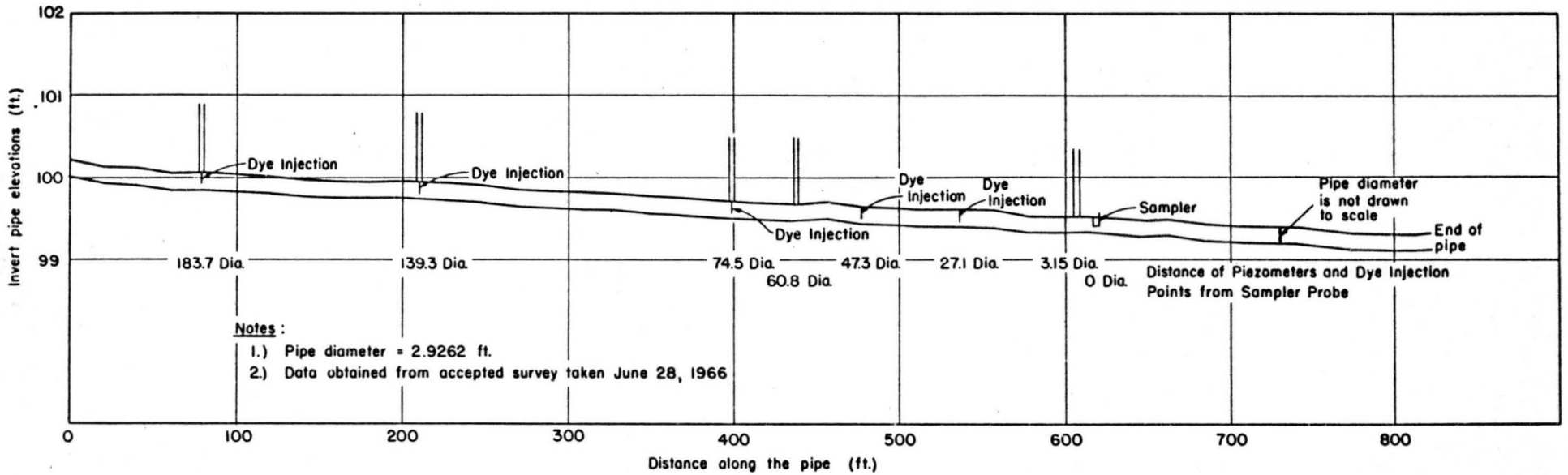

Fig. 18. Pipe profile

V. ANALYSIS AND PRESENTATION OF DATA

The 35 minute run, made at one sampling position, was analyzed by graphically integrating the fluorometer reading as a function of time for various periods of time, T:

$$\bar{v} = \frac{1}{T} \int_0^T V(t) dt = \frac{1}{T} \sum_{i=1}^n N_i(t) \Delta t .$$

These average readings were plotted in figure 19 versus time in order to determine the period in which the function becomes stationary, and if any long-term transients are present. From these results, it was concluded that a two-minute sampling time would be adequate for most of the sampling positions. The data in the form of fluorometer readings, over two-minute or one minute sampling periods, were then analyzed by graphically obtaining the average over the period T.

From the fluorometer calibrations, values were obtained for the concentrations corresponding to these mean fluorometer readings. Since the samples in space represented equal areas, these were weighted equally and the mean and variance were computed for each run. The standard deviation was then divided by the mean in order to obtain the coefficient of variation which was used to standardize all runs to a mean of unity and to provide an indication of how well the lateral mixing process had taken place. The data for each sampling position are tabulated in Appendix B. For each flow rate, the values of coefficient of variation, C_v , as a function of mixing distance, z, were fitted by the function $C_v = K e^{\alpha z}$ by a least squares fit. Initially, it was attempted to put this equation in the form $\text{Log } C_v = \text{Log } K + \alpha z$. However, the least square fit in the

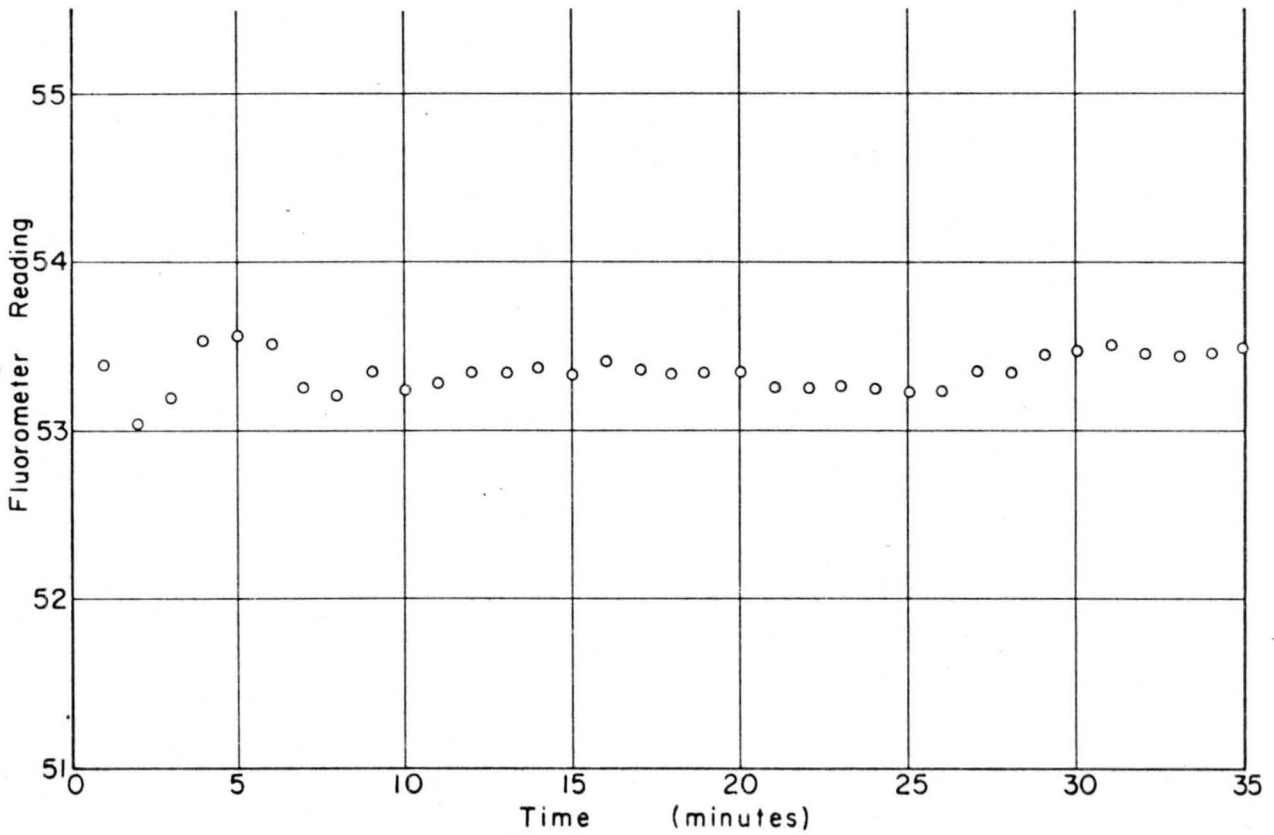
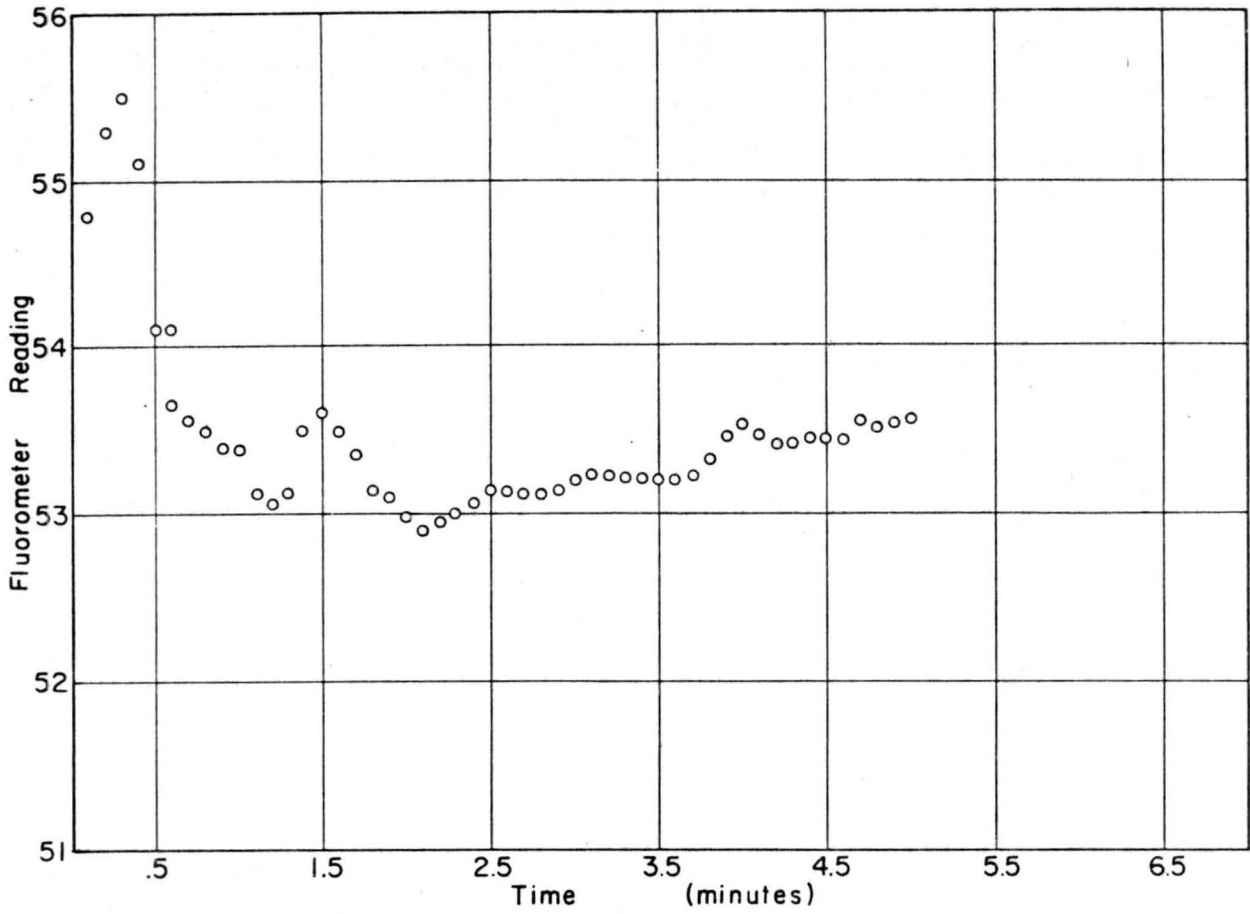

Fig. 19. Average fluorometer reading versus time

linearized variables placed undue weight on the smaller values of C_v and gave a fit which was unreasonably different from an eye fit. Utilizing the Bolzano process of iteration, a least squares fit was obtained for the exponential function by means of a computer determination. These results are shown in figures 20, 21, 22, 23, and 24. The data from the runs made at 54 cfs were then analyzed, using 28, 56, and 84 points to determine the effect of number of data on C_v . These results are given in table 1.

Table 1

COEFFICIENT OF VARIATION, C_v , VERSUS THE NUMBER OF SAMPLING POINTS

Run No.	Number of Points			
	28	56	56	84
	A	B	C	D
15	.1663	.1521	.1847	.1700
20	.0377	.0178	.0408	.0339
21	.0280	.0212	.0339	.0282
25	.0217	.1081	.0241	.0212
31	.3259	.3039	.3308	.3152
36	.5216	.5036	.5232	.5109

SAMPLING SETTINGS

Column A: 0° , 90° , 180° , 270° B: 0° , 30° , 60° , 90° , 180° , 210° , 240° , 270° C: 0° , 90° , 120° , 150° , 180° , 270° , 300° , 330° D: 0° , 30° , 60° , 90° , 120° , 150° , 180° , 210° , 240° , 270° , 300° , 330°

In addition to statistical parameters describing the degree of mixing, a graphical result was desired which would describe at least qualitatively the pattern of tracer distribution in a given cross-section. A

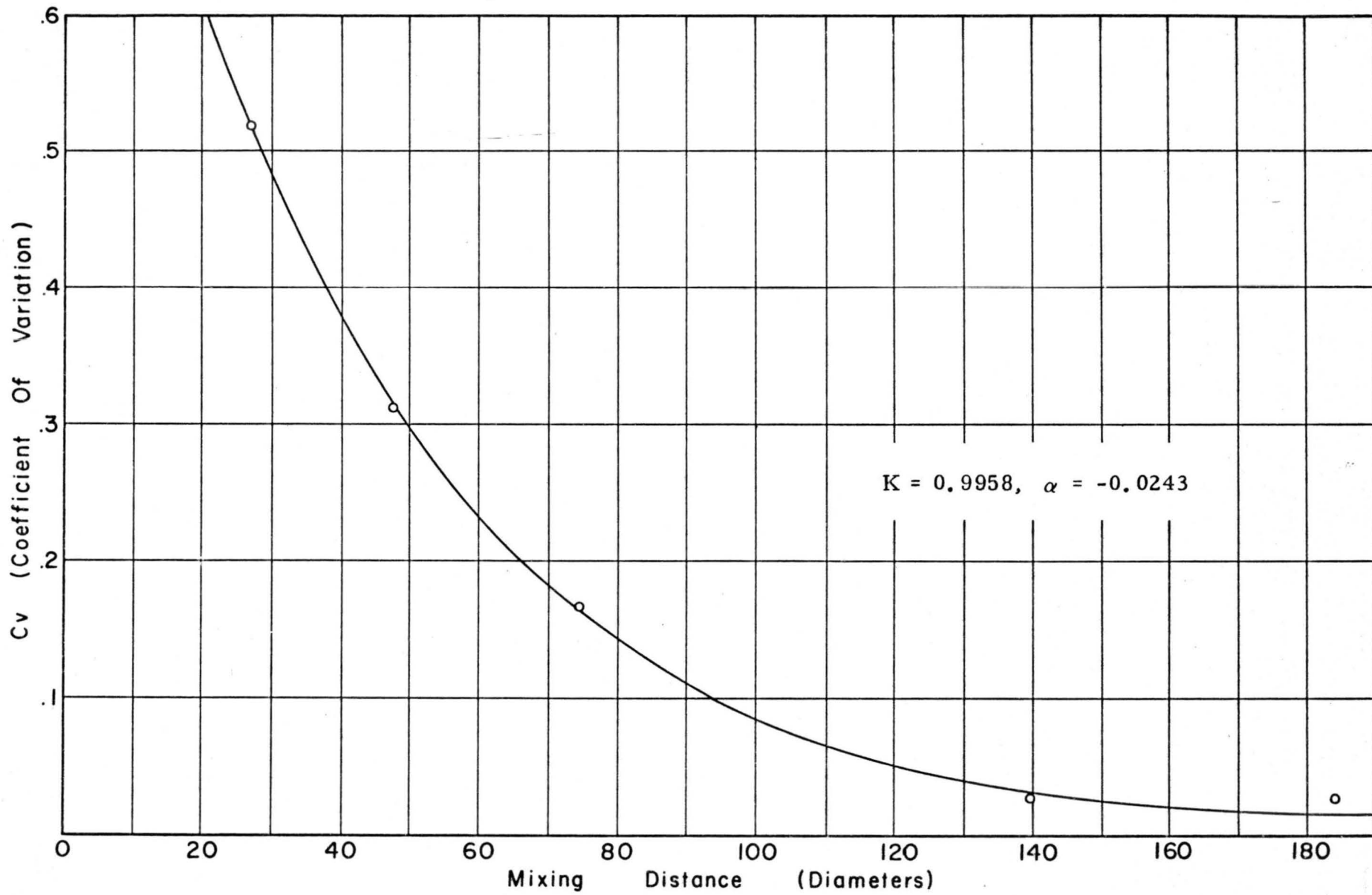

Fig. 20. Coefficient of variation vs. mixing distance for $Q = 42 \text{ CF/s}$

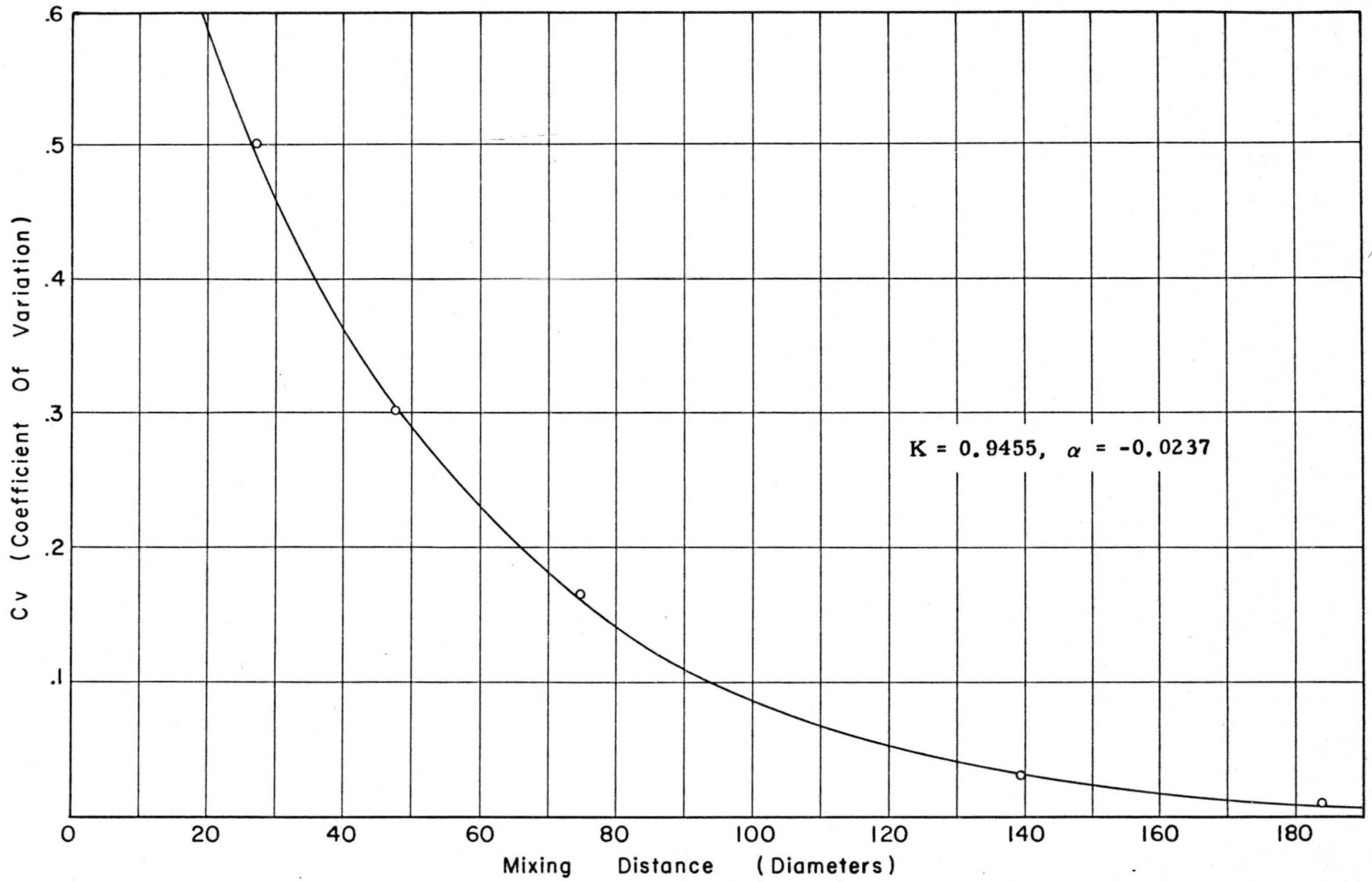

Fig. 21. Coefficient of variation vs. mixing distance for $Q = 61$ CF/s

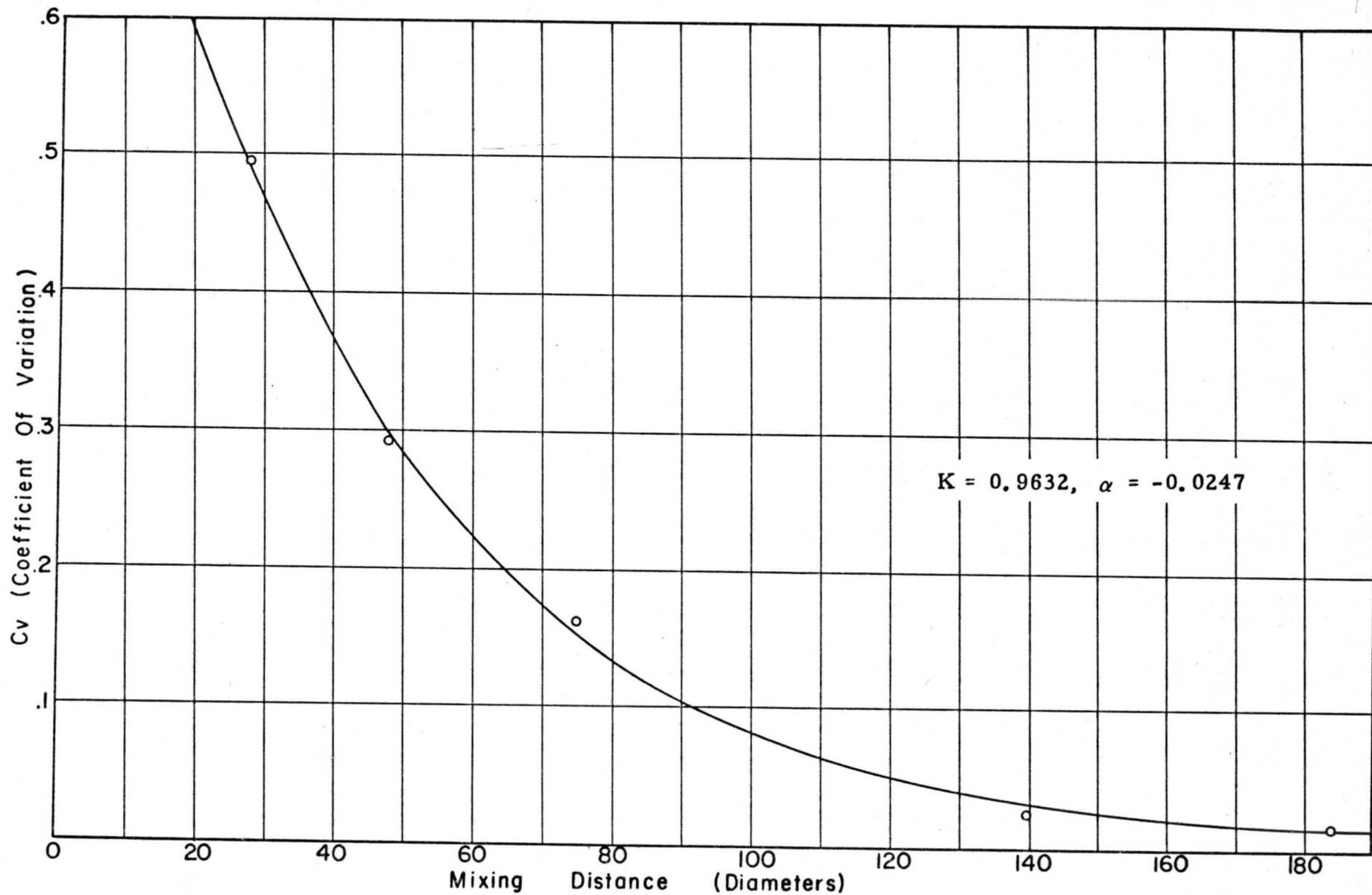

Fig. 22. Coefficient of variation vs. mixing distance for $Q = 33$ CF/s

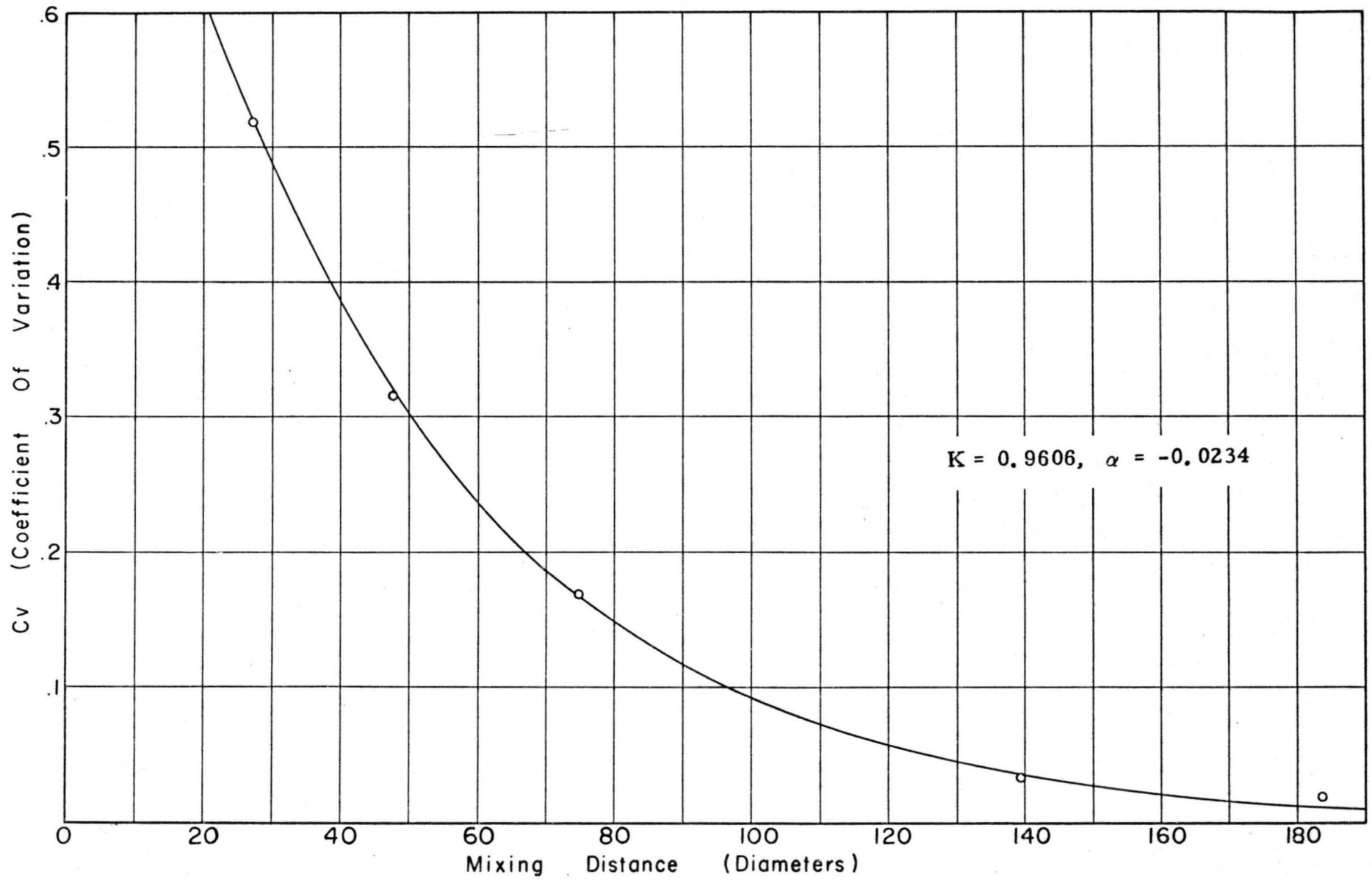

Fig. 23. Coefficient of variation vs. mixing distance for $Q = 54$ CF/s

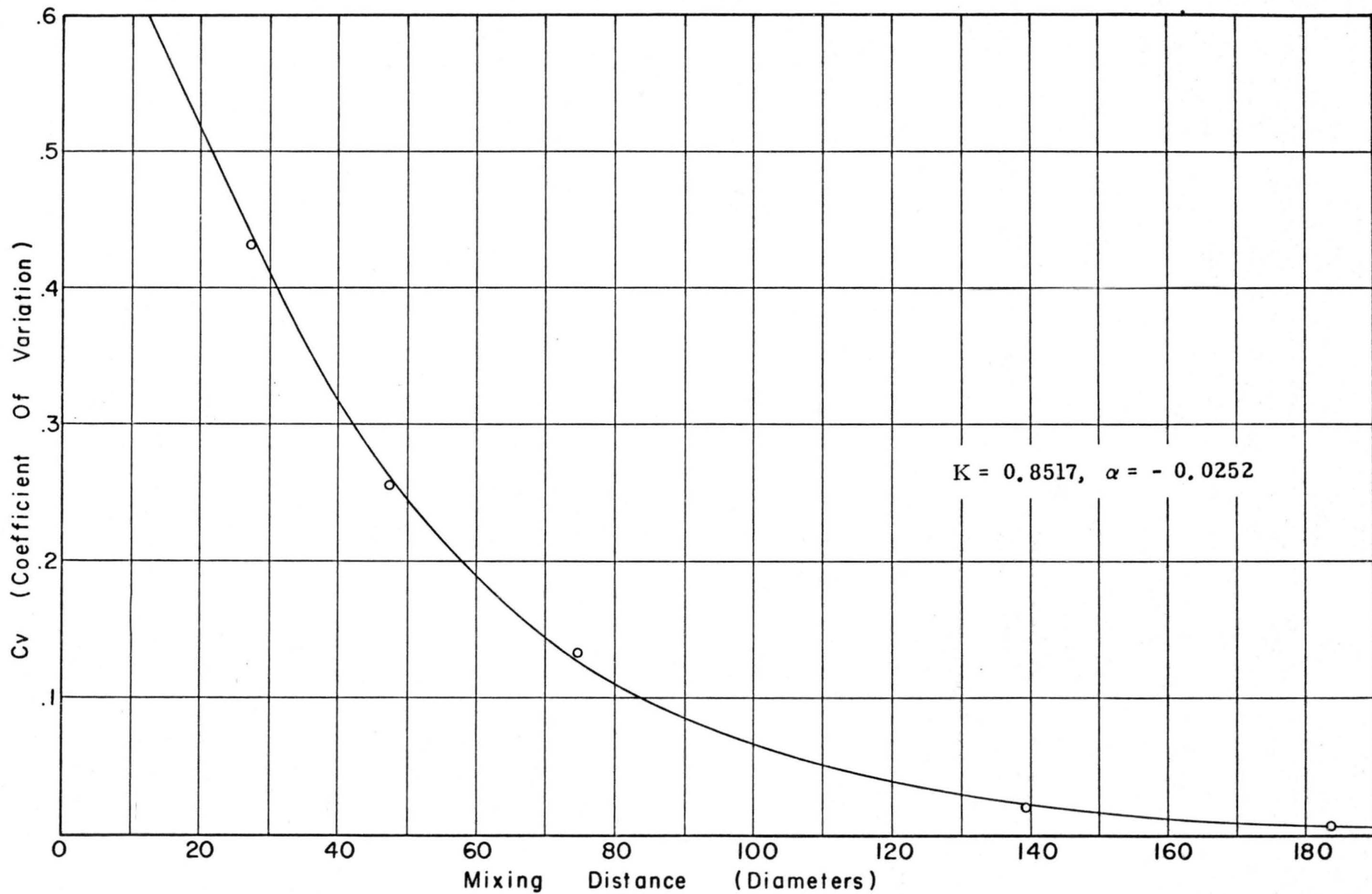

Fig. 24. Coefficient of variation vs. mixing distance for $Q = 7.8 \text{ CF/s}$

part of the overall data processing program included a sub-routine which was developed to plot contour lines of equal tracer concentration. This sub-routine made use of the capabilities of a cathode ray plotter, transferring the data through interpolation from a fixed set of polar coordinates to a rectangular grid which the plotter could then utilize to draw the contours.

The data were first converted to modular coefficients, i.e., each value of concentration was divided by the mean value so the new mean became unity and all data were then compared. Next, a contour interval of .05 was selected and utilized to obtain the topographic charts shown in figures 25, 26, 27, 28, 29, and 30. These may be thought of as "isocons" or lines of equal relative concentration with the mean concentration always being unity.

To specify the hydraulic conditions under which these data were taken, measurements were made of the piezometric head for each of the flow rates and from them, the Darcy-Weisbach f was computed for each of the flow rates. These data are plotted in figure 31 along with other data taken under both partially full and full pipe flow. The data for the particular flow conditions used in this study are tabulated below.

Q Discharge (cfs)	f Darcy-Weisbach friction factor	Re Reynolds Number
7.76	.0178	0.578×10^5
32.98	.01263	2.447×10^5
42.5	.01146	3.16×10^5
42.2	.01182	3.13×10^5
53.2	.01104	3.94×10^5
60.9	.01112	4.51×10^5

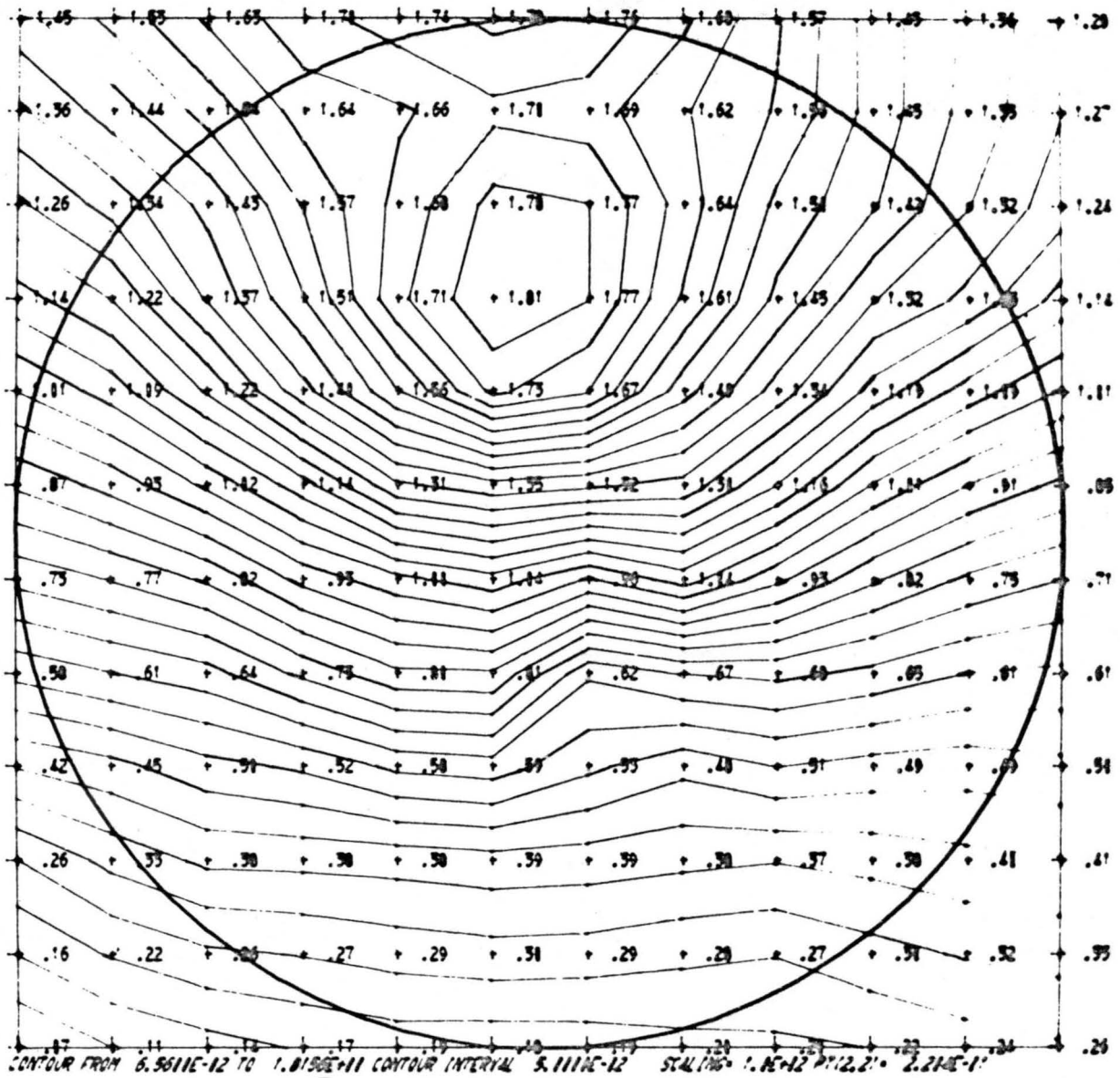

Fig. 25. Run No. 36D
 Mixing distance = 27.1 diameters

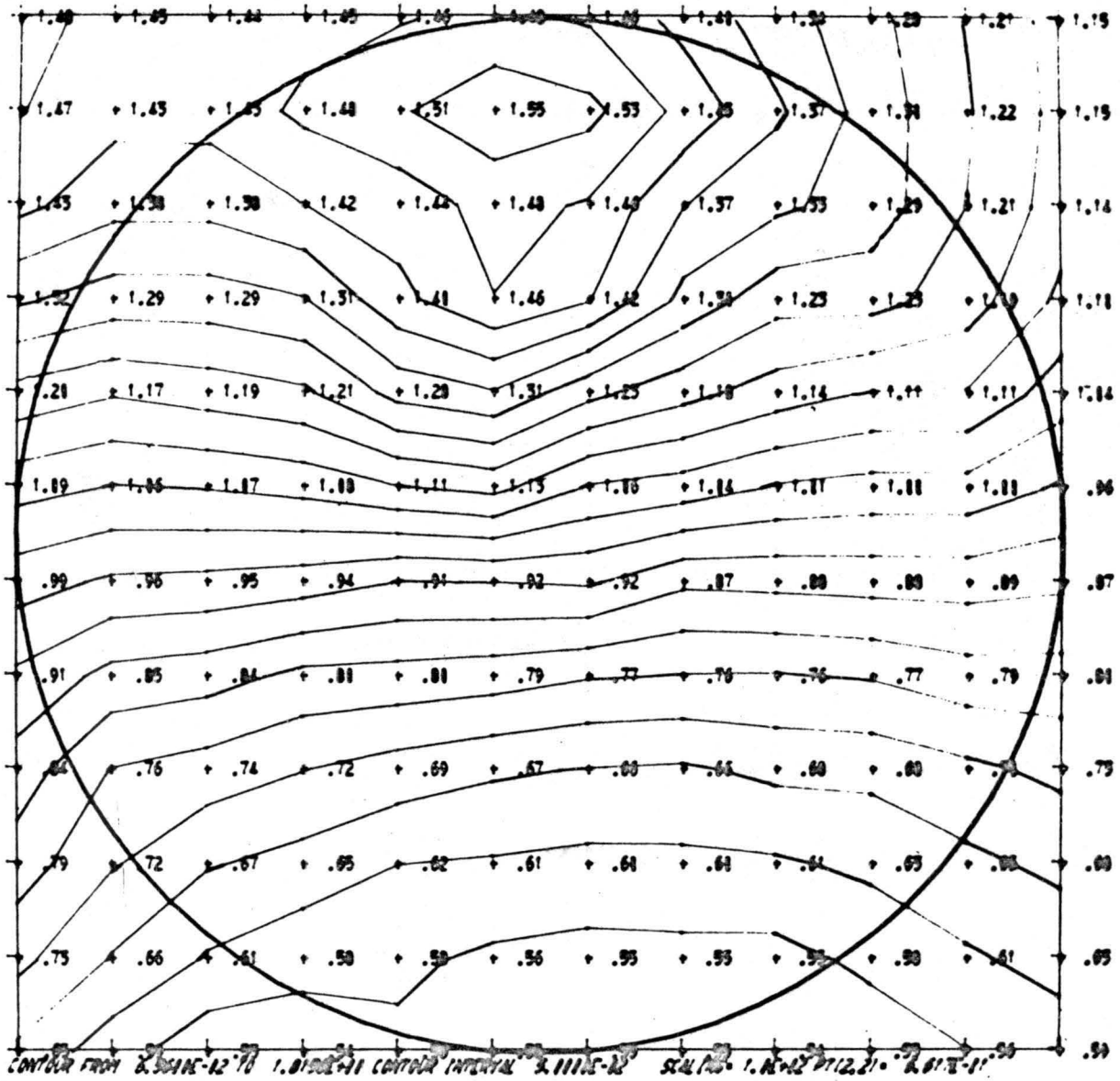

Fig. 26. Run No. 31D
 Mixing distance = 47.3 diameters

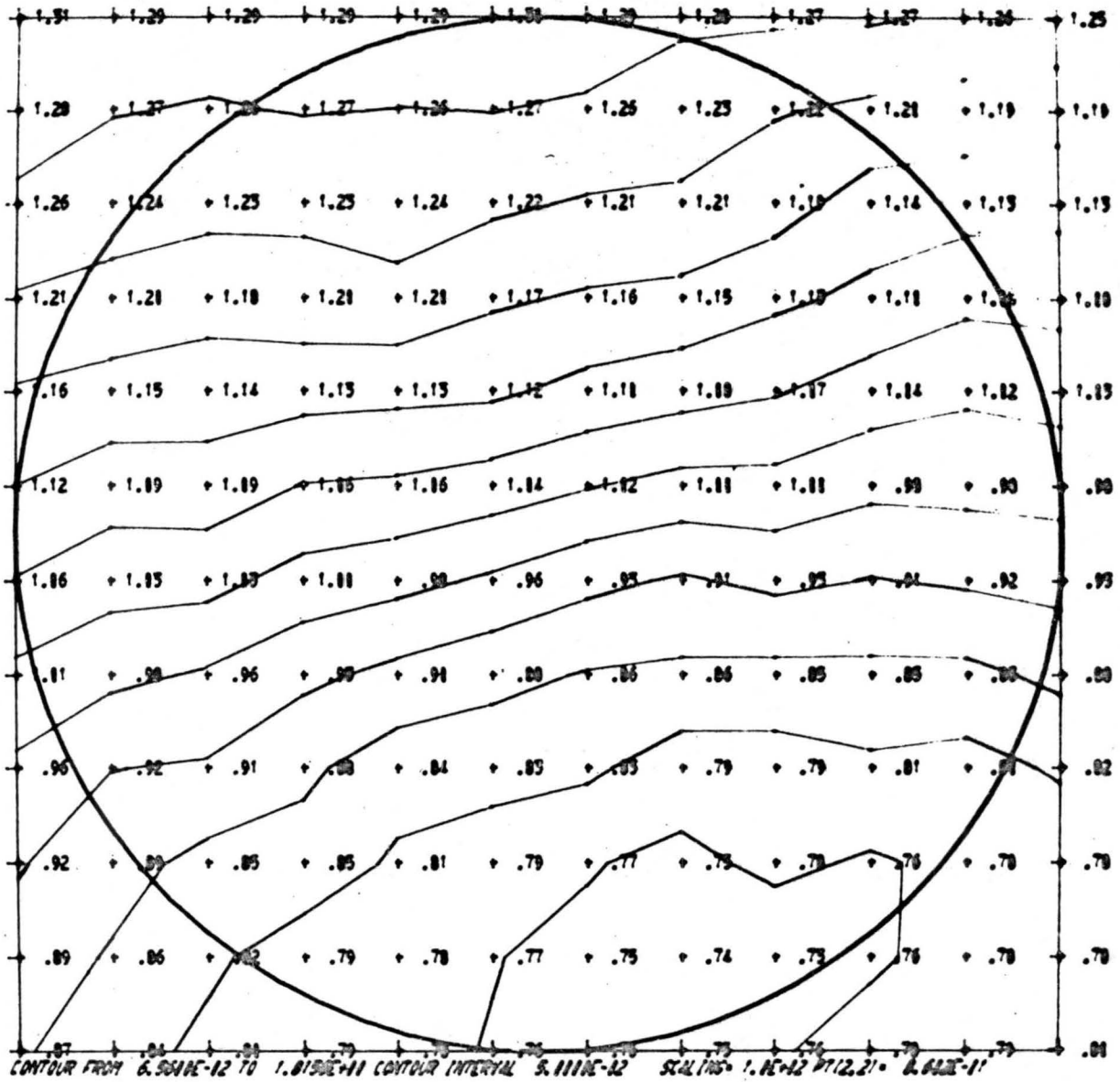

Fig. 27. Run No. 15D
 Mixing distance = 74.5 diameters

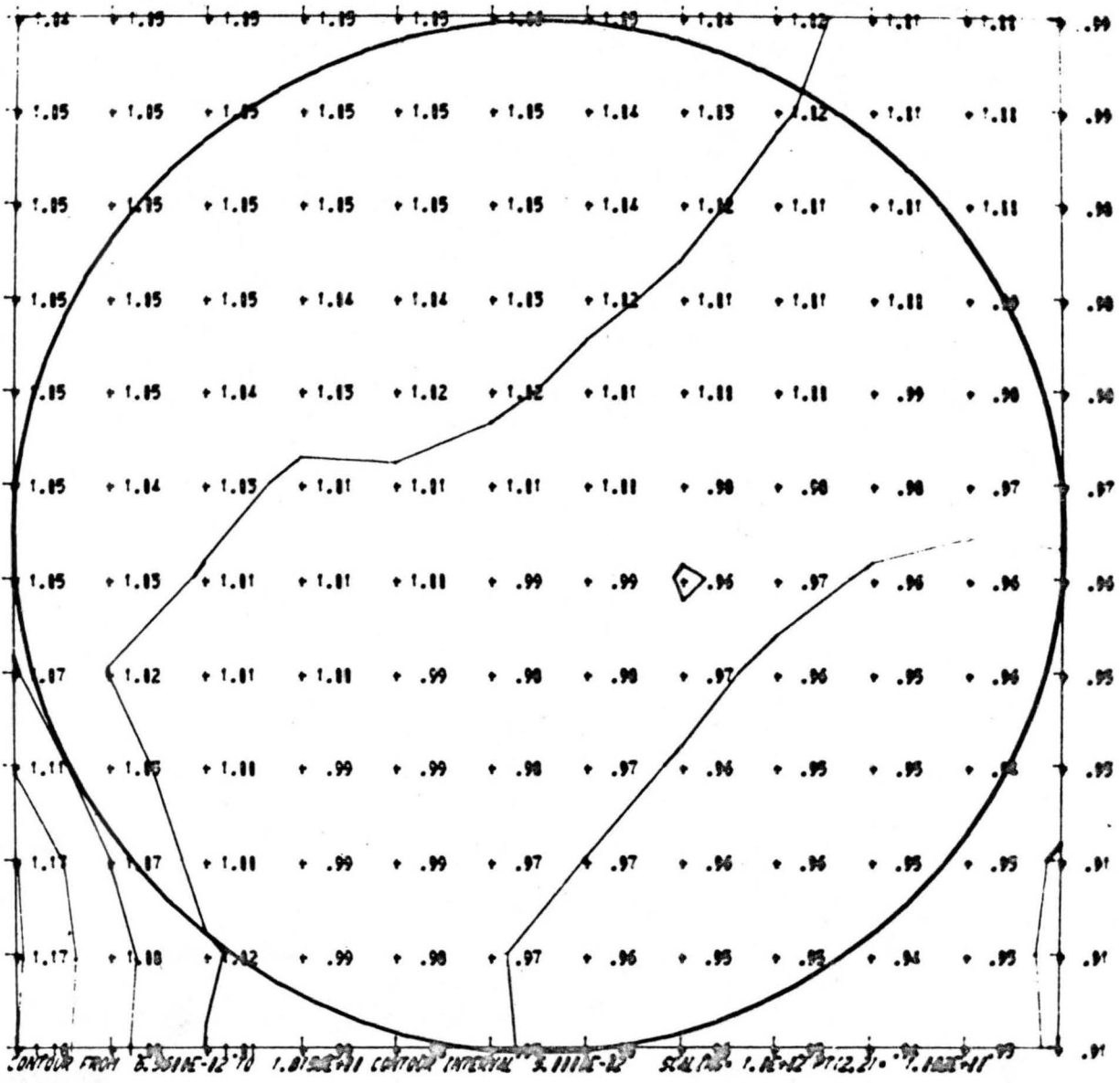

Fig. 28. Run No. 20D
 Mixing distance = 139.3 diameters

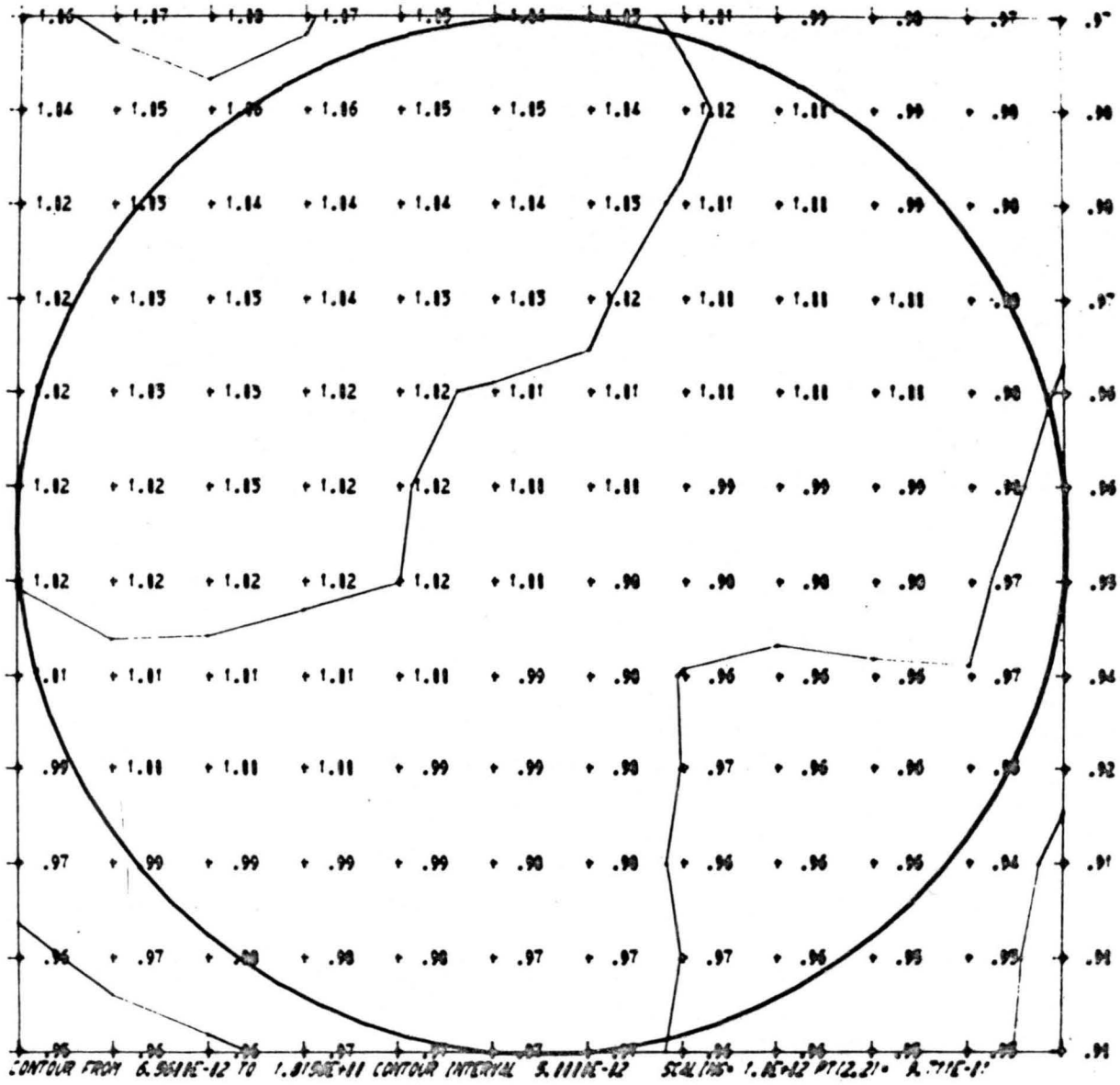

Fig. 29. Run No. 21D
 Mixing distance = 139.3 diameters

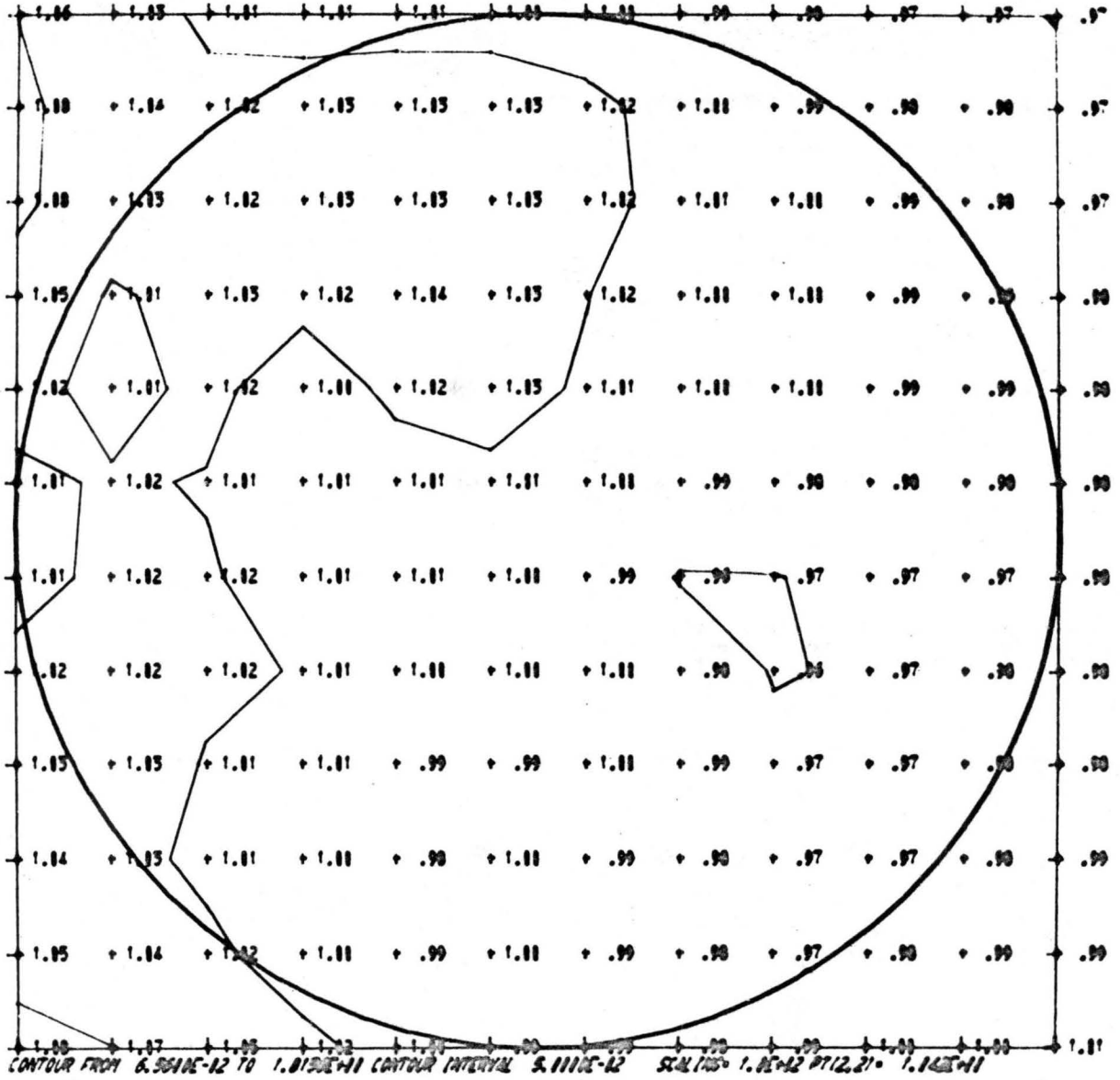

Fig. 30. Run No. 25D
 Mixing distance = 183.7 diameters

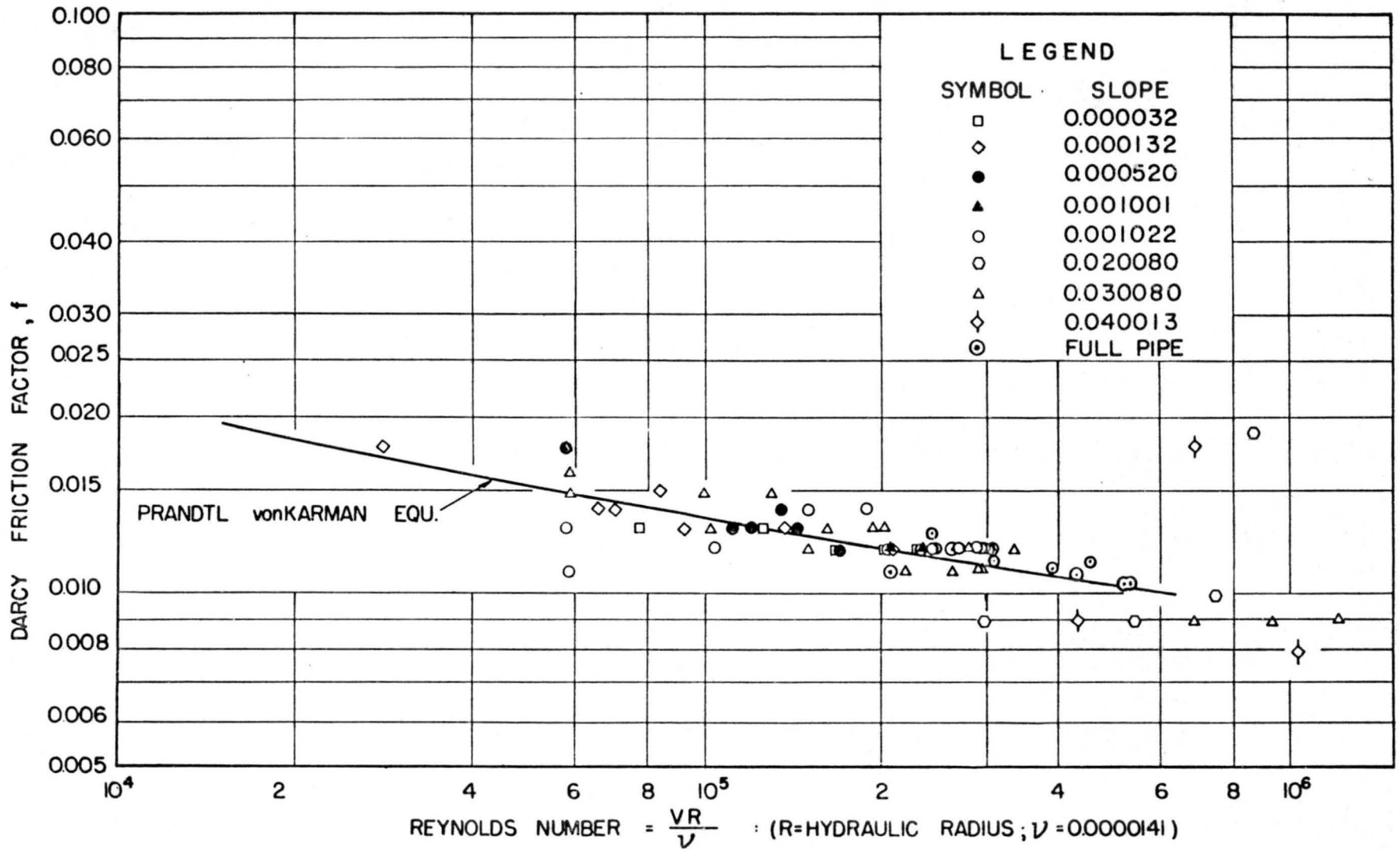

Fig. 31 Variation of friction factor f with Reynolds number based on the slope representative of the entire length

As a check on the quality of the diffusion measurements that were made on the overall accuracy of the procedure, it was decided to make some dye-dilution discharge measurements. These data are plotted in figure 32 along with the calibration for the orifice plate which was based on weight-time measurements.

The coefficient of variance, C_v , seemed to be a reasonable measure of dispersion. Quite often a quantity called percentage of mixing is quoted in the literature. This is computed as follows:

$$P_m = 100 - \frac{50}{\bar{C} A} \sum_{i=1}^N C_i A_i$$

where \bar{C} is the mean concentration, A is the total cross-sectional area, and C_i refers to a particular value of concentration taken to be representative of a particular areal segment, A_i , of the cross-section. To provide a comparison, table 2 lists a series of runs and the corresponding values of C_v and P_m (the percent mixing).

Analysis of accuracy in distribution of dye concentration. The measurement of dye concentrations across a given cross-section takes time. This total time depends on the number of points for which the dye concentration is determined. If some parameters--such as the flow discharge through the pipe and the flow discharge of the pump supplying the dye--vary with time, they will affect the variance of dye concentration distribution across this cross-section. For measuring the voltage out-put of the fluorometer, there is an electrical noise plus the errors in fluorometer calibration superimposed on the signal of dye concentration fluctuations. The following are the factors which affect the coefficient of variation of dye concentration:

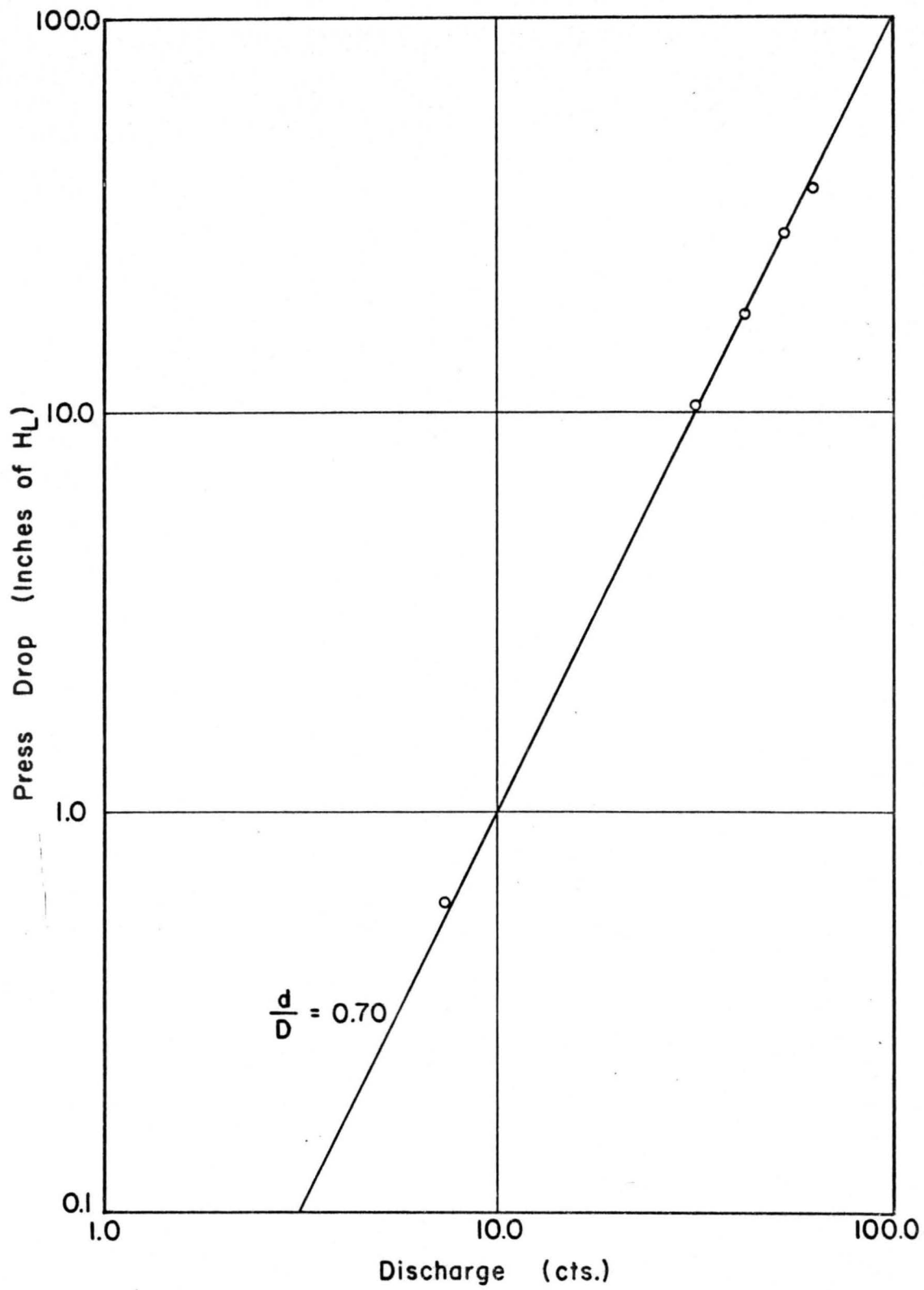

Fig. 32. Pressure drop vs. discharge

Table 2
 COMPARISON OF C_v WITH PERCENT MIXING AS A MEASURE
 OF LATERAL DISPERSION

Run No.	Station (diameters from injection point)	Discharge (cfs)	C_v Coefficient of variation	P_m percent mixing
33	27.1	7.8	.431	82.4
35	27.1	42.5	.518	79.4
27	47.3	7.8	.255	90.7
31	47.3	54	.315	86.3
12	74.5	7.8	.135	94.6
15	74.5	54	.170	92.5
16	139.3	7.8	.020	99.2
19	139.3	61	.036	98.2
22	183.7	7.8	.008	99.7
24	183.7	42.5	.026	98.9

1. Basic turbulence of a given flow discharge in the pipe;
2. Time of probe taking, as selected for the time-averaging of dye concentration at a point;
3. Number of sampling points in a cross-section, used to obtain an estimate of the true value of C_v ;
4. Variation with time of flow discharge through the pipe;
5. Variation with time of pump discharge, supplied with dye at the injection point;
6. Variation in fluorometer reading, produced by electrical noise plus the errors in fluorometer calibration; and
7. Background turbulence produced by pipe entrance conditions, (baffles, straightening vanes, orifice meter, and transitions).

The most important factor which affects dye concentration is the basic flow turbulence. Figures 20 through 24 demonstrate clearly that C_v decreases very fast with an increase of distance between the injection point and the probe position. At least this is true for the small distances (up to 100-150 pipe diameters). For large distances, the decrease in C_v becomes slower and slower. The main consequence of results given in Figures 20-24 is that the accuracy of flow measurement by tracer diffusion depends greatly on the distance between the injection point and probe position for a given manner of flow injection. The greater the required accuracy, the longer should be the distance between the injection and the probe position. However, the same accuracy may be obtained for a smaller distance but with more probes taken in the cross-section. For a desired accuracy or for a given C_v of dye concentration distribution, a compromise may be looked for between the distance and the number of

probes taken in a cross-section. For long penstocks, the largest distance and one probe may be indicated. For short penstocks, a maximum distance available with several probes taken in the cross-section should be a proper approach to use.

The longer the time for which each probe is taken, the more accurate becomes the time-average dye concentration at that point, and the smaller is C_v of dye concentration in a cross-section, for all other factors constant. A two-minute time averaging probe seems to cut down substantially the error in the time-average dye concentration. However, for greater accuracies, the time for the probe taking should be increased. The time-averaging is greatly affected by fluctuations with time of flow discharge and pump discharge. It was neither possible to separate in this study these three influences, by using one long run in time only, nor to obtain the time effect on the time-averaging of dye concentration at various points.

The effect of the number of points, for which the time-average dye concentration is determined in a cross-section, on the coefficient of variation C_v may be either positive or negative. Namely, the accuracy in estimating C_v depends on this number, but the deviation from the true value of C_v may be either positive or negative. The spread of points on graphs of Figures 20-24 around the true curves will decrease with an increase of the number of sampling points in a cross-section.

The time length in measuring the dye concentration at a point, the number of sampling points in the cross-section, and the distance between the injection and probe positions determine the overall accuracy of time-space sampling of tracer diffusion process in full flowing pipes.

There was a small variation in flow discharge through the experimental facility. As the water was drawn from the Horsetooth Reservoir through a lengthy system of pipes and control valves with some bends, reductions, bifurcations, and sharp turns, there are necessarily several zones of water separation from boundaries. The separations in a system like this are bound to create a degree of instability, with vortex zones configurations changing with time. Sometimes these zones are taken away temporarily and then regenerated. This process depends generally on flow discharge. Therefore, a small variation in flow discharge with time is unavoidable. In this case the errors are in the order of 1%-2%. The effect of this fluctuation on the average dye concentration can be decreased only by increasing the time for which dye concentration is averaged for any probe.

The variation in dye supply with time because of the variation in pump discharge--which pump supplies the diluted dye to the pipe--is also unavoidable. Some measurements have shown that the coefficient of variance of this discharge with time is of the order of 0.01. However, as the dye diffusion takes place both laterally in cross-sections and longitudinal along the pipe, it is very difficult to assess what is the variation in dye concentration at a probe position which is caused by the variation in pump discharge. A large attenuation of this variation must occur along the pipe and the longer the time of probe taking, the smaller is the final influence of this variation on C_v of dye concentration in a cross-section. Whenever a significant fluctuation in pump dye discharge is suspected, the longer should be the time of dye probe taking.

The electric noise of fluorometer readings, as well as errors in fluorometer calibration, are relatively small in comparison with the basic accuracy determined by the turbulence factor. These sources of error increase the variation of dye concentration (C_v) and the only way to decrease the effect of electric noise is by increasing the time of probe taking. The calibration of fluorometer creates systematic errors. The only way to decrease it is by frequent and careful calibrations of the fluorometer.

The additional turbulence as produced by the inlet condition affects the tracer diffusion process. Though there was in experiments a distance of 38 pipe diameters between the last baffle grid and the dye injection point, it must be assumed that the remaining grid turbulence is added to the main flow turbulence. This is the only factor which was likely to decrease the C_v values and thus decreased the sampling error. Because 38 diameters is sufficient to dampen appreciably the bulk of inlet turbulence created by orifice meter, vanes, transitions and grid baffles, it is considered here that this factor may be neglected in the analysis of accuracy in dye concentration measurements.

The graphs in Figures 20-24 give an integrated effect of various factors, including pipe and pump discharge fluctuations and fluorometer noise and calibration errors. The probable relative error is defined as being 2/3 of the coefficient of variation, or

$$e_r \approx \frac{2}{3} C_v$$

This error means that the probability of the true average dye concentration in a cross-section being greater or smaller than the dye concentration of

only one probe is 50%. Therefore, the approximate values of the probable relative error in percent for the five graphs of Figures 20-24 are given as follows:

Table 3
APPROXIMATE VALUES OF PROBABLE RELATIVE ERRORS AS
FUNCTION OF DISCHARGE (Q) AND DISTANCE (z)

z in pipe diameters	Q in cfs				
	7.8	33	42	54	61
	errors in percent				
100	4.4	5.4	5.8	6.2	6.0
125	2.4	2.9	3.3	3.4	3.3
150	1.2	1.6	1.7	1.8	1.8
175	0.7	0.8	1.0	1.1	1.0
200	0.4	0.5	0.6	0.7	0.7

The probable relative errors increase with an increase of Reynolds number (or flow discharge). Though a larger discharge means a greater turbulence than is the case with the small discharge, the average residence time of tracer in the pipe between the injection point and the probe cross-section (distance z) is much smaller for the large discharge than for the small discharge. The product of turbulence level and residence time may be considered as a measure of tracer diffusion process. It seems that this product decreases with an increase of pipe discharge. For the same distance z, the accuracy of dye sampling is greater for a small discharge than for a large discharge. By increasing the number of sampling points for probe taking, the accuracy in determining the average time-cross-section dye concentration may be greatly increased in comparison with those given in Table 3.

APPENDICES

APPENDIX A

PLANS FOR THE RADIAL ARM SAMPLING PROBE

Sampling Probe Materials List

The following items have gone into the manufacture of the sampling probe: (Dimensions in inches unless otherwise stated)

1. $\frac{1}{2}$ O.D. x $\frac{1}{8}$ wall SST tube $17\frac{11}{16}$ long
2. Several lengths small diameter brass telescoping tubing $\frac{9}{32}$ O.D.
3. Thick wall brass tubing to fit over item 2
4. $1\frac{1}{8}$ O.D. x $\frac{1}{8}$ wall SST tube 22 long
5. $1\frac{1}{2}$ O.D. x $\frac{5}{32}$ wall, 2 pieces
 - (a) 25 long
 - (b) 14 long
6. $\frac{3}{4}$ shaft, steel, 9 long
7. 2 pillow blocks Boston 4L $\frac{3}{4}$ bore
8. Flanged cartridge Boston 6F $1\frac{1}{8}$
9. $\frac{1}{4}$ x 2 angle, about 54 long
10. Bronze Bearing Boston B 1821-16
11. 7 Allen screws $\frac{1}{2}$ -zounf-1
12. 2 O.D. x $\frac{1}{4}$ wall SST tube 4 long
13. (a) 2 - $\frac{1}{2}$ SST plates 4 x 10
 - (b) 2 - $\frac{1}{4}$ SST plates $1\frac{1}{4}$ x 4
 - (c) 1 - $\frac{1}{8}$ SST plate $2\frac{1}{8}$ x $2\frac{1}{8}$

- (d) 1 - $\frac{1}{2}$ SST plate $4\frac{1}{4} \times 5\frac{1}{2}$
- (e) 1 - $\frac{1}{2}$ SST plate 4 x 7
- (f) 1 - $\frac{1}{8}$ SST plate 1 x 6
- 14. 2-Browning $\frac{1}{4}$ pitch 54 tooth sprocket 25B54
- 15. 8' of $\frac{1}{4}$ pitch SST roller chain
- 16. Existing aluminum handwheel
- 17. 2- $\frac{1}{2} \times 2$ rollpins

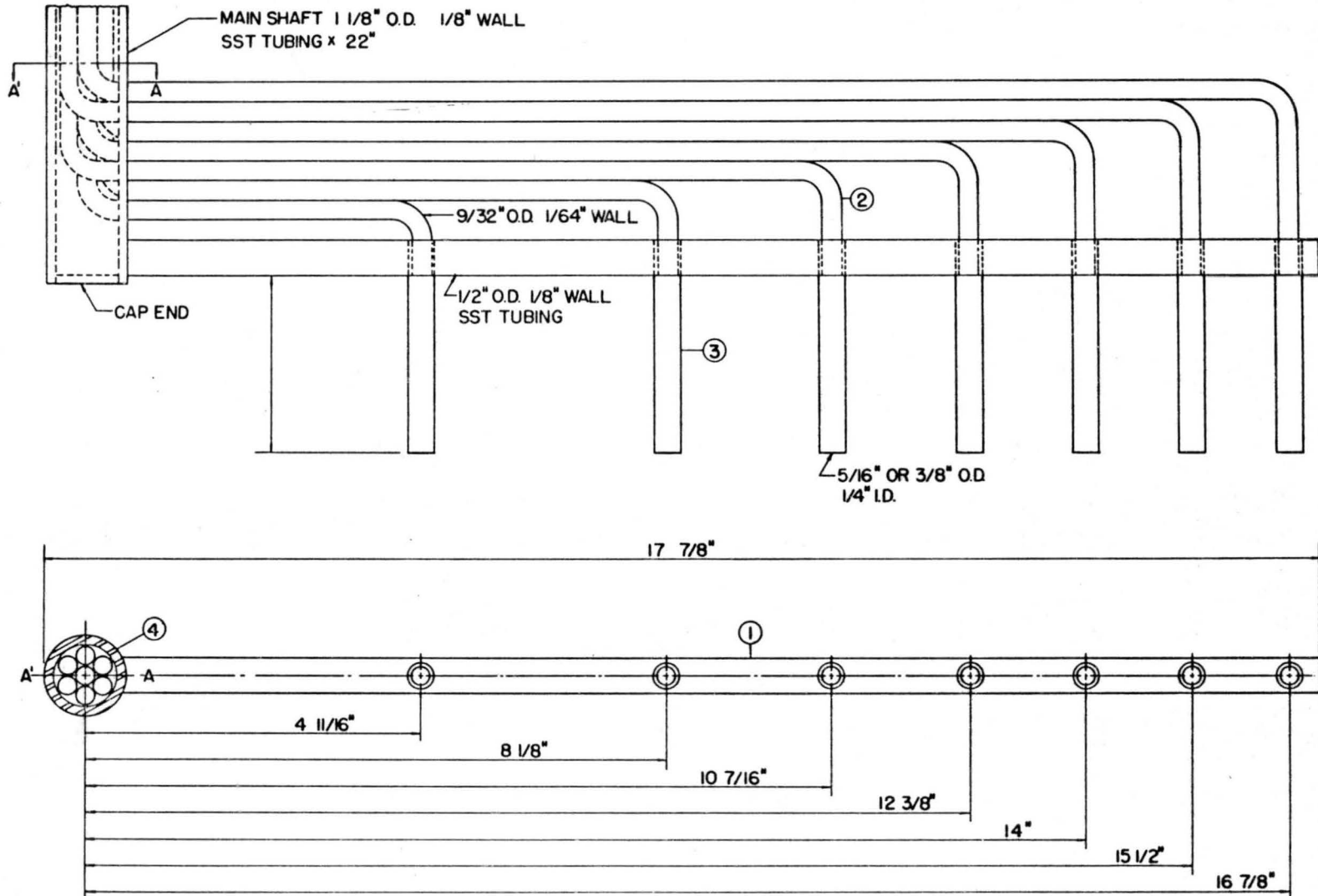

Fig. A. 1. Detail of radial arm

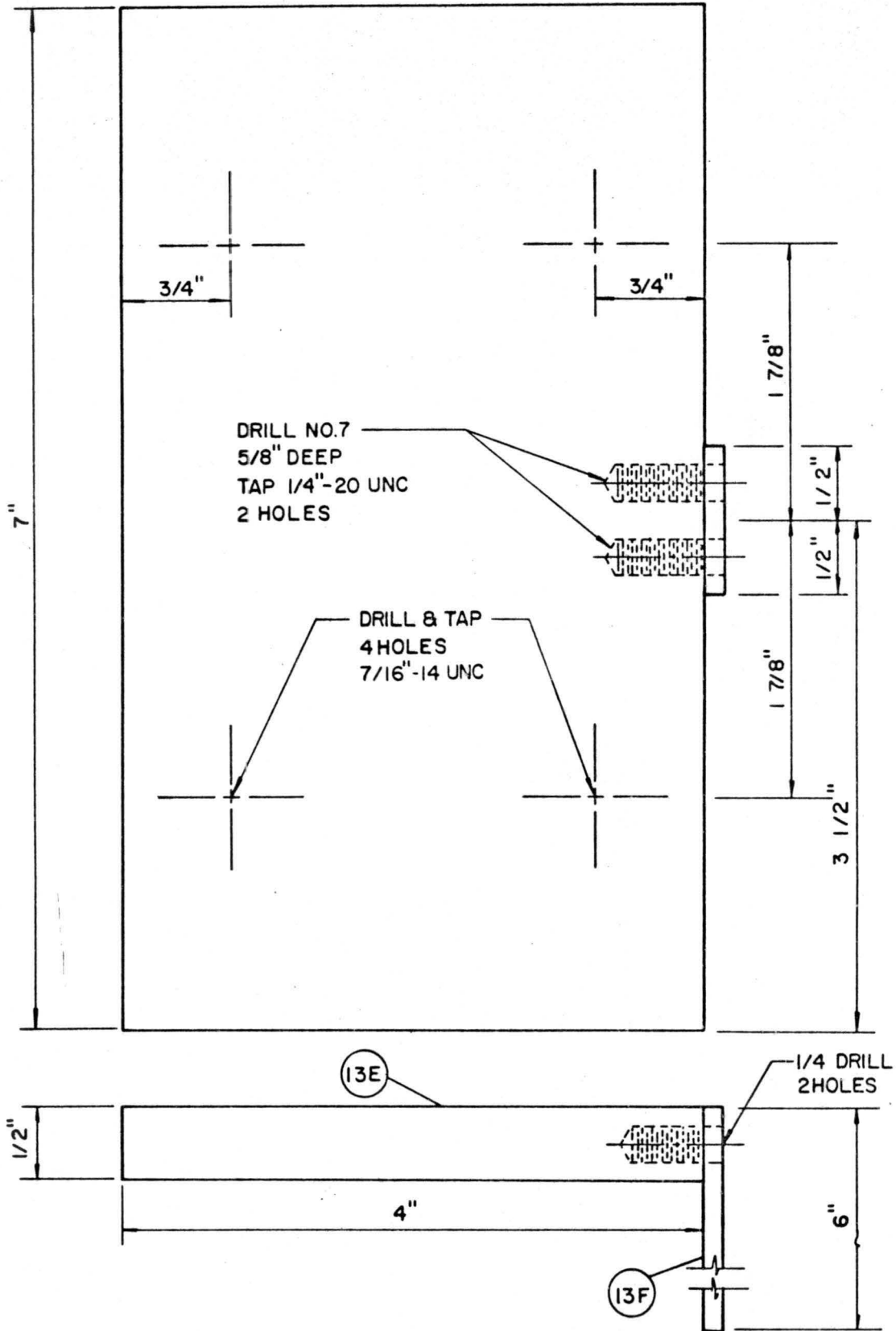

Fig. A. 2. Detail of upper shaft mounting plate

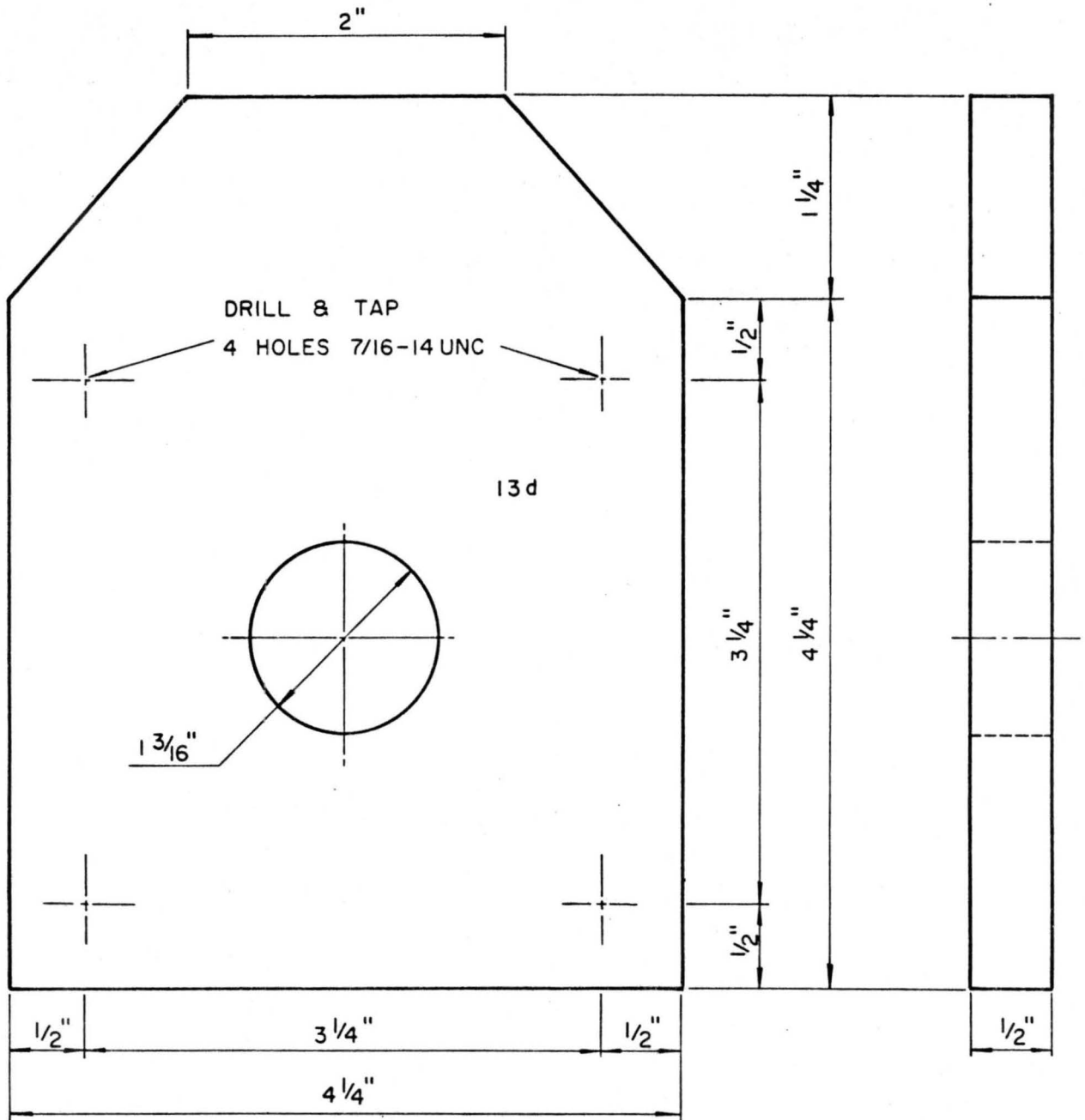

Fig. A. 3. Detail of thrust bearing flange for main shaft

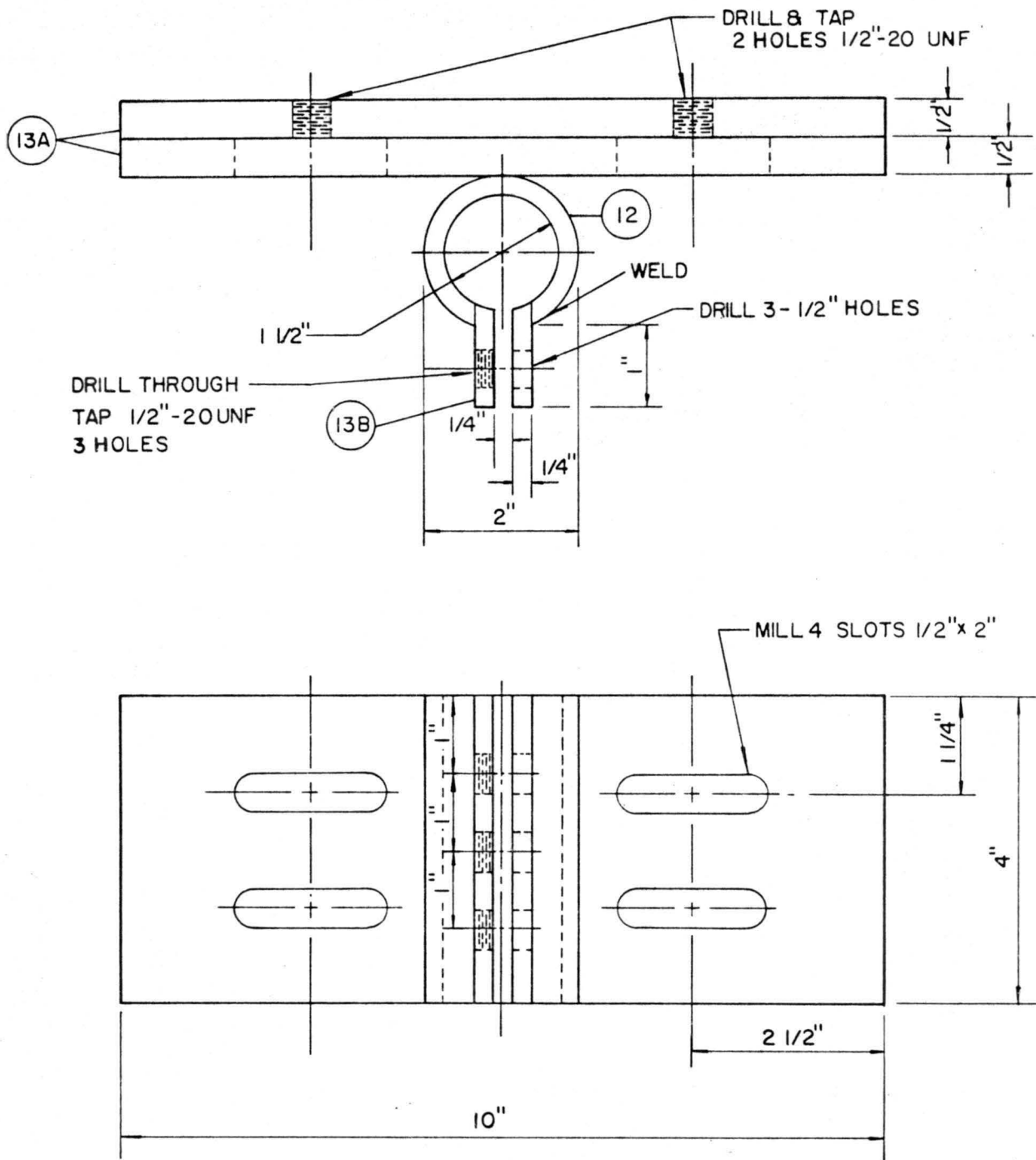

Fig. A. 4. Detail of probe support clamp

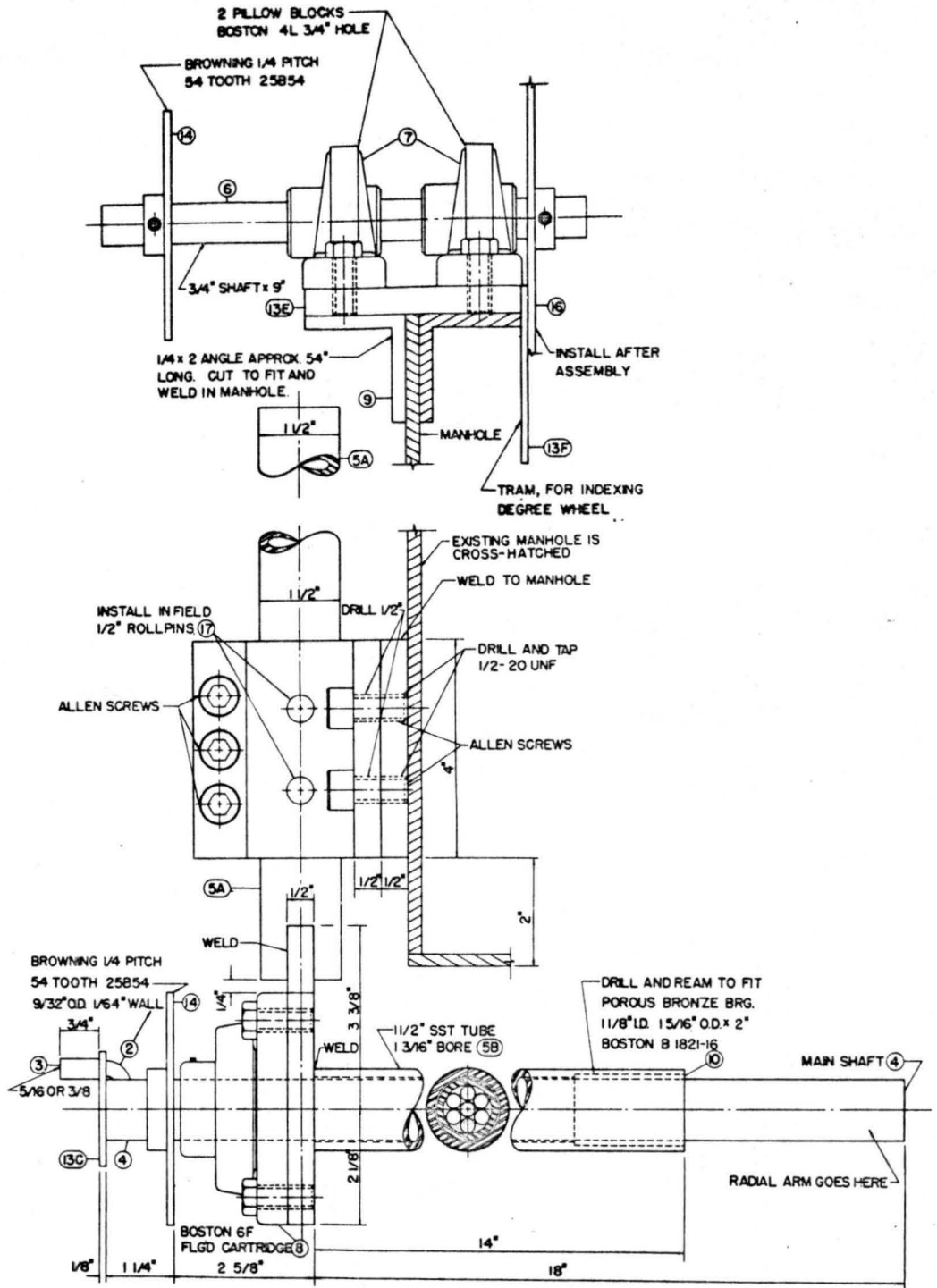

Fig. A. 5. Sampler probe assembly

APPENDIX B

TABULATION OF TRACER CONCENTRATION DATA

The following tables include the field data of tracer concentration distribution taken during the summer of 1965 in the 800' long pipe of the Outdoor Laboratory of the Engineering Research Center of Colorado State University, Fort Collins, Colorado.

Dye concentrations are reported in p.p.b. For seven sampling points, see Figure A-1 of Appendix A. The sampler number 7 is closest to the wall and the sampler number 1 is closest to the center of the pipeline. The other intervening samplers are set in numerical order between 1 and 7. The angular position of the radial arm was measured in the counterclockwise direction with respect to the axis coinciding with the vertical upward radius.

In the tabulation of dye concentration data, the following designations are used:

W.T. = Water temperature in F°

Scale = Fluorometer scale of reading

B.G. = Fluorometer back-ground reading

P.P. - Probe position

ΔH = Orifice manometer reading in feet of mercury

I.P. = Injection position upstream from the sampler (mixing distance)

W.T. = 47.1⁰F
 Scale = 10x
 B.G. = 0.2
 P.P. = Centerline
 ΔH = 0.051

Dye Concentrations (ppb)
 Run No. = 1
 Date = 7/10/66
 I.P. = 74.5 dia.

θ Degrees	SAMPLER NO.						
	1	2	3	4	5	6	7
0 ⁰	16.22	16.75	16.92	17.48	17.51	17.60	17.51
90 ⁰	14.58	14.30	14.52	14.56	14.36	14.56	14.13
180 ⁰	13.50	12.52	12.30	12.26	11.85	11.63	11.68
270 ⁰	14.95	14.83	14.57	14.86	14.43	14.43	14.73

W.T. = 47.0⁰F
 Scale = 10x
 B.G. = 0.2
 P.P. = 0.5r
 ΔH = 0.051

Dye Concentrations (ppb)
 Run No. = 2
 Date = 7/10/66
 I.P. = 74.5 dia.

θ Degrees	SAMPLER NO.						
	1	2	3	4	5	6	7
0 ⁰	16.39	17.05	17.96	18.30	18.97	19.24	19.10
90 ⁰	14.73	14.78	14.30	14.39	14.18	14.07	14.30
180 ⁰	12.58	11.41	10.91	10.49	10.30	10.30	10.17
270 ⁰	14.98	15.02	14.92	14.86	14.83	14.70	14.30

W.T. = 47.6⁰F
 Scale = 10x
 B.G. = 0.2
 P.P. = 0.9r
 ΔH = 0.05

Dye Concentrations (ppb)
 Run No. = 3
 Date = 7/11/66
 I.P. = 74.5 dia.

θ Degrees	SAMPLER NO.						
	1	2	3	4	5	6	7
0 ⁰	13.34	15.12	14.80	15.75	15.71	15.90	15.37
90 ⁰	12.52	12.52	12.28	12.66	12.36	12.30	12.88
180 ⁰	10.12	9.57	8.87	8.57	8.28	8.24	7.92
270 ⁰	11.21	11.00	10.45	10.74	10.68	10.60	10.08

W.T. = 47.6⁰F
 Scale = 10x
 B.G. = 0.2
 P.P. = 0.8r
 ΔH = 0.05

Dye Concentrations (ppb)
 Run No. = 4
 Date = 7/11/66
 I.P. = 74.5 dia.

θ Degrees	SAMPLER NO.						
	1	2	3	4	5	6	7
0 ⁰	14.05	14.25	14.98	15.34	15.46	15.54	16.31
90 ⁰	12.54	12.48	12.58	12.53	13.13	13.15	13.44
180 ⁰	10.57	9.50	9.20	8.38	8.06	8.06	8.03
270 ⁰	11.25	11.22	11.00	11.22	10.89	10.80	11.00

W.T. = 47.5°F
 Scale = 3x
 B.G. = 0
 P.P. = Centerline
 ΔH = 3.02

Dye Concentrations (ppb)
 Run No. = 11
 Date = 7/17/66
 I.P. = 74.5 dia.

		SAMPLER NO.						
θ		1	2	3	4	5	6	7
Degrees								
0°		22.20	22.80	24.00	24.36	24.55	24.46	25.34
90°		19.37	19.37	20.40	20.49	20.76	21.16	20.63
180°		16.90	16.24	15.60	15.10	14.56	14.40	14.10
270°		18.60	18.76	18.60	18.76	19.20	18.96	19.11

W.T. = 47.5°F
 Scale = 3x
 B.G. = 0
 P.P. = Centerline
 ΔH = 0.05

Dye Concentrations (ppb)
 Run No. = 12
 Date = 7/18/66
 I.P. = 74.5 dia.

		SAMPLER NO.						
θ		1	2	3	4	5	6	7
Degrees								
0°		29.40	30.10	31.00	31.53	31.35	31.46	32.05
90°		26.40	26.40	26.64	27.14	27.29	27.00	27.07
180°		22.60	22.44	21.80	21.53	20.86	21.16	20.80
270°		25.33	25.80	25.50	25.33	24.77	24.20	23.68

W.T. = 47.5°F
 Scale = 10x
 B.G. = 0.3
 P.P. = Centerline
 ΔH = 0.825

Dye Concentrations (ppb)
 Run No. = 13
 Date = 7/18/66
 I.P. = 74.5 dia.

		SAMPLER NO.						
θ		1	2	3	4	5	6	7
Degrees								
	0°	6.94	7.42	7.55	7.78	8.00	7.90	8.01
	90°	6.45	6.44	6.44	6.49	6.49	6.51	6.65
	180°	5.79	5.24	5.02	4.92	4.79	4.61	4.64
	270°	5.90	5.90	6.12	5.81	5.90	5.94	5.99

W.T. = 47.5°F
 Scale = 3x
 B.G. = 0
 P.P. = Centerline
 ΔH = 1.5

Dye Concentrations (ppb)
 Run No. = 14
 Date = 7/18/66
 I.P. = 74.5 dia.

		SAMPLER NO.						
θ		1	2	3	4	5	6	7
Degrees								
	0°	29.63	32.06	33.29	34.10	34.03	34.50	34.65
	90°	28.40	29.06	29.18	29.18	29.18	29.18	29.86
	180°	23.90	23.38	21.36	21.14	20.10	20.10	19.90
	270°	26.00	25.50	25.10	25.40	25.16	26.00	24.64

W.T. = 47.5⁰F
 Scale = 3x
 B.G. = 0
 P.P. = Centerline
 ΔH = 2.44

Dye Concentrations (ppb)

Run No. = 15
 Date = 7/18/66
 I.P. = 74.5 dia.

θ Degrees	SAMPLER NO.						
	1	2	3	4	5	6	7
0 ⁰	23.82	25.24	26.13	26.76	27.43	27.67	28.00
90 ⁰	22.00	22.40	23.13	23.13	22.82	23.53	23.60
180 ⁰	18.98	17.88	16.99	16.42	16.32	16.21	16.32
270 ⁰	20.87	20.75	20.40	20.40	20.75	20.17	20.58
30 ⁰	24.38	25.50	26.54	26.82	26.76	27.30	27.44
60 ⁰	23.30	23.93	24.95	25.08	25.40	25.77	26.13
120 ⁰	20.75	20.10	20.10	20.04	20.10	19.60	19.74
150 ⁰	19.22	18.26	17.80	17.74	17.88	17.10	17.10
210 ⁰	18.56	17.74	16.30	16.21	16.70	15.60	15.92
240 ⁰	18.90	18.90	18.00	17.88	17.55	17.17	17.10
300 ⁰	21.96	23.00	23.12	23.12	23.38	23.22	23.45
330 ⁰	23.52	24.78	25.08	26.13	26.20	26.00	26.46

W.T. = 47.5⁰F
 Scale = 3x
 B.G. = 0
 P.P. = Centerline
 ΔH = 0.05

Dye Concentrations (ppb)
 Run No. = 16
 Date = 7/19/66
 I.P. = 139.3 dia.

		SAMPLER NO.						
θ		1	2	3	4	5	6	7
Degrees								
0 ⁰		67.19	67.79	69.15	69.38	69.68	69.53	68.55
90 ⁰		67.64	68.17	68.40	68.25	67.79	66.81	67.27
180 ⁰		66.36	65.61	65.38	66.21	65.61	65.83	65.15
270 ⁰		67.05	67.19	67.27	65.23	66.21	65.76	66.36

W.T. = 47.5⁰F
 Scale = 10x
 B.G. = 0.2
 P.P. = Centerline
 ΔH = 0.87

Dye Concentrations (ppb)
 Run No. = 17
 Date = 7/19/66
 I.P. = 139.3 dia.

		SAMPLER NO.						
θ		1	2	3	4	5	6	7
Degrees								
0 ⁰		14.87	15.00	15.00	14.87	15.00	15.08	14.98
90 ⁰		14.57	14.57	14.60	14.43	14.69	14.50	14.50
180 ⁰		14.36	14.23	14.06	13.96	13.96	13.90	13.90
270 ⁰		14.57	14.57	14.43	14.23	14.43	14.43	14.43

W.T. = 47.5⁰F
 Scale = 3x
 B.G. = 0
 P.P. = Centerline
 ΔH = 1.53

Dye Concentrations (ppb)
 Run No. = 18
 Date = 7/19/66
 I.P. = 139.3 dia.

		SAMPLER NO.						
θ		1	2	3	4	5	6	7
Degrees								
0 ⁰		28.30	28.14	28.74	29.20	29.20	29.20	29.20
90 ⁰		28.46	28.74	29.20	28.53	28.74	28.81	28.40
180 ⁰		27.80	27.42	27.50	27.30	27.30	26.91	27.42
270 ⁰		27.64	27.50	27.38	27.38	27.50	27.38	27.50

W.T. = 47.5⁰F
 Scale = 10x
 B.G. = 0.2
 P.P. = Centerline
 ΔH = 3.06

Dye Concentrations (ppb)
 Run No. = 19
 Date = 7/19/66
 I.P. = 139.3 dia

		SAMPLER NO.						
θ		1	2	3	4	5	6	7
Degrees								
0 ⁰		20.34	20.23	20.34	20.54	20.54	20.54	20.60
90 ⁰		20.03	20.28	20.40	20.34	20.44	20.44	20.54
180 ⁰		19.40	19.20	19.00	19.00	18.85	18.87	18.73
270 ⁰		19.15	19.10	19.10	18.90	19.00	19.00	18.93

W.T. = 47.4⁰F
 Scale = 10x
 B.G. = 0.2
 P.P. = Centerline
 ΔH = 2.41

Dye Concentrations (ppb)
 Run No. = 20
 Date = 7/20/66
 I.P. = 139.3 dia.

θ Degrees	SAMPLER NO.						
	1	2	3	4	5	6	7
0 ⁰	23.19	23.32	23.70	23.75	23.76	23.76	23.91
30 ⁰	23.04	23.72	23.70	23.75	23.75	23.77	23.75
60 ⁰	23.07	23.00	23.60	23.60	23.83	23.94	23.91
90 ⁰	22.83	22.88	22.98	23.33	23.45	23.75	23.75
120 ⁰	22.53	22.68	22.53	22.73	22.75	22.56	23.68
150 ⁰	22.40	22.46	22.40	22.46	22.40	22.53	22.56
180 ⁰	22.22	22.16	21.95	22.00	21.83	21.68	21.77
210 ⁰	22.19	21.98	21.74	21.60	21.71	21.48	21.48
240 ⁰	22.19	21.95	21.63	21.57	21.57	21.57	21.32
270 ⁰	21.25	22.13	22.02	21.83	21.90	21.78	21.90
300 ⁰	22.75	22.68	22.68	22.68	22.60	22.60	22.50
330 ⁰	22.72	22.83	23.09	22.96	22.96	23.07	23.04

W.T. = 47.5⁰F
 Scale = 10x
 B.G. = 0.2
 P.P. = Centerline
 ΔH = 2.37

Dye Concentrations (ppb)
 Run No. = 21
 Date = 7/20/66
 I.P. = 139.3 dia.

θ Degrees	SAMPLER NO.						
	1	2	3	4	5	6	7
0 ⁰	23.39	23.67	23.74	23.83	23.98	24.19	23.89
30 ⁰	23.06	23.60	23.80	23.98	23.98	24.13	24.34
60 ⁰	23.30	23.27	23.57	23.60	23.57	23.60	23.50
90 ⁰	23.36	23.57	23.48	23.62	23.36	23.48	23.42
120 ⁰	23.23	23.04	23.08	23.04	23.08	23.11	22.91
150 ⁰	22.88	22.84	22.67	22.84	22.48	22.53	22.40
130 ⁰	22.57	22.71	22.46	22.50	22.28	22.23	22.28
210 ⁰	20.20	22.17	22.07	21.94	22.17	22.00	21.94
240 ⁰	22.09	22.00	21.94	21.90	21.98	21.94	21.62
270 ⁰	22.84	22.71	22.67	22.57	22.28	22.40	22.00
300 ⁰	22.71	22.84	22.80	22.91	22.80	22.57	22.53
330 ⁰	23.04	22.91	22.91	23.04	22.97	22.97	22.84

W.T. = 47.8⁰F
 Scale = 3x
 B.G. = 0
 P.P. = Centerline
 ΔH = 0.05

Dye Concentrations (ppb)
 Run No. = 22
 Date = 7/21/66
 I.P. = 183.7 dia.

		SAMPLER NO.						
θ		1	2	3	4	5	6	7
Degrees								
0 ⁰		70.59	71.27	71.72	71.49	70.98	70.51	70.68
90 ⁰		71.83	72.28	72.02	72.13	71.87	71.72	71.83
180 ⁰		72.40	71.49	72.17	71.11	70.89	71.04	71.04
270 ⁰		71.84	72.70	71.01	71.11	71.53	71.45	71.34

W.T. = 47.8⁰F
 Scale = 10x
 B.G. = 0.2
 P.P. = Centerline
 ΔH = 0.88

Dye Concentrations (ppb)
 Run No. = 23
 Date = 7/21/66
 I.P. = 183.7 dia.

		SAMPLER NO.						
θ		1	2	3	4	5	6	7
Degrees								
0 ⁰		15.94	15.97	15.97	16.04	16.04	16.40	16.18
90 ⁰		15.70	16.01	15.94	16.04	15.94	16.06	15.88
180 ⁰		16.04	15.88	15.82	15.85	15.70	15.53	15.50
270 ⁰		15.97	15.62	15.80	15.44	15.60	15.70	15.60

W.T. = 47.8⁰F
 Scale = 3x
 B.G. = 0
 P.P. = Centerline
 ΔH = 1.48

Dye Concentrations (ppb)
 Run No. = 24
 Date = 7/21/66
 I.P. = 183.7 dia.

θ Degrees	SAMPLER NO.						
	1	2	3	4	5	6	7
0 ⁰	27.18	27.84	27.84	27.68	28.00	28.37	27.92
90 ⁰	27.58	28.40	27.68	27.45	27.45	27.22	27.22
180 ⁰	26.60	26.53	26.46	26.39	26.67	26.32	27.00
270 ⁰	26.39	26.39	26.32	26.46	26.60	26.39	26.17

W.T. = 47.7⁰F
 Scale = 3x
 B.G. = 0
 P.P. = Centerline
 ΔH = 2.41

Dye Concentrations (ppb)
 Run No. = 25
 Date = 7/21/66
 I.P. = 183.7 dia.

θ Degrees	SAMPLER NO.						
	1	2	3	4	5	6	7
0 ⁰	21.40	21.48	21.55	21.62	21.62	21.40	21.08
30 ⁰	21.55	21.62	21.70	21.48	21.62	21.55	21.40
60 ⁰	21.00	21.08	20.86	21.40	21.40	20.86	21.32
90 ⁰	21.08	21.00	21.14	21.40	21.32	21.14	21.08
120 ⁰	21.08	21.14	21.32	21.25	21.32	21.40	21.48
150 ⁰	20.80	20.34	21.00	20.40	20.86	20.64	21.00
180 ⁰	20.86	20.93	20.80	20.86	20.86	20.86	20.73
210 ⁰	20.86	20.86	20.48	20.34	20.34	20.24	20.40
240 ⁰	20.17	20.17	20.10	20.24	20.34	20.34	20.40
270 ⁰	20.10	20.17	20.34	20.24	20.17	20.64	20.57
300 ⁰	21.00	21.00	20.72	20.80	20.72	20.64	20.57
330 ⁰	21.00	20.86	20.80	20.93	20.80	20.64	20.57

W.T. = 47.7⁰F
 Scale = 10x
 B.G. = 0.2
 P.P. = Centerline
 ΔH = 3.07

Dye Concentrations (ppb)
 Run No. = 26
 Date = 7/21/66
 I.P. = 183.7 dia.

		SAMPLER NO.						
θ		_____						
Degrees		1	2	3	4	5	6	7
0 ⁰		18.60	18.63	18.80	18.53	18.70	18.85	18.88
90 ⁰		18.63	18.80	18.88	18.66	18.90	18.85	18.96
180 ⁰		18.53	18.56	18.50	18.50	18.40	18.43	18.50
270 ⁰		18.46	18.35	18.37	18.28	18.28	18.21	18.28

W.T. = 47.6⁰F
 Scale = 3x
 B.G. = 0
 P.P. = Centerline
 ΔH = 0.05

Dye Concentrations (ppb)
 Run No. = 27
 Date = 7/28/66
 I.P. = 47.3 dia.

		SAMPLER NO.						
θ		_____						
Degrees		1	2	3	4	5	6	7
0 ⁰		53.50	56.55	58.85	61.72	62.44	63.23	62.44
90 ⁰		44.38	44.19	45.24	45.06	43.82	42.70	44.40
180 ⁰		37.16	34.36	30.42	27.70	27.00	25.10	26.69
270 ⁰		43.67	41.60	42.76	42.11	41.88	42.18	40.18

W.T. = 47.6⁰F
 Scale = 10x
 B.G. = 0.4
 P.P. = Centerline
 ΔH = 0.90

Dye Concentrations (ppb)
 Run No. = 28
 Date = 7/28/66
 I.P. = 47.3 dia.

		SAMPLER NO.						
θ		1	2	3	4	5	6	7
Degrees								
0 ⁰		11.53	12.40	12.93	13.45	13.32	13.55	13.83
90 ⁰		9.70	9.30	9.45	9.17	9.20	9.31	9.33
180 ⁰		7.05	6.25	5.65	5.35	5.23	4.97	4.88
270 ⁰		9.19	9.21	9.28	8.87	8.97	9.09	9.24

W.T. = 47.6⁰F
 Scale = 10x
 B.G. = 0.4
 P.P. = Centerline
 ΔH = 1.50

Dye Concentrations (ppb)
 Run No. = 29
 Date = 7/28/66
 I.P. = 47.3 dia.

		SAMPLER NO.						
θ		1	2	3	4	5	6	7
Degrees								
0 ⁰		9.32	10.21	10.73	10.96	11.10	11.32	11.56
90 ⁰		7.54	7.60	7.62	7.57	7.34	7.35	7.18
180 ⁰		5.73	5.17	4.52	4.42	4.14	4.03	3.94
270 ⁰		7.19	7.49	7.21	7.25	7.37	7.01	6.96

W.T. = 47.7⁰F
 Scale = 10x
 B.G. = 0.4
 P.P. = Centerline
 ΔH = 1.48

Dye Concentrations (ppb)
 Run No. = 30
 Date = 7/29/66
 I.P. = 47.3 dia.

θ Degrees	SAMPLER NO.						
	1	2	3	4	5	6	7
0 ⁰	9.17	10.08	10.40	10.37	10.71	10.63	10.75
90 ⁰	7.02	7.26	7.21	7.18	7.36	7.28	7.28
180 ⁰	5.58	4.82	4.30	4.05	3.84	3.75	3.60
270 ⁰	6.97	6.81	6.90	6.72	6.90	6.85	6.65

W.T. = 47.7⁰F
 Scale = 10x
 B.G. = 0.4
 P.P. = Centerline
 ΔH = 2.35

Dye Concentrations (ppb)
 Run No. = 31
 Date = 7/29/66
 I.P. = 47.3 dia.

θ Degrees	SAMPLER NO.						
	1	2	3	4	5	6	7
0 ⁰	8.26	9.70	9.73	9.97	10.24	10.16	9.81
30 ⁰	8.50	9.21	9.10	9.17	9.49	9.62	9.56
60 ⁰	7.67	7.80	7.79	8.10	8.17	8.29	8.55
90 ⁰	6.51	6.56	6.59	6.56	6.56	6.56	6.66
120 ⁰	5.60	5.35	5.11	5.10	4.98	4.82	4.95
150 ⁰	5.30	4.63	4.33	4.02	4.02	3.88	3.72
180 ⁰	5.01	4.21	3.96	3.75	3.55	3.41	3.53
210 ⁰	5.10	4.45	4.04	3.96	3.78	3.61	3.55
240 ⁰	5.41	5.05	4.88	4.66	4.52	4.53	4.52
270 ⁰	6.16	6.10	6.13	6.04	6.05	6.19	6.01
300 ⁰	7.14	7.32	7.42	7.57	7.90	7.87	7.73
330 ⁰	7.63	8.43	8.53	8.58	8.83	8.99	8.84

W.T. = 47.7⁰F
 Scale = 10x
 B.G. = 0.4
 P.P. = Centerline
 ΔH = 3.08

Dye Concentrations (ppb)
 Run No. = 32
 Date = 7/29/66
 I.P. = 47.3 Dia.

		SAMPLER NO.						
θ								
Degrees		1	2	3	4	5	6	7
0 ⁰		7.56	8.17	8.43	8.73	8.87	9.02	9.05
90 ⁰		6.07	6.13	6.07	6.10	6.13	5.98	6.10
180 ⁰		4.69	3.53	3.76	3.50	3.48	3.30	3.24
270 ⁰		5.93	5.76	5.79	5.60	5.63	5.60	5.60

W.T. = 48.0⁰F
 Scale = 3x
 B.G. = 0
 P.P. = Centerline
 ΔH = 0.04

Dye Concentrations (ppb)
 Run No. = 33
 Date = 7/30/66
 I.P. = 27.1

		SAMPLER NO.						
θ								
Degrees		1	2	3	4	5	6	7
0 ⁰		66.13	69.08	68.02	65.83	68.55	71.87	66.96
90 ⁰		52.18	48.48	45.52	45.20	38.30	37.36	33.61
180 ⁰		36.98	26.01	22.40	17.35	16.04	13.61	12.03
270 ⁰		49.61	43.57	38.30	36.90	35.30	33.16	31.40

W.T. = 47.7⁰F
 Scale = 3x
 B.G. = 0
 P.P. = Centerline
 ΔH = 0.87

Dye Concentrations (ppb)
 Run No. = 34
 Date = 7/30/66
 I.P. = 27.1 dia.

		SAMPLER NO.						
θ								
Degrees		1	2	3	4	5	6	7
0 ⁰		68.72	72.53	73.57	72.77	75.38	74.06	73.69
90 ⁰		47.12	43.90	37.20	35.55	34.13	32.09	35.69
180 ⁰		33.39	24.39	16.44	14.10	11.96	10.74	10.30
270 ⁰		49.23	45.43	42.42	38.30	38.22	37.52	35.60

W.T. = 47.7⁰F
 Scale = 10x
 B.G. = 1.6
 P.P. = Centerline
 ΔH = 1.47

Dye Concentrations (ppb)
 Run No. = 35
 Date = 7/30/66
 I.P. = 27.1 dia.

		SAMPLER NO.						
θ								
Degrees		1	2	3	4	5	6	7
0 ⁰		19.09	19.51	19.87	19.54	19.78	19.37	19.06
90 ⁰		13.23	11.77	10.60	9.69	9.10	9.18	8.73
180 ⁰		8.27	5.50	4.48	3.61	2.89	2.49	2.19
270 ⁰		12.64	11.53	10.09	10.10	9.26	9.03	9.06

W.T. = 47.7⁰F
 Scale = 10x
 B.G. = 1.0
 P.P. = Centerline
 ΔH = 2.40

Dye Concentrations (ppb)
 Run No. = 36
 Date = 7/30/66
 I.P. = 27.1 dia.

θ Degrees	SAMPLER NO.						
	1	2	3	4	5	6	7
0 ⁰	14.82	15.29	15.32	14.70	14.30	14.00	14.60
30 ⁰	13.81	14.40	13.91	13.58	13.39	13.45	13.52
60 ⁰	11.86	11.46	11.43	10.87	10.83	10.17	10.14
90 ⁰	9.19	8.21	7.68	7.08	6.98	6.68	6.62
120 ⁰	7.81	6.80	5.28	4.70	4.31	3.87	3.45
150 ⁰	6.92	5.50	3.93	3.15	2.77	2.46	2.10
180 ⁰	6.75	4.50	3.37	2.79	2.57	1.90	1.58
210 ⁰	4.30	4.08	3.70	3.10	2.64	2.35	2.16
240 ⁰	8.05	6.05	5.25	4.76	4.30	4.01	3.89
270 ⁰	9.84	8.59	7.65	7.11	6.82	6.50	6.37
300 ⁰	11.35	11.23	10.78	10.61	10.39	10.54	10.41
330 ⁰	13.00	13.40	13.30	13.20	12.77	12.98	12.75

W.T. = 47.8⁰F
 Scale = 10x
 B.G. = 0.9
 P.P. = Centerline
 ΔH = 3.08

Dye Concentrations (ppb)
 Run No. = 37
 Date = 8/2/66
 I.P. = 27.1 dia.

θ Degrees	SAMPLER NO.						
	1	2	3	4	5	6	7
0 ⁰	12.60	13.20	13.30	12.85	12.68	12.71	12.59
90 ⁰	9.02	7.70	6.83	6.25	6.11	6.00	5.96
180 ⁰	6.27	4.28	3.30	2.55	2.20	1.91	1.72
270 ⁰	8.60	7.75	6.90	6.24	6.07	5.93	5.57

APPENDIX C

METERING DEVICE TESTS

An accurate determination of the completeness of mixing at any given distance from the point of tracer injection is fundamentally dependent on precise, accurate, and dependable metering of the tracer. Many devices for accomplishing this are described in the literature and in manufacturers' catalogs along with claims about their accuracy. Regardless of the claims, the utility of any device depends on the ability of a particular shop to construct the mechanical parts and/or on the maintenance and operational skill possessed by the technicians who operate it. Only when a particular device has been constructed and tested in a particular lab can this utility be determined.

At Colorado State University, prolonged tests on a Mariotte system - orifice system and an "Aerofeeder"* showed that, with extreme care (and in the case of the aerofeeder, considerable modification), metering precision of ± 1 percent could be achieved for brief intervals of time. However, both devices were considered unreliable for flow rates in the range 0-50 ml. per minute.

The Mariotte system - orifice system was extremely sensitive to temperature changes, the presence of dissolved air in solution, and pressure fluctuations in the turbulent flow field at the point of injection.

* Aerofeed Corporation, Chalfont, Pennsylvania

The Aerofeeder operated satisfactorily for varying periods of time; however, sudden surges would deviate from the mean flow rate by as much as 3 percent, and were unpredictable.

A Jacco** positive displacement model 258 DJ2PN duplex proportioning pump was also tested intensively. A check valve was inserted in the discharge line to maintain a constant back-pressure on the system and the suction side was flooded under positive head according to the manufacturer's recommendations. The initial performance was grossly inadequate and the split-phase motor which operates the pumps was replaced with a constant speed synchronous motor to try to improve the metering precision.

The testing consisted of collecting the discharge on a continuously reading Mettler automatic balance and periodically recording the total weight. Over several two hour testing periods, the range of error was as high as ± 1.7 percent. The manufacturer claims a metering accuracy of $\pm .5$ percent and, upon consultation, suggested that the valves might be faulty and probably should be replaced. Nonetheless, the tenor of the whole conversation left the researcher with the impression that their claim of $\pm .5$ percent accuracy is unrealistic.

The Chemcon pump used in this study was subsequently ordered, tested and found to be acceptable. However, initial test results were far from good and it was only after considerable trial and error that satisfactory operation was achieved with it. The recommendations of the

** Jacco Pump Co., Warrington, Pennsylvania

of the manufacturer were poor. The polyvinyl chloride valving and pump head are brittle and in the frequent cleaning that is necessary with dye, are apt to break or strip threads. Also, our experiments indicate that stainless steel valves would be more positive and less apt to bind than the PVC valves which were provided. The PVC valves (spheres), because they were soft, sometimes stuck in the valve seats. The teflon diaphragm provided by the manufacturer was very thick and stiff and did not conform closely enough to the contours of the backing plate to deliver a constant volume per stroke. Fortunately, as the teflon warmed up, it would "flow" and start to assume the required shape. After a variable warm-up period of sometimes as long as 6 hours, the pump would operate satisfactorily. Replacement of the teflon diaphragm with one of Viton A greatly improved the performance.

In the final analysis, although the Chemcon pump provided better metering accuracy than any other device tested, a considerable number of adjustments had to be made during the experimental runs because of variation in the flow rate beyond ± 0.5 percent and the pump is not recommended for metering which requires this degree of accuracy.

This writer feels that probably the most reliable method for fluid metering would be through the use of a piston and cylinder arrangement driven by a precision screw and synchronous motor. Many such devices are described, particularly in the British literature, and a variable rate version of this is available from the BIF division of New York Air Brake Company, Providence, Rhode Island.

Although the cost is high (about \$2,000), the pump really appears to be a precision device judging from the photographs and the manufacturer's description. It is probably available on a trial basis as are most of the more expensive pumps.

Precautions Difficulties and Pitfalls

Multiple filtering of the dye was necessary to prevent clogging the ELF flowmeter and the orifice at the end of the pipe. This was accomplished by filtering the 20 percent solution through "Kimwipes,"* a laboratory wiping tissue with large surface area, followed by filtering the final diluted solution through a set of filters identical to the ones used in the metering apparatus and described in this report.

Frequent zeroing of the fluorometer became necessary on certain days when the humidity was high due to condensation of atmospheric moisture on the surface of the cuvette.

Daily calibration of the fluorometer in the field is a must and should be made under actual operating conditions.

Voltages were checked daily and, in the case of the dye-injection apparatus, continuously.

The presence of any air in the dye-injection lines, pump, or valving threw the metering accuracy way off, and considerable time and effort were required to prevent. The double tank system proved helpful in this respect since it allowed the system to be flushed without disassembly.

* Product of Kimberly-Clark Paper Company