

DISSERTATION

INTRODUCTION AND MANAGEMENT OF *MYXOBOLUS CEREBRALIS*-RESISTANT
RAINBOW TROUT IN COLORADO

Submitted by

Eric R. Fetherman

Department of Fish, Wildlife, and Conservation Biology

In partial fulfillment of the requirements

For the Degree of Doctor of Philosophy

Colorado State University

Fort Collins, Colorado

Summer 2013

Doctoral Committee:

Advisor: Dana Winkelman

Larissa Bailey

Kathryn Huyvaert

Lisa Angeloni

Copyright by Eric Raymond Fetherman 2013

All Rights Reserved

ABSTRACT

INTRODUCTION AND MANAGEMENT OF *MYXOBOLUS CEREBRALIS*-RESISTANT RAINBOW TROUT IN COLORADO

Myxobolus cerebralis, the pathogen responsible for salmonid whirling disease, was unintentionally introduced to Colorado in the late-1980s. Following its introduction, *M. cerebralis* caused significant declines in wild rainbow trout (*Oncorhynchus mykiss*) populations across the state. Hundreds of thousands of *M. cerebralis*-susceptible rainbow trout were stocked into Colorado's waters in an effort to reduce these population level declines, however, rainbow trout populations continued to disappear. In the early-2000s, a hatchery-derived, *M. cerebralis*-resistant rainbow trout strain, the German Rainbow (GR) strain, was discovered at a Bavarian hatchery in Germany. The GR strain was imported into Colorado and crossed with the Colorado River Rainbow (CRR) strain, a wild rainbow trout strain that had been widely stocked in Colorado and comprised many naturally reproducing wild rainbow trout fisheries prior to the introduction of *M. cerebralis*. Crosses of the GR and CRR were rigorously evaluated in laboratory experiments, and the first filial generational cross between the two strains (termed the H×C) was found to exhibit resistance characteristics similar to those of the GR strain. In addition, the H×C is capable of attaining critical swimming velocities similar to those of the CRR strain. Laboratory results suggested that the H×C was the best candidate for reintroducing rainbow trout in areas with a high prevalence of *M. cerebralis*; however, its utility needed to be evaluated in a natural setting.

In the first of two introduction experiments conducted as part of my dissertation research, the H×C was introduced to the upper Colorado River downstream of Windy Gap Reservoir in

Grand County, Colorado. The objectives of the introduction were to examine the abundance, survival and growth of the stocked H×C population. In addition, the age-0 rainbow trout genetic composition in the upper Colorado River was examined to determine if H×Cs had contributed offspring to the age-0 population. I also evaluated whether these offspring displayed increased resistance and survival characteristics compared to their wild CRR counterparts.

Adult H×C abundance (\hat{N} km⁻¹) did not differ from adult CRR abundance in the upper Colorado River in any year of the study (2008 – 2011). Both populations exhibited significant decreases in abundance (\pm SD) between 2008 (H×C: 57 ± 8 fish km⁻¹; CRR: 68 ± 15 fish km⁻¹) and 2011 (H×C: 4 ± 1 fish km⁻¹; CRR: 6 ± 1 fish km⁻¹). Apparent survival of the H×C over the entire study period was estimated (\pm SE) to be 0.007 (\pm 0.001), and survival appeared to be most affected by minimum discharge (cms) between study occasions.

Despite low survival of adult rainbow trout in the upper Colorado River, age-0 rainbow trout were found in every year of the study. Genetic assignments revealed a shift in the genetic composition of the rainbow trout fry population over time, with CRR and unknown fish comprising all of the fry population in 2007, and GR-cross fish comprising nearly 80% of the fry population in 2011. A decrease in average infection severity (myxospores fish⁻¹) was observed concurrent with the shift in the genetic composition of the rainbow trout fry population; average (\pm SE) myxospore count of the rainbow trout fry population decreased from 47,708 (\pm 8,950) myxospores fish⁻¹ in 2009 to an average myxospore count of 2,672 (\pm 4,379) myxospores fish⁻¹ in 2011. CRR fry exhibited a higher average myxospore count than did GR-cross and brown trout fry; GR-cross fry and brown trout fry did not differ in average myxospore count. Results from this experiment suggested that H×C could survive and reproduce in rivers with a high prevalence of *M. cerebralis*. In addition, reduced myxospore burdens in age-0 GR-cross fish

indicated that stocking this cross may ultimately lead to an overall reduction in infection prevalence and severity in the salmonid populations of the upper Colorado River.

In the second introduction experiment, conducted in the Cache la Poudre River in Larimer County, Colorado, brown trout (*Salmo trutta*) were removed from one of two rainbow trout introduction locations with the objective of determining whether brown trout removal would increase the survival and retention of GR-cross fish. Radio Frequency Identification (RFID) passive integrated transponder (PIT) tags and antennas were used to passively estimate survival and to track movements made by PIT-tagged fish (both stocked rainbow trout and wild brown trout) in reaches where brown trout had (removal reach; 1.0 km) or had not (control reach; 1.3 km) been removed. Additionally, two crosses of rainbow trout were stocked for this experiment, the H×C, and a cross between the GR and Harrison Lake rainbow trout strain (originating from Harrison Lake, Montana; termed the H×H); H×H fish had been stocked in Colorado rivers prior to this experiment, but their performance in the wild had not been rigorously evaluated. Multistate capture-recapture models, utilizing the recapture data from the PIT tag antennas, were used to estimate survival and movement probabilities for PIT-tagged fish on a weekly basis during both the primary study period (August 15 – November 3, 2010) and the winter study period (November 4, 2010 – April 14, 2011).

Apparent survival for the H×C during the primary study period did not differ for fish within the control or removal reaches; however, apparent survival of H×C fish that moved out of a reach (upstream or downstream) was much lower than that of H×C fish within a reach. Apparent survival for the H×H during the primary study period was higher for fish in the control reach than fish in the removal reach; similar to the H×Cs, survival was much lower for H×H fish

that moved out of reach than fish within a reach. Brown trout survival was higher in the control reach than it was in the removal reach during the primary study period.

The H×C exhibited similar movement probabilities (out of the reach) in both the control and removal reaches, suggesting that the presence of brown trout did not affect H×C movement. The H×H, however, exhibited higher movement probabilities out of the control reach than they did out of the removal reach, suggesting that the presence of brown trout affected H×H movement. Brown trout exhibited similar net movement probabilities into both reaches during the primary study period, and secondary movement patterns suggest that the brown trout population was in a state of equilibrium in both reaches, following initial movements into the reaches, during the primary study period.

Although the results of the removal experiment suggest that brown trout removal had a positive effect on the retention of the H×Hs, the overall benefit of the removal was equivocal and I suggest that brown trout removal may not be necessary for reintroduction of rainbow trout. Additionally, the logistical constraints of conducting removals in other large river systems in Colorado are substantial and may not be a viable management option in many rivers. Therefore, I suggest that future *M. cerebralis*-resistant rainbow trout introductions in Colorado be conducted without brown trout removal. The stocked rainbow trout (both crosses) appeared to be well suited for introduction, and seemed to be capable of overcoming many of the ecological resistance factors encountered, potentially becoming established in both the control and removal reaches of the Cache la Poudre River.

The use of PIT tag technology allowed passive detection of movement past stationary antenna stations and estimation of survival and retention of PIT-tagged salmonids in the Cache la Poudre River. In addition to the stationary antennas, two portable antennas were developed,

tested, and deployed to sample PIT-tagged fish in both the Cache la Poudre and St. Vrain Rivers. The raft antenna array, developed for sampling PIT-tagged fish over long distances (km), consisted of two antennas, a horizontal antenna that was used to detect fish under the raft in less than one meter of water, and a vertical antenna used to detect fish in sections deeper than one meter. Upon deployment in the Cache la Poudre River, the raft antenna array detected 44 unique PIT tagged fish, and had an estimated detection probability (p ; \pm SE) of 0.14 (\pm 0.14) and an estimated recapture probability (c) of 0.13 (\pm 0.07). The second array, a shore-deployed floating array, was developed to detect PIT-tagged fish over short distances and potentially be used in place of traditional sampling methods (i.e., electrofishing) for estimating the abundance of the PIT-tagged fish population. The array was deployed over short (hundreds of meters) sampling sections within both the Cache la Poudre and St. Vrain Rivers prior to electrofishing efforts conducted in the same sections, and population estimates obtained via electrofishing and the antenna array were compared. Results suggested that the shore-deployed floating array provided reasonable estimates of abundance when compared with standard electrofishing estimates, and when deployed in sections averaging less than one meter deep. The portable antenna systems developed for this experiment provide a noninvasive method for estimating PIT-tagged fish abundance and survival in both small (hundreds of m) and large (km) sections of river, and are novel designs for collecting data using relatively new RFID PIT tag technology.

ACKNOWLEDGEMENTS

I would like to thank Colorado Parks and Wildlife (CPW) and the Colorado Cooperative Fish and Wildlife Research Unit at Colorado State University for their funding and support of this project. Thank you to the CPW staff that assisted with this project, including the Glenwood Springs Hatchery Staff, the Rifle Hatchery staff, the Poudre Fish Rearing Unit staff, especially James Ingram, the Bellvue Hatchery staff, the Bellvue Fish Research Hatchery staff, and Joanne Tarman and the Brush Fish Health Lab staff. A special thanks to CPW aquatic biologists Kurt Davies and Jon Ewert for their assistance and for allowing me to manipulate fish populations in the waters that they manage. I am grateful for the volunteers and CPW staff that assisted with brown trout removal, including Chris Adams, Mike Avery, Rich Bader, Aaron Bartleson, Jon Becker, Kevin Bestgen, Rosemary Black, Mike Brown, Bob Cadera, Justin Callison, Gary Carlton, Matthew Cittadino, Andy Claus, Dennis Cook, Shane Craig, Morriah Cowden, Lee Evans, Matt Ferrier, Albert Fink, Lee Fritz, Kyle Gallatin, Amy Galy, Dennis Galyardt, Vince Griesemer, Matt Haworth, Jon Hess, Ian Hogan, Derrick Johnson, Derrick Johnson, Ken Kehmeier, Phil Keller, Norm Lindquist, Courtney Maine, Paul Matheu, Mark Miller, Jon Morgan, Chad Morgan, Andrew Nordick, Kyle Okeson, Chelsea OpDyke, Greg Parks, Mark Ratchpord, Scott Romatzke, Randy Schmidt, Nicholas Seipelt, Jeff Spohn, Ben Swigle, Kevin Thompson, Steve Thrapp, Laura Tully, Zack Underwood, Harry Vermillion, Scott Whetstone, Paul Winkle, and Phil Wright. I am grateful for the assistance of Brian Avila without whom this project would not have been possible. I especially appreciate the knowledge, support and guidance provided by my committee members Dr. Larissa Bailey, Dr. Kate Huyvaert, and Dr. Lisa Angeloni, my advisor Dr. Dana Winkelman, and Dr. George Schisler. Thanks also for the love and support provided by my parents, Ray and Sheri Fetherman, and Tiffany Warble.

TABLE OF CONTENTS

ABSTRACT.....	ii
ACKNOWLEDGEMENTS.....	vii
TABLE OF CONTENTS.....	viii
LIST OF TABLES.....	xiii
LIST OF FIGURES.....	xvi
CHAPTER 1: WHIRLING DISEASE (<i>MYXOBOLUS CEREBRALIS</i>) AND ITS MANAGEMENT HISTORY IN COLORADO.....	1
WHIRLING DISEASE, <i>MYXOBOLUS CEREBRALIS</i>	1
<i>MYXOBOLUS CEREBRALIS</i> IN COLORADO.....	3
Upper Colorado River.....	4
Gunnison River.....	6
Cache la Poudre River.....	7
<i>MYXOBOLUS CEREBRALIS</i> RESISTANT RAINBOW TROUT.....	8
Resistant Brood Stock Development.....	10
Physiological Effects and Heritability.....	12
Field Trials.....	14
Colorado River.....	14
Gunnison River.....	14
Ph.D. Study Objectives.....	16
LITERATURE CITED.....	22
CHAPTER 2: REINTRODUCTION OF RAINBOW TROUT TO THE UPPER COLORADO RIVER USING WHIRLING DISEASE-RESISATNT RAINBOW TROUT STRAINS.....	27

INTRODUCTION	27
METHODS	29
Site Description.....	29
Rainbow Trout Stocking.....	30
Adult Rainbow Trout Population.....	31
Population Sampling.....	31
Statistical Analyses	33
Age-0 Trout Population	34
Population Sampling.....	34
Genetic Assignment of Rainbow Trout Fry.....	35
Quantification of <i>M. cerebralis</i> Infection	36
Statistical Analyses	37
RESULTS	38
Adult Rainbow Trout Population.....	38
Age-0 Trout Population	39
DISCUSSION.....	40
Conclusions.....	45
LITERATURE CITED.....	56
APPENDIX 2.1: GENETIC DIFFERENTIATION TEST ACCURACY	60
CHAPTER 3: RAFT AND FLOATING RFID ANTENNA SYSTEMS FOR DETECTING PIT- TAGGED FISH IN LARGE RIVERS.....	63
INTRODUCTION	63
METHODS	64

Raft Antenna System	64
Field Test	66
Deployment.....	66
Statistical Analyses	68
Shore-deployed Floating Antenna System.....	68
Detection Distance	69
Field Test	69
Deployment.....	71
Statistical Analyses	71
RESULTS	72
Raft Antenna System	72
Field Test	72
Deployment.....	73
Shore-deployed Floating Antenna System.....	73
Detection Distance	73
Field Test	73
Deployment.....	74
DISCUSSION.....	75
LITERATURE CITED	82
APPENDIX 3.1: RAFT ANTENNA SYSTEM DETECTION DISTANCE TESTING ..	85
APPENDIX 3.2: SUPPLEMENTAL TABLES AND FIGURES	88

CHAPTER 4: BROWN TROUT REMOVAL EFFECTS ON SHORT-TERM SURVIVAL AND
MOVEMENT OF REINTRODUCED WHIRLING DISEASE-RESISTANT RAINBOW

TROUT92

 INTRODUCTION92

 METHODS94

 Site Description.....94

Myxobolus cerebralis-Resistant Rainbow Trout96

 Fish Marking Procedures98

 Statistical Analyses100

 Brown Trout Removal101

 Statistical Analyses102

 Rainbow Trout Introductions.....103

 RFID PIT Tag Antennas103

 Multistate Capture-Recapture Models105

RESULTS112

 Fish Marking.....112

 Brown Trout Removal113

 Apparent Survival and Movement114

 Antenna Performance.....114

 Apparent Survival115

 Movement117

DISCUSSION120

LITERATURE CITED152

APPENDIX 4.1: DISTANCE AND VELOCITY EFFECTS ON DETECTION PROBABILITY OF RFID PIT TAG ANTENNAS DEPLOYED IN HATCHERY RACEWAYS	160
APPENDIX 4.2: EMPIRICAL ESTIMATION OF DETECTION PROBABILITY OF DEPLOYED ANTENNA SYSTEMS IN THE CACHE LA POUFRE RIVER	165
APPENDIX 4.3: STOCHASTIC INFECTION RATES AND BROWN TROUT REMOVAL EFFECTS ON THE ESTABLISHMENT OF SELF-SUSTAINING, WHIRLING DISEASE-RESISTANT RAINBOW TROUT POPULATIONS	168
MODEL OBJECTIVES	168
METHODS	168
Model Assumptions	168
Rainbow Trout Age Classes and Leslie Matrix	169
Stochastic Exposure Rates	170
Predation and Competition	171
Simulations	173
Management Situations.....	174
RESULTS	174
Large Rivers with Few Alternative Prey Sources.....	174
Large Rivers with Many Alternative Prey Sources	175
Small Rivers with Few Alternative Prey Sources.....	176
Small Rivers with Many Alternative Prey Sources	176
DISCUSSION	177

LIST OF TABLES

2.1 Model selection results for factors influencing apparent survival (ϕ) and detection probability (p) of the Floy tagged H×C fish introduced to the upper Colorado River in June 200647

2.2 Model selection results for factors influencing the probability that a fish exhibits signs of *M. cerebralis* infection in the upper Colorado River in the years 2009 through 201148

3.1 Model selection results for factors influencing maximum detection distance for the shore-deployed floating antenna array79

A3.2-1 PIT-tagged rock placement, with regard to the depth and distance from center (DFC; cm) of the fifty rocks used in the detection probability experiment conducted in the Parvin Lake inlet stream89

4.1 Antenna efficiencies (E ; the probability of being detected at both antennas within an array) estimated on a weekly basis at each antenna location during the primary study period, and on a monthly basis during the winter study period129

4.2 Estimated transitions (ψ 's) included in the brown trout and rainbow trout model sets for both the primary and winter study periods130

4.3	Model selection results for differences in rainbow trout length and weight at stocking in the Cache la Poudre River in August 2010.....	131
4.4	Model selection results for Huggins closed-population models containing covariates thought to influence estimates of detection probability during the brown trout removal conducted August 14-16, 2010 in the Cache la Poudre River	132
4.5	Model selection results for multistate models fit to stocked rainbow trout data during the primary study period.....	133
4.6	Model selection results for multistate models fit to wild PIT-tagged brown trout data during the primary study period.....	134
4.7	Model selection results for multistate models fit to stocked rainbow trout data during the winter study period	135
4.8	Model selection results for multistate models fit to wild PIT-tagged brown trout data during the winter study period	136
4.9	Movement of relocated brown trout within the control and removal reaches	137
A4.3-1	Exposure rate (TAMs fish ⁻¹) and associated fry survival for introducing stochasticity to the model for yearly fry survival rates as a result of exposure to <i>M. cerebralis</i>	179

A4.3-2 Percentage of brown trout population removed corresponding brown trout population size used during model simulations180

A4.3-3 Rainbow trout introduction size and corresponding age class to which the rainbow trout were introduced during model simulations.....181

LIST OF FIGURES

1.1	Whirling disease positive streams and lakes in Colorado’s major river drainages.....	18
1.2	Upper Colorado River historic rainbow trout length-frequencies at the CPW Kemp Breeze State Wildlife Area	19
1.3	Number of brown trout, rainbow trout, and total salmonids per mile in the upper Colorado River downstream of Windy Gap Reservoir.....	20
1.4	Number of brown trout and rainbow trout per mile in the Ute Park section of the Gunnison River	21
2.1	Adult H×C and CRR abundance ($N\ km^{-1}$; SE bars) in the upper Colorado River study section for the years 2008 to 2011	49
2.2	Model-averaged monthly apparent survival rate (ϕ ; SE bars) for the H×C stocked in the upper Colorado in June 2006	50
2.3	Predictive model of growth (TL; mm) trends of the H×C stocked in the upper Colorado River in 2006.....	51
2.4	Rainbow trout fry abundance ($N\ km^{-1}$; SE bars) in June, July, August, September, and October of 2009, 2010, 2011, and 2012.....	52

2.5	Proportion of the wild rainbow trout fry population collected from the upper Colorado River in 2007 ($N = 16$), 2008 ($N = 21$), 2009 ($N = 79$), 2010 ($N = 57$), and 2011 ($N = 42$) that were assigned as CRR, GR-cross, or unknown (posterior probability < 0.80) using the microsatellite marker genetic differentiation test.....	53
2.6	Average myxospore count (myxospores fish ⁻¹ ; SE bars) of the brown trout ($N = 60$), CRR ($N = 13$), and H×C ($N = 11$) fry collected in October of 2009 and 2011 from the upper Colorado River.....	54
2.7	Proportion (SE bars) of the brown trout and rainbow trout fry populations in 2009 (brown trout: $N = 277$; rainbow trout: $N = 29$), 2010 (brown trout: $N = 64$; rainbow trout: $N = 41$), and 2011 (brown trout: $N = 138$; rainbow trout: $N = 19$) exhibiting signs of <i>M. cerebralis</i> infection	55
A2.1-1	Proportion of fish correctly assigned to strain or cross in the two blind tests for accuracy of the microsatellite marker development, and assignment by the NewHybrids program.....	62
3.1	(A) Schematic representation of the raft antenna system. (B) Diagram of the shore-deployed floating antenna system.....	80

3.2	Estimated number of PIT-tagged salmonids section ⁻¹ (95% CI bars) estimated via electrofishing (Cache la Poudre River: two passes; St. Vrain River: three passes) and the shore-deployed floating antenna system (two passes) within the surveyed sections of the Cache la Poudre River (A) and St. Vrain River (B)	81
A3.1-1	Maximum detection distance (heavy dotted line) measured on a horizontal (H), vertical (V), and 45 degree (45°) plane extending out from the horizontal array as seen from the rear (A) and side (B) of the raft	87
A3.2-1	Photo collage depicting parts of the raft antenna array.....	90
A3.2-2	Photo collage depicting parts and deployment of the shore-deployed floating antenna array	91
4.1	Location of the control, removal, and relocation reaches within the Cache la Poudre River, Colorado.....	138
4.2	Experimental design of the brown trout removal experiment conducted in the Cache la Poudre River	139
4.3	Example of the multistate model used to estimate transition (ψ), survival (ϕ), and detection probability (p) for a fish with the encounter history of CA000B0.....	140

4.4	Release (circle) and transition (square) states used in the multistate models estimating weekly apparent survival (ϕ) and movement (ψ) probabilities for rainbow trout (H×C and H×H) during the primary study period (August 15 – November 3, 2010)	141
4.5	Release (circle) and transition (square) states used in the multistate model estimating weekly apparent survival (ϕ) and movement (ψ) brown trout during the primary study period (August 15 – November 3, 2010)	142
4.6	Release (circle) and transition (square) states used in the multistate models estimating weekly apparent survival (ϕ) and movement (ψ) probabilities for brown trout and rainbow trout (H×C and H×H) during the winter study period (November 4, 2010 – April 14, 2011).....	143
4.7	Model-averaged estimates of pass-specific capture probability for two size classes (> 150 mm, ≤ 150 mm) of brown trout and rainbow trout during the removal (August 16-18, 2010)	144
4.8	Model-averaged apparent primary study period weekly survival probabilities (ϕ ; SE bars) for H×C (A) and H×H (B) below, within, and above the control and removal reaches..	145
4.9	Model-averaged apparent survival probabilities (ϕ ; SE bars) for brown trout below, within, and above the control and removal reaches during the primary study period	146

4.10	Model-averaged apparent winter weekly survival probabilities (ϕ ; SE bars) for H×C (A) and H×H (B) fish below, within, and above the control and removal reaches	147
4.11	Model-averaged apparent survival probabilities (ϕ ; SE bars) for brown trout below, within, and above the control and removal reaches during the winter study period	148
4.12	H×C (A) and H×H (B) initial movement probabilities (ψ ; SE bars), the sum of movements downstream and upstream out of the control (C→A and C→D, respectively) and removal (R→F and R→H, respectively) reaches during the primary study period	149
4.13	Brown trout net initial movement probabilities (ψ ; SE bars) into the control and removal reaches (difference in the sum of movement into and out of the reaches) during the primary study period	150
4.14	Brown trout initial pre-ice (11/5-12/16), ice (12/17-3/17), and post-ice (3/18-4/14) transition probabilities (ψ ; SE bars) into and out of the control (A) and removal (B) reaches during the winter study period	151
A4.1-1	Vertical detection probability experiments conducted at three height increments: 0-1 feet (A), 1-2 feet (B) and 2-3 feet (C)	163

A4.1-2 Diagram of vertical and velocity detection experiment set-up with a video camera positioned directly over the antenna array on the bottom of the raceway, allowing fish to pass over at various heights and water velocities164

A4.2-1 Grid used to determine detection efficiency of both the upstream and downstream wires of each antenna loop167

A4.3-1 Percent brown trout removed and the probability that a self-sustaining, whirling disease-resistant rainbow trout population is established following a single introduction of rainbow trout to large rivers with reduced levels of competition ($C = 0.00001$) and few alternative brown trout prey sources ($G = 1.0$).....182

A4.3-2 Percent brown trout removed and the probability that a self-sustaining, whirling disease-resistant rainbow trout population will be established following a single introduction of rainbow trout to large rivers with reduced levels of competition ($C = 0.00001$) and an abundance of alternative brown trout prey sources ($G = 0.5$).....183

A4.3-3 Percent brown trout removed and the probability that a self-sustaining, whirling disease-resistant rainbow trout population will be established following a single introduction of rainbow trout to small rivers with high levels of competition ($C = 0.0001$) and few alternative brown trout prey sources ($G = 1.0$).....184

A4.3-4 Percent brown trout removed and the probability that a self-sustaining, whirling disease-resistant rainbow trout population will be established following a single introduction of rainbow trout to small rivers with high levels of competition ($C = 0.00001$) and an abundance of alternative brown trout prey sources ($G = 0.5$).....185

CHAPTER 1

WHIRLING DISEASE (*MYXOBOLUS CEREBRALIS*) AND ITS MANAGEMENT HISTORY IN COLORADO

WHIRLING DISEASE, *MYXOBOLUS CEREBRALIS*

Whirling disease is caused by the parasite *Myxobolus cerebralis*, and was first detected in rainbow (*Oncorhynchus mykiss*) and brook (*Salvelinus fontinalis*) trout that were imported to Germany in 1893 for hatchery production (Höfer 1903). *M. cerebralis* is native to Europe and infects many salmonid species, including trout (*Oncorhynchus* spp., *Salmo trutta*, *Salvelinus* spp.), salmon (*Oncorhynchus* spp., *Salmo salar*), and mountain whitefish (*Prosopium williamsoni*). It is a member of the Phylum Cnidaria, based primarily on the structural features of the waterborne infectious triactinomyxon (TAM) stage of the parasite, which has extrusive filaments (cnidocysts) for attachment to the fish host (Siddall et al. 1995; Kent et al. 2001).

Whirling disease has a complex two-host life cycle that was not fully described until the mid-1980s when the oligochaete host *Tubifex tubifex* was discovered to be part of the life cycle (Markiw and Wolf 1983; Wolf and Markiw 1984). The waterborne triactinomyxon (TAM) stage of *M. cerebralis* attaches to a salmonid host (El-Matbouli et al. 1999a; Hedrick and El-Matbouli 2002). After penetrating the epidermis, germ cells from the sporoplasm disperse deeper into the layers of the epidermis, migrating and replicating among nerve bundles in ganglia and the central nervous system (El-Matbouli et al. 1995). The parasite migrates from the central nervous system and undergoes further replication in the host cartilage, eventually undergoing sporogenesis to form the multicellular myxospore stage (Lom and Dyková 1992; El-Matbouli et al. 1995). When the fish host dies, myxospores become available for ingestion by the second host, the oligochaete

T. tubifex (Hedrick and El-Matbouli 2002). Myxospores undergo several stages of transformation within the intestinal epithelial cells of *T. tubifex*, eventually transforming back into the infectious triactinomyxon form of the parasite (El-Matbouli et al. 1998; El-Matbouli and Hoffman 1998; El-Matbouli et al. 1999b). Triactinomyxons are then released into the water by *T. tubifex* where they again can infect salmonid hosts (Markiw 1986; Hedrick and El-Matbouli 2002).

After its discovery in Germany in the late 1800s, whirling disease was discovered in many other countries around the world. Between 1911 and 1970, whirling disease was found in several European countries including Denmark, Finland, France, Italy, the USSR, Czechoslovakia, Poland, Bulgaria, Yugoslavia, Sweden, Scotland, and Norway, and South Africa and Morocco in Africa (Bartholomew and Reno 2002). Hoffman (1970) estimated that the original home range of *M. cerebralis* covered an area from central Europe to northeast Asia; however, because it was a disease of brown trout (*Salmo trutta*), in which the infection is usually asymptomatic, it was the introduction of non-native rainbow trout that led to the discovery of the parasite in locations within its home range (Hoffman 1970; Gilbert and Granath 2003). Unrestricted transfers of live infected fish were suspected to be the main route of dissemination outside of the European home range (Hoffman 1970).

Between 1971 and the present, whirling disease has been found in several other European countries including Austria, Belgium, Hungary, England, Ireland, Netherlands, and Spain (Bartholomew and Reno 2002). Differences in monitoring and reporting, and inconsistencies in the literature, make it difficult to determine whether these introductions were caused by unrestricted transfers of live fish between rearing facilities and into natural populations, or if the

original range of *M. cerebralis* included most of the European countries where the disease was discovered (Halliday 1976).

In 1971, whirling disease was also discovered in New Zealand where it was reported to have caused a whirling motion, a condition known locally as “whirly-gig” disease, accompanied by heavy mortality in rainbow trout populations (Hewitt and Little 1972). Suspected introduction routes included live importation of salmonids, and live food for tropical fish which may have included infected tubificids; however, introduction routes are difficult to determine because examination of preserved specimens demonstrated that the parasite had been present at least five years before it was identified (Boustead 1993).

Whirling disease was first detected in the United States in brook trout at the Benner Springs Fish Research Station in Bellefonte, Pennsylvania in 1956. It is suspected that introduction occurred via infected ground fish tissue fed to hatchery brook trout (Hoffmann 1962). A second introduction was detected in 1965 in California, where frozen fish from a Danish merchant vessel fed to hatchery fish were implicated in the introduction (Hoffman 1990). Once established at these locations in the eastern and western United States, subsequent spread of the disease has been attributed to transfers of live fish (Hoffman 1970; Hoffman 1990), and has since been found in 22 states: Arizona, California, Colorado, Connecticut, Idaho, Maryland, Massachusetts, Michigan, Montana, Nevada, New Hampshire, New Mexico, New Jersey, New York, Ohio, Oregon, Pennsylvania, Utah, Virginia, Washington, West Virginia, and Wyoming (Bartholomew and Reno 2002).

MYXOBOLUS CEREBRALIS IN COLORADO

In Colorado, whirling disease was detected in rainbow trout at one public and three private aquaculture facilities in November 1987, and by April 1989 it had been detected at 11

fish culture facilities and 40 captive or free-ranging salmonid populations in 11 of the 15 major river drainages (Barney et al. 1988; Nehring and Thompson 2003). Introduction of the disease to Colorado was believed to have occurred accidentally through one or more legal shipments of trout to a private hatchery from an inspected source that subsequently tested positive (Walker and Nehring 1995). The disease became disseminated throughout the state as a result of transfers and introductions of infected fish from *M. cerebralis*-positive state and private hatcheries prior to its detection (Barney et al. 1988; Walker and Nehring 1995).

Affected drainages in Colorado, many of which experienced severe declines in the young-of-year portion of the rainbow trout population following introduction, include the North Platte, South Platte, Upper Arkansas, Rio Grande Headwaters, San Juan, Upper Colorado-Dolores, Gunnison, Colorado Headwaters, and White-Yampa drainages (Nehring and Thompson 2001; Figure 1.1). Walker and Nehring (1995) examined several possible reasons for the decline in young-of-year rainbow trout and identified whirling disease as the primary factor causing the declines in recruitment. Additional laboratory and field studies demonstrated that whirling disease was the primary factor explaining the loss of juvenile rainbow trout in many stream segments throughout Colorado (Schisler et al. 1999a; Schisler et al. 1999b; Nehring and Thompson 2001).

Upper Colorado River

Prior to the introduction of whirling disease, a thriving, self-sustaining rainbow trout population existed in the upper Colorado River. In 1981, Colorado Parks and Wildlife (CPW) started taking wild rainbow trout eggs from the stretch of river located below Windy Gap Reservoir to establish a wild rainbow trout brood stock known as the Colorado River Rainbow (CRR) trout. This CRR brood stock was used to stock several rivers across the state including

the Animas, Arkansas, Blue, Dolores, Fryingpan, Gunnison, North Platte, Rio Grande and Roaring Fork Rivers. In the early 1980s, rainbow trout fry comprised approximately 56% of the fry population in the upper Colorado River, with the other 44% comprised of brown trout fry. Rainbow trout fry density estimates ranged from 5,600 to 8,400 fry km⁻¹ (9,000 to 13,500 fry mi⁻¹), with brown trout fry density estimates of 2,600 to 5,700 fry km⁻¹ (4,200 to 9,100 fry mi⁻¹; Walker and Nehring 1995). Estimates indicate that age-1 and older rainbow trout existed in the river at an average density of 428 fish km⁻¹ (687 fish mi⁻¹), whereas age-1 and older brown trout were present at an average density of 239 fish km⁻¹ (384 fry mi⁻¹; calculated from data presented in Nehring and Thompson 2001), a ratio of rainbow trout to brown trout of 2:1.

Privately-reared rainbow trout exposed to *M. cerebralis* were stocked into three private lakes and ponds in the upper Colorado River basin in the mid-1980s, with two of the three sites located in the headwaters of the Colorado River upstream of Windy Gap Reservoir. Fish below Windy Gap Reservoir subsequently tested positive for the disease in 1988 (Nehring 2006). In the fall of 1993, population sampling revealed a highly unusual age structure, with age-1+, 2+, and 3+ rainbow trout cohorts comprising only 0.7%, 0.5% and 9.7% of the population (Walker and Nehring 1995). This pattern not only continued, but worsened throughout the 1994, 1995, and 1996 fall sampling periods (Nehring and Thompson 2001; Figure 1.2). Several reasons for the disappearance of the younger age-classes were investigated including heavy metal pollution, avian and piscine predation, emigration, short or long term fluctuations in stream discharge, and thermal stress (Walker and Nehring 1995), as well as gas supersaturation (Schisler et al. 1999a; Schisler et al. 2000) and ectoparasites (Schisler et al. 1999b). However, whirling disease was determined to be the primary factor causing the losses of the younger age-classes (Nehring and Thompson 2001). In an effort to restore the rainbow trout fishery in the upper Colorado River,

tens of thousands of CRR were stocked annually between 1994 and 2008. Unfortunately, stocking efforts have had little success, with rainbow trout density and biomass levels approximately 90% lower than those observed prior to the establishment of *M. cerebralis* (Nehring 2006; Figure 1.3).

Gunnison River

Prior to the introduction of *M. cerebralis*, age-1 rainbow trout were present in the upper Gunnison River at an average density of 592 fish ha⁻¹, ranging from 220 to 1,568 fish ha⁻¹; age-1 brown trout densities averaged 1,178 fish ha⁻¹, ranging from 495 to 2,118 fish ha⁻¹ (Nehring and Thompson 2001). Fish showing signs of whirling disease were first observed in the Gunnison River in 1994. The source of these infected fish was determined to be a private hatchery that tested positive for *M. cerebralis* in December 1987, following stocking of the infected fish. The introduction of infected fish to the Gunnison River basin occurred in Meridian Lake, located on the East River (tributary to the Gunnison), which subsequently tested positive for the disease in 1988. After a three to four year delay, the CPW Roaring Judy State Fish Rearing Unit, located 30 km (27.2 mi) downstream of Meridian Lake on the East River, tested positive for the disease. In 1994, 96% of the brown trout collected at two widely separated locations in the upper Gunnison River near Almont tested positive for the disease (Nehring 2006). The age-1 rainbow trout population subsequently collapsed in the upper Gunnison River, dropping to an average density of 31 fish ha⁻¹ in the years following introduction. Brown trout densities did not change significantly after introduction of the disease, dropping only slightly to an average density of 1,151 fish ha⁻¹ in the years following introduction (Nehring and Thompson 2001).

Initial introduction of the parasite to the lower river likely occurred in June or July of 1993 when an uncontrolled surface spill of water over Crystal Dam likely carried the parasite

over the dam. The lower Gunnison River below Crystal Dam had not been stocked with fish of any kind since the late-1970s, eliminating stocking as a potential introduction route (Nehring 2006). Prior to the introduction of *M. cerebralis*, age-1 rainbow trout densities through Ute Park averaged 233 fish ha⁻¹, ranging from 50 to 902 fish ha⁻¹. In comparison, age-1 brown trout densities averaged 498 fish ha⁻¹, ranging from 221 to 982 fish ha⁻¹ (Nehring and Thompson 2001). The rainbow trout population in the lower Gunnison River collapsed following *M. cerebralis* introduction, dropping to an average density of only 3 fish ha⁻¹ in the years following introduction. The brown trout population experienced an increase following *M. cerebralis* introduction, increasing to an average density of 721 fish ha⁻¹ (Nehring and Thompson 2001; Figure 1.4).

Cache la Poudre River

Prior to the introduction of *M. cerebralis* to the Cache la Poudre River, age-1 and older rainbow trout were found in higher average densities (170 fish ha⁻¹) than age-1 and older brown trout (103 fish ha⁻¹; calculated from data presented in Nehring and Thompson 2001). *Myxobolus cerebralis* was first detected in the Cache la Poudre River drainage at the CPW Poudre Rearing Unit (PRU) in 1988. PRU is a large catchable rainbow trout production facility with six earthen ponds located on the upper reaches of the river, approximately 73 miles west of Fort Collins (Nehring 2006). Allen and Bergersen (2002) showed that the earthen ponds at the unit supported dense populations of *T. tubifex* worms. Subsequent testing of the ponds revealed that they produced high densities of *M. cerebralis* TAMs, and effluent from the ponds containing high TAM densities was discharged into the river (Nehring and Thompson 2001). Prevalence of infection in rainbow trout held in the ponds was often as high as 100% with average myxospore counts greater than 470,000 myxospores fish⁻¹, ranging as high as 1.63 million for individual

trout (Nehring and Thompson 2003). In addition to the release of TAMs from the infected PRU, Schisler (2001) reported that more than one million trout from infected hatcheries and rearing units, a large majority of which originated from PRU, were stocked into the Cache la Poudre River, lakes, reservoirs, and tributaries to the Cache la Poudre River drainage between 1990 and 2001. However, Nehring (2006) suggests that despite the number of fish stocked in the drainage, TAM densities discharged to the river from ponds on PRU were sufficient to cause a complete loss of rainbow trout fry downriver of the unit. Following introduction of *M. cerebralis*, severe declines were experienced by the rainbow trout population; by 1995, no age-1 and older rainbow trout were detected in any of the population estimates. Brown trout did not suffer significant declines in the river following *M. cerebralis* introduction (Nehring and Thompson 2001).

MYXOBOLUS CEREBRALIS RESISTANT RAINBOW TROUT

Since the introduction of *M. cerebralis* to Colorado, several management strategies have been considered for reintroducing and managing rainbow trout. Although many of these management options work well in hatchery situations, they are not applicable to wild populations. The most promising potential management option for wild populations appeared to be the use of resistant hosts (Schisler et al. 2006).

An *M. cerebralis* resistant strain of rainbow trout was identified at the Hofer Rainbow Trout Farm in Germany (El-Matbouli et al. 2002). These rainbow trout had been imported into Germany in the late 1800s for hatchery production. Development of resistance was presumed to be a result of growth and reproduction of the German rainbow (GR) strain under continuous exposure to the parasite in the Bavarian hatchery (Hedrick et al. 2003). El-Matbouli et al. (2002) found that, under experimental laboratory conditions, the GR strain was at least as resistant to *M. cerebralis* as brown trout (*Salmo trutta*), which had presumably evolved with the parasite in its

European home range (Hoffman 1970). The GR strain was also found to be more resistant to *M. cerebralis* than either the North American Trout Lodge (TL) or CRR trout strains (Hedrick et al. 2003; Schisler et al. 2006). However, because the GR strain fish were domesticated, their survival and viability in the wild was questionable, and the consequences of stocking them directly into wild trout waters were unknown (Schisler et al. 2006). The GR strain was also known to be inbred, exhibiting low heterozygosity (El-Matbouli et al. 2006). Therefore, the GR likely lacked the genetic diversity necessary for survival and adaptation to dynamic river conditions.

The genetic basis for the resistance characteristics of the GR strain are under investigation. The mechanisms for resistance to whirling disease seen in the GR strain, like those seen in trout resistant to a similar myxosporean, *Ceratomyxa shasta*, were suspected to be polygenic and at least partly additive (Hedrick et al. 2001). Studies examining differential gene expression in resistant and susceptible strains of rainbow trout have identified several genes as possibly being involved in resistance (Severin and El-Matbouli 2007; Baerwald et al. 2008; Severin et al. 2010). Baerwald et al. (2010) discovered a major Quantitative Trait Locus (QTL) influencing resistance that explained 50 to 86% of the genetic variation relating to resistance in the GR strain, indicating that a single large-effect gene may be conferring the bulk of the resistance. However, other minor effect genes could also be contributing, as at least one other QTL was identified by Baerwald et al. (2010), and a microarray gene expression study found up-regulation of the Metallothionein-B gene in the same strain (Baerwald et al. 2008). Fetherman et al. (2012) found that it was likely that many alleles were involved in resistance, determining that the number of loci differentiating the GR strain from the CRR strain was 9 ± 5 , and that

dominance played a role in how resistance alleles were conferred to crosses of the GR and CRR strains.

Resistant Brood Stock Development

In 2004, CPW began a selective breeding program using the GR and CRR strains. Resistant GR fish were spawned with susceptible CRR fish to evaluate if whirling disease resistance could be incorporated into a rainbow trout strain that exhibited resistance characteristics similar to the GR strain but retained the desirable wild characteristics of the CRR strain (Schisler et al. 2006). The goal was to reestablish wild, self-sustaining rainbow trout populations in Colorado's rivers.

The first filial cross developed from the GR and CRR parental strains was the F1 cross (referred to as H×C in Chapters 2 through 4 of this dissertation). The F1 was created by spawning a GR male with a CRR female, or reciprocally, a GR female with a CRR male. Genetically, the F1 strain is heterozygous for all alleles. Schisler et al. (2006) found that the F1 exhibited intermediate resistance, measured by myxospore count, to the GR and CRR strains. Though not significant, the F1, CRR male × GR female families exhibited almost 40,000 more myxospores, on average, than the F1, GR male × CRR female families included in that experiment (Schisler 2006). Reciprocal families were therefore included in exposure experiments conducted by Fetherman et al. (2011). Results indicated that myxospore count did not differ between the reciprocal families; therefore, directionality of spawning did not affect the development of resistance characteristics in the F1, and directionality was not a major concern for future spawning operations used to create F1 brood stock (Fetherman et al. 2011). A survival experiment used to test the survival of the F1 in relation to that of the pure CRR and pure GR strains in the wild, conducted in an artificial stream channel located below Antero Reservoir in

South Park, showed that the F1 exhibited significantly higher survival than either pure strain two months post-release into the channel; 47% of the introduced F1 remained, compared to 30% of the pure GR, and only 20% of the pure CRR (Schisler 2006). Currently, H×Cs have been experimentally introduced into several of Colorado's major rivers, including the upper Colorado and Gunnison Rivers.

A backcross between the F1 and CRR, known as the B2 backcross, was also created and evaluated to determine if a cross containing more wild rainbow trout characteristics could be created without a significant loss of resistance. The B2 is effectively 75% CRR and 25% GR, with any given genotype having a 50% chance of being expressed as heterozygous GR and CRR or as homozygous CRR. Schisler et al. (2007) and Fetherman et al. (2011) determined that there was a loss of resistance in the B2, with the backcross exhibiting a significantly higher mean myxospore count than the F1 or GR strain. However, the B2 fish still exhibited a significantly lower mean myxospore count than the CRR strain, indicating that some resistance still existed within individual fish; therefore, resistant B2 offspring should survive exposure to the disease in the wild and recruit to the population (Fetherman et al. 2011). B2 fish have been introduced into the Ute Park section of the Gunnison River for survival evaluation and comparison to F1 strain fish stocked in the same river section. As a result of the potential for a loss of resistance, the B2 backcross has not been incorporated into Colorado's brood stock program.

The resistance characteristics of an F2 intercross have also been evaluated. F2 offspring result from the spawning of two F1 individuals. The F2 strain is effectively 50% GR and 50% CRR, with any given genotype having a 25% chance of being expressed as homozygous GR, a 50% chance of being expressed as heterozygous GR and CRR, or a 25% chance of being expressed as homozygous CRR. The F2 fish exhibited a significantly higher mean myxospore

count than F1 or GR strains in exposure experiments conducted by Fetherman et al. (2011). Therefore, subsequent generations produced by introduced F1 fish could experience a reduction in resistance and, as a result, recruitment in the wild. The F2 intercross has not been integrated into Colorado's brood stock program nor been stocked into any Colorado rivers.

The Harrison Lake (HL) rainbow trout strain, a wild, self-sustaining rainbow trout strain from Harrison Lake, Montana has proven to be more resistant to whirling disease than other North American rainbow trout strains (Vincent 2002; Schisler 2006; Wagner et al. 2006). In addition, continued exposure to the parasite in the wild appears to have naturally increased the resistance of the HL strain, returning populations to about 70% of what they were prior to the introduction of whirling disease (Miller and Vincent 2008). Though resistance is not equivalent to the GR strain, the HL strain still displays a significantly lower mean myxospore count than the CRR strain (Schisler 2006). Several crosses of the GR and HL strains have been created by CPW, including a GR×HL (50:50) cross, a GR×HL (75:25) cross, and a GR×HL (87.5:12.5) cross. The first filial generational cross between the GR and HL strains (GR×HL 50:50; referred to as H×H in this dissertation) exhibited a mean myxospore count similar to the GR strain (Schisler 2006; Schisler et al. 2008), indicating that crosses between the two strains may possess the best combination of resistant and wild rainbow trout characteristics necessary for survival in Colorado. However, researchers question the retention of the HL strain following introduction to a river due to its affinity for lakes and reservoirs. The retention of the H×H following introduction is examined in Chapter 4.

Physiological Effects and Heritability

In addition to resistance characteristics, heritability of myxospore count and the physiological effects of whirling disease have also been examined in the laboratory for the GR,

CRR, and their crosses (Fetherman et al. 2011; Fetherman et al. 2012). Whirling disease does not appear to affect growth or critical swimming velocity, as there were no differences in performance observed between exposed and unexposed individuals within any of the five strains. However, performance differences were observed between strains. Very few differences were observed between the GR strain and F1 with respect to swimming ability and resistance characteristics, and the GR strain outperformed the F1 with respect to growth. These results suggested that the GR strain would be a good candidate for reintroducing rainbow trout to Colorado (Fetherman et al. 2011). However, the GR strain is highly domesticated (Schisler et al. 2006) and inbred (El-Matbouli et al. 2006). Therefore, it was suggested that additional field trials be conducted to determine whether the performance differences seen under controlled experimental conditions are paralleled by similar results in the field (Fetherman et al. 2011).

Estimates of broad sense heritability (h^2_b) and average myxospore counts were lowest in the GR strain, and F1 and F2 crosses (h^2_b : 0.34, 0.42, and 0.34; myxospores fish⁻¹: 275, 9,566, and 45,780, respectively), and highest in the B2 cross and CRR strain (h^2_b : 0.93 and 0.89; myxospores fish⁻¹: 97,865 and 187,595, respectively; Fetherman et al. 2012). Comparison of means and a joint-scaling test suggested that resistance alleles arising from the GR strain were dominant to susceptible alleles from the CRR strain. Resistance was retained in the crosses but decreased the further removed a cross was from the parental GR strain. The results indicated that resistance to *M. cerebralis* was a heritable trait within these populations and should respond to either artificial selection in hatcheries or natural selection in the wild (Fetherman et al. 2012).

Field Trials

Colorado River

In June 2006, 3,000 F1 rainbow trout were stocked in the upper Colorado River between Windy Gap Reservoir and the town of Hot Sulphur Springs, just upstream of Byers Canyon. Due to low survival observed in fingerling CRRs planted in this location over the previous decade, suspected to be partially a result of heavy brown trout predation, the F1 fish were stocked at 241 mm total length (TL) to prevent predation loss. Prior to stocking, the F1 fish were measured to the nearest 5 mm, and marked with an individually numbered fine filament Floy anchor tag. In November 2006, a standard two-pass removal estimate was conducted in a 0.31 m (0.19 mi) section of the upper Colorado River. The introduced F1 fish were estimated to exist in the river at a density of 272 fish km⁻¹ (438 fish mi⁻¹), indicating that survival of the introduced fish was high within the first six months post-stocking (Schisler et al. 2007). Introductions of F1 fish to the upper Colorado River also occurred in 2009 and 2010, and monitoring the survival and reproductive success of the fish from these introductions, as well as those introduced in 2006, was an objective of this Ph.D. work (see Chapter 2).

Gunnison River

In October 2004, 10,115 F1 strain fish (119 mm TL) and 10,105 CRR strain fish (136 mm TL) were stocked into the Ute Park section of the Gunnison River, each containing a unique visual implant elastomer (VIE) tag for identification. Survival of the introduced fish was relatively low over the first year, with only 12 CRR and 24 F1 fish detected in a population estimate conducted in September 2005. However, myxospore count data for the resistant fish were promising, with F1 individuals displaying an average myxospore count of only 4,055

myxospores fish⁻¹ compared to an average myxospore count of 124,603 myxospores fish⁻¹ for the CRR individuals (Schisler 2006).

In November 2005, 5,000 B2 and 5,000 CRR fish, each possessing a different fin clip for identification, were stocked into the Ute Park section of the Gunnison River. For this introduction, fish were held in holding cages for 30-45 minutes prior to their release in an effort to increase survival. Loss of marks made survival difficult to determine during population estimates conducted in September 2006. Rainbow trout ($N = 10$) encountered during the estimates were retained, identified using the Amplified Fragment Length Polymorphism (AFLP) genetic technique (visual identification was not possible due to tag loss), and myxospore counts were obtained from each fish. The CRR displayed an average myxospore count of 83,929 myxospores fish⁻¹, compared to an average myxospore count of 40,480 myxospores fish⁻¹ in the B2 backcross. B2 and CRR fish were stocked again in 2006 at a larger size than fish stocked in 2005 to determine if the larger fish would survive better and develop fewer myxospores than the fish from the 2005 introduction. However, poor tag retention continued to make survival estimates of all introduced strains difficult.

AFLP analyses on fry collected during density estimates in 2007 showed a range of GR markers, indicating that GR-variety offspring were produced by either, or both, the F1 and B2 strain fish in spring 2007, and were still present by October of that year. In November 2007, the number of fish stocked was increased to 20,000 CRR and 20,000 F1 fish, with each fish receiving a batch-marked coded wire tag, inserted in the nose, in an effort to increase tag retention and strain and cross identification (Schisler et al. 2008). Survival and reproduction of the introduced rainbow trout strains in the Ute Park section of the Gunnison River is a subject of ongoing research for CPW.

Ph.D. Study Objectives

The overarching goal of the whirling disease resistant rainbow trout program is to establish wild, self-sustaining rainbow trout populations in Colorado's rivers. The objectives of this Ph.D. project were to determine the survival of the introduced *M. cerebralis*-resistant rainbow trout, if offspring were produced by the introduced rainbow trout, if offspring displayed increased survival and resistance to *M. cerebralis*, and if brown trout removal was a viable management option for increasing the survival and retention of the introduced rainbow trout.

Though introductions of *M. cerebralis*-resistant rainbow trout have occurred experimentally in several rivers throughout Colorado, this project focused specifically on introductions that occurred in the upper Colorado River below Windy Gap Reservoir. Monitoring objectives included obtaining survival estimates for introduced rainbow trout populations in the upper Colorado River and determining if the offspring produced by these fish exhibited increased survival and resistance to *M. cerebralis*. By examining characteristics unique to the offspring produced in the upper Colorado River, specific questions regarding whether rainbow trout fry show temporal variation in disease sign; whether disease sign, infection prevalence, and myxospore counts have been reduced over time as a result of *M. cerebralis* resistant rainbow trout introductions; and whether offspring genotype confers resistance, were answered (Chapter 2).

Brown trout densities increased following the introduction of *M. cerebralis* (Baldwin et al. 1998; Nehring and Thompson 2001) suggesting that brown trout may have expanded to fill the biological niche vacated by the lost rainbow trout (Baldwin et al. 1998). Therefore, a brown trout removal experiment was conducted in the Cache la Poudre River with the objective of determining if removal increased the survival and retention of the introduced *M. cerebralis*-

resistant rainbow trout. A secondary objective was to determine if there were differences in survival and retention between two crosses of rainbow trout (H×C and H×H) commonly used in river introductions in Colorado. Specific questions focused on how quickly brown trout moved back into the removal section, if removed brown trout reintroduced to the river several miles downstream of the removal section returned and how quickly, what the overall survival and retention of the introduced rainbow trout was in sections where brown trout were or were not removed, and if there were survival and retention differences between the two rainbow trout crosses (Chapter 4). The results from both the Colorado River rainbow trout introduction and the Cache la Poudre River brown trout removal will be used to improve upon *M. cerebralis*-resistant rainbow trout introduction strategies to achieve the goal of producing wild, self-sustaining rainbow trout populations in Colorado's rivers.

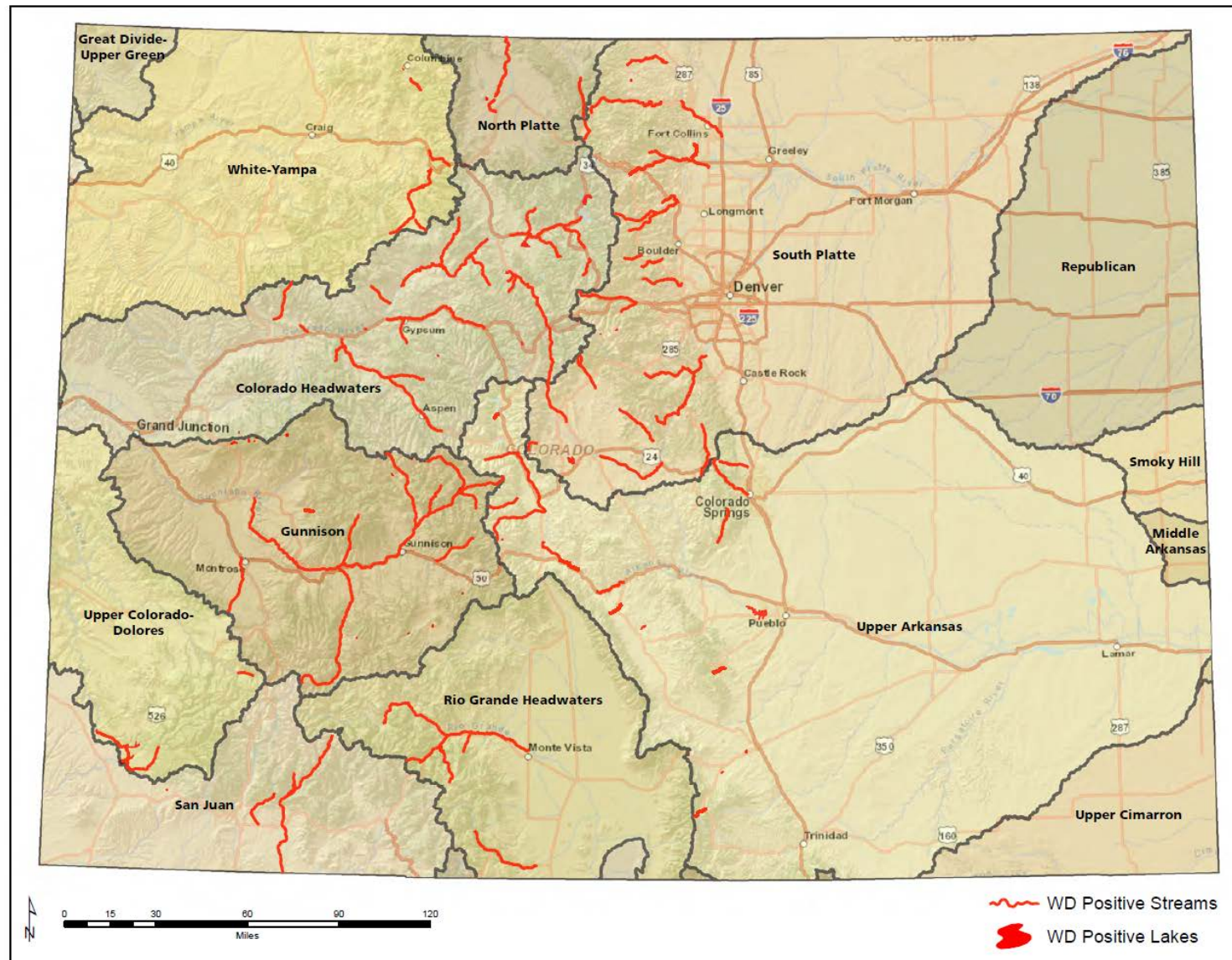

Figure 1.1. Whirling disease positive streams and lakes in Colorado’s major river drainages.

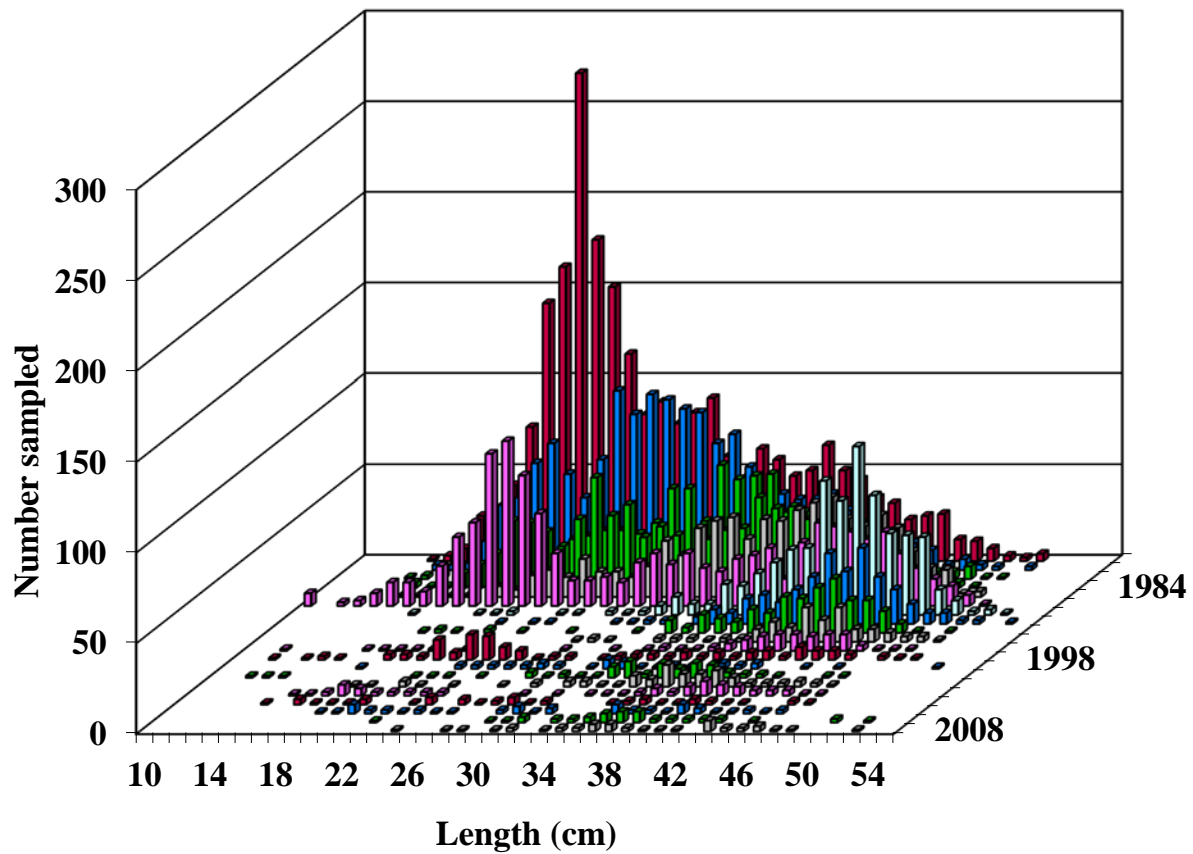

Figure 1.2. Upper Colorado River historic rainbow trout length-frequencies at the CPW Kemp-Breeze State Wildlife Area. Notice the decline in the smaller length classes following introduction of *Myxobolus cerebralis* in the 1980s. A decline in recruitment to the larger age classes followed the loss of the smaller age classes (seen in the early to mid 1990s), leading to a collapse of the rainbow trout population in the upper Colorado River. Despite numerous restocking events, the rainbow trout population remains low in the late 2000s.

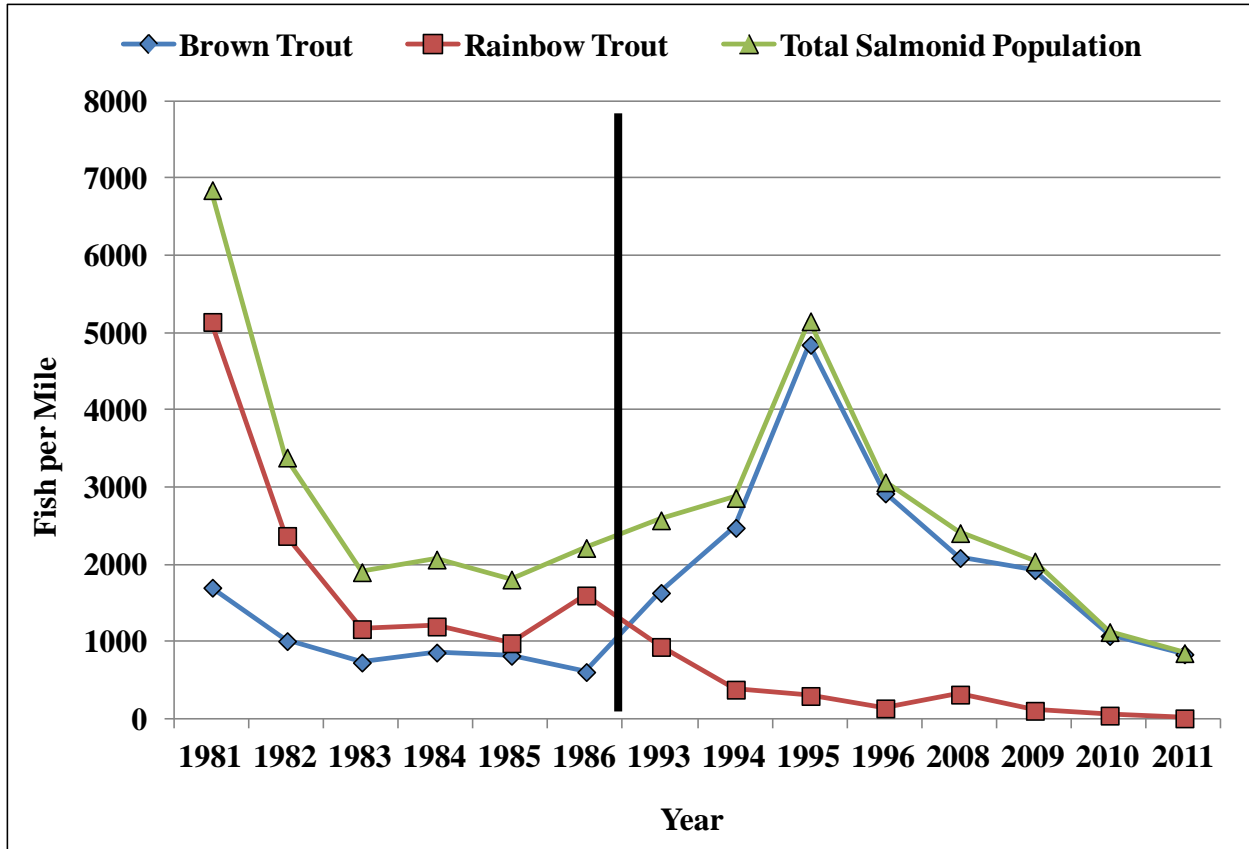

Figure 1.3. Number of brown trout, rainbow trout, and total salmonids per mile in the upper Colorado River downstream of Windy Gap Reservoir. Note the decrease in rainbow trout and increase in brown trout following the introduction of *Myxobolus cerebralis* in the 1980s (solid black line). Brown trout comprise a large proportion of the total salmonid population in the late 2000s.

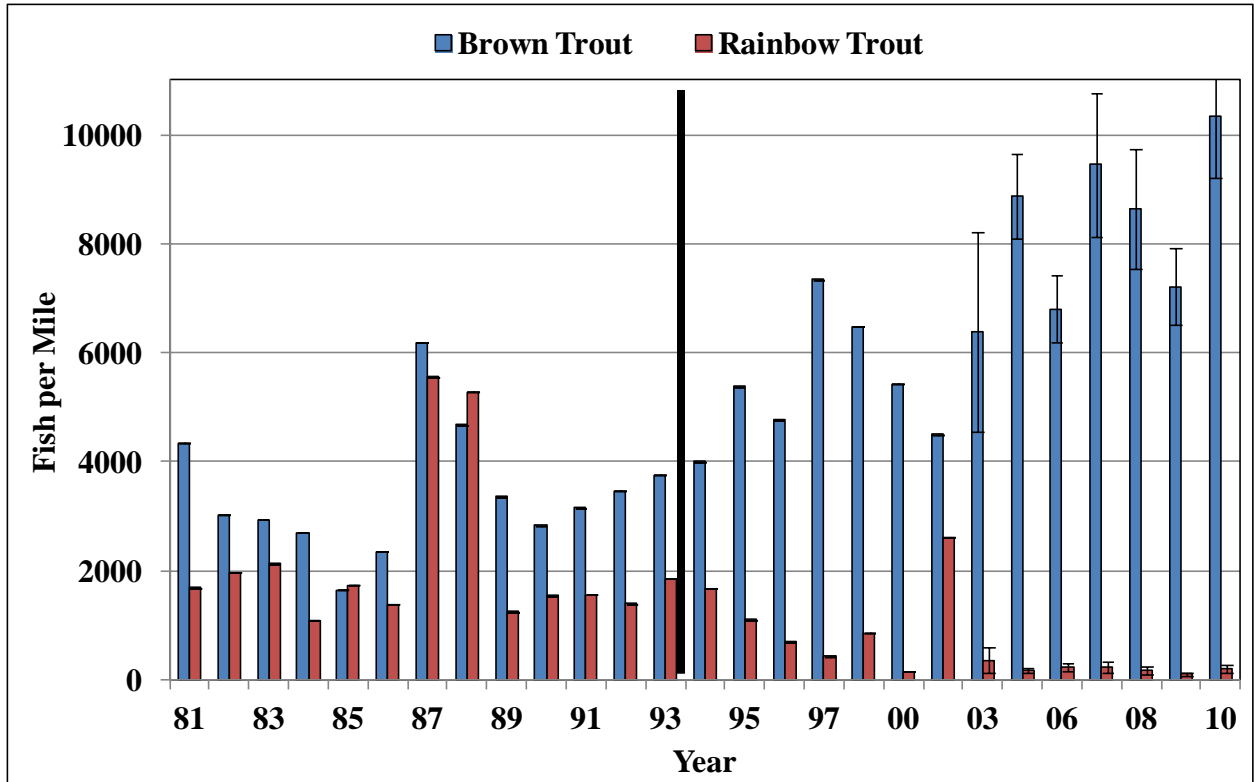

Figure 1.4. Number of brown trout and rainbow trout per mile in the Ute Park section of the Gunnison River. Notice the decrease in rainbow trout and increase in brown trout following the introduction of *Myxobolus cerebralis* to the lower Gunnison River in the 1990s (solid black line). Despite repeated introductions with *M. cerebralis*-resistant rainbow trout strains, rainbow trout numbers remain low, and brown trout numbers high, in the late 2000s.

LITERATURE CITED

- Allen, M. B., and E. P. Bergersen. 2002. Factors influencing the distribution of *Myxobolus cerebralis*, the causative agent of whirling disease, in the Cache la Poudre River, Colorado. *Diseases of Aquatic Organisms* 49:51-60.
- Baerwald, M. R., A. B. Welsh, R. P. Hedrick and B. May. 2008. Discovery of genes implicated in whirling disease infection and resistance in rainbow trout using genome-wide expression profiling. *BMC Genomics* 9:37.
- Baerwald, M. R., J. L. Petersen, R. P. Hedrick, G. J. Schisler, and B. May. 2010. A major effect quantitative trait locus for whirling disease resistance identified in rainbow trout (*Oncorhynchus mykiss*). *Heredity* (2010):1-7.
- Baldwin, T. J., J. E. Peterson, G. C. McGhee, K. D. Staigmiller, E. S. Motteram, C. C. Downs, and D. R. Stanek. 1998. Distribution of *Myxobolus cerebralis* in salmonid fishes in Montana. *Journal of Aquatic Animal Health* 10:361-371.
- Barney, P., D. E. Anderson, and P. G. Walker. 1988. Whirling disease identified in Colorado. *American Fisheries Society, Fish Health Section Newsletter* 16:3.
- Bartholomew, J. L. and P. W. Reno. 2002. The history and dissemination of whirling disease. Whirling Disease: Reviews and Current Topics. Edited by J. L. Bartholomew and J. C. Wilson. *American Fisheries Society Symposium* 29:3-24.
- Boustead, N. C. 1993. Detection and New Zealand distribution of *Myxobolus cerebralis*, the cause of whirling disease of salmonids. *New Zealand Journal of Marine and Freshwater Research* 27:431-436.
- El-Matbouli, M., and R. W. Hoffman. 1998. Light and electron microscopic study on the chronological development of *Myxobolus cerebralis* in *Tubifex tubifex* to the actinosporean stage triactinomyxon. *International Journal of Parasitology* 28:195-217.
- El-Matbouli, M., R. W. Hoffman, and C. Mandok. 1995. Light and electron microscopic observations on the route of the triactinomyxon-sporoplasm of *Myxobolus cerebralis* from epidermis into rainbow trout (*Oncorhynchus mykiss*) cartilage. *Journal of Fish Biology* 46:919-935.
- El-Matbouli, M., T. W. Holstein, and R. W. Hoffman. 1998. Determination of the nuclear DNA concentration in cells of *Myxobolus cerebralis* and triactinomyxon spores, the causative agent of whirling disease. *Parasitological Research* 84:694-699.
- El-Matbouli, M., R. W. Hoffman, H. Shoel, T. S. McDowell, and R. P. Gedrick. 1999a. Whirling disease: host specificity and interaction between the actinosporean stage of *Myxobolus cerebralis* and rainbow trout (*Oncorhynchus mykiss*) cartilage. *Disease of Aquatic Organisms* 35:1-12.

- El-Matbouli, M., T. S. McDowell, D. B. Antonio, K. B. Andree, and R. P. Hedrick. 1999b. Effects of water temperature on the development, release and survival of the triactinomyxon stage of *Myxobolus cerebralis* in its oligochaete host. *International Journal for Parasitology* 29:627-641.
- El-Matbouli, M., R. W. Hoffman, and M. P. Küppers. 2002. Identification of a whirling disease resistant strain of rainbow trout in Germany. Pages 29-32 in 8th Annual Whirling Disease Symposium: Putting a Fresh Spin on Whirling Disease. February 13-15, Denver, Colorado.
- El-Matbouli, M., A. Oucible, V. Severin, U. Meyer, D. Grabner, and R. P. Hedrick. 2006. Data on the mechanisms associated with the resistance of Hofer- and wild rainbow trout strains to whirling disease. Pages 22-23 in 12th Annual Whirling Disease Symposium: War of the Whirls. February 9-10, Denver, Colorado.
- Fetherman, E. R., D. L. Winkelman, G. J. Schisler, and C. A. Myrick. 2011. The effects of *Myxobolus cerebralis* on the physiological performance of whirling disease resistant and susceptible strains of rainbow trout. *Journal of Aquatic Animal Health* 23:169-177.
- Fetherman, E. R., D. L. Winkelman, G. J. Schisler, and M. M. Antolin. 2012. Broad sense heritability of myxospore count in whirling disease resistant and susceptible strains of rainbow trout. *Diseases of Aquatic Organisms* 102:97-106.
- Gilbert, M. A. and W. O. Granath, Jr. 2003. Whirling disease of salmonid fish: life cycle, biology, and disease. *Journal of Parasitology* 89(4):658-667.
- Halliday, M. M. 1976. The biology of *Myxosoma cerebralis*: the causative organism of whirling disease of salmonids. *Journal of Fish Biology* 9:339-357.
- Hedrick, R. P. and M. El-Matbouli. 2002. Review: recent advances with taxonomy, life cycle, and development of *Myxobolus cerebralis* in the fish and oligochaete host. Whirling Disease: Reviews and Current Topics. Edited by J. L. Bartholomew and J. C. Wilson. *American Fisheries Society Symposium* 29:45-53.
- Hedrick, R. P., T. S. McDowell, K. Mukkatira, and M. P. Georgiadis. 2001. Salmonids resistant to *Ceratomyxa shasta* are susceptible to experimentally induced infections with *Myxobolus cerebralis*. *Journal of Aquatic Animal Health* 13:35-42.
- Hedrick R. P., T. S. McDowell, G. D. Marty, G. T. Fosgate, K. Mukkatira, K. Myklebust, and M. El-Matbouli. 2003. Susceptibility of two strains of rainbow trout (one with suspected resistance to whirling disease) to *Myxobolus cerebralis* infection. *Disease of Aquatic Organisms* 55:37-44.
- Hewitt, G. C., and R. W. Little. 1972. Whirling disease in New Zealand trout caused by *Myxosoma cerebralis* (Höfer, 1903) (Protozoa: Myxosporidia). *New Zealand Journal of Marine and Freshwater Research* 6:1-10.

- Höfer, B. 1903. Ueber die Drehkrankheit der Regenbogenforelle. Allgemeine Fischerei Zeitschrift 28:7-8.
- Hoffmann, G. L. 1962. Whirling disease of trout. United States Department of the Interior. Fishery Leaflet 508. U.S. Fish and Wildlife Service.
- Hoffmann, G. L. 1970. Intercontinental and transcontinental dissemination and transfaunation of fish parasites with emphasis on whirling disease (*Myxosoma cerebralis*) and its effects on fish. Symposium on Diseases of fisheries and Shellfishes. Edited by S. F. Snieszko. American Fisheries Society, Special Publication Number 5:69-81.
- Hoffman, G. L. 1990. *Myxobolus cerebralis*, a worldwide cause of salmonid whirling disease. Journal of Aquatic Animal Health 2:30-37.
- Kent, M. L., K. B. Andree, J. L. Bartholomew, M. El-Matbouli, S. S. Desser, R. H. Devlin, S. W. Feist, R. P. Hedrick, R. W. Hoffmann, J. Khattra, S. L. Hallett, R. J. G. Lester, M. Longshaw, O. Palenzeula, M. E. Siddall, and C. Xiao. 2001. Recent advances in our knowledge of the Myxozoa. The Journal of Eukaryotic Microbiology 48(4):395-413.
- Lom, J., and I. Dyková. Protozoan Parasites of Fishes. Elsevier, Amsterdam, 1992.
- Markiw, M. E. 1986. Salmonid whirling disease: dynamics of experimental production of the infective stage – the triactinomyxon spore. Canadian Journal of Fisheries and Aquatic Sciences 43:521-526.
- Markiw, M. E., and K. Wolf. 1983. *Myxosoma cerebralis* (Myxozoa, Myxosporidia) etiological agent of salmonid whirling disease requires tubificid worm (Annelida, Oligochaeta) in its life cycle. Journal of Protozoology 30(3):561-564.
- Miller, M. P., and E. R. Vincent. 2008. Rapid natural selection for resistance to an introduced parasite of rainbow trout. Evolutionary Applications 1(2008):336-341.
- Nehring, R. B. 2006. Colorado's cold water fisheries: whirling disease case histories and insights for risk management. Colorado Division of Wildlife. Aquatic Wildlife Research Special Report Number 79. February 2006.
- Nehring, R. B., and K. G. Thompson. 2001. Impact assessment of some physical and biological factors in the whirling disease epizootic among wild trout in Colorado. Colorado Division of Wildlife. Aquatic Research Special Report Number 76. March 2001.
- Nehring, R. B., and K. G. Thompson. 2003. Whirling disease risk assessment: the Colorado perspective. Pages 31-32 in 9th Annual Whirling Disease Symposium: Managing the Risk. February 6-7, Seattle, Washington.

- Schisler, G. J. 2001. Whirling Disease Investigations. Federal Aid in Fish and Wildlife Restoration Job Progress Report. Colorado Division of Wildlife, Fish Research Section. Fort Collins, Colorado.
- Schisler, G. J. 2006. Salmonid Disease Studies. Federal Aid in Fish and Wildlife Restoration Job Progress Report. Colorado Division of Wildlife, Fish Research Section. Fort Collins, Colorado.
- Schisler, G. J., E. P. Bergersen, and P. G. Walker. 1999a. Evaluation of chronic gas supersaturation on growth, morbidity, and mortality of fingerling rainbow trout infected with *Myxobolus cerebralis*. North American Journal of Aquaculture 61:175-183.
- Schisler, G. J., P. G. Walker, L. A. Chittum, and E. P. Bergersen. 1999b. Gill ectoparasites of juvenile rainbow trout and brown trout in the upper Colorado River. Journal of Aquatic Animal Health 11:170-174.
- Schisler, G. J., E. P. Bergersen, and P. G. Walker. 2000. Effects of multiple stressors on morbidity and mortality of fingerling rainbow trout infected with *Myxobolus cerebralis*. Transactions of the American Fisheries Society 129:859-865.
- Schisler, G. J., K. A. Myklebust, and R. P. Hedrick. 2006. Inheritance of *Myxobolus cerebralis* resistance among F1-generation crosses of whirling disease resistant and susceptible rainbow trout strains. Journal of Aquatic Animal Health 18:109–115.
- Schisler, G. J., P. J. Schler, and E. R. Fetherman. 2007. Salmonid Disease Studies. Federal Aid in Fish and Wildlife Restoration, Job Progress Report. Colorado Division of Wildlife, Fish Research Section. Fort Collins, Colorado.
- Schisler, G. J., E. R. Fetherman, and P. J. Schler. 2008. Salmonid Disease Studies. Federal Aid in Fish and Wildlife Restoration, Job Progress Report. Colorado Division of Wildlife, Fish Research section. Fort Collins, Colorado.
- Severin, V. I., and M. El-Matbouli. 2007. Relative quantification of immune-regulatory genes in two rainbow trout strains, *Oncorhynchus mykiss*, after exposure to *Myxobolus cerebralis*, the causative agent of whirling disease. Parasitology Research 101(4):1019-1027.
- Severin, V. I. C., H. Soliman, and M. El-Matbouli. 2010. Expression of immune regulatory genes, arginase-2 and inducible nitric oxide synthase (iNOS), in two rainbow trout (*Oncorhynchus mykiss*) strains following exposure to *Myxobolus cerebralis*. Parasitology Research 106:325-334.
- Siddall, M. E., D. S. Martin, D. Bridge, S. S. Desser, and D. K. Cone. 1995. The demise of a phylum of protists: phylogeny of Myxozoa and other parasitic cnidaria. Journal of Parasitology 8:961-967.

- Vincent, E. R. 2002. Relative susceptibility of various salmonids to whirling disease with emphasis on rainbow trout and cutthroat trout. American Fisheries Society Symposium 29:109-115.
- Wagner, E. J., C. Wilson, R. Arndt, P. Goddard, M. Miller, A. Hodgson, R. Vincent and K. Mock. 2006. Evaluation of disease resistance of the fish Lake De-Smet, Wounded Man, and Harrison Lake strains of rainbow trout exposed to *Myxobolus cerebralis*. Journal of Aquatic Animal Health 18:128-135.
- Walker, P. G., and R. B. Nehring. 1995. An investigation to determine the cause(s) of the disappearance of young wild rainbow trout in the Upper Colorado River, in Middle Park, Colorado. Colorado Division of Wildlife Report. Denver.
- Wolf, K., and M. E. Markiw. 1984. Biology contravenes taxonomy in the Myxozoa: new discoveries show alternation of invertebrate and vertebrate hosts. Science 225:1449-1452.

CHAPTER 2

REINTRODUCTION OF RAINBOW TROUT TO THE UPPER COLORADO RIVER USING WHIRLING DISEASE-RESISTANT RAINBOW TROUT STRAINS

INTRODUCTION

Extirpations of wild salmonid populations have been caused by a variety of factors and have led to a focus on captive breeding (i.e., hatcheries) to sustain or reintroduce populations (Hesthagen and Larsen 2003; Flagg et al. 2004; Bosch et al. 2007; Carmona-Catot et al. 2012). However, successful reintroduction attempts using captive-reared salmonids usually involve mitigating or removing the factors responsible for the original extirpation (Fraser 2008). For instance, artificial liming has been used to reduce river acidification and has aided in successful reintroduction of Atlantic salmon (*Salmo salar*; Hesthagen and Larsen 2003). Greenback cutthroat trout have also been successfully reintroduced in streams with suitable habitat that are protected from reinvasion by other invasive trout species (Harig and Fausch 2000). However, when factors causing extirpations have not been fully mitigated prior to reintroduction, stocking has generally been unsuccessful (Fraser 2008).

In Colorado, introduction of *Myxobolus cerebralis*, the parasite responsible for salmonid whirling disease, caused the extirpation of wild rainbow trout (*Oncorhynchus mykiss*) populations from many of the state's rivers (Nehring and Thompson 2001). Unlike extirpations caused by factors that could potentially be mitigated or reversed, pathogens such as *M. cerebralis* cannot be removed once introduced into an ecosystem. However, disruption of the parasite's life cycle has been attempted either through habitat manipulation to reduce populations of the intermediate oligochaete host (*Tubifex tubifex*) or through introduction of resistant lineages of *T.*

tubifex. Neither approach has been completely successful (Thompson 2011). One promising approach for the recovery of Colorado's rainbow trout populations has been the production of rainbow trout that are genetically resistant to the parasite. To this end, management and research in Colorado have focused on using crosses between resistant, hatchery-derived rainbow trout and wild rainbow trout strains (Schisler et al. 2006).

The German Rainbow (GR) is a hatchery-derived rainbow trout strain that was exposed to *M. cerebralis* for decades in a Bavarian hatchery in Germany (Hedrick et al. 2003). Although the GR strain can be infected with *M. cerebralis*, parasite burdens are usually low (Hedrick et al. 2003; Schisler et al. 2006; Fetherman et al. 2012) and the GR strain is known to survive and reproduce in the presence of and infected with *M. cerebralis*. Low parasite burdens and the strain's ability to persist when exposed to *M. cerebralis* have been termed "resistance," and this resistance is presumed to be a result of long-term exposure to the parasite over multiple generations (Hedrick et al. 2003). Despite the resistance seen in the GR strain, its survival and viability in the wild was uncertain due to the strain's history of domestication (Schisler et al. 2006). Therefore, the GR strain was experimentally crossed with the Colorado River Rainbow (CRR; Schisler et al. 2006; Fetherman et al. 2011; Fetherman et al. 2012), a wild rainbow trout strain that had been widely stocked in Colorado and comprised many naturally reproducing wild rainbow trout fisheries prior to the introduction of *M. cerebralis* (Walker and Nehring 1995).

Intermediate crosses of the two strains have been rigorously evaluated. Laboratory experiments showed that the first filial generational cross between the two strains (termed the H×C) exhibited resistance characteristics similar to those of the GR strain (Schisler et al. 2006; Fetherman et al. 2012), and was capable of attaining critical swimming velocities similar to those of the CRR strain (Fetherman et al. 2011). It was suggested that the H×C cross may be the best

candidate for reintroducing rainbow trout populations; however, its utility needed to be evaluated in a natural setting (Fetherman et al. 2012). Overall, I wanted to evaluate the performance of H×C that were stocked into the upper Colorado River in an attempt to reintroduce a self-sustaining population in the presence of *M. cerebralis*. The objectives of this study were to examine the survival, abundance and growth of the stocked H×C population. Additionally, if offspring were produced, indicating that reproduction had occurred, I wanted to evaluate the genetic composition of the age-0 individuals and whether they displayed increased resistance and survival characteristics compared to their wild CRR counterparts.

METHODS

Site Description

The 4.2 km (3.9 mi) upper Colorado River study site is situated approximately 1.6 km downstream of Windy Gap Reservoir and 3.2 km upstream of the town of Hot Sulphur Springs in Grand County, Colorado. Flows in this section are partially regulated by Windy Gap dam, with a mean annual discharge of 7.2 cubic meters per second (cms), ranging from a mean of 2.2 cms in the winter to 22.5 cms during peak flows; temperatures range from 3.4°C in the winter to 16.2°C in the summer, with an mean annual temperature of 10.7°C (USGS 2009). The study section is on private land, primarily managed for cattle grazing; however, land owners also allow private fishing access.

Prior to the introduction of *M. cerebralis* in the upper Colorado River, adult CRR had an average abundance of 428 fish km⁻¹ (687 fish mi⁻¹) and adult brown trout averaged 239 fish km⁻¹ (384 fish mi⁻¹; Nehring and Thompson 2001), resulting in a ratio of rainbow trout to brown trout of 2:1. Rainbow trout fry abundance ranged from 5,600 to 8,400 fry km⁻¹ of stream bank and brown trout fry ranged from 2,600 to 5,700 fry km⁻¹ (Walker and Nehring 1995). Traditionally,

eggs were harvested from this wild CRR brood stock, reared in state hatcheries, and used to stock many rivers across the state.

M. cerebralis was unintentionally introduced to the upper Colorado River in the 1980s when privately-reared rainbow trout previously exposed to *M. cerebralis* were stocked into three private water bodies located upstream of Windy Gap Reservoir. Fish below Windy Gap Reservoir tested positive for *M. cerebralis* in 1988, and a subsequent decline in the younger age classes of rainbow trout was observed in the early 1990s (Nehring 2006). While several reasons for the declines were investigated (Schisler et al. 1999^{a,b}; Schisler et al. 2000), exposure to *M. cerebralis* was determined to be the primary cause for the disappearance of the younger age classes (Nehring and Thompson 2001). In an effort to restore the rainbow trout fishery, tens of thousands of CRR were stocked annually between 1994 and 2008. Despite these repeated stocking efforts, the CRR exhibited low survival and little recruitment success, resulting in rainbow trout abundances that were approximately 90% lower than those observed prior to the establishment of *M. cerebralis* (Nehring 2006). Into the 2000s, the upper Colorado River below Windy Gap Reservoir continued to be one of the rivers with the highest prevalence of *M. cerebralis* infection in the state.

Rainbow Trout Stocking

The first introduction of *M. cerebralis*-resistant rainbow trout to the upper Colorado River occurred on June 2, 2006, with an introduction of 3,000 H×Cs. Prior to being stocked, each fish was tagged with an individually numbered fine-filament Floy tag, secondarily adipose clipped for identification in the event of tag loss, and measured to the nearest mm; fish averaged (\pm SD) 238 (\pm 23) mm in total length (TL). Larger rainbow trout were used in the introduction because they were 1) less susceptible to *M. cerebralis* infection (Ryce et al. 2005), and 2) less

susceptible to brown trout predation. Fish were distributed throughout the study section, with approximately 1,250 fish stocked at the upstream end of the section, 1,100 stocked in the middle of the section, and 650 stocked at the downstream end of the section.

Additional stocking attempts occurred in January 2009, with an introduction of 5,000 H×Cs averaging 209 (\pm 23) mm TL, and June 2010, with an introduction of 2,000 H×Cs averaging 172 (\pm 18) mm TL; these fish were similarly tagged with an individually numbered Floy tags and measured to the nearest mm prior to stocking. Hatchery space constraints required the 2009 introduction to occur in winter, and fish were stocked through a hole drilled in the ice cover. As a result, the 2009 introduction was unsuccessful; no H×Cs from the 2009 introduction have been encountered in subsequent sampling events, and so these fish will not be discussed in the remainder of this chapter. In addition, only one sampling occasion occurred following the introduction of H×Cs to the upper Colorado River in 2010, and as a result, survival was not estimated for these fish; however, these fish contributed to adult fish population abundance estimates in 2011 and potentially contributed offspring produced during the study. Therefore, survival and growth analyses regarding the adult rainbow trout population are performed using only data collected from the group of H×Cs introduced to the upper Colorado River in 2006, but abundance estimates include fish introduced in 2006 and 2010.

Adult Rainbow Trout Population

Population Sampling

Adult rainbow trout abundance and survival were estimated during recapture occasions occurring in the fall of 2006 and 2007, and the spring of 2008, 2009, 2010, and 2011. Efforts in the fall of 2006 and 2007 consisted of two-pass removal estimates (Temple and Pearsons 2007) conducted in a 305-m stretch of the upper Colorado River located at the upstream end of the

study section, and were used to estimate abundance on a local habitat scale and recapture fish for survival estimation. Estimates were completed using a four-electrode bank shocking unit and removal passes were conducted subsequently within the same day. Floy tag numbers, lengths, and weights were recorded for all H×Cs encountered during the sampling. As the 2006 and 2007 abundance estimates were conducted on a smaller geographical scale and during a different season (fall) than those conducted in 2008 through 2011 (spring), recapture information from the 2006 and 2007 sampling events was used only in the adult H×C survival analyses.

A two-pass, mark-recapture electrofishing effort, with a minimum of one day between passes to allow for the redistribution of marked fish, was used to sample the adult rainbow trout population in the upper Colorado River in the spring of 2008, 2009, 2010, and 2011. Two raft-mounted electrofishing units were used to complete the sampling, with one raft covering each half of the river. Fish encountered on both the mark and recapture passes were processed approximately every 0.8 km and returned to the river following processing. On the mark pass, fish were given a caudal fin punch for identification on the recapture pass. Floy tag presence/absence and number, TL (mm), and weight (g) were recorded for all rainbow trout captured on both passes.

Floy-tagged fish were identified as H×Cs and were therefore included in the survival, growth, and abundance analyses; however, Floy tag loss occasionally prevented individual identification of H×Cs. Rainbow trout missing a Floy tag but retaining an adipose clip were identified as H×Cs for the purpose of abundance estimation, but were not included as part of the survival or growth analyses. Rainbow trout from which a Floy tag and adipose clip were absent were identified as CRR, which were presumed to be remaining in the section from previous

stocking events, allowing CRR abundance to be estimated separately from H×C abundance during the 2008, 2009, 2010, and 2011 sampling occasions.

Statistical Analyses

A Lincoln-Peterson estimator with a Bailey (1951) modification, which accounted for fish being returned to the population following examination of marks on the recapture pass (Van Den Avyle and Hayward 1999), was used to obtain H×C and CRR abundance estimates (\hat{N}) for each year of the study. Estimates were calculated for the entire study reach and divided by 4.2 (km sampled) to obtain an estimate of adult H×C and CRR km⁻¹ of river. Variance in abundance estimates was calculated using the equation presented in Van Den Avyle and Hayward (1999), and 95% confidence intervals (CIs) calculated from the variance estimates were used to compare differences in abundance between the H×C and CRR within and across years.

Apparent survival probability (ϕ), the probability that fish survived and were retained within the study section, was estimated for the H×C on a monthly basis, accounting for varying time intervals between primary sampling occasions, using the Cormack-Jolly-Seber (CJS) open capture-recapture estimator in Program MARK (White and Burnham 1999). If tagged fish were encountered during either secondary sampling occasion (i.e., pass), the associated recapture data were used to create the encounter histories for the primary sampling occasions (fall 2006 and 2007, and spring 2008, 2009, 2010, and 2011). The model set included models in which detection probability (p) was constant (\cdot), varied with discharge at time of sampling (cms), or varied by effort (effort; bank electrofishing in the fall versus raft electrofishing in the spring), or the additive combination of cms and effort. For survival estimation, the model set included models in which ϕ was constant (\cdot), varied by length at release (length; included as an individual covariate), with minimum discharge between primary sampling occasions (min), maximum

discharge (max) between primary sampling occasions, or followed a trend with time (T). Although length was allowed to appear additively with min, max, or T, these three covariates never appeared in the same model. Models were ranked using Akaike's Information Criterion corrected for small sample sizes (AICc; Burnham and Anderson 2002). Model averaging was used to incorporate model selection uncertainty into the parameter estimates, and unconditional standard errors (SE) were reported for the model averaged parameter estimates (Anderson 2008).

Absolute growth (TL) and absolute growth rate (TL year⁻¹) of the H×C were calculated using equations presented in Busacker et al. (1990). Repeated measures of TL from individuals stocked in 2006 and recaptured between 2008 and 2011 were used to fit a von Bertalanffy growth curve by means of the Fabens (1965) method, where time at large (days), TL at release, and TL upon recapture were known. Time at large was converted from days to years prior to analysis, and parameters for the growth curve were estimated iteratively using a nonlinear regression approach (Isely and Grabowski 2007) implemented in SAS (Proc NLIN; SAS Institute, Inc. 2010). Age at recapture was calculated based on the knowledge that H×Cs were approximately 1.6 years of age at stocking. The von Bertalanffy model is a predictive model of growth, where growth rate declines with age, becoming zero as fish near a maximum possible size. The model is represented as $l_t = L_\infty(1 - e^{-K(t-t_0)})$, where l_t is length at time t , L_∞ is the asymptotic length, K is a growth coefficient, and t_0 is a time coefficient at which length would theoretically be zero (von Bertalanffy 1938).

Age-0 Trout Population

Population Sampling

The age-0 (fry) population was sampled in September 2007 and October 2008 to determine the baseline genetic composition of the rainbow trout fry population produced in the

upper Colorado River in these years. From 2009 to 2012, the salmonid fry population was sampled once a month, June through October, to determine fry abundance, as well as to determine if shifts in genetic composition of the rainbow trout fry population changed over time. Three pass removal estimates were conducted using two LR-24 Smith-Root backpack electrofishing units run side-by-side to include all available fry habitat at four, 15.2 m-long sites, one located at the downstream end of the study section, two in the middle of the study section, and one at the upstream end of the study section.

All fry encountered during the sampling were identified to species, measured (TL; mm), and examined for signs of *M. cerebralis* infection. A fin clip was taken from all rainbow trout fry encountered during this sampling for genetic analysis. Additional electrofishing efforts outside of the population estimation sites were used to increase the number of the rainbow trout fry used in the genetic and disease (myxospore enumeration) analyses.

Genetic Assignment of Rainbow Trout Fry

The Genomic Variation Laboratory at the University of California at Davis identified a suite of microsatellite markers capable of distinguishing pure GR and GR-cross fish, including H×C (F1), second generation H×C (F2), and backcross generations (B2C: F1 × CRR; B2H: F1 × GR), from pure CRR fish. Over 300 microsatellite markers were specifically identified for the purpose of genetically screening wild rainbow trout fry to detect and differentiate offspring produced by GR-cross fish from those produced by residual CRR fish. Known samples of pure GR, pure CRR, and their crosses, were used to identify microsatellite markers that were most effective for differentiation based on the frequency of appearance in the pure strains; the ability of this microsatellite array to differentiate known samples was assessed prior to use on unknown samples from the wild (Appendix 2.1).

The software program NewHybrids (Anderson and Thompson 2002) was used to differentiate the parentage of individuals based on microsatellite differences. The NewHybrids program uses the framework of Bayesian model-based clustering to compute, by Markov Chain Monte Carlo, the posterior probability that an individual belongs to each of a distinct set of defined hybrid classes. The posterior probability reflects the level of certainty that an individual belongs to a hybrid category (Anderson and Thompson 2002); an individual was positively identified as a specific strain or hybrid if the posterior probability for the given category was \geq 80% for that individual. If none of the hybrid categories met this criterion, the individual was classified as unknown. Using the NewHybrids software program, unclassified rainbow trout fry collected from the upper Colorado River were identified to strain (pure GR, pure CRR) or cross (F1, F2, B2C, and B2H). The proportion of the rainbow trout fry population assigned to the pure CRR or GR-cross hybrid categories, as well as classified as unknown, was ascertained on a per year basis, and trends across years were examined to determine if the H×C had successfully reproduced in the upper Colorado River.

Quantification of M. cerebralis Infection

Signs of infection as a result of exposure to *M. cerebralis*, including cranial, spinal, opercular, and lower jaw deformities, and blacktail, were recorded for each salmonid fry encountered between 2009 and 2012. In October of 2009 and 2011, five brown trout fry and up to five rainbow trout fry were collected from each of the four sites to quantify myxospores, a measure of the severity of infection following exposure to *M. cerebralis*. Myxospores were enumerated (O'Grodnick 1975) using the pepsin-trypsin digest (PTD) method (Markiw and Wolf 1974) by the Colorado Parks and Wildlife (CPW) Fish Health Laboratory (Brush, Colorado).

Statistical Analyses

A three pass removal estimator (Seber and Whale 1970) was used to obtain rainbow trout fry population abundance estimates (\hat{N}) at each of the sampling sites. Estimates were converted to \hat{N} km⁻¹ of river bank by multiplying the estimate by 65.8; estimates from the four sampling sites were averaged within a month, providing an estimate of fry km⁻¹ of river bank for the entire study section. Confidence intervals (Seber and Whale 1970) were used to compare differences in rainbow trout fry abundance both within and across years.

To evaluate the difference in myxospore counts of rainbow trout fry collected in 2009 and 2011, I used a general linear model (GLM) as implemented in SAS ProcGLM; two models were included in the models set, an intercept-only model and a model including year as a categorical variable to capture inter-annual variation. The genetic assignment test was then used to associate myxospore count with rainbow trout fry determined to have CRR or GR-cross origins. A second GLM was run to examine if genotype conferred resistance to *M. cerebralis*, and if CRR and GR-cross fry differed from brown trout fry in average myxospore count. Two models were included in the model set, an intercept-only model, and a model including species as a categorical variable to capture inter-species variation. Logistic regression (SAS ProcLOGISTIC) was used to assess the factors that influenced the probability that an individual fry would exhibit signs of *M. cerebralis* infection (cranial, spinal, opercular, and lower jaw deformities, and blacktail); disease sign was treated as a binary response variable (response was 'yes' or 'no'). For the logistic regression analysis, I considered an intercept-only model, as well as models that included effects of species only, year only (2009, 2010, and 2011), and models with additive and interactive effects between species and year. Model weights and delta AICc ranking were used to determine support for each of the models included in the model sets, and

parameter estimates were reported from the candidate model with the lowest AICc value (Burnham and Anderson 2002).

RESULTS

Adult Rainbow Trout Population

Adult H×C abundance (\hat{N} km⁻¹; fish stocked in 2006 only) did not differ from adult CRR abundance in the upper Colorado River in any year. Both populations exhibited significant decreases in abundance between 2008 and 2011, declining from an estimated (\pm SD) 57 (\pm 8) H×C and 68 (\pm 15) CRR km⁻¹ in 2008, to only 4 (\pm 1) H×C and 6 (\pm 1) CRR km⁻¹ in 2011 (Figure 2.1). Floy tag loss likely caused the annual estimates of H×C abundance to be biased low. Interestingly, the adult brown trout population also exhibited a significant decrease in abundance between 2009 and 2011, declining from an estimated 1,201 (\pm 78) km⁻¹ in 2009 to 525 (\pm 47) km⁻¹ in 2011 (Chapter 1).

Apparent survival (ϕ) was more affected by discharge than a general trend with time. Models that allowed survival to vary as a function of minimum flow (top two models) between primary sampling occasions had twice as much support as those that modeled survival as a function of maximum flows (models ranked three and four; Table 2.1). Discharge had a positive effect on survival ($\hat{\beta} = 0.033 \pm 0.007$), with survival increasing with an increase in minimum flow. Survival was also positively affected by length at release ($\hat{\beta} = 0.006 \pm 0.002$), with length at release appearing in all six of the models with a Δ AICc value < 4.0 . In general, model-averaged monthly apparent survival was lower in 2006 and 2007 than it was in later years of the study (2008 through 2011; Figure 2.2), primarily due to minimum flows between primary sampling occasions that were nearly twice as low, on average, in 2006 and 2007 (1.21 ± 0.13 cms) than in 2008 through 2011 (2.06 ± 0.06 cms). Apparent survival for the entire study period

(June 2006 to May 2011) was estimated to be 0.007 (SE < 0.001). Detection probability differed with effort (bank electrofishing $p = 0.05$ [SE ± 0.008]; raft electrofishing $p = 0.22$ [SE ± 0.06]), with effort appearing in all six models with a $\Delta\text{AICc} < 4.0$ (Table 2.1), and was likely due to the amount of stream length covered by the two sampling methods and the season in which sampling occurred. Discharge had a weak negative effect on p (associated 95% confidence intervals overlapped zero), and appeared in only three of the models with a ΔAICc value < 4.0, and not in the top model.

Average absolute increase in TL (\pm SE) of the H×C was 111 (± 3.5) mm, with an average absolute annual rate of increase in TL of 45 (± 1.3) mm. Parameter estimates for the von Bertalanffy equation were $\hat{L}_\infty = 424.5$, $\hat{K} = 0.37$, and $\hat{t}_0 = -0.16$ (Figure 2.3).

Age-0 Trout Population

Wild rainbow trout fry abundance exhibited a declining trend in 2009 and 2010, and no rainbow trout fry were detected in any of the sampling sites in October of either year. Rainbow trout fry abundance patterns differed in 2011 and 2012 in that a decreasing trend in abundance was not apparent. Potentially indicative of an increase in resistance and survival, rainbow trout fry were still detected within the study sites in October of both 2011 and 2012 (Figure 2.4).

Genetic assignments revealed a shift in the genetic composition of the rainbow trout fry population over time. In 2007, CRR and unknown fish comprised the entirety of the population (Figure 2.5). GR-cross fish first appeared in the fry population in 2008, comprising about 35% of the population. The proportion of GR-cross fish in the fry population increased over time, with GR-cross fish comprising nearly 80% of the fry population in 2011 (Figure 2.5).

Model selection results for differences in average myxospore count in rainbow trout indicated that the model that included year was more supported by the data than the intercept

model (AICc weight = 0.98). Fry collected in October of 2009 averaged (\pm SE) 47,708 (\pm 8,650) myxospores fish⁻¹, whereas fry collected in October of 2011 averaged 2,672 (\pm 4,379) myxospores fish⁻¹. When brown trout were included in the analysis and myxospore count was assigned to specific CRR or GR-cross rainbow trout individuals using the genetic assignment test, model selection results indicated that a model containing species/cross differences in myxospore count was most supported by the data (AICc weight = 0.93). CRR fry exhibited a higher myxospore count than either the GR-cross or brown trout fry (Figure 2.6).

A species by year interaction had the largest influence on the probability that an individual fry would exhibit signs of *M. cerebralis* infection (AICc weight = 0.99; Table 2.3). A higher proportion of rainbow trout than brown trout fry exhibited signs of infection in 2009; however, no differences in the proportion of fish exhibiting signs of infection was observed between the two species in 2010 or 2011. The proportion of rainbow trout fry exhibiting signs of infection decreased between 2009 and 2011 (Figure 2.7), concurrent with the increase in the proportion of GR-cross fish in the fry population and decrease in infection severity (myxospores fish⁻¹).

DISCUSSION

The objectives of this study were to examine abundance, survival, growth, and reproduction of a stocked H×C population in the upper Colorado River, and determine if the offspring produced had parental genotypes and displayed increased resistance characteristics compared to their wild counterparts. Stocked adult rainbow trout exhibited low survival following stocking; however, they did reproduce. Age-0 rainbow trout exhibited lower infection severity over time as a result. Genetic results suggest that infection severity decreased with a shift in genetic composition of the rainbow trout fry population from susceptible to resistant

genotypes over time. In addition, GR-cross fry exhibited significantly lower myxospore counts relative to their wild CRR counterparts.

In 2006, H×C rainbow trout were stocked into my study section and they began to reproduce in 2008. Initially, CRR individuals comprised the entire fry population due to ongoing stocking of this strain in the upper Colorado River. Subsequent age-0 sampling indicates that GR-cross genotypes are increasing in prevalence, relative the CRR strain. Interestingly, I observed the first age-0 recruitment into October in 2010 and 2011. I believe that the 2009 stocking was a failure due to stocking in the winter and that fish stocked in 2010 probably did not begin to reproduce until 2012; therefore, neither group is responsible for the observed changes in the genetic composition of the population.

As resistant genotypes increased, average infection severity (myxospores fish⁻¹) and percentage of age-0 exhibiting signs of exposure to *M. cerebralis* decreased. The myxospore counts of age-0 fish collected in 2009 were similar to those obtained from age-0 rainbow trout collected in the upper Colorado River from about 1990 to 2000 and were indicative of infection levels that caused the original decline (Nehring and Thompson 2001; Nehring 2006).

Myxospore counts of fish collected in 2011 were significantly lower than most myxospore counts observed in earlier studies (Thompson et al. 1999; Ryce et al. 2001) and as low as those observed for brown trout. *M. cerebralis* is endemic in brown trout from central Europe to southeastern Asia and does not cause disease in these populations (Granath et al. 2007).

Similarly, GR strain fish were artificially selected for resistance to *M. cerebralis* in a German fish hatchery (Hedrick et al. 2003). In the upper Colorado River, age-0 GR-cross did not differ in infection severity from the age-0 brown trout, suggesting that they were just as resistant to infection and development of clinical signs as the brown trout.

Age-0 CRR had significantly higher myxospore levels than both the GR-cross and brown trout and this is consistent with other studies showing that CRR are highly susceptible to *M. cerebralis* infection (Ryce et al. 2001; Schisler et al. 2006; Fetherman et al. 2012). Myxospore levels in CRR individuals indicate that the parasite is still prevalent in the upper Colorado River and that the low myxospore levels in the GR strain are not a result of reduced parasite numbers. Although differences in myxospore count were previously observed during laboratory experiments (Schisler et al. 2006; Fetherman et al. 2012), my field observations are the first to document such differences in wild populations. Reduced myxospore burdens in age-0 GR-cross trout indicate that stocking this cross may ultimately lead to an overall reduction in infection prevalence and severity in the salmonid populations of the upper Colorado River.

Recruitment of age-0 fish into October, observed in 2011 and 2012, was associated with the shift in genetic composition and decrease in infection severity. Prior to 2011, age-0 rainbow trout quickly developed clinical signs and were not observed in the river by October (Nehring and Thompson 2001; Nehring 2006). I attribute the lack of recruitment to low survival in the younger age classes following exposure to *M. cerebralis* and this is supported by *in situ* studies conducted in the same area (Nehring and Thompson 2001). Survival of rainbow trout fry into October of 2011 and 2012 suggests that GR-cross rainbow trout fry produced in the river may be better able to survive exposure to *M. cerebralis* than their wild CRR counterparts, and that natural recruitment may soon start to aid in the recovery of the wild rainbow trout population in the upper Colorado River.

Fetherman et al. (2012) suggest that resistance to *M. cerebralis* is a heritable trait that should respond to natural selection in the wild. Therefore, continued exposure to *M. cerebralis* in the wild should favor retention of resistance traits, increasing the probability of their

persistence. Resistance to *M. cerebralis* in a similar rainbow trout population from Harrison Lake, Montana has increased with continued exposure to the parasite (Miller and Vincent 2008). Miller and Vincent (2008) suggest that as more resistant young from the population mature and reproduce, it may be possible for the population to return to abundance levels observed prior to parasite establishment. Although recovery of wild rainbow trout populations in Colorado was expected to be relatively slow given the low survival of *M. cerebralis* infected fish in wild CRR populations (Nehring and Thompson 2003), the introduction of resistant GR-crosses may facilitate quicker recovery of these populations (Fetherman et al. 2012).

Apparent survival was low in stocked H×C rainbow trout. The hatchery derived origin and history of domestication selection for growth and resistance in the GR strain may have contributed to the low survival rates observed in the reintroduced H×C population; the GR strain is also known to exhibit low heterozygosity (El-Matbouli et al. 2006) which may be an issue with stocked H×C populations. In addition, research has shown that the GR-strain and high proportion GR-crosses (≥ 0.75) exhibit lower survival and increased predation susceptibility when introduced to natural systems with many terrestrial predators and piscivorous fish species (Fetherman and Schisler 2012). Despite potential drawbacks associated with the resistant, domestic GR strain, laboratory experiments confirmed that H×C exhibited a higher resistance to *M. cerebralis* relative to the susceptible, wild CRR strain, and that critical swimming velocities did not differ from that of the CRR strain (Fetherman et al. 2011). Therefore, the H×C was expected to be better suited for survival in the upper Colorado River than either parental strain.

Survival was also influenced by environmental factors, particularly flow. Both H×C and wild brown trout populations exhibited similar population declines over the study period suggesting that environmental conditions may have influence H×C survival, and results suggest

that minimum discharge had a large negative effect on H×C survival. Lower flows result in higher summer water temperatures and lower dissolved oxygen levels (Williams et al. 2009), both of which can directly affect salmonid survival (Hicks et al. 1991). Increased stress due to low flow may have also intensified the effects of *M. cerebralis* infection. Ectoparasite infestation peaks during periods of low flow and high mean water temperatures in the upper Colorado River and could significantly increase mortality in these populations (Schisler et al. 1999b). Low flows also reduce suitable habitat and can lead to high densities and overcrowding, increased predation, and increased competition (Arismendi et al. 2012). Brown trout competition with rainbow trout results in exclusion of rainbow trout from preferred feeding and resting habitats, possibly resulting in population level effects with respect to abundance and survival (Gatz et al 1987).

Food resources may be another environmental factor that will influence reintroduction efforts. The upper Colorado River below Windy Gap Reservoir has undergone significant changes to aquatic invertebrate diversity and abundance; in particular the abundance of the giant stonefly (*Pteronarcys californica*) has significantly decreased in recent years (Nehring et al. 2011). I believe that differences in prey diversity, abundance and size may explain current adult rainbow trout size and differences with historic rainbow trout size. My von Bertalanffy modeling and parameter estimates provide the first description of growth for *M. cerebralis*-resistant rainbow trout in a natural system. Maximum asymptotic length (424.5 mm) is similar to maximum lengths observed in brown trout during the study (CPW, unpublished data). However, prior to the introduction of *M. cerebralis*, rainbow trout (CRR) and brown trout greater than 425 mm were consistently observed during annual population estimates (Nehring and Thompson 2001). Laboratory experiments indicate that H×C fish grew faster and were

significantly larger than CRR fish of the same age (Fetherman et al. 2011) and I would expect that H×C fish would attain larger sizes than those observed in the pre-*M. cerebralis* CRR population. I believe that differences in fish length pre- and post-*M. cerebralis* introduction are, at least in part, due to changes in food resources rather than *M. cerebralis* infection or strain performance differences.

Conclusions

Reintroduction of a self-sustaining population of rainbow trout in the upper Colorado River will be influenced by environmental conditions as well as disease resistance. It has been suggested that successful reintroduction of salmonids may take 15 to 20 years or longer (Fraser 2008). Success will likely depend on favorable environmental conditions as well as increased resistance to *M. cerebralis*. Although the rainbow trout population in the upper Colorado River is showing signs of recovery, it has not yet become a self-sustaining population (Fraser 2008). My results suggest that supplemental stocking will be needed for continued persistence in the upper Colorado River; however, age-0 results clearly show that resistant fish reproduced, and that their offspring survived at least until the fall in the upper Colorado River. The survival of age-0 fish to the fall suggests that recruitment may be forthcoming. However, lack of recruitment continues to contribute to the decline in the adult rainbow trout population in the upper Colorado River. Recruitment may have occurred in 2012 as age-0 rainbow trout were still present in October 2011; low water prevented population evaluation in the spring of 2012.

I suggest that artificial supplementation and annual monitoring of the rainbow trout population should continue to evaluate whether my observed survival of age-0 fish is followed by subsequent recruitment to the adult reproductive population. Future management should focus on increasing adult rainbow trout survival and retention in locations where H×C are

reintroduced. Such management strategies may include brown trout removal or habitat modifications. Additional introduction strategies should be evaluated, such as introducing large numbers of smaller H×C. I believe that the introduction of *M. cerebralis* resistant rainbow trout remains a promising management strategy for the reintroduction of rainbow trout fisheries in Colorado and elsewhere.

Table 2.1. Model selection results for factors influencing apparent survival (ϕ) and detection probability (p) of the Floy tagged H×C fish introduced to the upper Colorado River in June 2006. Models for which there was weight are shown.

Model	log(L)	K	AICc	Δ_i	w_i
$\phi(L,MIN) p(E)$	-873.51	5	1757.04	0.00	0.35
$\phi(L,MIN) p(E,CMS)$	-872.82	6	1757.67	0.64	0.25
$\phi(L,MAX) p(E, CMS)$	-873.27	6	1758.57	1.53	0.16
$\phi(L,MAX) p(E)$	-874.63	5	1759.28	2.25	0.11
$\phi(L,T) p(E)$	-875.14	5	1760.31	3.27	0.07
$\phi(L,T) p(E,CMS)$	-874.27	6	1760.56	3.52	0.06
$\phi(MIN) p(E)$	-881.02	4	1770.05	13.01	< 0.01
$\phi(MIN) p(E,CMS)$	-880.58	5	1771.18	14.14	< 0.01
$\phi(L) p(E)$	-881.72	4	1771.45	14.41	< 0.01
$\phi(L) p(E,CMS)$	-880.85	5	1771.73	14.69	< 0.01
$\phi(MAX) p(E, CMS)$	-881.00	5	1772.03	15.00	< 0.01
$\phi(MAX) p(E)$	-882.06	4	1772.13	15.09	< 0.01
$\phi(T) p(E)$	-882.51	4	1773.03	15.99	< 0.01
$\phi(T) p(E,CMS)$	-881.89	5	1773.81	16.77	< 0.01
$\phi(L,MIN) p(CMS)$	-882.29	5	1774.60	17.56	< 0.01
$\phi(L) p(CMS)$	-884.09	4	1776.20	19.16	< 0.01
$\phi(L,T) p(CMS)$	-883.40	5	1776.83	19.80	< 0.01
$\phi(L,MAX) p(CMS)$	-884.00	5	1778.03	20.99	< 0.01

The maximized log-likelihood ($\log(L)$), the number of parameters (K) in each model, and the small sample size-corrected AICc values (AICc) are shown. Models are ranked by their AICc differences (Δ_i) relative to the best model in the set and Akaike weights (w_i) quantify the probability that a particular model is the best model in the set given the data and the model set. NOTE: L = length, E = effort, CMS = discharge, MIN = minimum discharge between primary sampling occasions, MAX = maximum discharge between primary sampling occasions, and T = trend over time.

Table 2.2. Model selection results for factors influencing the probability that a fish exhibits signs of *M. cerebralis* infection in the upper Colorado River in the years 2009 through 2011.

Model	R^2	$\log(L)$	K	AICc	Δ_i	w_i
Species*Year	0.15	-214.06	6	445.06	0.00	0.99
Species+Year	0.10	-222.27	4	454.65	9.58	0.01
Species	0.08	-226.23	2	457.03	11.97	0.00
Year	0.06	-230.44	3	468.09	23.02	0.00
Intercept-only	0.00	-239.75	1	481.68	36.62	0.00

R^2 values are maximum rescaled R^2 values. The maximized log-likelihood ($\log(L)$), the number of parameters (K) in each model, and the small sample size-corrected AICc values (AICc) are shown. Models are ranked by their AICc differences (Δ_i) relative to the best model in the set and Akaike weights (w_i) quantify the probability that a particular model is the best model in the set given the data and the model set.

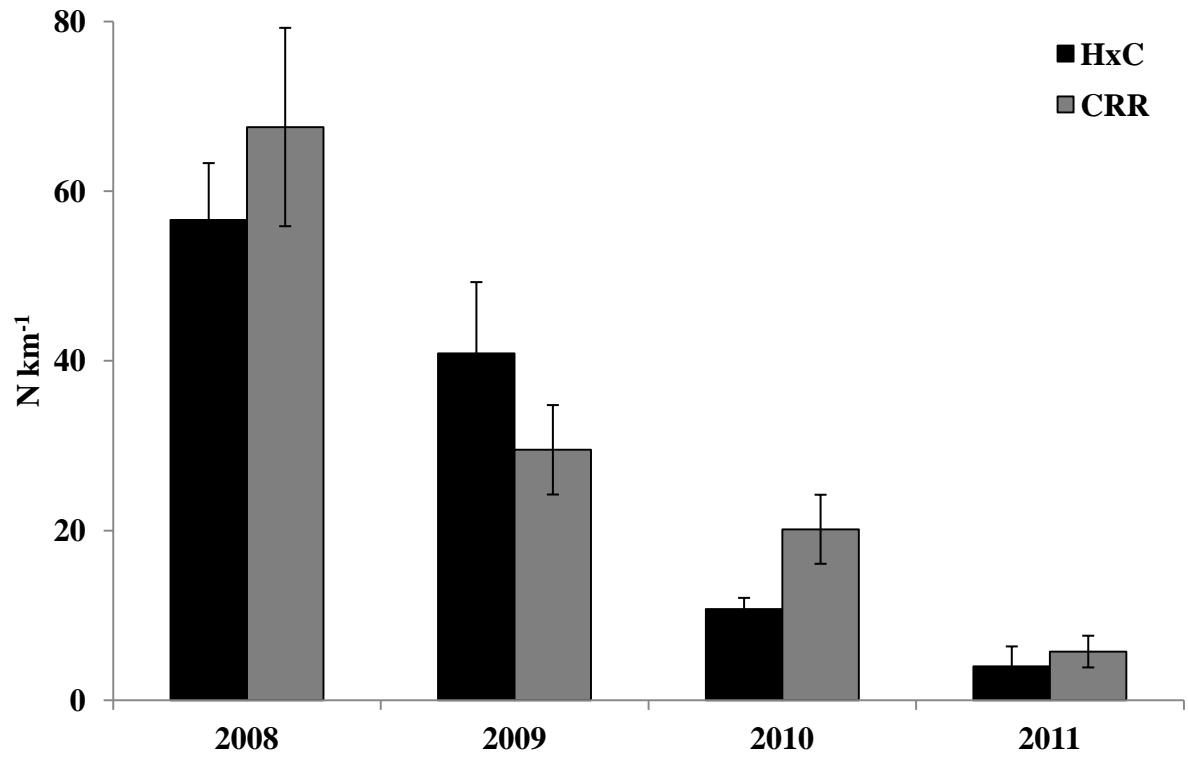

Figure 2.1. Adult HxC and CRR abundance ($N\ km^{-1}$; SE bars) in the upper Colorado River study section for the years 2008 to 2011.

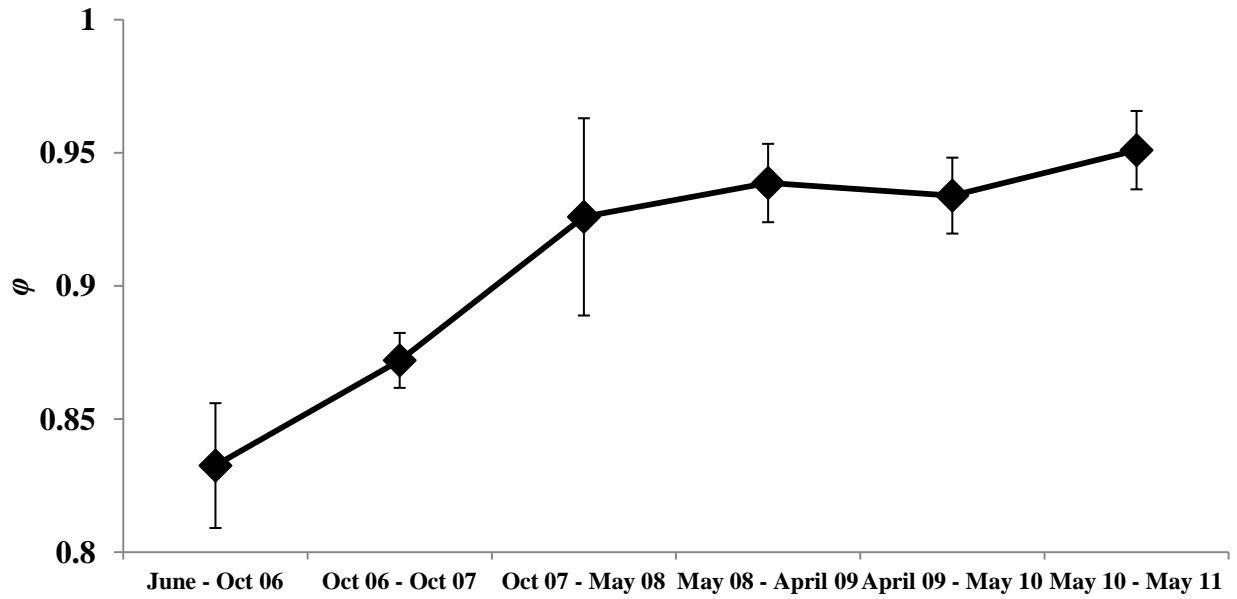

Figure 2.2. Model-averaged monthly apparent survival rate (ϕ ; SE bars) for the H×C stocked in the upper Colorado in June 2006. Date ranges (x-axis) represent the periods between primary sampling occasions for the adult rainbow trout population.

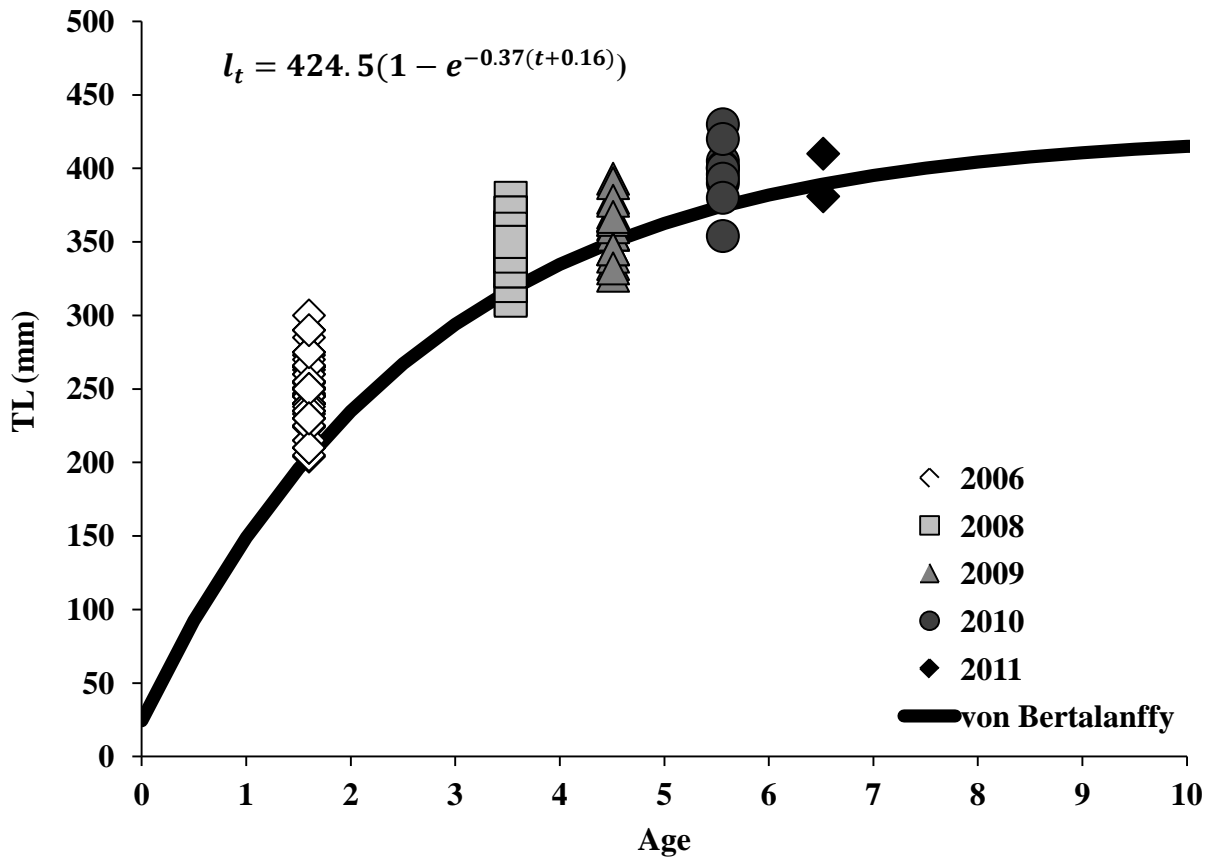

Figure 2.3. Predictive model of growth (TL; mm) trends of the H×C stocked in the upper Colorado River in 2006. The von Bertalanffy growth function was determined using repeated measures of length from fish stocked in 2006 (1.6 years of age) and recaptured in 2008, 2009, 2010, or 2011.

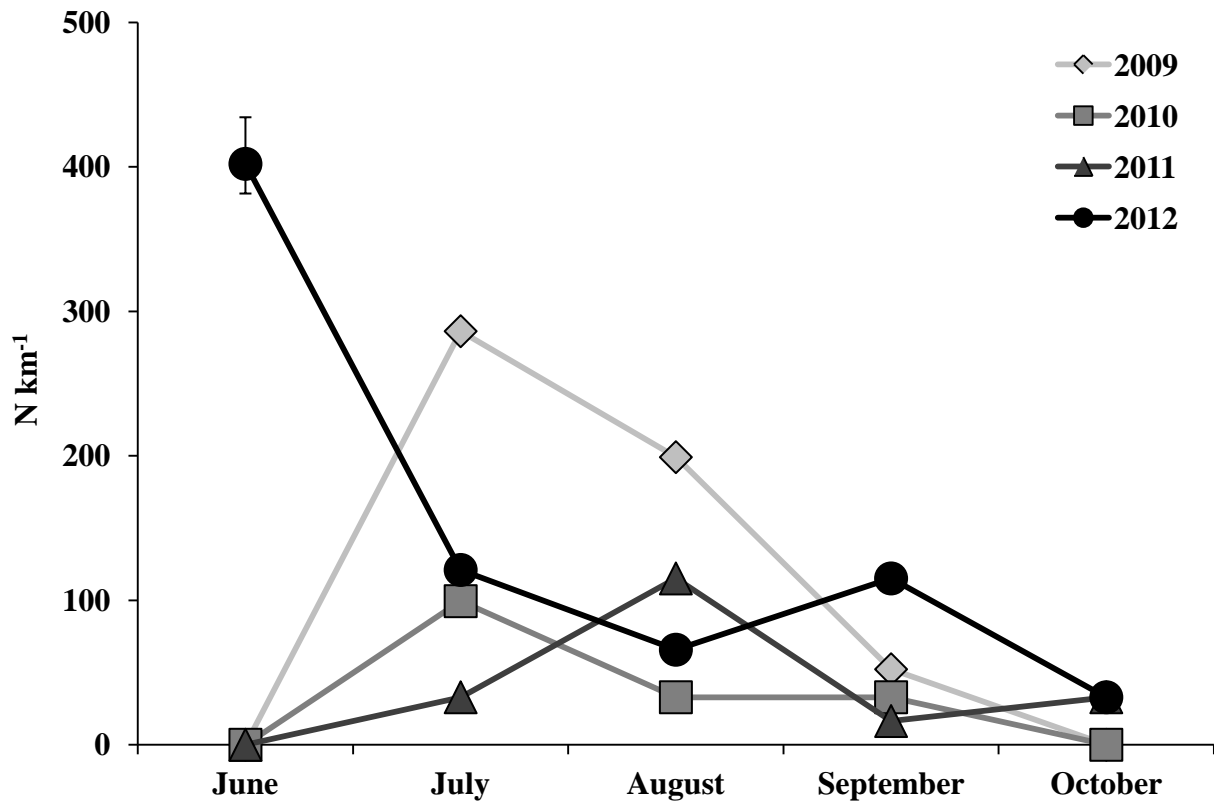

Figure 2.4. Rainbow trout fry abundance ($N\ km^{-1}$; SE bars) in June, July, August, September, and October of 2009, 2010, 2011, and 2012.

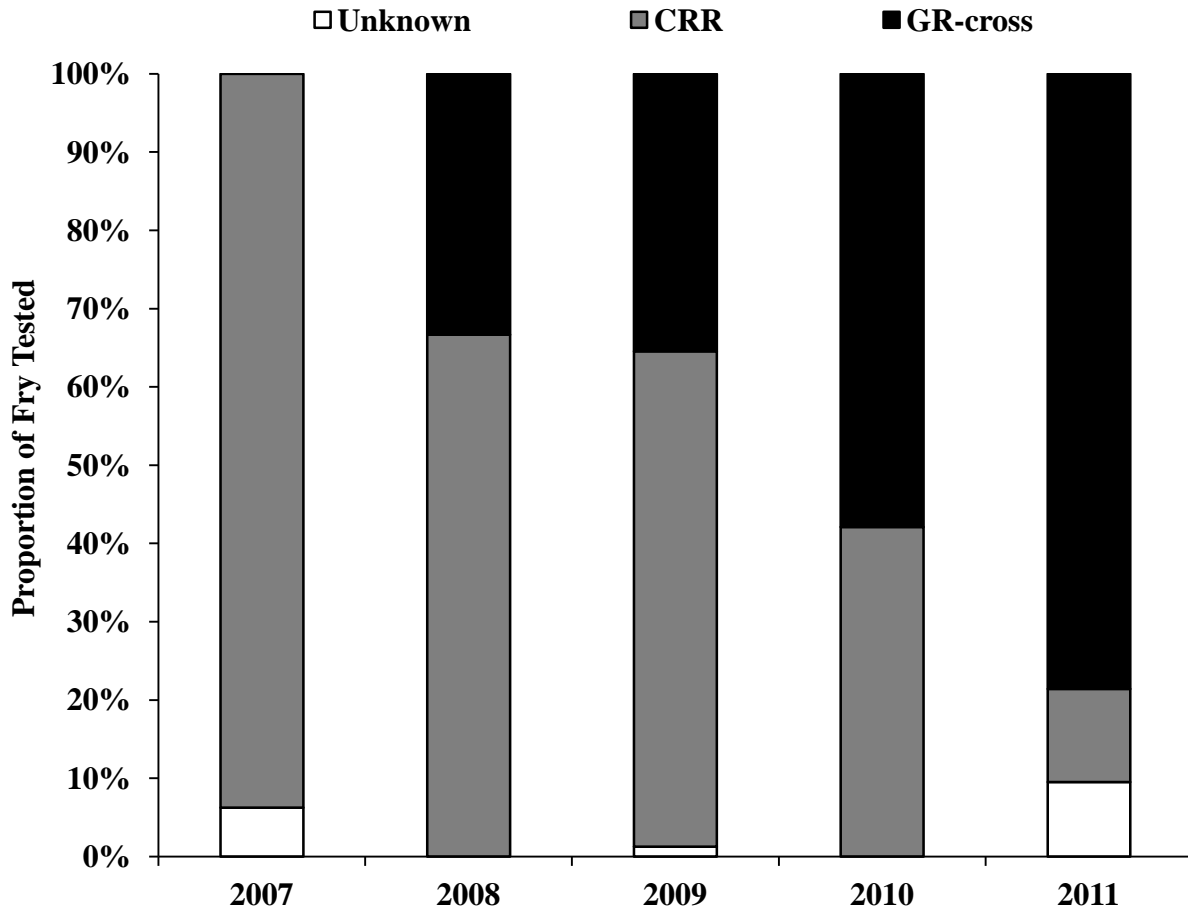

Figure 2.5. Proportion of the wild rainbow trout fry population collected from the upper Colorado River in 2007 ($N = 16$), 2008 ($N = 21$), 2009 ($N = 79$), 2010 ($N = 57$), and 2011 ($N = 42$) that were assigned as CRR, GR-cross, or unknown (posterior probability < 0.80) using the microsatellite marker genetic differentiation test.

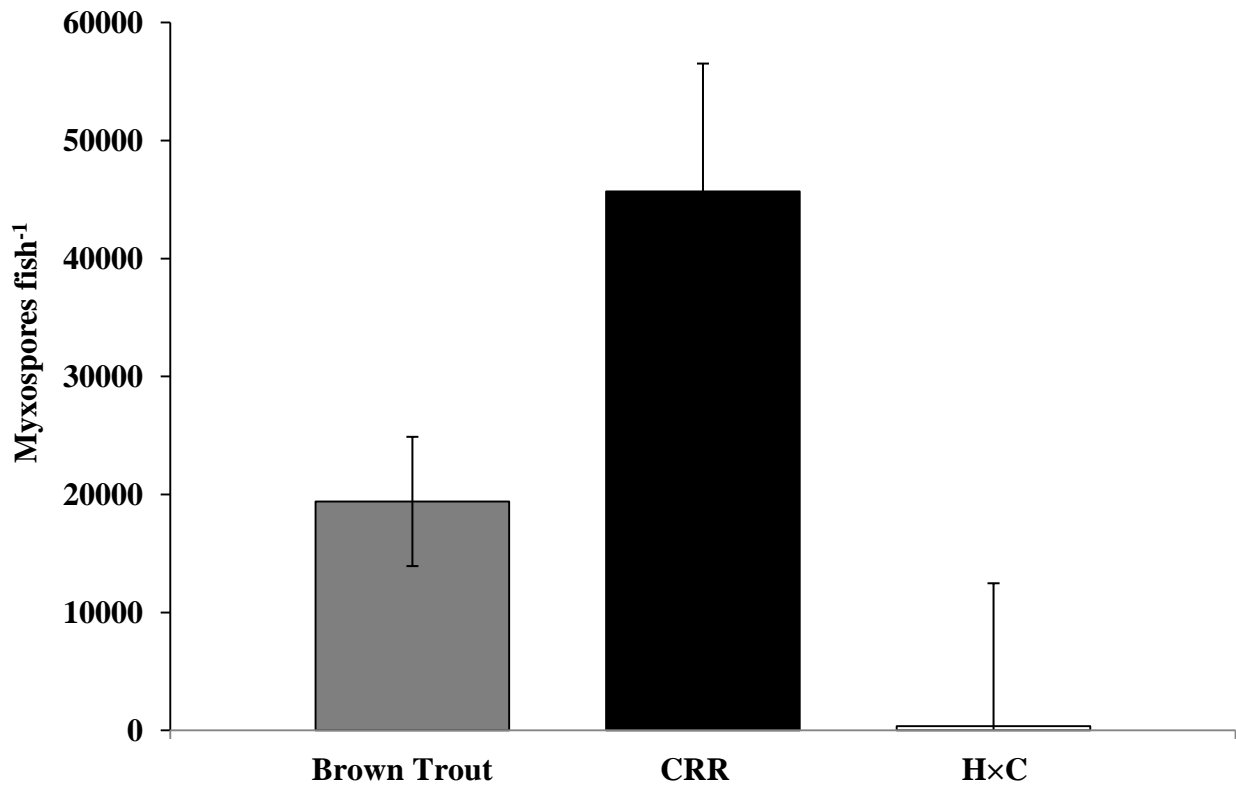

Figure 2.6. Average myxospore count (myxospores fish⁻¹; SE bars) of the brown trout ($N = 60$), CRR ($N = 13$), and H×C ($N = 11$) fry collected in October of 2009 and 2011 from the upper Colorado River.

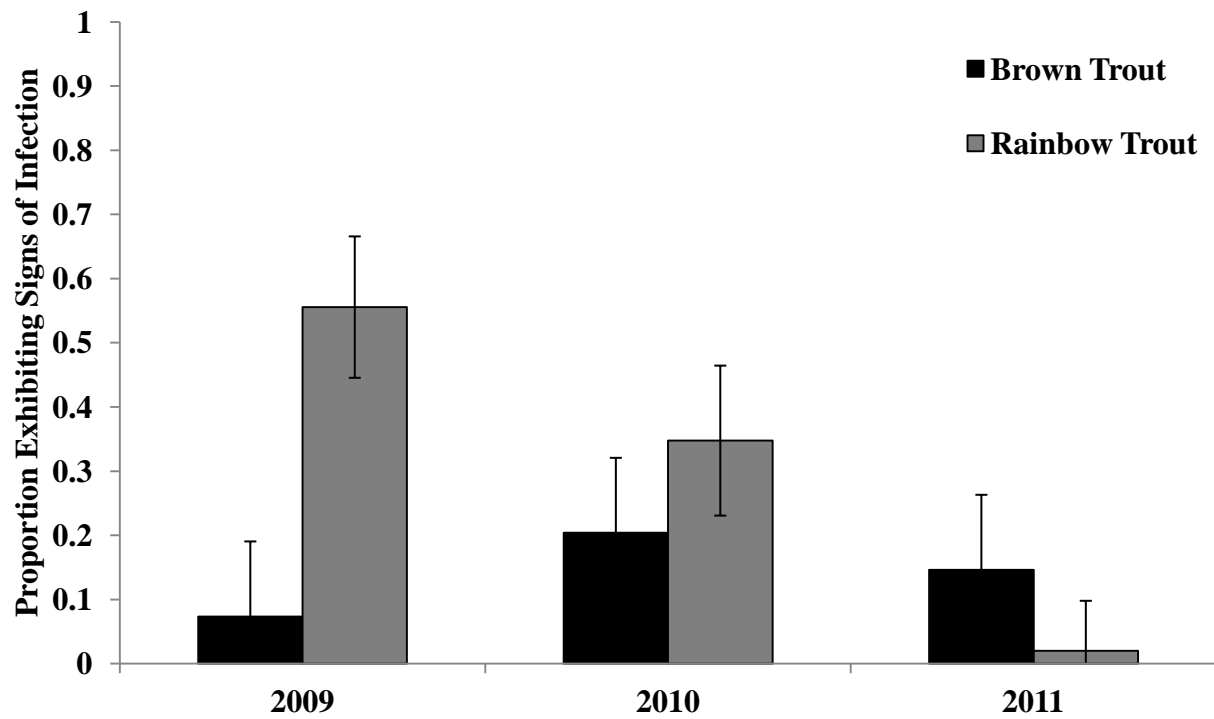

Figure 2.7. Proportion (SE bars) of the brown trout and rainbow trout fry populations in 2009 (brown trout: $N = 277$; rainbow trout: $N = 29$), 2010 (brown trout: $N = 64$; rainbow trout: $N = 41$), and 2011 (brown trout: $N = 138$; rainbow trout: $N = 19$) exhibiting signs of *M. cerebralis* infection.

LITERATURE CITED

- Anderson, D. R. 2008. Model based inference in the life sciences: A primer on evidence. Springer, LLC, New York, New York.
- Anderson, E. C., and E. A. Thompson. 2002. A model-based method for identifying species hybrids using multilocus genetic data. *Genetics* 160:1217-1229.
- Arismendi, I., M. Safeeq, S. L. Johnson, J. B. Dunham, and R. Haggerty. 2012. Increasing synchrony of high temperature and low flow in western North America streams: double trouble for coldwater biota? *Hydrobiologia* (2012):1-10.
- Bailey, N. J. J. 1951. On estimating the size of mobile populations from recapture data. *Biometrika* 38:293-306.
- Bosch, W. J., T. H. Newsome, J. L. Dunnigan, J. D. Hubble, and D. Neeley. 2007. Evaluating the feasibility of reestablishing a Coho salmon population in the Yakima River, Washington. *North American Journal of Fisheries Management* 27:198-214.
- Burnham, K. P., and D. R. Anderson. 2002. Model selection and multimodel inference: A Practical information-theoretic approach (second ed.). Springer-Verlag, New York, New York.
- Busacker, G. P., I. R. Adelman, and E. M. Goolish. 1990. Growth. Pages 363-387 in Schreck, C. B., and P. B. Moyle, editors. *Methods for Fish Biology*. American Fisheries Society, Bethesda, Maryland.
- Carmona-Catot, G., P. B. Moyle, and R. E. Simmons. 2012. Long-term captive breeding does not necessarily prevent reestablishment: lessons learned from Eagle Lake rainbow trout. *Reviews in Fish Biology and Fisheries* 22:325-342.
- El-Matbouli, M., A. Oucible, V. Severin, U. Meyer, D. Grabner, and R. P. Hedrick. 2006. Data on the mechanisms associated with the resistance of Hofer- and wild rainbow trout strains to whirling disease. Pages 22-23 in *War of the Whirls*. Proceedings of the 12th Annual Whirling Disease Symposium. Whirling Disease Initiative, Bozeman, MT
- Fabens, A. J. 1965. Properties and fitting of the von Bertalanffy growth curve. *Growth* 29: 265-289.
- Fetherman, E. R. and G. J. Schisler. 2012. Sport Fish Research Studies. Federal Aid in Fish and Wildlife Restoration, Job Progress Report. Colorado Parks and Wildlife, Aquatic Wildlife Research Section. Fort Collins, Colorado.
- Fetherman, E. R., D. L. Winkelman, G. J. Schisler, and C. A. Myrick. 2011. The effects of *Myxobolus cerebralis* on the physiological performance of whirling disease resistant and susceptible strains of rainbow trout. *Journal of Aquatic Animal Health* 23:169-177.

- Fetherman, E. R., D. L. Winkelman, G. J. Schisler, and M. F. Antolin. 2012. Genetic basis of differences in myxospore count between whirling disease-resistant and –susceptible strains of rainbow trout. *Diseases of Aquatic Organisms* 102:97-106.
- Flagg, T. A., M. C. McAuley, P. A. Kline, M. S. Powell, D. Taki, and J. C. Gislason. 2004. Application of captive broodstocks to preservation of ESA-listed stocks of Pacific salmon: Redfish Lake Sockeye Salmon case example. *American Fisheries Society Symposium* 44:387-400.
- Fraser, D. J. 2008. How well can captive breeding programs conserve biodiversity? A review of salmonids. *Evolutionary Applications* 1:535-586.
- Gatz, A. J., M. J. Sale, and J. M. Loar. 1987. Habitat shifts in rainbow trout: competitive influences of brown trout. *Oecologia (Berlin)* 74:7-19.
- Granath, W. O., Jr., M. A. Gilbert, E. J. Wyatt-Pescador, and E. R. Vincent. 2007. Epizootiology of *Myxobolus cerebralis*, the causative agent of salmonid whirling disease in the Rock Creek drainage of west-central Montana. *Journal of Parasitology* 93(1):104-119.
- Harig, A. L., and K. D. Fausch. 2002. Minimum habitat requirements for establishing translocated cutthroat trout populations. *Ecological Applications* 12:535-551.
- Hedrick R. P., T. S. McDowell, G. D. Marty, G. T. Fosgate, K. Mukkatira, K. Myklebust, and M. El-Matbouli. 2003. Susceptibility of two strains of rainbow trout (one with suspected resistance to whirling disease) to *Myxobolus cerebralis* infection. *Disease of Aquatic Organisms* 55:37-44.
- Hesthagen, T., and B. M. Larsen. 2003. Recovery and re-establishment of Atlantic salmon, *Salmo salar*, in limed Norwegian rivers. *Fisheries Management and Ecology* 10:87-95.
- Hicks, B. J., R. L. Beschta, and R. D. Harr. 1991. Long-term changes in streamflow following logging in western Oregon and associated fisheries implications. *Water Resources Bulletin* 27(2):217-226.
- Hoffman, A. A., and J. Merilä. 1999. Heritable variation and evolution under favourable and unfavourable conditions. *Trends in Ecology and Evolution* 14:96-101.
- Isely, J. J., and T. B. Grabowski. 2007. Age and growth. Pages 187-228 in Guy, C. S., and M. L. Brown, editors. *Analysis and Interpretation of Freshwater Fisheries Data*. American Fisheries Society, Bethesda, Maryland.
- Markiw, M. E., and K. Wolf. 1974. *Myxosoma cerebralis*: isolation and centrifugation from fish skeletal elements – sequential enzymatic digestions and purification by differential centrifugation. *Journal of Fisheries Research Board Canada* 31:15-20.

- Miller, M. P., and E. R. Vincent. 2008. Rapid natural selection for resistance to an introduced parasite of rainbow trout. *Evolutionary Applications* 1:336-341.
- Nehring, R. B. 2006. Colorado's cold water fisheries: whirling disease case histories and insights for risk management. Colorado Division of Wildlife. Aquatic Wildlife Research Special Report Number 79. February 2006.
- Nehring, R. B., and K. G. Thompson. 2001. Impact assessment of some physical and biological factors in the whirling disease epizootic among wild trout in Colorado. Colorado Division of Wildlife. Aquatic Research Special Report Number 76. March 2001.
- Nehring, R. B., and K. G. Thompson. 2003. Whirling disease risk assessment: the Colorado perspective. Pages 31-32 *in* Managing the risk. Proceedings of the 9th Annual Whirling Disease Symposium. Whirling Disease Initiative, Bozeman, MT
- Nehring, R. B., B. Heinold, and J. Pomeranz. 2011. Colorado River Aquatic Resources Investigations. Federal Aid in Fish and Wildlife Restoration, Job Progress Report. Colorado Division of Wildlife, Aquatic Wildlife Research Section. Fort Collins, Colorado.
- O'Grodnick, J. J. 1975. Whirling disease *Myxosoma cerebralis* spore concentration using the continuous plankton centrifuge. *Journal of Wildlife Diseases* 11:54-57.
- Ryce, E. K. N., A. V. Zale, E. MacConnell, and M. Nelson. 2005. Effects of fish age versus size on the development of whirling disease in rainbow trout. *Diseases of Aquatic Organisms* 63:69-76.
- Ryce, E. K. N., A. V. Zale, and R. B. Nehring. 2001. Lack of selection for resistance to whirling disease among progeny of Colorado River rainbow trout. *Journal of Aquatic Animal Health* 12:63-68.
- SAS Institute, Inc. 2010. SAS system software, Release 9.2. Cary, North Carolina.
- Schisler, G. J., E. P. Bergersen, and P. G. Walker. 1999a. Evaluation of chronic gas supersaturation on growth, morbidity, and mortality of fingerling rainbow trout infected with *Myxobolus cerebralis*. *North American Journal of Aquaculture* 61:175-183.
- Schisler, G. J., P. G. Walker, L. A. Chittum, and E. P. Bergersen. 1999b. Gill ectoparasites of juvenile rainbow trout and brown trout in the upper Colorado River. *Journal of Aquatic Animal Health* 11:170-174.
- Schisler, G. J., E. P. Bergersen, and P. G. Walker. 2000. Effects of multiple stressors on morbidity and mortality of fingerling rainbow trout infected with *Myxobolus cerebralis*. *Transactions of the American Fisheries Society* 129:859-865.

- Schisler, G. J., K. A. Myklebust, and R. P. Hedrick. 2006. Inheritance of *Myxobolus cerebralis* resistance among F1-generation crosses of whirling disease resistant and susceptible rainbow trout strains. *Journal of Aquatic Animal Health* 18:109–115.
- Seber, G. A. F., and J. F. Whale. 1970. The removal method for two and three samples. *Biometrics* 26(3):393-400.
- Temple, G. M., and T. N. Pearsons. 2007. Electrofishing: backpack and drift boat. Pages 95-132 in D. H. Johnson, B. M. Schrier, J. S. O’Neal, J. A. Knutzen, X. Augerot, T. A. O’Neal, and T. N. Pearson, editors. *Salmonid field protocols handbook: techniques for assessing status and trends in salmon and trout populations*. American Fisheries Society, Bethesda, Maryland.
- Thompson, K. G. 2011. Evaluation of small-scale habitat manipulation to reduce the impact of the whirling disease parasite in streams. *Aquatic Ecosystem Health and Management* 14(3):305-317.
- Thompson, K. G., R. B. Nehring, D. C. Bowden, and T. Wygant. 1999. Field exposure of seven species of subspecies of salmonids to *Myxobolus cerebralis* in the Colorado River, Middle Park, Colorado. *Journal of Aquatic Animal Health* 11:312-329.
- USGS. 2009. USGS Real Time Water Data for the Nation. Retrieved July 17, 2009, from <<http://nwis.waterdata.usgs.gov/co/nwis/uv/?>>.
- Van Den Avyle, M. J., and R. S. Hayward. 1999. Dynamics of exploited fish populations. Pages 127-166 in Kohler, C. G., and W. A. Hubert, editors. *Inland Fisheries Management in North America* (second ed.). American Fisheries Society, Bethesda, Maryland.
- von Bertalanffy, L. 1938. A quantitative theory of organic growth. *Human Biology* 10:181-213.
- Walker, P. G., and R. B. Nehring. 1995. An investigation to determine the cause(s) of the disappearance of young wild rainbow trout in the Upper Colorado River, in Middle Park, Colorado. Colorado Division of Wildlife Report. Denver, CO.
- White, G. C., and K. P. Burnham. 1999. Program MARK: Survival estimation from populations of marked animals. *Bird Study* 46 Supplement, 120-138.
- Williams, J. E., A. L. Haak, H. M. Neville, and W. T. Colyer. 2009. Potential consequences of climate change to persistence of cutthroat trout populations. *North American Journal of Fisheries Management* 29(3):533-548.

APPENDIX 2.1

GENETIC DIFFERENTIATION TEST ACCURACY

The accuracy of the genetic differentiation test to correctly identify GR, GR-cross and CRR fish was tested using known samples run through the NewHybrids program. The NewHybrids program uses the framework of Bayesian model-based clustering to compute, by Markov Chain Monte Carlo, the posterior probability that an individual belongs to each of a distinct set of defined hybrid class. The posterior probability reflects the level of certainty that an individual belongs to a hybrid category (Anderson and Thompson 2002); an individual was positively identified as a specific strain or hybrid if the posterior probability for the given category was ≥ 0.80 for that individual. All of the known GR fish were correctly assigned as pure GR, whereas 0.935 of the known CRR individuals were correctly assigned as pure CRR. Most commonly, pure CRR individuals were misidentified as B2. For the GR-crosses, 0.875 of the F1 individuals were correctly assigned as F1s, and were most commonly misidentified as F2s. Similarly, 0.872 of the B2 individuals were correctly assigned as B2s, and were most commonly misidentified as F2s. Finally, 0.80 of the F2 individuals were correctly assigned as F2s, and both individuals incorrectly assigned were misidentified as B2s. Results indicated that the microsatellite markers and associated NewHybrids probability tests were capable of distinguishing between pure and hybrid individuals, and that the majority of GR-cross individuals could be correctly assigned.

Blind sample tests were also used to check the accuracy of the differentiation test; samples were known to Colorado Parks and Wildlife (CPW), but the geneticist did not know which samples belonged to which strain or cross. Known samples (48) for each test came from a

previous laboratory experiment examining the resistance of the pure strains and their crosses (Fetherman et al. 2012). In both tests, all GR individuals were correctly assigned. Averaging between the two tests, 0.82 of the CRR individuals were correctly assigned (Figure A2.1-1), with a large majority of those incorrectly assigned misidentified as B2s. Similarly, when B2s were misidentified, they were most commonly identified as CRRs. Misidentification of CRR and B2 individuals was not entirely unexpected as B2 individuals could genetically resemble CRRs. The F2 individuals were most commonly misidentified; this result was also not entirely unexpected as F2 individuals could genetically resemble everything from a Pure GR to pure CRR due to recombination. Due to the accuracy of the test to correctly identify greater than 0.80 of the GR and CRR individuals, and the lack of a need for a test that could assign individuals to a specific cross (the fact that an individual fish possessed GR markers was sufficient for my needs), it appeared that the test was ready to use for wild fish testing. Therefore, the microsatellite differentiation test was used to genetically screen wild rainbow trout fry to determine if H×C fish had successfully reproduced in the upper Colorado River.

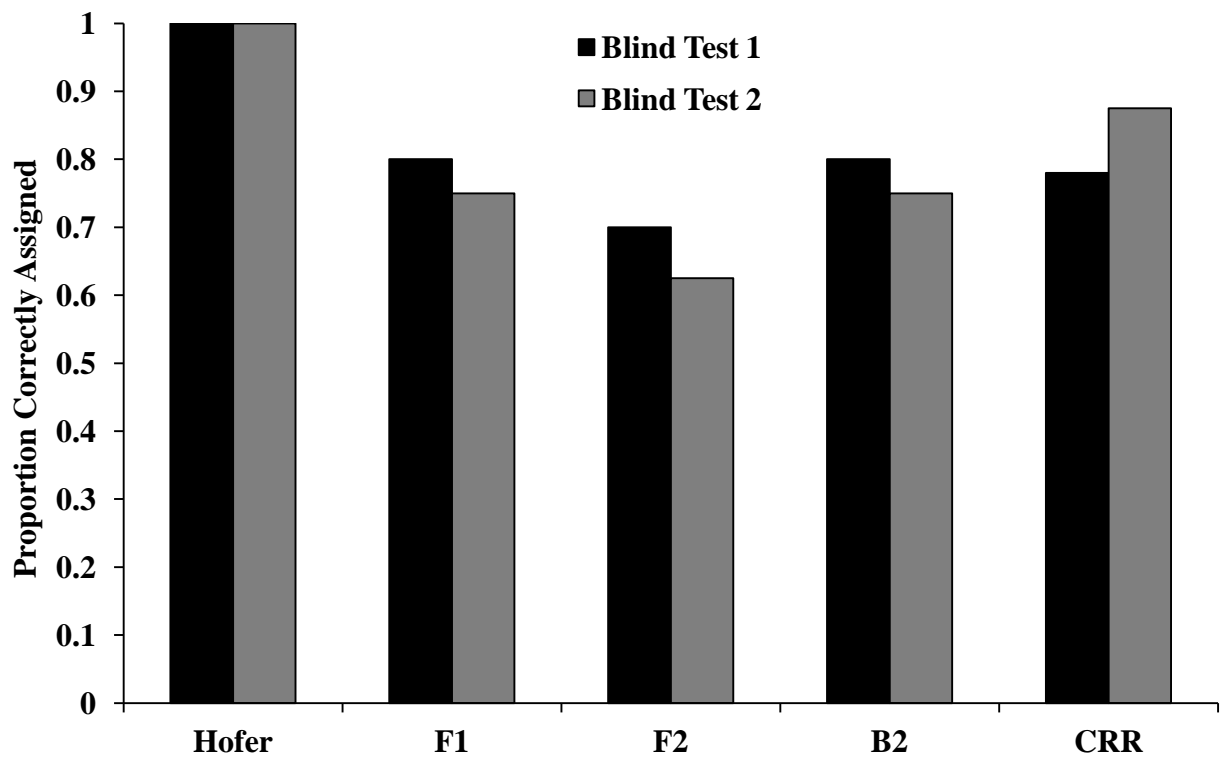

Figure A2.1-1. Proportion of fish correctly assigned to strain or cross in the two blind tests for accuracy of the microsatellite marker development, and assignment by the NewHybrids program.

CHAPTER 3

RAFT AND FLOATING RFID ANTENNA SYSTEMS FOR DETECTING PIT-TAGGED FISH IN LARGE RIVERS

INTRODUCTION

Passive integrated transponder (PIT) tag technology has many advantages over traditional marking techniques. PIT tags allow individual identification, have an infinite life, are easily applied and well retained, and have minimal effects on growth and survival (Gries and Letcher 2002; Zydlewski et al. 2006). Traditionally, the utility of PIT tagging has been limited to physical recapture events (Zydlewski et al. 2006). However, stationary antennas have recently been used to detect PIT-tagged fish in behavior studies, especially those examining habitat selection or migration processes (Nunnallee et al. 1998; Zydlewski et al. 2006; Bond et al. 2007; Compton et al. 2008; Connolly et al. 2008; Aymes and Rives 2009).

Stationary antenna arrays are typically used to detect PIT tagged fish, but the use of portable antenna arrays is becoming more common. Portable arrays have been used in studies examining aquatic animal movement, survival, and habitat use, and their design flexibility permits application in a wide variety of settings. Initial technological advances in portable PIT tag antenna systems enabled effective detection of salmonids in small rivers, including Atlantic salmon (*Salmo salar*; Roussel et al. 2000; Zydlewski et al. 2001), brown trout (*Salmo trutta*; Cucherousset et al. 2005), and steelhead (*Oncorhynchus mykiss*; Hill et al. 2006). Additionally, portable antennas have been developed to detect and locate age-0 pike (*Esox lucius*; Cucherousset et al. 2007), and various age-classes of European eel (*Anguilla anguilla*) and common dace (*Leuciscus leuciscus*; Cucherousset et al. 2010). Previous designs of portable

antenna systems have limited their effectiveness to shallow, wadable floodplains or small streams; however, a boat-mounted antenna system was recently developed for monitoring mussel populations in larger, non-wadable rivers (Fischer et al. 2012).

Portable antenna systems are limited by factors affecting detection efficiency including tag size, power source, tag orientation, antenna proximity if using multiple antennas (Zydlewski et al. 2006), and disruption of the magnetic field by the presence of metal (Greenberg and Giller 2000; Bond et al. 2007). For example, tag orientation relative to the antenna affects detection and is higher when the tag is oriented perpendicular rather than parallel to the antenna array (Nunnallee et al. 1998; Morhardt et al. 2000; Zydlewski et al. 2006; Compton et al. 2008; Aymes and Rives 2009). Disruption due to antenna proximity can be reduced through the use of multiplexers (Aymes and Rives 2009), and disruption from metal can be reduced by utilizing non-inductive materials such as epoxy coil encasements or nylon nuts and bolts (Fischer et al. 2012). Potential array limitations should be accounted for during the design process.

I describe the construction, use, and performance of two, portable floating Radio Frequency Identification (RFID) PIT tag antenna systems designed for use in large rivers. I had two objectives: 1) create an antenna that could be used to detect PIT-tagged rainbow and brown trout in relatively long-river sections; and 2) create an antenna that could be used in place of traditional sampling methods (i.e., electrofishing) for estimating PIT-tagged rainbow and brown trout abundance in shorter river segments.

METHODS

Raft Antenna System

I designed two antenna arrays to detect PIT-tagged rainbow and brown trout in the Cache la Poudre River, Colorado. Both arrays were deployed using a 4.9-m inflatable river raft. One

array was installed in the bottom of the raft (horizontal) and used to detect fish in shallower sections of the river, and the other was a dropper array (vertical) used to detect fish in deeper pools.

Both arrays consisted of two continuous loops of 12 gauge thermoplastic high heat-resistant nylon-coated (THHN) wire. The horizontal array was a 4×1.2 m elliptical array located in the self-bailing channel of the raft. Array shape and loop proximity were maintained by threading the THHN wire through sections of flexible plastic tubing secured to the self-bailing holes in the floor of the raft with soft nylon cord. The vertical array was a 2.7×1.2 m rectangle, maintained by four, 19-mm polyvinyl chloride (PVC) crossbeams secured to the antenna wire with expandable spray foam insulation (Figure 3.1, A3.2-1). Holes were drilled in each crossbeam to allow water entry and 51-mm PVC caps filled with cement were attached to the lower-most crossbeam to facilitate submersion. Foam pipe insulation placed on the first crossbeam prevented the array from becoming fully submerged. Connectors produced for welding applications were used to allow quick disconnection of the vertical array in the event that the array got caught on submerged rocks or vegetation.

The horizontal and vertical arrays were both connected to an Oregon RFID half-duplex (HDX) multiplex reader, which helped prevent proximity detection errors (Aymes and Rivas 2009). The HDX reader stored detections from both arrays along with date and time of detection. Two 12-V marine, deep-cycle batteries, connected in parallel, powered the raft antenna system. Batteries, tuner boxes, and the reader were placed in plastic, top-locking containers and strapped to a rigid plastic deck located on the floor of the raft, preventing equipment shifts and submersion during deployment (Figure 3.1, A3.2-1).

Field Test

To verify operation of the raft antenna system under riverine conditions, I epoxied 50, 32 x 3.85 mm HDX PIT tags to rocks and placed them in a 95.5 m (5.6 m average width) section of an inlet stream located at Parvin Lake (Red Feather Lakes, Colorado). I divided the section into transects and two rocks with tags were placed on each transect. The first transect was located 6.8 m downstream from the raft put-in allowing the raft to be underway before the first detection occurred. Subsequent transects were located at random distances from the first by using a random number generator. Depths and locations of the two PIT-tagged rocks placed on each transect were chosen deliberately to provide a variety of distances and depths for analysis. Distance from the south bank and water depth was recorded for each tag, and the metric distance-from-center (DFC) was calculated by halving transect length and subtracting distance from south bank (Table A3.2-1). Rocks were placed such that PIT tags were oriented perpendicular to the long edge of the horizontal array.

Both arrays were utilized during the field test. Floats were attached to the vertical array because the stream section was too shallow to deploy the antenna without dragging or moving PIT-tagged rocks. Ten passes were conducted, and the raft was maneuvered down the center of the inlet stream on each pass; approximately the same course was followed on all passes.

Deployment

The raft antenna system was deployed in an 11.3-km section of the Cache la Poudre River (19.6 m average width) near Rustic, Colorado. In another study, I PIT tagged approximately 5,000 rainbow and brown trout with 32 mm HDX tags, inserted posterior of the pectoral fin through the midventral body wall into the peritoneal cavity using a hypodermic needle (Prentice et al. 1990; Acolas et al. 2007). Movement and survival were monitored with

eight stationary antennas surrounding reaches from which brown trout had (removal) or had not (control) been removed. The objective of using the raft antenna system was to detect PIT-tagged trout that were not detected by the stationary antennas, namely individuals that had migrated from the study reaches or individuals alive within the study reaches that had never moved between reaches.

Prior to deployment, the horizontal and vertical arrays were tuned and tested with a PIT tag to ensure proper operation. A crew of six was used to maneuver the raft downstream: a captain, four paddlers, and a person to operate the antenna equipment. Four paddlers were needed because an oar frame would interfere with the operation of the antennas (Greenberg and Giller 2000; Bond et al. 2007; Appendix 3.1). The raft antenna system was deployed in low water conditions, which were conducive for higher detection probabilities, but made maneuvering the raft difficult; however, we attempted to maneuver the raft within the river's thalweg. The horizontal array detected fish in shallower sections of the river (less than one meter deep), while the vertical array was deployed in pools greater than one meter deep. The vertical array design facilitated easy deployment at the head of a pool, retrieval at the tail end of the pool, and on-board storage in an accordion-like fashion for swift, later deployment (Figure A3.2-1).

Two passes were made through the section on subsequent days; raft course and vertical array deployment was similar among the passes. On each pass, operator watches were synchronized with the antenna reader clock. I recorded start and stop times, as well as times at which recognizable landmarks were passed, allowing us to pair PIT tag detection times and locations for analysis.

Statistical Analyses

For the Parvin Lake field test, detection probabilities (p) for the horizontal and vertical arrays were estimated using the Huggins closed capture-recapture estimator in program MARK (White and Burnham 1999). Detections made by each antenna were considered independently within the same analysis (by including them as ‘groups’ in the analysis) to capture antenna differences in detection; depth and DFC were included as individual covariates for each PIT-tagged rock, and models in which p was constant, or varied by depth, DFC, or the additive combination of the two, were included in the model set. Models were ranked using Akaike’s Information Criterion corrected for small sample sizes (AICc; Burnham and Anderson 2002), and model averaged parameter estimates and unconditional standard errors (SE) were reported (Anderson 2008). In addition, cumulative AICc weights were used to assess the relative importance of each covariate.

Following deployment in the Poudre River, two-pass detection data from the horizontal and vertical arrays were pooled to obtain an overall estimate of p and the recapture probability (c) for the raft antenna system using the Huggins estimator in program MARK. Rainbow trout and brown trout were included as groups in the same analysis. The model set included models in which p and c were constant and equal, constant but not equal, or varied by species. Models were ranked using AICc, and I report model averaged parameter estimates and associated standard errors. In addition, model averaged, tagged fish abundance (\hat{N}) was obtained for the section as a derived estimate (Huggins 1989).

Shore-deployed Floating Antenna System

A shore-deployed floating antenna system was designed to span the width of the Poudre and St. Vrain (Lyons, Colorado) Rivers for the purpose of detecting PIT-tagged rainbow and

brown trout in both rivers. The objective was to determine if a large, floating array could be used to estimate the population size of tagged fish (N) in place of traditional sampling methods, such as electrofishing.

The rectangular floating array, 14.6×0.6 m, consisted of a single loop of insulated eight-gauge multi-strand speaker wire. Array shape was maintained by threading the wire through foam pipe insulation (used for floatation) and 13-mm PVC crossbeams, located every 1.8 m along the length of the antenna (Figure 3.1, A3.2-2). Floating nylon rope was threaded through the upstream side of the foam pipe insulation, allowing operators to maintain tension and array shape during deployment. An Oregon RFID HDX reader and tuner box, located in the top compartment of a plastic framed, sling-load pack, and a 12-V marine, deep-cycle battery, secured to the pack via the sling, were used to power the array (Figure 3.1, 3.A2-2).

Detection Distance

Detection distance was tested by running a 32 mm PIT tag over the antenna in the horizontal, vertical and 45° detection planes both perpendicular and parallel to the antenna. Both sides of the array were tested to determine if there were differences in detection symmetry. When the tag was detected by the reader, a piezoelectric buzzer attached to the reader produced an audible beep. Maximum continuous detection distance was determined as the distance between when a beep was heard for every movement of the tag past the antenna (100% detection rate) and when a lack of beep indicated that detections were being missed.

Field Test

Array design facilitated two-person deployment. One person carried the sling-load pack and was the primary guide for the array. The second person retained tension on the nylon rope, maintaining array shape and guiding the antenna over obstacles (Figure A3.2-2). The fully-

extended array was maneuvered downstream during deployment, allowing the river current to carry the array over the majority of the obstacles, primarily large boulders. A third person was occasionally needed to help guide the antenna over major obstructions.

The capacity of the floating array to produce estimates of the abundance of tagged fish similar to those obtained through electrofishing was tested at four sites in the Poudre River and six sites in the St. Vrain River in the fall of 2011. PIT-tagged rainbow and brown trout, tagged using the same methods described for the Poudre River, had been previously released in the St. Vrain as part of another study examining movement rates through man-made whitewater park structures thought to be at least a partial barrier to upstream movement. Two passes were conducted through each site by maneuvering the fully-extended floating array downstream; the array was folded up and returned to the top of the section between passes. Following array deployment, two- (Poudre River) or three-pass (St. Vrain River) removal estimates were conducted in each section using a four-electrode bank electrofishing unit. All fish captured during electrofishing efforts were weighed, measured, and scanned for PIT tags using a hand-held reader. Study sections within the St. Vrain River were closed using block nets at both the upstream and downstream ends prior to array deployment and electrofishing; Poudre River sites were not closed during sampling with either gear.

Sampling sites varied in length, width, and habitat characteristics. In the Poudre River, the two upstream-most sites (upper treatment: 114 m long \times 17 m wide; lower treatment: 165 \times 12 m) were characterized by slower velocity pool habitat with higher velocity riffles on the upstream end. The two downstream-most sites (upper control: 91 \times 21 m; lower control: 124 \times 19 m) were both characterized by moderate riffle habitat with higher velocity riffle habitat on their upstream end. The Poudre River was sampled at an average discharge of 3.4 cms and

average site depth was 0.6 m. Sampling sites within the St. Vrain River consisted of naturally occurring (natural) and man-made (whitewater park; WWP) pools of varying depth. The three man-made pools (lower, middle, and upper WWP) were 1.6, 1.4, and 2.1 m deep, respectively, and the three naturally occurring pools (lower, middle, and upper natural) were 0.5, 0.4, and 1.0 m deep, respectively. Average width of the pools was 7.6 m, and the pools were sampled at an average discharge of 0.7 cms.

Deployment

Two-pass deployment of the floating array occurred in two, 0.8-km sections of the St. Vrain River: 1) the WWP section, consisting of deep, man-made pools with little riffle habitat; and, 2) the natural section, consisting of naturally occurring pools with a typical pool-riffle structure. All six of the previously described pools were contained within these sections. Due to the narrow width of the sections, the array was deployed at a 45° angle to the stream banks, allowing full extension of the array for proper tuning. Recognizable structures within the 0.8-km sections were later identified within the reader logs by passing a PIT tag of known number over the array as it passed these structures so that detected fish location relative to these structures could be identified during analysis.

Statistical Analyses

To evaluate antenna symmetry and influence of plane of detection on maximum detection distance, I used a general linear model (GLM) as implemented in SAS ProcGLM (SAS Institute, Inc. 2010). I considered an intercept-only model, as well as models that included effects of side only, plane of detection only, and models with additive and interactive effects between side and plane of detection. Model weights and delta AICc were used to determine support for each of

the models included in the model set, and parameter estimates were reported from the candidate model with the lowest AICc value (Burnham and Anderson 2002).

Estimates of the number of PIT-tagged rainbow and brown trout in the study sites (Poudre) or pools (St. Vrain) were obtained using the Huggins estimator in program MARK (White and Burnham 1999). The model sets included models in which p and c were constant and equal, constant but not equal, and varied by species. Estimates of N were similarly obtained from the electrofishing data, except because fish were removed following capture, recapture probability, c , was fixed to zero in all models (Hense et al. 2010; Saunders et al. 2011). Detection data from captured tagged fish in each study site or pool was analyzed using separate model sets for each. Rainbow trout and brown trout were included in groups in the same analysis and p was modeled as constant over all individuals and varied among individuals by length, species, or both. Models were ranked using AICc, and I report model averaged parameter estimates. Model averaged estimates of the number of tagged fish (\hat{N}) were obtained for each species as a derived estimate. Abundance estimates obtained with the shore-deployed floating antenna system and electrofishing were compared within each study site or pool, and significant differences in \hat{N} between the two gears were determined by an overlap in 95% confidence intervals (CIs).

RESULTS

Raft Antenna System

Field Test

In the field test conducted in the Parvin Lake inlet stream, additive effects of DFC and depth were included in the top model ($p(\text{DFC}, \text{depth})$; AICc weight = 0.999). A negative relationship was observed between DFC and p ($\hat{\beta} = -0.011 \pm 0.001$), indicating that the further a

tag was from the center of the inlet stream, the less likely it was to be detected. Interestingly, there was a positive relationship between p and depth ($\hat{\beta} = 0.02 \pm 0.005$) because tags located near the center of the inlet stream were deeper than those placed closer to the banks. Overall, model-averaged \hat{p} (\pm SE) was higher for the horizontal array (0.32 ± 0.02) than for the vertical array (0.24 ± 0.02).

Deployment

A total of 44 PIT-tagged fish were detected by the raft antenna system (both arrays combined) in the Cache la Poudre River, 32 rainbow trout and 12 brown trout. Two unique fish were detected by the vertical array, whereas 42 unique fish were detected by the horizontal array. Sixteen fish were located in the 10 km section between the two study reaches, confirming that fish that had emigrated from the study reaches were surviving in other locations in the river. Three fish were detected on both passes; \hat{N} (\pm SE) of PIT-tagged salmonids in the 11.3 km section of the Cache la Poudre River was 174 (\pm 130). Detection probability of the entire antenna system was 0.14 (\pm 0.14), and \hat{c} was 0.13 (\pm 0.07).

Shore-deployed Floating Antenna System

Detection Distance

Plane of detection had the largest influence on maximum detection distance (AICc weight = 0.55; Table 3.1). Tags in the vertical detection plane were detected at a greater distance (79.9 cm) than tags in the horizontal or angled detection planes ($P < 0.001$). Horizontal (71.6 cm) and angled (72.3 cm) detection planes did not differ ($P = 1.000$).

Field Test

In the Cache la Poudre River, PIT-tagged abundances (\hat{N}) obtained from the floating array and electrofishing were similar in two of the four study sections, indicated by overlapping

95% CIs (Figure 3.2). The estimate of the number of PIT-tagged fish in the lower control section was higher with electrofishing than the floating array, potentially a function of the differences in maneuverability of the two gears around the large boulders located within this site. Abundance estimation via electrofishing was not possible in the upper treatment site due to depletion failure (i.e., same number of fish caught on both passes); however, estimates of N were obtainable for this section using the floating array (Figure 3.2).

The floating array failed to obtain comparable estimates of N in the St. Vrain River WWP pools, which was likely a function of depth; the shallowest pool (middle WWP; 1.4 m) exceeded the maximum read range of the array by 0.6 m. In the natural pool section, similar estimates of N were obtained in the lower and middle pools, where maximum pool depth did not exceed 0.5 m. However, in the upper pool, which had a maximum depth of 1 m, the estimate obtained using the floating array was lower than that obtained with electrofishing (Figure 3.2).

Deployment

Thirty-two PIT-tagged fish, 16 rainbow trout and 16 brown trout, were detected within the 0.8-km natural pool section, resulting in an \hat{N} (\pm SE) of 44 (\pm 12) PIT-tagged fish (22 \pm 9 of each species) in the section. In the 0.8-km WWP section, 49 PIT-tagged fish were detected by the floating array, 18 rainbow trout and 31 brown trout. An estimated 59 (\pm 6) PIT-tagged fish were present in this section, with estimates of 19 (\pm 2) rainbow trout and 43 (\pm 10) brown trout. In both sections, PIT-tagged fish were detected in locations that had not been previously surveyed via electrofishing or the floating array. Estimated detection probabilities via the floating array did not differ between the sections, with model-averaged $\hat{p} = 0.52$ (\pm 0.15) in the natural pool section, and $\hat{p} = 0.60$ (\pm 0.10) in the WWP section. Average deployment time was roughly 45 minutes per pass.

DISCUSSION

Both my raft and shore-deployed floating antenna systems were successful at detecting PIT-tagged fish. My raft antenna system successfully detected PIT-tagged fish over an 11.3 km section of the Cache la Poudre River in locations that would not have otherwise been sampled, allowing determination of fish location and fate (i.e., survival). My shore-deployed floating array covered the entire width of both the Cache la Poudre and St. Vrain Rivers during low flow sampling periods and provided reasonable estimates of abundance of tagged fish when compared with standard electrofishing estimates. Overall, the raft and shore-deployed floating antenna systems have overcome limitations recognized with other portable systems, namely antenna size, stream distance surveyed, coverage, and detection distances.

Detection distances for both antenna systems were > 0.7 m and can be partially attributed to using 32 mm tags (Zydlewski et al. 2006). Other studies have used 12 or 23 mm tags, resulting in lower detection distances (Cucherousset et al. 2005; Roussel et al. 2000; Zydlewski et al. 2001; Hill et al. 2006). However, despite relatively large detection distances, capture probabilities for the raft antenna system were relatively low. Low capture probabilities could be a result of the coverage of the raft antenna system relative to the width of the river. In the Parvin Lake field test, the raft antenna system covered an average of only 32% of the width of the inlet stream. Consequently, \hat{p} for the horizontal array in the Parvin test was 0.32, and modeling indicated that p was affected by tag distance from the raft, suggesting that had coverage been wider, \hat{p} would have been higher.

Only two fish were solely detected by the vertical array when deployed in the Cache la Poudre River, potentially contributing to the low \hat{p} of the raft antenna system. Linnansaari and Cunjak (2007) suggest that there may be a fright bias associated with larger submerged arrays if

fish are being tracked in their active state. Therefore, my vertical array may have caused some behavioral avoidance when deployed in pools. In addition, the vertical antenna was tuned fully extended prior to deployment. Antenna shape may have differed when deployed in pools, or continuous deployment and storage may have caused the antenna to become detuned, thereby reducing detection distance of the vertical antenna upon deployment.

Overall, detection probability (i.e., the probability of detecting an individual at least once) could be increased by increasing the number of passes made through a study section. Despite low \hat{p} , estimates of N were obtainable over large sections of river using only two passes, although the estimates were imprecise. Most portable antenna designs, with the exception of the boat-mounted antenna for monitoring mussels (Fischer et al. 2012), have been constrained to use in shallow, wadable streams; as a result, survey length was limited by the length of river an operator could walk. Although my estimates of N exhibited high variability, the ability to determine the location and fate of PIT-tagged fish over long distances is a major advantage of this antenna system relative to other portable antenna designs.

Portable PIT-tag antenna systems have shown to be fairly accurate in estimating abundance of PIT-tagged fish in small streams (O'Donnell et al. 2010; Sloat et al. 2011). Portable antennas have the advantage of allowing frequent sampling for N estimation without subjecting study animals to excessive handling stress or mortality (Sloat et al. 2011). However, this feature also excludes the ability to examine fish for growth or physiological parameters (Zydlewski et al. 2001) or to estimate the overall abundance (marked and unmarked) of fish within a designated area. My results suggest that if estimates of tagged fish are desired and handling fish (beyond tagging) is not necessary to collect individual information (e.g., fish size

or signs of disease) from the population, portable antennas present a good alternative to traditional sampling methods such as electrofishing.

I believe that my relatively large detection distance and wide coverage resulted in abundance estimates obtained with the shore-based floating antenna system similar to those obtained with electrofishing. In one instance, the floating array produced an abundance estimate that was inestimable with electrofishing data due to depletion failure. However, one possible disadvantage of greater detection distance is an increased chance of multiple tags being present in the detection field of the array, resulting in no tags being detected (tag collision; Axel et al. 2005; O'Donnell et al. 2010). In addition, detection of ghost tags, tags lodged in the substrate through a combination of tag loss, predation, and natural mortality (O'Donnell et al. 2010), could result in an overestimation of population abundance. Ghost tag detections cannot be removed from the data without locating ghost tags using a smaller wand-type antenna systems or electrofishing recaptures to confirm that tags have been retained by the fish in that section. Finally, although detection distance is greater than other portable antenna designs, the shore-deployed floating array is still limited to use in shallower (< 1 m) sections of river.

The shore-deployed floating array overcomes some of the drawbacks observed with other antenna systems, such as antenna size, or those caused by lack of operator experience and animal behavior (O'Donnell et al. 2010). Many of the previously described portable antenna systems were small, designed to be operated by one person in a small stream (Roussel et al. 2000; Cucherousset et al. 2005; Hill et al. 2006), and as such, antenna detection coverage was small relative to the width of the river. My shore-based floating array is the largest two person portable antenna described to date, with previous two-person PIT antennas not exceeding 5 m in length (Linnansaari and Cunjak 2007). Submersion of the antenna is not required, theoretically

reducing the chance of a behavioral response to an array located within the water column. Although overhead stimuli may also illicit an avoidance response, fish are less likely, relative to smaller designs, to move completely out of the detection field due to antenna coverage (i.e., the entire width of the river). The effect of operator experience is also reduced due to antenna coverage as the operator is not required to identify specific locations or habitats to sample. However, fish located directly behind large boulders or other obstacles may not be detected by the floating array when passing over these obstacles.

The design flexibility of these antenna systems provides an opportunity to potentially combine designs and create a larger detection field for greater river coverage. For example, floating arrays could be combined with the raft antenna systems to create a larger floating system that could cover a large area of the river over long distances. Multiplexers could be used to power the system and prevent proximity detection errors (Aymes and Rivas 2009). The larger size of the system, however, could potentially result in a greater chance of entanglement with obstacles such as boulders or submerged trees; this would need to be considered during the design of these larger systems.

My portable antenna systems provide a noninvasive method for estimating PIT-tagged fish N and survival in both small (hundreds of m) and large (km) sections of river. In addition, through the use of marker tags and accurate timing devices, the location of fish can be determined fairly accurately using these systems. More research is needed to examine the effects of ghost tags within the study section, fish behavioral response to the antenna systems, and to determine an effective number of passes for increasing \hat{p} and reducing the variability in estimates of N , while balancing the amount of time it takes to complete a pass through the study sections.

Table 3.1. Model selection results for factors influencing maximum detection distance for the shore-deployed floating antenna array.

Model	R^2	$\log(L)$	K	AICc	Δ_i	w_i
Plane	0.64	-43.43	3	94.06	0.00	0.55
Side+Plane	0.66	-42.27	4	94.65	0.60	0.41
Side*Plane	0.68	-41.33	6	99.60	5.54	0.03
Intercept-only	0.00	-64.98	1	132.13	38.08	0.00
Side	0.02	-64.57	2	133.71	39.66	0.00

The maximized log-likelihood ($\log(L)$), the number of parameters (K) in each model, and the small sample size-corrected AICc values (AICc) are shown. Models are ranked by their AICc differences (Δ_i) relative to the best model in the set and Akaike weights (w_i) quantify the probability that a particular model is the best model in the set given the data and the model set.

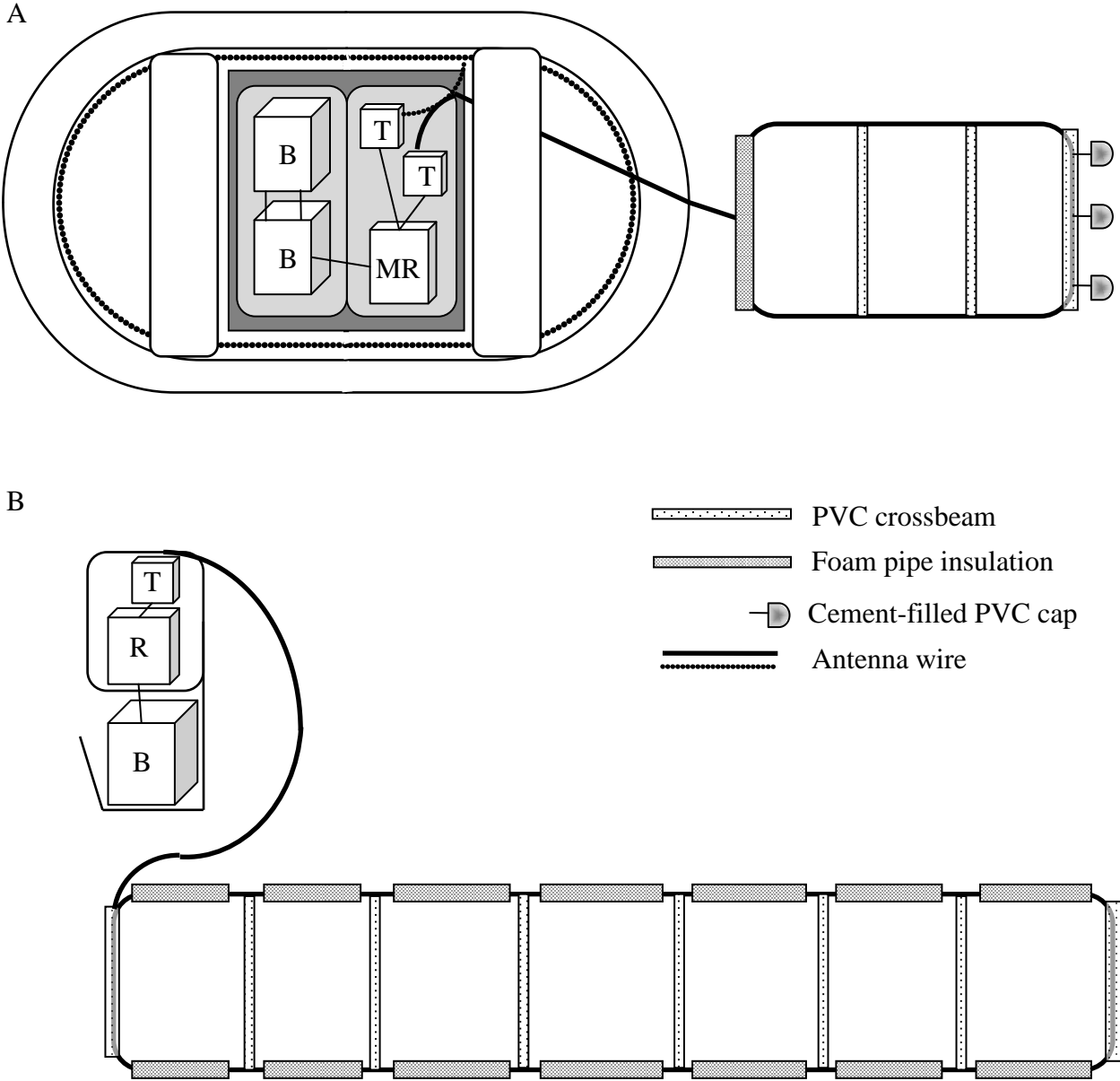

Figure 3.1. (A) Schematic representation of the raft antenna system (not to scale). Two continuous loops of twelve gauge THHN wire were used to create the horizontal (heavy dotted line) and vertical (heavy solid line) arrays. Both arrays were connected to tuning boxes (T), which were in turn connected to a multiplex reader (MR) and batteries (B) housed inside plastic, top-locking containers (light gray) and strapped to a rigid plastic deck (dark gray). (B) Diagram of the shore-deployed floating antenna system (not to scale). The array consisted of a single loop of eight-gauge multi-strand speaker wire connected to a tuner box (T), which interfaced with the reader (R) and battery (B) enclosed in the sling-load backpack.

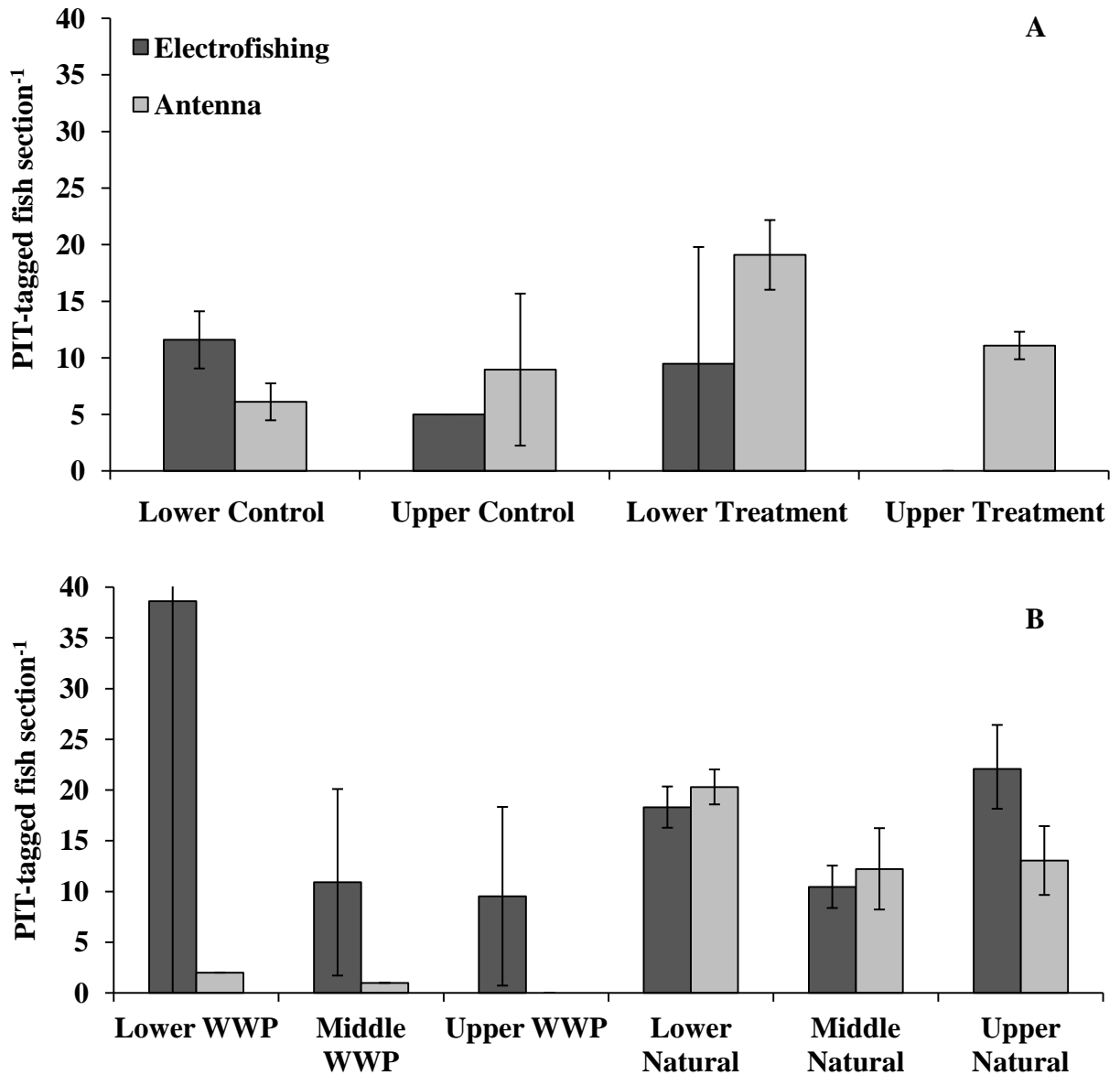

Figure 3.2. Estimated number of PIT-tagged salmonids section⁻¹ (95% CI bars) estimated via electrofishing (Cache la Poudre River: two passes; St. Vrain River: three passes) and the shore-deployed floating antenna system (two passes) within the surveyed sections of the Cache la Poudre River (A) and St. Vrain River (B).

LITEARTURE CITED

- Acolas, M. L., J.-M. Roussel, J. M. Lebel, and J. L. Baglinière. 2007. Laboratory experiment on survival, growth and tag retention following PIT injection into the body cavity of juvenile brown trout (*Salmo trutta*). *Fisheries Research* 86:280-284.
- Anderson, D. R. 2008. *Model based inference in the life sciences: A primer on evidence*. Springer, LLC, New York, New York.
- Axel, G. A., E. F. Prentice, and B. P. Sandford. 2005. PIT-tag detection system for larger-diameter juvenile fish bypass pipes at Columbia River basin hydroelectric dams. *North American Journal of Fisheries Management* 25:646-651.
- Aymes, J. C., and J. Rives. 2009. Detection efficiency of multiplexed passive integrated transponder antennas is influenced by environmental conditions and fish swimming behavior. *Ecology of Freshwater Fish* 18:507-513.
- Bond, M. H., C. V. Hanson, R. Baertsch, S. A. Hayes, and R. B. MacFarlane. 2007. A new low cost instream antenna system for tracking passive integrated transponder (PIT)-tagged fish in small streams. *Transactions of the American Fisheries Society* 136:562-566.
- Burnham, K. P., and D. R. Anderson. 2002. *Model selection and multimodel inference: A Practical information-theoretic approach*. Second edition. Springer-Verlag, New York, New York.
- Compton, R. I., W. A. Hubert, F. J. Rahel, M. C. Quist, and M. R. Bower. 2008. Influences of fragmentation on three species of native warmwater fish in a Colorado River Basin headwater stream system, Wyoming. *North American Journal of Fisheries Management* 28: 1733-1743.
- Connolly, P. J., I. G. Jezorek, K. D. Martens, and E. F. Prentice. 2008. Measuring the performance of two stationary interrogation systems for detecting downstream and upstream movement of PIT-tagged salmonids. *North American Journal of Fisheries Management* 28:402-417.
- Cucherousset, J., J.-M. Roussel, R. Keeler, R. A. Cunjak, and R. Stump. 2005. The use of two new portable 12-mm PIT tag detectors to track small fish in shallow streams. *North American Journal of Fisheries Management* 25(1):270-274.
- Cucherousset, J., J.-M. Paillisson, and J.-M. Roussel. 2007. Using PIT technology to study the fate of hatchery-reared YOY northern pike released into shallow vegetated areas. *Fisheries Research* 85:159-164.

- Cucherousset, J., J. R. Britton, W. R. C. Beaumont, M. Nyqvist, K. Sievers, and R. E. Gozlan. 2010. Determining the effect of species, environmental conditions and tracking method on the detection efficiency of portable PIT telemetry. *Journal of Fish Biology* 76:1035-1045.
- Fischer, J. R., T. E. Neebling, and M. C. Quist. 2012. Development and evaluation of a boat-mounted RFID antenna for monitoring freshwater mussels. *Freshwater Science* 31(1):148-153.
- Greenberg, L. A., and P. S. Giller. 2000. The potential of flat-bed passive integrated transponder antennae for studying habitat use by stream fishes. *Ecology of Freshwater Fish* 9:74-80.
- Gries, G., and B. H. Letcher. 2002. Tag retention and survival of age-0 Atlantic salmon following surgical implantation with passive integrated transponder tags. *North American Journal of Fisheries Management* 22:219-222.
- Hense, Z., R. W. Martin, and J. T. Petty. 2010. Electrofishing capture efficiencies for common stream fish species to support watershed-scale studies in the central Appalachians. *North American Journal of Fisheries Management* 30:1041-1050.
- Hill, S. A., G. B. Zydlewski, J. D. Zydlewski, and J. M. Gasvoda. 2006. Development and evaluation of portable PIT tag detection units: PITpacks. *Fisheries Research* 77:102-109.
- Huggins, R. M. 1989. On the statistical analysis of capture experiments. *Biometrika* 76(1): 133-140.
- Linnansaari, T. P., and R. A. Cunjak. 2007. The performance and efficacy of a two-person operated portable PIT-antenna for monitoring spatial distribution of stream fish populations. *River Research and Applications* 23:559-564.
- Morhardt, J. E., D. Bishir, C. I. Handlin, and S. D. Mulder. 2000. A portable system for reading large passive integrated transponder tags from wild trout. *North American Journal of Fisheries Management* 20:276-283.
- Nunnallee, E. P., E. F. Prentice, B. F. Jonasson, and W. Patten. 1998. Evaluation of a flat-plate PIT tag interrogation system at Bonneville Dam. *Aquaculture Engineering* 17:261-272.
- O'Donnell, M. J., G. E. Horton, and B. H. Letcher. 2010. Use of portable antennas to estimate abundance of PIT-tagged fish in small streams: Factors affecting detection probability. *North American Journal of Fisheries Management* 30(2):323-336.
- Prentice, E. F., T. A. Flagg, C. S. McCutcheon, D. F. Brastow, and D. C. Cross. 1990. Equipment, methods, and an automated data-entry station for PIT tagging. Fish Marking Techniques. Edited by N. C. Parker, A. E. Giorgi, R. C. Heidinger, D. B. Jester, Jr., E. D. Prince, and G. A. Winans. American Fisheries Society, Symposium 7, Bethesda, Maryland, pgs. 335-340.

- Roussel, J.-M., A. Haro, and R. A. Cunjak. 2000. Field test of a new method for tracking small fishes in shallow rivers using passive integrated transponder (PIT) technology. *Canadian Journal of Fisheries and Aquatic Sciences* 57:1326-1329.
- SAS Institute, Inc. 2010. SAS system software, Release 9.2. Cary, North Carolina.
- Saunders, W. C., K. D. Fausch, and G. C. White. 2011. Accurate estimation of salmonid abundance in small streams using nighttime removal electrofishing: an evaluation using marked fish. *North American Journal of Fisheries Management* 31:403-415.
- Sloat, M. R., P. F. Baker, and F. K. Ligon. 2011. Estimating habitat-specific abundances of PIT-tagged juvenile salmonids using mobile antennas: A comparison with standard electrofishing techniques in small streams. *North American Journal of Fisheries Management* 31: 986-993.
- White, G. C., and K. P. Burnham. 1999. Program MARK: Survival estimation from populations of marked animals. *Bird Study* 46 Supplement, 120-138.
- Zydlewski, G. B., A. Haro, K. G. Whalen, and S. D. McCormick. 2001. Performance of stationary and portable passive transponder detection systems for monitoring of fish movements. *Journal of Fish Biology* 58:1471-1475.
- Zydlewski, G. B., G. Horton, T. Dubreuil, B. Letcher, S. Casey, and J. Zydlewski. 2006. Remote monitoring of fish in small streams: a unified approach using PIT tags. *Fisheries* 31(10):492-502.

APPENDIX 3.1

RAFT ANTENNA SYSTEM DETECTION DISTANCE TESTING

Presence of an oar frame was thought to affect the maximum detection distance of the raft antenna systems horizontal array as metal within detection field had been shown to disrupt both detection occurrence and detection distance (Greenberg and Giller 2000; Bond et al. 2007). To test this, the raft was elevated on stands, and detection distances were measured with and without the oar frame by running a 32 mm PIT tag past the antenna on a horizontal, vertical and 45° detection plane both perpendicular and parallel to the antenna (Figure A3.1-1). When the tag was detected, a piezoelectric buzzer connected to the reader produced an audible beep. Maximum continuous detection distance was determined as the distance between when a beep was heard for every movement of the tag past the antenna (100% detection rate) and when a lack of beep indicated that detections were being missed.

A two-factor (frame presence and plane of detection) analysis of variance (ANOVA) was used to separately compare maximum detection distances for tags oriented perpendicular or parallel to the horizontal array in SAS Proc GLM (SAS Institute, Inc. 2010). Similarly, maximum detection distances were compared in the absence of the oar frame using a two-factor (orientation and plane of detection) ANOVA in SAS Proc GLM. Values for both analyses were reported from the Type III sum of squares. If significant main effects were identified ($\alpha < 0.05$), the least squares means method (Bonferroni adjustment), was used to determine effects of frame presence, plane, and orientation on maximum detection distance.

Perpendicular-oriented tag detection distance was affected by both the presence of the aluminum oar frame and the tag detection plane ($F_{5,66} = 10.63$, $P < 0.001$), but not their

interaction ($F_{1,66} = 0.89$, $P = 0.680$). Greater detection distances were obtained in the absence of the oar frame (86 cm) relative to when the frame was present (76 cm; $P < 0.001$). Detection distance was greatly reduced for parallel-oriented tags (20.5 cm), but was not affected by the presence of the frame or plane of detection ($F_{5,66} = 1.90$, $P = 0.107$).

In the absence of the aluminum oar frame, detection distance was affected by both tag orientation and plane of detection ($F_{5,66} = 140.02$, $P < 0.001$). Perpendicular-oriented tags were detected at a greater distance (86 cm) than those oriented parallel to the wire (18 cm; $P < 0.001$). Greater detection distances were obtained in the vertical plane (96 cm) compared to the angled plane (78 cm; $P = 0.003$), but the horizontal (85 cm) and vertical planes did not differ when tags were oriented perpendicular to the antenna wire ($P > 0.223$). No differences between planes of detection were observed with a parallel tag orientation ($P = 1.000$).

Results confirmed that the presence of the aluminum oar frame affected detection distance of the horizontal array. Therefore, the oar frame was not used to maneuver the raft during field testing or deployment of the raft antenna system.

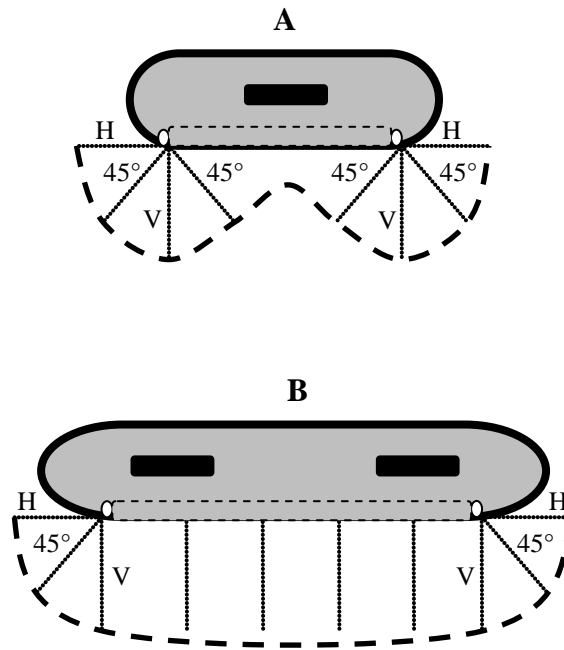

Figure A3.1-1. Maximum detection distance (heavy dotted line) measured on a horizontal (H), vertical (V), and 45 degree (45°) plane extending out from the horizontal array as seen from the rear (A) and side (B) of the raft.

APPENDIX 3.2

SUPPLEMENTAL TABLES AND FIGURES

Table A3.2-1. PIT-tagged rock placement, with regard to the depth and distance from center (DFC; cm) of the fifty rocks used in the detection probability experiment conducted in the Parvin Lake inlet stream. Depth and DFC were included as individual covariates in the Huggins closed capture-recapture models used to determine detection probability of the horizontal and vertical arrays of the raft antenna system.

Transect #	Rock #	Tag #	Depth	DFC
1	40	173863112	38.1	53.34
1	41	173863108	38.1	190.5
2	33	173863115	64.77	22.86
2	36	173863111	25.4	257.81
3	24	173863122	53.34	20.32
3	39	173863114	35.56	147.32
4	35	173863113	44.45	121.92
4	38	173863120	48.26	138.43
5	26	173863116	52.07	85.09
5	37	173863119	48.26	82.55
6	19	173863131	33.02	269.24
6	30	173863124	39.37	55.88
7	25	173863126	44.45	90.17
7	31	173863121	25.4	214.63
8	10	173863139	17.78	299.72
8	34	173863117	25.4	35.56
9	9	173863144	17.78	194.31
9	23	173863129	44.45	293.37
10	21	173863127	34.29	93.98
10	28	173863128	20.32	82.55
11	18	173863135	16.51	330.2
11	27	173863123	34.29	25.4
12	11	173863138	45.72	180.34
12	22	173863132	30.48	53.34
13	7	173863146	33.02	104.14
13	14	173863140	30.48	195.58
14	13	173863136	33.02	190.5
14	16	173863137	39.37	144.78
15	1	173863149	41.91	180.34
15	15	173863134	35.56	93.98
16	2	173863151	22.86	342.9
16	3	173863147	30.48	358.14
17	5	173863148	35.56	107.95
17	6	173863143	30.48	257.81
18	4	173863145	22.86	298.45
18	8	173863142	29.21	158.75
19	32	173863103	5.08	346.71
19	50	173863099	30.48	19.05
20	47	173863110	25.4	171.45
20	48	173863105	22.86	224.79
21	45	173863107	25.4	36.83
21	49	173863101	12.7	450.85
22	17	173863133	15.24	237.49
22	44	173863109	53.34	615.95
23	42	173863118	38.1	2.54
23	43	173863104	27.94	271.78
24	29	173863125	46.99	22.86
24	46	173863106	26.67	205.74
25	12	173863141	33.02	381
25	20	173863130	17.78	15.24



Figure A3.2-1. Twelve gauge THHN wire was used to create the horizontal and vertical arrays of the raft antenna system. For the horizontal array, proximity of the wire and array shape were maintained using flexible plastic tubing secured to the self-bailing holes using soft nylon cord (A). Submersion of electronic equipment was prevented by storing the equipment in top-locking plastic containers strapped to a rigid plastic deck on the bottom of the raft (B). The design of the vertical array allowed it to be stored in accordion-like fashion when not in use (C) and facilitated quick deployment in holes deeper than one meter (D).



Figure A3.2-2. The shore-deployed floating antenna array, 14.6 x 0.6 m, was constructed using eight gauge speaker wire; PVC supports placed every 1.8 m helped maintain array shape (A). Foam pipe insulation was used to float the array on the river surface and the array was controlled using floating nylon rope (B). The sling-load pack was carried by one operator and housed the 12-V marine, deep-cycle battery, reader, and tuner box (C); a second operator helped maintain array shape and guide the array over obstacles in the river (D).

CHAPTER 4

BROWN TROUT REMOVAL EFFECTS ON SHORT-TERM SURVIVAL AND MOVEMENT OF REINTRODUCED WHIRLING DISEASE-RESISTANT RAINBOW TROUT

INTRODUCTION

Following its introduction to Colorado, *Myxobolus cerebralis*, the parasite responsible for salmonid whirling disease, caused a significant decline in wild rainbow trout (*Oncorhynchus mykiss*) populations across the state. Brown trout (*Salmo trutta*), however, are more resistant to *M. cerebralis* than rainbow trout because they evolved with *M. cerebralis* in their native, European home ranges (Hoffman 1970; Hedrick et al. 1999; Hedrick et al. 2003) and therefore did not experience similar population level declines (Nehring and Thompson 2001; Nehring 2006). Consequently, brown trout population densities have increased in many of Colorado's rivers following the loss of the rainbow trout populations (Nehring and Thompson 2001). Similar brown trout population increases were observed in several drainages in Montana following rainbow trout population declines from exposure to *M. cerebralis* (Baldwin et al. 1998; Granath et al. 2007).

Competition with and predation by brown trout can cause significant declines in salmonid populations living in sympatry, including brook trout (*Salvelinus fontinalis*; Fausch and White 1981; Alexander 1977), cutthroat trout (*Oncorhynchus clarki*; Wang and White 1994), and rainbow trout populations (Gatz et al. 1987). Competition between brown trout and rainbow trout results in exclusion of rainbow trout from preferred feeding and resting habitats, possibly causing population-level effects (Gatz et al. 1987). High densities of large brown trout exert

heavy predation pressure on stocked rainbow trout fingerlings (Nehring 2006) as well as compete with sub-catchable- and catchable-sized *M. cerebralis*-resistant rainbow trout being reintroduced to Colorado waters. Brown trout switch to piscivory after reaching three years of age (> 175 mm total length [TL]; Jonsson et al. 1999), at which time energy intake and growth tend to increase markedly (Elliott and Hurley 2000). Piscivorous brown trout can significantly alter both sympatric salmonid and other prey species' population structure and dynamics. Large brown trout are known to consume considerable numbers of small trout and are a significant source of fry and fingerling mortality in sympatric salmonid populations (Alexander 1977). In addition, brown trout prey largely on other salmonid species rather than consuming juveniles of their own species, and the number consumed increases with an increase in brown trout length (Jensen et al. 2004). Jensen et al. (2006) calculated that a brown trout population (8,445 individuals > 25 cm TL) consumed about 1.5 million vendace (*Coregonus albula*) and 400,000 whitefish (*Coregonus clupeaformis*) annually, illustrating the catastrophic effects large piscivorous brown trout can have on other fish populations.

Control and eradication of brown trout are potential management options for reducing competition and predation effects and increasing the survival of other salmonid and prey fish species in rivers (Gatz et al. 1987). Considerable removal efforts may be needed to attain a desired effect on the target populations. For example, removal of 66% of the brown trout population in the Au Sable River in Michigan did not result in population or size at age increases in the target sympatric brook trout population (Shetter and Alexander 1970). Therefore, predatory brown trout numbers may need to be reduced by considerably more than 60% to attain a significant increase in survival or change in other population characteristics of the target species (Alexander 1977).

The objective of my study was to determine if brown trout removal increased the short-term survival and retention probabilities of reintroduced, *M. cerebralis*-resistant rainbow trout. I used Radio Frequency Identification (RFID) passive integrated transponder (PIT) tags and antennas to passively estimate survival and to track movements made by brown trout and rainbow trout in reaches where brown trout had or had not been removed. Additionally, survival and movement probabilities were estimated for two crosses of rainbow trout introduced to the river following brown trout removal to determine which cross is best for use in river reintroductions.

METHODS

Site Description

The Cache la Poudre River is a high-gradient freestone river that originates in Rocky Mountain National Park and flows north and east until joining the South Platte River on the eastern plains of Colorado (Sipher and Bergersen 2005). Maximum summer temperatures of the upper reaches of the Cache la Poudre River range from 5°C to 12°C annually and rarely exceed 13°C (Nehring and Thompson 2001). Rainbow trout and brown trout are the principle game fish in the Cache la Poudre River, but brook trout, native cutthroat trout, and mountain whitefish (*Prosopium williamsoni*) are also present in low numbers (Klein 1963; Allen and Bergersen 2002). Prior to the introduction of *M. cerebralis* to the Cache la Poudre River, \geq age-1 rainbow trout were found in higher than average densities (170 fish ha⁻¹) than \geq age-1 brown trout (103 fish ha⁻¹; Nehring and Thompson 2001), and were historically present in an average ratio of 60 rainbow trout to 40 brown trout (Klein 1963).

Myxobolus cerebralis was first detected in the Cache la Poudre River drainage at the Colorado Parks and Wildlife (CPW) Poudre Rearing Unit (PRU) in 1988. PRU is a large

rainbow trout production facility with six earthen ponds located on the upper reaches of the river, approximately 117.5 km west of Fort Collins (Nehring 2006). Allen and Bergersen (2002) showed that the earthen ponds at the unit supported dense populations of *Tubifex tubifex* worms, a necessary intermediate host for the parasite life cycle. Subsequent testing revealed that *T. tubifex* in the ponds produced high densities of *M. cerebralis* triactinomyxons (TAMs) that were discharged into the river (Nehring and Thompson 2001). Infection prevalence of rainbow trout held in the ponds was often as high as 100% with average myxospore counts greater than 470,000 myxospores fish⁻¹, ranging as high as 1.63 million for individual trout (Nehring and Thompson 2003). In addition to TAM releases from PRU, Schisler (2001) reported that more than one million trout from infected hatcheries and rearing units, a large majority of which originated from PRU, were stocked into the Cache la Poudre River, as well as into lakes, reservoirs, and tributaries within the Cache la Poudre River drainage between 1990 and 2001. However, Nehring (2006) suggests that despite the number of infected fish stocked in the drainage, TAM densities discharged to the river from PRU ponds alone were sufficient to cause a complete loss of rainbow trout fry downriver of the unit. Following introduction of *M. cerebralis*, severe declines were experienced by the rainbow trout population; by 1995, no \geq age-1 rainbow trout were detected in population estimates. Brown trout did not suffer significant population level declines in the river following *M. cerebralis* introduction (Nehring and Thompson 2001), and brown trout biomass compensated for the loss of rainbow trout biomass to some degree (Allen and Bergersen 2002).

Two reaches of the Cache la Poudre River were designated for this experiment, a control reach (no removal) and a removal reach (brown trout removal). The moderate-gradient, 1.3-km control reach was located just downstream of the town of Rustic, Colorado, in a section of the

Cache la Poudre Canyon known as Indian Meadows, and the higher-gradient, 1.0-km removal reach was located eight km upstream of the control reach in a narrower section of the canyon known as Black Hollow (Figure 4.1, 4.2). Both study reaches were located downstream of the CPW PRU and were part of special regulation catch-and-release sections of the river; the study sites were placed here in part to prevent angler removal of PIT-tagged fish.

All brown trout taken out of the removal reach were relocated approximately 24.1 km downstream, released below a section of the river known as the Narrows (Figure 4.1); fish were relocated rather than sacrificed to maintain public support for the experiment. The Narrows is a high-gradient, high velocity section of the Cache la Poudre River, suspected to be at least a partial barrier to upstream movement. A potential barrier to upstream movement was desired as brown trout are known to exhibit directed and rapid homing to locations from which they have been displaced (Armstrong and Herbert 1997).

***Myxobolus cerebralis*-Resistant Rainbow Trout**

The German Rainbow (GR; Hofer) is a hatchery-derived rainbow trout strain that was exposed to *M. cerebralis* for decades in a Bavarian hatchery in Germany where it was reared as a food fish for human consumption (Hedrick et al. 2003). Although the GR strain can be infected with *M. cerebralis*, parasite burdens are usually low (Hedrick et al. 2003; Schisler et al. 2006; Fetherman et al. 2012) and the GR strain can survive and reproduce in the presence of *M. cerebralis*. Low parasite burdens and the strain's ability to persist following exposure to *M. cerebralis* have been termed "resistance," and this resistance is presumed to be a result of long-term exposure to the parasite (Hedrick et al. 2003). Despite the resistance of the GR strain, its survival and viability in the wild was uncertain due to its history of domestication (Schisler et al. 2006). Therefore, the GR strain was experimentally crossed with the Colorado River Rainbow

(CRR; Schisler et al. 2006; Fetherman et al. 2011; Fetherman et al. 2012), a wild rainbow trout strain that had been widely stocked in Colorado and comprised many of the naturally reproducing wild rainbow trout fisheries prior to the introduction of *M. cerebralis* (Walker and Nehring 1995). However, the CRR strain exhibits high susceptibility to infection by *M. cerebralis* (Ryce et al. 2001; Sipher and Bergersen 2005; Schisler et al. 2006; Fetherman et al. 2012), and experienced widespread population declines following its introduction (Nehring and Thompson 2001).

Intermediate crosses of the two strains have been rigorously evaluated. Laboratory experiments showed that the first filial generational cross between the two strains (termed the H×C) exhibited resistance characteristics similar to that of the GR strain (Schisler et al. 2006; Fetherman et al. 2012), and critical swimming velocities similar to those of the CRR strain (Fetherman et al. 2011). As such, it was suggested that this cross may be the best candidate for reintroducing rainbow trout populations; however, its utility needed to be evaluated in a natural setting (Fetherman et al. 2012). The H×C has been experimentally introduced to other systems within the state (e.g., the Colorado River); however, it has exhibited low apparent survival in high density, brown trout-dominated systems. Therefore the effect of brown trout removal on the survival and retention of this cross was evaluated in this experiment. H×C fish for this experiment were spawned and reared at the CPW Glenwood Springs Hatchery, Glenwood Springs, Colorado.

The GR has also been experimentally crossed with the Harrison Lake rainbow trout strain (origin: Harrison Lake, Montana), a cross termed the H×H. The Harrison Lake strain of rainbow trout has exhibited enhanced resistance to *M. cerebralis* relative to other rainbow trout strains (Vincent 2002; Wagner et al. 2006). Resistance was suspected to be partially a result of the

common ancestry of the Harrison Lake and Wounded Man Lake strains, with both exhibiting resistance despite no previous exposure to the parasite (Wagner et al. 2006). The Harrison Lake strain has also exhibited rapid development of resistance to *M. cerebralis* in the presence of the parasite through natural selection (Miller and Vincent 2008). Although marginally resistant itself, resistance to *M. cerebralis* was increased significantly when Harrison Lake fish were crossed with GR strain fish (Schisler 2006). However, due to its history as a lake strain (Wagner et al. 2006), its survival and retention following introduction to a river was unknown, and was therefore evaluated in this experiment. H×H fish for this experiment were spawned and reared at the CPW Bellvue Fish Research Hatchery in Bellvue, Colorado.

Fish Marking Procedures

Brown trout and rainbow trout were tagged with 32 × 3.85 mm half-duplex (HDX) PIT tags, inserted posterior of the pectoral fin through the midventral body wall into the peritoneal cavity using a hypodermic needle (Prentice et al. 1990; Acolas et al. 2007); the insertion opening was not closed (e.g., with stitching or glue) following tag insertion. Four thousand rainbow trout, 2,000 of each cross, were tagged at the CPW Glenwood Springs Hatchery (H×C) and Bellvue Fish Research Hatchery (H×H) 1.5 months prior to their introduction to the Cache la Poudre River. Total length (TL; mm), weight (g), and PIT tag number were recorded for each fish. Crosses were also differentially fin clipped (H×C: adipose; H×H: adipose and right pelvic) so that cross identification would be possible during population estimates in the event of tag loss. During tagging, H×Cs and H×Hs were randomly separated into two groups of 1,000 fish each, with known tag numbers in each group, designated for introduction to either the control or removal reaches of the Cache la Poudre River.

Tagging fish 1.5 months prior to their introduction to the Cache la Poudre River provided an opportunity to monitor tag retention and mortality as a result of the tagging procedure. One month post-tagging, 100 fish from each group of 1,000 were scanned for tags using a handheld, portable PIT tag reader. Tag retention was calculated by averaging the proportion of the 100 scanned fish missing a tag, and subtracting from one. Mortality was calculated based on the number of dead fish removed from the raceway by CPW staff.

Wild brown trout and rainbow trout above, within, and below the control reach were captured using two raft-mounted electrofishing units (one fixed-boom and one throw electrode) and were PIT-tagged one week prior to the introduction of rainbow trout. Three passes, made on consecutive days, were used to capture and tag approximately equal numbers of brown trout within the 1.3-km control reach and in two 0.8-km sections above and below the control reach. All fish encountered on the first pass were PIT-tagged, measured (TL; mm) and weighed (g). On subsequent passes, untagged fish were similarly tagged, measured, and weighed. Tag number was also recorded from all previously tagged fish captured on subsequent passes. PIT-tagging fish within the control reach, as well as in the sections directly upstream and downstream of the reach, allowed us to estimate the survival and directional movement probabilities of brown trout following rainbow trout introduction.

Wild brown trout and rainbow trout located above and below the removal reach were PIT-tagged during the brown trout removal. Two passes were made through the 0.8-km sections upstream and downstream of the removal reach to collect brown trout for tagging; fish were tagged using the same methods described above and returned to the section from which they had been caught. PIT tagging brown trout above and below the removal reach allowed us to monitor movement back into the reach following the removal. In addition, a subsample of 200 brown

trout captured within the removal reach were PIT tagged prior to being relocated below the Narrows to determine if brown trout could navigate the Narrows and return to the removal reach in the months following relocation.

Statistical Analyses

To evaluate if there were differences in length or weight among the rainbow trout crosses (H×C and H×H) stocked into the control or removal reaches, I used a general linear model (GLM) as implemented in SAS ProcGLM (SAS Institute, Inc. 2010). I considered an intercept-only model, as well as models that included effects of cross only, reach only, and models with additive and interactive effects between cross and reach. Model weights and delta AICc were used to determine support for each of the models included in the model set, and parameter estimates were reported from the candidate model with the lowest AICc value (Burnham and Anderson 2002).

Brown trout and wild rainbow trout abundance was estimated above, within, and below the control reach, and above and below the removal reach to provide a baseline estimate of the wild salmonid population prior to the introduction of rainbow trout to the Cache la Poudre River. Three-pass mark-recapture population estimates for the brown trout and wild rainbow trout were obtained using the Huggins closed capture-recapture estimator in program MARK (White and Burnham 1999). The Huggins form of the closed capture-recapture estimator differs from the traditional closed capture-recapture estimator in that only two types of parameters (initial capture, p , and recapture, c , probabilities) are included in the likelihood; abundance, N , is conditioned out of the likelihood and estimated as a derived parameter using capture probability estimates (Huggins 1989). Encounter histories were constructed by denoting the pass or passes in which a fish was captured or recaptured (denoted by a '1') and the pass or passes in which a

fish was not encountered (denoted by a '0'). For example, an encounter history of '011' represents a fish that was captured and tagged on the second pass and recaptured on the third pass. Brown trout and wild rainbow trout were included as groups in the analysis. Models in which detection probability (p) and recapture probability (c) were independently estimable or equal with regards to each other (i.e., same probability of capture and recapture) were included in the model set. Group, fish length, and pass were included as covariates affecting the estimation of p and c (20 models total). Models were ranked using Akaike's Information Criterion corrected for small sample sizes (AICc; Burnham and Anderson 2002). Model averaging was used to incorporate model selection uncertainty into the parameter estimates, and unconditional standard errors (SE) were reported for the model averaged parameter estimates (Anderson 2008).

Brown Trout Removal

Brown trout removal occurred August 16-18, 2010, one week following the wild salmonid PIT tagging operations in the control reach and antenna installation in both reaches. Prior to the removal, block fences, constructed of chicken wire fencing attached to t-bar posts pounded into the riverbed, were erected across the river at the upstream and downstream ends of the removal reach to prevent fish from moving into the section during the removal. Fences were monitored continuously throughout the removal to prevent build-up of debris; fencing did not fail at any point during the removal. The removal was accomplished using 14 Smith-Root LR-24 backpack electrofishing units, four raft-mounted, fixed-boom electrofishing units, and one three electrode cat-raft; over 100 CPW biologists, researchers, and volunteers assisted with the removal. Backpack and cat-raft crews formed one continuous line across the width of the Cache la Poudre River and worked upstream from the bottom of the reach. These crews were able to make five passes total through the section over the three day removal, one pass on the first day,

and two passes on each of the subsequent days. Raft electrofishing crews made several passes through the section daily, following the thalweg of the river on each pass. Fish collected by the raft electrofishing crews were combined with the fish collected by the backpack and cat-raft crews; therefore, brown trout removal was accomplished using five removal passes.

All fish removed from the reach were measured (mm) and weighed (g) before being relocated. Brown trout captured throughout the day were kept in well oxygenated tanks on hatchery trucks. At the end of each day, fish were taken 15 miles downstream to the relocation section below the Narrows. All other species of fish encountered during the removal were returned to the river below the downstream block fence. Other species encountered included rainbow trout, mountain whitefish, longnose sucker (*Catostomus catostomus*), and white sucker (*Catostomus comersonii*).

Statistical Analyses

Five pass removal population estimates for the number of brown trout and wild rainbow trout present in the removal reach prior to removal were obtained using a Huggins closed-capture recapture estimator in program MARK. Although both p and c are included in the likelihood, c was fixed to zero since individuals removed on any given pass were not available for recapture (Hense et al. 2010; Saunders et al. 2011). Encounter histories were constructed by denoting the pass in which a fish was removed from the reach by a '1' and all other passes by a '0' (e.g., an encounter history of '00100' represents a fish that was removed on the third pass). Group was used as a categorical covariate, and four groups were included in the analysis: 1) adult brown trout (> 150 mm), 2) fry and juvenile brown trout (≤ 150 mm), 3) adult rainbow trout (> 150 mm), and 4) fry and juvenile rainbow trout (≤ 150 mm). Models in which p was constant or varied by group, pass, fish length (continuous, individual covariate), and all additive

combinations were included in the set (eight models). Models were ranked using AICc; model averaging was used to incorporate model selection uncertainty into the parameter estimates, and unconditional standard errors (SE) were reported for the model averaged parameter estimates.

Rainbow Trout Introduction

Rainbow trout were introduced to the control and removal reaches the day following brown trout removal. In the removal reach, block fences remained in place until after the rainbow trout were introduced. The removal reach runs parallel and adjacent to Highway 14, allowing easy access for stocking. Rainbow trout were stocked in this section at three locations, one about a third of a mile downstream of the upper end of the reach, one in the middle of the reach, and one at the lower end of the reach. In each of these locations, fish were evenly distributed throughout the reach using buckets. Block fences were removed immediately following rainbow trout introduction.

The control reach at Indian Meadows is located about 0.5 km from Highway 14 and can only be accessed by foot. Therefore, rainbow trout were exchanged from the hatchery truck into coolers containing a mix of hatchery and river water, and loaded onto rafts about 0.5 miles above the upstream end of the reach. Rafts were used to transport the rainbow trout down to the control reach. Stocking commenced upon entering the control reach, and rainbow trout were evenly distributed throughout the reach.

RFID PIT Tag Antennas

The use of PIT tag technology has increased in fisheries within the past decade as a result of easy application, high retention, infinite life, and minimal effects on growth and survival (Gries and Letcher 2002; Zydlewski et al. 2006). In addition, stationary antennas have been used in conjunction with PIT tagging to study fish behavior, specifically habitat selection and

migration processes (Nunnallee et al. 1998; Zydlewski et al. 2006; Bond et al. 2007; Compton et al. 2008; Connolly et al. 2008; Aymes and Rives 2009). In my study, RFID HDX PIT tag antennas were deployed prior to brown trout removal to detect movements of PIT-tagged brown trout and rainbow trout in the Cache la Poudre River. Pass-over antenna loops were constructed of eight-gauge, multi-strand copper speaker wire and were anchored to the bottom of the river using duckbill anchors jack-hammered into the substrate. The speaker wire was connected to a tuner box, used to tune the antenna for optimal detection distance, and tuner boxes were connected to a reader using twin-ax cable. In addition, antenna loops were paired at both the upstream and downstream ends of the control (upper and lower control, respectively) and removal (upper and lower removal, respectively) reaches to determine directionality of movement (Figure 4.2). Paired antennas at each location were run off a multiplexer reader to prevent proximity detection errors (Aymes and Rivas 2009). Readers were powered by two 12-volt marine, deep cycle batteries (120 Ah) connected in parallel. Solar panel arrays were used to charge the batteries, increasing battery life and preventing more frequent battery changes, especially during the winter months.

Antennas spanned the width of the river, ranging from 60 to 80.5 feet in length, and averaging 3 feet in width. Optimal antenna placement in the river was chosen based on hatchery detection experiments that showed that antenna detection was greater than 0.89 when fish passed over the array within two vertical feet of the antenna coil and when velocity did not exceed 0.50 m sec^{-1} (Appendix 4.1). Antennas were placed at the tail end of pools that satisfied these conditions; average depth at the antennas during the highest discharge period (September 3-9, 2010) did not exceed 1.37 ft. In addition, antennas were placed such that velocity refuges were not contained within or between the antenna loops to reduce the possibility of multiple tags being

present within the detection field, resulting in no tags being detected (tag collision; Axel et al. 2005; O'Donnell et al. 2010).

Antennas were run continuously from August 15, 2010 to April 14, 2011. Antenna efficiency (Zydlewski et al. 2006) was monitored on a weekly basis during the primary study period (August 15 – November 3, 2010) and on a monthly basis during the winter study period (November 4, 2010 – April 14, 2011; Table 4.1), and was assessed using the stick test methods of Nunnallee et al. (1998) and Compton et al. (2008; Appendix 4.2). Continuous operation of the antenna system was monitored using marker tags, and weekly efficiencies (i.e., the probability that a tag is detected at both antennas within an array) were adjusted based on the proportion of the week an antenna system was operational (Table 4.1). Adjusted efficiencies were used to fix weekly detection probability, p , for each antenna system within the multistate capture-recapture analyses (below). Velocity measurements were also collected on a weekly basis during the primary study period; discharge (cms) was calculated from these velocity estimates and included as a variable affecting transition probability in the primary study period multistate capture-recapture analyses. Velocity measurements were not collected over the winter study period due to ice formation.

Multistate Capture-Recapture Models

Multistate capture-recapture models (Hestbeck et al. 1991; Brownie et al. 1993; Lebreton and Pradel 2002) provide a useful approach to interpreting highly structured tagging data collected during complex studies of fish movement and migration patterns (Buchanan and Skalski 2010; Horton et al. 2011; Frank et al. 2012). These models allow estimation of apparent survival probabilities (ϕ), detection probability (p), and transition probabilities (ψ ; Lebreton and Pradel 2002) between and among states. States can be defined in variety of ways including

spatial or geographical location and physiological status (Buchanan and Skalski 2010). In my study, states were defined by spatial location (control and removal reach) and transition location (representing directional movement past an antenna station). Primary assumptions of multistate models include that 1) marks are not lost, 2) individuals act independently, and 3) all marked individuals assigned to a state have the same probabilities of survival, movement, and capture (Hestbeck 1995).

In a traditional multistate model, apparent survival is conditional on the departure state, and movement is conditional on survival (Lebreton and Pradel 2002); therefore, apparent survival in the departure state is estimated first, and movement between the departure state and a new state is estimated second. Because I did not physically capture or recapture individual fish, with the exception of when they were tagged at the outset of the study, I used antenna detections as recaptures when estimating the parameters of the multistate capture-recapture models (O'Donnell et al. 2010). Using the paired antenna array, fish were recaptured at the stationary antenna stations as they were moving between states. I assumed that if a tag was detected at an antenna station, the tag was 1) in a live fish, and 2) in the original fish that had been given that tag. Therefore, survival prior to the movement was known (1.0) and survival following movement was unknown. A paired record was included in the encounter history for each week, with the first value in the pair representing observed movement (transition state letter or '0' for fish that did not move). The second value used was a dummy variable (always '0') that allowed me to reverse the usual order of events in the model, and estimate movement (transitions, ψ) before apparent survival (ϕ ; Figure 4.3).

Encounter histories were developed for each tagged individual. Each encounter history began with a release state (Figure 4.3). For instance, rainbow trout were either released into the

removal reach (release state R) or into the control reach (state C; Figure 4.4). Brown trout had five release states depending on their location at tagging (Figure 4.5). Release states appeared only once in the encounter history because fish were not detectable by the antennas within the release area (i.e., $p = 0$ for the release state). The remainder of the encounter history consisted of transition states when fish were detected moving over an antenna station (Figure 4.4, 4.5, 4.6). Unique states were used to represent both the direction of movement and antenna location at which movement occurred (Figure 4.3). Known movement occurred if two conditions were met: 1) the fish was detected by both antennas within the array (i.e., directionality of movement was *known*), and 2) there was no return movement within the same week (i.e., a fish did not begin and end the week in the same location). Lack of movement was indicated by including a '0' in the encounter history. For example, the three week encounter history CA000B0 represents a rainbow trout that was initially released in the control reach (state C; Figure 4.3). In the first week, the fish moved downstream out of the control reach and was detected at both antennas of the lower control antenna array (state A; Figure 4.3, 4.4). The zero following the A is the dummy variable described above. The fish was not detected in week two of the study, so both paired entries for week two were '0' (Figure 4.3). In week three, the fish made an upstream movement returning to the control section and was detected by both antennas at the lower array (state B; Figure 4.3, 4.4). Encounter histories were constructed in this way using the detection data from the antennas for every PIT-tagged brown trout and rainbow trout in the Cache la Poudre River.

Multistate models were constructed to estimate apparent survival (ϕ) and movement (ψ) probabilities for brown trout and rainbow trout (H×C and H×H) in both the control and removal reaches; weekly estimates of ϕ and ψ were obtained during both the primary (11 weeks; August

15 – November 3, 2010) and winter (23 weeks; November 4, 2010 – April 14, 2011) study periods. The primary study period was used to determine the short-term retention and survival of rainbow trout within the two reaches following introduction and brown trout removal. In addition, the primary study period was used to determine how quickly brown trout moved back into the removal reach and if the addition of rainbow trout resulted in movement out of the control reach by resident brown trout. Three model sets were used to separately estimate apparent survival and movement, one each for the brown trout, H×Cs, and H×Hs during the primary study period; although desired, model set size and parameter number limited the ability to include both crosses as groups in a single rainbow trout analysis. The brown trout model set included 13 states, five release states and eight additional states representing upstream and downstream movement (Figure 4.5), whereas the rainbow trout model sets included 10 states, two release states and eight movement states (Figure 4.4). Brown trout were tagged and released upstream (state L), within (state C), and downstream (state K) of the control reach, and upstream (state O) and downstream (state M) of the removal reach. Rainbow trout (H×C and H×H) were introduced within both the control (state C) and removal (state R) reaches. The eight movement states remained the same among the model sets, with each representing directional movement obtained via detections at each antenna location (Figures 4.4, 4.5).

I estimated movement between all species-specific states for each weekly time interval; however, because of the distance between the two study reaches, there was very little movement between the reaches (only 4 brown trout and 2 rainbow trout were observed making movements between the two reaches during the primary study period). Therefore, all movements (transitions; ψ 's) between the two reaches (e.g., movement from state C to state G) were fixed to zero to reduce the number of parameters to estimate; all other movements were considered

estimable (Table 4.2). In all three model sets, detection probability (p) for each release state was fixed to zero because individuals were never recaptured within a release state. Detection probabilities for each movement state was fixed to the adjusted efficiencies measured weekly at each antenna array (Table 4.1).

Movement past an antenna array was required for the estimation of transition probability (ψ). Therefore, initial transitions (ψ 's) represented the first movement made by tagged fish from their initial release sites (states). Initial movement probabilities for rainbow trout were compared between removal and control reaches and among the two genetic strains. I expected that rainbow trout released into the removal reach may exhibit lower movement out of the study reach compared to the control. I also expected the H×H individuals may be more likely to move than H×C individuals. Likewise, I compared initial brown trout movement probabilities among sections to determine if movement into the removal reach was higher than into the control reach, representing a desire to fill open habitat despite the presence of the stocked rainbow trout population. Subsequent movement probabilities are estimated for fish that moved out of their original release state (Table 4.2). This allowed me to differentiate initial movements of fish that may be elevated as a result of capture, marking, and introduction, from subsequent weekly movement probabilities of fish into or out of the study reaches after the fish had acclimated.

Brown trout, H×C, and H×H model sets included models in which apparent survival (ϕ) was constant, varied by section (above, within, or below the control and removal reaches; six survival parameters), and varied by fish length or fish weight (included as individual covariates). Fish length was included to test whether apparent survival was size specific, potentially a result of competition. Fish weight was included to test whether apparent survival was affected by the PIT tag in relation to fish size. All additive combinations of apparent survival covariates were

included in the model set, except length and weight were never included in the same model because they were correlated. Models also included variation in movement probability (ψ) structures. Specifically, I considered models in which the probability of movement was: constant over time and states, varied by state (estimable transitions only; Table 4.2), varied with discharge (categorical covariate), varied with fish length, or varied within the first two weeks (FTW). Fish length was included to test whether the probability of movement was size specific, again addressing the idea of competition among size classes. The FTW variable was used to examine whether the probability of movement was higher during the first two weeks because I thought that the stocking of rainbow trout into a novel environment might influence movement patterns. The brown trout model set also included models with an interaction between state and spawn because the study occurred during the brown trout spawning season and I wanted to test whether brown trout movement probabilities varied during the pre-spawn (August 15 – September 3) versus spawning period (September 24 – November 3). Similar to survival, all additive combinations of movement probability covariates were included in the brown trout, H×C, and H×H model sets.

I conducted similar analyses to estimate weekly apparent survival and movement probabilities over the winter. The winter study period was used to determine the survival and retention of rainbow trout and brown trout within the two study reaches over the winter months, specifically during periods with ice cover and no ice cover as competition for resources under the ice was expected to cause higher movement and lower survival during periods of ice cover. Three model sets were used to estimate apparent survival and movement for brown trout, H×C, and H×H over the winter study period. The model sets included 14 states, six starting states, and the same eight movement states included in the primary study period model sets (Figure 4.6).

Starting states for the winter study period, lettered similar to the release states from the brown trout and rainbow trout primary study period model sets, were defined as the last known location of an individual upon conclusion of the primary study period. Like the primary study period models, only certain transitions were considered estimable (Table 4.2). The number of estimable transitions was reduced from those of the primary study period because movement generally occurred on a smaller scale. In all three model sets, detection probability (p) for the starting states was fixed to zero; p for the movement states was fixed to the adjusted efficiencies (Table 4.1).

Apparent survival (ϕ) in all three model sets was either constant or varied by section. Length and weight were not included as covariates in the winter model sets because size was unknown during this time period. Movement probabilities (ψ) were either constant, varied by state only (Table 4.2), varied by ice cover only, or varied by the additive and interactive effects between state and ice cover. Ice cover consisted of three separately estimated time periods, a pre-ice period (November 4 – December 16, 2010), an ice cover period (December 17, 2010 – March 17, 2011), and a post-ice period (March 18 – April 14, 2011), and was included to determine variability in ψ during periods where ice cover was present (ice cover period) or absent (pre-ice and post-ice periods).

I fit all models to the data using program MARK (White and Burnham 1999) and used model selection procedures to determine relative support for each candidate model (Burnham and Anderson 2002). I report the difference in AICc values (ΔAICc) and model weights for supported models (Burnham and Anderson 2002). Model averaged estimates and unconditional 95% confidence intervals were used to incorporate model selection uncertainty in the parameter estimates of apparent survival and movement.

RESULTS

Fish Marking

Model selection results for differences in average total length (TL) of the stocked rainbow trout indicated that the model that included an interaction between cross and reach was most supported by the data (AICc weight = 0.99; Table 4.3). H×Cs stocked in both reaches were longer than the stocked H×Hs, but the difference was slightly larger in the control reach (H×C average TL (\pm SE) = 199.5 (\pm 0.8) mm; H×H average TL = 156.9 (\pm 0.8) mm) compared to the removal reach (H×C average TL (\pm SE) = 195.6 (\pm 0.8) mm; H×H average TL = 157.7 (\pm 0.5) mm). Similarly, model selection results for differences in average weight of the stocked rainbow trout indicated that the model that included an interaction between cross and reach was most supported by the data (AICc weight = 0.99; Table 4.3). Again, H×Cs stocked in both reaches were heavier than the stocked H×Hs, but the differences were slightly larger in the control reach (H×C average weight (\pm SE) = 92.8 (\pm 1.0) g; H×H average weight = 41.2 (\pm 1.0) g) compared to the removal reach (H×C average weight = 86.8 (\pm 1.0) g; H×H average weight = 40.3 (\pm 0.7) g). Differences in total length and weight within a cross was considered biologically negligible, suggesting that apparent survival and movement differences between the reaches within a cross were not due to differences in fish size.

Tagging mortality was estimated to be 2.95% (59 mortalities) for the H×C and 0.55% (11 mortalities) for the H×H. The 32 × 3.85 mm PIT tags weighed 0.8 g (0.9% and 2.0% of the average H×C and H×H weight, respectively) and it is unlikely that mortality was associated with PIT tag weight (Zale et al. 2005). Based on scanning 100 fish from each group of 1,000, estimated tag retention was 98.5% for the H×C and 99% for the H×H and was similar to that

observed in other studies (Roussel et al. 2000; Zydlewski et al. 2001; Compton et al. 2008). Therefore, differences in apparent survival and movement were not due to differential tag loss.

A total of 676 brown trout were PIT-tagged throughout the control reach, 222 upstream of the reach, 270 within the reach, and 184 downstream of the reach. Model-averaged abundance estimates (\pm SE) indicated that 1,028 (\pm 387) brown trout were present upstream of the reach, and 1,354 (\pm 784) brown trout were present downstream of the reach; therefore, approximately 21% and 13% of the brown trout population was tagged in these two sections, respectively. Within the control reach, model-averaged abundance estimates (\pm SE) indicated that 1,679 (\pm 451) brown trout were present; therefore approximately 16% of the brown trout population was tagged within the reach. Average length (\pm SD) of the brown trout tagged throughout the control reach was 275 (\pm 9) mm and average weight was 221 (\pm 17) g. Model-averaged abundance estimates (\pm SE) of wild rainbow trout upstream of, within, and downstream of the control reach indicated that there were 38 (\pm 25), 59 (\pm 42), and 20 (\pm 19) fish section⁻¹, respectively.

One hundred eighty two brown trout were PIT-tagged upstream of the removal reach, and 216 brown trout were PIT-tagged downstream of the reach. Average length (\pm SD) of the brown trout PIT-tagged around the removal reach was 270 (\pm 17) mm and average weight was 203 (\pm 30) g. Average length (\pm SD) of the 200 brown trout taken out of the removal reach, PIT-tagged, and relocated below the Narrows was 276 (\pm 47) mm and average weight was 217 (\pm 90) g.

Brown Trout Removal

A total of 1,399 brown trout were removed from the removal reach, 726 on the first day, 429 on the second day, and 263 on the third day. Model-averaged removal estimates indicated that 1,975 (1,184-2,765; 95% CI) brown trout were present in the reach prior to the removal;

therefore, 71% of the brown trout population was removed. Seven hundred and forty-four of the estimated (\pm SE) 834 (\pm 49) adult brown trout were removed, equating to about 89% of the adult population. In contrast, 655 of the estimated (\pm SE) 1,141 (\pm 354) fry and juvenile brown trout were removed, equating 57% of the fry or juvenile population. Fewer rainbow trout were estimated to be present in the removal reach, with an estimated 26 (\pm 2) adult rainbow trout and 4 (\pm 2) fry or juvenile rainbow trout present in the reach prior to the removal.

Detection probability during the removal was most affected by fish length and pass (Table 4.4). Group (species/size class) had less of an effect on detection probability, included only in the second best model of the set (Δ AICc = 4.88, AICc weight = 0.08). For all fish, estimates of detection probability were higher during the first passes compared to the subsequent passes (Figure 4.7).

Apparent Survival and Movement

Antenna Performance

Average antenna efficiency (i.e., the probability of detection by both antennas within an array) was 0.90 for the lower control antenna station, 0.54 for the upper control antenna station, 0.88 for the lower removal antenna station, and 0.86 for the upper removal antenna station during the primary study period; antenna efficiencies during the primary study period were similar to those reported in other studies (Zydlewski et al. 2006; Compton et al. 2008). All antenna stations were functioning 100% of the time during the primary study period. Antenna efficiencies were higher during the winter study period, with an average antenna efficiency of 0.99 for the lower control antenna station, 0.74 for the upper control antenna station, 0.93 for the lower removal antenna station, and 0.98 for the upper removal antenna station; antenna efficiencies during the winter study period were similar to those reported in other studies

(Nunnallee et al. 1998; Connelly et al. 2008). The percentage of time during which the antennas were functioning properly was lower during the winter study period, ranging from 84% for the upper control station to 94% for the lower removal antenna station (Table 4.1).

Apparent Survival

Rainbow trout apparent survival during the primary study period was affected by section (above, within, or below the control or removal reaches), fish length, and to a lesser extent, fish weight (Table 4.5). Apparent survival for both rainbow trout crosses was most affected by section, which appeared in all supported models within the H×C and H×H model sets. Fish length and fish weight had less of an effect on apparent survival for both crosses, appearing in fewer supported models than section; total length affected survival more in the H×Cs than the H×Hs, appearing in the top model of the H×C model set. Estimates for the effect of length and weight on apparent survival were both positive (taken from the top model in which they appeared), but these estimates suggested a weak relationship, and the associated 95% confidence intervals overlapped zero (H×C: $\hat{\beta}_{length} = 0.003$ [-0.0009, 0.007] and $\hat{\beta}_{weight} = 0.001$ [-0.002, 0.004]; H×H: $\hat{\beta}_{length} = 0.004$ [-0.002, 0.011] and $\hat{\beta}_{weight} = 0.005$ [-0.003, 0.013]).

The H×C did not exhibit differences in apparent survival between fish within the control and removal reaches during the primary study period (Figure 4.8A). For the H×H, apparent survival was higher for fish in the control reach than in the removal reach (Figure 4.8B). Comparing longitudinally for both rainbow trout crosses, apparent survival was higher within the control and removal reaches than in the 0.8-km sections above or below the reaches; however, estimates of apparent survival in the sections above and below the study reaches likely reflect permanent emigration from the study areas, which cannot be differentiated from survival in my

study. Survival did not differ in the sections above or below the reaches for either cross (Figure 4.8).

Apparent survival probabilities of brown trout during the primary study period were affected by section, fish length, and fish weight, all of which appeared in the top models (Table 4.6). Survival was most affected by section, appearing in all six of the top models within the set; but fish length and fish weight also had some influence on apparent survival probabilities. Estimates of the effect size and associated 95% CIs from the top models including length or weight suggested a positive, but small relationship between fish length or weight on apparent survival ($\hat{\beta}_{length} = 0.002$ [0.0004, 0.005] and $\hat{\beta}_{weight} = 0.001$ [0.0003, 0.002]).

Comparing removal and control reaches, brown trout survival was lower for fish within the removal reach than fish within the control reach during the primary study period (Figure 4.9). Apparent survival probabilities for brown trout in the 0.8-km sections above the removal and control reaches were lower than those in the sections below the two study reaches. Comparing longitudinally in the removal reach, survival of fish within the reach did not differ from that of fish upstream; however, survival of fish downstream was higher than those of fish either within or upstream of the reach. Comparing longitudinally in the control reach, survival of fish within the reach did not differ from that of fish downstream, although survival of fish upstream was lower than that of fish within or downstream of the reach (Figure 4.9).

Winter weekly apparent survival probabilities of both the H×C and H×H fish were affected by section (Table 4.7). During the winter study period, model-averaged H×C apparent survival did not differ among fish within the control or removal reaches; however, the H×H fish exhibited lower apparent survival in the control reach than within the removal reach (Figure 4.10). Comparing longitudinally, apparent survival of H×C fish did not differ among fish within

the control reach compared to those in the 0.8-km sections above or below the reach (Figure 4.10A). For the H×H fish, apparent survival was extremely low for fish in the 0.8-km section downstream of the control reach, suggesting that fish in this section were seen only once prior to permanently emigrating from the study area; apparent survival probabilities increased for fish within the control reach and in the 0.8-km section above the reach (Figure 4.10B). Apparent survival probabilities of H×C fish and H×H fish within the removal reach did not differ from those of H×C and H×H fish in the 0.8-km section upstream of the reach; however, both were higher than those of H×C and H×H fish in the 0.8-km section downstream of the reach (Figure 4.10).

Brown trout exhibited differences in apparent survival among sections during the winter study period (Table 4.8). Brown trout survival did not differ for fish within the control and removal reaches during the winter study period (Figure 4.11). Comparing longitudinally, model-averaged apparent survival probabilities for fish within the removal reach did not differ from that of fish in the 0.8-km section upstream of the reach; however, survival of fish in the 0.8-km section downstream of the reach was lower than that of fish within or upstream of the reach. Apparent survival did not differ between fish within the control reach compared to fish in the 0.8-km sections upstream or downstream of the reach (Figure 4.11).

Movement

Movement probabilities for both the H×C and H×H during the primary study period were most affected by state (estimable transitions) and discharge, both of which appeared in the top models for both crosses (Table 4.5). Model selection results also suggested that movement probabilities were lower in the first two weeks of the study period compared to subsequent weeks (H×C: $\hat{\beta}_{treatment} = -0.40$ [-0.46, -0.35]; H×H: $\hat{\beta}_{treatment} = -0.54$ [-0.76, -0.33]). Fish

length had less of an effect on movement probabilities in both crosses, though length did appear in the top model for both crosses; estimates of the effect size suggest that there was a positive, but small relationship between length and movement probabilities in the H×H ($\hat{\beta}_{length} = 0.009$ [0.001, 0.016]), and a negative, but small relationship between length and movement probabilities in the H×C ($\hat{\beta}_{length} = -0.007$ [-0.008, -0.007]). Weekly model-averaged movement out of the control and removal reaches was similar for the H×C (Figure 4.12A); however, weekly movement out of the control reach was higher than out of the removal reach for the H×H (Figure 4.12B). For both crosses, movement was lower for the weeks in which discharge was high (> 1.98 cms; 8/19-9/23); movement did not differ among weeks during which discharge was low (< 1.98 cms; 9/24-11/4). Patterns from secondary movements suggest that movement back into both the control and removal reaches was higher than movement out of the reaches for both the H×C and H×H on a weekly basis. Average net secondary movement (difference in the average of secondary movements into and out of a reach \pm SE) into the removal reach was higher than into the control reach for both the H×C and H×H (H×C: control = 0.67 ± 0.09 and removal = 0.92 ± 0.02 ; H×H: control = 0.51 ± 0.30 and removal = 0.95 ± 0.01), suggesting that both crosses were more likely to return to the reach in which brown trout were absent following initial movement out of the reaches.

Rainbow trout estimates of movement during the winter study period were extremely low and highly variable. Initial movement estimates for both crosses were low (< 0.015) and showed little difference among the pre-ice, ice, and post-ice periods for either cross. As a result of low initial movement, the effects of secondary movements are not applicable for either cross.

Movement probabilities for brown trout during the primary study period were most affected by discharge (CMS), differences in the first two weeks (FTW), and the interaction

between state and spawn, all of which appeared in the top models of the set (Table 4.4). Brown trout moved into both the control and removal reaches during the primary study period. Movement into the removal reach was slightly higher than into the control reach, especially during the first and third weeks of the study. Discharge negatively affected movement ($\hat{\beta}_{CFS} = 0.0278 [0.0276, 0.0279]$), with more movement occurring during low rather than high discharge periods. Movement probabilities for all states (estimable transitions) were also higher during the brown trout spawning period than the pre-spawning period (Figure 4.13). Directional movements were similar in both the control and removal reach. Additionally, directionality of movement into or out of the control or removal reaches was similar for secondary movements, suggesting that brown trout were in a state of equilibrium in both reaches after initial movement past the antenna stations.

Movement probabilities for brown trout during the winter study period were most affected by state (estimable transitions), with ice cover having a smaller effect; there was no evidence of a state by ice cover interaction (Table 4.8). Within the control reach, movement was lowest during the pre-ice period (Figure 4.14). Movement was higher during the ice cover and post-ice periods in the control reach; however, there was no difference in directionality of movement (in or out of the reach) during these three periods in the control reach. Within the removal reach, movement during the ice cover period was higher than during the pre-ice period; no differences in directionality of movement were evident for these two periods. In the post-ice period, movement into the removal reach was similar to that which occurred during the ice cover period, and was higher than the movement out of the reach. There was no difference in model-averaged movement between the control and removal reaches during the pre-ice, ice, or post-ice periods (Figure 4.14). Directionality of movement into or out of the control or removal reaches

did not differ for secondary movements made during the pre-ice, ice, or post-ice periods, suggesting that brown trout were in a state of equilibrium in both reaches after initial movement past an antenna station. Brown trout movement was higher than rainbow trout movement during the ice and post-ice periods.

Seven of the 200 brown trout relocated from the removal reach to below the Narrows were observed entering the control reach (a 16.1-km upstream movement; Table 4.9). Upstream movement from the relocation section occurred relatively quickly for two of these fish, entering the control reach only two and ten days after being relocated, and slower for others, entering the control reach 2.5 months after being relocated. Six of the seven fish remained in or around the control reach. Only one brown trout successfully returned to the removal reach, with return to the reach occurring 2.5 months after being relocated (Table 4.9).

DISCUSSION

Recovery of wild rainbow trout populations in Colorado is dependent on the development of rainbow trout that are resistant to *Myxobolus cerebralis*, and the ability of these fish to survive and reproduce in the presence of abundant brown trout populations. Through an intensive selective breeding program and subsequent laboratory experiments, crosses of rainbow trout have been developed that both exhibit resistance to *M. cerebralis* (Schisler et al. 2006; Fetherman et al. 2012) and may have the wild characteristics necessary to produce self-sustaining rainbow trout populations in Colorado's rivers (Fetherman et al. 2011). However, evaluations of these populations following introduction suggested that apparent survival for the reintroduced populations was low (Chapter 2) and it was suspected that low survival might be due to abundant brown trout populations (Nehring and Thompson 2001). My primary goal was to evaluate whether the removal of brown trout would increase the retention and survival of

reintroduced, *M. cerebralis*-resistant rainbow trout. Overall, brown trout removal did not appear to affect H×C apparent survival, and H×H apparent survival was initially lower in the removal section than the control section. These observations suggest that brown trout removal may not be necessary for increasing initial survival of stocked rainbow trout.

Analogous to the establishment of an invasive species, reintroduced rainbow trout are subject to the three basic phases of the invasion process: arrival or introduction, establishment, and integration (Vermeij 1996). Introduction in this case was facilitated by the stocking of rainbow trout into locations from which they had been eliminated by whirling disease, and introduction success was partially dependent upon the characteristics of the rainbow trout (Townsend 1996). For example, the H×C was developed using the Colorado River Rainbow trout strain, a wild rainbow trout strain that had been widely stocked in Colorado and comprised many of the naturally reproducing wild rainbow trout fisheries prior to the introduction of *M. cerebralis* (Walker and Nehring 1995).

Brown trout presence or absence did not have a large effect on the H×C in the Cache la Poudre River and H×C movement and survival were similar in reaches in which brown trout were present or absent. In addition, survival probabilities were similar between the control and removal reaches during the winter study period. The lack of effects on H×C survival and movement due to brown trout removal is consistent with historic observations regarding the wild parental CRR background of the H×C. Historical ratios of rainbow trout to brown trout in the Cache la Poudre River (60:40; Klein 1963) suggest that the CRR strain was able to survive and reproduce in the wild despite the presence of brown trout. Overall, brown trout removal did not appear to influence survival or movement of H×C, suggesting that, like the parental CRR strain, the H×C was well suited for river reintroductions.

The H×H exhibited similar responses to brown trout removal as the H×C but may have shown greater preference for areas in which brown trout had been removed. For example, initial movements out of the control reach were higher compared to the reach where brown trout had been removed. In addition, secondary movement by H×H fish back into the removal reach was higher than that of H×H fish into the control section, suggesting that H×H fish were more likely to return to the reach where brown trout abundance was lower. Although there was evidence of movement back into the removal reach by brown trout, survival by the H×H within the removal reach was higher during the winter study period, presumably because of the lower brown trout abundance within the reach due to the removal. Taken together, these results suggest that brown trout removal had a positive effect on retention of reintroduced H×H populations; however retention rates were higher than expected in both experimental reaches, regardless of removal status. Higher retention occurred despite the Harrison Lake rainbow trout's reputation as a lake strain (Wagner et al. 2006) and low apparent survivals in other river stockings in Colorado. Since the H×H exhibits lower mortality and myxospore development following exposure to *M. cerebralis* compared to other rainbow trout strains (Fetherman and Schisler 2012; Wagner et al. 2012) it may warrant further consideration in river reintroductions, particularly because the H×H and H×C performed similarly in regards to both survival and retention within the removal reach.

Successful introduction and establishment of a species is also dependent upon the characteristics of the receiving community (Townsend 1996). Newly arriving or introduced species may experience ecological resistance (Elton 1958), consisting of three interacting elements, environmental, biotic, and demographic resistance (Moyle and Light 1996; Vermeij 1996). Reduction of biotic resistance through brown trout removal was the primary focus of this study. The increase in brown trout densities following the introduction of *M. cerebralis*

(Baldwin et al. 1998; Nehring and Thompson 2001) suggests that brown trout may have expanded to fill the biological niche vacated by the lost rainbow trout (Baldwin et al. 1998). The introduction of rainbow trout to rivers in which these populations are established could result in changes in the frequency of competitive interactions, levels of food availability, or a functional response to predators, and influence the growth and survival of the wild fish (Einum and Fleming 2001). The addition of large numbers of fish into limited habitat also inevitably affects population density (Einum and Fleming 2001), affecting any density-dependent characteristics of the environment or the fish themselves (Elliot 1989). Although we did not observe low brown trout survival rates in the control section following rainbow trout stocking, this effect could account for the lower survival rates for brown trout returning to the removal reach during the primary study period, where the competitive interactions likely changed due to rainbow trout establishment in the absence of brown trout.

Competitive interactions in the control reach likely favored the better established and relatively undisturbed brown trout population. Rainbow trout exhibit niche shifts away from preferred brown trout habitat when the two species occur in sympatry, and as a result, rainbow trout are forced into areas with deficiencies such as higher water velocities, greater distance from cover, or lower food availability (Gatz et al. 1987). As such, it was expected that the rainbow trout would have a harder time competing with the expanded brown trout populations in the control reach, and this competition is one likely explanation for the higher movement rates observed in the control reach for the H×H.

The timing of the removal and the behavior of the brown trout population itself may have also increased the biotic resistance of the system to rainbow trout establishment, especially during the primary study period. Brown trout typically occupy the same core area and exhibit

little movement except during the spawning season (Solomon and Templeton 1976; Burrell et al. 2000), during which time they exhibit increased activity and extensive movements associated with spawning (Burrell et al. 2000; Bettinger and Bettoli 2004; James et al. 2007). We observed an increase in movement into both the control and removal sections during periods of low discharge and during the brown trout spawning period, and this was associated with higher rates of movement out of the sections by both strains of rainbow trout. In addition, brown trout have been shown to return to their home ranges following artificial displacement (Halvorsen and Stabell 1990). Although only one tagged brown trout returned to the removal section, while six others arrived in the control section, these movements suggest that untagged relocated brown trout also moved back to both of the reaches, potentially further increasing the competitive interactions between brown trout and rainbow trout in these reaches. As a result, the brown trout removal did not appear to change survival or movement rates to the extent we expected.

Mechanical removals of piscivorous fish species have been used to promote the survival of target species in other systems across the United States with varying degrees of success. In West Long Lake, Nebraska, a three year removal of northern pike was successful in altering the size structure of the yellow perch (*Perca flavescens*) and increasing the relative abundance and size structure of the bluegill (*Lepomis macrochirus*; Jolley et al. 2008). The relative abundance of six native littoral species increased within two years as a result of a six-year smallmouth bass (*Micropterus dolomieu*) removal in Little Moose Lake in the Adirondacks (Weidel et al. 2007). Additionally, repeated yearly removals in the Colorado River have resulted in declines in large non-native predators (McAda 1997; Brooks et al. 2000; Modde and Fuller 2002). These studies suggest that mechanical removal can be utilized to obtain desired changes in predator and prey dynamics in wild systems.

Several factors must be considered when determining whether mechanical removal is necessary and has the potential to be successful. The first consideration is whether the removal is necessary for the reintroduction and establishment of the target species. In my case, the data suggest that brown trout removal did not dramatically effect apparent survival or emigration from the study site. The long-term goal of the resistant rainbow trout reintroduction program is to produce and maintain self-sustaining whirling disease resistant rainbow trout populations in Colorado waters in which there is a high prevalence of *M. cerebralis* infection (Schisler et al. 2006; Fetherman et al. 2011; Fetherman et al. 2012). Models examining the interactions between rainbow trout introduction size (propagule pressure [Townsend 1996]; demographic resistance [Moyle and Light 1996]), environmentally stochastic *M. cerebralis* exposure rates, and brown trout population size (biotic resistance; Moyle and Light 1996) suggest that a single introduction of rainbow trout will not result in a self-sustaining rainbow trout population in rivers like the Cache la Poudre River (Appendix 4.3). Therefore, multiple reintroductions, with or without brown trout removal, will likely be needed to overcome ecological resistance factors and to see long-term positive effects of brown trout removal in Colorado's rivers.

The second consideration is whether the removal will be successful after one removal effort, or if multiple removal efforts are needed to overcome biotic resistance and see an effect. For example, a single removal of 66% of the brown trout population in the Au Sable River in Michigan did not result in population or size at age increases in the sympatric brook trout population (Shetter and Alexander 1970). Movement probabilities of brown trout moving back into the removal section in my study suggest that brown trout returned to the removal section fairly quickly. Therefore, the observed benefits of the removal on the short term may not

necessarily translate to a continued positive response in reintroduced rainbow trout populations over the long term.

Exposure to *M. cerebralis* also contributes to biotic resistance (Moyle and Light 1996) and could result in low survival in reintroduced rainbow trout populations as disease can interact with predation to have an even larger effect on survival. Exposure to disease has been shown to increase susceptibility to predation (Seppälä et al. 2004), and diseased prey are often eaten in higher than expected proportions due to increased prey vulnerability or active predator selection (Mesa and Warren 1997). Parasites also lower the energy reserves of their host (Poulin 1993), and parasitized fish often take more risks to feed in the presence of a predator than unparasitized fish (Milinski 1985; Godin and Sproul 1988). Therefore, compounding effects of disease exposure and increased susceptibility to predation may lead to lower survival in locations where *M. cerebralis* and predator abundance (aquatic or terrestrial) is high.

A third consideration is whether environmental resistance factors (temperature, flow, abiotic resources; Moyle and Light 1996) may prevent the removal from being a success. Reintroductions in Colorado occur in rivers that have large annual fluctuations in water flow and temperature. Rivers like the Colorado and Cache la Poudre Rivers can experience extensive low flow periods during the summer months (USGS 2009), and minimum discharge has been shown to have a large effect on the survival of reintroduced rainbow trout (Chapter 2). Lower flows result in higher summer water temperatures and lower dissolved oxygen levels (Williams et al. 2009), both of which can directly affect salmonid survival (Hicks et al. 1991). Biotic resistance may also be increased as a result of low flows and high temperatures. Increased stress due to low flow may intensify the effects of *M. cerebralis* infection, and ectoparasite infestation has been shown to peak during periods of low flow and high mean water temperature, potentially

significantly increasing mortality in these rivers (Schisler et al. 1999b). Low flows also reduce suitable habitat and can lead to high densities and overcrowding, increased predation, and increased competition (Arismendi et al. 2012).

Finally, the cost of the removal and the benefits received from such a cost must be considered. For example, nearly \$4.4 million has been spent to mechanically remove > 1.5 million non-native predatory fish from the Colorado River; however, 86% of published reports (as of 2005) suggested that native species did not benefit from the removal efforts (Mueller 2005). Additionally, the logistic constraints associated with large removal efforts may be limiting. In this study, over 100 volunteers were utilized to remove 89% of the brown trout population from a 1.0-km reach of the Cache la Poudre River. Assembling and maintaining this large of a volunteer base for removals of the same size in multiple locations, or a removal effort over longer distances, would not be an easy feat.

Although the results of this study suggest that brown trout removal did have a positive effect on the retention of the H×Hs, the overall benefit of the removal is questionable. Due to the logistical constraints of conducting removals in other large river systems in Colorado, the return of brown trout to the removal reach, and the fact that removal did not appear to have an effect on the survival of either cross or the retention of the H×Cs, I conclude that adult brown trout removal is not a viable management option to pursue in future *M. cerebralis*-resistant rainbow trout introductions in Colorado. The stocked rainbow trout appeared to be well suited for introduction, and seem to be capable of overcoming many of the ecological resistance factors encountered, potentially becoming established in both reaches of the Cache la Poudre River. Further study is needed to determine if rainbow trout have become established and integrated into the Cache la Poudre River ecosystem. Additional research should also focus on rainbow

trout reintroduction strategies, with regard to fish size, reintroduction size, and the number of reintroductions needed to produce a self-sustaining rainbow trout population in Colorado.

Table 4.1. Antenna efficiencies (E ; the probability of being detected at both antennas within an array) estimated on a weekly basis at each antenna location during the primary study period, and on a monthly basis during the winter study period. Efficiencies were adjusted based on the proportion of the week a reader was functioning (Op), and adjusted efficiencies were used to fix detection probability (p) for each location in the multistate capture-recapture analyses.

Week	Lower Control			Upper Control			Lower Removal			Upper Removal		
	E	Op	p	E	Op	p	E	Op	p	E	Op	p
Primary Study Period												
8/19-8/26	0.91	1.00	0.91	0.54	1.00	0.54	0.73	1.00	0.73	0.77	1.00	0.77
8/27-9/2	0.90	1.00	0.90	0.65	1.00	0.65	0.88	1.00	0.88	0.88	1.00	0.88
9/3-9/9	0.71	1.00	0.71	0.29	1.00	0.29	0.66	1.00	0.66	0.76	1.00	0.76
9/10-9/16	0.85	1.00	0.85	0.38	1.00	0.38	0.78	1.00	0.78	0.82	1.00	0.82
9/17-9/23	0.91	1.00	0.91	0.44	1.00	0.44	0.91	1.00	0.91	0.82	1.00	0.82
9/24-9/30	0.96	1.00	0.96	0.67	1.00	0.67	1.00	1.00	1.00	0.89	1.00	0.89
10/1-10/7	0.92	1.00	0.92	0.54	1.00	0.54	0.96	1.00	0.96	0.94	1.00	0.94
10/8-10/14	0.90	1.00	0.90	0.63	1.00	0.63	0.91	1.00	0.91	0.89	1.00	0.89
10/15-10/21	0.94	1.00	0.94	0.60	1.00	0.60	0.96	1.00	0.96	0.88	1.00	0.88
10/22-10/28	0.92	1.00	0.92	0.58	1.00	0.58	0.93	1.00	0.93	0.90	1.00	0.90
10/29-11/4	0.92	1.00	0.92	0.58	1.00	0.58	0.93	1.00	0.93	0.90	1.00	0.90
Winter Study Period												
11/5-11/11	0.92	1.00	0.92	0.58	1.00	0.58	0.93	1.00	0.93	0.90	1.00	0.90
11/12-11/18	0.92	1.00	0.92	0.58	1.00	0.58	0.93	0.86	0.80	0.90	0.42	0.38
11/19-11/25	1.00	1.00	1.00	0.55	1.00	0.55	1.00	1.00	1.00	0.95	1.00	0.95
11/26-12/2	1.00	1.00	1.00	0.55	1.00	0.55	1.00	0.42	0.42	0.95	0.71	0.68
12/3-12/9	1.00	1.00	1.00	0.55	1.00	0.55	1.00	1.00	1.00	0.95	1.00	0.95
12/10-12/16	1.00	1.00	1.00	0.55	1.00	0.55	1.00	1.00	1.00	0.95	1.00	0.95
12/17-12/23	1.00	1.00	1.00	0.63	1.00	0.63	1.00	1.00	1.00	1.00	1.00	1.00
12/24-12/30	1.00	1.00	1.00	0.63	1.00	0.63	1.00	1.00	1.00	1.00	1.00	1.00
12/31-1/6	1.00	0.29	0.29	0.63	1.00	0.63	1.00	1.00	1.00	1.00	1.00	1.00
1/7-1/13	1.00	0.42	0.42	0.63	1.00	0.63	1.00	1.00	1.00	1.00	1.00	1.00
1/14-1/20	1.00	1.00	1.00	0.63	1.00	0.63	1.00	1.00	1.00	1.00	1.00	1.00
1/21-1/27	1.00	0.42	0.42	0.91	1.00	0.91	1.00	0.71	0.71	1.00	1.00	1.00
1/28-2/3	1.00	1.00	1.00	0.91	0.57	0.52	1.00	0.71	0.71	1.00	1.00	1.00
2/4-2/10	1.00	1.00	1.00	0.91	1.00	0.91	1.00	1.00	1.00	1.00	1.00	1.00
2/11-2/17	1.00	1.00	1.00	0.91	0.86	0.78	1.00	1.00	1.00	1.00	0.14	0.14
2/18-2/24	1.00	1.00	1.00	0.91	1.00	0.91	1.00	1.00	1.00	1.00	1.00	1.00
2/25-3/3	1.00	1.00	1.00	0.91	1.00	0.91	1.00	1.00	1.00	1.00	0.29	0.29
3/4-3/10	1.00	1.00	1.00	0.91	1.00	0.91	1.00	1.00	1.00	1.00	1.00	1.00
3/11-3/17	1.00	1.00	1.00	0.91	0.86	0.78	1.00	1.00	1.00	1.00	1.00	1.00
3/18-3/24	1.00	1.00	1.00	0.91	0.00	0.00	1.00	1.00	1.00	1.00	0.71	0.71
3/25-3/31	1.00	1.00	1.00	0.78	1.00	0.78	0.52	1.00	0.52	0.96	0.42	0.41
4/1-4/7	1.00	0.71	0.71	0.78	1.00	0.78	0.52	1.00	0.52	0.96	0.71	0.67
4/8-4/14	1.00	0.71	0.71	0.78	1.00	0.78	0.52	1.00	0.52	0.96	1.00	0.96

Table 4.2. Estimated transitions (ψ 's) included in the brown trout and rainbow trout model sets for both the primary and winter study periods. Initial ψ represent the first movement made by tagged fish from their release site (state). Secondary ψ were only estimated for fish that moved out of their release state, representing weekly movement into and out of the study reaches.

Species	Study Period	Study Reach	Initial ψ	Secondary ψ	
Brown Trout	Primary	Control	C \rightarrow A	A \rightarrow B	
			C \rightarrow D	A \rightarrow D	
			K \rightarrow B	B \rightarrow A	
			K \rightarrow D	B \rightarrow D	
			L \rightarrow A	D \rightarrow A	
			L \rightarrow E	D \rightarrow E	
				E \rightarrow A	
			E \rightarrow D		
		Removal	M \rightarrow G	F \rightarrow G	
			M \rightarrow H	F \rightarrow H	
			O \rightarrow F	G \rightarrow F	
			O \rightarrow I	G \rightarrow H	
				H \rightarrow F	
				H \rightarrow I	
	I \rightarrow F				
	I \rightarrow H				
HxC HxH	Primary	Control	C \rightarrow A	A \rightarrow B	
			C \rightarrow D	A \rightarrow D	
				B \rightarrow A	
				B \rightarrow D	
				D \rightarrow A	
				D \rightarrow E	
				E \rightarrow A	
			E \rightarrow D		
		Removal	R \rightarrow F	F \rightarrow G	
			R \rightarrow H	F \rightarrow H	
				G \rightarrow F	
				G \rightarrow H	
				H \rightarrow F	
				H \rightarrow I	
	I \rightarrow F				
	I \rightarrow H				
Brown Trout HxC HxH	Winter	Control	C \rightarrow A	A \rightarrow B	
			C \rightarrow D	B \rightarrow A	
			K \rightarrow B	D \rightarrow E	
			L \rightarrow E	E \rightarrow D	
			Removal	R \rightarrow F	F \rightarrow G
				R \rightarrow H	G \rightarrow F
				M \rightarrow G	H \rightarrow I
		O \rightarrow I		I \rightarrow H	

Table 4.3. Model selection results for differences in rainbow trout length and weight at stocking in the Cache la Poudre River in August 2010.

Model	R^2	$\log(L)$	K	AICc	Δ_i	w_i
Length						
Cross*Reach	0.58	-11181.40	4	22372.86	0.00	0.99
Cross+Reach	0.58	-11190.30	3	22387.80	14.94	0.01
Cross	0.58	-11194.20	2	22393.04	20.18	0.00
Reach	0.00	-12895.50	2	25795.59	3422.73	0.00
Intercept-only	0.00	-12897.10	1	25796.37	3423.51	0.00
Weight						
Cross*Reach	0.57	-12032.40	4	24074.88	0.00	0.99
Cross+Reach	0.57	-12039.30	3	24085.88	11.00	0.01
Cross	0.57	-12052.00	2	24108.65	33.77	0.00
Reach	0.00	-13706.10	2	27416.84	3341.96	0.00
Intercept-only	0.00	-13711.50	1	27425.12	3350.24	0.00

The maximized log-likelihood ($\log(L)$), the number of parameters (K) in each model, and the small sample size-corrected AICc values (AICc) are shown. Models are ranked within the length or weight model sets by their AICc differences (Δ_i) relative to the best model in the set and Akaike weights (w_i) quantify the probability that a particular model is the best model in the set given the data and the model set.

Table 4.4. Model selection results for Huggins closed-population models containing covariates thought to influence estimates of detection probability during the brown trout removal conducted August 14-16, 2010 in the Cache la Poudre River.

Model	log(L)	K	AICc	Δ_i	w_i
p (P,TL)	-1849.64	6	3711.33	0.00	0.92
p (G,P,TL)	-1849.04	9	3716.21	4.88	0.08
p (TL)	-1887.73	2	3779.46	68.13	0.00
p (G,TL)	-1886.26	5	3782.57	71.24	0.00
p (P)	-1889.04	4	3786.10	74.78	0.00
p (G)	-1903.71	4	3815.44	104.12	0.00
p (•)	-1933.09	1	3868.18	156.85	0.00

The maximized log-likelihood ($\log(L)$), the number of parameters (K) in each model, and the small sample size-corrected AICc values (AICc) are shown. Models are ranked by their AICc differences (Δ_i) relative to the best model in the set and Akaike weights (w_i) quantify the probability that a particular model is the best model in the set given the data and the model set. NOTE: P = pass, TL = total length, G = group (brown trout > 150 mm, brown trout \leq 150 mm, rainbow trout > 150 mm, rainbow trout \leq 150 mm), and • = intercept model.

Table 4.5. Model selection results for multistate models fit to stocked rainbow trout data during the primary study period. The candidate model sets included over 150 models with various structures for apparent survival (ϕ) and movement (ψ); models for which there were weight are shown for both the H×C and H×H crosses.

Model	$\log(L)$	K	AICc	Δ_i	w_i
H×C					
$\phi(S, TL) \psi(ST, CMS, TL, FTW)$	-5510.79	30	11082.54	0.00	0.27
$\phi(S) \psi(ST, CMS, FTW)$	-5512.85	28	11082.55	0.01	0.27
$\phi(S, W) \psi(ST, CMS, TL, FTW)$	-5511.44	30	11083.84	1.30	0.14
$\phi(S, TL) \psi(ST, CMS, FTW)$	-5512.83	29	11084.56	2.02	0.10
$\phi(S, W) \psi(ST, CMS, FTW)$	-5512.84	29	11084.59	2.05	0.10
$\phi(S) \psi(ST, CMS, TL, FTW)$	-5512.85	29	11084.60	2.06	0.10
$\phi(S, TL) \psi(ST, CMS, TL)$	-5514.49	29	11087.89	5.36	0.02
$\phi(S) \psi(ST, CMS)$	-5516.54	28	11089.93	7.39	0.01
$\phi(S) \psi(ST, CMS, TL)$	-5520.07	28	11096.98	14.45	< 0.01
$\phi(S) \psi(ST, CMS)$	-5521.23	27	11097.24	14.70	< 0.01
$\phi(S, W) \psi(ST, CMS, TL)$	-5519.64	29	11098.18	15.64	< 0.01
$\phi(S, W) \psi(ST, CMS)$	-5521.22	28	11099.28	16.74	< 0.01
H×H					
$\phi(S) \psi(ST, CMS, TL, FTW)$	-3969.38	29	7997.64	0.00	0.28
$\phi(S, TL) \psi(ST, CMS, TL, FTW)$	-3968.45	30	7997.86	0.23	0.25
$\phi(S, W) \psi(ST, CMS, TL, FTW)$	-3968.53	30	7998.02	0.38	0.23
$\phi(S, TL) \psi(ST, CMS, FTW)$	-3970.28	29	7999.45	1.80	0.11
$\phi(S, W) \psi(ST, CMS, FTW)$	-3970.42	29	7999.73	2.09	0.10
$\phi(S) \psi(ST, CMS, FTW)$	-3972.27	28	8001.37	3.73	0.04
$\phi(S) \psi(ST, CMS, TL)$	-3981.30	28	8019.43	21.79	< 0.01

The maximized log-likelihood ($\log(L)$), the number of parameters (K) in each model, and the small sample size-corrected AICc values (AICc) are shown. Models are ranked within the H×C or H×H model sets by their AICc differences (Δ_i) relative to the best model in the set and Akaike weights (w_i) quantify the probability that a particular model is the best model in the set given the data and the model set. NOTE: S = section (above, within, or below the control or removal reaches), TL = length, W = weight, ST = state (estimable transitions), CMS = discharge, FTW = first two weeks.

Table 4.6. Model selection results for multistate models fit to wild PIT-tagged brown trout data during the primary study period. The model set included over 300 models with various structures for apparent survival (ϕ) and movement (ψ); models for which there was weight are shown.

Model	log(L)	K	AICc	Δ_i	w_i
$\phi(S,W) \psi(ST*SP,CMS,FTW)$	-3056.20	61	6241.89	0.00	0.52
$\phi(S,W) \psi(ST*SP,CMS,TL,FTW)$	-3056.03	62	6243.80	1.90	0.20
$\phi(S,L) \psi(ST*SP,CMS,FTW)$	-3057.32	61	6244.14	2.25	0.17
$\phi(S,L) \psi(ST*SP,CMS,TL,FTW)$	-3057.22	62	6246.18	4.29	0.06
$\phi(S) \psi(ST*SP,CMS,FTW)$	-3060.19	60	6247.62	5.72	0.03
$\phi(S) \psi(ST*SP,CMS,TL,FTW)$	-3059.57	61	6248.64	6.75	0.02

The maximized log-likelihood ($\log(L)$), the number of parameters (K) in each model, and the small sample size-corrected AICc values (AICc) are shown. Models are ranked by their AICc differences (Δ_i) relative to the best model in the set and Akaike weights (w_i) quantify the probability that a particular model is the best model in the set given the data and the model set. NOTE: S = section (above, within, or below the control or removal reaches), TL = length, W = weight, ST = state (estimable transitions), SP = spawn, CMS = discharge, FTW = first two weeks, and * = interaction.

Table 4.7. Model selection results for multistate models fit to stocked rainbow trout data during the winter study period. The candidate model sets had 10 models each with various structures for apparent survival (ϕ) and movement (ψ); models for which there were weight are shown for both the H×C and H×H crosses.

Model	$\log(L)$	K	AICc	Δ_i	w_i
H×C					
$\phi(S) \psi(ST)$	-3937.85	22	7920.22	0.00	0.83
$\phi(\bullet) \psi(ST)$	-3944.96	17	7924.23	4.01	0.11
$\phi(\bullet) \psi(ST,IC)$	-3943.77	19	7925.93	5.71	0.05
$\phi(S) \psi(ST,IC)$	-3940.43	24	7929.49	9.27	0.01
H×H					
$\phi(S) \psi(ST)$	-1777.23	22	3598.97	0	0.54
$\phi(S) \psi(ST,IC)$	-1775.33	24	3599.28	0.31	0.46
$\phi(\bullet) \psi(ST)$	-1789.80	17	3613.92	14.95	< 0.01
$\phi(\bullet) \psi(ST,IC)$	-1788.92	19	3616.23	17.26	< 0.01

The maximized log-likelihood ($\log(L)$), the number of parameters (K) in each model, and the small sample size-corrected AICc values (AICc) are shown. Models are ranked within the H×C or H×H model sets by their AICc differences (Δ_i) relative to the best model in the set and Akaike weights (w_i) quantify the probability that a particular model is the best model in the set given the data and the model set. NOTE: S = section (above, within, or below the control or removal reaches), ST = state (estimable transitions), IC = ice cover, and \bullet = intercept model.

Table 4.8. Model selection results for multistate models fit to wild PIT-tagged brown trout data during the winter study period. The candidate model set had 10 models with various structures for apparent survival (φ) and movement (ψ); models for which there was weight are shown.

Model	log(L)	K	AICc	Δ_i	w_i
$\varphi(S) \psi(ST)$	-7272.71	22	14590.38	0	0.48
$\varphi(S) \psi(ST,IC)$	-7272.26	24	14591.57	1.19	0.26
$\varphi(\bullet) \psi(ST,IC)$	-7276.85	19	14592.43	2.05	0.17
$\varphi(\bullet) \psi(ST)$	-7279.57	17	14593.71	3.33	0.09
$\varphi(\bullet) \psi(IC)$	-7297.72	4	14603.48	13.10	< 0.01
$\varphi(S) \psi(IC)$	-7293.50	9	14605.16	14.79	< 0.01
$\varphi(\bullet) \psi(\bullet)$	-7300.83	2	14605.68	15.30	< 0.01
$\varphi(S) \psi(\bullet)$	-7295.88	7	14605.87	15.49	< 0.01

The maximized log-likelihood ($\log(L)$), the number of parameters (K) in each model, and the small sample size-corrected AICc values (AICc) are shown. Models are ranked by their AICc differences (Δ_i) relative to the best model in the set and Akaike weights (w_i) quantify the probability that a particular model is the best model in the set given the data and the model set. NOTE: S = section (above, within, or below the control or removal reaches), ST = state (estimable transitions), IC = ice cover, and \bullet = intercept model.

Table 4.9. Movement of relocated brown trout within the control and removal reaches. The dates at which brown trout entered and exited each reach, direction of movement upon exit from a reach, and the last known location is shown for each of the relocated brown trout detected within the control and removal reaches.

Tag #	Control Reach			Removal Reach			Last Known Location
	Enter	Exit	Direction	Enter	Exit	Direction	
173863414	9/18	---	---	---	---	---	Control
173863424	9/22	9/24	Upstream	11/1	11/5	Downstream	Below Removal
173863427	8/28	---	---	---	---	---	Control
173863486	10/4	10/8	Downstream	---	---	---	Below Control
173863525	11/5	11/6	Upstream	---	---	---	Above Control
173863546	8/20	10/4	Upstream	---	---	---	Above Control
173863571	10/21	10/24	Upstream	---	---	---	Above Control

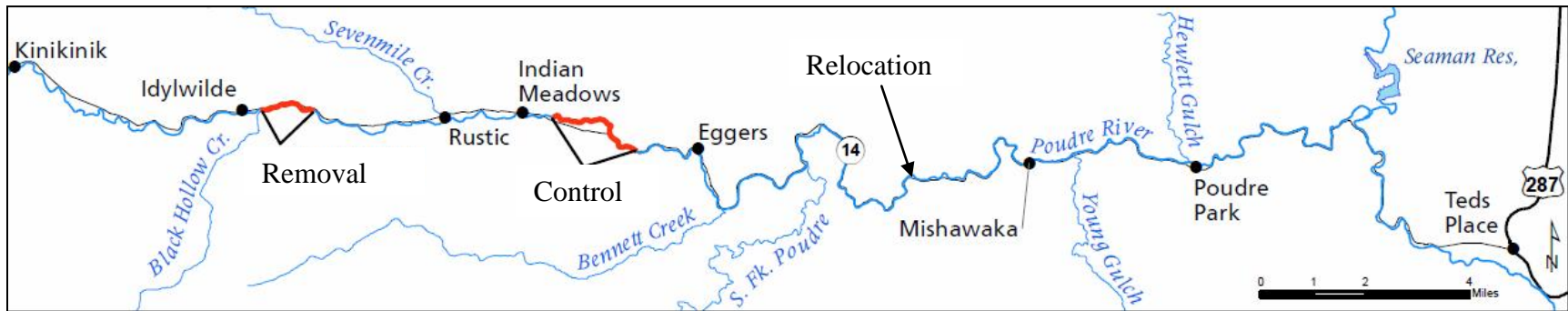

Figure 4.1. Location of the control, removal, and relocation reaches within the Cache la Poudre River, Colorado.

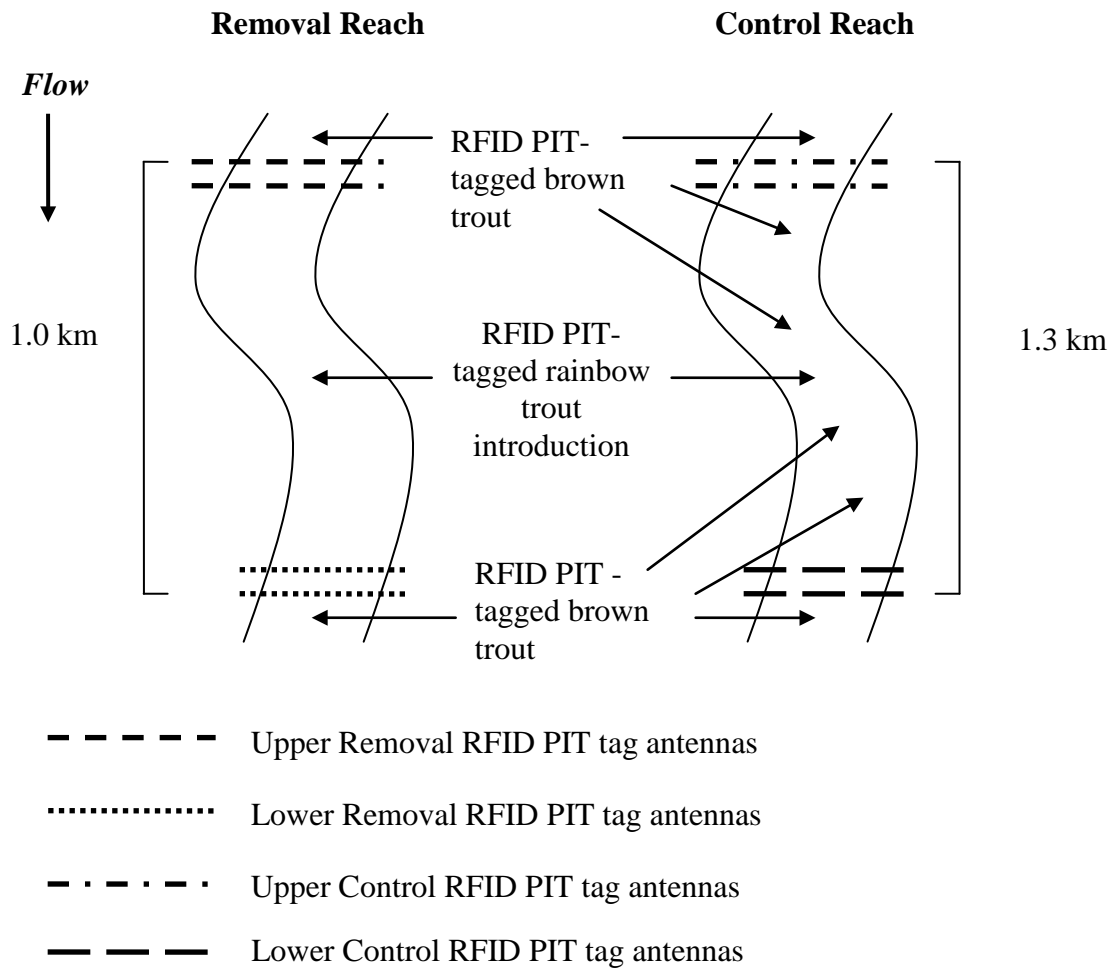

Figure 4.2. Experimental design of the brown trout removal experiment conducted in the Cache la Poudre River. The experiment consisted of a 1.3-km control reach (no removal) and a 1.0-km removal reach (brown trout removal). Both reaches were bordered by paired RFID PIT tag antennas used to determine directionality of movement of PIT-tagged brown trout and rainbow trout into and out of the reaches.

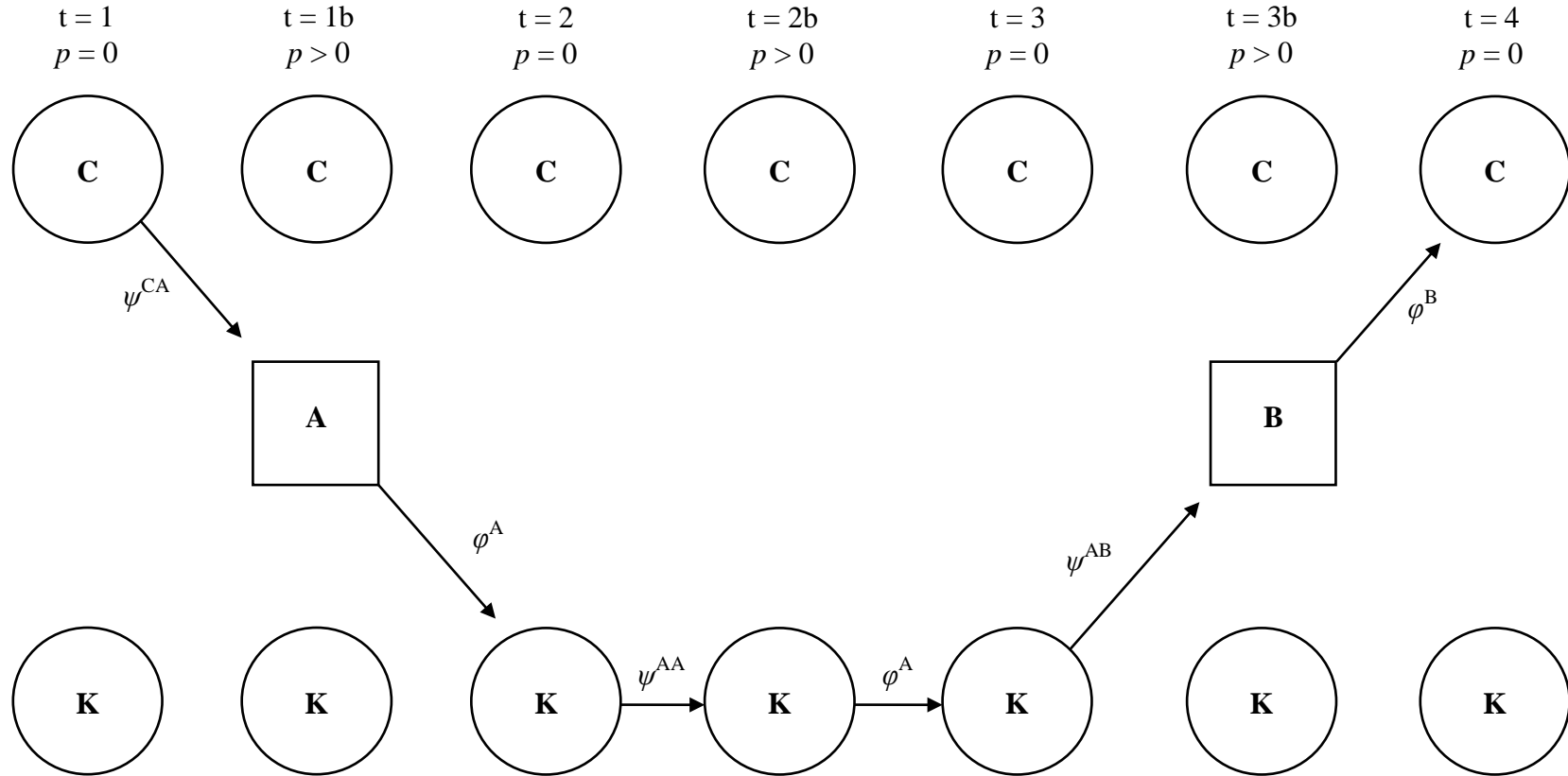

Figure 4.3. Example of the multistate model used to estimate transition (ψ), survival (ϕ), and detection probability (p) for a fish with the encounter history of CA000B0. This fish was released in the control reach (release state C) at time 1. Because the fish is undetectable (circles) in C and the downstream state (K), p is zero. Between time 1 and 2, the fish was recaptured (squares) by the reader making a downstream movement past the lower control antenna station (transition state A) and the transition probability (ψ^{CA}) was estimated between time periods 1 and 1b. The fish was assumed to be alive while making the transition; therefore, survival (ϕ^A) was estimated between time periods 1b and 2 once the transition had been made. Between time periods 2 and 3, the fish remained in the downstream section, and the probability of retention (ψ^{AA}) and ϕ^A were estimated. Between time periods 3 and 4, the fish was observed making an upstream movement (transition state B); ψ^{AB} was estimated between time periods 3 and 3b, and ϕ^B was estimated between time periods 3b and 4. At time periods 1b, 2b, and 3b, p was fixed to the adjusted efficiency for the lower control antenna station (Table 4.1).

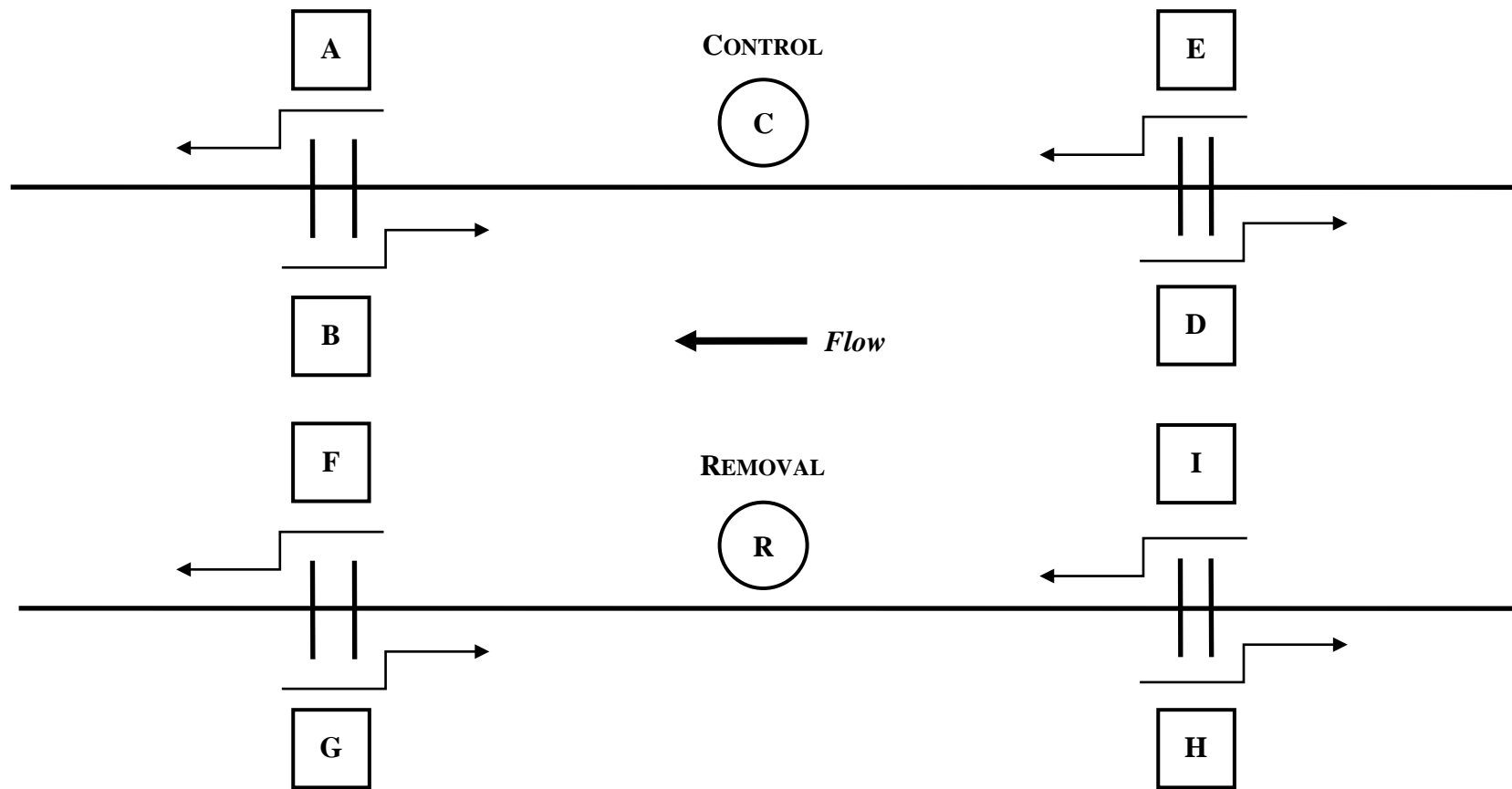

Figure 4.4. Release (circle) and transition (square) states used in the multistate models estimating weekly apparent survival (ϕ) and movement (ψ) probabilities for rainbow trout (H×C and H×H) during the primary study period (August 15 – November 3, 2010).

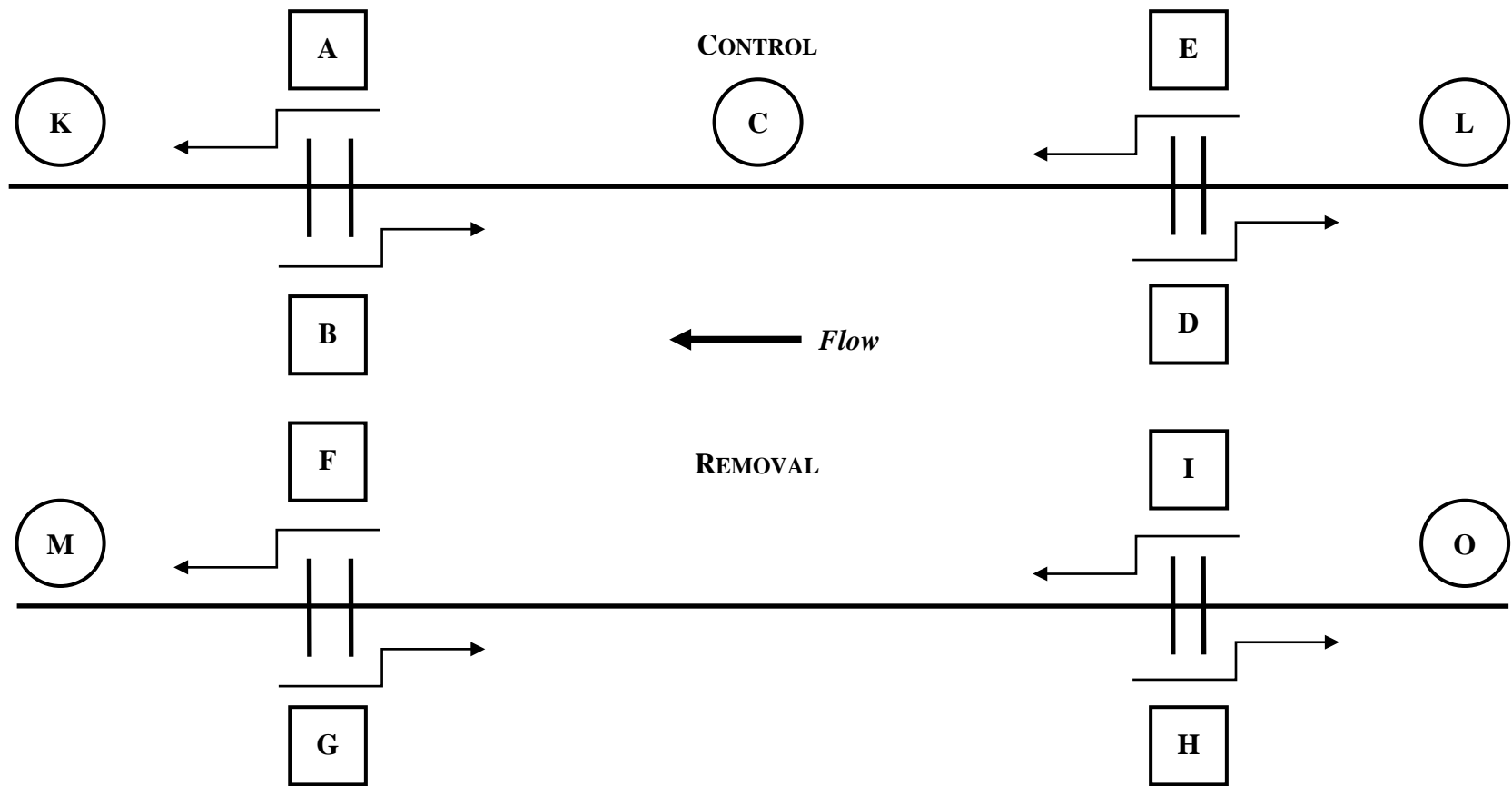

Figure 4.5. Release (circle) and transition (square) states used in the multistate model estimating weekly apparent survival (ϕ) and movement (ψ) brown trout during the primary study period (August 15 – November 3, 2010).

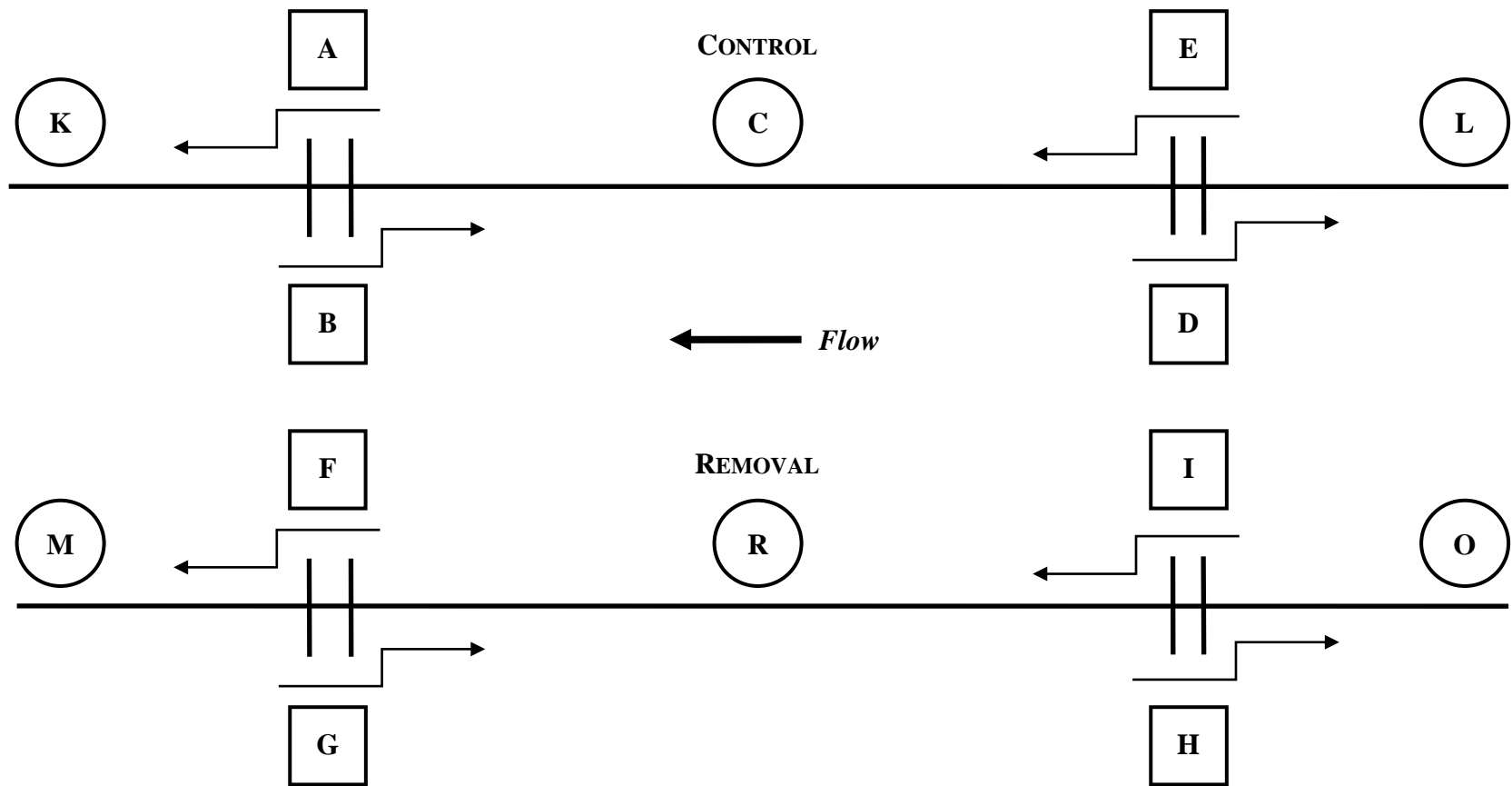

Figure 4.6. Release (circle) and transition (square) states used in the multistate models estimating weekly apparent survival (ϕ) and movement (ψ) probabilities for brown trout and rainbow trout (H×C and H×H) during the winter study period (November 4, 2010 – April 14, 2011).

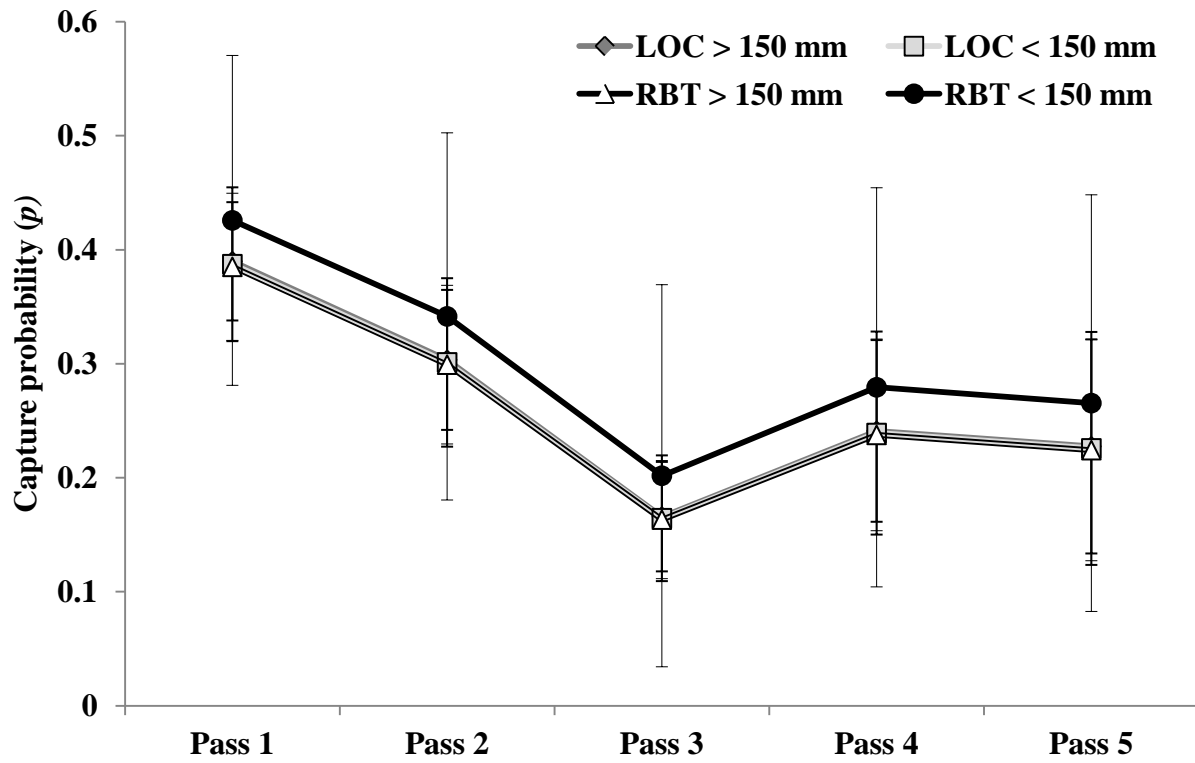

Figure 4.7. Model-averaged estimates of pass-specific capture probability for two size classes (> 150 mm, ≤ 150 mm) of brown trout and rainbow trout during the removal (August 16-18, 2010).

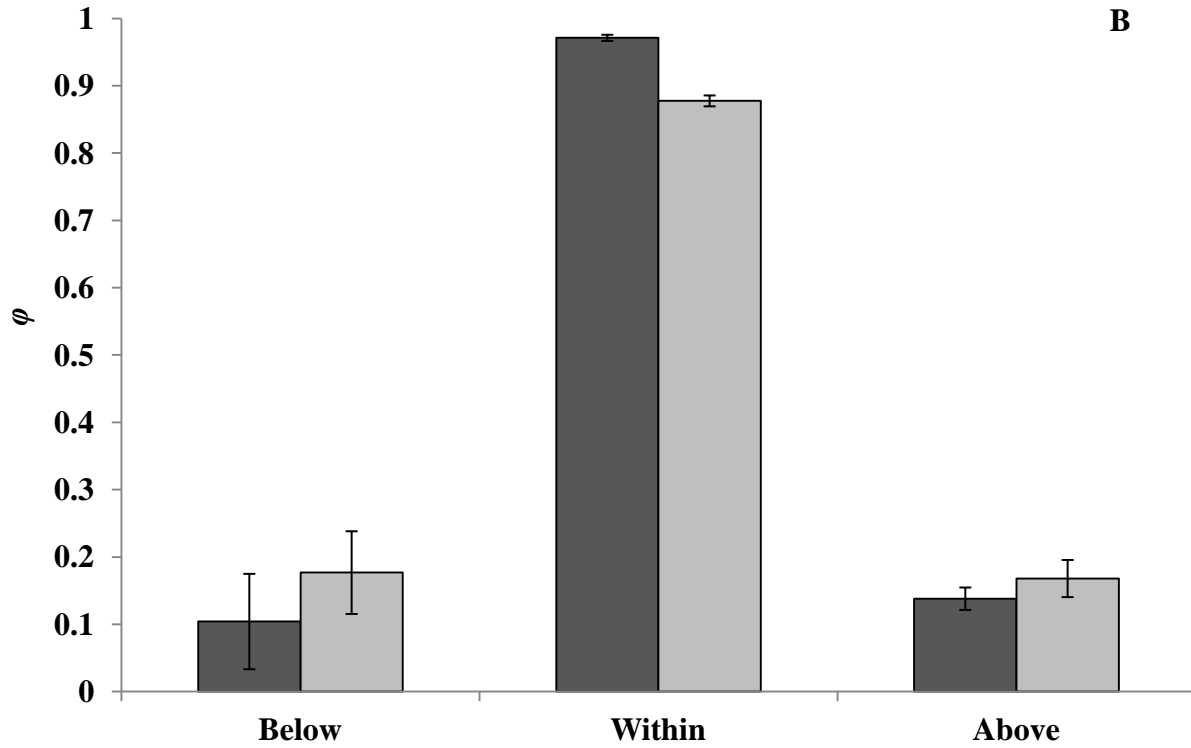
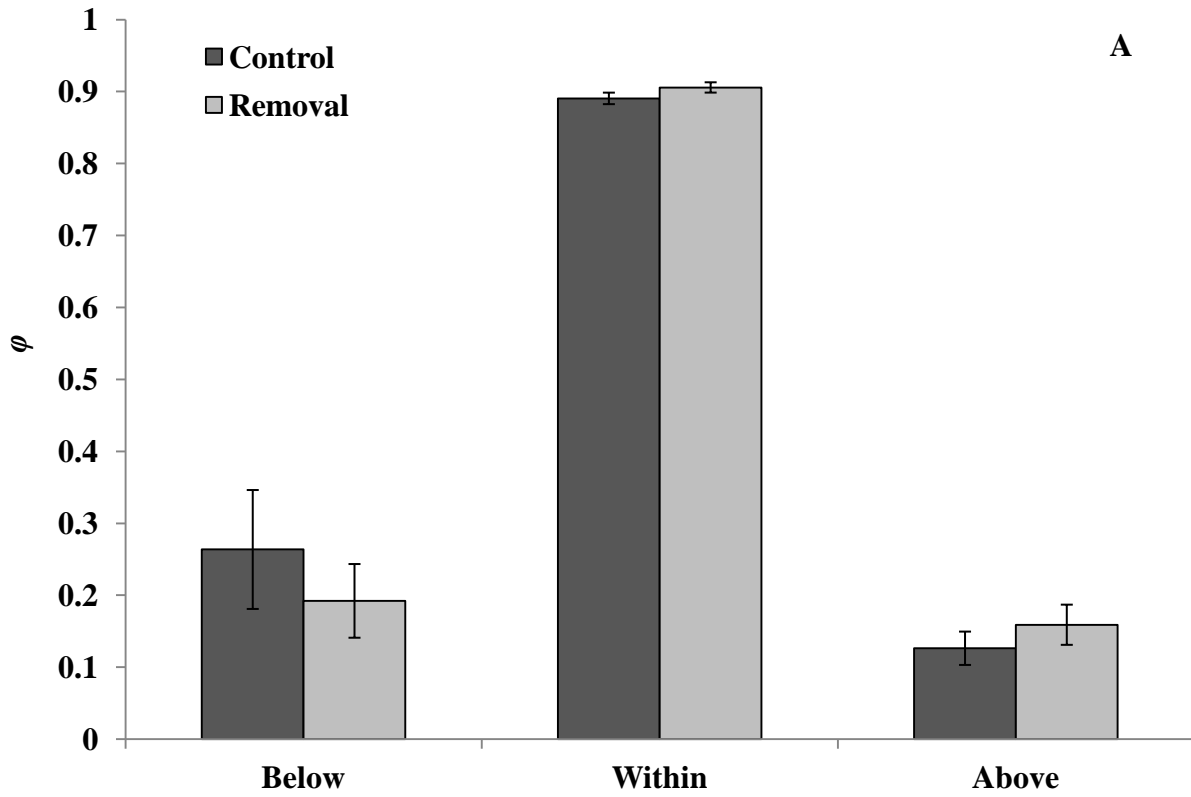

Figure 4.8. Model-averaged apparent primary study period weekly survival probabilities (ϕ ; SE bars) for HxC (A) and HxH (B) below, within, and above the control and removal reaches.

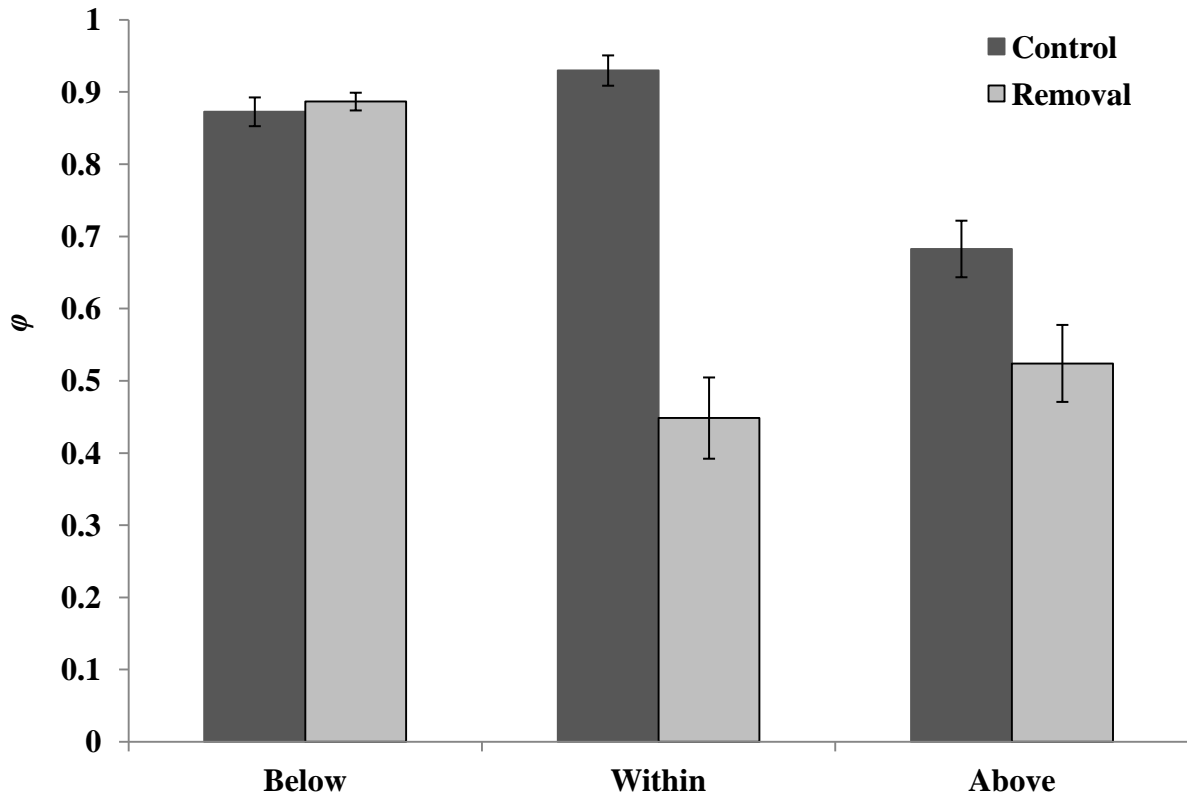

Figure 4.9. Model-averaged apparent survival probabilities (φ ; SE bars) for brown trout below, within, and above the control and removal reaches during the primary study period.

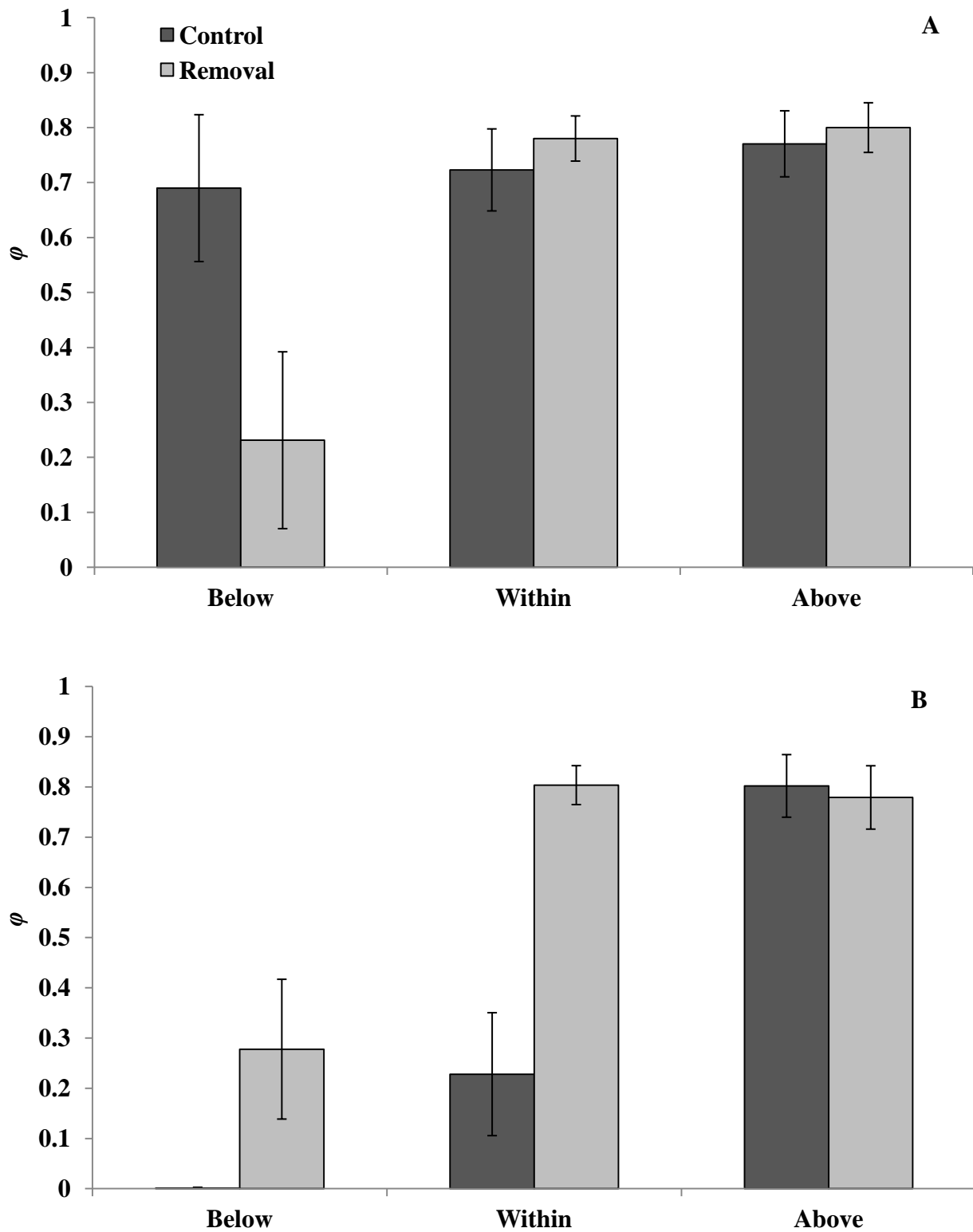

Figure 4.10. Model-averaged apparent winter weekly survival probabilities (ϕ ; SE bars) for H×C (A) and H×H (B) fish below, within, and above the control and removal reaches.

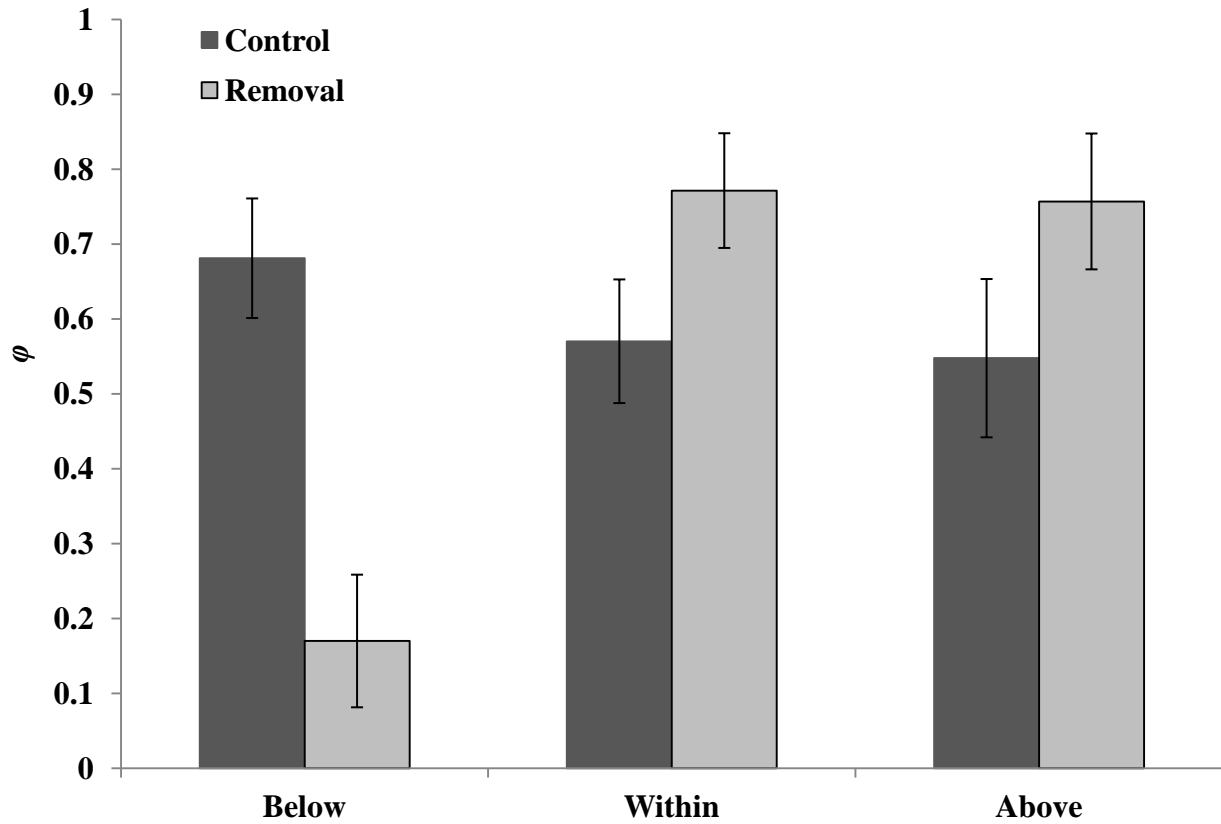

Figure 4.11. Model-averaged apparent survival probabilities (ϕ ; SE bars) for brown trout below, within, and above the control and removal reaches during the winter study period.

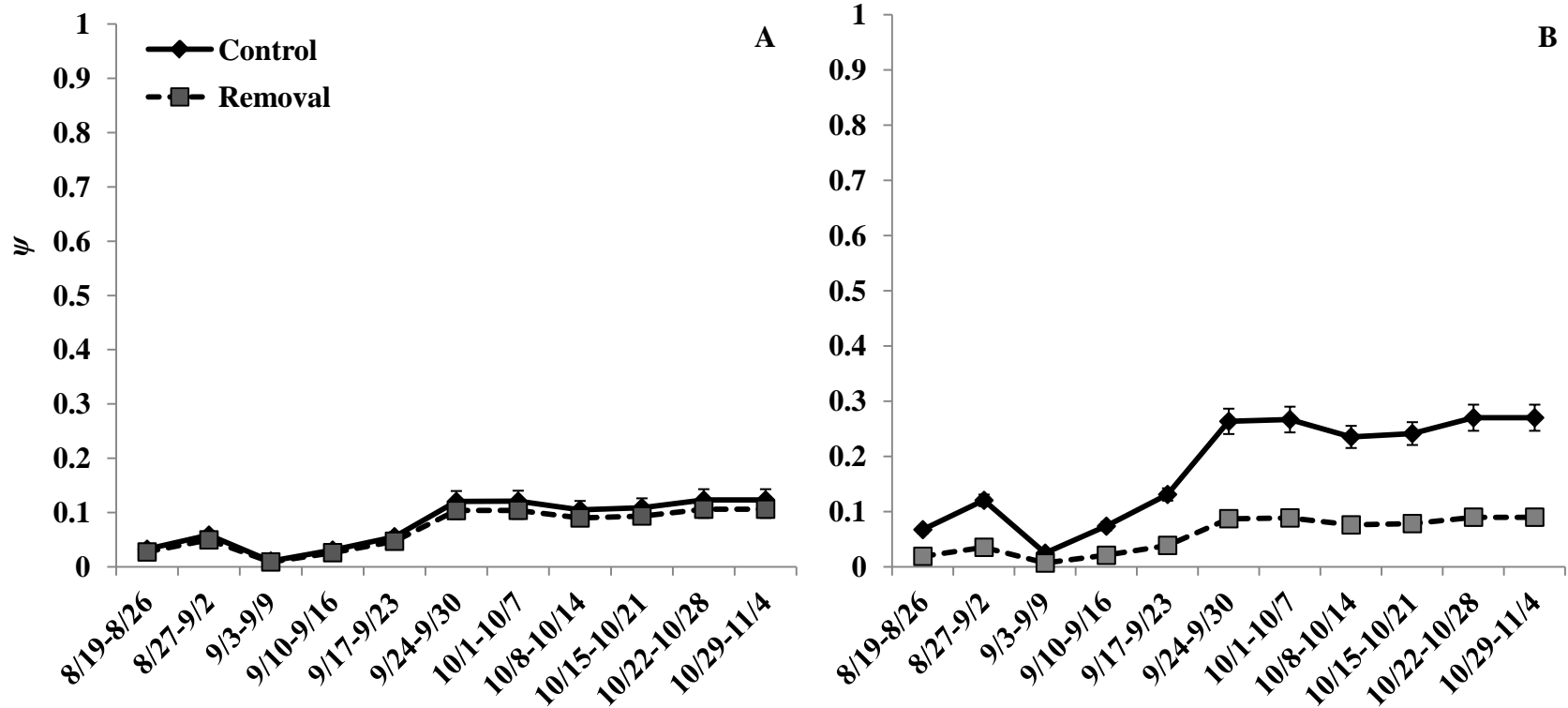

Figure 4.12. HxC (A) and HxH (B) initial movement probabilities (ψ ; SE bars), the sum of movements downstream and upstream out of the control (C→A and C→D, respectively) and removal (R→F and R→H, respectively) reaches during the primary study period.

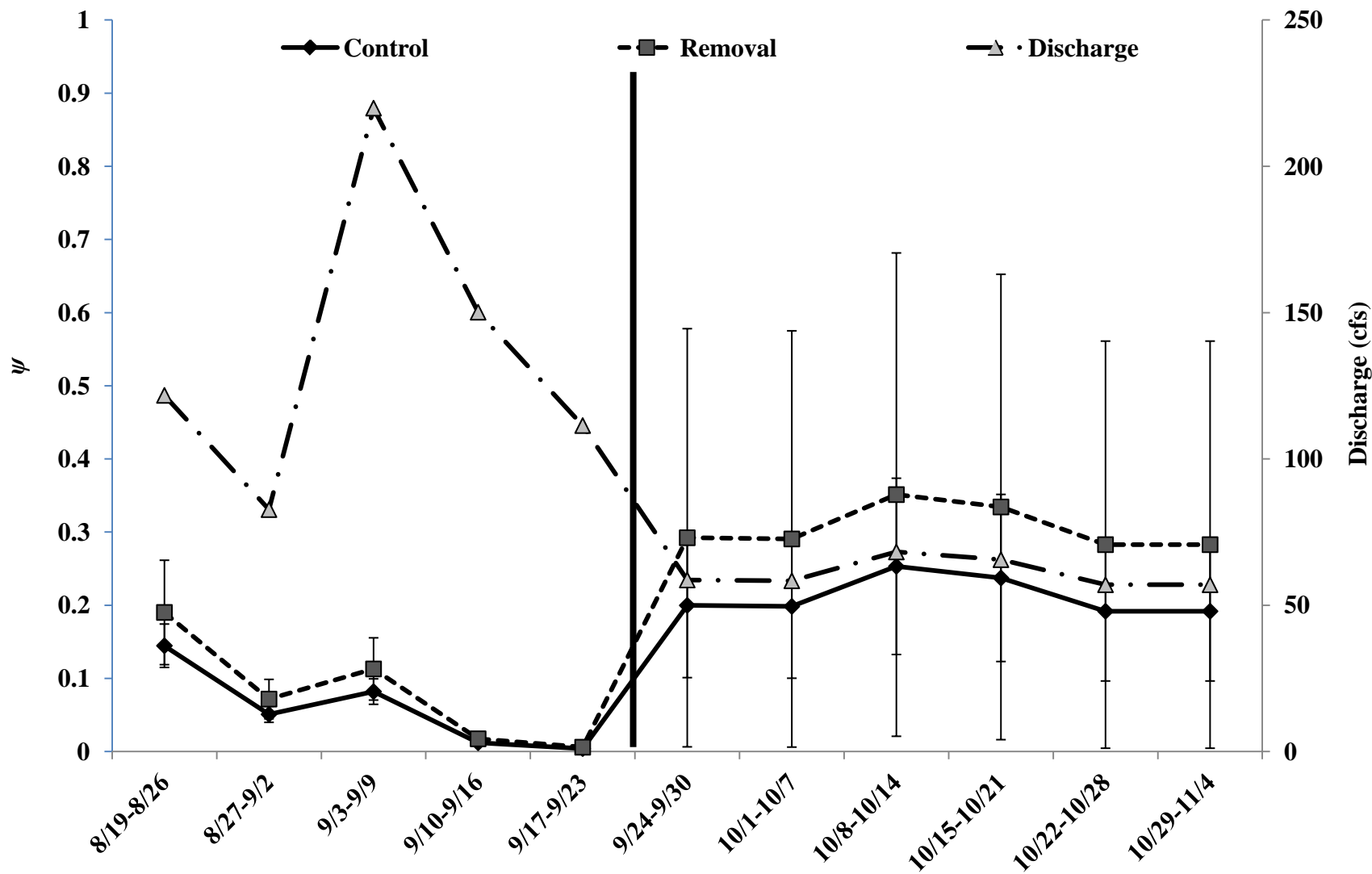

Figure 4.13. Brown trout net initial movement probabilities (ψ ; SE bars) into the control and removal reaches (difference in the sum of movement into and out of the reaches) during the primary study period. Discharge and spawn (solid black line; indicates transition from pre-spawn to spawning period) had a large effect on movement probabilities within the primary study period.

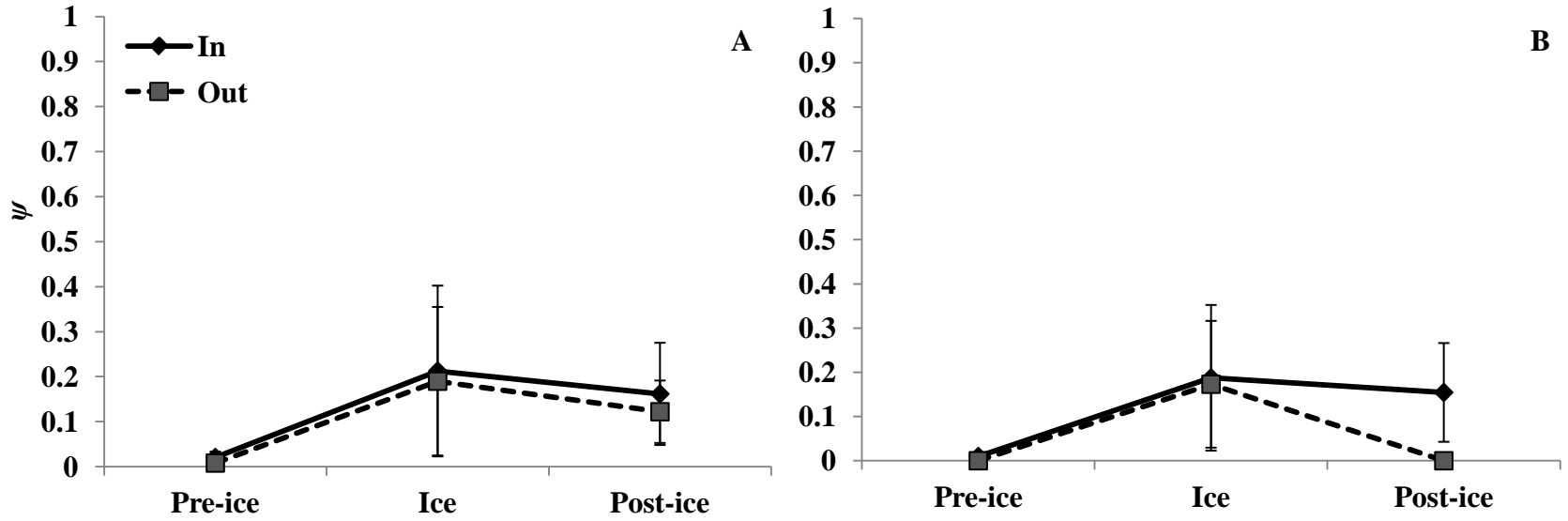

Figure 4.14. Brown trout initial pre-ice (11/5-12/16), ice (12/17-3/17), and post-ice (3/18-4/14) movement probabilities (ψ ; SE bars) into and out of the control (A) and removal (B) reaches during the winter study period.

LITERATURE CITED

- Acolas, M. L., J.-M. Roussel, J. M. Lebel, and J. L. Baglinière. 2007. Laboratory experiment on survival, growth and tag retention following PIT injection into the body cavity of juvenile brown trout (*Salmo trutta*). *Fisheries Research* 86:280-284.
- Alexander, G.R. 1977. Consumption of small trout by large predatory brown trout in the north branch of the Au Sable River, Michigan. Michigan Department of Natural Resources, Fisheries Research Report Number 1855.
- Allen, M. B., and E. P. Bergersen. 2002. Factors influencing the distribution of *Myxobolus cerebralis*, the causative agent of whirling disease, in the Cache la Poudre River, Colorado. *Diseases of Aquatic Organisms* 49:51-60.
- Anderson, D. R. 2008. Model based inference in the life sciences: A primer on evidence. Springer, LLC, New York, New York.
- Armstrong, J. D., and N. A. Herbert. 1997. Homing movements of displaced stream-dwelling brown trout. *Journal of Fish Biology* 50:445-449.
- Axel, G. A., E. F. Prentice, and B. P. Sandford. 2005. PIT-tag detection system for larger-diameter juvenile fish bypass pipes at Columbia River basin hydroelectric dams. *North American Journal of Fisheries Management* 25:646-651.
- Aymes, J. C., and J. Rives. 2009. Detection efficiency of multiplexed passive integrated transponder antennas is influenced by environmental conditions and fish swimming behavior. *Ecology of Freshwater Fish* 18:507-513.
- Baldwin, T. J., J. E. Peterson, G. C. McGhee, K. D. Staigmiller, E. S. Motteram, C. C. Downs, and D. R. Stanek. 1998. Distribution of *Myxobolus cerebralis* in salmonid fishes in Montana. *Journal of Aquatic Animal Health* 10:361-371.
- Bettinger, J. M., and P. W. Bettoli. 2004. Seasonal movement of brown trout in the Clinch River, Tennessee. *North American Journal of Fisheries Management* 24:1480-1485.
- Bond, M. H., C. V. Hanson, R. Baertsch, S. A. Hayes, and R. B. MacFarlane. 2007. A new low cost instream antenna system for tracking passive integrated transponder (PIT)-tagged fish in small streams. *Transactions of the American Fisheries Society* 136:562-566.
- Brooks, J. E., M. J. Buntjer, and J. R. Smith. 2000. Non-native species interactions: Management implications to aid in recovery of the Colorado pikeminnow *Ptychocheilus lucius* and razorback sucker *Xyrauchen texanus* in the San Juan River, CO-NM-UT. San Juan River Basin Recovery Implementation Program, U.S. Fish and Wildlife Service, Albuquerque, New Mexico.

- Brownie, C., J. E. Hines, J. D. Nichols, K. H. Pollock, and J. B. Hestbeck. 1993. Capture recapture studies for multiple strata including non-Markovian transitions. *Biometrics* 49:1173-1187.
- Buchanan, R. A., and J. R. Skalski. 2010. Using multistate mark-recapture methods to model adult salmonid migration in an industrialized river. *Ecological Modeling* 221:582-589.
- Burnham, K. P., and D. R. Anderson. 2002. *Model selection and multimodel inference: A practical information-theoretic approach*. Second edition. Springer-Verlag, New York, New York.
- Burrell, K. H., J. J. Isely, D. B. Bunneell, D. H. Van Lear, and C. A. Dolloff. 2000. Seasonal movement of brown trout in a southern Appalachian river. *Transactions of the American Fisheries Society* 129:1373-1379.
- Compton, R. I., W. A. Hubert, F. J. Rahel, M. C. Quist, and M. R. Bower. 2008. Influences of fragmentation on three species of native warmwater fish in a Colorado River Basin headwater stream system, Wyoming. *North American Journal of Fisheries Management* 28: 1733-1743.
- Connolly, P. J., I. G. Jezorek, K. D. Martens, and E. F. Prentice. 2008. Measuring the performance of two stationary interrogation systems for detecting downstream and upstream movement of PIT-tagged salmonids. *North American Journal of Fisheries Management* 28:402-417.
- Elliott, J. M., and M. A. Hurley. 2000. Daily energy intake and growth of piscivorous brown trout, *Salmo trutta*. *Freshwater Biology* 44:237-245.
- Elton, C. S. 1958. *The ecology of invasive plants and animals*. Methuen, London.
- Fausch, K. D., and R. J. White. 1981. Competition between brook trout (*Salvelinus fontinalis*) and brown trout (*Salmo trutta*) for positions in a Michigan stream. *Canadian Journal of Fisheries and Aquatic Sciences* 38:1220-1227.
- Fetherman, E. R. 2009. Heritability of myxospore count and the effects of *Myxobolus cerebralis* exposure on the physiological performance of whirling disease resistant and susceptible strains of rainbow trout. M.S. thesis, Department of Fish, Wildlife and Conservation Biology, Colorado State University, Fort Collins, CO.
- Fetherman, E. R., and G. J. Schisler. 2012. Sport Fish Research Studies. Federal Aid in Fish and Wildlife Restoration, Job Progress Report. Colorado Parks and Wildlife, Aquatic Wildlife Research Section. Fort Collins, Colorado.
- Fetherman, E. R., D. L. Winkelman, G. J. Schisler, and C. A. Myrick. 2011. The effects of *Myxobolus cerebralis* on the physiological performance of whirling disease resistant and susceptible strains of rainbow trout. *Journal of Aquatic Animal Health* 23:169-177.

- Fetherman, E. R., D. L. Winkelman, G. J. Schisler, and M. F. Antolin. 2012. Genetic basis of differences in myxospore count between whirling disease-resistant and –susceptible strains of rainbow trout. *Diseases of Aquatic Organisms* 102:97-106.
- Frank, B. M., O. Gimenez, and P. V. Baret. 2012. Assessing brown trout (*Salmo trutta*) spawning movements with multistate capture-recapture models: a case study in a fully controlled Belgian brook. *Canadian Journal of Fisheries and Aquatic Sciences* 69:1091-1104.
- Fraser, D. J. 2008. How well can captive breeding programs conserve biodiversity? A review of salmonids. *Evolutionary Applications* 1:535-586.
- Gatz, A. J., M. J. Sale, and J. M. Loar. 1987. Habitat shifts in rainbow trout: competitive influences of brown trout. *Oecologia (Berlin)* 74:7-19.
- Godin, J.-G. J., and C. D. Sproul. 1988. Risk taking in parasitized sticklebacks under threat of predation: effects of energetic need and food availability. *Canadian Journal of Zoology* 66:2360-2367.
- Granath, W. O., Jr., M. A. Gilbert, E. J. Wyatt-Pescador, and E. R. Vincent. 2007. Epizootiology of *Myxobolus cerebralis*, the causative agent of salmonid whirling disease in the Rock Creek drainage of west-central Montana. *Journal of Parasitology* 93(1):104-119.
- Gries, G., and B. H. Letcher. 2002. Tag retention and survival of age-0 Atlantic salmon following surgical implantation with passive integrated transponder tags. *North American Journal of Fisheries Management* 22:219-222.
- Halvorsen, M., and O. B. Stabell. 1990. Homing behaviour of displaced stream-dwelling brown trout. *Animal Behavior* 39:1089-1097.
- Hedrick, R. P., and M. El-Matbouli. 2002. Review: Recent advances with taxonomy, life cycle, and development of *Myxobolus cerebralis* in the fish and oligochaete hosts. Pages 45-54 in Bartholomew, J. L., and J. C. Wilson, editors. *Whirling disease: Reviews and current topics*. American Fisheries Society Symposium 29, Bethesda, Maryland.
- Hedrick, R. P., T. S. McDowell, G. D. Marty, G. T. Fosgate, K. Mukkatira, K. Myklebust, and M. El-Matbouli. 2003. Susceptibility of two strains of rainbow trout (one with suspected resistance to whirling disease) to *Myxobolus cerebralis* infection. *Disease of Aquatic Organisms* 55:37-44.
- Hense, Z., R. W. Martin, and J. T. Petty. 2010. Electrofishing capture efficiencies for common stream fish species to support watershed-scale studies in the central Appalachians. *North American Journal of Fisheries Management* 30:1041-1050.
- Hestbeck, J. B. 1995. Bias in transition-specific survival and movement probabilities estimated using capture-recapture data. *Journal of Applied Statistics* 22:737-750.

- Hestbeck, J. B., J. D. Nichols, and R. A. Malecki. 1991. Estimates of movement and site fidelity using mark resight data of wintering Canada geese. *Ecology* 72:523-533.
- Hoffmann, G. L. 1970. Intercontinental and transcontinental dissemination and transfaunation of fish parasites with emphasis on whirling disease (*Myxosoma cerebralis*) and its effects on fish. Symposium on Diseases of fisheries and Shellfishes. Edited by S. F. Snieszko. American Fisheries Society, Special Publication Number 5:69-81.
- Horton, G. E., B. H. Letcher, and W. L. Kendall. 2011. A multistate capture-recapture modeling strategy to separate true survival from permanent emigration for a passive integrated transponder tagged population of stream fish. *Transactions of the American Fisheries Society* 140(2):320-333.
- Huggins, R. M. 1989. On the statistical analysis of capture experiments. *Biometrika* 76:133-140.
- James, D. A., J. W. Erickson, and B. A. Barton. 2007. Brown trout seasonal movement patterns and habitat use in an urbanized South Dakota stream. *North American Journal of Fisheries Management* 27:978-985.
- Jensen, H., P. -A. Amundsen, J. M. Elliott, T. Bøhn, and P. E. Aspholm. 2006. Prey consumption rates and growth of piscivorous brown trout in a subarctic watercourse. *Journal of Fish Biology* 68:838-848.
- Jolley, J. C., D. W. Willis, T. J. DeBates, and D. D. Graham. 2008. The effects of mechanically reducing northern pike density on the sport fish community of West Long Lake, Nebraska, USA. *Fisheries Management and Ecology* 15:251-258.
- Jonsson, N., T. F. Næsje, B. Jonsson, R. Saksgård, and O. T. Sandlund. 1999. The influence of piscivory on life history traits of brown trout. *Journal of Fish Biology* 55:1129-1141.
- Klein, W. D. 1963. Quality fishing on the Poudre River. Colorado Department of Game, Fish and Parks. Fisheries Research Division Report Number 1.
- Lebreton, J. D., and R. Pradel. 2002. Multistate recapture models: Modeling incomplete individual histories. *Journal of Applied statistics* 29:353-369.
- Letcher, B. H., and G. E. Horton. 2008. Seasonal variation in size-dependent survival of juvenile Atlantic salmon (*Salmo salar*): performance of multistate capture-mark-recapture models. *Canadian Journal of Fisheries and Aquatic Sciences* 65:1649-1666.
- McAda, C. W. 1997. Mechanical removal of northern pike from the Gunnison River, 1995-1996. Colorado River Recovery Implementation Program, project 58. U.S. Fish and Wildlife Service, Grand Junction, Colorado.

- Mesa, M. G., and J. J. Warren. 1997. Predator avoidance ability of juvenile Chinook salmon (*Oncorhynchus tshawytscha*) subjected to sublethal exposures of gas supersaturated water. *Canadian Journal of Fisheries and Aquatic Sciences* 54:757-764.
- Milinski, M. 1985. Risk of predation of parasitized sticklebacks (*Gasterosteus aculeatus* L.) under competition for food. *Behavior* 93:203-216.
- Miller, M. P., and E. R. Vincent. 2008. Rapid natural selection for resistance to an introduced parasite of rainbow trout. *Evolutionary Applications* 1:336-341.
- Modde, T. and M. Fuller. 2002. Feasibility of channel catfish reduction in the lower Yampa River. Upper Colorado River Basin Recovery Implementation Program Project 88. Colorado River Fish Project, Vernal, Utah.
- Moyle, P. B., and T. Light. 1996. Biological invasions of fresh water: empirical rules and assembly theory. *Biological Conservation* 78:149-161.
- Mueller, G. A. 2005. Predatory fish removal and native fish recovery in the Colorado River mainstem: what have we learned? *Fisheries* 30(9):10-19.
- Nehring, R. B. 2006. Colorado's cold water fisheries: whirling disease case histories and insights for risk management. Colorado Division of Wildlife. Aquatic Wildlife Research Special Report Number 79. February 2006.
- Nehring, R. B., and K. G. Thompson. 2001. Impact assessment of some physical and biological factors in the whirling disease epizootic among wild trout in Colorado. Colorado Division of Wildlife. Aquatic Research Special Report Number 76. March 2001.
- Nehring, R. B., and K. G. Thompson. 2003. Whirling disease risk assessment: the Colorado perspective. Pages 31-32 in 9th Annual Whirling Disease Symposium: Managing the Risk. February 6-7, Seattle, Washington.
- Nunnallee, E. P., E. F. Prentice, B. F. Jonasson, and W. Patten. 1998. Evaluation of a flat-plate PIT tag interrogation system at Bonneville Dam. *Aquaculture Engineering* 17:261-272.
- O'Donnell, M. J., G. E. Horton, and B. H. Letcher. 2010. Use of portable antennas to estimate abundance of PIT-tagged fish in small streams: Factors affecting detection probability. *North American Journal of Fisheries Management* 30(2):323-336.
- Piper, R. G., I. B. McElwain, L. E. Orme, J. P. McCraren, L. G. Fowler, and J. R. Leonard. Fish Hatchery Management. U. S. Department of the Interior, Fish and Wildlife Service, Washington, D. C., 1982.
- Poulin, R. 1993. Age-dependent effects of parasites on anti-predator responses in two New Zealand freshwater fish. *Oecologia* 96:431-438.

- Prentice, E. F., T. A. Flagg, C. S. McCutcheon, D. F. Brastow, and D. C. Cross. 1990. Equipment, methods, and an automated data-entry station for PIT tagging. Fish Marking Techniques. Edited by N. C. Parker, A. E. Giorgi, R. C. Heidinger, D. B. Jester, Jr., E. D. Prince, and G. A. Winans. American Fisheries Society, Symposium 7, Bethesda, Maryland, pgs. 335-340.
- Roussel, J.-M., A. Haro, and R. A. Cunjak. 2000. Field test of a new method for tracking small fishes in shallow rivers using passive integrated transponder (PIT) technology. *Canadian Journal of Fisheries and Aquatic Sciences* 57:1326-1329.
- Ryce, E. K. N., A. V. Zale, and R. B. Nehring. 2001. Lack of selection for resistance to whirling disease among progeny of Colorado River rainbow trout. *Journal of Aquatic Animal Health* 12:63-68.
- SAS Institute, Inc. 2010. SAS system software, Release 9.2. Cary, North Carolina.
- Saunders, W. C., K. D. Fausch, and G. C. White. 2011. Accurate estimation of salmonid abundance in small streams using nighttime removal electrofishing: an evaluation using marked fish. *North American Journal of Fisheries Management* 31:403-415.
- Schisler, G. J. 2001. Whirling Disease Investigations. Federal Aid in Fish and Wildlife Restoration Job Progress Report. Colorado Division of Wildlife, Fish Research Section. Fort Collins, Colorado.
- Schisler, G. J. 2006. Salmonid Disease Studies. Federal Aid in Fish and Wildlife Restoration Job Progress Report. Colorado Division of Wildlife, Fish Research Section. Fort Collins, Colorado.
- Schisler, G. J., K. A. Myklebust, and R. P. Hedrick. 2006. Inheritance of *Myxobolus cerebralis* resistance among F1-generation crosses of whirling disease resistant and susceptible rainbow trout strains. *Journal of Aquatic Animal Health* 18:109–115.
- Schisler, G. J., P. J. Schler, and E. R. Fetherman. 2007. Salmonid Disease Studies. Federal Aid in Fish and Wildlife Restoration, Job Progress Report. Colorado Division of Wildlife, Fish Research Section. Fort Collins, Colorado.
- Schisler, G. J., E. R. Fetherman, and P. J. Schler. 2008. Salmonid Disease Studies. Federal Aid in Fish and Wildlife Restoration, Job Progress Report. Colorado Division of Wildlife, Fish Research section. Fort Collins, Colorado.
- Seppälä, O., A. Karvonen and E. T. Valtonen. 2004. Parasite-induced change in host behavior and susceptibility to predation in an eye fluke-fish interaction. *Animal Behavior* 68(2):257-263.

- Shetter, D. S., and G. R. Alexander. 1970. Results of predator reduction on brook trout and brown trout in 4.2 miles (6.76 km) of the north branch of the Au Sable River. *Transactions of the American Fisheries Society* 99:312-319.
- Sipher, C. R., and E. P. Bergersen. 2005. The effects of whirling disease on growth and survival of Snake River cutthroat and Colorado River rainbow trout fingerlings. *Journal of Aquatic Animal Health* 17(4):353-364.
- Solomon, D. J., and R. E. Templeton. 1976. Movements of brown trout *Salmo trutta* L. in a chalk stream. *Journal of Fish Biology* 9:411-423.
- Townsend, C. R. 1996. Invasion biology and ecological impacts of brown trout *Salmo trutta* in New Zealand. *Biological Conservation* 78:13-22.
- USGS. 2009. USGS Real Time Water Data for the Nation. Retrieved July 17, 2009, from <<http://nwis.waterdata.usgs.gov/co/nwis/uv/?>>.
- Vermeij, G. J. 1996. An agenda for invasion biology. *Biological Conservation* 78:3-9.
- Vincent, E. R. 2002. Relative susceptibility of various salmonids to whirling disease with emphasis on rainbow and cutthroat trout. *American Fisheries Society Symposium* 29:109-115.
- Wagner, E. J., C. Wilson, R. Arndt, P. Goddard, M. Miller, A. Hodgson, R. Vincent, and K. Mock. 2006. Evaluation of disease resistance of the fish Lake-DeSmet, Wounded Man, and Harrison Lake strains of rainbow trout exposed to *Myxobolus cerebralis*. *Journal of Aquatic Animal Health* 18:128-135.
- Wagner, E. J., M. Bartley, R. Arndt, R. W. Oplinger, and M. D. Routledge. 2012. Comparison of hatchery and field performance between a whirling-disease-resistant strain and the Ten Sleep strain of rainbow trout. *Journal of Aquatic Animal Health* 24:110-120.
- Walker, P. G., and R. B. Nehring. 1995. An investigation to determine the cause(s) of the disappearance of young wild rainbow trout in the Upper Colorado River, in Middle Park, Colorado. Colorado Division of Wildlife Report. Denver.
- Wang, L., and R. J. White. 1994. Competition between wild brown trout and hatchery Greenback cutthroat trout of largely wild parentage. *North American Journal of Fisheries Management* 14:475-487.
- Weidel, B. C., D. C. Josephson, and C. E. Kraft. 2007. Littoral fish community response to smallmouth bass removal from and Adirondack lake. *Transactions of the American Fisheries Society* 136:778-789.
- White, G. C., and K. P. Burnham. 1999. Program MARK: Survival estimation from populations of marked animals. *Bird Study* 46 Supplement, 120-138.

- White, G. C., D. R. Anderson, K. P. Burnham, and D. L. Otis. 1982. Capture-recapture and removal methods for sampling closed populations. Los Alamos National Laboratory, LA-8787-NERP, Los Alamos, New Mexico.
- Zale, A. V., C. Brooke, and W. C. Fraser. 2005. Effects of surgically implanted transmitter weights on growth and swimming stamina of small adult west slope cutthroat trout. *Transactions of the American Fisheries Society* 136:778-789.
- Zydlewski, G. B., A. Haro, K. G. Whalen, and S. D. McCormick. 2001. Performance of stationary and portable passive transponder detection systems for monitoring of fish movements. *Journal of Fish Biology* 58:1471-1475.
- Zydlewski, G. B., G. Horton, T. Dubreuil, B. Letcher, S. Casey, and J. Zydelewski. 2006. Remote monitoring of fish in small streams: a unified approach using PIT tags. *Fisheries* 31(10):492-502.

APPENDIX 4.1

DISTANCE AND VELOCITY EFFECTS ON DETECTION PROBABILITY OF RFID PIT TAG ANTENNAS DEPLOYED IN HATCHERY RACEWAYS

Detection probability experiments were conducted at the CPW Bellvue Fish Research Hatchery to determine vertical detection probabilities of the pass-over antennas array, and ultimately, optimal antenna location within the Cache la Poudre River. Thirty rainbow trout were PIT tagged using 32 mm tags inserted posterior of the pectoral fin through the midventral body wall into the peritoneal cavity using a hypodermic needle (Prentice et al. 1990; Acolas et al. 2007) two days prior to experimentation to allow for healing and recovery. The antenna array, which consisted of two loops of eight gauge multi-strand speaker wire and measured one foot wide by three feet long, was assembled, placed on the bottom of a raceway, and tuned for optimal read range prior to the start of each detection probability trial.

Vertical detection probability of the antennas was tested at three different heights, and all trials were conducted at the lowest velocity setting for the raceway. For the first trial, maximum vertical swimming height was restricted to one foot above the antenna array; flash boards were used to adjust water depth within the raceway. For the second trial, water height was adjusted using flash boards so that maximum vertical swimming height above the antenna array was two feet. In addition, a mesh crowding screen was placed on stacked bricks horizontally above the antenna, restricting minimum swimming height above the antenna array to one foot. For the third trial, water height was adjusted using flash boards so that maximum vertical swimming height above the antenna array was three feet. Similar to the second trial, a mesh crowding screen was placed on stacked bricks horizontally above the antenna, restricting minimum

swimming height above the antenna array to two feet (Figure A4.1-1). Because the expected vertical detection distance of a pass-over antenna is about 45 cm (1.5 ft; Oregon RFID 2009), we expected detection to be 1.0 in the first trial, high but less than 1.0 in the second trial, and low in the third trial.

Detection probability was also tested at multiple velocity increments. All velocity trials were conducted at a maximum raceway depth of one foot as detection at this depth was expected to be 1.0. Velocity was increased by using a pump to push water down the raceway. Three velocities were tested: 0.10 m/s, 0.25 m/s and 0.5 m/s; 0.5 m/s was the maximum speed that could be reached within the raceway. During the velocity trials, fish were encouraged to move over the antenna array from both upstream and downstream of the antenna to determine if direction of movement affected detection probability at the different velocities.

Three groups of ten fish each were randomly selected from the 30 PIT tagged rainbow trout, and a different group was used for each trial so that use in a previous trial would not influence the results. Fish were crowded down to the lower end of the raceway prior to the start of a trial using a mesh crowding screen, and the trial began when the crowding screen was removed from the raceway and fish were allowed to move freely over the antenna. All trials were conducted for two hours, allowing fish to move over the antenna multiple times during the trial. If movement over the antenna array did not occur for longer than 15 minutes, fish were encouraged to move over the antenna array by passing an object through the water. An observer was present for the duration of each trial to record movement over the antenna array. Positive detection by the array was signified by an audible whistle from a piezoelectric buzzer attached to the reader. A video camera was used to record movement over the antenna that may have escaped the observer, or to help determine if movements over the antenna were positively

detected by the antenna if the fish moved in groups (Figure A4.1-2). Upon conclusion of all of the trials, detection data from the antenna was downloaded and compared to both observer and camera recorded movement over the antenna array to calculate detection probability for each height and velocity setting.

Detection probability for the first trial in which fish were restricted to within one foot of the antenna was 1.0. Detection probability decreased as vertical distance from the antenna increased, dropping to a detection probability of 0.89 when fish were restricted to between one to two feet above the antenna and a detection probability of 0.004 when fish were restricted to between two to three feet above the antenna. Detection probability for all three of the velocities (0.10, 0.25, and 0.50 m/s) was 1.0. These results indicated that antennas placed in the Cache la Poudre River should be put in a location where average maximum water depth was two feet, and if possible, a location where velocities were less than 0.50 m/s. Several locations met these criteria in the Cache la Poudre River, and the distance between the most ideal sites was maximized to produce the largest possible control and removal reaches for the experiment.

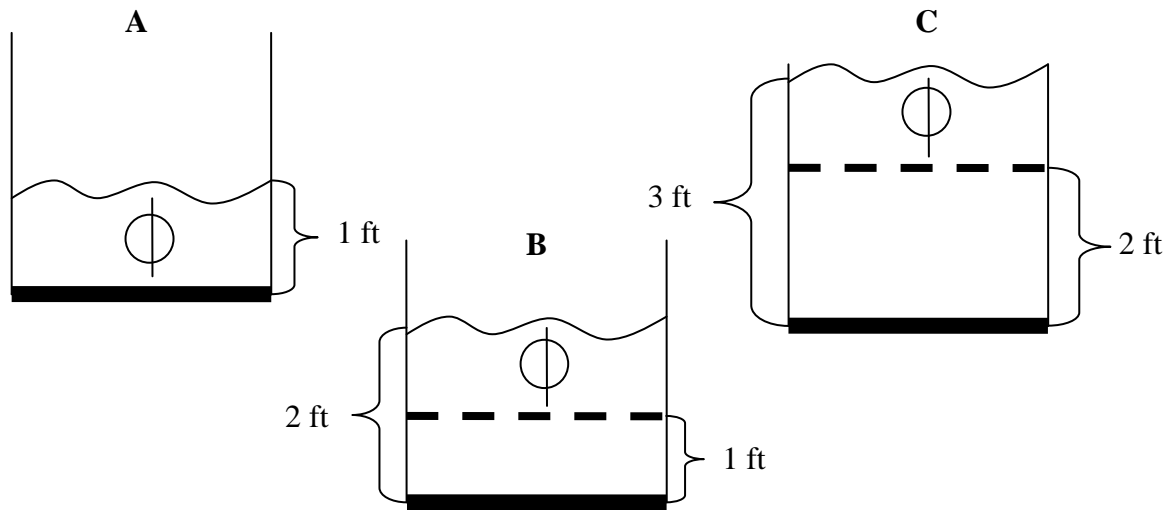

Figure A4.1-1. Vertical detection probability experiments conducted at three height increments: 0-1 feet (A), 1-2 feet (B) and 2-3 feet (C). The antenna array (thick black line) was placed on the bottom of the raceway in all three trials. The mesh crowding screen (dashed line) restricted fish to one (B) or two (B) feet above the antenna array.

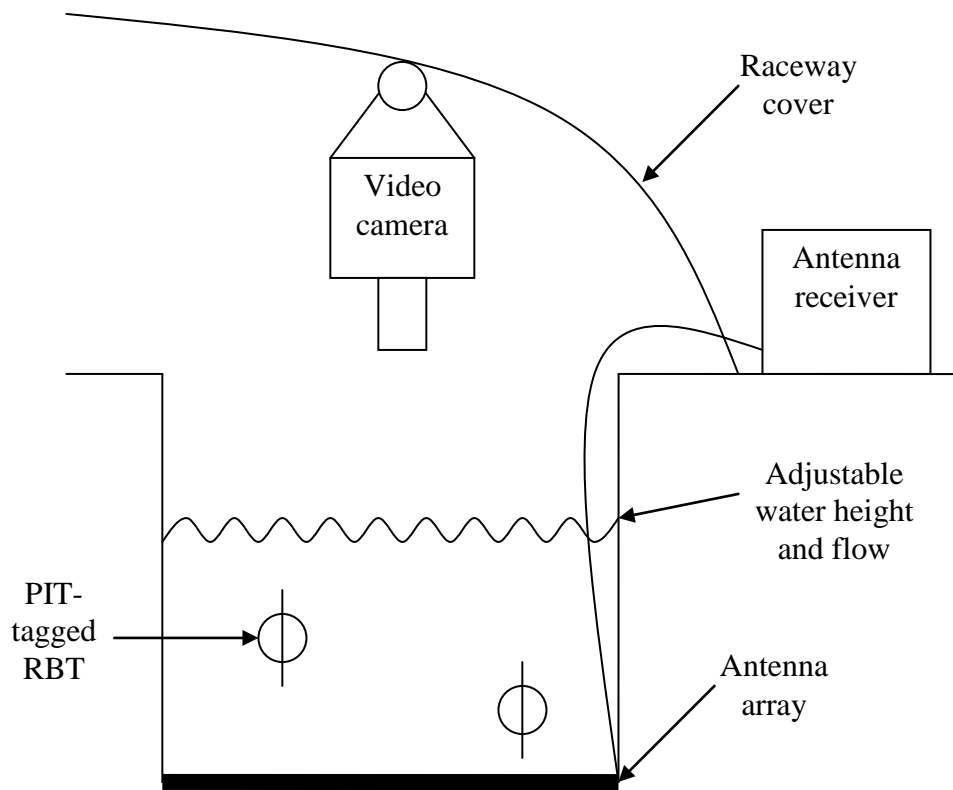

Figure A4.1-2. Diagram of vertical and velocity detection experiment set-up with a video camera positioned directly over the antenna array on the bottom of the raceway, allowing fish to pass over at various heights and water velocities.

APPENDIX 4.2

EMPIRICAL ESTIMATION OF DETECTION PROBABILITY OF DEPLOYED ANTENNA SYSTEMS IN THE CACHE LA POUFRE RIVER

The simplest method for assessing antenna efficiency is the use of a drone, where the drone is tagged and passed through the antenna array multiple times and the proportion of successful attempts is assessed (Zydlewski et al. 2006). A stick with an embedded PIT tag has been employed as a drone to assess antenna detection in the field on a daily or weekly basis. The stick with the embedded PIT tag is passed parallel and perpendicular to the antenna array at set intervals both vertically and horizontally along the length of the antenna; the number of successful detections is recorded and used to calculate antenna detection efficiency (Nunnallee et al. 1998; Compton et al. 2008).

Antenna detection efficiency of the antennas deployed in the Cache la Poudre River was assessed using the stick test methods of Nunnallee et al. (1998) and Compton et al. (2008). Efficiency was determined both horizontally along the entire length of both the upstream and downstream wires of the antenna loop, and vertically to the water surface. Measurements were taken in a grid-like fashion, with horizontal measurements occurring at 300 cm intervals, and vertical measurements occurring every 15 cm to the water surface (Figure A4.2-1). At each grid intersection, the stick with the embedded PIT tag was passed over the antenna array at two orientations, one perpendicular and one parallel to the array. Positive detection of a tag was indicated by an audible beep produced by a piezoelectric buzzer connected to the reader. The number of successes (positive detections) was recorded for each of the orientations and used to calculate antenna detection efficiency. Assessments of antenna detection efficiency occurred

weekly during the primary study period (August 15 – November 4, 2010) and once a month during the winter study period (November 4, 2010 – April 14, 2011). Only perpendicular detection probabilities, averaged over each antenna pair, were used to fix detection probability in the multistate analysis, as this was the most likely orientation of fish passing over the antenna.

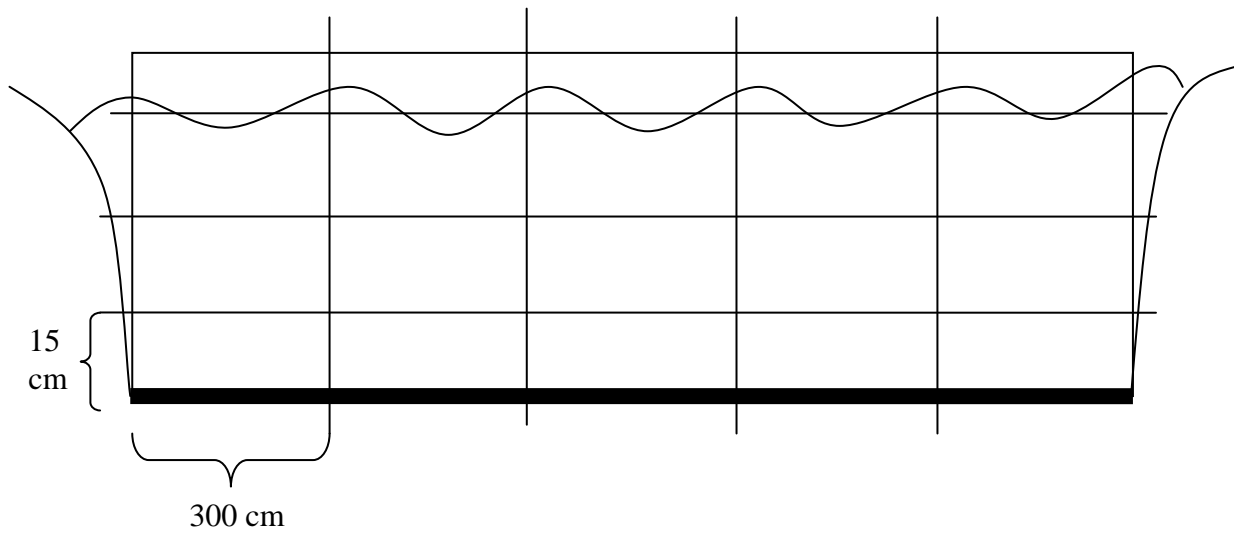

Figure A4.2-1. Grid used to determine detection efficiency of both the upstream and downstream wires of each antenna loop. The stick with the embedded PIT tag was passed through each grid intersection at both a perpendicular and parallel orientation to the array.

APPENDIX 4.3

STOCHASTIC INFECTION RATES AND BROWN TROUT REMOVAL EFFECTS ON THE ESTABLISHMENT OF SELF-SUSTAINING, WHIRLING DISEASE-RESISTANT RAINBOW TROUT POPULATIONS

MODEL OBJECTIVES

As a result of the interactions between brown trout, rainbow trout, and *Myxobolus cerebralis*, there are a number of factors influencing the success or failure of whirling disease-resistant rainbow trout introductions in Colorado. The objective of the work presented here was to develop a model that explored the interactions between rainbow trout introduction size, environmentally stochastic *M. cerebralis* exposure rates, and brown trout population size, to determine the probability that a self-sustaining, whirling disease-resistant rainbow trout population could be established and maintained. Specifically, models were developed to determine whether a single introduction of rainbow trout had the potential to become a self-sustaining population at a given brown trout population size.

METHODS

Model Assumptions

The brown trout and rainbow trout interaction model operates under a number of assumptions. Environmental conditions, determining exposure rates for whirling disease, were assumed to be variable. To account for this, a stochastic infection rate and subsequent loss of rainbow trout was included in the model. Loss of rainbow trout due to whirling disease exposure and brown trout predation effect on the fry and juvenile age classes were assumed to be the only factors that affected rainbow trout population size in a given year. Brown trout predation rates

were assumed to be constant across all years of the simulation, dependant only on brown trout population size. Rainbow trout reproduction from the three adult reproductive age classes was assumed to be equal and constant across all years of the simulation. Adult rainbow trout were assumed to have a competitive advantage over the brown trout (Nehring and Thompson 2001), remaining constant throughout all years of the simulation. Once a certain percentage of the brown trout population was removed, it was assumed that immigration of the removed brown trout back into the system did not occur.

Rainbow Trout Age Classes and Leslie Matrix

Seven age classes of rainbow trout were included in the model: a fry age class, a juvenile age class, three spawning adult age classes, a post-spawning adult age class, and a death class. The death class was included to ensure that all individuals in the post-spawning adult age class would move into the death class and be removed from the population in each year of the simulation. An individual remained in a single age class for a duration of one year. The probability of remaining in the current age class for more than one year was zero, meaning that all surviving individuals progressed to the next age class in each year of the simulation.

The three adult spawning age classes were the only age classes that reproduced and contributed to the growth of the population. Fecundity was assumed to be equal across all three age classes. Average egg production by a female rainbow trout is approximately 2,000 eggs per two pound female (1,000 eggs produced per pound; Piper et al. 1982). With a survival to hatch rate of 10%, and a post-hatch survival to swim-up rate of 10%, the contribution by a single adult female to the fry age class was 20 individuals.

Survival of the rainbow trout was assumed to be completely dependent on exposure rate and brown trout predation of the fry and juvenile age classes, which were included in the model

separate from the discrete age structure model. Therefore, survival probabilities for all of the age classes were set at one. The Leslie matrix for this model was,

$$RBT = \begin{pmatrix} 0 & 0 & F3 & F4 & F5 & 0 & 0 \\ 1 & 0 & 0 & 0 & 0 & 0 & 0 \\ 0 & 1 & 0 & 0 & 0 & 0 & 0 \\ 0 & 0 & 1 & 0 & 0 & 0 & 0 \\ 0 & 0 & 0 & 1 & 0 & 0 & 0 \\ 0 & 0 & 0 & 0 & 1 & 0 & 0 \\ 0 & 0 & 0 & 0 & 0 & 1 & 0 \end{pmatrix}$$

where F3, F4 and F5 are the fecundity of the three adult spawning age classes (20 offspring per adult). The fecundity for each adult spawning age class can be changed based on the biology of the system so that each of the age classes produce a different number of offspring; however, no differences in fecundity between the age classes were simulated in this study.

Stochastic Exposure Rates

Peak triactinomyxon (TAM; infectious waterborne stage of *M. cerebralis*) release has been shown to correspond with water temperature (Nehring and Thompson 2001; Hedrick and El-Matbouli 2002), with temperatures between 10 to 15°C being optimal for TAM release from infected worms (Hedrick and El-Matbouli 2002). TAM release often corresponds to post-swim-up fry development when fry are most vulnerable to exposure and infection by whirling disease (Nehring and Thompson 2001); however, the number of TAMs and timing of release varies depending on environmental conditions. Therefore, exposure rate was made to vary stochastically from year to year, reducing the fry age class by a fixed percentage depending on the rate.

Stochasticity was added to the model using a random number generator, which generated a number for exposure rate for each year of the simulation. Exposure rate, represented as the

number of TAMs a single fry was exposed to within a given year, ranged from 0 to 2500, with zero representing no exposure to whirling disease and 2500 representing the expected maximum exposure rate experienced by fish in Colorado (Table A4.3-1). Survival rates were applied to the fry age class after reproduction and recruitment to the fry age class occurred. Mortality associated with a given exposure rate was estimated from laboratory exposure experiments (Schisler et al. 2006; Schisler et al. 2007; Schisler et al. 2008; Fetherman 2009). Mortality was exaggerated downward to account for the higher mortality that is expected to occur in a wild river system as a result of dealing with multiple environmental stressors, in addition to whirling disease exposure, including water temperature and flow conditions, increased susceptibility to predation, and difficulty finding food.

Predation and Competition

Brown trout predation of the rainbow trout fry and juvenile age classes, and competition between brown trout and the adult rainbow trout age classes, was applied to the model after the reduction in the fry age class due to whirling disease exposure. Both predation and competition were calculated using a variation of the Lotka-Volterra predator-prey and competition models and using an ordinary differential equation (ODE) model.

Predation resulted in a reduction of the rainbow trout fry and juvenile age classes, and was a function of the interaction between the number of rainbow trout in an age class and the brown trout population size. Reduction of the fry and juvenile age classes as a result of brown trout predation was applied using the equations,

$$\frac{dRBT_{Fry}}{dt} = -G(N_1 * BT)$$

$$\frac{dRBT_{Juv}}{dt} = -G(N_2 * BT),$$

where $\frac{dRBT_{Fry}}{dt}$ and $\frac{dRBT_{Juv}}{dt}$ are the change in fry and juvenile age classes over time, G is the predation interaction constant, N_1 is the number of fish in the fry age class, N_2 is the number of fish in the juvenile age class, and BT is the brown trout population size. Two levels of predation were tested: a normal level of predation ($G = 1.0$) in which every interaction between a rainbow trout and a brown trout resulted in a loss of the rainbow trout to predation, and a reduced level of predation ($G = 0.5$) in which only half of the interactions between a rainbow trout and a brown trout resulted in a loss of the rainbow trout individual to predation. Biologically, these levels of predation correspond to the presence of few alternative brown trout food sources in the river, and an abundance of alternative brown trout food sources in the river, respectively.

Competitive interactions between rainbow trout and brown trout resulted in a decrease in the brown trout population, conferring the competitive to the rainbow trout. In Colorado, rainbow trout populations have been shown to have a slight competitive advantage over brown trout in well-established rainbow trout populations (Nehring and Thompson 2001; R. B. Nehring, CPW, pers. comm.). As a result, competitive interactions between rainbow trout and brown trout were expected to result in a reduction in the brown trout population only. The reduction in the brown trout population as a result of competition was applied using the equation,

$$\frac{dBT}{dt} = -C * BT * (N_3 + N_4 + N_5 + N_6)$$

where $\frac{dBT}{dt}$ is the change in the brown trout population over time, C is the competition interaction constant, BT is the brown trout population size, N_3 , N_4 , and N_5 , are the number of rainbow trout in the first, second, and third spawning adult age classes, and N_6 is the number of rainbow trout in the post-spawning adult age class. Two levels of competition were tested: a high level of competition ($C = 0.0001$) and a level of relaxed competition ($C = 0.00001$).

Biologically, these levels of competition correspond to small river situations where competition for food and spatial resources between the two species is high, and larger rivers (similar brown trout abundance) where competition for food and spatial resources between the two species is reduced due to the distribution of the species across a larger area.

The ODE model was run for 20 weeks in each year of the simulation, representing the five months in which predatory and competitive interactions can result in reductions in the rainbow trout and brown trout populations in wild river systems. This time span corresponds to the five month period between rainbow trout fry swim-up in late June/July and brown trout spawn in late October/November.

Simulations

Fraser (2008) defines a self-sustaining population as a population that persists for multiple generations in the absence of *any* human intervention, such as supplementation, artificial habitat enhancement or any degree of captive breeding or genetic modification. A minimum of 15-20 years is likely necessary to establish a self-sustaining salmonid population due to the amount of time required to initiate a captive breeding program, carry out reintroduction attempts, and monitor post-release success following multiple generations (Fraser 2008). For this reason, simulations were run for twenty five years, with stochastic reductions of the fry age class, predation, and competition occurring in each year of the simulation. Rainbow trout age classes were advanced in each year of the simulation via the Leslie matrix described above. Persistence of the rainbow trout population after twenty five years corresponded to the establishment of self-sustaining, whirling disease resistant rainbow trout population, whereas lack of persistence in the rainbow trout population after twenty five years corresponded to a failure to establish a self-sustaining population. Simulations of each management strategy were

run one hundred times to provide an estimate of the probability of establishing a self-sustaining, whirling disease resistant rainbow trout population.

Management Situations

The two levels of predation and two levels of competition resulted in a combination of four management situations: small rivers with high levels of competition ($C = 0.0001$) and few alternative brown trout prey sources ($G = 1.0$), small rivers with high levels of competition ($C = 0.0001$) and an abundance of alternative brown trout prey sources ($G = 0.5$), large rivers with relaxed competition ($C = 0.00001$) and few alternative brown trout prey sources ($G = 1.0$), and large rivers with relaxed competition ($C = 0.00001$) and an abundance of alternative brown trout prey sources ($G = 0.5$).

Each of the management situations were run with eleven levels of brown trout removal, ranging from no removal to 100% removal of the population (Table A4.3-2). The initial brown trout population was based on abundance estimates of brown trout in the upper Colorado River in 2009. Five rainbow trout introduction sizes were tested within each of the management situations and levels of brown trout removal, corresponding to current or proposed introduction strategies being used by the CPW (Table A4.3-3). The probability (100 runs) of establishing a self-sustaining population was estimated for each management situation and level of brown trout removal, and graphs were produced to show the level of brown trout removal and corresponding probability of establishing a self-sustaining, whirling disease resistant rainbow trout population.

RESULTS

Large Rivers with Few Alternative Prey Sources

In large rivers experiencing a reduced level of competition between the two trout species ($C = 0.00001$) and with few alternative brown trout prey sources ($G = 1.0$), an introduction of

1,000,000 rainbow trout to the fry age class is the only strategy for which a self-sustaining rainbow trout population is established in the absence of brown trout removal. No other strategy produced a self-sustaining population until brown trout removal is greater than 50%. The probability of establishing a self-sustaining population using an introduction of 10,000 rainbow trout to the first spawning adult age class was less than 0.1 when only 60% of the brown trout population was removed; however, the probability increased rapidly as the percent of brown trout removed increased. Introduction of 5,000 rainbow trout to the first spawning adult age class had a probability of establishing a self-sustaining population of only 0.12 when 80% of the brown trout population was removed; a probability of 1 did not occur for this strategy until greater than 90% of the brown trout population was removed. Finally, introductions of 2,000 rainbow trout to the first adult spawning age class or 40,000 to the juvenile age class did not have a probability of establishing a self-sustaining population of greater than 0 until over 90% of the brown trout population was removed (Figure A4.3-1).

Large Rivers with Many Alternative Prey Sources

In large rivers experiencing a high level of competition between the two trout species ($C = 0.00001$) and an abundance of alternative brown trout prey sources ($G = 0.5$), an introduction of 1,000,000 rainbow trout to the fry age class is the only strategy for which a self-sustaining rainbow trout population is established in the absence of brown trout removal. The probability of establishing a self-sustaining population using an initial introduction of 10,000 rainbow trout to the first adult spawning age class was less than 0.1 following a 20% reduction in the brown trout population; however, the probability increased with an increase in the percent of brown trout removed, with a self-sustaining population established once 70% of the population was removed. Introductions of 2,000 or 5,000 rainbow trout to the first adult spawning age class

have a high probability of establishing a self-sustaining population when greater than 80% of the brown trout population is removed. However, an introduction of 40,000 rainbow trout to the juvenile age class did not have a probability of establishing a self-sustaining population of greater than 0 until over 90% of the brown trout population was removed (Figure A4.3-2).

Small Rivers with Few Alternative Prey Sources

In small rivers experiencing a high level of competition between the two trout species ($C = 0.0001$) and with few alternative brown trout prey sources ($G = 1.0$), none of the introduction strategies established a self-sustaining rainbow trout population until over 30% of the brown trout population was removed. Even then, introduction of 1,000,000 rainbow trout to the fry age class was the only strategy that established a self-sustaining population if brown trout are present, ranging from a probability of 0.18 when 40% of the brown trout population was removed, to 1 when 80% of the population was removed. Introductions of 2,000, 5,000, and 10,000 rainbow trout to the first adult spawning age class, or 40,000 to the juvenile age class do not have a probability of establishing a self-sustaining population of greater than 0 until over 90% of the brown trout population was removed (Figure A4.3-3).

Small Rivers with Many Alternative Prey Sources

In small rivers experiencing a high level of competition between the two trout species ($C = 0.0001$) and an abundance of alternative brown trout prey sources ($G = 0.5$), an introduction of 1,000,000 rainbow trout to the fry age class is the only strategy for which a self-sustaining rainbow trout population is established in the absence of brown trout removal. This probability increased as the percent of brown trout removed increased, with a probability of 1 once over 70% of the population was removed. Introductions of 2,000, 5,000, and 10,000 rainbow trout to the first adult spawning age class or 40,000 to the juvenile age class did not have a probability of

producing a self-sustaining population of greater than 0 until over 90% of the brown trout population was removed (Figure A4.3-4).

DISCUSSION

Model results predict that self-sustaining, whirling disease resistant rainbow trout populations are unlikely to become established without some level of brown trout removal. However, the model used to determine if self-sustaining rainbow trout populations become established does have some limitations. Although it has been suggested that well-established rainbow trout populations have a competitive advantage over brown trout in Colorado (Nehring and Thompson 2001; R. B. Nehring, CPW, pers. comm.), competition from brown trout has been shown to result in exclusion of rainbow trout from preferred feeding and resting habitats, possibly resulting in population-level effects (Gatz et al. 1987). In situations where brown trout are shown to have a competitive advantage over the rainbow trout, this model would predict that a self-sustaining rainbow trout population would occur with a higher probability than expected. Brown trout reproduction and recruitment did not occur in this model. In the wild, it is unlikely that a brown trout population would show negative growth based solely on competitive influences from the rainbow trout population. Movement back into and recolonization of the removal locations by the brown trout population is also likely to occur. Both reproduction and recolonization by the brown trout would increase their population size, increasing predation, reducing the competitive advantage of the rainbow trout, and reducing the probability that a self-sustaining rainbow trout population would occur. In addition, competition between fry of the two species as a result of brown trout reproduction is likely to occur, also leading to a reduction in the probability of establishing a self-sustaining population.

Despite limitations, the model still provides a good prediction of the probability of establishing a self-sustaining rainbow trout population utilizing various rainbow trout introduction strategies currently in use by CPW. For example, in June 2006, 3,000 adult whirling disease-resistant rainbow trout were stocked into the upper Colorado River below Windy Gap Reservoir. This stretch of the upper Colorado River is privately owned and used for private fishing access; therefore, removal of brown trout is not an option at this location. In the Ute Park section of the Gunnison River, reintroduction attempts have thus far been unsuccessful despite multiple introductions of several age classes of rainbow trout, including introductions of over 10,000 fish to the first adult spawning age class, over several years to this location. The brown trout population in this section of the Gunnison River is estimated to be approximately 1.5 times larger than the modeled population size (D. Kowalski, CPW, pers. comm.); therefore, the probability of establishing a self-sustaining rainbow trout population in this location is greatly reduced from the predictions made by the model. In addition, no attempt at brown trout removal has occurred in this section of the Gunnison River. The results from the model simulations suggest that the introduced rainbow trout populations in the upper Colorado and Gunnison Rivers are unlikely to establish self-sustaining rainbow trout populations if brown trout removal or additional supplementation of the population does not occur. In locations that brown trout removal is not possible, multiple introductions occurring over multiple years will likely prove to be the only management strategy that has the potential to establish self-sustaining, whirling disease-resistant rainbow trout populations.

Table A4.3-1. Exposure rate (TAMs fish⁻¹) and associated fry survival for introducing stochasticity to the model for yearly fry survival rates as a result of exposure to *M. cerebralis*.

Exposure Rate (TAMs fish⁻¹)	Fry Survival (%)
0-500	95
501-1000	90
1001-1500	80
1501-2000	75
2001-2500	50

Table A4.3-2. Percentage of brown trout population removed corresponding brown trout population size used during model simulations.

Percentage removed	Brown Trout Pop. Size
0	2,092
10	1,883
20	1,674
30	1,464
40	1,255
50	1,046
60	837
70	628
80	418
90	209
100	0

Table A4.3-3. Rainbow trout introduction size and corresponding age class to which the rainbow trout were introduced during model simulations.

Introduction Size	Age Class Introduced
2,000	First adult spawning
5,000	First adult spawning
10,000	First adult spawning
40,000	Juvenile
1,000,000	Fry

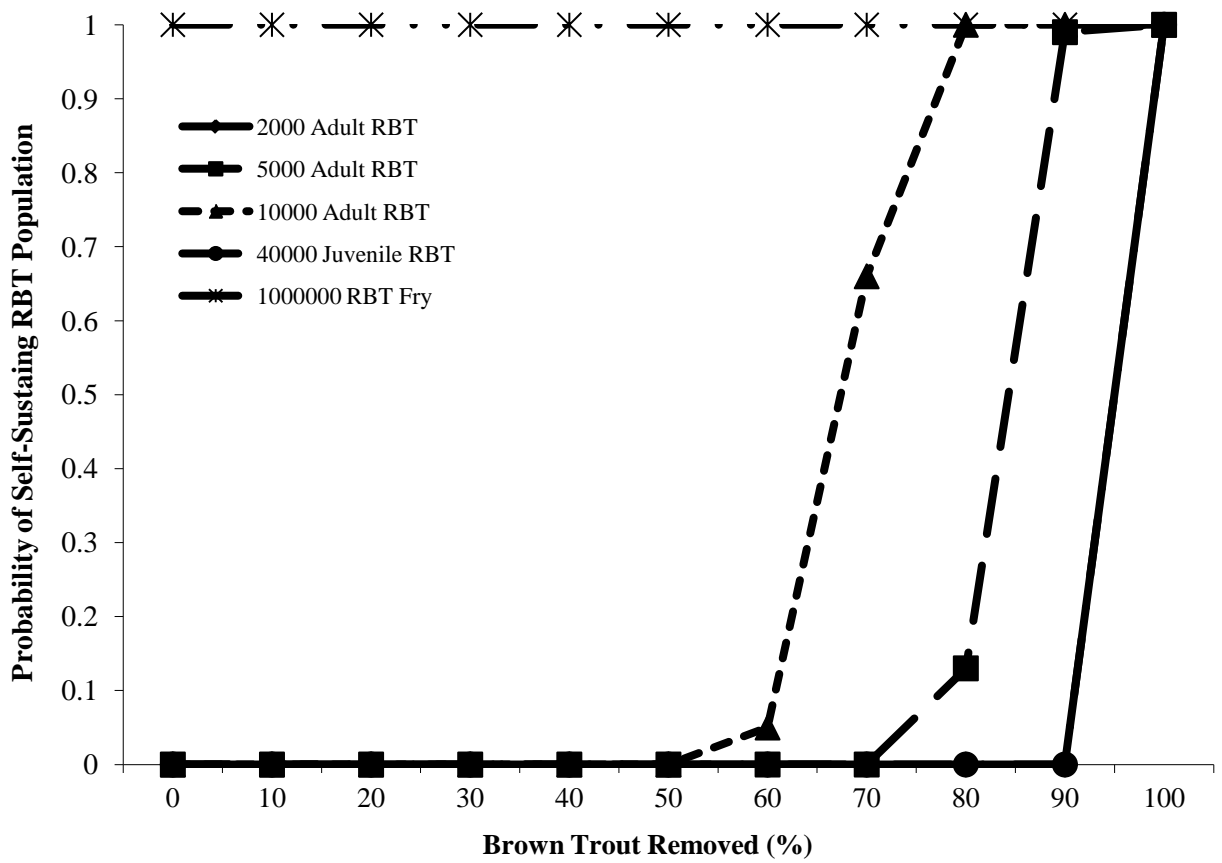

Figure A4.3-1. Percent brown trout removed and the probability that a self-sustaining, whirling disease-resistant rainbow trout population is established following a single introduction of rainbow trout to large rivers with reduced levels of competition ($C = 0.00001$) and few alternative brown trout prey sources ($G = 1.0$).

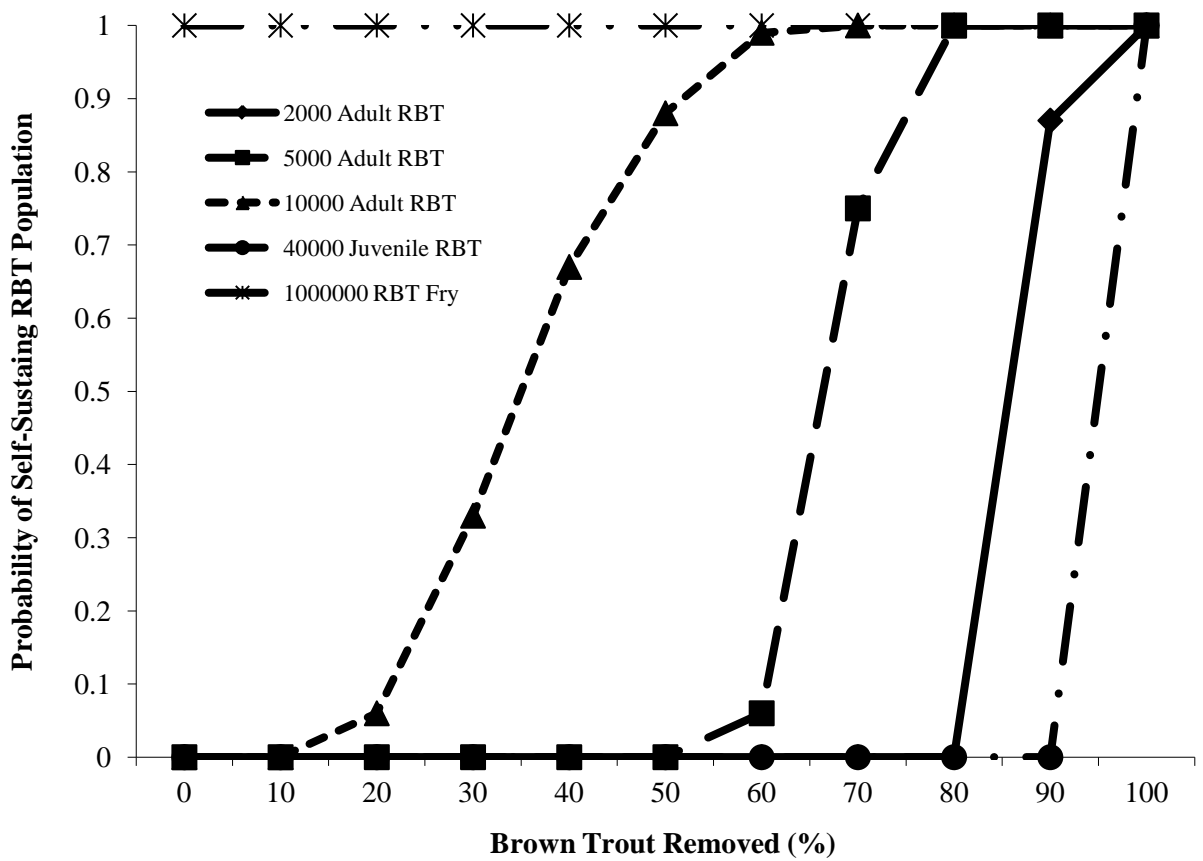

Figure A4.3-2. Percent brown trout removed and the probability that a self-sustaining, whirling disease-resistant rainbow trout population will be established following a single introduction of rainbow trout to large rivers with reduced levels of competition ($C = 0.00001$) and an abundance of alternative brown trout prey sources ($G = 0.5$).

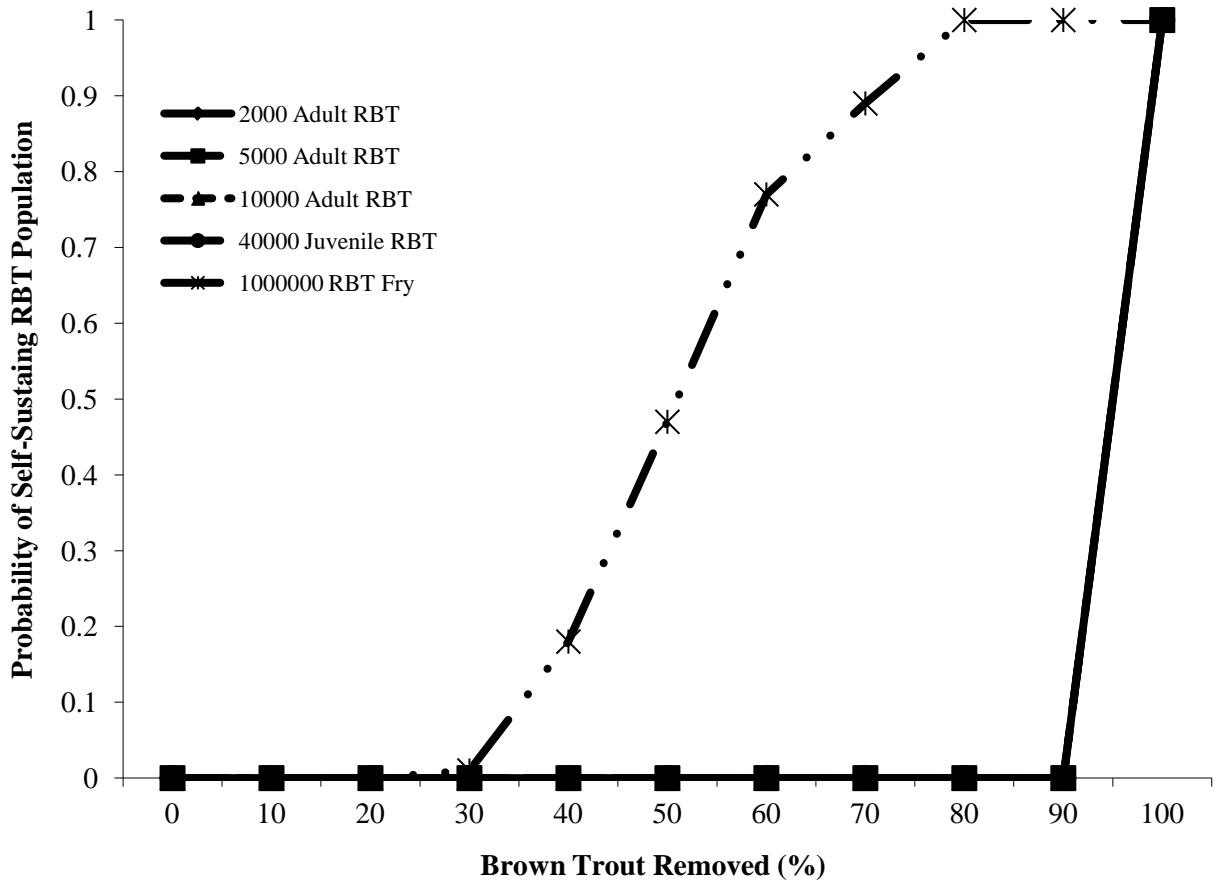

Figure A4.3-3. Percent brown trout removed and the probability that a self-sustaining, whirling disease-resistant rainbow trout population will be established following a single introduction of rainbow trout to small rivers with high levels of competition ($C = 0.0001$) and few alternative brown trout prey sources ($G = 1.0$).

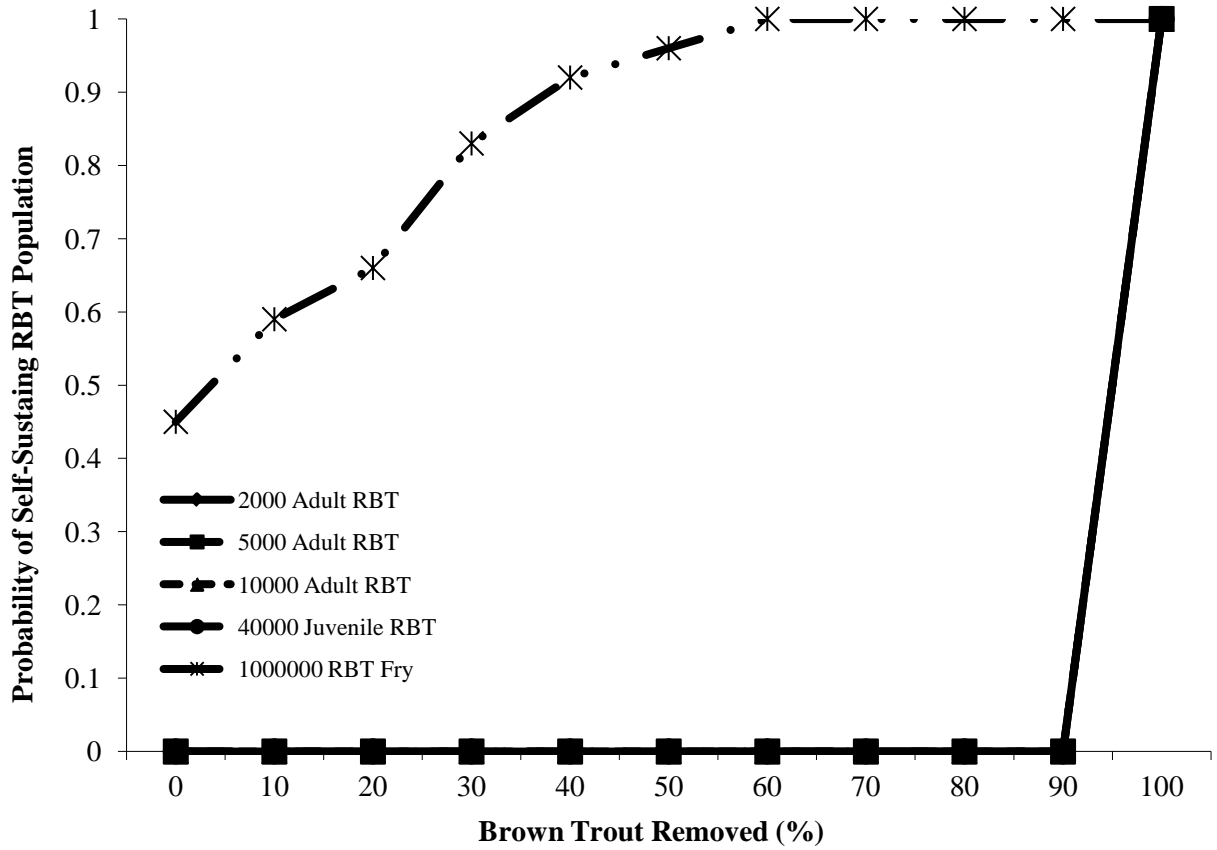

Figure A4.3-4. Percent brown trout removed and the probability that a self-sustaining, whirling disease-resistant rainbow trout population will be established following a single introduction of rainbow trout to small rivers with high levels of competition ($C = 0.00001$) and an abundance of alternative brown trout prey sources ($G = 0.5$).