

QC852
.C6
no.616

**TEMPERATURE DATA CONTINUITY
WITH THE AUTOMATED SURFACE
OBSERVING SYSTEM**

Alison D. Schrumpf
Thomas B. McKee

**Colorado
State**
University

Climatology Report No. 96-2

**DEPARTMENT OF
ATMOSPHERIC SCIENCE**

PAPER NO. 616

**TEMPERATURE DATA CONTINUITY WITH THE
AUTOMATED SURFACE OBSERVING SYSTEM**

**Alison D. Schrumpf
Thomas B. McKee**

**Department of Atmospheric Science
Colorado State University
Fort Collins, CO 80523-1371**

**This research was supported by the National
Weather Service, Office of Meteorology,
under NOAA grant #NA37RJ0202 - Item 9.**

June 1996



U18401 3937397

Atmospheric Science Paper No. 616

Climatology Report No. 96-2

TEMPERATURE DATA CONTINUITY WITH THE AUTOMATED SURFACE OBSERVING SYSTEM

ABSTRACT

The National Weather Service has been installing Automated Surface Observing Systems (ASOS) at all first-order weather stations since 1991 as a part of their modernization program. The introduction of this new, automated method of observing the atmosphere has brought with it inherent differences in measuring surface meteorological conditions. One such affected variable is surface air temperature. When ASOS temperature readings at various weather stations were compared to simultaneous temperature readings reported by the Model HO83 instrument, which is used in conventional, man-made observations at those stations, discrepancies were often noted. These discrepancies lead to inevitable inhomogeneity in the temperature time series at stations where ASOS is installed. This investigation examines the sources contributing to these temperature differences for each of the 76 stations in this study.

Examination of temperature differences between conventional observations (using the Model HO83 and designated as CONV for this study) and pre-commissioned ASOS observations have shown conventional observations are warmer (for a large majority of stations) than the corresponding ASOS temperature measurements. Comparing all synoptic hours for all seasons, the average ASOS – CONV temperature differences ranged from -2.56°F (ATL) to $+0.61^{\circ}\text{F}$ (ORH), with a mean value of -0.79°F . Of the 76 stations

in this study, only 5 displayed an overall positive difference indicating ASOS was warmer than CONV. Major sources for the temperature differences between the two instruments were attributed to instrument bias, local effects, and solar effects.

Instrument biases, which resulted from the introduction of the ASOS temperature instrument, were calculated using nighttime observations when overcast skies were reported. Seasonal instrument biases were calculated for all of the 76 stations for every available season. Of the four seasons, summer had the fewest number of nighttime, overcast-sky observations for most stations. Despite this fact, all but five stations did have at least 30 sampled temperature comparisons from which to calculate the summer instrument bias. The seasonal instrument biases were predominantly negative indicating ASOS was cooler than CONV by an average of 0.53°F , and ranged from -2.17°F (ATL in the fall) to $+1.17^{\circ}\text{F}$ (ORH in the spring). Annual instrument biases were calculated using the seasonal values, and again these numbers were largely negative with a range of -1.96°F (ATL) to $+1.16^{\circ}\text{F}$ (ORH). Of the 76 stations, only 9 had positive annual instrument biases. Seasonal instrument biases did fluctuate slightly with the changing seasons, most likely due to electronic instabilities in the CONV instrument. For more than 67 percent of the stations, these fluctuations were $< 0.5^{\circ}\text{F}$, with at least 20 percent of the stations in each season having instrument biases in excess of -1.0°F .

Nighttime local effects were introduced as a contributing factor in the overall temperature differences since ASOS was most often installed at an entirely new location, rather than immediately next to the CONV instrument. Seasonal nighttime local effects, calculated by removing the seasonal instrument biases from the seasonal nighttime

temperature differences, were fairly variable throughout the year with changes in both magnitude and sign convention quite common. These seasonal values were predominantly negative with a range of -1.29°F (SAV in the spring) to $+0.91^{\circ}\text{F}$ (TLH in the summer). Annual contributions by these nocturnal effects were negative for 47 of the 76 stations, indicating that ASOS were most often placed in locations which were cooler at night than the CONV sites. Annual values ranged from -1.11°F (INW) to $+0.70^{\circ}\text{F}$ (TLH) with an average value of -0.16°F . As mentioned above, the seasonal nighttime local effects did fluctuate over the course of the year. Of the 31 four-season stations, 5 displayed evidence of an annual cycle in these nocturnal contributions with summer having the largest negative value and winter the least. In addition, 12 out of the 66 stations with at least three seasons of data displayed trends in temperature differences over the course of the year. Instead of displaying the sinusoidal fluctuations in local effects like many stations, these differences constantly became more negative, and in a few cases more positive, over time. The large remainder of stations showed considerably more moderate fluctuations over the four seasons, or had only one season which behaved quite differently than the other three.

The final contributions to the temperature differences between ASOS and CONV were the daytime local and solar effects. Seasonal values, calculated by removing the seasonal instrument biases from the seasonal daytime temperature differences, were largely negative and ranged from -2.26°F (JKL in the summer) to $+0.91^{\circ}\text{F}$ (DSM in the fall). Annually averaged contributions by daytime local and solar effects were overwhelmingly negative as 67 of the 76 stations had negative values ranging from -1.54°F (JKL) to

+0.61°F (VTN), with a mean of -0.37°F. These findings support evidence that the HO83 hygrothermometer is subject to a solar heating problem not experienced by the ASOS instruments, which is apparent in the daytime observations. Fluctuations in the seasonal daytime effects were also observed, with 33 percent of the four-season stations providing an indication of annual cycles in the daytime effects, with summer having the largest negative value.

Also noted in this investigation was a time dependence on temperature differences between ASOS and CONV readings. Seasonal diurnal cycles for 60 percent of the stations showed the largest, negative difference during the daylight hours, with a noticeable decrease in temperature difference at night, evidence again of the warm bias due to solar heating in the CONV instrument. At 21 percent of the stations, however, this diurnal cycle pattern was reversed due to strong, nocturnal, local influences. This particular nighttime phenomena is the direct result of ASOS quite often being installed at a new location which is cooler at night than the location of the CONV instrument.

Finally, regional similarities were noted during analysis of local and solar effects and temperature time series. Stations in high-sunshine climatic zones, such as TUS, LAS, and ABQ had the largest negative daytime local and solar effects, once more evidence in favor of an existing warm bias in the HO83 hygrothermometer. In addition, coastal sites displayed particularly stable temperature time series plots in contrast to inland, continental sites which showed considerably more variability over the course of this investigation.

ACKNOWLEDGMENTS

This research was supported by the National Weather Service, Office of Meteorology, Climate Data Continuity with ASOS Project under NOAA grant #NA37RJ0202 - Item 9. Data for this project came from the National Climate Data Center in Asheville, North Carolina.

The authors would like to thank Dr. Wayne Schubert and Dr. Paul Mielke for their time and support. Also, thanks and appreciation to John Kleist for his unwavering patience and assistance in programming and to Odie Bliss for her expert talents in helping with the design and presentation of this document.

Captain Alison Schrupf would also like to extend a very special thank you to her husband, Brad, for all his support, companionship, and love. She would also like to thank the United States Air Force for providing her this opportunity for graduate study.

TABLE OF CONTENTS

	Page
ABSTRACT	iii
ACKNOWLEDGMENTS	vii
LIST OF TABLES	x
LIST OF FIGURES	xi
1.0 INTRODUCTION	1
1.1 Modernization.....	1
1.2 The Data Set.....	2
1.3 Purpose	4
2.0 THE DATA	
2.1 The Instruments	6
2.1.1 HO83 Hygrothermometer	6
2.1.2 ASOS Hygrothermometer	9
2.2 Site Locations and Classification.....	13
2.3 Location Effects.....	15
2.4 Observations.....	20
3.0 TEMPERATURE COMPARISONS	
3.1 Concept, $\Delta T = \Delta T_i + \Delta T_l + \Delta T_s$	22
3.2 Data Problems	23
3.2.1 Accumulated ΔT Plots.....	25
3.2.2 Time Series Analysis.....	34
3.3 Instrument Bias, ΔT_i	38
3.3.1 Nighttime, High-wind Analysis	38
3.3.2 Nighttime, Overcast-sky Analysis	48
3.4 Nighttime Local Effects, ΔT_l	58
3.5 Daytime Local and Solar Effects, ΔT_s	64
3.6 Diurnal Cycles	68
3.7 Annual Cycles and Trends.....	71
3.8 Regional Effects	76
4.0 CONCLUSIONS.....	84

5.0 REFERENCES	86
APPENDIX A -- Temperature Time Series Plots	89
APPENDIX B -- Seasonal Diurnal ΔT Cycles	166

LIST OF TABLES

Table 2.1 Stations Used in Temperature Comparison Study.....	14
Table 2.2 Seasonal Division of Days.....	15
Table 3.1 (A) Tabulated ΔT vs. Wind Speed for CLE.....	40
(B) Tabulated ΔT vs. Wind Speed for TUS.....	41
(C) Tabulated ΔT vs. Wind Speed for ACY.....	42
(D) Tabulated ΔT vs. Wind Speed for FSD.....	43
(E) Tabulated ΔT vs. Wind Speed for TLH.....	44
Table 3.2 (A) Tabulated ΔT vs. Cloud Cover for SAV.....	50
(B) Tabulated ΔT vs. Cloud Cover for LAS.....	50
(C) Tabulated ΔT vs. Cloud Cover for MHS.....	50
Table 3.3 (A) Seasonal and Annual Instrument Biases for 4-Season Stations.....	53
(B) Seasonal and Annual Instrument Biases for 3-Season Stations.....	54
(C) Seasonal and Annual Instrument Biases for 2-Season Stations.....	55
Table 3.4 (A) Seasonal and Annual Nighttime Local Effects for 4-Season Stations.....	61
(B) Seasonal and Annual Nighttime Local Effects for 3-Season Stations.....	62
(C) Seasonal and Annual Nighttime Local Effects for 2-Season Stations.....	63
Table 3.5 (A) Seasonal and Annual Daytime Local & Solar Effects for 4-Season Stations.....	65
(B) Seasonal and Annual Daytime Local & Solar Effects for 3-Season Stations.....	66
(C) Seasonal and Annual Daytime Local & Solar Effects for 2-Season Stations.....	67

LIST OF FIGURES

Fig 2.1 Typical Schematic of Model HO83 and ASOS Hygrothermometers	7
Fig 2.2 Three Components of Model HO83 Hygrothermometer	8
Fig 2.3 Typical ASOS Sensor Array	11
Fig 2.4 Graphical Locations of 4-Season Stations	16
Fig 2.5 Graphical Locations of 3-Season Stations	17
Fig 2.6 Graphical Locations of 2-Season Stations	18
Fig 3.1 (A) Accumulated DT Plots for CYS	26
(B) Accumulated DT Plots for ACY	27
(C) Accumulated DT Plots for CLE	28
(D) Accumulated DT Plots for ERI	29
(E) Accumulated DT Plots for TUS	30
(F) Accumulated DT Plots for VTN	31
(G) Accumulated DT Plots for SGF	32
Fig 3.2 (A) $\Delta T_{\text{highest hourly}}$ and $\Delta T_{\text{lowest hourly}}$ Time Series Analysis for ACY	35
(B) $\Delta T_{\text{highest hourly}}$ and $\Delta T_{\text{lowest hourly}}$ Time Series Analysis for CLE	36
(C) $\Delta T_{\text{highest hourly}}$ and $\Delta T_{\text{lowest hourly}}$ Time Series Analysis for TUS	37
Fig 3.3 (A) ΔT vs. Wind Speed for FSD	46
(B) ΔT vs. Wind Speed for SAV	46
(C) ΔT vs. Wind Speed for DSM	47
(D) ΔT vs. Wind Speed for SGF	47
Fig 3.4 (A) ΔT vs. Cloud Cover for FSD	51
(B) ΔT vs. Cloud Cover for SAV	51
(C) ΔT vs. Cloud Cover for DSM	52
(D) ΔT vs. Cloud Cover for SGF	52
Fig 3.5 (A) Seasonal Instrument Biases Including 95% Confidence Intervals for 4-Season Stations for Fall	57

Fig 3.5 (B) Seasonal Instrument Biases Including 95% Confidence Intervals for 4-Season Stations for Winter	57
(C) Seasonal Instrument Biases Including 95% Confidence Intervals for 4-Season Stations for Spring	57
(D) Seasonal Instrument Biases Including 95% Confidence Intervals for 4-Season Stations for Summer.....	57
Fig 3.6 Overlay of Instrument Biases for all Four Seasons	59
Fig 3.7 (A) Seasonal Diurnal Cycle for CAE.....	69
(B) Seasonal Diurnal Cycle for CYS	69
(C) Seasonal Diurnal Cycle for TUS	69
(D) Seasonal Diurnal Cycle for JKL.....	69
(E) Seasonal Diurnal Cycle for GRB.....	70
(F) Seasonal Diurnal Cycle for SAV.....	70
Fig 3.8 (A) Annual Cycles & Trends in Nighttime Local Effects for 4-Season Stations	72
(B) Annual Cycles & Trends in Nighttime Local Effects for 3-Season Stations	73
Fig 3.9 (A) Annual Cycles & Trends in Daytime Local & Solar Effects for 4-Season Stations.....	74
(B) Annual Cycles & Trends in Daytime Local & Solar Effects for 3-Season Stations	75
Fig 3.10 (A) $\Delta T_{\text{highest hourly}}$ and $\Delta T_{\text{lowest hourly}}$ Time Series Analysis for JKL	77
(B) $\Delta T_{\text{highest hourly}}$ and $\Delta T_{\text{lowest hourly}}$ Time Series Analysis for CAE	78
Fig 3.11 (A) $\Delta T_{\text{highest hourly}}$ and $\Delta T_{\text{lowest hourly}}$ Time Series Analysis for DAB.....	79
(B) $\Delta T_{\text{highest hourly}}$ and $\Delta T_{\text{lowest hourly}}$ Time Series Analysis for LCH	80
(C) $\Delta T_{\text{highest hourly}}$ and $\Delta T_{\text{lowest hourly}}$ Time Series Analysis for FSD.....	82
(D) $\Delta T_{\text{highest hourly}}$ and $\Delta T_{\text{lowest hourly}}$ Time Series Analysis for SLN	83

1.0 INTRODUCTION

A comparison of temperature measurements reported by conventional (CONV) observations at manned National Weather Service stations using the Model HO83 temperature instrument and pre-commissioned ASOS observations at those same stations has been conducted. The predominantly negative differences (ASOS – CONV) in ambient air temperature between the two instruments are indicative of the warm bias in the CONV measurements as compared to ASOS measurements. Sources contributing to these temperature differences have been categorized as being due to instrument bias, local effects, and solar effects, and were analyzed on both seasonal and annual scales. At the time of this writing, there has not been a great deal published on temperature comparisons between conventional and ASOS observations outside of the quarterly and annual progress reports for the *Climate Data Continuity with ASOS* project conducted by the Colorado Climate Center since 1991. Similar to those reports, this study investigates the sources of the temperature differences between ASOS and CONV measurements and illustrates how current weather, specifically winds and cloud cover, affect temperature differences between the two instruments.

1.1 Modernization

In keeping with an agreement reached in the late 1980s between the National Weather Service, Federal Aviation Administration, and the Department of the Navy, the

National Weather Service has been installing ASOS throughout the United States since 1991 (Nadolski, 1995). The installation of these automated systems is part of the National Weather Service's Modernization Program. According to the March 1996 *National Weather Service Modernization Update*, as of March 7, 1996 there were 699 ASOS installed throughout the United States, and of these 673 had been accepted and 245 of those were commissioned. Approximately 800 systems will be commissioned when the National Weather Service modernization effort is complete.

ASOS was designed to automate the weather observing process and allow weather station personnel more time to accomplish other tasks such as forecasting. In addition, automating the surface observing process is intended to reduce costs, expand areal coverage, provide data 24 hours each day and get rid of the subjectivity inherent in manual observations such as visibility and estimates of winds. A general introduction to ASOS is included in the *ASOS User's Guide* (National Weather Service, 1992). ASOS is a microprocessor-based system which uses an array of sensors with advanced algorithms to process not only synoptic weather data, but to disseminate a Surface Aviation Observation (SAO) for the station (Nadolski, 1995).

1.2 The Data Set

The data used for this investigation was obtained from the National Climate Data Center (NCDC) in Asheville, North Carolina. The data was transmitted electronically to the Colorado Climate Center (CCC) at Colorado State University for use in the *Climate Data Continuity with ASOS* project. The data set consists of hourly SAOs for both

conventional observations and pre-commissioned ASOS observations, when available, for 76 sites across the continental United States for the period of September 1, 1994 through August 31, 1995. Due to installation and commissioning dates, not all stations have complete ASOS data for the whole year of study. Temperature data are reported in whole degrees Fahrenheit.

This investigation took advantage of a brief National Weather Service moratorium on ASOS commissionings during the winter of 1994-1995. During this period no ASOS systems were commissioned as the official observing and reporting method for any stations, but they had been accepted and were transmitting observed weather data. This moratorium allows a unique comparison between pre-commissioned ASOS temperature observations and conventional hourly SAOs.

Overall, a total of 1,017,646 temperature observations were used during this study. Never before has there been such an extensive comparison between ASOS and conventional methods of temperature measurement. The hourly data allowed exploration of diurnal cycles in ASOS - CONV temperature differences, as well as enhancing daytime and nighttime effects.

One item to note is that there are no daily maximum and minimum temperature comparisons in this investigation since CONV observations were no longer required to report maximum and minimum temperatures as of January 1, 1995. Instead, this study compared the highest ($\Delta T_{\text{highest hourly}}$) and lowest ($\Delta T_{\text{lowest hourly}}$) hourly temperature values reported by both ASOS and CONV during each 24-hour period (midnight to midnight local standard time). It is also important to add that the hours of highest and lowest temperature for ASOS and CONV did not often coincide, such that the ASOS highest

hourly temperature for a certain day did not necessarily occur at the same hour as did the CONV highest hourly temperature, and the same was true for the lowest hourly temperatures.

1.3 The Purpose

At present, the National Weather Service is still a few years away from completing the installation of all ASOS systems in the United States. The moratorium on ASOS commissionings allowed a unique opportunity to compare temperature measurements made by conventional methods (HO83) and pre-commissioned ASOS systems at quite a number of stations, most of which were not previously considered for any comparisons.

The main goal of this investigation was to determine specific causes for relative temperature differences between ASOS and CONV temperature measurements. Factors affecting temperature differences were attributed to either instrument biases inherent in the manufacture of the instruments, local effects due to instrument separation, and solar heating effects due to exposure to the sun. Mean values for each of these factors at each station were determined both seasonally and annually in an attempt to provide a fairly accurate measure of the temperature differences throughout the year.

Other goals were to determine temporal variabilities in temperature differences between ASOS and CONV readings. Seasonal diurnal cycles were plotted for each station to see how temperature differences varied over the course of an average day within that season. Also, seasonal accumulated temperature differences were examined for changes in the temperature relationship between ASOS and CONV instruments. Time

series analysis of daily highest hourly and lowest hourly temperature differences plotted for the entire period record shifts between instruments and indicate annual cycles at a few sites. Of particular interest in isolating instrument biases were wind and sky cover conditions, since these meteorological variables have the most profound impact on temperature differences.

2.0 THE DATA

2.1 The Instruments

Physically the two instruments compared in this study are very similar in appearance and design. The main visual difference is the air deflection skirt located at the bottom of the aspirator cylinder on the ASOS instrument. Figure 2.1 shows a typical schematic representation of the Model HO83 and the ASOS hygrothermometers. Both instruments measure ambient air temperature using a platinum Resistive Temperature Device (RTD) enclosed in an aspirated, shielded cylinder. An important fact to note here is since the HO83 is an older instrument it is perhaps not quite as electronically stable as the newer ASOS hygrothermometer. Plus, the CONV instrument has been in the field for a number of years now, and in many cases the sensor housing has weathered, no longer retaining its original bright white and highly reflective surface.

2.1.1 HO83 Hygrothermometer

The Model HO83 Hygrothermometer System was manufactured by Technical Services Laboratory to be a climatic thermometer and dew/frost point indicator for the National Weather Service (Instruction Manual Hygrothermometer HO83, 1984). The system consists of three separate components: aspirator, transmitter, and a display unit as shown in Figure 2.2. Ideally the aspirator was placed outdoors in a location where it

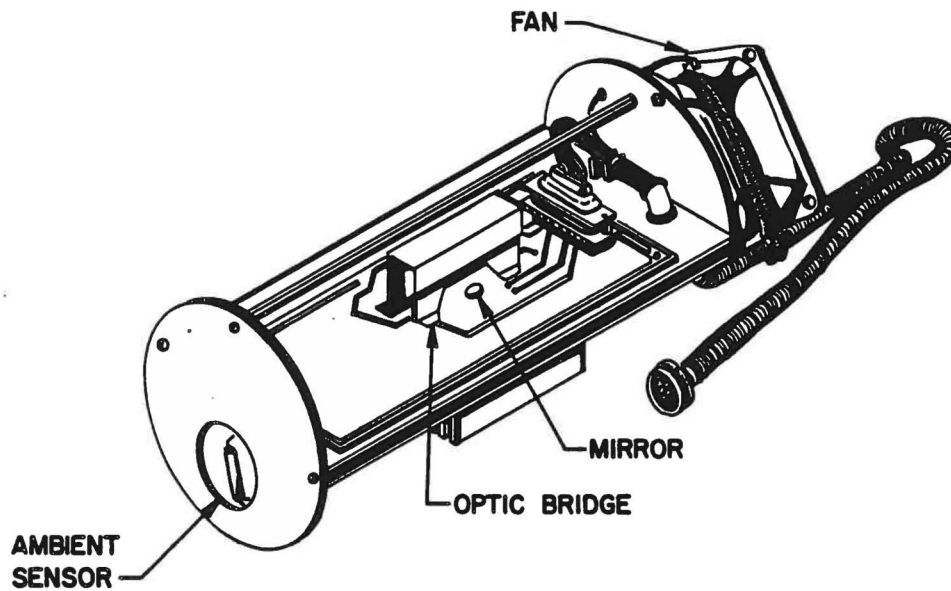
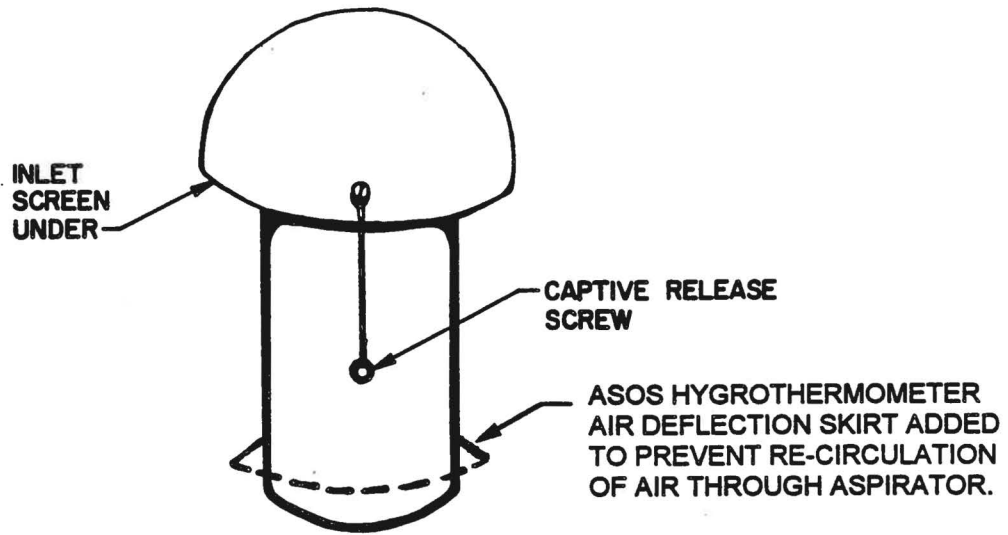

Fig. 2.1 Typical schematic of Model HO83 Hygrothermometer. The ASOS Hygrothermometer is very similar in appearance with the addition of the air deflection skirt pictured above. (Instruction Manual Hygrothermometer HO83, Vol 1, 1984.)

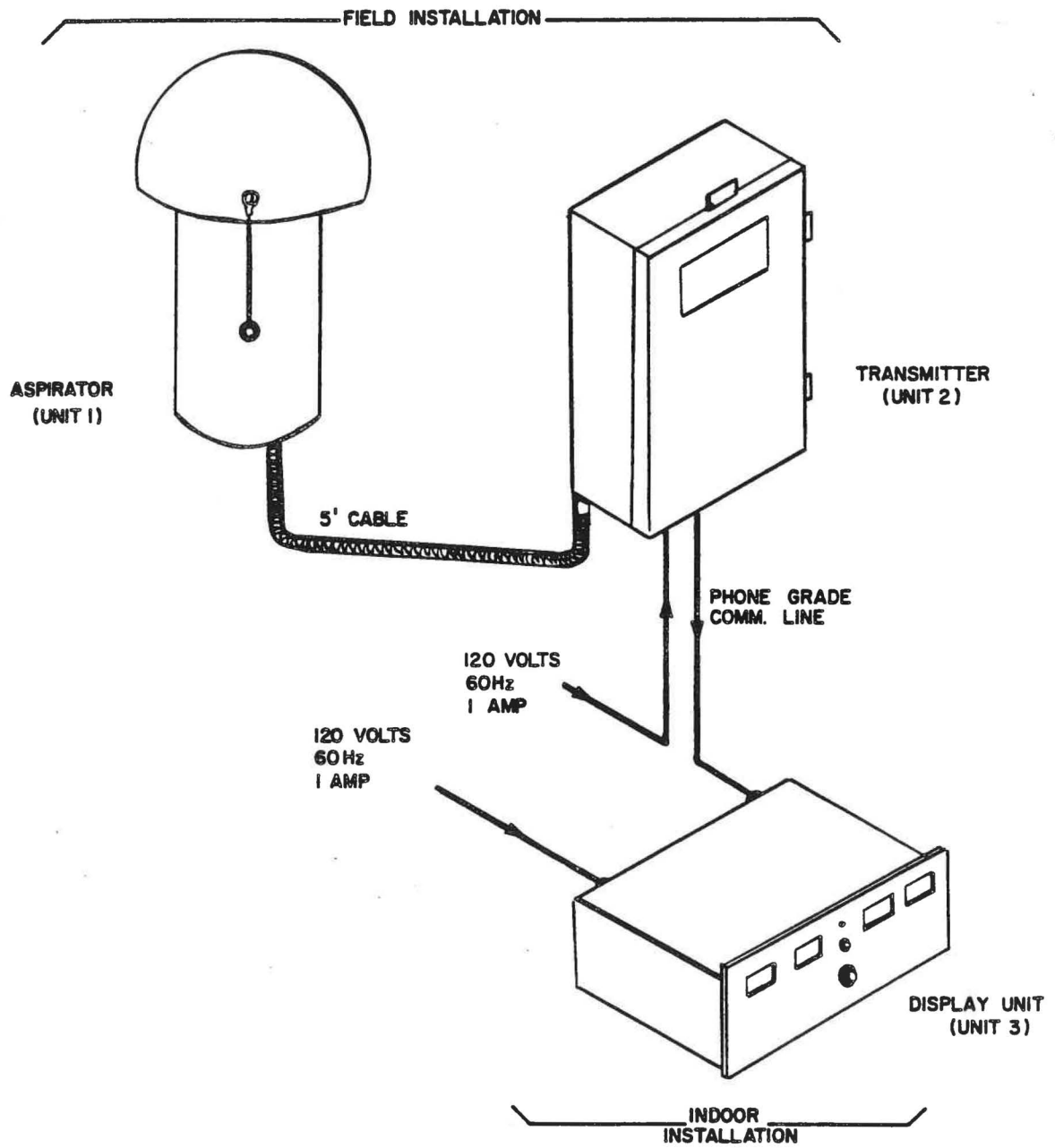

Fig. 2.2 Schematic representation of the three components of the Model HO83 Hygrothermometer. (Instruction Manual Hygrothermometer HO83, Vol 1, 1984).

could sample the surface atmosphere without contamination due to ground water, vegetation, and other distractive influences. Airflow is drawn into the top of the aspirator dome and directed downward through the cylinder casing where it is sampled by the ambient air temperature sensor before being expelled from the bottom of the cylinder housing. The transmitter is positioned close by the aspirator, usually within five feet, and is designed to be weatherproof. The final component, the remote display unit, is connected via telephone line to the transmitter and is located some distance away from the other two components in an indoor environment.

The HO83 as originally designed features a range of -76°F to $+140^{\circ}\text{F}$ with a resolution of 0.18°F and an accuracy of $\pm 0.9^{\circ}\text{F}$ (Instruction Manual Hygrothermometer HO83, 1984). The platinum-wire RTD is encased in a ceramic cylinder about 1/8 inches in diameter and 3/4 inches in length. At a temperature of $+32^{\circ}\text{F}$ (0°C), the RTD has an electrical resistance of exactly 100 ohms. The resistance varies linearly with temperature at a rate of 0.392 percent per degree Celsius. Both a maximum and minimum temperature display are available, but values for each are simply the highest and lowest temperature readings since the last system “reset,” which is accomplished by manually depressing both the Max/Min Reset Switch and the Fahrenheit Display Switch located on the display panel at the same time. Data for this investigation from the Model HO83 instruments used the 5-minute average temperature output.

2.1.2 ASOS Hygrothermometer

The ASOS hygrothermometer has a design that is similar to the Model HO83 hygrothermometer, and operates in much the same way using a platinum RTD. The

current ASOS instrument, fielded in late 1993 and early 1994, incorporates several modifications to the original ASOS hygrothermometer. The aspiration rate was increased to allow more air flow past the sensor, and the aspirator fan was moved from the bottom to the top of the aspirator changing the direction of air flow to upward instead of downward through the instrument casing. Also, an air deflection skirt was placed around the lower portion of the aspirator body to prevent recirculating expunged air from the top of the shield. Next, the RTD element was changed from a 0.1% to a 0.03% basic accuracy. And finally, the electrical circuitry was improved with low temperature coefficient resistors (Crosby and Nadolski, 1993). Figure 2.3 shows a typical ASOS sensor array with the temperature/dewpoint sensor positioned second from the left end.

System specifications for the ASOS temperature sensor report range limits of -80°F to $+130^{\circ}\text{F}$, with 0.1°F resolution. Accuracy for this sensor is $\pm 0.9^{\circ}\text{F}$ for readings between -58°F and 122°F , and $\pm 1.8^{\circ}\text{F}$ for readings between -80°F and -58°F and between 122°F and 130°F (ASOS User's Guide, 1992).

According to the ambient temperature algorithm, the sensor samples the atmosphere six times each minute to obtain a one-minute average ambient temperature value. If any consecutive one-minute readings differ by more than 6°F , then the current reading is marked as missing. Next, a 5-minute average temperature value is calculated using the last five one-minute readings. If four or more temperature values are valid in the last five minutes, ASOS performs a linear average to obtain the new 5-minute temperature reading. However, if less than four temperature readings are available for the previous five minutes, ASOS does not calculate a new 5-minute reading but uses the most current reading for the last 15 minutes. If there are no new temperature readings computed in the

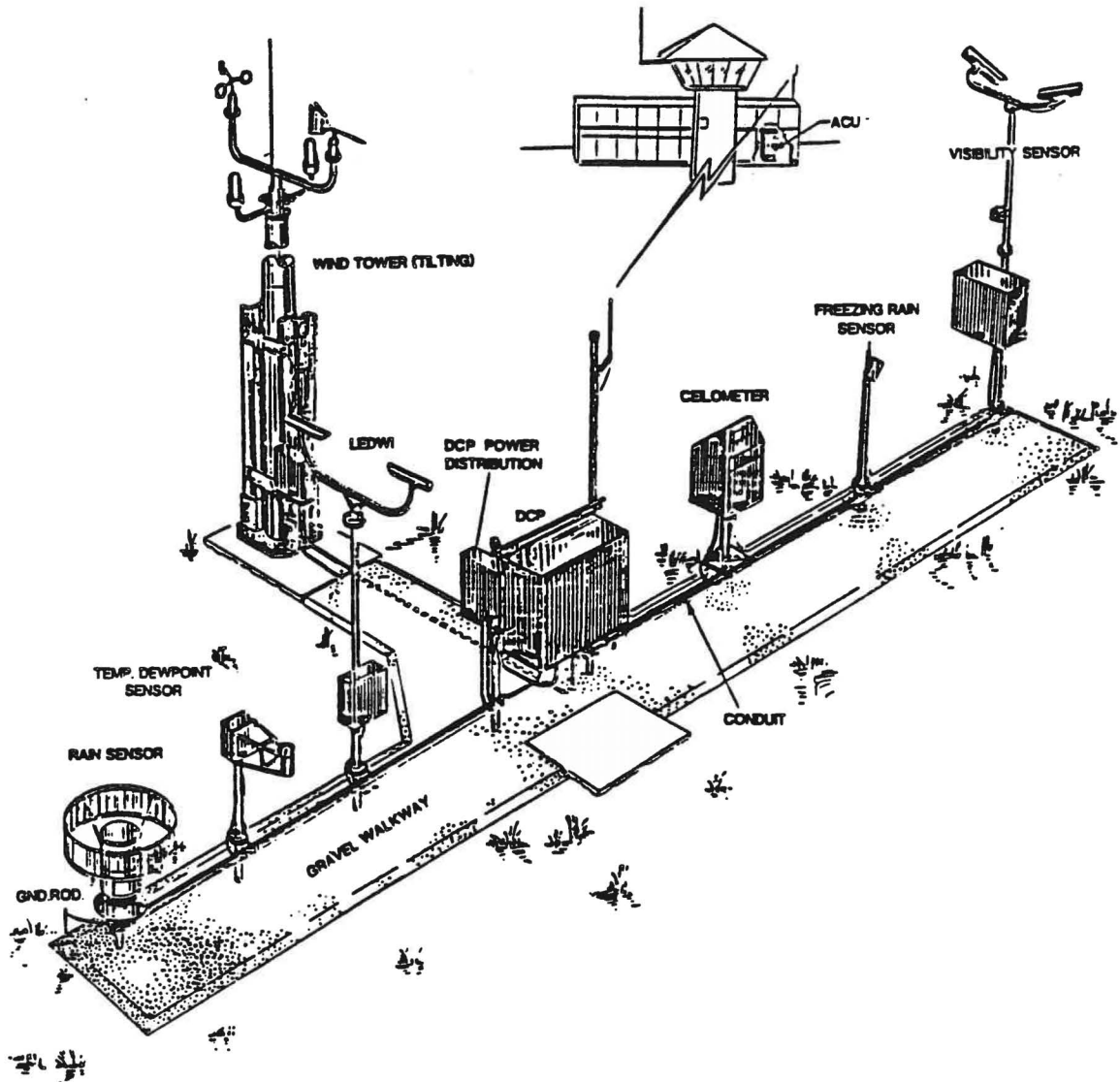

Fig. 2.3 Typical ASOS sensor array. (ASOS Level II System Manager Training Course Student Guide, 1992.)

last 15 minutes, then the output is marked as missing “-99” (Chu, 1994). The one-minute data can be stored for 12 hours before being written over by new data. And all the daily and monthly averages are calculated at midnight local standard time each night and on the first day of each month for the previous month, respectively. Data for this investigation used the ASOS 5-minute average temperature measurements.

As to the reliability and availability of the ASOS temperature sensor, the *Third ASOS Aviation Demonstration Industry Briefing* (National Weather Service, 1995) reported that the sensor was available on an average of 99.65% of the time with mean outages of 2.4 hours usually caused by sensor hardware, power failure, or on-site maintenance. Among all of the meteorological sensors in the ASOS array, the temperature sensor had the second highest number of outage times with an average of 639 hours between missing sensor events. Also, comparisons have been made to determine the performance characteristics of ASOS with respect to “true” ambient air temperature (McKee, et al., 1996). Direct comparisons between three modified ASOS hygrometers and a calibrated, National Weather Service secondary field standard (R. M. Young) in 1994 “found no systematic bias [of the ASOS instruments] relative to the National Weather Service secondary standard.” The tests indicated that ASOS has a range between instruments of approximately $\pm 0.3^{\circ}\text{F}$, with more of the instruments being cooler as opposed to warmer. Since there is no calibration against a field standard before each ASOS is commissioned, this range is presumably accurate for the current ASOS temperature instruments.

2.2 Site Locations and Classifications

The 76 stations chosen for this investigation were widely scattered across the continental United States (CONUS). Table 2.1 gives a complete listing of all the stations investigated in this study including station identifier (SID), station name, station location, and commissioning date when applicable.

Much of the data analysis involved stratifying the data into daytime and nighttime hours. In order to use the same set of hours for daytime and nighttime analysis, the stations were divided into groups based on their respective Local Standard Time Zone. Daytime was defined as the seven-hour period inclusive of 9:00am to 3:00pm LST, and night as the seven-hour period inclusive of 10:00pm to 4:00am LST. Table 2.1 also shows which time zone each of the stations is in, as well as the number of seasons each station had available for a complete analysis.

Each of the stations is classified based on the amount of data available for comparison at that station. The amount of data available is largely a function of installation dates, commissioning dates, and system outages. Since the ASOS systems used during the period of comparison with CONV temperature observations were not commissioned, it is likely that the pre-commissioned ASOS maintenance standards were different from those required for commissioned ASOS instruments. There are three categories of stations for analysis: four-season stations, three-season stations, and two-season stations. ACY is in the 4-season group, but was analyzed separately for the additional summer season because the ASOS instrument was relocated during this study. Each season consists of three consecutive months based on the following divisions:

Table 2.1 Stations used in Temperature Comparison Study

SID	Station Name and Location	LST Zone	# of seasons	Date Commissioned
ABE	Allentown, PA	Eastern	3	
ABQ	Abuquerque, NM	Mountain	3	
ACY [#]	Atlantic City, NJ	Eastern	4	
ALB	Albany, NY	Eastern	3	Commissioned Aug-95
ALO	Waterloo, IA	Central	3	
APN ^c	Alpena, MI	Eastern	3	
ATL	Atlanta, GA	Eastern	3	Commissioned Aug-95
AUS	Austin, TX	Central	3	Commissioned Jul-95
BFF	Scottsbluff, NE	Mountain	3	Commissioned Jun-95
BGM	Binghamton, NY	Eastern	4	
BIL	Billings, MT	Mountain	2	Commissioned May-95
BIS	Bismarck, ND	Central	4	
CAE	Columbia, SC	Eastern	4	
CAK	Akron, OH	Eastern	2	
CLE	Cleveland, OH	Eastern	4	
COU	Columbia, MO	Central	4	
CYS	Cheyenne, WY	Mountain	4	
DAB	Daytona Beach, FL	Eastern	3	Commissioned Jun-95
DAY	Dayton, OH	Eastern	3	
DRA	Mercury, NV	Pacific	2	
DSM	Des Moines, IA	Central	4	
DTW	Detroit, MI	Eastern	3	Commissioned Jul-95
ERI	Erie, PA	Eastern	4	
EUG	Eugene, OR	Pacific	3	
FAR	Fargo, ND	Central	4	
FNT	Flint, MI	Eastern	2	Commissioned Jun-95
FSD [#]	Sioux Falls, SD	Central	4	
FWA	Fort Wayne, IN	Eastern	3	
GEG	Spokane, WA	Pacific	2	
GJT	Grand Junction, CO	Mountain	3	
GRB	Green Bay, WI	Central	4	
HON	Huron, SD	Central	3	
INL	International Fall, MN	Central	3	
INW	Winslow, AZ	Mountain	3	Commissioned Jul-95
ISN	Williston, ND	Central	2	
JAX	Jacksonville, FL	Eastern	4	
JKL	Jackson, KY	Eastern	4	
LAN	Lansing, MI	Eastern	3	
LAS	Las Vegas, NV	Pacific	4	
LBB	Lubbock, TX	Central	3	
LBF [#]	North Platte, NE	Central	2	
LCH	Lake Charles, LA	Central	3	
LEX ^c	Lexington, KY	Eastern	4	
MCI	Kansas City, MO	Central	3	Commissioned Jul-95
MCO	Orlando, FL	Eastern	4	
MGM	Montgomery, AL	Central	3	Commissioned Jul-95
MHS	Mount Shasta, CA	Pacific	4	
MKE	Milwaukee, WI	Central	3	Commissioned Jul-95
MKG	Muskegon, MI	Eastern	3	
MLI	Moline, IL	Central	3	Commissioned Jul-95
MOB	Mobile, AL	Central	4	
MSN	Madison, WI	Central	2	
MSO	Missoula, MT	Mountain	3	
OFK	Norfolk, NE	Central	3	
ORH	Worcester, MA	Eastern	3	Commissioned Jul-95
PAH [#]	Paducah, KY	Central	3	Commissioned Aug-95
PDT	Pendleton, OR	Pacific	3	Commissioned Jun-95
PDX	Portland, OR	Pacific	3	
PIA	Peoria, IL	Central	3	
RAP	Rapid City, SD	Mountain	4	
RDD	Redding, CA	Pacific	4	
RFD	Rockford, IL	Central	3	Commissioned Jul-95
RSL	Russell, KS	Central	4	
RST	Rochester, MN	Central	3	
SAV	Savannah, GA	Eastern	4	
SBN	South Bend, IN	Eastern	4	
SGF [#]	Springfield, MO	Central	4	
SJT	San Angelo, TX	Central	2	
SLN	Salina, KS	Central	4	
SPI	Springfield, IL	Central	4	
SUX	Sioux City, IA	Central	3	Commissioned Jun-95
TLH	Tallahassee, FL	Eastern	4	
TRI	Bristol, TN	Eastern	2	
TUS	Tucson, AZ	Mountain	4	
VTN	Valentine, NE	Central	4	
YNG ^c	Youngstown, OH	Eastern	4	
^c	Collocated Station			
[#]	Station moved			

Table 2.2 Seasonal Divisions

Season	From	To
Fall	September 1, 1994	November 30, 1994
Winter	December 1, 1994	February 28, 1995
Spring	March 1, 1995	May 31, 1995
Summer	June 1, 1995	August 31, 1995

A station is considered to have enough data for a full season's analysis if there are enough observations from both CONV and ASOS present to yield 2/3 of the possible number of temperature comparisons for that season (basically two out of three months worth of data must be present). Of the 76 stations, 31 comprise the four-season list, 35 are on the three-season list, and 10 qualified for the two-season list. Figures 2.4, 2.5, and 2.6 are geographical representations of the locations of the four-season, three-season, and two-season stations, respectively.

A few sites, APN, LEX, and YNG, were found to be collocated sites meaning the two temperature instruments were within several yards of each other. However at other sites, it was discovered that the two instruments were often positioned much farther from each other, in some cases distances greater than one mile were reported, which leads to our next discussion.

2.3 Location Effects

One of the most complicating factors in maintaining integrity in the temperature time series at any station is changing the location of the temperature measuring device. With the installation of ASOS came the decision to place the ASOS sensor array out in the airfield close to the touchdown zone of a primary runway. This new location was, in many

FOUR-SEASON STATIONS



Fig. 2.4 Geographical locations of the four-season stations.

THREE-SEASON STATIONS



Fig. 2.5 Geographical locations of the three-season stations.

TWO-SEASON STATIONS



Fig. 2.6 Geographical locations of the two-season stations.

cases, quite different from where the CONV instrument was taking ambient air temperature measurements.

Site requirements for the HO83 aspirator called for mounting the unit approximately five feet above the ground in any location that could provide unobstructed air flow through the sensor assembly (Instruction Manual Hygrothermometer HO83, 1984). Consequently, these instruments were placed at various distances away from the weather station building, and preferably in locations as far away from standing water and dense vegetation as possible to minimize their effects, especially on the dew point.

Location changes of only a few hundred yards put ASOS further away from buildings and interference from other anthropogenic structures. Occasionally there were times when the ASOS location coincided with the HO83 installation site and the two instruments essentially wound up being collocated. The placement of ASOS in a new location could cause the instrument to be affected by a variety of local effects, which are much different from a site near a building, especially if ASOS is installed near the end of a runway as intended.

Obviously, altering exposure elements between the two sensors is going to cause differences in measured ambient air temperature. In the most extreme cases, when ASOS is installed up to miles away, these differences can be quite distinct. This investigation examines the effects on temperature difference between ASOS and CONV measurements due to these instrument relocations.

2.4 Observations

The data examined in this study consists of over 1,500,000 hourly SAOs from 76 weather stations across the continental United States for a one-year period. Each station had two data streams for comparison. One was the conventional data which included all official observations transmitted during the year of study, including hourly observations, special observations, and record special observations along with any corrections (CORs) to those observations; and the second was the unofficial, pre-commissioned ASOS observations for the same time period, when available, for the same stations. First, the CONV and ASOS hourly SAOs were separated from the rest of the observations. Next, ambient surface air temperature data, reported in whole degrees Fahrenheit, was extracted for each hour from each of the data streams for comparison. Needless to say, when one or both of the data streams were missing for any of the hours, no comparisons were made for those times.

An important note on observation timing should be included here. ASOS is a fully automated observing system and the temperature value which is sent as the current ambient value is the latest 5-minute average at 56 minutes past the hour. On the other hand, CONV SAOs are recorded for transmission sometime between 50 and 59 minutes after the hour. Since the temperature value must be physically read by the observer and entered into the computer for transmission, there is no guarantee that the ASOS and the CONV 5-minute average temperature values will even be for the same five minutes since the observer can read the HO83 Display Unit at any time within roughly a 15 minute

window. These timing differences may lead to even greater temperature differences between reported ASOS and CONV values, especially during periods when the temperature is changing rapidly. These effects cannot be isolated since it is not possible to know exactly when an observer recorded the HO83 ambient temperature, which could be several minutes prior to transmission time.

3.0 TEMPERATURE COMPARISONS

3.1 Concepts

The installation of ASOS marks a transition from CONV observations to automated observations with three important factors: a change of instruments, a change in location of instruments, and an expectation that solar heating effects will be larger for the conventional HO83 instrument (McKee, et al., 1996). Any contribution to temperature differences between ASOS and CONV will be due to a combination of these components.

For each station the hourly SAO temperature values, which are transmitted in whole degrees Fahrenheit, were compared using the difference technique where

$$\Delta T = T_{ASOS} - T_{CONV} \quad (3.1)$$

with the symbols being the ASOS temperature (T_{ASOS}), the CONV temperature (T_{CONV}), and the difference between them (ΔT). The resulting ΔT was expressed as a linear combination of its three contributions: instrument bias (inherent in the manufacture of the temperature sensor), local effects (due to instrument separation and determined by local climatic anomalies), and solar effects (due to exposure to solar radiation, a daytime phenomena only), such that

$$\Delta T = \Delta T_i + \Delta T_l + \Delta T_s \quad (3.2)$$

where the subscripts i = instrument bias, l = local effects, and s = solar effects (McKee, et al., 1996).

Ideally, the three components are separate and distinct contributions. However in reality, it is not possible to completely separate the components, especially the daytime local effects and solar effects. In addition, the temperature differences often fluctuate over time due to various causes discussed in the next section.

3.2 Data Problems

In addition to the data gaps caused by installation dates, commissioning dates, and systems outages previously mentioned, several other data problems affected this investigation. As a rule, temperature differences between ASOS and CONV measurements were ignored if the difference was greater than +9°F or less than -9°F. Differences beyond this range were considered to be outliers caused by some sort of instrument malfunction or data processing problem and were excluded from this analysis. Indeed in many instances, these outliers occurred just before an ASOS system outage.

Compounding the location effects caused by installing ASOS at some distance away from the HO83 was the decision by the National Weather Service to relocate an ASOS instrument sometime during the course of this investigation and after the initial installation. Included as an example, the ASOS at ACY was installed and transmitting weather observations at the beginning of this study. Then in late spring, the ASOS was moved to a site which clearly changed the observed temperature. Other stations like PAH underwent relocation which made continual analysis at those stations for the complete year impossible since CONV data was no longer available for the original site.

Close examination of the temperature differences between ASOS and CONV instruments at each station also revealed several unexplained irregularities in the data. For

example, why did ΔT suddenly change sign convention from negative to positive (ACY), now known to be the result of an instrument move, or positive to negative (VTN)? And why does ΔT have short excursions that don't seem to match long-term, temperature-difference patterns at certain stations (ERI, SGF)? In order to answer these and other questions, it was decided to examine the temperature differences between the two instruments at each station looking at the complete year's worth of data in a single snapshot. The resulting analysis was very helpful in discovering when the two stations exhibited a change in the normal temperature-difference pattern. First, seasonal accumulated temperature difference plots were generated for each station using all hours. These graphs were helpful in depicting significant fluctuations in temperature differences at each site. Any fluctuations indicate that something happened to one or both of the instruments at that site. Since there are two instruments at each location for comparison it is impossible to know which instrument changed without a third, control instrument. What is for certain is that something changed the temperature relationship between the two instruments. These changes could be the result of an instrument being moved, maintenance, replacement of a sensor, or electrical problems. To further investigate the shifts in temperature differences between the two instruments, $\Delta T_{\text{highest hourly}}$ and $\Delta T_{\text{lowest hourly}}$ time series plots were generated for each station for the whole year. These plots were very helpful in determining exactly when a shift occurred, how long it lasted, and whether it affected both the highest and lowest hourly temperatures values equally.

3.2.1 Accumulated ΔT Plots

If two sensors behave the same way all of the time, then a reasonable assumption would be that any temperature difference distinguished between the two should remain fairly constant with time. Graphically, there would be a linear relationship between the accumulated ΔT and time, with the slope of this line being proportional to the overall bias (McKee, et al., 1996). However, any changes in the slope of this line indicate that something changed the temperature relationship between the two instruments.

Figures 3.1(A) - (G) depict seasonal accumulated temperature difference plots for seven stations. Fall and winter comprise the first row while spring and summer are on the second row. Accumulated ΔT are the y-axis values, with days per season along the x-axis. For each season, all of the hourly temperature differences are plotted as a running total over time. Due to the large numbers of hourly observations, the beginning of each new season starts over with accumulated $\Delta T = 0$.

Beginning with a fairly well-behaved station in Figure 3.1(A), CYS exhibits a reasonably constant, linear relationship between accumulated ΔT and time. The slope of the line is such that -2000°F would be accumulated in 100 days in the fall. A total of 100 days with 24 observations per day with a -1°F difference each hour would lead to a total accumulated ΔT of -2400°F . Thus the hourly temperature difference for CYS in the fall is roughly -0.83°F each hour. All four seasons are quite smooth and have similar slopes, except for a slight shift during the summer season. The next Figure 3.1(B) strongly supports evidence of an ASOS instrument move at ACY sometime in late spring. Until that point, the overall pattern of the slope at ACY is negative; but after the instrument

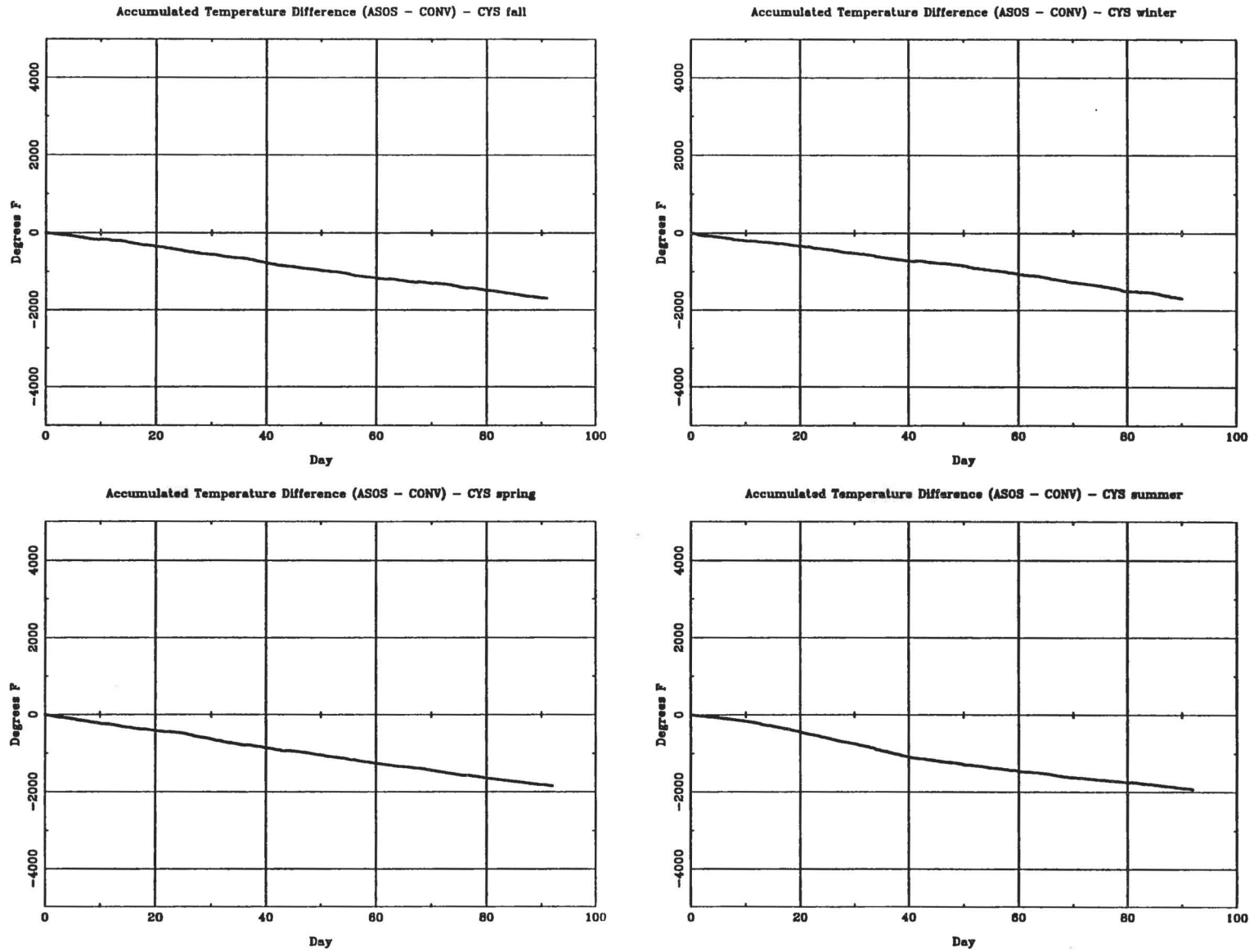

Fig. 3.1 (A) Seasonal accumulated temperature difference plots for Cheyenne, WY.

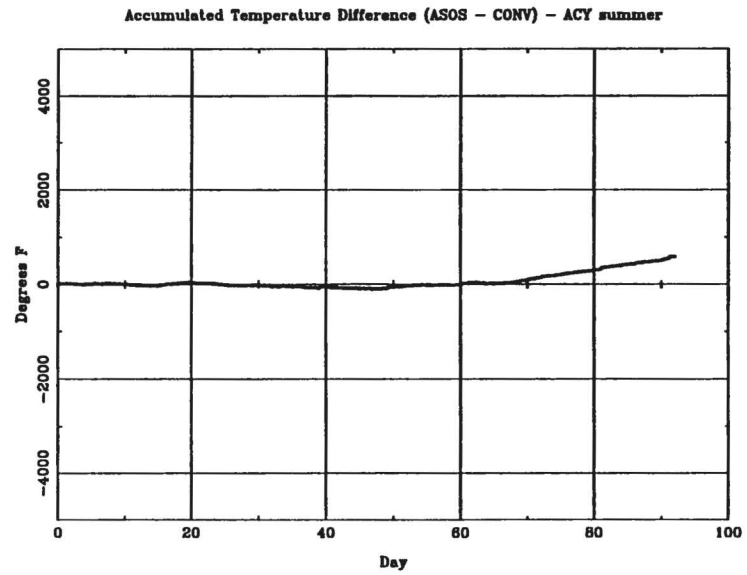
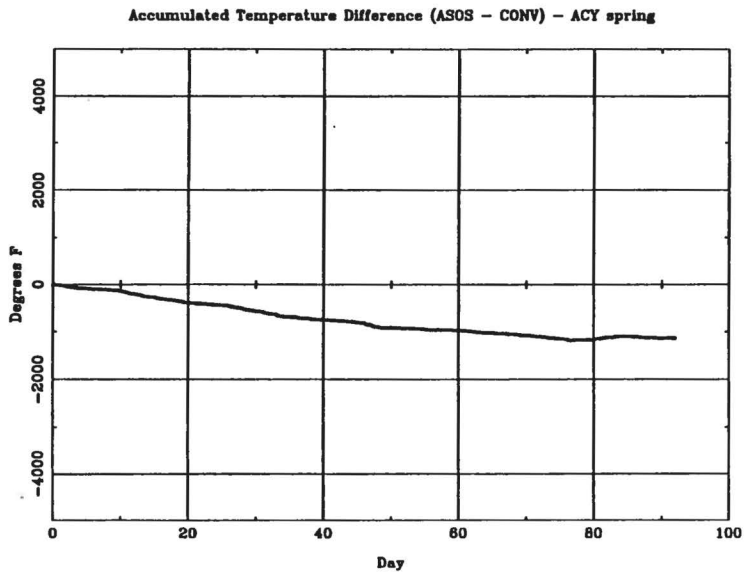
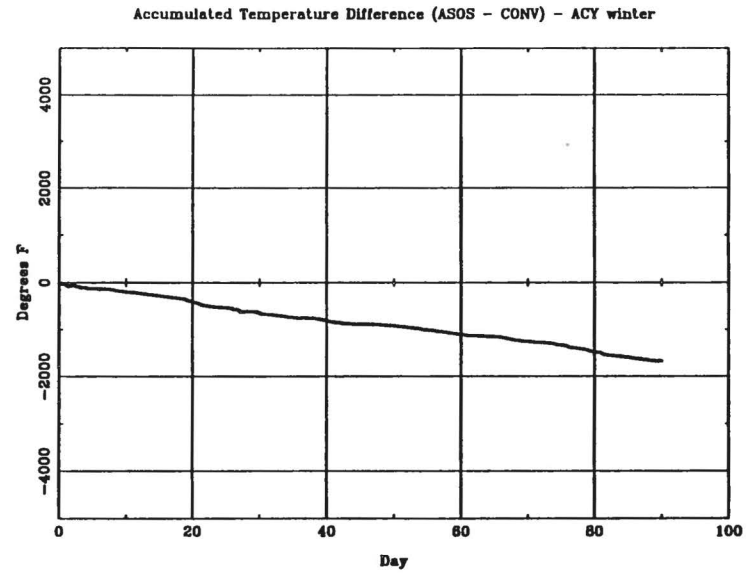
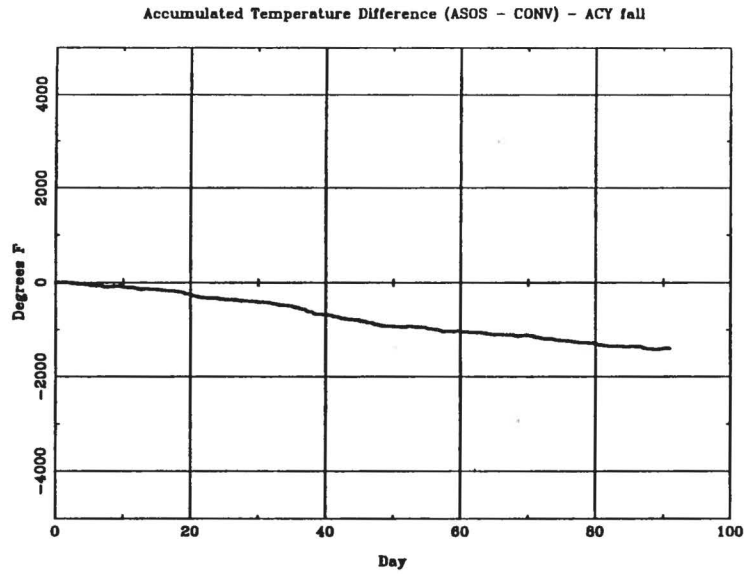

Fig. 3.1 (B) Seasonal accumulated temperature difference plots for Atlantic City, NJ.

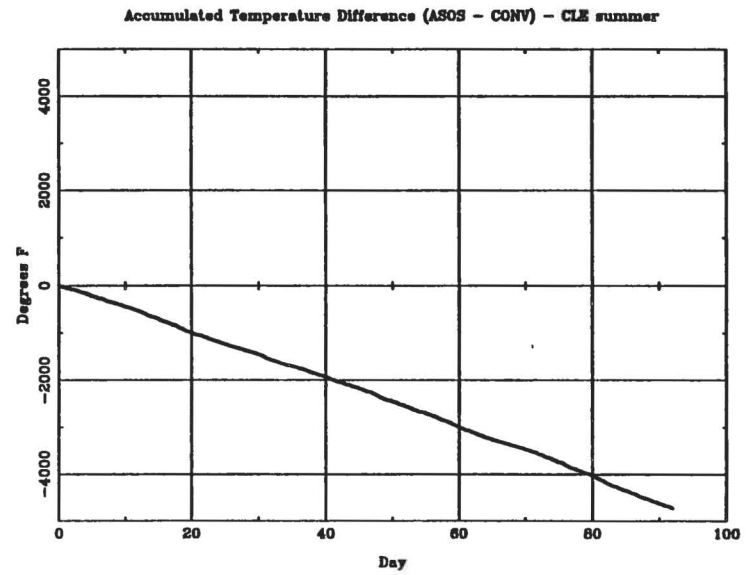
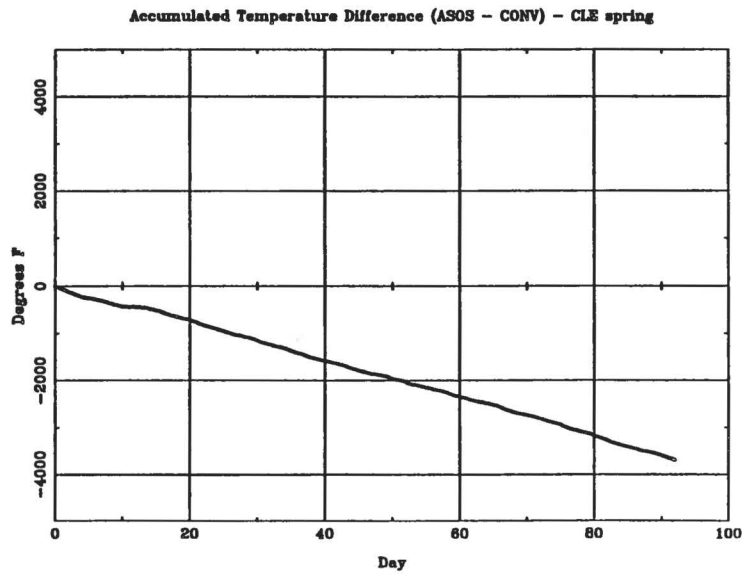
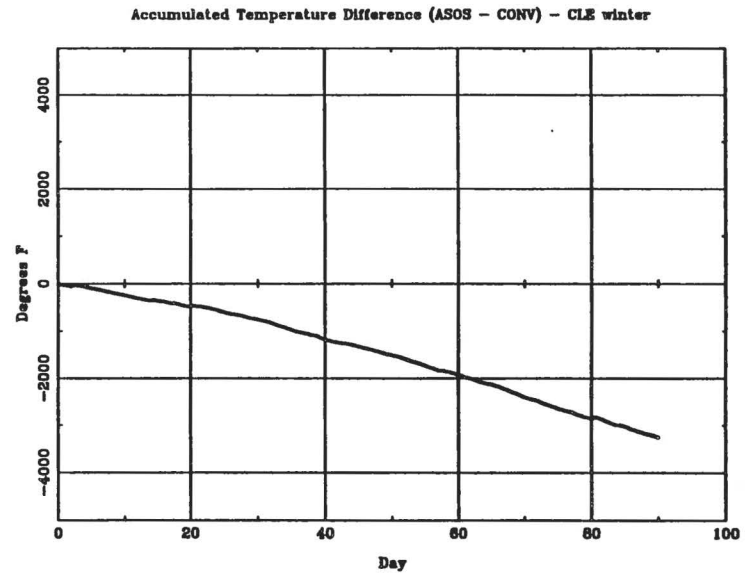
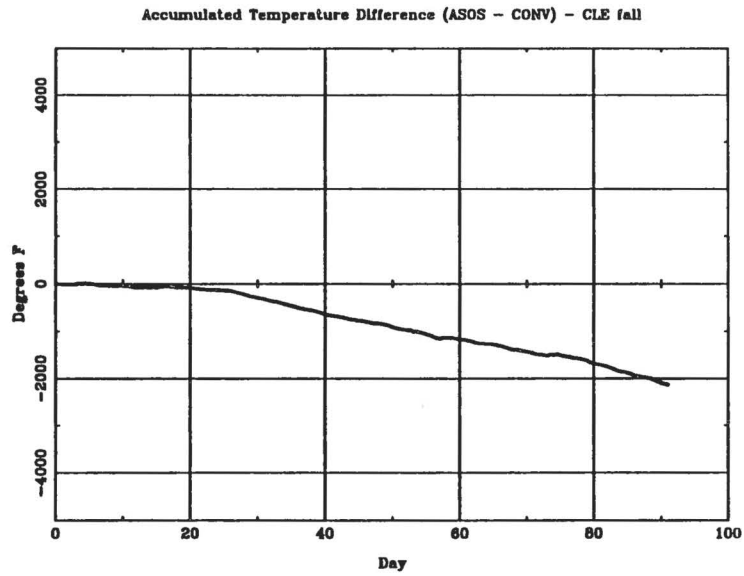

Fig. 3.1 (C) Seasonal accumulated temperature difference plots for Cleveland, OH.

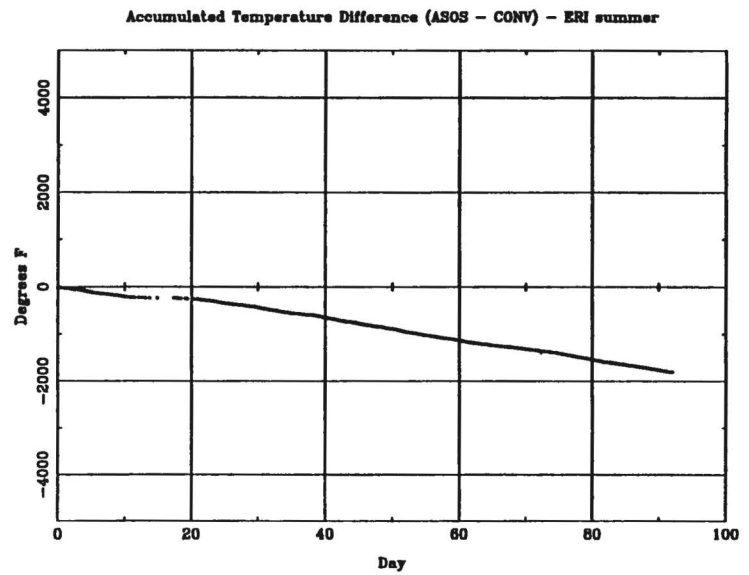
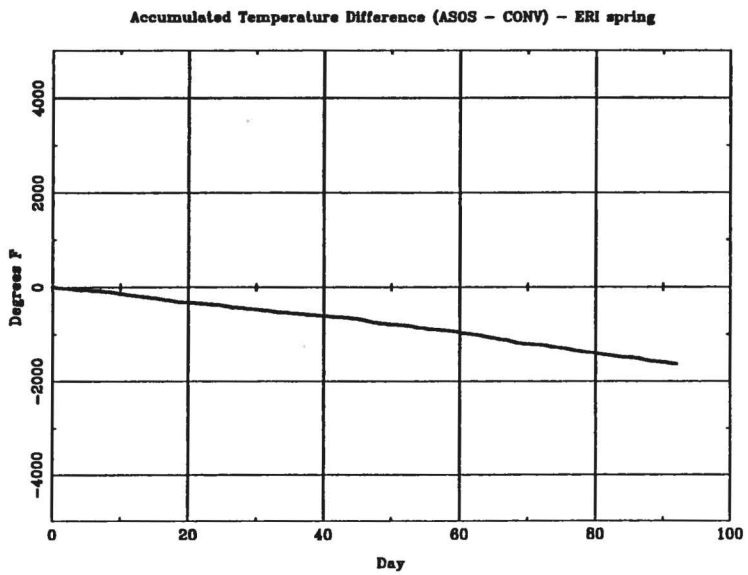
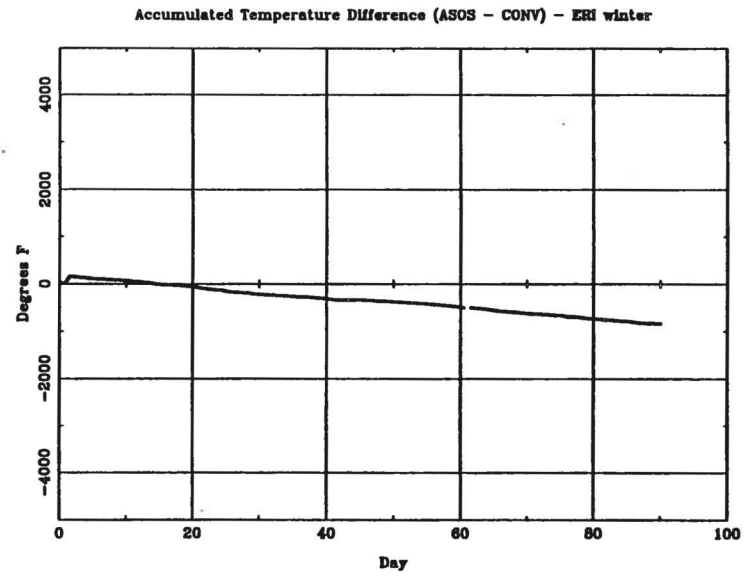
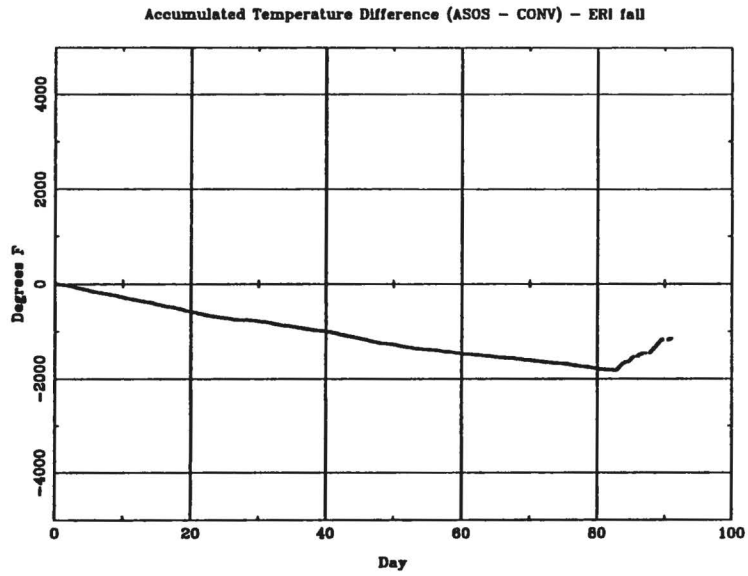

Fig. 3.1 (D) Seasonal accumulated temperature difference plots for Erie, PA.

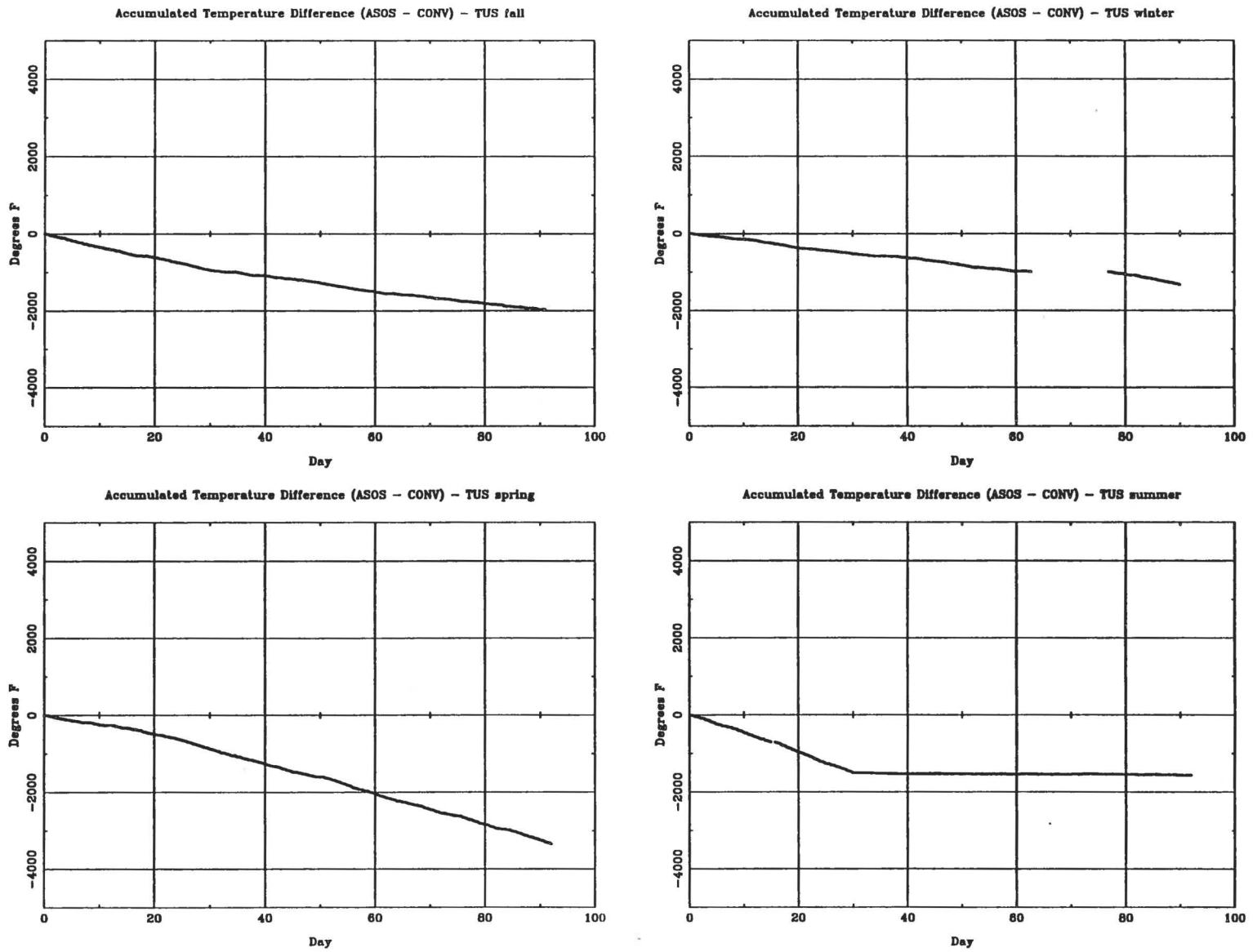

Fig. 3.1 (E) Seasonal accumulated temperature difference plots for Tucson, AZ.

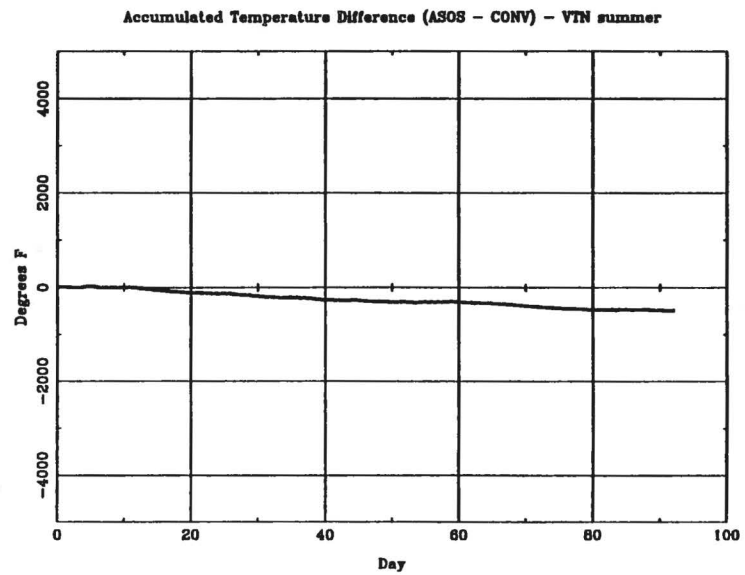
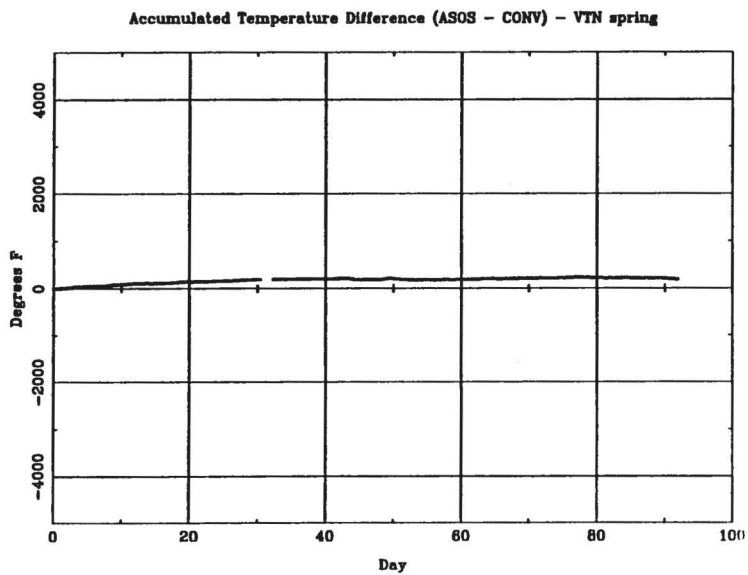
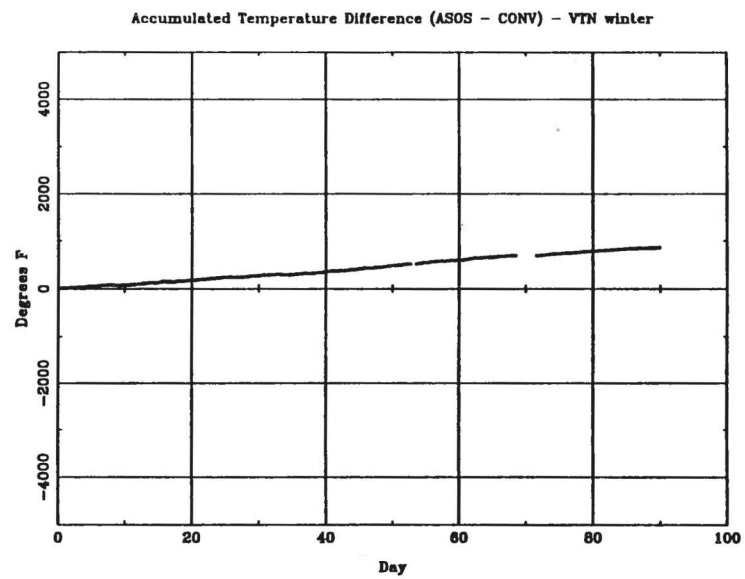
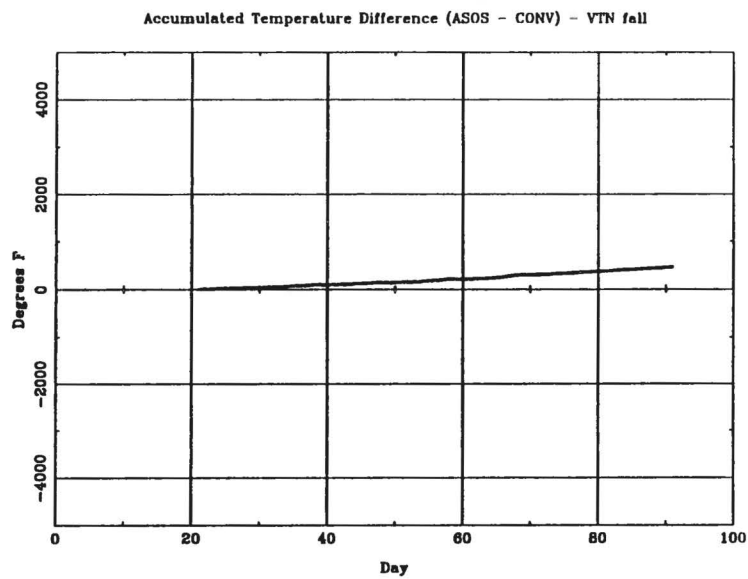

Fig. 3.1 (F) Seasonal accumulated temperature difference plots for Valentine, NE.

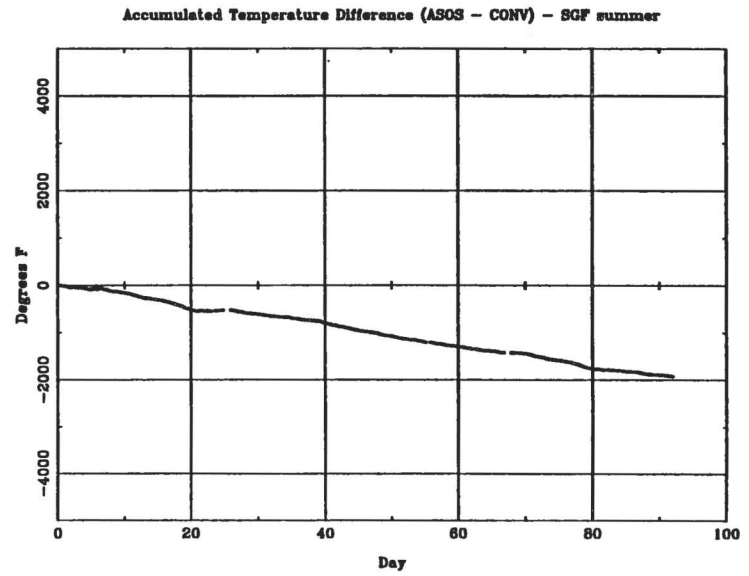
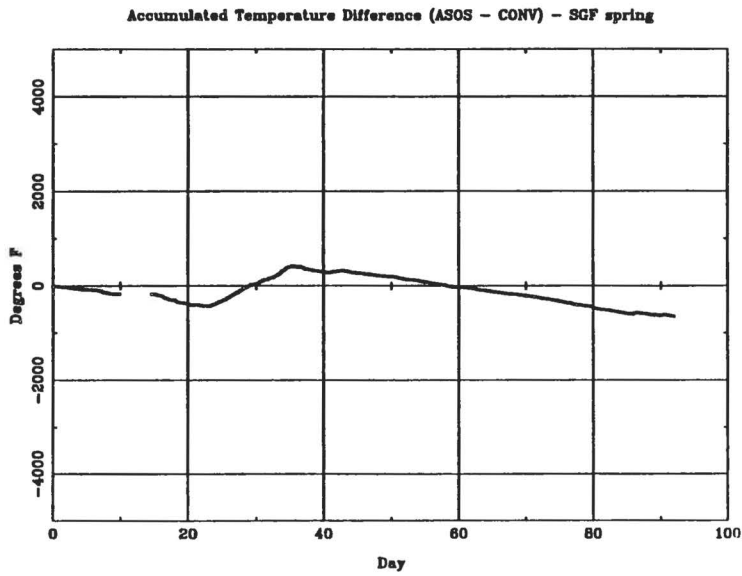
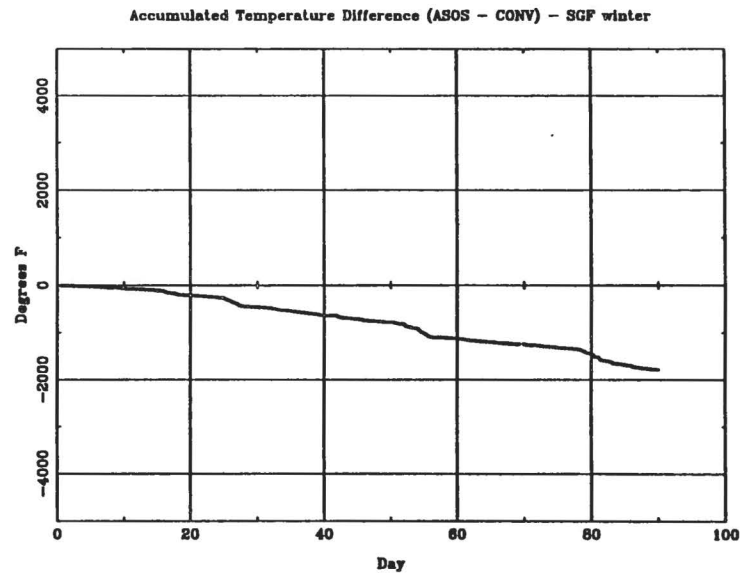
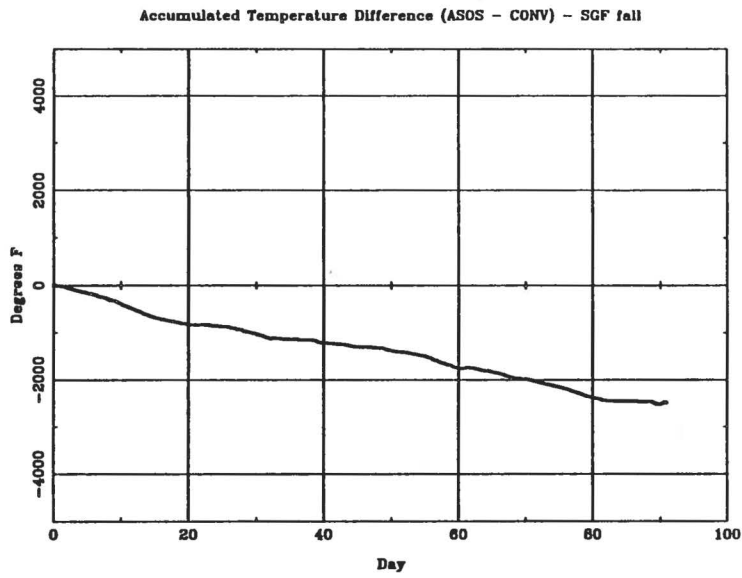

Fig. 3.1 (G) Seasonal accumulated temperature difference plots for Springfield, MO.

move, the relationship between the two instruments is dramatically different with an emerging positive slope toward the end of the summer season. Figure 3.1(C) is a nice example of a station which exhibits a trend over time. In other words, with each passing season, the accumulated ΔT between the two sensors at CLE is becoming larger resulting in a more negative slope over time. ERI in Figure 3.1(D) shows a quite dramatic, but only temporary, anomaly during late fall and early winter. The slope of the line changes considerably both in sign and value. The overall slope of the anomaly itself is positive over the course of its duration. Afterwards, ERI seems to return to its previous relationship between the two sensors. In Figure 3.1(E) TUS is moderately well-behaved in the first three seasons. The slope does change slightly quite often, and there is a brief period of missing data in the winter; but the overall behavior is fairly consistent. Then something happened in the summer! All of a sudden there is no longer a constant accumulation in the temperature difference between the two instruments. Upon examination of the raw data, it was discovered that the two instruments reported the exact same temperature value for most hours during the months of July and August. This likely means that one of the observations was edited. There is still a very slight, negatively sloped accumulation of temperature differences after June, but the relationship is significantly different. Next, one of the few stations with a positive bias, seen in Figure 3.1(F), VTN suffers a significant change in its slope sometime in the spring. The change is dramatic enough to completely alter the sign of the slope to a negative value by the summer season. In the last plot, Figure 3.1(G), SGF is plagued by problems. The accumulated ΔT plot meanders constantly with time. Despite an overall trend toward a

negatively sloped relationship, there are several periods of varying duration that display an obviously positive slope.

There could be many reasons for these changes in accumulated temperature differences over time. They include instrument moves, maintenance, sensor changes, electrical problems, weather events, and seasonal effects. Any of these could affect either the ASOS or CONV instrument.

3.2.2 Time Series Analysis

To further investigate shifts in temperature differences over the period of study, time series plots of temperature differences between the daily ASOS and CONV highest hourly and lowest hourly values were generated for each of the stations for the whole year (see Appendix A). Figures 3.2(A) - (C) are examples of these temperature time series analysis for $\Delta T_{\text{highest hourly}}$ and $\Delta T_{\text{lowest hourly}}$. Again, shifts in the now non-accumulated ΔT patterns indicate changes between the two instruments. Differences between the highest hourly values are plotted in the top graph, and differences between the lowest hourly values are on the bottom. Both graphs run sequentially from fall through summer, with daily legend values given in the upper right-hand corner of each plot.

In Figure 3.2(A), the instrument move in late spring is again quite noticeable for ACY, especially for $\Delta T_{\text{lowest hourly}}$ although not so obvious for $\Delta T_{\text{highest hourly}}$. The annual trend at CLE is notable in both temperature difference patterns in Figure 3.2 (B) as the mean of each plot becomes more negative with time. In Figure 3.2(C), the summer shift at TUS is significant in $\Delta T_{\text{highest hourly}}$, and quite perceptible in the $\Delta T_{\text{lowest hourly}}$. These plots

Daily $\Delta T_{\text{(highest hourly)}}$ (ASOS - CONV) for ACY

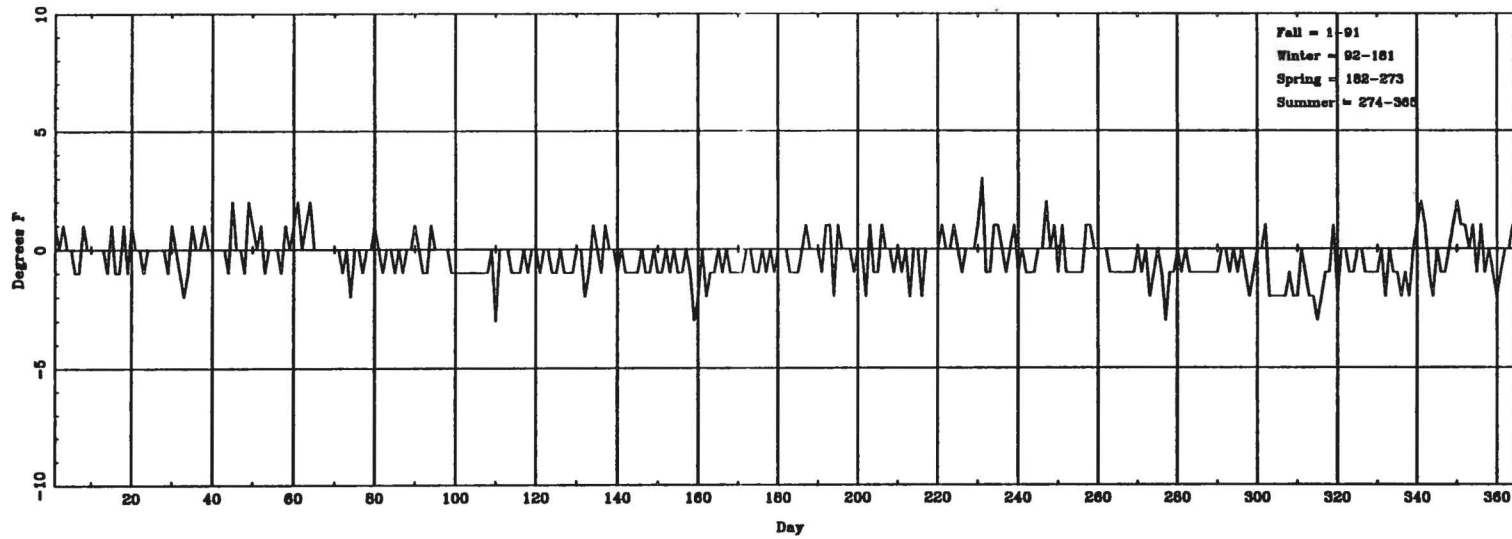

Daily $\Delta T_{\text{(lowest hourly)}}$ (ASOS - CONV) for ACY

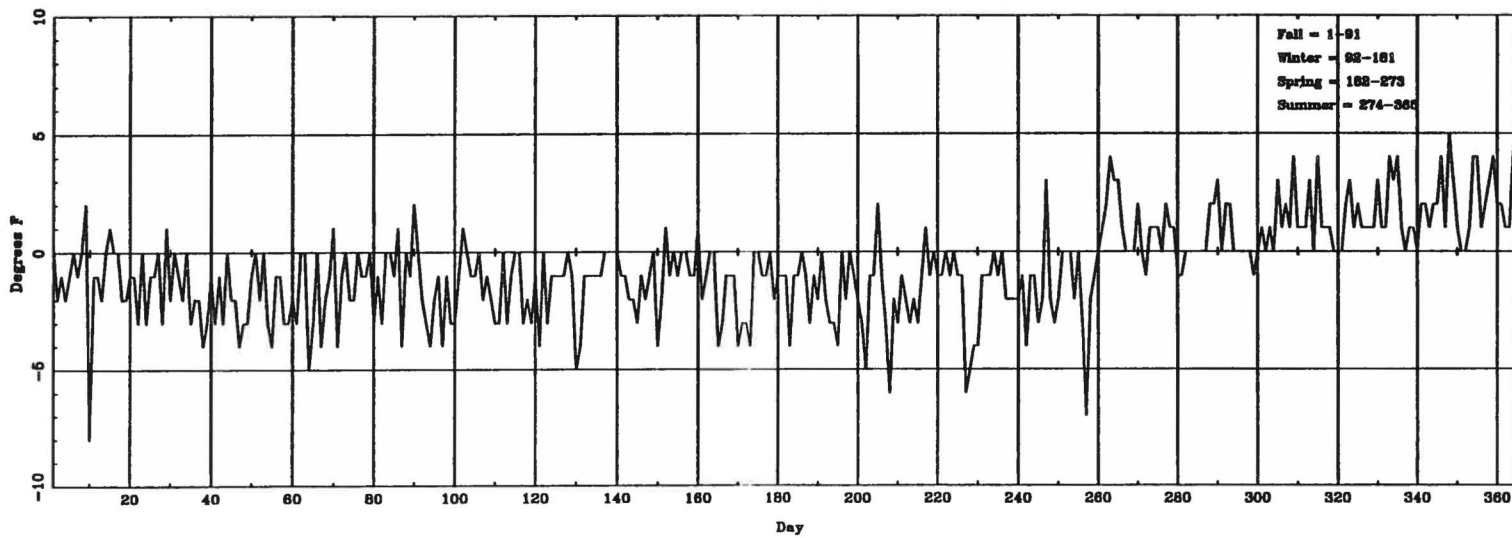

Fig. 3.2 (A) Temperature time series plots for Atlantic City, NJ.

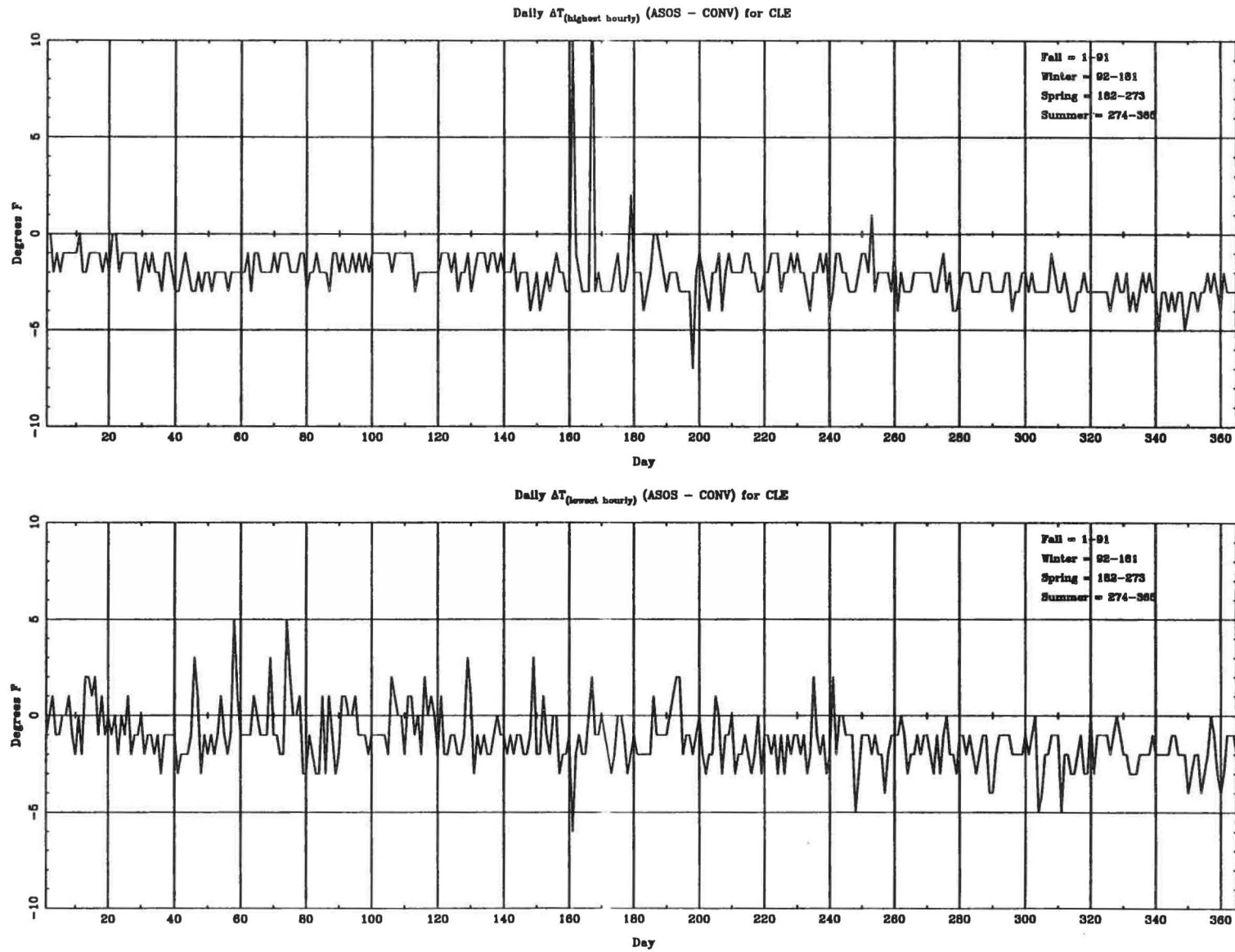
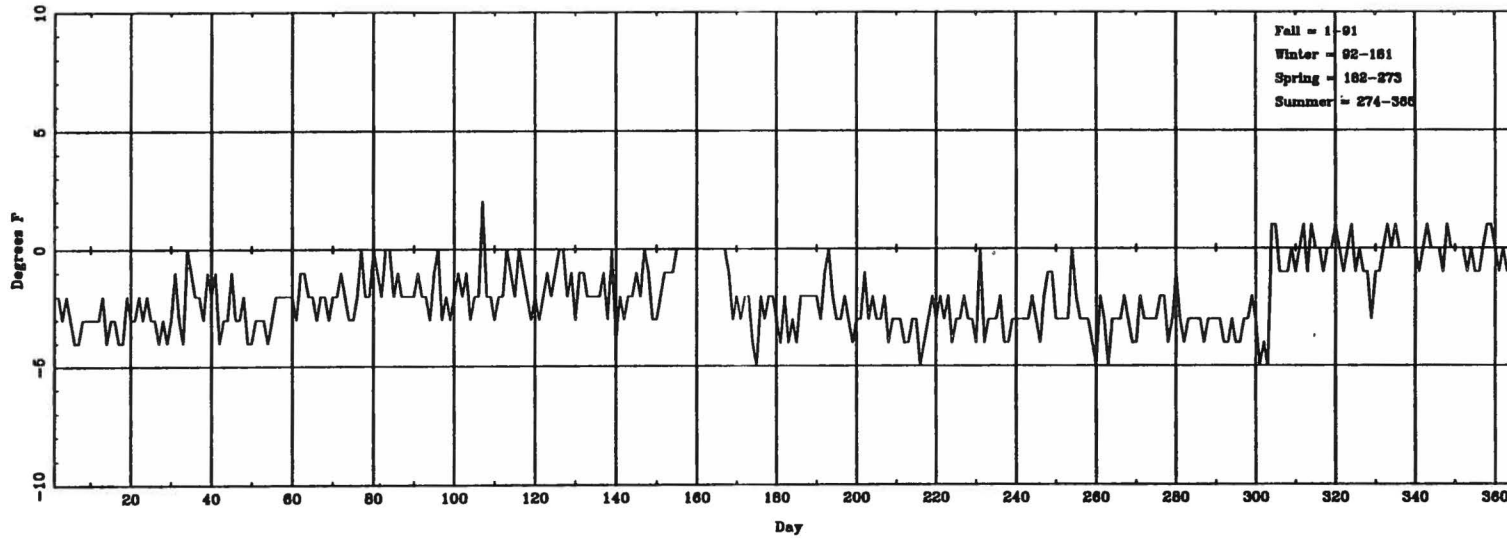

Fig. 3.2 (B) Temperature time series plots for Cleveland, OH.

Daily $\Delta T_{(highest\ hourly)}$ (ASOS - CONV) for TUS



Daily $\Delta T_{(lowest\ hourly)}$ (ASOS - CONV) for TUS

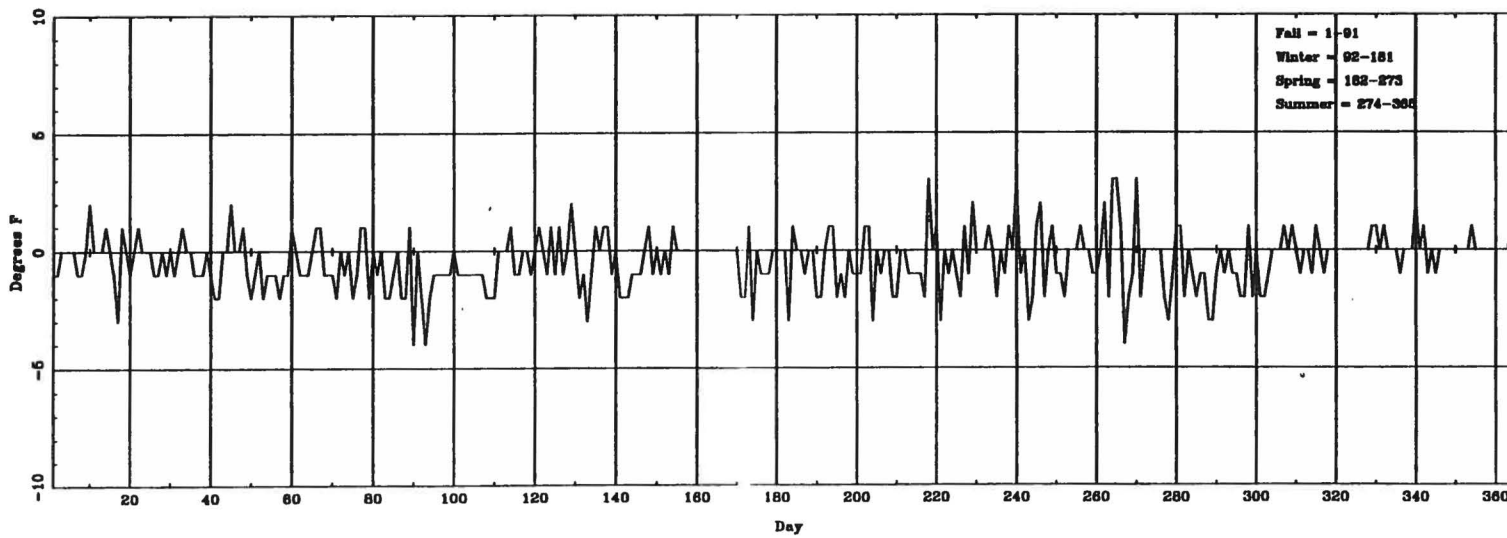

Fig. 3.2 (C) Temperature time series plots for Tucson, AZ.

confirm that ASOS is cooler than CONV measurements as evidenced by the negative averages of the time series plots. Most of these figures, the rest of which are located in Appendix A, do not present strong evidence supporting the existence of annual cycles in the temperature difference patterns, but more is discussed on this topic in section 3.7. After examining the irregularities in temperature difference patterns, the next focus was to isolate, as much as possible, the three contributions to the differences in temperature values between ASOS and CONV measurements.

3.3 The Instrument Bias, ΔT_i

Determining the temperature difference caused solely by the instrument bias required finding meteorological conditions which would reduce the other two effects. Eliminating the solar effect was quite easy by requiring nighttime analysis of the data. In order to eliminate local effects between the two instruments, conditions were selected which would minimize these local effects by homogenizing the surface boundary layer. The optimum conditions selected for this criteria were nighttime, high-wind analysis and nighttime, overcast-sky analysis such that $\Delta T = \Delta T_i$, since $\Delta T_i \sim 0$ and $\Delta T_s = 0$. Nighttime was defined as the seven-hour period inclusive of 10:00pm to 4:00am LST.

3.3.1 Nighttime, High-wind Analysis

Once the solar effect was eliminated, attention was turned to finding a relationship between ΔT and wind speed. With sufficient wind speeds at the surface, the boundary layer should be adequately mixed to eliminate local effects between the two instruments.

Homogenizing the boundary layer diminishes local temperature differences due to drainage currents, cold pools, radiational effects, and effects due to placement close to water. A consistent surface layer should be sampled by both instruments and reported as the same temperature unless there are differences in the two instruments inherent in their manufacture.

It was proposed that as wind speeds near the surface increased, the distribution of temperature differences between the two instruments would narrow to a range of only a few values which would include the instrument bias. In order to examine the population distribution of temperature differences within the range of $-9^{\circ}\text{F} \leq \Delta T \leq +9^{\circ}\text{F}$, tabular results for ΔT versus increasing wind speed were computed for each station for each season, both for all synoptic hours and all wind speeds (top table), and for nighttime hours with wind speeds ≥ 10 knots (bottom table) as seen in Tables 3.1(A) - (E). In each of the columns is recorded the number of comparisons having a temperature difference equal to ΔT along the first row with the corresponding wind speed category in the far left-hand column. All of the graphs display similar characteristics of having a broad temperature difference population distribution at lower wind speeds, and a narrowing of the distribution as wind speed increases. This narrowing of the ΔT distribution at higher wind speed is also evident in the nighttime, high-wind tables as well, though not quite as dramatic. Tables 3.1(A) & (B) are examples of stations with fairly even distributions at low wind speeds which taper to a range of only two to three values for ΔT at higher wind speeds. The other three tables depict the same overall pattern; but 3.1(C) & (D) have distributions which are skewed toward the negative ΔT values at low wind speeds, and 3.1(E) is skewed toward the more positive ΔT values at low wind speeds.

Table 3.1 (A) Tabulated temperature differences versus wind speeds for Cleveland, OH.

CLE fall, all hours, all wind speeds											ASOS - Conv									Sum	Mean	% top 3		
Wind Spd	-9	-8	-7	-6	-5	-4	-3	-2	-1	0	1	2	3	4	5	6	7	8	9					
0							4	16	26	16	10	4	2	2							80,	-0.47		
1																						0,	0.00	
2																						0,	0.00	
3							1	6	9	16	20	24	12	8	4							100,	-0.68	
4							4	8	11	35	43	41	15	14	3							174,	-0.84	
5								4	23	57	58	38	14	14	3	4	1					216,	-0.86	
6							2	6	4	24	55	71	42	12	16	6	4	1				243,	-0.94	
7						1	1	2	1	13	53	53	28	23	12	10	4	1				202,	-0.63	
8							2	2	14	69	97	47	9	10	1	2						253,	-1.01	
9							2	10	45	61	31	4	4	2	1							160,	-1.04	
10							1	12	51	79	36	8	3	1								191,	-1.07	
11							1	7	26	50	28	4	2									118,	-1.01	
12								10	37	44	32	2	2									127,	-1.12	
13								5	27	34	10	2										78,	-1.29	
14								7	16	18	14	1										56,	-1.25	
15								7	22	19	4											52,	-1.62	
16								4	14	19	4											41,	-1.44	
17								2	4	10												16,	-1.50	
18								2	16	6												24,	-1.83	
19							1	1	1	4												7,	-1.86	
20								3	7	3												13,	-2.00	
21									3	1												4,	-1.75	
22									4	3												7,	-1.57	
23									1	2												3,	-1.33	
24									2	1												3,	-1.67	
25										1												1,	-1.00	
26										1												1,	-1.00	
27									1	1												2,	-1.50	
28																						0,	0.00	
29																						0,	0.00	
30																						0,	0.00	
31																						0,	0.00	
32																						0,	0.00	
Total	0	0	1	3	15	30	168	578	725	395	116	89	32	17	3	0	0	0	0	0	2172,	-0.98	78.2*	

CLE fall, night, high winds											ASOS - Conv									Sum	Mean	% top 3		
Wind Spd	-9	-8	-7	-6	-5	-4	-3	-2	-1	0	1	2	3	4	5	6	7	8	9					
10							1	5	9	14	6	3	1									39,	-1.18	
11									4	12	9	1	1									27,	-0.63	
12								1	12	9	9	1	1									33,	-1.00	
13								1	7	7	2	1										18,	-1.28	
14								2	2	5	4											13,	-1.15	
15									4	4												8,	-1.50	
16									4	5	1											10,	-1.30	
17									1	2												3,	-1.67	
18									1	2	1											4,	-2.00	
19							1															1,	-4.00	
20								2	1	1												4,	-2.25	
21										1												1,	-1.00	
22																						0,	0.00	
23										2												2,	-1.00	
24										1	1											2,	-1.50	
25											1											1,	-1.00	
26																						0,	0.00	
27											1											1,	-1.00	
28																						0,	0.00	
29																						0,	0.00	
30																						0,	0.00	
31																						0,	0.00	
32																						0,	0.00	
Total	0	0	0	0	0	2	13	46	66	31	6	3	0	0	0	0	0	0	0	0	167,	-1.16	85.6*	

Table 3.1 (B) Tabulated temperature differences versus wind speeds for Tucson, AZ.

TUS winter, all hours, all wind speeds											ASOS - Conv									Sum	Mean	% top 3				
Wind Spd	-9	-8	-7	-6	-5	-4	-3	-2	-1	0	1	2	3	4	5	6	7	8	9							
0																							253,	-0.43		
1		1																						0,	0.00	
2																								0,	0.00	
3																								191,	-0.64	
4						3	1	16	34	98	65	22	8	3									250,	-0.74		
5						1	4	19	50	74	69	21	2	1									242,	-0.89		
6							2	16	39	60	49	21	5	1									194,	-0.79		
7							1	2	9	40	60	38	16	3									169,	-0.95		
8							1	2	16	23	45	28	11	7	1								134,	-0.93		
9							1	3	4	19	22	19	5	4	1								78,	-0.94		
10								1	4	15	17	12	7	3	1								61,	-0.67		
11									2	7	9	12	4	1									35,	-0.66		
12									2	3	7	8	6	5	1								32,	-1.00		
13												10	9	2									21,	-0.38		
14										1	1	5	8	2									17,	-0.47		
15										1	3	7	6	2									19,	-0.74		
16											4	9	3	1									17,	-0.94		
17											2	7	9										18,	-0.61		
18											2	2	6										10,	-0.60		
19											4	3	2										9,	-1.22		
20												1											1,	-1.00		
21												2											2,	-1.00		
22												1											1,	-1.00		
23												1	1										2,	-0.50		
24											1	2	1										4,	-1.00		
25											1		1										2,	-1.00		
26												1											1,	-1.00		
27																							0,	0.00		
28																							0,	0.00		
29																							0,	0.00		
30																							0,	0.00		
31																							0,	0.00		
32																							0,	0.00		
Total	0	1	0	1	8	21	121	307	570	477	184	58	12	0	0	1	1	1	0				1763,	-0.75	76.8%	

TUS winter, night, high winds											ASOS - Conv									Sum	Mean	% top 3			
Wind Spd	-9	-8	-7	-6	-5	-4	-3	-2	-1	0	1	2	3	4	5	6	7	8	9						
10												2	5	5	1								17,	-0.29	
11												1	3	1									5,	0.00	
12												2	2	1	1								6,	0.17	
13												1	1	1									3,	0.00	
14												1	1	2									4,	0.25	
15												1		2									3,	0.33	
16												2		1									3,	-0.33	
17												1	3										4,	-0.25	
18												1	1										2,	-0.50	
19													1										1,	0.00	
20																							0,	0.00	
21																							0,	0.00	
22													1										1,	-1.00	
23																							0,	0.00	
24																							0,	0.00	
25																							0,	0.00	
26																							0,	0.00	
27																							0,	0.00	
28																							0,	0.00	
29																							0,	0.00	
30																							0,	0.00	
31																							0,	0.00	
32																							0,	0.00	
Total	0	0	0	0	0	0	2	2	13	17	13	2	0	0	0	0	0	0	0				49,	-0.12	87.8%

Table 3.1 (C) Tabulated temperature differences versus wind speeds for Atlantic City, NJ.

ACY fall, all hours, all wind speeds														ASOS - Conv					Sum	Mean	% top 3		
Wind Spd	-9	-8	-7	-6	-5	-4	-3	-2	-1	0	1	2	3	4	5	6	7	8				9	
0	3	2	4	9	13	28	38	33	42	26	13	1	1		1					214,	-2.34		
1																					0,	0.00	
2																					0,	0.00	
3	1	2	3	4	6	10	23	25	49	47	5	8			1					184,	-1.53		
4		1	3	1	7	20	41	87	89	33	5	1	1							289,	-0.82		
5		1	2	4	4	14	31	104	113	44	15	2	1	1			2			338,	-0.48		
6			1	2	10	17	78	114	37	15	5	1	1							281,	-0.23		
7				3	15	55	92	36	3	1	1									206,	-0.22		
8				1	3	57	56	31	2	1	2									153,	-0.13		
9				1	2	4	37	62	18	2										126,	-0.26		
10					3	26	56	12	3											100,	-0.14		
11					1	2	20	36	6	1										66,	-0.29		
12					1	16	17	8	1											43,	-0.19		
13					1	15	22	7												45,	-0.22		
14						8	20	5	2											35,	0.03		
15						7	15	3												25,	-0.16		
16						1	12	3	1											18,	0.06		
17						5	9	2												16,	-0.19		
18						3	6													9,	-0.33		
19						1	1	1												3,	-0.33		
20						1	3													4,	-0.25		
21						2														2,	0.00		
22						1														1,	0.00		
23								3												3,	1.00		
24						1														1,	0.00		
25																				0,	0.00		
26																				0,	0.00		
27																				0,	0.00		
28																				0,	0.00		
29																				0,	0.00		
30																				0,	0.00		
31																				0,	0.00		
32																				0,	0.00		
Total	4	5	8	19	24	52	113	177	611	800	267	59	11	5	5	0	2	0	0	2162,	-0.65	77.6%	

ACY fall, night, high winds														ASOS - Conv					Sum	Mean	% top 3	
Wind Spd	-9	-8	-7	-6	-5	-4	-3	-2	-1	0	1	2	3	4	5	6	7	8				9
10									6	13										19,	-0.32	
11									3	7										10,	-0.30	
12									5	1	2									8,	-0.38	
13								1	1	2										4,	-0.75	
14								1	2											3,	-0.33	
15								1	1											2,	-0.50	
16									3											3,	0.00	
17								1												1,	-1.00	
18									1											1,	0.00	
19																				0,	0.00	
20								1												1,	-1.00	
21									1											1,	0.00	
22																				0,	0.00	
23																				0,	0.00	
24																				0,	0.00	
25																				0,	0.00	
26																				0,	0.00	
27																				0,	0.00	
28																				0,	0.00	
29																				0,	0.00	
30																				0,	0.00	
31																				0,	0.00	
32																				0,	0.00	
Total	0	0	0	0	0	0	0	1	19	31	2	0	0	0	0	0	0	0	0	53,	-0.36	98.1%

Table 3.1 (D) Tabulated temperature differences versus wind speeds for Sioux Falls, SD.

FSD spring, all hours, all wind speeds											ASOS - Conv									Sum	Mean	% top 3		
Wind Spd	-9	-8	-7	-6	-5	-4	-3	-2	-1	0	1	2	3	4	5	6	7	8	9					
0			4	3	7	9	13	19	10	11	10	1									87,	-3.21		
1							1															1,	-4.00	
2						3	5	4	6	5	1											24,	-2.67	
3		1	1	1	6	6	5	8	14	9	8	2										61,	-2.77	
4				1	4	2	8	17	22	42	19	2		1								118,	-1.74	
5					2	4	9	16	24	55	21	5	1									137,	-1.55	
6		1				2	4	23	27	73	34	9	1									174,	-1.26	
7			1	1	1	1	2	16	17	65	35	6										145,	-1.21	
8					4	3	4	15	26	92	45	9	4									202,	-1.12	
9					1			6	19	65	42	3										136,	-0.91	
10						1	1	6	36	89	55	4	1									193,	-0.94	
11						1	1	8	19	72	35	10										146,	-0.91	
12							2	8	9	89	48	5	1									162,	-0.81	
13							1	2	5	52	43	5	1									109,	-0.60	
14						1	3	4	8	50	29	8										103,	-0.84	
15							2	4	12	54	31	5	3									111,	-0.78	
16								3	6	19	26	1										55,	-0.71	
17								1	12	29	18	3										63,	-0.84	
18								3	10	31	20	2	1									67,	-0.84	
19								1	3	11	7	2										24,	-0.75	
20								1		9	4	1										15,	-0.73	
21										3	4	1										8,	-0.25	
22									1	6	1	1										9,	-0.78	
23									3	5	2											10,	-1.10	
24									1	5												6,	-1.17	
25										5	1											6,	-0.83	
26									1		2											3,	-0.67	
27										2												2,	-1.00	
28											1											1,	0.00	
29																						0,	0.00	
30										1												1,	-1.00	
31										1												1,	-1.00	
32																						0,	0.00	
Total	2	6	6	25	33	61	165	291	950	542	85	13	1	0	0	0	0	0	0	0	0	2180,	-1.18	81.8%

FSD spring, night, high winds											ASOS - Conv									Sum	Mean	% top 3		
Wind Spd	-9	-8	-7	-6	-5	-4	-3	-2	-1	0	1	2	3	4	5	6	7	8	9					
10								9	24	15	1	1										50,	-0.78	
11							1	5	19	5	4											34,	-0.82	
12								1	23	12	2											38,	-0.61	
13									12	10												22,	-0.55	
14								1	10	9												20,	-0.60	
15									1	18	8		1									28,	-0.64	
16								2	4	3												9,	-0.89	
17									8	4												12,	-0.67	
18									5	3												8,	-0.62	
19									2	3												5,	-0.40	
20									2													2,	-1.00	
21										1												1,	0.00	
22									3		1											4,	-0.50	
23									2													2,	-1.00	
24																						0,	0.00	
25									1	1												2,	-0.50	
26																						0,	0.00	
27																						0,	0.00	
28																						0,	0.00	
29																						0,	0.00	
30																						0,	0.00	
31																						0,	0.00	
32																						0,	0.00	
Total	0	0	0	0	0	0	1	19	133	74	8	2	0	0	0	0	0	0	0	0	0	237,	-0.68	95.4%

Table 3.1 (E) Tabulated temperature differences versus wind speeds for Tallahassee, FL.

TLH summer, all hours, all wind speeds											ASOS - Conv									Sum	Mean	% top 3	
Wind Spd	-9	-8	-7	-6	-5	-4	-3	-2	-1	0	1	2	3	4	5	6	7	8	9				
0						2	14	32	73	151	136	60	15	3					1	487,	0.27		
1																					0,	0.00	
2																					0,	0.00	
3							7	32	71	70	48	21	9	3	3						264,	-0.05	
4						2	12	47	112	54	16	6	4	4	1						258,	-0.73	
5						2	11	56	112	29	9	11	1	1							232,	-0.98	
6							9	44	115	48	9	1	1		1						228,	-0.93	
7						2	2	23	109	24	1										161,	-1.04	
8					1		5	29	89	28	2	2									156,	-1.03	
9							8	15	58	19	1										101,	-1.10	
10								24	45	14	2										85,	-1.07	
11					1		1	11	42	13	2	1									71,	-0.96	
12							1	11	24	11	1										48,	-1.00	
13						1	1	1	18	6	1										28,	-0.93	
14							1	3	8	2		1									15,	-1.00	
15								2	7		1										10,	-1.00	
16						1		2		1											4,	-2.00	
17									7	1											8,	-0.88	
18						1	1	4	5												11,	-1.82	
19								1	5												6,	-1.17	
20								1	5	1											7,	-1.14	
21								1		2											3,	-1.00	
22		1							1												2,	-5.00	
23									1												1,	-1.00	
24																					0,	0.00	
25									1												1,	-1.00	
26																					0,	0.00	
27																					0,	0.00	
28																					0,	0.00	
29																					0,	0.00	
30																					0,	0.00	
31																					0,	0.00	
32																					0,	0.00	
Total	1	0	0	0	2	11	75	337	908	474	229	103	30	11	5	0	1	0	0	2187,	-0.58	78.6%	

TLH summer, night, high winds											ASOS - Conv									Sum	Mean	% top 3	
Wind Spd	-9	-8	-7	-6	-5	-4	-3	-2	-1	0	1	2	3	4	5	6	7	8	9				
10									1	3											4,	-1.25	
11										5											5,	-1.00	
12										2	1										3,	-0.67	
13										3											3,	-1.00	
14										1											1,	-1.00	
15										1											1,	-1.00	
16																					0,	0.00	
17																					0,	0.00	
18									1												1,	-2.00	
19									1	1											2,	-1.50	
20										2											2,	-1.00	
21																					0,	0.00	
22																					0,	0.00	
23										1											1,	-1.00	
24																					0,	0.00	
25																					0,	0.00	
26																					0,	0.00	
27																					0,	0.00	
28																					0,	0.00	
29																					0,	0.00	
30																					0,	0.00	
31																					0,	0.00	
32																					0,	0.00	
Total	0	0	0	0	0	0	0	3	19	1	0	0	0	0	0	0	0	0	0	23,	-1.09	100.0%	

Initially, wind speeds of 15 knots and greater were used in attempting to isolate the instrument bias. Observations were chosen for analysis when the ASOS winds were reported to be in excess of 14 knots, unless the ASOS winds were missing, in which case the CONV winds had to be in excess of 14 knots. However, compared to the total numbers of temperature comparisons available for each station, there were just too few nighttime observations with wind speeds greater than 14 knots to conclude that the instrument bias had been determined with any certainty. Lowering the wind speed requirement to 10 knots and greater did allow for more temperature comparisons, but the resulting biases were plagued by a few erratic numbers in the highest wind speed categories.

Graphical examples of these findings can be seen in Figures 3.3(A) - (D) which depict average temperature difference as a function of wind speed using every observation available during the course of the year. Nighttime observations are shown with a dotted line, daytime with a dashed line, and the average over all observations with a solid line. One item to note about these plots is the omission of reported wind speeds at 1 and 2 knots. Since wind speeds are reported as either calm (< 3 knots) or as 3 knots and above, the lowest wind speed categories (0 knots, 1 knot, and 2 knots) were all assigned the value computed for calm winds. It was initially suggested that ΔT would asymptotically approach some fixed value very near the instrument bias as wind speeds increased. And indeed the overall trend toward a fixed value in these plots reflects that potential. However, as seen in each of the figures, the temperature difference did not smoothly approach a fixed value for the instrument bias. At the highest wind speeds, all of the lines become more erratic and unstable as the numbers of observations decrease considerably.

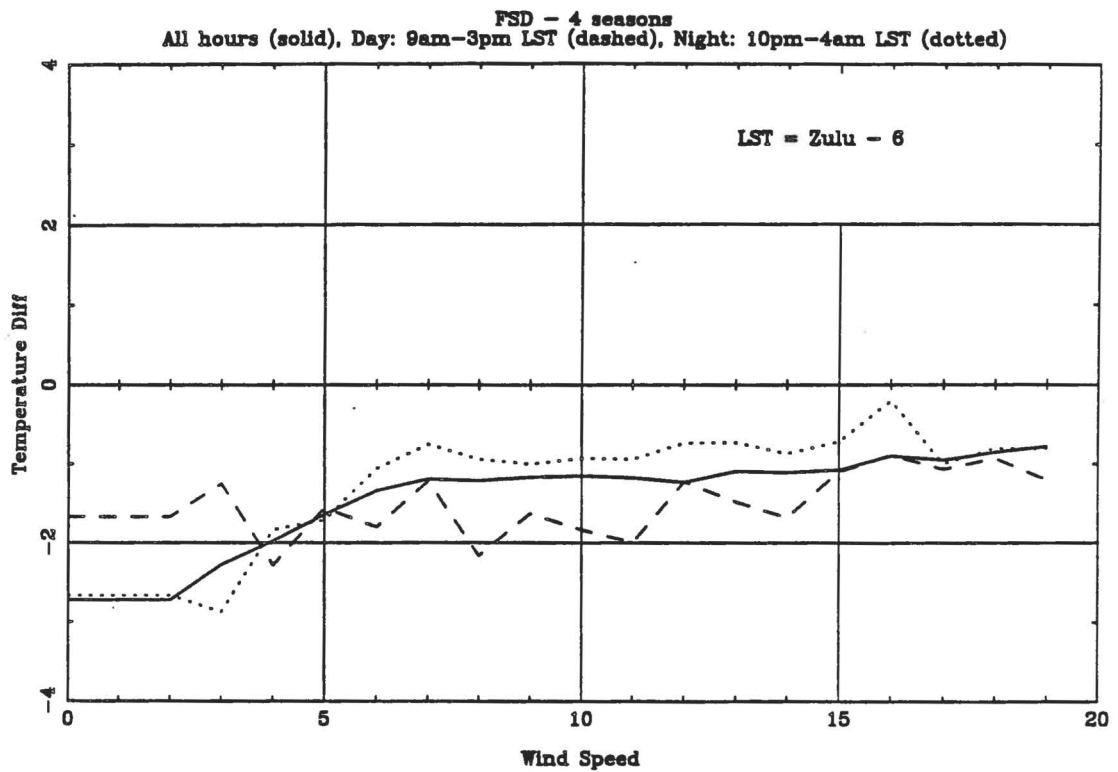

Fig. 3.3 (A) Wind speed versus temperature difference for Sioux Falls, SD.

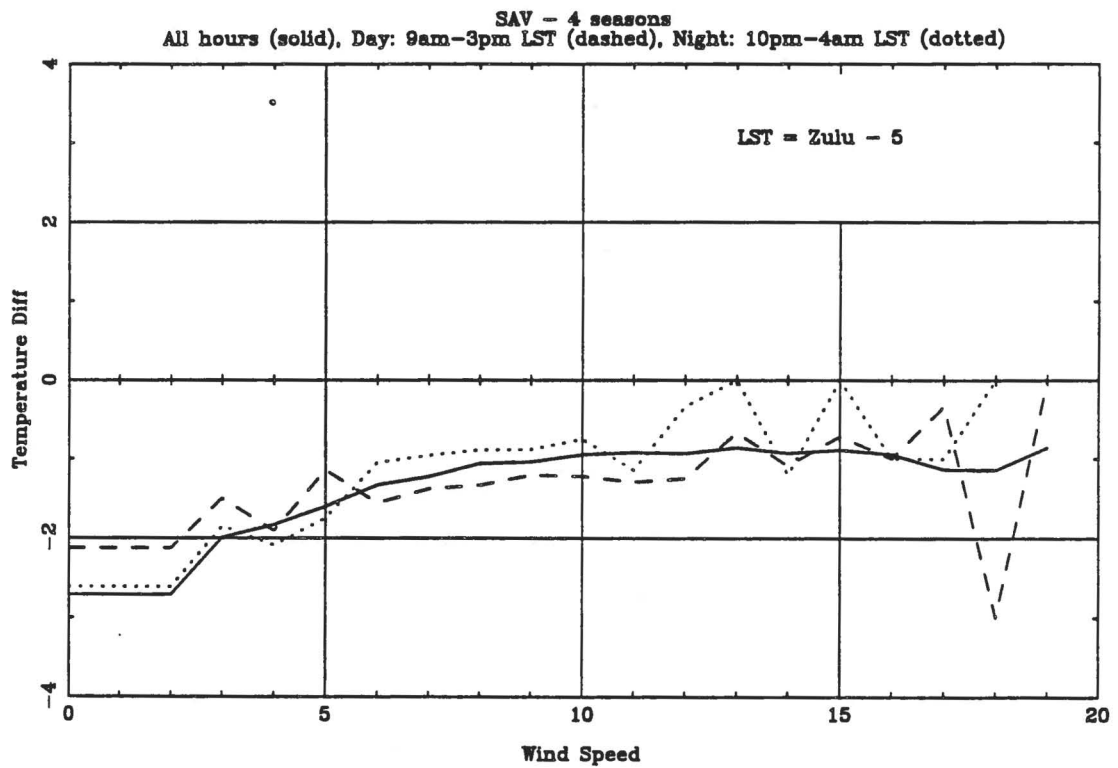

Fig. 3.3 (B) Wind speed versus temperature difference for Savannah, GA.

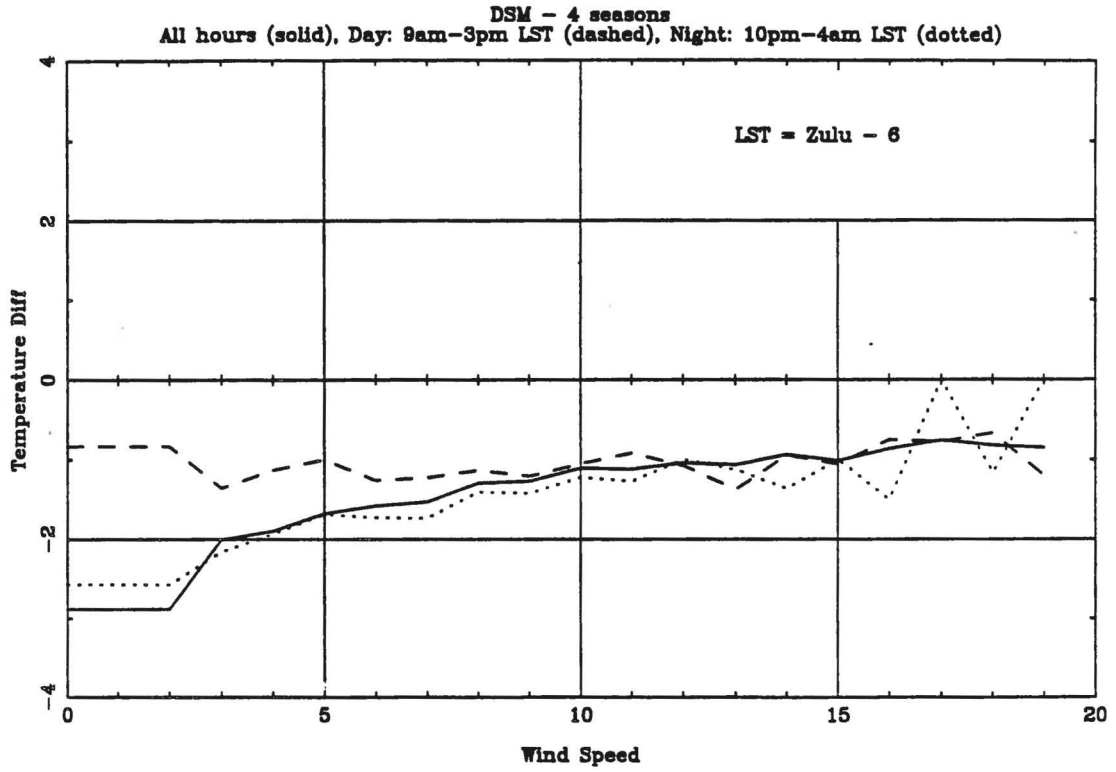

Fig. 3.3 (C) Wind speed versus temperature difference for Des Moines, IA.

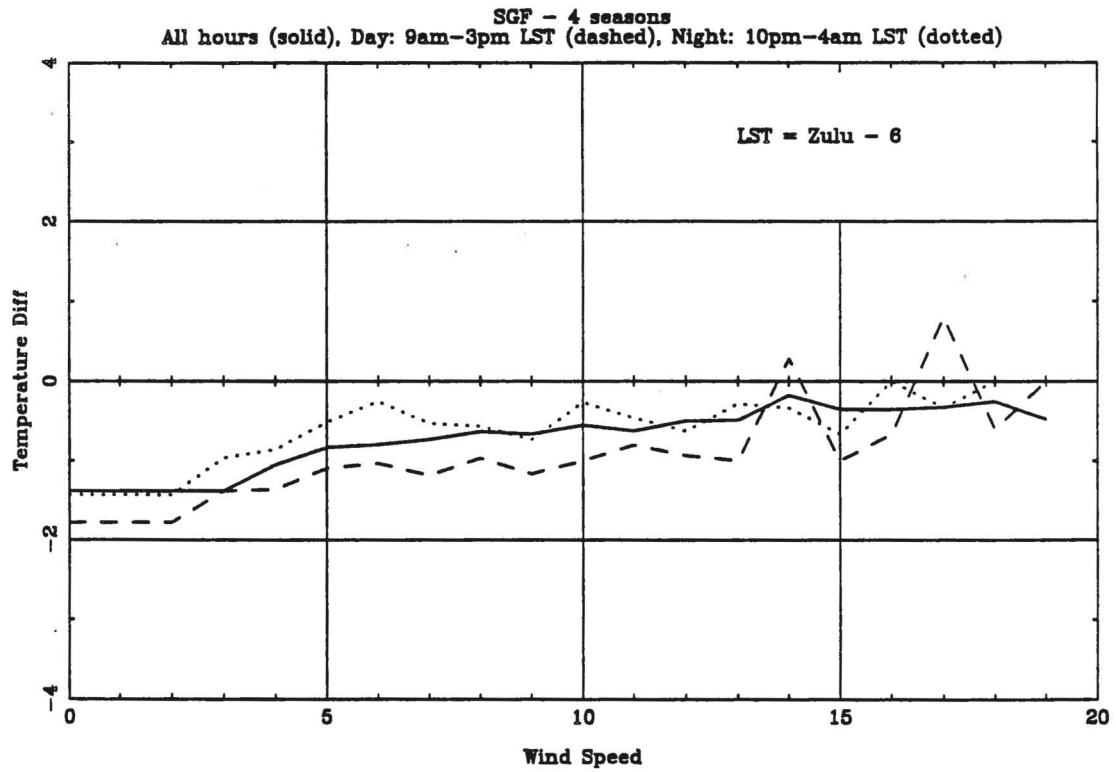

Fig. 3.3 (D) Wind speed versus temperature difference for Springfield, MO.

As a result of the low numbers problem associated with the nighttime, high-wind analysis, it was decided to use nighttime observations with overcast skies to determine instrument biases for each location.

3.3.2 Nighttime, Overcast-sky Analysis

The theory behind using overcast skies at night was to have enough cloud cover over an area to provide a downward infrared radiation source at the cloud base which would reduce horizontal temperature differences at the surface (McKee, et al., 1996). If the cloud cover is thick enough and covers an area somewhat larger than the distance between the ASOS and CONV instruments, and assuming that the cloud is radiating at a uniform temperature, then it would not take long for the downward infrared flux from the cloud to decrease temperature inhomogeneities in the surface layer below the clouds. This is accomplished through the net infrared radiation at the surface as the downward flux acts to diminish the magnitude of cold pools and warm spots at the surface.

Observations were selected for comparison when the highest sky cover category reported by ASOS was overcast, unless the ASOS sky cover field was missing, in which case, the temperature comparison was not done. The 12,000 feet limit of the ASOS ceilometer ensures low clouds were detected. There were many more nighttime observations reported with overcast skies than nighttime observations reported with high winds for an overwhelming number of stations. Population distributions of temperature differences versus cloud cover amount were calculated in Tables 3.2(A) - (C). For each station, the top table represents all observations from a particular season, while the bottom

table is only the nighttime hours for that same season. Each table shows a broad distribution of ΔT values for clear skies. But as the cloud cover amount increases to scattered, then to broken, and then to overcast, there is a significant narrowing of the distribution to a range of only a few values. In fact for all of the stations, as cloud cover increased to overcast, the distribution of the temperature differences narrowed such that over 90% of all the measured ΔT s were always within the top three numbers. Graphically, plots of ΔT versus cloud cover smoothly approach a fixed value for the instrument bias as seen in Figures 3.4(A) - (D). Although both nighttime, high-wind and overcast-sky analyses showed that ASOS was cooler than CONV at most stations, the nighttime, overcast-sky analysis was selected as the method for isolating the instrument biases.

Seasonal instrument biases were calculated for each station using the following technique:

$$\Delta T_i = \frac{\sum_{m=0}^{\pm 9} ((\Delta T_m)(\text{Number of Observations with } \Delta T_m))}{\sum (\text{Total Number of Observations})} \quad (3.3)$$

with m defined as the range of possible temperature difference values between -9°F and $+9^\circ\text{F}$. Annual values were calculated by adding up the seasonal instrument biases multiplied by the number of observations used to determine each seasonal bias, then dividing by the total number of nighttime overcast observations for the whole year. The resulting seasonal and annual instrument bias values, which are given in Tables 3.3(A) - (C), are predominantly negative. Seasonal contributions range from -2.17°F (ATL in the fall) to $+1.17^\circ\text{F}$ (ORH in the spring). Annual instrument biases ranged from -1.96°F

Table 3.2 (A) Tabulated temperature differences versus cloud cover for Savannah, GA.

SAV winter, all hours, all wind speeds											ASOS - Conv									Sum	Mean	% top 3
Sky Cover	-9	-8	-7	-6	-5	-4	-3	-2	-1	0	1	2	3	4	5	6	7	8	9			
CLR	2	6	8	12	31	66	108	160	414	219	32	7	1							1066,	-1.52	74.4%
SCT							9	16	52	24	2									103,	-1.06	89.3%
BKN						4		17	68	29	3									121,	-0.95	94.2%
OVC							4	53	450	211	4									722,	-0.78	98.9%
Total	2	6	8	12	31	70	121	246	984	483	41	7	1	0	0	0	0	0	0	2012,	-1.20	

SAV winter, night only											ASOS - Conv									Sum	Mean	% top 3
Sky Cover	-9	-8	-7	-6	-5	-4	-3	-2	-1	0	1	2	3	4	5	6	7	8	9			
CLR	1			4	18	49	52	49	104	52	7	4	1							341,	-1.93	61.0%
SCT							2	3	6	1										12,	-1.50	91.7%
BKN								7	17	4										28,	-1.11	100.0%
OVC								17	147	48										212,	-0.85	100.0%
Total	1	0	0	4	18	49	54	76	274	105	7	4	1	0	0	0	0	0	0	593,	-1.50	

Table 3.2 (B) Tabulated temperature differences versus cloud cover for Las Vegas, NV.

LAS spring, all hours, all wind speeds											ASOS - Conv									Sum	Mean	% top 3
Sky Cover	-9	-8	-7	-6	-5	-4	-3	-2	-1	0	1	2	3	4	5	6	7	8	9			
CLR				2	16	93	298	475	326	68	28	9								1315,	-0.97	83.6%
SCT				1	5	24	39	42	12	1	1									125,	-0.71	84.0%
BKN						3	7	47	44	8	1									110,	-0.55	90.0%
OVC							2	39	63	5										109,	-0.35	98.2%
Total	0	0	0	0	2	17	101	331	600	475	93	30	10	0	0	0	0	0	0	1659,	-0.88	

LAS spring, night only											ASOS - Conv									Sum	Mean	% top 3
Sky Cover	-9	-8	-7	-6	-5	-4	-3	-2	-1	0	1	2	3	4	5	6	7	8	9			
CLR				1	4	17	65	148	117	32	14	5								403,	-0.68	81.9%
SCT							1	5	9	3										18,	-0.22	94.4%
BKN								8	14	1	1									24,	-0.21	95.8%
OVC								17	22	2										41,	-0.37	100.0%
Total	0	0	0	0	1	4	17	66	178	162	38	15	5	0	0	0	0	0	0	486,	-0.62	

Table 3.2(C) Tabulated temperature differences versus cloud cover for Mount Shasta, CA

MHS summer, all hours, all wind speeds											ASOS - Conv									Sum	Mean	% top 3
Sky Cover	-9	-8	-7	-6	-5	-4	-3	-2	-1	0	1	2	3	4	5	6	7	8	9			
CLR				6	23	62	164	320	406	270	138	93	48	8	2					1540,	-0.93	64.7%
SCT				1	6	12	32	51	36	15	3		1							157,	-0.99	75.8%
BKN						3	11	21	48	36	10	5	1							135,	-0.83	77.8%
OVC			1			1	4	15	74	76	8	3	1			1				184,	-0.57	89.7%
Total	0	0	1	6	24	72	191	388	579	418	171	104	50	9	2	1	0	0	0	2016,	-0.89	

MHS summer, night only											ASOS - Conv									Sum	Mean	% top 3
Sky Cover	-9	-8	-7	-6	-5	-4	-3	-2	-1	0	1	2	3	4	5	6	7	8	9			
CLR				1	10	23	68	138	147	63	10									460,	-1.66	76.7%
SCT						2	4	14	23	8										51,	-1.39	88.2%
BKN							2	11	16	11										40,	-1.10	95.0%
OVC							4	30	26	1										61,	-0.61	98.4%
Total	0	0	0	1	10	25	74	167	216	108	11	0	0	0	0	0	0	0	0	612,	-1.50	

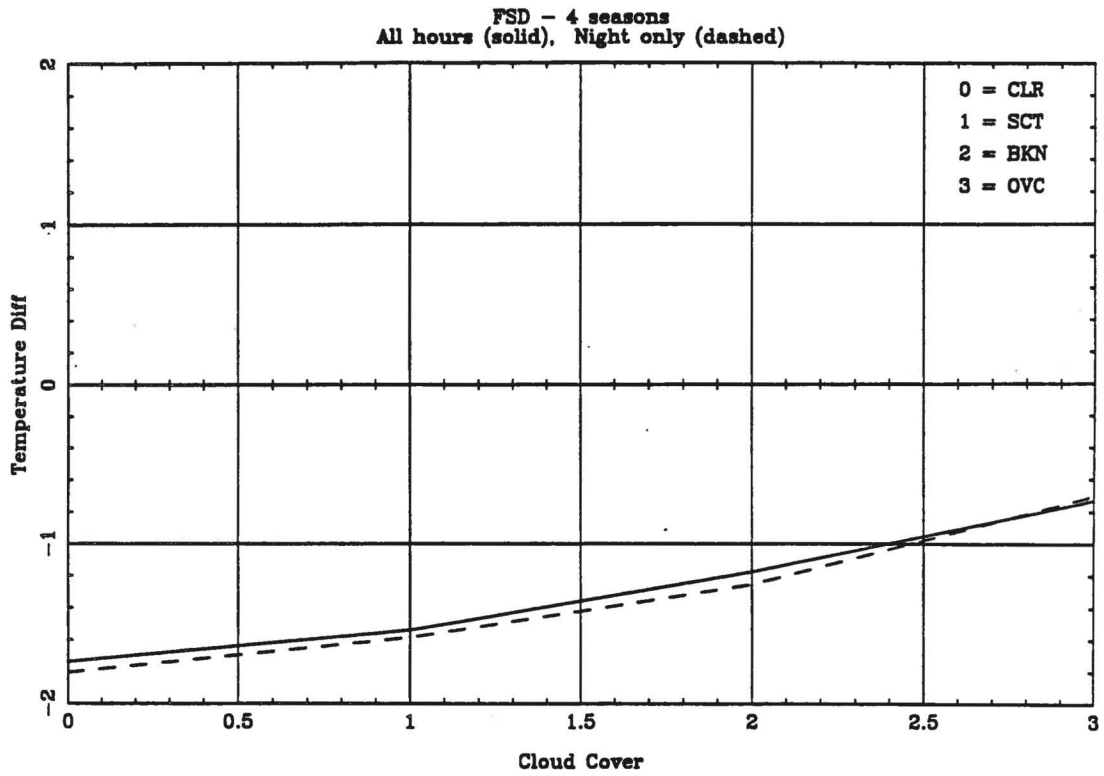

Fig. 3.4 (A) Cloud cover versus temperature difference for Sioux Falls, SD.

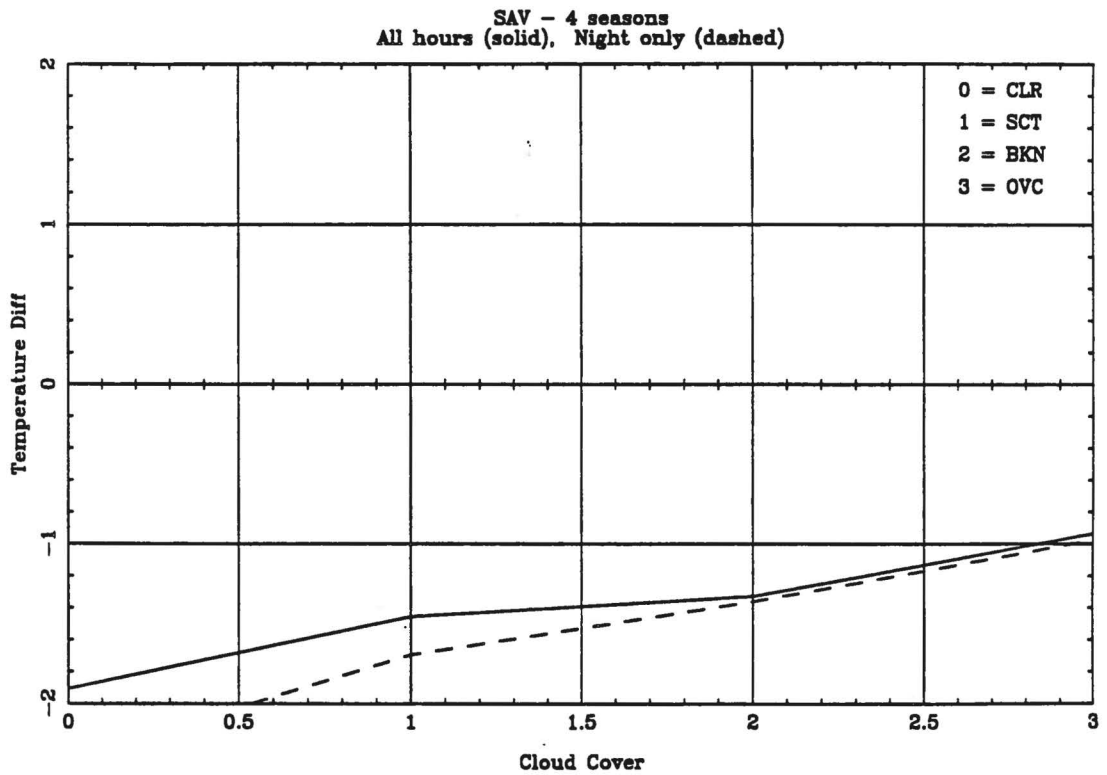

Fig. 3.4 (B) Cloud cover versus temperature difference for Savannah, GA.

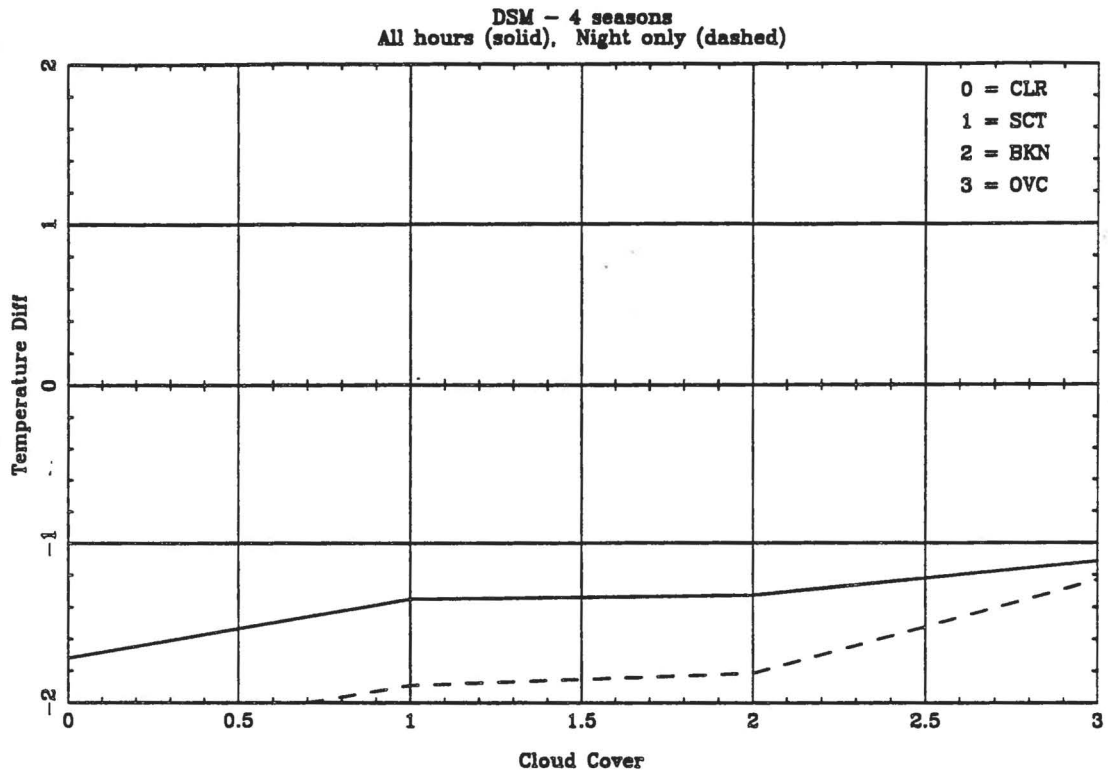

Fig. 3.4 (C) Cloud cover versus temperature difference for Des Moines, IA.

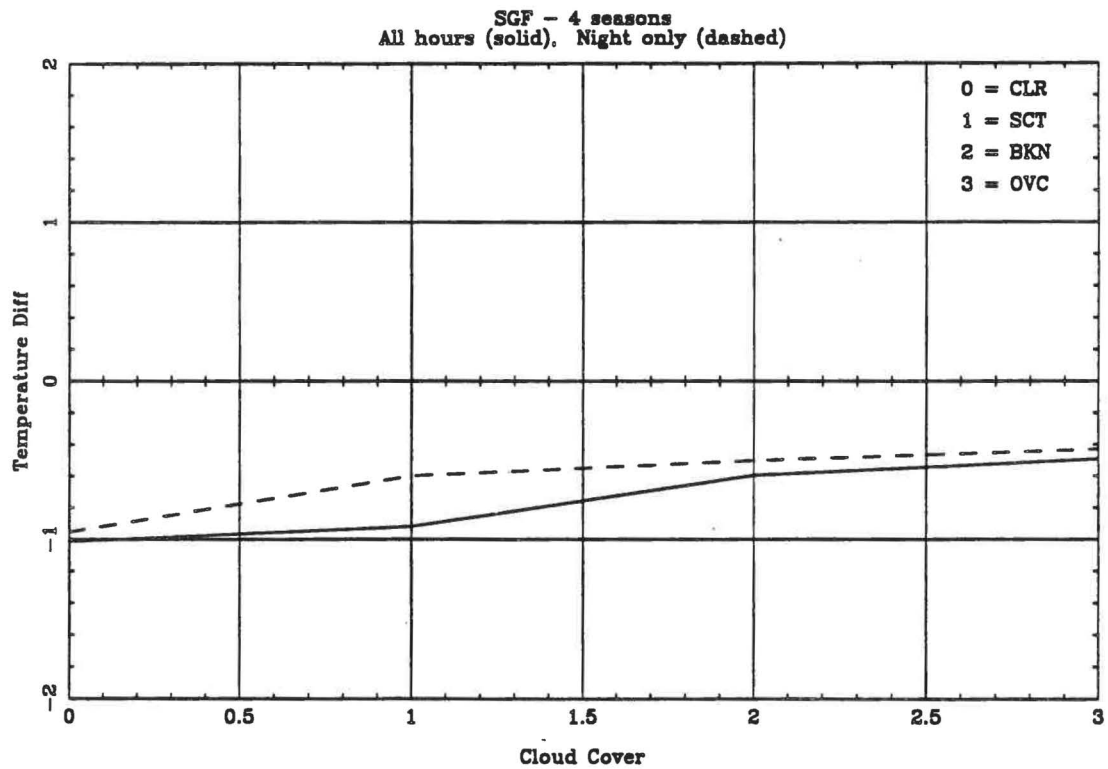

Fig. 3.4 (D) Cloud cover versus temperature difference for Springfield, MO.

Table 3.3 (A) Seasonal and Annual Instrument Biases for Four-season Stations and Average Temperature Difference over all Observations

Station	Fall Instrument Bias		Winter Instrument Bias		Spring Instrument Bias		Summer Instrument Bias		Annual Instrument Bias		All Possible Observations	
	ΔT_i	number of night ovc obs	ΔT_i	number of night ovc obs	ΔT_i	number of night ovc obs	ΔT_i	number of night ovc obs	ΔT_i	number of night ovc obs	ΔT	Number
ACY	-0.41	112	-0.58	230	-0.46	224	-0.16	103	-0.499	568	-0.649	6508
BGM	-0.49	247	-0.55	349	-0.82	227	-0.57	303	-0.597	1128	-0.680	7670
BIS	-0.43	207	-0.15	303	-0.32	279	0.09	107	-0.239	896	-0.387	8667
CAE	-0.51	162	-0.13	235	0.12	91	-0.07	94	-0.187	592	-0.218	8705
CLE	-1.31	187	-1.57	361	-1.71	242	-1.73	71	-1.572	841	-1.583	8716
COU	0.07	188	-0.08	267	-0.43	242	-0.79	70	-0.219	785	-0.408	8580
CYS	-0.72	125	-0.48	148	-0.7	278	-0.64	83	-0.645	632	-0.820	8674
DSM	-1.24	187	-1.13	272	-1.24	284	-1.46	87	-1.227	830	-1.470	8603
ERI	0.02	203	-0.32	409	-0.45	258	-0.47	91	-0.297	959	-0.651	8320
FAR	-0.82	147	-1.12	280	-1.01	278	-0.97	92	-1.009	795	-1.232	8027
FSD	-0.79	182	-0.47	275	-0.75	319	-1.09	86	-0.701	842	-1.350	8287
GRB	-1.68	208	-1.37	313	-1.4	181	-1.5	130	-1.474	830	-1.959	8132
JAX	-0.33	151	-0.43	195	-0.28	81	0.08	77	-0.296	484	-0.441	7877
JKL	0.39	141	0.31	328	-0.08	208	0.16	50	0.210	725	-0.274	8680
LAS	-0.23	26	-0.4	115	-0.37	41	-0.75	12	-0.393	194	-0.969	7958
LEX	-0.26	151	-0.12	314	-0.34	184	-0.2	54	-0.214	703	-0.354	8710
MCO	0.48	85	0.32	105	0.62	29	0.31	29	0.409	248	0.174	7025
MHS	-0.09	147	-0.09	322	-0.16	181	-0.61	61	-0.152	711	-0.420	7288
MOB	-0.35	184	-0.24	222	-0.32	187	-0.26	27	-0.296	600	-0.406	8709
RAP	-0.72	109	-0.45	165	-0.4	280	-0.86	102	-0.537	656	-0.875	7995
RDD	-0.42	113	-0.47	354	-0.46	197	-0.75	4	-0.460	668	-0.579	7837
RSL	-0.03	118	-0.39	163	-0.38	216	-0.38	60	-0.310	555	-0.559	8017
SAV	-1.03	202	-0.85	212	-1.1	77	-1.12	43	-0.976	534	-1.568	7617
SBN	-0.6	75	-0.28	406	-0.48	288	0.01	69	-0.353	838	-0.616	8548
SGF	-0.73	202	-0.52	263	-0.08	194	-0.02	48	-0.428	705	-0.833	8238
SLN	-0.29	127	-0.09	202	-0.1	223	0.1	59	-0.117	611	-0.436	7949
SPI	-1	201	-0.76	300	-0.88	310	-0.57	47	-0.849	858	-1.104	8398
TLH	-0.73	180	-0.84	208	-0.68	131	-0.78	54	-0.759	573	-0.545	8678
TUS	-0.81	37	-0.32	82	-0.92	25	-0.25	12	-0.527	158	-0.989	8299
VTN	0.24	124	0.52	183	0.15	287	-0.31	71	0.219	665	0.139	7570
YNG	-0.49	185	-1.25	361	-1.51	181	-1.38	72	-1.161	779	-1.257	7660
SUMS		4827		7940		6197		2183		20927		251942
MEANS	-0.494		-0.461		-0.545		-0.559		-0.505		-0.752	

Table 3.3 (B) Seasonal and Annual Instrument Biases for Three-season Stations and Average Temperature Difference over all Observations

Station	Fall Instrument Bias		Winter Instrument Bias		Spring Instrument Bias		Summer Instrument Bias		Annual Instrument Bias		All Possible Observations	
	ΔT_i	number of night ovc obs	ΔT_i	number of night ovc obs	ΔT_i	number of night ovc obs	ΔT_i	number of night ovc obs	ΔT_i	Tot number of night ovc obs	ΔT	Number
ABE			-1.15	233	-0.97	217	-0.67	130	-0.975	580	-1.418	5932
ABQ			-0.94	112	-1.02	99	-0.48	56	-0.873	267	-1.410	6380
ALB	-0.41	205	-0.88	337	-0.65	267			-0.685	809	-0.783	6419
ALO	-0.65	156	-0.56	288	-0.72	265			-0.640	709	-0.689	5497
APN	-0.3	233	-0.4	401	-0.31	267			-0.347	901	-0.506	6064
ATL	-2.17	185	-1.78	264	-2.04	113			-1.961	562	-2.557	6449
AUS	-0.46	195	-0.4	254	-0.25	302			-0.355	751	-0.419	8491
BFF	-0.54	134	-0.24	157	-0.37	283			-0.374	574	-0.606	6455
DAB	0.01	140	0.1	172	-0.06	82			0.035	394	-0.165	6317
DAY			-0.29	287	-0.3	193	-0.13	61	-0.276	541	-0.455	5912
DTW	-0.7	174	-0.89	361	-0.68	239			-0.782	774	-0.946	6512
EUG			-1.08	313	-0.9	252	-0.53	161	-0.896	726	-1.148	5761
FWA	-1.03	159	-0.64	349	-0.6	215			-0.714	723	-1.053	6081
GJT	-0.68	119	-0.56	218	-0.51	164			-0.572	501	-0.888	7979
HON	-0.15	182			-0.24	279	0.12	72	-0.161	513	-0.223	6568
INL	-0.61	162	-0.53	322	-0.77	206			-0.620	690	-0.887	5233
INW	0.4	40	0.73	117	0.5	74			0.599	231	0.026	5565
LAN	0.3	152			0.18	201	0.75	109	0.354	462	0.160	5624
LBB			-0.61	140	-0.64	130	-0.67	43	-0.631	313	-0.920	6195
LCH	-1.24	176	-1.37	208	-1.4	212			-1.342	596	-1.367	5797
MCI	-0.22	174	-0.56	268	-0.7	249			-0.525	691	-0.449	6359
MGM	-1.3	173	-1.59	211	-1.72	102			-1.514	486	-1.644	5345
MKE	-1.66	166	-1.37	275	-1.62	264			-1.532	705	-2.035	6413
MKG	-0.23	202	-0.2	397	-0.29	259			-0.234	858	-0.287	6089
MLI	-0.44	198	-0.53	311	-0.43	218			-0.476	727	-0.353	6282
MSO	-0.36	139			-1.19	181	-0.53	104	-0.756	424	-1.143	5229
OFK			-0.58	256	-0.61	284	-0.76	68	-0.614	608	-1.061	6500
ORH	1.16	172	1.15	202	1.17	227			1.160	601	0.606	5668
PAH	-0.59	169	-0.54	239	-0.62	169			-0.578	577	-0.605	6063
PDT	-0.5	179	-0.25	342	-0.42	205			-0.360	726	-0.616	6320
PDX			0.16	331	0.16	255	0.12	209	0.149	795	-0.056	6371
PIA	-0.21	194	-0.33	288	-0.26	205			-0.275	687	-0.529	6115
RFD	0.09	202	0.01	312	-0.27	260			-0.063	774	-0.191	6365
RST	-0.02	241	-0.2	247	-0.13	229			-0.117	717	-0.075	5973
SUX	-0.28	180	-0.59	250	-0.41	290			-0.440	720	-0.820	6502
SUMS		4781		8462		7457		1013		21713		216805
MEANS	-0.457		-0.528		-0.545		-0.278		-0.497		-0.729	

Table 3.3 (C) Seasonal and Annual Instrument Biases for Two-season Stations and Average Temperature Difference over all Observations

Station	Fall Instrument Bias		Winter Instrument Bias		Spring Instrument Bias		Summer Instrument Bias		Annual Instrument bias		All Possible Observations	
	ΔT_i	number of night ovc obs	ΔT_i	number of night ovc obs	ΔT_i	number of night ovc obs	ΔT_i	number of night ovc obs	ΔT_i	Tot number of night ovc obs	ΔT	Number
BIL	-1.29	147	-1.06	192					-1.160	339	-1.216	4286
CAK					-0.92	213	-0.39	116	-0.733	329	-0.785	4144
DRA	-1.33	43	-1.27	135					-1.284	178	-1.455	4300
FNT			0.22	353	0.3	246			0.253	599	-0.026	4314
GEG					-0.39	104	-0.34	61	-0.372	165	-0.548	3579
ISN			-0.2	225	-0.39	233			-0.297	458	-0.642	3763
LBF			-0.04	158			-0.62	58	-0.192	214	-1.100	3925
MSN	-0.97	223	-1.02	310					-0.999	533	-1.311	4192
SJT			-0.6	223	-0.58	125			-0.593	348	-0.799	3757
TRI	-0.53	183					-0.47	110	-0.507	293	-0.887	3816
SUMS		596		1596		921		343		3456		40076
MEANS	-1.030		-0.567		-0.396		-0.455		-0.588		-0.877	

(ATL) to +1.16°F (ORH), with only 9 stations having a positive instrument bias. This data clearly shows that the CONV instrument is warmer on average than the ASOS instrument by 0.53°F. There were fluctuations in the seasonal instrument biases at each site, which were probably due to maintenance, changing of a sensor, or electrical problems in the sensor. For 2/3 of the stations, these fluctuations were < 0.5°F.

To establish the expected range in the instrument bias at each site, 95% confidence intervals were computed for the seasonal biases which were then plotted in order from most positive to most negative as seen in Figures 3.5(A) - (D). A majority of the confidence intervals (55%) were smaller in range than 0.16°F. Two observations are very apparent on each of these plots. First, most stations have negative instrument biases which translate to a warm biases in the CONV instrument as compared to ASOS. Second, there are a number of stations with instrument biases in excess of -1.0°F. In calculating the 95% confidence intervals, it was assumed that the data had normal population distributions of temperature differences with sample sizes well in excess of 30, and the Central Limit Theorem was applied in calculating the confidence intervals such that:

$$\left(\bar{x} - (1.96) \frac{\sigma_{\bar{x}}}{\sqrt{n}} < \mu < \bar{x} + (1.96) \frac{\sigma_{\bar{x}}}{\sqrt{n}} \right) \quad (3.4)$$

where \bar{x} is the sample mean, n is the sample size, $\sigma_{\bar{x}}$ is the standard deviation of the sample, and μ is the population mean. For stations with seasonal sample sizes $n < 30$, a t -distribution with $n-1$ degrees of freedom was used to calculate the 95% confidence interval by:

$$\left(\bar{x} - (t_{0.025, n-1}) \frac{\sigma_{\bar{x}}}{\sqrt{n}} < \mu < \bar{x} + (t_{0.025, n-1}) \frac{\sigma_{\bar{x}}}{\sqrt{n}} \right) \quad (3.5)$$

A. Instrument Bias for 4-season stations for Fall

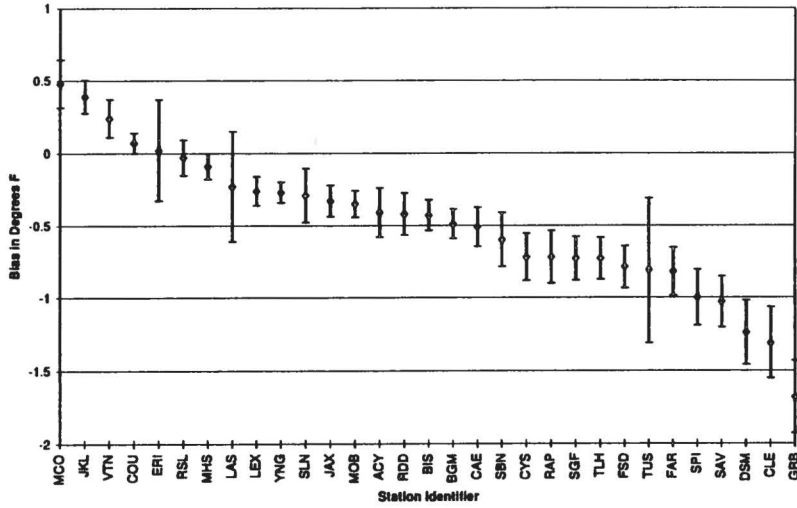

B. Instrument Bias for 4-season stations for Winter

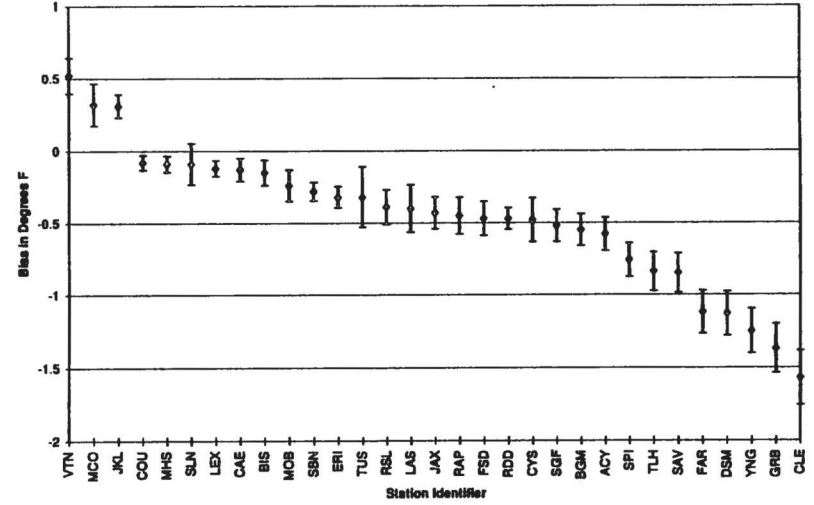

C. Instrument Bias for 4-season stations for Spring

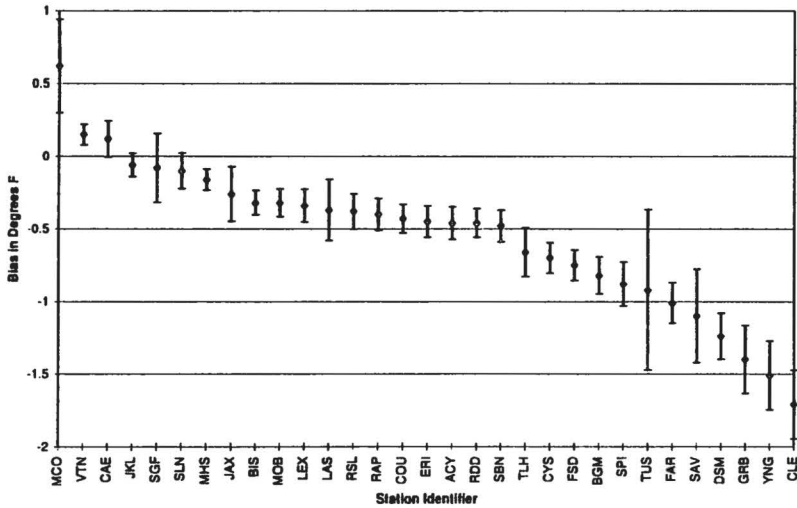

D. Instrument Bias for 4-season stations for Summer

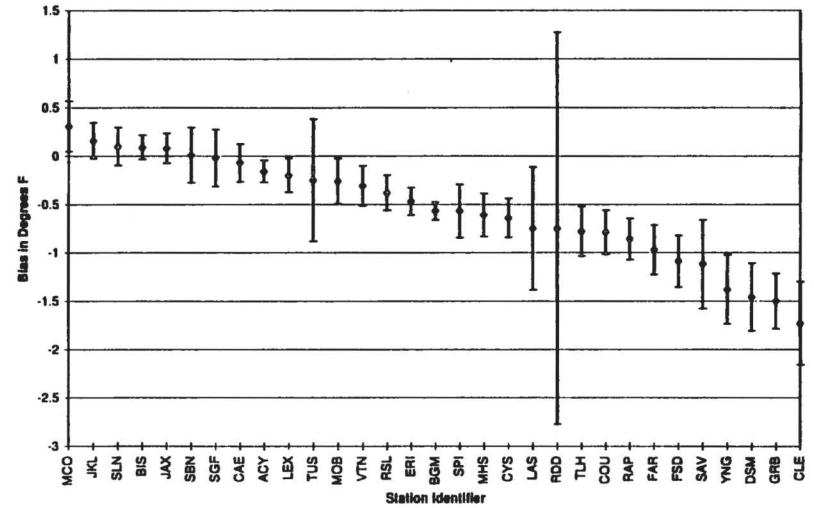

Fig. 3.5 Seasonal Instrument Biases for four-season stations plotted in order from most positive to most negative for the (A) fall, (B) winter, (C) spring, and (D) summer seasons.

where $t_{0.025}$ is the t value with 2.5% of the distribution above and below it (Devore, 1995). Figure 3.5(D), which shows the instrument biases for the summer season, has a few stations with very large error bars due to the low number of nighttime overcast observations during that particular season. Redding, CA for example had sufficient numbers of nighttime, overcast skies for three months, but due to its climatic region, it reported only 4 observations with the required nocturnal cloud cover for the whole summer season.

To check the stability of the annual instrument bias, seasonal plots were overlaid on each other to see if they were relatively close to one another at each station. Figure 3.6 shows the mean bias for each season and the confidence interval for summer. The summer season was chosen because it had the widest range of confidence intervals for most stations. For 14 of the 31 four-season stations, all of the seasonal biases were within (or very close to) the 95% confidence interval from the summer season, so calculations of annual instrument biases for these stations are useful. There were still a number of stations, however, whose seasonal values did not always fall within the summer season's confidence intervals for the instrument bias. This is probably due to fluctuations in the ΔT field discussed previously and indicates that unexplained variations are present in the data.

3.4 Nighttime Local Effects, ΔT_1

Once seasonal instrument biases were determined for each station, attention was turned to isolating the nocturnal local effects at each site. The temperature-difference

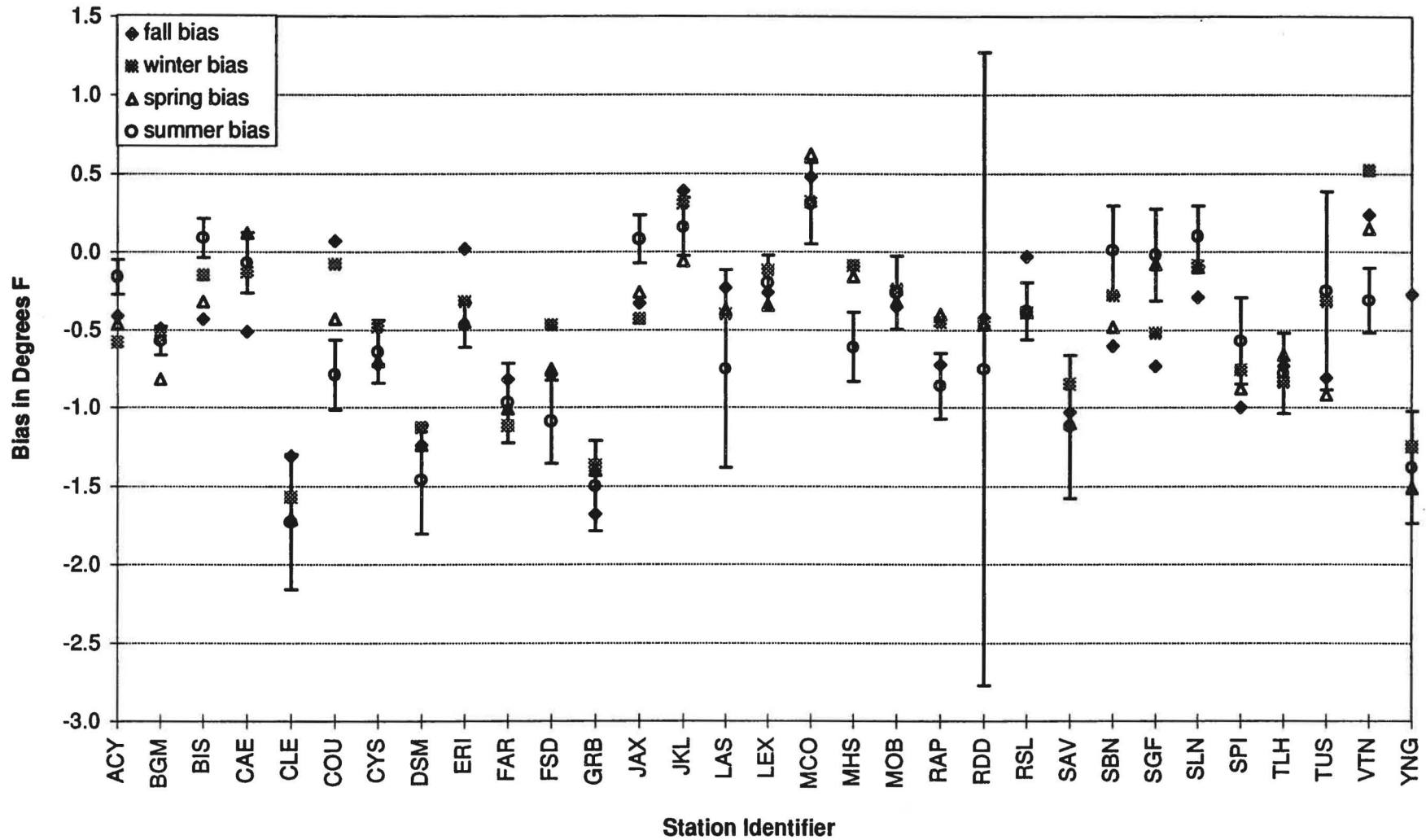

Fig. 3.6 Seasonal instrument biases for four-season stations plotted with summer season 95% confidence intervals.

equation at night now becomes $\Delta T = \Delta T_i + \Delta T_1$, with ΔT_i no longer unknown. To determine the seasonal, nocturnal local effect, the seasonal instrument bias was removed from the seasonal temperature difference for all nighttime observations, which included all wind speeds and all sky conditions. Once the instrument bias was removed, the remaining temperature difference was due to nighttime, local temperature inhomogeneities between the two sensors. Tables 3.4(A) - (C) give the seasonal and annual contributions to the temperature differences due to nocturnal local effects at all stations.

Seasonal nighttime local effects were quite variable over the course of the year at most stations, with changes in both magnitude and sign very common. Seasonal and annual nighttime local effects were calculated in an analogous manner to how seasonal and annual instrument biases were calculated. Some sites show large annual contributions by nighttime local effects. Remember at some locations the two instruments are quite a distance from each other. Seasonal values ranged from -1.29°F (SAV in the spring) to $+0.91^{\circ}\text{F}$ (TLH in the summer). Annual nocturnal local effects ranged from -1.11°F (INW) to $+0.70^{\circ}\text{F}$ (TLH), and showed that ASOS was cooler at night than CONV measurements on average by 0.16°F . The predominance of negative, annually averaged contributions by nocturnal local effects indicate ASOS systems were installed at locations which are predominantly cooler at night than the CONV site. On the other hand, collocated stations like APN, LEX, and YNG had negligible local effects since, by definition, collocated instruments are not far enough apart to be influenced by temperature inhomogeneities in the surface boundary layer. Indeed, all of these stations showed a marked decrease in contributions by nocturnal local effects with annual averages smaller than or close to 0.15°F .

Table 3.4 (A) Seasonal and Annual Nighttime Local Effects for Four-season Stations

Station	Fall	FALL (night only)			Winter	WINTER (night only)			Spring	SPRING (night only)			Summer	SUMMER (night only)			ANNUAL LOCAL EFFECTS
	ΔT_i	ΔT	ΔT_i	# of obs	ΔT_i	ΔT	ΔT_i	# of obs	ΔT_i	ΔT	ΔT_i	# of obs	ΔT_i	ΔT	ΔT_i	# of obs	
ACY	-0.41	-0.92	-0.510	633	-0.58	-0.91	-0.330	630	-0.46	-0.74	-0.280	643	-0.16	1.15	1.310	640	-0.373
BGM	-0.49	-0.39	0.100	630	-0.55	-0.51	0.040	540	-0.82	-0.76	0.060	483	-0.57	-0.61	-0.040	578	0.041
BIS	-0.43	-0.38	0.050	635	-0.15	-0.17	-0.020	610	-0.32	-0.34	-0.020	640	0.09	0.33	0.240	642	0.064
CAE	-0.51	0.06	0.570	636	-0.13	0.27	0.400	630	0.12	0.48	0.360	643	-0.07	0.4	0.470	636	0.450
CLE	-1.31	-0.76	0.550	637	-1.57	-1.29	0.280	626	-1.71	-1.57	0.140	644	-1.73	-1.82	-0.090	644	0.219
COU	0.07	0.21	0.140	622	-0.08	0.02	0.100	626	-0.43	-0.25	0.180	615	-0.79	-0.73	0.060	644	0.119
CYS	-0.72	-0.57	0.150	632	-0.48	-0.47	0.010	626	-0.7	-0.59	0.110	641	-0.64	-0.7	-0.060	642	0.052
DSM	-1.24	-1.9	-0.660	637	-1.13	-1.38	-0.250	617	-1.24	-1.76	-0.520	640	-1.46	-2.45	-0.990	634	-0.607
ERI	0.02	-0.49	-0.510	618	-0.32	-0.31	0.010	610	-0.45	-0.79	-0.340	640	-0.47	-0.8	-0.330	576	-0.293
FAR	-0.82	-0.94	-0.120	447	-1.12	-1.28	-0.160	617	-1.01	-1.11	-0.100	641	-0.97	-1.42	-0.450	644	-0.216
FSD	-0.79	-1.48	-0.690	551	-0.47	-0.78	-0.310	595	-0.75	-1.33	-0.580	636	-1.09	-1.92	-0.830	636	-0.604
GRB	-1.68	-2.54	-0.860	634	-1.37	-1.83	-0.460	595	-1.4	-2.06	-0.660	503	-1.5	-2.7	-1.200	641	-0.809
JAX	-0.33	-0.57	-0.240	608	-0.43	-0.19	0.240	596	-0.26	0.62	0.890	471	0.08	0.33	0.250	638	0.247
JKL	0.39	0.69	0.300	637	0.31	0.44	0.130	626	-0.06	0.14	0.200	634	0.18	0.24	0.090	642	0.177
LAS	-0.23	-0.83	-0.600	617	-0.4	-0.79	-0.390	628	-0.37	-0.61	-0.240	486	-0.75	-0.78	-0.030	593	-0.323
LEX	-0.26	-0.17	0.090	635	-0.12	-0.03	0.090	627	-0.34	-0.26	0.090	641	-0.2	-0.11	0.090	636	0.087
MCO	0.48	0.38	-0.100	502	0.32	0.02	-0.300	466	0.62	0.02	-0.800	470	0.31	-0.13	-0.440	635	-0.362
MHS	-0.09	-0.34	-0.250	557	-0.09	-0.11	-0.020	578	-0.16	-0.3	-0.140	460	-0.61	-1.5	-0.890	612	-0.344
MOB	-0.35	-0.18	0.170	634	-0.24	-0.14	0.100	622	-0.32	-0.22	0.100	644	-0.26	-0.35	-0.090	643	0.069
RAP	-0.72	-1.02	-0.300	434	-0.45	-0.96	-0.510	625	-0.4	-0.63	-0.230	642	-0.86	-1.39	-0.530	644	-0.400
RDD	-0.42	-0.46	-0.040	616	-0.47	-0.46	0.010	627	-0.46	-0.44	0.020	557	-0.75	-0.6	0.150	501	0.030
RSL	-0.03	-0.63	-0.600	556	-0.39	-0.67	-0.290	545	-0.38	-0.73	-0.350	594	-0.38	-0.87	-0.490	612	-0.431
SAV	-1.03	-1.92	-0.890	635	-0.85	-1.5	-0.650	593	-1.1	-2.39	-1.290	475	-1.12	-1.96	-0.840	537	-0.899
SBN	-0.6	-0.54	0.060	592	-0.28	-0.34	-0.060	626	-0.48	-0.7	-0.220	642	0.01	-0.22	-0.230	632	-0.116
SGF	-0.73	-1.13	-0.400	599	-0.52	-0.93	-0.410	619	-0.08	-0.45	-0.370	569	-0.02	-0.48	-0.460	591	-0.410
SLN	-0.29	-0.99	-0.700	558	-0.09	-0.82	-0.730	566	-0.1	-0.84	-0.740	595	0.1	-0.96	-1.060	605	-0.811
SPI	-1	-1.3	-0.300	636	-0.76	-0.82	-0.060	622	-0.88	-1.03	-0.150	642	-0.57	-1.49	-0.920	545	-0.338
TLH	-0.73	-0.13	0.600	635	-0.84	-0.2	0.640	625	-0.66	-0.01	0.850	644	-0.78	0.13	0.910	643	0.701
TUS	-0.81	-0.28	0.530	634	-0.32	-0.46	-0.140	519	-0.92	-0.51	0.410	642	-0.25	-0.33	-0.090	637	0.196
VTN	0.24	0.04	-0.200	480	0.52	0.35	-0.170	591	0.15	-0.04	-0.190	611	-0.31	-0.78	-0.470	629	-0.263
YNG	-0.49	-0.27	0.220	636	-1.25	-1.11	0.140	624	-1.51	-1.34	0.170	499	-1.38	-1.31	0.070	533	0.152
SUMS				18513				18647				18287				18425	
MEANS	-0.494	-0.637	-0.143		-0.461	-0.560	-0.099		-0.545	-0.663	-0.118		-0.546	-0.769	-0.222		-0.161

Table 3.4 (B) Seasonal and Annual Nighttime Local Effects for Three-season Stations

Station	Fail	FALL (night only)			Winter	WINTER (night only)			Spring	SPRING (night only)			Summer	SUMMER (night only)			ANNUAL LOCAL EFFECTS
	ΔT_i	ΔT	ΔT_i	# of obs	ΔT_i	ΔT	ΔT_i	# of obs	ΔT_i	ΔT	ΔT_i	# of obs	ΔT_i	ΔT	ΔT_i	# of obs	
ABE					-1.15	-1.6	-0.450	514	-0.97	-1.75	-0.780	597	-0.67	-1.89	-1.020	640	-0.771
ABQ					-0.94	-1.19	-0.250	619	-1.02	-1.27	-0.250	620	-0.48	-0.85	-0.370	629	-0.290
ALB	-0.41	-0.54	-0.130	636	-0.88	-0.84	0.040	627	-0.65	-0.64	0.010	615					-0.027
ALO	-0.65	-0.62	0.030	437	-0.56	-0.51	0.050	613	-0.72	-0.64	0.080	550					0.055
APN	-0.3	-0.16	0.140	637	-0.4	-0.35	0.050	623	-0.31	-0.35	-0.040	539					0.055
ATL	-2.17	-3.03	-0.860	626	-1.78	-1.95	-0.170	617	-2.04	-2.68	-0.640	644					-0.559
AUS	-0.46	-0.06	0.400	432	-0.4	-0.01	0.390	625	-0.25	-0.06	0.190	629					0.318
BFF	-0.54	-0.66	-0.120	628	-0.24	-0.33	-0.090	619	-0.37	-0.28	0.090	639					-0.039
DAB	0.01	-0.19	-0.200	634	0.1	0.06	-0.040	626	-0.06	-0.62	-0.560	585					-0.260
DAY					-0.29	-0.24	0.050	572	-0.3	-0.06	0.240	517	-0.13	0.06	0.190	640	0.159
DTW	-0.7	-0.83	-0.130	636	-0.89	-0.89	0.000	623	-0.68	-0.73	-0.050	637					-0.060
EUG					-1.08	-1.07	0.010	443	-0.9	-1.37	-0.470	616	-0.53	-1.33	-0.800	636	-0.468
FWA	-1.03	-1.57	-0.540	624	-0.64	-0.51	0.130	602	-0.6	-0.69	-0.090	548					-0.174
GJT	-0.68	-0.98	-0.300	434	-0.56	-0.79	-0.230	576	-0.51	-0.97	-0.460	530					-0.329
HON	-0.15	-0.11	0.040	635					-0.24	-0.15	0.090	642	0.12	0.11	-0.010	638	0.040
INL	-0.61	-0.86	-0.250	447	-0.53	-0.74	-0.210	597	-0.77	-1.1	-0.330	468					-0.259
INW	0.4	-0.78	-1.180	512	0.73	-0.37	-1.100	608	0.5	-0.55	-1.050	582					-1.107
LAN	0.3	0	-0.300	582					0.18	0.05	-0.130	431	0.75	0.52	-0.230	639	-0.229
LBB					-0.61	-1.24	-0.630	581	-0.64	-0.84	-0.200	620	-0.67	-0.46	0.210	620	-0.188
LCH	-1.24	-1.31	-0.070	586	-1.37	-1.4	-0.030	520	-1.4	-1.52	-0.120	570					-0.075
MCI	-0.22	-0.04	0.190	626	-0.56	-0.25	0.310	620	-0.7	-0.43	0.270	625					0.253
MGM	-1.3	-1.31	-0.010	626	-1.59	-1.41	0.180	490	-1.72	-1.54	0.180	450					0.104
MKE	-1.66	-1.88	-0.220	636	-1.37	-1.45	-0.080	584	-1.62	-1.78	-0.160	644					-0.155
MKG	-0.23	-0.18	0.050	627	-0.2	-0.15	0.050	598	-0.29	-0.27	0.020	558					0.041
MLJ	-0.44	0.16	0.600	635	-0.53	-0.4	0.130	618	-0.43	0.08	0.510	581					0.413
MSO	-0.36	-0.37	-0.010	447					-1.19	-1.19	0.000	440	-0.53	-0.74	-0.210	643	-0.091
OFK					-0.58	-0.67	-0.090	617	-0.61	-0.74	-0.130	641	-0.76	-1	-0.240	633	-0.154
ORH	1.16	1.13	-0.030	621	1.15	1.14	-0.010	511	1.17	1.12	-0.050	547					-0.030
PAH	-0.59	-0.05	0.540	634	-0.54	-0.2	0.340	518	-0.62	-0.63	-0.010	629					0.288
PDT	-0.5	-1.05	-0.550	633	-0.25	-0.5	-0.250	595	-0.42	-0.67	-0.250	826					-0.352
PDX					0.16	0.32	0.160	617	0.16	0.51	0.350	622	0.12	0.33	0.210	639	0.240
PIA	-0.21	-0.25	-0.040	636	-0.33	-0.3	0.030	620	-0.26	-0.22	0.040	529					0.008
RFD	0.09	0.21	0.120	601	0.01	0.1	0.090	621	-0.27	-0.13	0.140	638					0.117
RST	-0.02	0.11	0.130	633	-0.2	-0.12	0.090	573	-0.13	0.25	0.390	541					0.191
SUX	-0.28	-1.16	-0.880	636	-0.59	-1.14	-0.550	622	-0.41	-0.89	-0.480	640					-0.637
SUMS				16477				18810				20290				6358	
MEANS	-0.457	-0.585	-0.128		-0.528	-0.584	-0.065		-0.545	-0.650	-0.105		-0.278	-0.505	-0.227		-0.114

Table 3.4 (C) Seasonal and Annual Nighttime Local Effects for Two-season Stations

Station	Fall	FALL (night only)			Winter	WINTER (night only)			Spring	SPRING (night only)			Summer	SUMMER (night only)			ANNUAL LOCAL EFFECTS
	ΔT_i	ΔT	ΔT_i	# of obs	ΔT_i	ΔT	ΔT_i	# of obs	ΔT_i	ΔT	ΔT_i	# of obs	ΔT_i	ΔT	ΔT_i	# of obs	
BIL	-1.29	-1.31	-0.020	634	-1.06	-1.08	-0.020	622									-0.020
CAK									-0.92	-0.93	-0.010	589	-0.39	-0.53	-0.140	629	-0.077
DRA	-1.33	-1.33	0.000	629	-1.27	-1.39	-0.120	628									-0.060
FNT					0.22	0.16	-0.060	616	0.3	0.08	-0.220	643					-0.142
GEG									-0.39	-0.77	-0.390	484	-0.34	-0.61	-0.270	554	-0.321
ISN					-0.2	-0.53	-0.330	611	-0.39	-0.44	-0.050	490					-0.205
LBF					-0.04	-1.31	-1.270	611					-0.62	-1.54	-0.920	537	-1.106
MSN	-0.97	-0.49	0.490	629	-1.02	-0.86	0.160	594									0.325
SJT					-0.6	-0.56	0.040	601	-0.58	-0.73	-0.150	500					-0.046
TRI	-0.53	-1.18	-0.650	632									-0.47	-0.83	-0.360	487	-0.524
SUMS				2524				4283				2706				2207	
MEANS	-1.030	-1.078	-0.048		-0.567	-0.796	-0.229		-0.396	-0.558	-0.162		-0.455	-0.878	-0.423		-0.218

3.5 Daytime Local and Solar Heating Effects, ΔT_s

The final contribution to the temperature differences observed between the ASOS and CONV observations was that of the daytime local plus solar effects. It is impossible to separate these two influences from each other, so the temperature difference equation becomes $\Delta T = \Delta T_i + \Delta T_l + \Delta T_s$, with ΔT_i no longer unknown. Isolating the combined effect of these two contributions was accomplished by removing the seasonal instrument bias from the seasonal temperature difference for all daytime observations. Tables 3.5 (A) - (C) show both seasonal and annual contributions to the temperature differences at each site due to daytime local and solar influences. Seasonal ranges for these daytime effects were from -2.26°F (JKL in the summer) to $+0.91^\circ\text{F}$ (DSM in the fall). The range of annual contributions from the daytime effects was from -1.54°F (JKL) to $+0.61^\circ\text{F}$ (VTN), with an overwhelming number on the negative side. The annually averaged contributions show that CONV instruments are warmer by 0.37°F during the daytime hours than ASOS instruments. Note that for about half of the stations the summer local and solar effects are more negative than these effects in the winter time. Indeed, the average over all stations in the four-season group of the seasonal biases is more negative in the summer (-0.50°F) than in the winter (-0.21°F). This supports evidence that the older HO83 hygrothermometer is subject to solar heating problems not experienced by the ASOS instrument. Indeed, it was proposed (Jones and Young, 1994) that the original version of the HO83 exhibits this warm bias due to "heating of the instrument housing by internal heat sources coupled with inadequate ventilation." Further evidence that the HO83 suffers more from solar heating effects is found in examining the daytime effects at

Table 3.5 (A) Seasonal and Annual Daytime Local and Solar Effects for Four-season Stations

Station	Fall	FALL (day only)			Winter	WINTER (day only)			Spring	SPRING (day only)			Summer	SUMMER (day only)			ANNUAL LOCAL & SOLAR EFFECTS
	ΔT_i	ΔT	$\Delta T_i + \Delta T_s$	# of obs	ΔT_i	ΔT	$\Delta T_i + \Delta T_s$	# of obs	ΔT_i	ΔT	$\Delta T_i + \Delta T_s$	# of obs	ΔT_i	ΔT	$\Delta T_i + \Delta T_s$	# of obs	
ACY	-0.41	0.01	0.420	627	-0.58	-0.49	0.090	627	-0.46	-0.21	0.250	634	-0.67	-0.76	-0.090	641	0.253
BGM	-0.49	-0.61	-0.120	632	-0.55	-0.82	-0.270	542	-0.82	-0.8	0.020	490	-0.57	-0.84	-0.270	579	-0.190
BIS	-0.43	-0.63	-0.200	635	-0.15	-0.78	-0.630	617	-0.32	-0.78	-0.460	637	0.06	-0.42	-0.510	641	-0.440
CAE	-0.51	-1.47	-0.960	637	-0.13	-0.61	-0.480	624	0.12	-0.85	-0.970	639	-0.07	-1.11	-1.040	638	-0.865
CLE	-1.31	-1.28	0.030	629	-1.57	-1.81	-0.240	618	-1.71	-1.86	-0.150	643	-1.73	-2.53	-0.800	643	-0.292
COU	0.07	-0.28	-0.350	626	-0.08	-0.15	-0.070	622	-0.43	-0.61	-0.180	611	-0.79	-1.8	-0.810	635	-0.356
CYS	-0.72	-1.17	-0.450	621	-0.48	-1.32	-0.840	610	-0.7	-1.24	-0.540	627	-0.64	-1.07	-0.430	642	-0.563
DSM	-1.24	-0.33	0.910	635	-1.13	-0.77	0.360	617	-1.24	-0.78	0.460	641	-1.46	-1.52	-0.060	627	0.420
ERI	0.02	-0.51	-0.530	605	-0.32	-0.51	-0.190	595	-0.45	-0.7	-0.250	638	-0.47	-1.18	-0.710	570	-0.414
FAR	-0.82	-0.91	-0.090	453	-1.12	-1.54	-0.420	606	-1.01	-1.28	-0.270	635	-0.07	-1.22	-0.250	642	-0.260
FSD	-0.79	-1.03	-0.240	547	-0.47	-1.08	-0.610	611	-0.75	-1.04	-0.290	640	-1.00	-1.93	-0.840	641	-0.503
GRB	-1.68	-1.32	0.360	634	-1.37	-1.37	0.000	591	-1.4	-1.08	0.320	501	-1.5	-1.78	-0.280	640	0.088
JAX	-0.33	-0.86	-0.530	616	-0.43	-0.79	-0.360	583	-0.26	-1.22	-0.960	473	0.08	-1.15	-1.230	629	-0.767
JKL	0.39	-1.3	-1.890	630	0.31	-0.57	-0.880	625	-0.06	-1.39	-1.330	641	0.18	-2.1	-2.260	634	-1.542
LAS	-0.23	-1.46	-1.230	617	-0.4	-1.34	-0.940	619	-0.37	-1.49	-1.120	479	-0.75	-1.47	-0.720	601	-0.997
LEX	-0.26	-0.8	-0.540	634	-0.12	-0.32	-0.200	628	-0.34	-0.78	-0.440	639	-0.2	-0.8	-0.600	642	-0.396
MCO	0.48	0.24	-0.240	502	0.32	0.41	0.090	461	0.62	0.52	-0.100	461	0.31	0.32	0.010	628	-0.058
MHS	-0.09	-0.22	-0.130	552	-0.09	-0.09	0.000	580	-0.18	-0.37	-0.210	493	-0.61	-0.13	0.480	614	0.053
MOB	-0.35	-0.62	-0.270	636	-0.24	-0.66	-0.420	627	-0.32	-0.57	-0.250	634	-0.26	-0.86	-0.600	640	-0.385
RAP	-0.72	-0.79	-0.070	433	-0.45	-0.57	-0.120	620	-0.4	-1.29	-0.890	631	-0.86	-0.68	0.180	640	-0.237
RDD	-0.42	-0.79	-0.370	600	-0.47	-0.61	-0.140	620	-0.46	-0.77	-0.310	544	-0.75	-0.96	-0.210	507	-0.257
RSL	-0.03	0.09	0.120	562	-0.39	-0.27	0.120	567	-0.38	-0.35	0.030	611	-0.38	-0.05	0.330	603	0.151
SAV	-1.03	-1.09	-0.060	621	-0.85	-0.59	0.260	579	-1.1	-1.11	-0.010	467	-1.12	-1.51	-0.390	536	-0.048
SBN	-0.8	-0.96	-0.160	599	-0.28	-0.45	-0.170	627	-0.48	-1	-0.520	639	0.01	-0.75	-0.760	637	-0.455
SGF	-0.73	-1.12	-0.390	612	-0.52	-0.61	-0.090	621	-0.08	-0.3	-0.220	582	-0.02	-1.37	-1.390	612	-0.515
SLN	-0.29	0.48	0.770	563	-0.09	0.25	0.340	550	-0.1	0.45	0.550	602	0.1	0.79	0.690	597	0.590
SPI	-1	-0.82	0.180	636	-0.76	-0.87	-0.110	629	-0.88	-1	-0.120	643	-0.57	-1.34	-0.770	542	-0.183
TLH	-0.73	-1.09	-0.360	627	-0.84	-1.1	-0.260	628	-0.66	-1.19	-0.530	634	-0.78	-1.31	-0.530	634	-0.421
TUS	-0.81	-1.66	-0.850	633	-0.32	-1.17	-0.850	513	-0.92	-2.66	-1.740	626	-0.25	-1.09	-0.840	635	-1.079
VTN	0.24	1.03	0.790	478	0.52	1.05	0.530	589	0.15	0.42	0.270	608	-0.31	0.58	0.890	627	0.813
YNG	-0.49	-0.88	-0.390	621	-1.25	-1.38	-0.130	619	-1.51	-1.94	-0.430	445	-1.38	-2.61	-1.230	534	-0.528
SUMS				17826				17938				17554				18390	
MEANS	-0.484	-0.708	-0.214		-0.461	-0.675	-0.214		-0.545	-0.880	-0.335		-0.563	-1.050	-0.500		-0.310

Table 3.5 (B) Seasonal and Annual Daytime Local and Solar Effects for Three-season Stations

Station	Fall				Winter				Spring				Summer				ANNUAL LOCAL & SOLAR EFFECTS
	ΔT_1	ΔT	$\Delta T_1 + \Delta T_s$	# of obs	ΔT_1	ΔT	$\Delta T_1 + \Delta T_s$	# of obs	ΔT_1	ΔT	$\Delta T_1 + \Delta T_s$	# of obs	ΔT_1	ΔT	$\Delta T_1 + \Delta T_s$	# of obs	
ABE					-1.15	-1.51	-0.360	613	-0.97	-1.32	-0.350	574	-0.67	-0.76	-0.090	641	-0.257
ABQ					-0.94	-1.77	-0.830	613	-1.02	-1.79	-0.770	610	-0.48	-2.07	-1.590	620	-1.066
ALB	-0.41	-0.7	-0.290	631	-0.88	-1.12	-0.240	626	-0.65	-0.94	-0.290	610					-0.273
ALO	-0.65	-0.73	-0.090	444	-0.56	-1.05	-0.490	609	-0.72	-0.77	-0.050	548					-0.226
APN	-0.3	-0.75	-0.450	633	-0.4	-0.78	-0.380	625	-0.31	-0.93	-0.620	446					-0.469
ATL	-2.17	-2.5	-0.430	623	-1.78	-1.97	-0.190	620	-2.04	-2.72	-0.680	638					-0.436
AUS	-0.46	-1.01	-0.550	429	-0.4	-0.86	-0.460	623	-0.25	-0.76	-0.510	630					-0.502
BFF	-0.54	-1.02	-0.480	613	-0.24	-0.86	-0.620	621	-0.37	-0.43	-0.060	628					-0.385
DAB	0.01	-0.27	-0.260	636	0.1	-0.06	-0.160	627	-0.06	-0.31	-0.250	581					-0.230
DAY					-0.29	-0.88	-0.590	580	-0.3	-0.88	-0.580	504	-0.13	-1.2	-1.070	635	-0.764
DTW	-0.7	-1.22	-0.520	632	-0.89	-1.07	-0.180	627	-0.68	-1.12	-0.440	642					-0.381
EUG					-1.08	-1.37	-0.290	433	-0.9	-1.37	-0.470	599	-0.53	-0.51	0.020	625	-0.236
FWA	-1.03	-1.06	-0.030	624	-0.64	-1.17	-0.530	597	-0.6	-1.22	-0.620	544					-0.381
GJT	-0.68	-0.84	-0.160	429	-0.56	-1.04	-0.480	580	-0.51	-0.82	-0.310	529					-0.332
HON	-0.15	-0.3	-0.150	635					-0.24	-0.53	-0.290	643	0.12	-0.31	-0.430	642	-0.291
INL	-0.61	-0.8	-0.190	454	-0.53	-0.92	-0.390	601	-0.77	-0.99	-0.220	478					-0.278
INW	0.4	0.99	0.590	517	0.73	0.97	0.240	565	0.5	1.2	0.700	577					0.504
LAN	0.3	-0.13	-0.430	545					0.18	-0.16	-0.340	437	0.75	0.49	-0.260	641	-0.339
LBB					-0.61	-0.5	0.110	576	-0.64	-0.97	-0.330	607	-0.67	-1.16	-0.490	612	-0.243
LCH	-1.24	-1.25	-0.010	588	-1.37	-1.13	0.240	554	-1.4	-1.36	0.040	577					0.067
MCI	-0.22	-0.43	-0.210	624	-0.56	-0.64	-0.080	625	-0.7	-0.71	-0.010	613					-0.101
MGM	-1.3	-1.82	-0.520	616	-1.59	-1.89	-0.300	485	-1.72	-2.19	-0.470	442					-0.437
MKE	-1.66	-2.38	-0.720	634	-1.37	-2.8	-1.430	601	-1.62	-2.4	-0.790	643					-0.968
MKG	-0.23	-0.32	-0.090	622	-0.2	-0.29	-0.090	578	-0.29	-0.5	-0.210	551					-0.128
MLI	-0.44	-0.8	-0.360	637	-0.53	-1.05	-0.520	623	-0.43	-1	-0.570	583					-0.481
MSO	-0.36	-1.34	-0.980	440					-1.19	-1.99	-0.800	444	-0.53	-1.53	-1.000	640	-0.936
OFK					-0.56	-1.27	-0.690	620	-0.61	-1.19	-0.580	642	-0.76	-1.53	-0.770	638	-0.690
ORH	1.16	0.34	-0.820	613	1.15	0.27	-0.880	550	1.17	0.28	-0.890	591					-0.662
PAH	-0.59	-1.01	-0.420	637	-0.54	-0.87	-0.330	504	-0.62	-1.35	-0.730	618					-0.503
PDT	-0.5	-0.41	0.090	632	-0.25	-0.55	-0.300	582	-0.42	-0.37	0.050	617					-0.047
PDX					0.16	-0.42	-0.590	603	0.16	-0.68	-0.540	623	0.12	-1	-1.120	637	-0.852
PIA	-0.21	-1	-0.790	627	-0.33	-0.99	-0.660	624	-0.26	-0.94	-0.680	530					-0.712
RFD	0.09	-0.41	-0.500	595	0.01	-0.5	-0.510	617	-0.27	-0.67	-0.400	639					-0.538
RST	-0.02	-0.22	-0.200	627	-0.2	-0.13	0.070	557	-0.13	-0.43	-0.300	546					-0.145
SUX	-0.28	-0.01	0.270	633	-0.59	-1.25	-0.660	623	-0.41	-0.37	0.040	637					-0.113
SUMS				16370				18812				20122				6331	
MEANS	-0.457	-0.766	-0.311		-0.528	-0.921	-0.393		-0.545	-0.940	-0.395		-0.278	-0.958	-0.666		-0.400

Table 3.5 (C) Seasonal and Annual Daytime Local and Solar Effects for Two-season Stations

Station	Fall		FALL (day only)		Winter		WINTER (day only)		Spring		SPRING (day only)		Summer		SUMMER (day only)		ANNUAL LOCAL & SOLAR EFFECTS
	ΔT_i	ΔT	$\Delta T_i + \Delta T_o$	# of obs	ΔT_i	ΔT	$\Delta T_i + \Delta T_o$	# of obs	ΔT_i	ΔT	$\Delta T_i + \Delta T_o$	# of obs	ΔT_i	ΔT	$\Delta T_i + \Delta T_o$	# of obs	
BIL	-1.29	-1.32	-0.030	626	-1.06	-1.11	-0.050	618									-0.040
CAK									-0.02	-0.04	-0.020	581	-0.39	-0.7	-0.310	619	-0.170
DRA	-1.33	-1.54	-0.210	630	-1.27	-1.76	-0.490	617									-0.349
FNT					0.22	-0.19	-0.410	621	0.3	-0.28	-0.590	643					-0.496
GEG									-0.39	-0.55	-0.160	497	-0.34	-0.36	-0.020	545	-0.067
ISN					-0.2	-0.89	-0.890	613	-0.39	-0.87	-0.480	482					-0.598
LBF					-0.04	-0.6	-0.560	613					-0.62	-0.39	0.230	530	-0.194
MSN	-0.97	-2.71	-1.740	630	-1.02	-2.16	-1.140	592									-1.449
SJT					-0.6	-0.94	-0.340	590	-0.58	-0.96	-0.390	494					-0.358
TRI	-0.53	-0.97	-0.440	630									-0.47	-0.56	-0.090	479	-0.289
SUMS				2516				4264				2697				2173	
MEANS	-1.030	-1.635	-0.605		-0.567	-1.093	-0.526		-0.396	-0.720	-0.324		-0.455	-0.503	-0.048		-0.403

stations located in high-sunshine climatic regions. Sites like LAS, TUS, and ABQ which are located in the southwestern United States have large annual contributions to temperature differences due to daytime effects of -1.0°F or more. Examination of the collocated sites, APN, LEX, and YNG, reveal daytime contributions to the temperature differences on average around -0.5°F .

3.6 Diurnal Cycles (ΔT versus Time of Day)

Having thoroughly examined the sources contributing to the temperature differences between ASOS and CONV measurements, seasonal diurnal cycles were generated to show how temperature differences varied with time of day. Figures 3.7 (A) - (F) show the average, hourly temperature differences versus time of day using all available observations for each station during each season. It is obvious that over 60% of the stations (see Appendix B) exhibit noticeable fluctuations to varying amounts over the course of an average 24-hour period. Figures 3.7 (A) - (D) provide evidence of the daytime warm bias of the HO83. During the daytime hours, ΔT is more negative because the CONV instrument is warmer than ASOS. At night these differences diminish; and in the case of JKL, it appears that ASOS is located in a spot which is warmer at night than that of the CONV site. Figures 3.7(E) - (F) are examples of pronounced but reversed diurnal cycles. For both GRB and SAV the daytime ΔT is still negative, but the nighttime local effects are quite significant being in excess of -0.8°F . These nocturnal influences are strong enough to reverse the diurnal-cycle patterns at these stations.

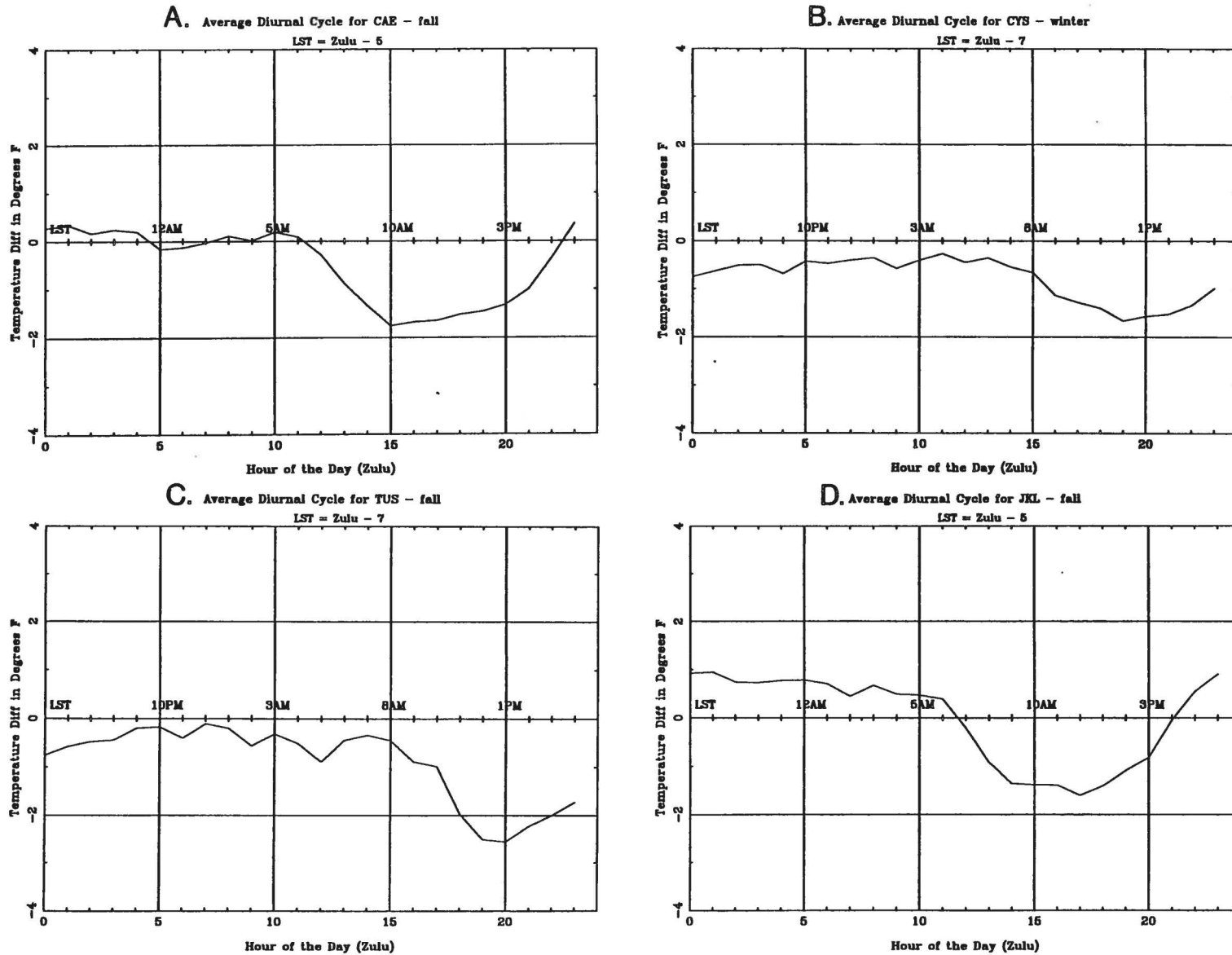

Fig. 3.7 (A) - (D) Seasonal diurnal temperature difference cycles showing daily pattern for majority of stations (daytime exhibits largest negative temperature differences.)

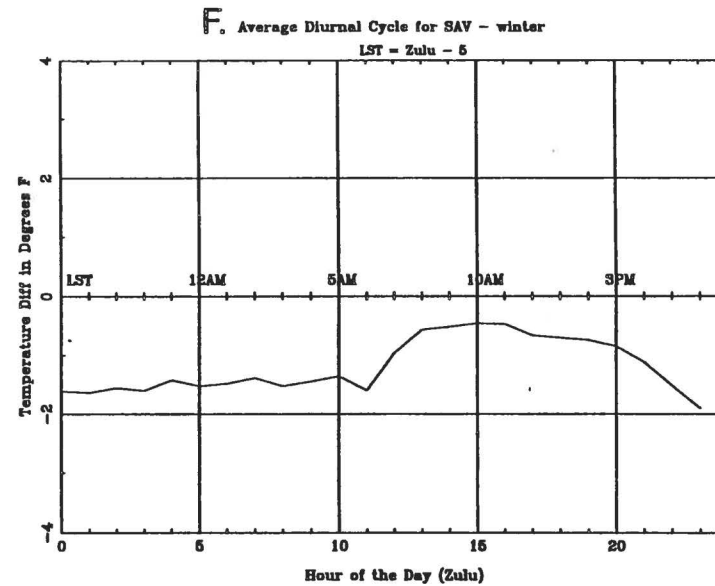
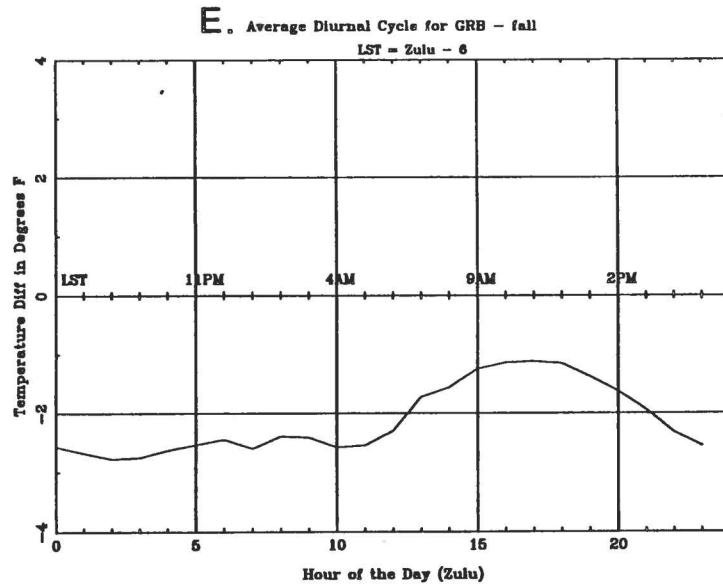

Fig. 3.7 (E) - (F) Seasonal diurnal temperature difference cycles showing reversed daily pattern depicted in 21 percent of stations (daytime still exhibits negative temperature differences, but nocturnal local effects are much more negative.)

3.7 Annual Cycles and Trends

In addition to daily temperature difference patterns, the nocturnal local effects and daytime local plus solar effects were examined for evidence of annual cycles and trends in the data. To help visually detect evidence of such patterns in the local and solar effects, bar graphs were generated for each station in the four-season and three-season lists using all available seasonal data shown in Figures 3.8(A) - (B). A seasonal cycle is identified by equitable values for the spring and fall seasons with winter and summer having opposite, more extreme values (DSM). In these cycles, it is the summer season which exhibits the largest negative value, while winter is the least negative. Of the 31 four-season stations, 5 exhibit evidence of an annual cycle in the nocturnal local effects. In addition, 12 out of 66 stations showed trends in their nocturnal seasonal effects. In other words, as time went by the contributions to seasonal temperature differences due to the nocturnal local effects became either more positive (ACY and SUX), or in most cases more negative (CLE, SBN, ABE, and EUG). These trends could be the result of seasonal weather phenomena, changing anthropogenic sources near the instruments, or simply changes in the instruments themselves.

Annual cycles and trends were also noted in similar bar graph plots of the seasonal daytime local and solar effects shown in Figures 3.9(A) - (B). Of the 31 four-season sites, 10 exhibit evidence of an annual cycle, with YNG, JKL, and SAV being the strongest examples. Of the 66 stations plotted, 26 had the most negative daytime bias during the summer season. Only 7 out of the 66 four-season and three-season stations exhibited trends in seasonal daytime local and solar effects.

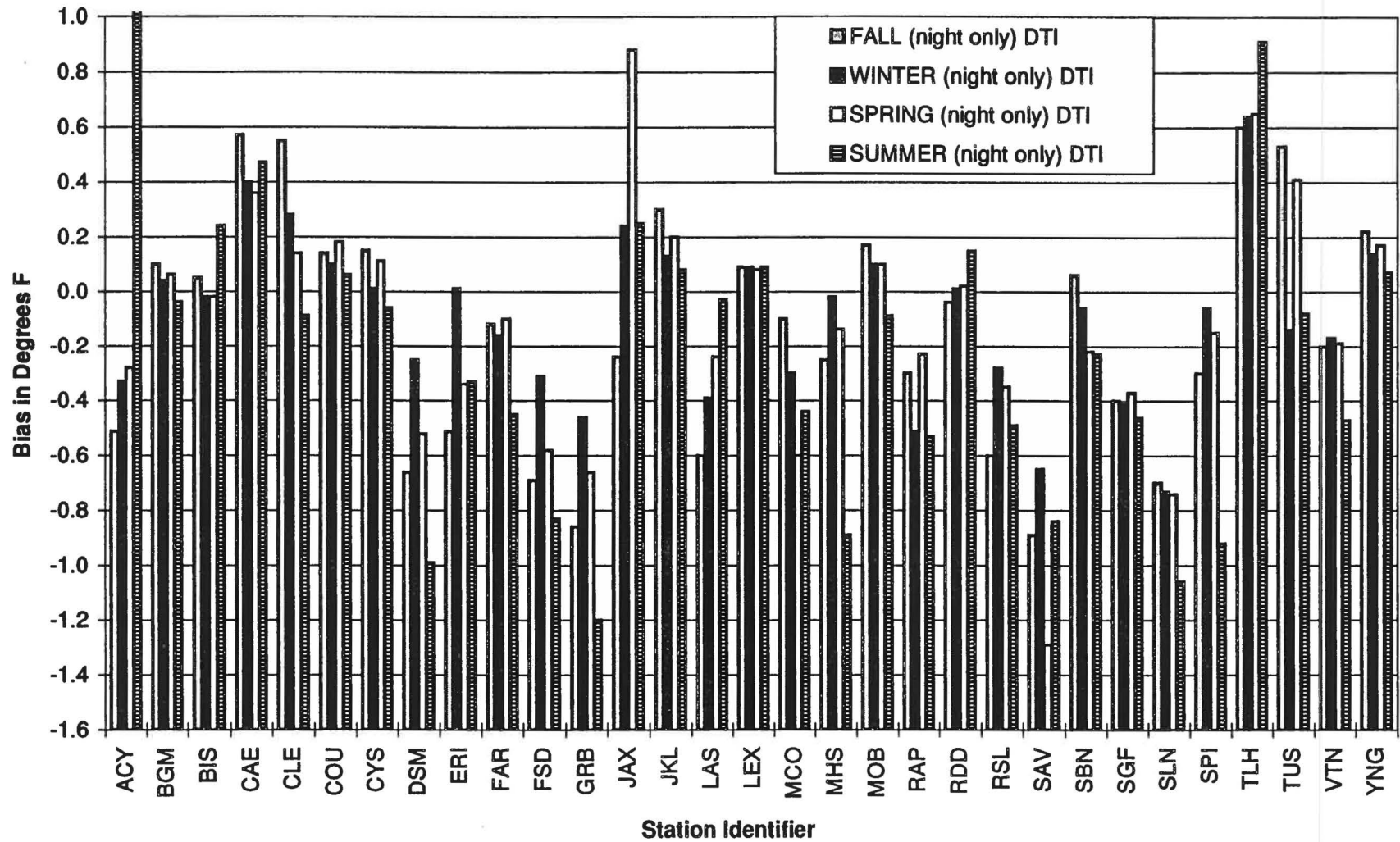

Fig. 3.8 (A) Seasonal distribution of nighttime local effects for four-season stations.

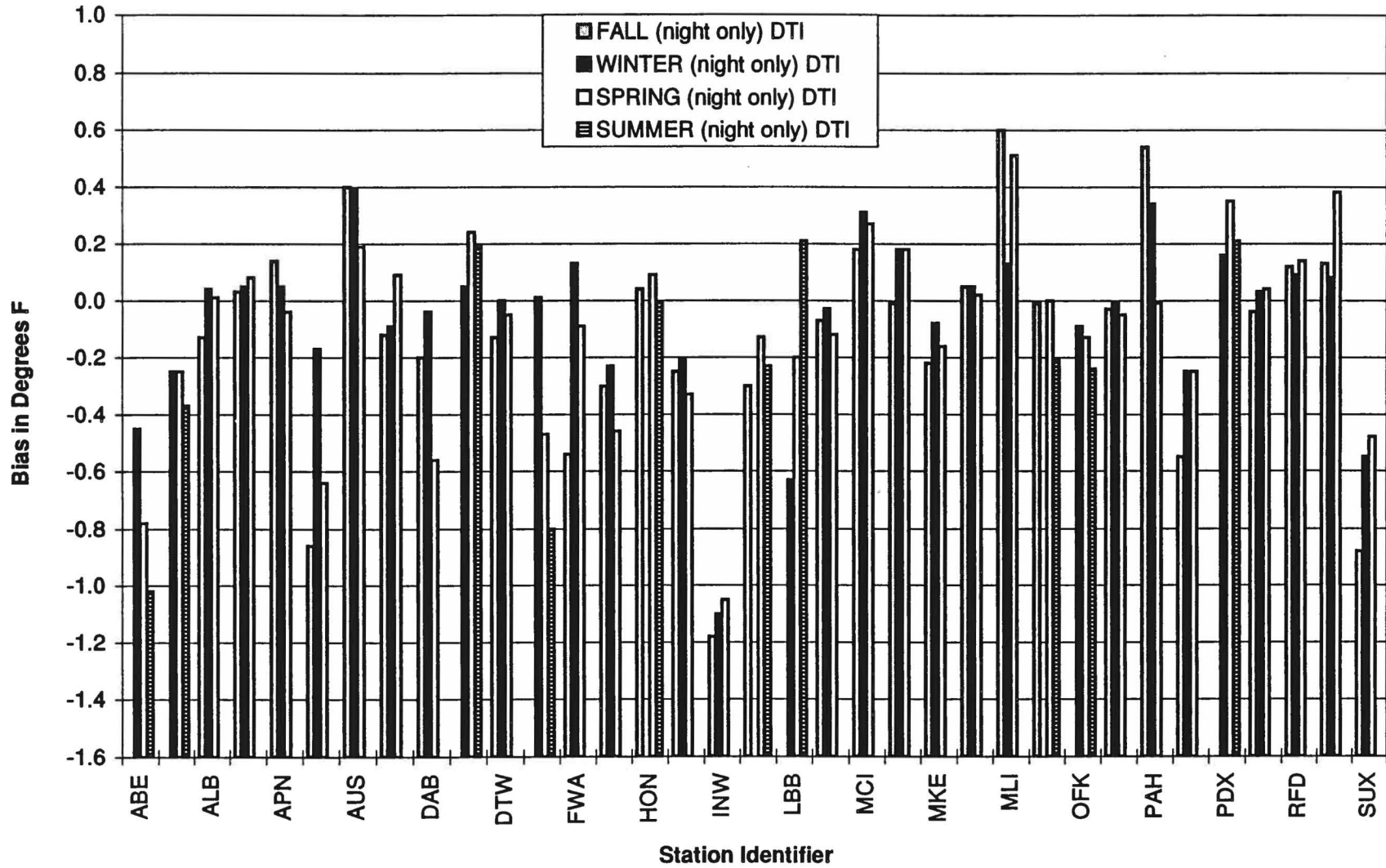

Fig. 3.8 (B) Seasonal distribution of nighttime local effects for three-season stations.

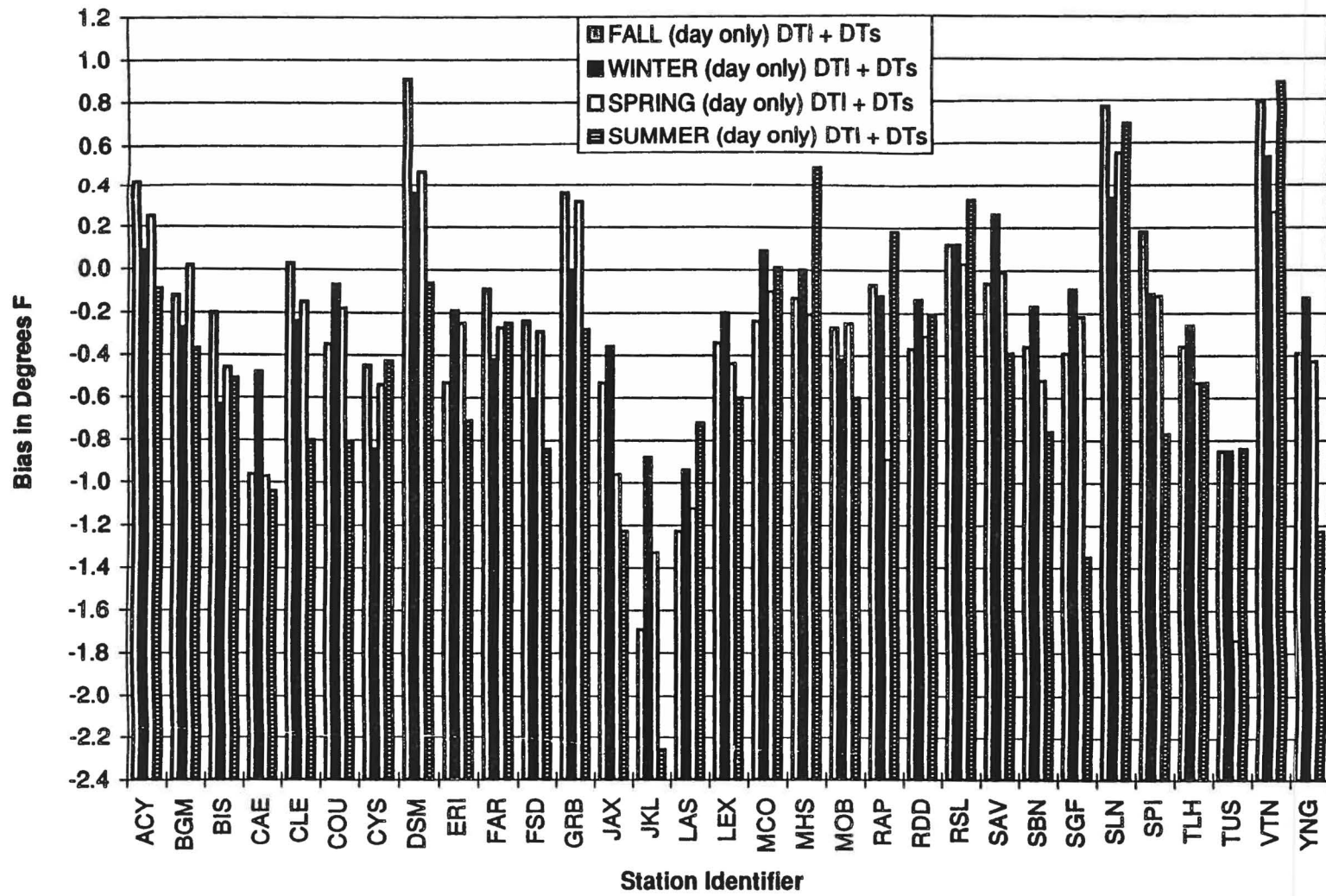

Fig. 3.9 (A) Seasonal distribution of daytime local and solar effects for four-season stations.

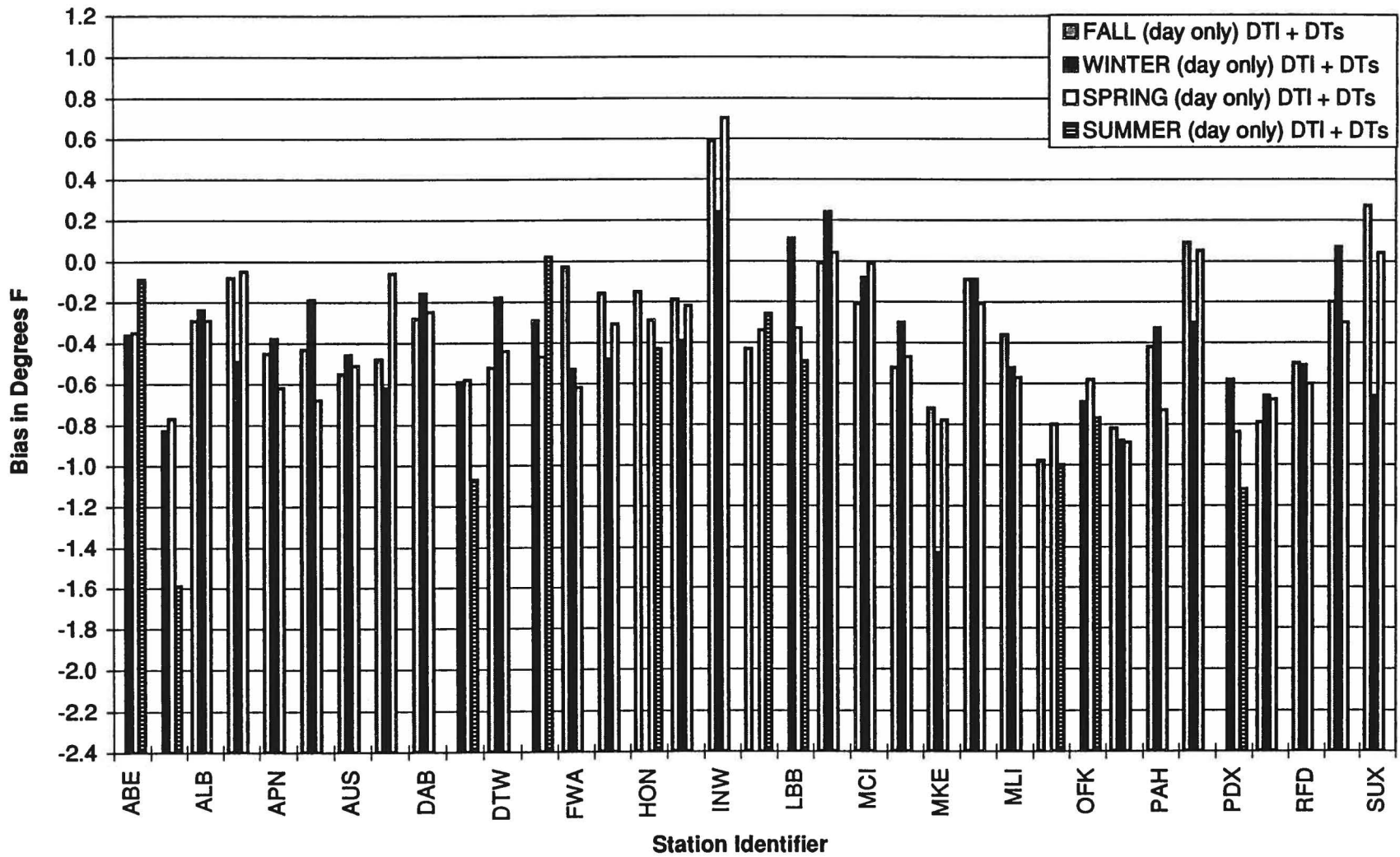

Fig. 3.9 (B) Seasonal distribution of daytime local and solar effects for three-season stations.

Returning to the temperature time series analyses, only a couple of stations exhibited signs of annual cycles in the temperature differences between $\Delta T_{\text{highest hourly}}$ and $\Delta T_{\text{lowest hourly}}$. JKL and CAE, shown in Figures 3.10 (A) - (B), were the best examples of well-behaved sites with fairly convincing evidence for the presence of an annual cycle in $\Delta T_{\text{highest hourly}}$. The mean temperature difference for these plots seems to fluctuate sinusoidally with the changing seasons. This could be due to an annual cycle in the temperature differences, or merely instabilities in the instruments. Again, it should be noted that most stations did not exhibit any evidence of having annual cycles in the time series data.

3.8 Regional Effects

Lastly, the data was examined to see if stations in like climatic zones exhibited similar temperature difference patterns. As mentioned earlier, several stations located in the sunny southwest such as LAS, TUS, and ABQ, had significant annual contributions due to daytime local and solar effects in excess of -1.0°F , supporting evidence of a warm bias in the HO83.

An interesting discovery in the temperature time series analysis showed that coastal sites had very stable and moderate temperature difference plots over the course of the year as seen in Figures 3.11(A) - (B) for DAB and LCH. The stability of these plots is most likely attributable to the moderating effects of coastal sea breezes and land breezes prevalent at these sites. In striking contrast to the coastal stations, inland-continental stations like FSD and SLN exhibit more erratic, fluctuating temperature difference time

Daily $\Delta T_{(highest\ hourly)}$ (ASOS - CONV) for JKL

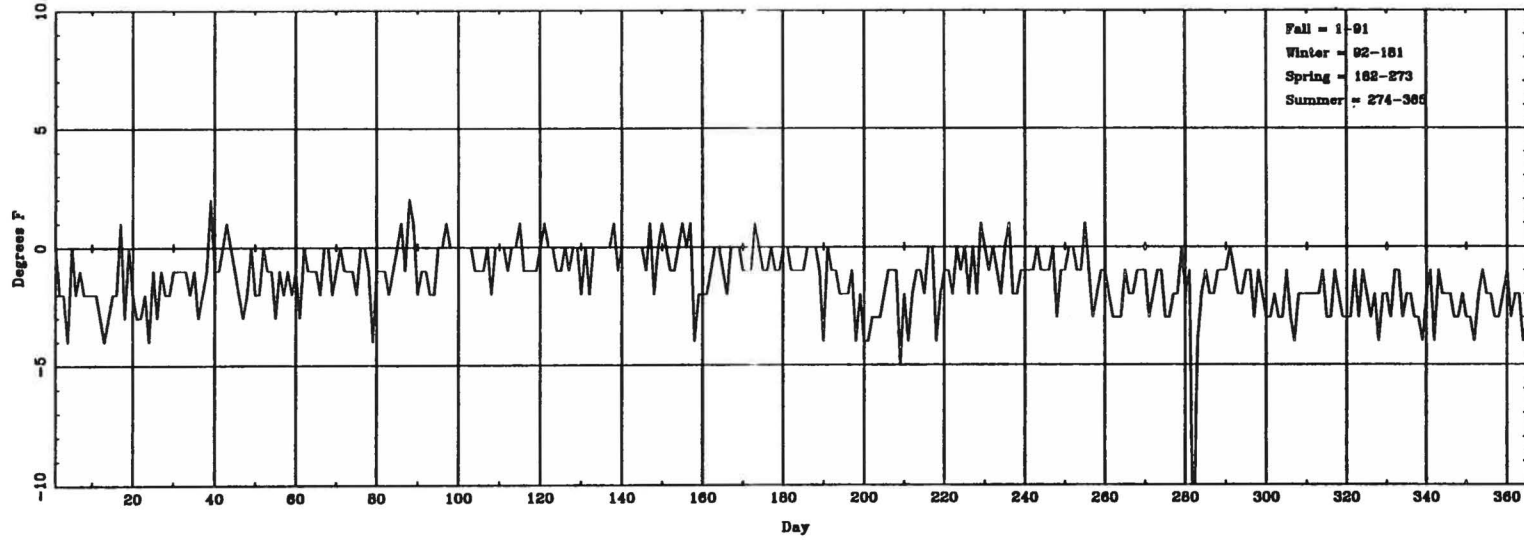

Daily $\Delta T_{(lowest\ hourly)}$ (ASOS - CONV) for JKL

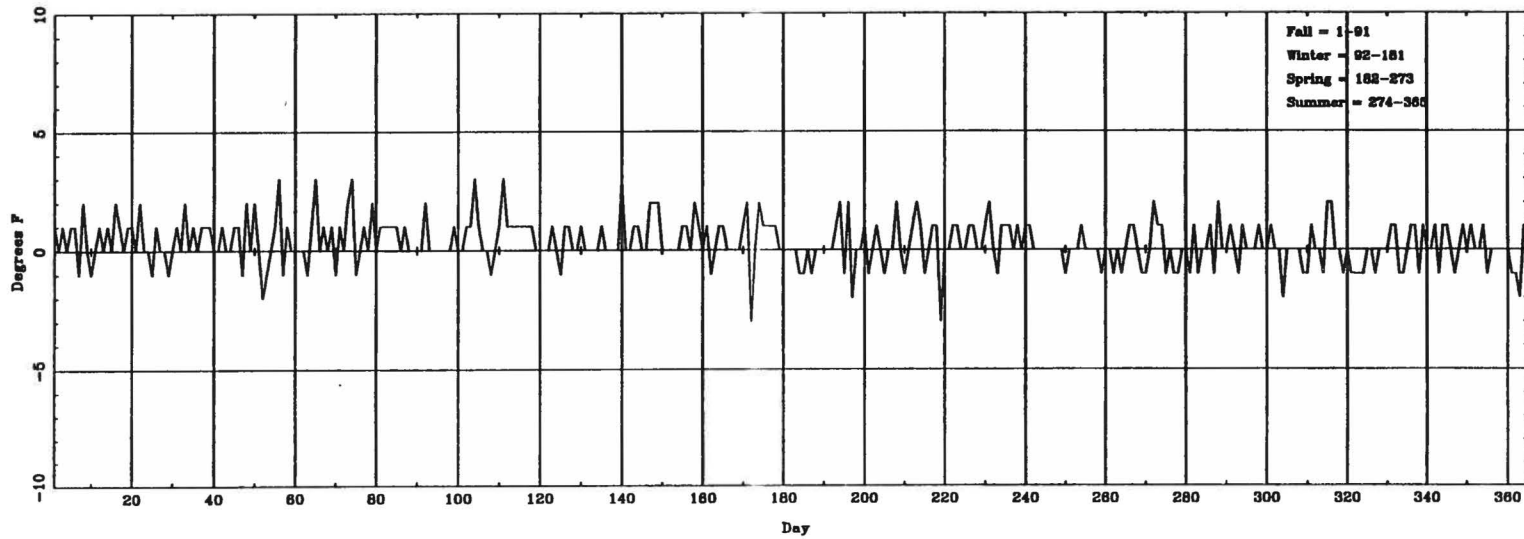

Fig. 3.10 (A) Temperature time series analysis for Jackson, KY.

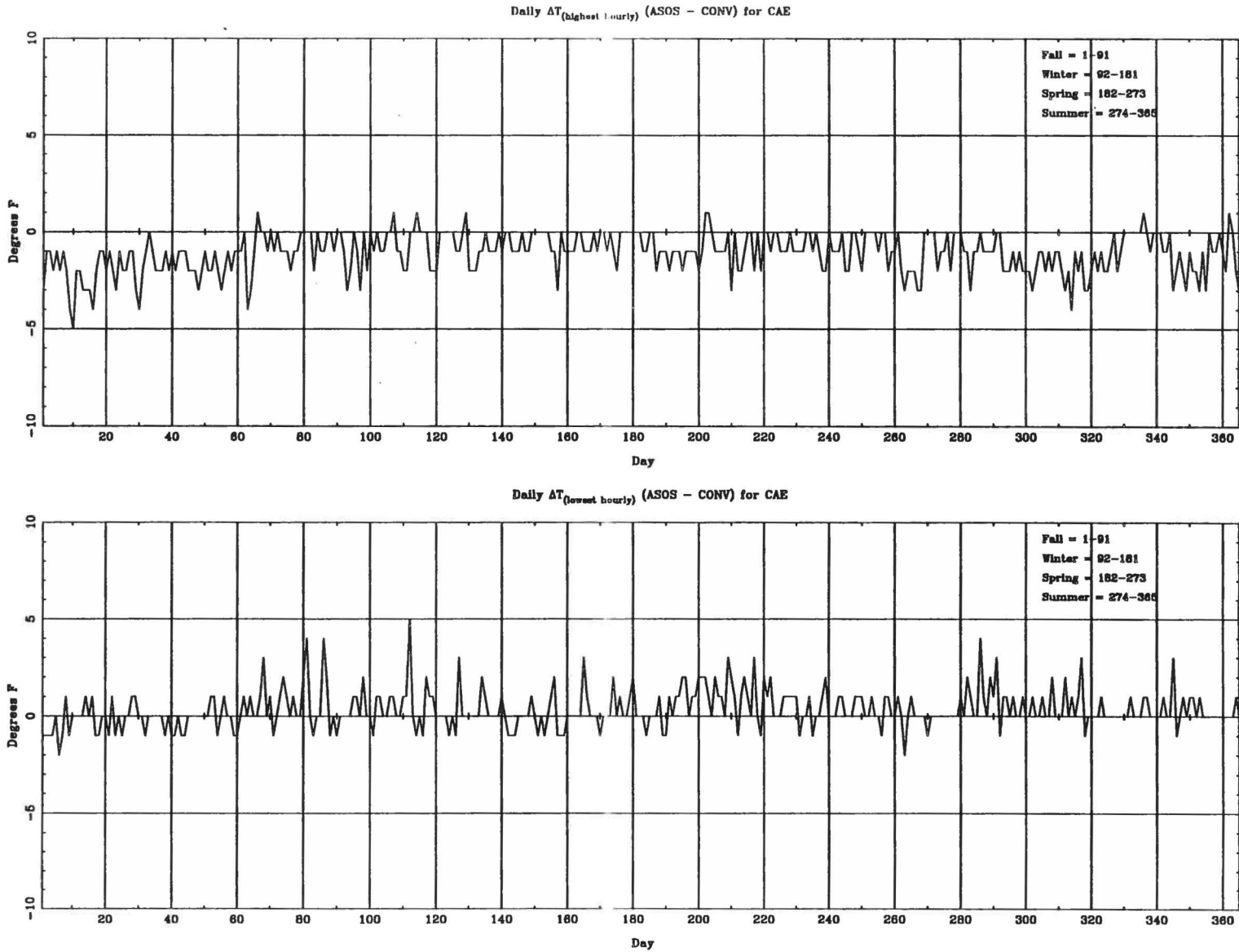

Fig. 3.10 (B) Temperature time series analysis for Columbia, SC.

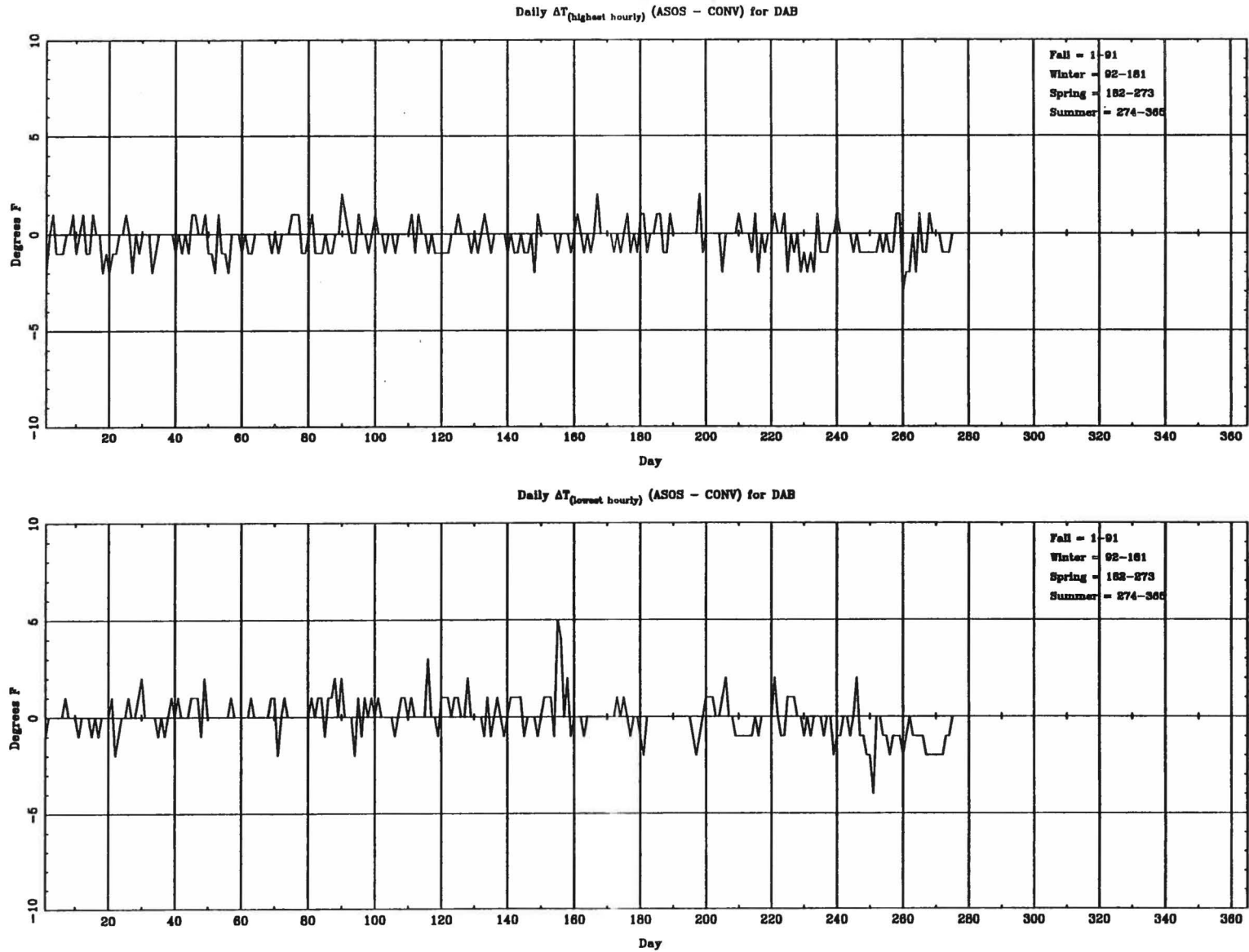

Fig. 3.11 (A) Temperature time series analysis for the coastal site of Daytona Beach, FL.

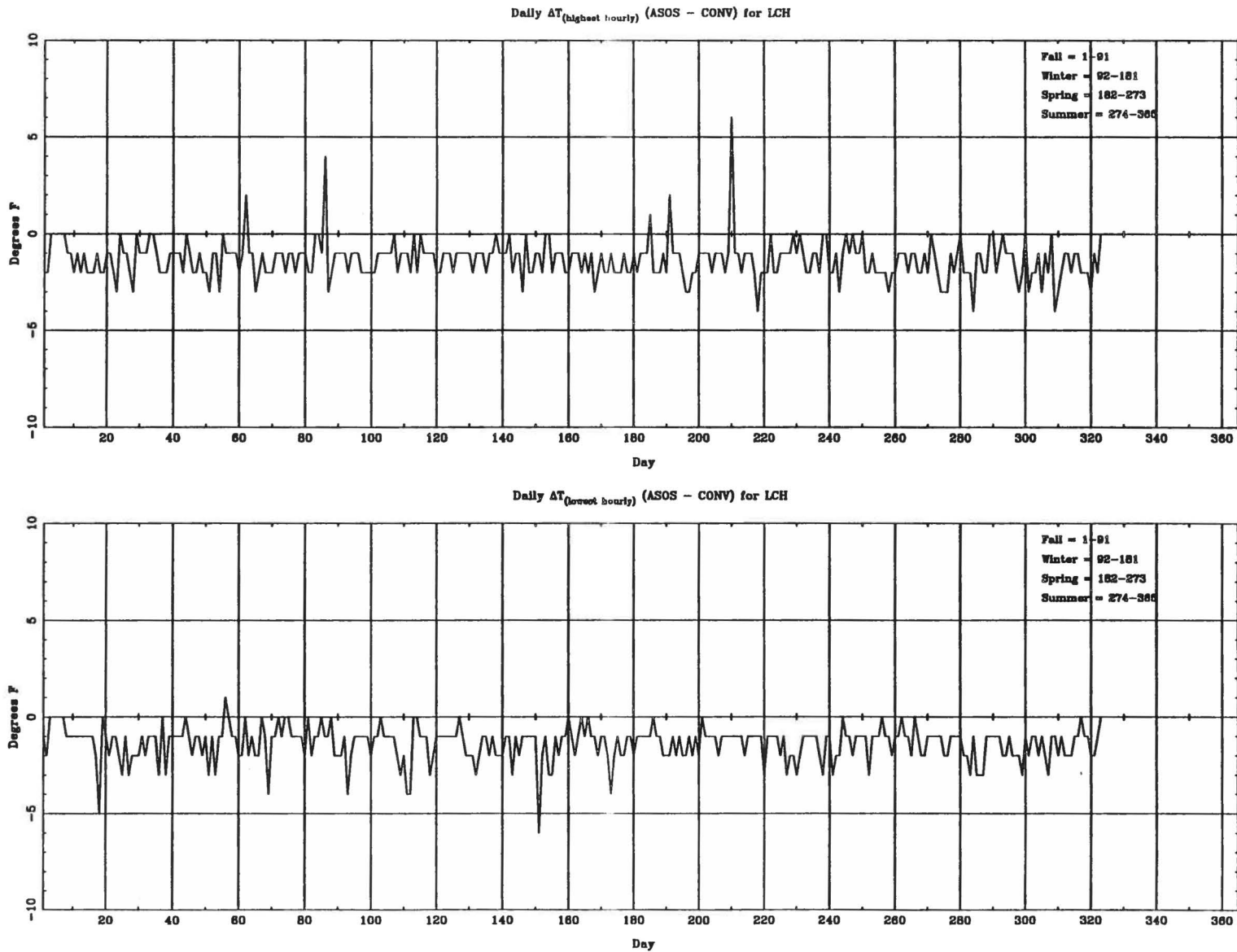

Fig. 3.11 (B) Temperature time series analysis for the coastal site of Lake Charles, LA.

series plots, as seen in Figures 3.11(C) - (D), probably in response to passing weather systems and large differentials in daytime heating and nighttime cooling patterns.

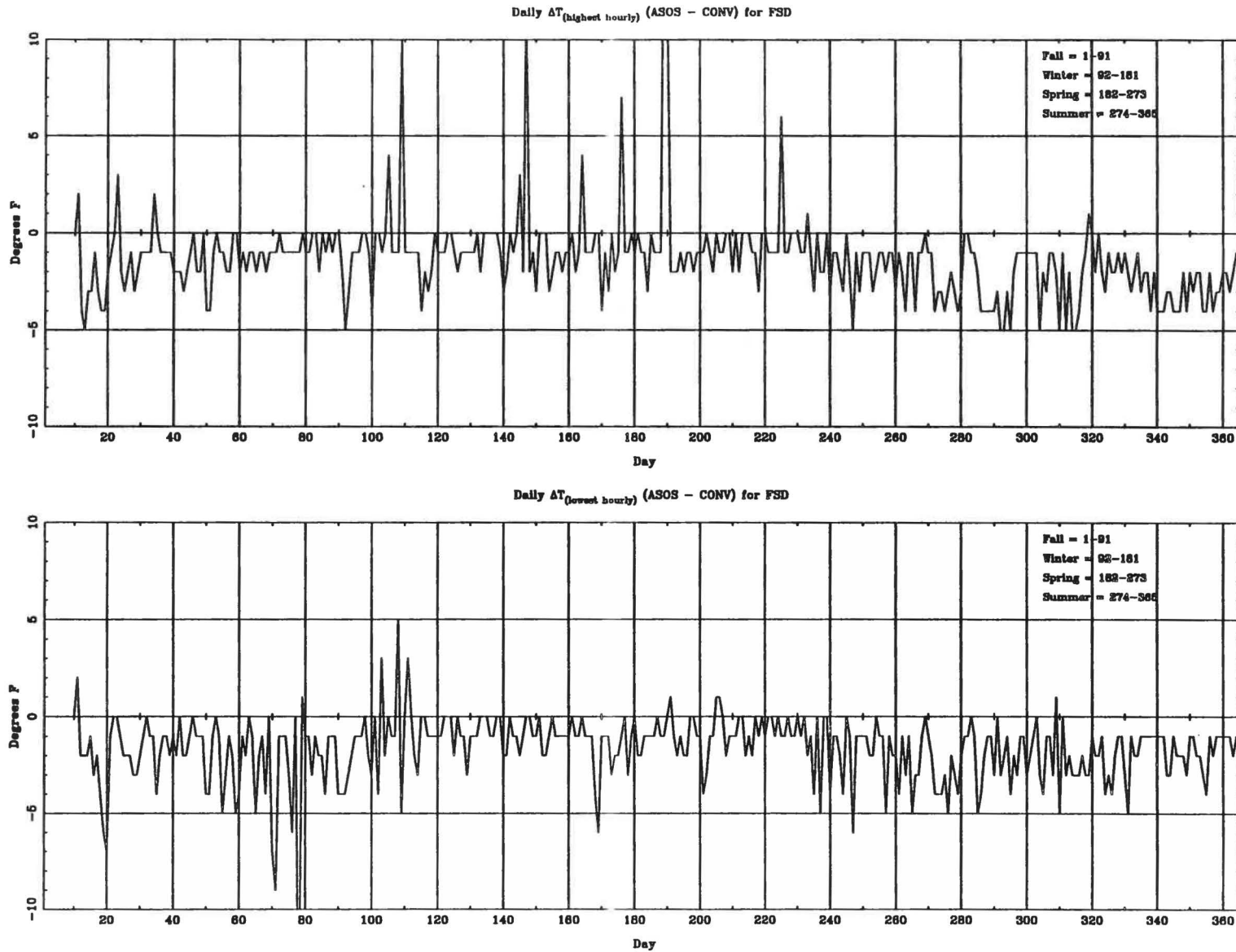

Fig. 3.11 (C) Temperature time series analysis for the continental site of Sioux Falls, SD.

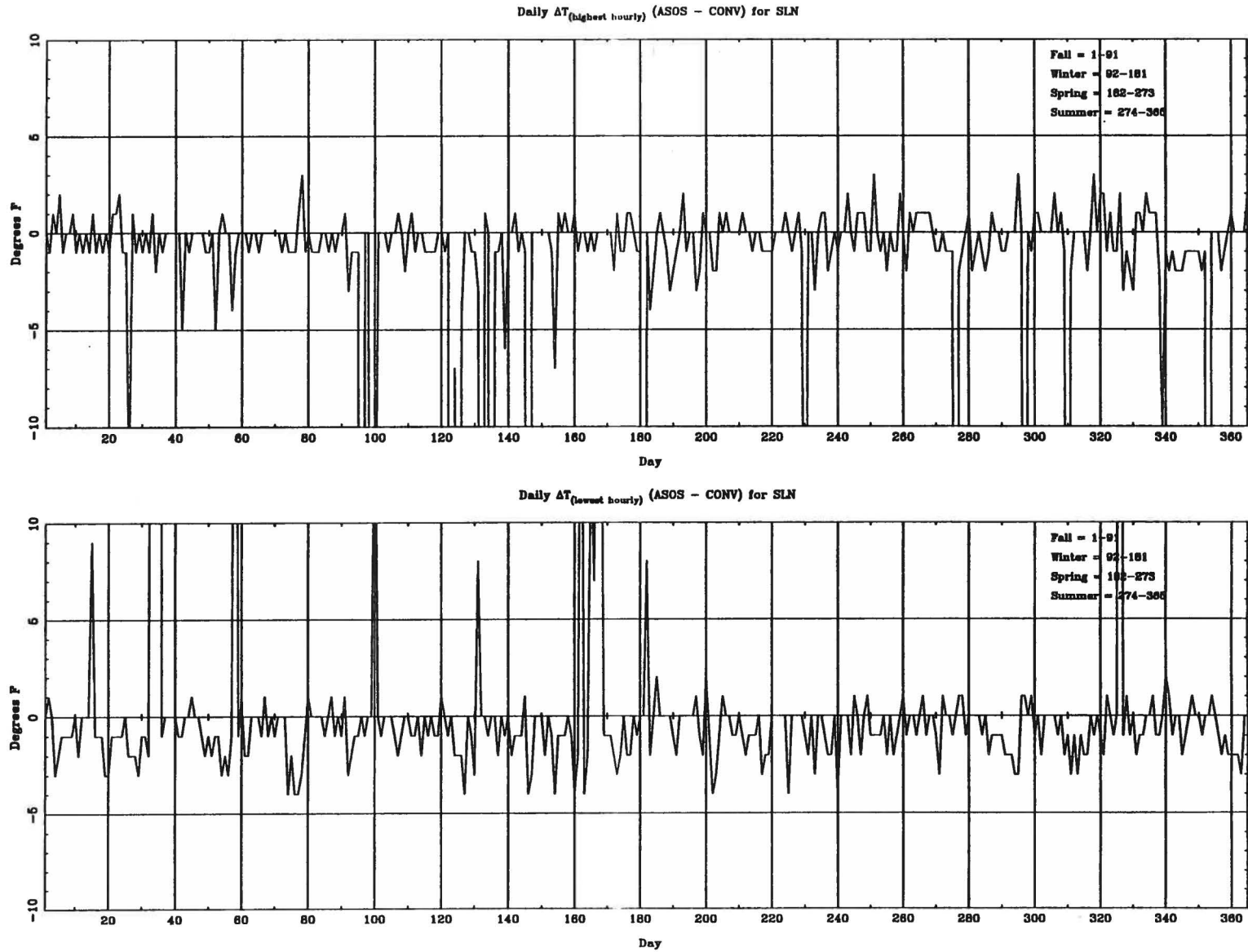

Fig. 3.11 (D) Temperature time series analysis for the continental site of Salina, KS.

4.0 CONCLUSIONS

The results of temperature comparisons between ASOS and CONV measurements examined in this investigation show that the CONV instrument, the Model HO83 hygrothermometer, is predominantly warmer compared to its ASOS replacement. The average temperature difference (ASOS - CONV) for all observations for all 76 sites is -0.79°F , with a considerable range of -2.56°F to $+0.61^{\circ}\text{F}$, resulting in a fair amount of variability among the CONV instruments.

ASOS has no systematic bias in measuring “true” ambient air temperature, although the ASOS hygrothermometers do vary by $\pm 0.3^{\circ}\text{F}$ in comparison to a calibrated field standard. Instrument biases, determined using nighttime overcast observations, between the ASOS and CONV hygrothermometers show that the ASOS instrument is most often cooler than the CONV instrument. On the average, the CONV instruments were 0.53°F warmer than the ASOS instruments with seasonal ranges of up to 2.17°F warmer and 1.17°F cooler than ASOS, with only 9 stations having a positive, annually-averaged instrument bias. It is both the variability and the prevailing warm bias among the HO83 hygrothermometers which indicate that ASOS is an improvement over CONV temperature measurements.

Installation of ASOS instruments at locations which were largely cooler at night than the CONV site resulted in negative, annually-averaged, nocturnal local effects at 47 of the 76 sites. These location effects do fluctuate considerably with the seasons both in

magnitude and sign convention with an annually averaged range of -1.11°F to $+0.70^{\circ}\text{F}$, and a mean of -0.16°F . In addition, the combined influences of the daytime local and solar effects are overwhelmingly negative adding to evidence of a solar heating problem in the CONV instrument. Seasonal ranges in the daytime effects showed CONV measurements were warmer than ASOS by as much as 2.26°F and could be cooler by as much as 0.91°F . Overall, 67 of the 76 stations had negative, annually-averaged contributions due to daytime local and solar effects, with a mean value of -0.37°F . Direct comparisons of the daytime bias at collocated sites showed typical solar heating effects of -0.5°F . Diurnal cycle plots also added considerable evidence of a warm bias in the CONV hygrometer with a majority of stations having the largest negative temperature differences during the daylight hours.

While there is some evidence of annual cycles and trends in the nocturnal local effects as well as the daytime local and solar effects at some stations, there is not enough evidence to support seasonal correction factors for manipulating all data reported by CONV and ASOS instruments. For the stations with probable annual cycles, the summer season most often has the largest negative values with winter usually having the least negative value of the four seasons. Again, these facts point to a solar heating problem experienced by the conventional HO83 hygrometer.

5.0 REFERENCES

- Chu, R., 1994: Algorithms for the Automated Surface Observing System (ASOS). *ISL Office Note 94-4*, National Weather Service, NOAA, U. S. Department of Commerce, 106 pp.
- Devore, J. L., 1995: *Probability and Statistics for Engineers and the Sciences*. (Fourth Edition.) Duxbury Press, Belmont, CA., p. 293.
- Jones, C.G. and Young, K.C., 1995: An investigation of temperature discontinuities introduced by the installation of the HO83 thermometer. *Journal of Climate*, 8, No. 5, Part II, (May), p. 1394-1402.
- McKee, T.B. and Doesken, N.J., 1994: Progress Report for Climate Data Continuity with ASOS for the Period April - June 1994. Department of Atmospheric Science, Colorado State University, Fort Collins, CO, 48 pp.
- McKee, T.B. and Doesken, N.J., 1994: Progress Report for Climate Data Continuity with ASOS for the Period September - November 1994. Department of Atmospheric Science, Colorado State University, Fort Collins, CO, 44 pp.
- McKee, T.B., Doesken, N.J., and Kleist, J., 1996: Climate Data Continuity with ASOS Report for the Period September 1994 - March 1996. Climatology Report No. 96-1, Department of Atmospheric Science, Colorado State University, Fort Collins, CO, 117 pp.
- Nadolski, V. L., 1995: Operational experiences with the automated surface observing system - ASOS. Preprints, International Workshop on Experiences with Automatic Weather Stations on Operational use within National Weather Services, Vienna, Austria, 15 - 17 May 1995, WMO Report No. 58, 3 pp.
- National Weather Service, 1992: ASOS (Automated Surface Observing System) User's Guide. NOAA, U. S. Department of Commerce, 57 pp.
- National Weather Service, 1984: Instruction Manual Hygrothermometer (HO83). Volume 1 Support Volume. Prepared by Engineering Division of the National Weather Service, Silver Spring, MD.

National Weather Service, 1992: Automated Surface Observing System (ASOS) Level II System Manager Training Course Student Guide. Report No. RSMI1005-00051C, CDRL No. A50. Prepared for National Weather Service, Silver Spring, MD.

National Weather Service, 1995: Briefing given at Third ASOS Aviation Demonstration Industry Briefing on October 3, 1995, Silver Spring, MD.

National Weather Service, 1996: March 1996 Modernization Update. Distributed via electronic mail by R. McLeod, prepared by the National Implementation Staff at National Weather Service Headquarters, Silver Spring, MD.

Systems Management Incorporated, 1992: Software User's Manual for the Automated Surface Observing System (ASOS). Report No. RSMI005-00019B Change 1, CDRL No. C04. Prepared for the U. S. Dept of Commerce, NOAA, National Weather Service, Silver Spring, MD, 567 pp.

APPENDICES

APPENDIX A: Temperature Time Series Plots

The following graphs depict the time series analysis of the temperature differences between ASOS and CONV SAOs with the highest hourly temperature and lowest hourly temperature for each 24-hour day (midnight to midnight LST). Beginning with September 1, 1994 as day 1, days run sequentially through the fall, winter, spring, and summer according to the legend in the upper right-hand corner of each graph. Temperature differences are plotted in whole degrees Fahrenheit with range of $-10^{\circ}\text{F} \leq \Delta T \leq +10^{\circ}\text{F}$ along the y-axis.

Daily AT_(light hourly) (ASOS - CONV) for ABE

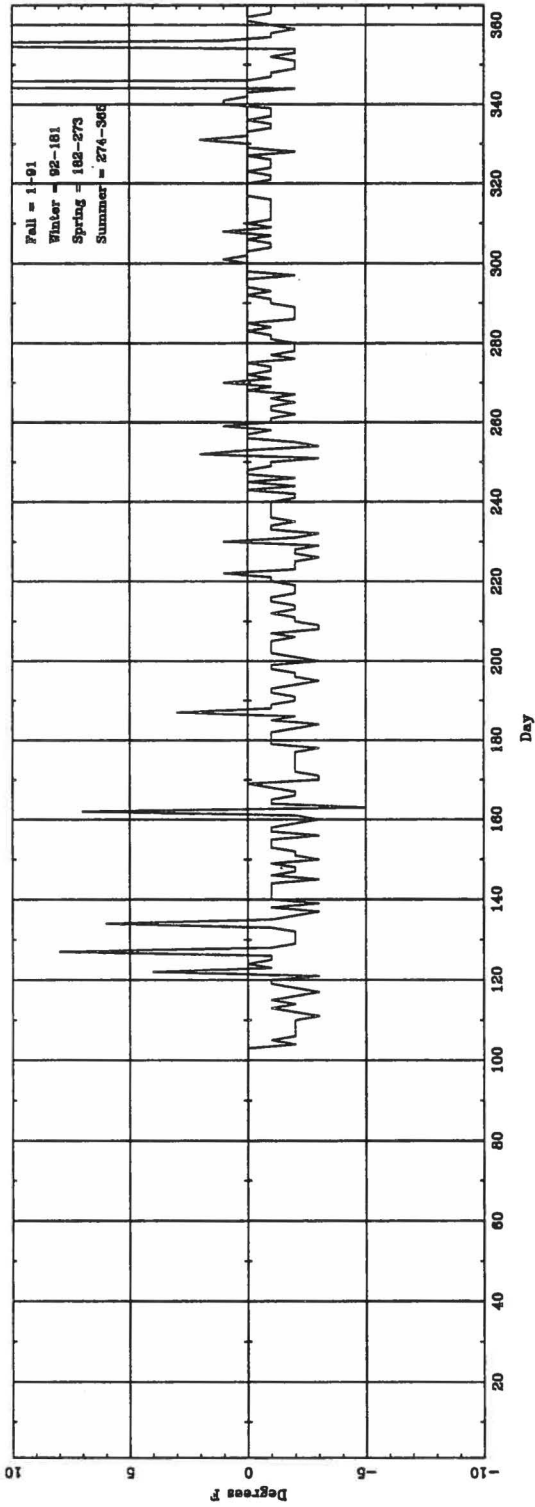

Daily AT_(frequent hourly) (ASOS - CONV) for ABE

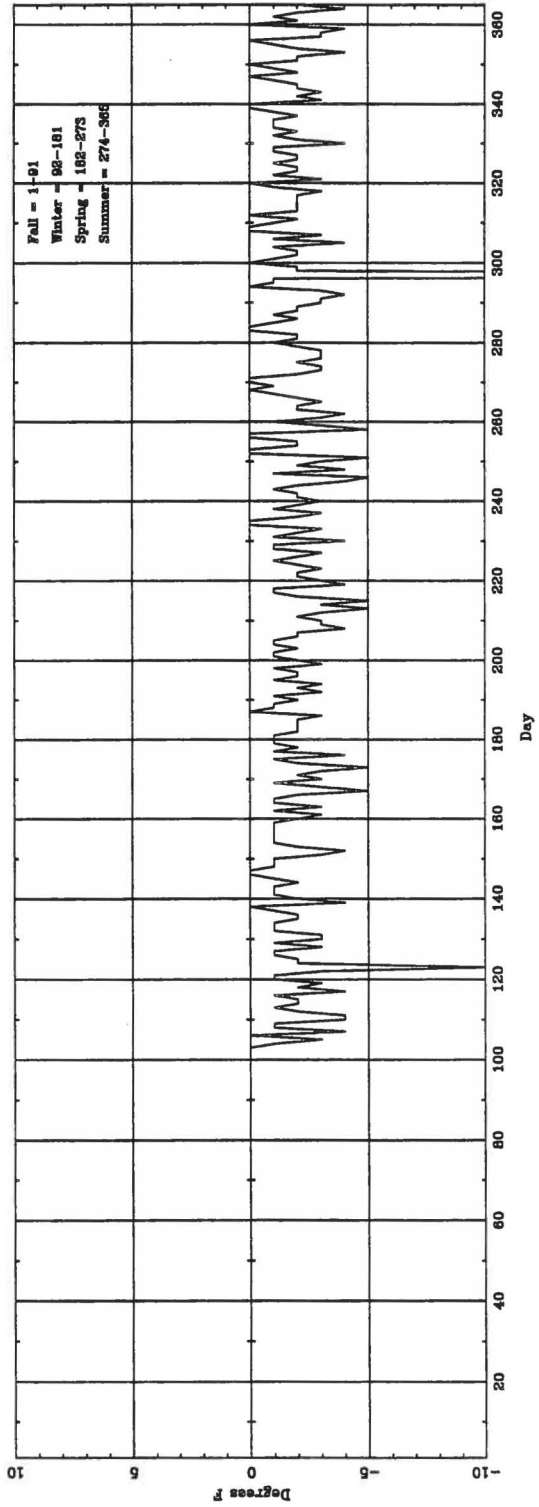

Daily $\Delta T_{(highest\ hourly)}$ (ASOS - CONV) for ABQ

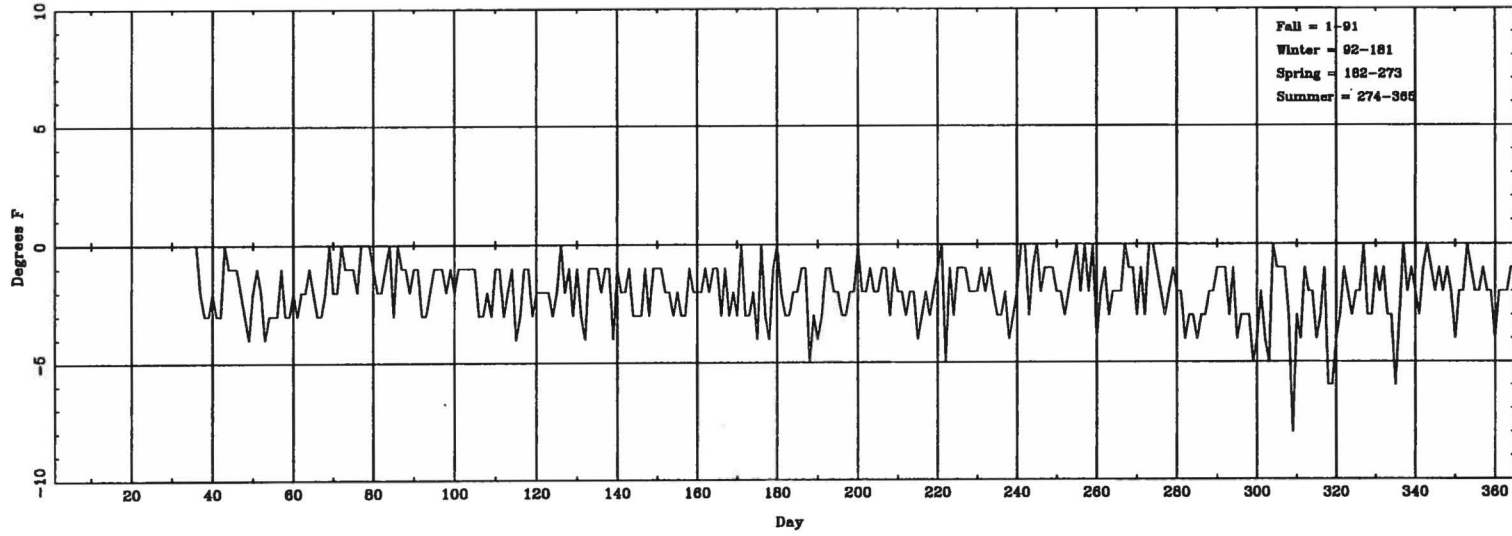

Daily $\Delta T_{(lowest\ hourly)}$ (ASOS - CONV) for ABQ

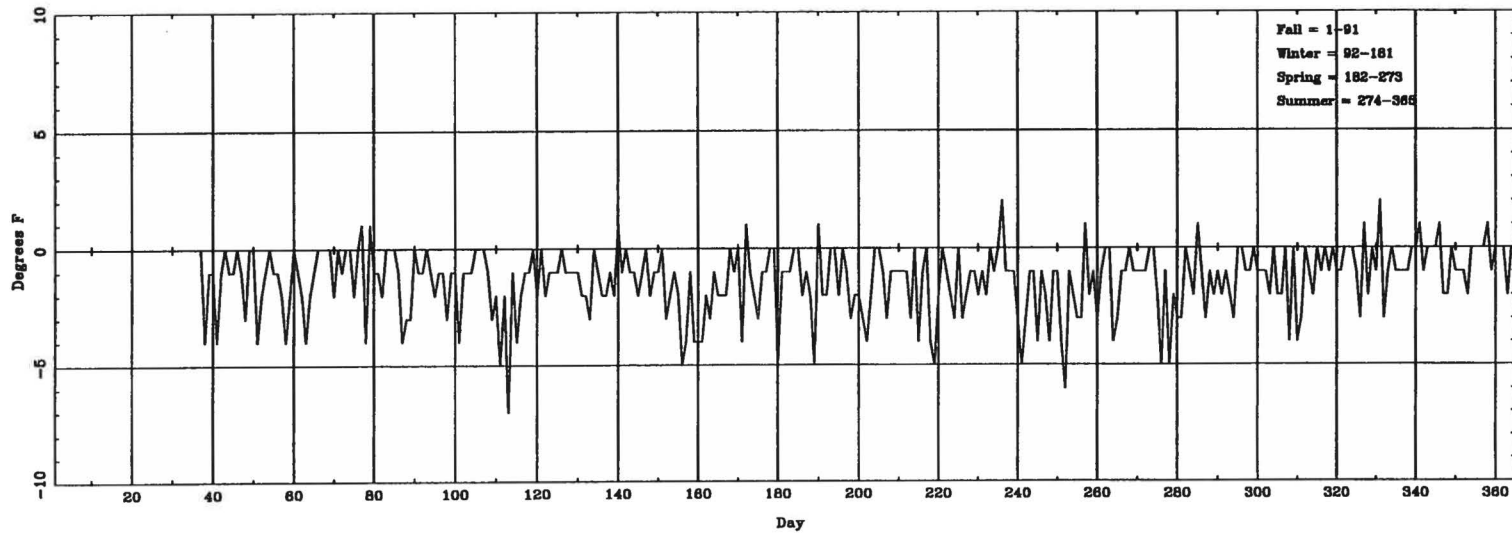

Daily $\Delta T_{\text{lightest hourly}}$ (ASOS - CONV) for ACY

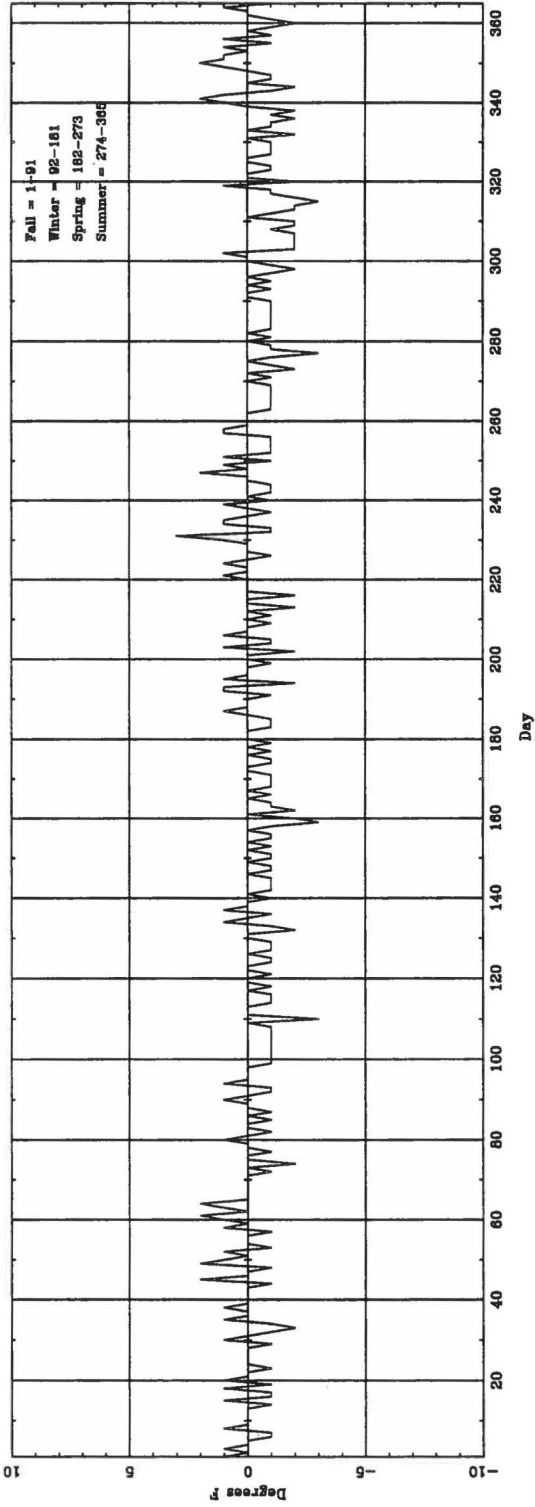

Daily $\Delta T_{\text{wettest hourly}}$ (ASOS - CONV) for ACY

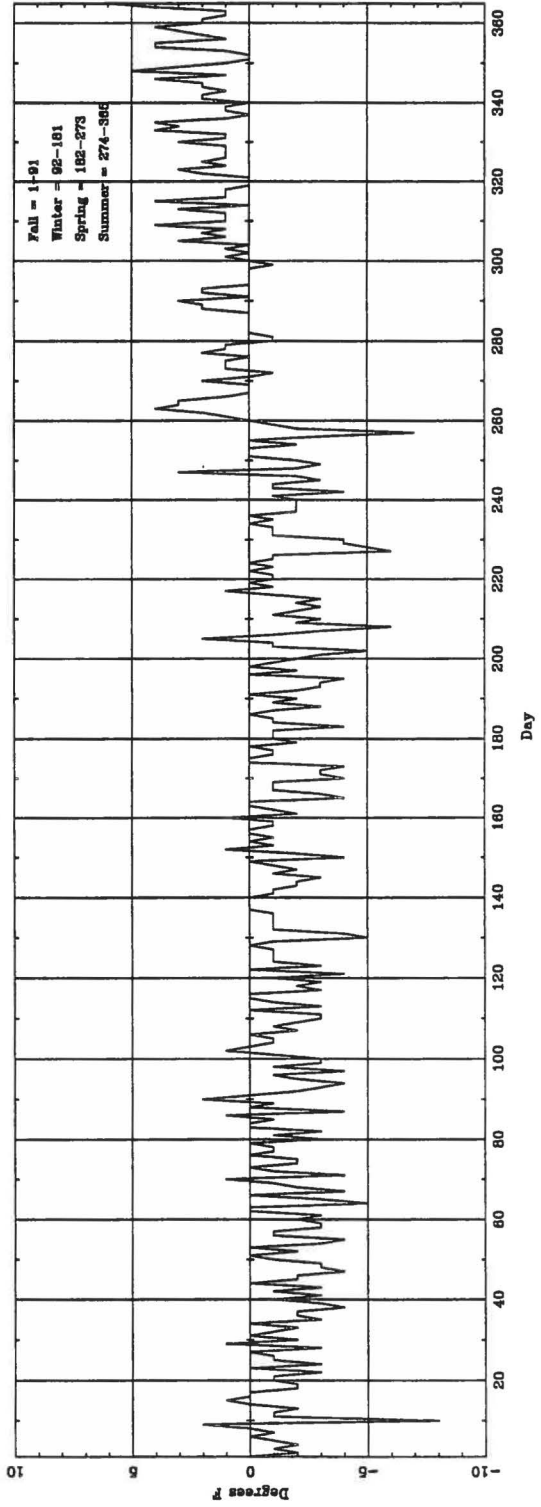

Daily $\Delta T_{(highest\ hourly)}$ (ASOS - CONV) for ALB

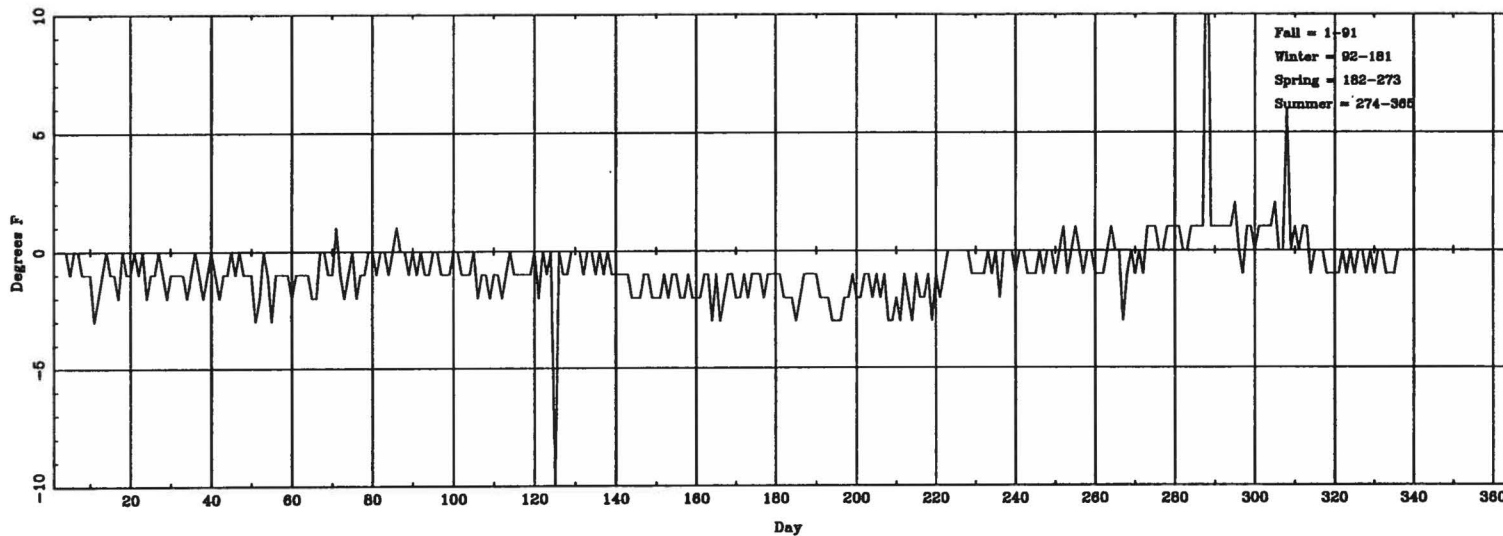

Daily $\Delta T_{(lowest\ hourly)}$ (ASOS - CONV) for ALB

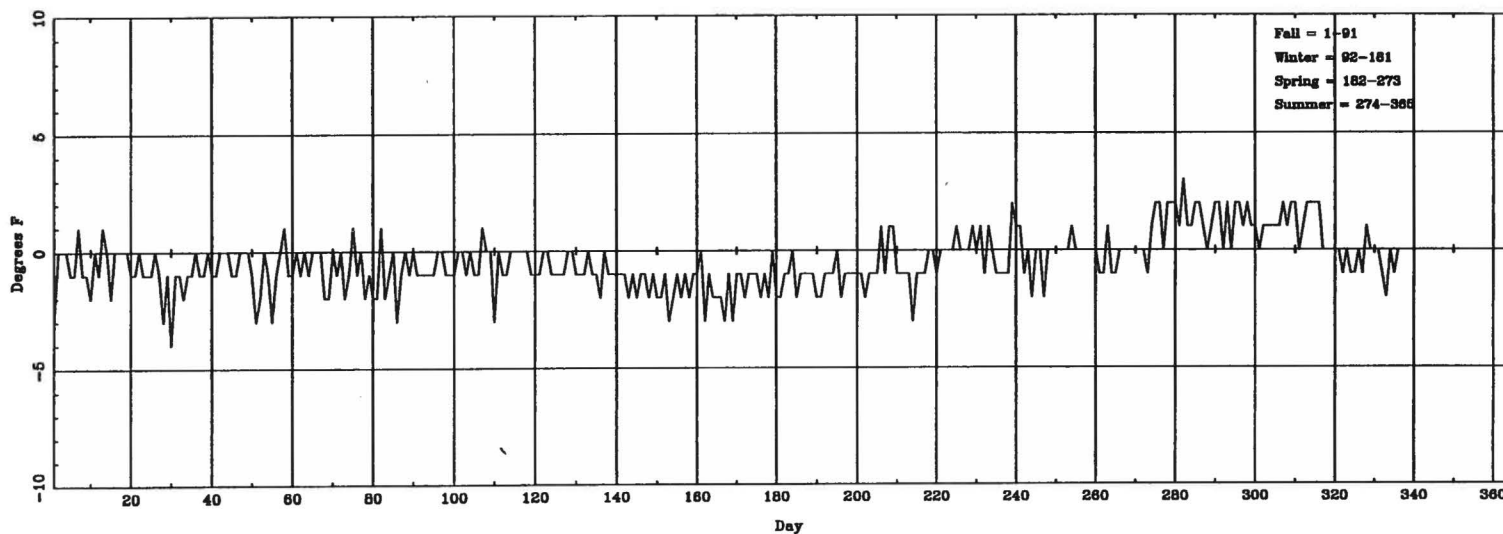

Daily AT_(request hourly) (ASOS - CONV) for ALO

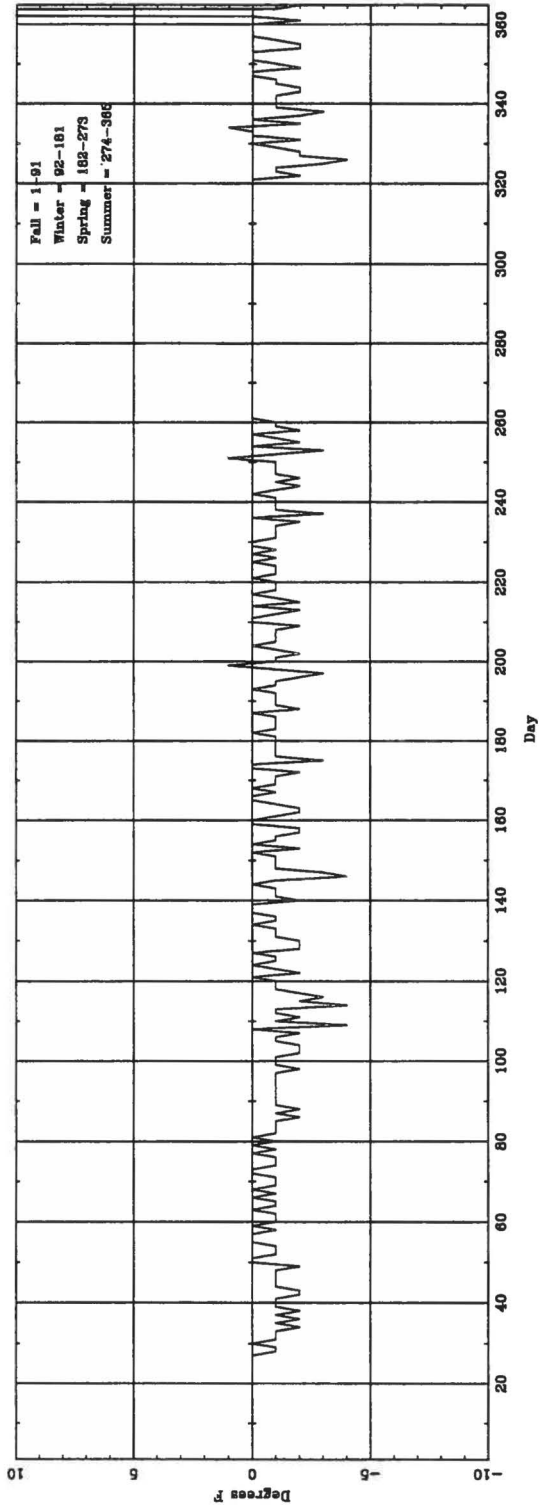

Daily AT_(lowest hourly) (ASOS - CONV) for ALO

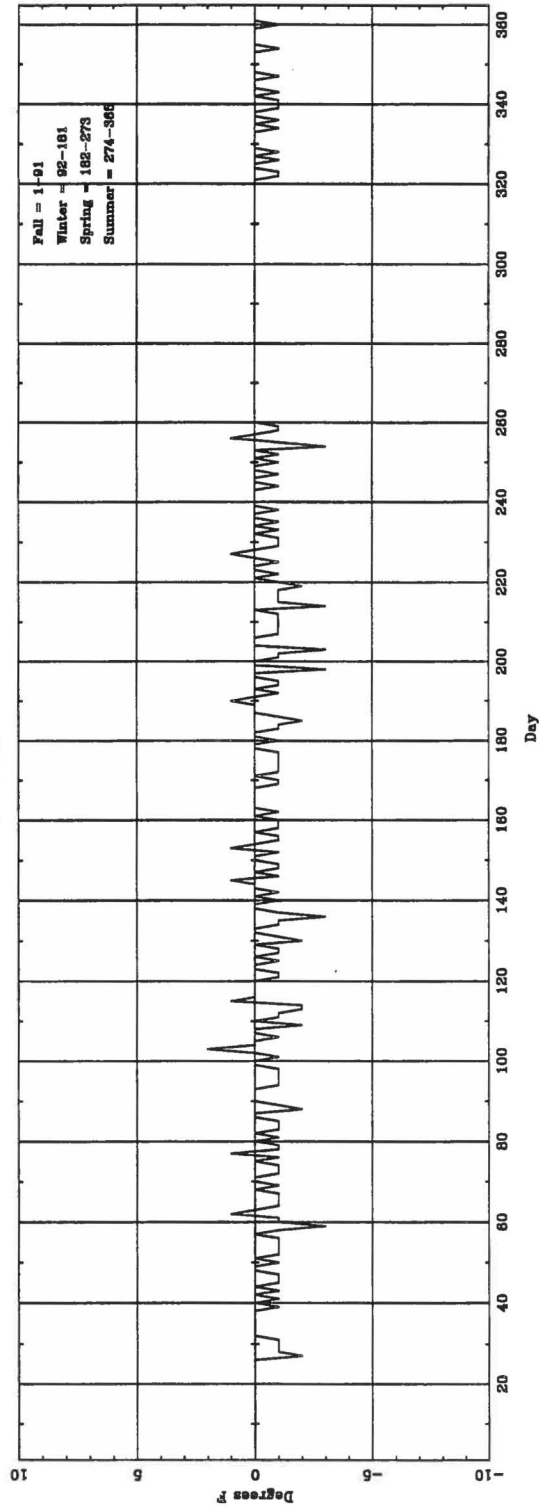

Daily $\Delta T_{\text{(highest hourly)}}$ (ASOS - CONV) for APN

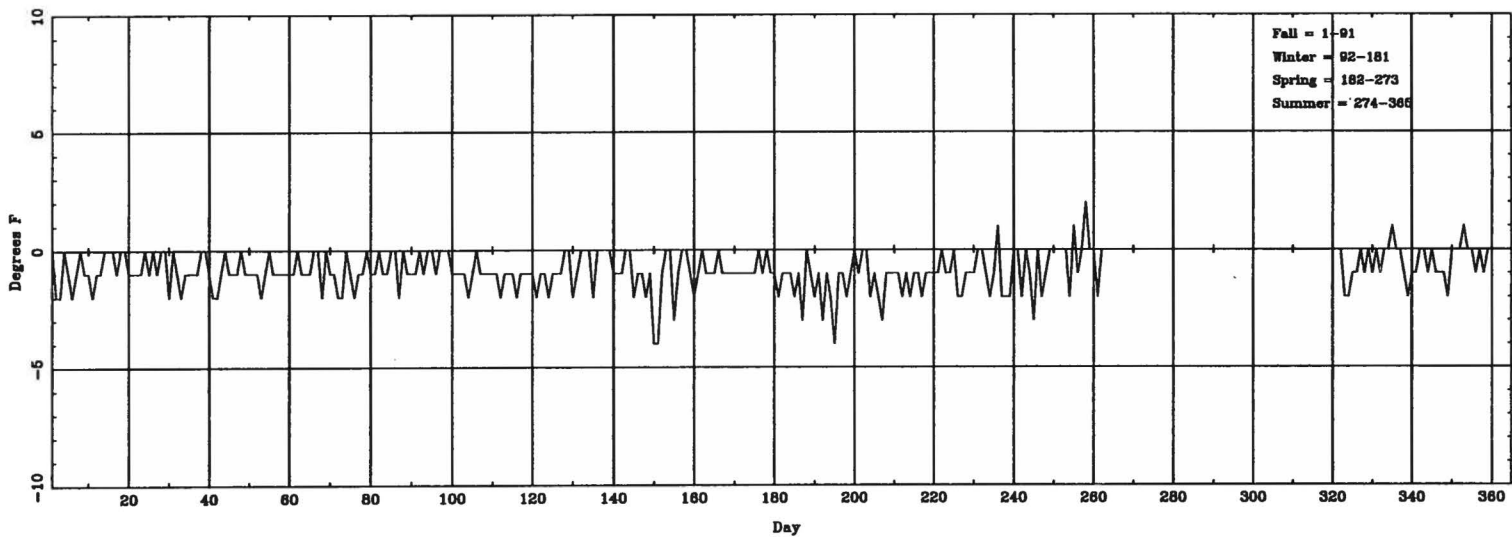

Daily $\Delta T_{\text{(lowest hourly)}}$ (ASOS - CONV) for APN

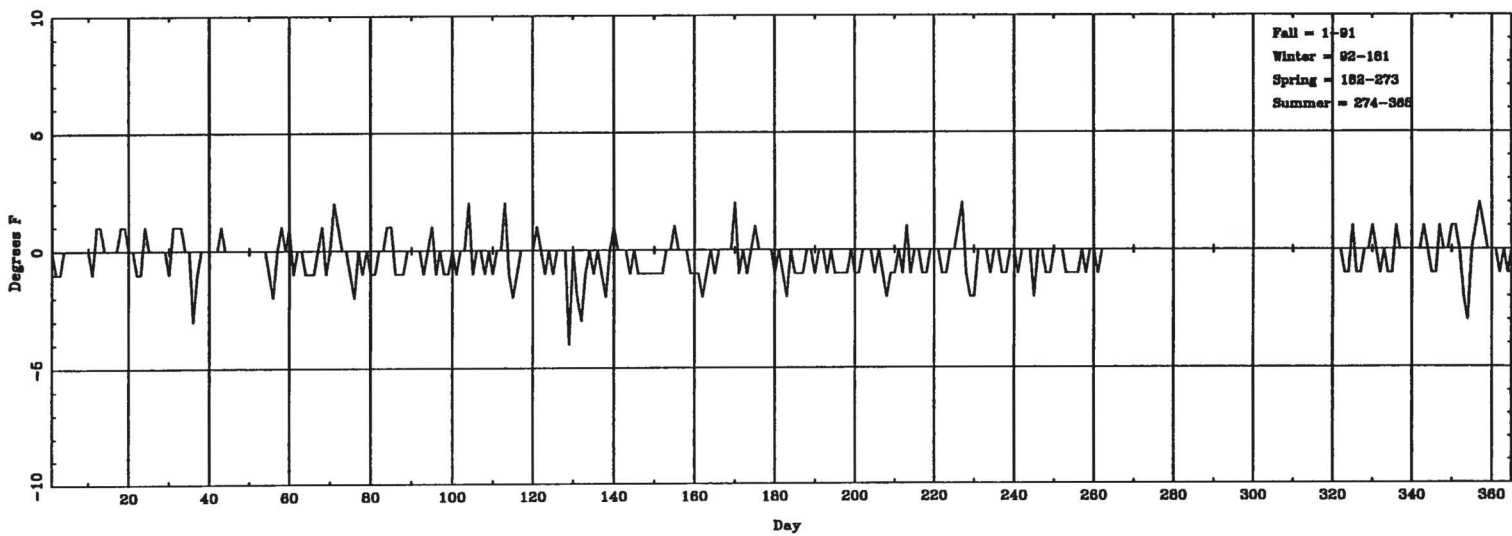

Daily $\Delta T_{\text{(highest hourly)}}$ (ASOS - CONV) for ATL

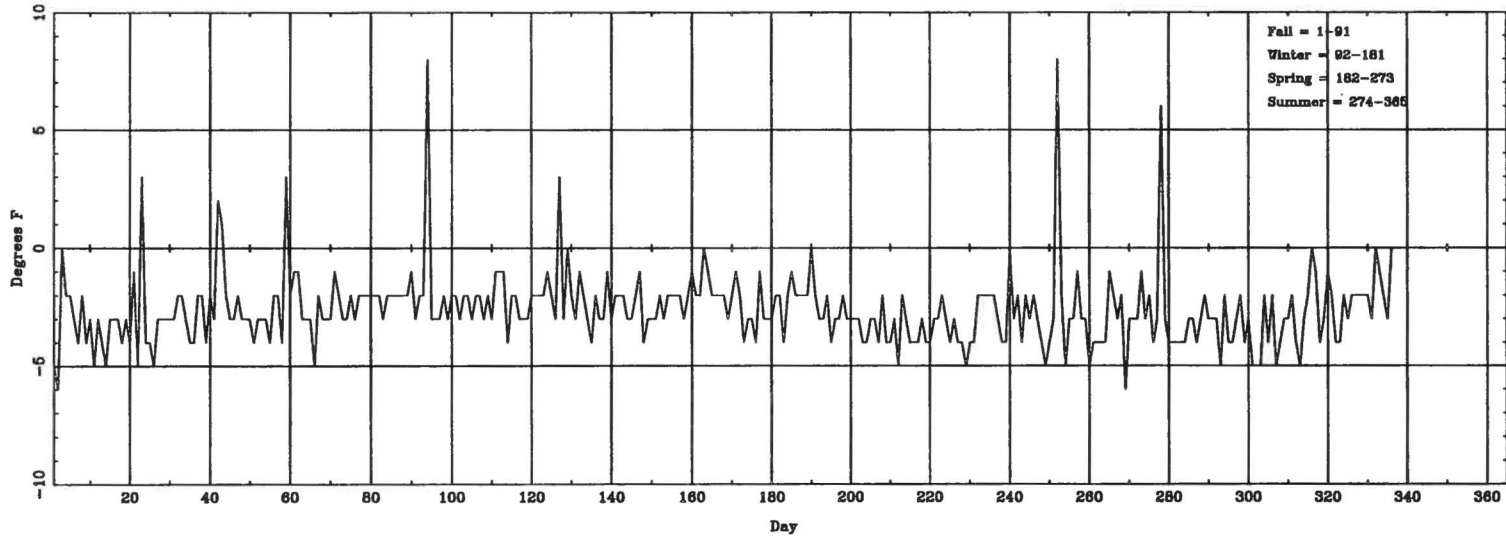

Daily $\Delta T_{\text{(lowest hourly)}}$ (ASOS - CONV) for ATL

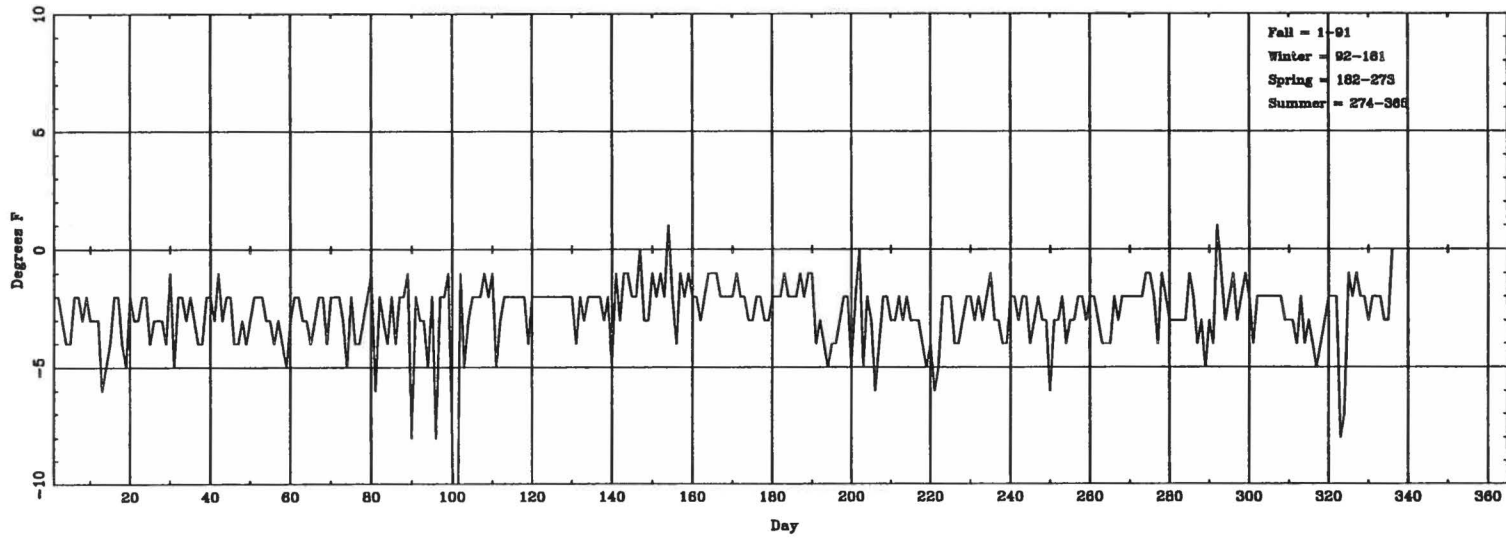

Daily $\Delta T_{(night\ hour)}$ (ASOS - CONY) for AUS

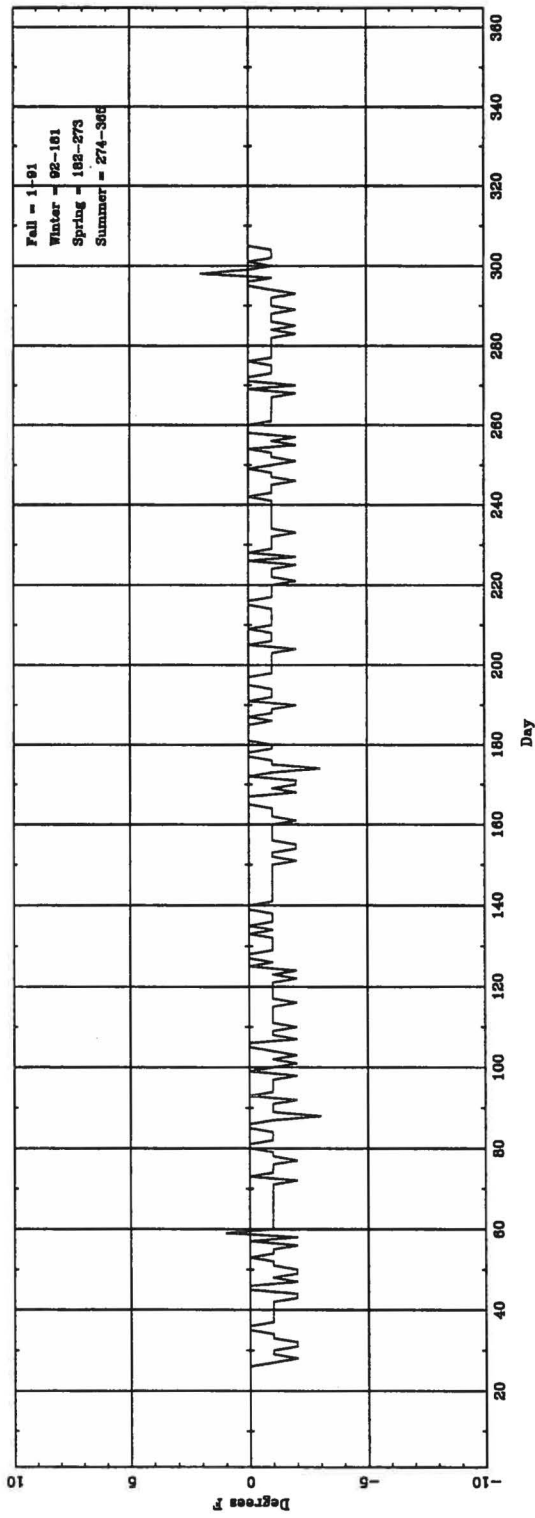

Daily $\Delta T_{(morning\ hour)}$ (ASOS - CONY) for AUS

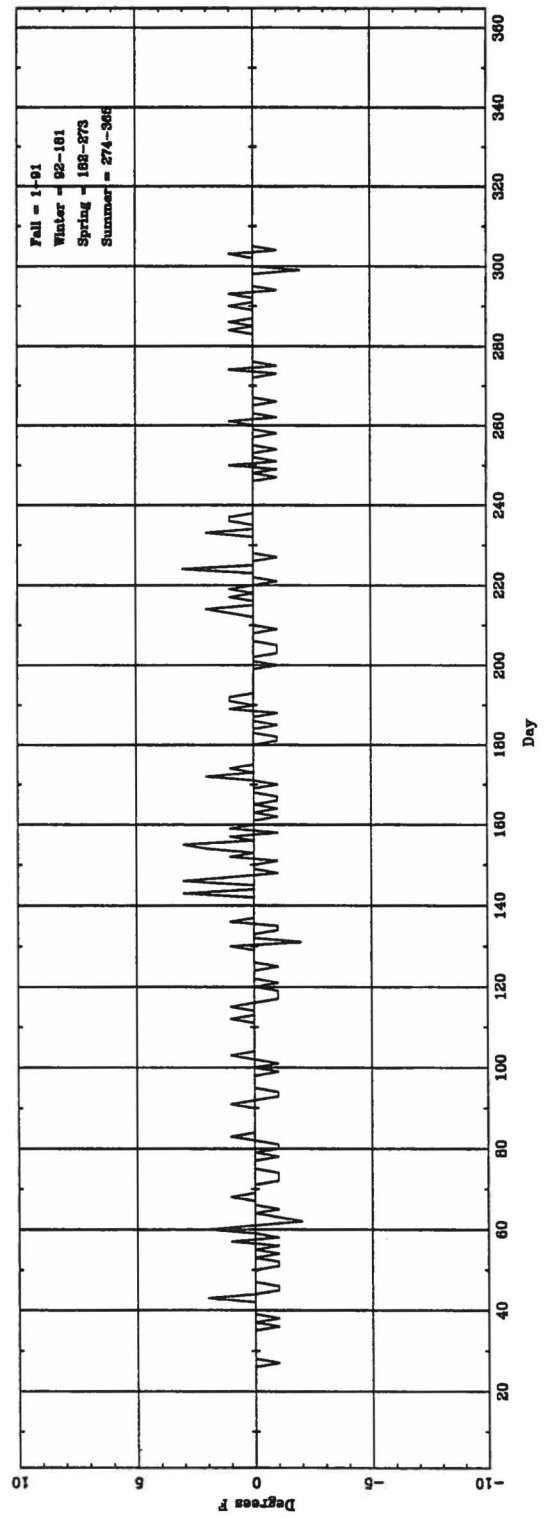

Daily $\Delta T_{(highest\ hourly)}$ (ASOS - CONV) for BFF

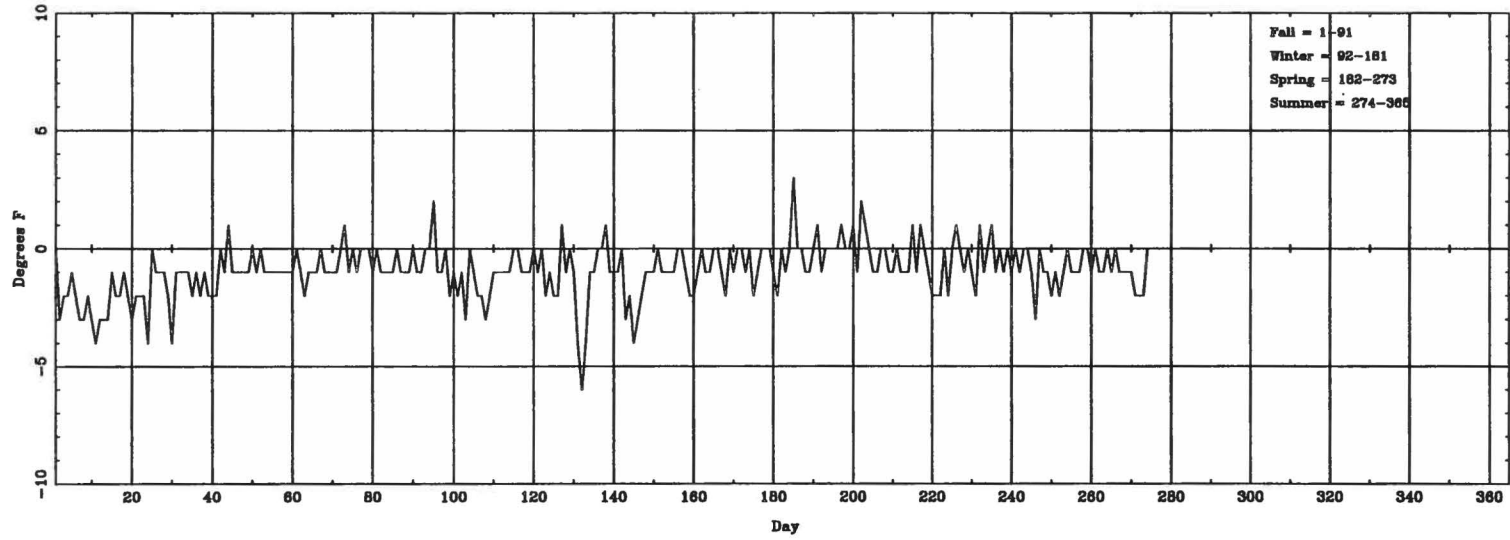

Daily $\Delta T_{(lowest\ hourly)}$ (ASOS - CONV) for BFF

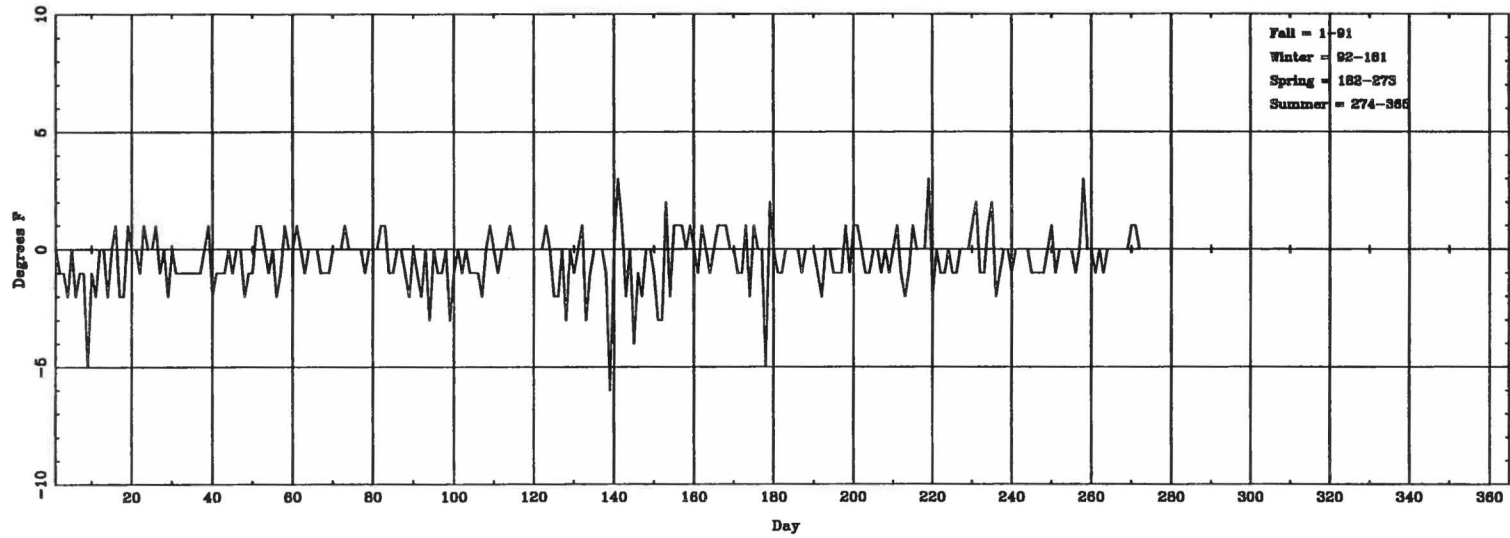

Daily $\Delta T_{(highest\ hourly)}$ (ASOS - CONV) for BGM

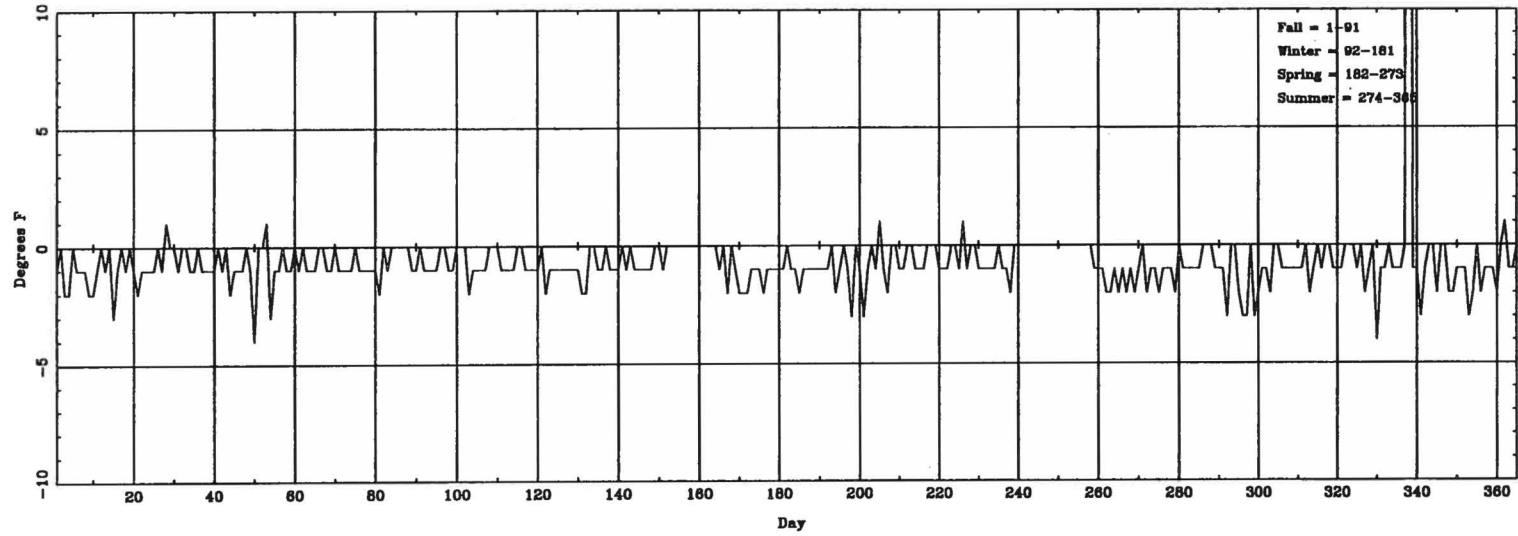

Daily $\Delta T_{(lowest\ hourly)}$ (ASOS - CONV) for BGM

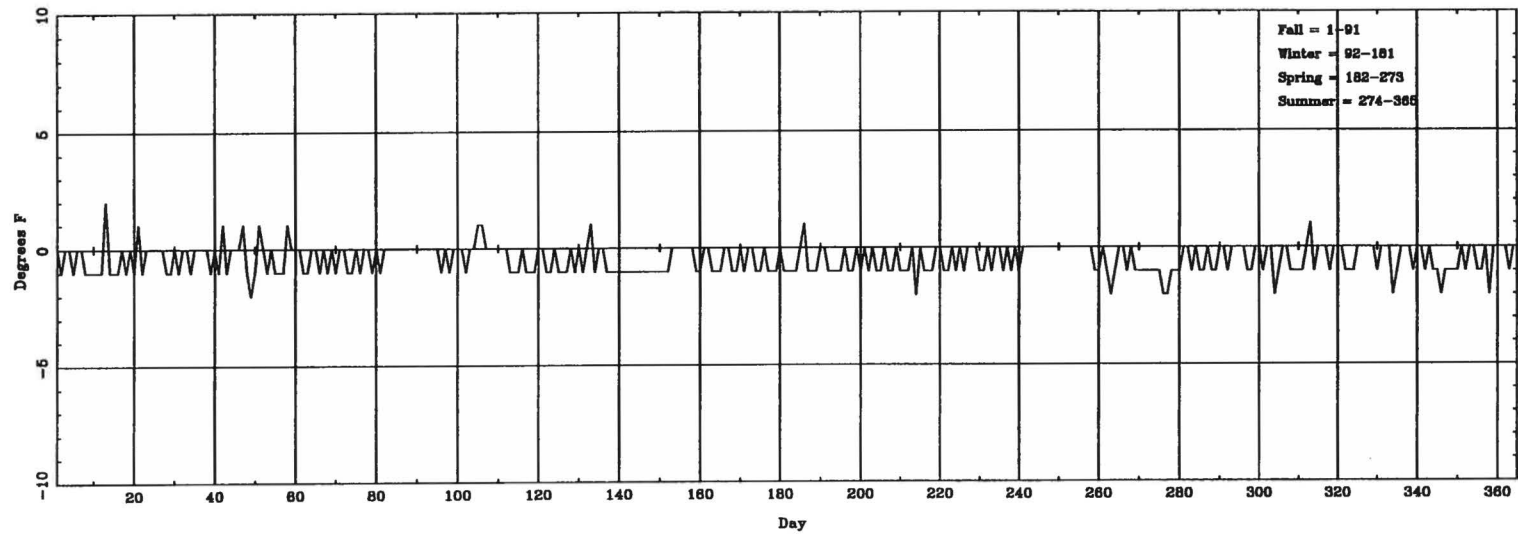

Daily $\Delta T_{(light\ hour)}$ (ASOS - CONV) for BIL

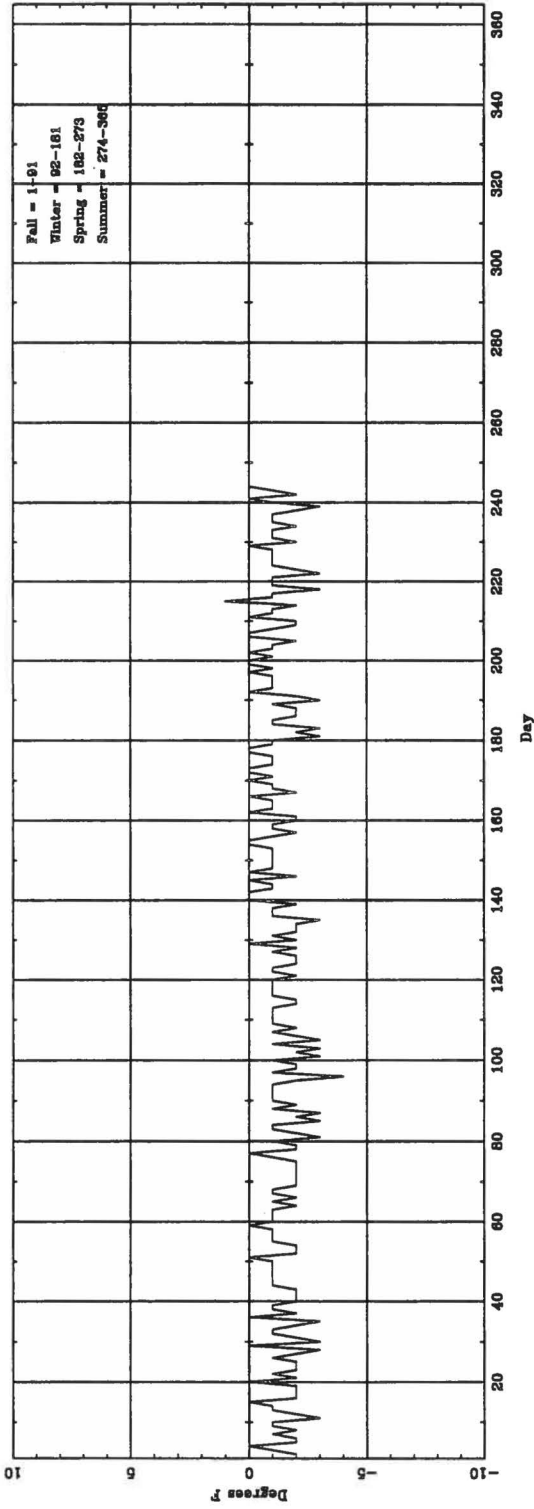

Daily $\Delta T_{(correct\ hour)}$ (ASOS - CONV) for BIL

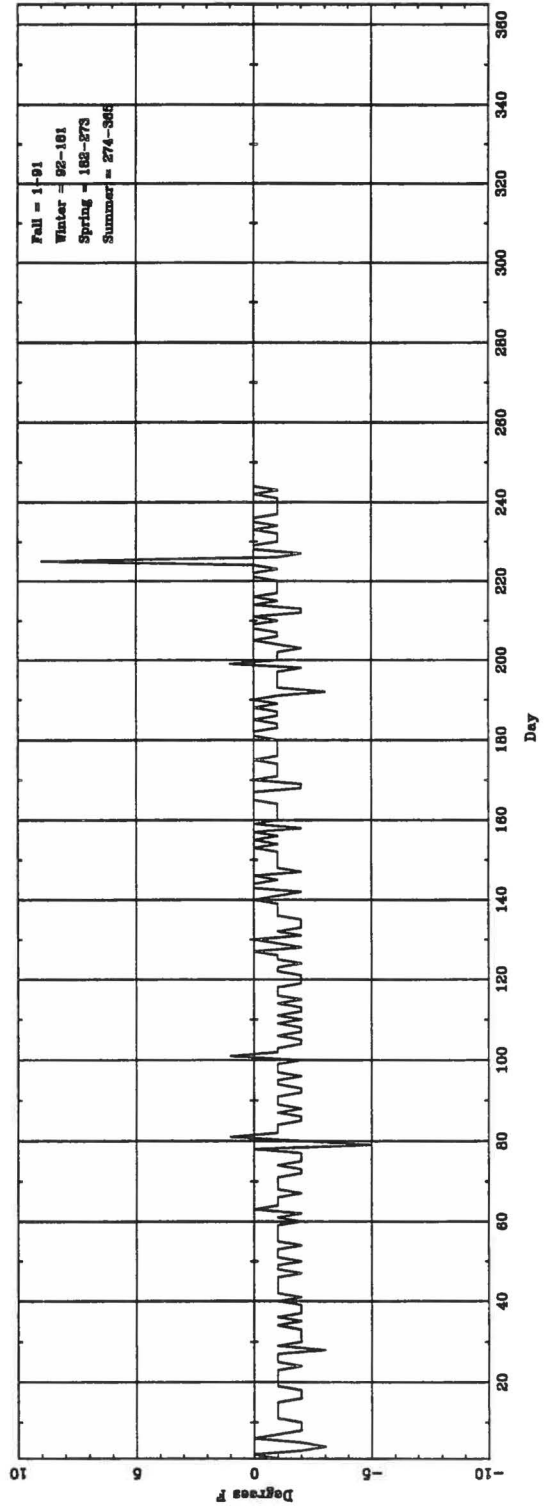

Daily $\Delta T_{\text{(highest hourly)}}$ (ASOS - CONV) for BIS

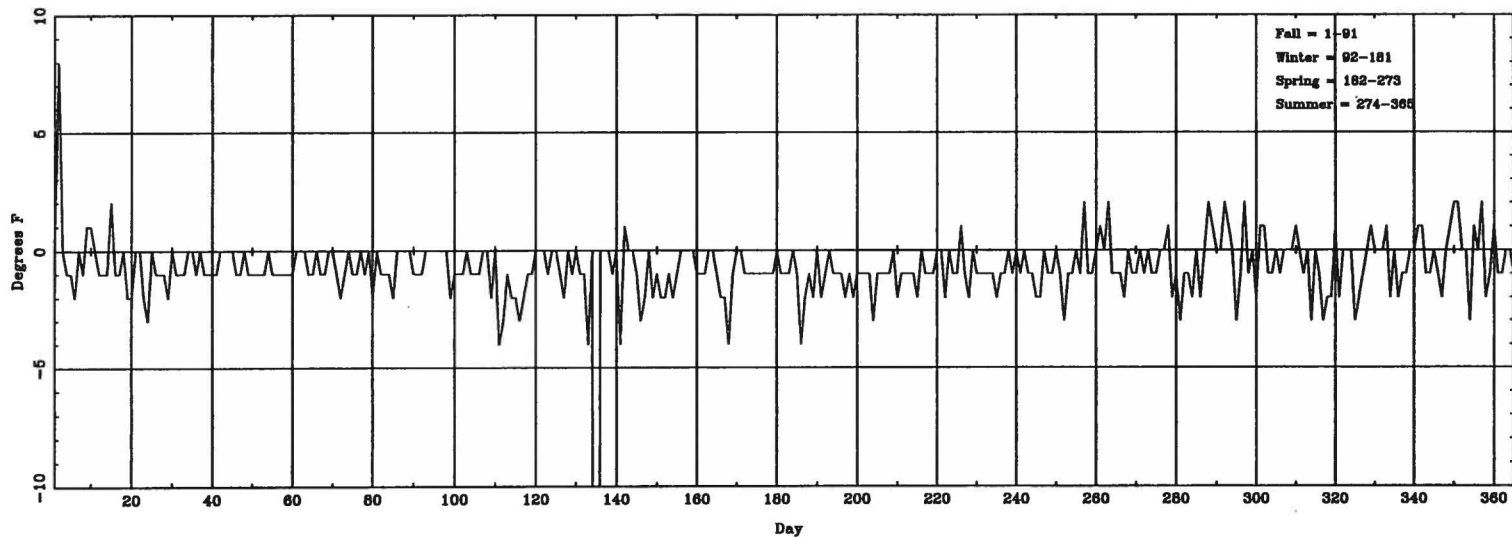

Daily $\Delta T_{\text{(lowest hourly)}}$ (ASOS - CONV) for BIS

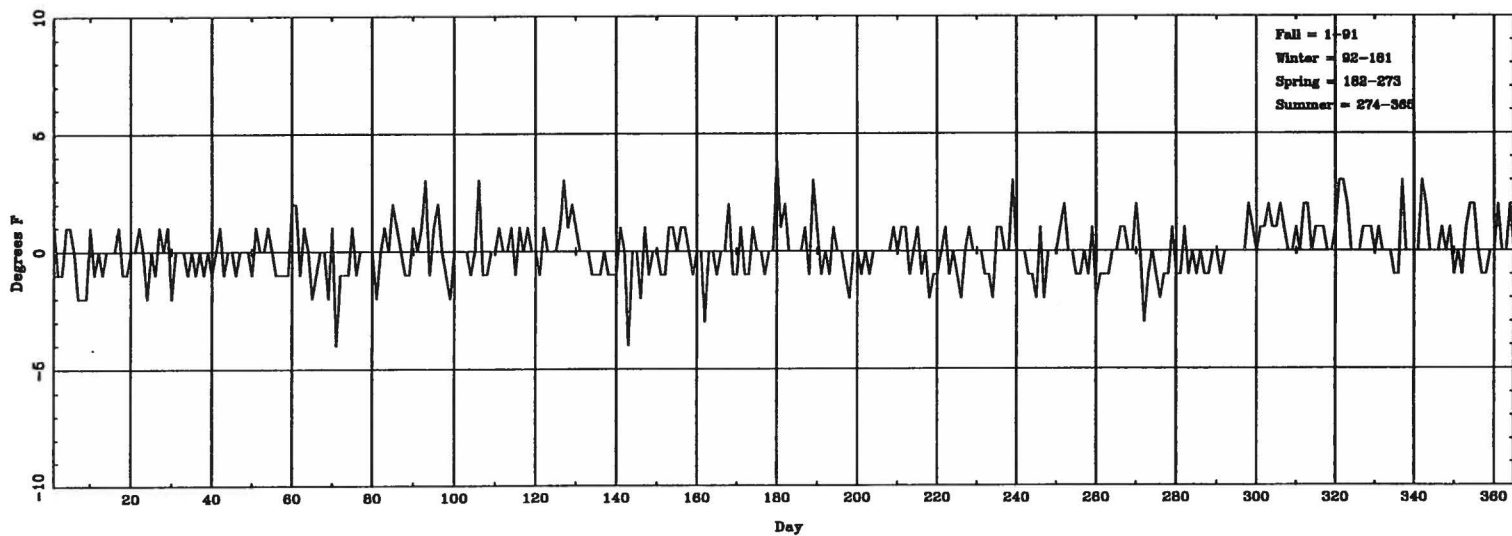

Daily $\Delta T_{\text{(highest hourly)}}$ (ASOS - CONV) for CAE

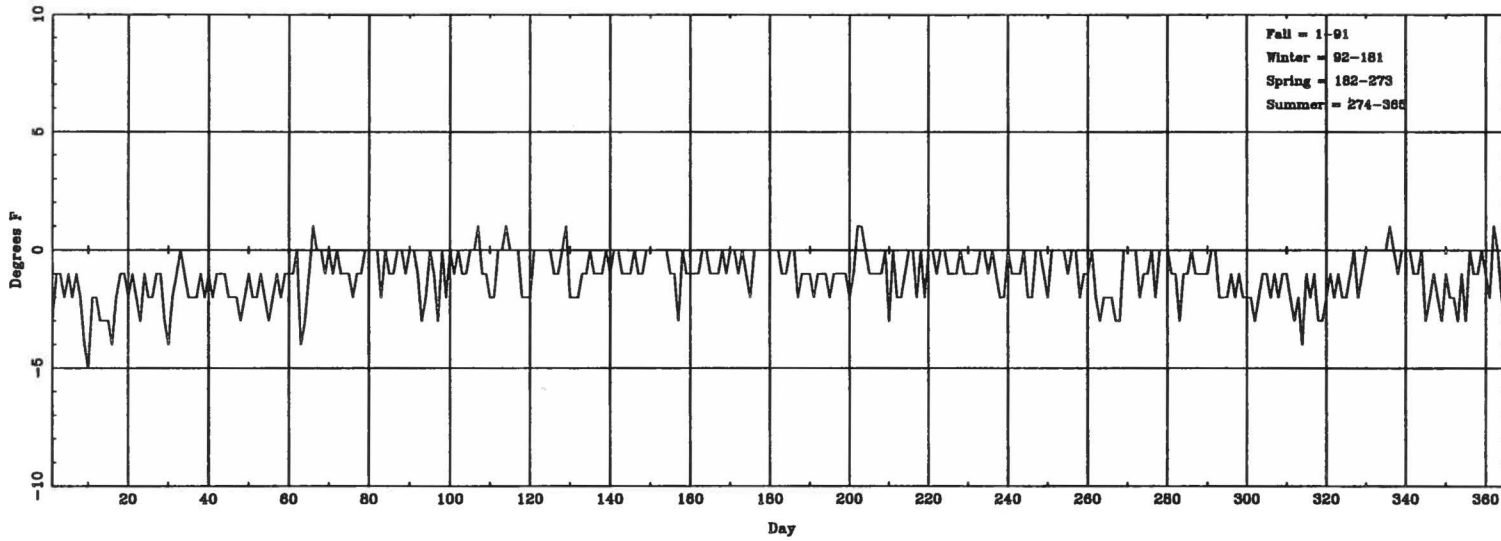

Daily $\Delta T_{\text{(lowest hourly)}}$ (ASOS - CONV) for CAE

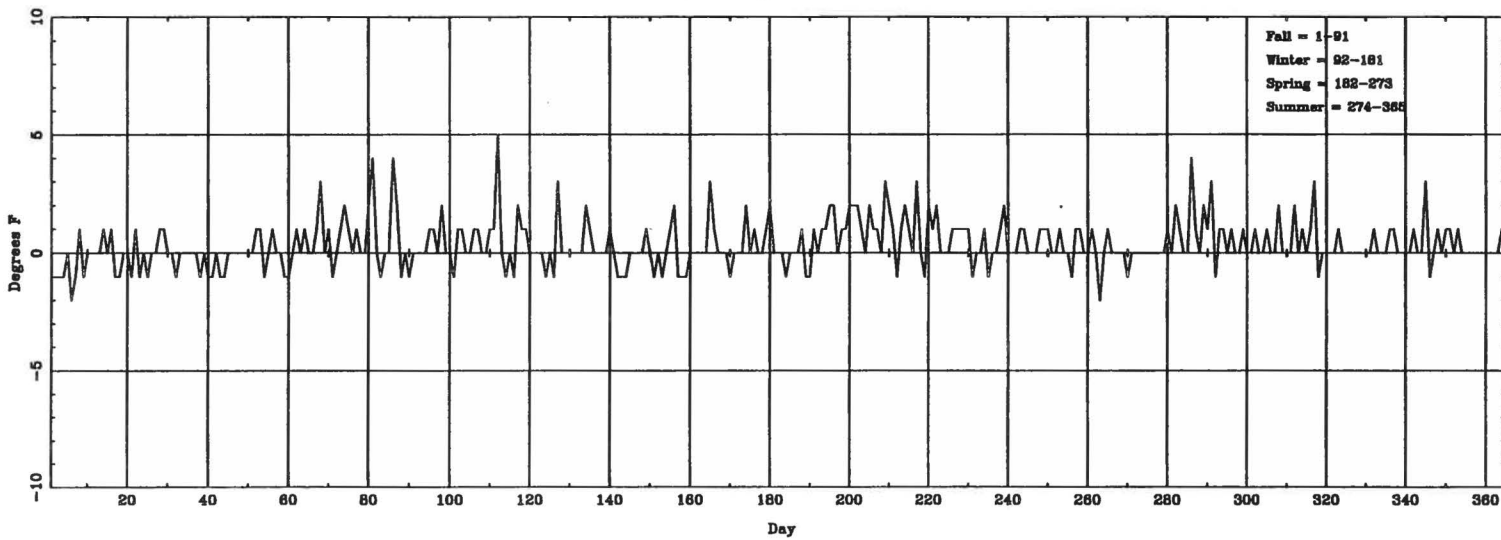

Daily $\Delta T_{(\text{highest hourly})}$ (ASOS - CONV) for CAK

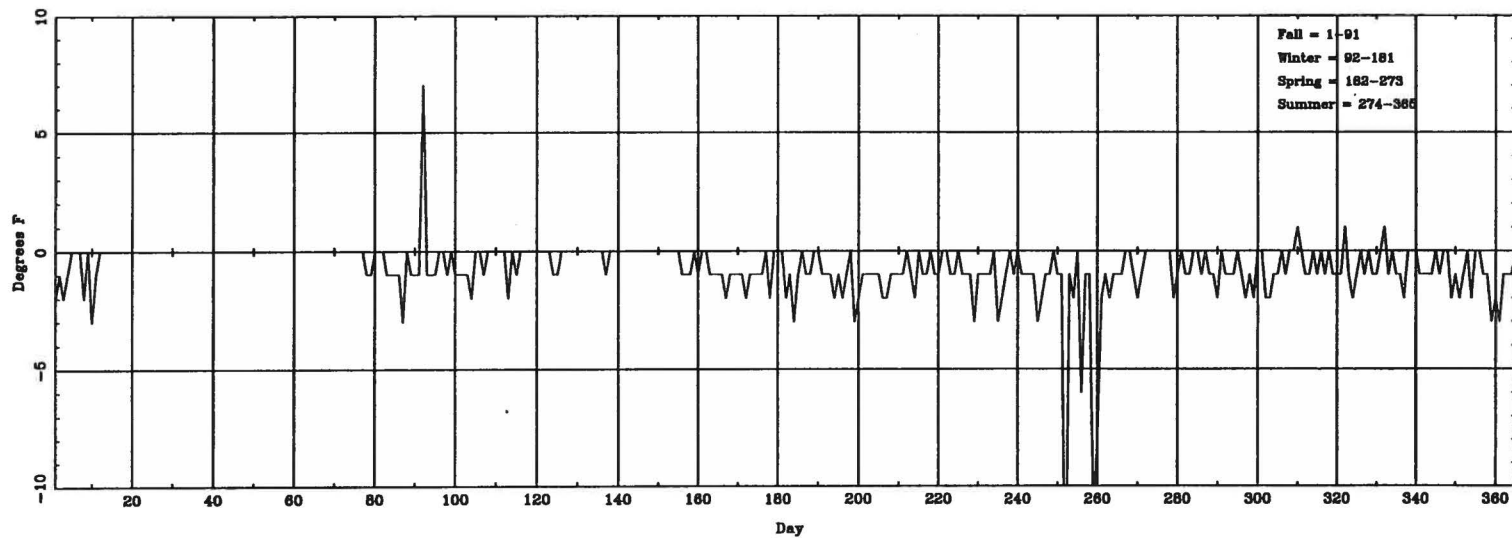

Daily $\Delta T_{(\text{lowest hourly})}$ (ASOS - CONV) for CAK

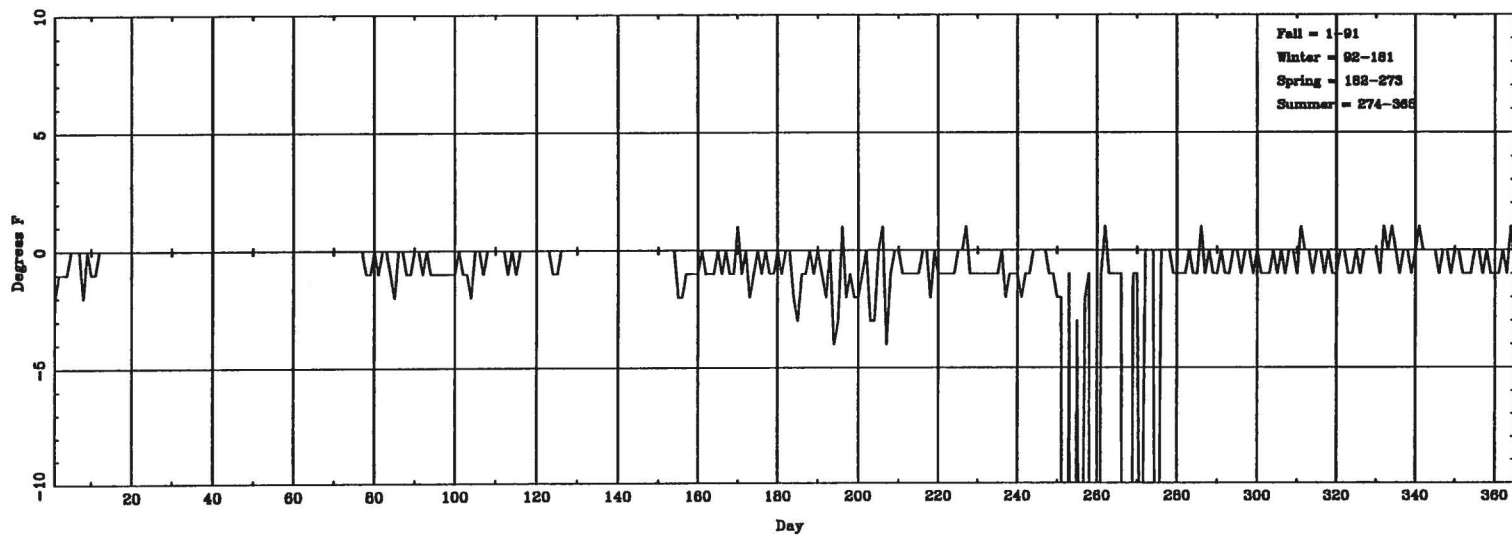

Daily $\Delta T_{(highest\ hourly)}$ (ASOS - CONV) for CLE

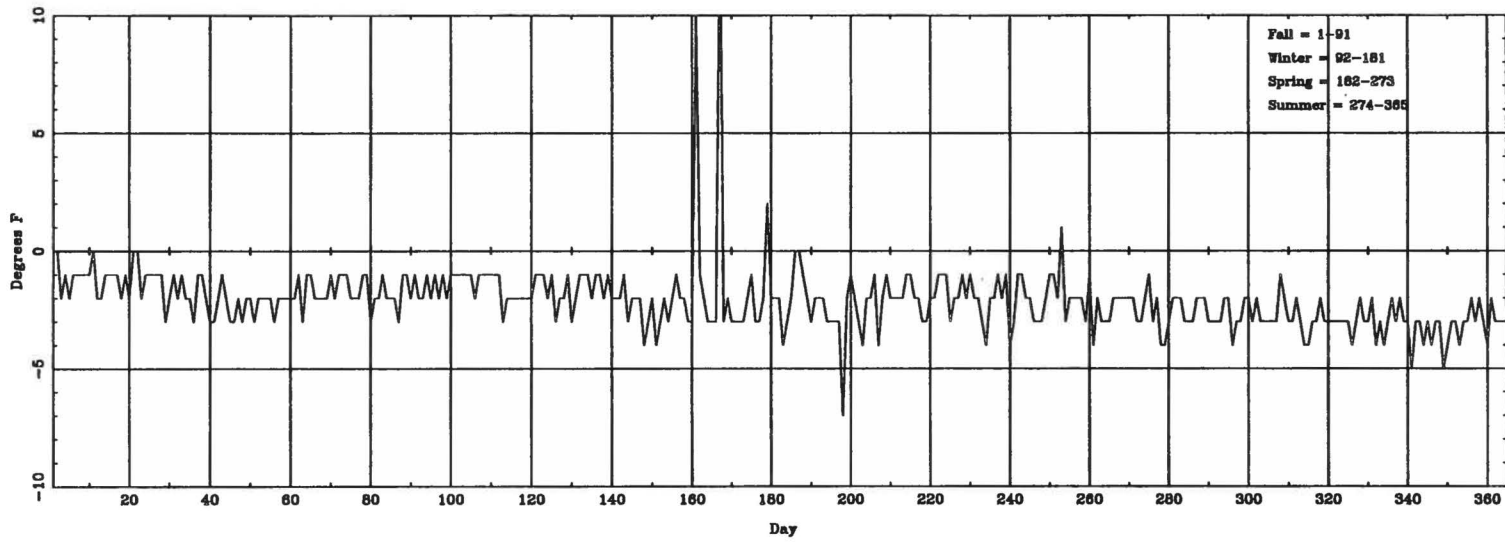

Daily $\Delta T_{(lowest\ hourly)}$ (ASOS - CONV) for CLE

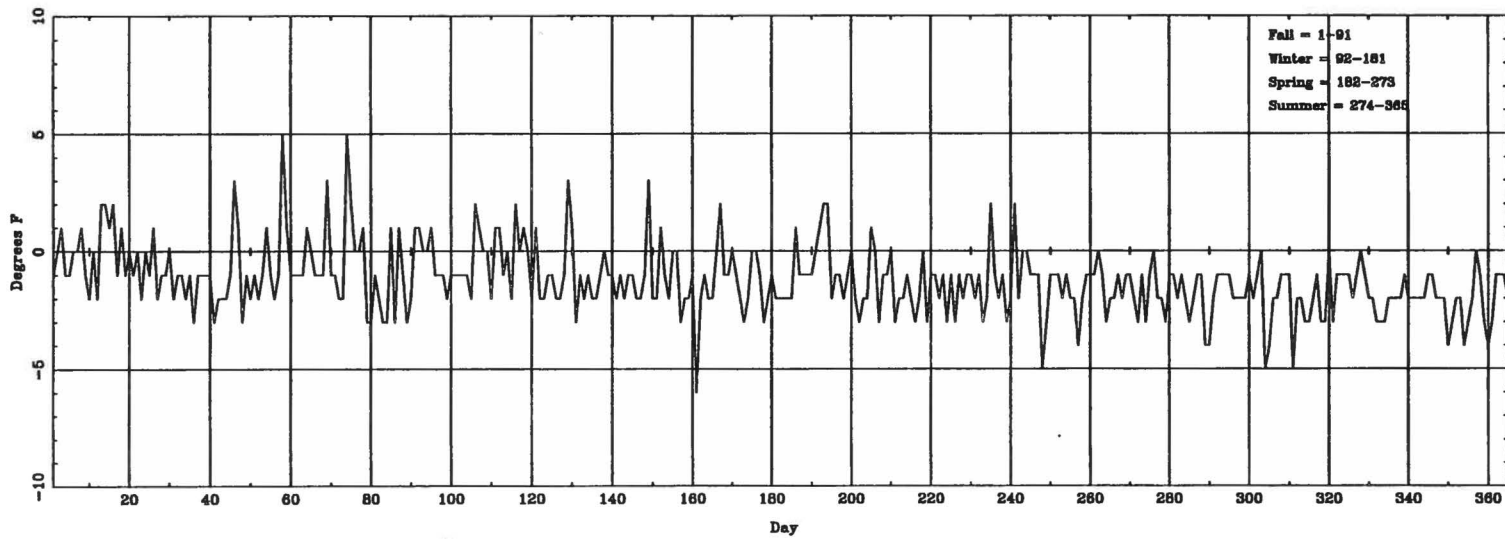

Daily $\Delta T_{\text{(highest hourly)}}$ (ASOS - CONV) for COU

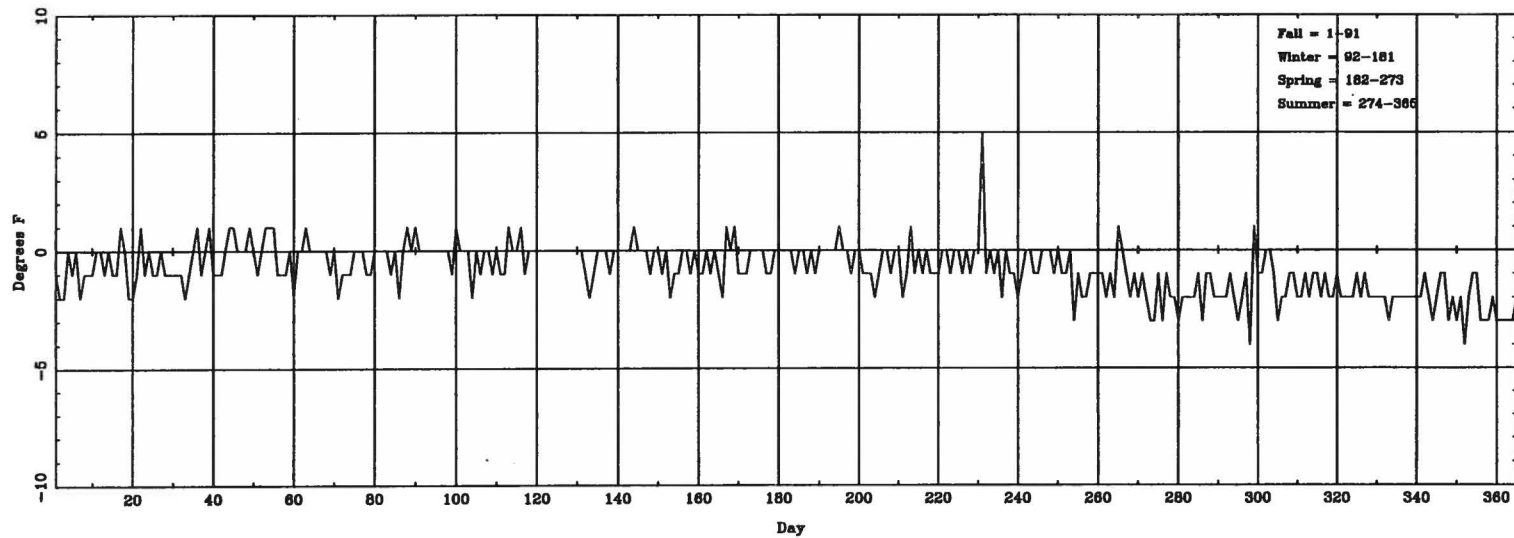

Daily $\Delta T_{\text{(lowest hourly)}}$ (ASOS - CONV) for COU

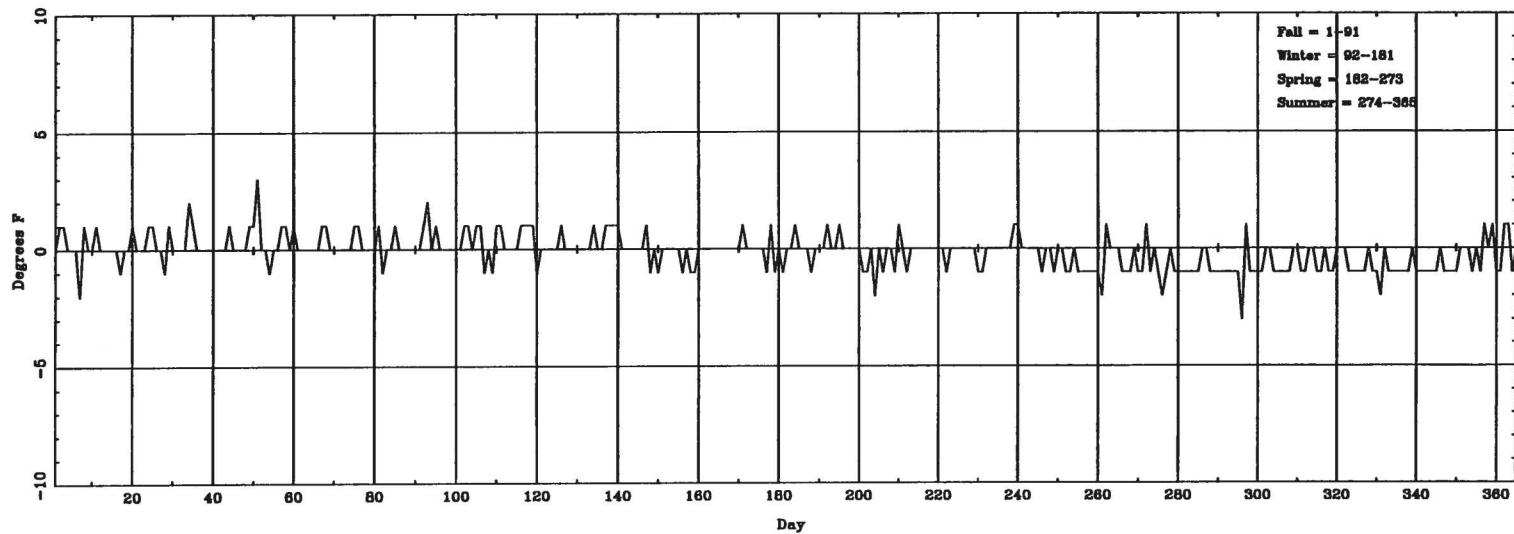

Daily $\Delta T_{(highest\ hourly)}$ (ASOS - CONV) for CYS

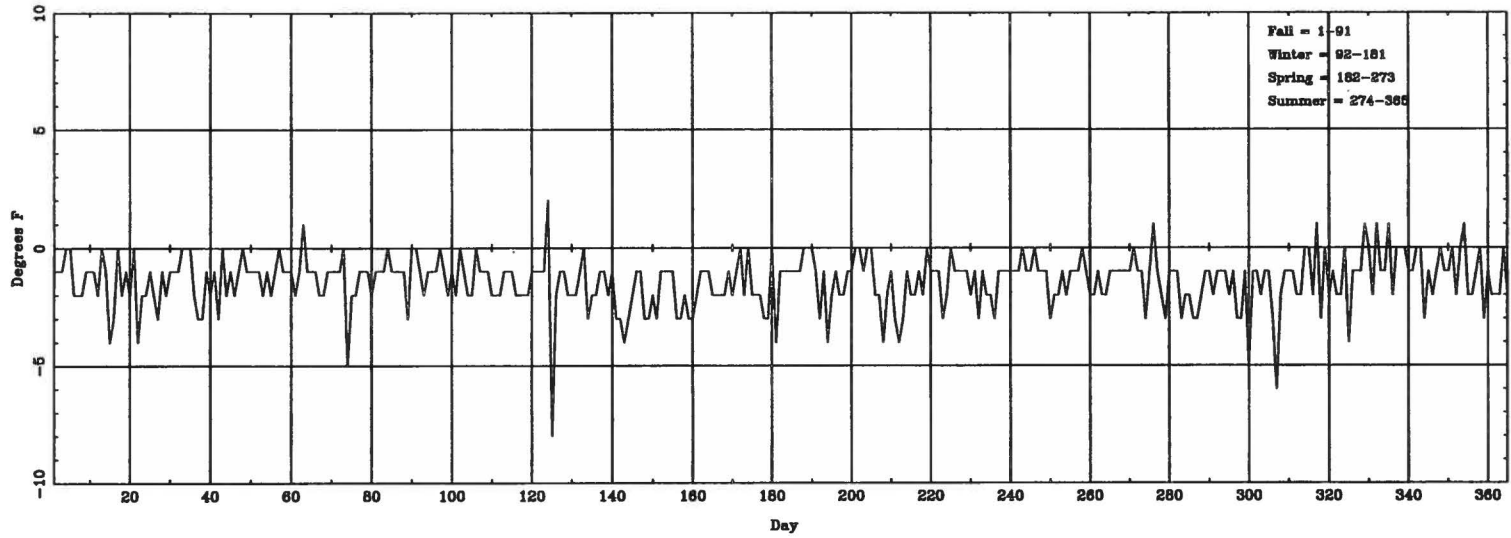

Daily $\Delta T_{(lowest\ hourly)}$ (ASOS - CONV) for CYS

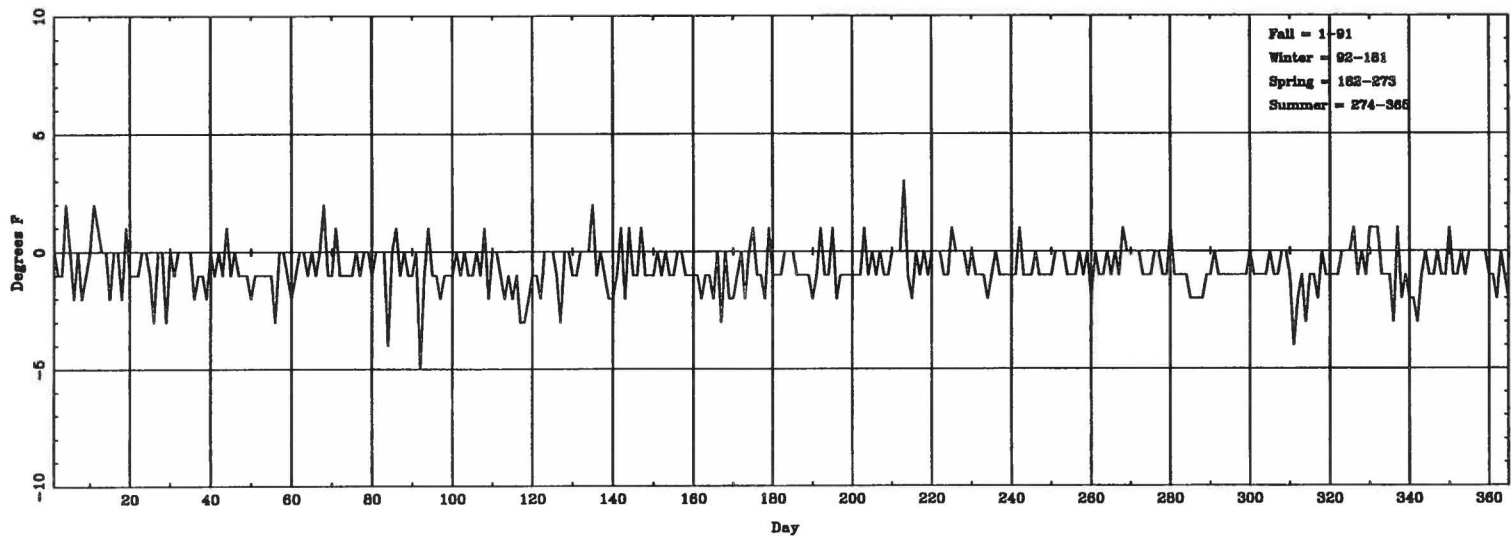

Daily $\Delta T_{(highest\ height)}$ (ASOS - CONV) for DAB

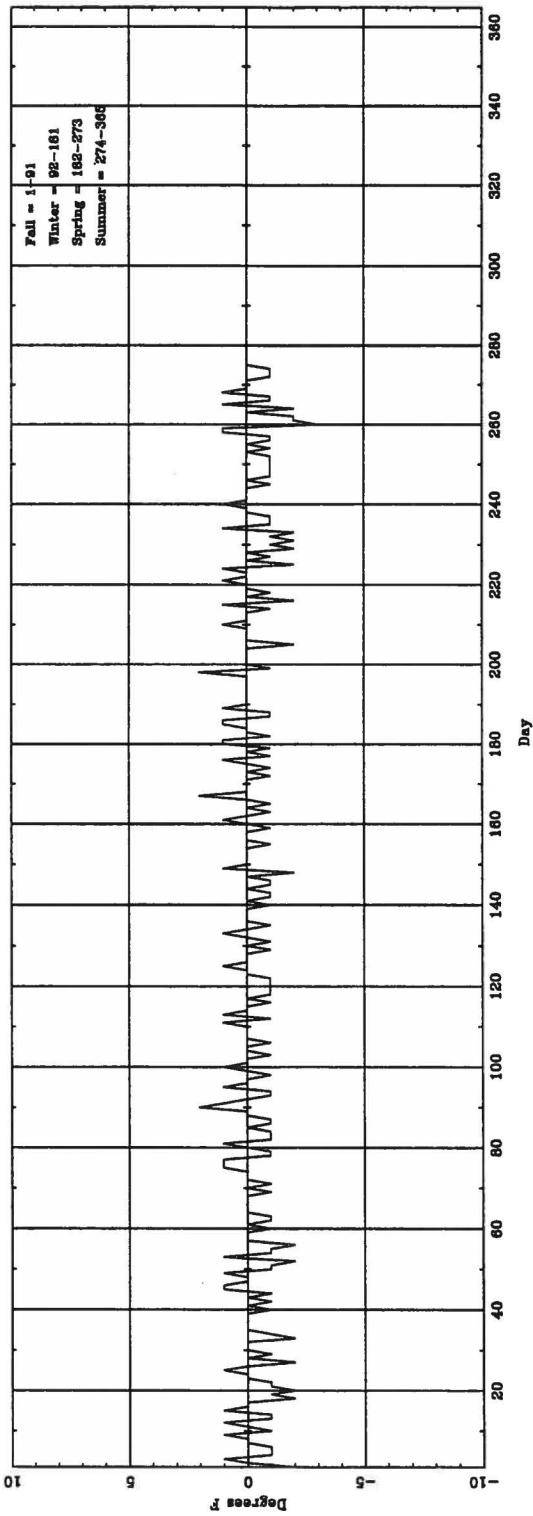

Daily $\Delta T_{(lowest\ height)}$ (ASOS - CONV) for DAB

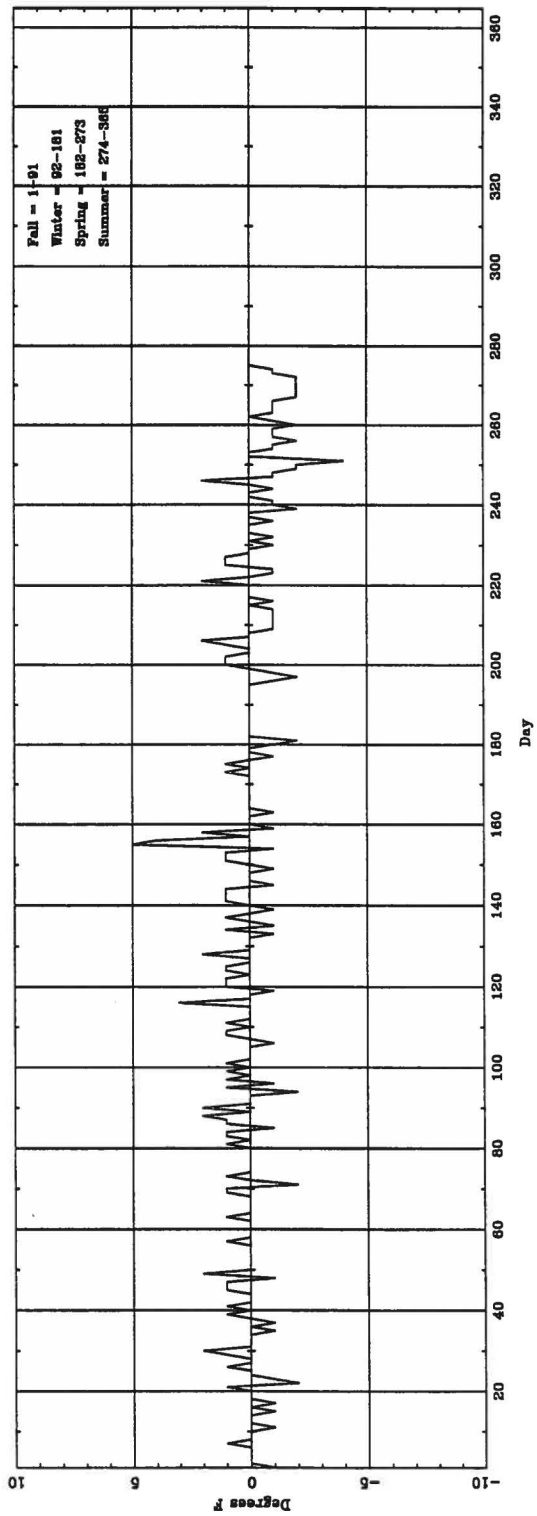

Daily $\Delta T_{(highest\ hourly)}$ (ASOS - CONV) for DAY

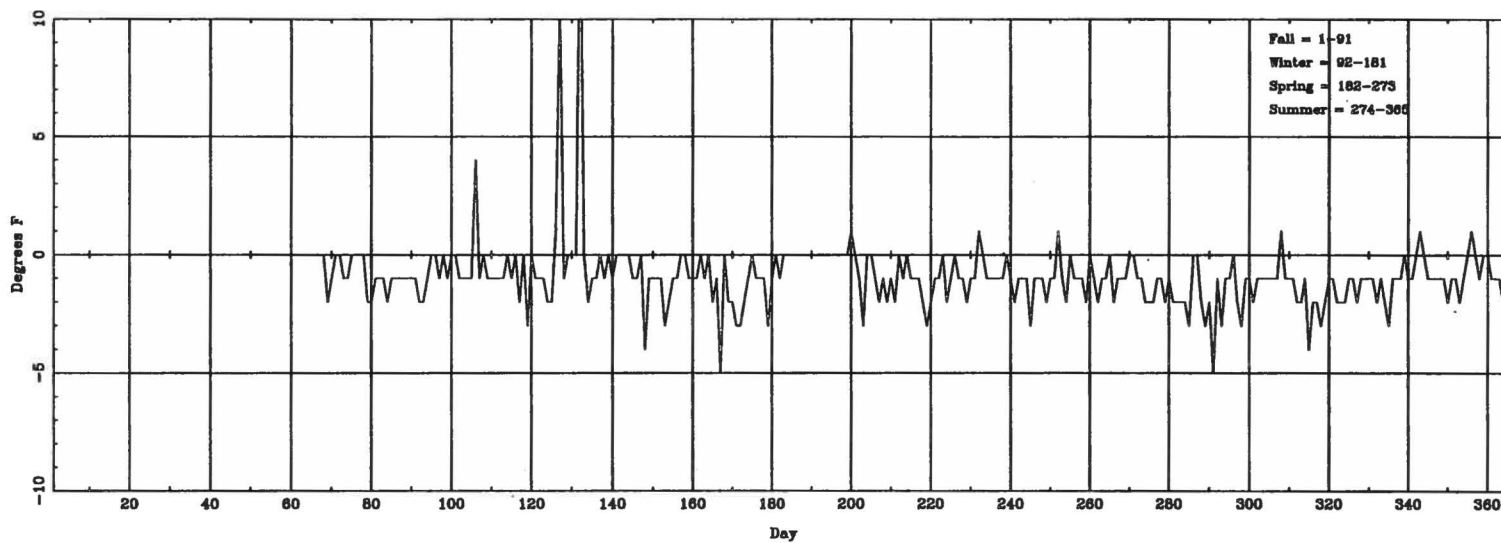

Daily $\Delta T_{(lowest\ hourly)}$ (ASOS - CONV) for DAY

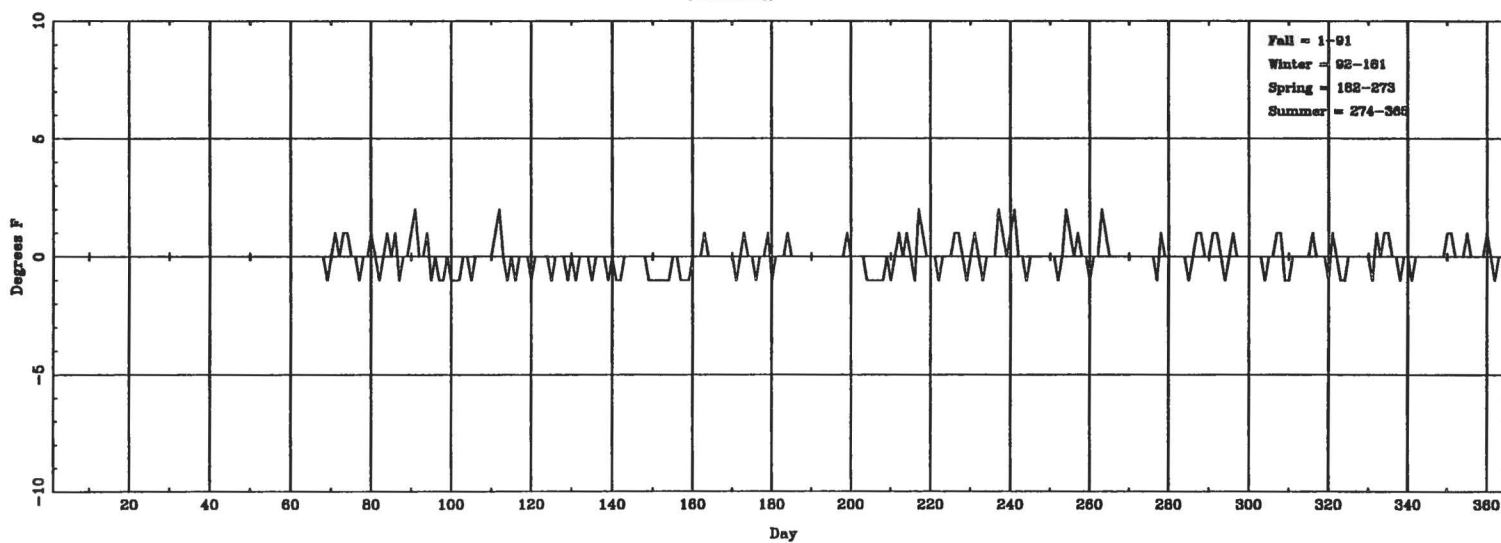

Daily $\Delta T_{(equipment\ battery)}$ (ASOS - CONY) for DRA

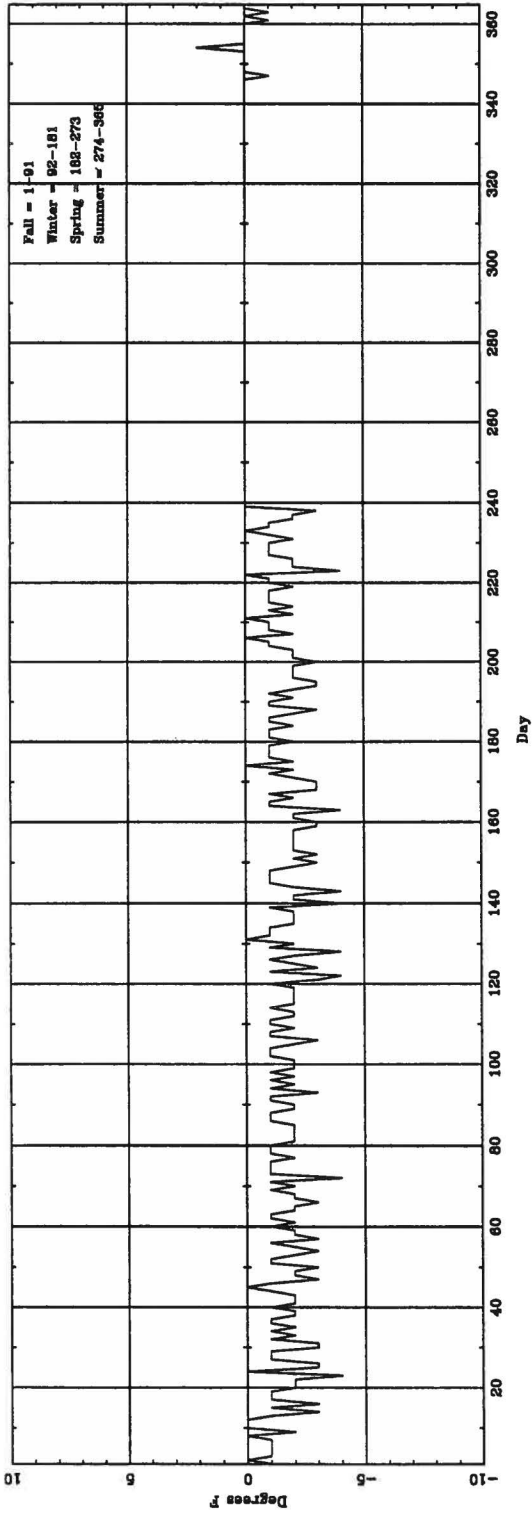

Daily $\Delta T_{(equipment\ battery)}$ (ASOS - CONY) for DRA

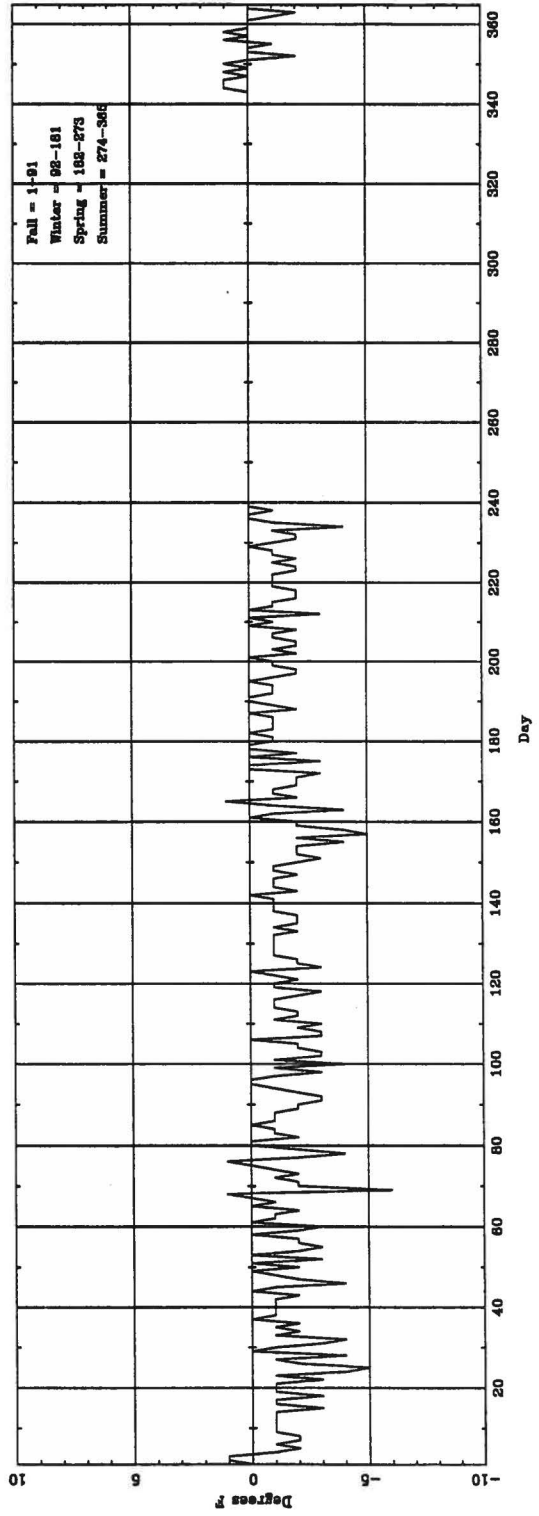

Daily ΔT (highest hourly) (ASOS - CONV) for DSM

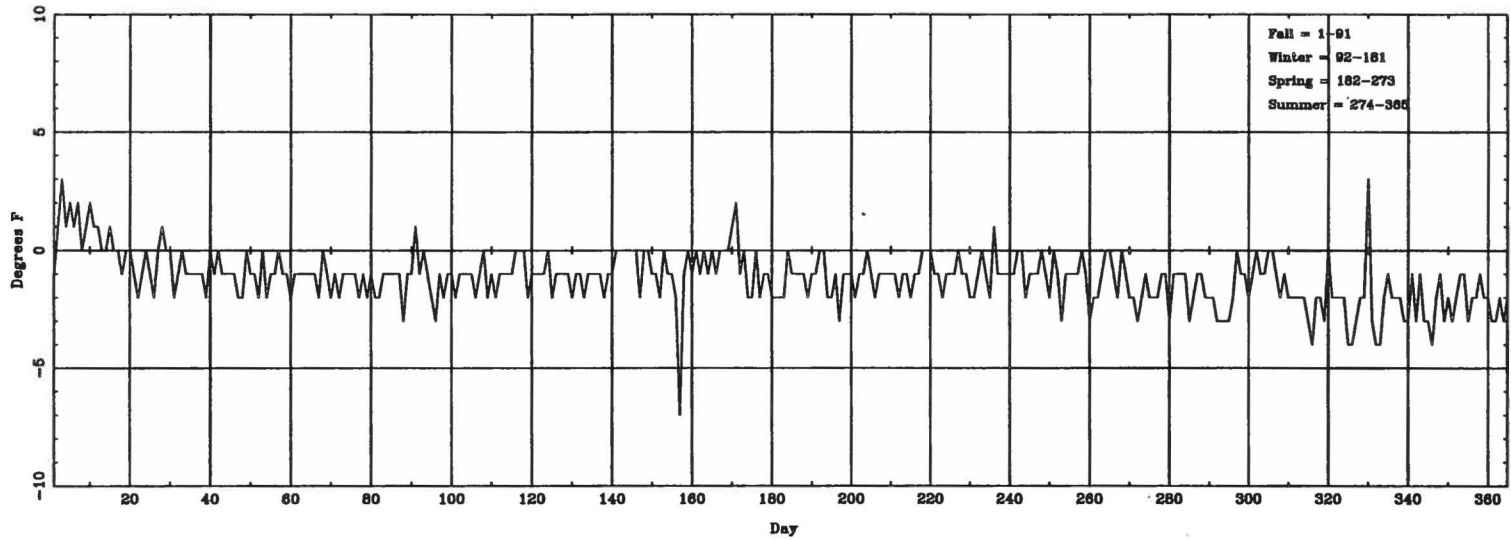

Daily ΔT (lowest hourly) (ASOS - CONV) for DSM

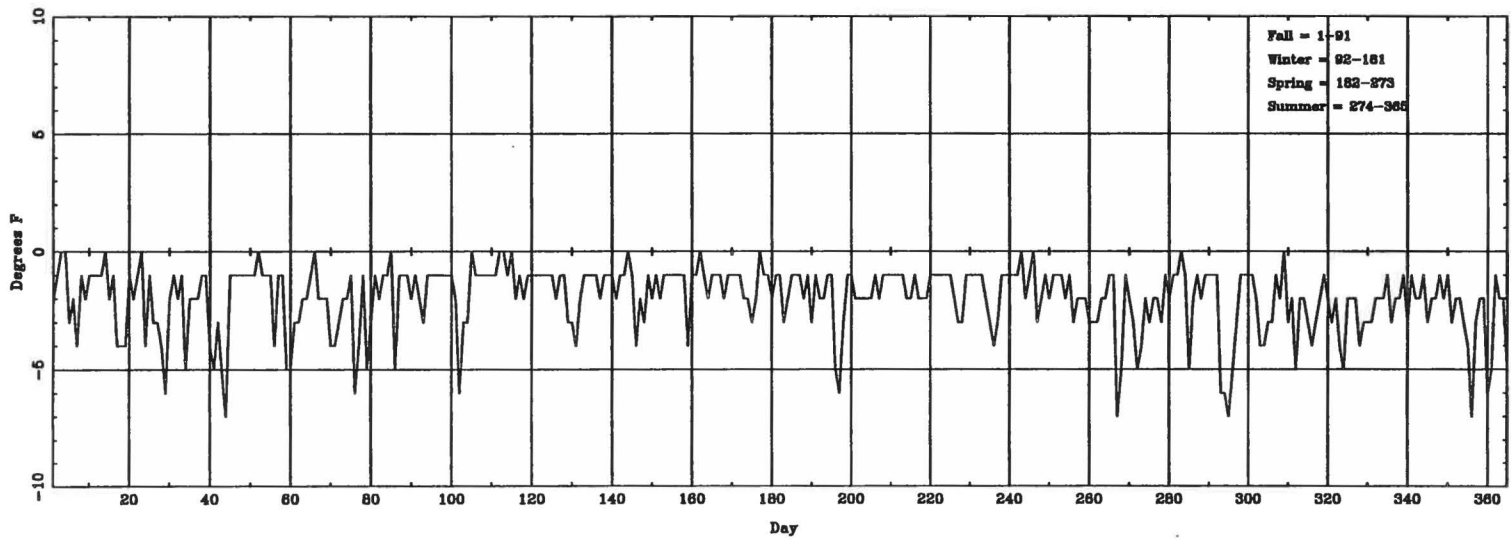

Daily $\Delta T_{\text{(highest hourly)}} (ASOS - CONV)$ for DTW

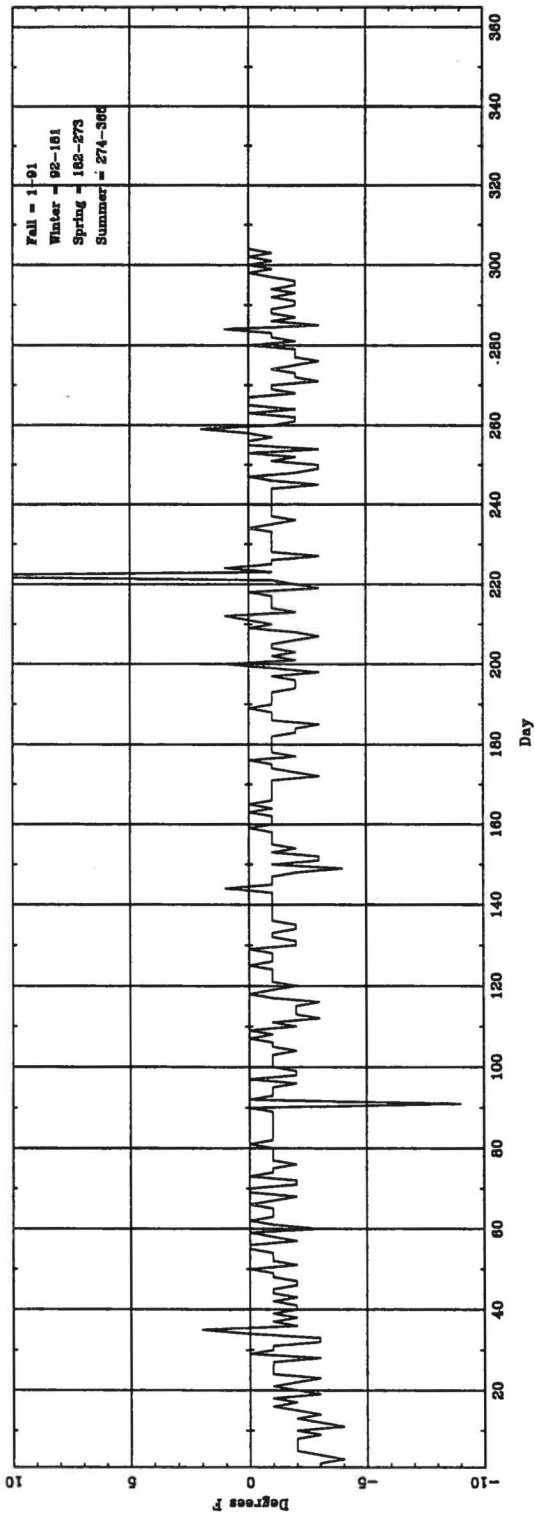

Daily $\Delta T_{\text{(lowest hourly)}} (ASOS - CONV)$ for DTW

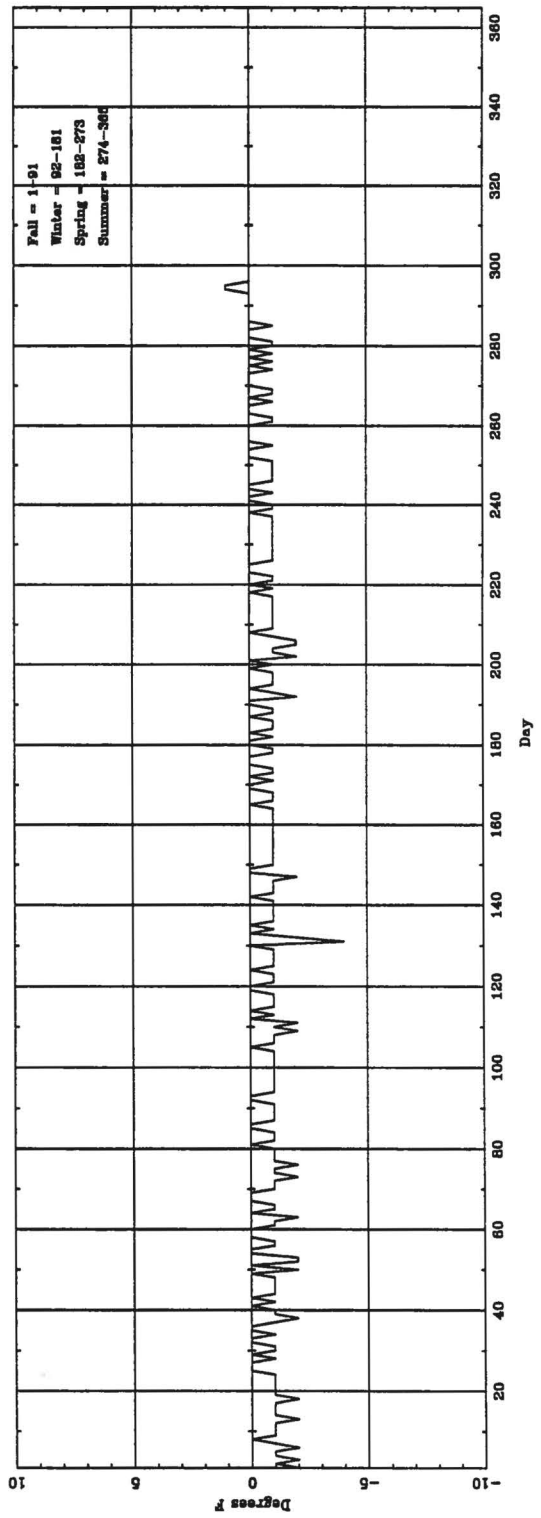

Daily $\Delta T_{\text{(highest hourly)}}$ (ASOS - CONV) for ERI

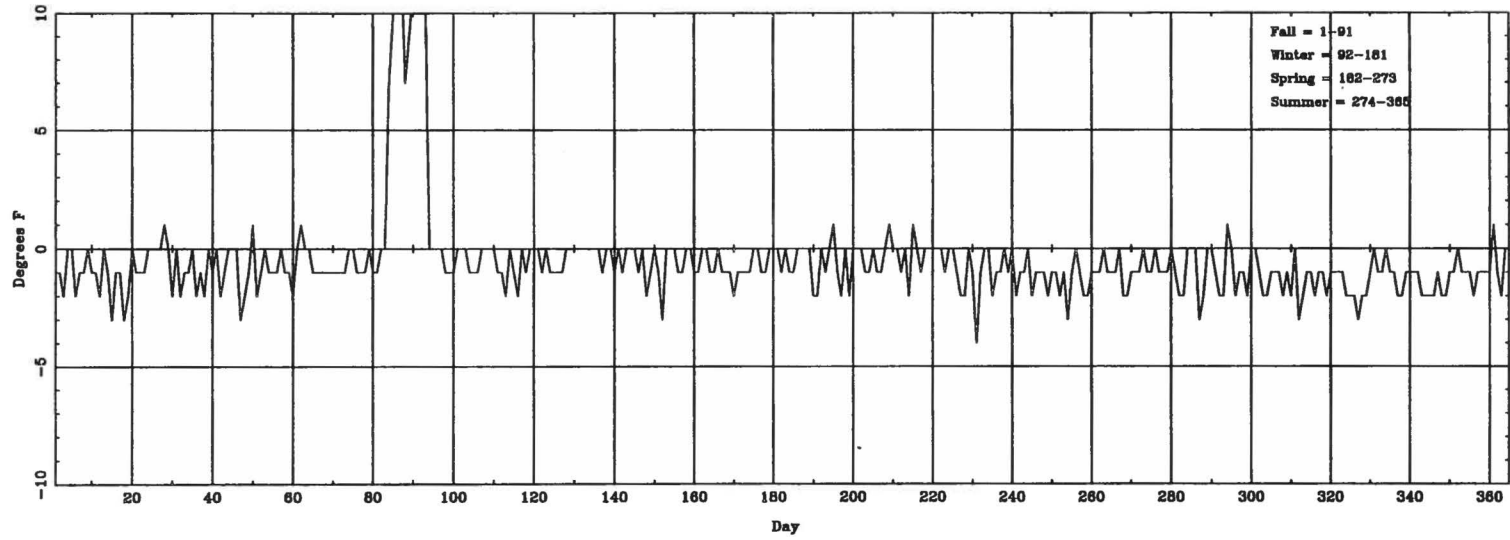

Daily $\Delta T_{\text{(lowest hourly)}}$ (ASOS - CONV) for ERI

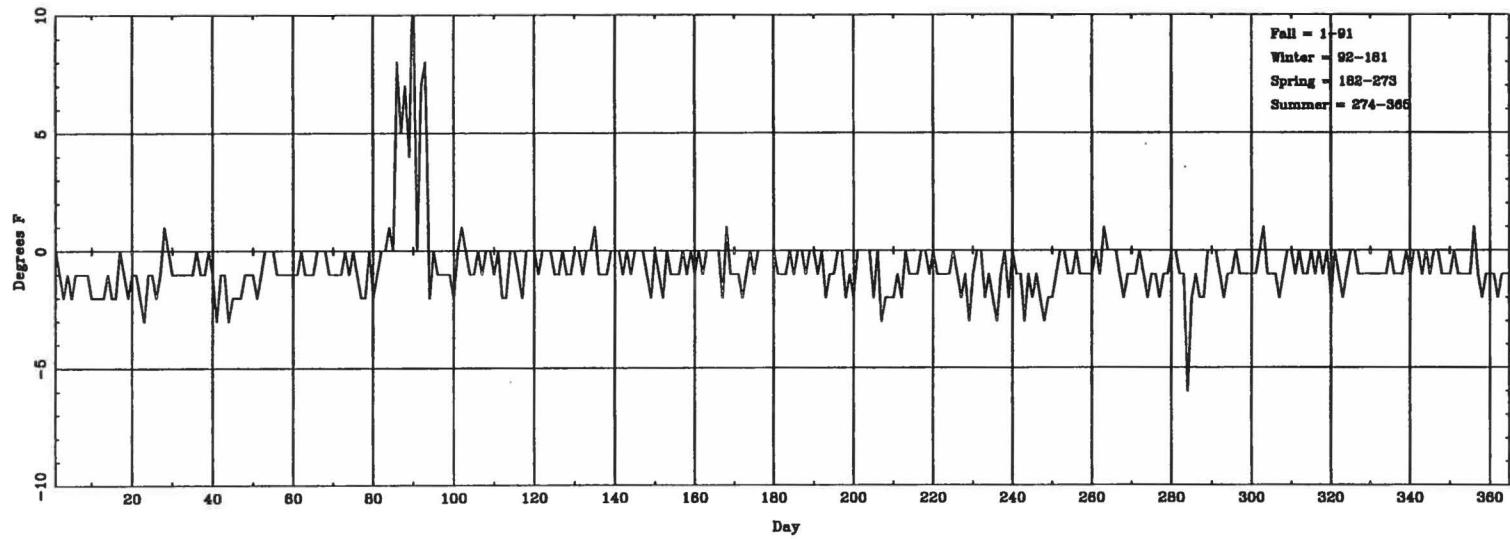

Daily $\Delta T_{(night\ hour)}$ (ASOS - CONV) for EUG

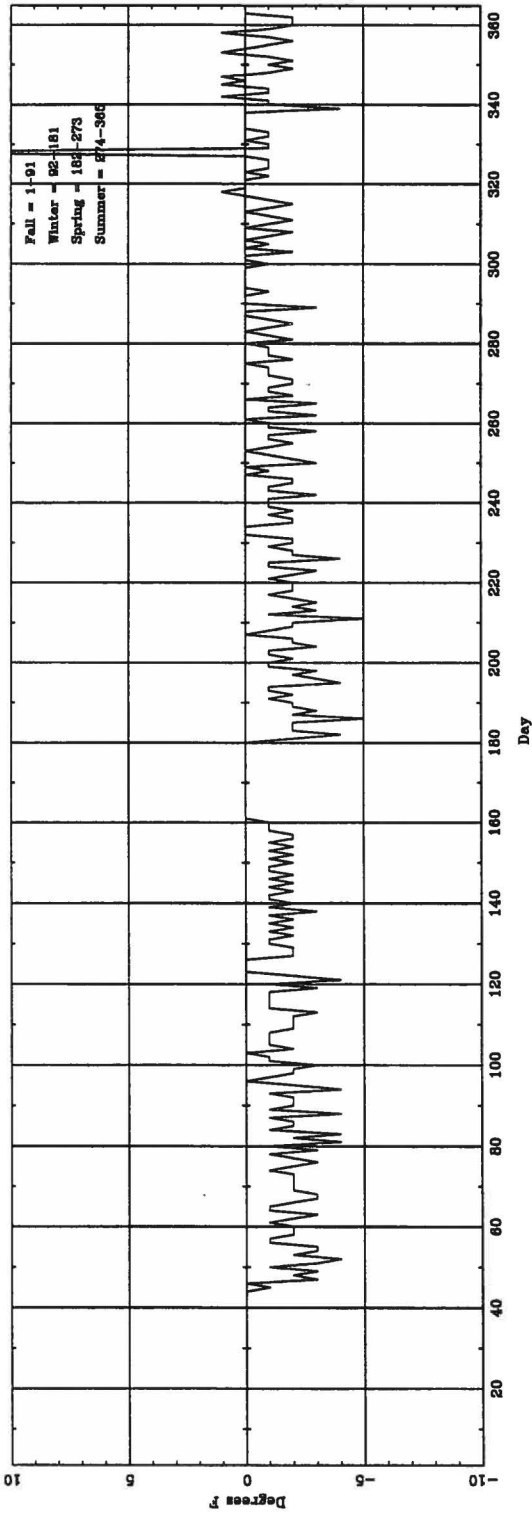

Daily $\Delta T_{(morn\ hour)}$ (ASOS - CONV) for EUG

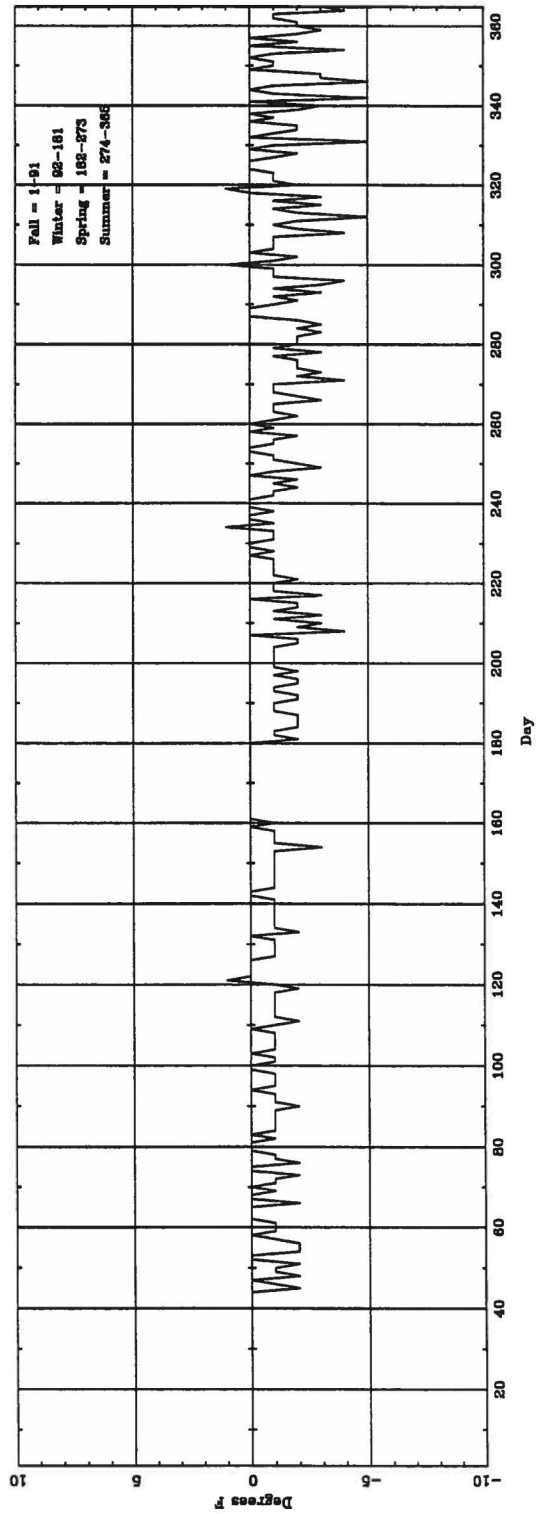

Daily $\Delta T_{\text{lightest beauty}}$ (ASOS - CONY) for FAR

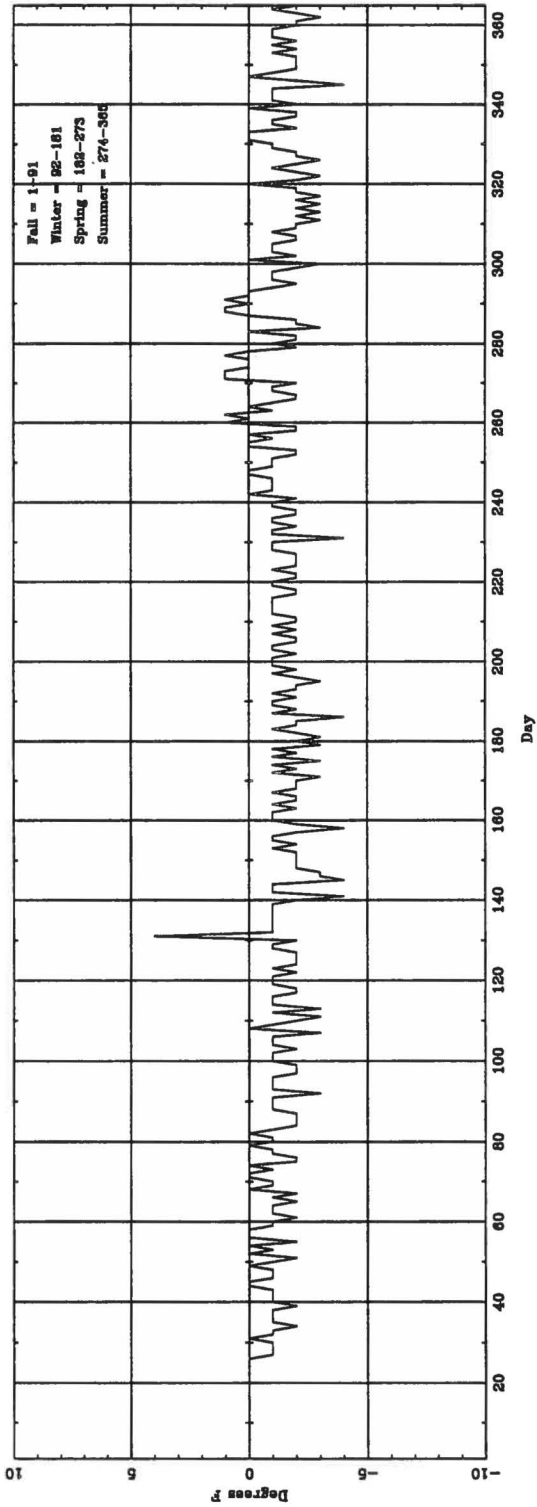

Daily $\Delta T_{\text{hardest beauty}}$ (ASOS - CONY) for FAR

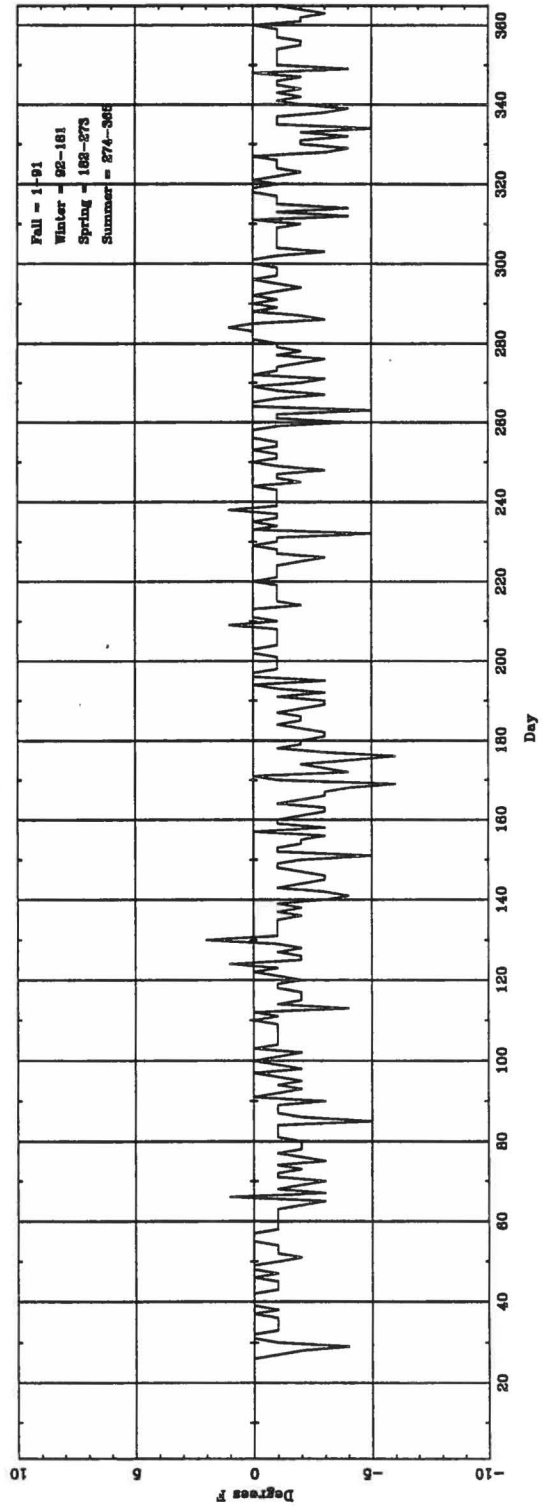

Daily $\Delta T_{\text{(highest hourly)}}$ (ASOS - CONV) for FNT

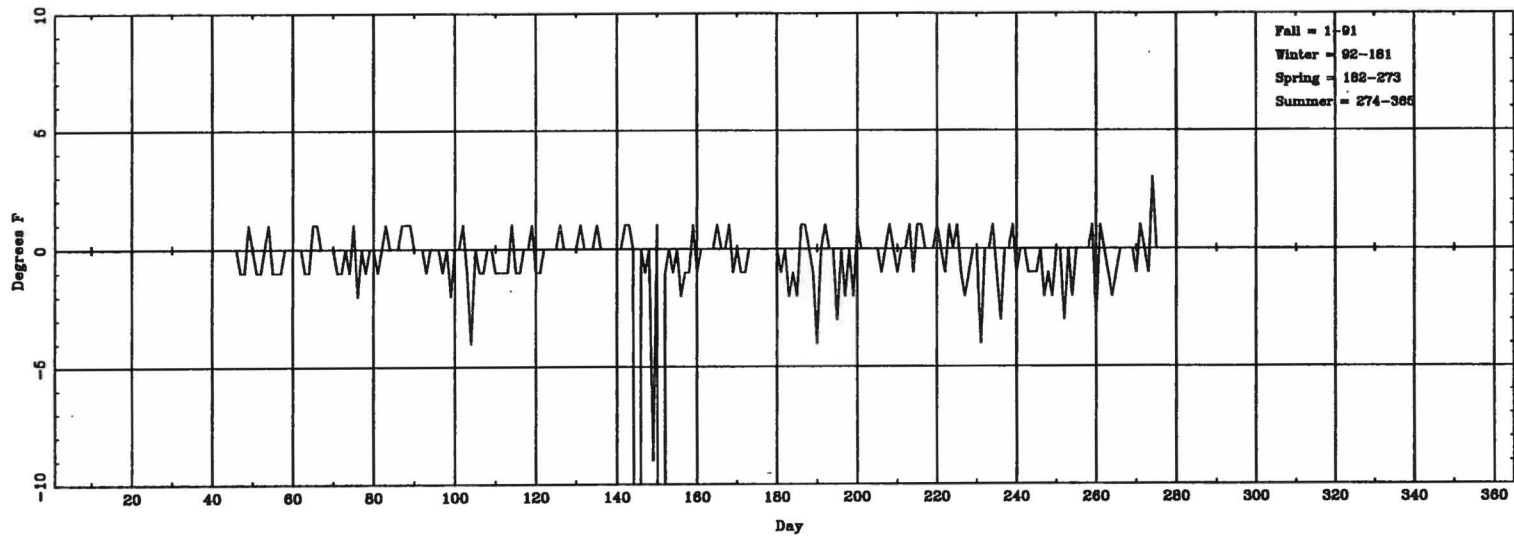

Daily $\Delta T_{\text{(lowest hourly)}}$ (ASOS - CONV) for FNT

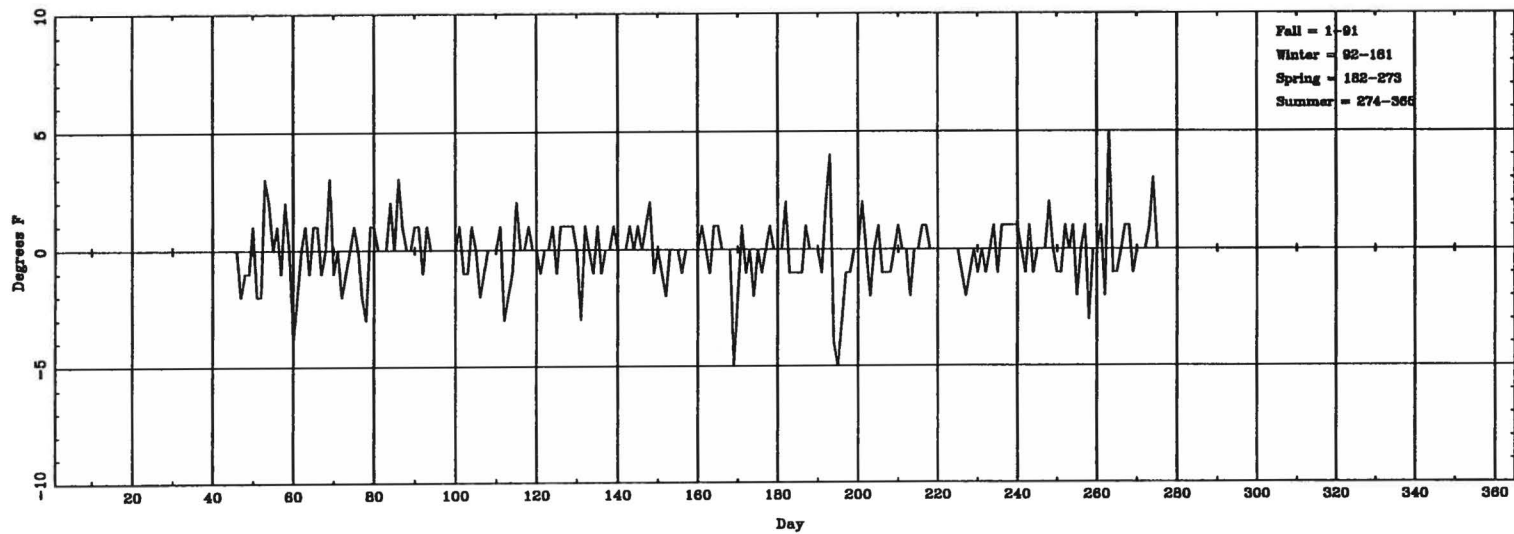

Daily $\Delta T_{\text{(highest hourly)}}$ (ASOS - CONV) for FSD

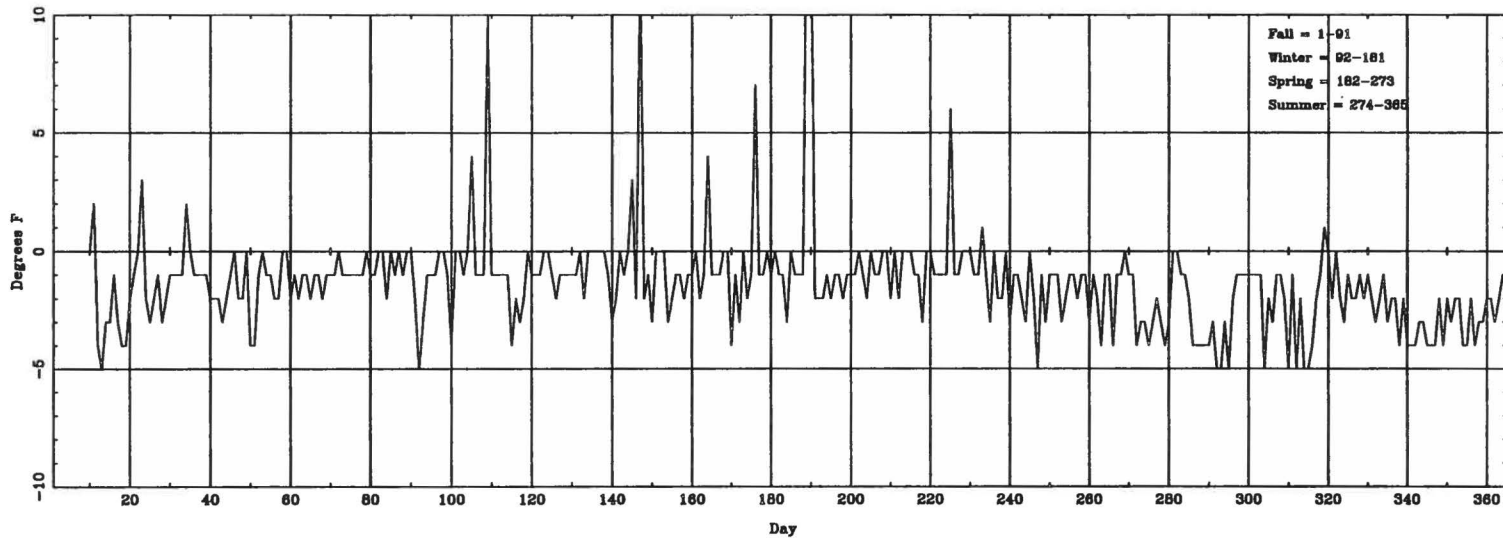

Daily $\Delta T_{\text{(lowest hourly)}}$ (ASOS - CONV) for FSD

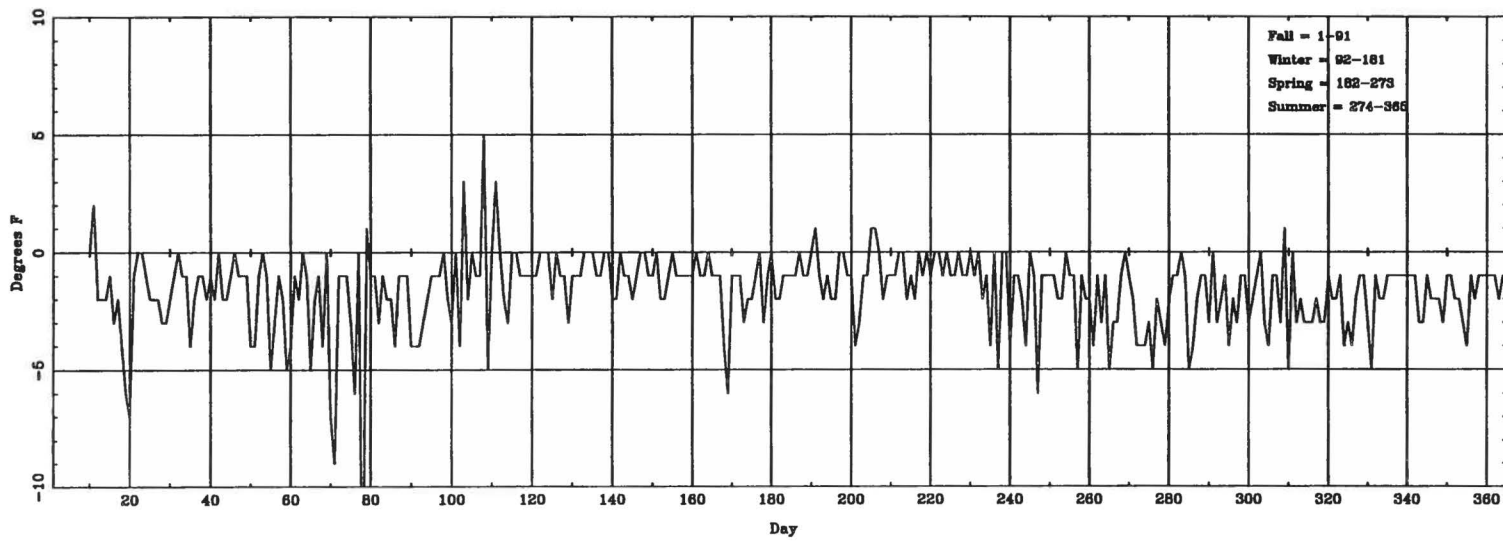

Daily $\Delta T_{(highest\ hourly)}$ (ASOS - CONV) for FWA

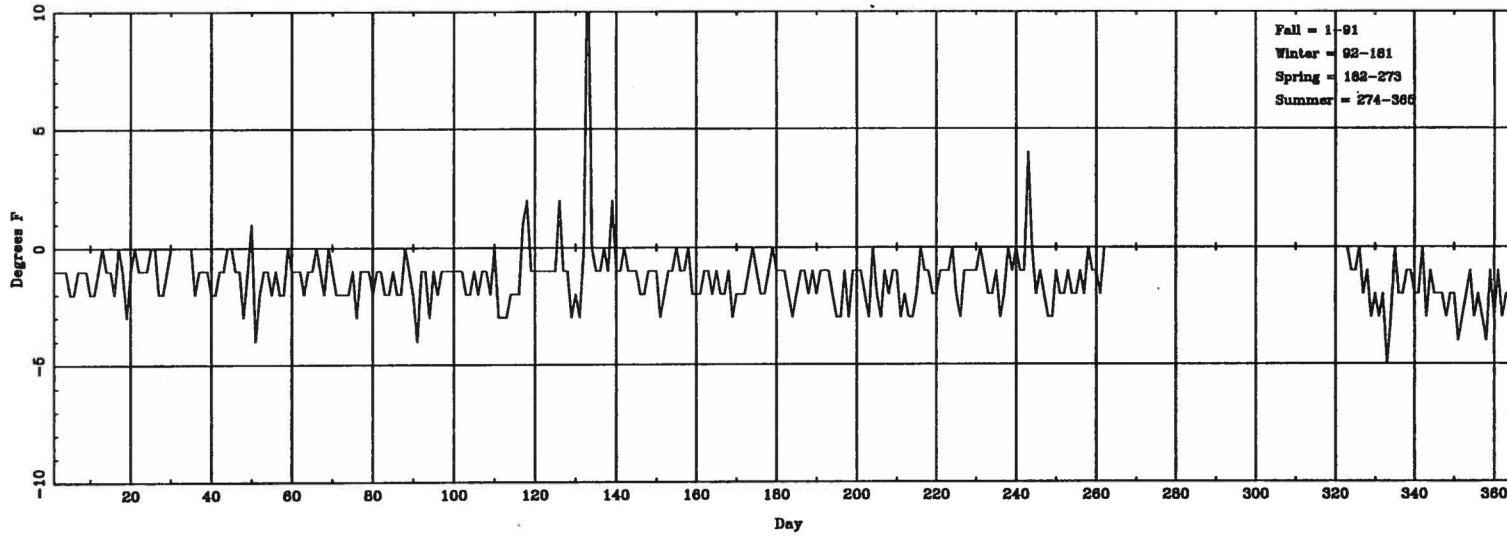

Daily $\Delta T_{(lowest\ hourly)}$ (ASOS - CONV) for FWA

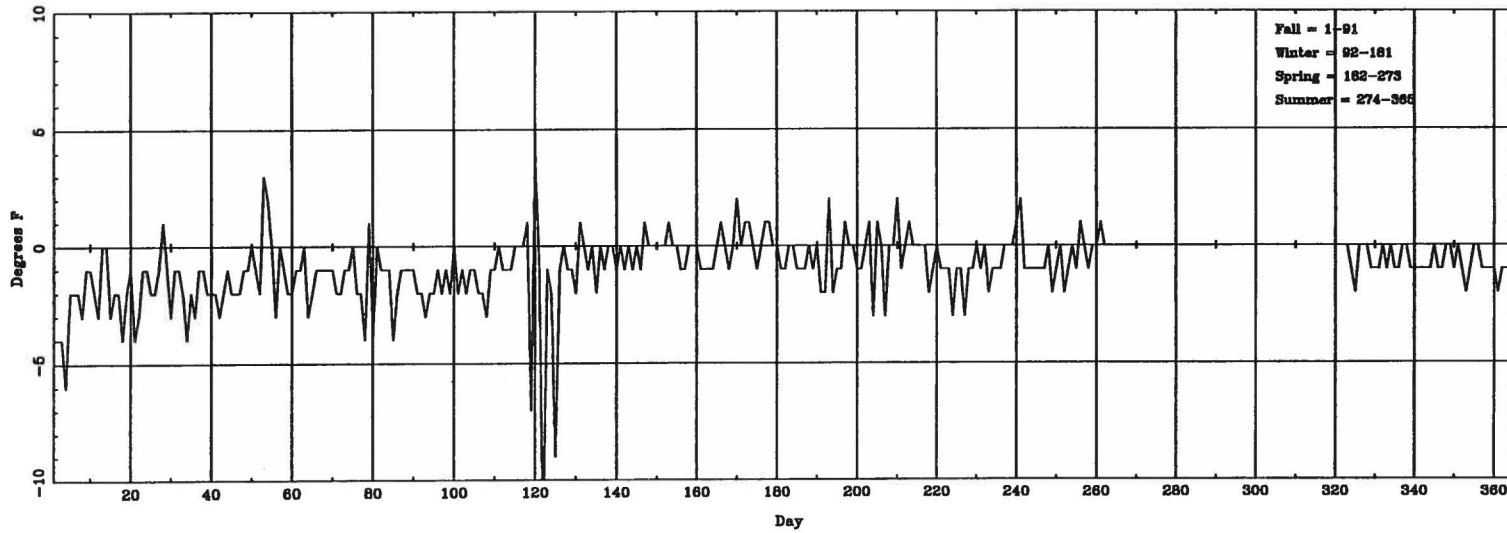

Daily $\Delta T_{\text{lightest hourly}}$ (ASOS - CONY) for GEG

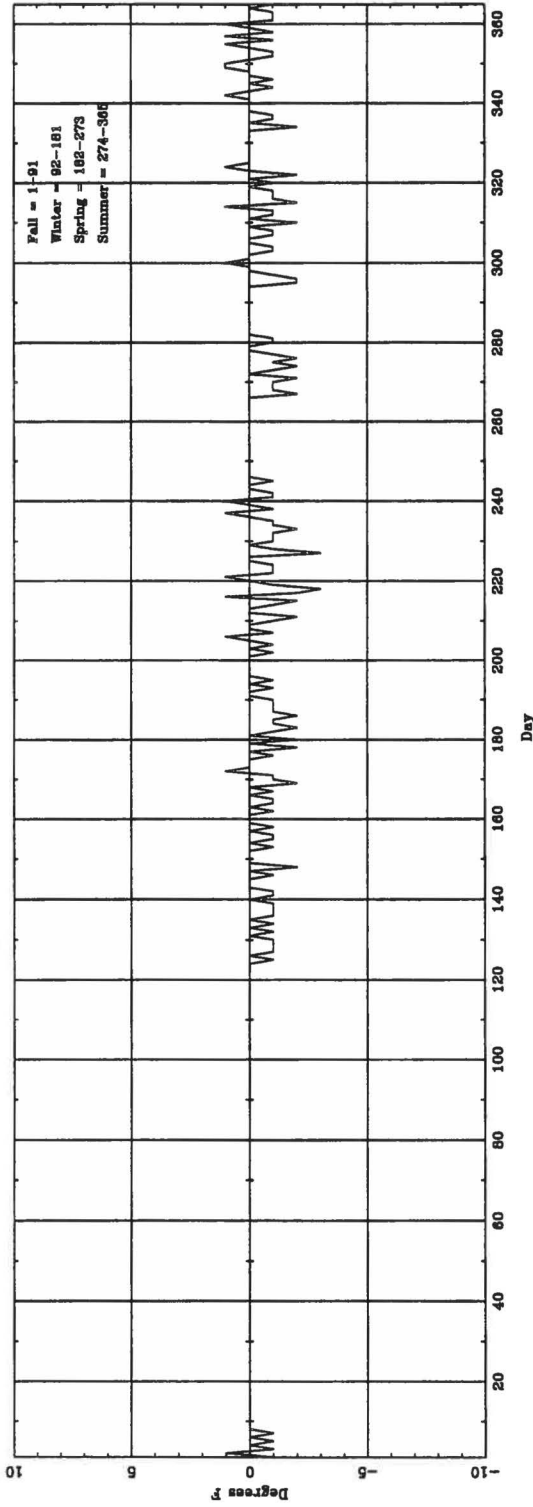

Daily $\Delta T_{\text{warmest hourly}}$ (ASOS - CONY) for GEG

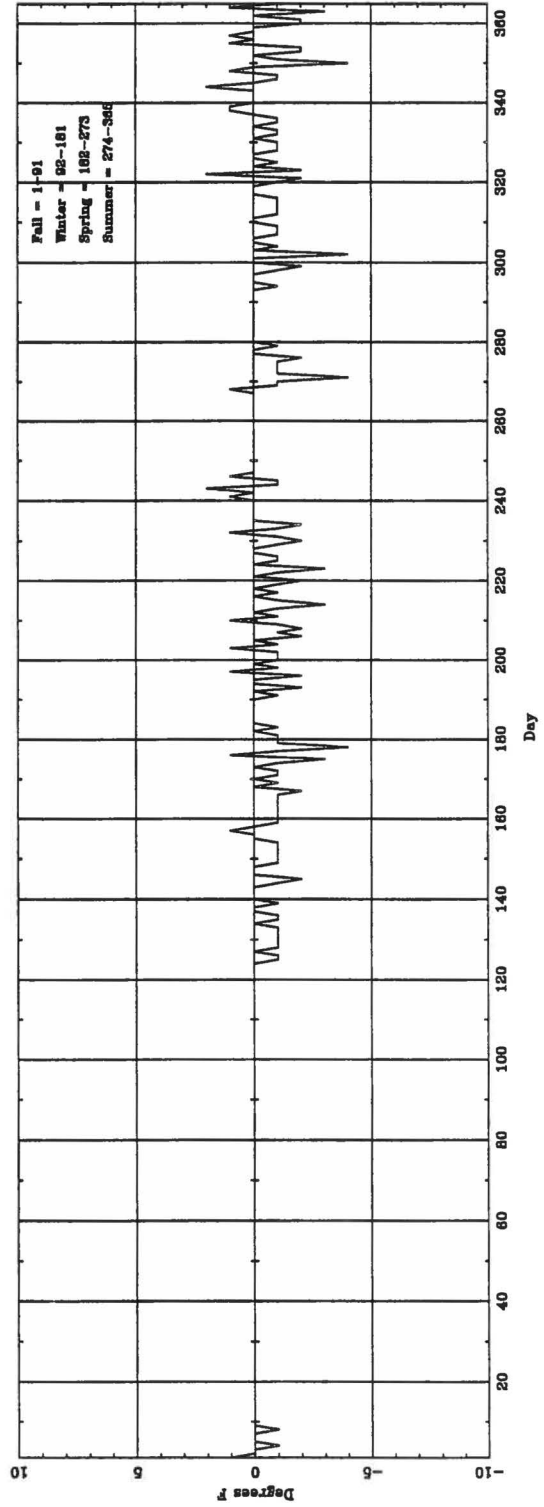

Daily $\Delta T_{(highest\ beauty)}$ (ASOS - CONY) for GJT

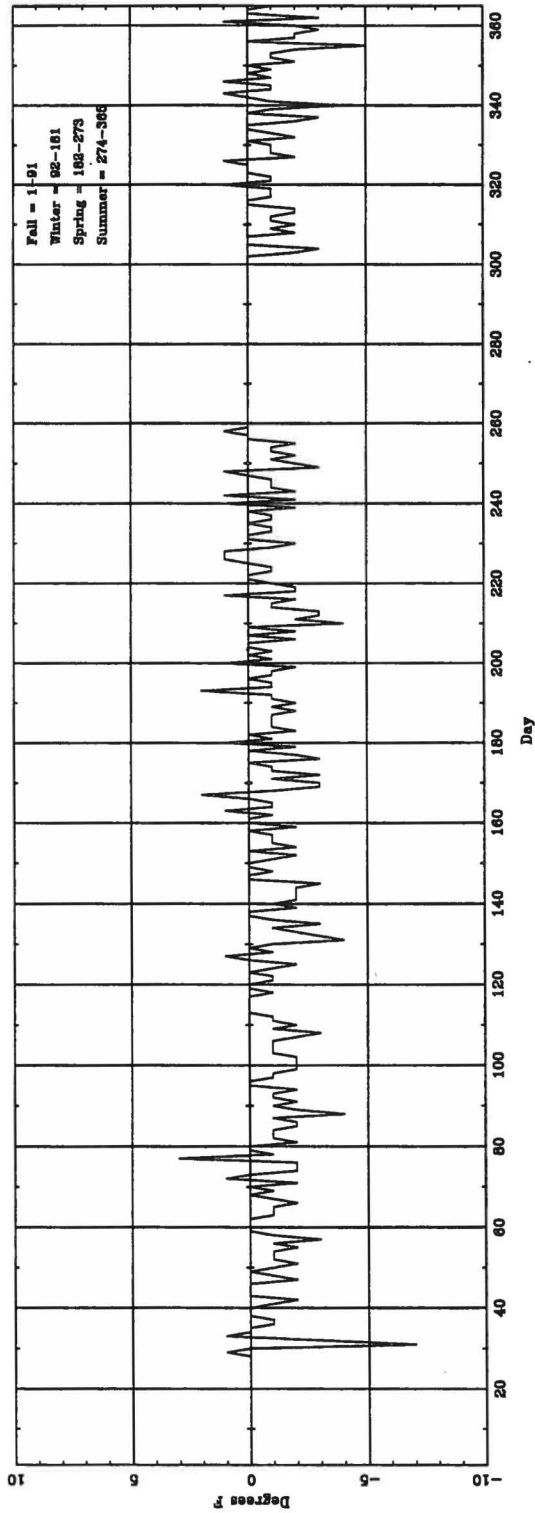

Daily $\Delta T_{(current\ beauty)}$ (ASOS - CONY) for GJT

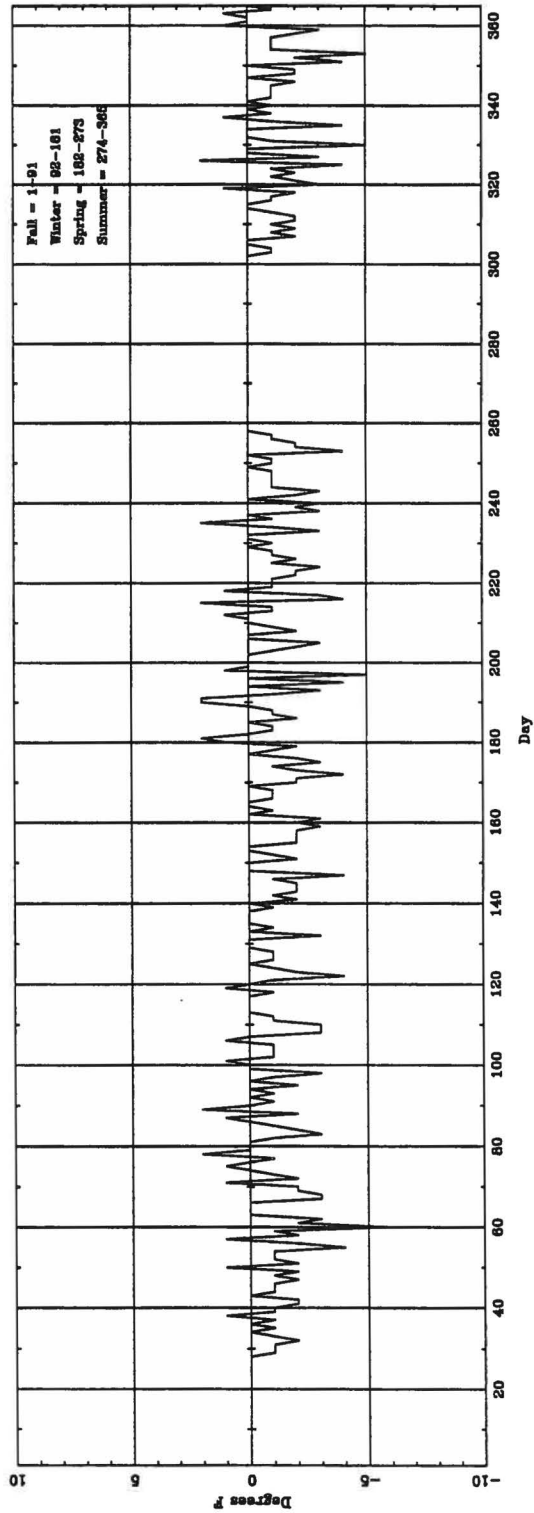

Daily $\Delta T_{\text{(highest hourly)}}$ (ASOS - CONV) for GRB

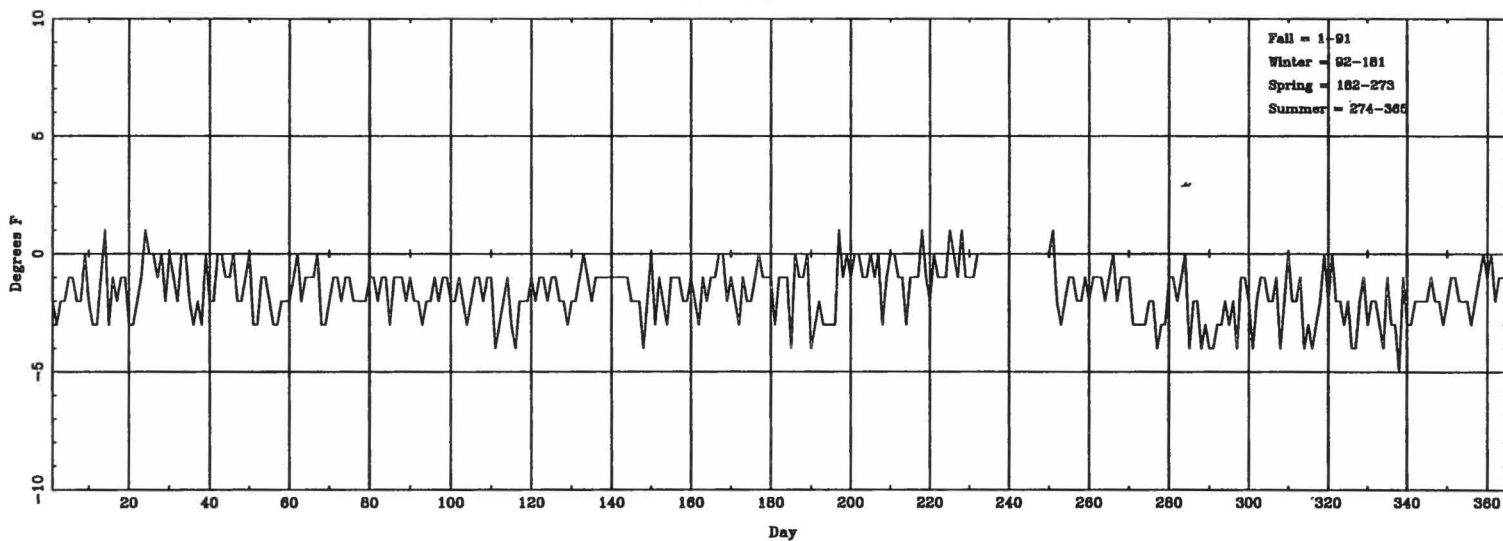

Daily $\Delta T_{\text{(lowest hourly)}}$ (ASOS - CONV) for GRB

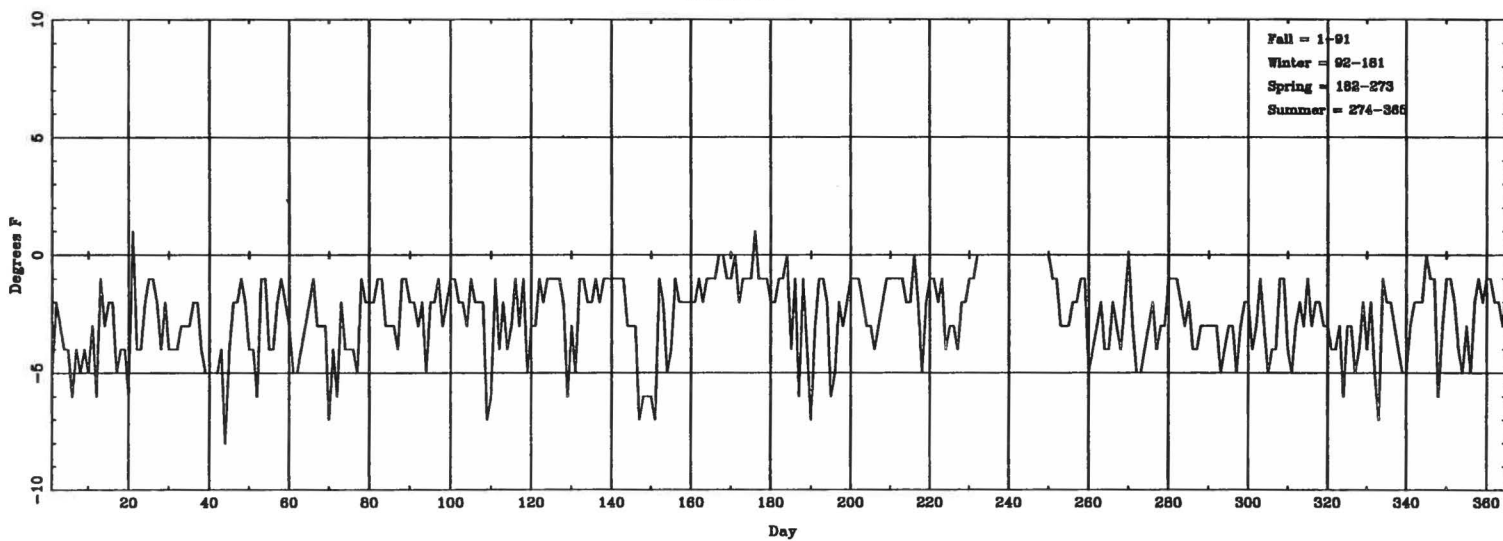

Daily $\Delta T_{\text{(highest hourly)}}$ (ASOS - CONV) for HON

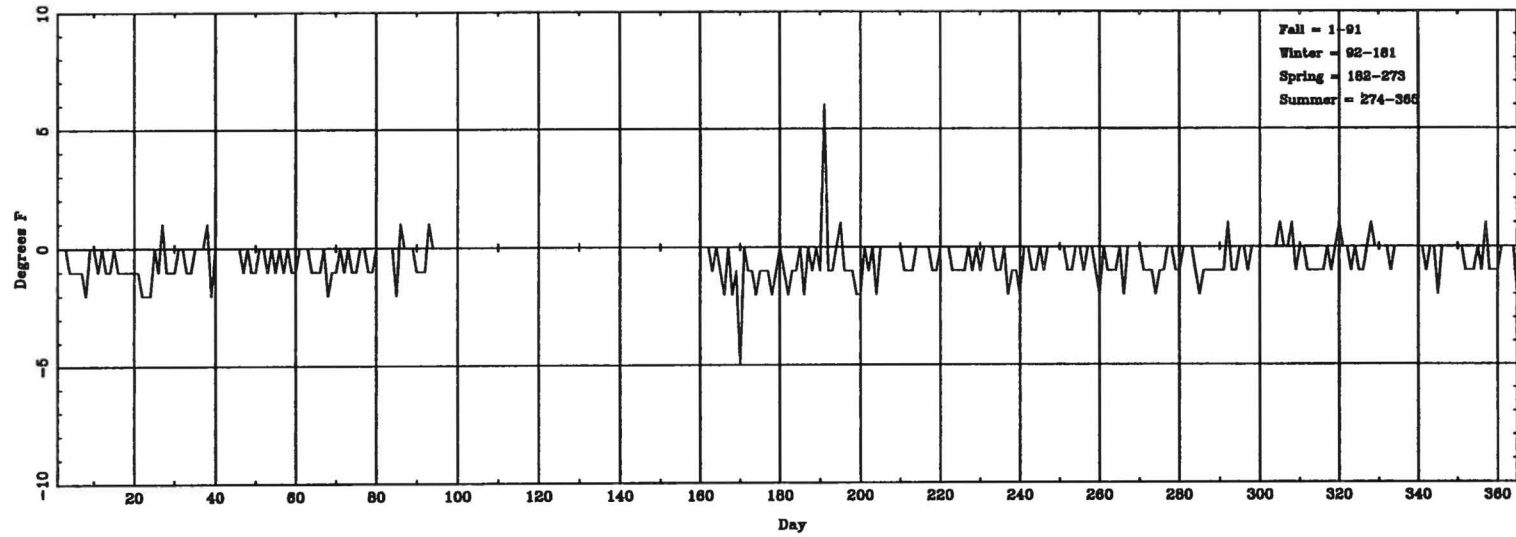

Daily $\Delta T_{\text{(lowest hourly)}}$ (ASOS - CONV) for HON

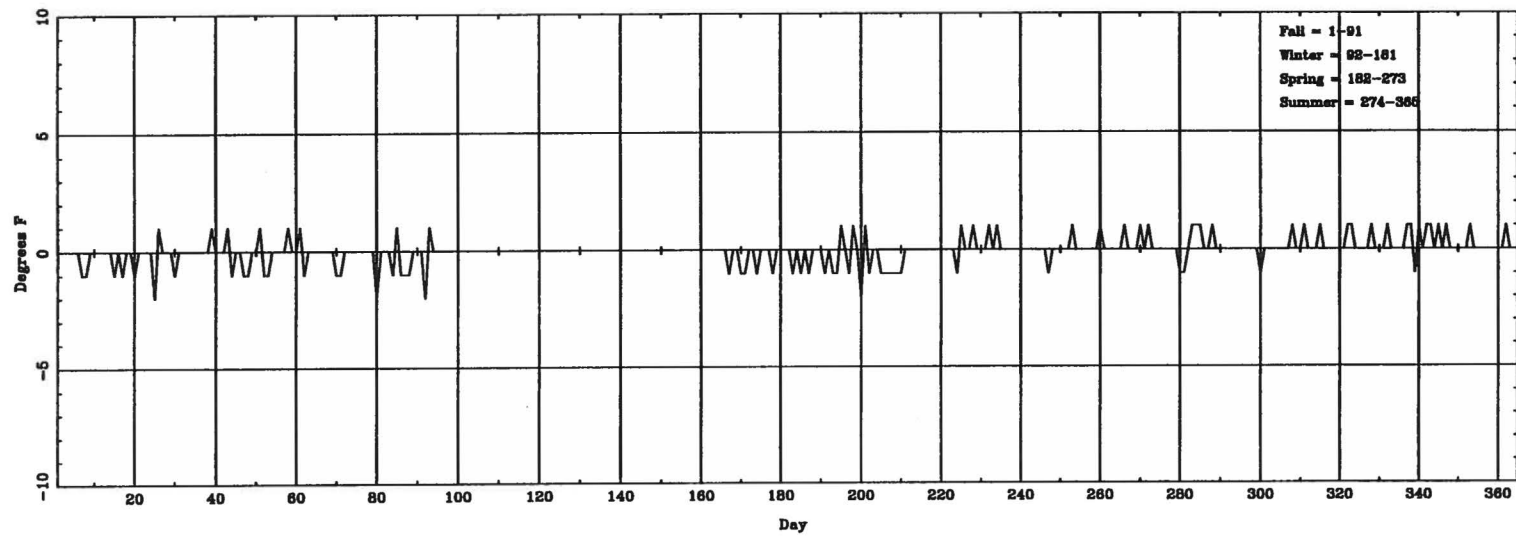

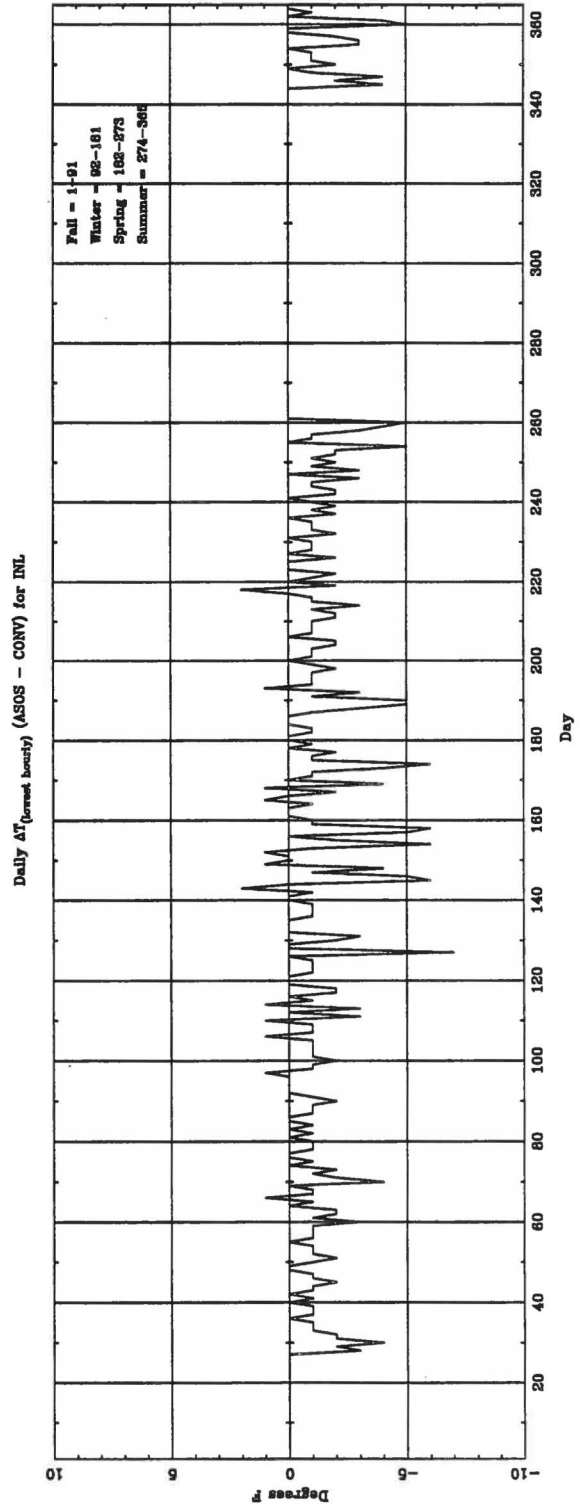
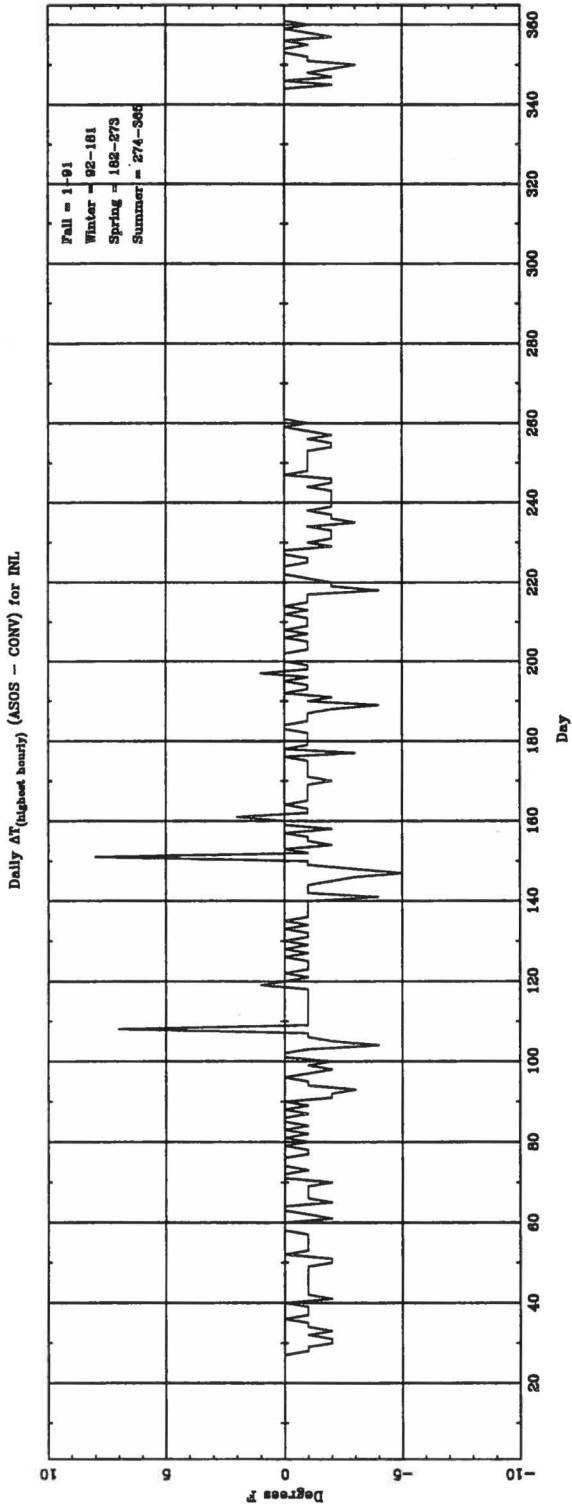

Daily $\Delta T_{(highest\ hourly)}$ (ASOS - CONV) for INW

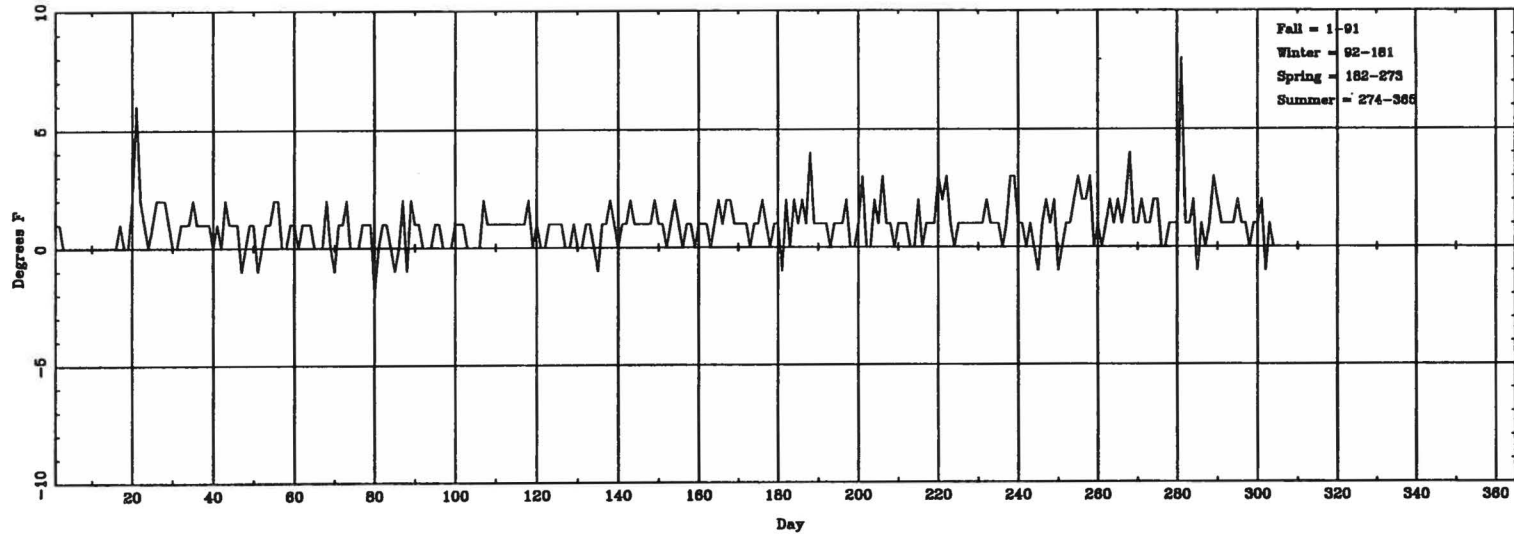

Daily $\Delta T_{(lowest\ hourly)}$ (ASOS - CONV) for INW

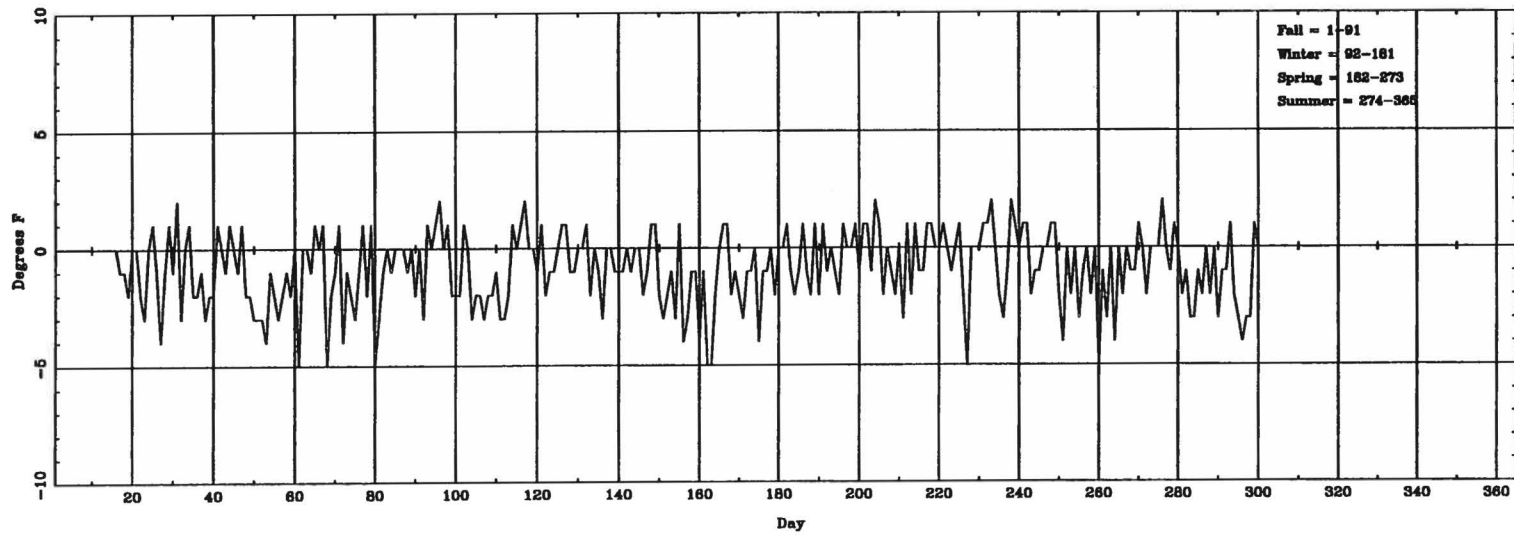

Daily AT_(highest hourly) (ASOS - CONV) for ISN

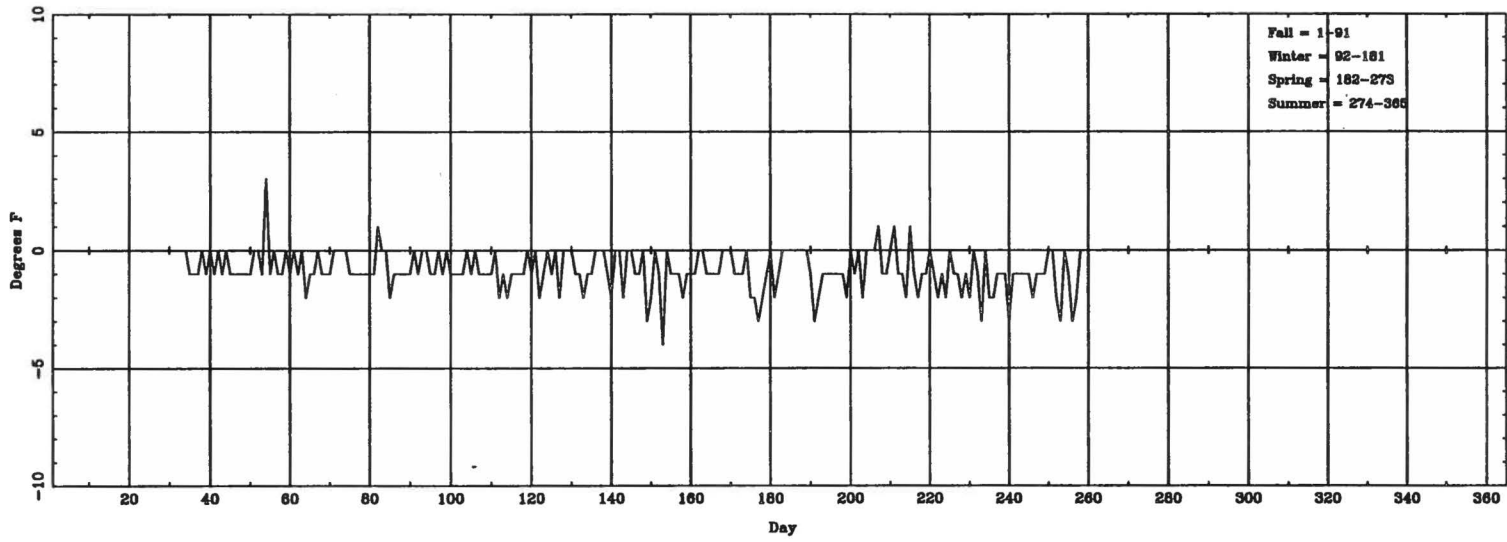

Daily AT_(lowest hourly) (ASOS - CONV) for ISN

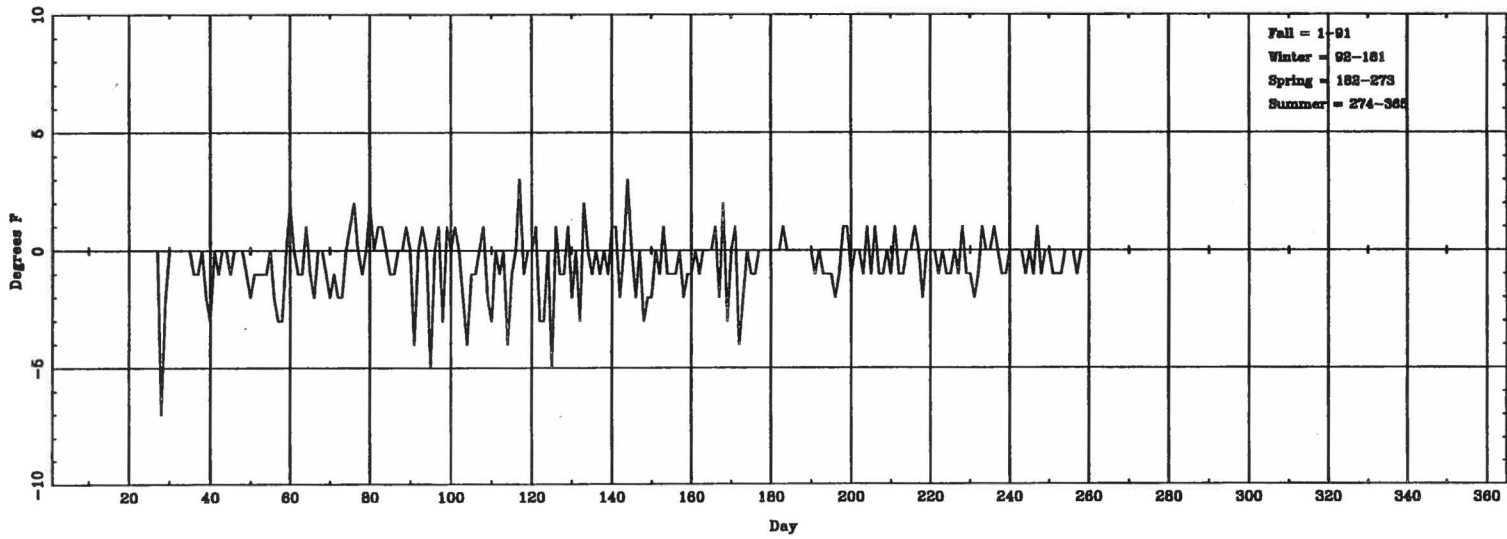

Daily $\Delta T_{\text{(highest hourly)}}$ (ASOS - CONV) for JAX

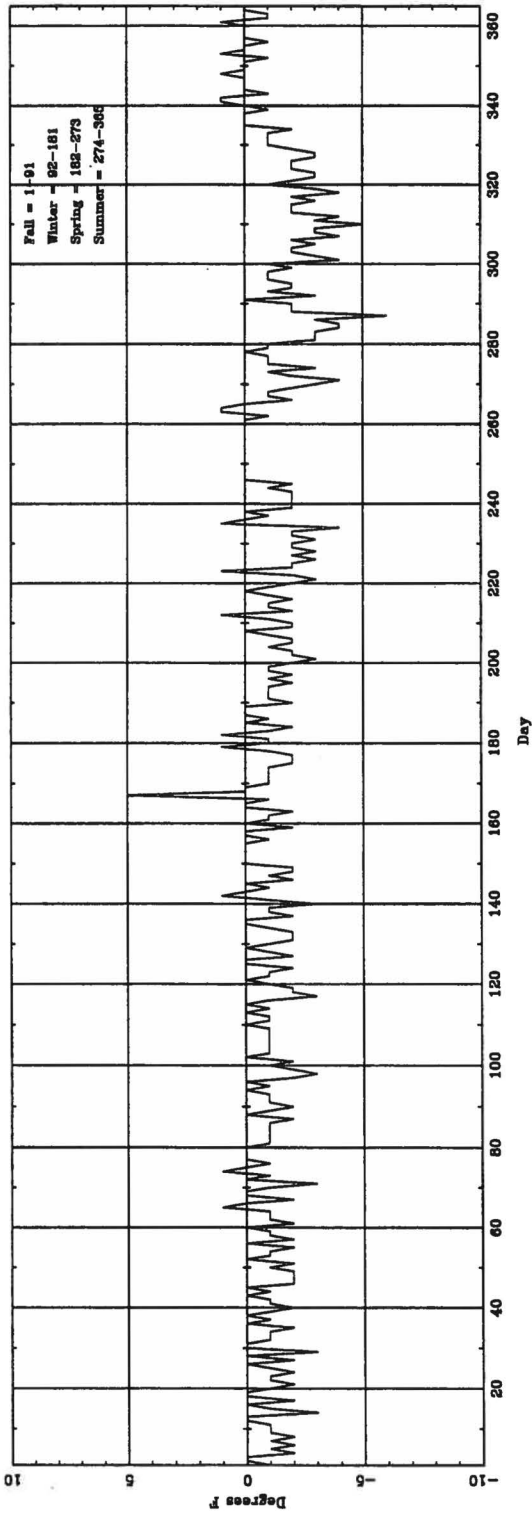

Daily $\Delta T_{\text{(lowest hourly)}}$ (ASOS - CONV) for JAX

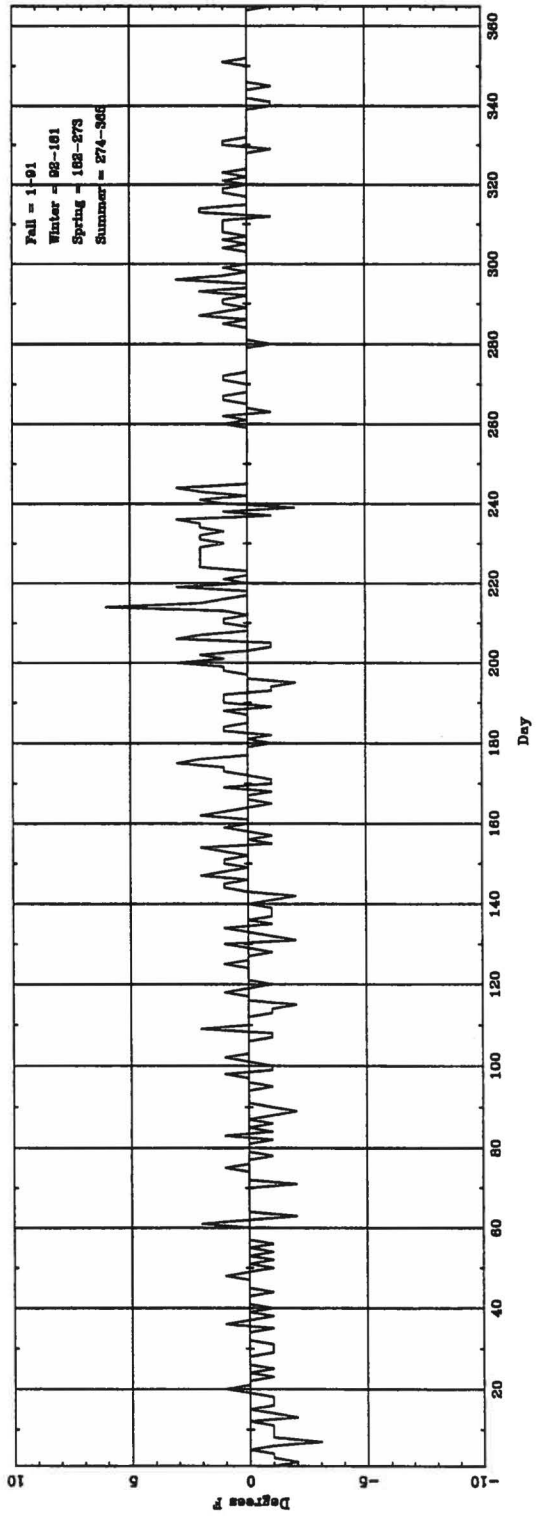

Daily $\Delta T_{\text{(highest hourly)}}$ (ASOS - CONV) for JKL

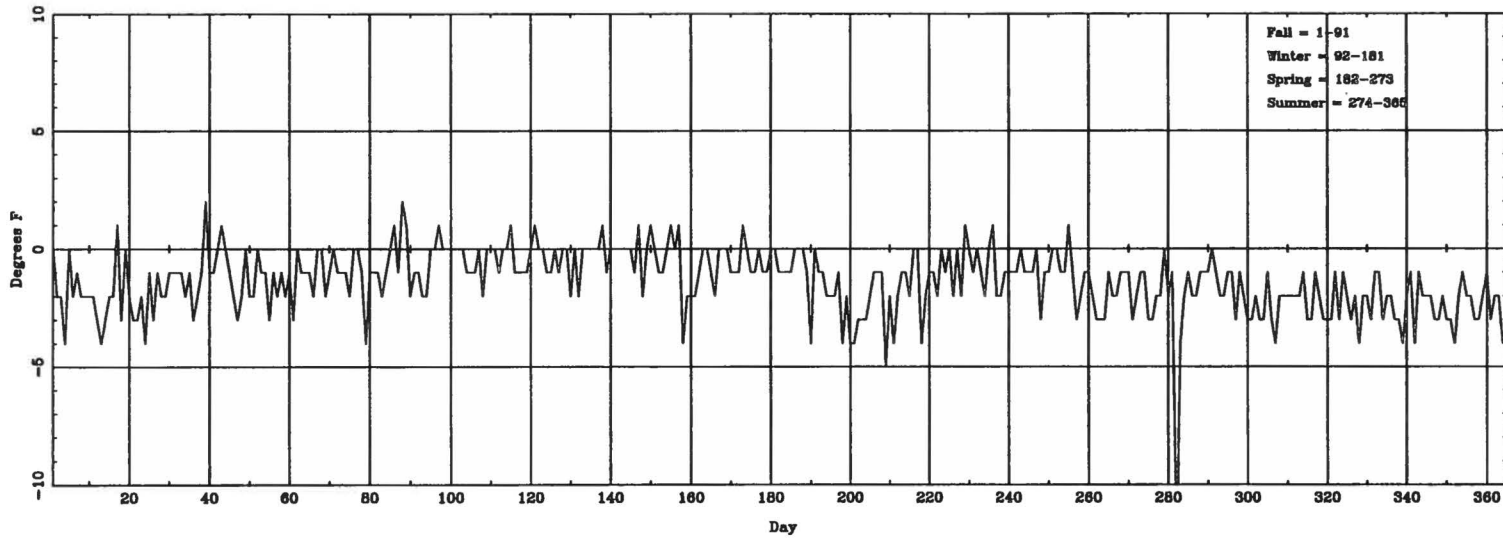

Daily $\Delta T_{\text{(lowest hourly)}}$ (ASOS - CONV) for JKL

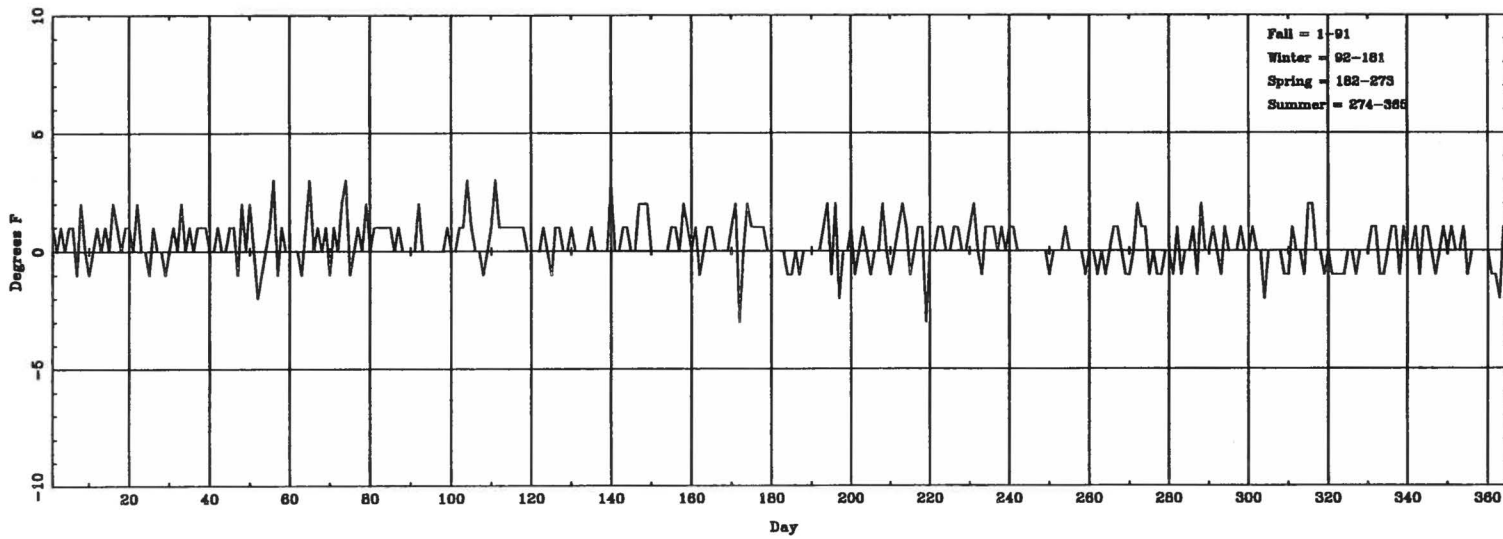

Daily $\Delta T_{(highest\ hourly)}$ (ASOS - CONV) for LAN

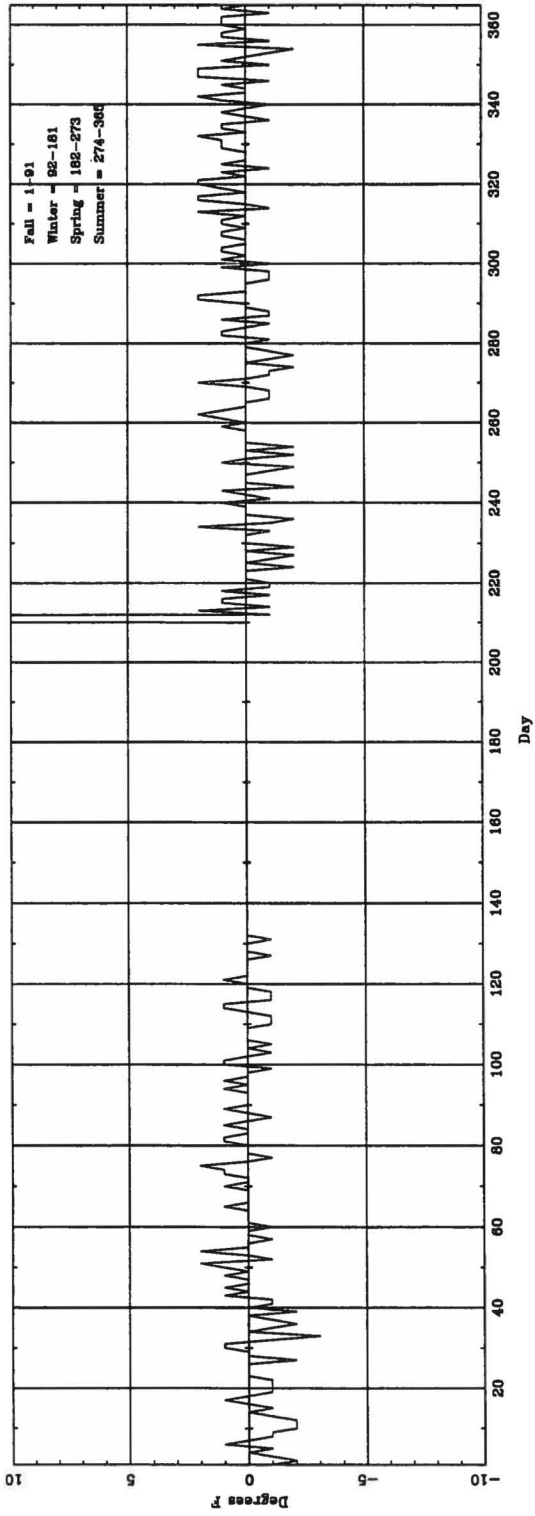

Daily $\Delta T_{(lowest\ hourly)}$ (ASOS - CONV) for LAN

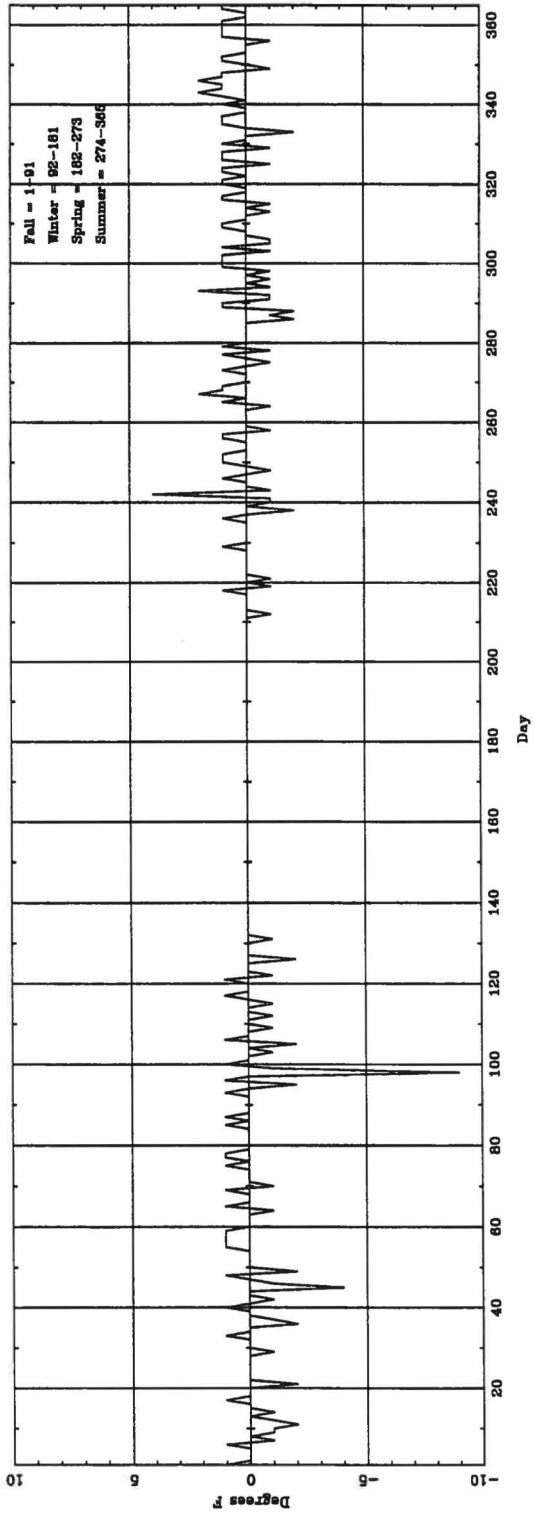

Daily $\Delta T_{(light\ beam)}$ (ASOS - CONV) for LAS

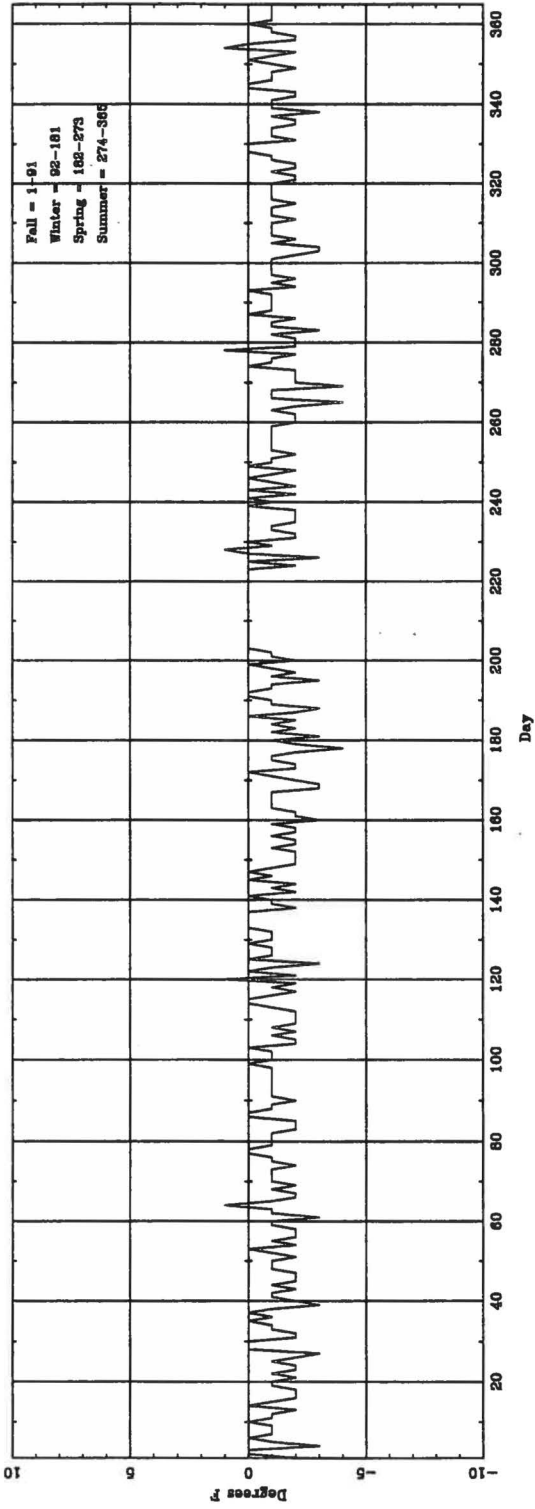

Daily $\Delta T_{(network\ beam)}$ (ASOS - CONV) for LAS

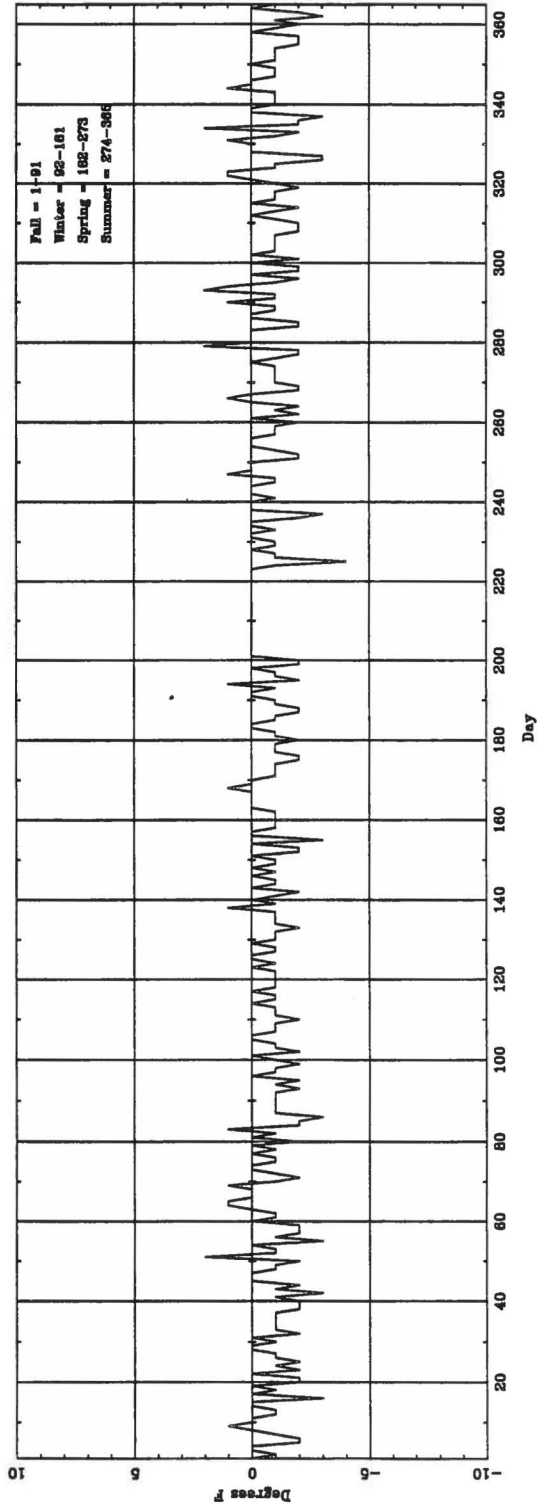

Daily $\Delta T_{\text{(highest hourly)}}$ (ASOS - CONV) for LBB

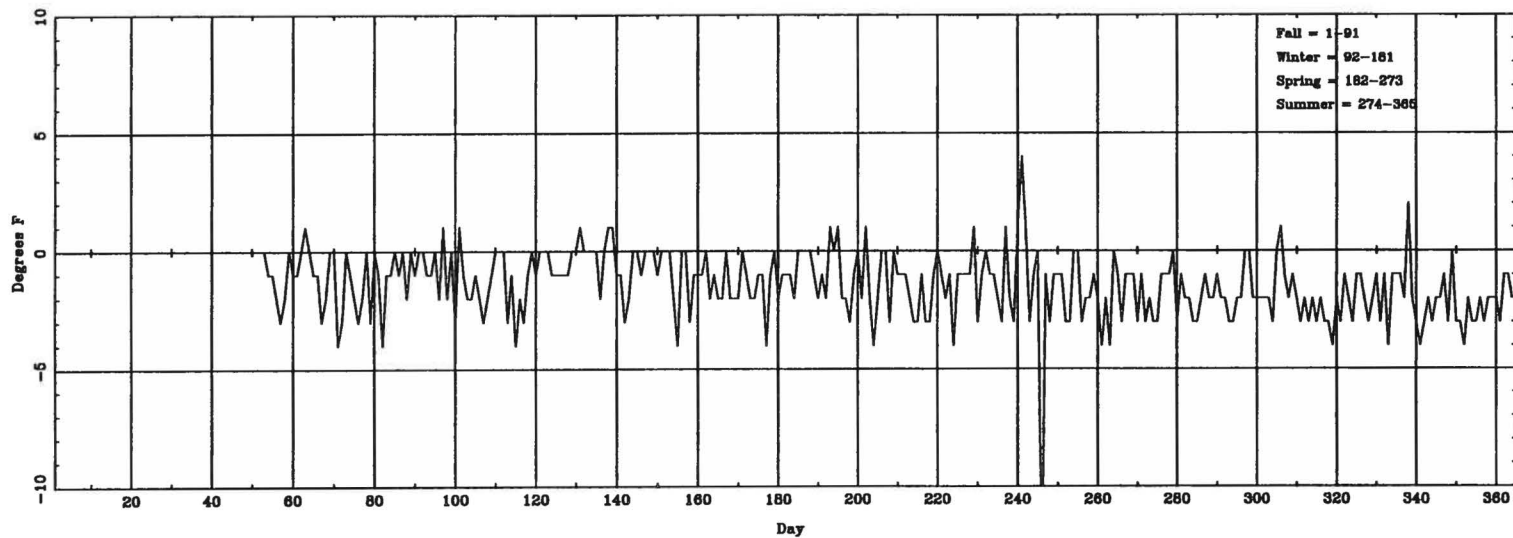

Daily $\Delta T_{\text{(lowest hourly)}}$ (ASOS - CONV) for LBB

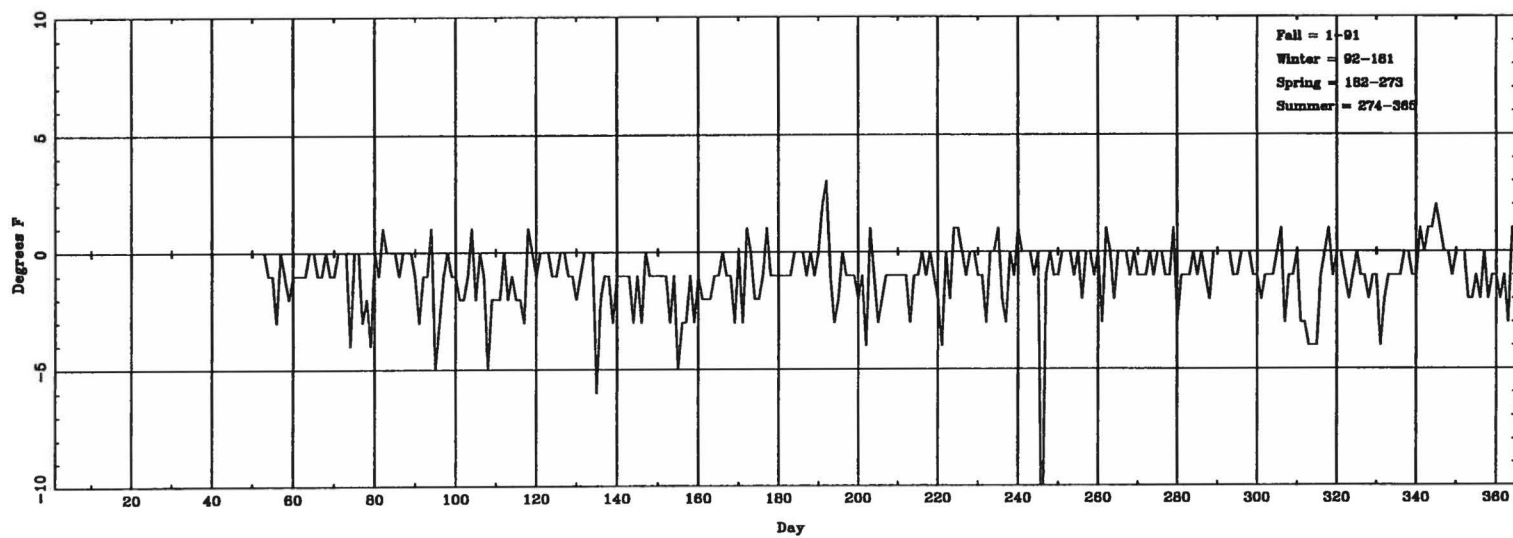

Daily $\Delta T_{\text{(highest hourly)}}$ (ASOS - CONV) for LBF

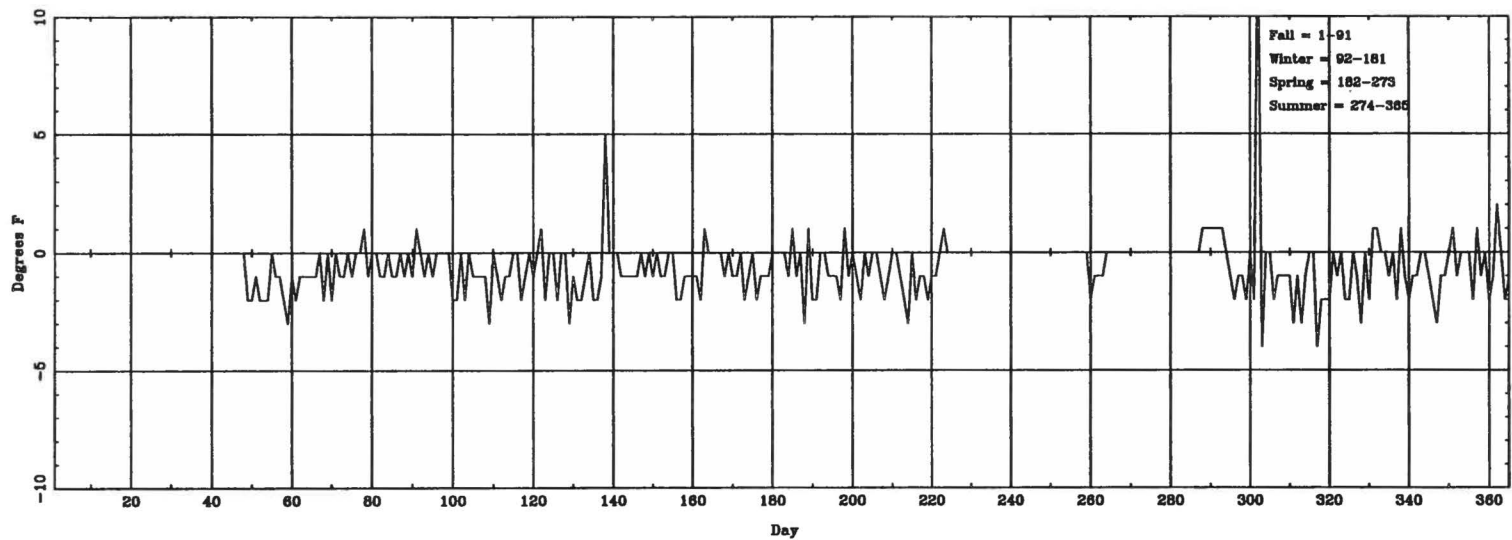

Daily $\Delta T_{\text{(lowest hourly)}}$ (ASOS - CONV) for LBF

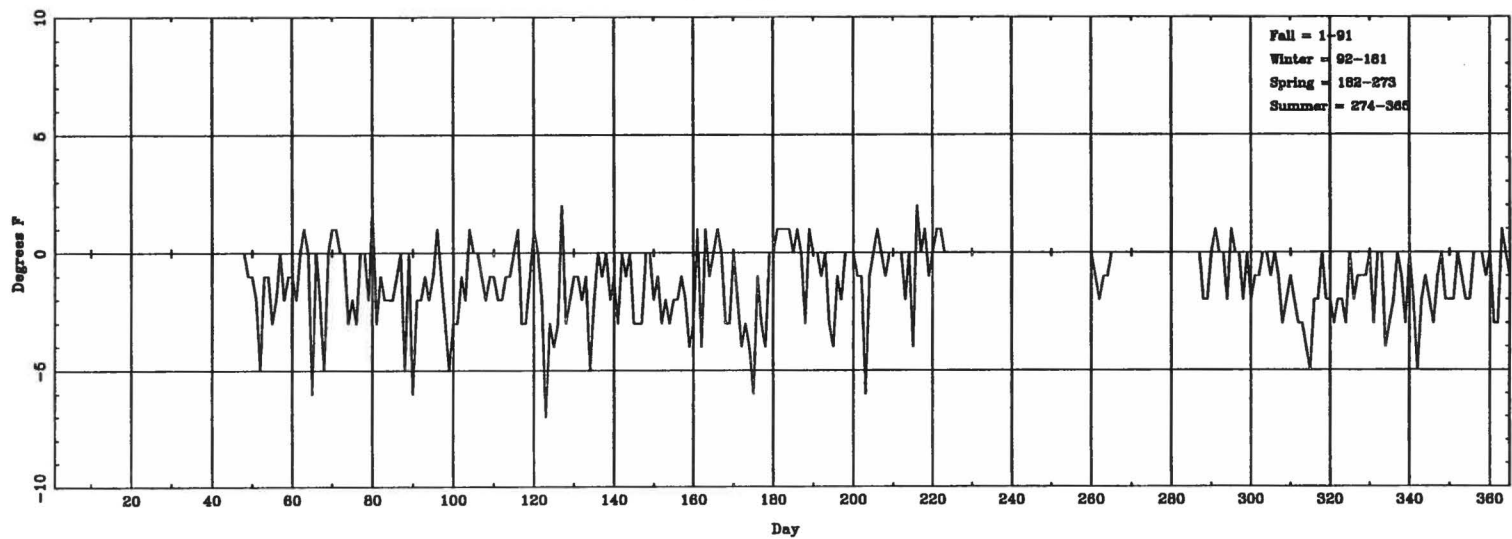

Daily $\Delta T_{(highest\ hourly)}$ (ASOS - CONV) for LCH

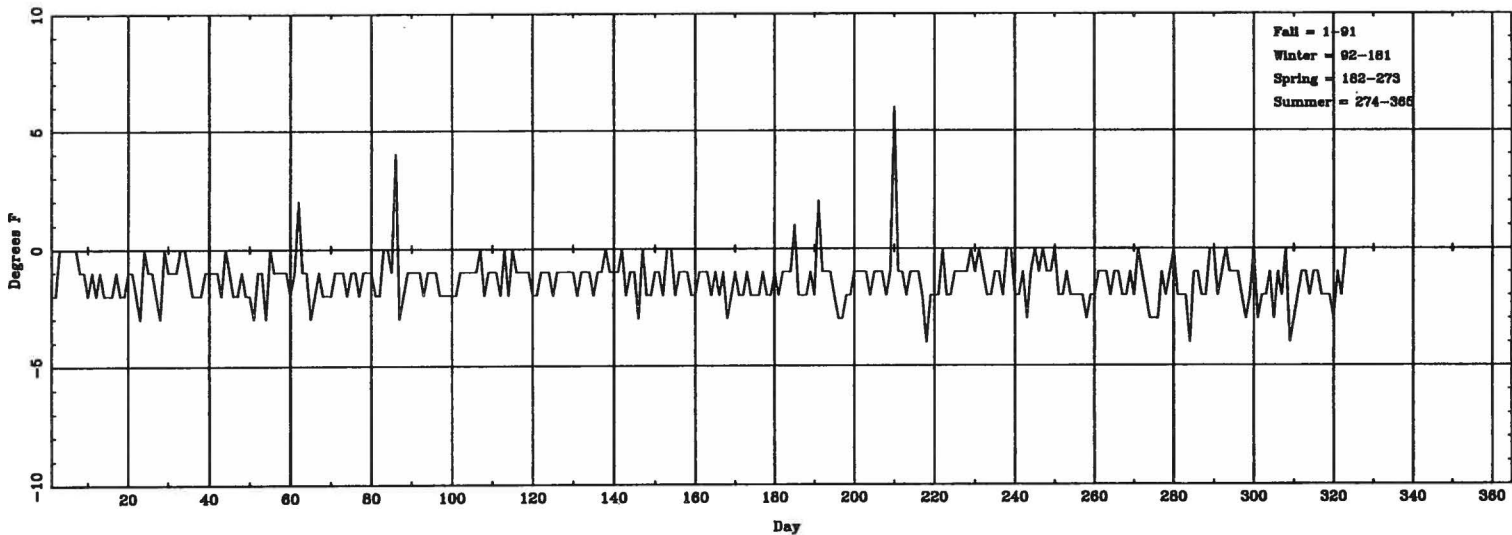

Daily $\Delta T_{(lowest\ hourly)}$ (ASOS - CONV) for LCH

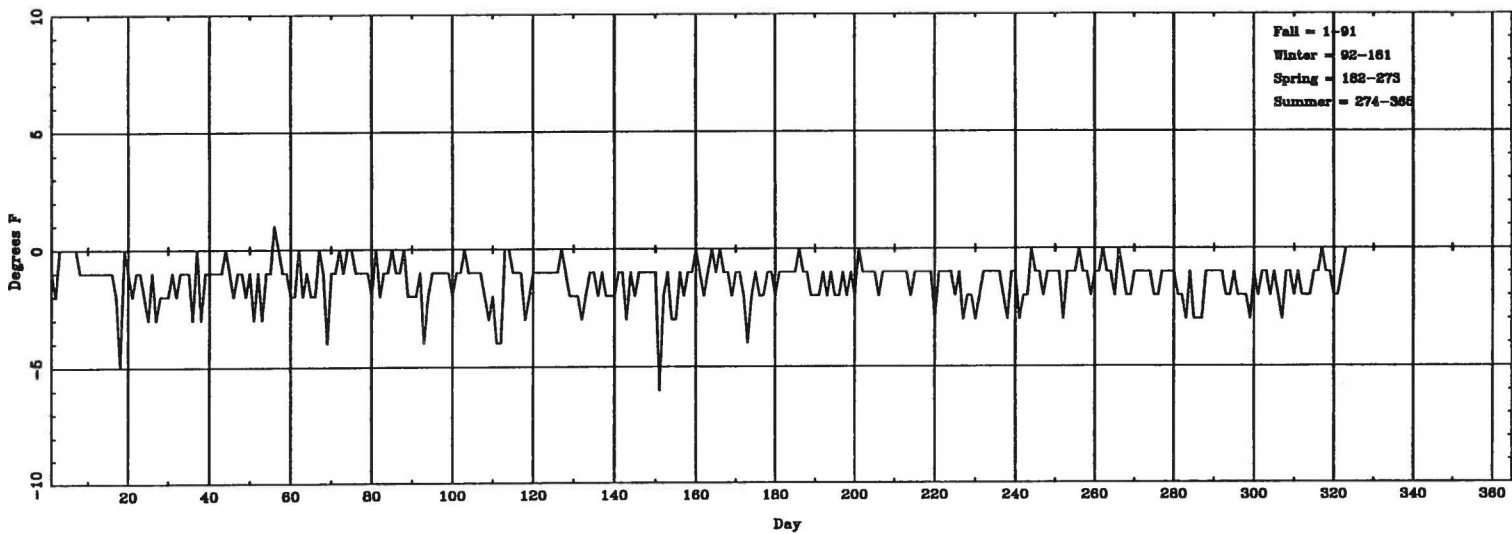

Daily ΔT (lightest hourly) (ASOS - CONV) for LEX

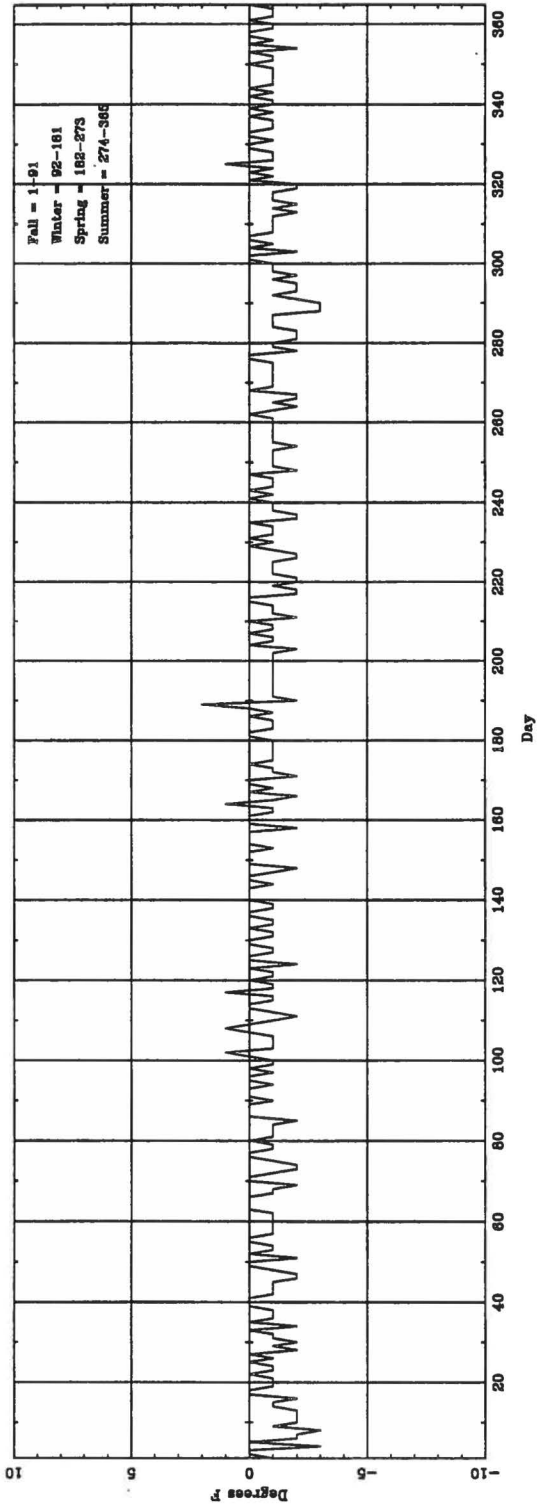

Daily ΔT (nearest hourly) (ASOS - CONV) for LEX

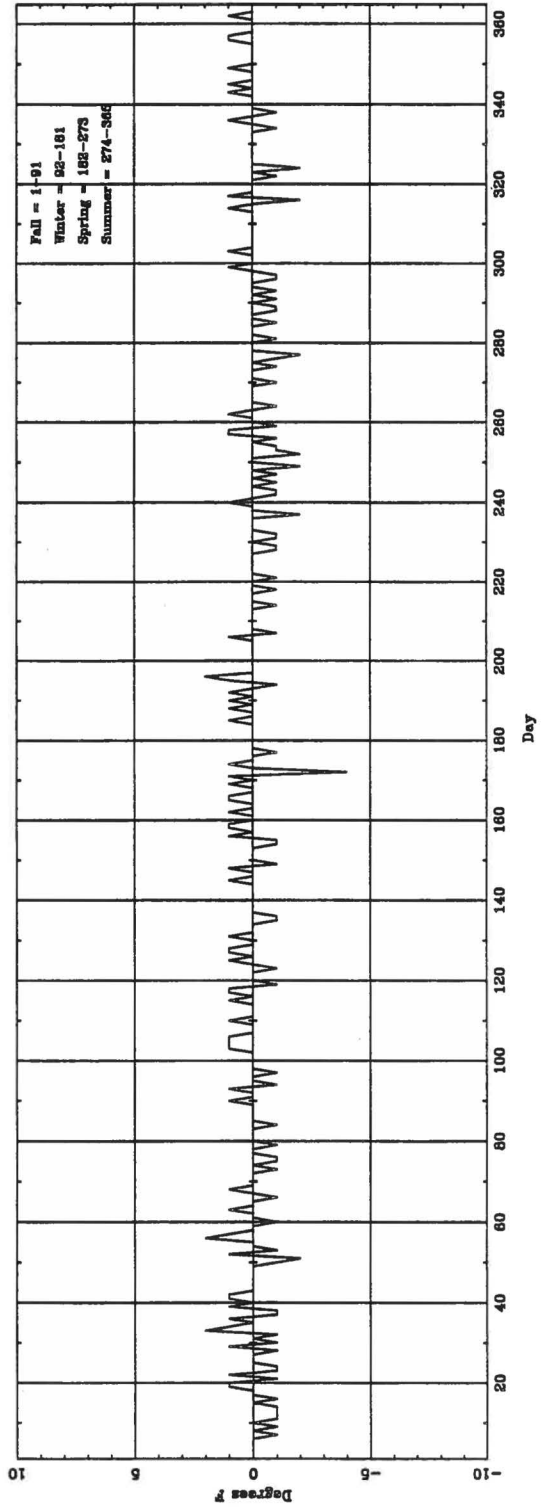

Daily $\Delta T_{\text{(highest hourly)}}$ (ASOS - CONV) for MCI

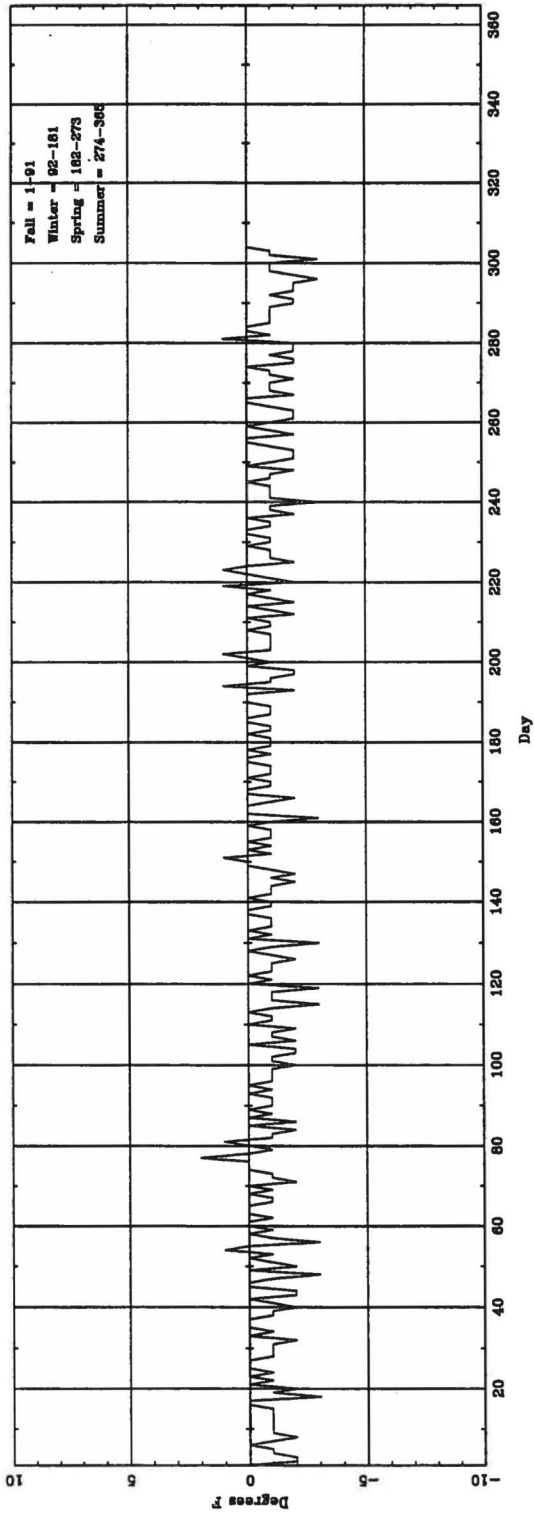

Daily $\Delta T_{\text{(lowest hourly)}}$ (ASOS - CONV) for MCI

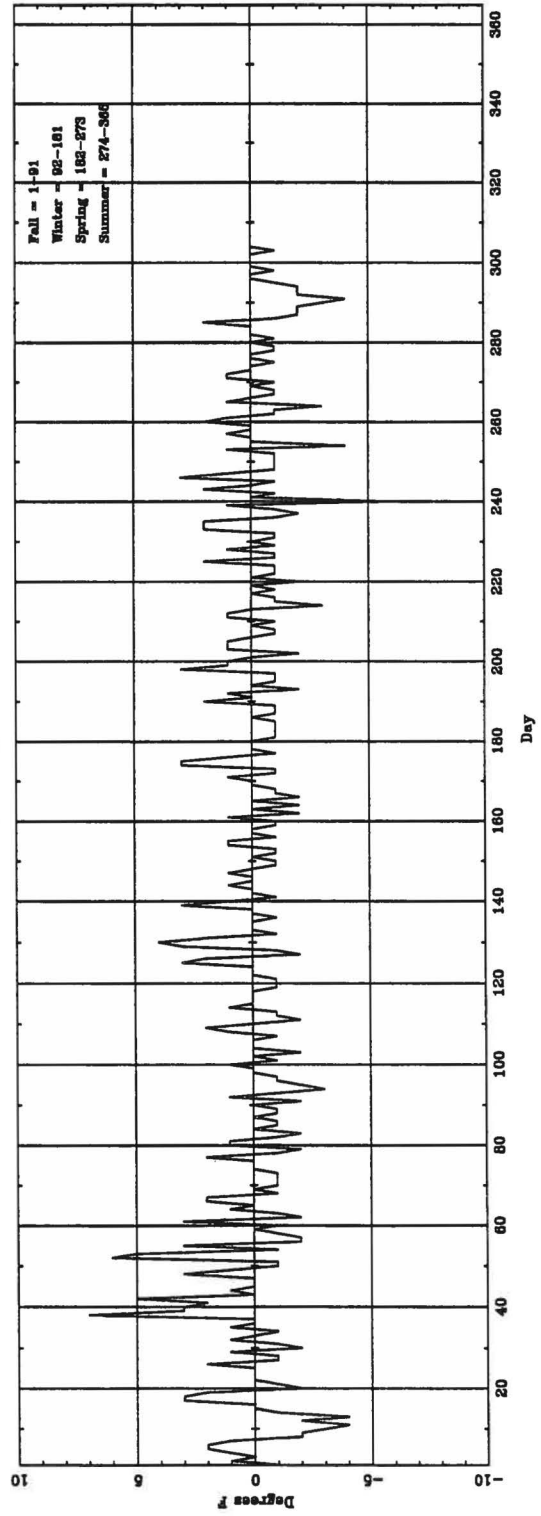

Daily $\Delta T_{(light\ hour)}$ (ASOS - CONV) for MCO

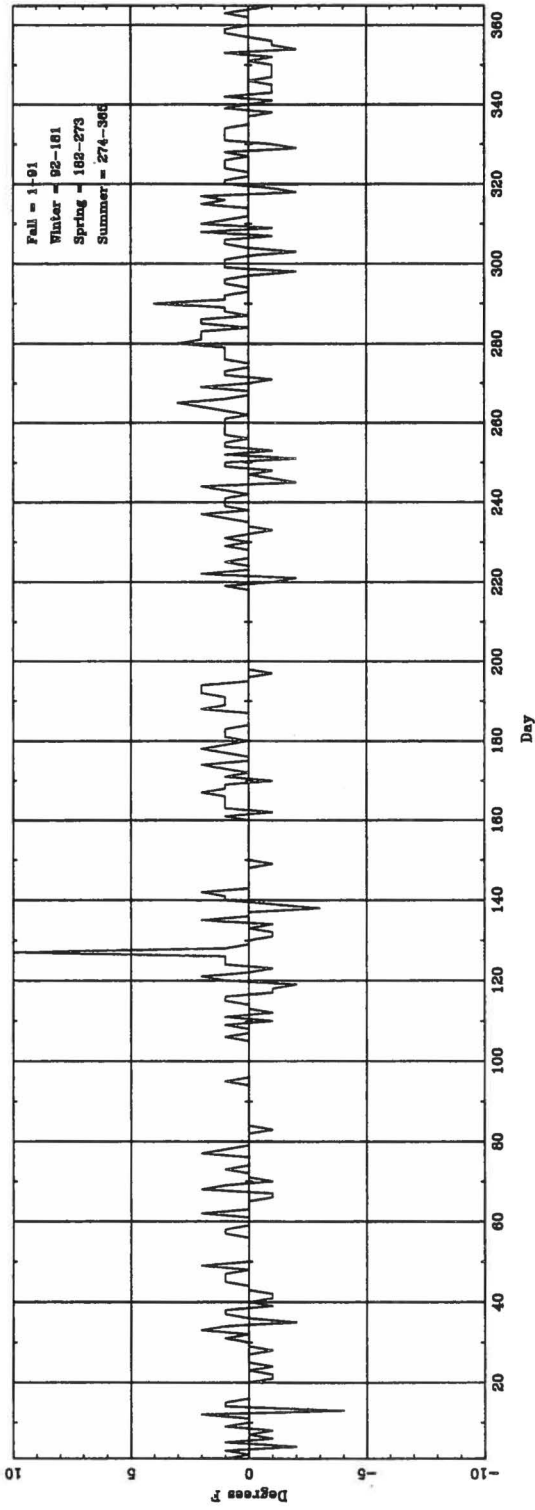

Daily $\Delta T_{(overcast\ hour)}$ (ASOS - CONV) for MCO

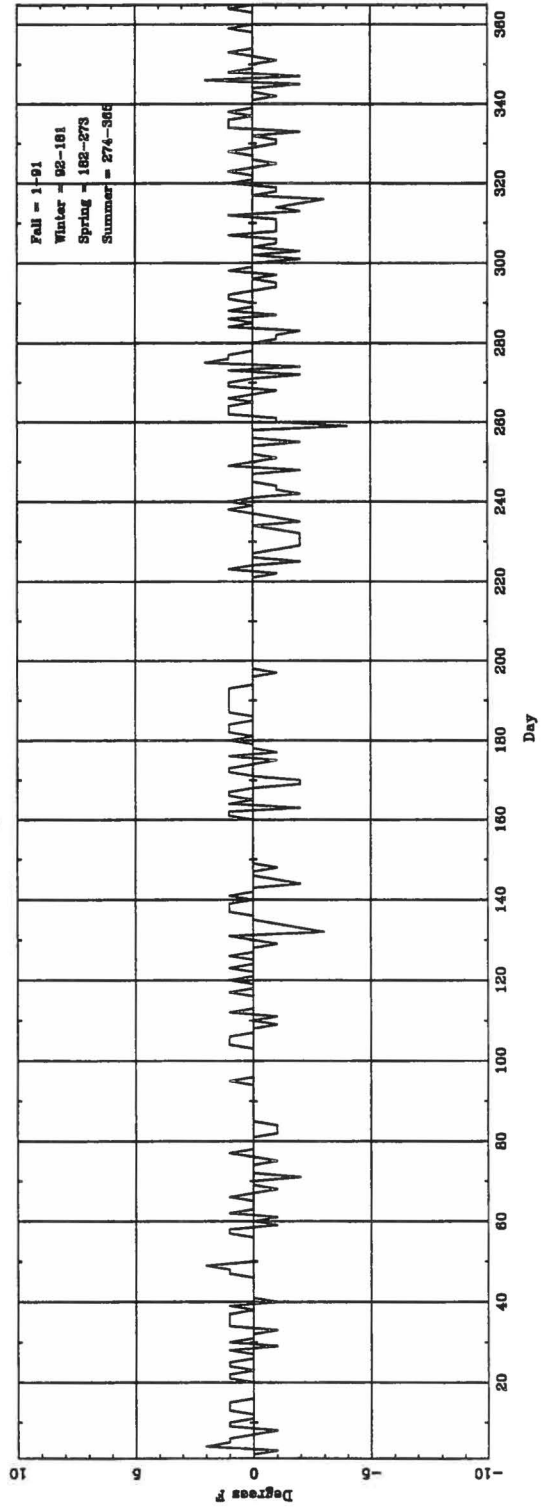

Daily $\Delta T_{(lightest\ hour)}$ (ASOS - CONV) for MGM

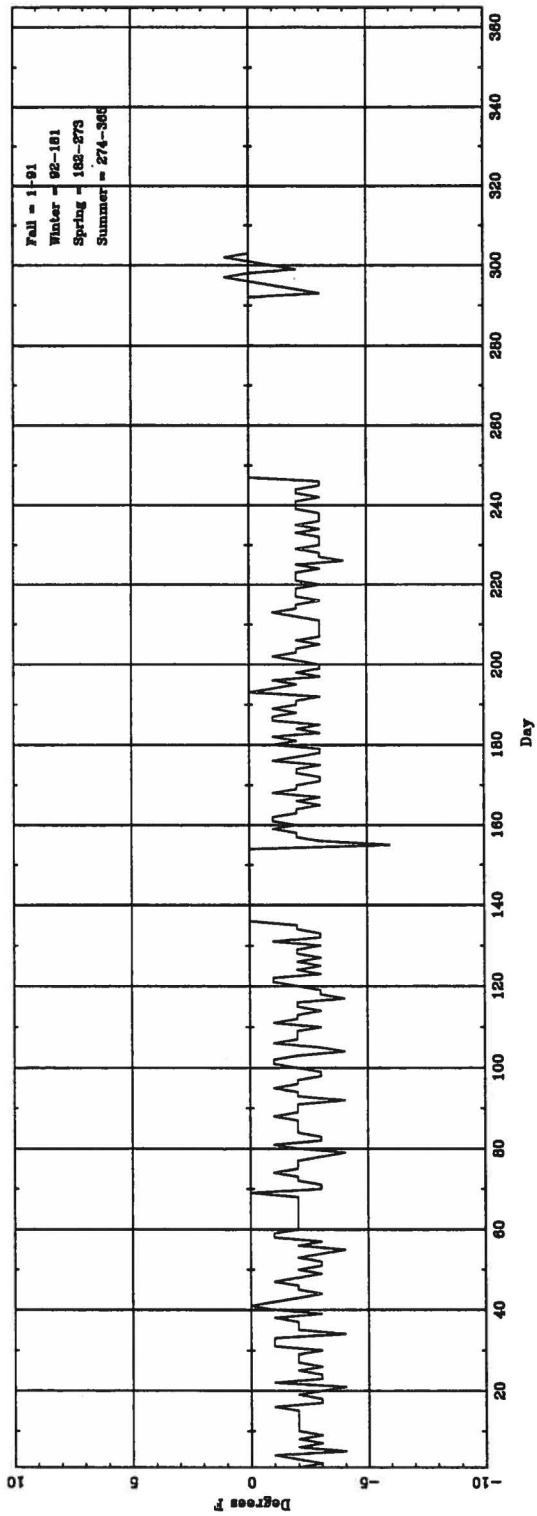

Daily $\Delta T_{(prewet\ hour)}$ (ASOS - CONV) for MGM

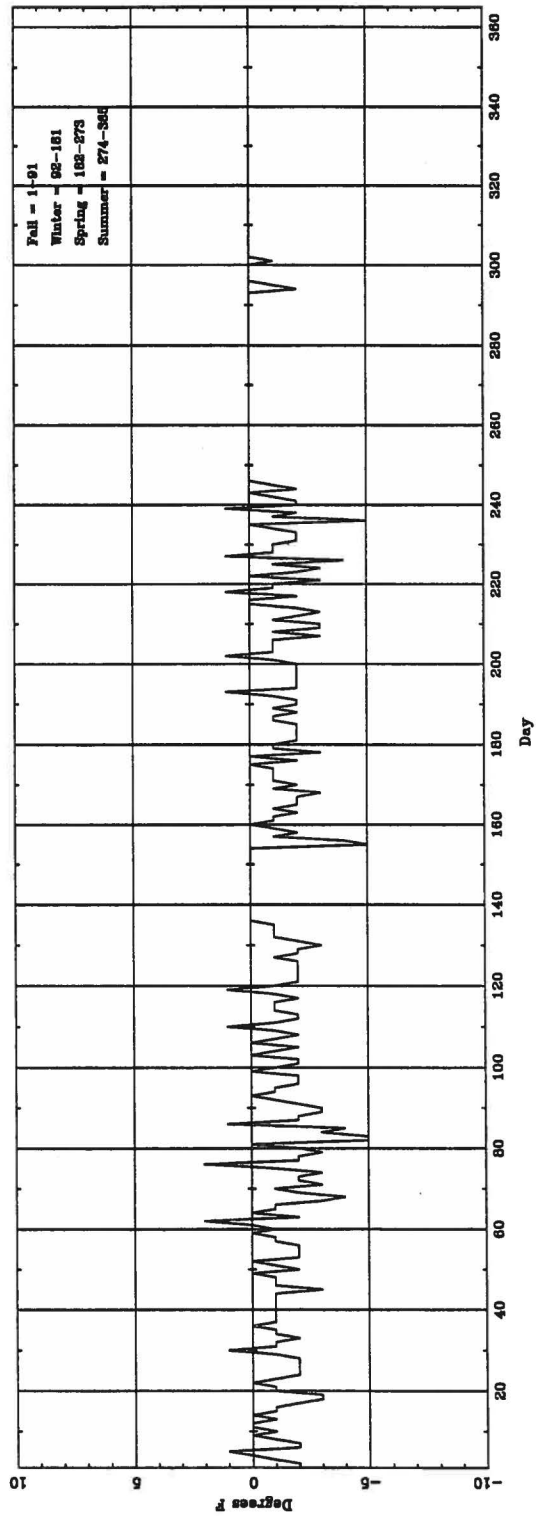

Daily $\Delta T_{\text{(highest hourly)}}$ (ASOS - CONV) for MHS

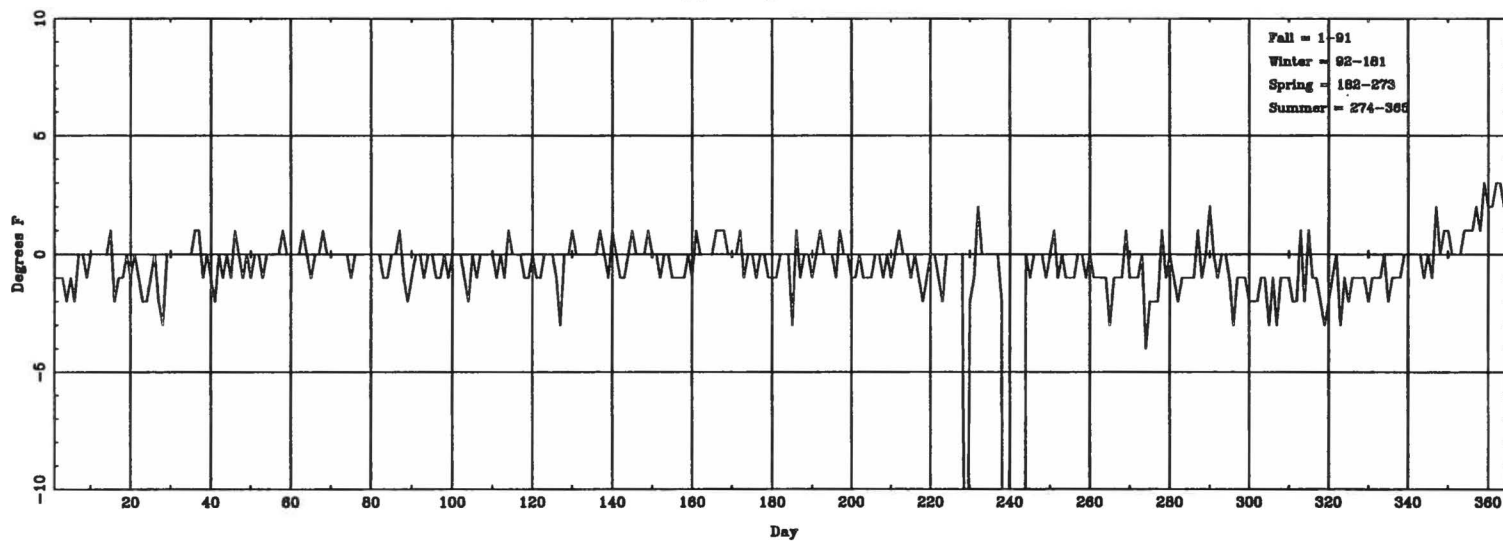

Daily $\Delta T_{\text{(lowest hourly)}}$ (ASOS - CONV) for MHS

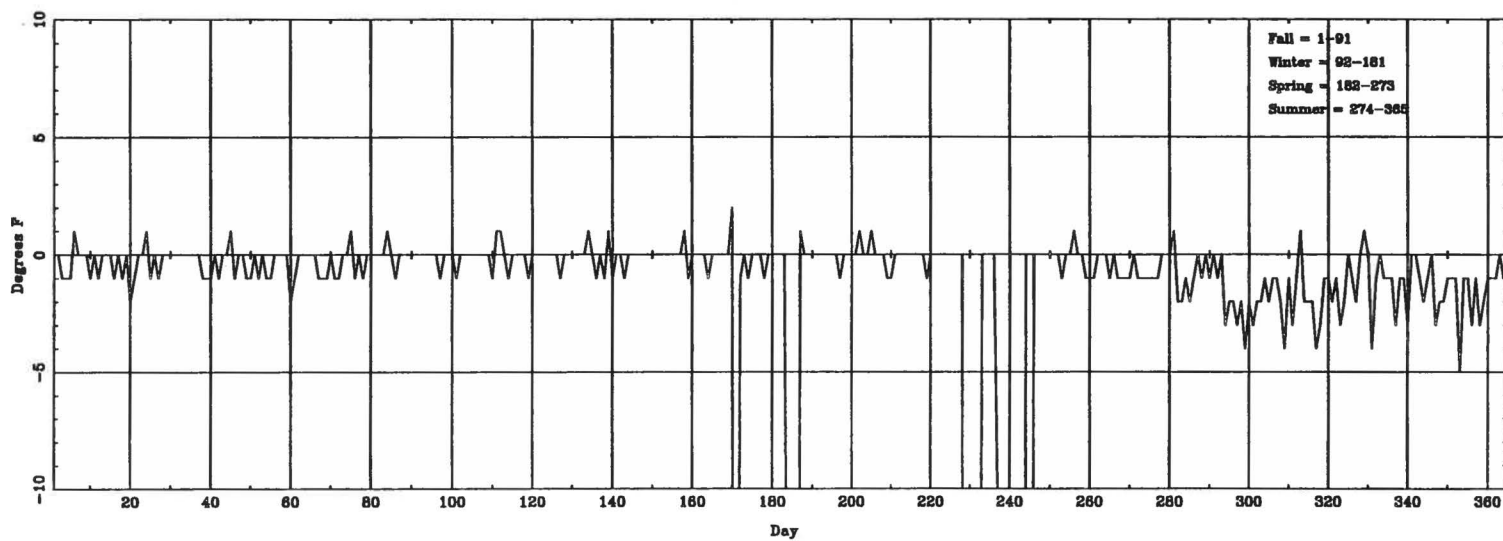

Daily AT (lightest hourly) (ASOS - CONV) for MIKE

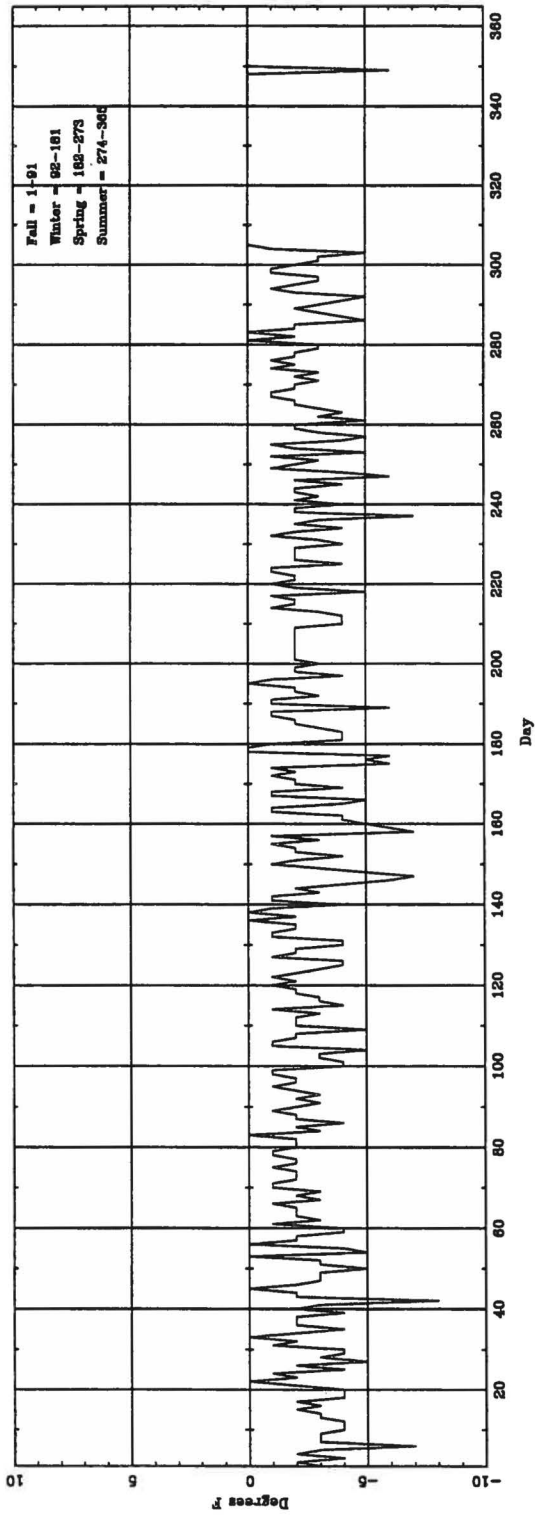

Daily AT (frequent hourly) (ASOS - CONV) for MIKE

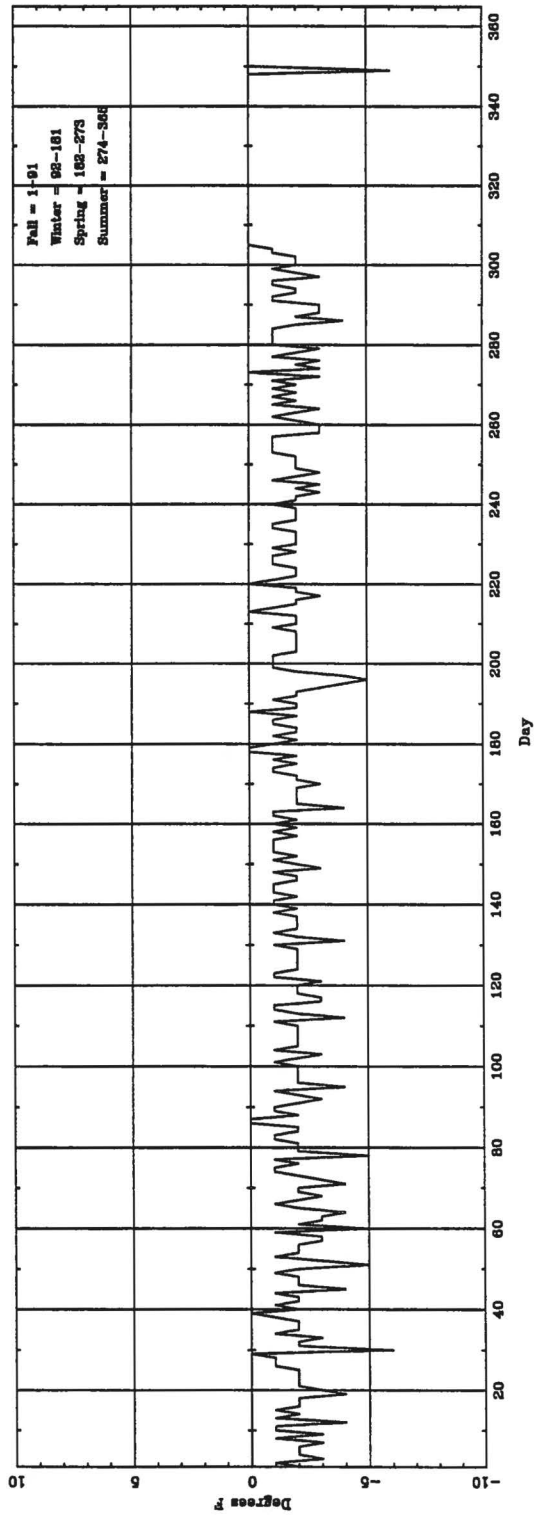

Daily ΔT (lightest hourly) (ASOS - CONY) for MKG

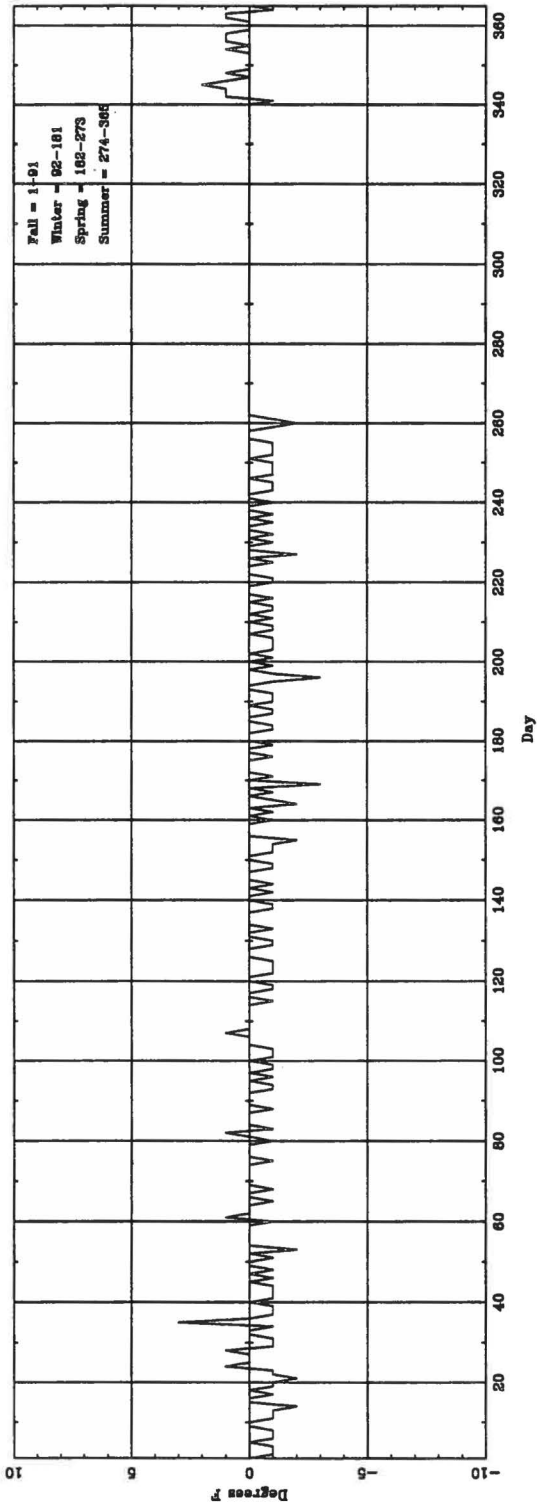

Daily ΔT (warmest hourly) (ASOS - CONY) for MKG

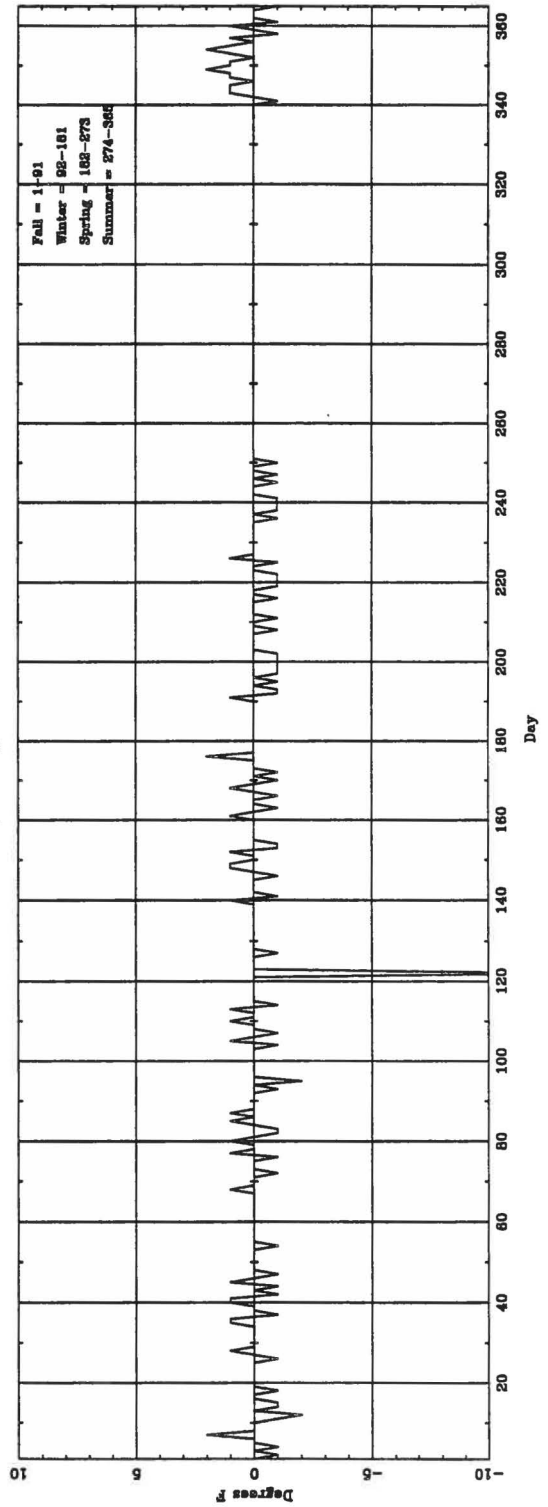

Daily $\Delta T_{(highest\ hourly)}$ (ASOS - CONV) for MLI

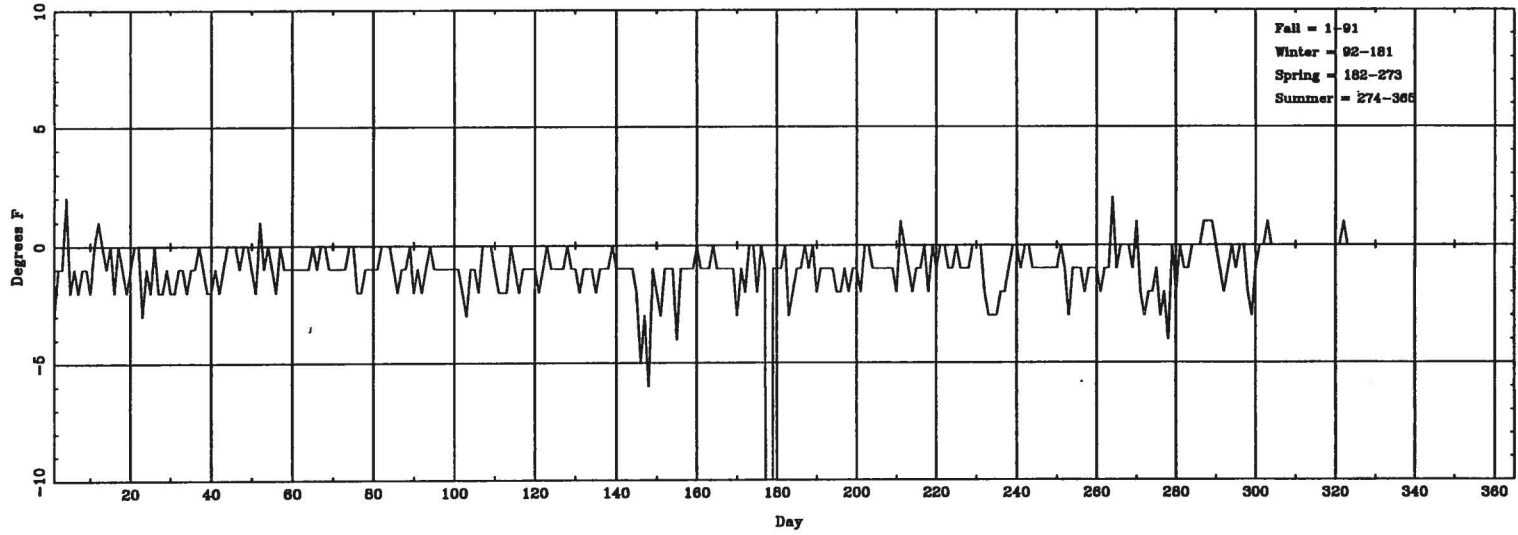

Daily $\Delta T_{(lowest\ hourly)}$ (ASOS - CONV) for MLI

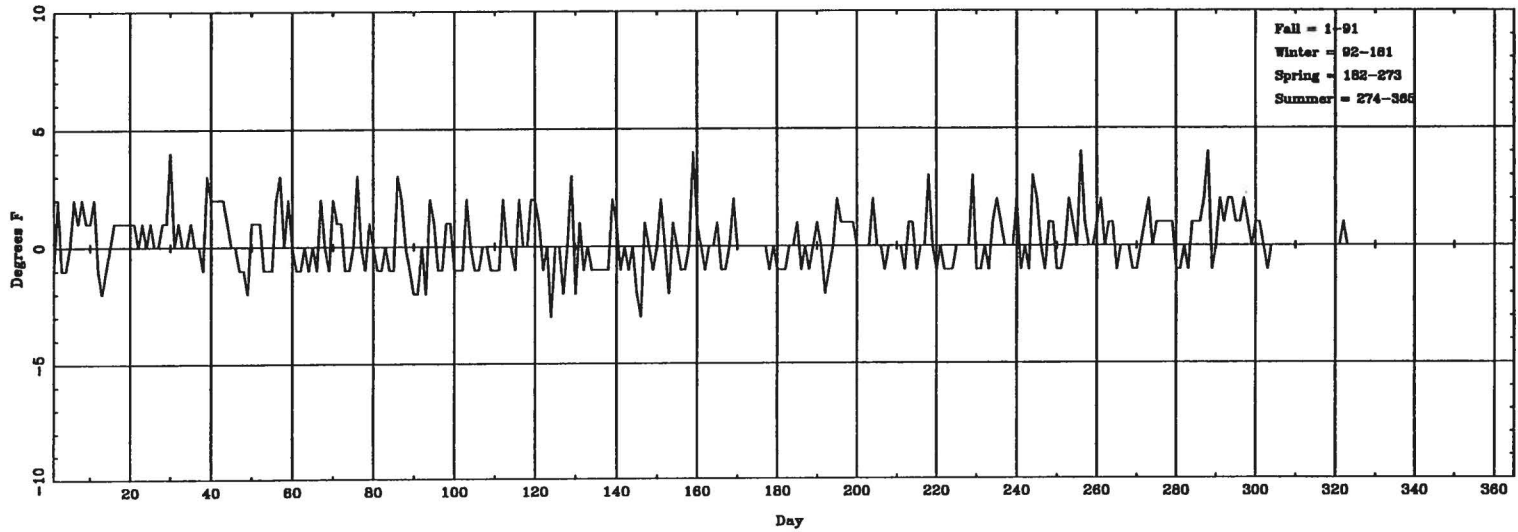

Daily $AT_{(highest\ hourly)}$ (ASOS - CONV) for MOB

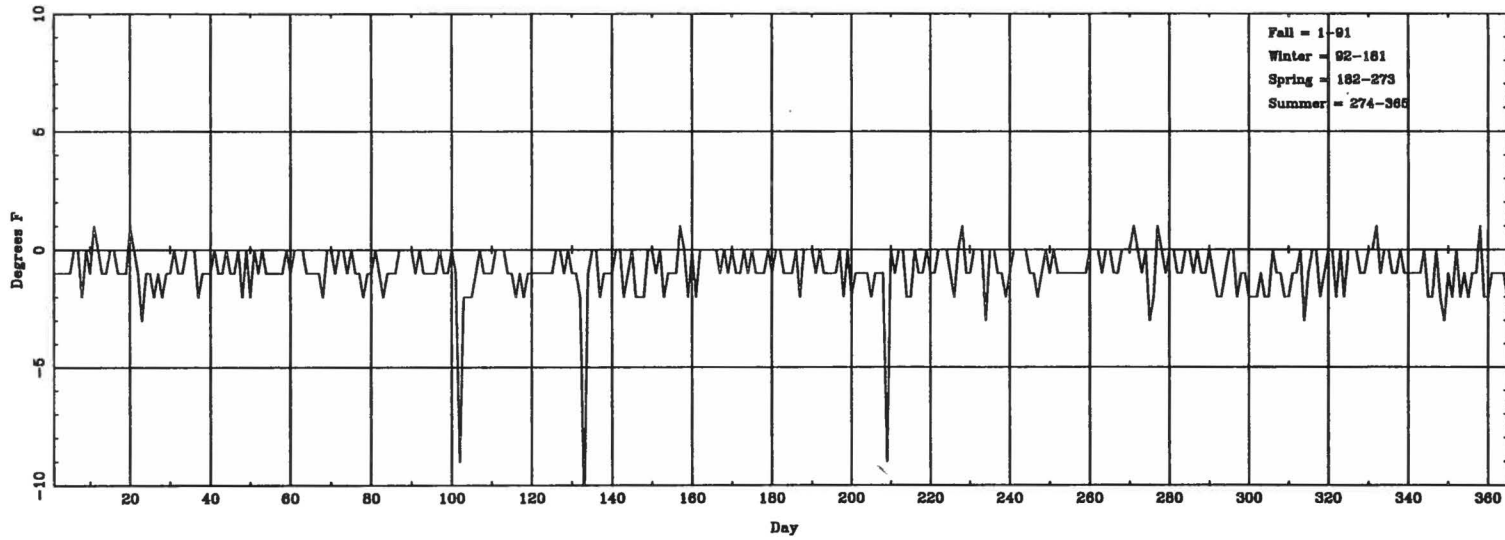

Daily $AT_{(lowest\ hourly)}$ (ASOS - CONV) for MOB

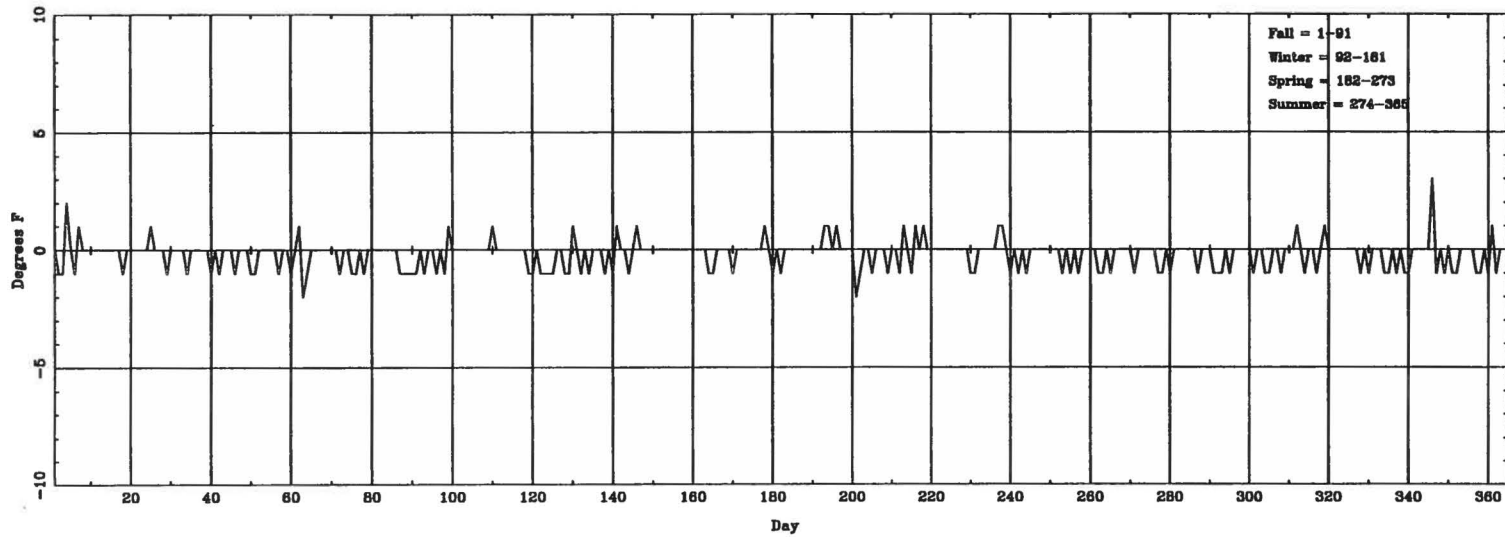

Daily $\Delta T_{\text{lightest beauty}}$ (ASOS - CONV) for MSN

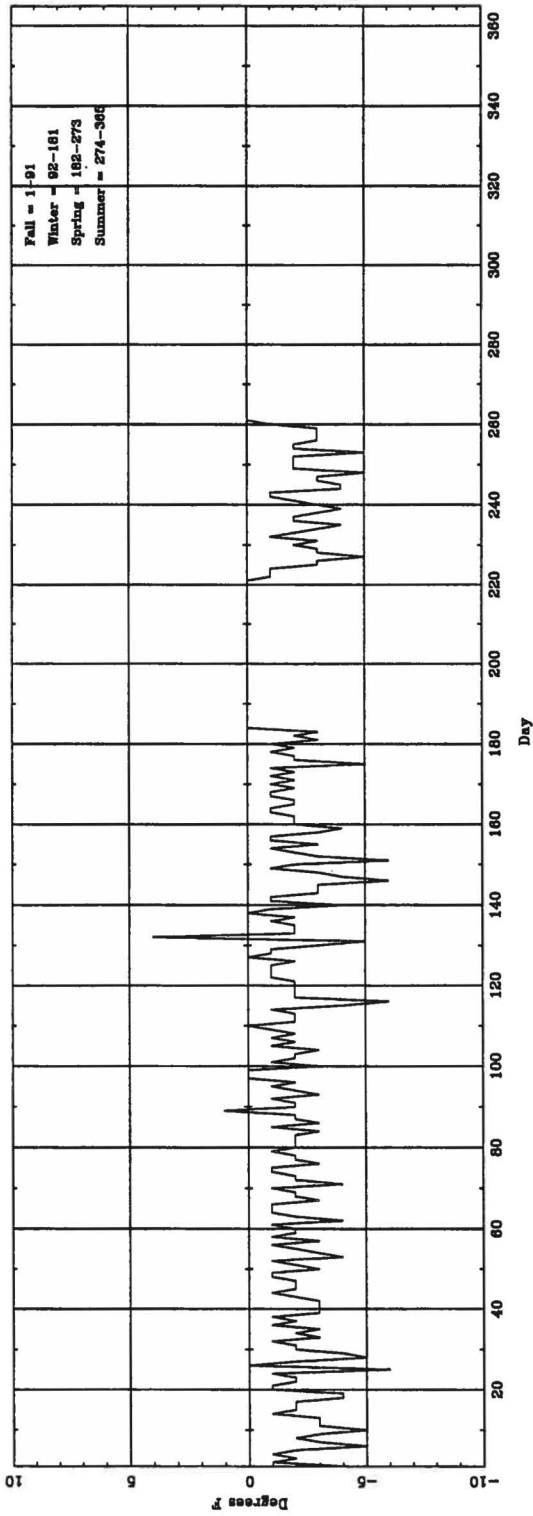

Daily $\Delta T_{\text{wettest beauty}}$ (ASOS - CONV) for MSN

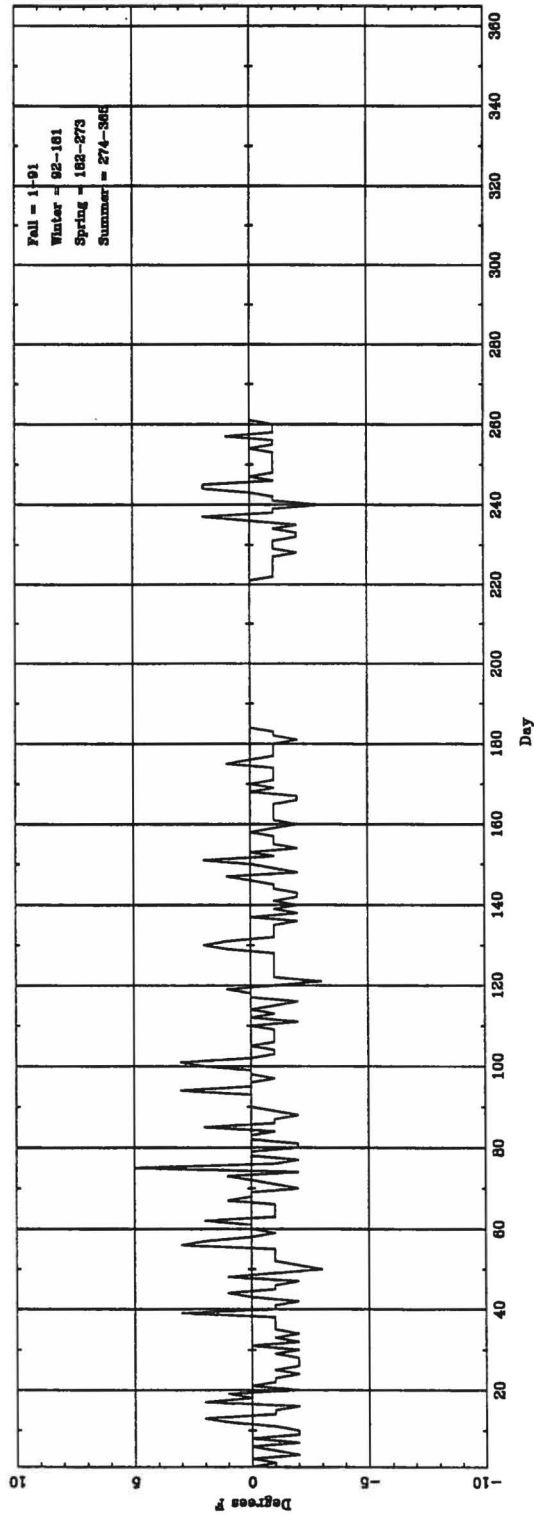

Daily $\Delta T_{\text{(highest hourly)}}$ (ASOS - CONV) for MSO

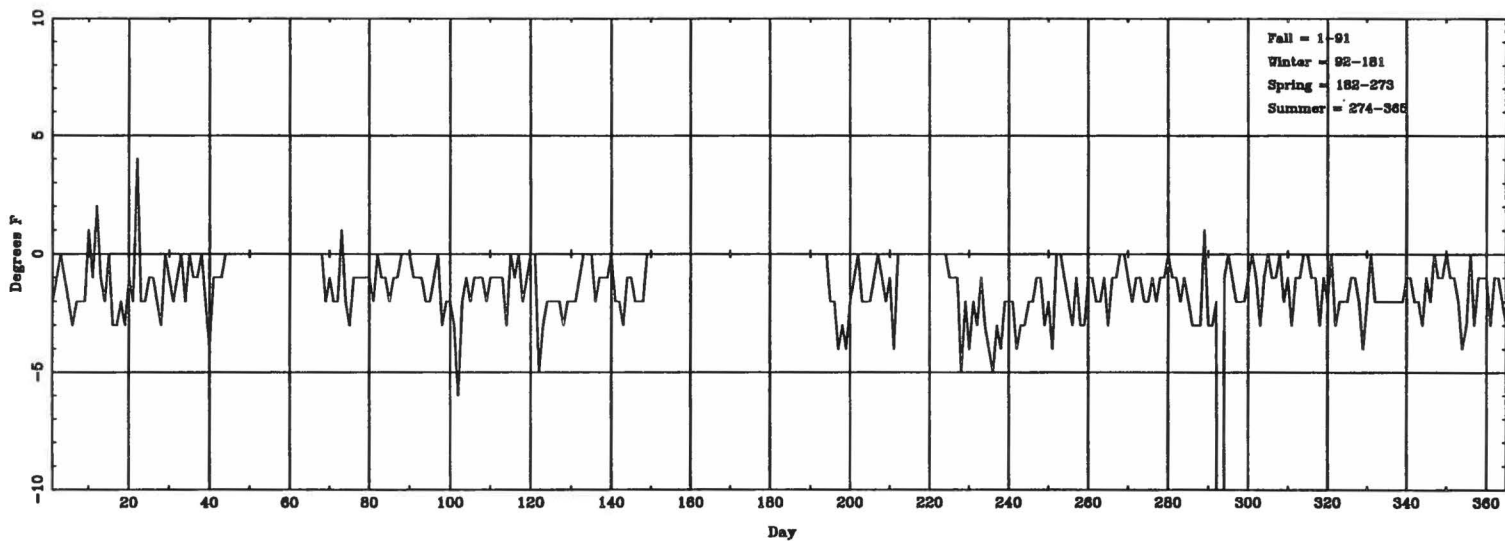

Daily $\Delta T_{\text{(lowest hourly)}}$ (ASOS - CONV) for MSO

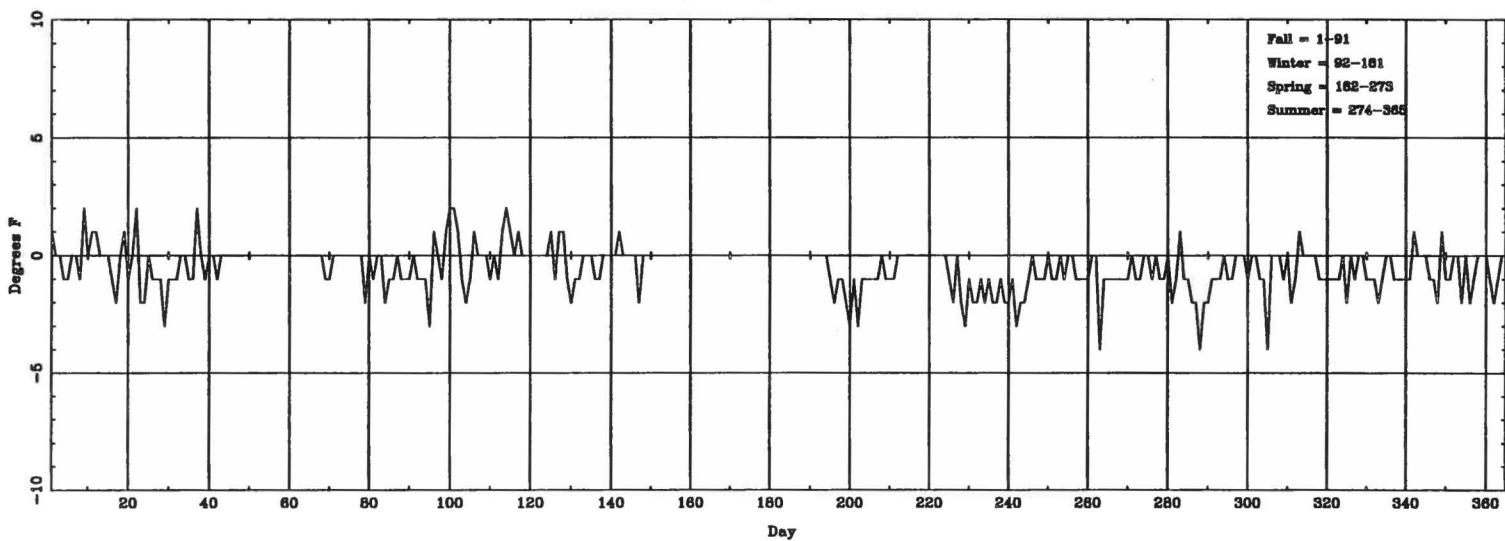

Daily ΔT (night hourly) (ASOS - CONV) for OFK

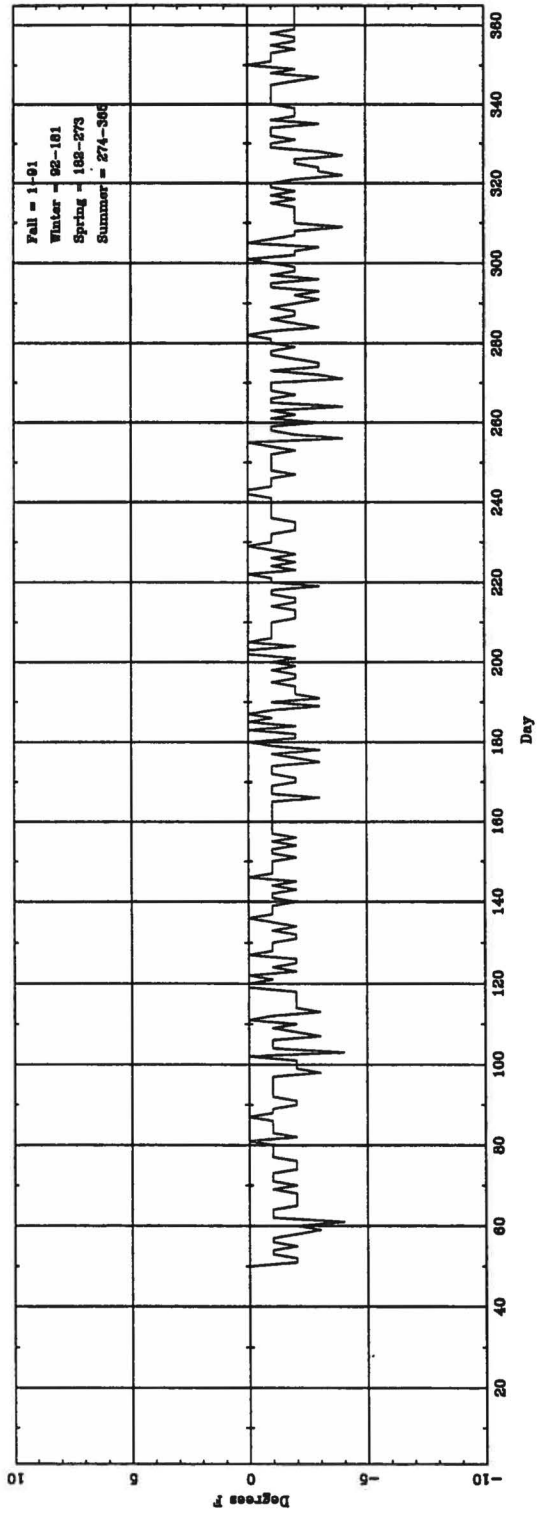

Daily ΔT (current hourly) (ASOS - CONV) for OFK

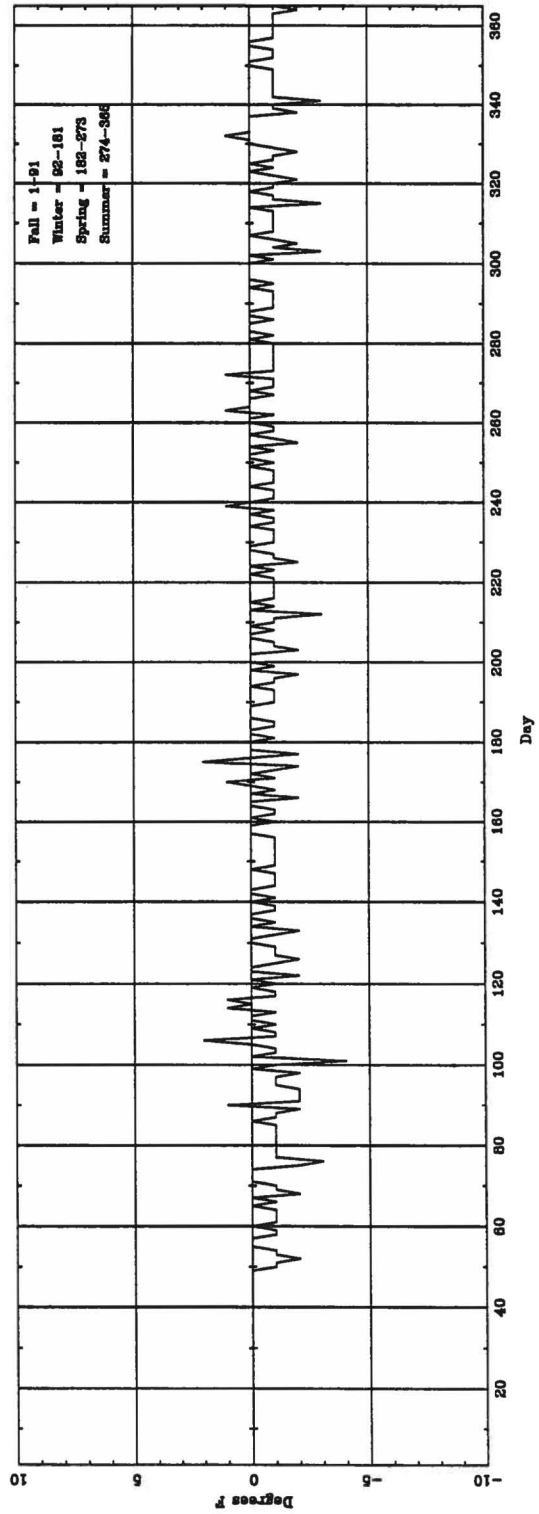

Daily ΔT (highest hourly) (ASOS - CONV) for ORH

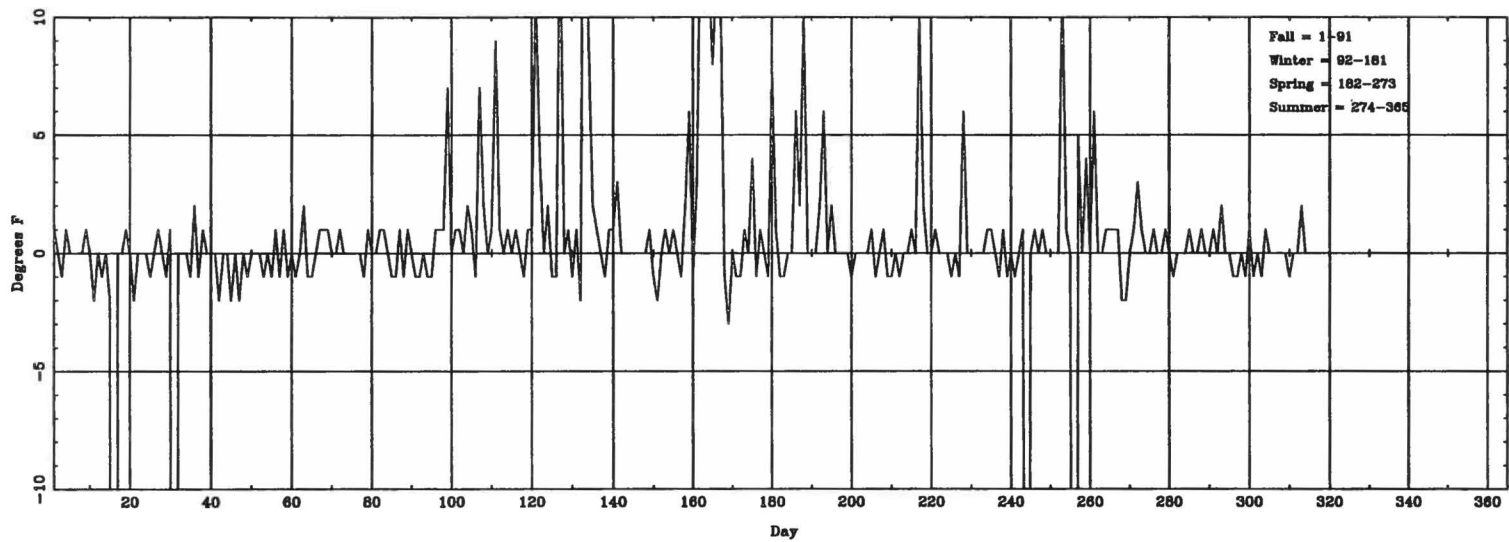

Daily ΔT (lowest hourly) (ASOS - CONV) for ORH

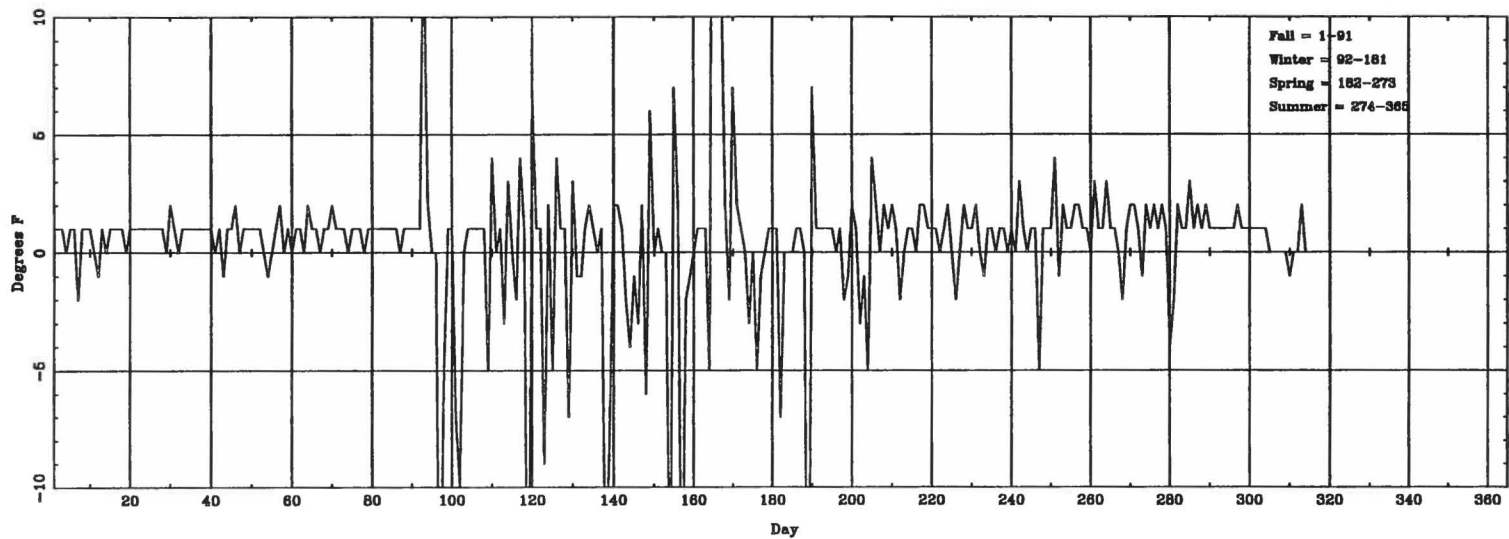

Daily $\Delta T_{(highest\ hourly)}$ (ASOS - CONY) for PAH

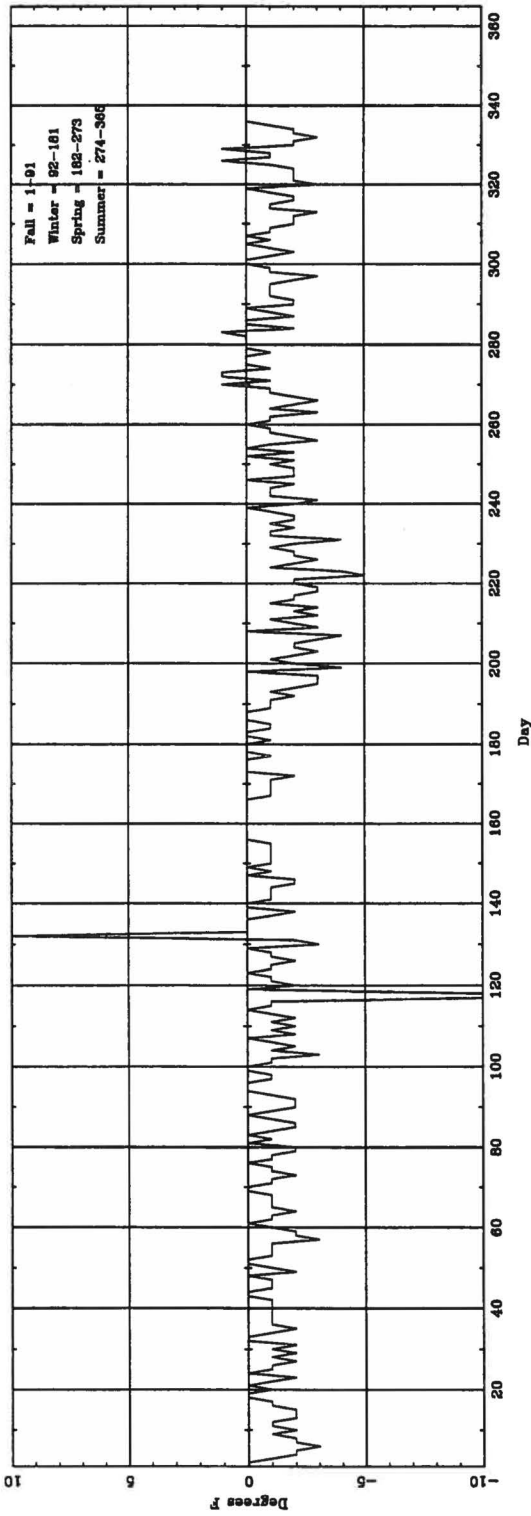

Daily $\Delta T_{(lowest\ hourly)}$ (ASOS - CONY) for PAH

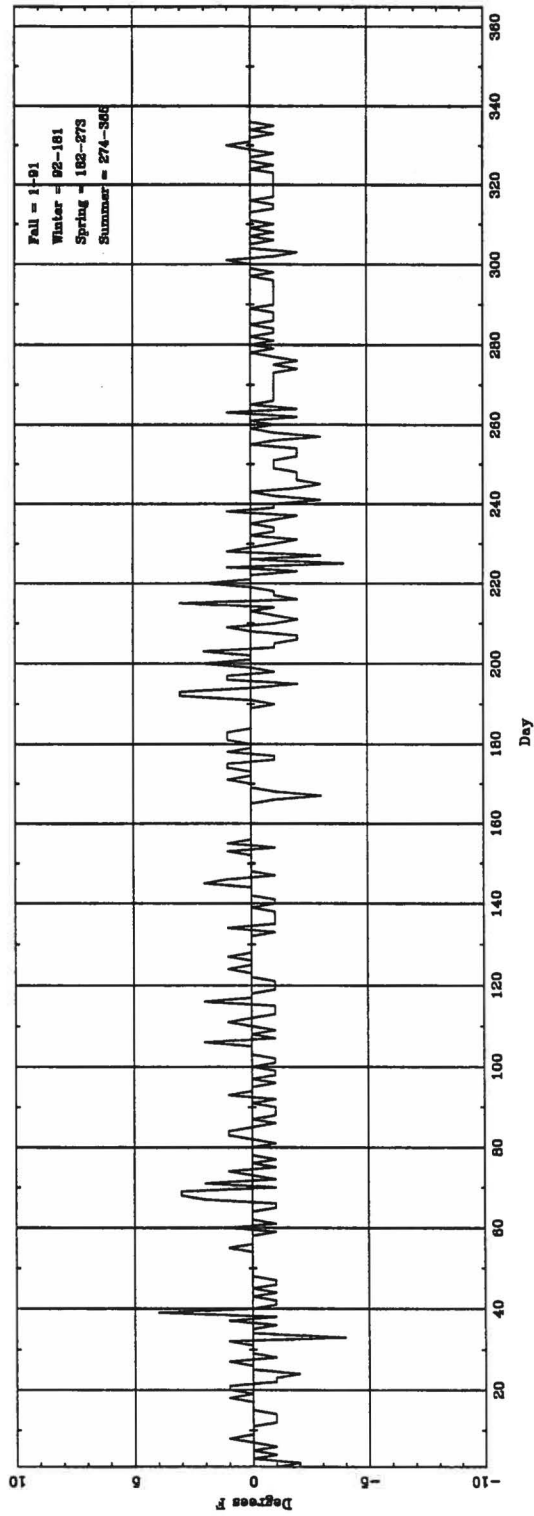

Daily $\Delta T_{\text{(highest hourly)}}$ (ASOS - CONV) for PDT

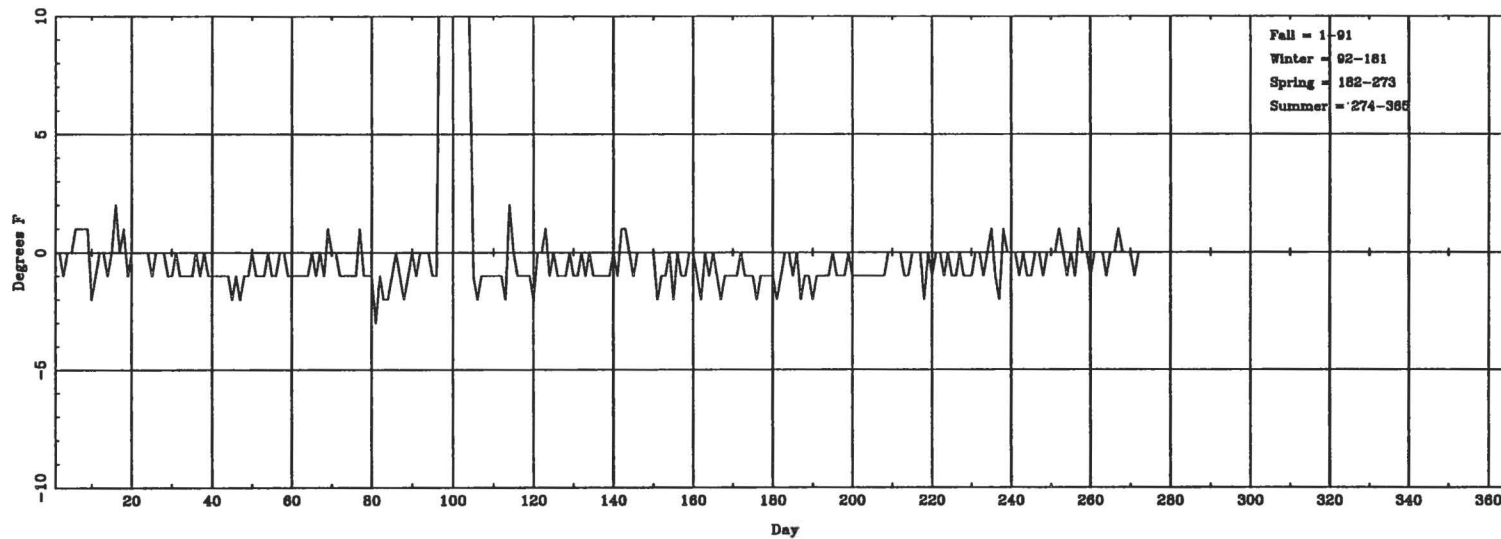

Daily $\Delta T_{\text{(lowest hourly)}}$ (ASOS - CONV) for PDT

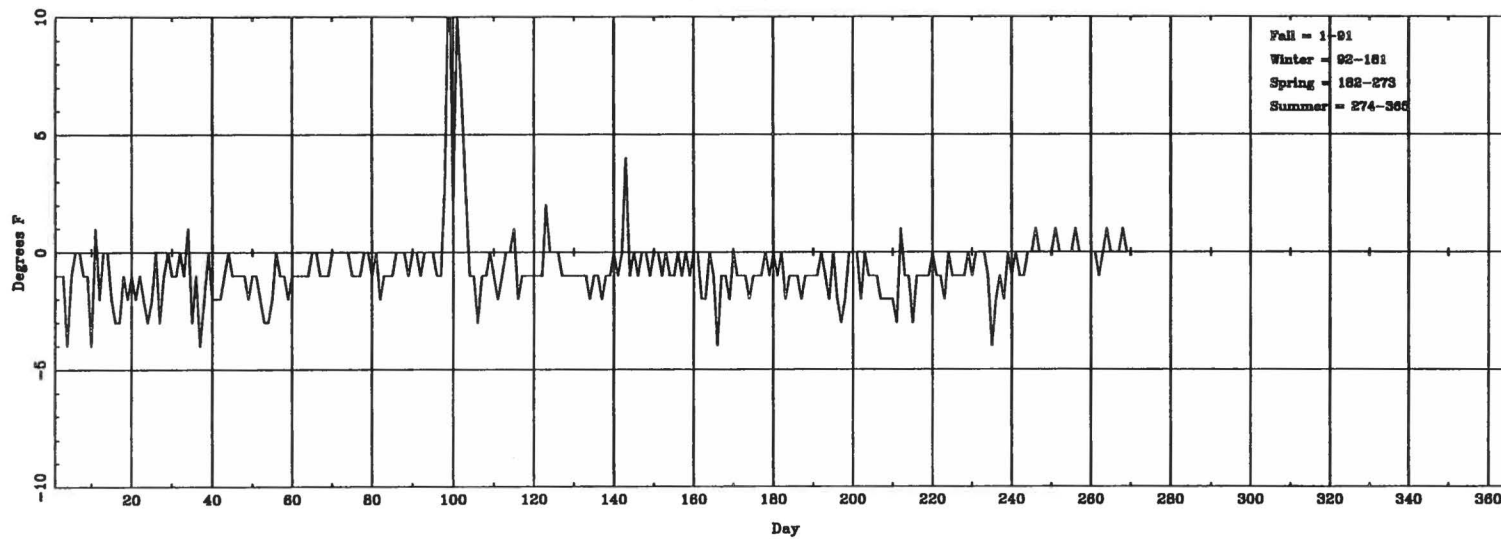

Daily $\Delta T_{(highest\ hourly)}$ (ASOS - CONV) for PDX

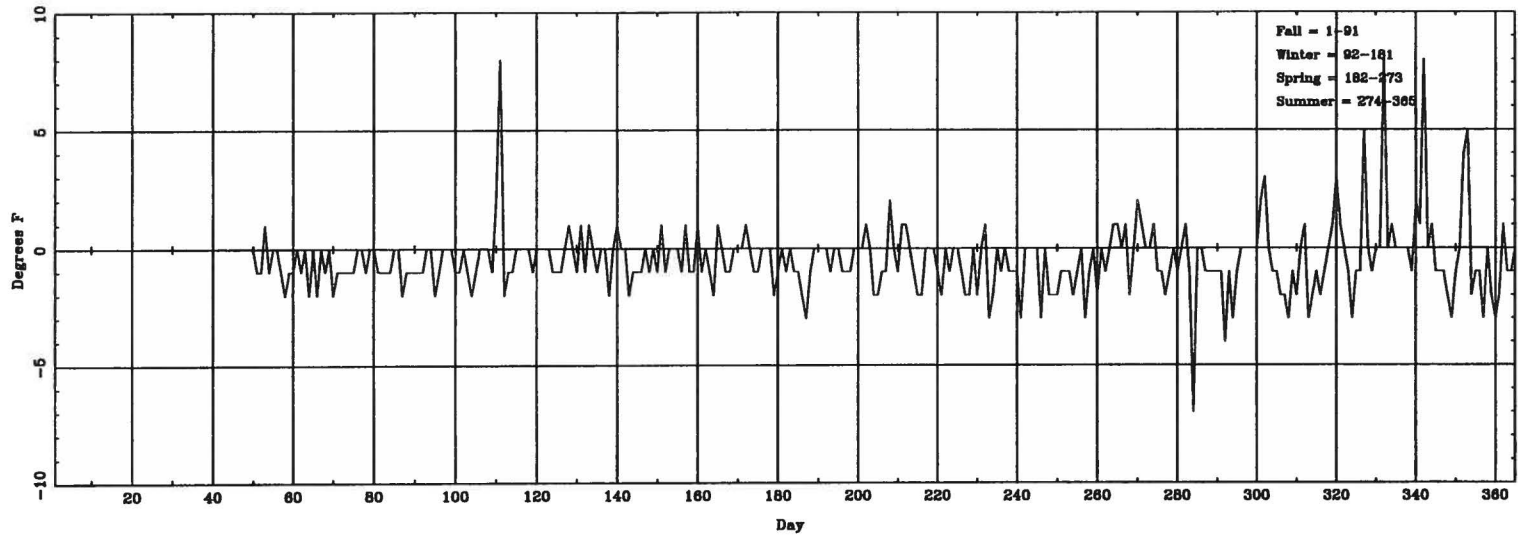

Daily $\Delta T_{(lowest\ hourly)}$ (ASOS - CONV) for PDX

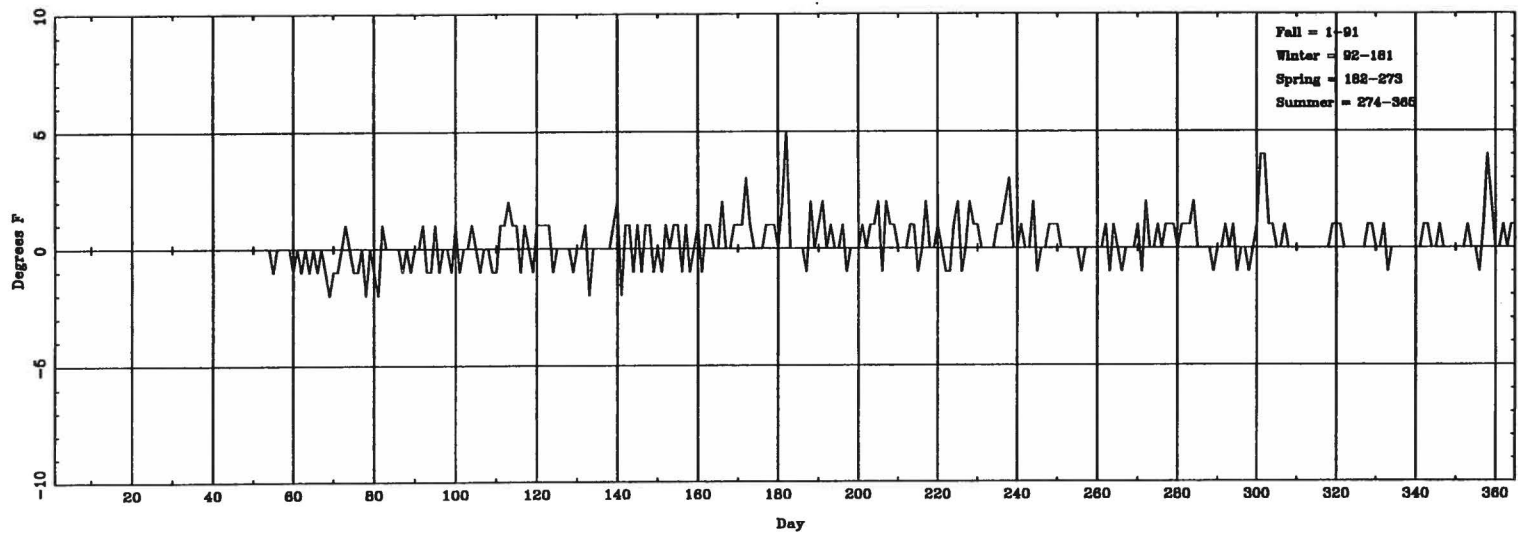

Daily $\Delta T_{(high\text{-}hourly)}$ (ASOS - CONV) for PIA

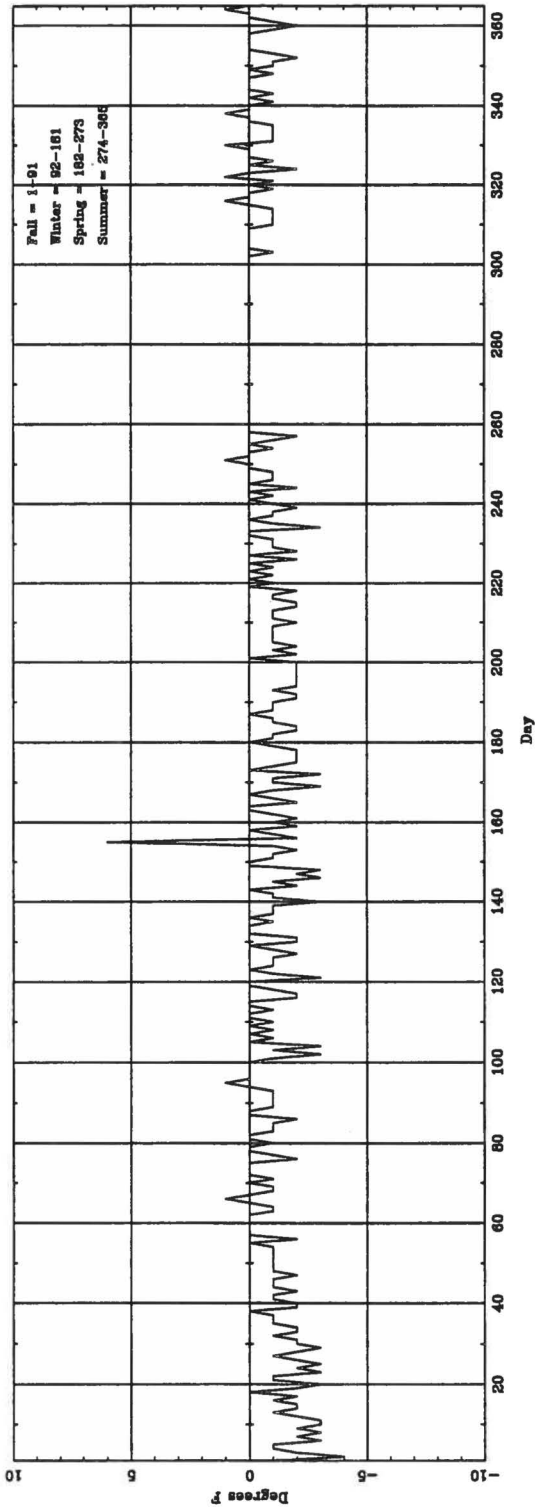

Daily $\Delta T_{(low\text{-}hourly)}$ (ASOS - CONV) for PIA

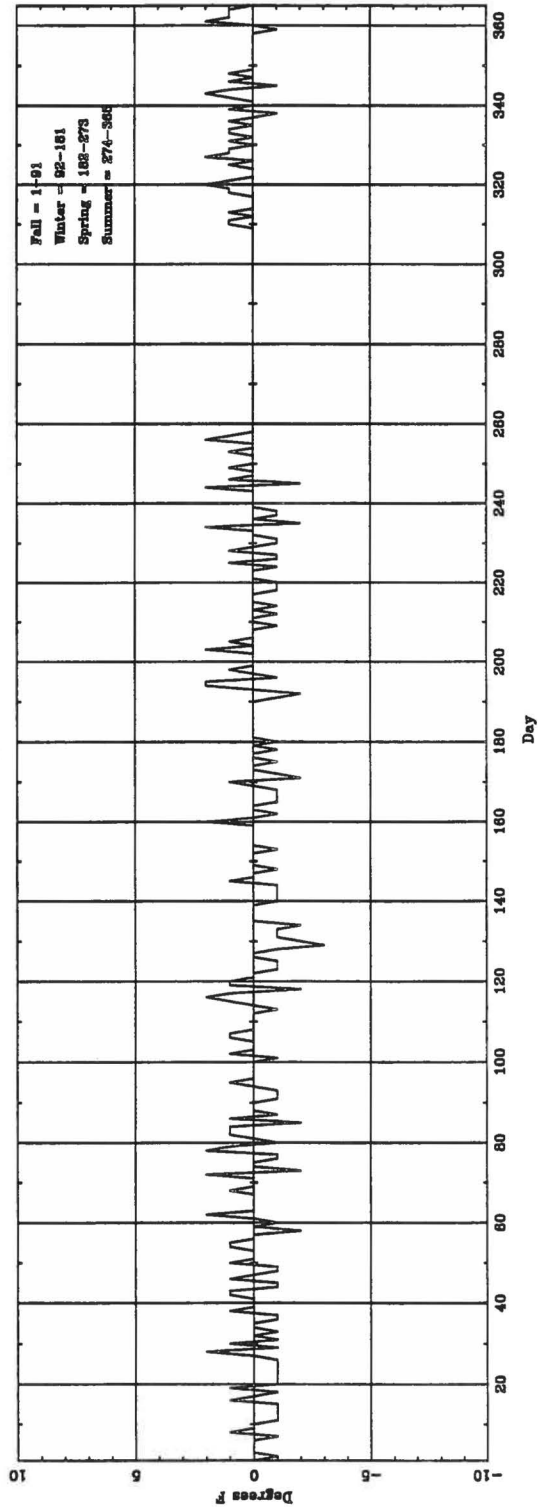

Daily $\Delta T_{\text{lightest hourly}}$ (ASOS - CONY) for RAP

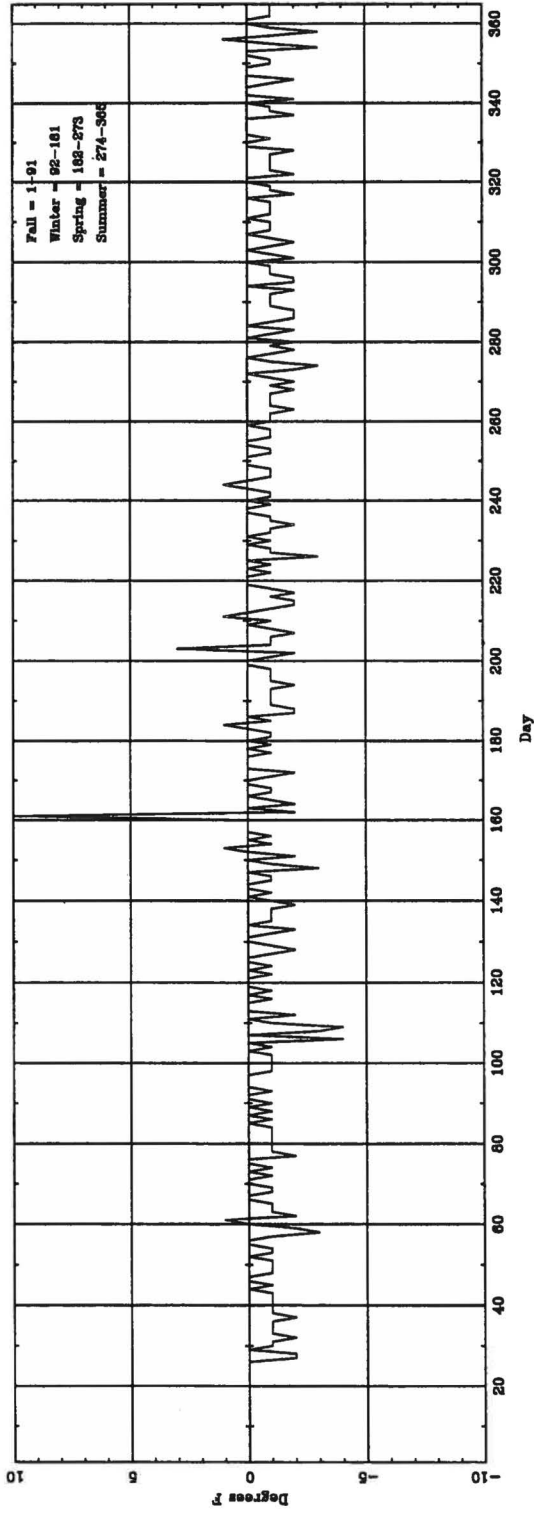

Daily $\Delta T_{\text{darkest hourly}}$ (ASOS - CONY) for RAP

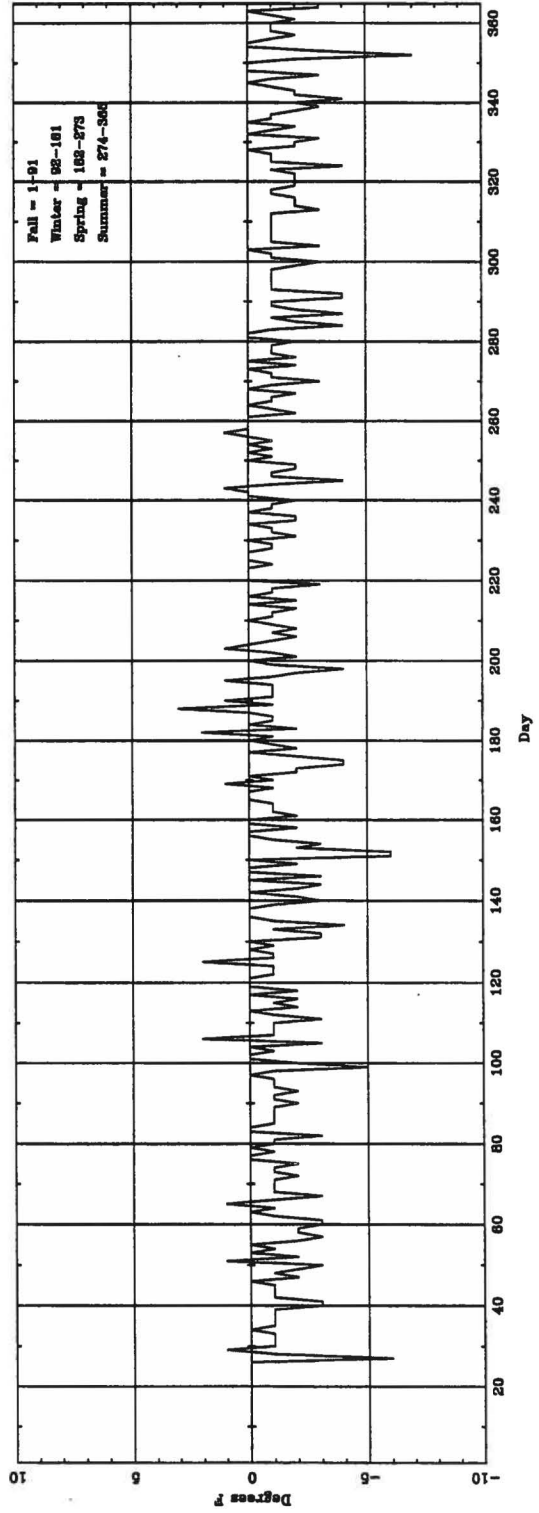

Daily $\Delta T_{\text{(highest hourly)}}$ (ASOS - CONV) for RDD

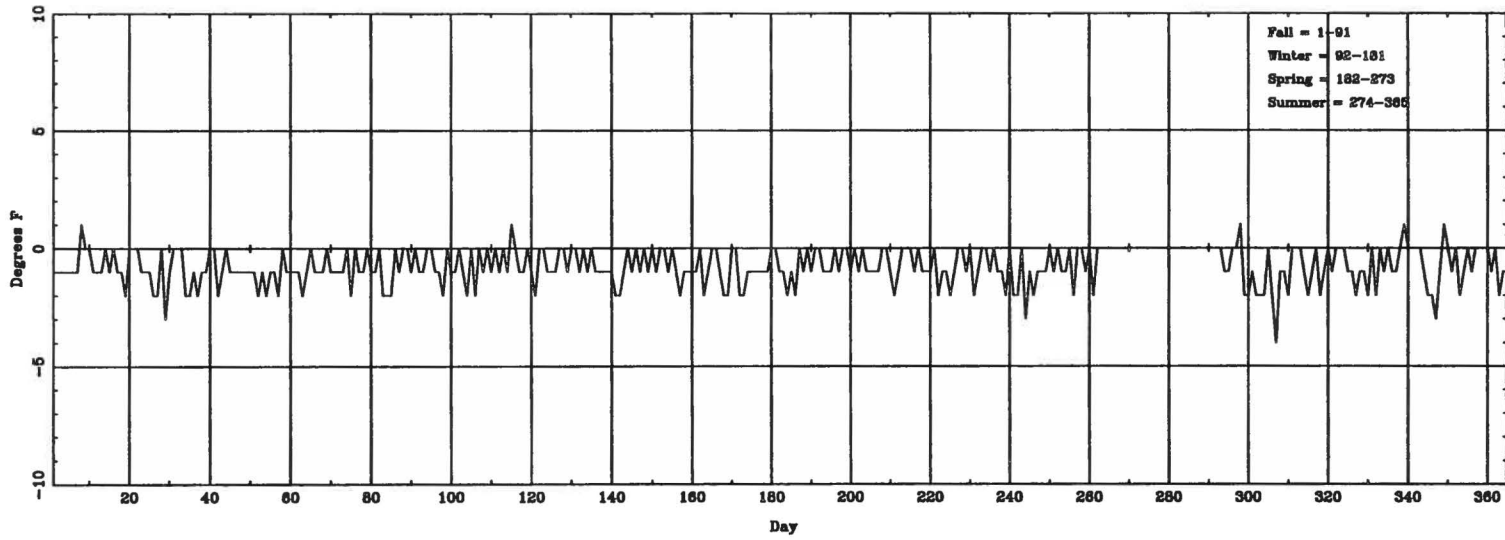

Daily $\Delta T_{\text{(lowest hourly)}}$ (ASOS - CONV) for RDD

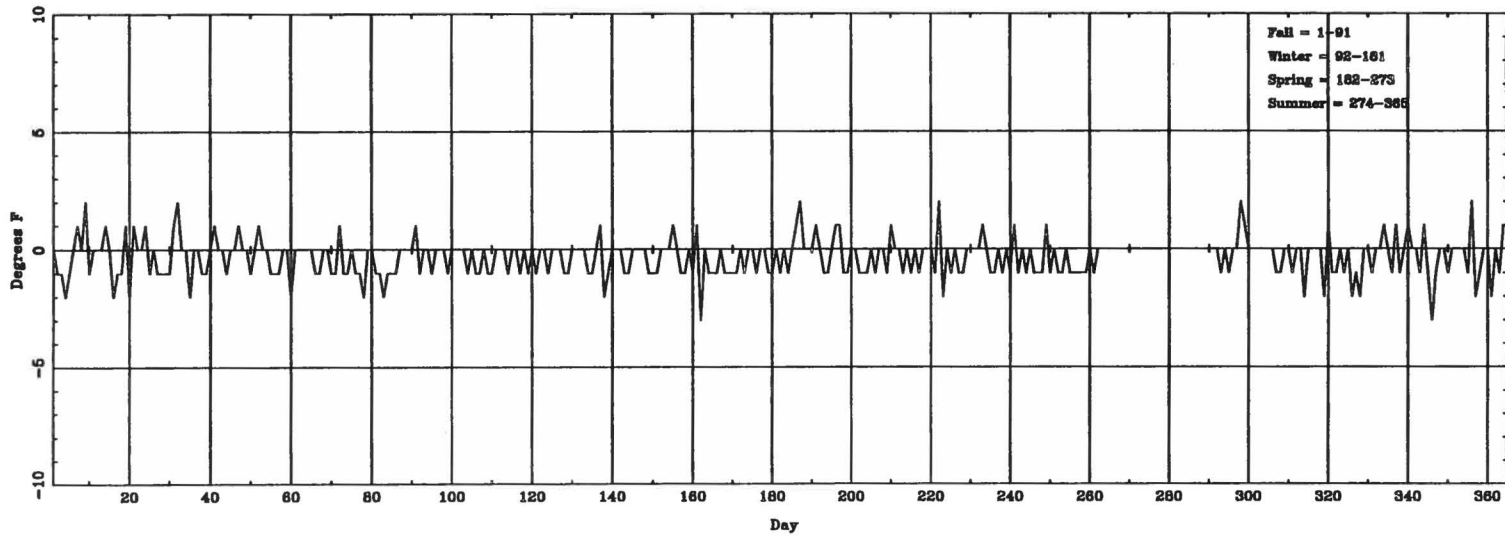

Daily $\Delta T_{(distant\ buoy)}$ (ASOS - CONV) for RFD

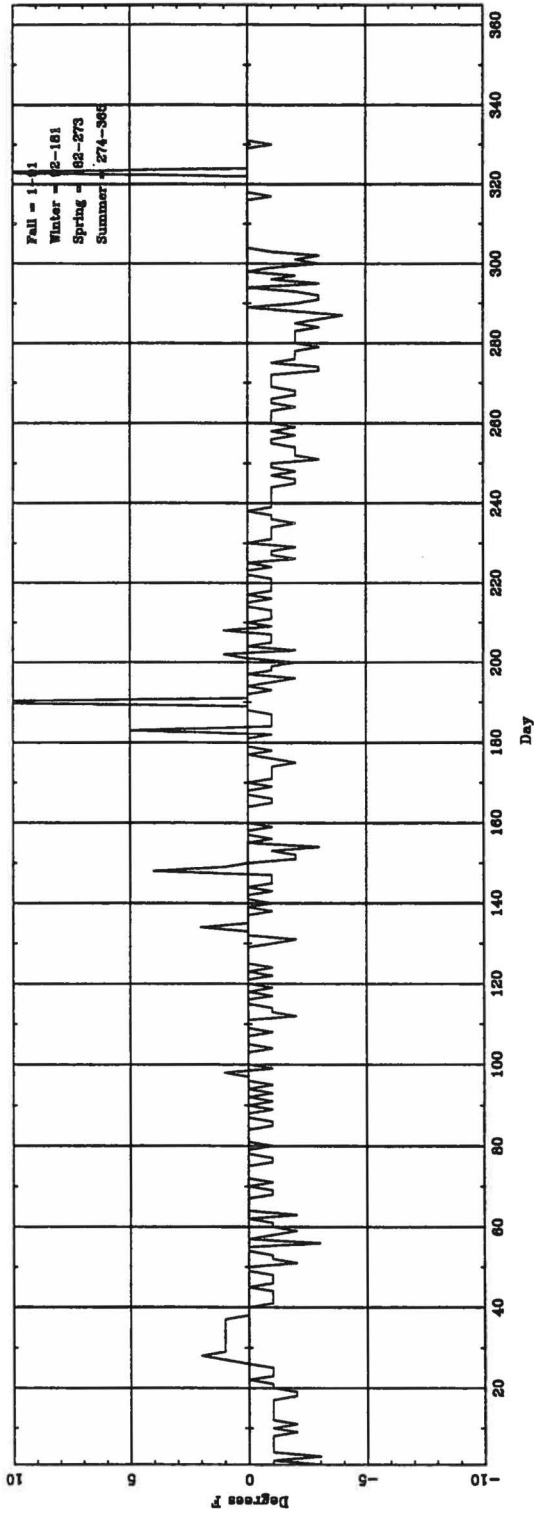

Daily $\Delta T_{(nearest\ buoy)}$ (ASOS - CONV) for RFD

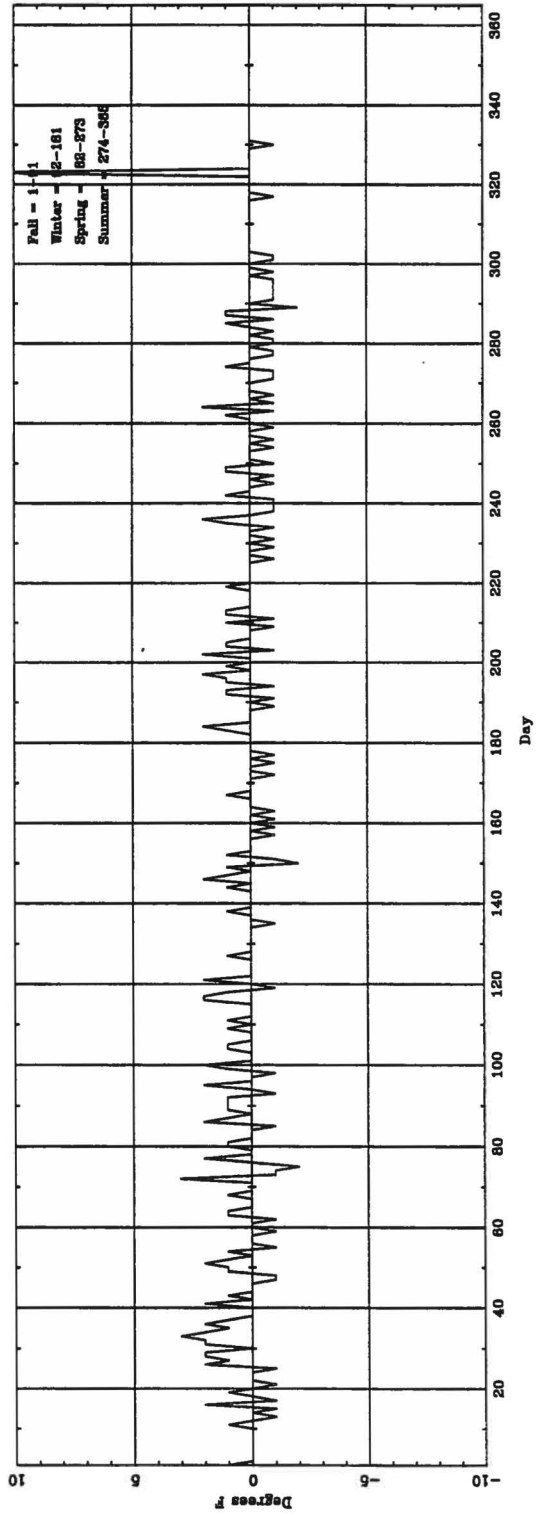

Daily $\Delta T_{\text{(highest hourly)}}$ (ASOS - CONV) for RSL

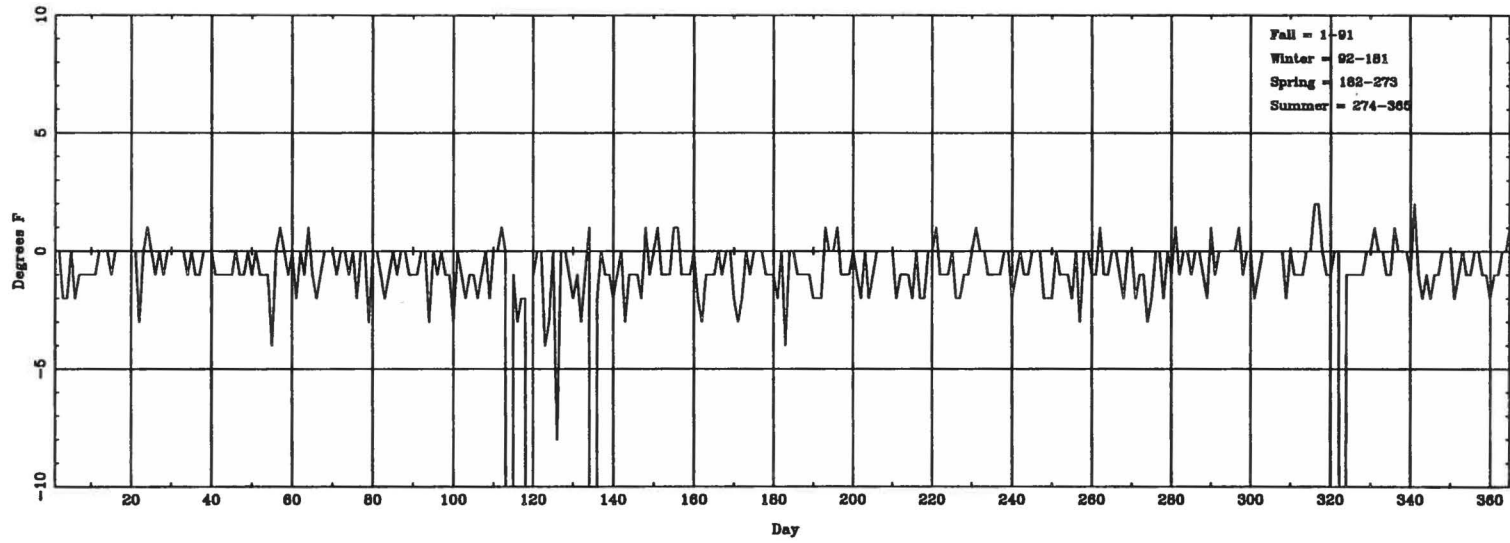

Daily $\Delta T_{\text{(lowest hourly)}}$ (ASOS - CONV) for RSL

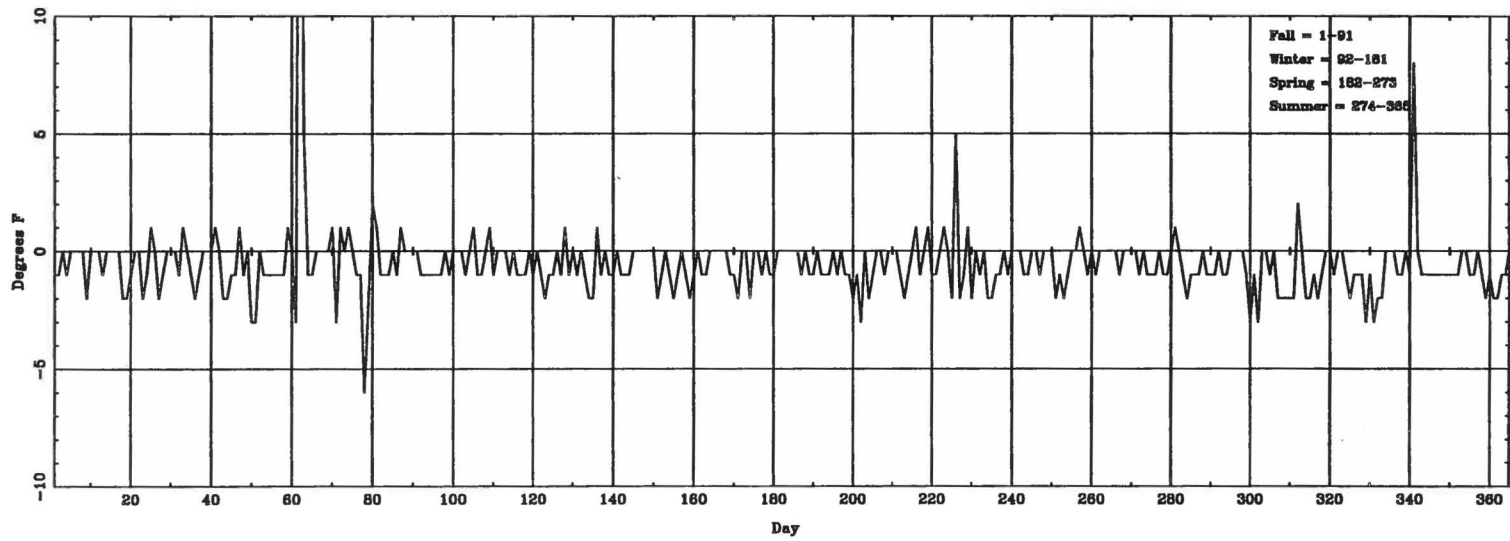

Daily $\Delta T_{\text{(highest hourly)}}$ (ASOS - CONV) for RST

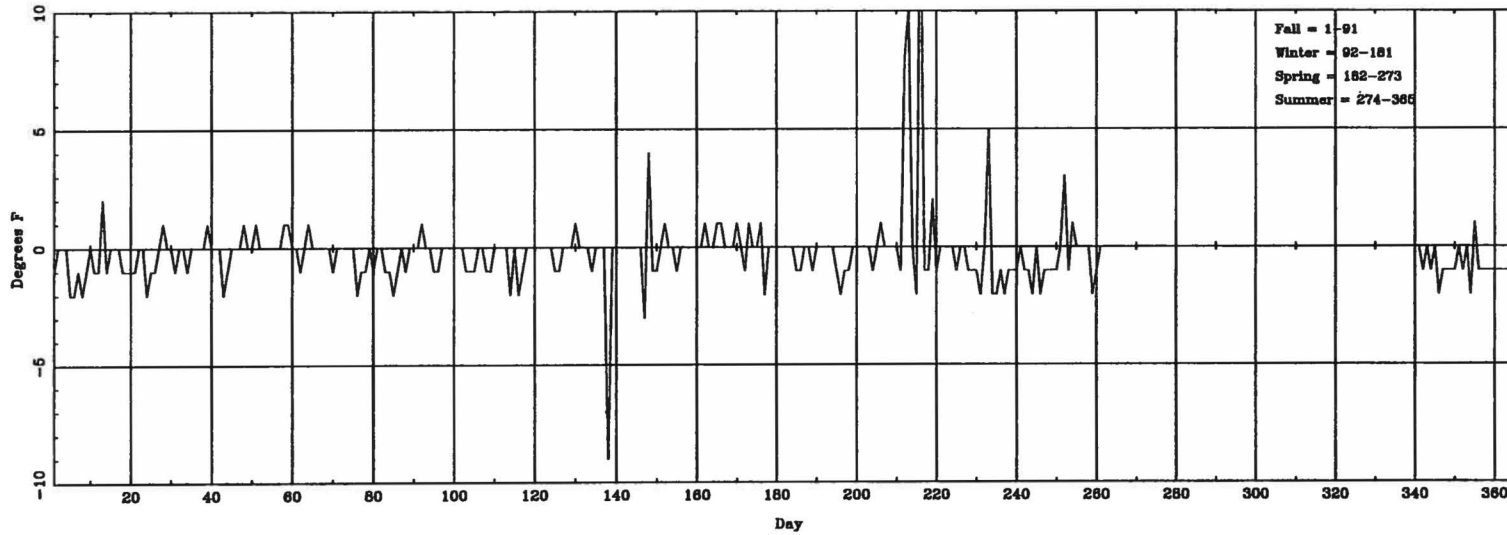

Daily $\Delta T_{\text{(lowest hourly)}}$ (ASOS - CONV) for RST

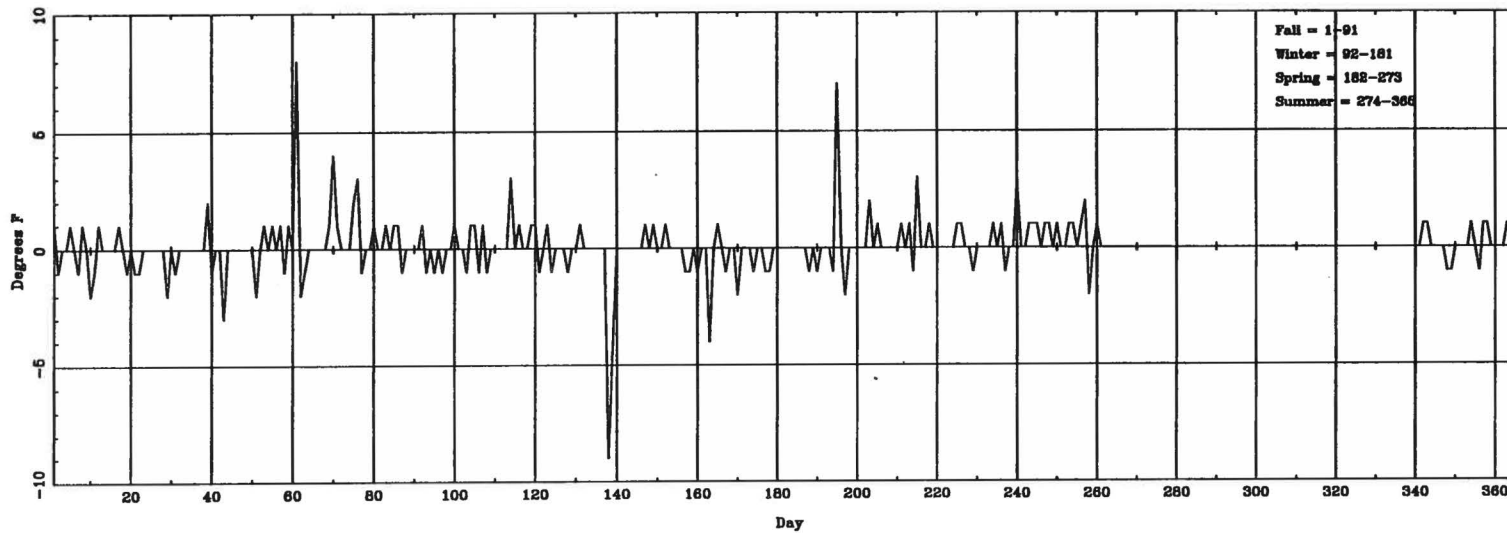

Daily ΔT (lightest hourly) (ASOS - CONV) for SAV

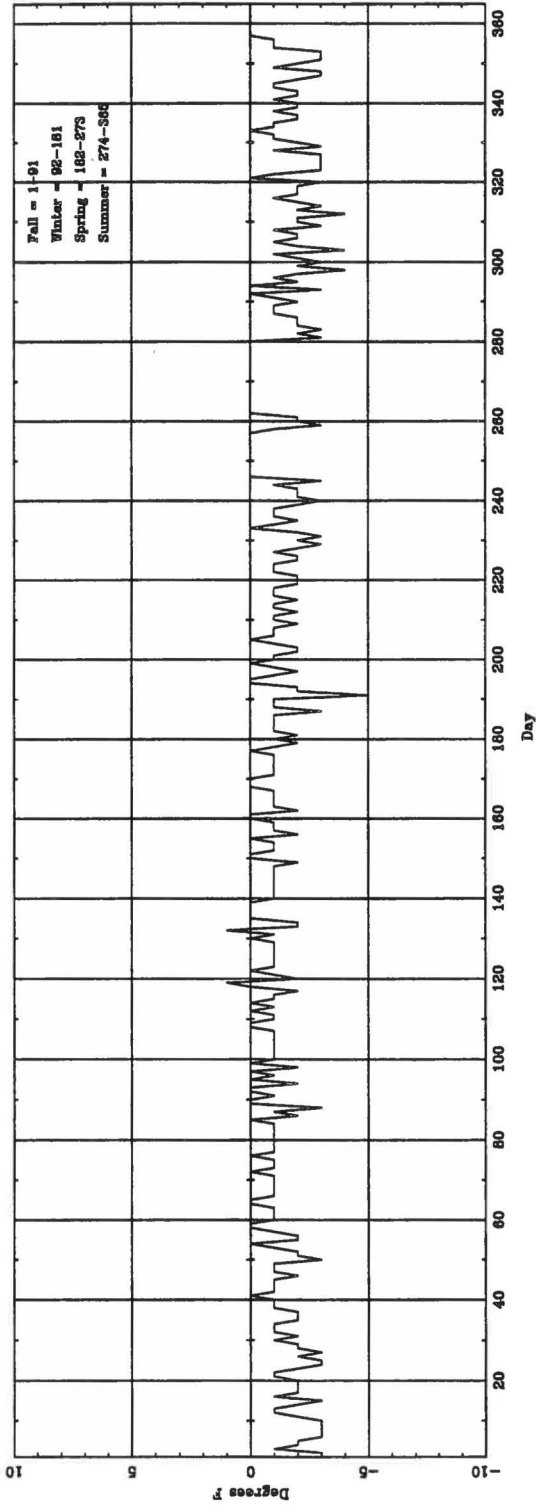

Daily ΔT (lowest hourly) (ASOS - CONV) for SAV

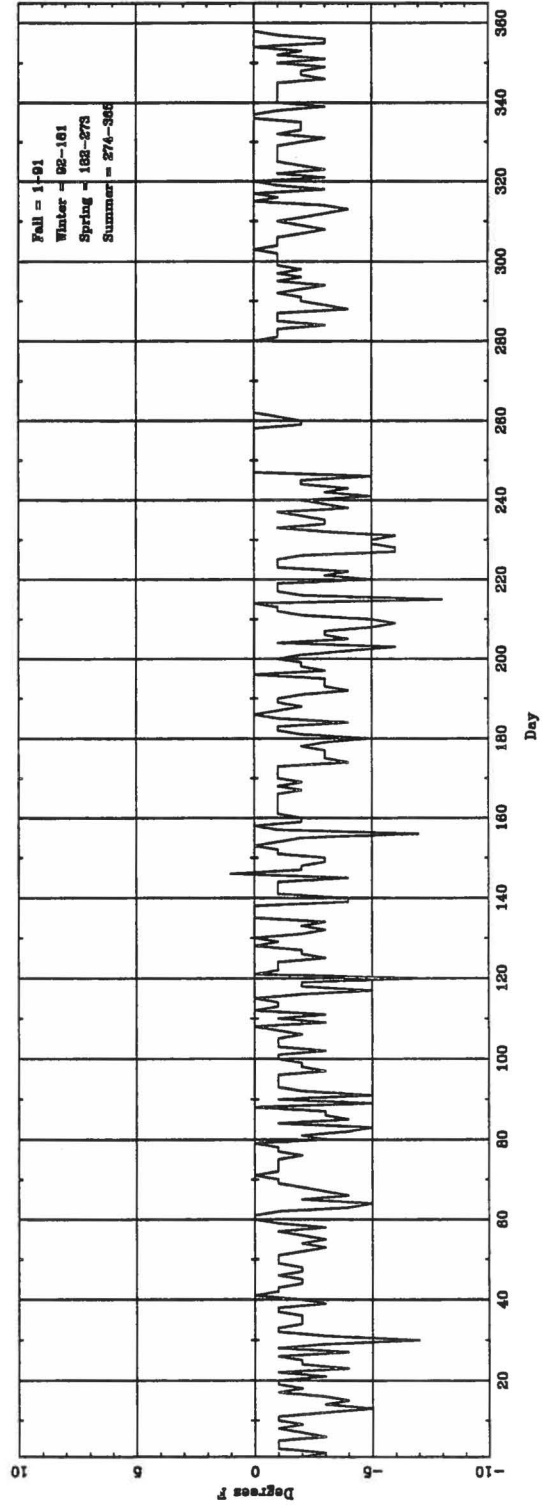

Daily $\Delta T_{\text{(highest hourly)}}$ (ASOS - CONV) for SBN

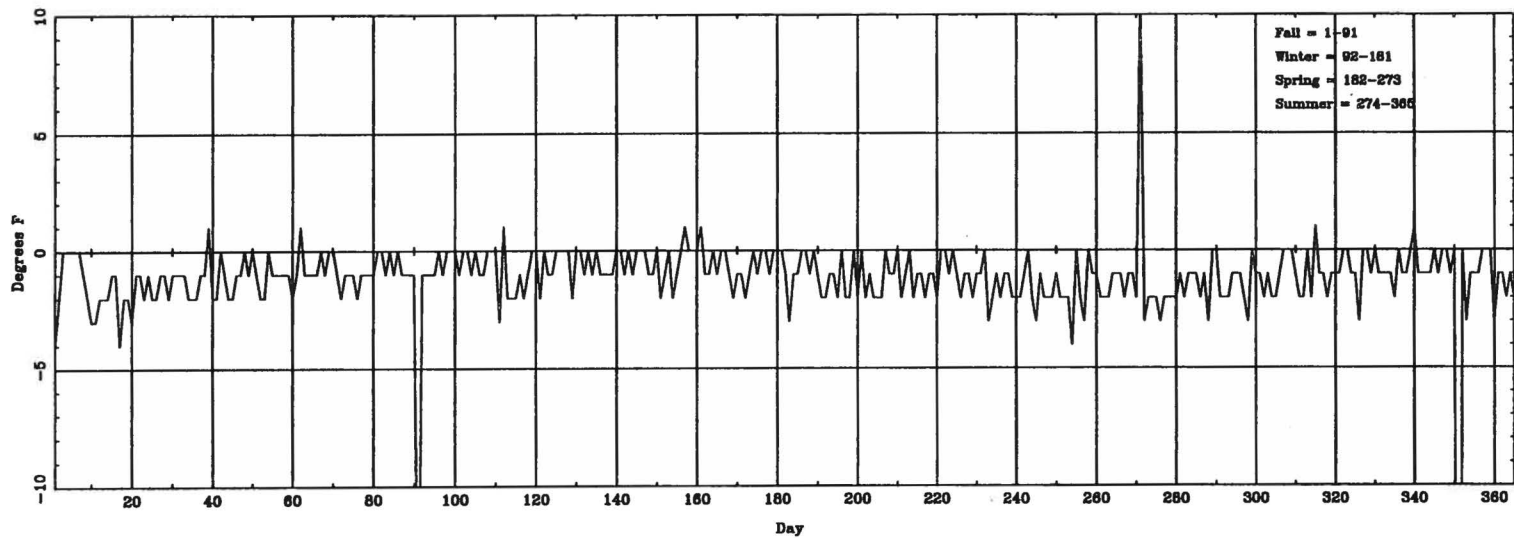

Daily $\Delta T_{\text{(lowest hourly)}}$ (ASOS - CONV) for SBN

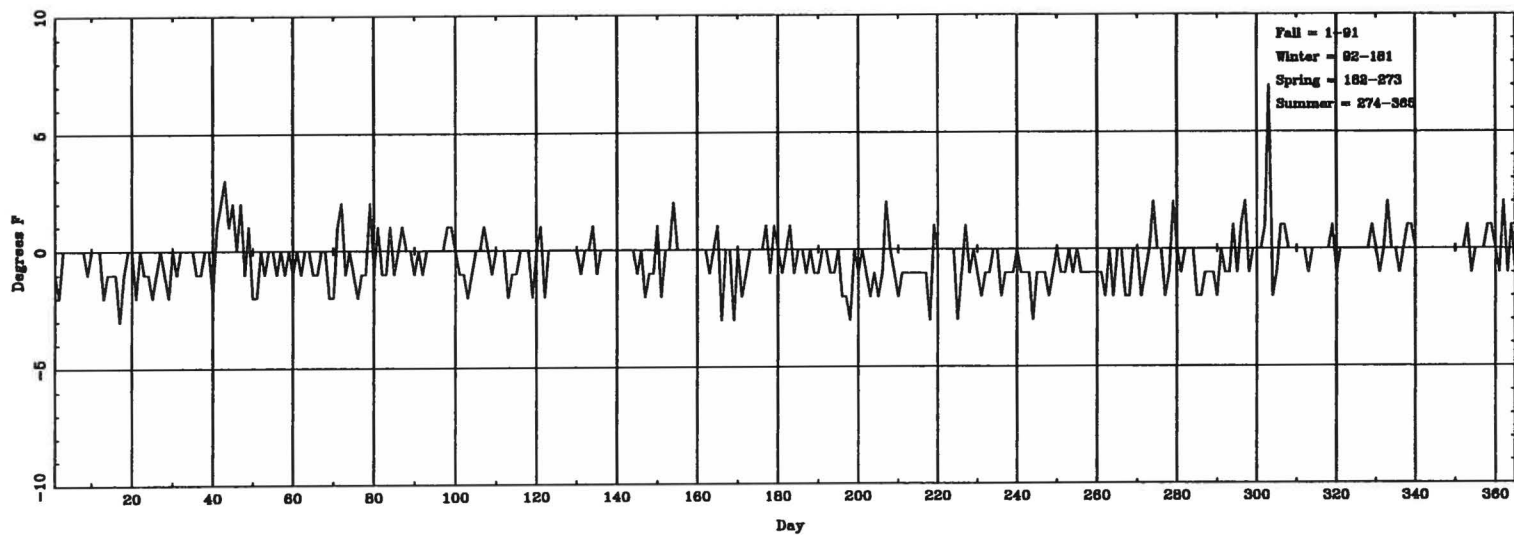

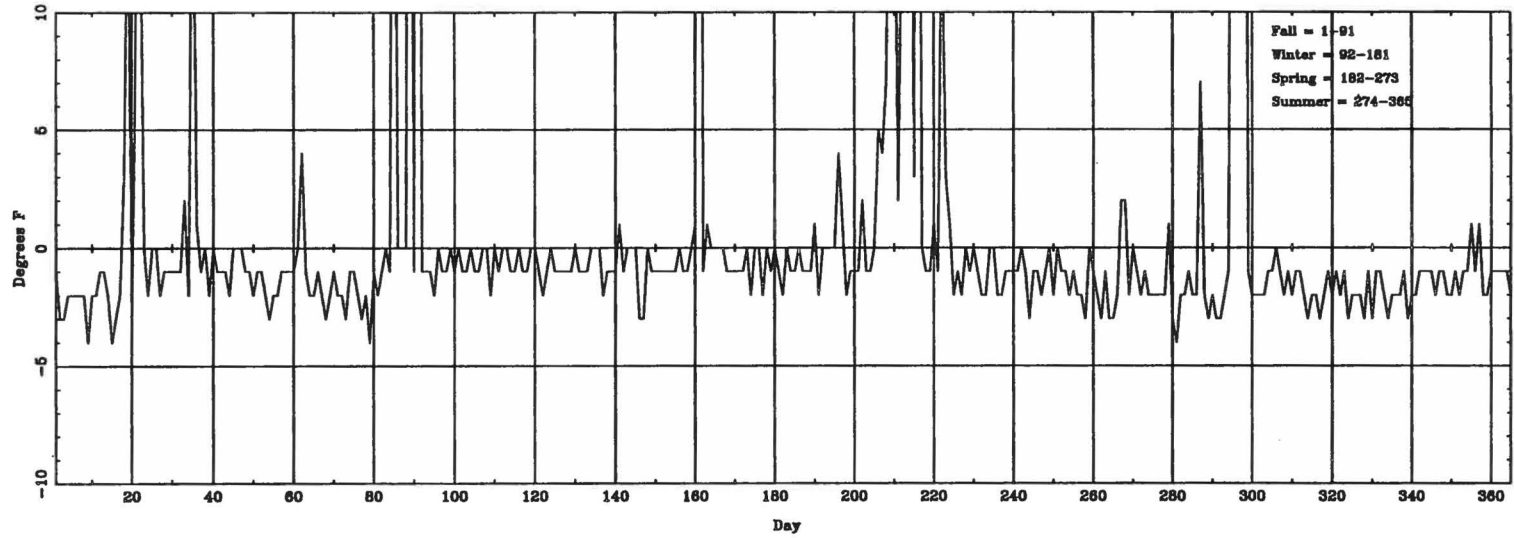
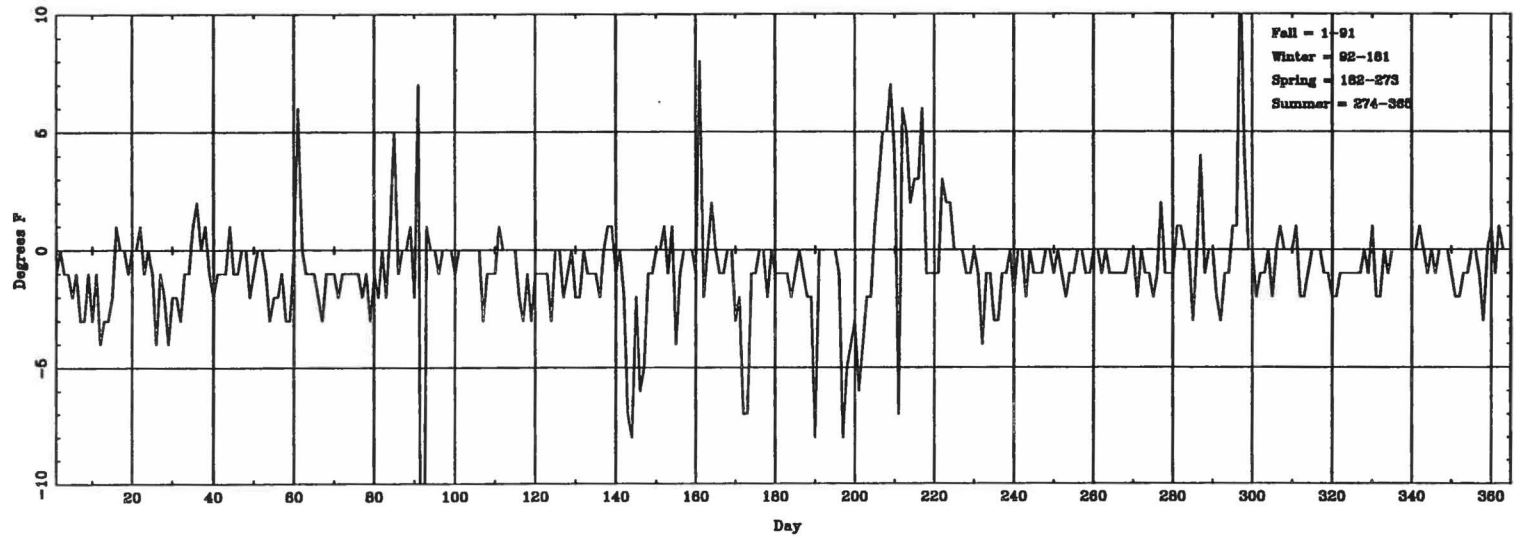
Daily $\Delta T_{(\text{highest hourly})}$ (ASOS - CONV) for SGFDaily $\Delta T_{(\text{lowest hourly})}$ (ASOS - CONV) for SGF

Daily $\Delta T_{(highest\ hourly)}$ (ASOS - CONY) for SIT

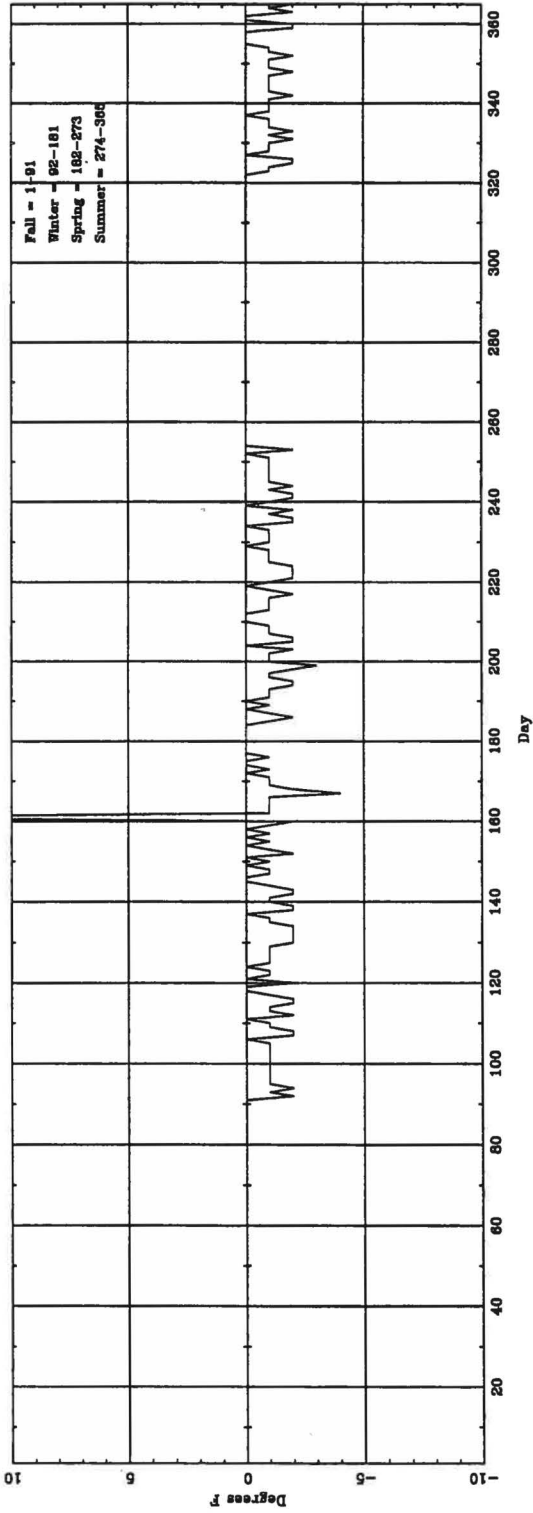

Daily $\Delta T_{(lowest\ hourly)}$ (ASOS - CONY) for SIT

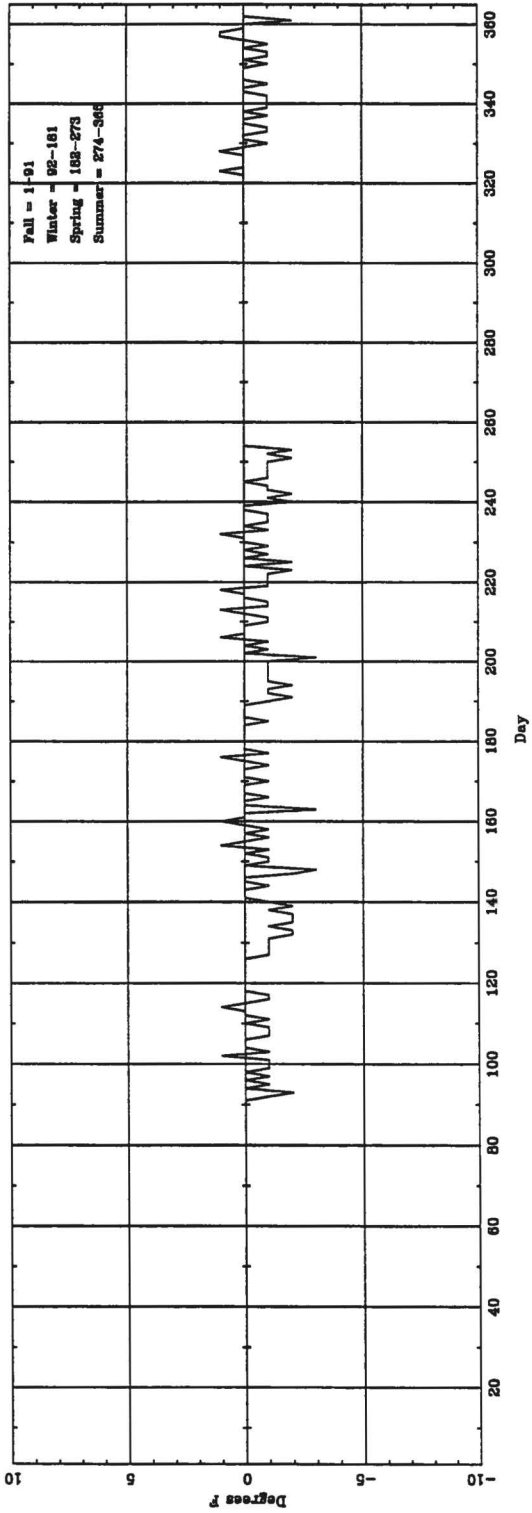

Daily AT (adjusted hourly) (ASOS - CONY) for SLN

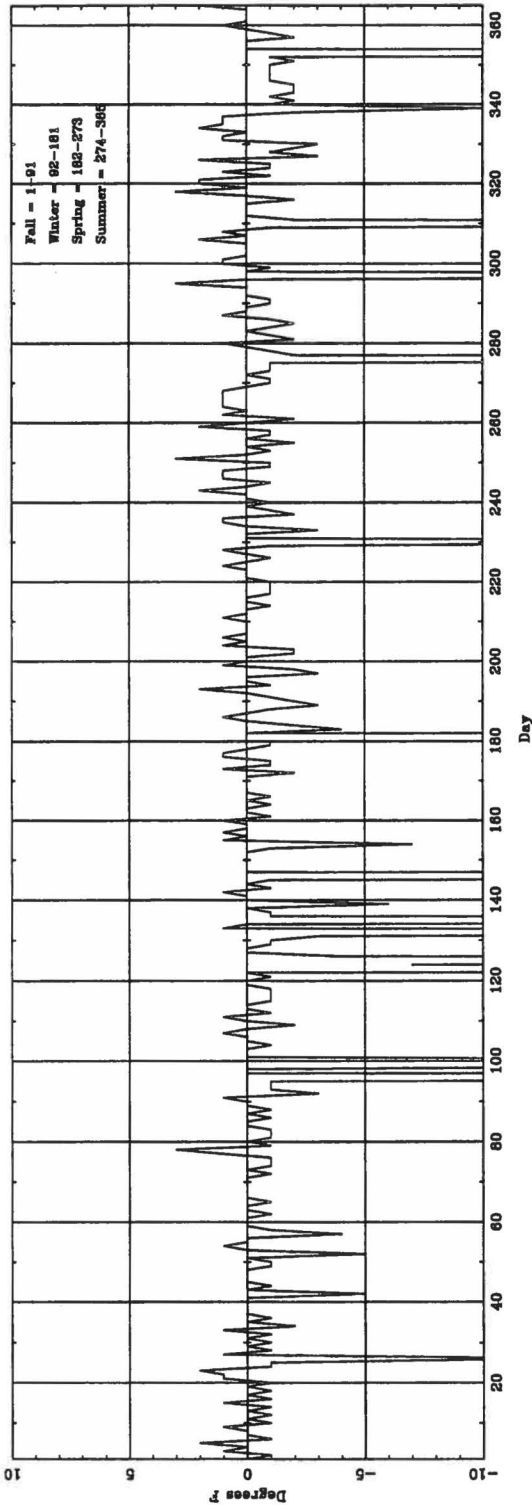

Daily AT (rawest hourly) (ASOS - CONY) for SLN

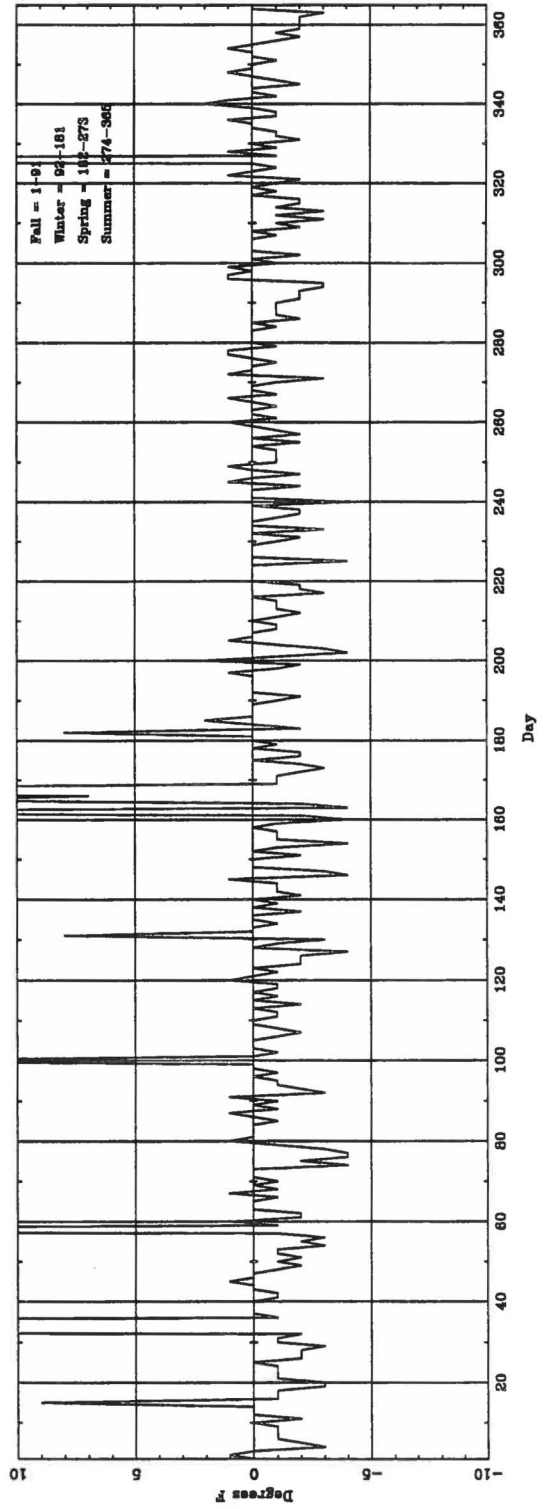

Daily $\Delta T_{(highest\ hourly)}$ (ASOS - CONV) for SPI

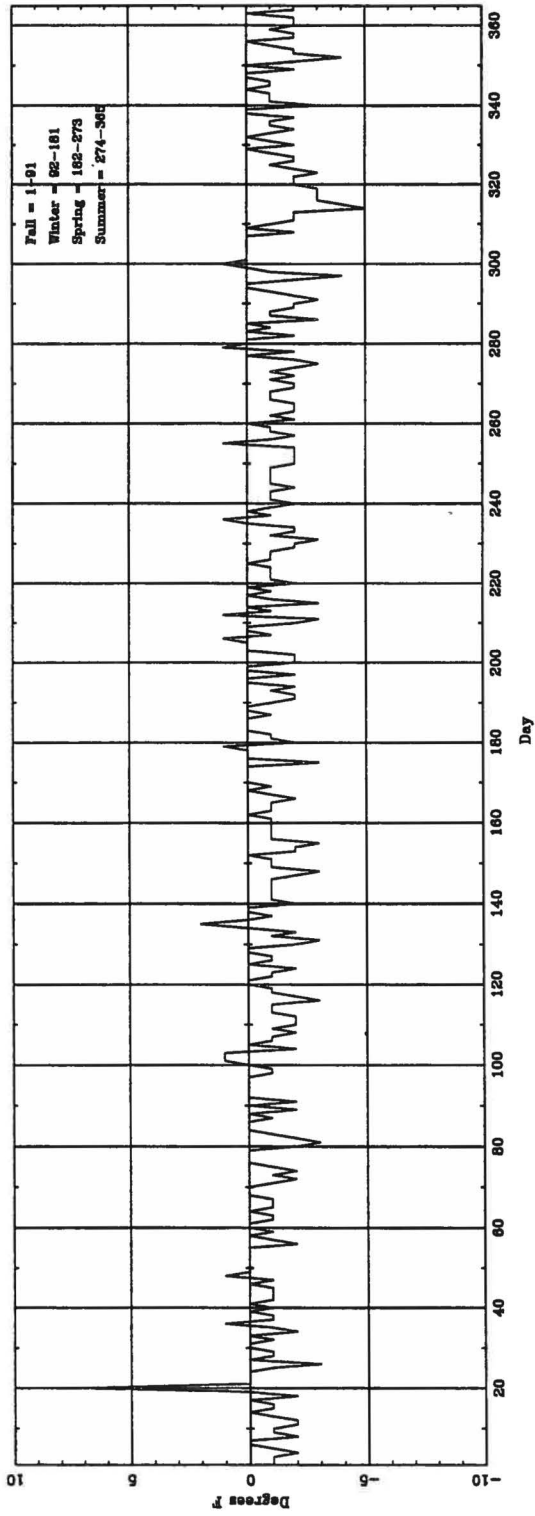

Daily $\Delta T_{(lowest\ hourly)}$ (ASOS - CONV) for SPI

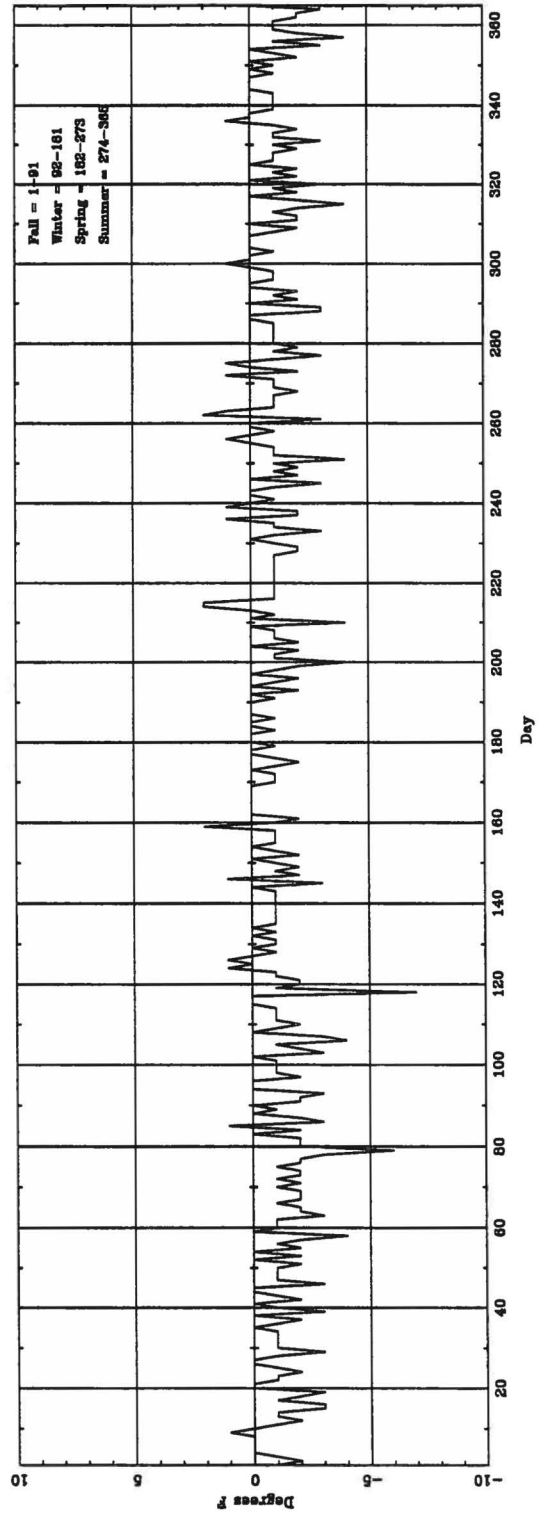

Daily $\Delta T_{(high\text{-}w\text{-}h\text{-}h\text{-}h)}$ (ASOS - CONV) for SUX

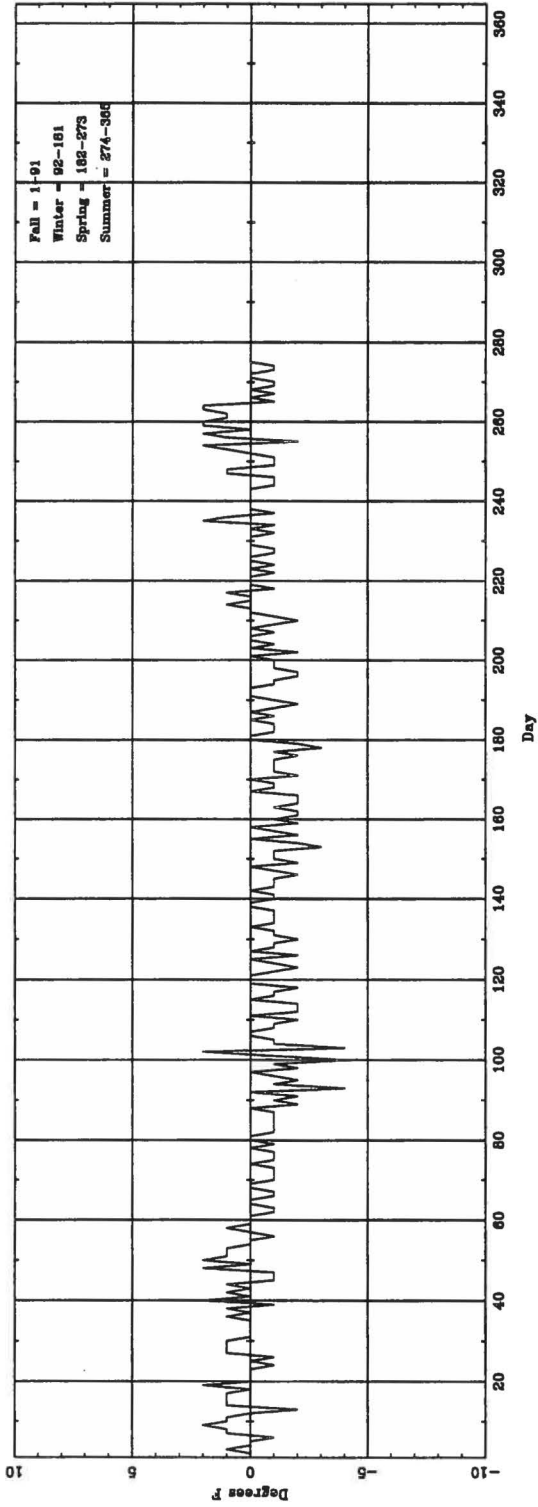

Daily $\Delta T_{(low\text{-}w\text{-}h\text{-}h)}$ (ASOS - CONV) for SUX

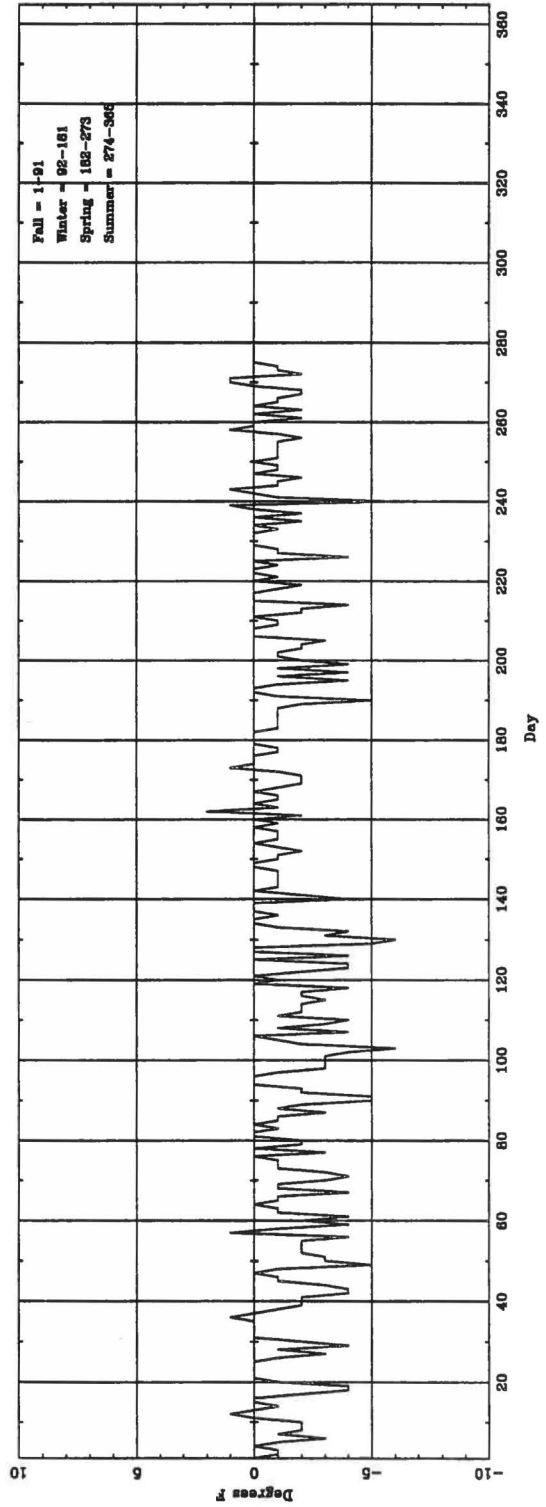

Daily $\Delta T_{(highest\ hourly)}$ (ASOS - CONV) for TLH

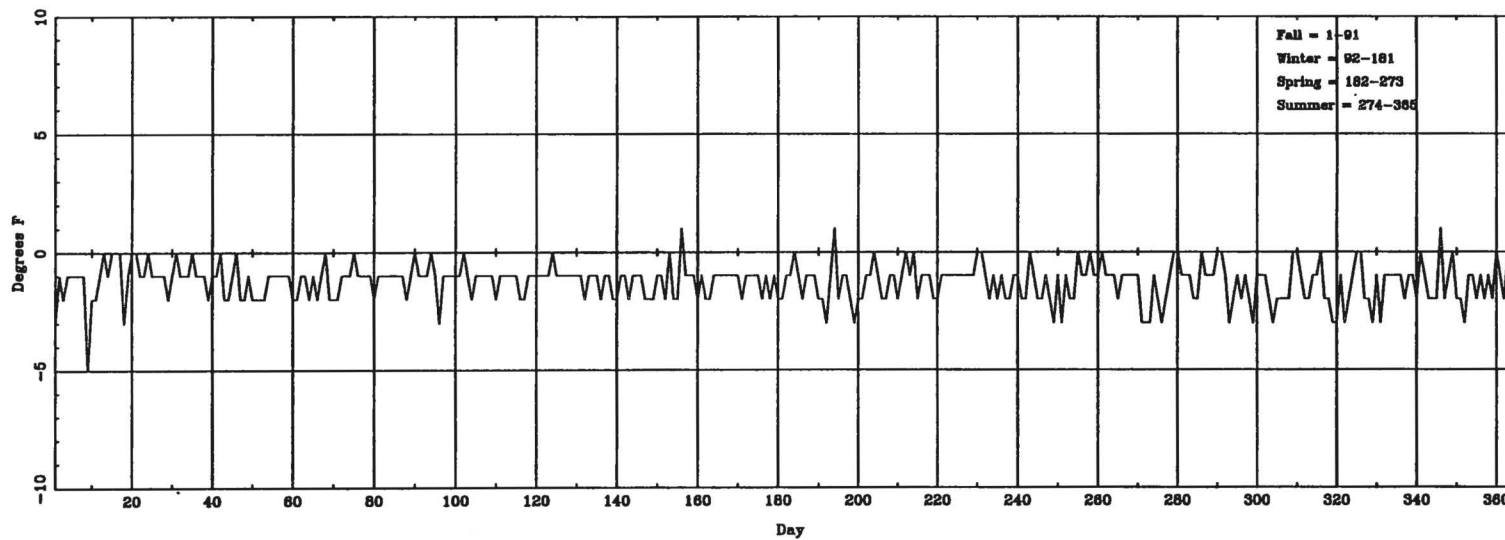

Daily $\Delta T_{(lowest\ hourly)}$ (ASOS - CONV) for TLH

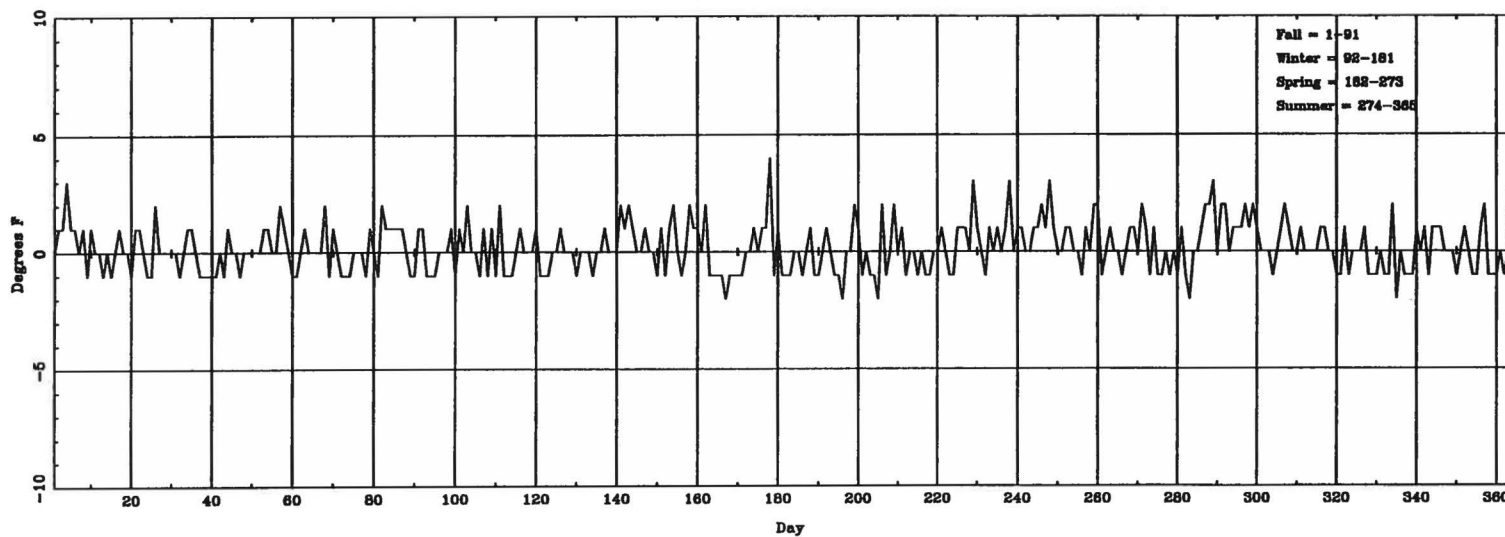

Daily $\Delta T_{(upbeat\ hourly)}$ (ASOS - CONV) for TRI

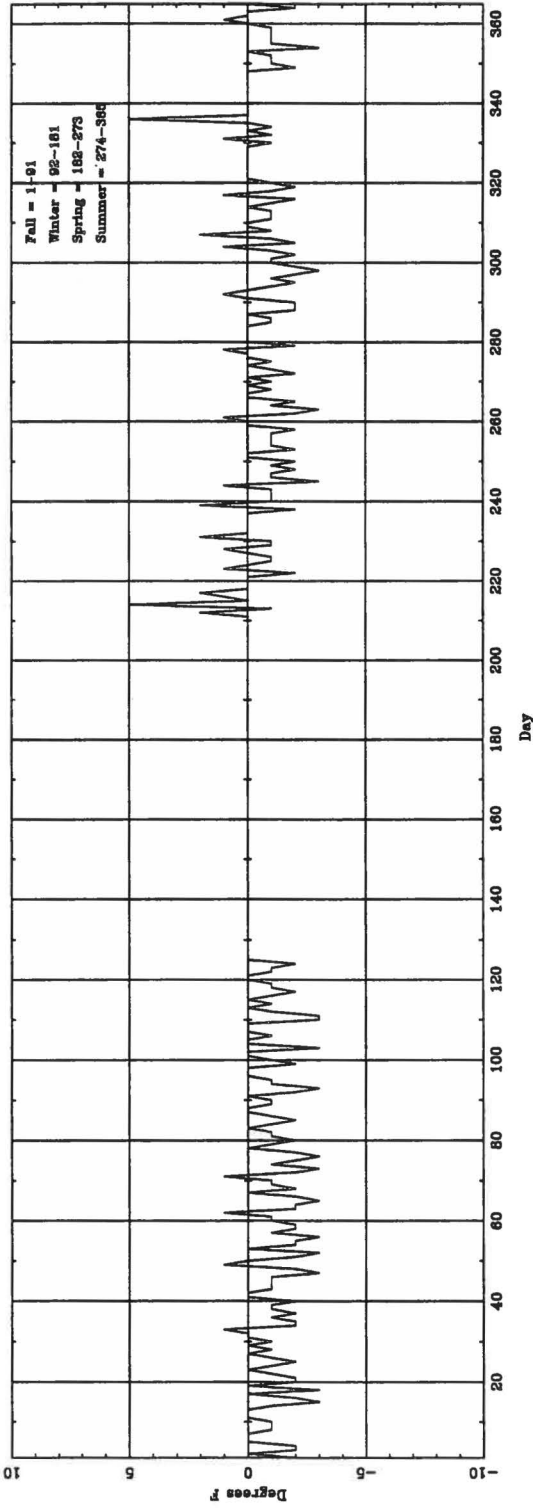

Daily $\Delta T_{(downbeat\ hourly)}$ (ASOS - CONV) for TRI

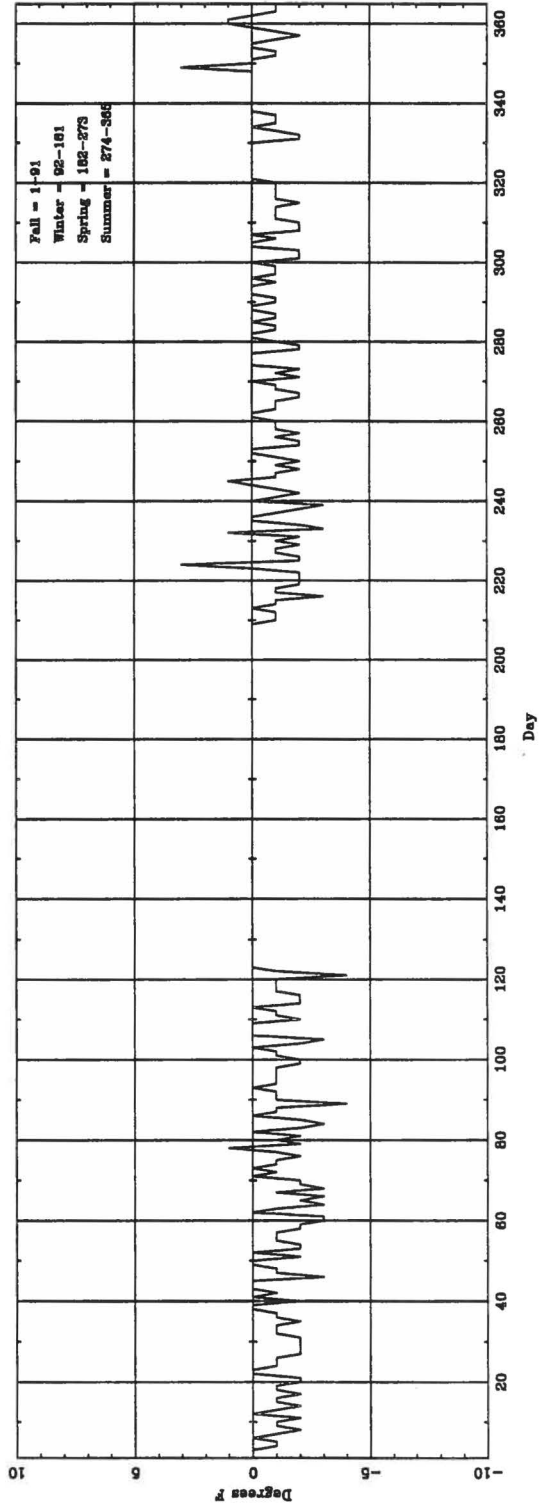

Daily $\Delta T_{(highest\ hourly)}$ (ASOS - CONV) for TUS

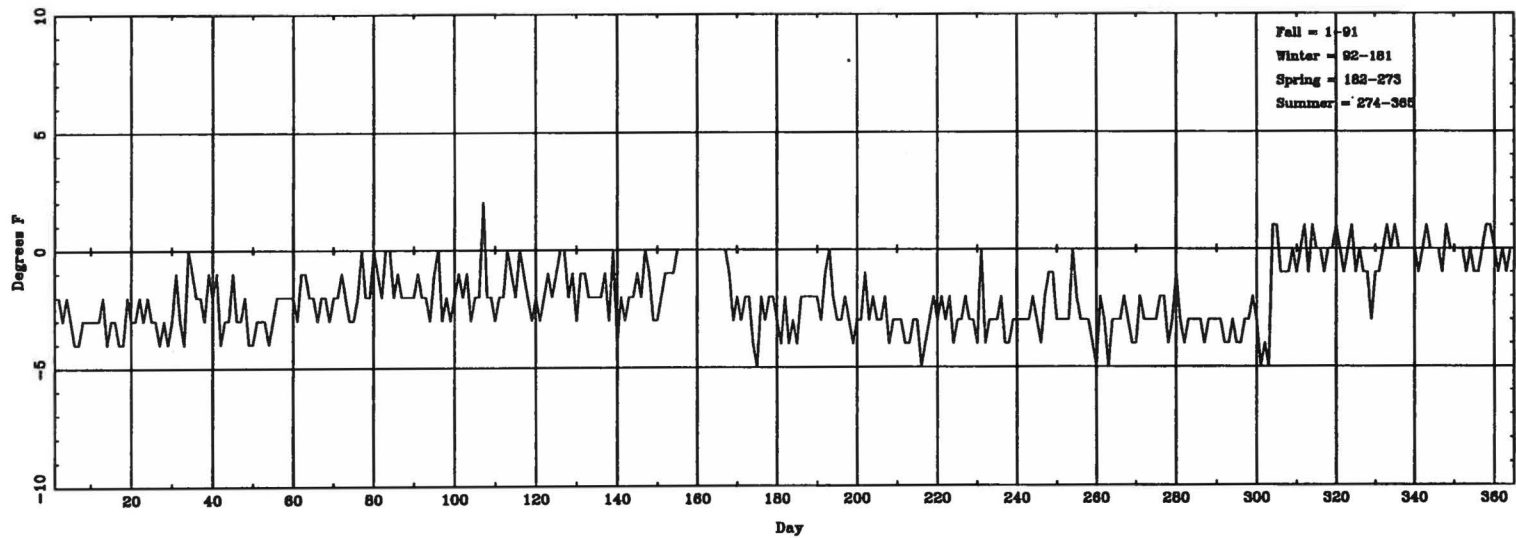

Daily $\Delta T_{(lowest\ hourly)}$ (ASOS - CONV) for TUS

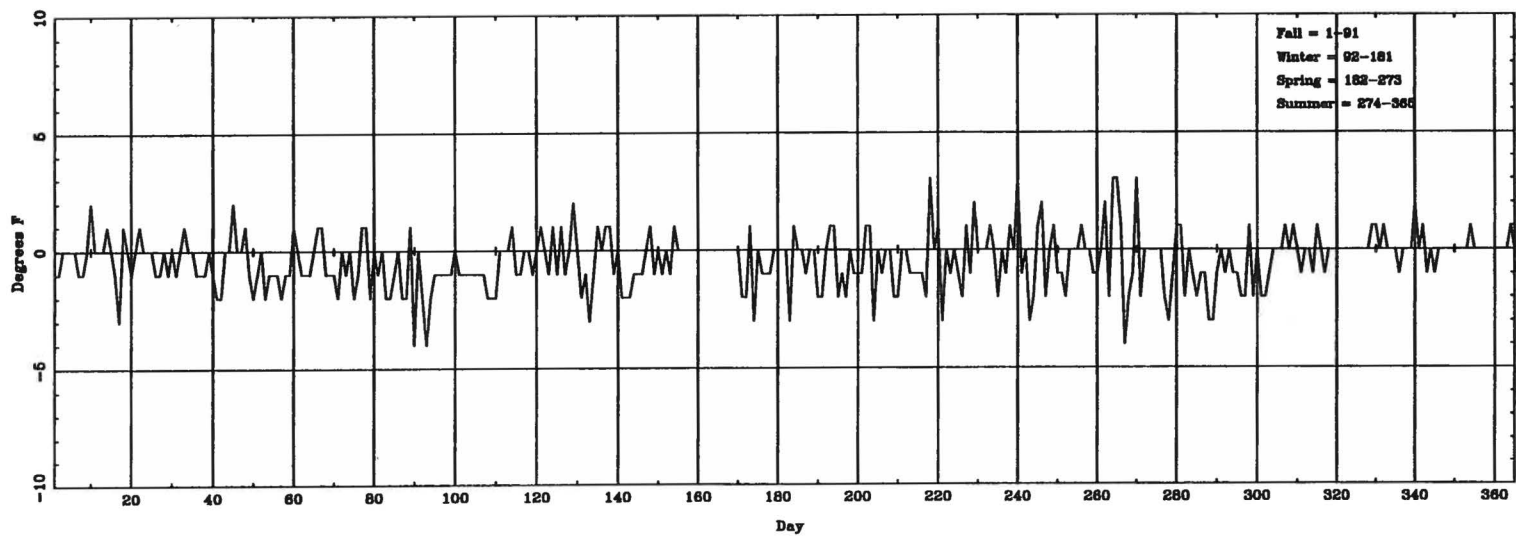

Daily $\Delta T_{\text{(highest hourly)}}$ (ASOS - CONV) for VTN

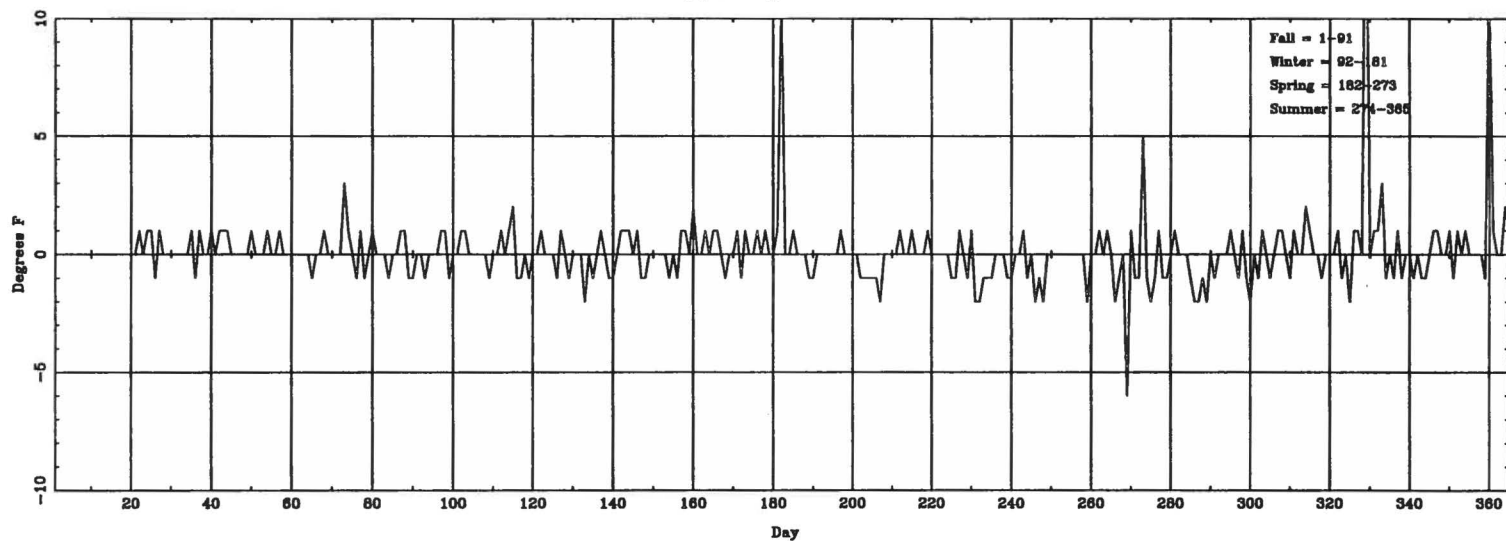

Daily $\Delta T_{\text{(lowest hourly)}}$ (ASOS - CONV) for VTN

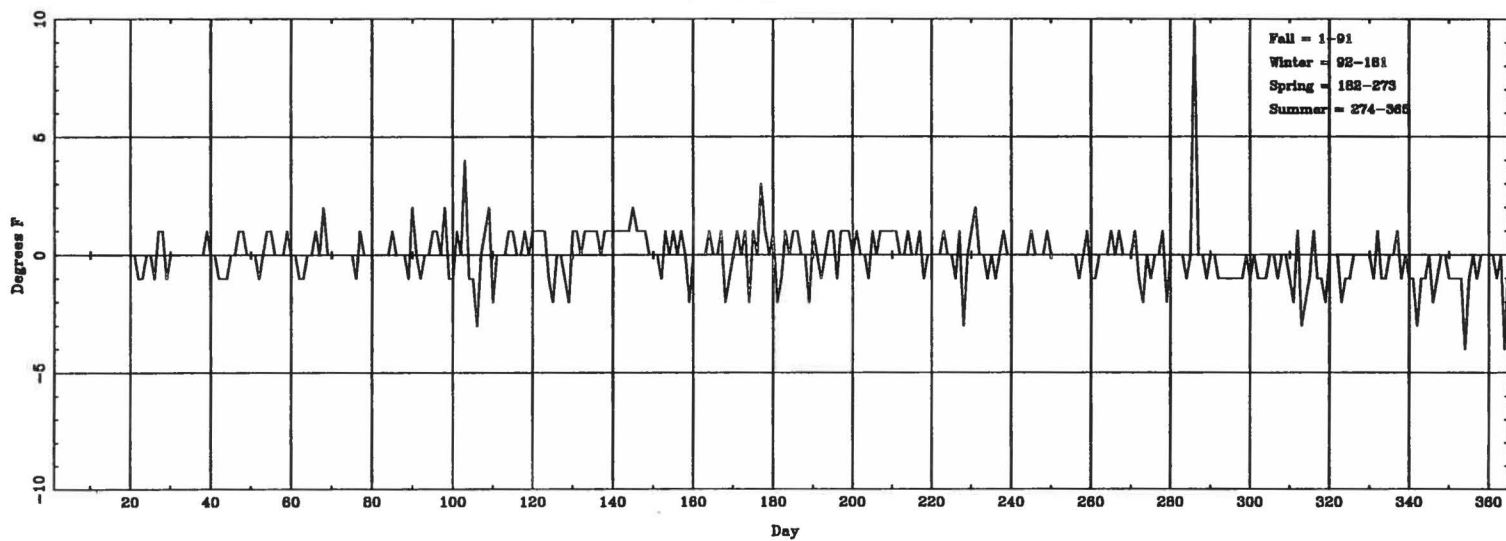

Daily $\Delta T_{(highest\ hourly)}$ (ASOS - CONV) for YNG

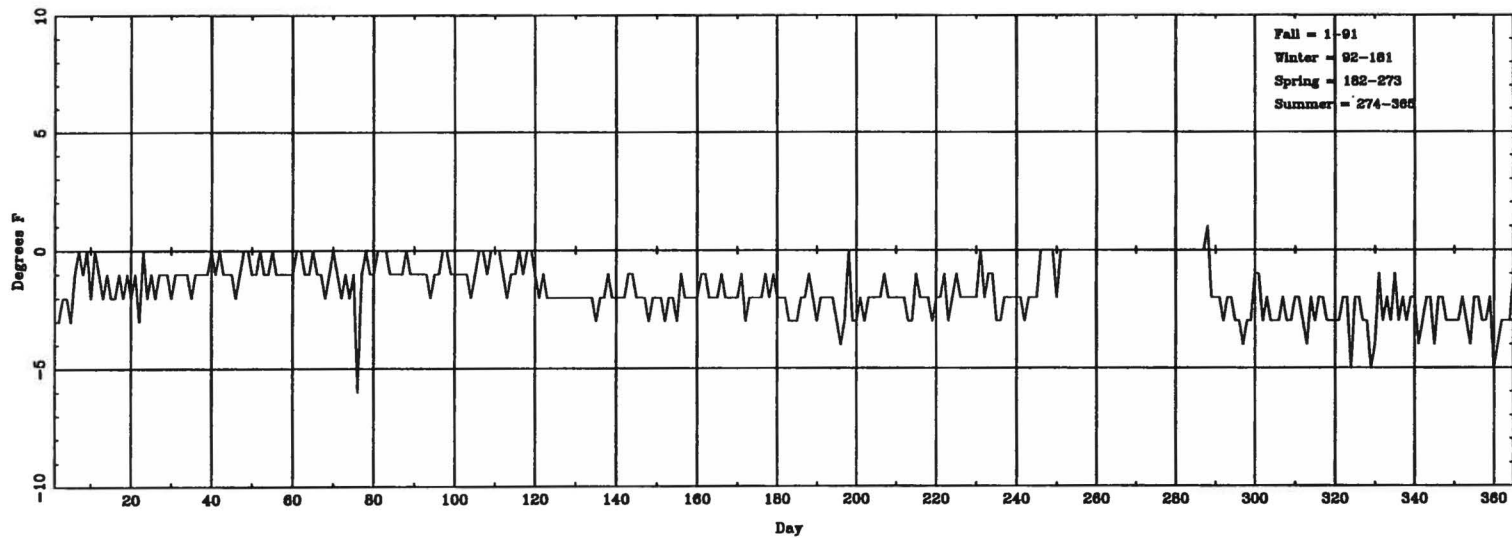

Daily $\Delta T_{(lowest\ hourly)}$ (ASOS - CONV) for YNG

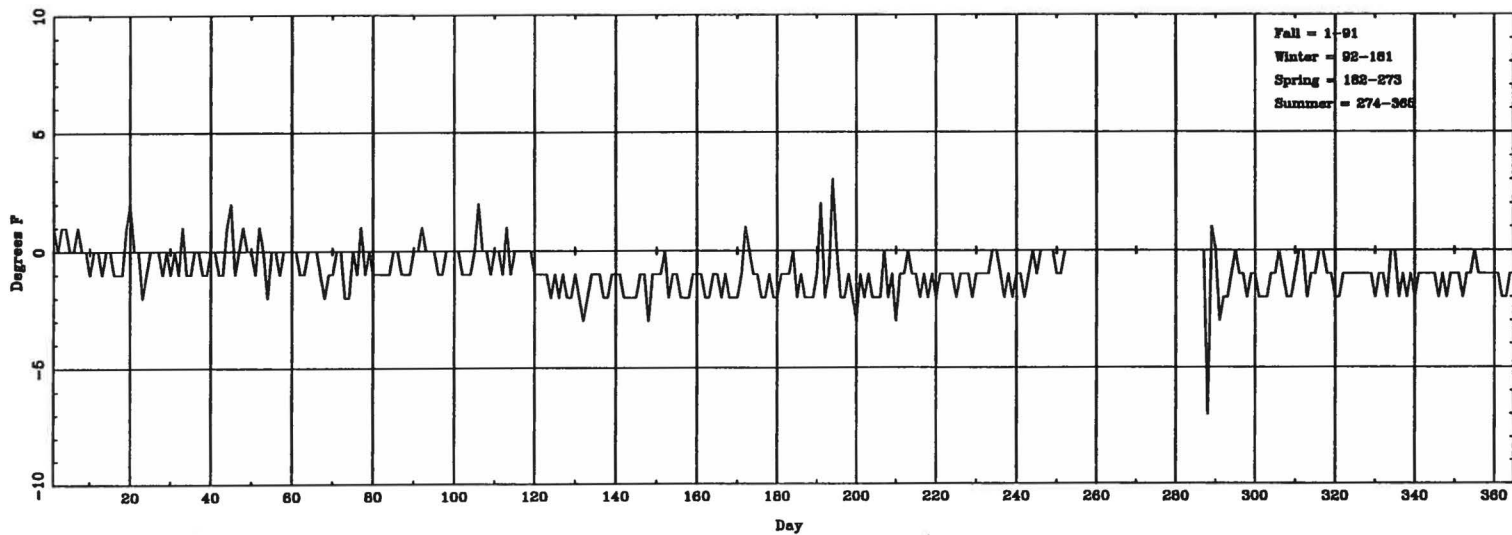

APPENDIX B: Seasonal Diurnal ΔT Cycles

The following graphs depict the seasonal diurnal cycles of temperature difference as a function of the hour of day at each station. The hour of day is plotted in Zulu time at the bottom of each graph with a LST reference plotted above the “0” temperature difference line. Temperature difference is averaged over all hourly values during each season and plotted with a range of $-4^{\circ}\text{F} \leq \Delta T \leq +4^{\circ}\text{F}$ along the y-axis.

Average Diurnal Cycle for ABE - fall
LST = Zulu - 5

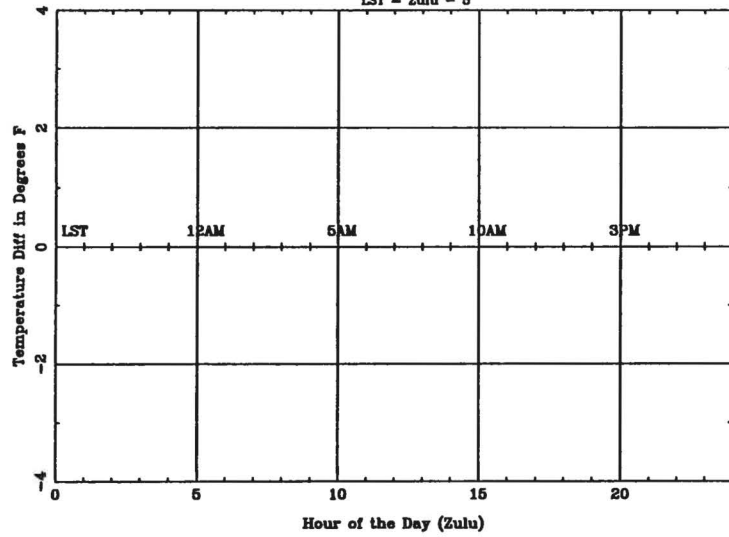

Average Diurnal Cycle for ABE - winter
LST = Zulu - 5

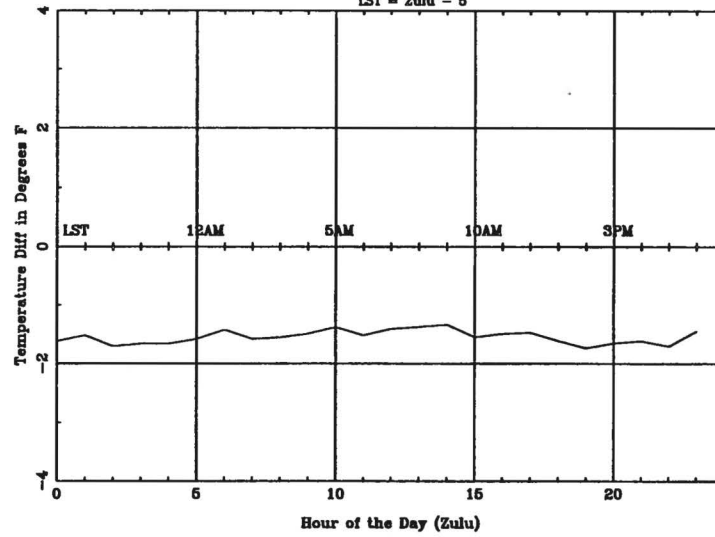

Average Diurnal Cycle for ABE - spring
LST = Zulu - 5

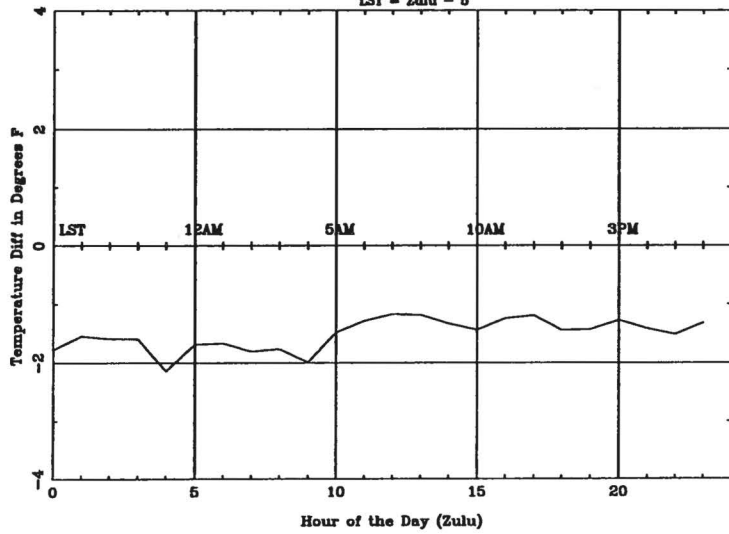

Average Diurnal Cycle for ABE - summer
LST = Zulu - 5

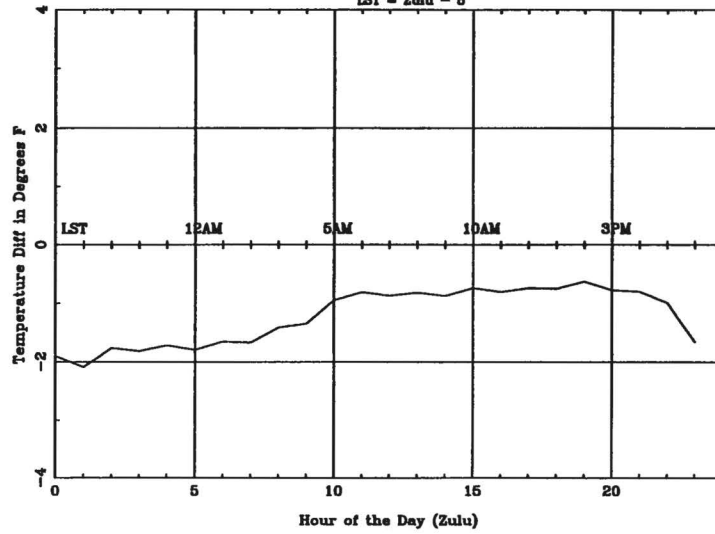

Average Diurnal Cycle for ABQ - fall
LST = Zulu - 7

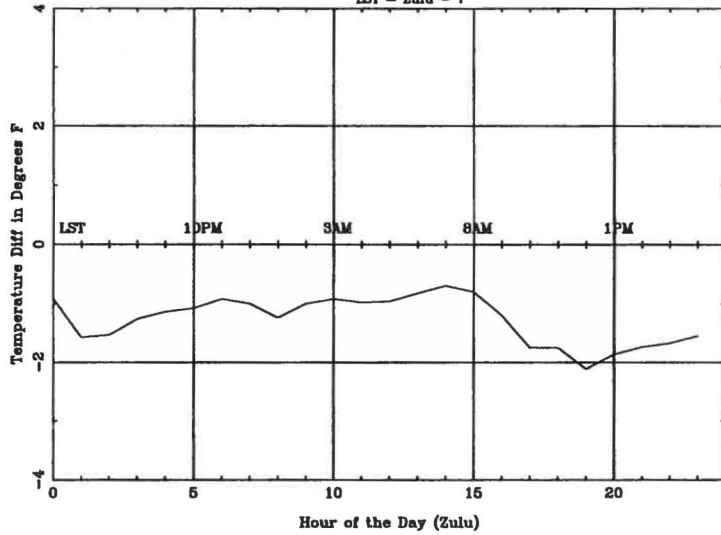

Average Diurnal Cycle for ABQ - winter
LST = Zulu - 7

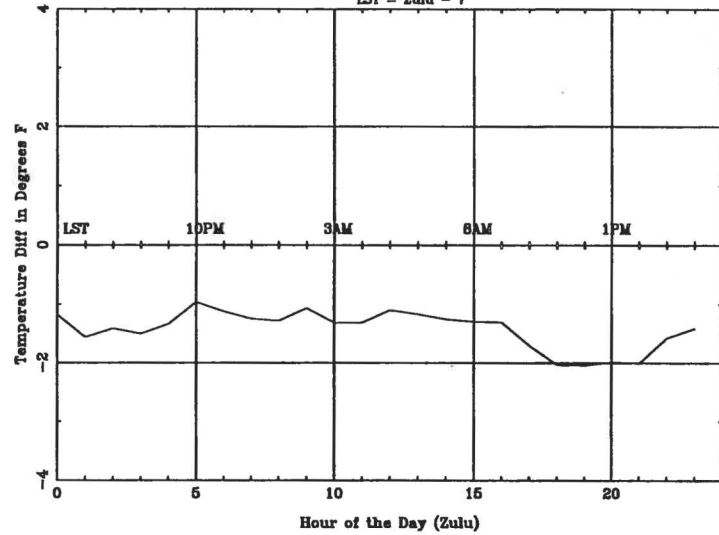

Average Diurnal Cycle for ABQ - spring
LST = Zulu - 7

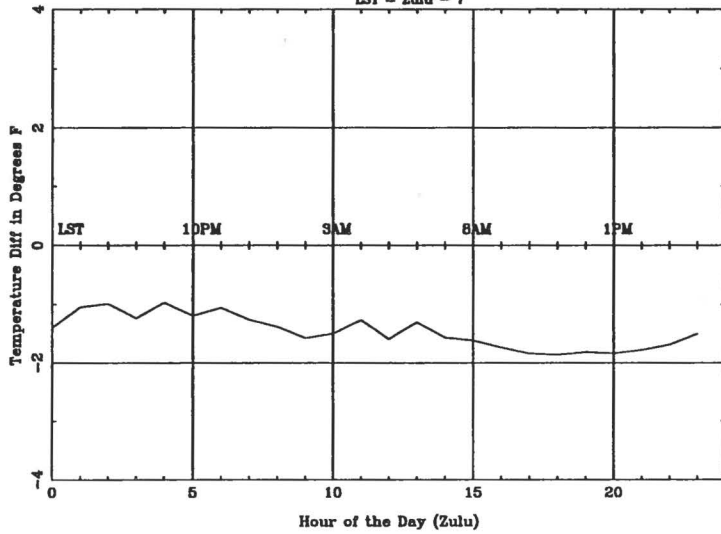

Average Diurnal Cycle for ABQ - summer
LST = Zulu - 7

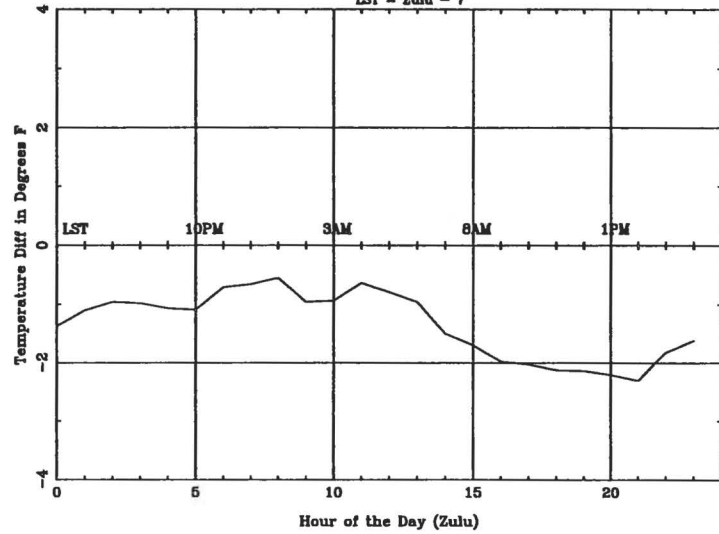

Average Diurnal Cycle for ACY - fall
LST = Zulu - 5

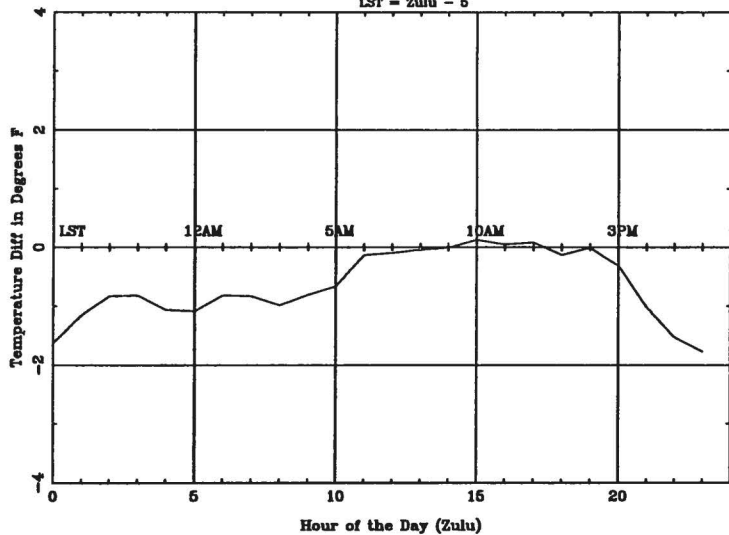

Average Diurnal Cycle for ACY - winter
LST = Zulu - 5

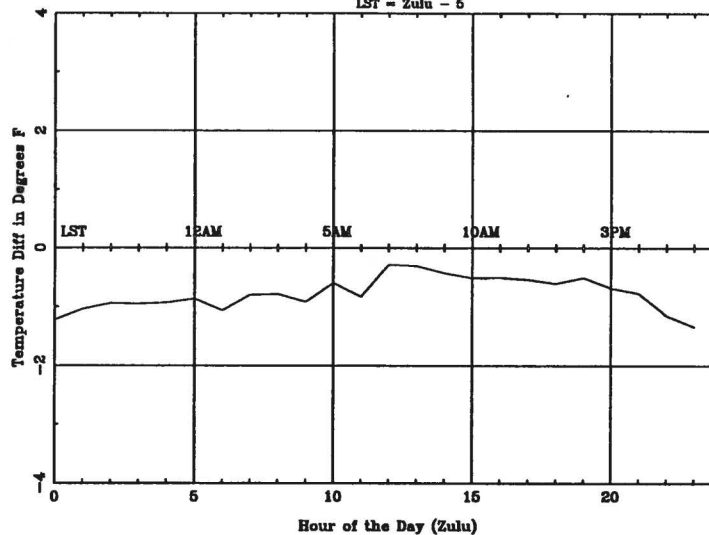

Average Diurnal Cycle for ACY - spring
LST = Zulu - 5

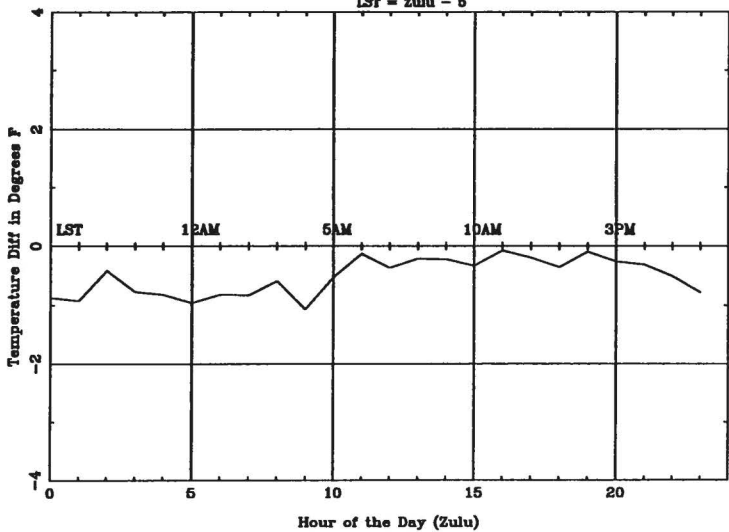

Average Diurnal Cycle for ACY - summer
LST = Zulu - 5

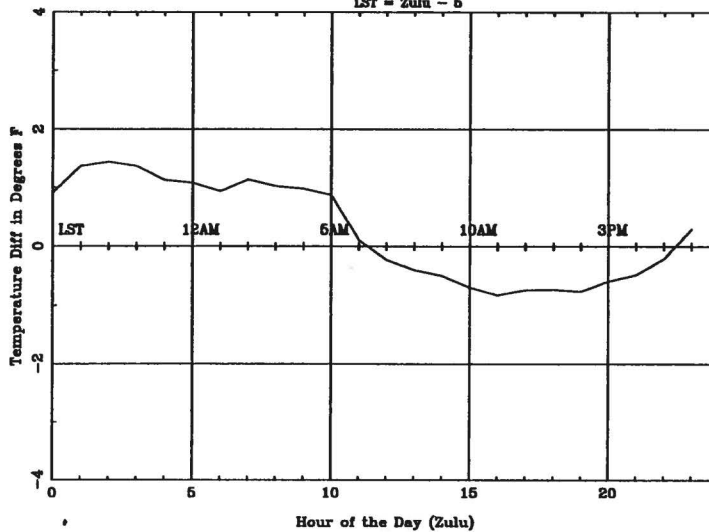

Average Diurnal Cycle for ALB - fall

LST = Zulu - 5

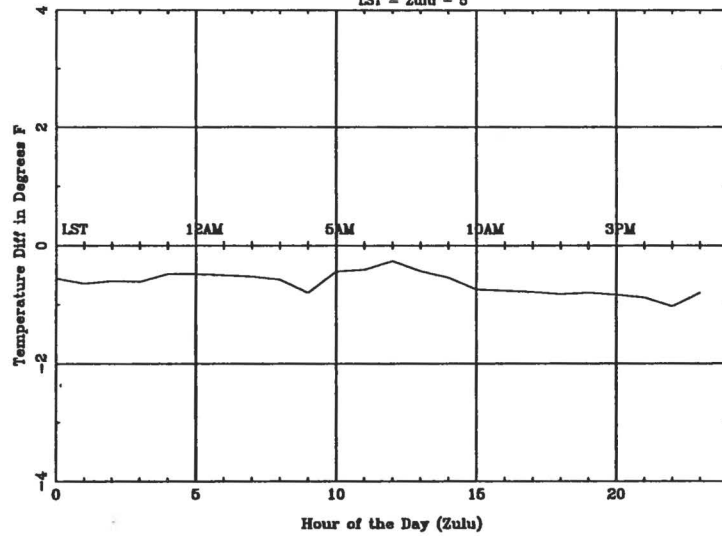

Average Diurnal Cycle for ALB - winter

LST = Zulu - 5

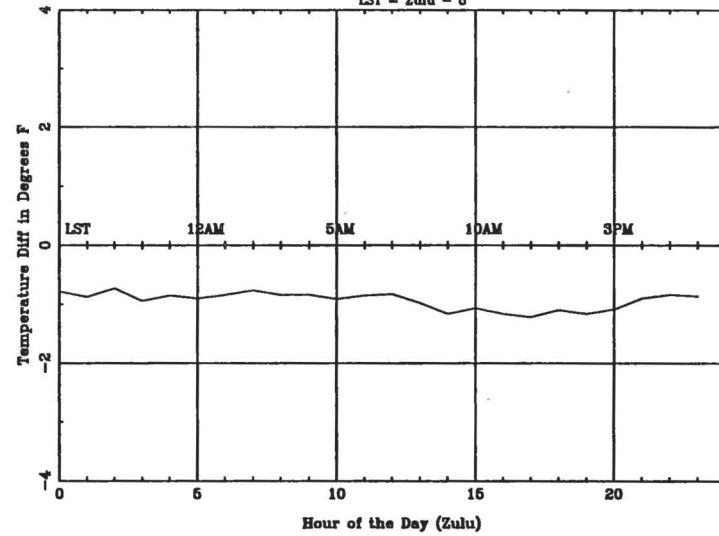

Average Diurnal Cycle for ALB - spring

LST = Zulu - 5

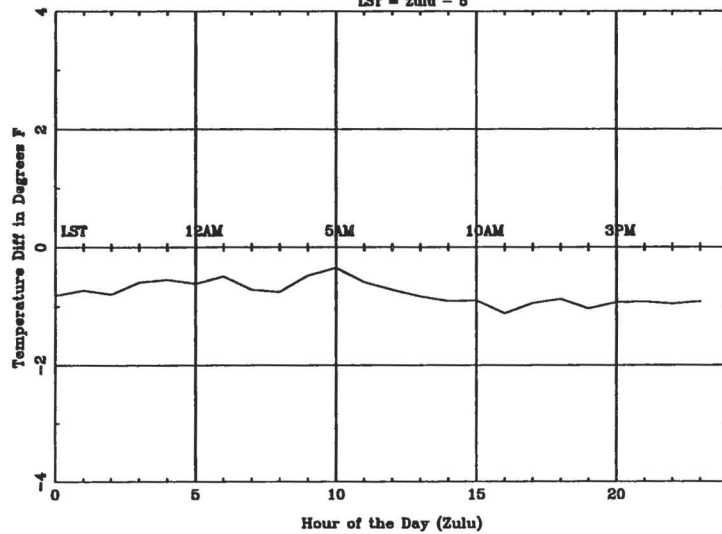

Average Diurnal Cycle for ALB - summer

LST = Zulu - 5

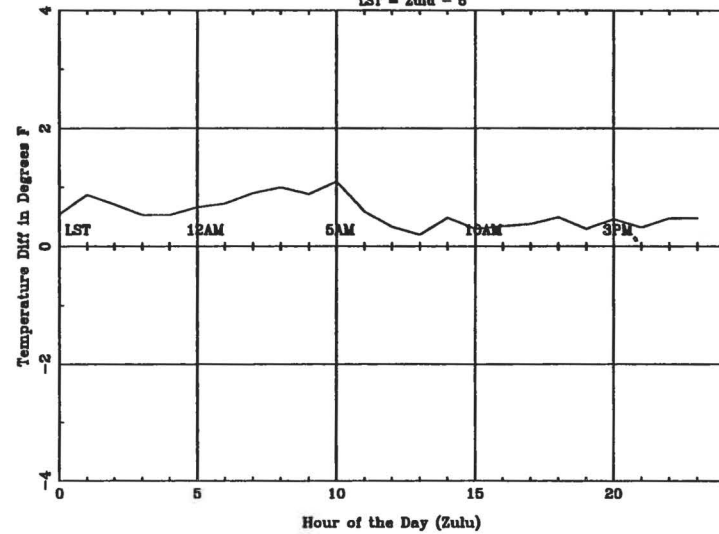

Average Diurnal Cycle for ALO - fall

LST = Zulu - 6

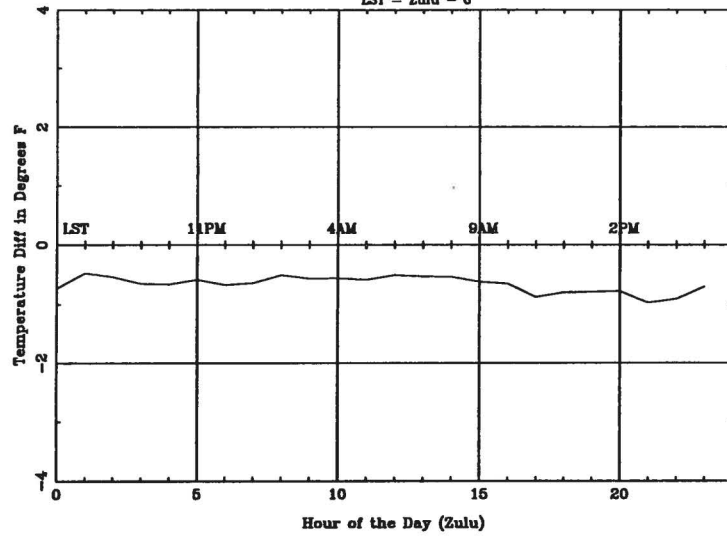

Average Diurnal Cycle for ALO - winter

LST = Zulu - 6

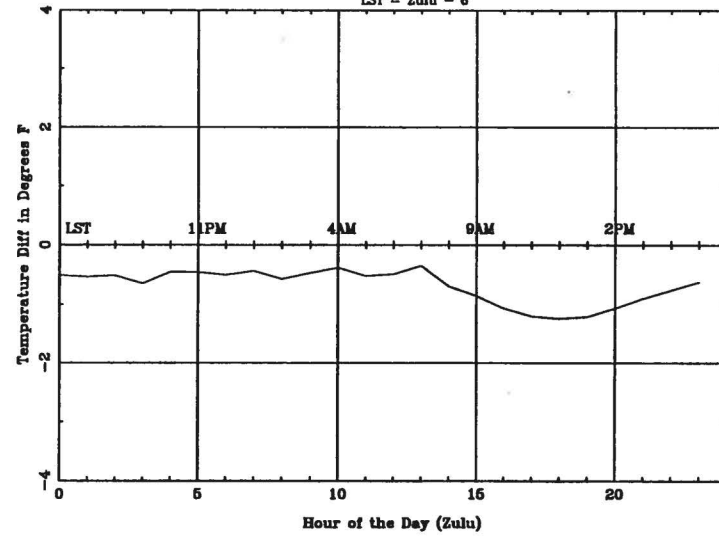

Average Diurnal Cycle for ALO - spring

LST = Zulu - 6

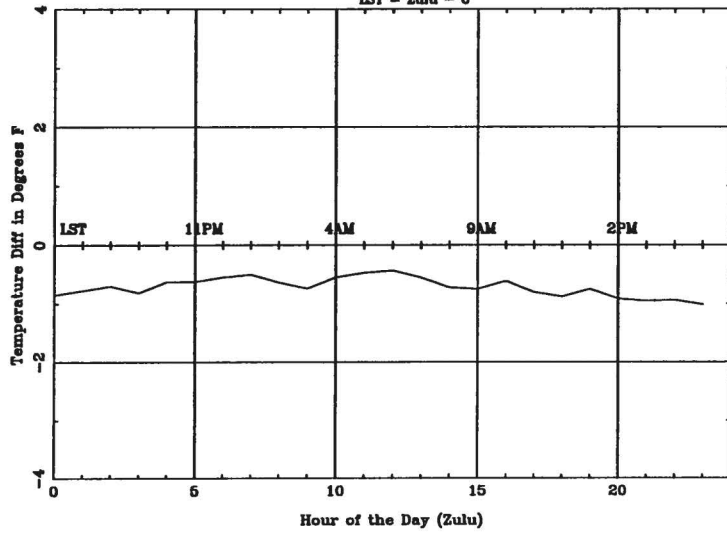

Average Diurnal Cycle for ALO - summer

LST = Zulu - 6

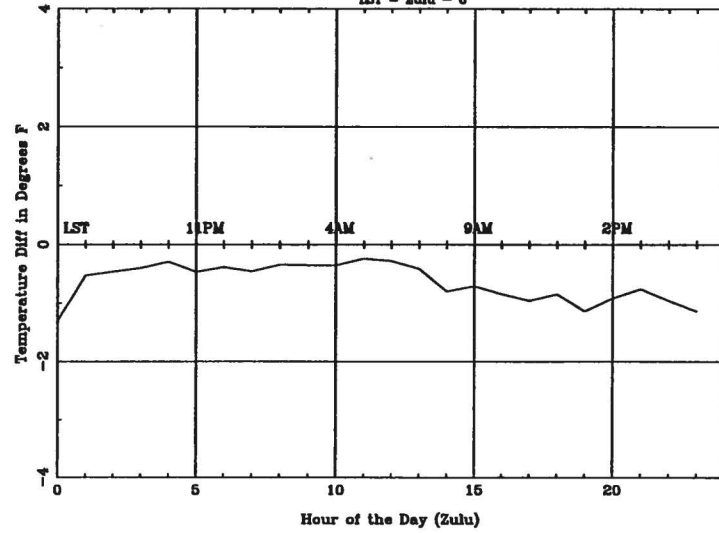

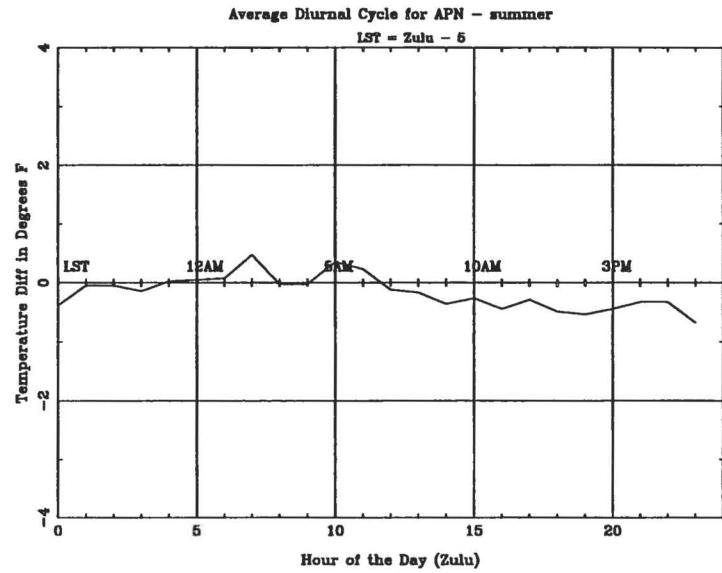
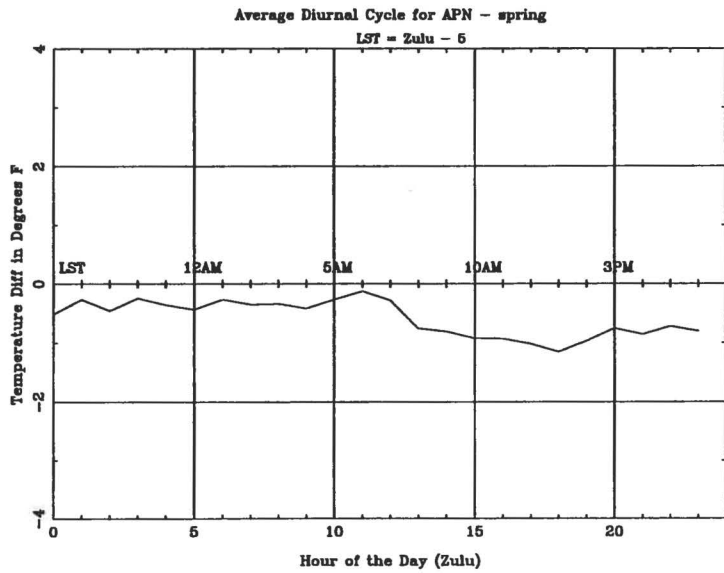
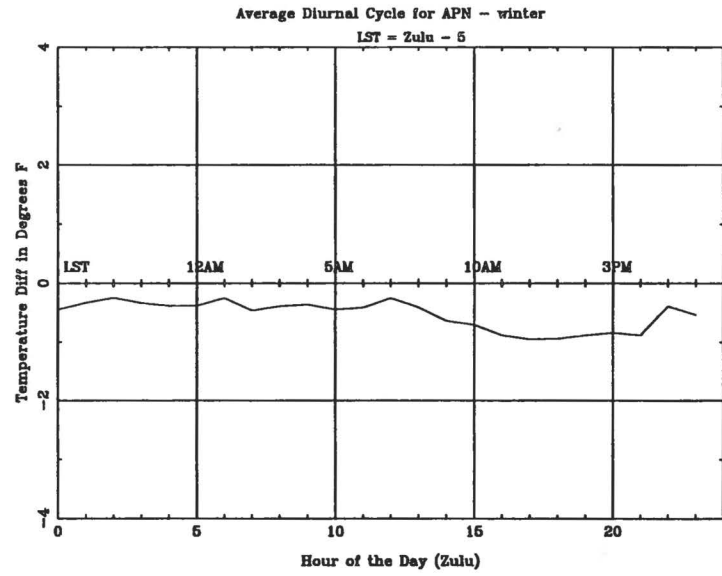
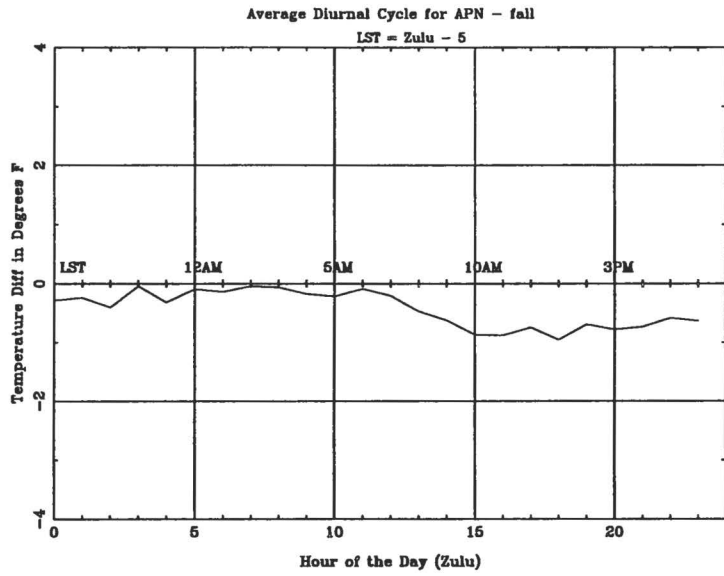

Average Diurnal Cycle for ATL - fall

LST = Zulu - 5

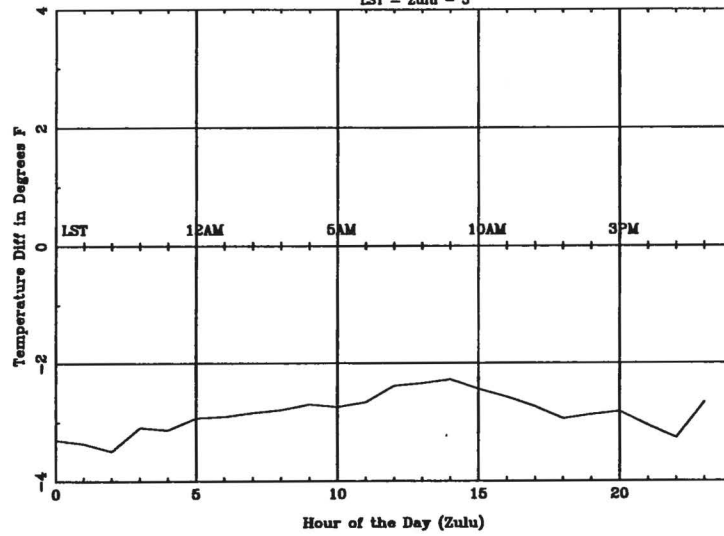

Average Diurnal Cycle for ATL - winter

LST = Zulu - 5

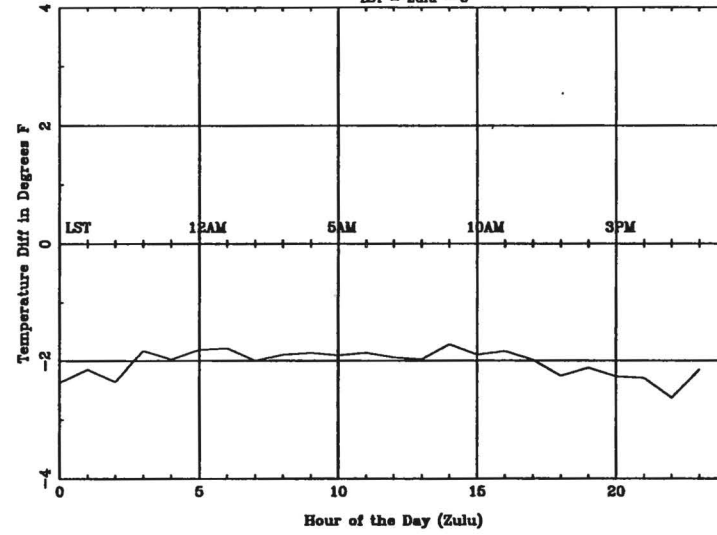

Average Diurnal Cycle for ATL - spring

LST = Zulu - 5

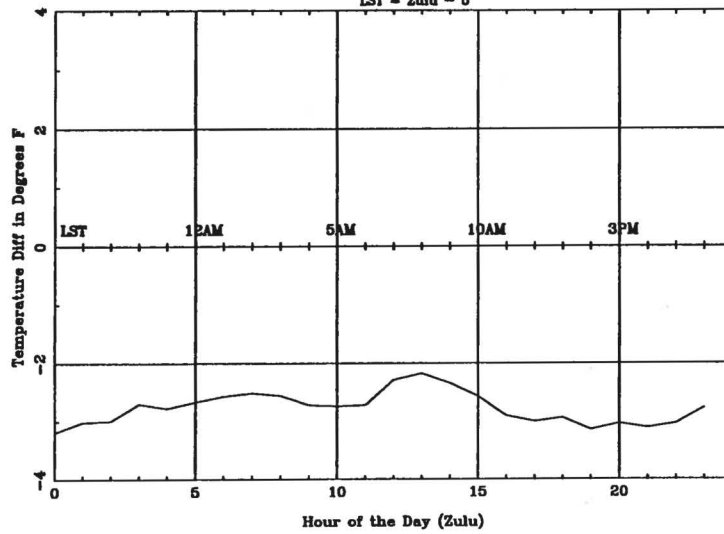

Average Diurnal Cycle for ATL - summer

LST = Zulu - 5

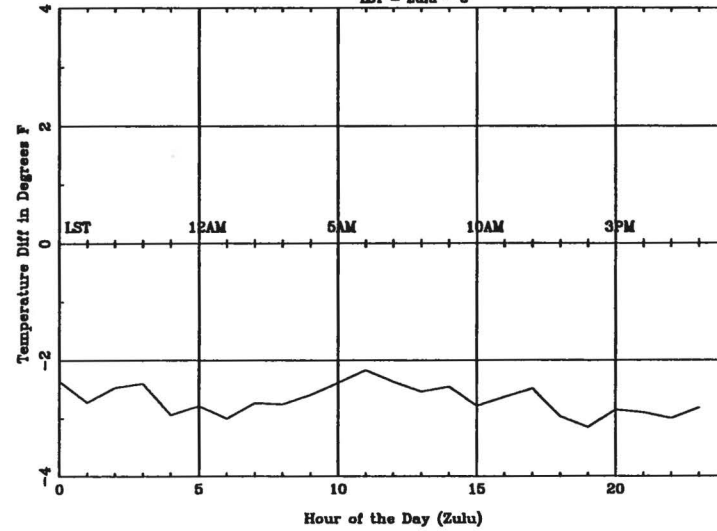

Average Diurnal Cycle for AUS - fall
LST = Zulu - 6

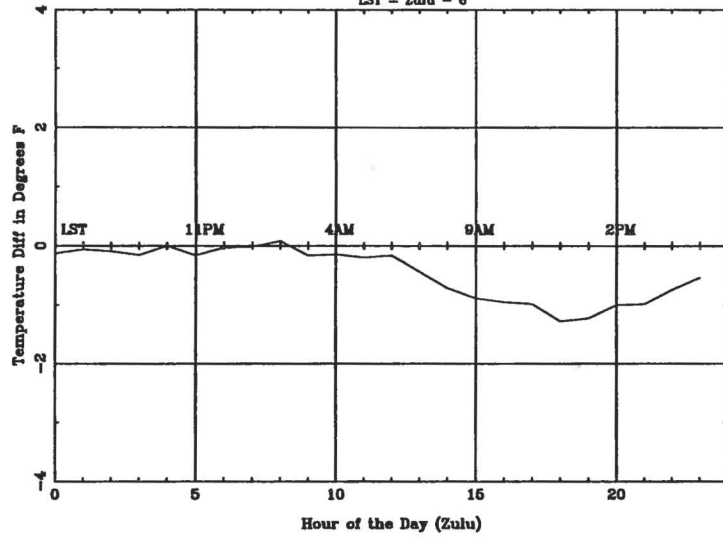

Average Diurnal Cycle for AUS - winter
LST = Zulu - 6

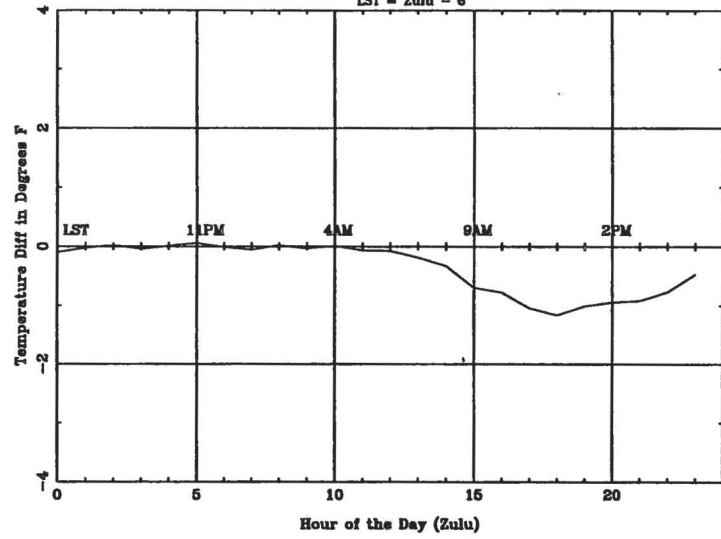

Average Diurnal Cycle for AUS - spring
LST = Zulu - 6

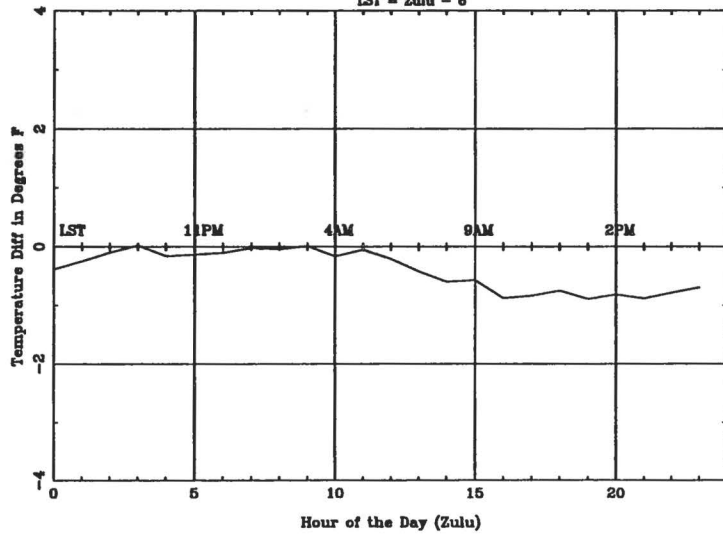

Average Diurnal Cycle for AUS - summer
LST = Zulu - 6

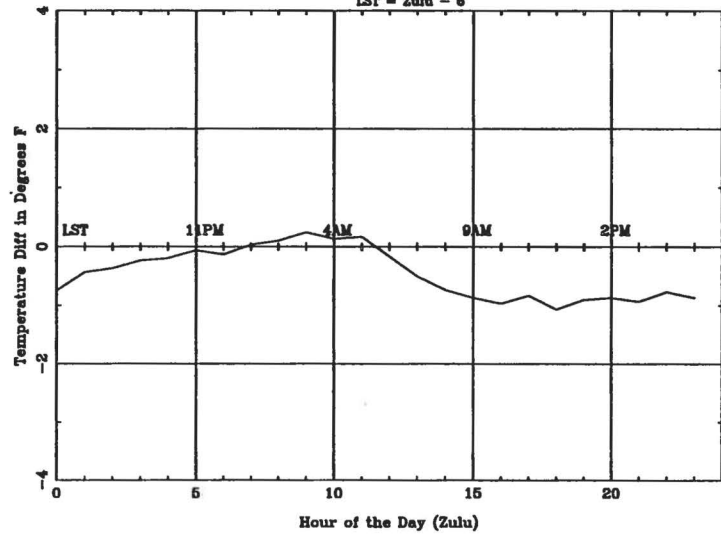

Average Diurnal Cycle for BFF - fall

LST = Zulu - 7

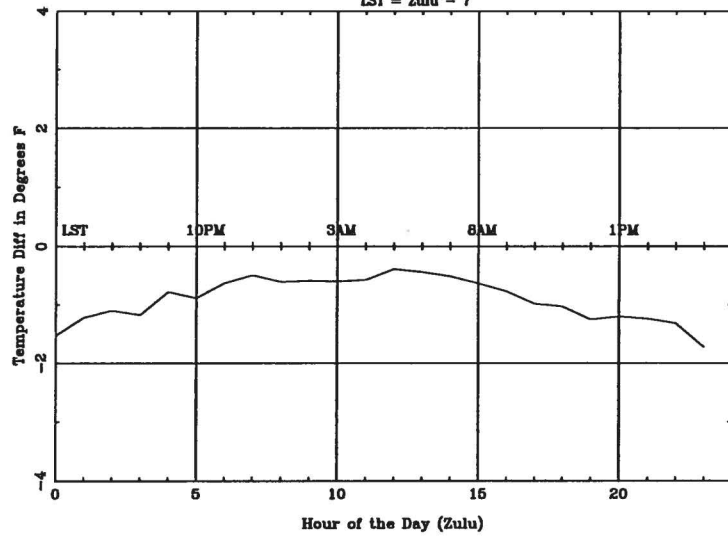

Average Diurnal Cycle for BFF - winter

LST = Zulu - 7

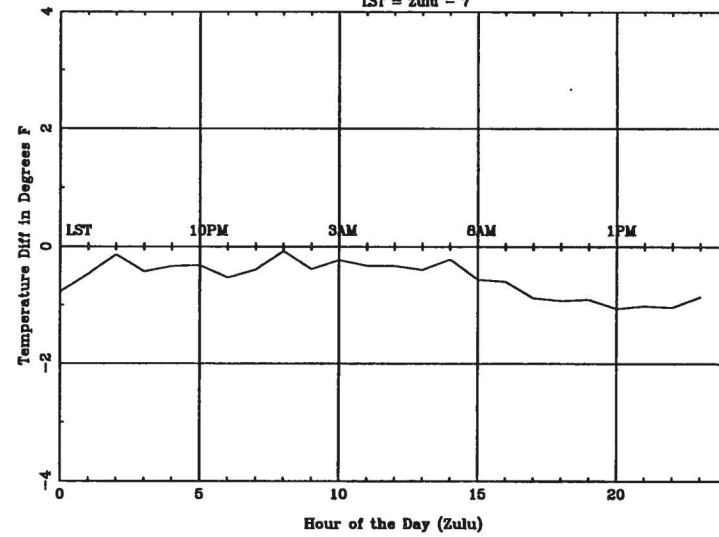

Average Diurnal Cycle for BFF - spring

LST = Zulu - 7

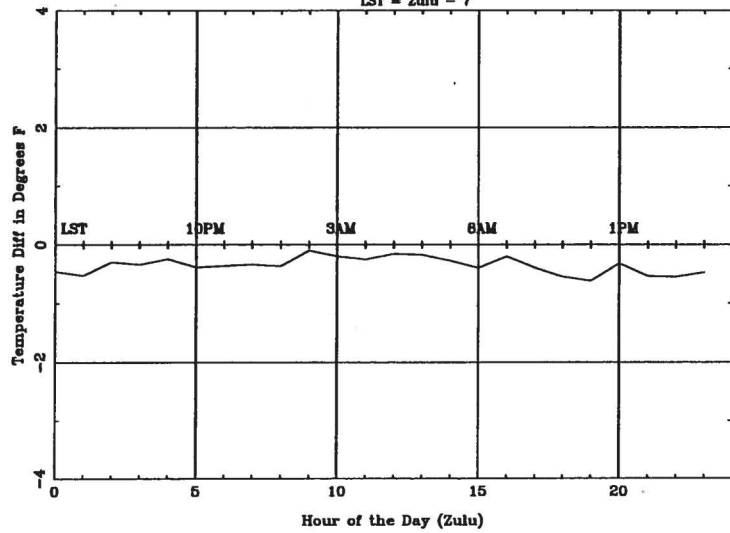

Average Diurnal Cycle for BFF - summer

LST = Zulu - 7

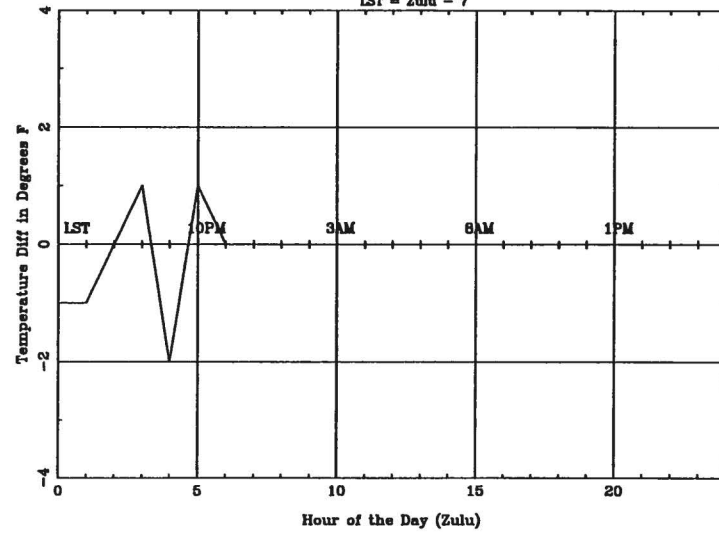

Average Diurnal Cycle for BGM - fall
LST = Zulu - 5

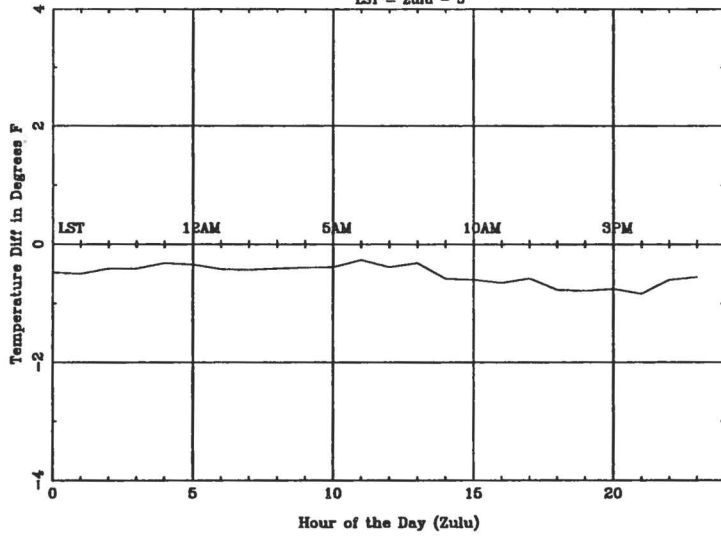

Average Diurnal Cycle for BGM - winter
LST = Zulu - 5

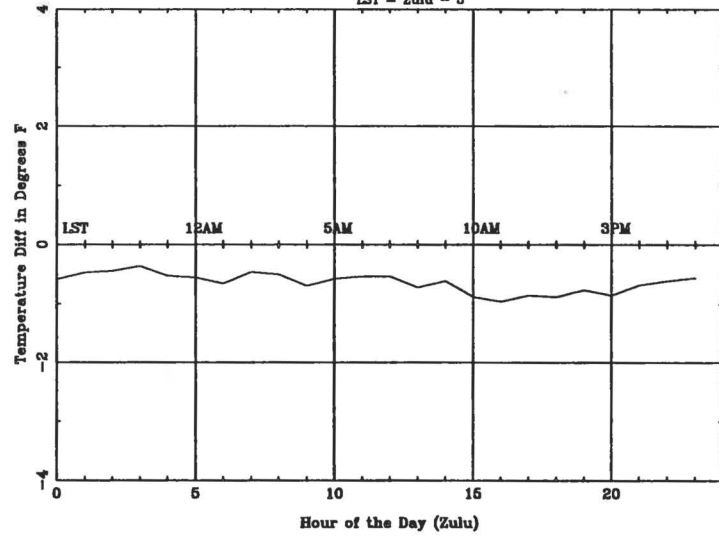

Average Diurnal Cycle for BGM - spring
LST = Zulu - 5

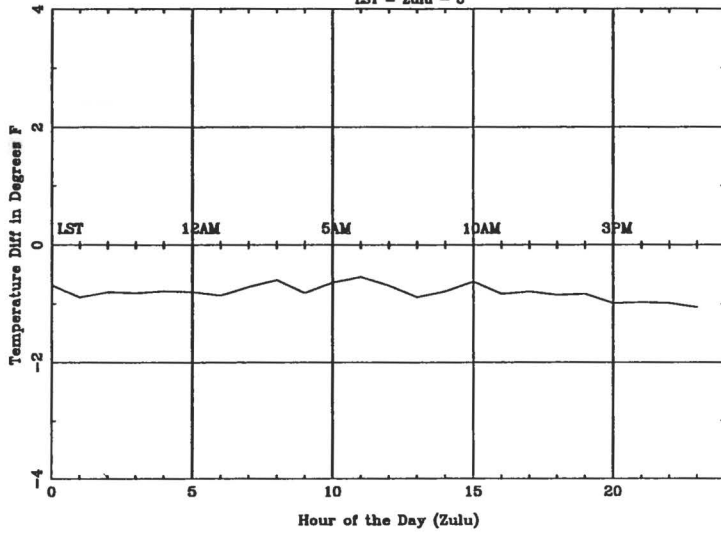

Average Diurnal Cycle for BGM - summer
LST = Zulu - 5

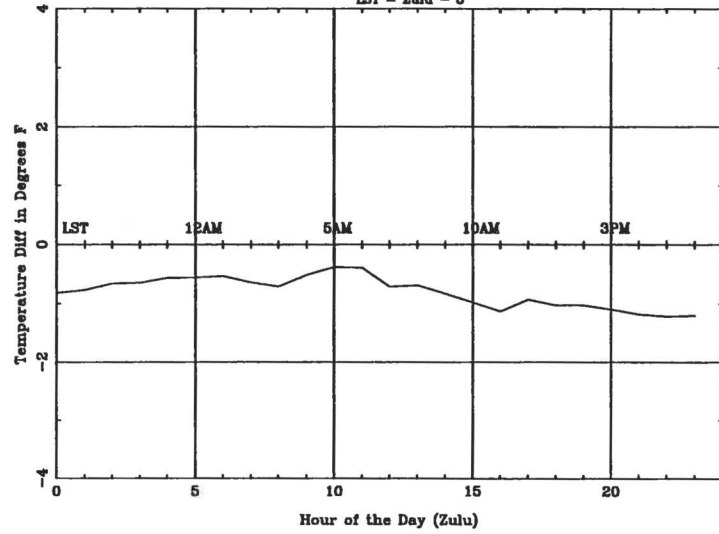

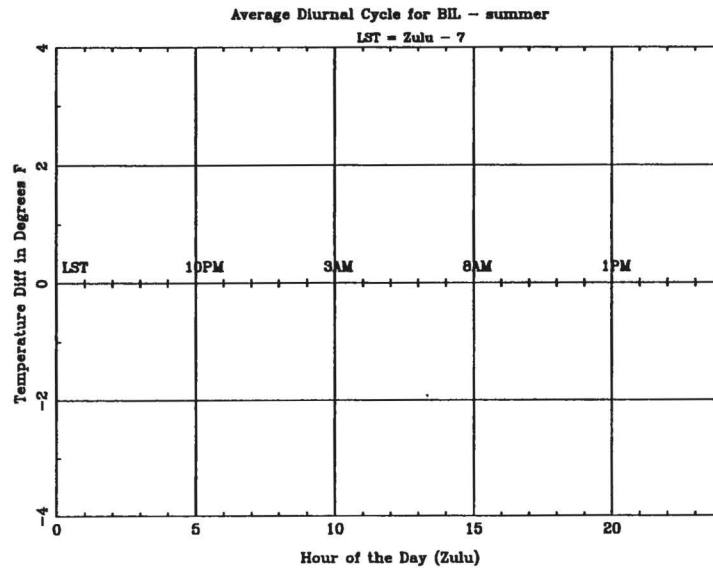
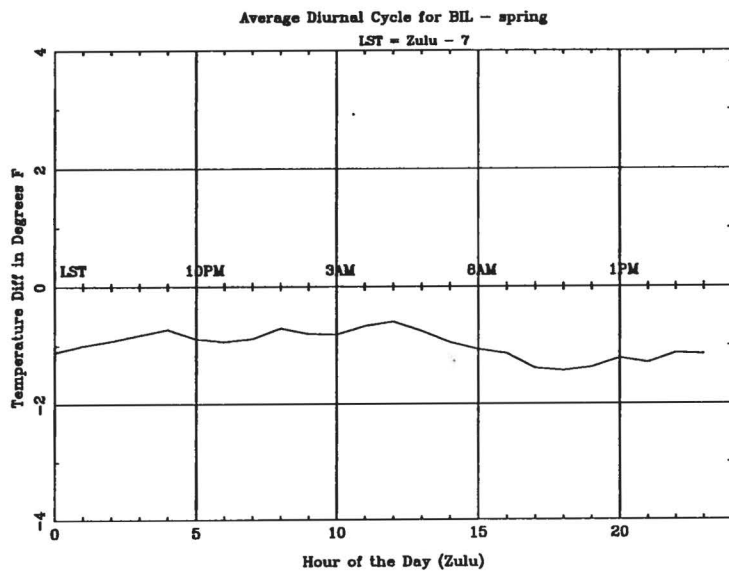
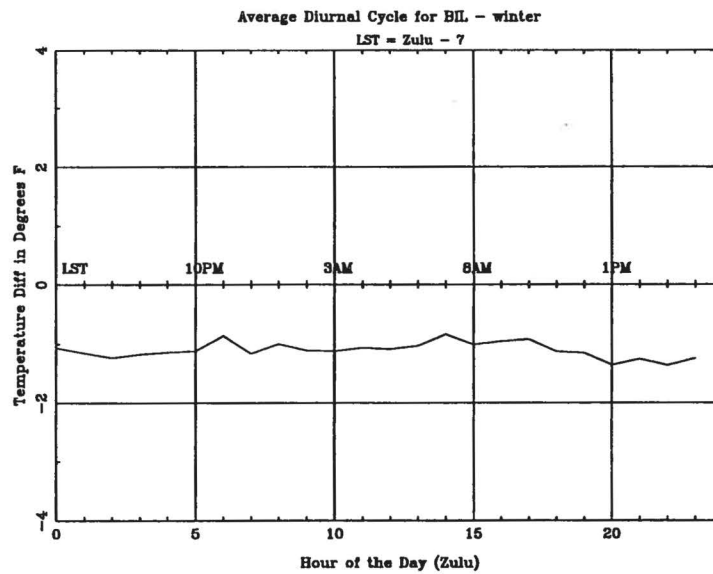
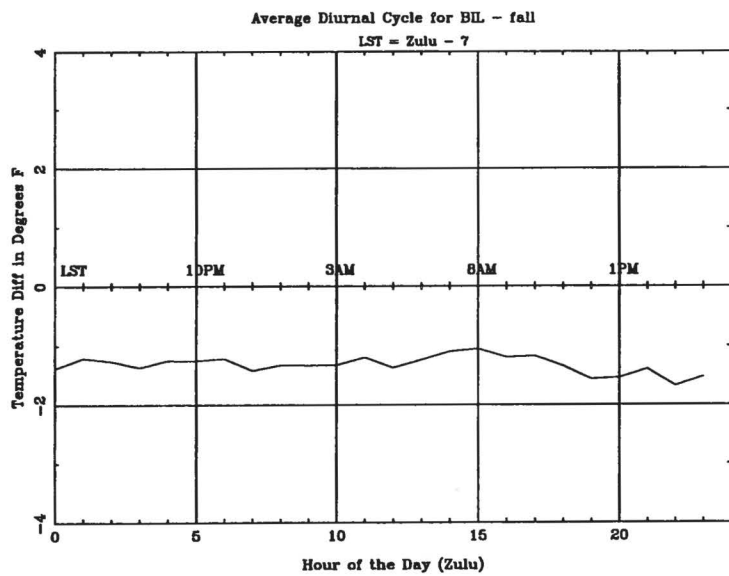

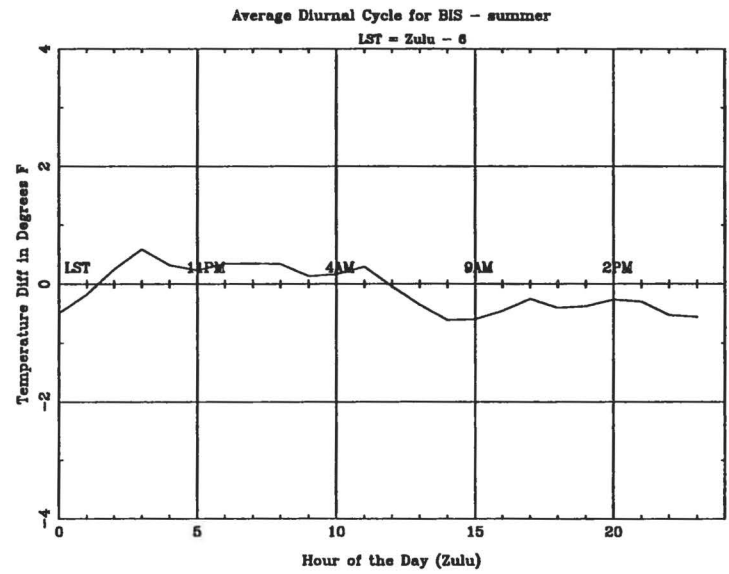
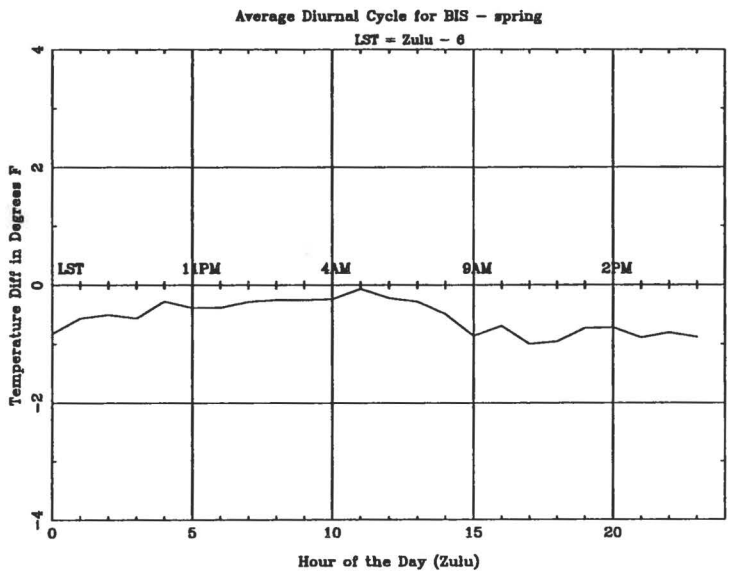
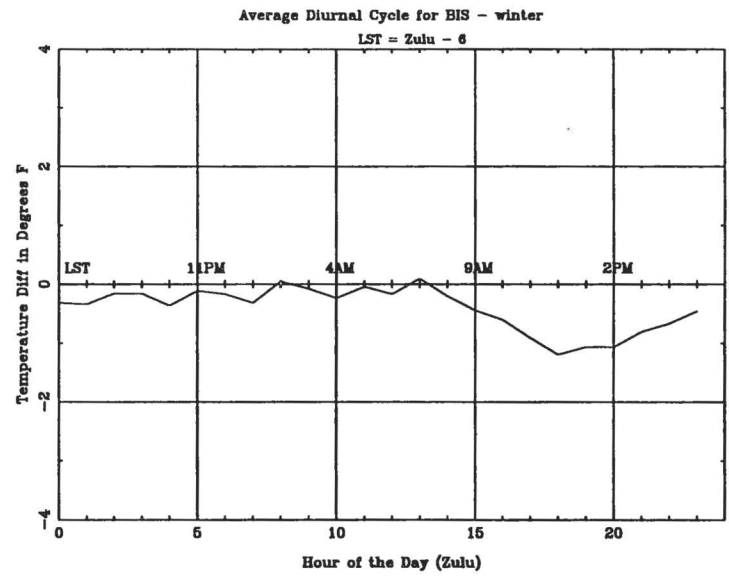
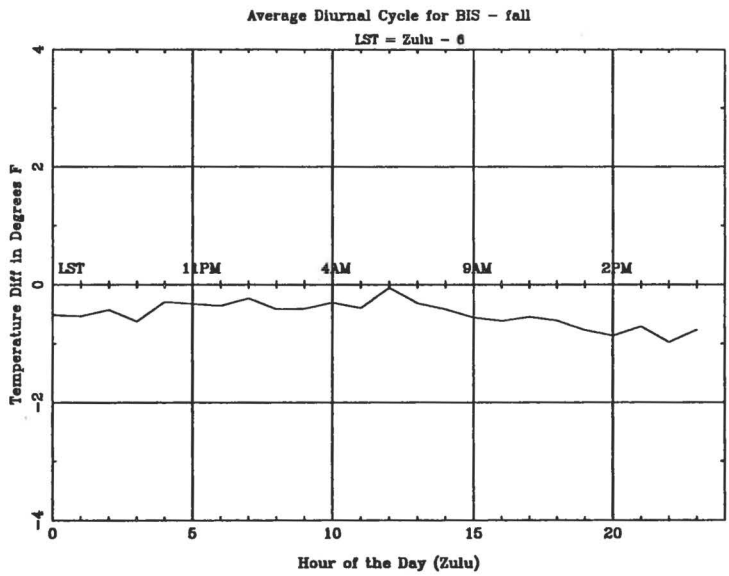

Average Diurnal Cycle for CAE - fall

LST = Zulu - 5

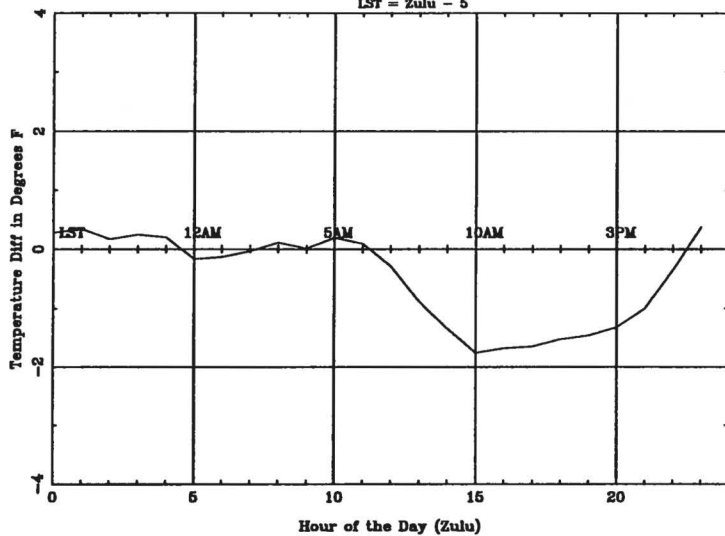

Average Diurnal Cycle for CAE - winter

LST = Zulu - 5

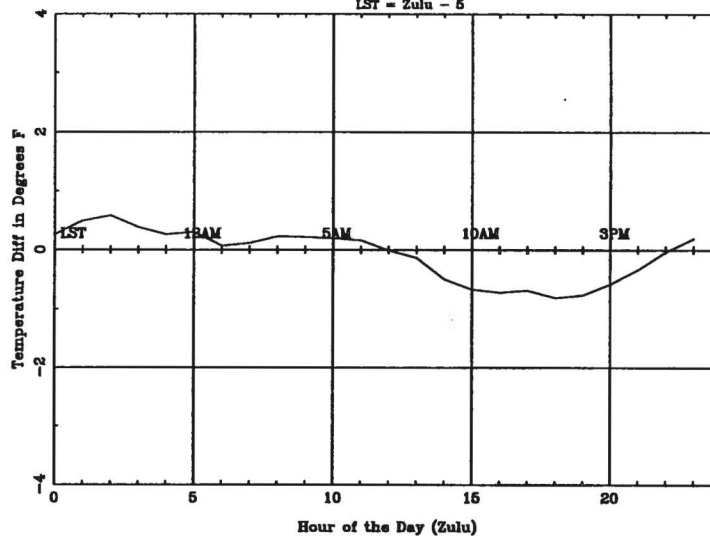

Average Diurnal Cycle for CAE - spring

LST = Zulu - 5

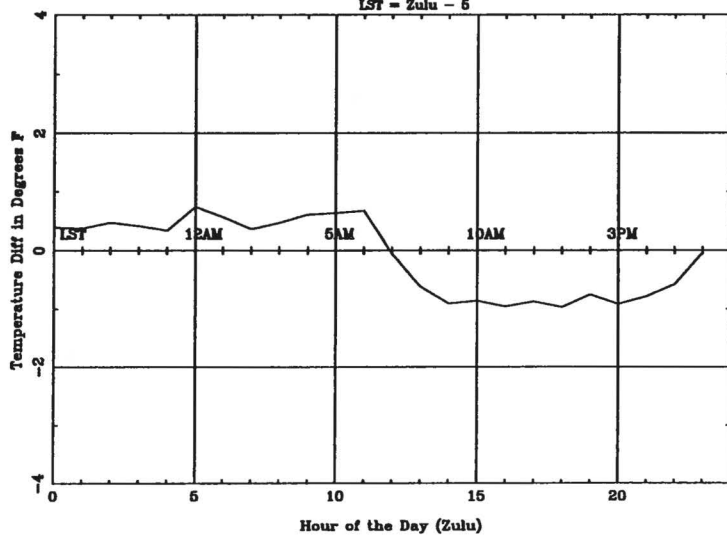

Average Diurnal Cycle for CAE - summer

LST = Zulu - 5

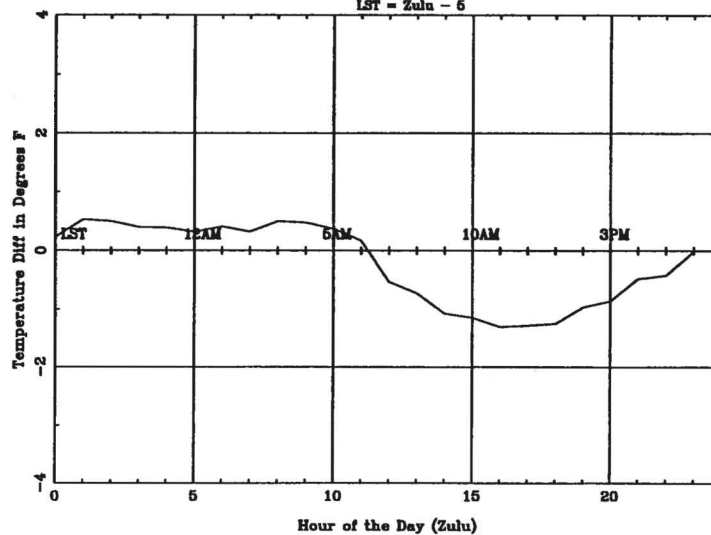

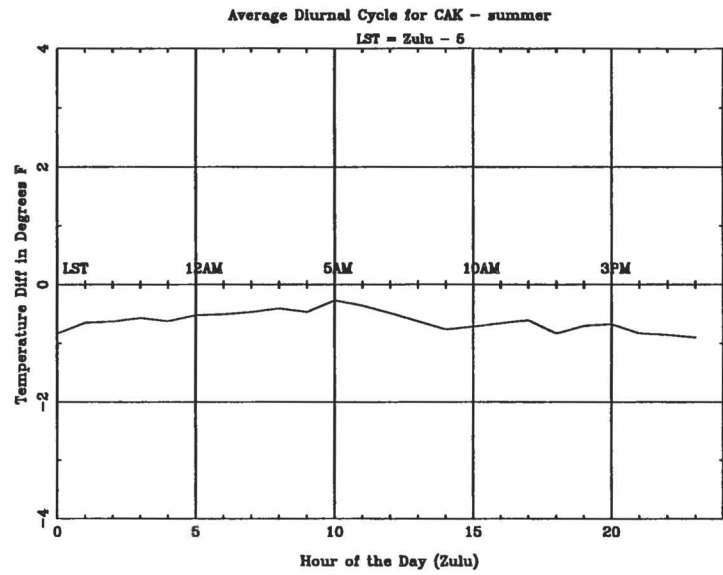
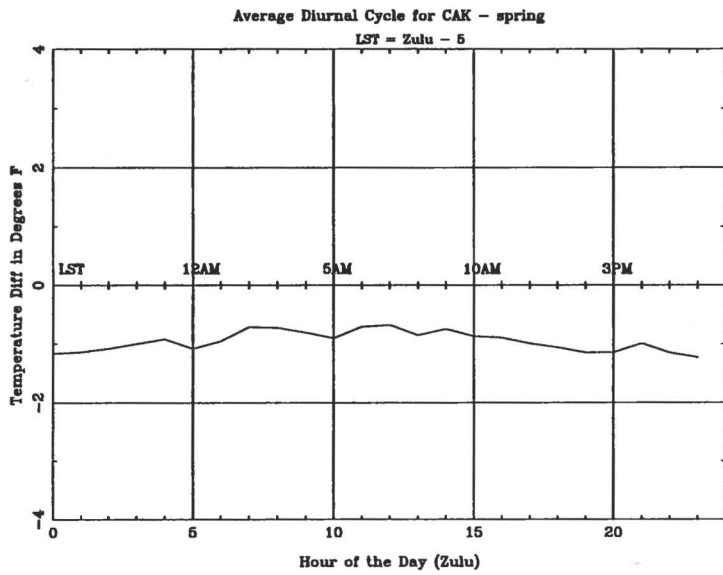
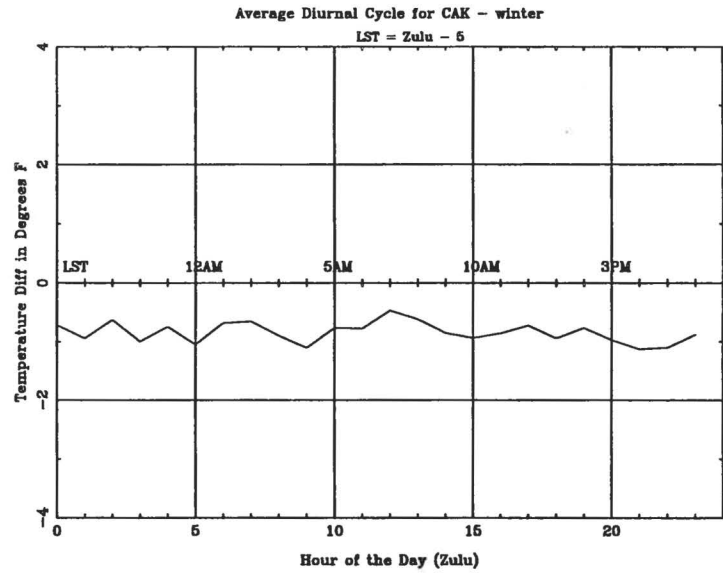
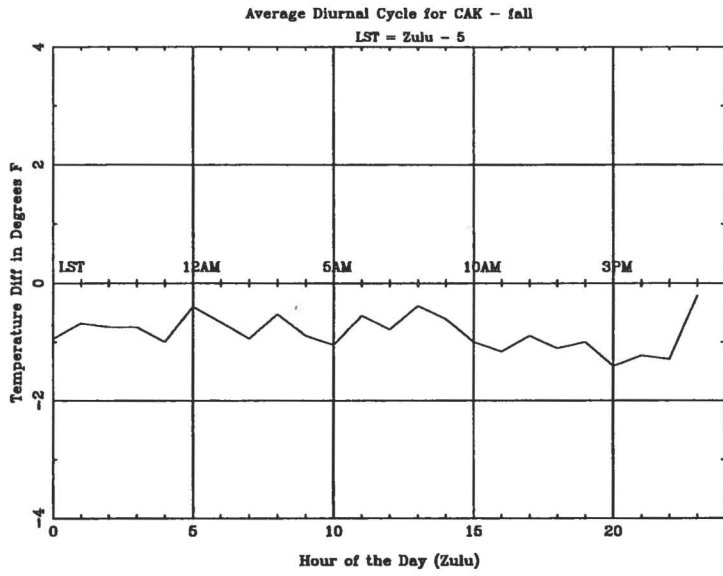

Average Diurnal Cycle for CLE - fall

LST = Zulu - 5

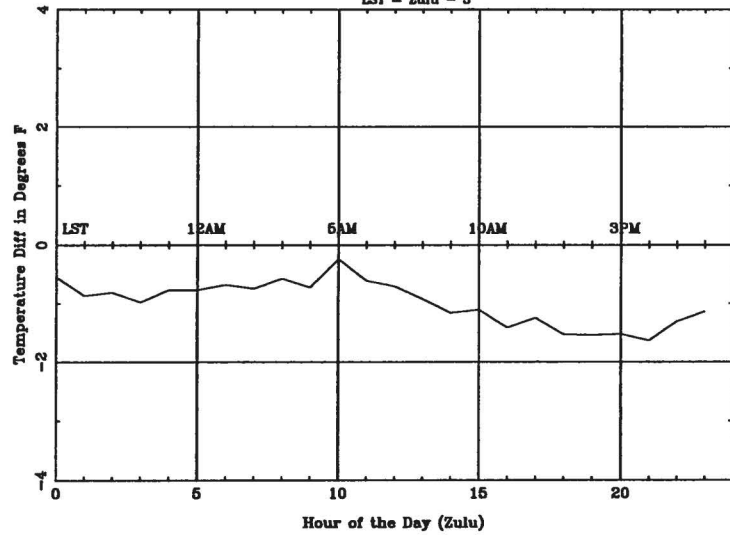

Average Diurnal Cycle for CLE - winter

LST = Zulu - 5

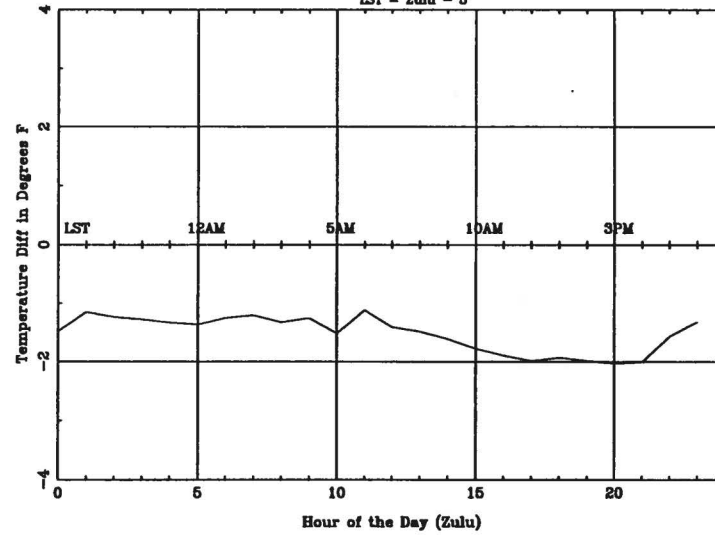

Average Diurnal Cycle for CLE - spring

LST = Zulu - 5

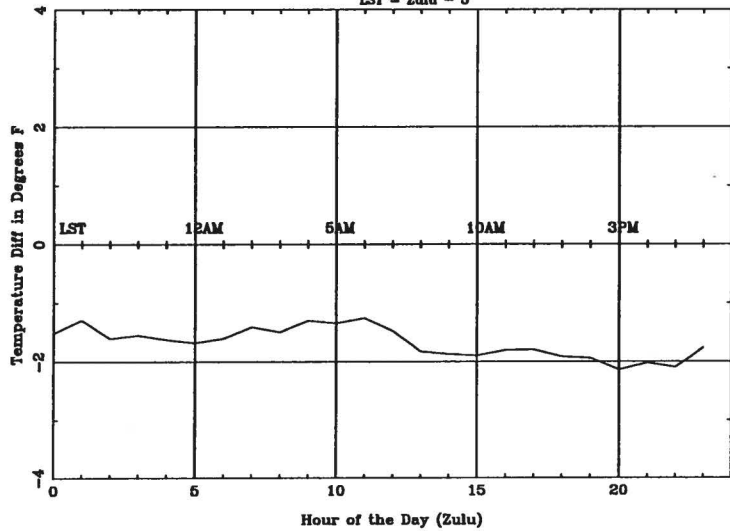

Average Diurnal Cycle for CLE - summer

LST = Zulu - 5

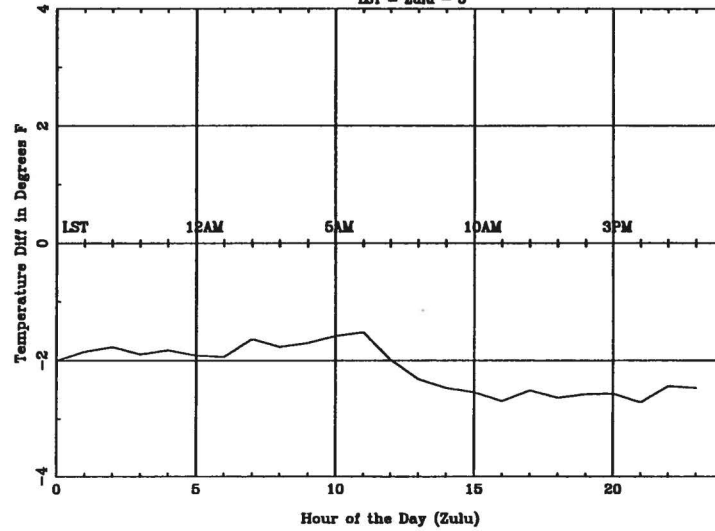

Average Diurnal Cycle for COU - fall

LST = Zulu - 6

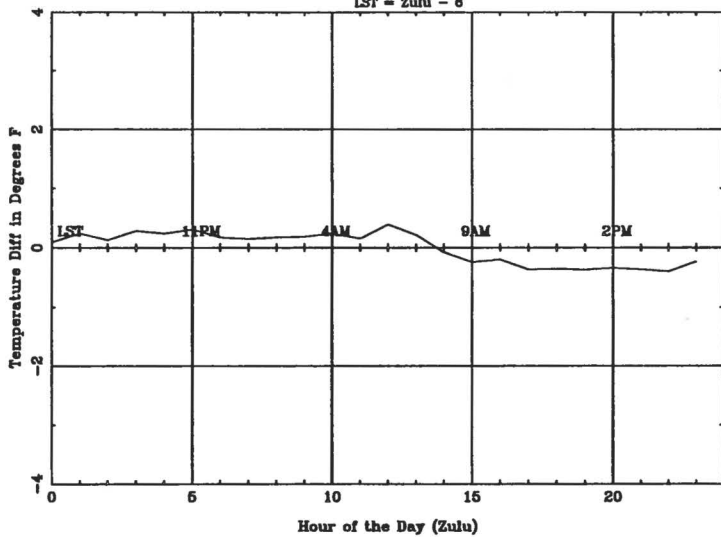

Average Diurnal Cycle for COU - winter

LST = Zulu - 6

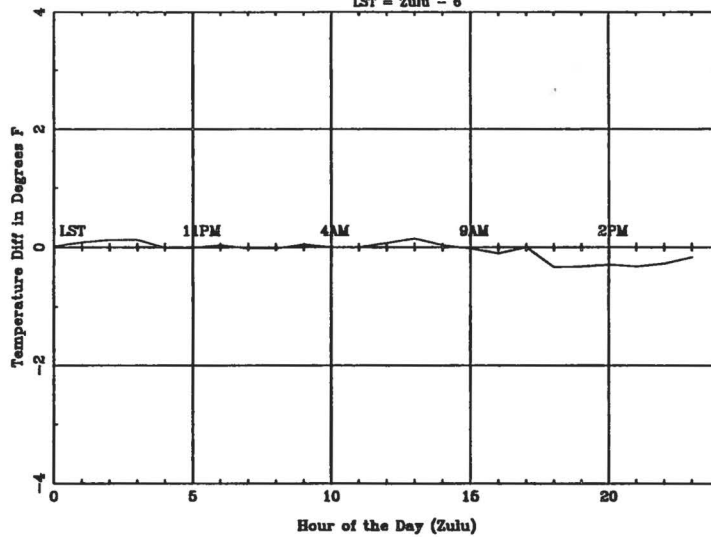

Average Diurnal Cycle for COU - spring

LST = Zulu - 6

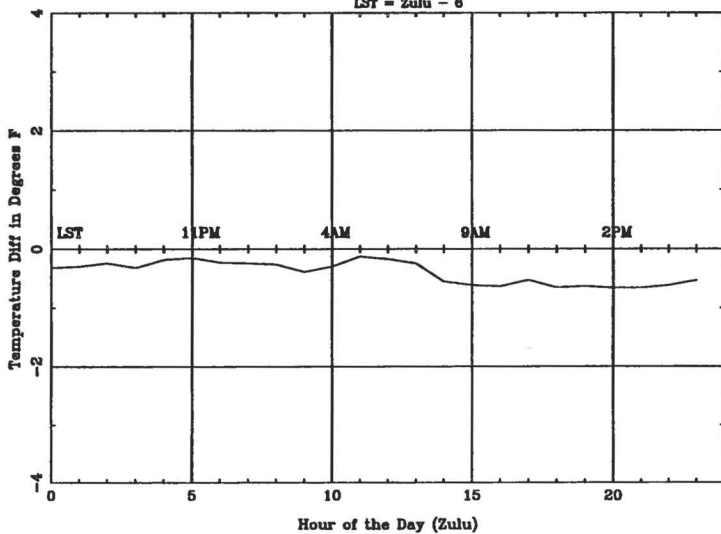

Average Diurnal Cycle for COU - summer

LST = Zulu - 6

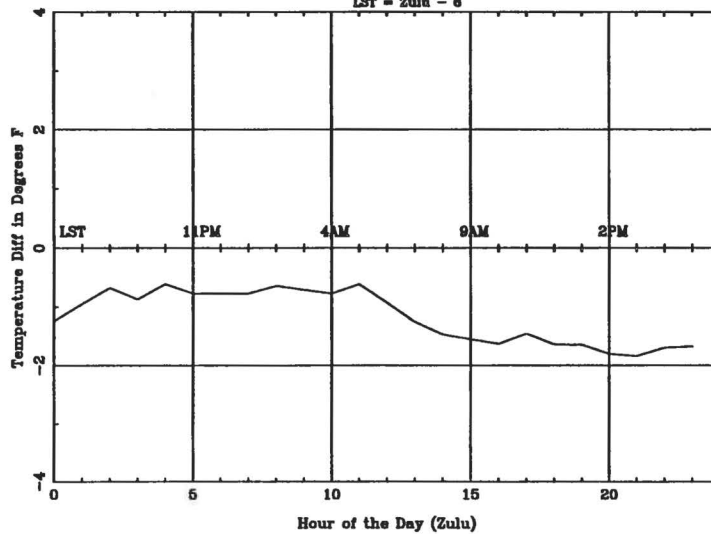

Average Diurnal Cycle for CYS - fall
LST = Zulu - 7

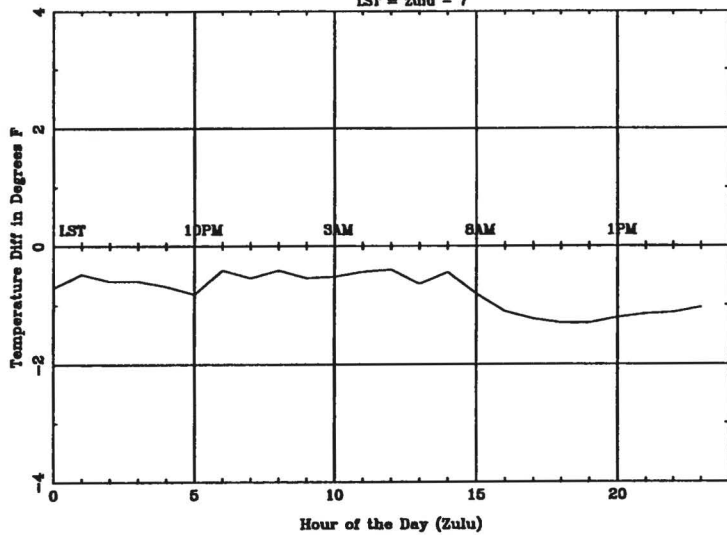

Average Diurnal Cycle for CYS - winter
LST = Zulu - 7

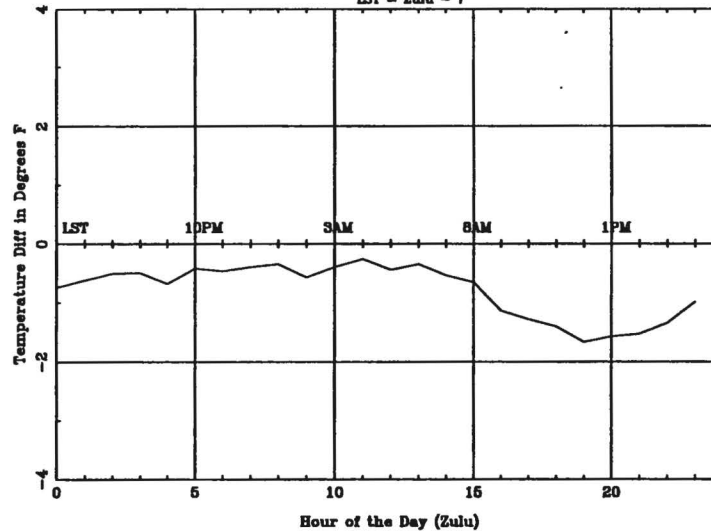

Average Diurnal Cycle for CYS - spring
LST = Zulu - 7

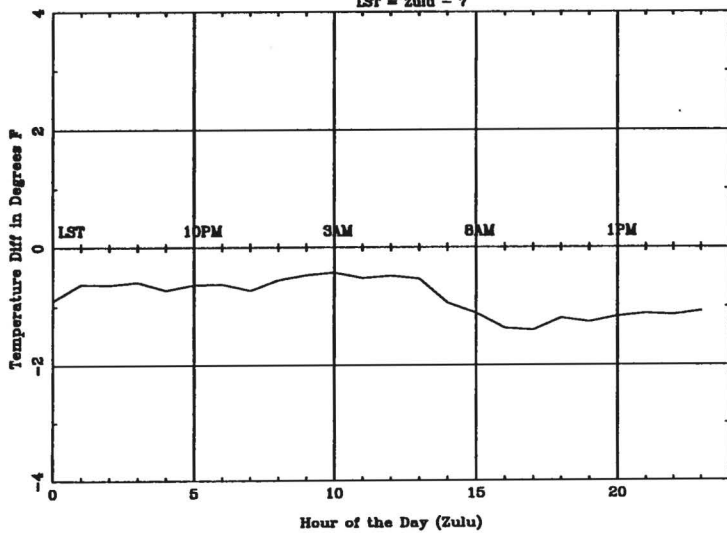

Average Diurnal Cycle for CYS - summer
LST = Zulu - 7

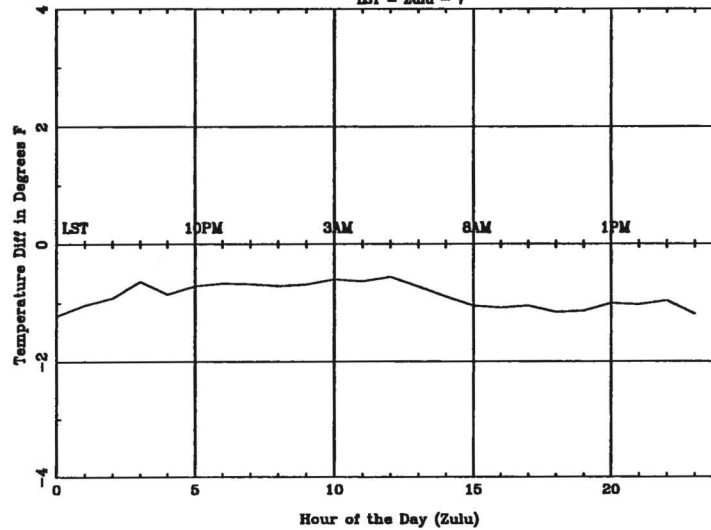

Average Diurnal Cycle for DAB - fall

LST = Zulu - 5

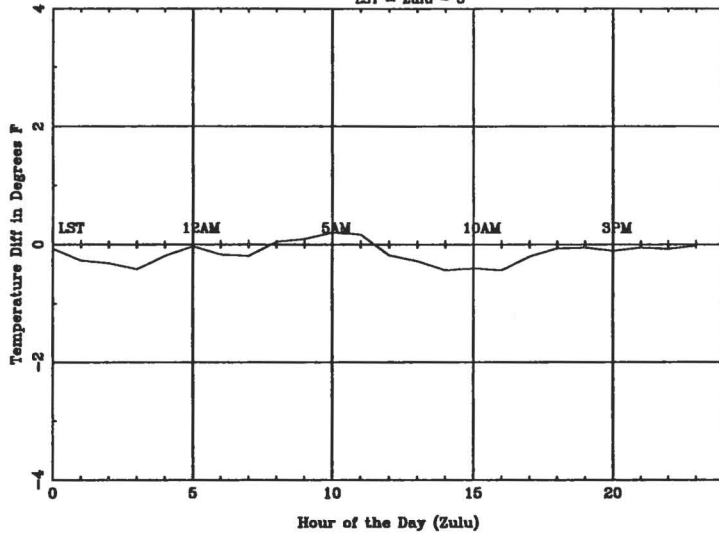

Average Diurnal Cycle for DAB - winter

LST = Zulu - 5

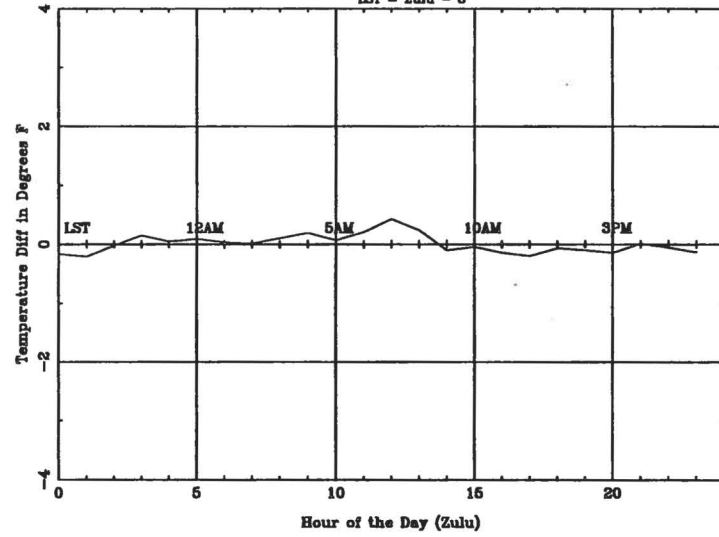

Average Diurnal Cycle for DAB - spring

LST = Zulu - 5

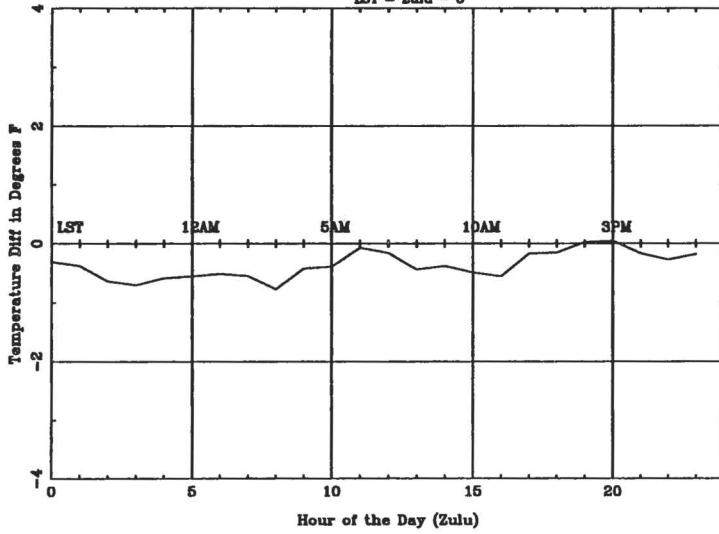

Average Diurnal Cycle for DAB - summer

LST = Zulu - 5

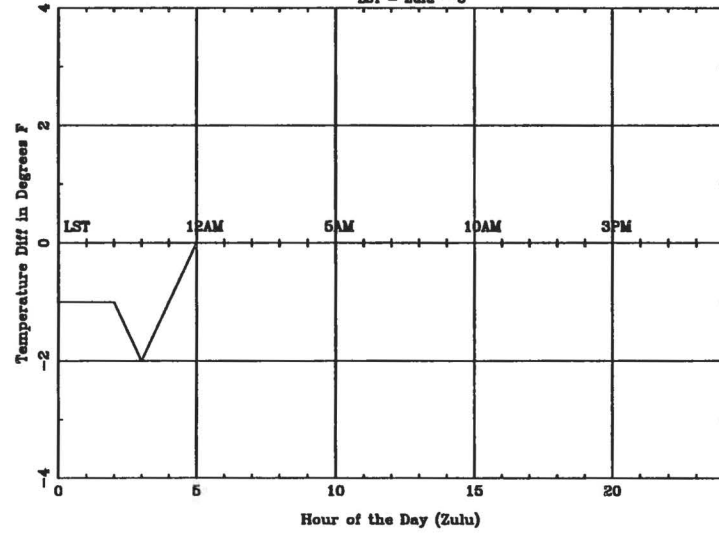

Average Diurnal Cycle for DAY - fall
LST = Zulu - 5

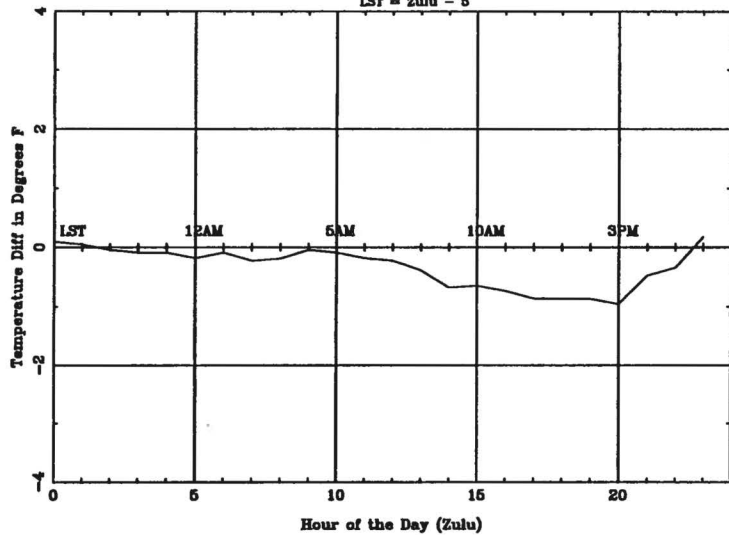

Average Diurnal Cycle for DAY - winter
LST = Zulu - 5

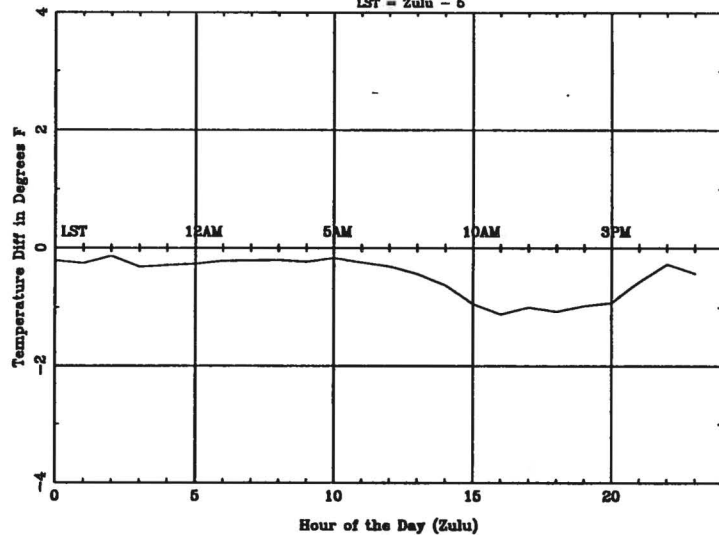

Average Diurnal Cycle for DAY - spring
LST = Zulu - 5

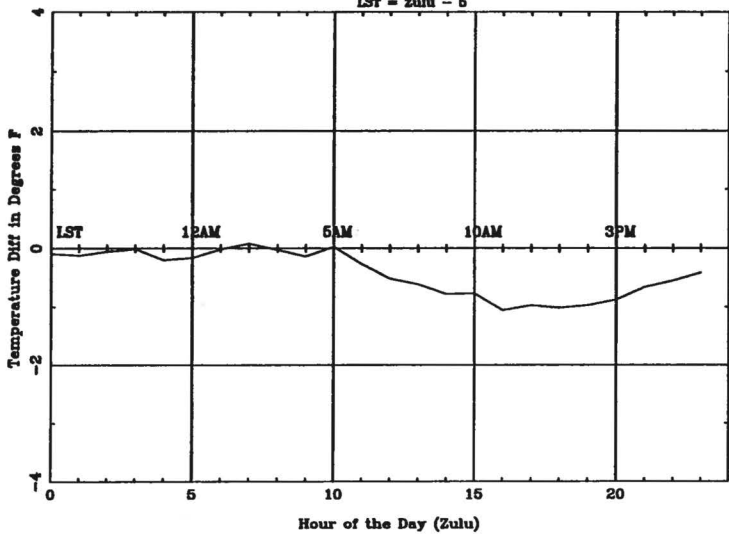

Average Diurnal Cycle for DAY - summer
LST = Zulu - 5

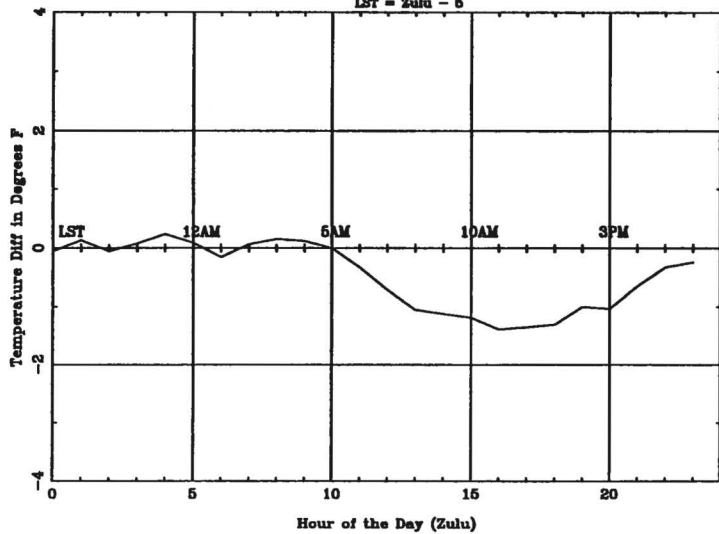

Average Diurnal Cycle for DRA - fall
LST = Zulu - 8

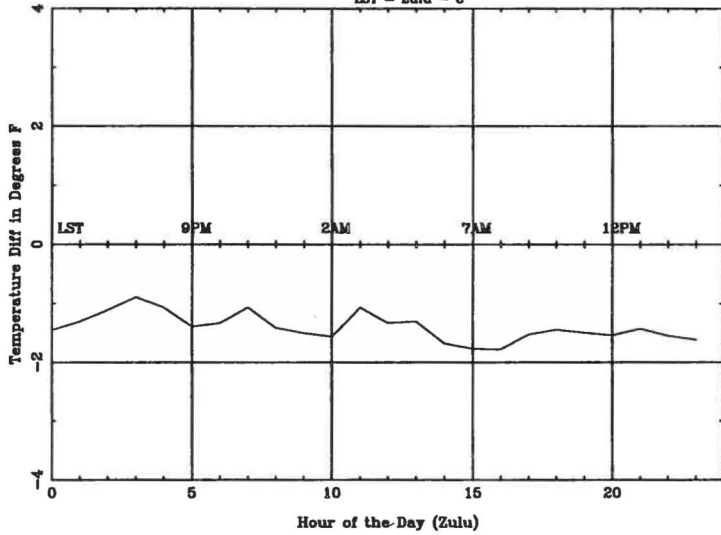

Average Diurnal Cycle for DRA - winter
LST = Zulu - 8

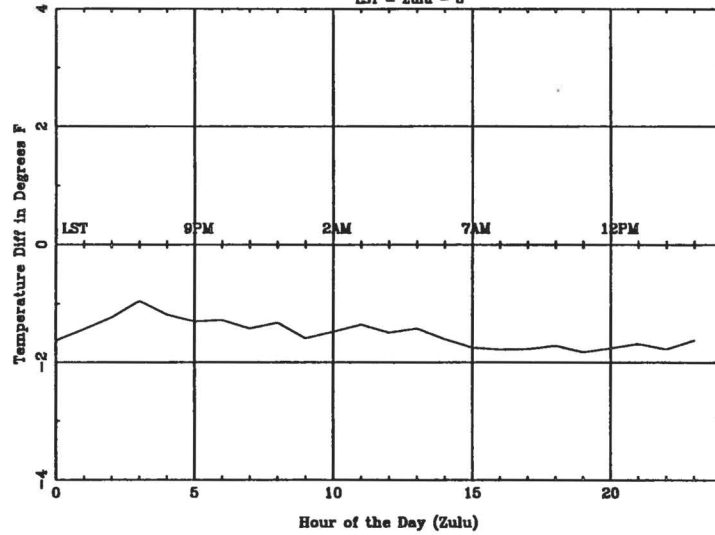

Average Diurnal Cycle for DRA - spring
LST = Zulu - 8

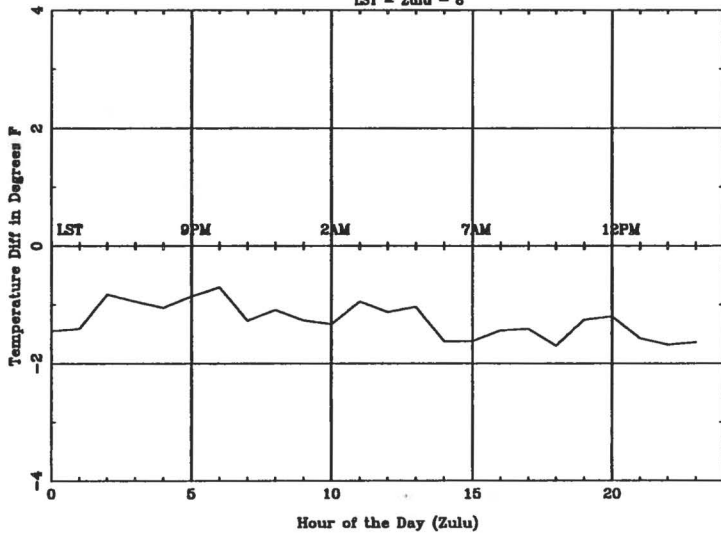

Average Diurnal Cycle for DRA - summer
LST = Zulu - 8

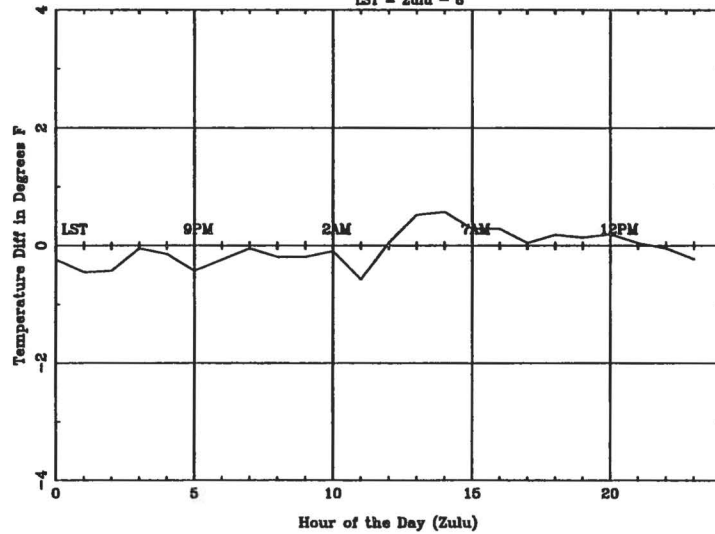

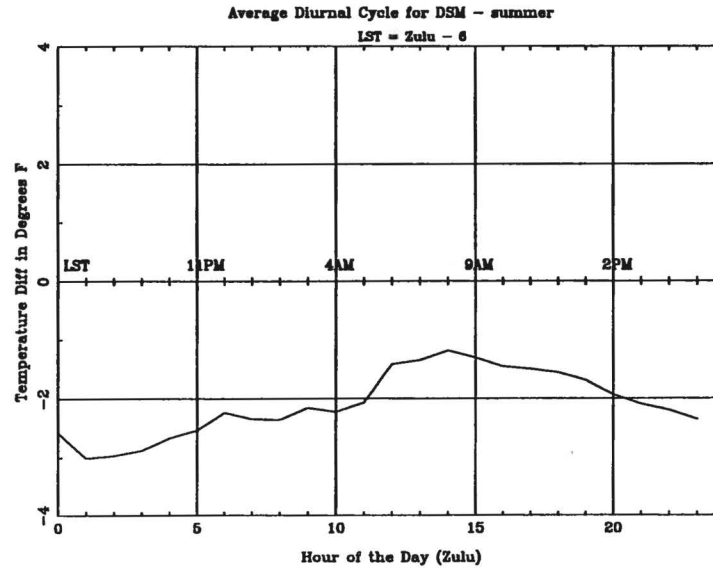
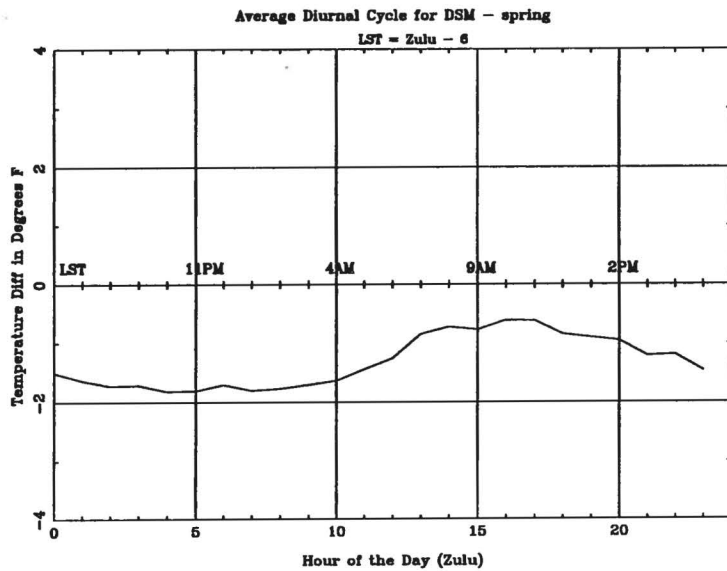
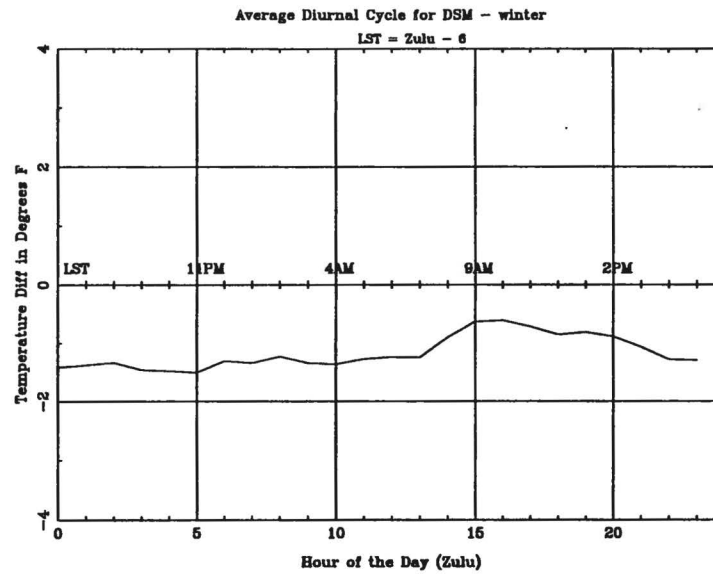
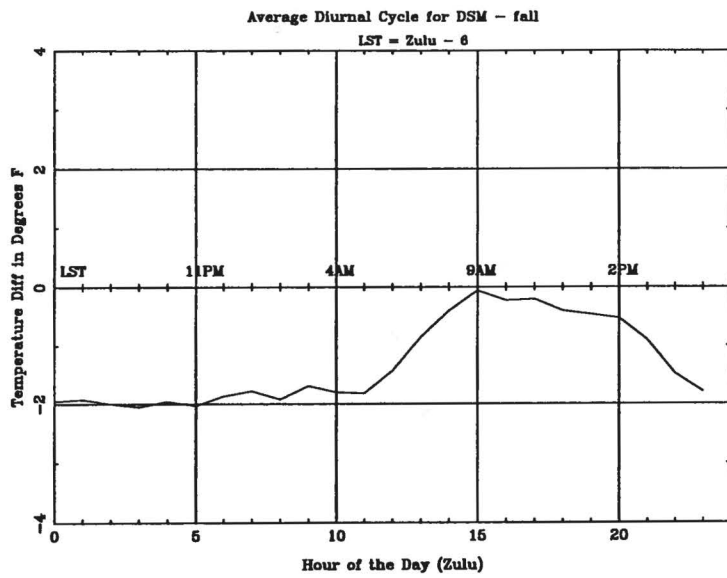

Average Diurnal Cycle for DTW - fall
LST = Zulu - 5

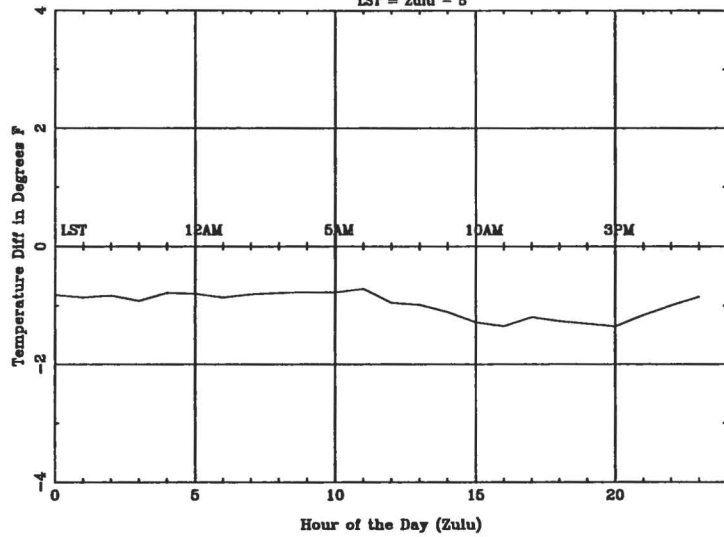

Average Diurnal Cycle for DTW - winter
LST = Zulu - 5

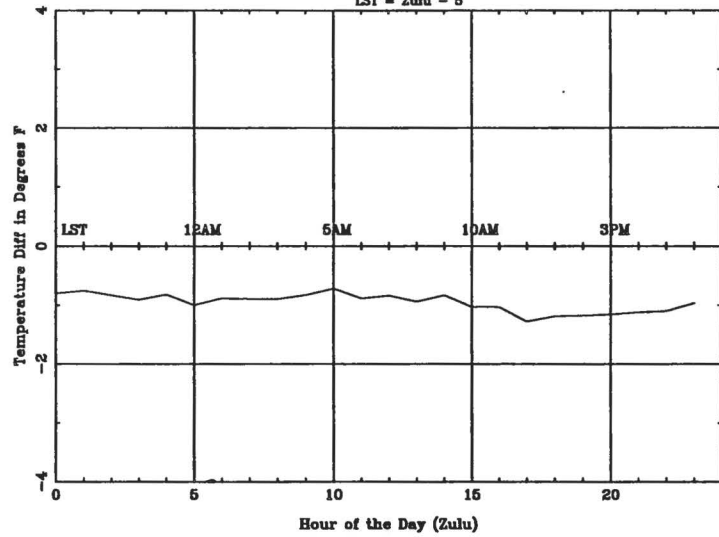

Average Diurnal Cycle for DTW - spring
LST = Zulu - 5

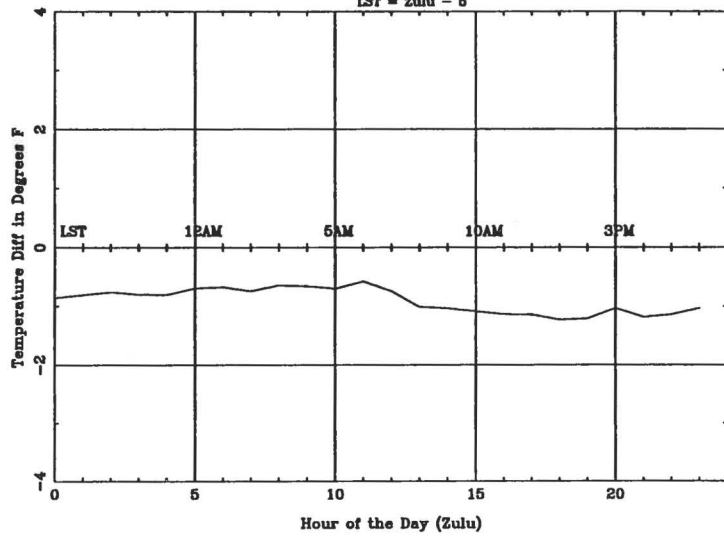

Average Diurnal Cycle for DTW - summer
LST = Zulu - 5

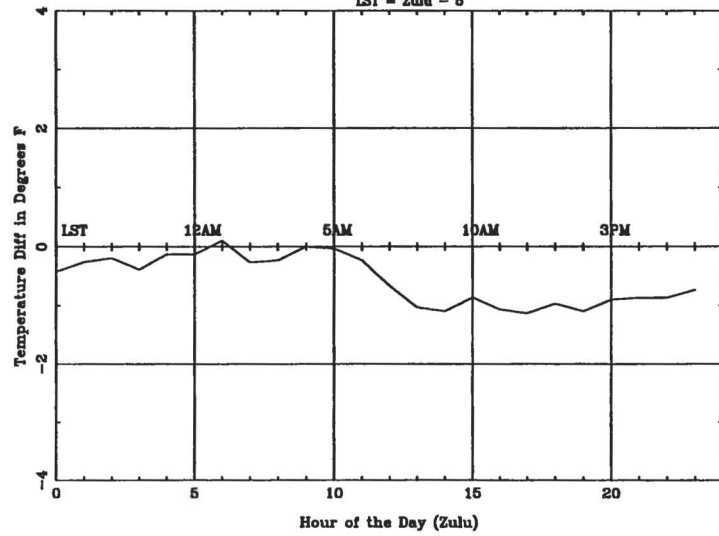

Average Diurnal Cycle for ERI - fall
LST = Zulu - 6

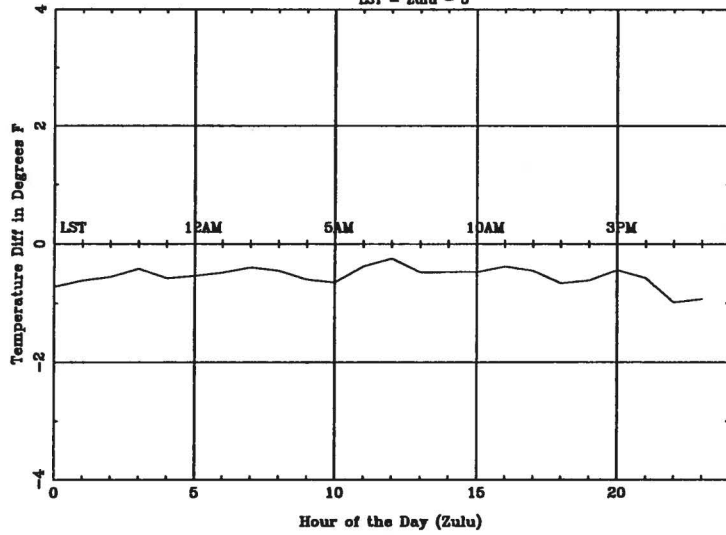

Average Diurnal Cycle for ERI - winter
LST = Zulu - 6

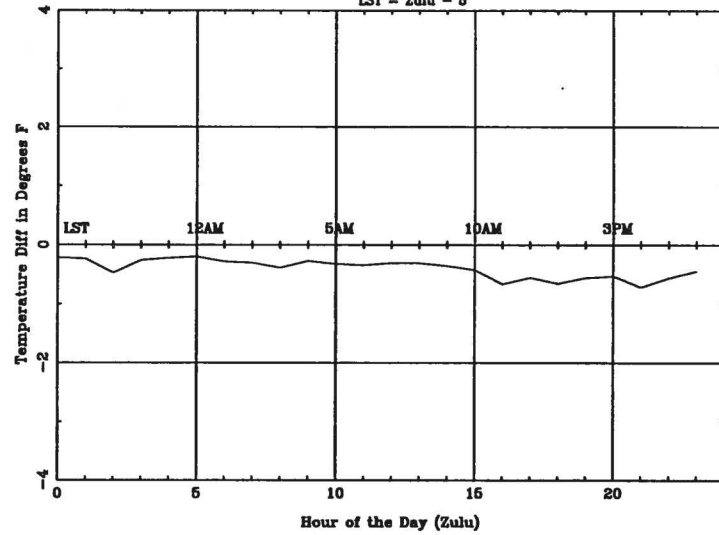

Average Diurnal Cycle for ERI - spring
LST = Zulu - 6

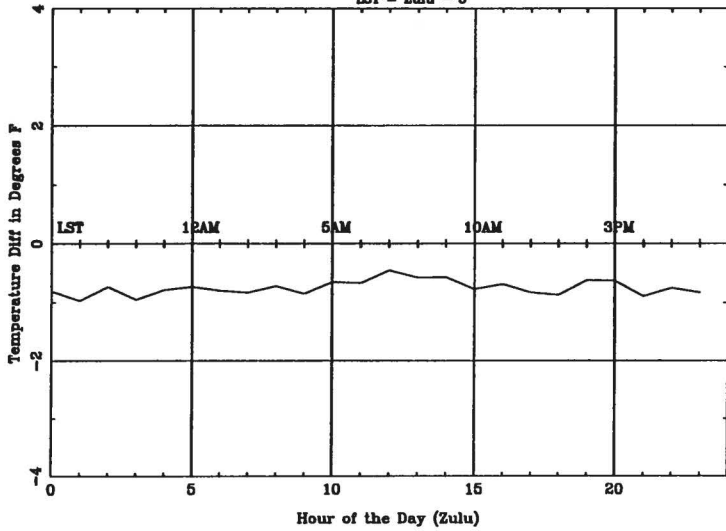

Average Diurnal Cycle for ERI - summer
LST = Zulu - 6

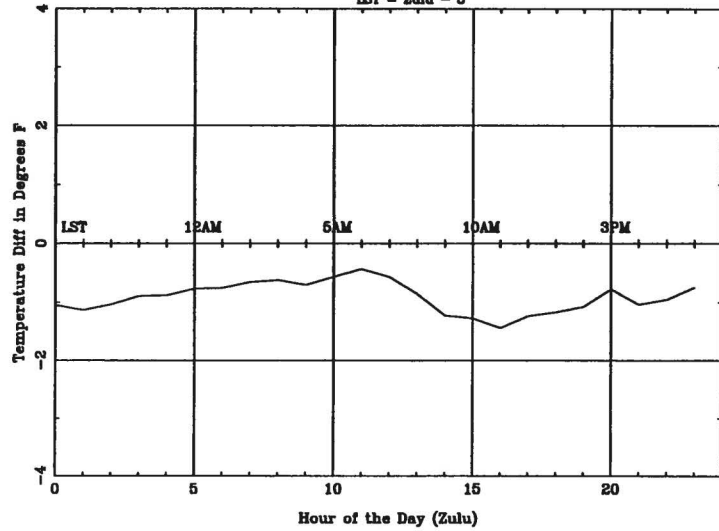

Average Diurnal Cycle for EUG - fall

LST = Zulu - 8

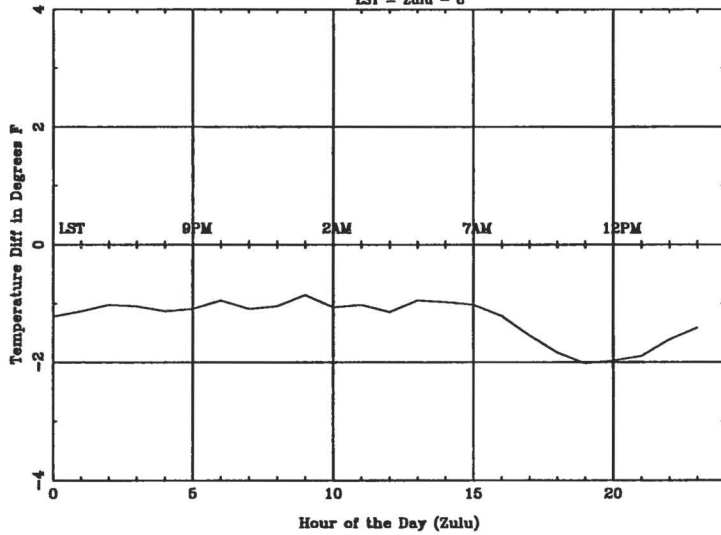

Average Diurnal Cycle for EUG - winter

LST = Zulu - 8

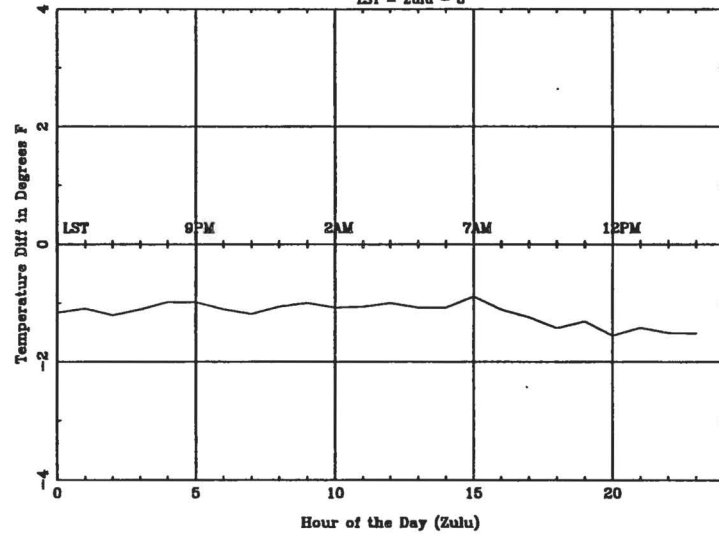

Average Diurnal Cycle for EUG - spring

LST = Zulu - 8

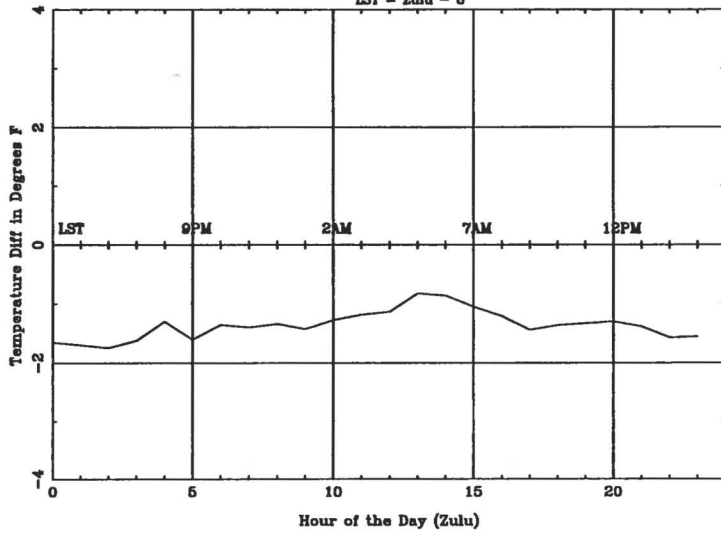

Average Diurnal Cycle for EUG - summer

LST = Zulu - 8

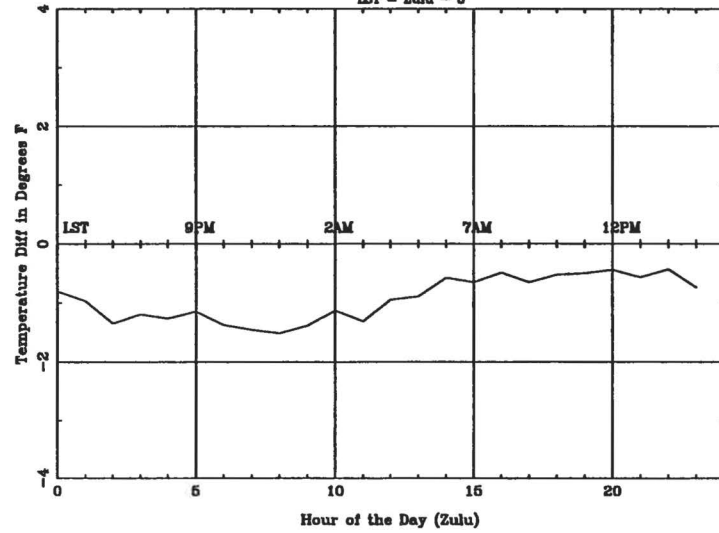

Average Diurnal Cycle for FAR - fall
LST = Zulu - 6

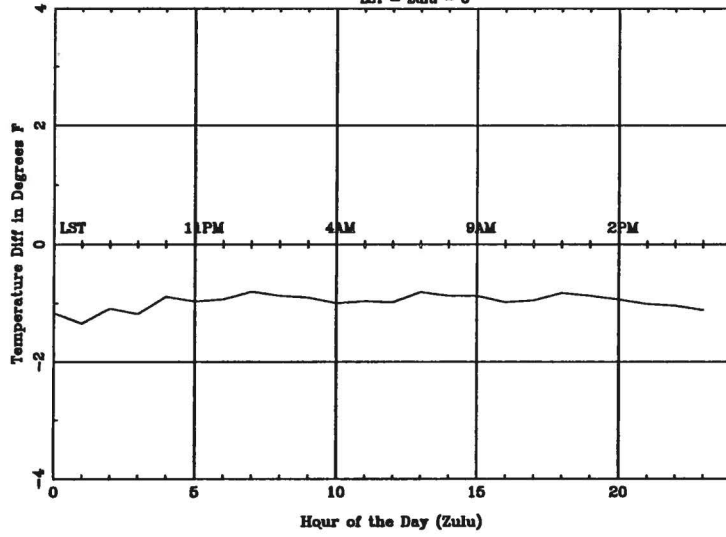

Average Diurnal Cycle for FAR - winter
LST = Zulu - 6

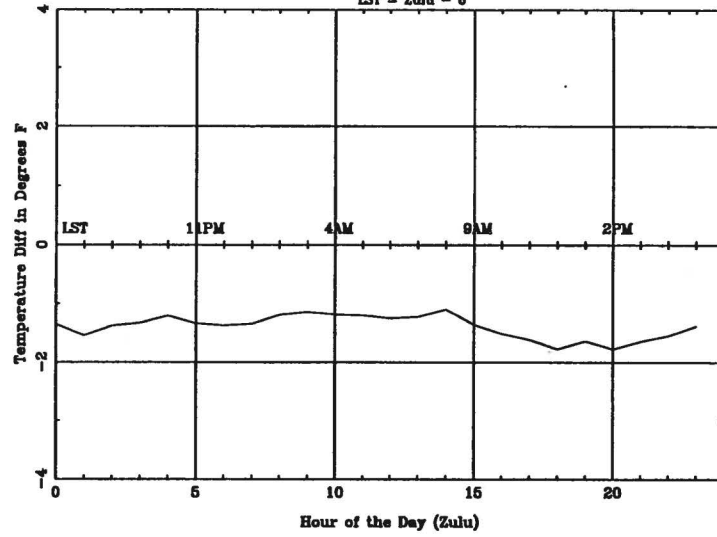

Average Diurnal Cycle for FAR - spring
LST = Zulu - 6

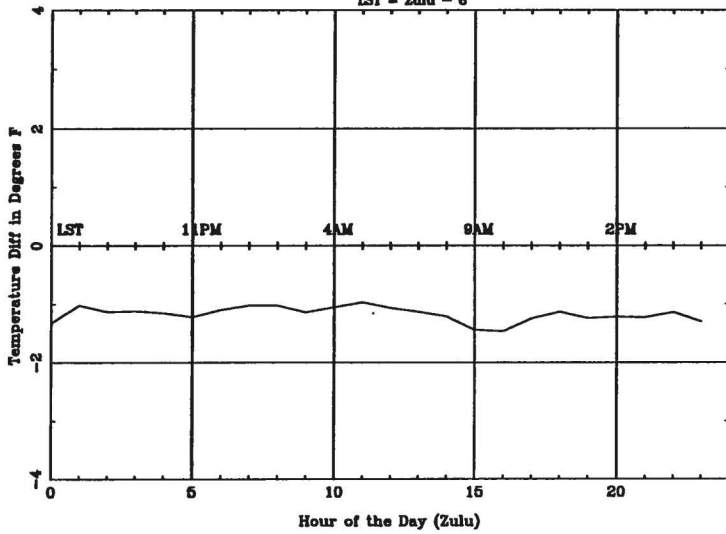

Average Diurnal Cycle for FAR - summer
LST = Zulu - 6

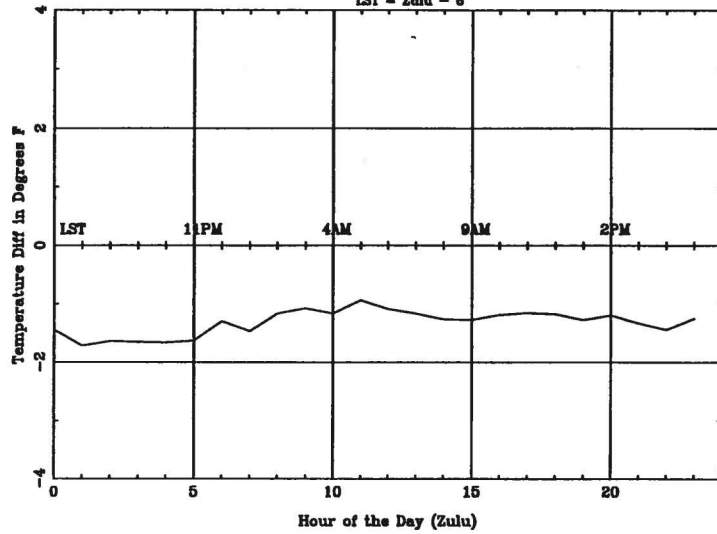

Average Diurnal Cycle for FNT - fall
LST = Zulu - 5

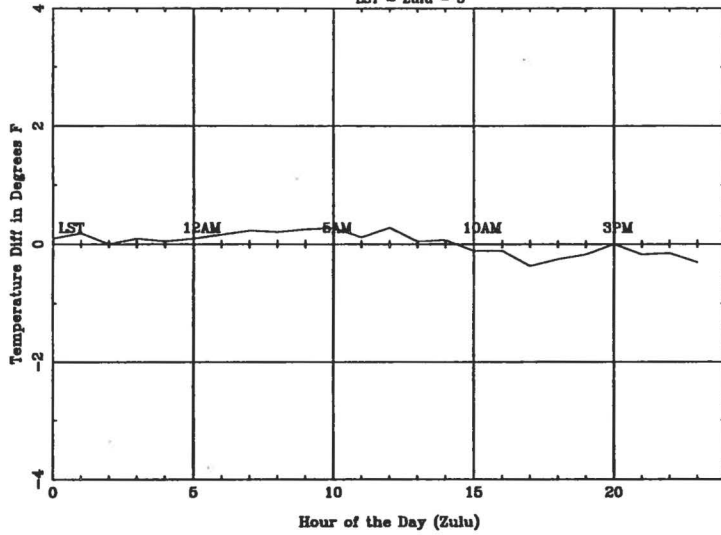

Average Diurnal Cycle for FNT - winter
LST = Zulu - 5

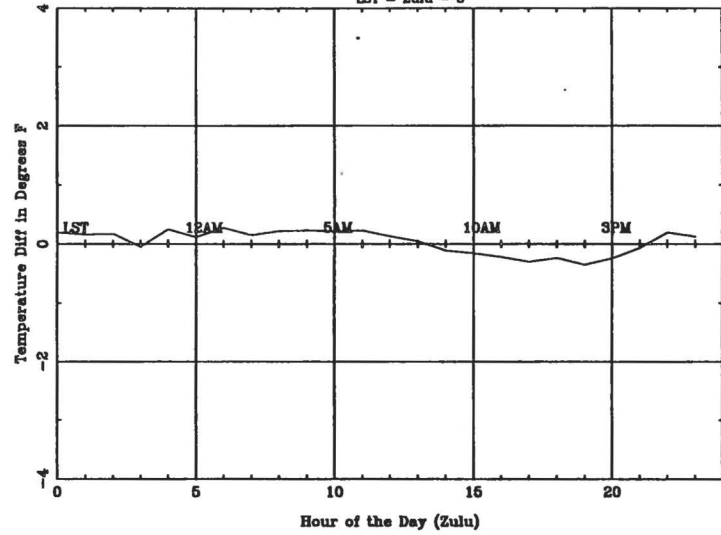

Average Diurnal Cycle for FNT - spring
LST = Zulu - 6

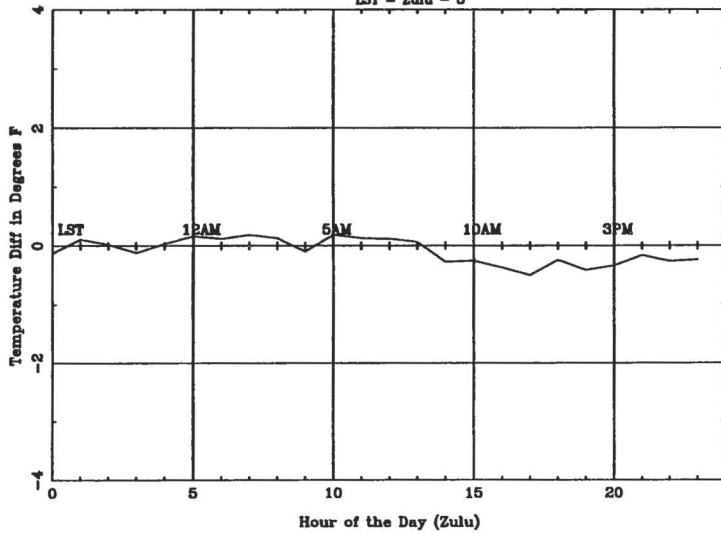

Average Diurnal Cycle for FNT - summer
LST = Zulu - 6

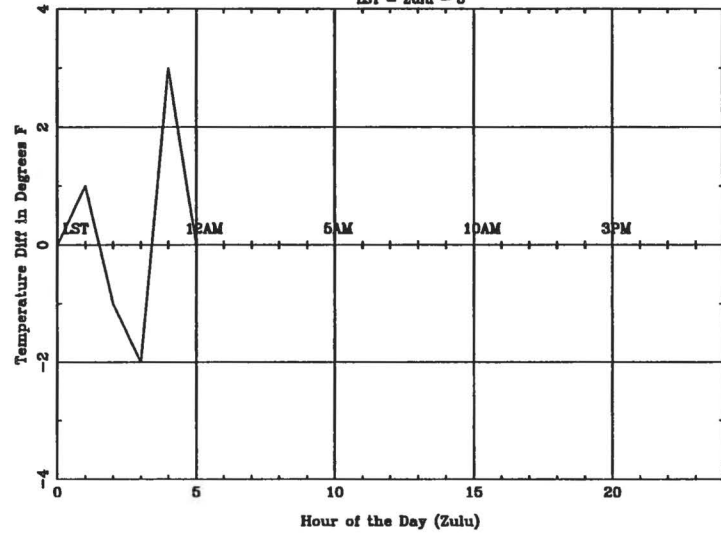

Average Diurnal Cycle for FSD - fall

LST = Zulu - 6

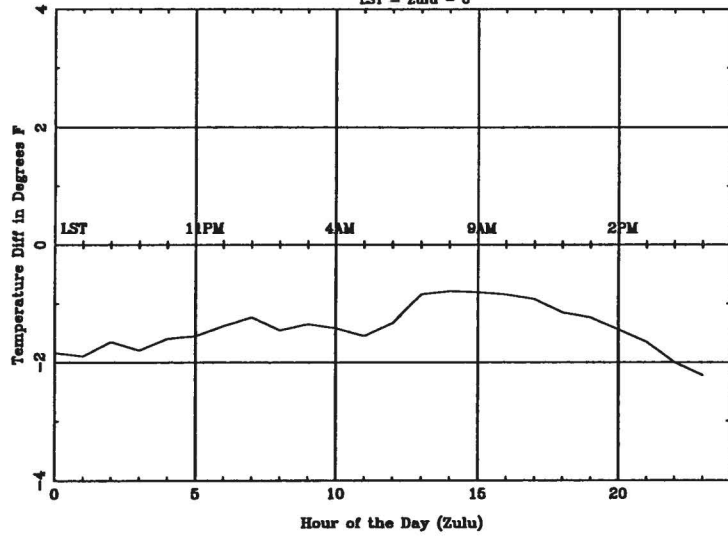

Average Diurnal Cycle for FSD - winter

LST = Zulu - 6

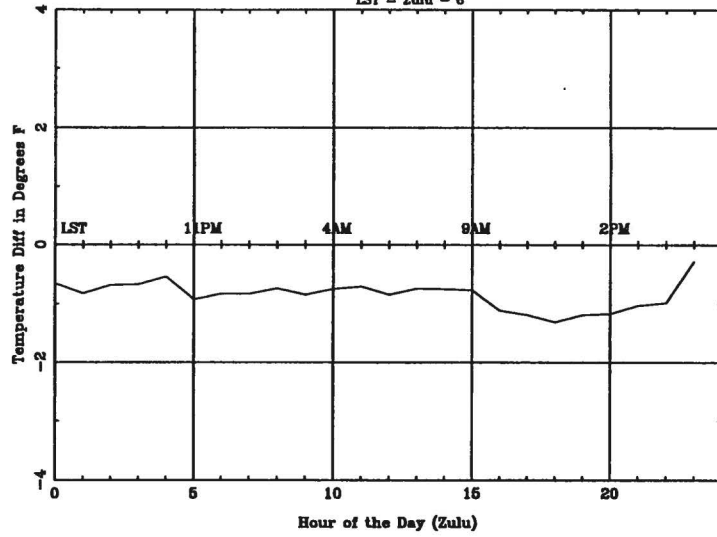

Average Diurnal Cycle for FSD - spring

LST = Zulu - 6

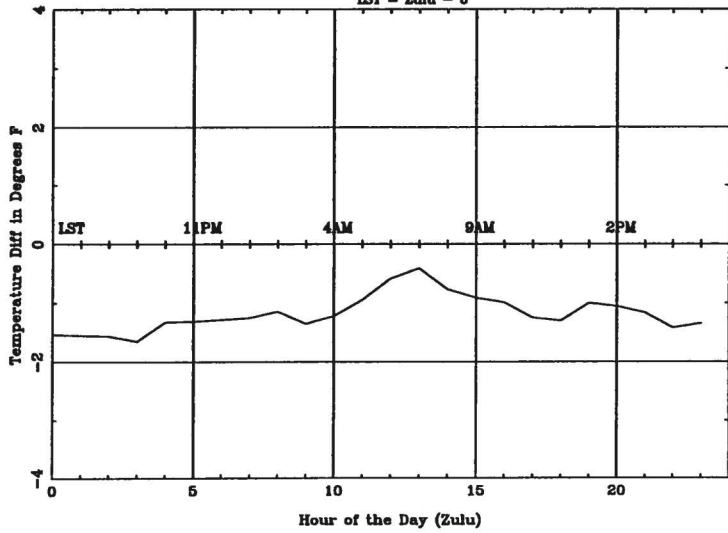

Average Diurnal Cycle for FSD - summer

LST = Zulu - 6

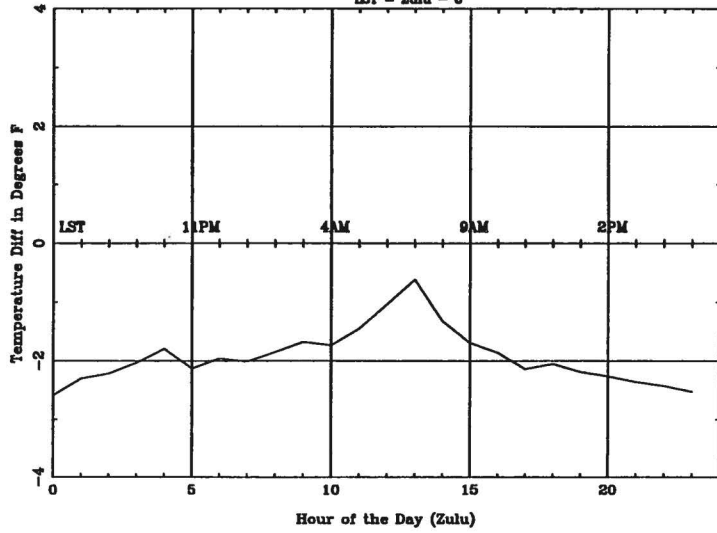

Average Diurnal Cycle for FWA - fall
LST = Zulu - 5

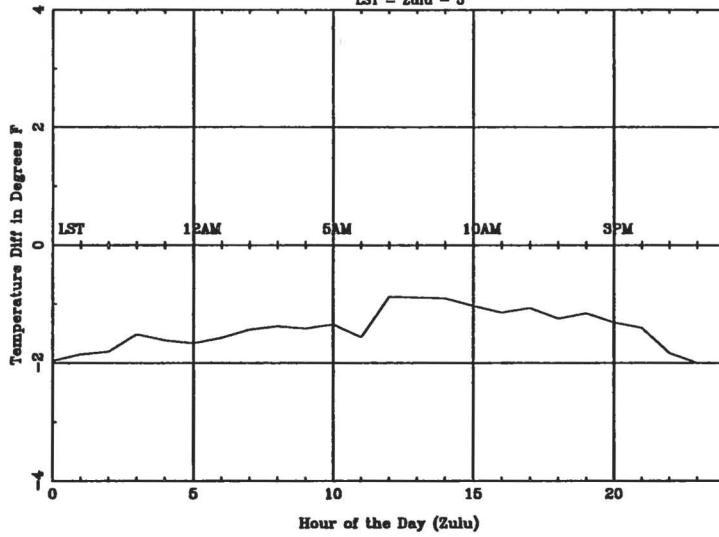

Average Diurnal Cycle for FWA - winter
LST = Zulu - 5

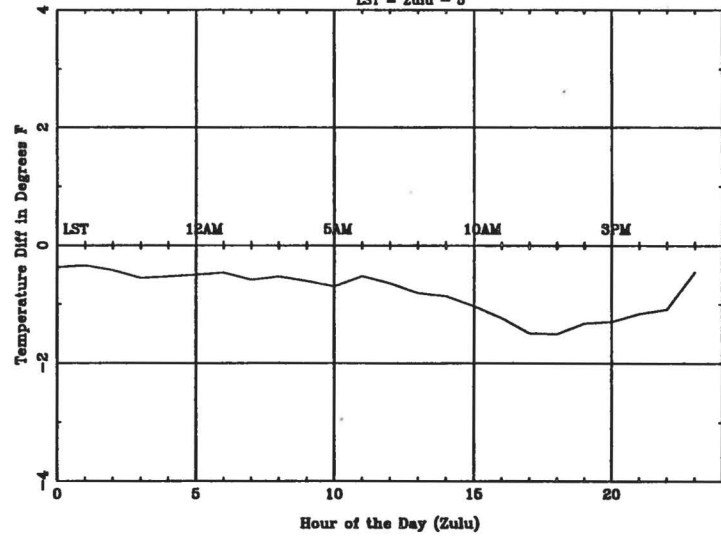

Average Diurnal Cycle for FWA - spring
LST = Zulu - 5

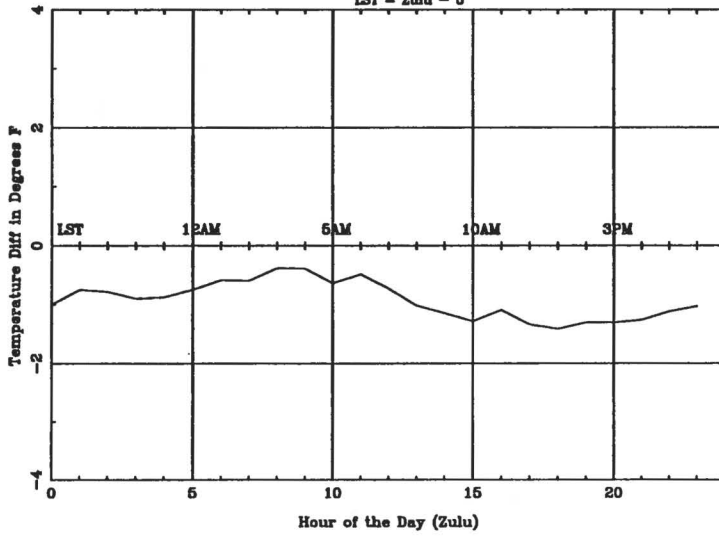

Average Diurnal Cycle for FWA - summer
LST = Zulu - 5

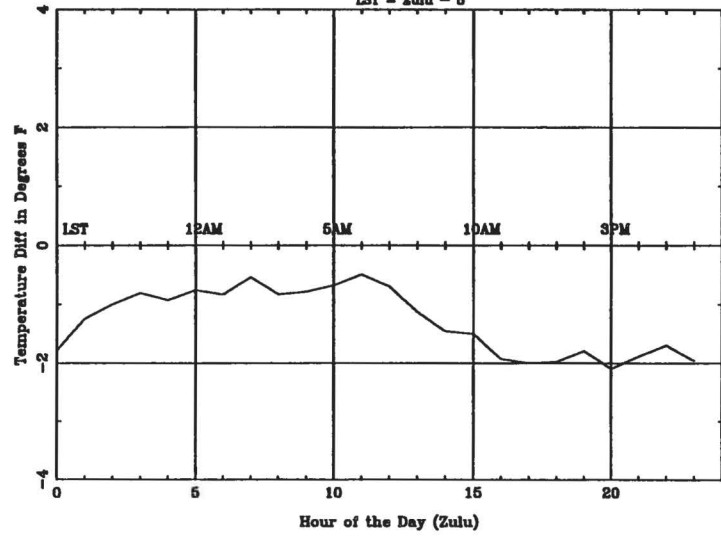

Average Diurnal Cycle for GEG - fall

LST = Zulu - 8

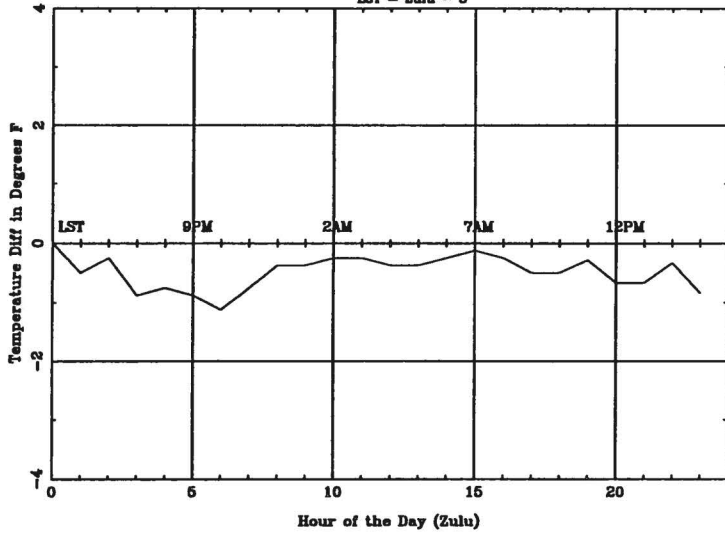

Average Diurnal Cycle for GEG - winter

LST = Zulu - 8

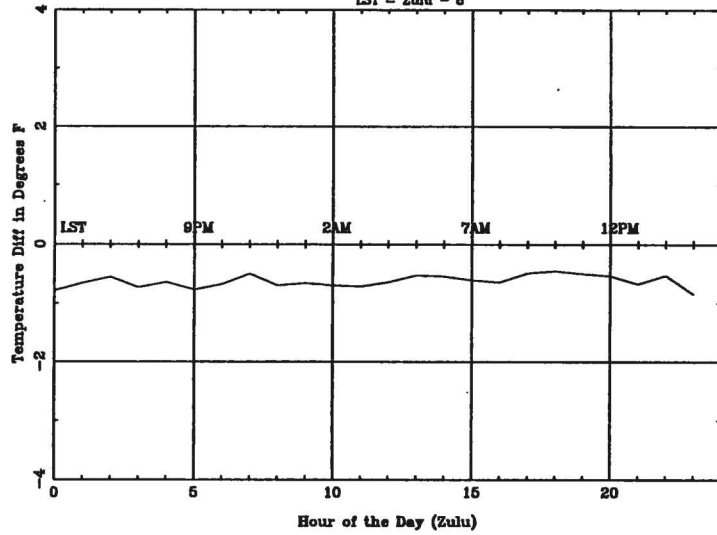

Average Diurnal Cycle for GEG - spring

LST = Zulu - 8

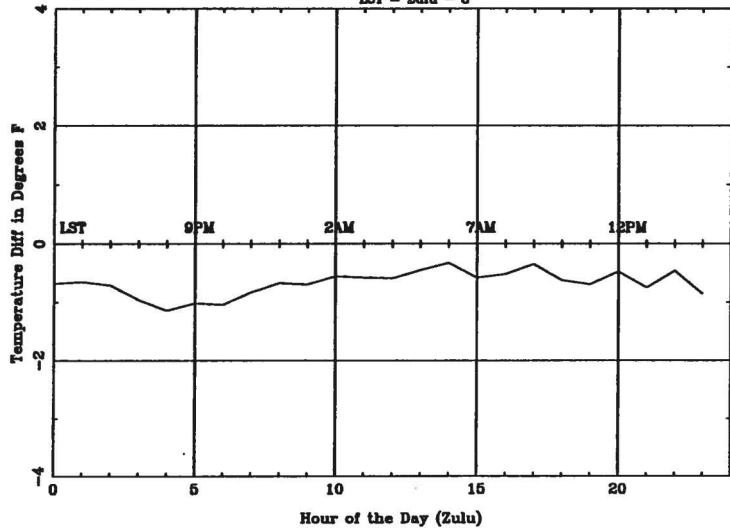

Average Diurnal Cycle for GEG - summer

LST = Zulu - 8

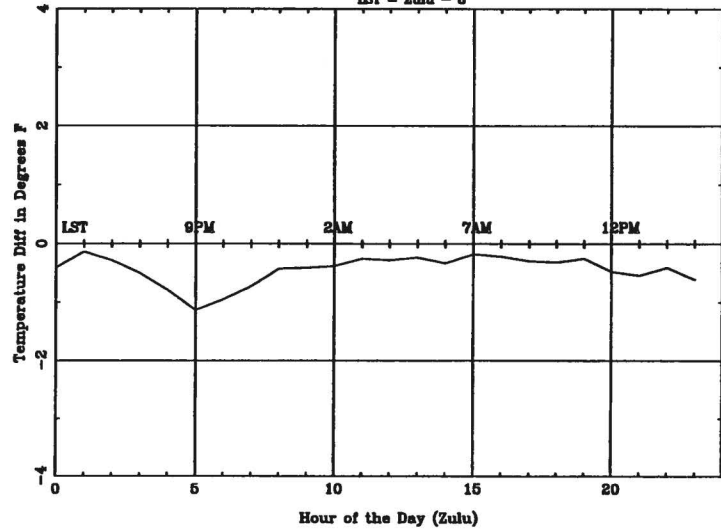

Average Diurnal Cycle for GJT - fall
LST = Zulu - 7

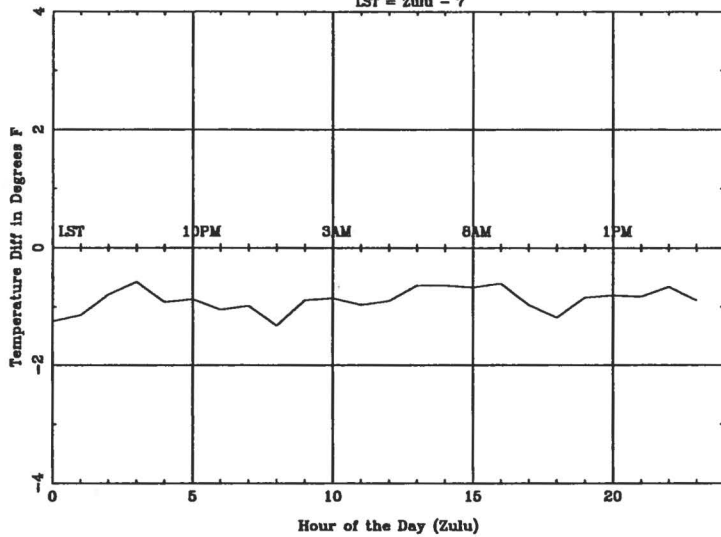

Average Diurnal Cycle for GJT - winter
LST = Zulu - 7

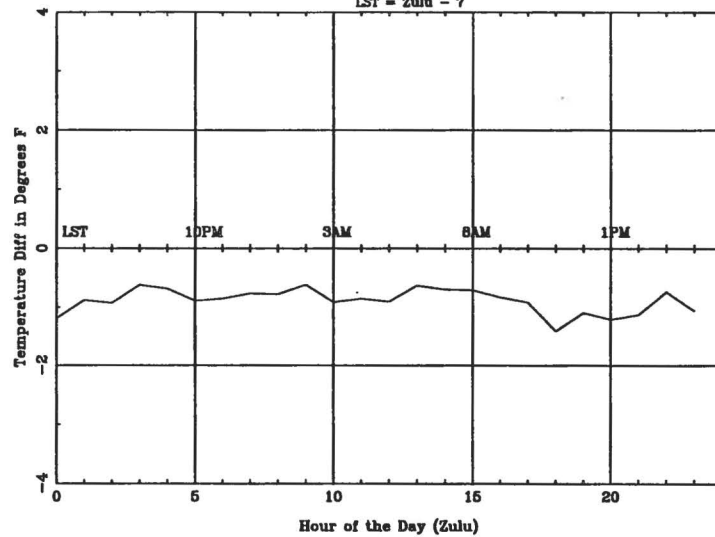

Average Diurnal Cycle for GJT - spring
LST = Zulu - 7

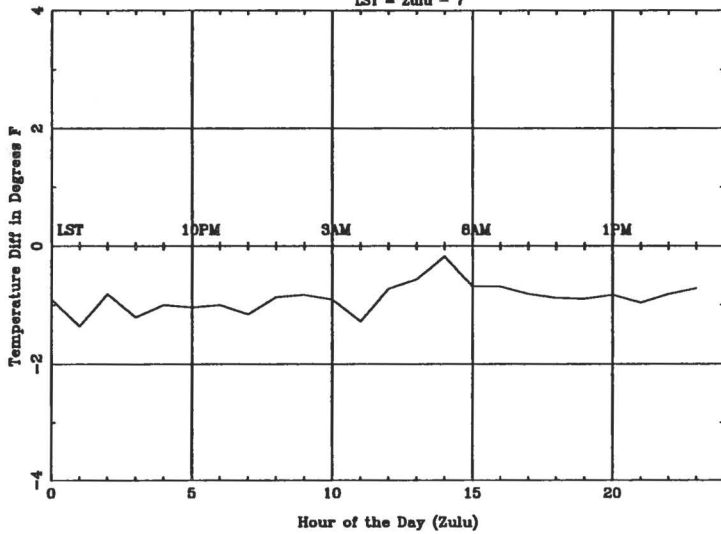

Average Diurnal Cycle for GJT - summer
LST = Zulu - 7

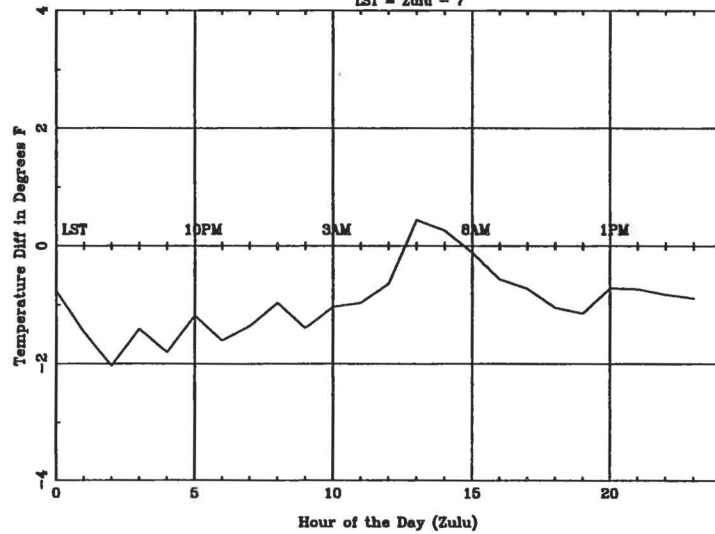

Average Diurnal Cycle for GRB - fall
LST = Zulu - 6

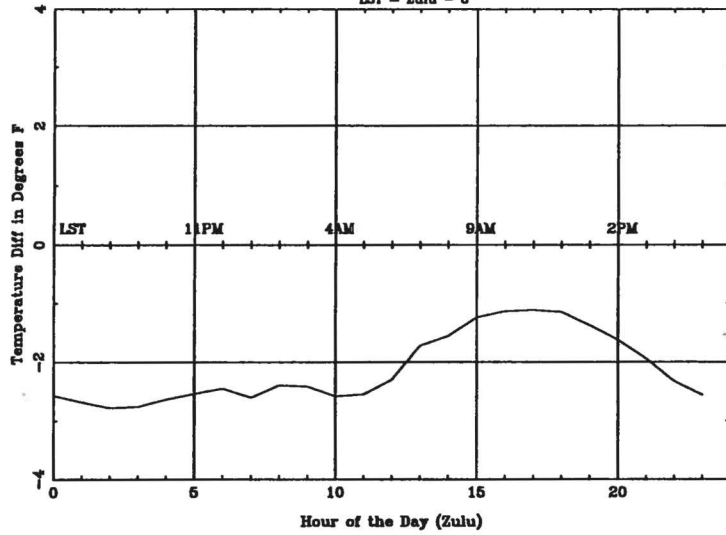

Average Diurnal Cycle for GRB - winter
LST = Zulu - 6

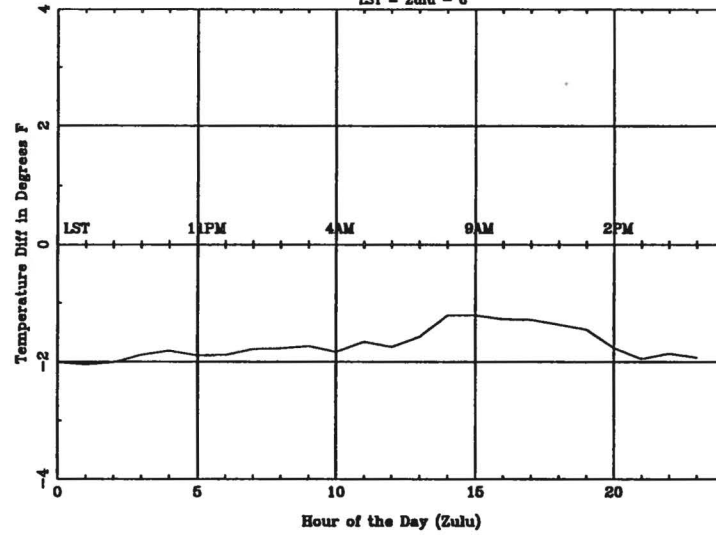

Average Diurnal Cycle for GRB - spring
LST = Zulu - 6

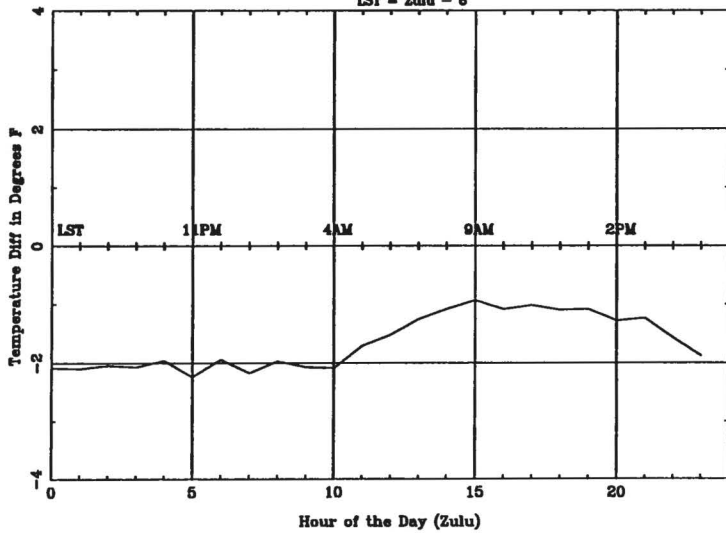

Average Diurnal Cycle for GRB - summer
LST = Zulu - 6

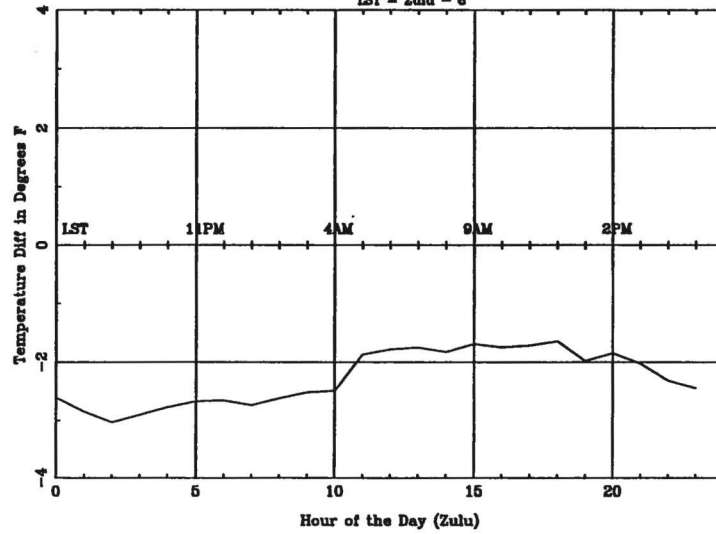

Average Diurnal Cycle for HON - fall
LST = Zulu - 6

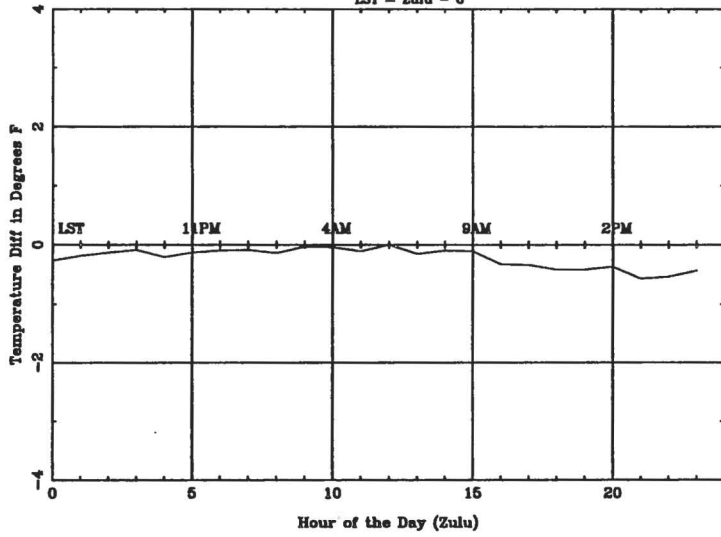

Average Diurnal Cycle for HON - winter
LST = Zulu - 6

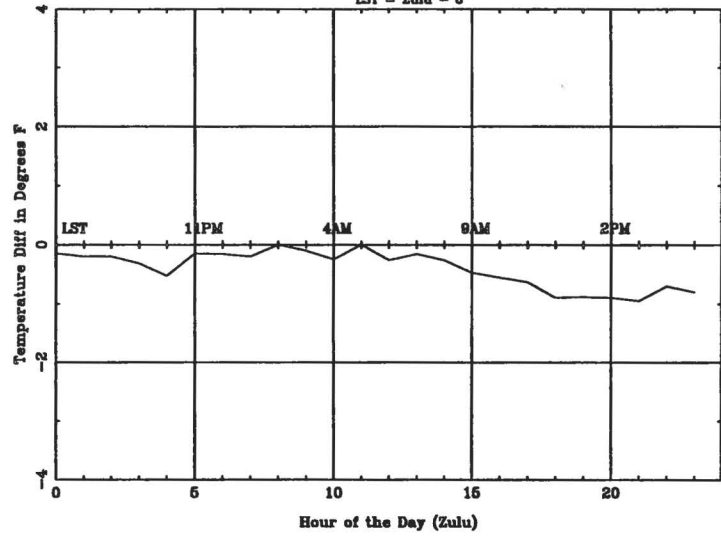

Average Diurnal Cycle for HON - spring
LST = Zulu - 6

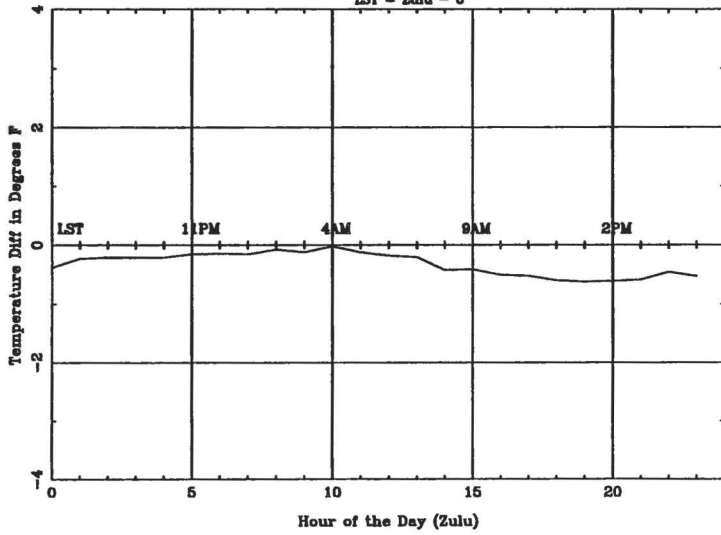

Average Diurnal Cycle for HON - summer
LST = Zulu - 6

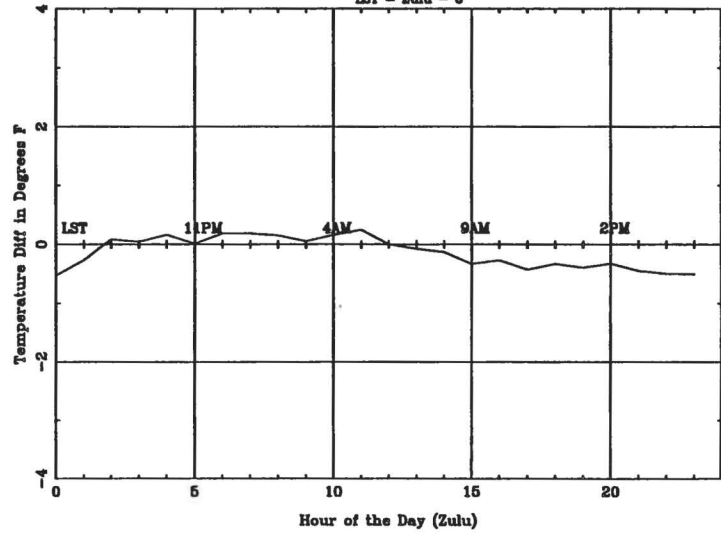

Average Diurnal Cycle for INL - fall

LST = Zulu - 6

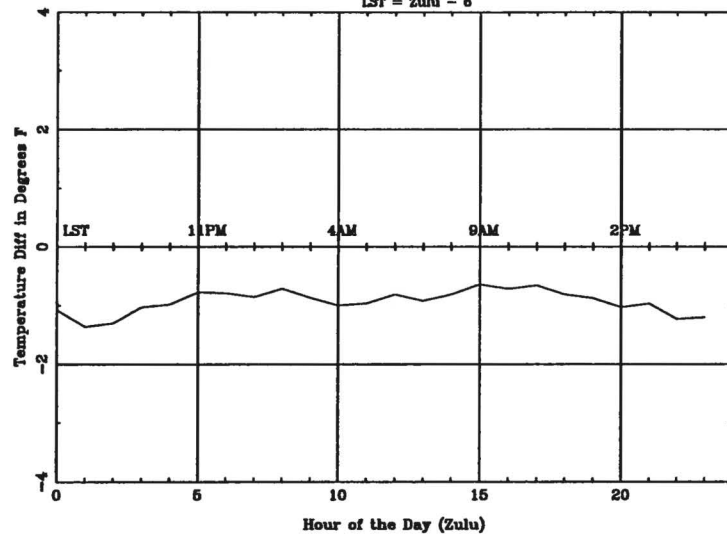

Average Diurnal Cycle for INL - winter

LST = Zulu - 6

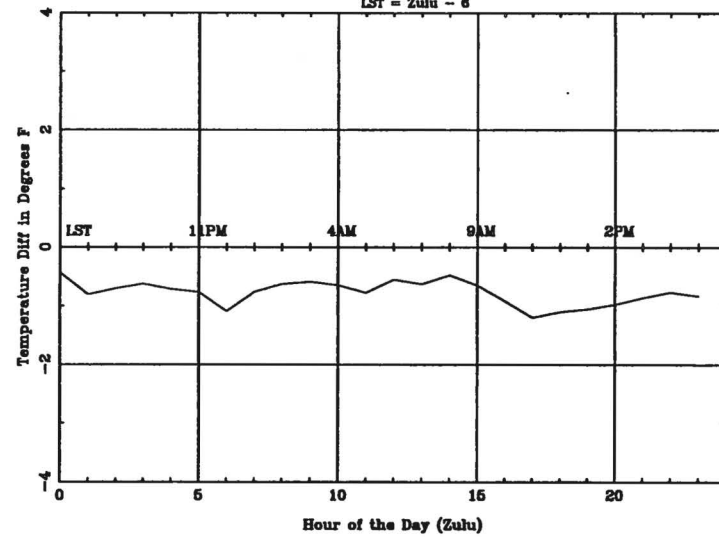

Average Diurnal Cycle for INL - spring

LST = Zulu - 6

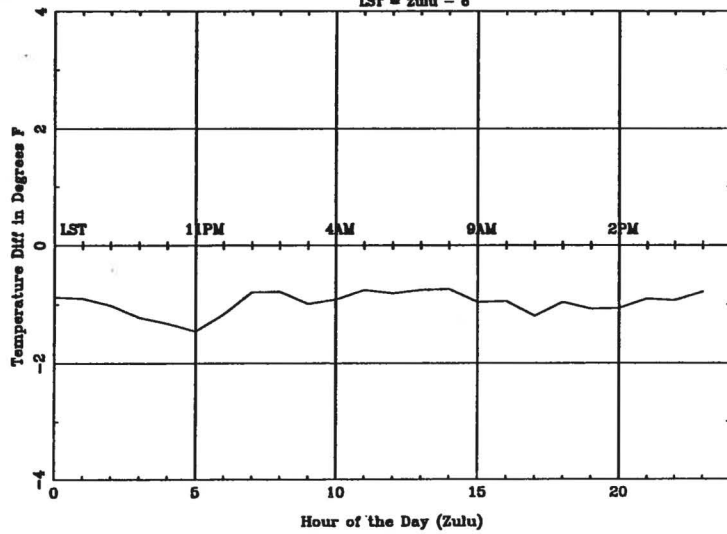

Average Diurnal Cycle for INL - summer

LST = Zulu - 6

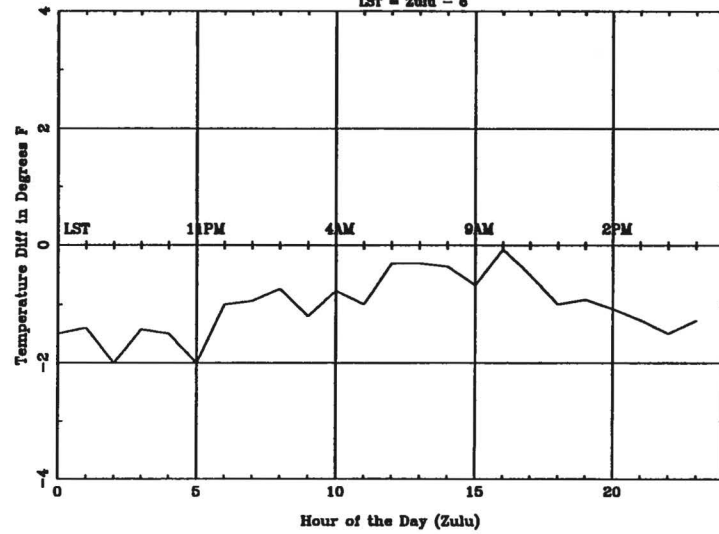

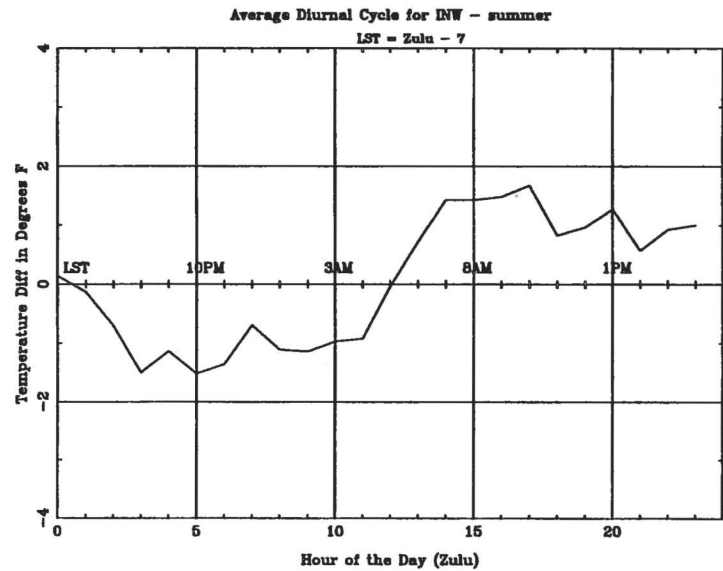
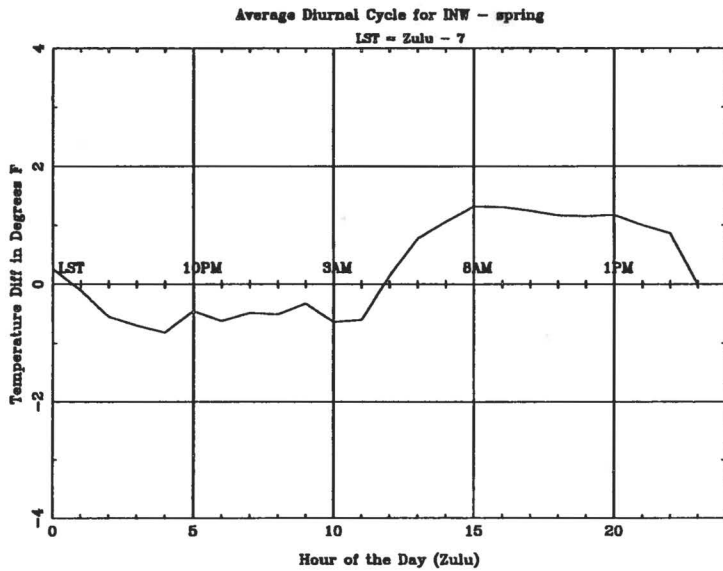
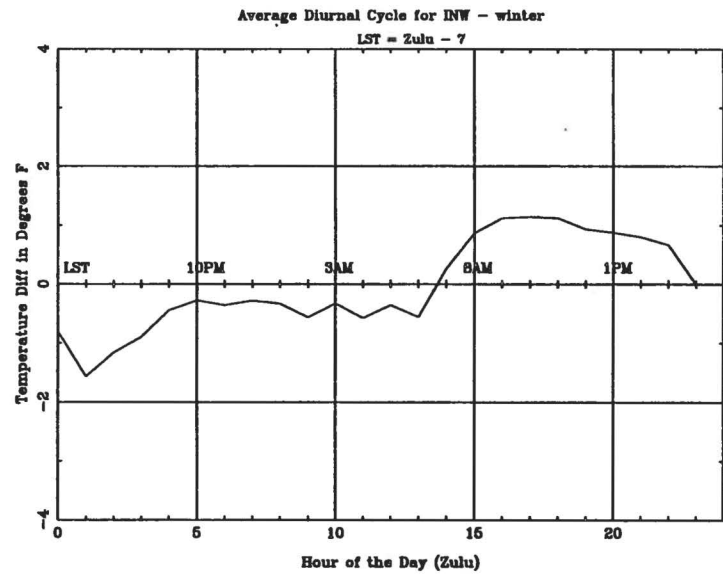
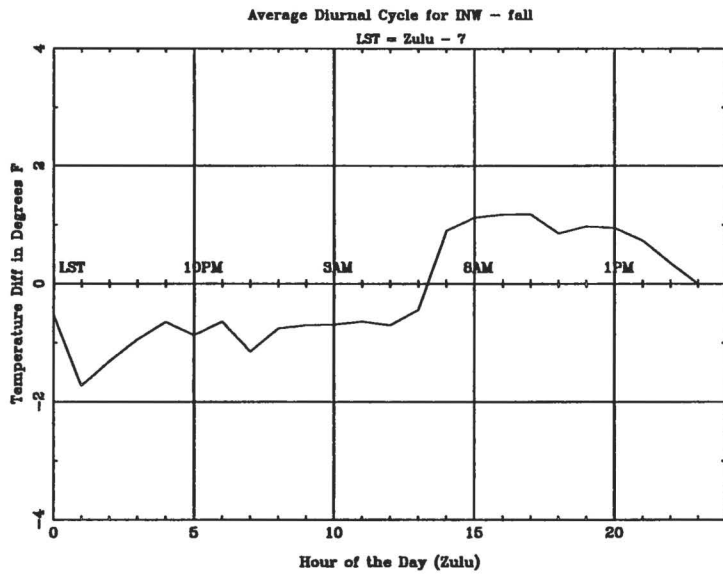

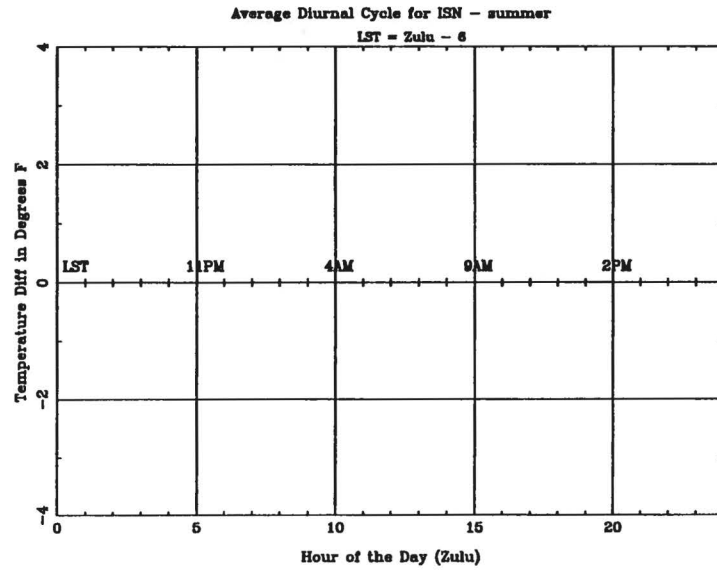
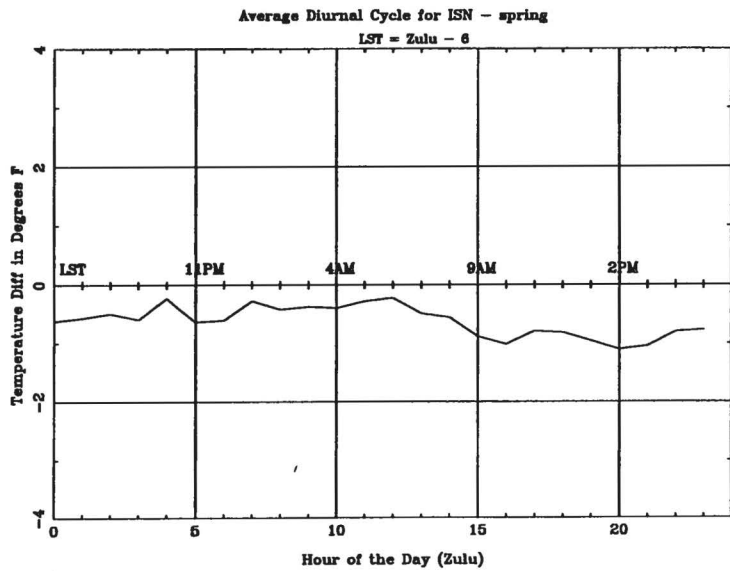
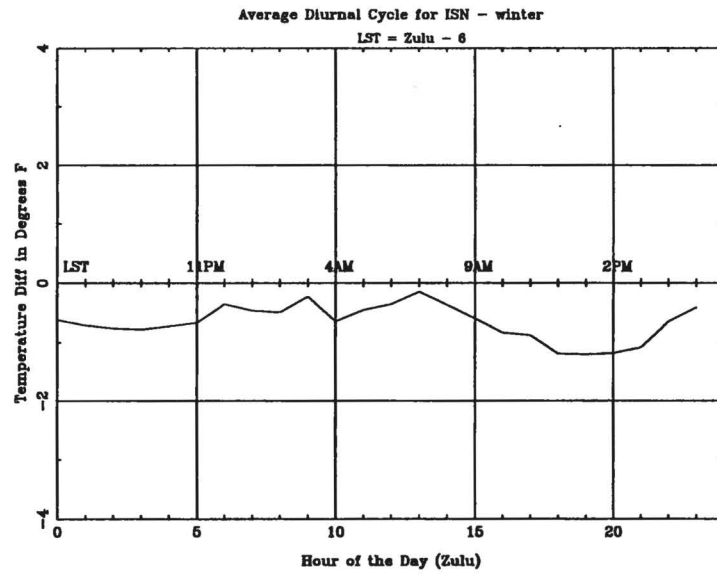
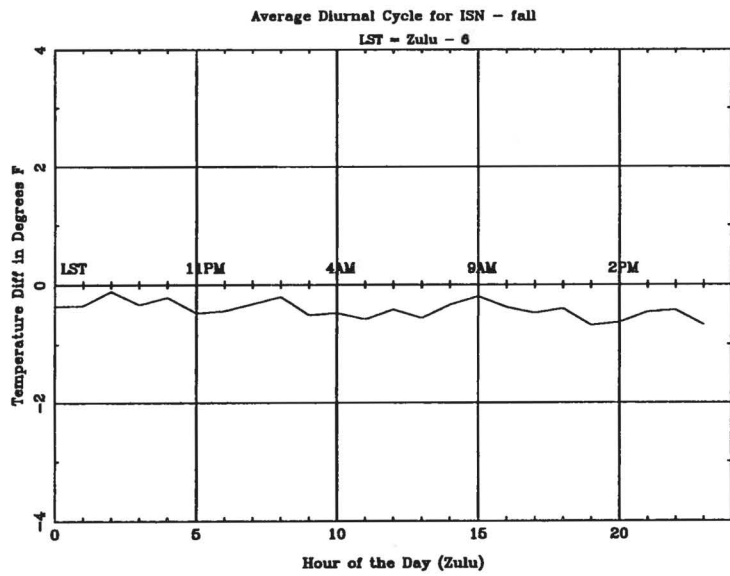

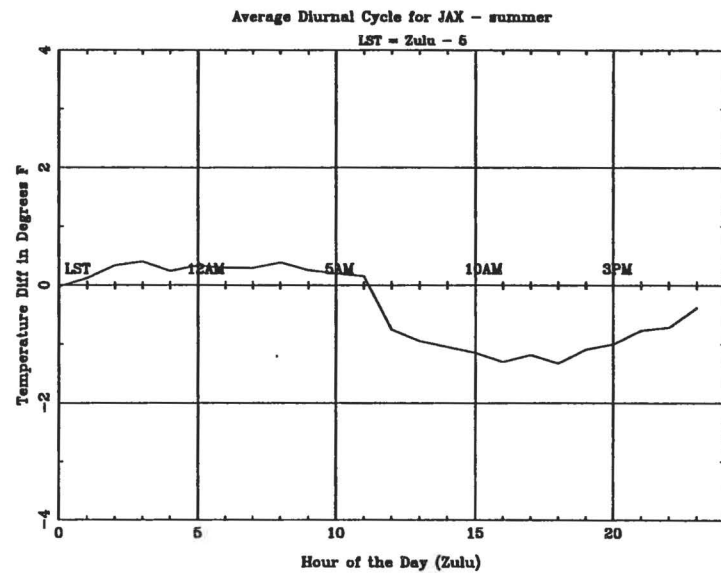
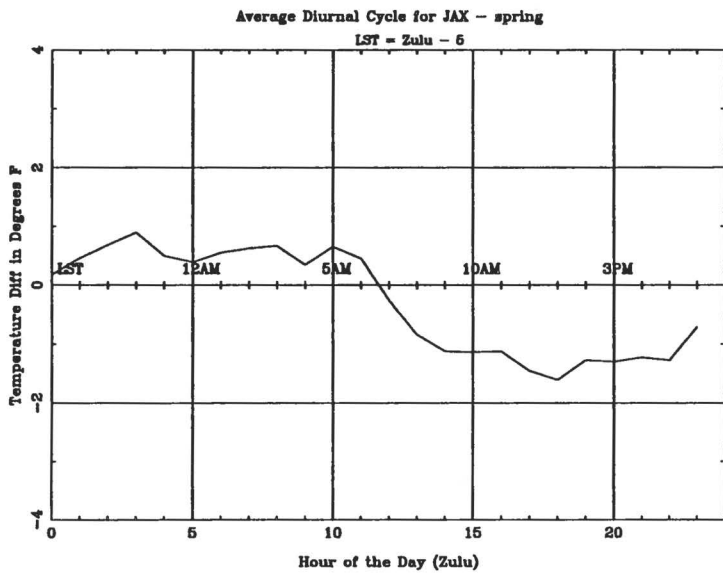
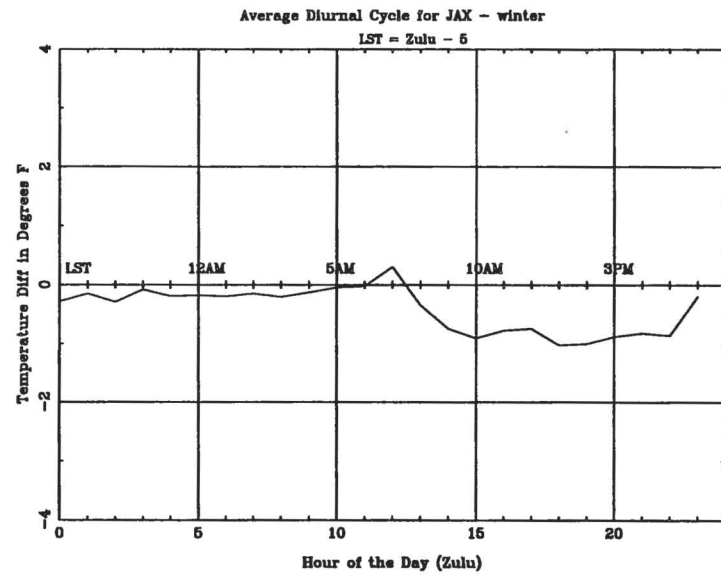
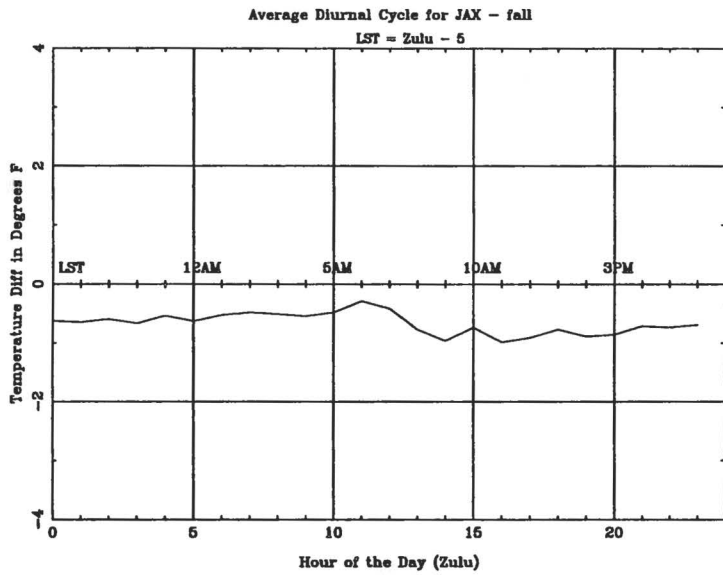

Average Diurnal Cycle for JKL - fall

LST = Zulu - 5

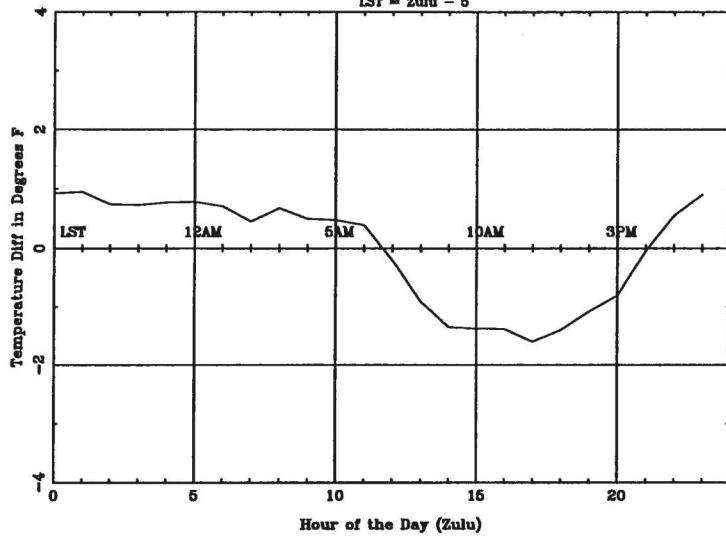

Average Diurnal Cycle for JKL - winter

LST = Zulu - 5

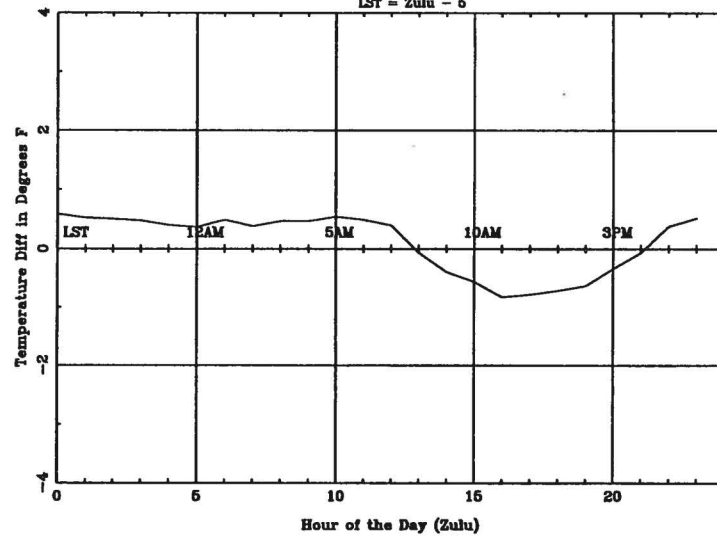

Average Diurnal Cycle for JKL - spring

LST = Zulu - 5

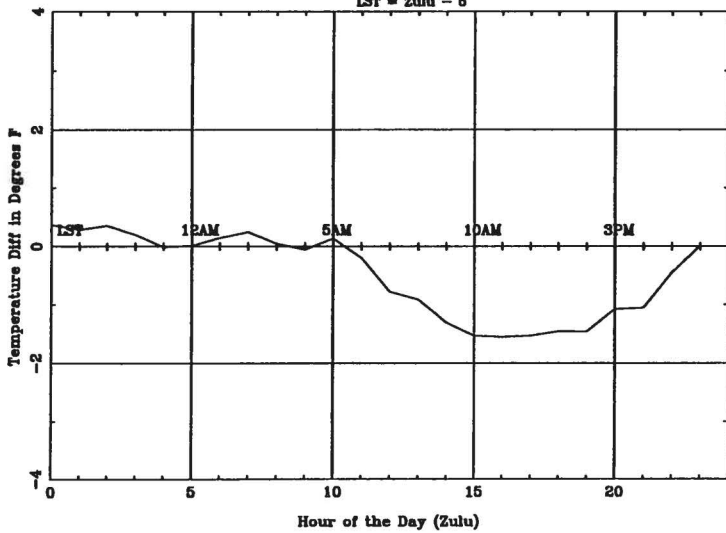

Average Diurnal Cycle for JKL - summer

LST = Zulu - 5

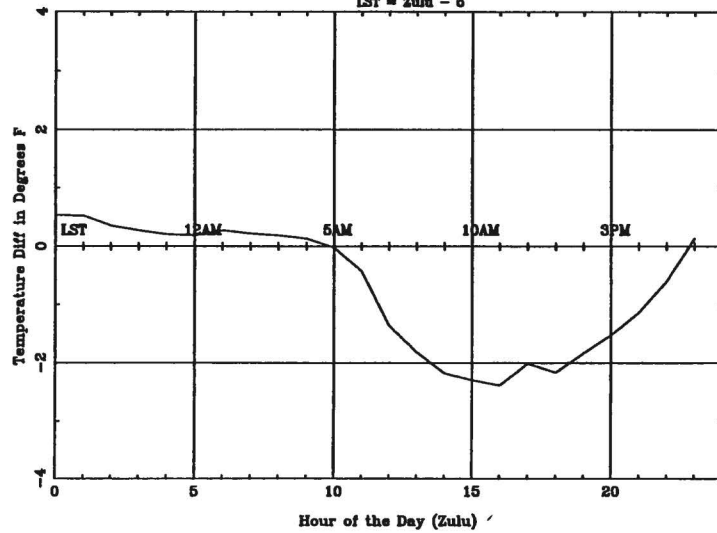

Average Diurnal Cycle for LAN - fall
LST = Zulu - 5

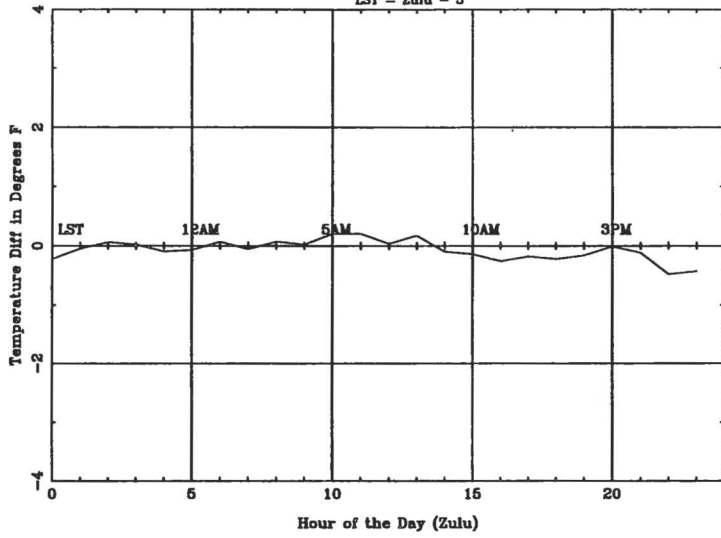

Average Diurnal Cycle for LAN - winter
LST = Zulu - 5

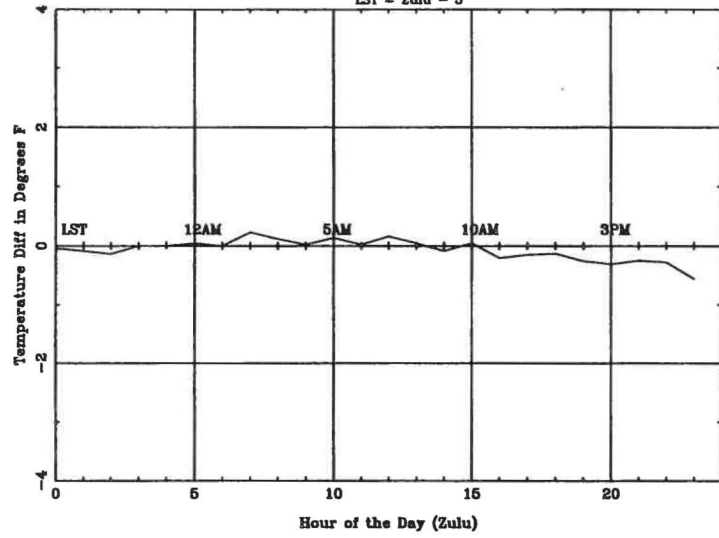

Average Diurnal Cycle for LAN - spring
LST = Zulu - 5

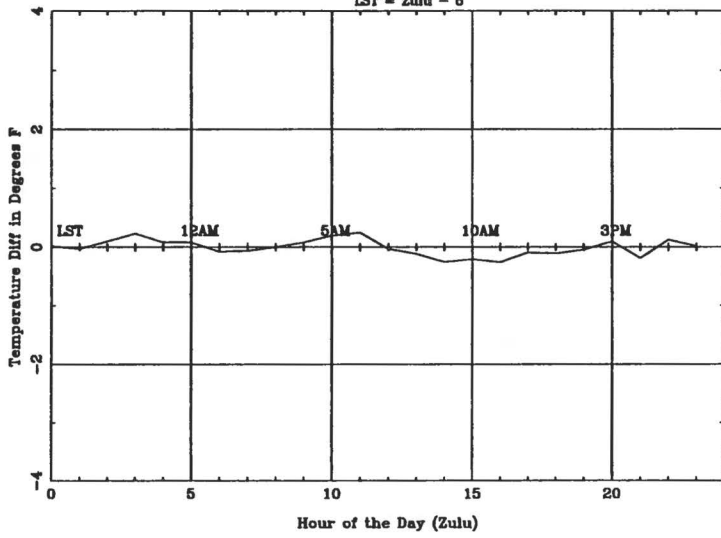

Average Diurnal Cycle for LAN - summer
LST = Zulu - 5

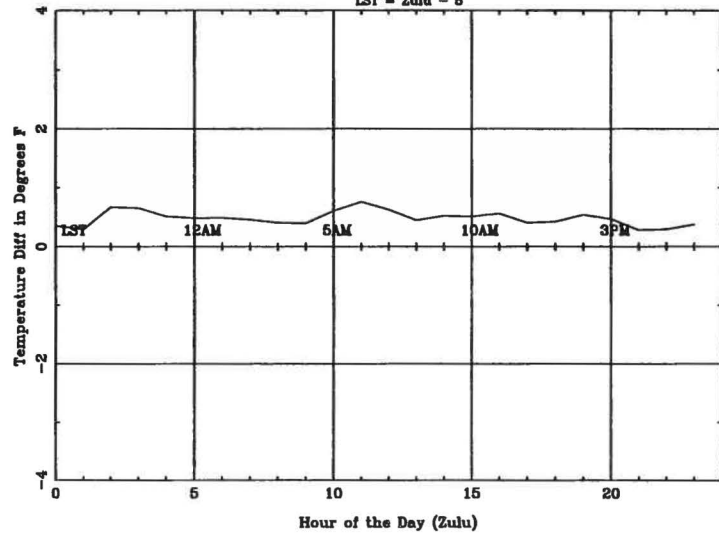

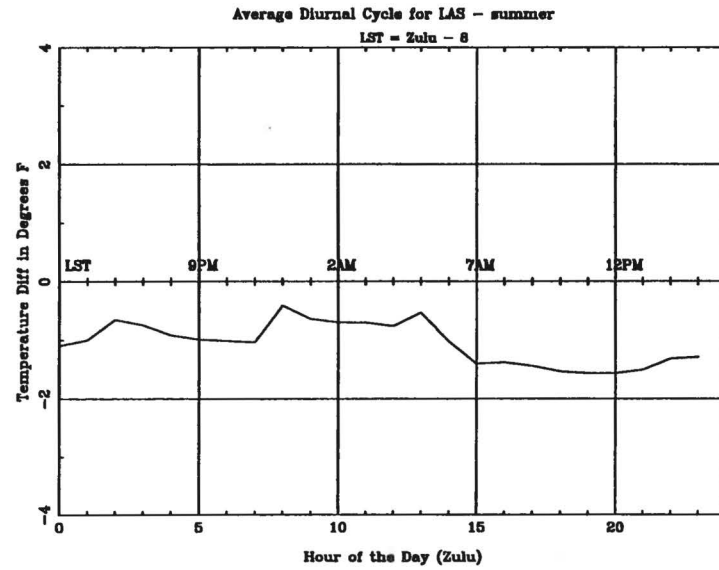
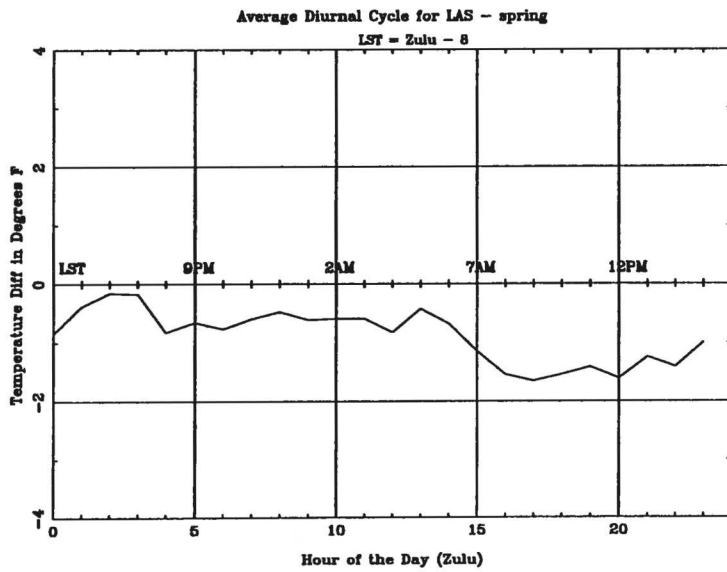
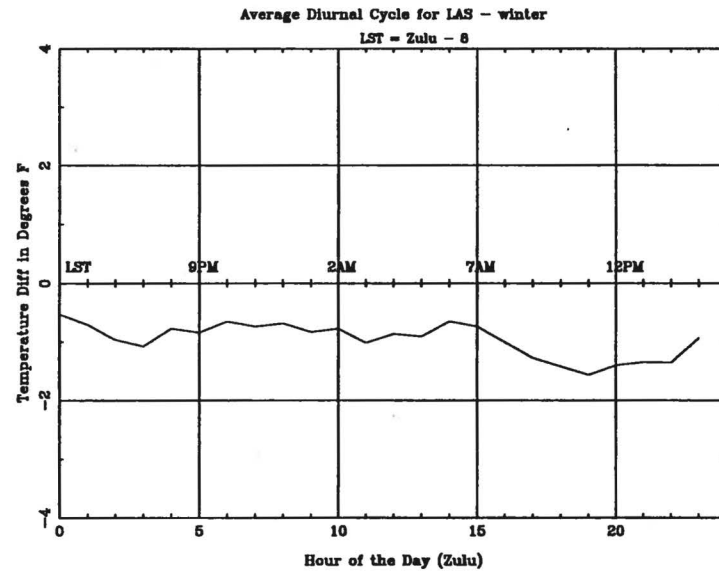
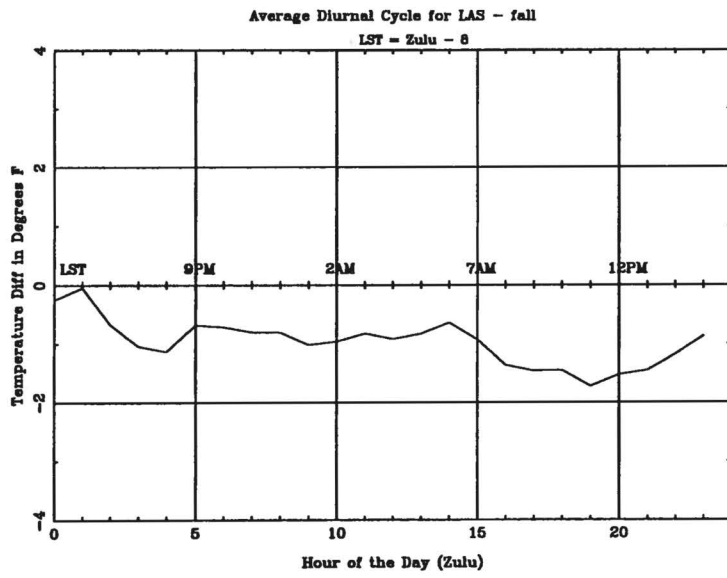

Average Diurnal Cycle for LBB - fall
LST = Zulu - 6

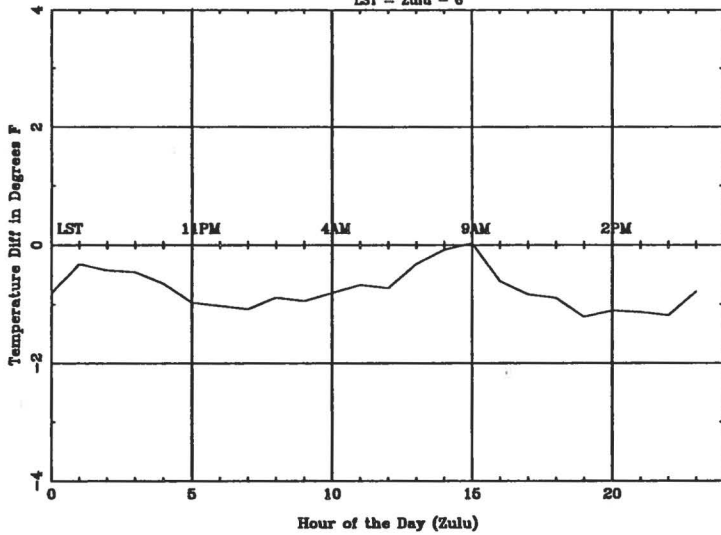

Average Diurnal Cycle for LBB - winter
LST = Zulu - 6

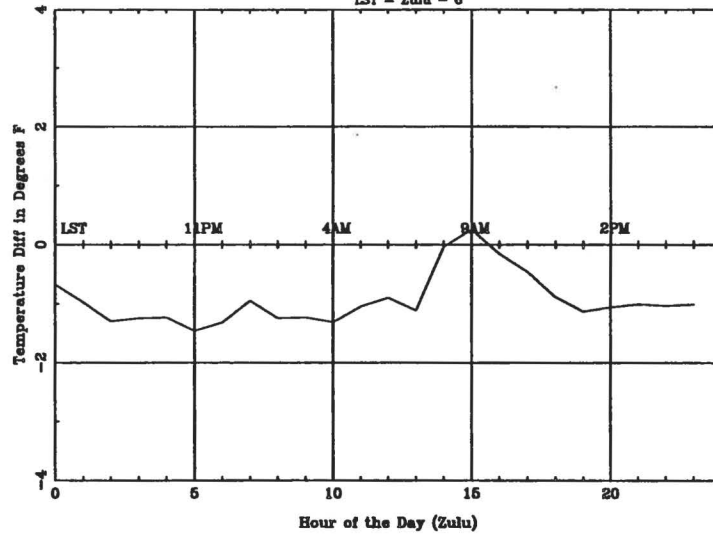

Average Diurnal Cycle for LBB - spring
LST = Zulu - 6

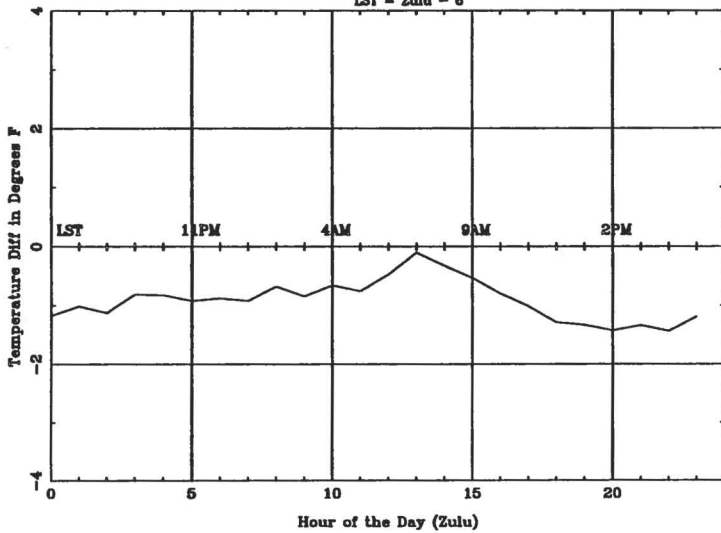

Average Diurnal Cycle for LBB - summer
LST = Zulu - 6

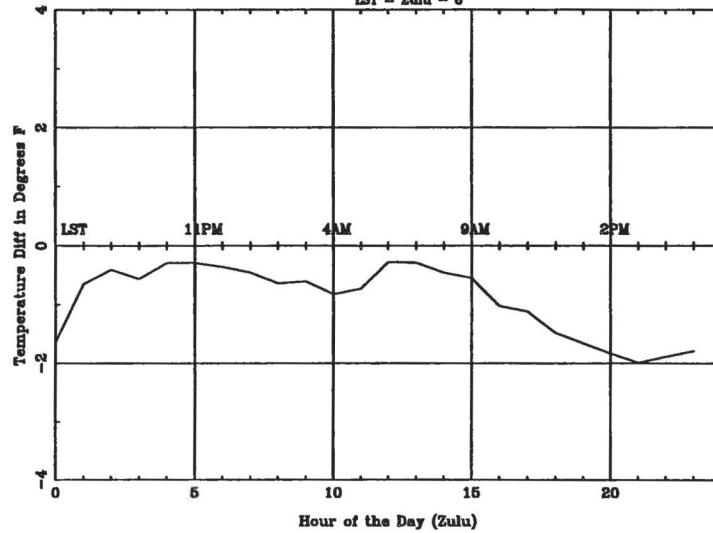

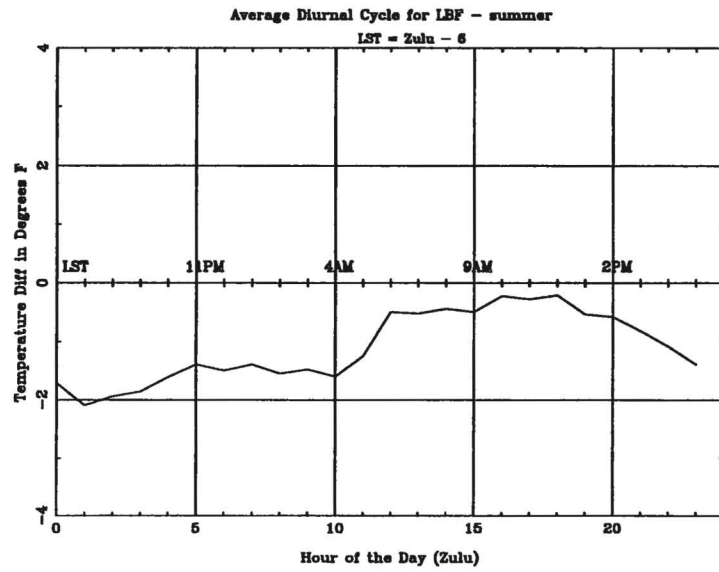
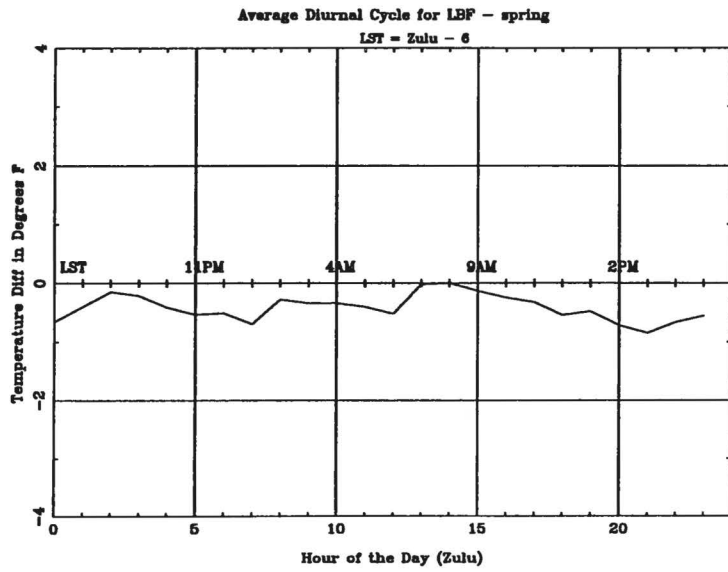
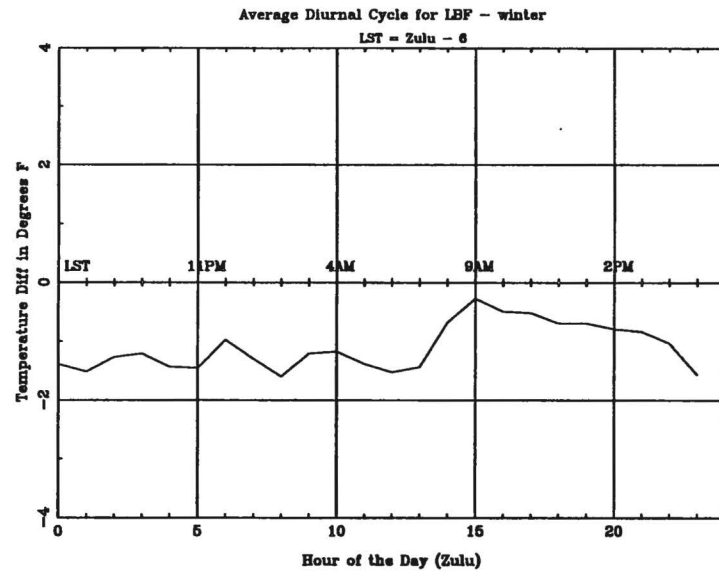
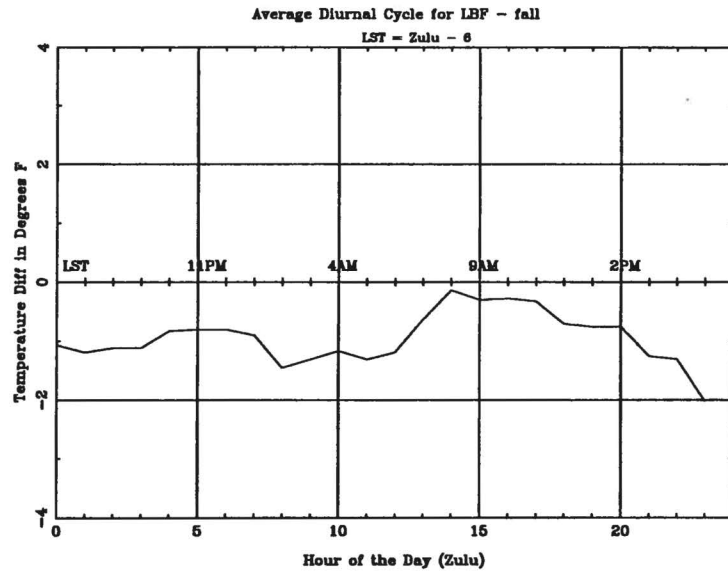

Average Diurnal Cycle for LCH - fall

LST = Zulu - 6

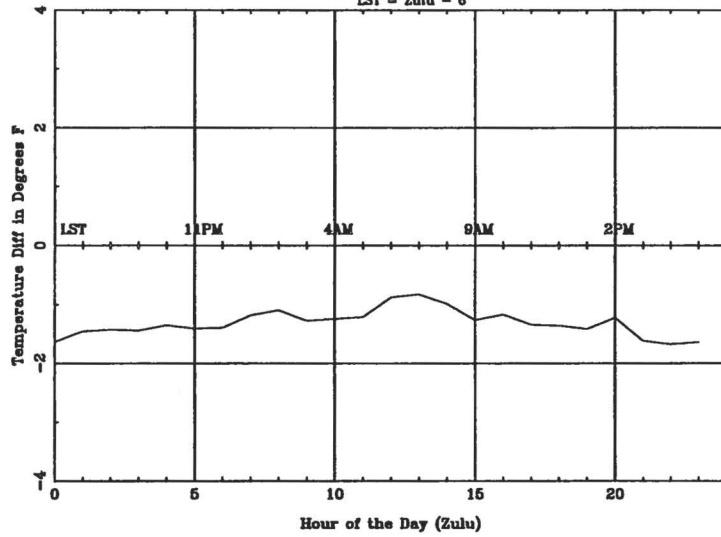

Average Diurnal Cycle for LCH - winter

LST = Zulu - 6

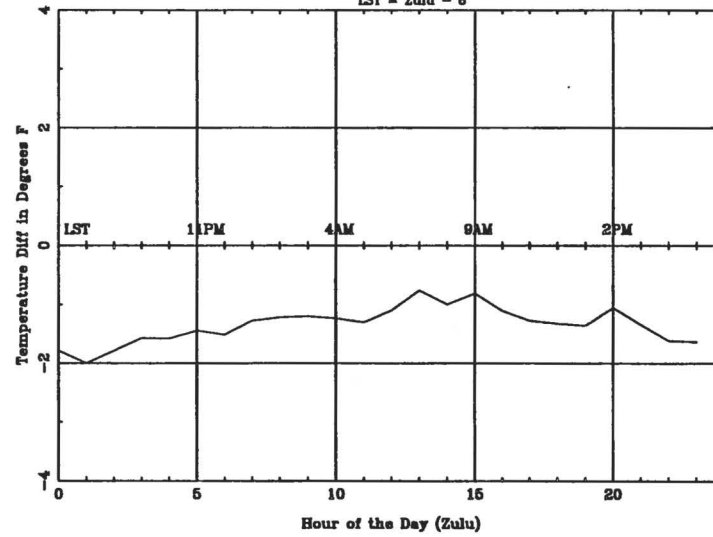

Average Diurnal Cycle for LCH - spring

LST = Zulu - 6

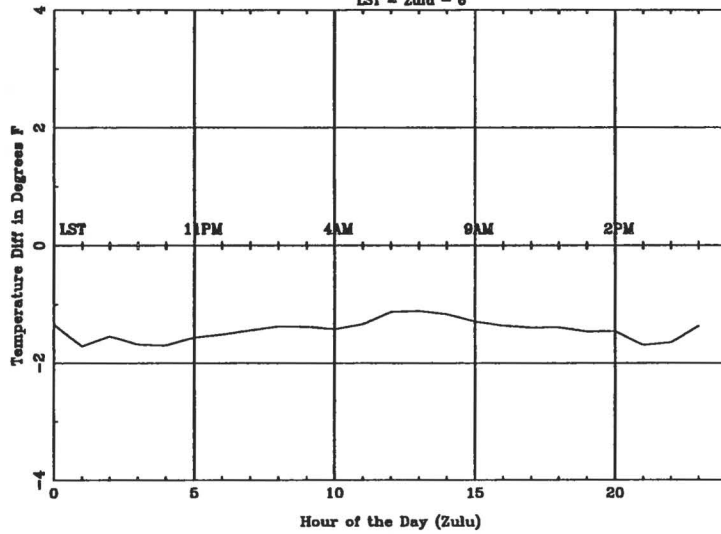

Average Diurnal Cycle for LCH - summer

LST = Zulu - 6

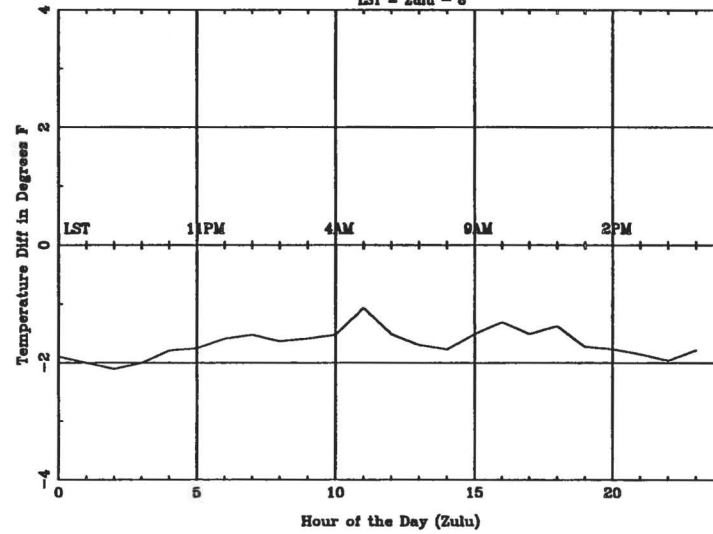

Average Diurnal Cycle for LEK - fall
LST = Zulu - 5

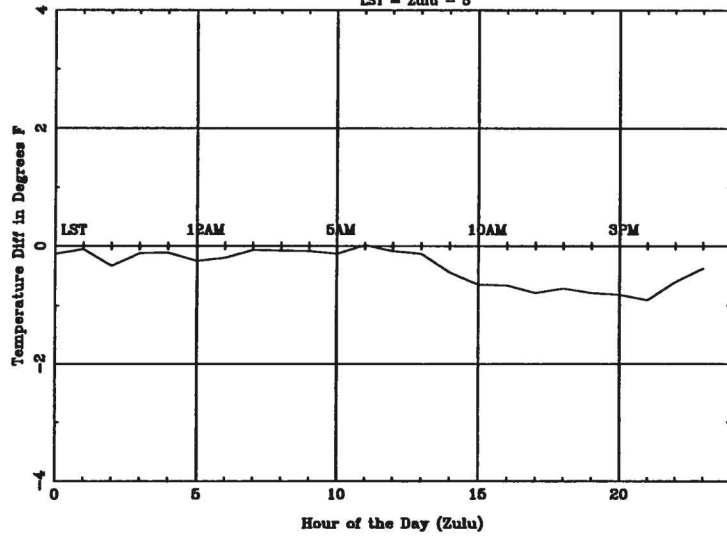

Average Diurnal Cycle for LEK - winter
LST = Zulu - 5

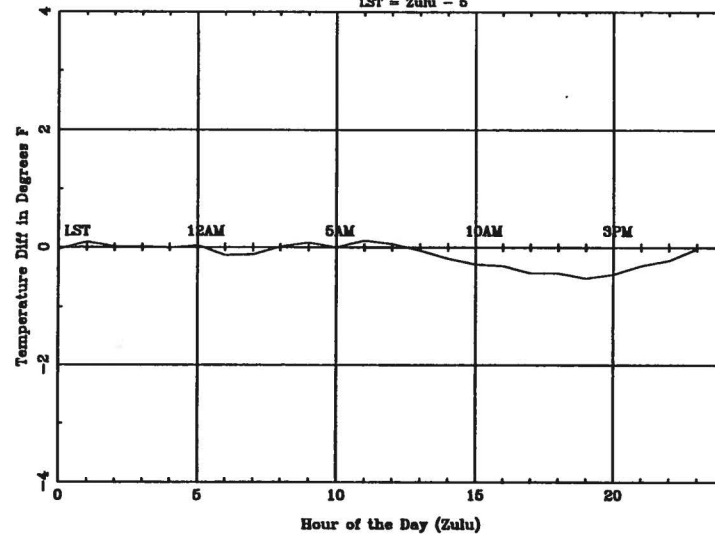

Average Diurnal Cycle for LEK - spring
LST = Zulu - 5

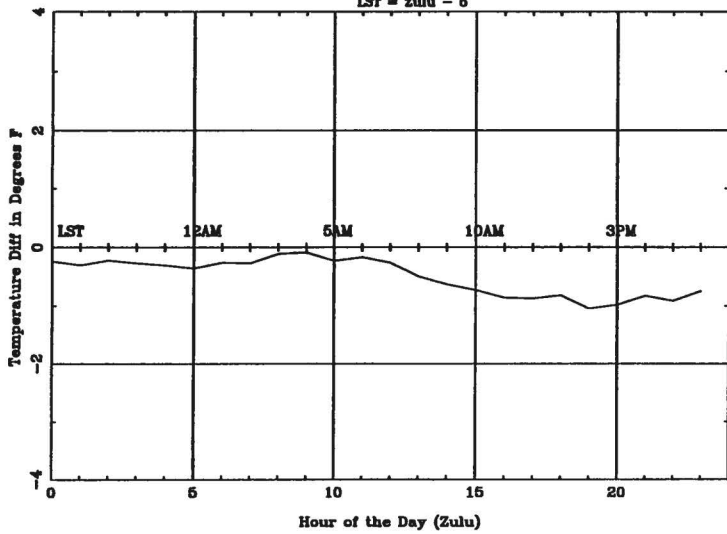

Average Diurnal Cycle for LEK - summer
LST = Zulu - 5

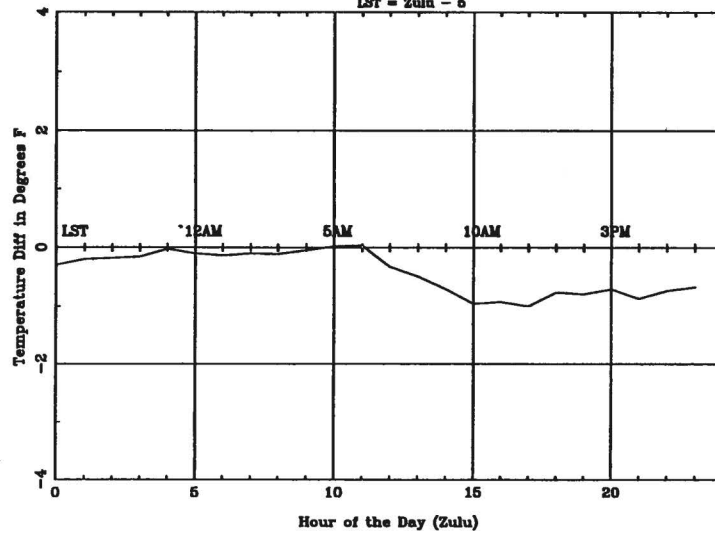

Average Diurnal Cycle for MCI - fall

LST = Zulu - 6

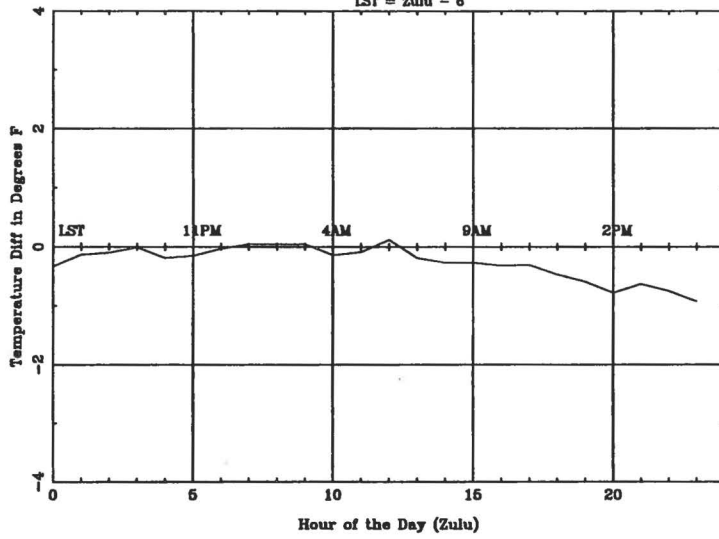

Average Diurnal Cycle for MCI - winter

LST = Zulu - 6

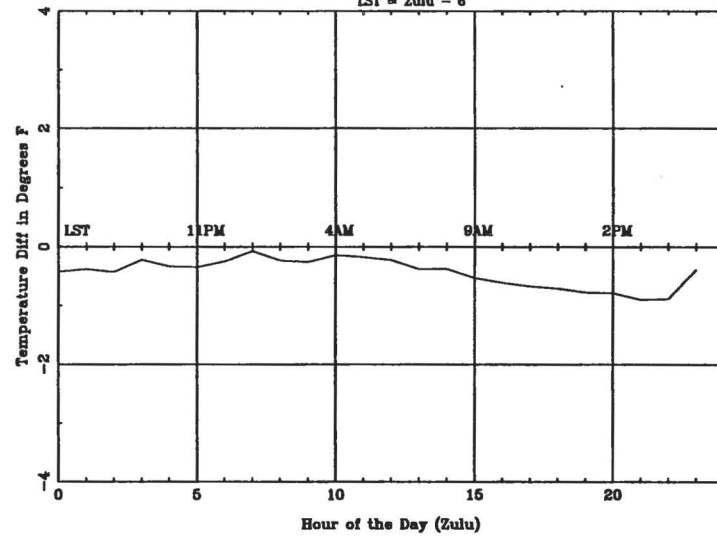

Average Diurnal Cycle for MCI - spring

LST = Zulu - 6

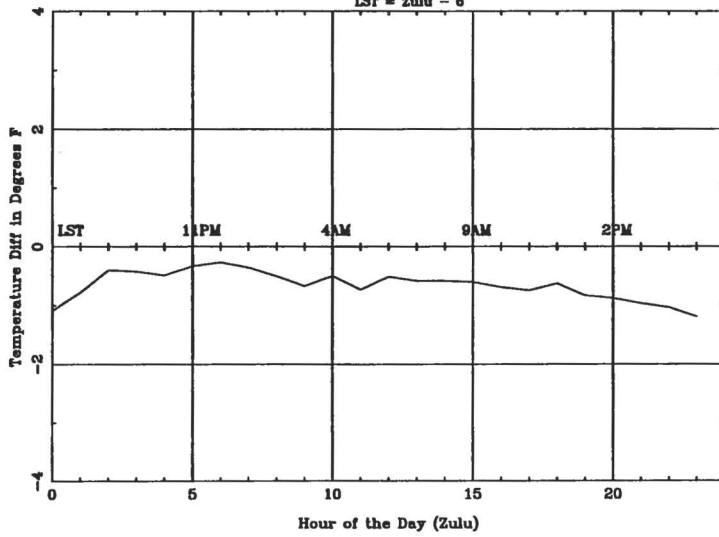

Average Diurnal Cycle for MCI - summer

LST = Zulu - 6

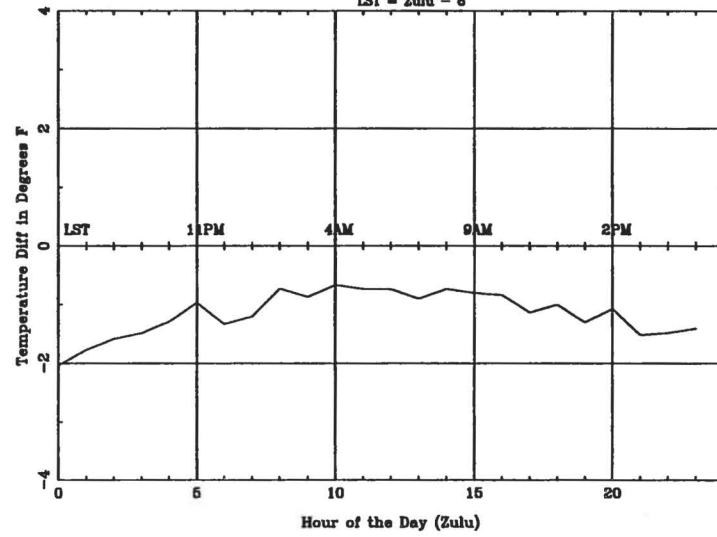

Average Diurnal Cycle for MCO - fall
LST = Zulu - 5

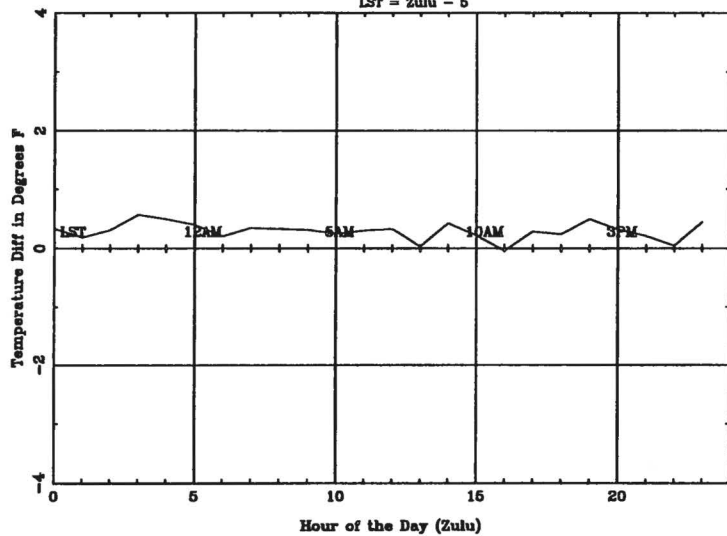

Average Diurnal Cycle for MCO - winter
LST = Zulu - 5

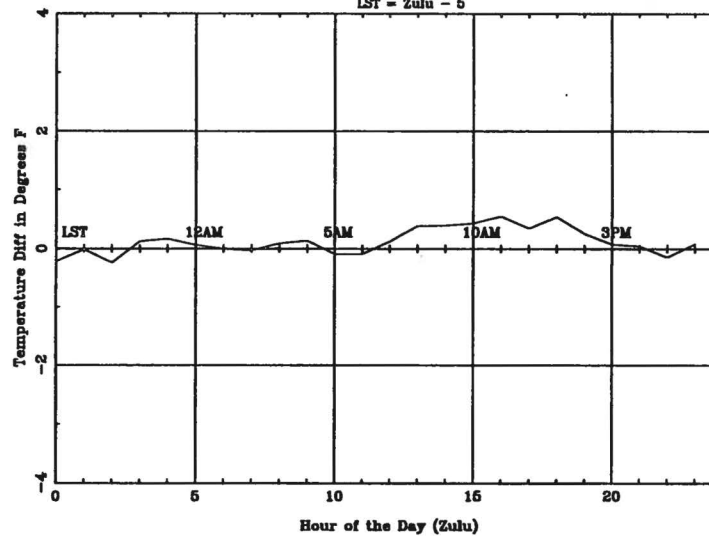

Average Diurnal Cycle for MCO - spring
LST = Zulu - 5

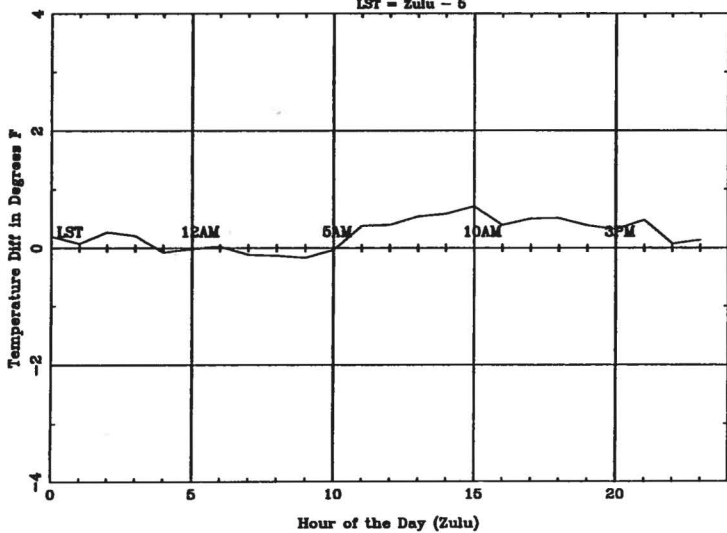

Average Diurnal Cycle for MCO - summer
LST = Zulu - 5

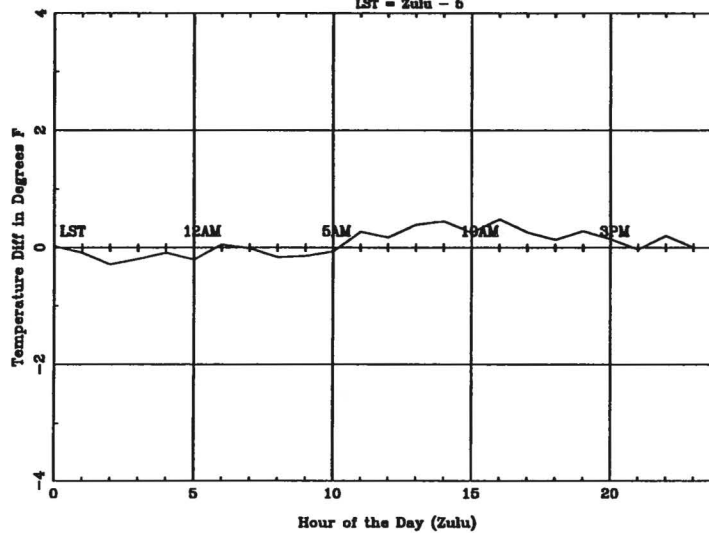

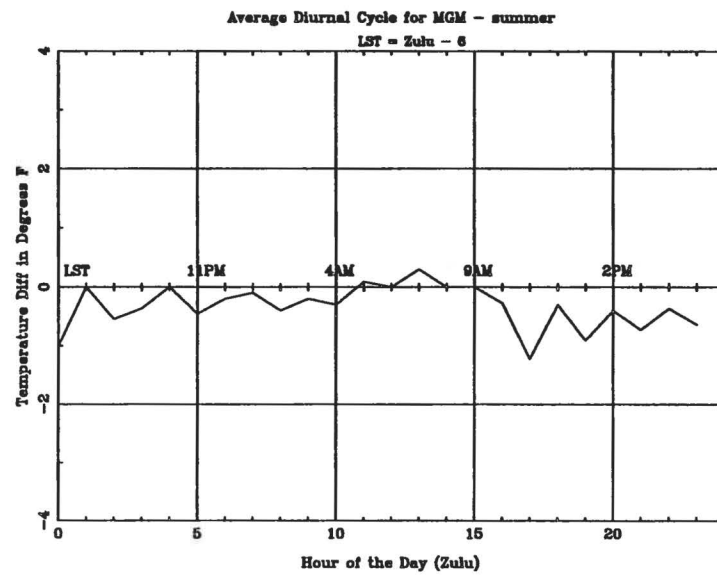
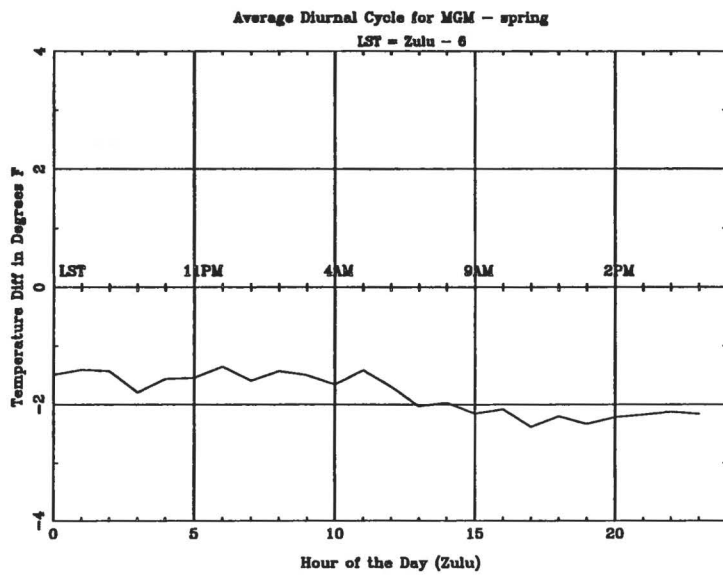
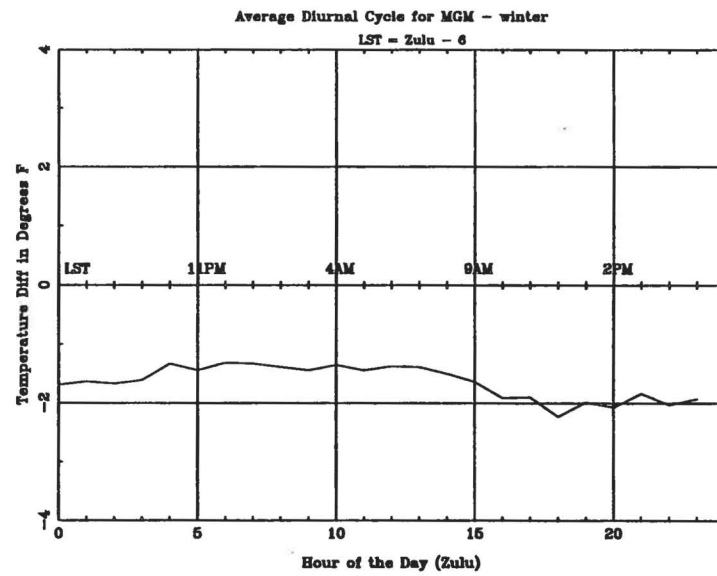
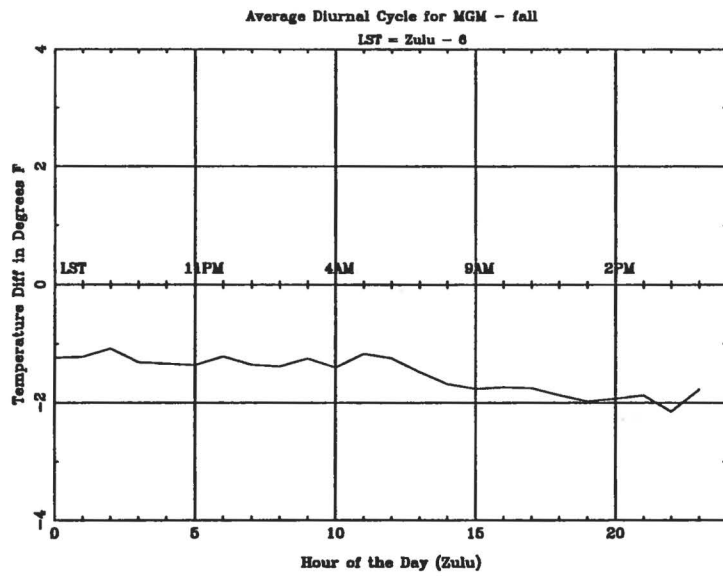

Average Diurnal Cycle for MHS - fall

LST = Zulu - 8

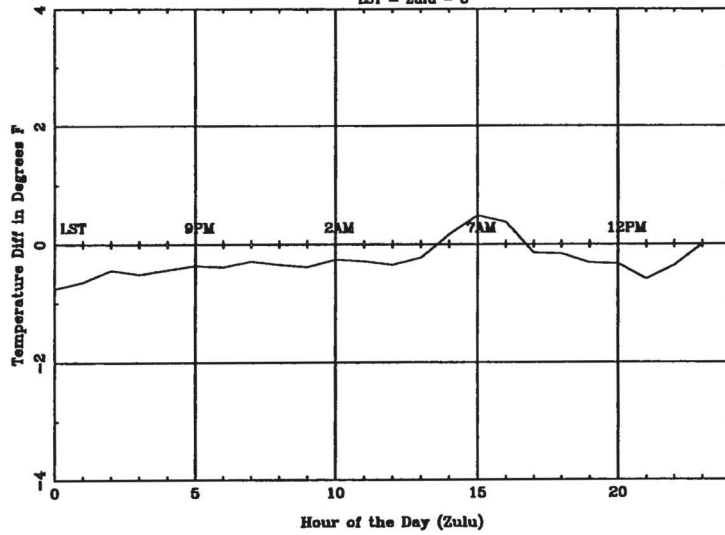

Average Diurnal Cycle for MHS - winter

LST = Zulu - 8

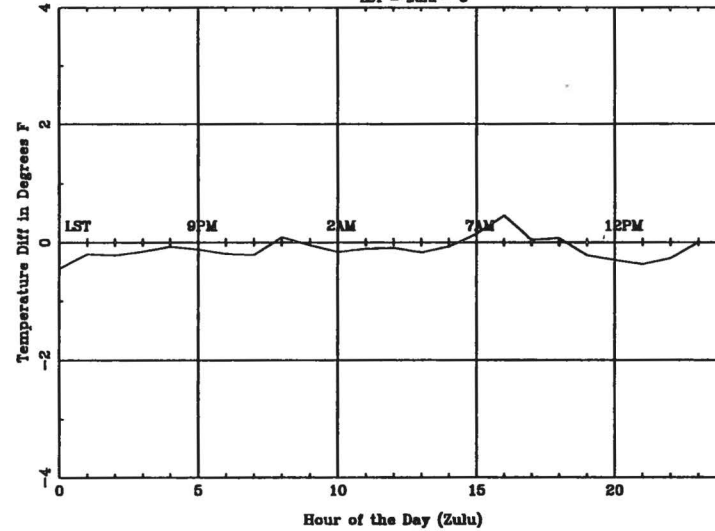

Average Diurnal Cycle for MHS - spring

LST = Zulu - 8

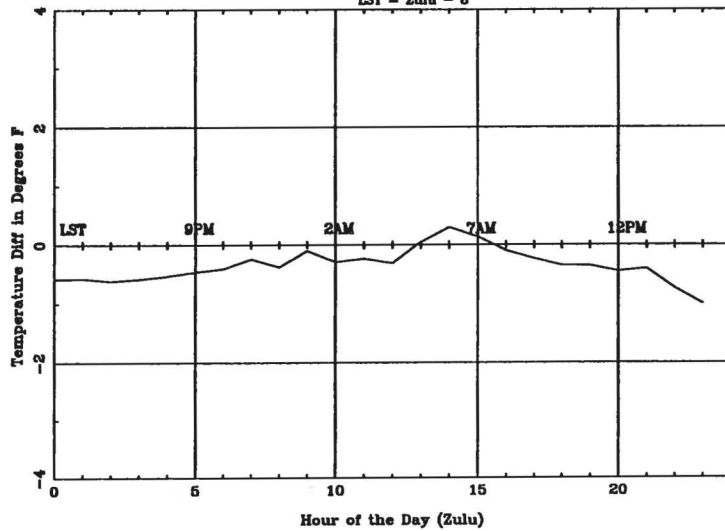

Average Diurnal Cycle for MHS - summer

LST = Zulu - 8

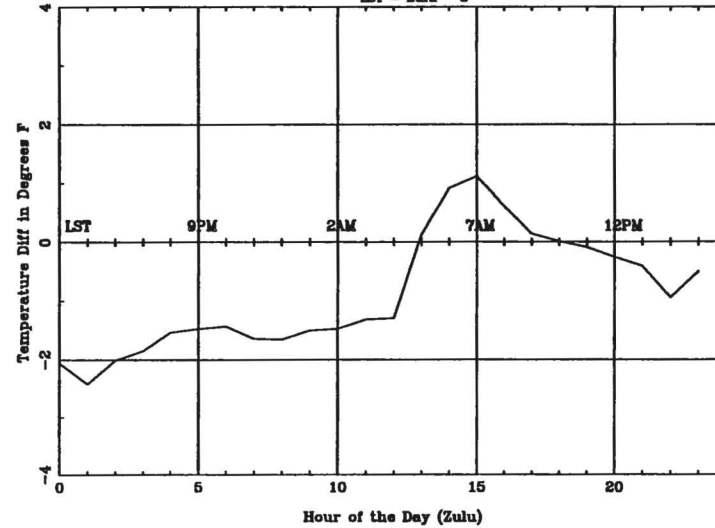

Average Diurnal Cycle for MKE - fall

LST = Zulu - 6

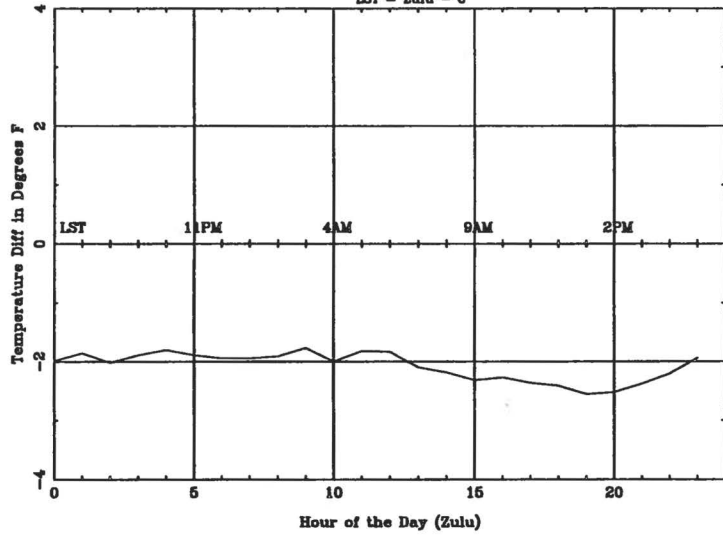

Average Diurnal Cycle for MKE - winter

LST = Zulu - 6

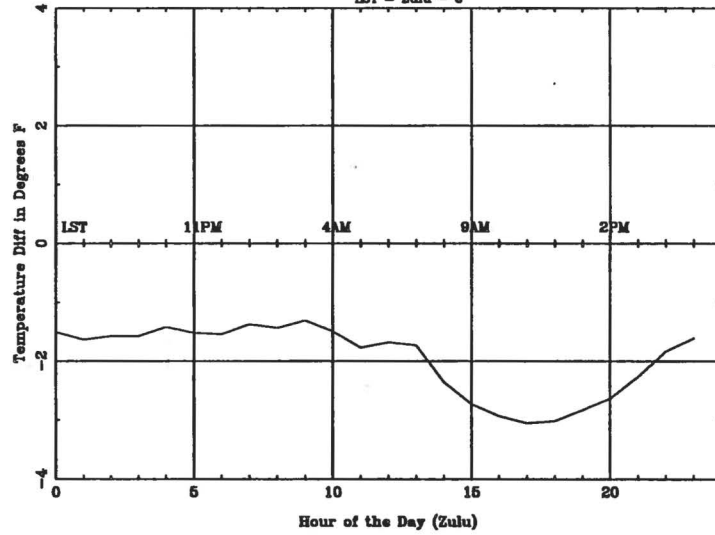

Average Diurnal Cycle for MKE - spring

LST = Zulu - 6

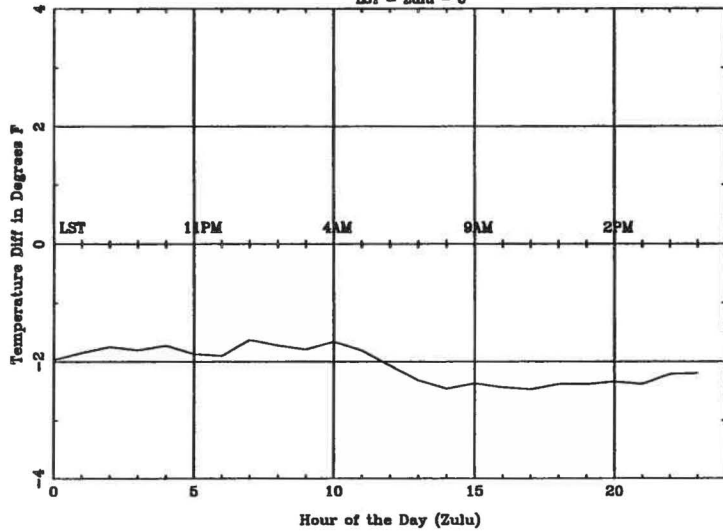

Average Diurnal Cycle for MKE - summer

LST = Zulu - 6

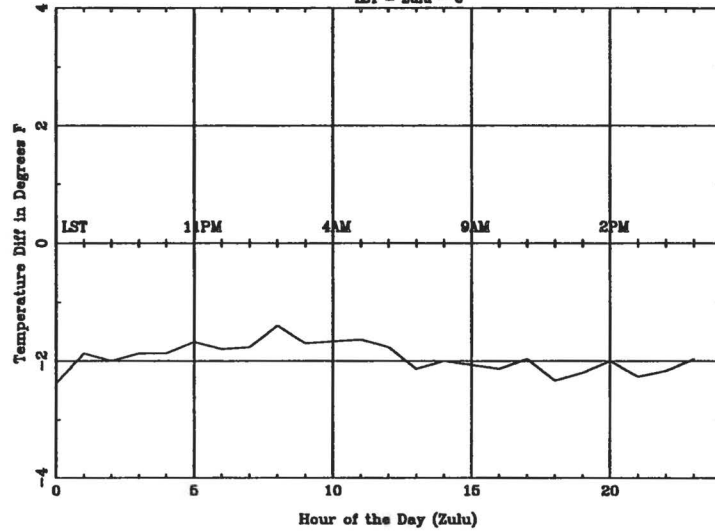

Average Diurnal Cycle for MKG - fall
LST = Zulu - 5

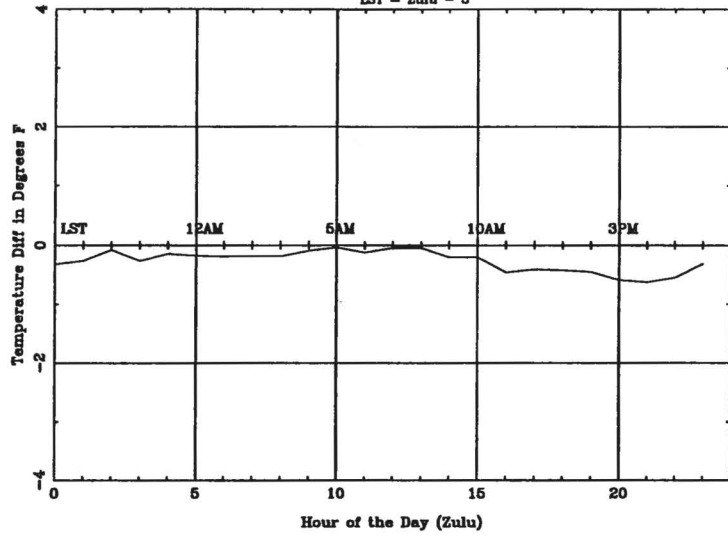

Average Diurnal Cycle for MKG - winter
LST = Zulu - 5

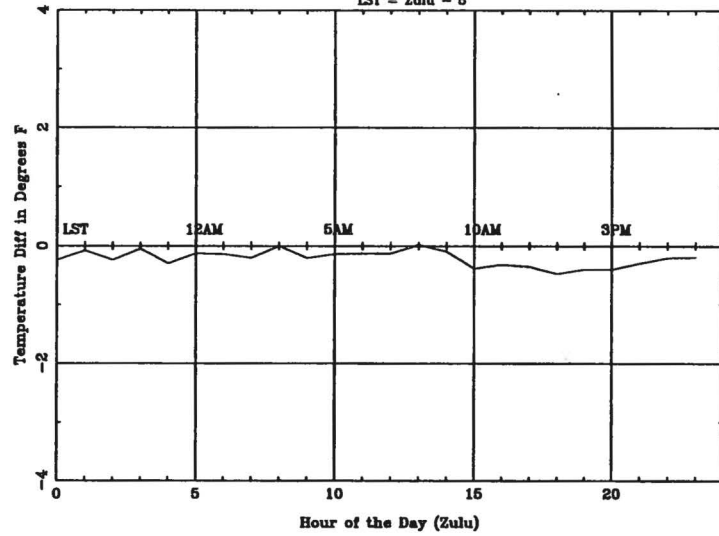

Average Diurnal Cycle for MKG - spring
LST = Zulu - 5

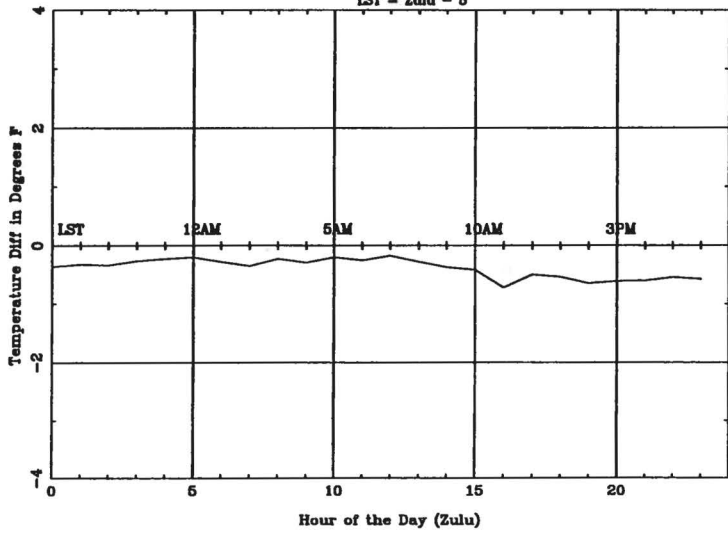

Average Diurnal Cycle for MKG - summer
LST = Zulu - 5

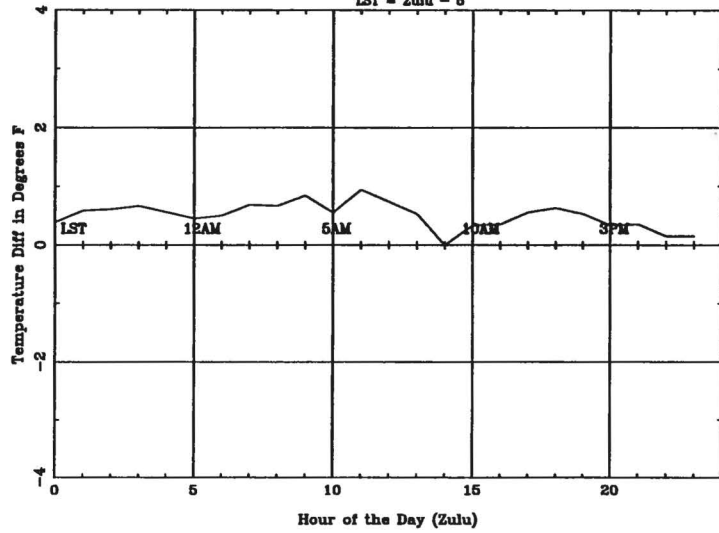

Average Diurnal Cycle for MLI - fall

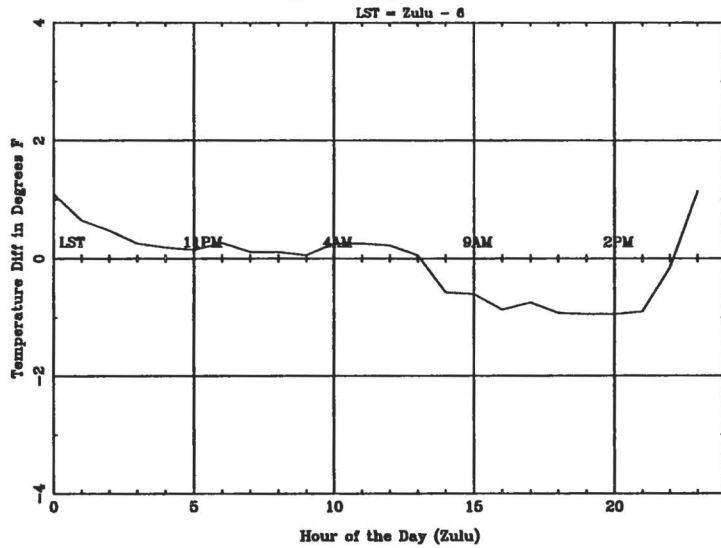

Average Diurnal Cycle for MLI - winter

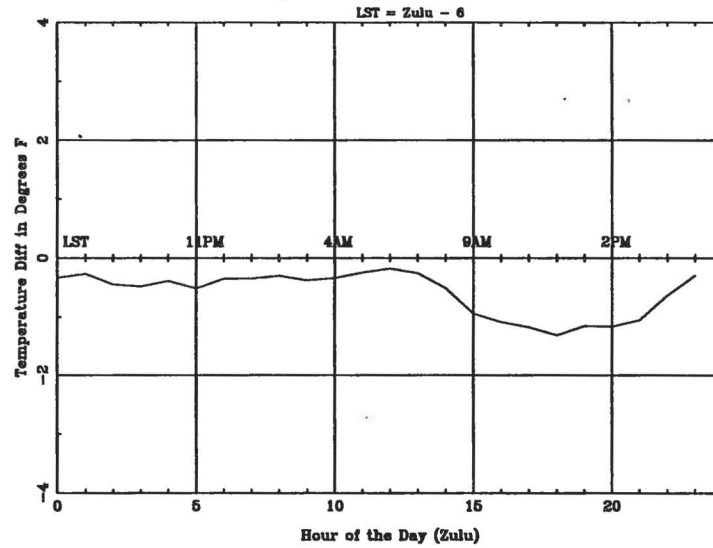

Average Diurnal Cycle for MLI - spring

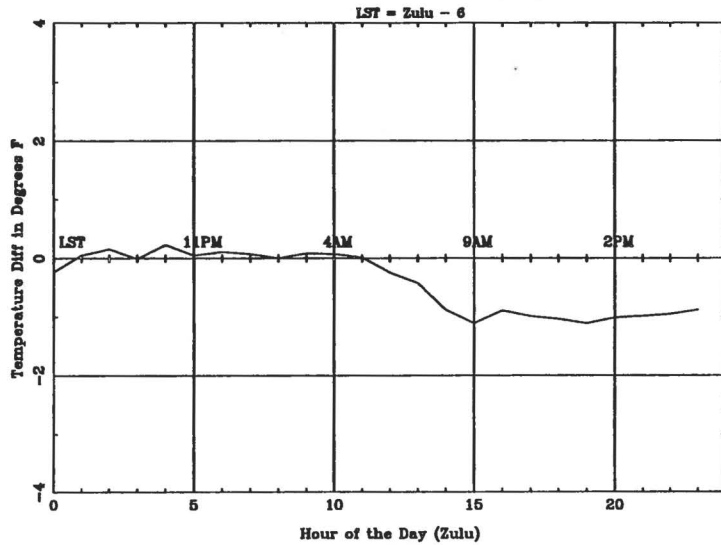

Average Diurnal Cycle for MLI - summer

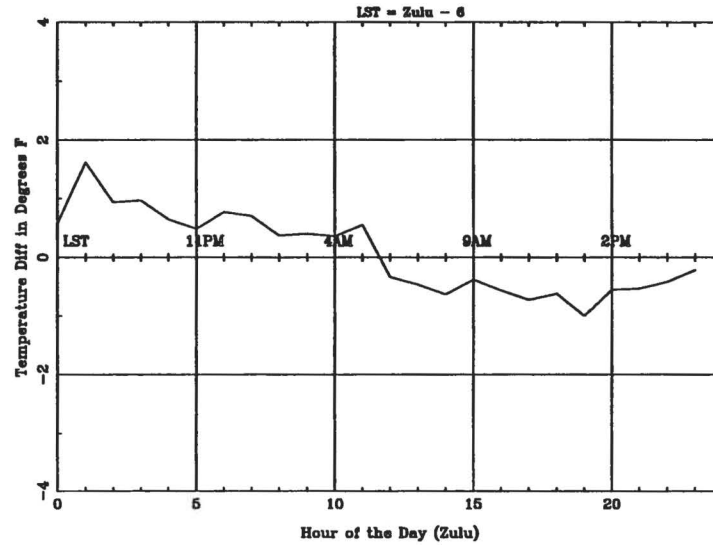

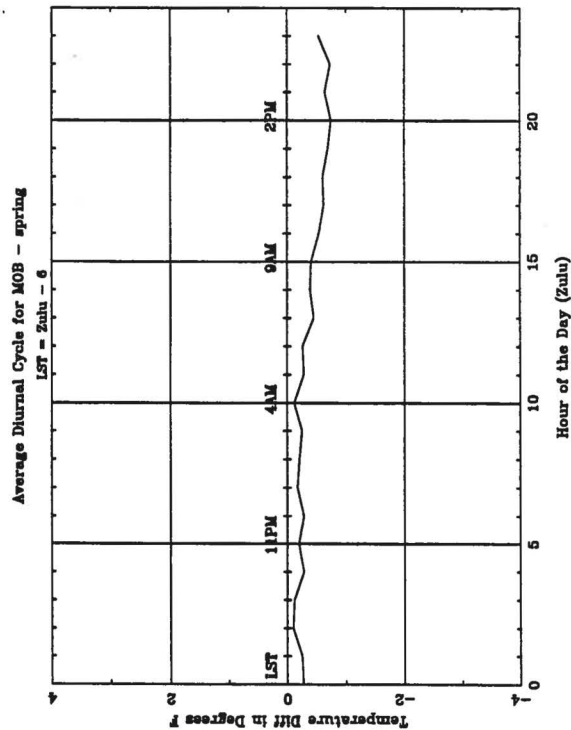
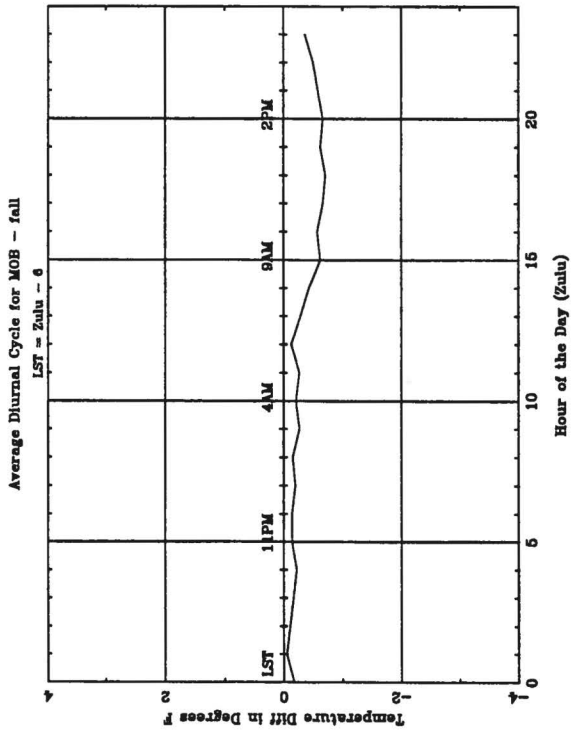
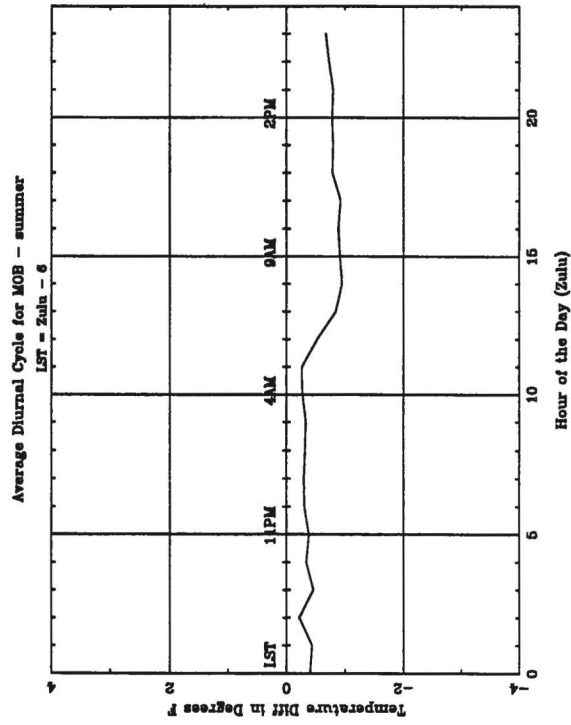
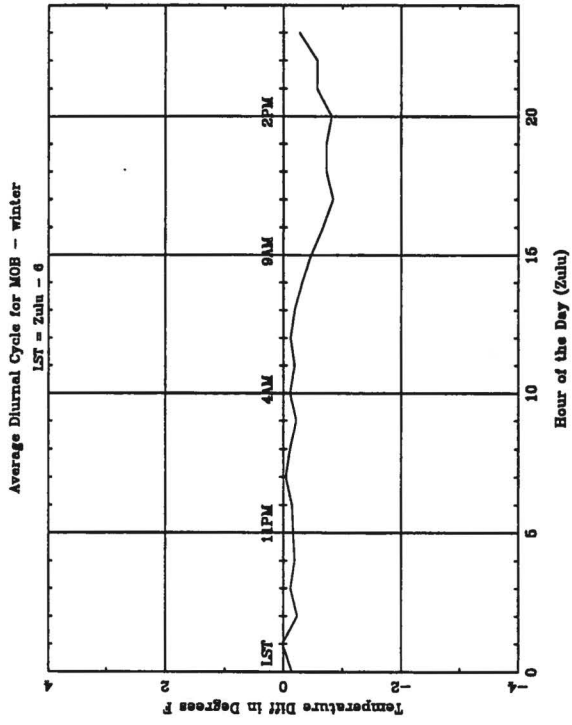

Average Diurnal Cycle for MSN - fall

LST = Zulu - 6

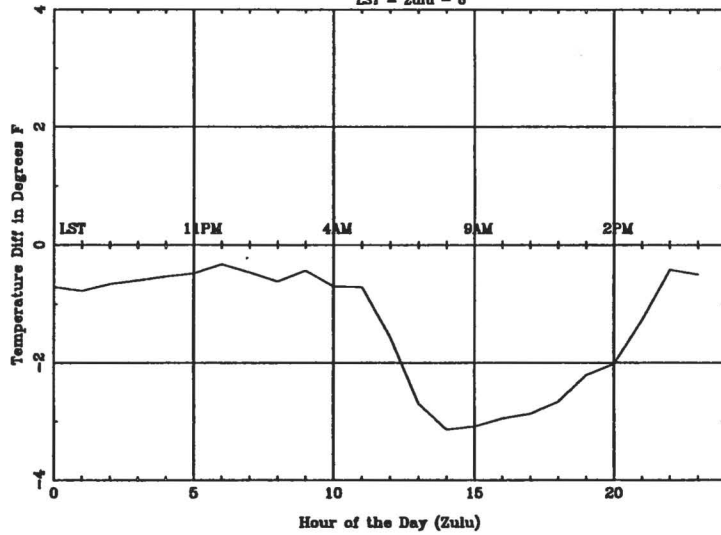

Average Diurnal Cycle for MSN - winter

LST = Zulu - 6

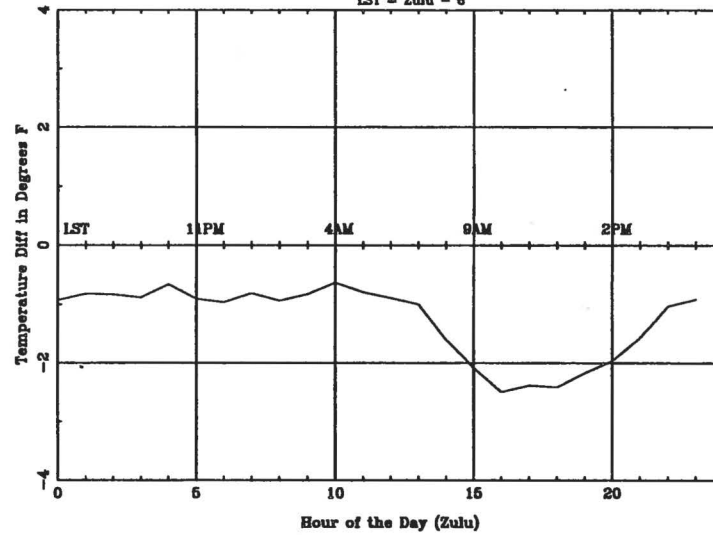

Average Diurnal Cycle for MSN - spring

LST = Zulu - 6

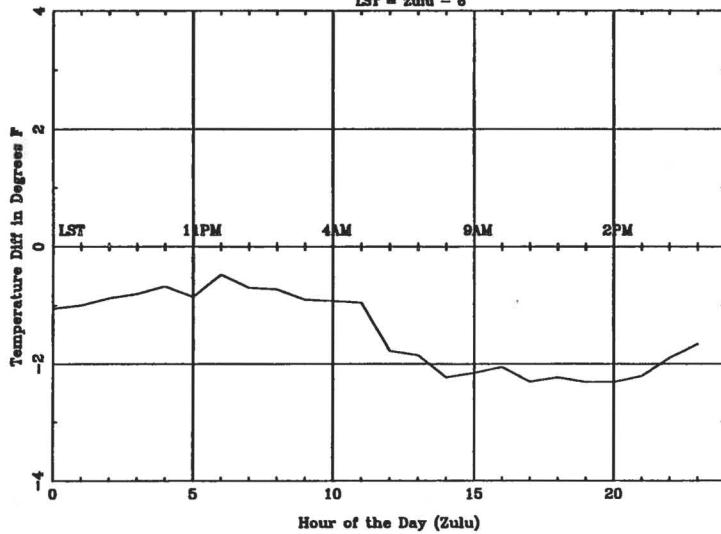

Average Diurnal Cycle for MSN - summer

LST = Zulu - 6

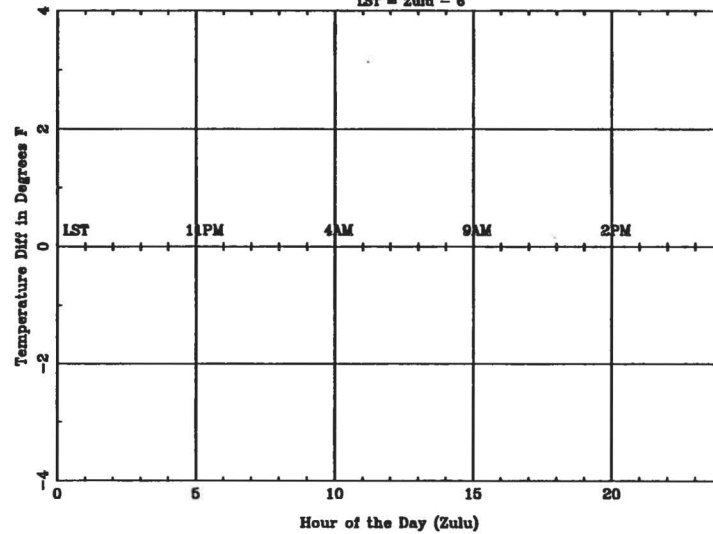

Average Diurnal Cycle for MSO - fall

LST = Zulu - 7

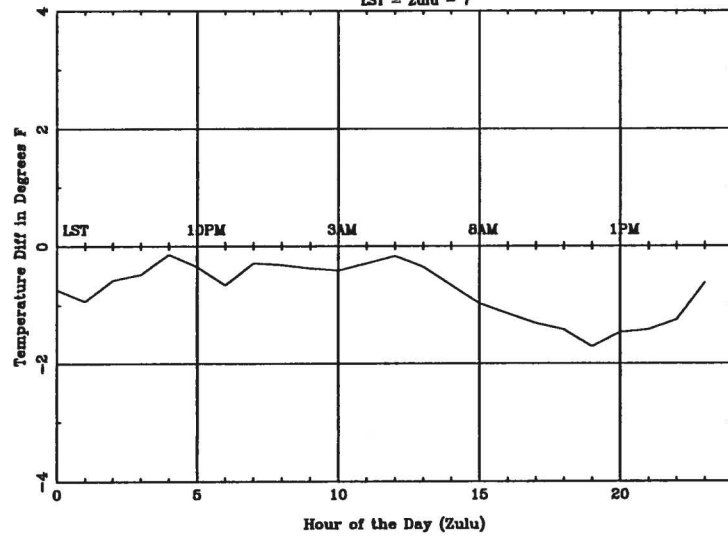

Average Diurnal Cycle for MSO - winter

LST = Zulu - 7

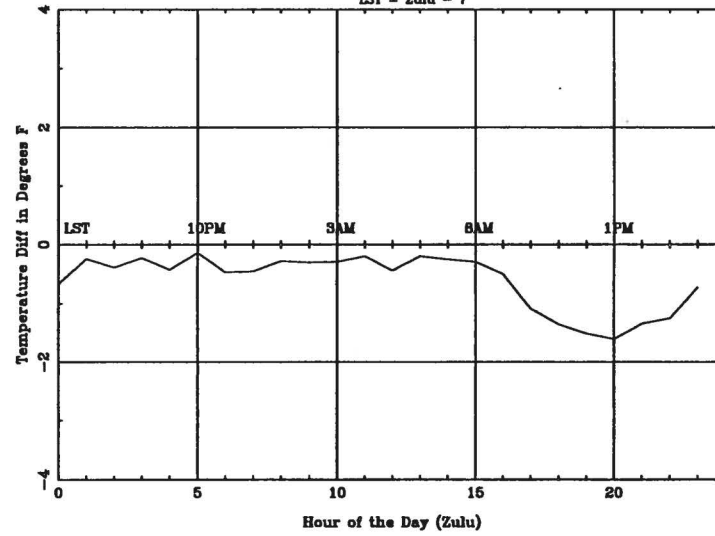

Average Diurnal Cycle for MSO - spring

LST = Zulu - 7

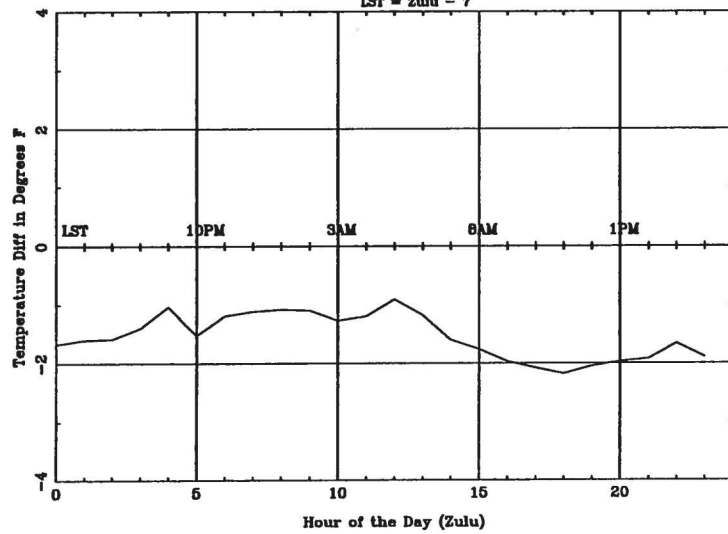

Average Diurnal Cycle for MSO - summer

LST = Zulu - 7

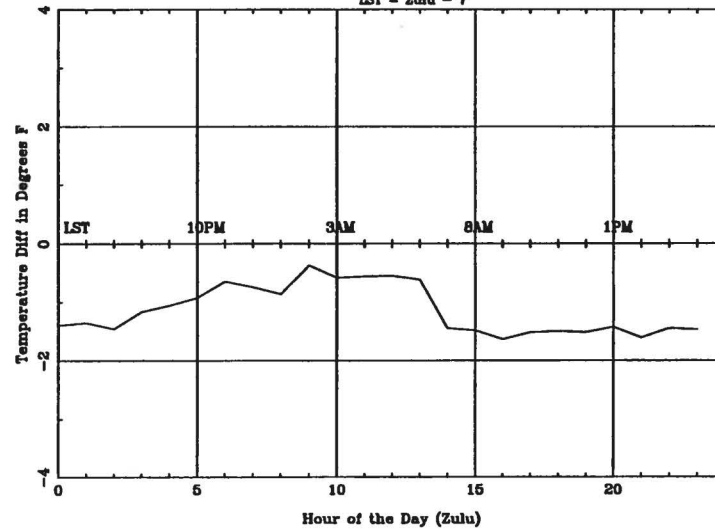

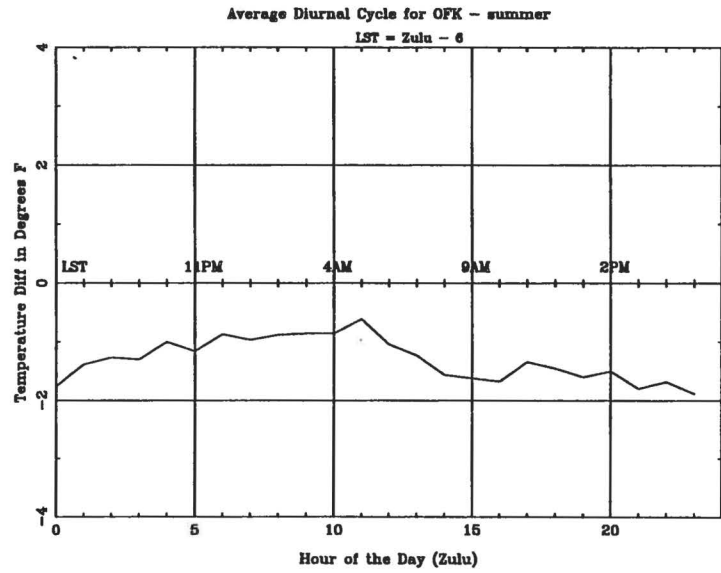
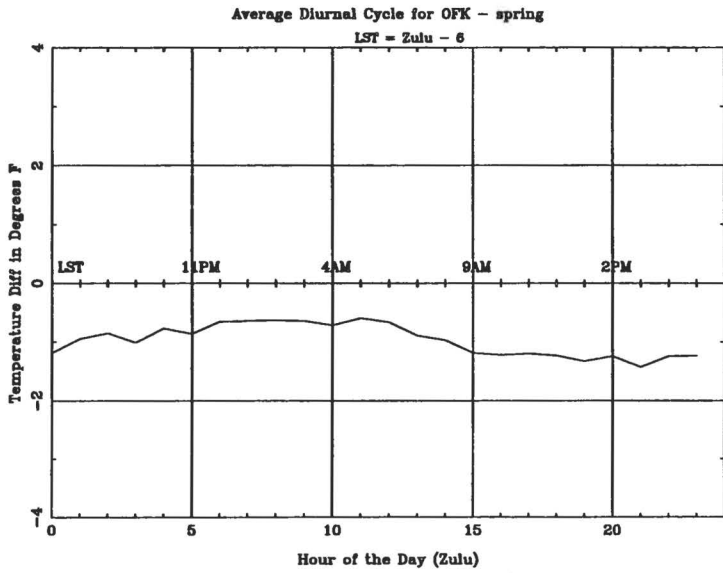
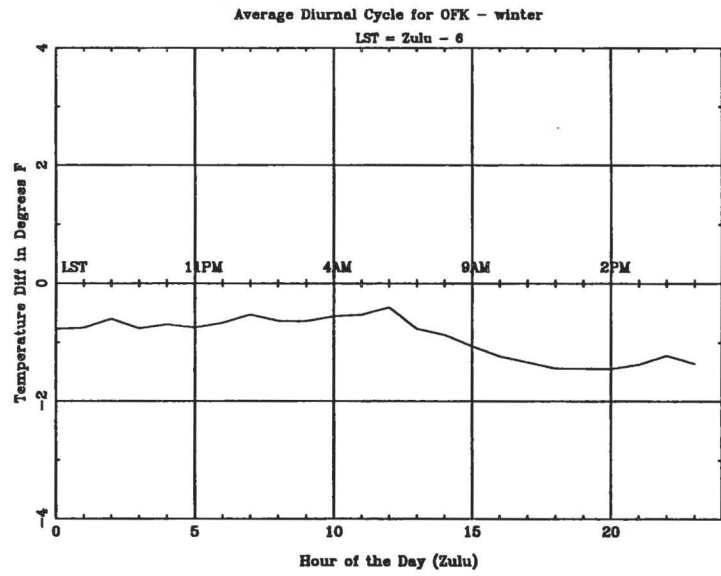
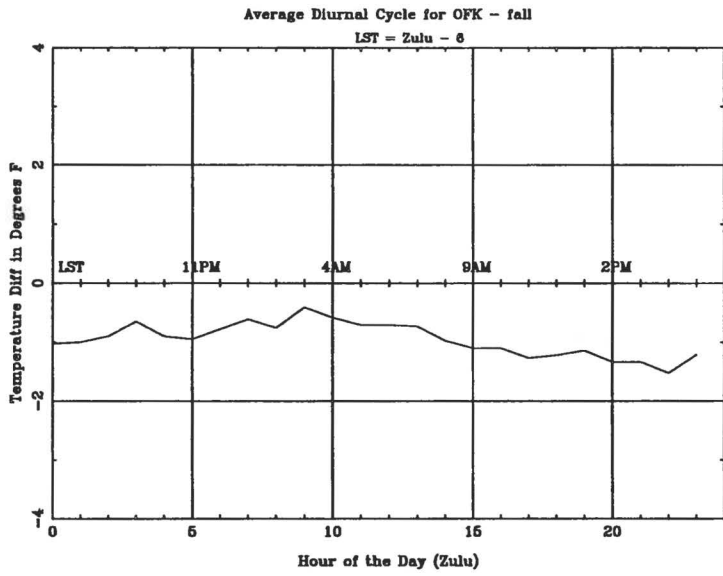

Average Diurnal Cycle for ORH - fall
LST = Zulu - 5

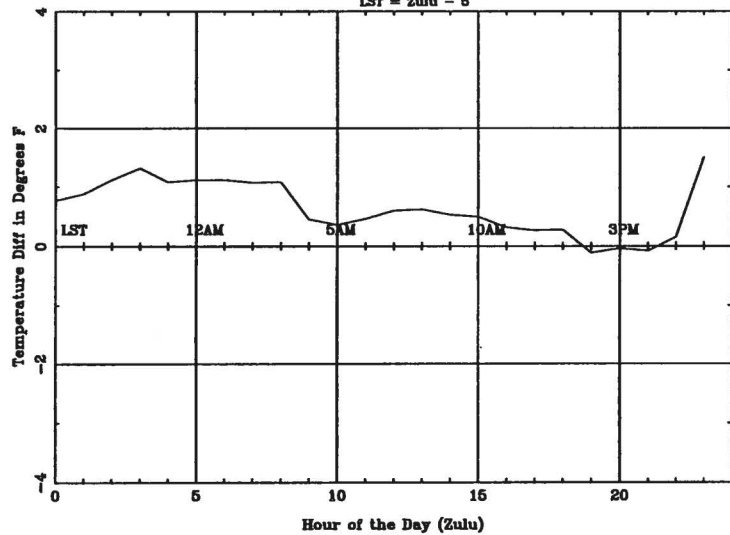

Average Diurnal Cycle for ORH - winter
LST = Zulu - 5

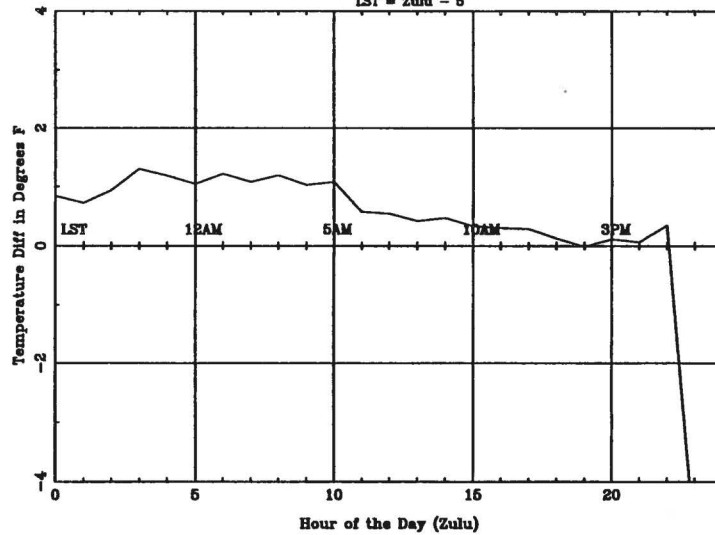

Average Diurnal Cycle for ORH - spring
LST = Zulu - 5

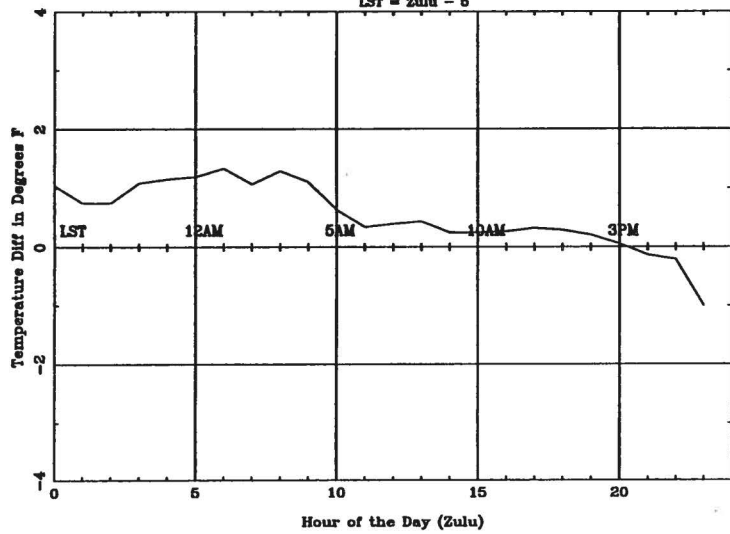

Average Diurnal Cycle for ORH - summer
LST = Zulu - 5

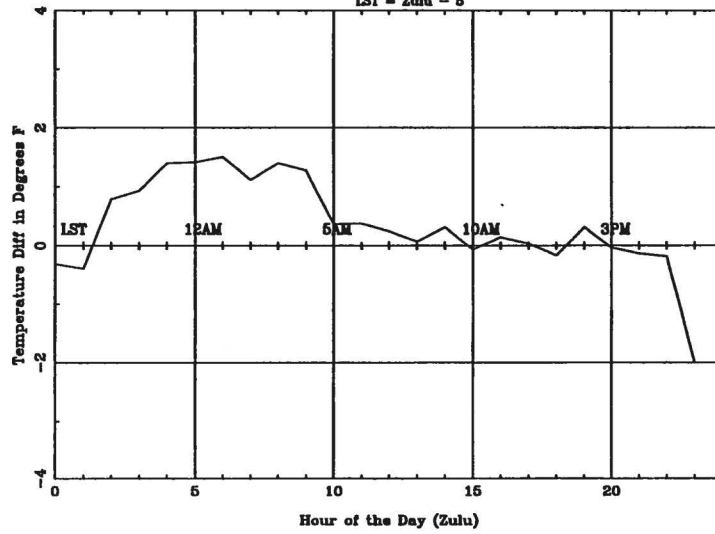

Average Diurnal Cycle for PAH - fall

LST = Zulu - 6

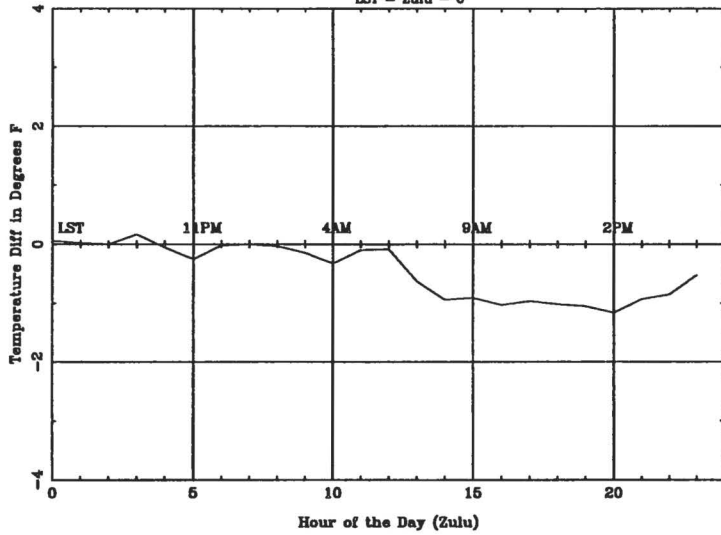

Average Diurnal Cycle for PAH - winter

LST = Zulu - 6

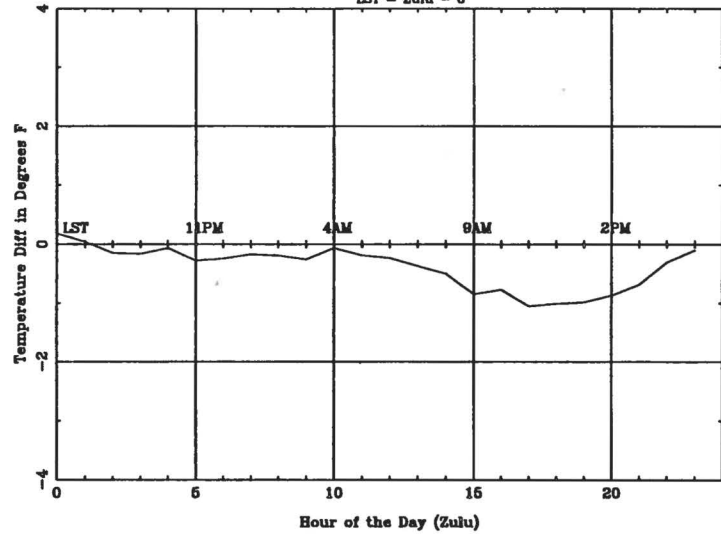

Average Diurnal Cycle for PAH - spring

LST = Zulu - 6

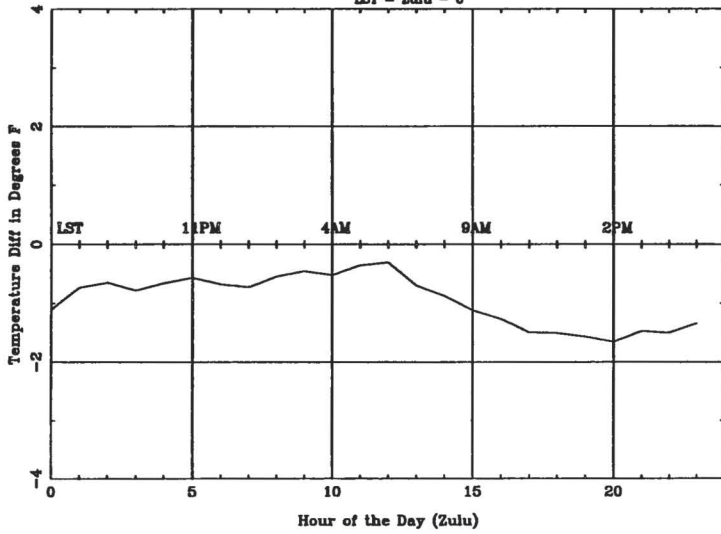

Average Diurnal Cycle for PAH - summer

LST = Zulu - 6

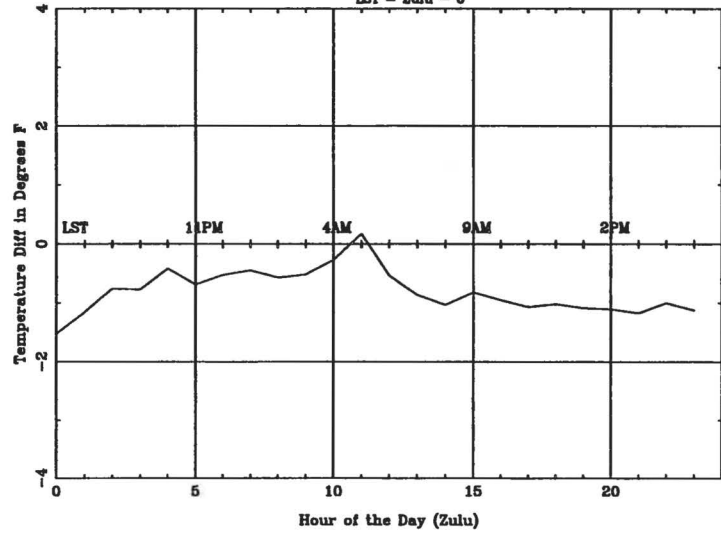

Average Diurnal Cycle for PDT - fall

LST = Zulu - 8

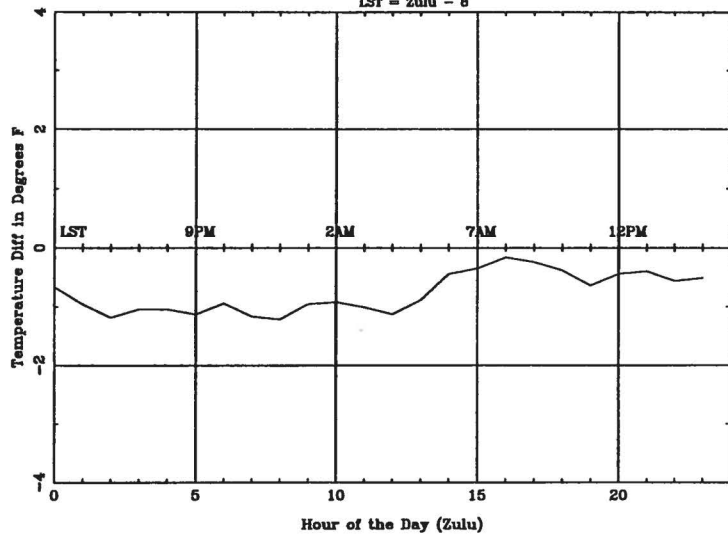

Average Diurnal Cycle for PDT - winter

LST = Zulu - 8

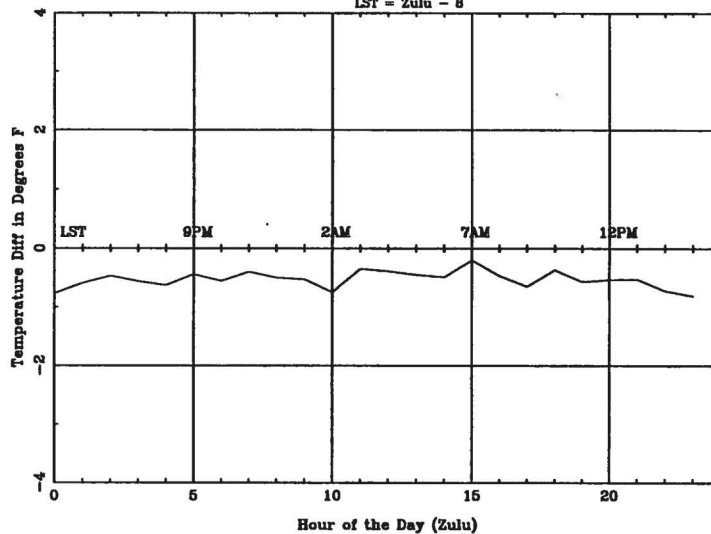

Average Diurnal Cycle for PDT - spring

LST = Zulu - 8

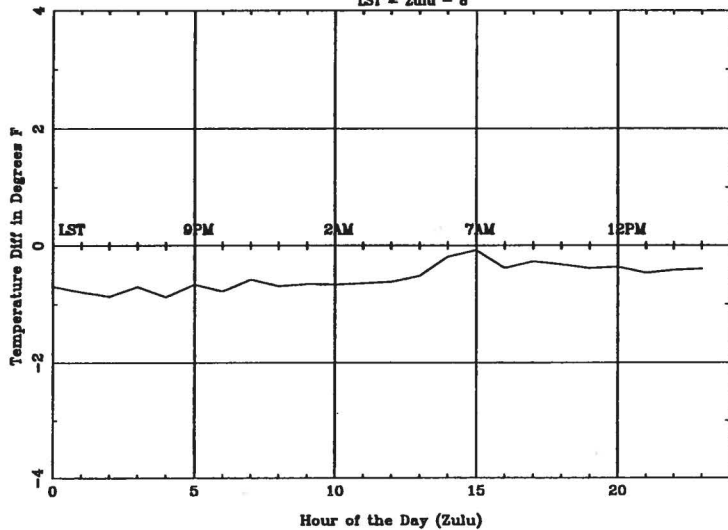

Average Diurnal Cycle for PDT - summer

LST = Zulu - 8

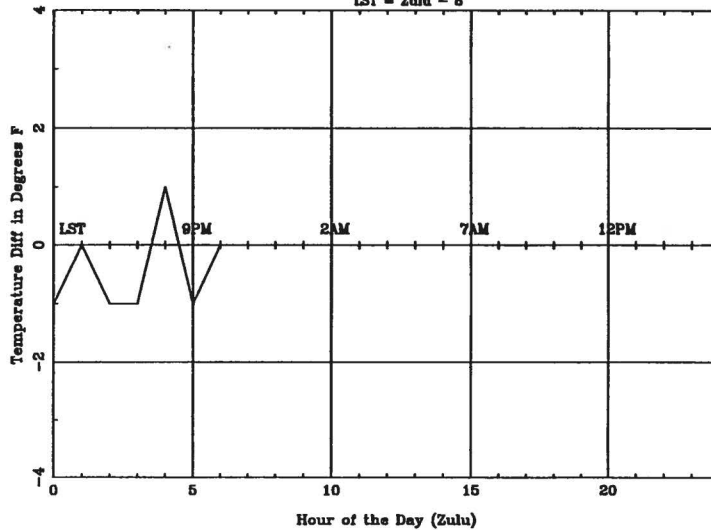

Average Diurnal Cycle for PDX - fall
LST = Zulu - 8

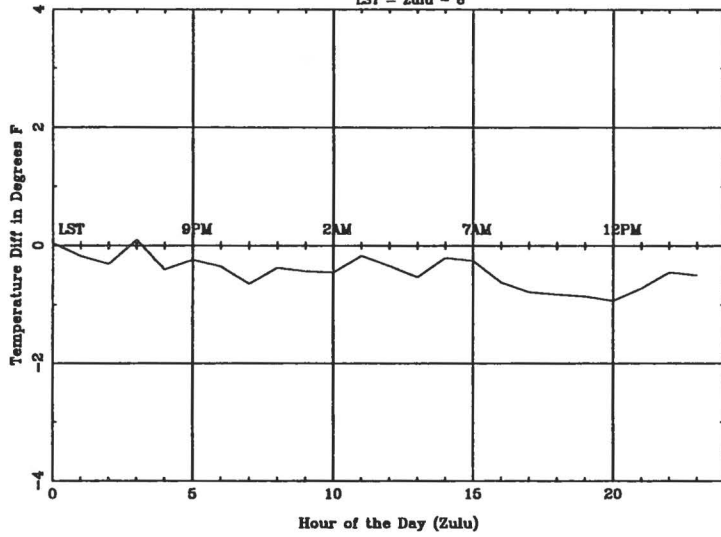

Average Diurnal Cycle for PDX - winter
LST = Zulu - 8

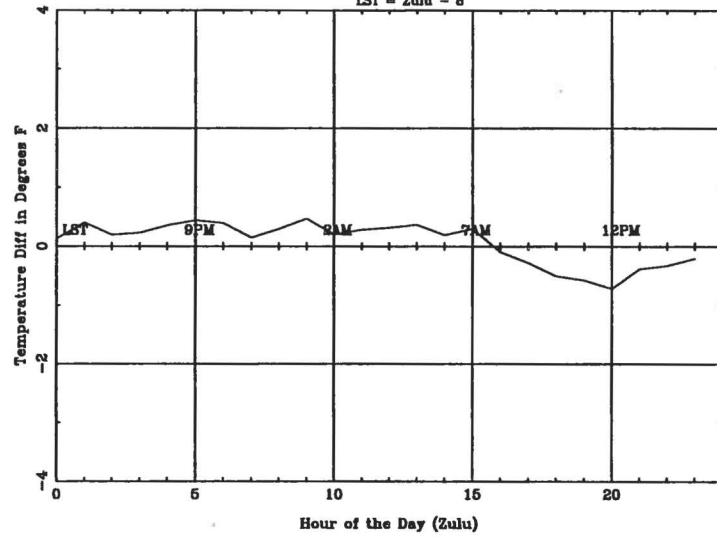

Average Diurnal Cycle for PDX - spring
LST = Zulu - 8

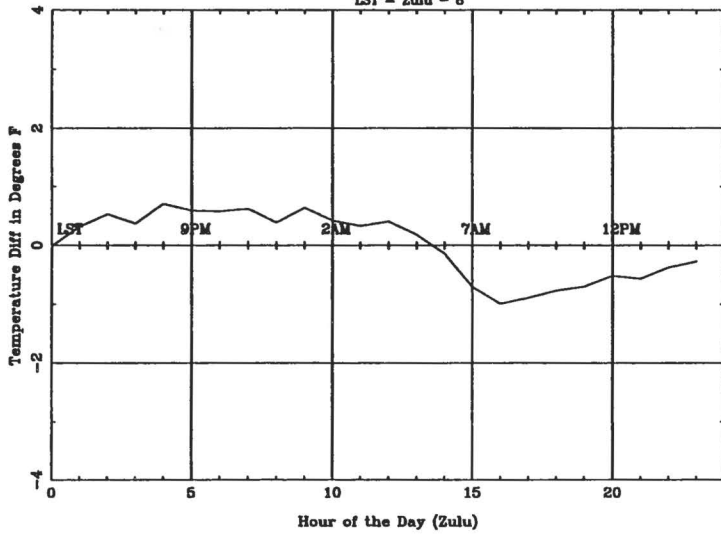

Average Diurnal Cycle for PDX - summer
LST = Zulu - 8

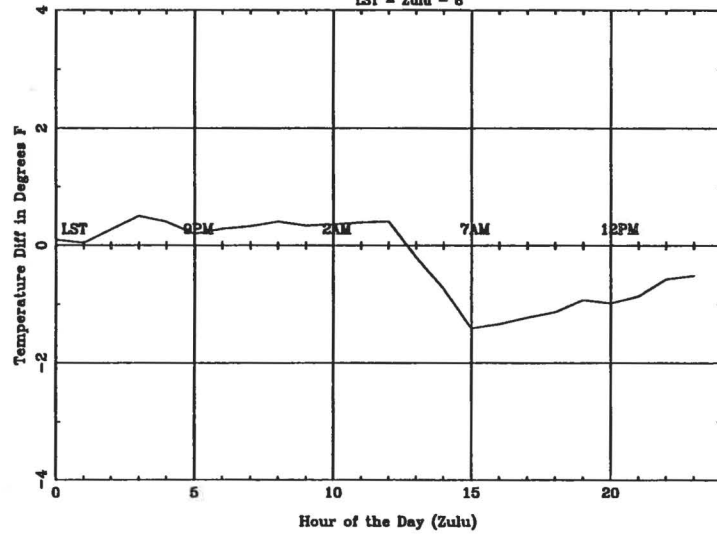

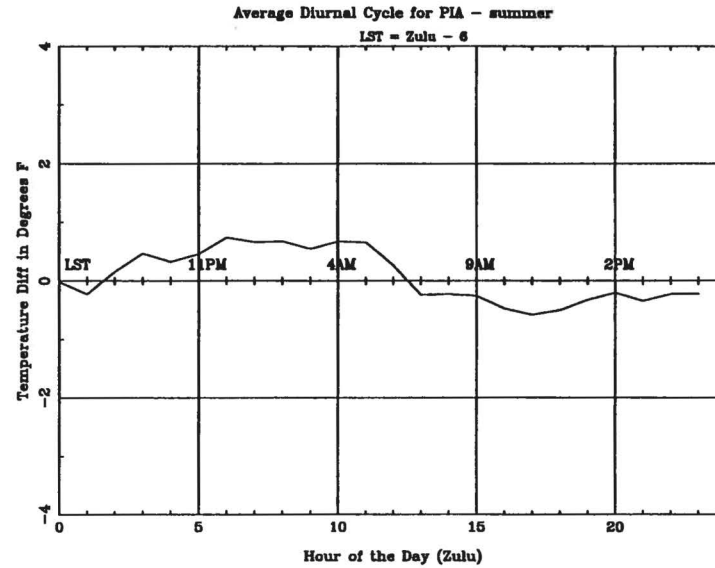
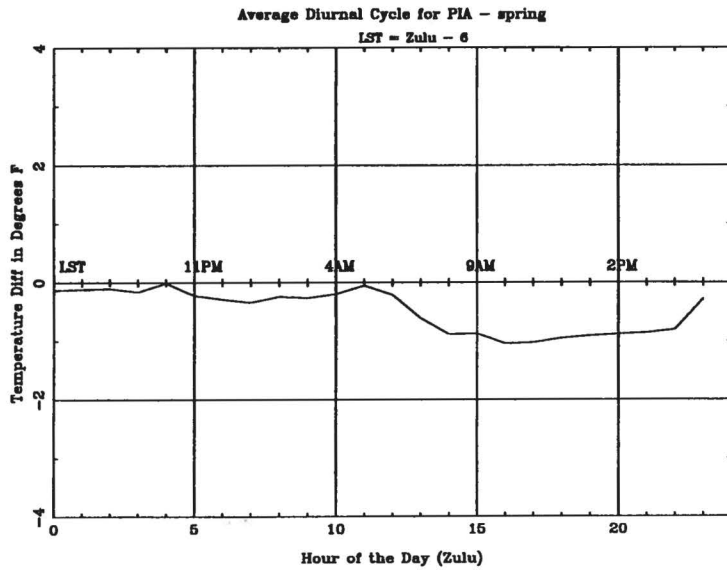
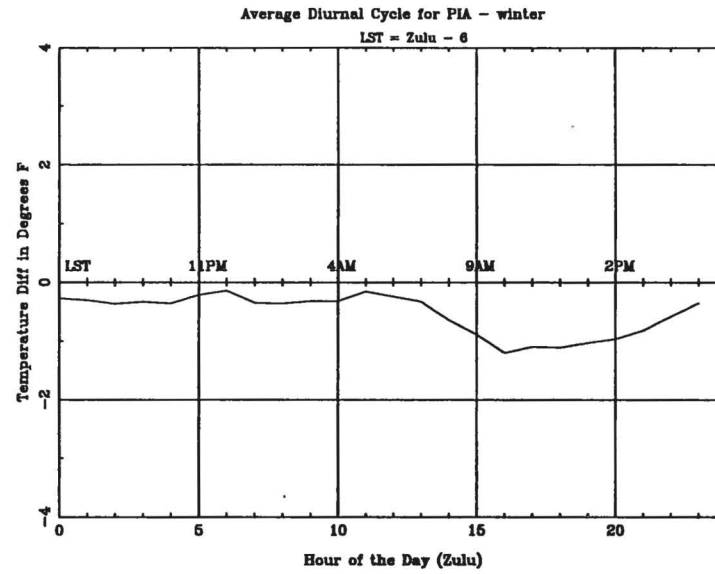
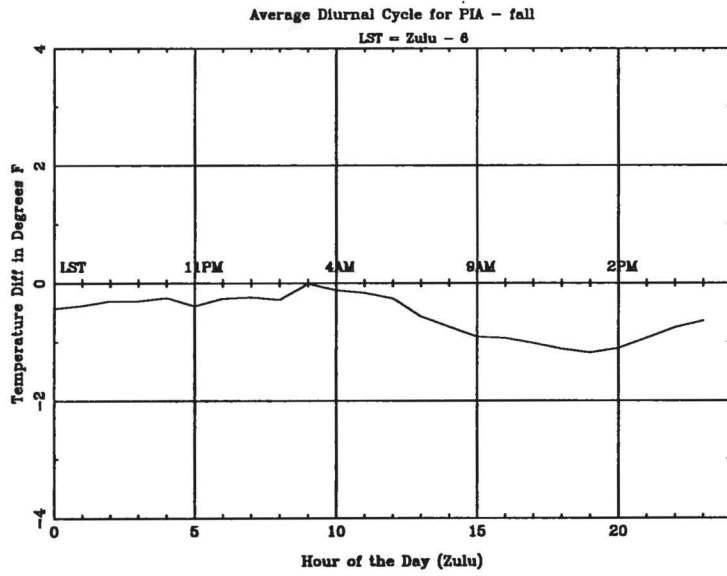

Average Diurnal Cycle for RAP - fall
LST = Zulu - 7

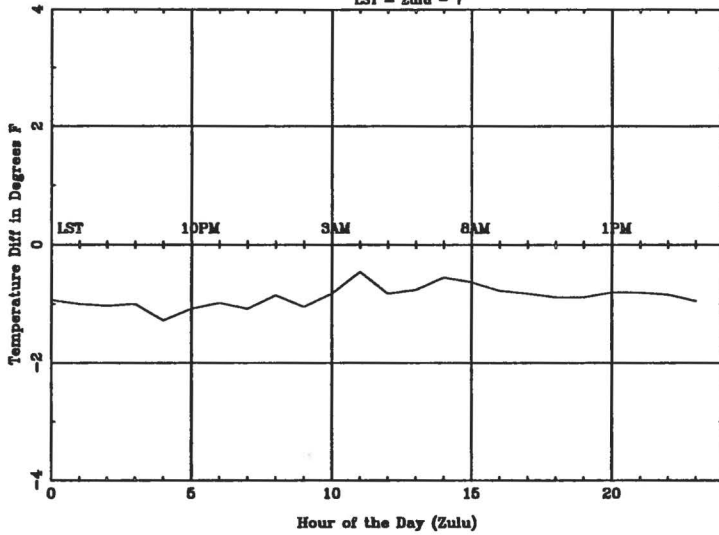

Average Diurnal Cycle for RAP - winter
LST = Zulu - 7

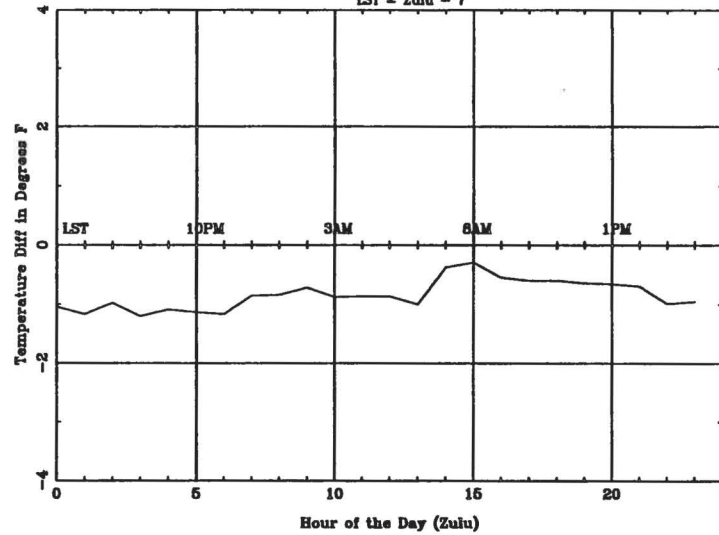

Average Diurnal Cycle for RAP - spring
LST = Zulu - 7

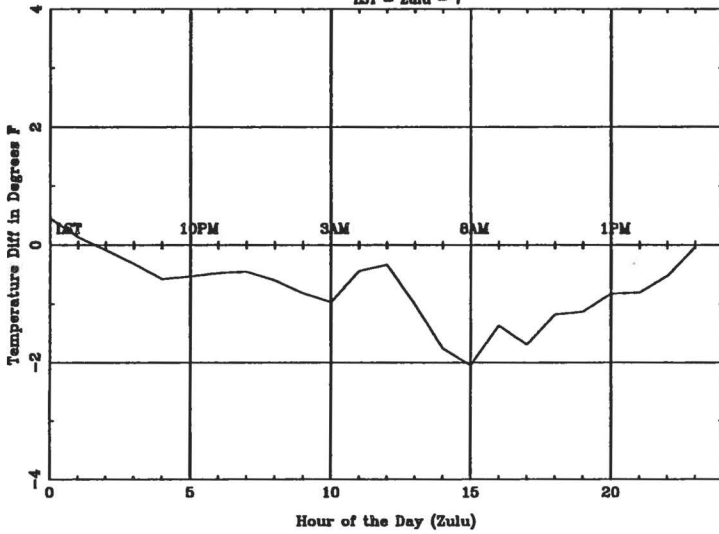

Average Diurnal Cycle for RAP - summer
LST = Zulu - 7

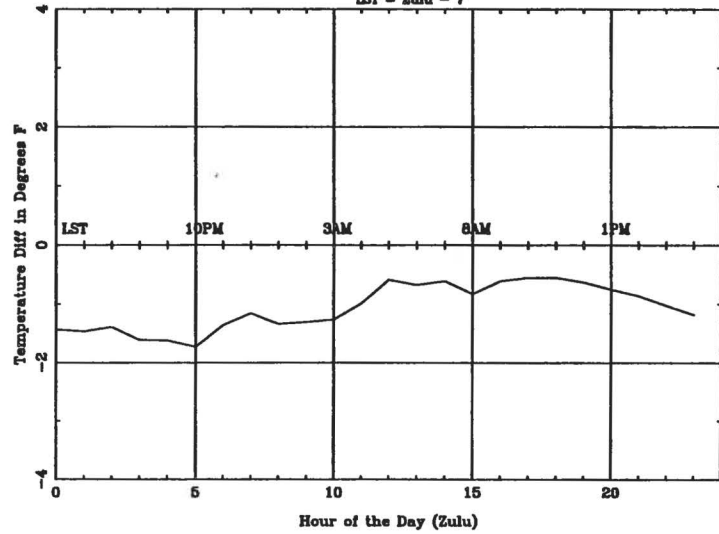

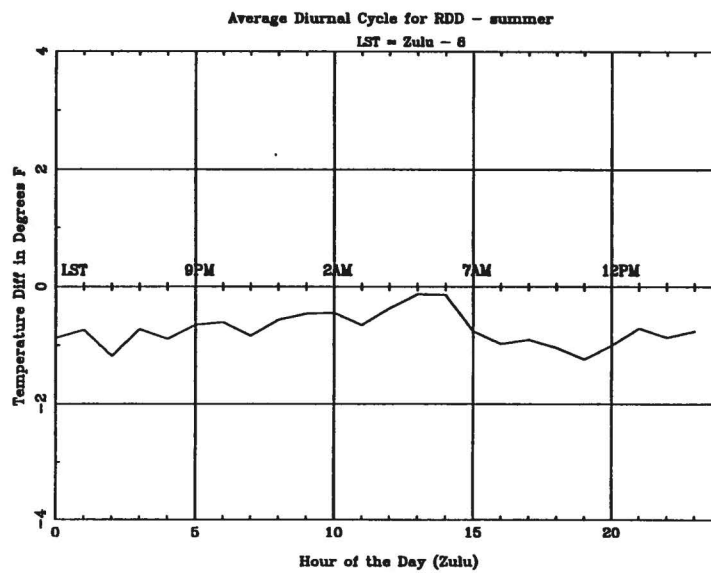
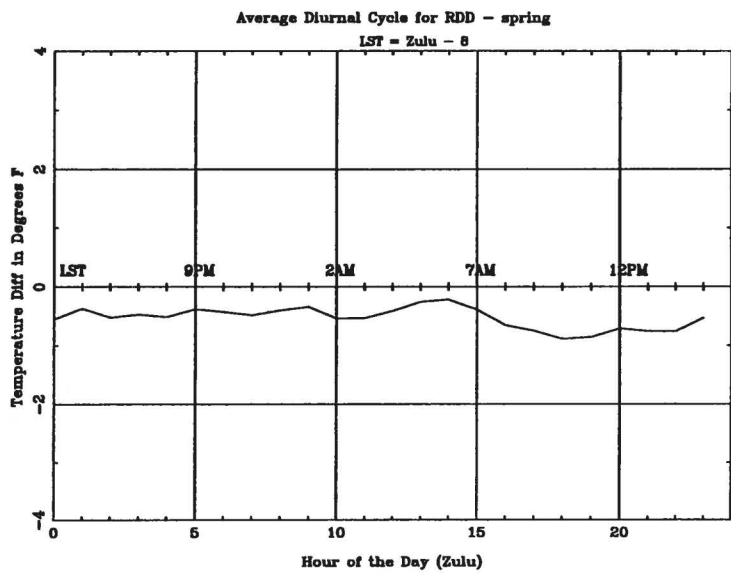
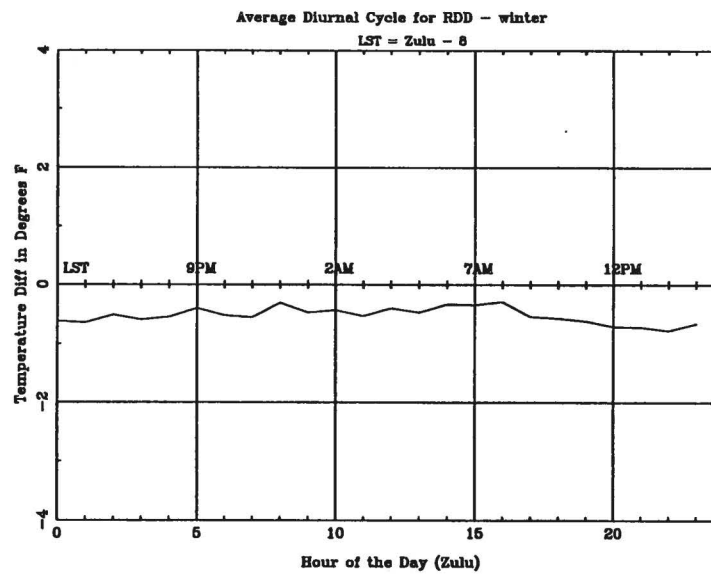
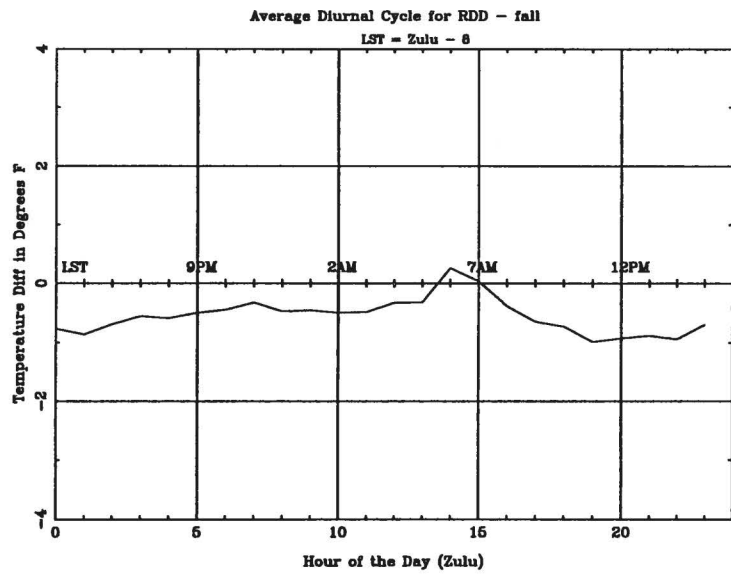

Average Diurnal Cycle for RFD - fall
LST = Zulu - 6

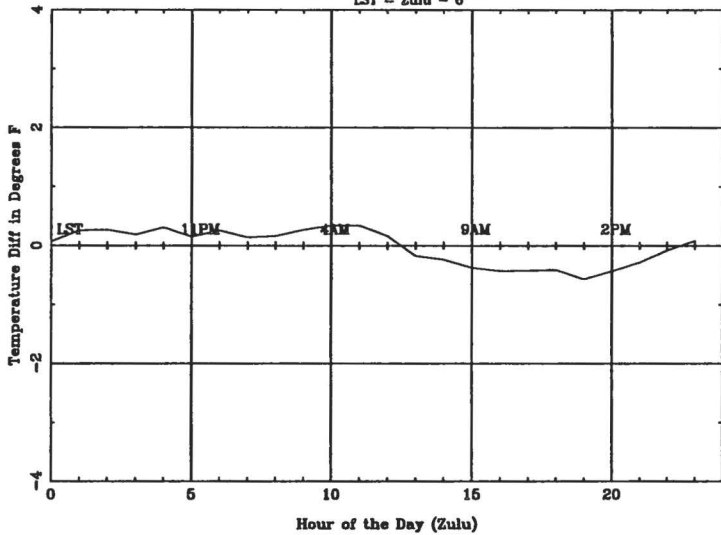

Average Diurnal Cycle for RFD - winter
LST = Zulu - 6

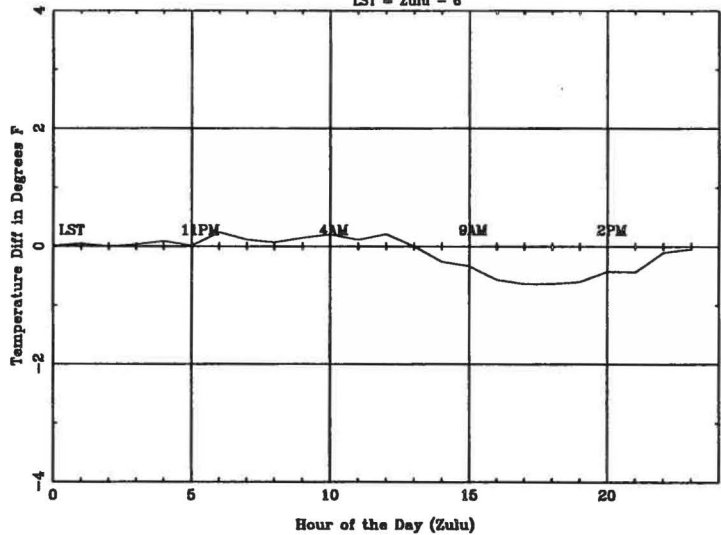

Average Diurnal Cycle for RFD - spring
LST = Zulu - 6

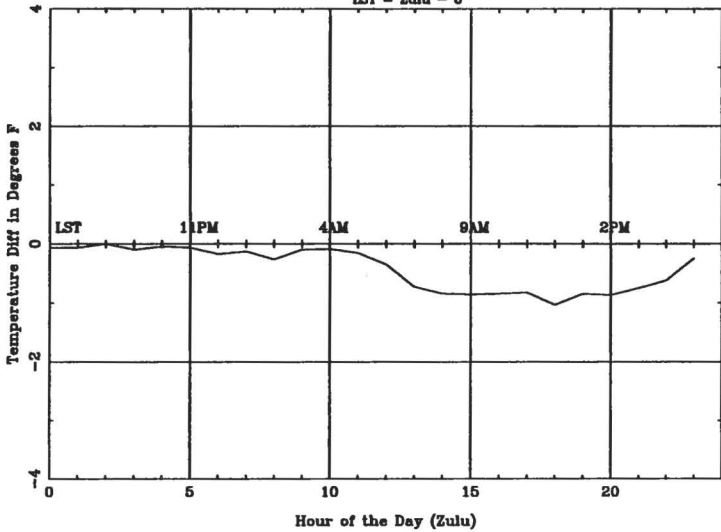

Average Diurnal Cycle for RFD - summer
LST = Zulu - 6

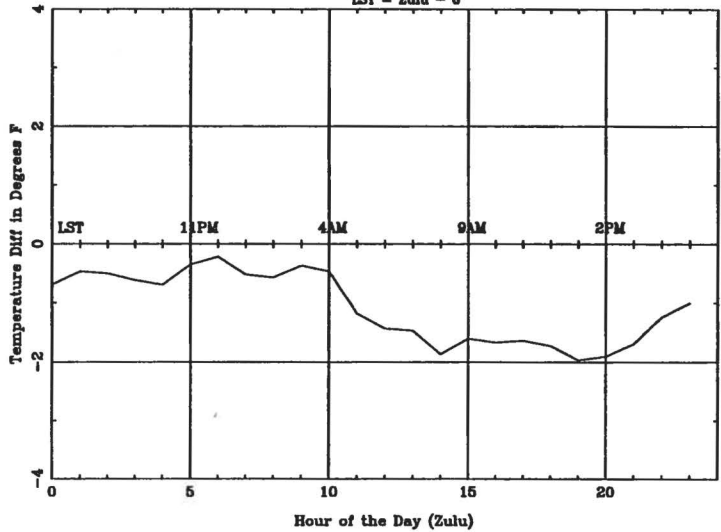

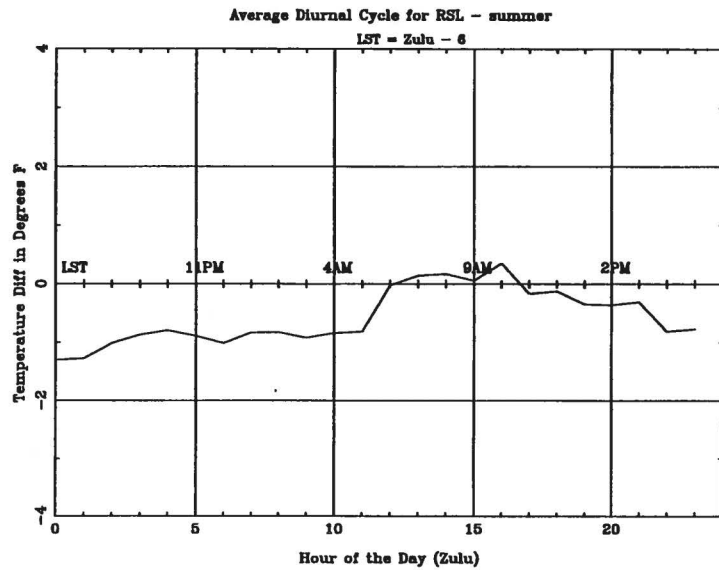
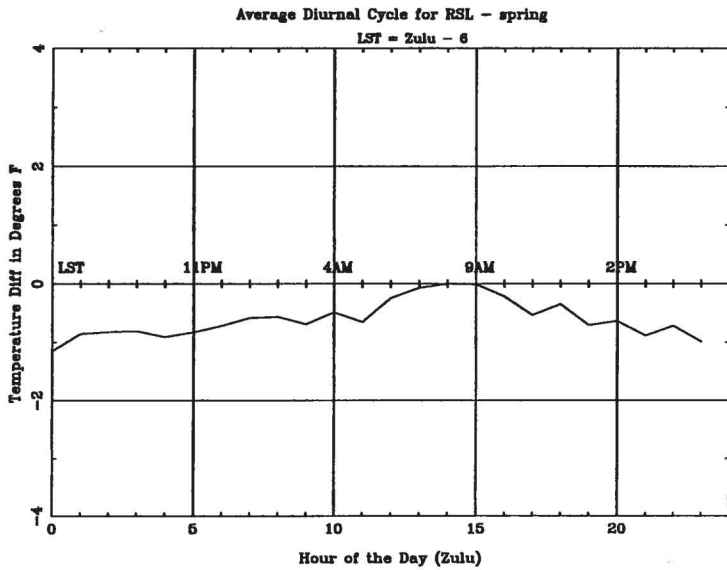
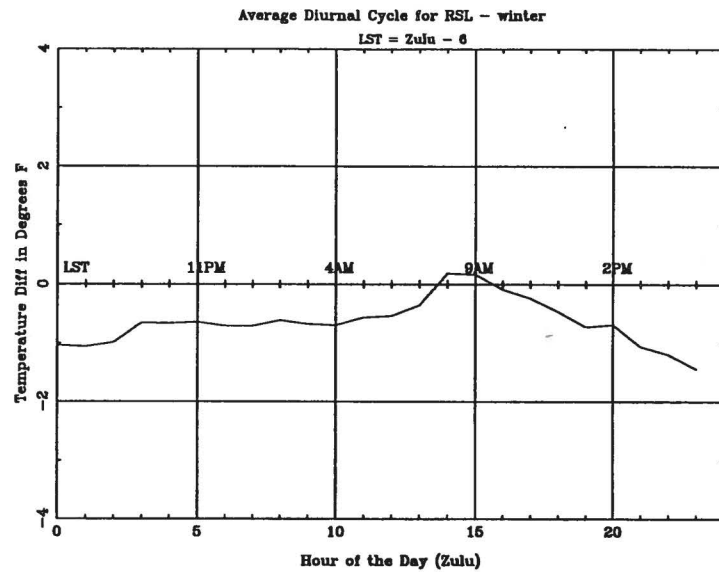
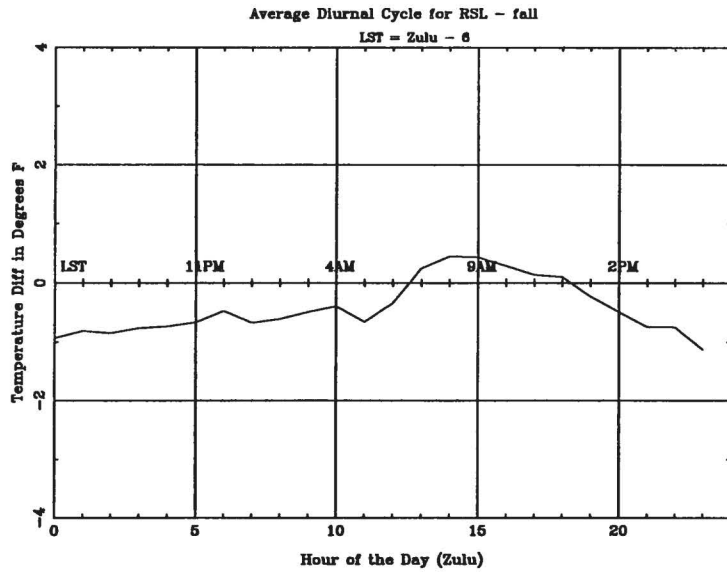

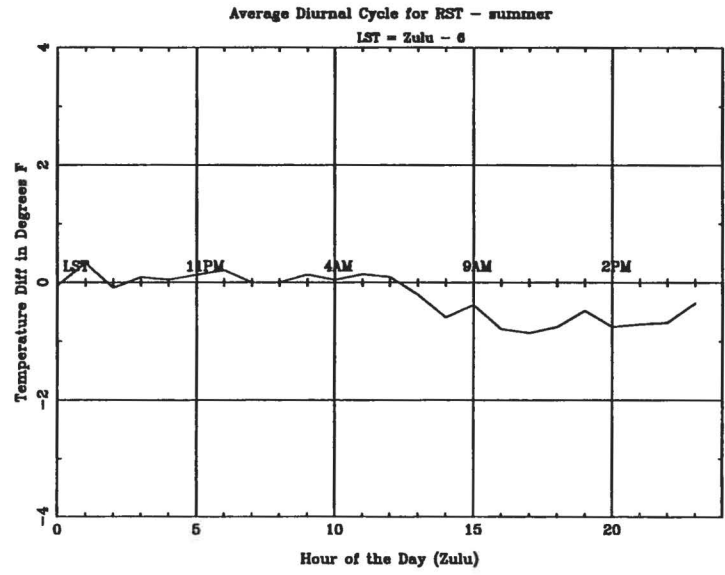
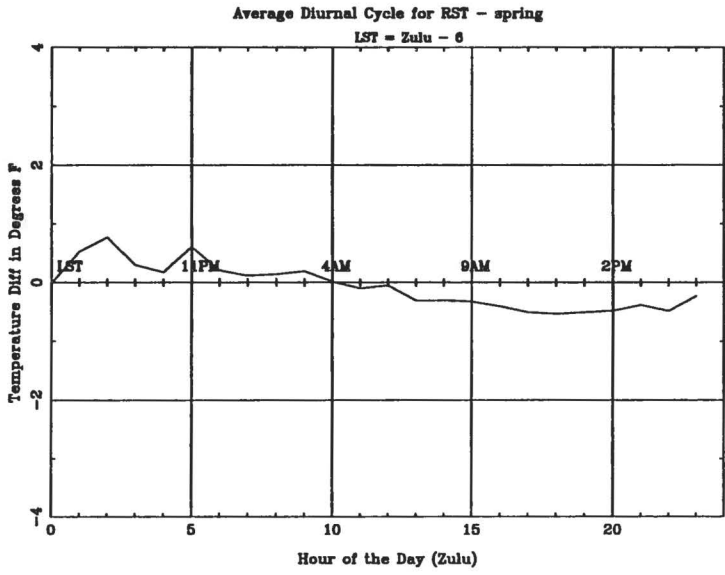
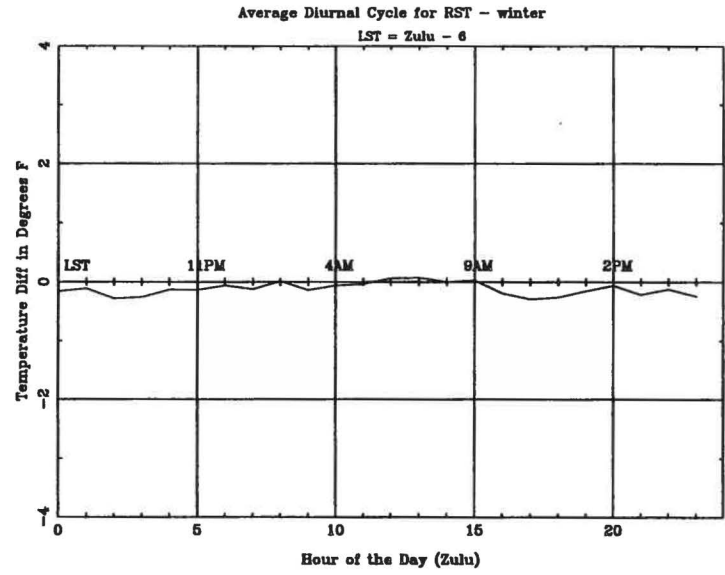
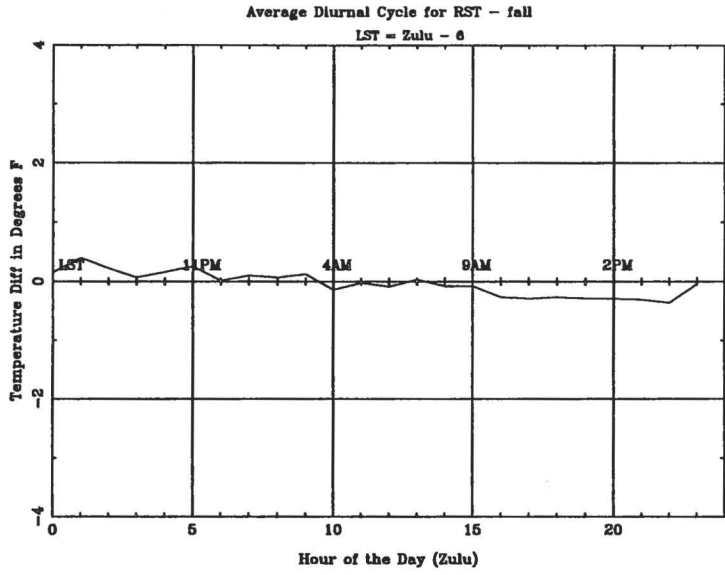

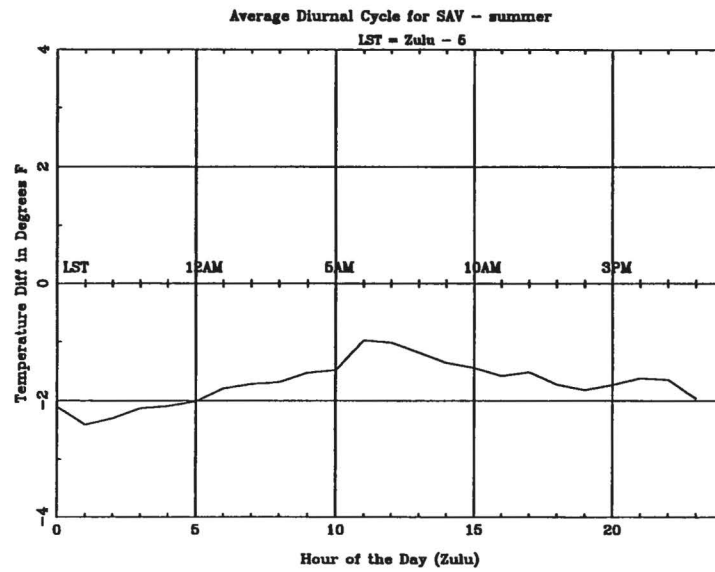
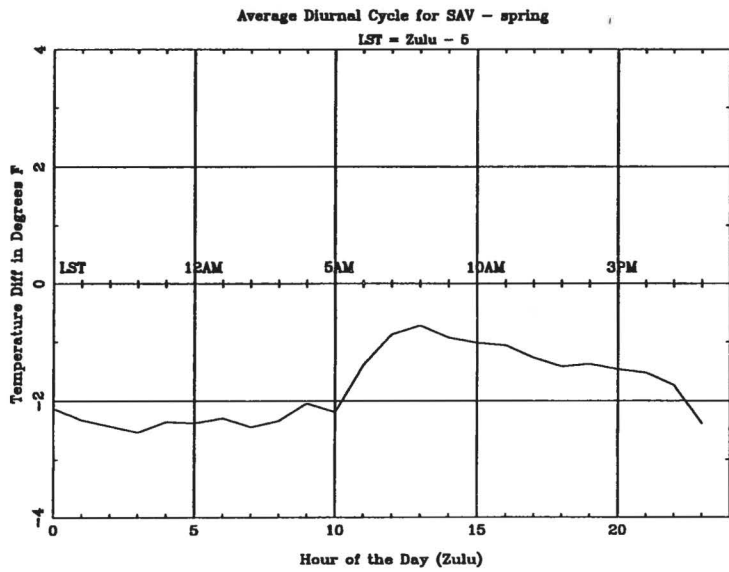
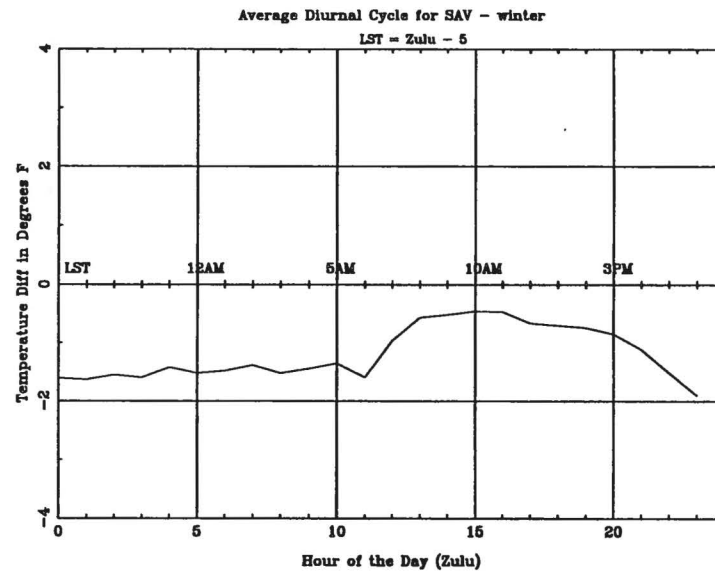
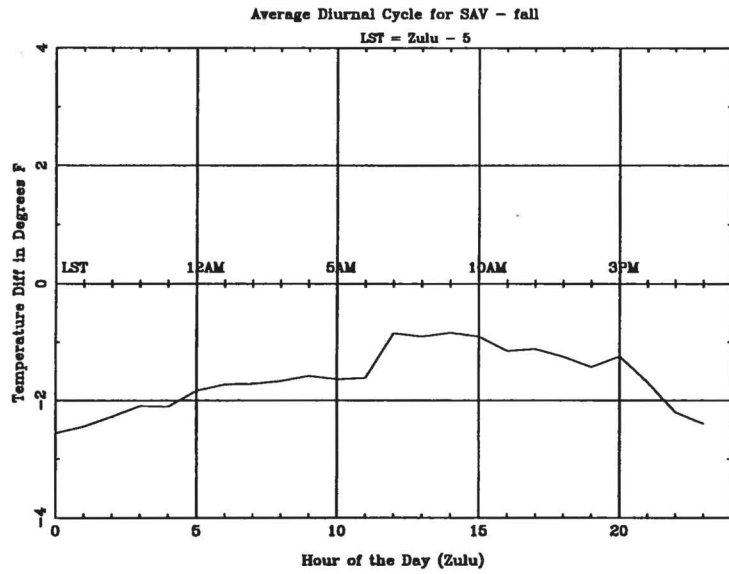

Average Diurnal Cycle for SBN - fall
LST = Zulu - 5

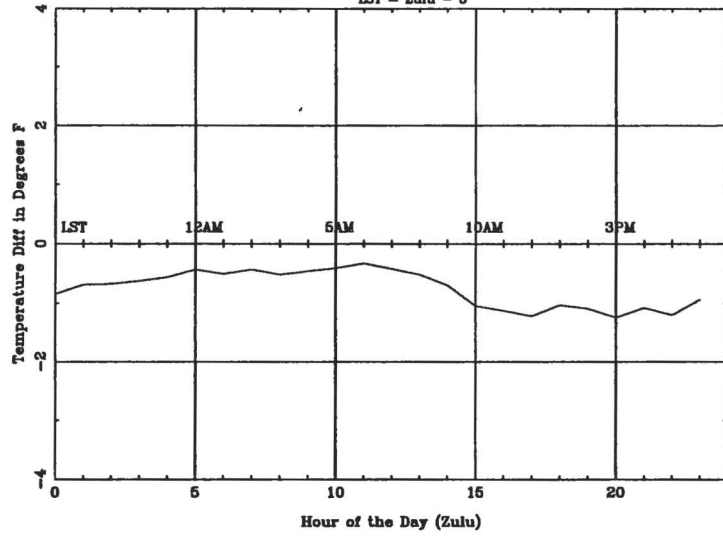

Average Diurnal Cycle for SBN - winter
LST = Zulu - 5

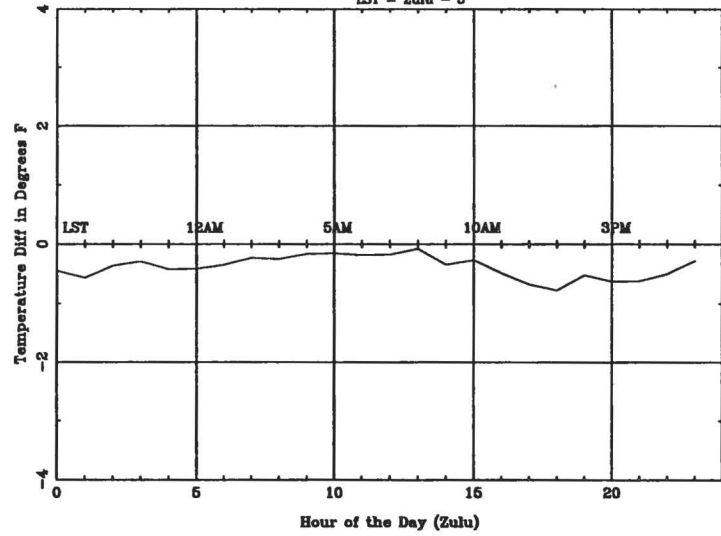

Average Diurnal Cycle for SBN - spring
LST = Zulu - 5

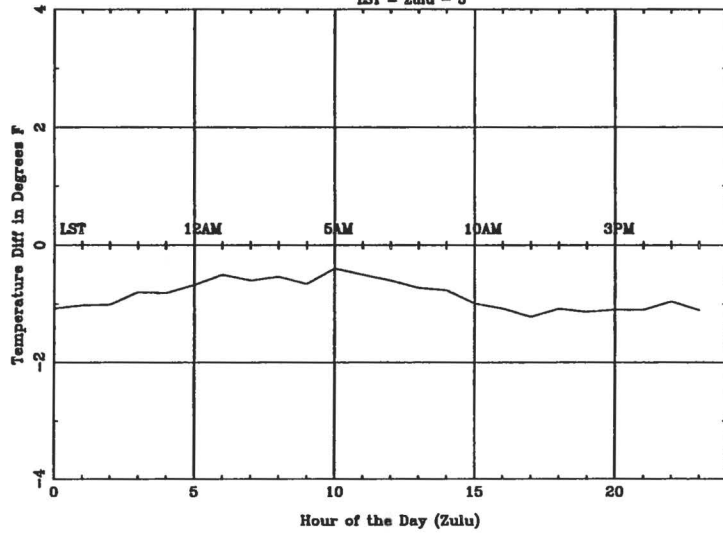

Average Diurnal Cycle for SBN - summer
LST = Zulu - 5

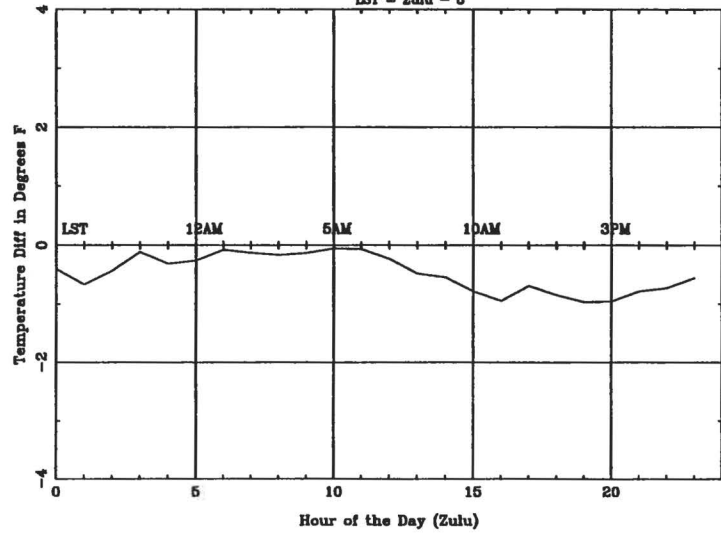

Average Diurnal Cycle for SGF - fall
LST = Zulu - 6

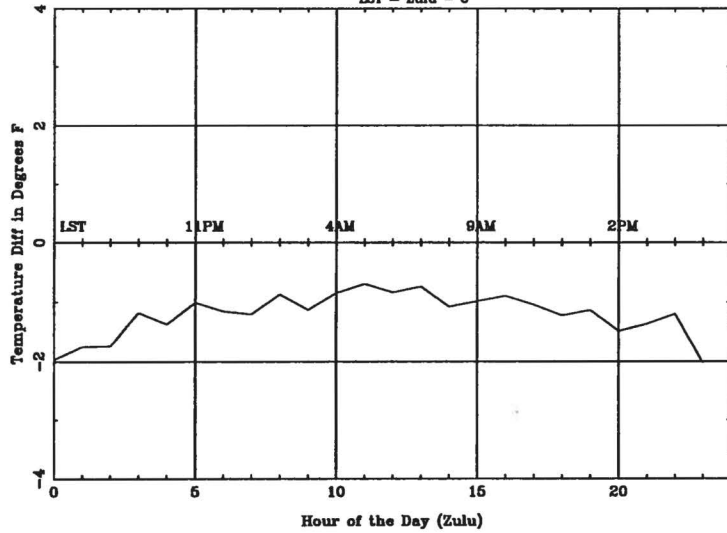

Average Diurnal Cycle for SGF - winter
LST = Zulu - 6

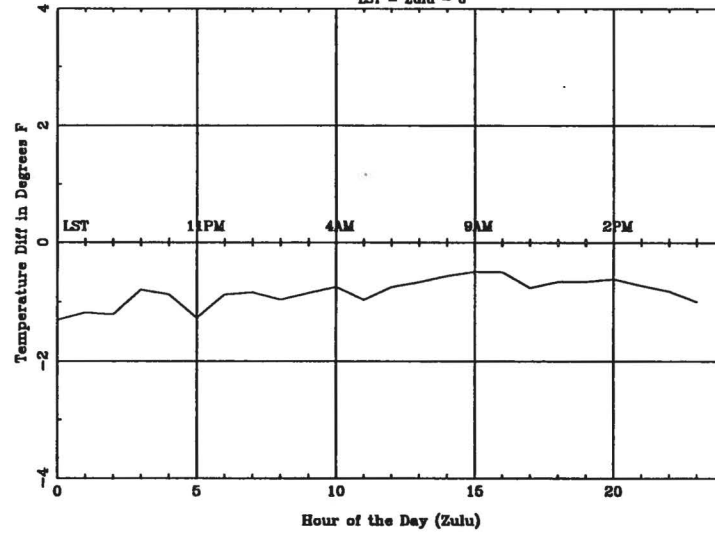

Average Diurnal Cycle for SGF - spring
LST = Zulu - 6

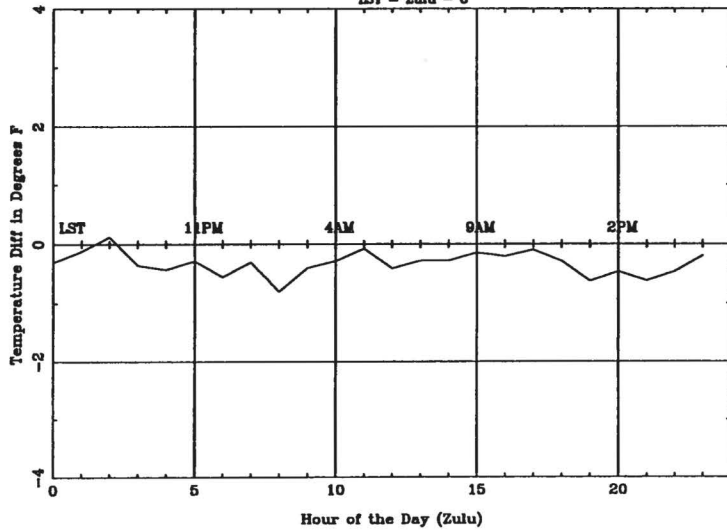

Average Diurnal Cycle for SGF - summer
LST = Zulu - 6

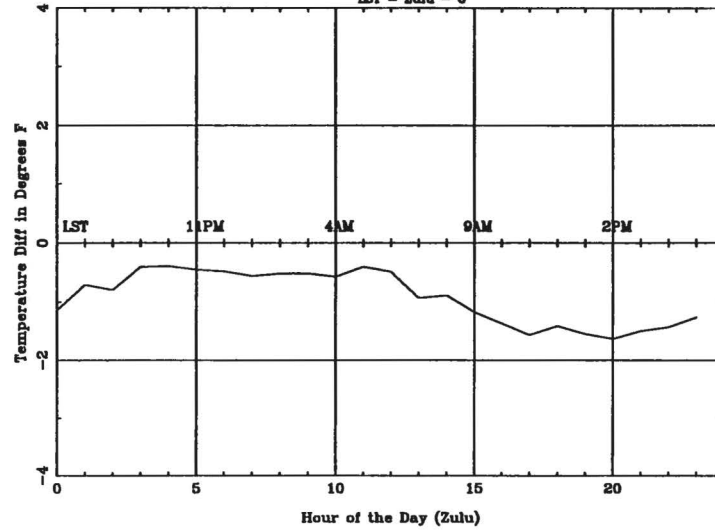

Average Diurnal Cycle for SJT - fall
LST = Zulu - 6

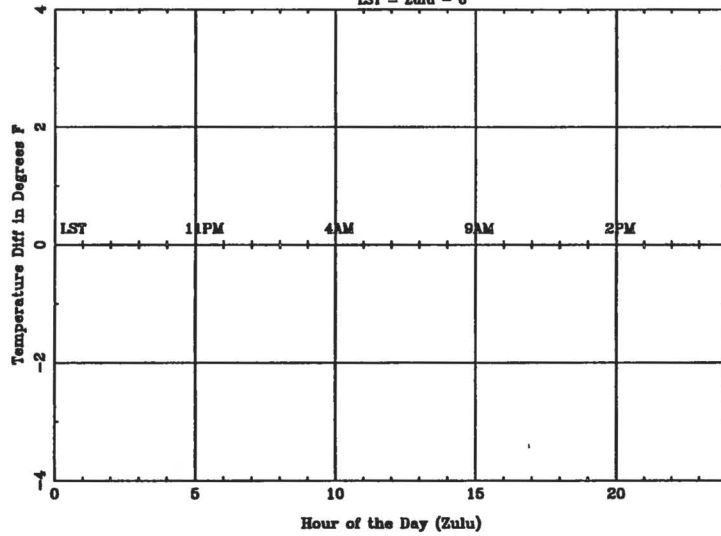

Average Diurnal Cycle for SJT - winter
LST = Zulu - 6

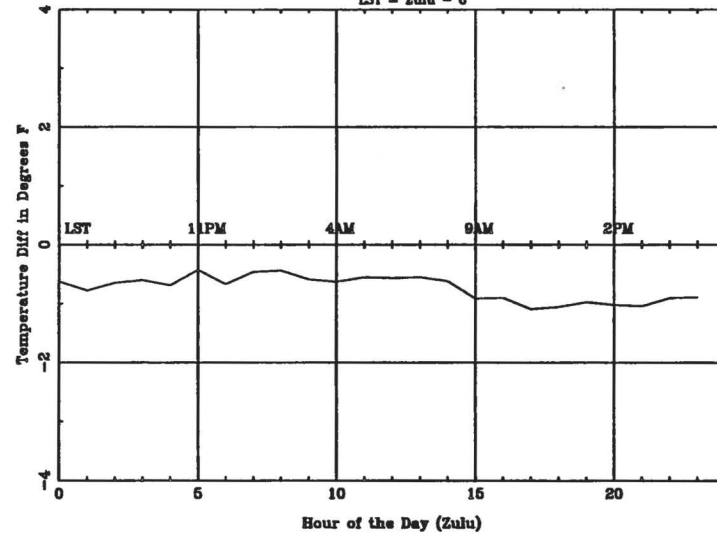

Average Diurnal Cycle for SJT - spring
LST = Zulu - 6

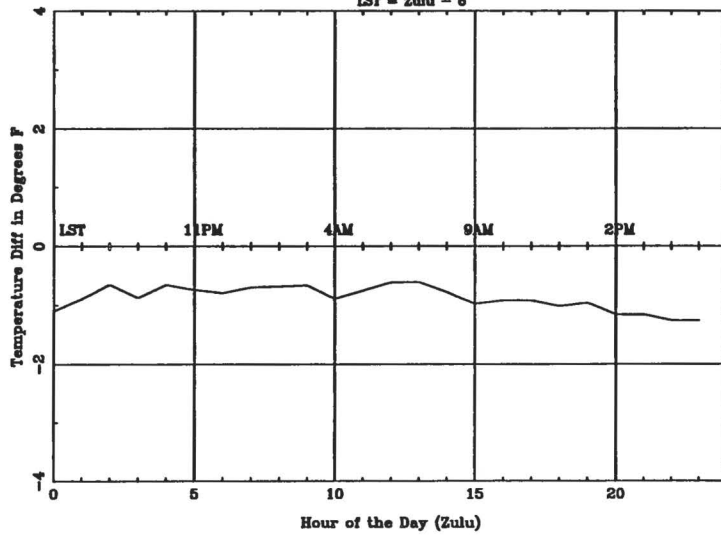

Average Diurnal Cycle for SJT - summer
LST = Zulu - 6

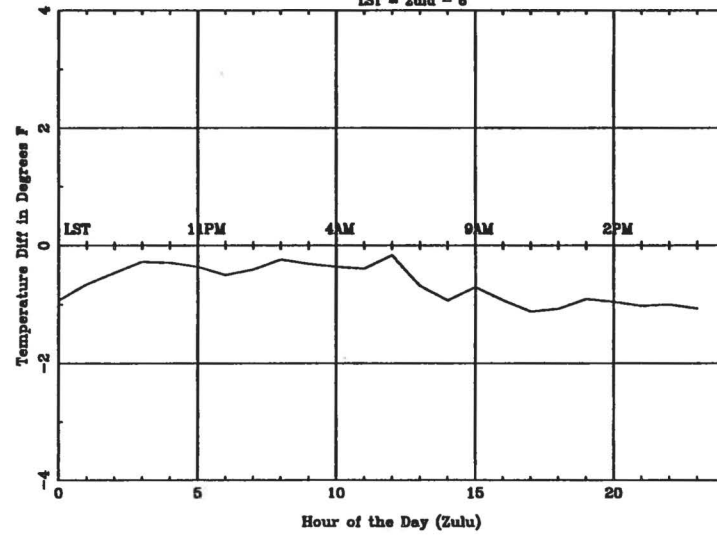

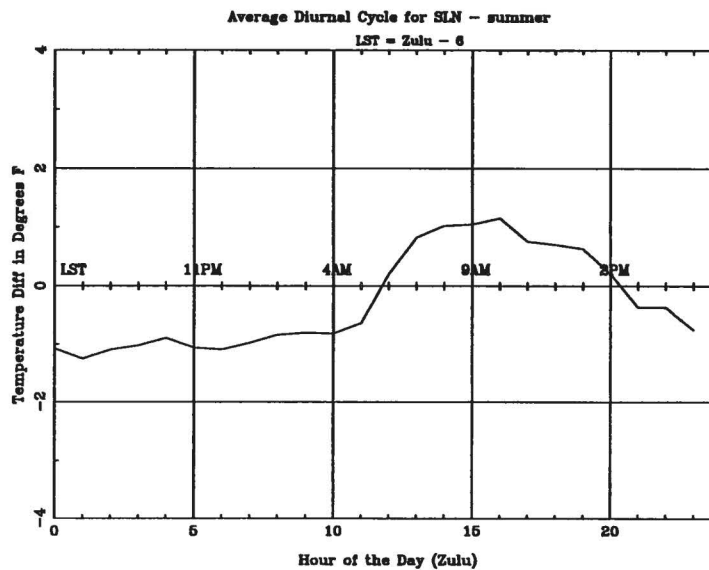
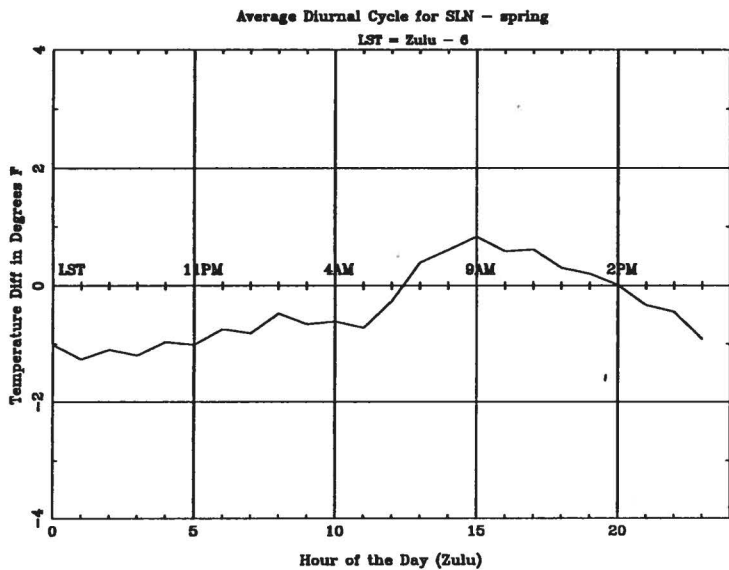
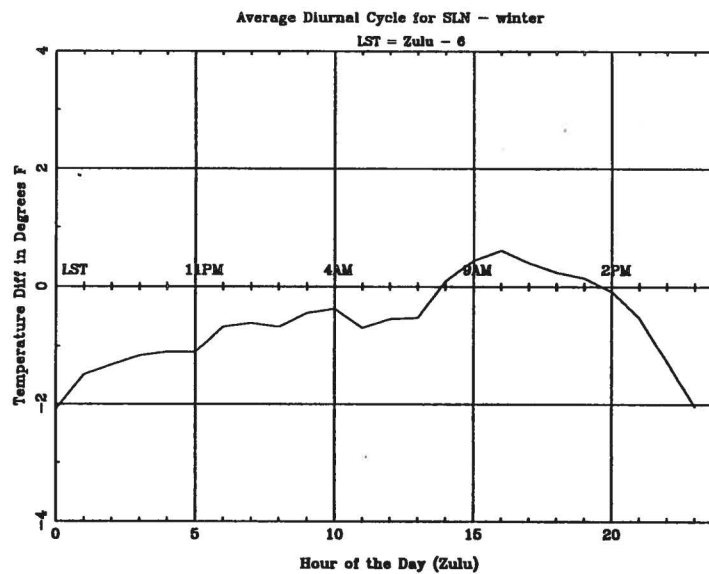
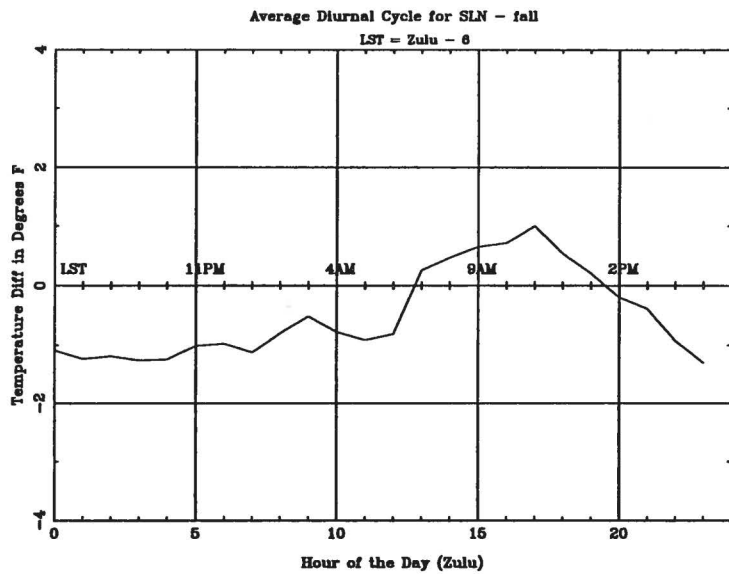

Average Diurnal Cycle for SPI - winter

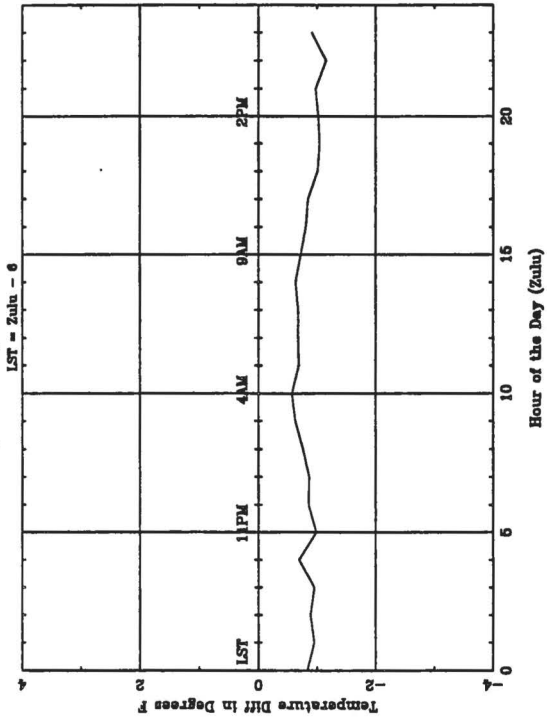

Average Diurnal Cycle for SPI - summer

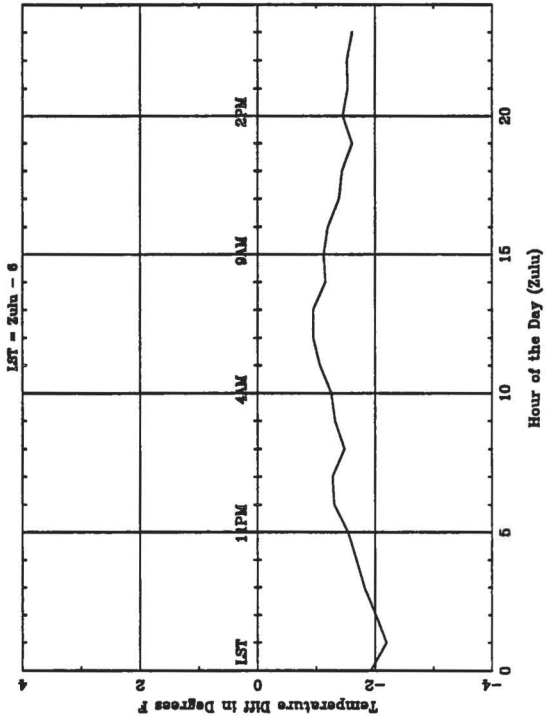

Average Diurnal Cycle for SPI - fall

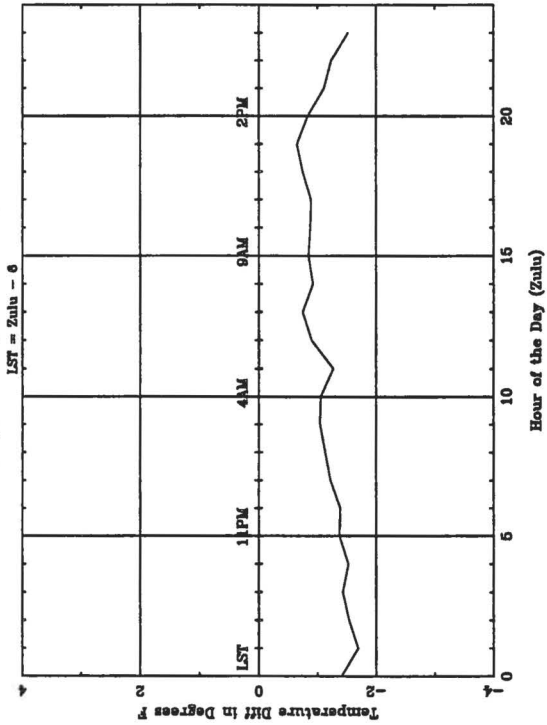

Average Diurnal Cycle for SPI - spring

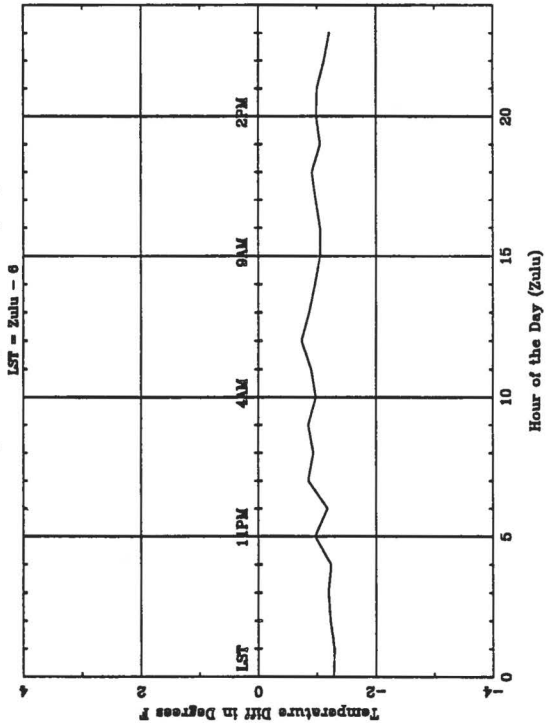

Average Diurnal Cycle for SUX - fall

LST = Zulu - 6

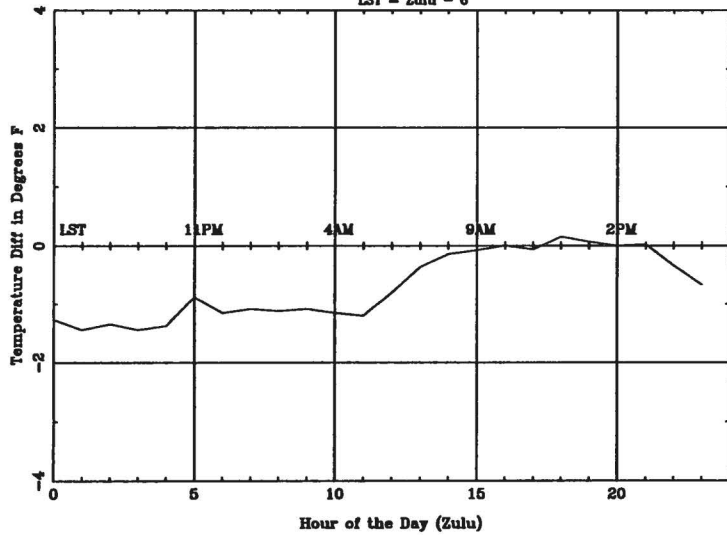

Average Diurnal Cycle for SUX - winter

LST = Zulu - 6

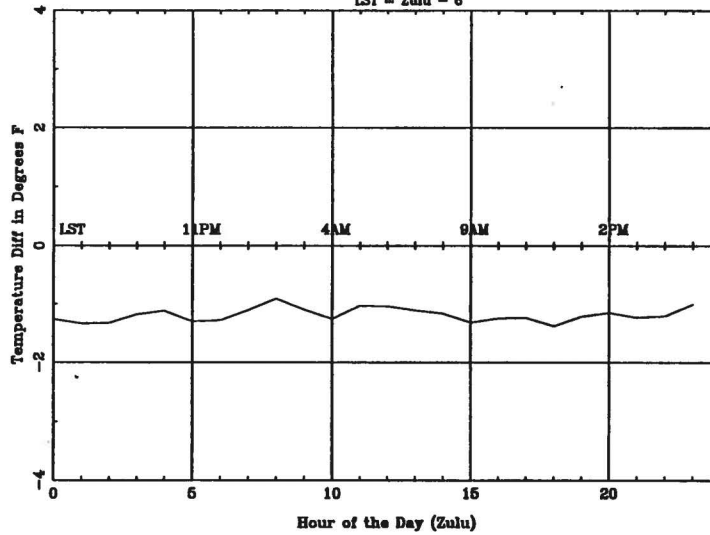

Average Diurnal Cycle for SUX - spring

LST = Zulu - 6

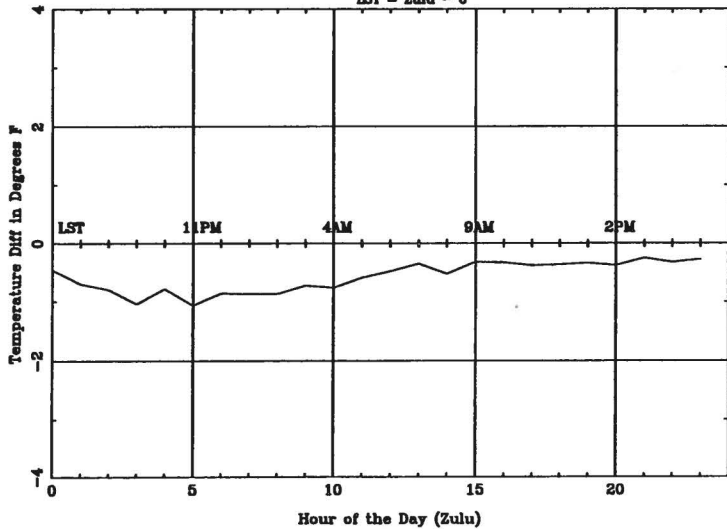

Average Diurnal Cycle for SUX - summer

LST = Zulu - 6

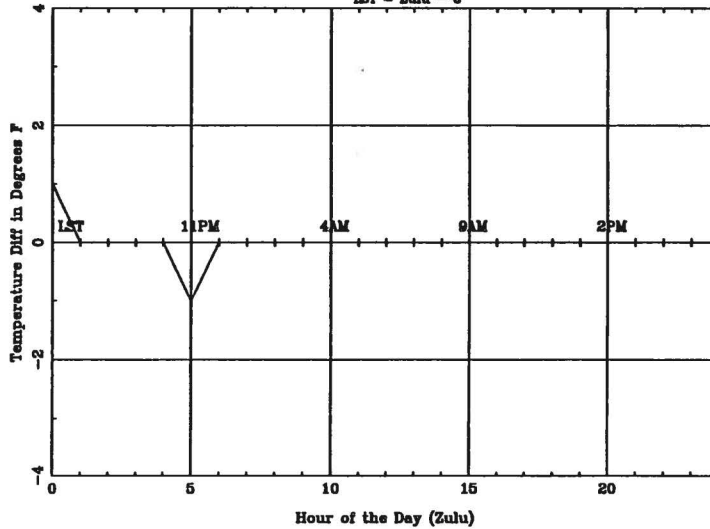

Average Diurnal Cycle for TLH - fall
LST = Zulu - 5

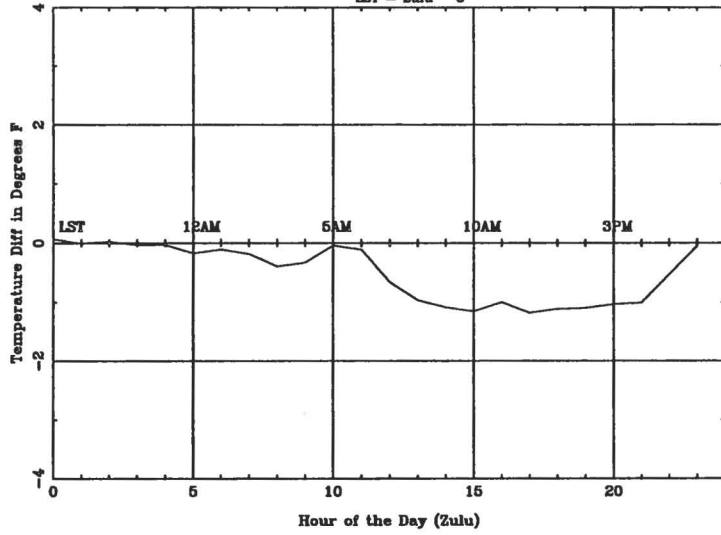

Average Diurnal Cycle for TLH - winter
LST = Zulu - 5

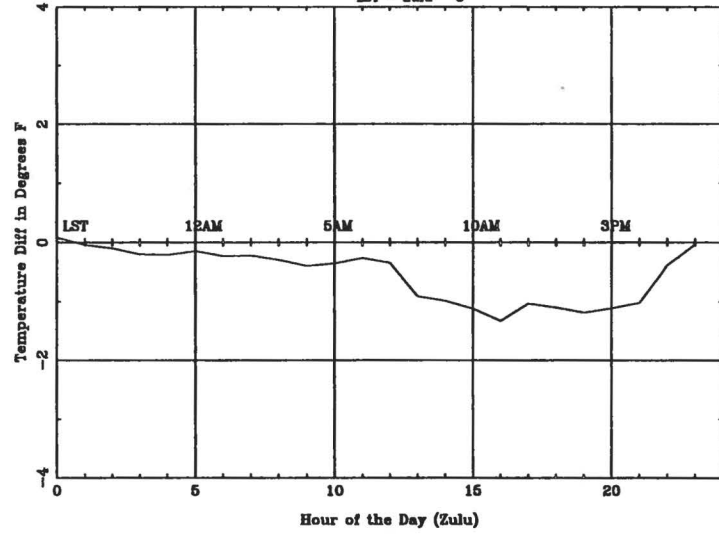

Average Diurnal Cycle for TLH - spring
LST = Zulu - 5

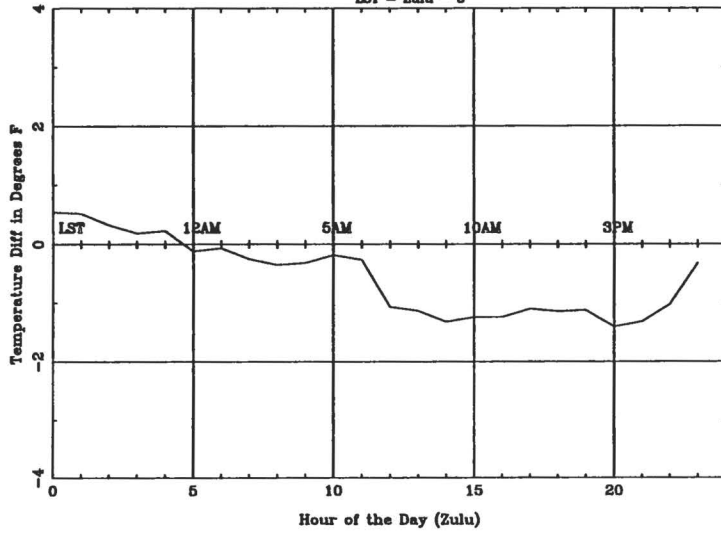

Average Diurnal Cycle for TLH - summer
LST = Zulu - 5

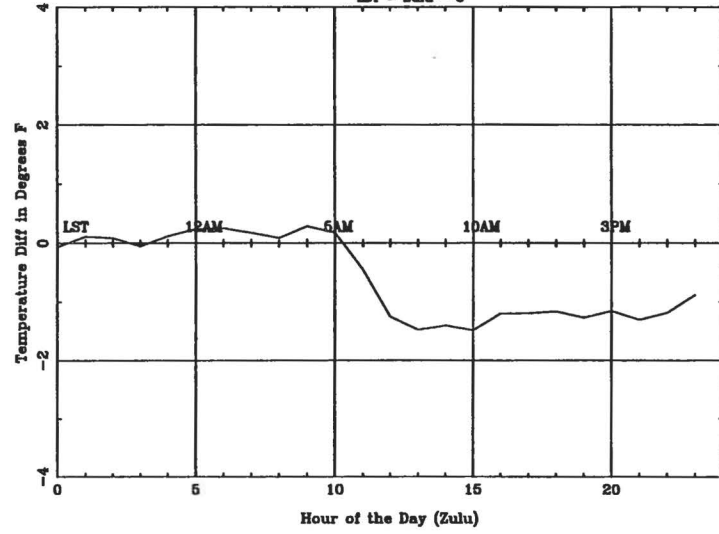

Average Diurnal Cycle for TRI - fall

LST = Zulu - 5

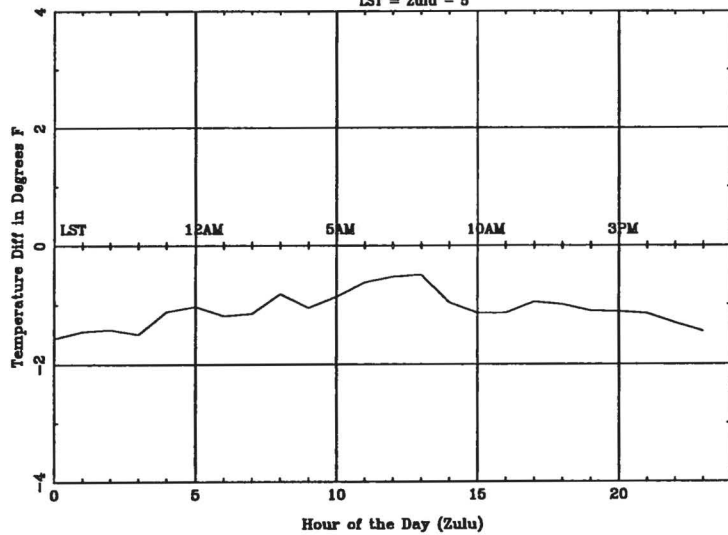

Average Diurnal Cycle for TRI - winter

LST = Zulu - 5

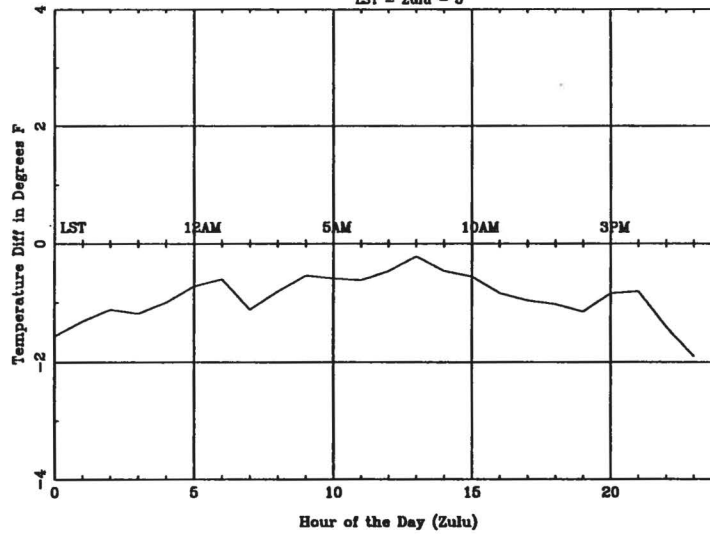

Average Diurnal Cycle for TRI - spring

LST = Zulu - 5

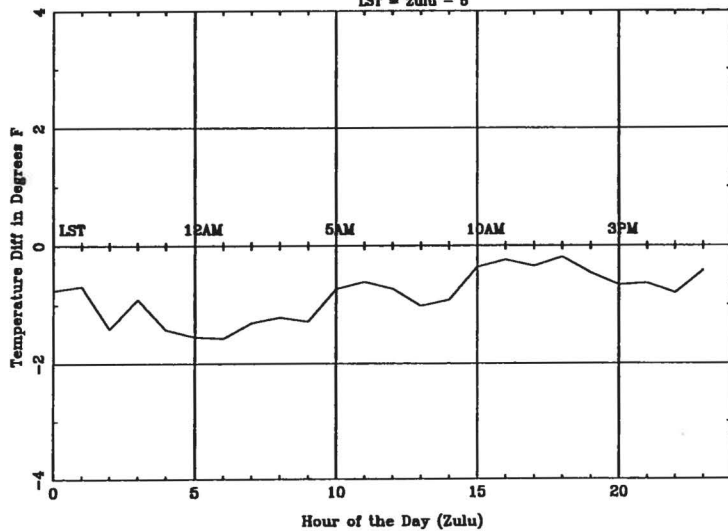

Average Diurnal Cycle for TRI - summer

LST = Zulu - 5

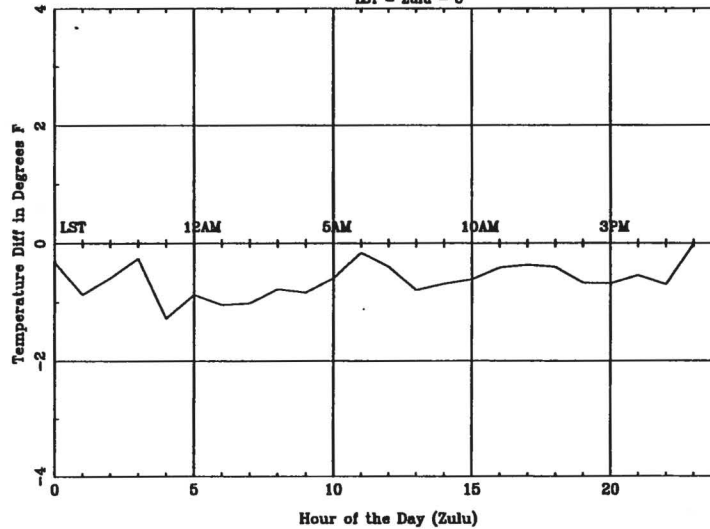

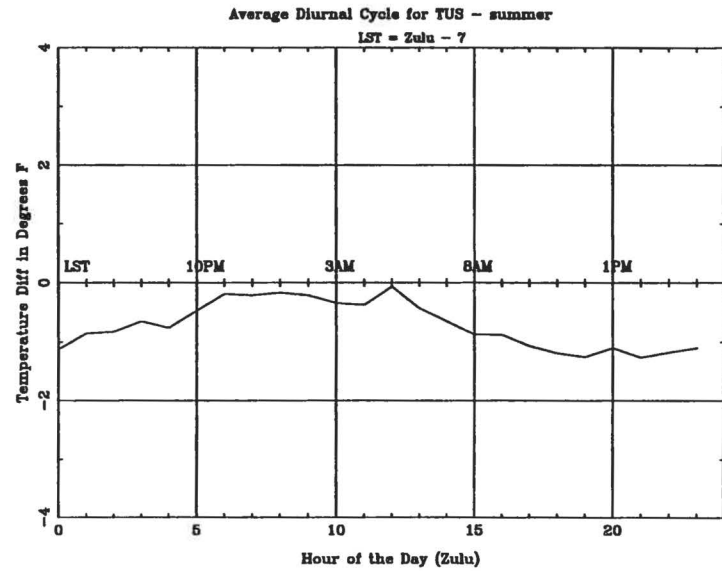
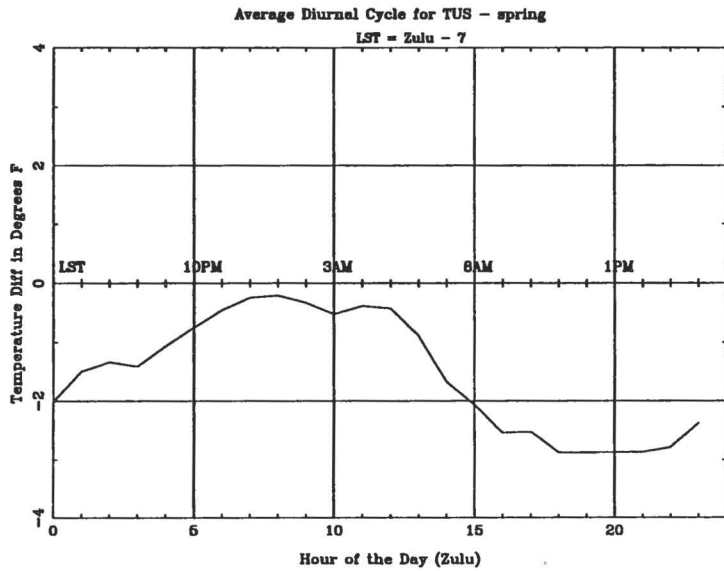
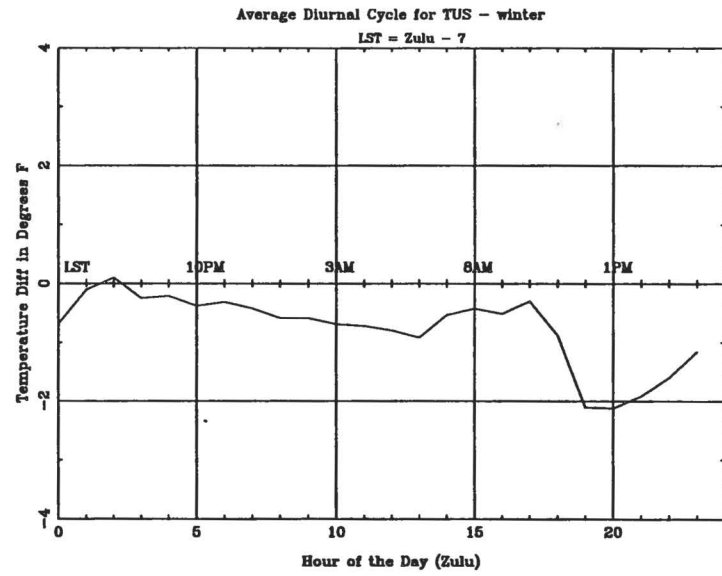
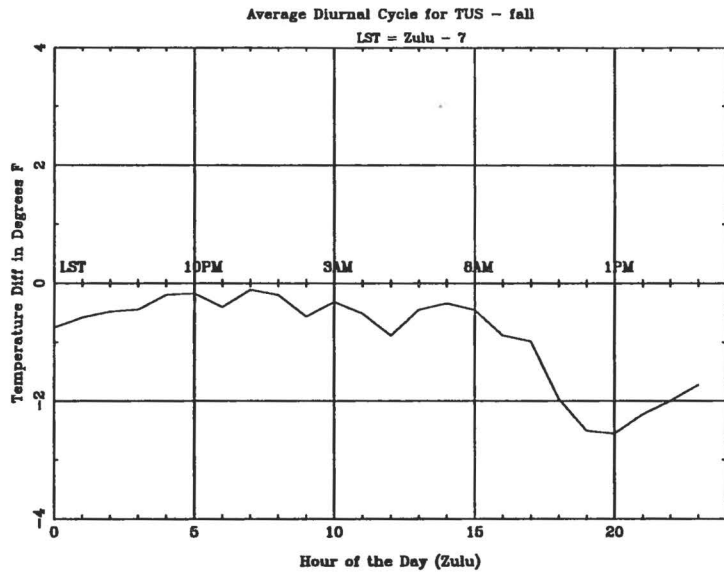

Average Diurnal Cycle for VTN - fall

LST = Zulu - 6

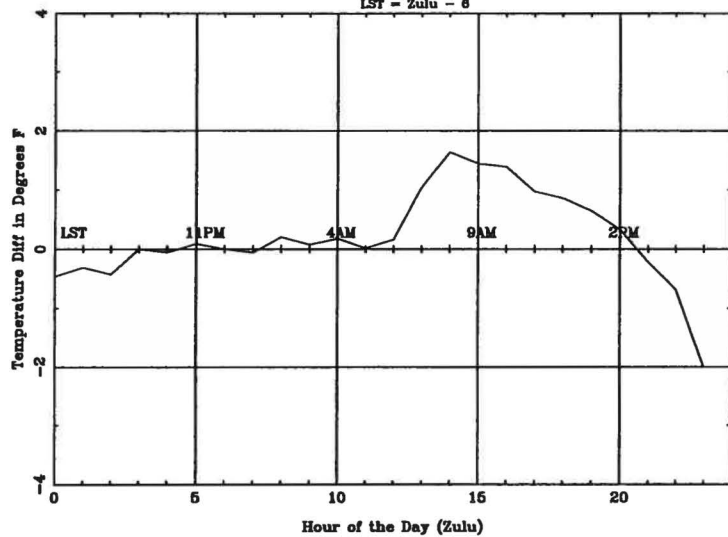

Average Diurnal Cycle for VTN - winter

LST = Zulu - 6

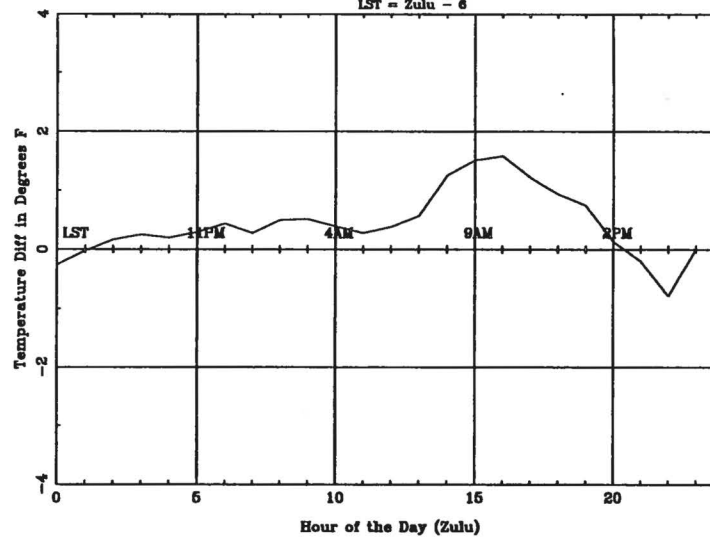

Average Diurnal Cycle for VTN - spring

LST = Zulu - 6

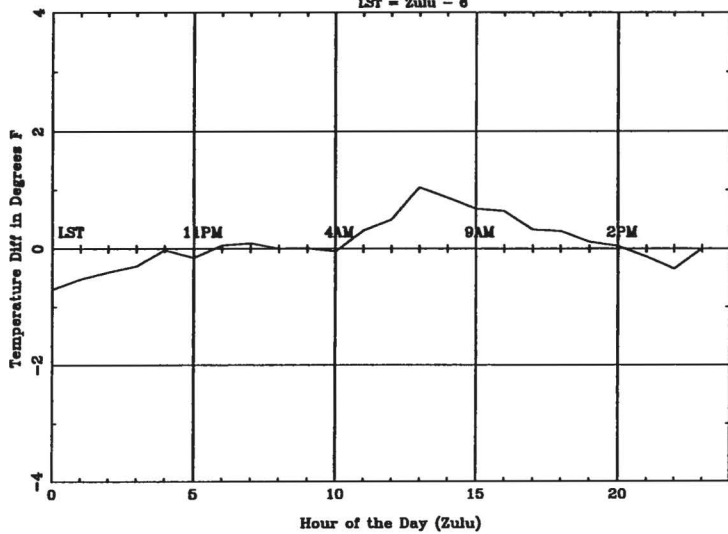

Average Diurnal Cycle for VTN - summer

LST = Zulu - 6

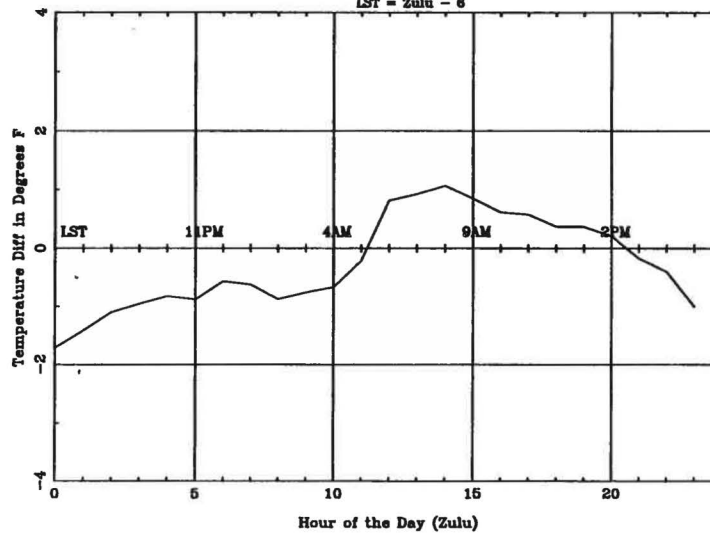

Average Diurnal Cycle for YNG - fall
LST = Zulu - 5

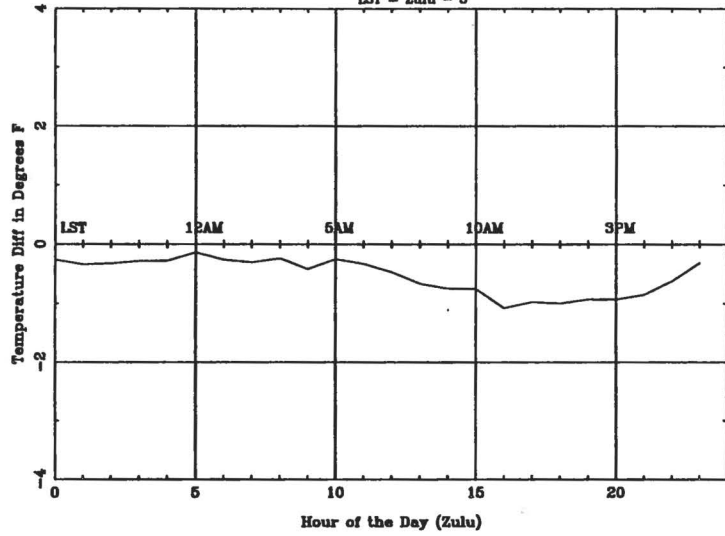

Average Diurnal Cycle for YNG - winter
LST = Zulu - 5

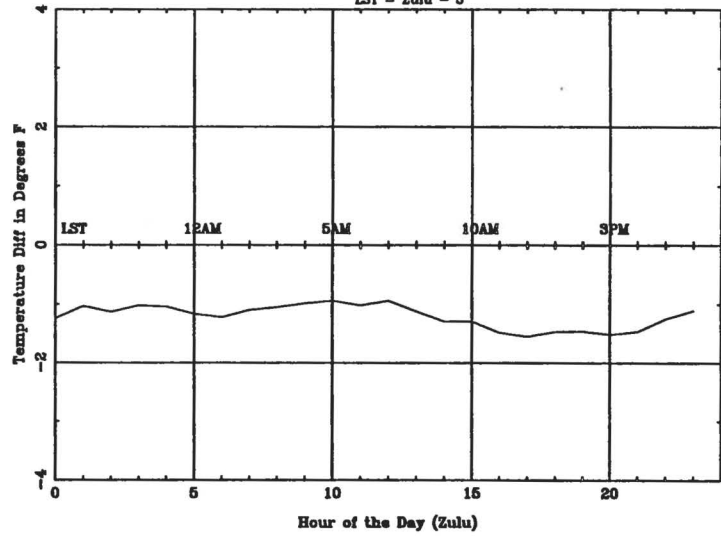

Average Diurnal Cycle for YNG - spring
LST = Zulu - 5

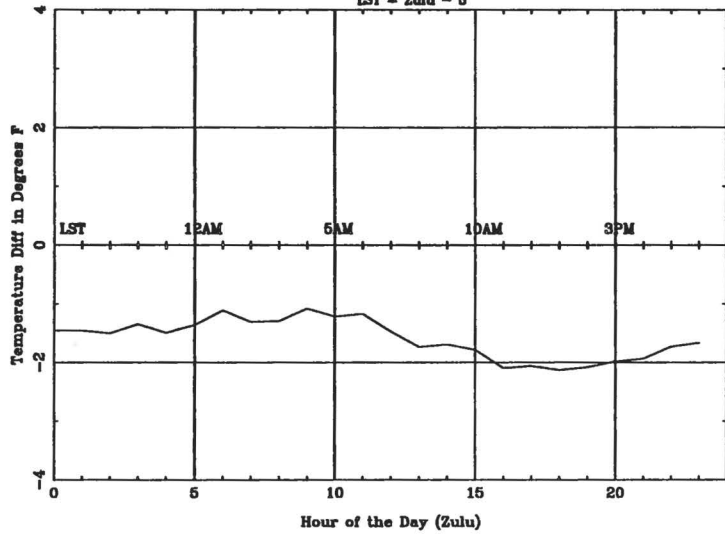

Average Diurnal Cycle for YNG - summer
LST = Zulu - 5

