

TAT
CG
CER 62-18

~~B-99~~

COPY 2

ENGINEERING RESEARCH

SEP 20 1973

FOOTHILLS READING ROOM

Hydraulic Model Studies
STREAM GAGING CONTROL STRUCTURE
for
CARRIZO-CORDUROY PROJECT, ARIZONA

by

E. V. Richardson

U. S. Geological Survey
Fort Collins, Colorado

CER62EVR18

Hydraulic Model Studies
STREAM GAGING CONTROL STRUCTURE
for
CARRIZO-CORDUROY PROJECT, ARIZONA

by
E. V. Richardson

U. S. Geological Survey
Fort Collins, Colorado

CER62EVR18



U18401 0593518

TABLE OF CONTENTS

	Page
Table of Contents	i
Illustrations	ii
Tables	iii
Abstract	1
Introduction	2
Acknowledgments	3
Description of the Prototype	4
Cibecue Ridge No. 1	4
Cibecue Ridge No. 2	5
Model Study of Prototype Controls	5
Cibecue Ridge No. 1	6
Cibecue Ridge No. 2	8
Flow Through the Controls	8
Modified Controls	9
Plans of the Modified Controls	9
Flow Through Modified Controls	11
Depth-Discharge Relations	11
Recommendations	12
Lag in Recorded Water-Surface Elevation	12
Stage-Discharge Relation for Prototype Controls	13
Modified Controls	13
Literature Cited	13

ILLUSTRATIONS

Figure		
1	Cibecue Ridge No. 1 gaging station and approach channel. . . .	14
2	Details of Cibecue Ridge No. 1 control.	14
3	Plan view of approach channel and gaging station, Cibecue Ridge No. 1.	15
4	Profile of the control structure and stream bed for Cibecue Ridge No. 1.	16
5	Cross-sections of the approach channel for Cibecue Ridge No. 1.	17
6	Plan of Cibecue Ridge No. 1 control.	18
7	Cibecue Ridge No. 2 gaging station and control.	19
8	Details of Cibecue Ridge No. 2 control.	19
9	Plan view of approach channel and gaging station, Cibecue Ridge No. 2.	20
10	Profile of the control structure and stream bed for Cibecue Ridge No. 2.	21
11	Cross-sections of the approach channel for Cibecue Ridge No. 2.	22
12	Plan of Cibecue Ridge No. 2 control.	23
13	Depth-discharge relation for Cibecue Ridge No. 1 control, . . .	24
14	Stage-discharge relation for Cibecue Ridge No. 1 control. . . .	25
15	Depth-discharge relation for Cibecue Ridge No. 2 control. . . .	26
16	Stage-discharge relation for Cibecue Ridge No. 2 control. . . .	27
17	Flow through model of Cibecue Ridge No. 1 control.	28
18	Flow through model of Cibecue Ridge No. 2 control.	29
19	Plan and cross-sections of modified Cibecue Ridge No. 1 control.	30
20	Plan and profile of modified Cibecue Ridge No. 1 control. . . .	31
21	Plan and cross-section of modified Cibecue Ridge No. 2 control.	32
22	Plan and profile of modified Cibecue Ridge No. 2 control. . . .	33
23	Modified model of the Cibecue Ridge No. 1 control.	34

ILLUSTRATIONS (cont'd)

Figure

24	Flow through the modified model of the Cibecue No. 1 control.	35
25	Flow through the modified model of the Cibecue No. 2 control.	36
26	Depth-discharge relation for the modified Cibecue Ridge No. 1 control.	37
27	Depth-discharge relation for the modified Cibecue Ridge No. 2 control.	38

TABLES

Table

1	Data for model study of Cibecue Ridge No. 1 control.	39
2	Data for model study of Cibecue Ridge No. 2 control.	40
3	Data for model study of modified Cibecue Ridge No. 1 control.	41
4	Data for model study of modified Cibecue Ridge No. 2 control.	42

Hydraulic Model Studies
STREAM GAGING CONTROL STRUCTURE
for
CARRIZO-CORDUROY PROJECT, ARIZONA

ABSTRACT

Stage-discharge relations for two artificial controls were determined in a model study conducted at Colorado State University. The controls are used to measure the discharge at two gaging stations (Cibecue Ridge No. 1 and Cibecue Ridge No. 2), that form a part of an intensive hydrologic investigation of the semi-arid environment of Central Arizona. The gaging stations are located in a remote area where the runoff is infrequent and of brief duration. The model studies were conducted because it was virtually impossible to calibrate the controls in the field.

In addition to determining the stage-discharge relation, modifications in the controls are proposed to improve the discharge records for the two stations. A hydraulic jump occurs in the present controls at the section where the stage is measured. The hydraulic jump keeps the controls clear of the large sediment discharge of the streams, but causes large fluctuations of the water surface in the stilling wells. The modified controls eliminate the hydraulic jump, make extensive use of the construction that presently exists, will pass the sediment discharge of the streams, and have a fairly sensitive stage-discharge relation.

The recorded elevation of the water surface in the stilling well lags the actual elevation of the stream because the connection between the control and the stilling well is too small in relation to the size of the stilling well. The lag can be decreased by replacing the present stilling well with a tube 14 to 20 inches in diameter.

INTRODUCTION

The Carrizo-Corduroy Project is an investigation of the hydrology of small drainage areas in the semi-arid environment of Central Arizona. Two adjacent drainage areas on Cibecue Ridge near the mouth of Corduroy Creek, were selected and instrumented for the measurement of wind speed over the area, soil moisture, humidity, precipitation, precipitation interception, temperature (air and soil), solar radiation, tree growth, and runoff. The investigation was started in the spring of 1958 but some instruments were not installed until the spring of 1959. Hydrologic data for the two areas will be collected for a period of years, after which the trees on one of the drainage areas (Cibecue Ridge No. 1) will be removed to determine the effect of deforestation on the hydrology. The other area (Cibecue Ridge No. 2) will serve as a control for this latter study.

To determine the runoff from the areas, two gaging stations (Cibecue Ridge No. 1 and Cibecue Ridge No. 2) with artificial controls were established in the spring of 1958. In the fall of 1958, it was discovered that sediment deposits in the controls affected the stage-discharge relation. The controls were altered in the spring of 1959 to eliminate this problem. The alterations were effective in keeping the controls free of silt although they created unfavorable flow conditions through the control and excessive surge in the stilling well. The stage-discharge relations for the controls were to be established by conventional stream gaging practice. However, the opportunities for making discharge measurements are very limited because of the remote location of the study area and the infrequent and unsteady nature of the discharge. Therefore, a model study was conducted at Colorado State University with the following objectives:

1. Determine the stage-discharge relation for the controls as they now exist so that past (1959-1960 water year) and future water discharge records can be determined.

2. Determine the characteristics of the flow through the control at all discharges.
3. Modify the control to eliminate any unfavorable flow characteristics that were determined in 2.
4. Determine the stage-discharge relation for the modified controls.

In addition to the problems of unfavorable flow conditions through the control and lack of a stage-discharge relation, the large change in discharge with time that occurs on these streams created another problem. The relation of the intake opening to the size of the stilling well was so small that the measured stage always lagged the actual stage. The problem of the lagging stage can be eliminated by decreasing the size of the well or increasing the size of the intake opening and was not part of the model study.

ACKNOWLEDGMENTS

The author wishes to acknowledge the contribution of J. E. Caffey and L. P. Fangmeier, graduate and undergraduate students in Engineering, respectively, to the successful completion of the model study. The two students constructed the models and gathered the data with relatively little supervision of the author after the general framework of the study had been established. The construction of the models was aided by the many suggestions of R. V. Asmus, the shop supervisor.

The author is also grateful for the advice D. B. Simons gave on the various problems encountered during the study.

The extensive data available for the prototype gaging stations and controls, which materially helped the model study, were furnished by R. C. Culler, Project Leader of the Carrizo-Corduoy Project.

DESCRIPTION OF THE PROTOTYPE

The controls for the two gaging stations were modifications of the critical flow meters described by Balloffett, 1955. The differences between Balloffett's controls and the Cibecue Ridge controls were (1) the low water constrictions, shown in Figs. 2 and 8, installed in the throat of the controls to improve the sensitivity of the low-water stage-discharge relation, (2) the contraction ratio (ratio of width of throat to width of approach channel) for Cibecue Ridge No. 1 control was 3:4 and for Cibecue Ridge No. 2, was 2:3; whereas, Balloffett's ratios were either 1:3 or 2:3, and (3) the wooden sills (see Fig. 7) installed at the entrance to the controls to accelerate the flow and keep it free of sediment. The change in contraction ratio for Cibecue Ridge No. 1 from those used in Balloffett's controls was not too important because the other changes had already eliminated the possible use of Balloffett's results to determine the stage-discharge relation. However, it would have helped the model study if the two controls had been geometrically similar. In the following sections, the details of the two gaging stations and controls are given.

Cibecue Ridge No. 1. -- The Cibecue Ridge No. 1 gaging station has a drainage area of 63 acres. Five discharge measurements made in the fall of 1958 prior to the installation of the wooden sill, were available to determine the velocity of approach to the control. The measurements which had discharges ranging from 5.1 to 16.4 cfs, were made at a cross-section about 10 ft upstream from the entrance to the control. The gage-height for zero flow was 0.22 ft. The maximum observed stage after installation of the wooden sill was 2.47 ft.

The gaging station and approach channel are illustrated in Fig. 1 and the details of the control in Fig. 2. The plan and profile for the gaging station and approach channel are given in Figs. 3 and 4. It was observed in the field and from study of the preceding figures that the flow approached the control at an angle. In the model study, the control was also skewed an equivalent amount

to the approaching flow. Cross-sections for the approach channel are given in Fig. 5. The plan of the control structure is given in Fig. 6.

Cibecue Ridge No. 2. -- The Cibecue Ridge No. 2 gaging station has a drainage area of 42 acres. Discharge measurements were available for this station but because they were made in the control prior to the installation of the wooden sill, could not be used to determine the velocity of approach. The gage-height for zero flow was 0.08 ft. The maximum observed stage after installation of the wooden sill was 2.90 ft.

An overall view of Cibecue Ridge No. 2 gaging station is given in Fig. 7A. This photograph was taken in August 1958, prior to the installation of the sill. In Fig. 7B, a close-up view of the control after the installation of the wooden sill is given. The forebay in front of the sill was filled with sediment by the first major flow after installation. This sill was effective in keeping the control free of silt. Details of this low-water constriction are illustrated in Fig. 8. Plan and profile of the gaging station and approach channel are given in Figs. 9 and 10. As illustrated in the preceding figures and from field observation, the control was not skewed to the approaching flow. In the model study, the control was set parallel to the flow lines. Cross-sections for the approach channel are given in Fig. 11. The plan of the control structure is given in Fig. 12.

MODEL STUDY OF PROTOTYPE CONTROLS

The model study was conducted in Colorado State University's outdoor flume, located on the Cache La Poudre River near Bellvue, Colorado. The flume is 14 ft wide, 10 ft deep, 90 ft long. Discharges up to 50 cfs are available depending on flow in the river and type of model in the flume.

Discharges were measured using a 15 ft or a 4 ft stainless steel rectangular weir. The 4 ft weir was used for discharges up to 14 cfs, and the 15 ft weir for discharges greater than 8 cfs. The approach channel to the weir is 25 ft wide and 6 ft deep. Head on the weir was determined by averaging point gage readings from stilling wells located on each side of the approach

channel, 10 ft upstream from the weir. The head discharge relation for each weir was determined using the equation and procedure described by Kindsvater and Carter, 1955.

The models were constructed out of plywood with a 1:1 scale relation. All elevations of the model controls were the same as the prototypes. Also the model controls were located at the same angle to the flow as the prototype and at an elevation that would assure free fall for all flow conditions.

Stage or depth for the discharges through the control were measured with a point gage in a small stilling well connected to the control by an intake the same size, shape, and location as in the prototype. The surge in the stilling wells was so great that the intake opening was reduced in size by decreasing its length from 6 inches to 1/4 inch. Even with this constriction, a realistic stage or depth could only be obtained by averaging many high and low point gage readings. All point gage readings for the stage or depth in the control were referred to gage datum by precise leveling from the low point in the control between the low water constriction. This point had gage datum of 0.22 ft for Cibecue Ridge No. 1 and 0.08 ft for Cibecue Ridge No. 2. The elevation of the point gage, as were the other control elevations, was checked periodically to assure no changes in elevation had occurred during the study. The wing walls from the control structure were extended to the flume walls where a waterproof bulkhead was placed. Upstream from the bulkhead, a 14 ft long approach channel was constructed. The slope of the approach channel could be changed so that the velocity of approach observed in the prototype could be simulated in the model by varying slope rather than constructing the approach channel to the prototype slope and simulating the roughness.

Cibecue Ridge No. 1. -- The contraction of the natural channel by the controls (bottom width contracted from about 7 ft to 4 ft for Cibecue Ridge No. 1 and from about 7 ft to 3 ft for Cibecue Ridge No. 2) would indicate that the velocity in the approach channel would have little effect on the stage-discharge relation.

The control, by contracting the channel, would establish the velocity of approach rather than channel slope. However, to be sure that the velocity of approach has little or no effect on the stage-discharge relationship, the effect of changes in the approach velocity on the stage-discharge relation was studied in the Cibecue Ridge No. 1 model. The study was made by determining the depth-discharge relation for the model control with various approach velocities. The approach velocity was changed by adjusting the slope and cross-sectional area of the approach channel.

The results of the study on the effect of approach velocity on the depth-discharge relation are given in Fig. 13. In Run A the approach channel was the full width of the flume (14 ft) and the slope was zero. In Run B the slope of the approach channel was increased to 3 percent but the width was not changed. In Run C the slope was not changed from that for Run B, but the geometry and area of the approach channel were changed. The approach channel had the same geometry as that shown in Fig. 17A, except that the bottom width was 8 ft. In Run D the slope of the approach channel was increased to 4.6 percent and the approach channel area was decreased from that for Run C by moving the left wall of the approach channel so that the bottom width was decreased to 7 ft. The approach channel for Run D is given in Fig. 17A. In Run D the mean velocity of the flow was approximately the same as the measured mean velocity in the prototype for a comparable discharge and cross-section. As illustrated in Fig. 13, there was essentially no effect on the depth-discharge relation for changes in the velocity of approach for Runs A, B, and C. However, Run D indicated some effects of a change in the velocity of approach on the depth-discharge relation. The effect being as much as 5 percent in the extreme case. The data for Runs A through D are given in Table 1.

The curve on Fig. 13 is the best fit line for Run D, and is the recommended depth-discharge relation for Cibecue Ridge No. 1. The curve is extended beyond a discharge of 40 cfs by using the Cibecue Ridge No. 2

model study as a 2:3 scale model of Cibecue Ridge No. 1. The recommended stage-discharge relation is given in Fig. 14 where the gage height of zero flow (0.22 ft) has been added to the depths given in Fig. 13.

Cibecue Ridge No. 2. -- In the model study to determine the stage-discharge relation for Cibecue Ridge No. 2, prototype approach velocities were not available to compare with the model. However, the Cibecue Ridge No. 1 model study indicated that the effect of the approach velocities on the depth-discharge relation was small. Also, with a channel slope of 4.6 percent and channel area and geometry about the same as the prototype, the approach velocities in the Cibecue Ridge No. 1 model study were similar to the prototype. Therefore, the approach channel for the Cibecue Ridge No. 2 model study was set at a slope of 4.6 percent with the geometry and area of the approached channel similar to the prototype. The approach channel is illustrated in Fig. 18A. The depth-discharge relation for Cibecue Ridge No. 2 is given in Fig. 15, and the stage-discharge relation (depth plus 0.08 ft) is given in Fig. 16. The data for Run A is given in Table 2.

Flow Through the Controls. -- The installation of the wooden sills at the upstream end of the controls, shifted the critical flow section from the downstream contraction to the entrance. The downstream contraction then served as an obstruction to the supercritical flow so that a hydraulic jump occurred immediately downstream from the sill. What was supposed to be the approach section with tranquil flow for the measurement of stage or depth of a critical depth control became a stilling basin. The results were a lot of turbulence and variation in depth which was good for keeping the control free of sediment but extremely poor as a section to measure stage. These flow conditions, critical flow at entrance to the control and hydraulic jump at the intake, existed for all discharges. Flow conditions in the approach channel and through the controls for Cibecue Ridge No. 1, and Cibecue Ridge No. 2, respectively, are given in Figs. 17 and 18.

MODIFIED CONTROLS

The large fluctuations of the water surface in the stilling well that results from the hydraulic jump in the control will always produce poor quality water-discharge records. Also, fluctuations of the water surface in the stilling wells will be amplified if remedial measures are made to decrease the lag between the recorded water surface elevation and the actual water surface elevation in the controls. Therefore, the controls should be changed to improve the water-discharge records for these two stations. If at all possible, the new controls should be simple alterations of the present structures to take advantage of the extensive construction that exists at the gaging stations. In addition to eliminating the large water surface fluctuations in the stilling wells, the modified controls must be unaffected by the sediment discharge of the streams, have a sensitive rating (small change in discharge for a 0.01 ft change in stage), and if possible, the two controls should be geometrically similar so that discharge measurements at one station could be transferred by model laws to the other.

The simplest alteration to the control that would take advantage of the construction that already exists, eliminate the hydraulic jump, pass the sediment discharge of the streams, and have a fairly sensitive stage-discharge relation was to:

1. Eliminate the downstream constriction and the wooden sill at the entrance.
2. Slope the floor of the control. The sloping floor would assure supercritical flow through the control and eliminate the possibility of sediment deposits. Stage would be the supercritical depth in the control.
3. Install a trapezoidal section in the control to increase the sensitivity of the stage-discharge relation for the smaller discharges.

Plans of the Modified Controls. -- The plan, profile, and cross-sections are given in Figs. 19 and 20 for the modified Cibecue Ridge No. 1 control and in Figs. 21 and 22 for the modified Cibecue Ridge No. 2 control. The modified

model of the Cibecue Ridge No. 1 control, is illustrated in Fig. 23. Photographs of the modified model of the Cibecue Ridge No. 2 control are not given, as it was geometrically similar to the other control. The modified controls have a 3:2 scale relation in cross-section, although their length and bed slopes are the same. The floors of the controls have a slope of 4 percent. The transitions at the entrance to the controls have a slope of 1 percent. The trapezoidal sections of the controls have a 1:1 slope. The intake for each control is a 6 inch by 1 inch vertical slot. In the model study, it was connected by a sloping rectangular section to the original control intake. In the prototype, a larger pipe could connect the intake to the stilling well. However, the intake opening in the control should not be changed from the 6 inch x 1 inch rectangular opening used in the model study.

The transitions at the entrance to the controls were molded by hand out of concrete. The lines showing the profile and plan of the transition in Figs. 19, 20, 21 and 22 were drawn on the floor and wing wall of the approach section, and wet concrete was molded between the lines to form a smooth transition to the trapezoidal sections of the controls. Care was used to make a smooth junction between the transition and the trapezoidal control sections. The right side of the transition for the modified Cibecue Ridge No. 1 control was terminated at the right bank of the approach channel, Fig. 23A. However, the banks of the approach channel for Cibecue Ridge No. 2 were far enough back from the control that the transition for the modified control terminated at the wing walls. The transitions at the entrance to the modified controls must be incorporated in the prototype so that separation of the flow does not take place at the entrance. A satisfactory transition can be molded out of concrete using the dimensions given in the plans as guides if care is used to make the junction between the transition and trapezoidal control sections as smooth as possible. The junction between the two sections is critical because a poor junction will cause separation of the flow which may affect the stage-discharge relation. However, minor variations in the transition, both in

alignment and shape, will have little effect on the stage-discharge relation.

Flow through the Modified Controls. -- Flow through the controls, as illustrated in Figs. 24 and 25, was fairly smooth. A standing wave, which increased in size with an increase in discharge, formed in the controls downstream from the intake to the stilling well. The standing wave in the modified Cibecue No. 2 control, because of the greater contraction of the flow, was larger and more pronounced than the wave in the modified Cibecue Ridge No. 1 control. Fluctuations of the water surface in the stilling wells were small. Even with the small stilling basins used in the model study, the fluctuations were so small that only the average of three or four point gage readings were needed to determine the depth of flow in the control.

Depth Discharge Relations. -- The depth-discharge relation for the modified Cibecue Ridge No. 1 control is given in Fig. 26. The data for the Runs is given in Table 3. Depth of flow is the elevation of the water in the stilling well minus the elevation of the floor of the control in front of the intake. On log log paper, the depth-discharge relation for the modified Cibecue Ridge No. 1 control is a straight line above 1 cfs with a slope of 0.54. The extension of the relation is based on its straight line property, and the points from the modified Cibecue Ridge No. 2 control as a 2:3 model of this control. As will be discussed later, the depth-discharge relation for the modified Cibecue Ridge No. 2 control is not a straight line relation on log log paper.

The depth-discharge relation for the modified Cibecue Ridge No. 2 control is given in Fig. 27. The data for the Runs is given in Table 4. Depth of flow is the elevation of the water in the stilling well minus the elevation of the floor of the control in front of the intake.

In the modified Cibecue No. 2 model study, two sets of runs (B and C) were made to determine the sensitivity of the depth-discharge relation to changes in the transition to the control. In the B Runs, the opposite sides of the junction between the transition and the control were offset from each other.

The right side of the junction was two inches downstream of the left side. In the C Runs, the opposite sides of the junction between the transition and the control were directly across from each other as shown in Fig. 21. In addition to the lack of symmetry of the junctions between the transition and control, the shape of the transition was different from Run B to Run C. However, the transition for both B and C Runs was smooth, without abrupt changes or angles. As illustrated in Fig. 27, the effect of these differences on the depth-discharge relation was small. Therefore, if the transition at the entrance to the control is kept smooth, without abrupt changes or angles, and essentially conforms to the plans for the two modified controls, the depth-discharge relation for the models will be transferable to the prototypes.

The plot of the depth-discharge relation on log log paper for the modified Cibecue Ridge No. 2 control has a change in slope between 6 and 13 cfs. The depth-discharge relation is a straight line with a slope of 0.48 for discharges between 1.2 and 6 cfs and another straight line with a slope of 0.60 for discharges greater than 13 cfs. The change in the slope of the depth-discharge relation results from a shift in the position of the standing wave in the modified Cibecue Ridge No. 2 control.

RECOMMENDATIONS

Lag in Recorded Water Surface Elevation. -- There is considerable lag in the elevation of the water surface in the stilling well behind the elevation of the water surface in the control. On a rising stage, the elevation of the water surface in the stilling well will be lower than the elevation of the water surface in the control, whereas, on a falling stage the elevation of the water surface in the stilling well may be higher than the elevation of the water surface in the control. To decrease this lag in water surface elevation, it is recommended that a pipe 14 inches in diameter be installed in the gage house to serve as the stilling well. This pipe may have a door at the bottom to serve as a cleanout. The door need not be water-tight although the less leakage through the door, the better.

Stage-Discharge Relation for Prototype Controls. -- The stage-discharge relation for Cibecue Ridge No. 1 control is given in Fig. 14, and the data for this relation is given in Table 1, Run D . The stage-discharge relation for the Cibecue Ridge No. 2 is given in Fig. 16. The data for this relation is given in Table 2, Run A .

Modified Controls. -- The characteristics of the flow through the controls is poor. Critical depth occurs at the entrance to the controls and the contraction at the downstream end of the controls creates a hydraulic jump at the intake to the stilling well. The control should be modified to eliminate the hydraulic jump, which creates a considerable amount of surge in the stilling well making it difficult to determine the gage height for the stage-discharge relation.

Modifications of the control which take advantage of the construction that already exists, eliminates the hydraulic jump, passes the sediment discharge of the stream, and has a fairly sensitive depth-discharge relation, are given in Figs. 19 and 20 for Cibecue Ridge No. 1 and Figs. 21 and 22 for Cibecue Ridge No. 2.

The depth-discharge relation for the modified Cibecue Ridge No. 1 control is given in Fig. 26. The data for this depth-discharge relation is given in Table 3.

The depth-discharge relation for the modified Cibecue Ridge No. 2 control is given in Fig. 27. The data for this relation is given in Table 4.

LITERATURE CITED

- Balloffett, A., 1955, Critical Flow Meters (Venturi Flumes): Am. Soc. Civil Engineers Proc., v. 81, No. 743.
- Kindsvater, C. E., and Carter, R. W., 1957, Discharge Characteristics of Rectangular Thin-Plate Weirs: Am. Soc. Civil Engineers Proc., v. 83, HY6.

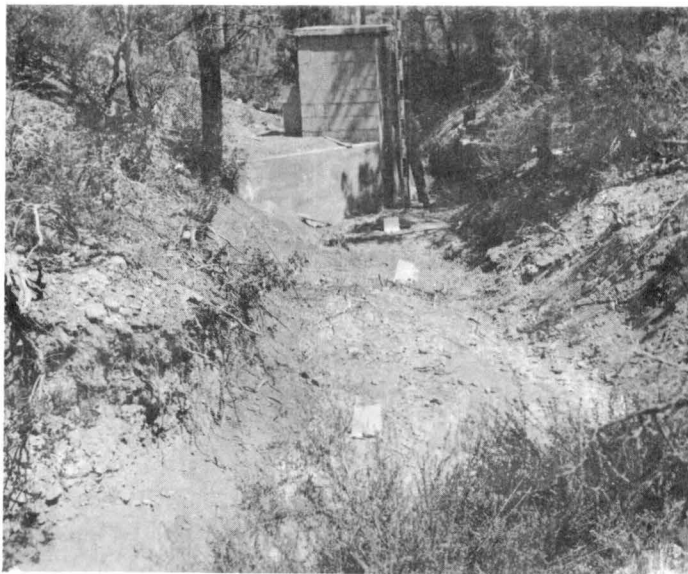

A. Downstream view



B. Upstream view

Figure 1. Cibecue Ridge No. 1 gaging station, and approach channel. (white cards are on line of the cross-sections)



A. Upstream view showing low-water constriction

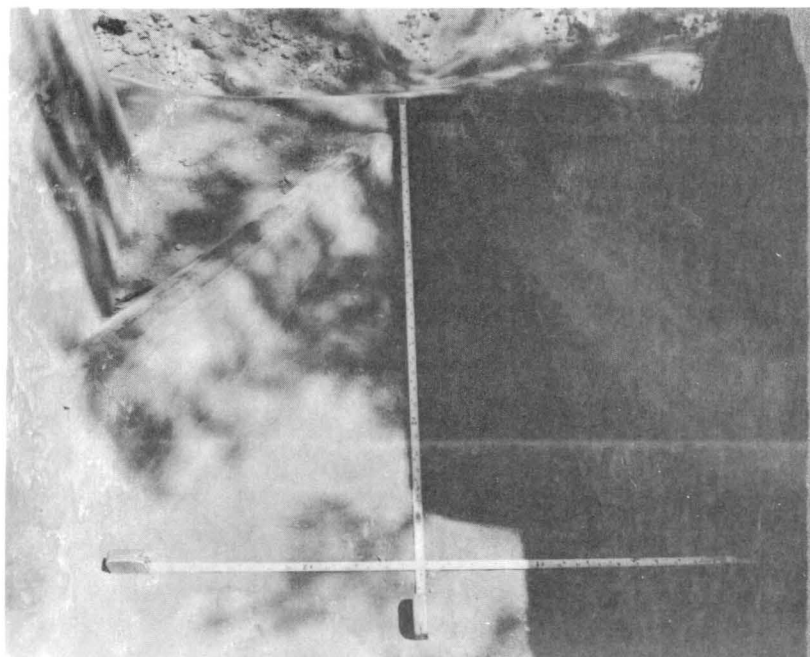

B. Downstream view of low-water constriction

Figure 2. Details of Cibecue Ridge No. 1 control.

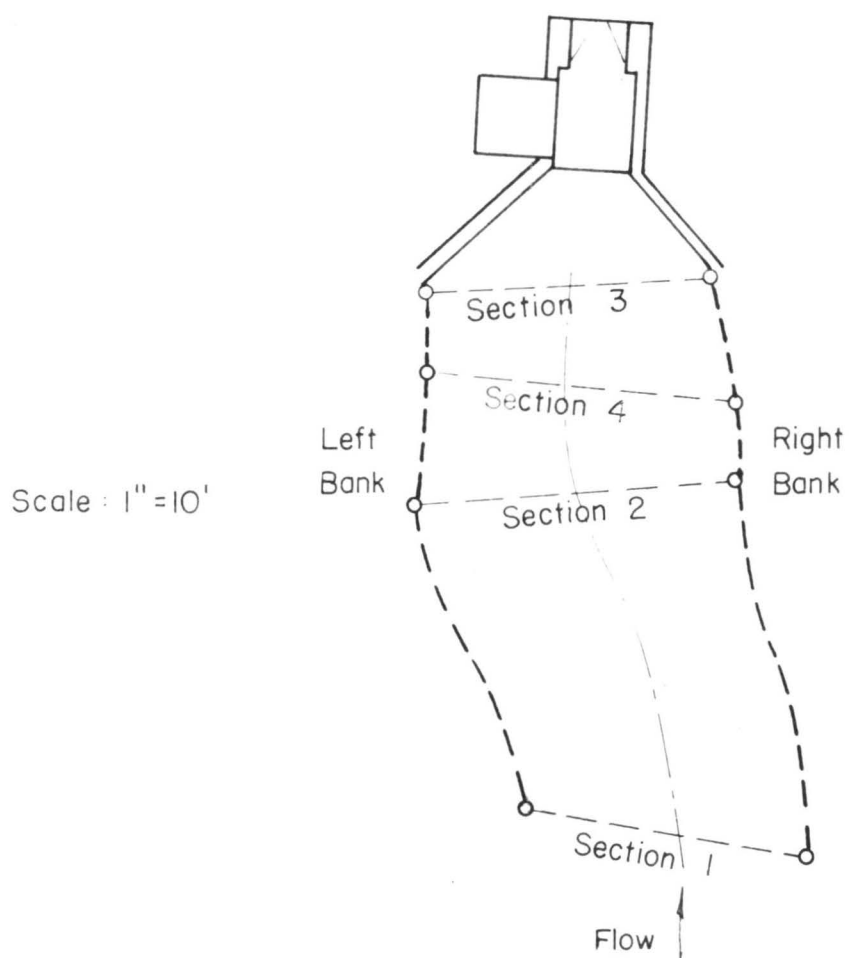

Figure 3. Plan view of approach channel and gaging station, Cibecue Ridge No. 1

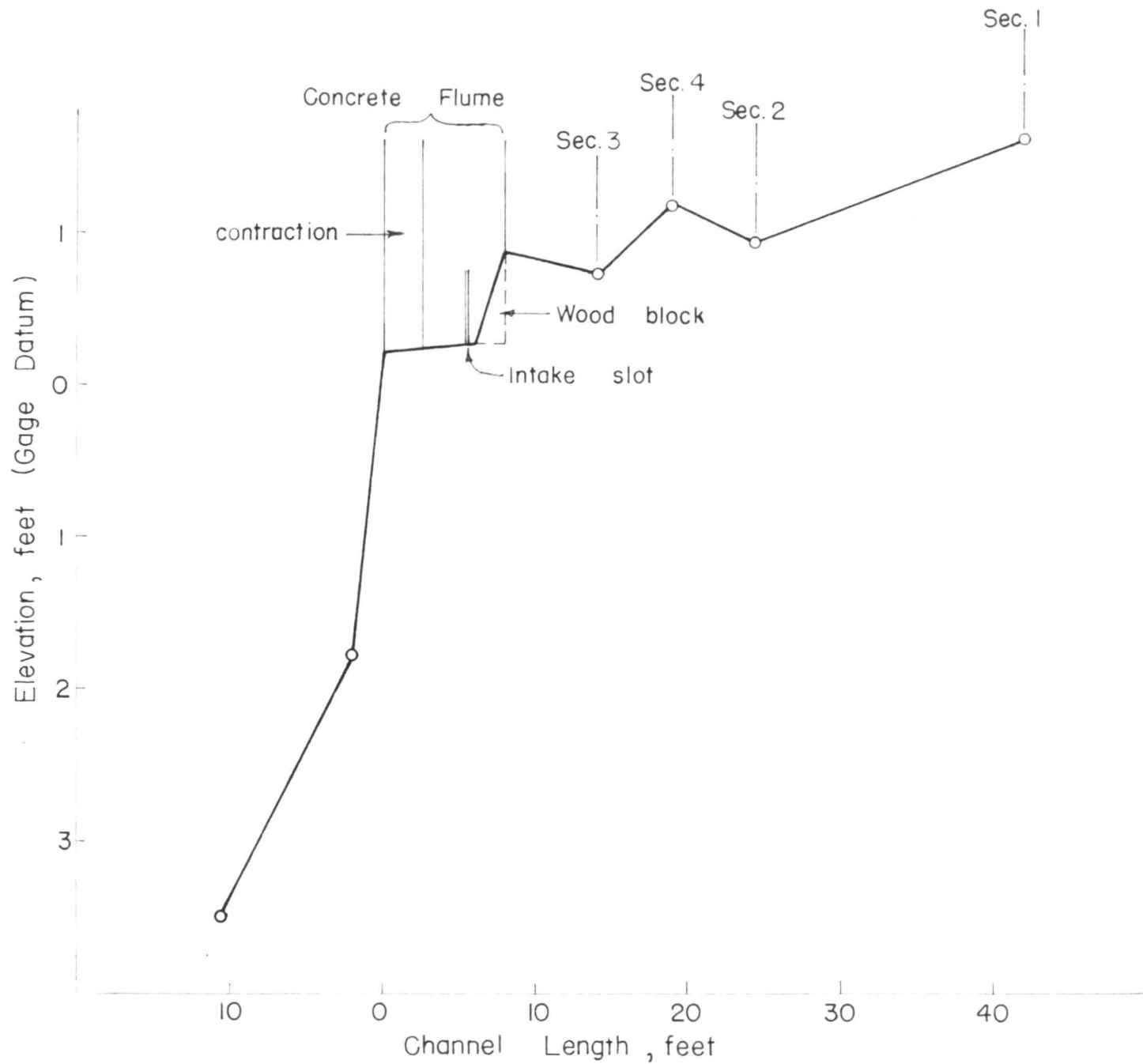

Figure 7. Profile of the control structure and stream bed for Cibecue Ridge No. 1

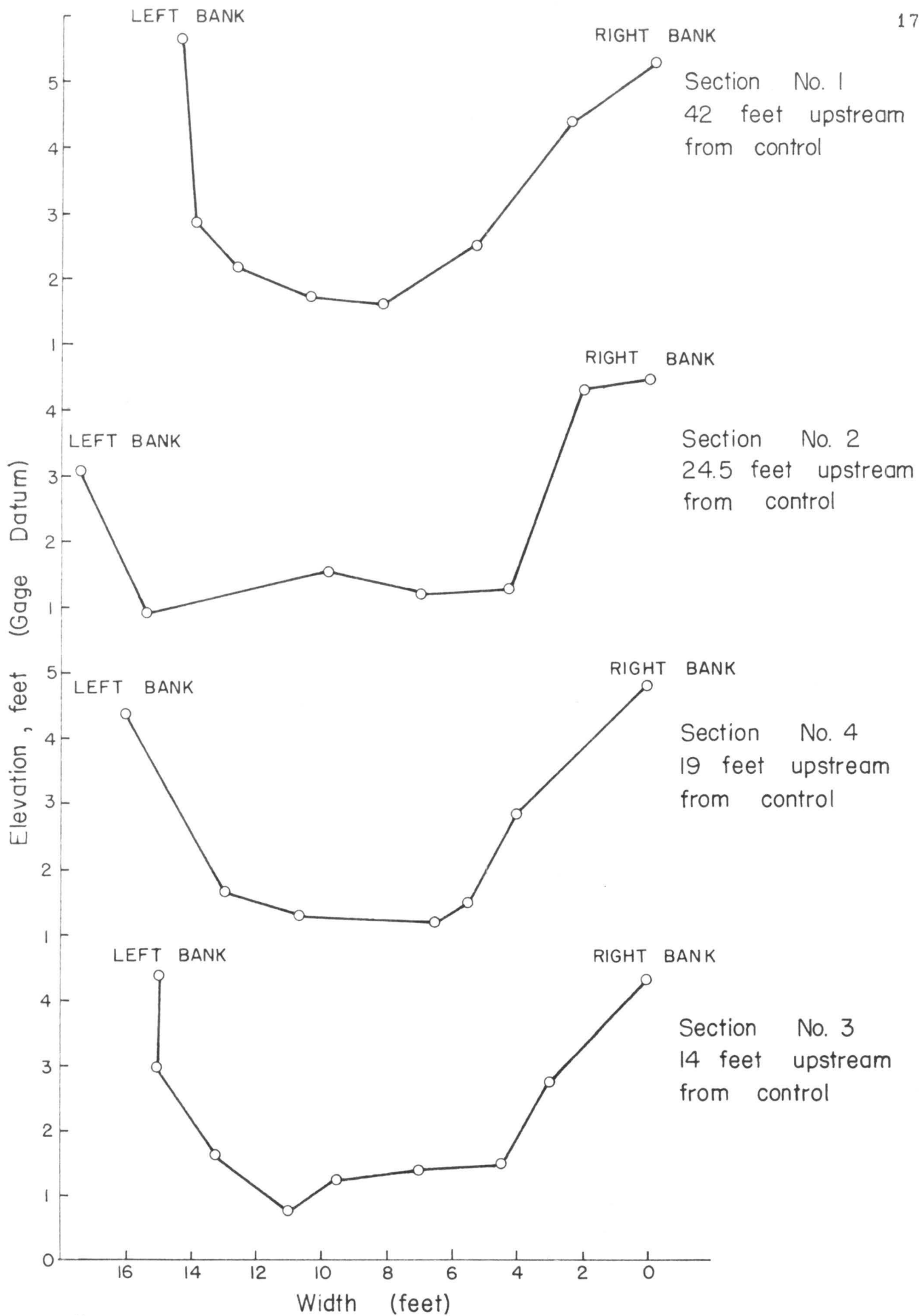

Figure 5. Cross-sections of the approach channel for Cibecue Ridge No. 1

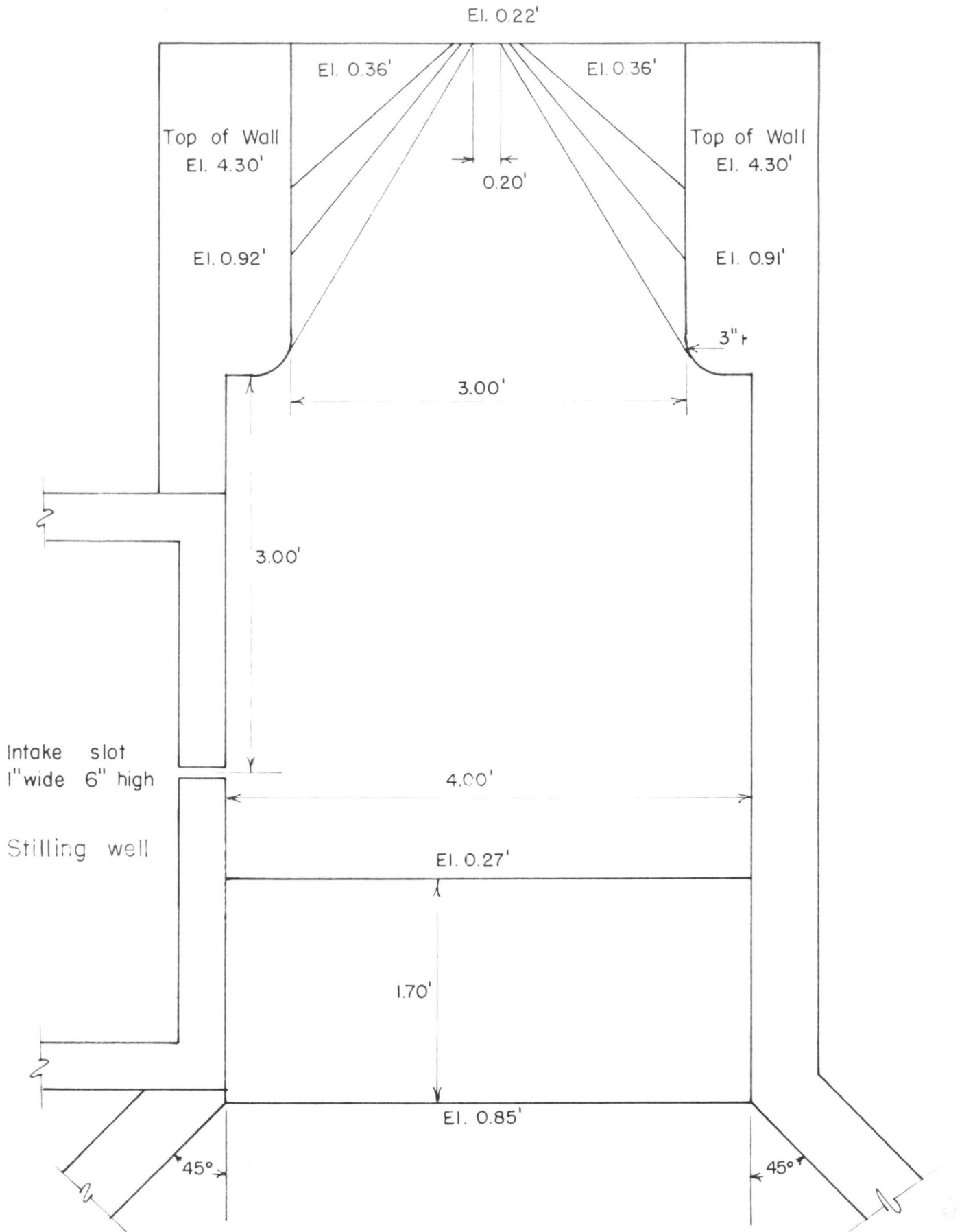

Figure 6. Plan of Gibecue Ridge No. 1 control (Scale: 1"=1')



A. Downstream view of gaging station



B. Downstream view of control and wooden sill

Figure 7. Cibecue Ridge No. 2 gaging station and control.

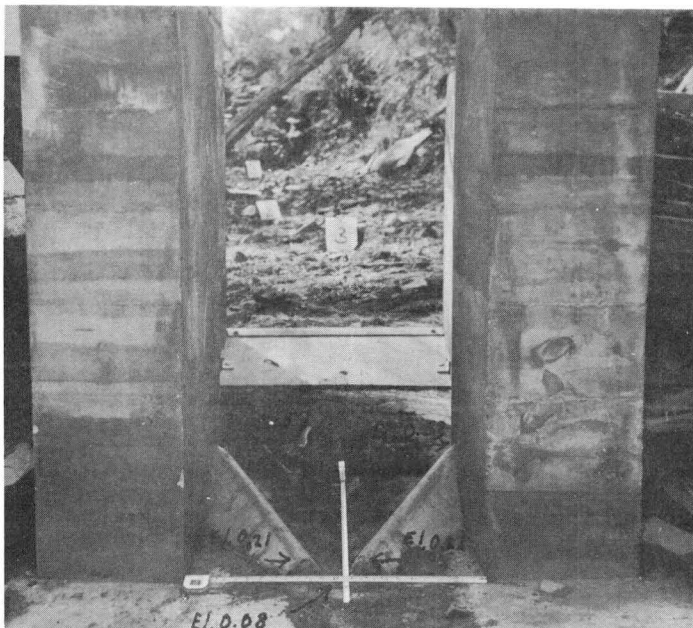

A. Upstream view showing low-water constriction

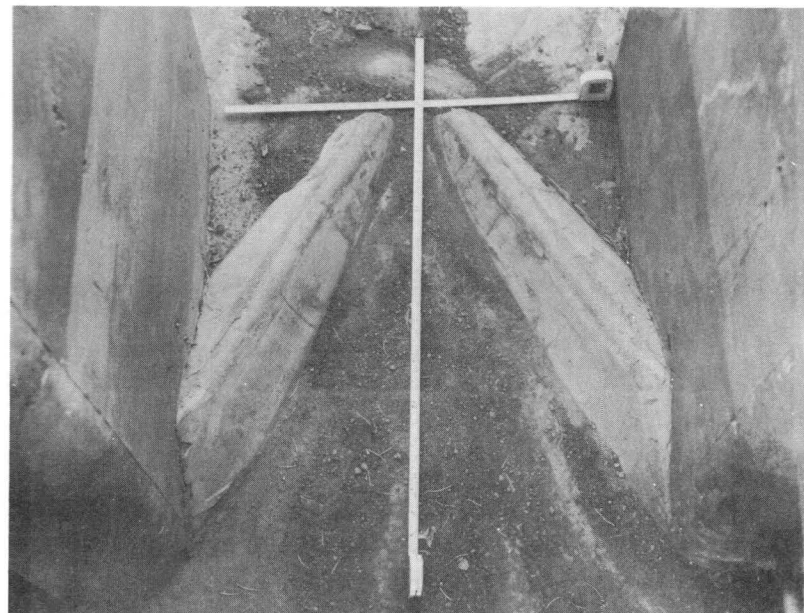

B. Downstream view of low-water constriction

Figure 8. Details of Cibecue Ridge No. 2 control. (white cards indicate line of the cross-sections)

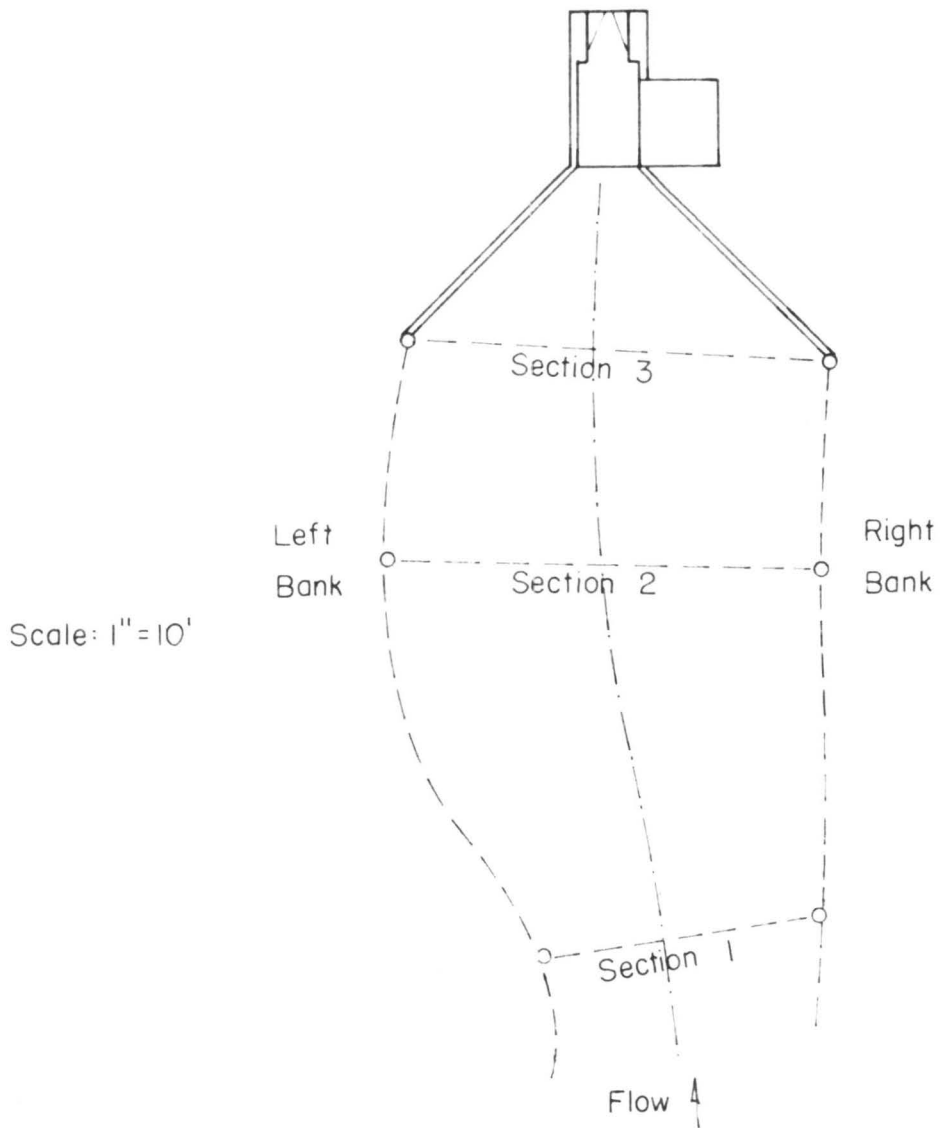

Figure 9. Plan view of approach channel and gaging station, Cibecue Ridge No.2

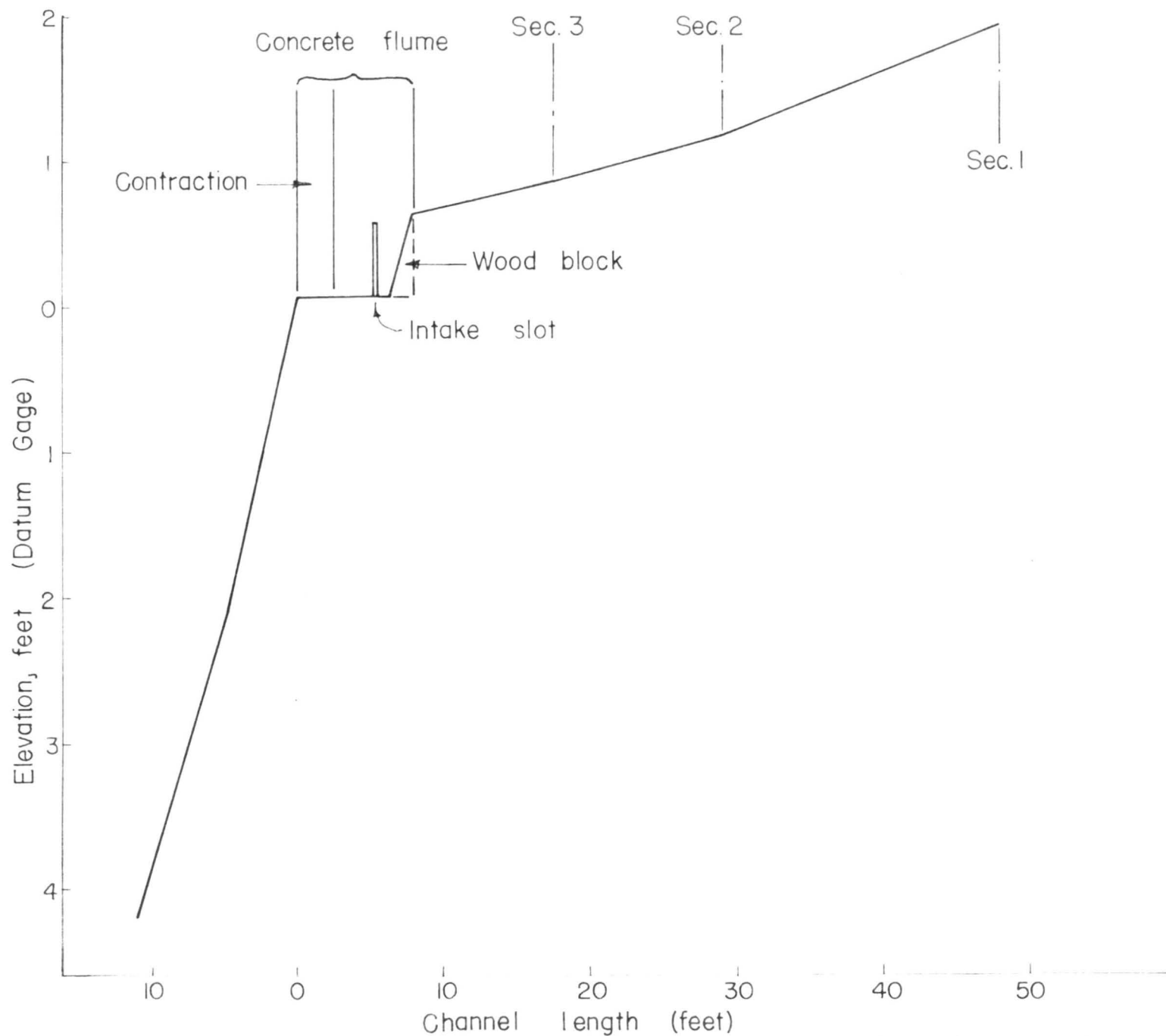

Figure 10. Profile of the control structure and stream bed for Cibecue Ridge No. 2

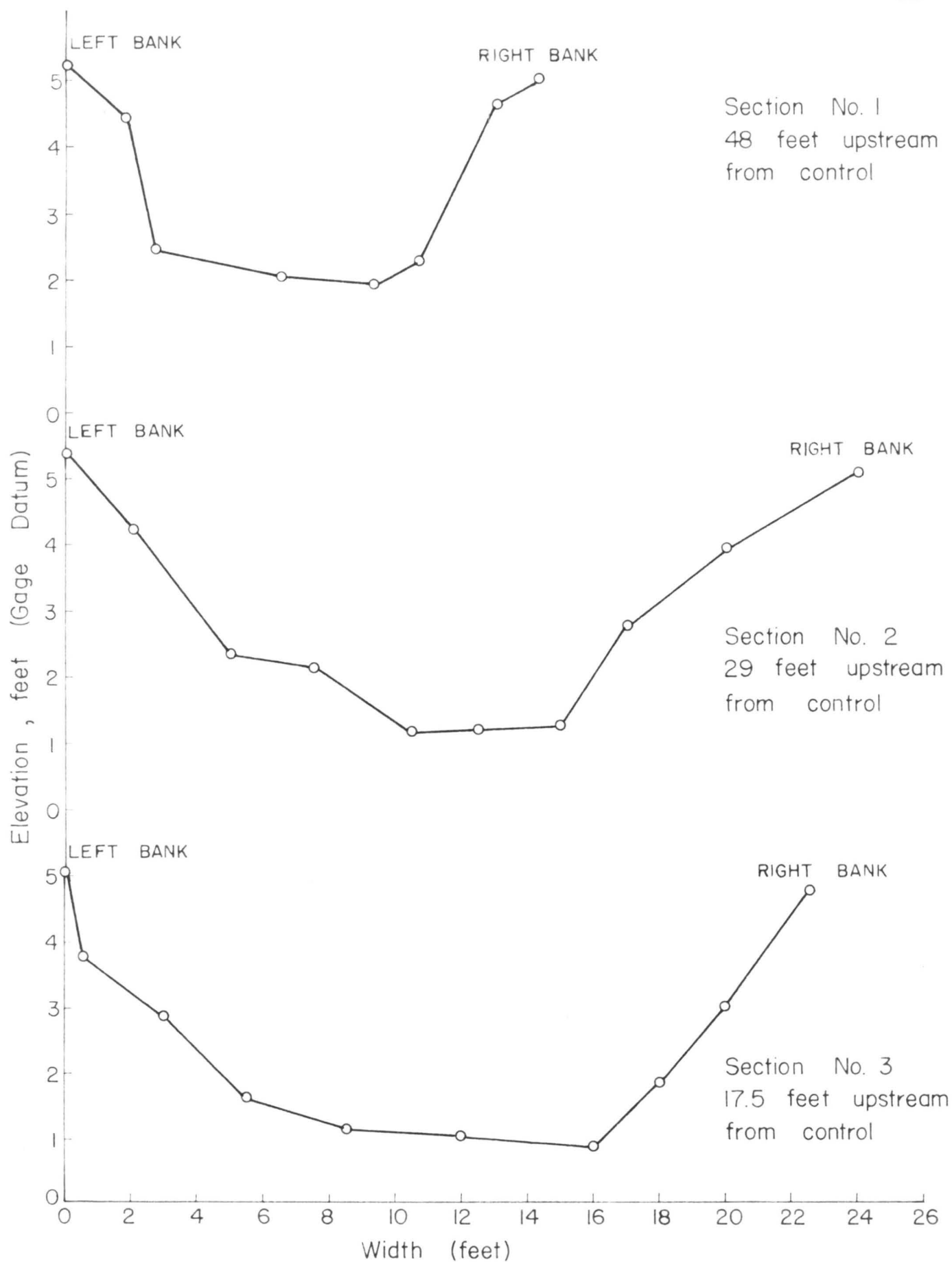

Figure 11. Cross-Sections of the approach channel for Cibecue Ridge No. 2

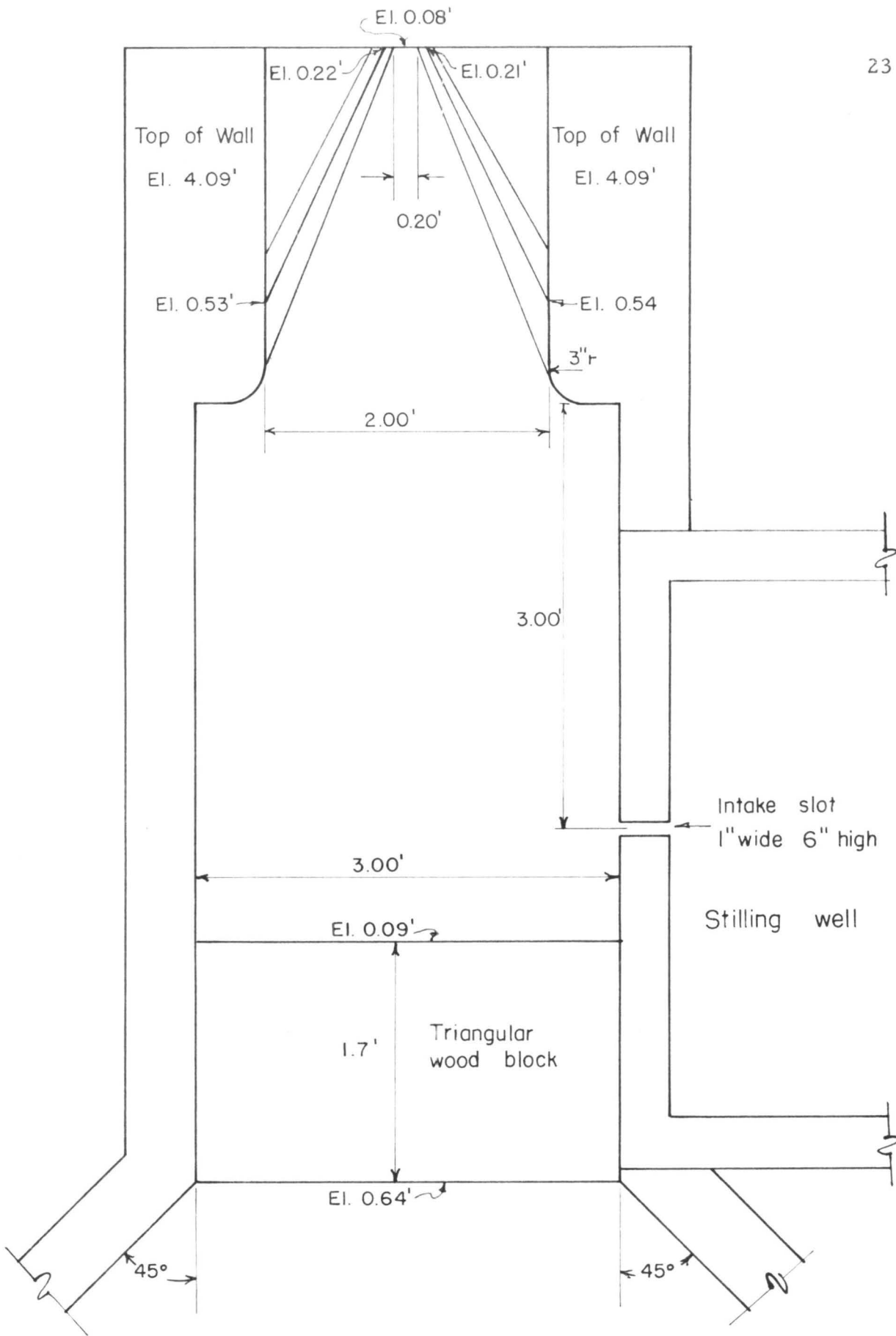

Figure 12. Plan of Cibecue Ridge No. 2 control (Scale: 1"=1')

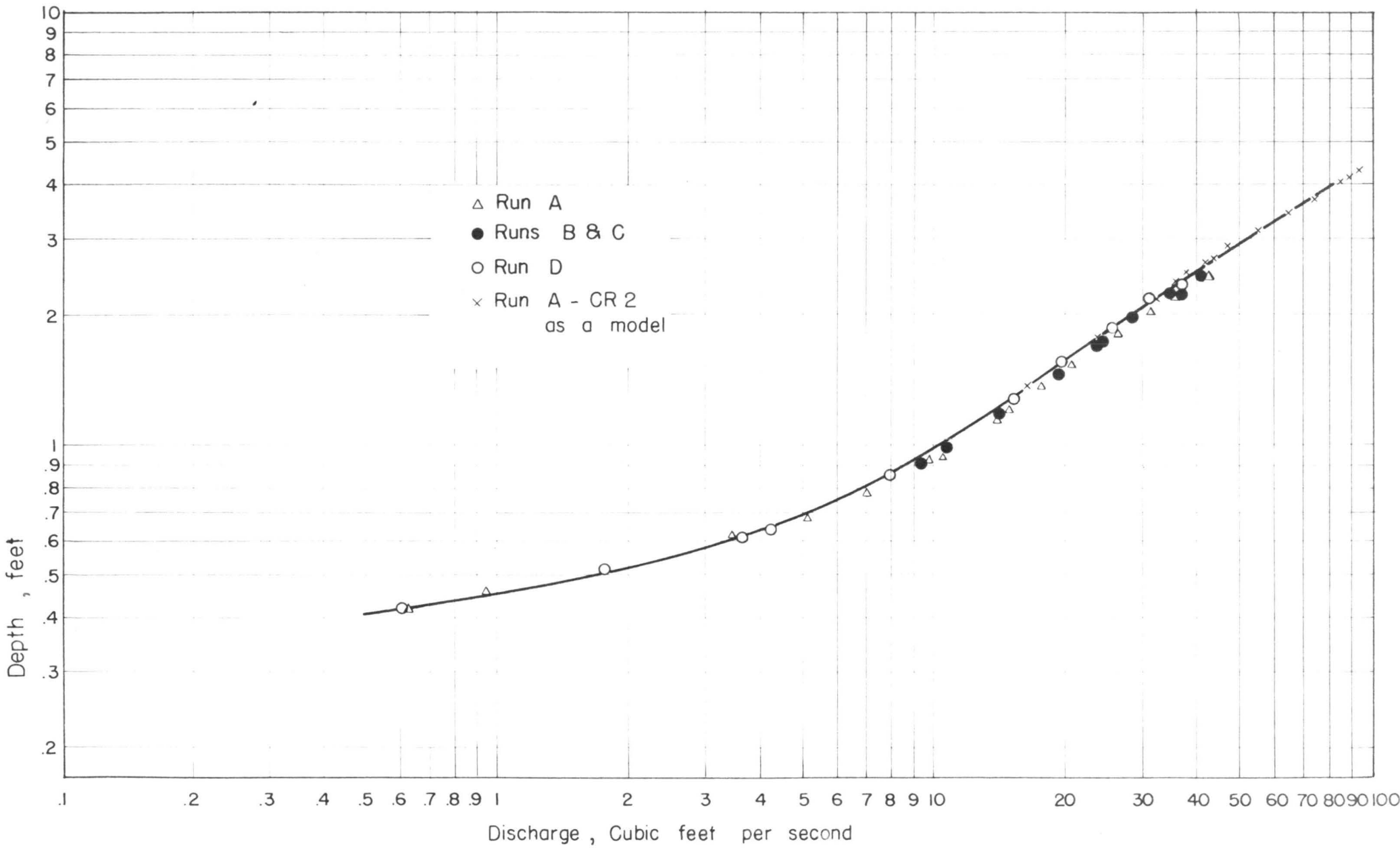

Figure 13. Depth-Discharge relation for Cibecue Ridge No. 1 Control.

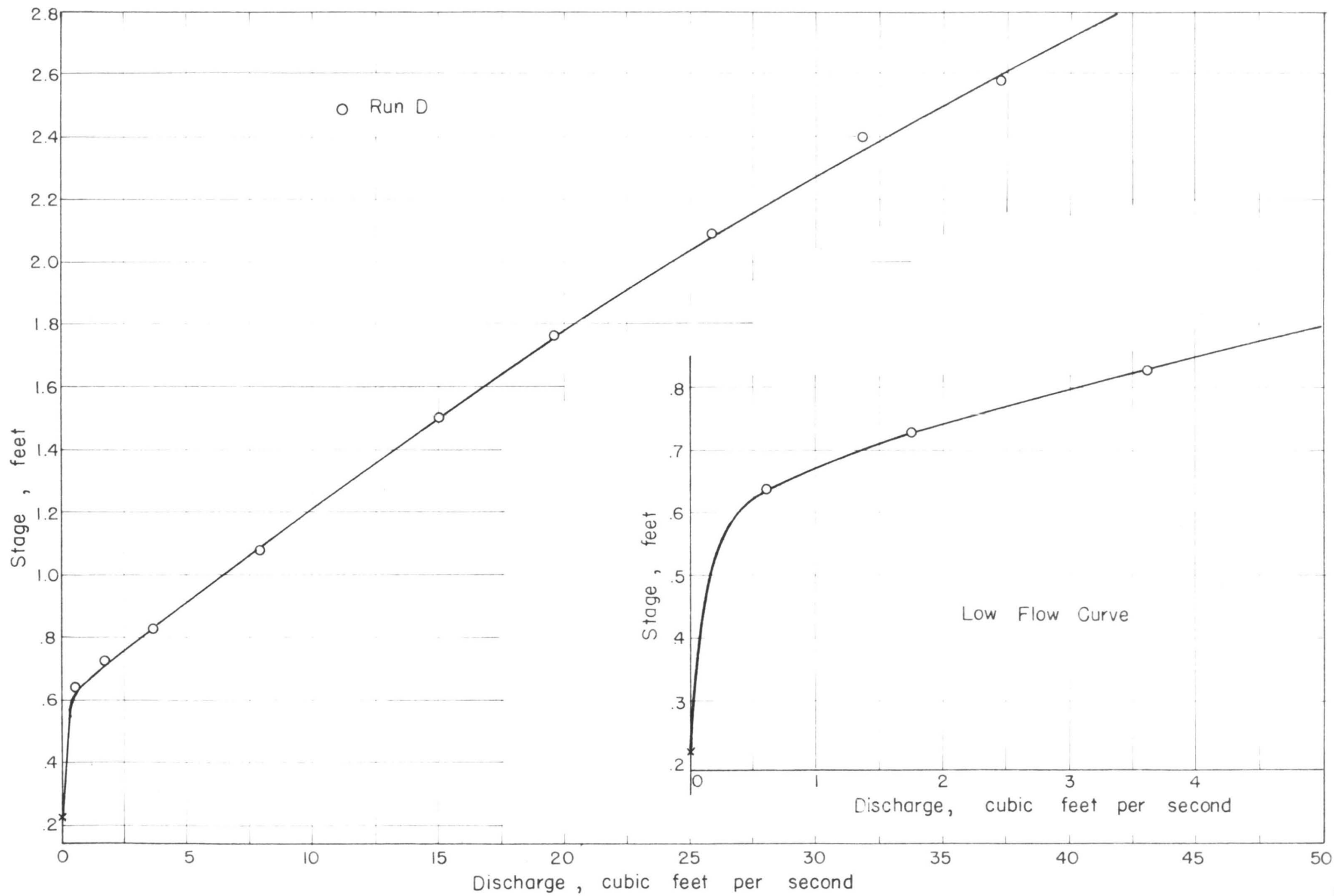

Figure 14. Stage - discharge Relation for Cibécue Ridge No. 1 Control.

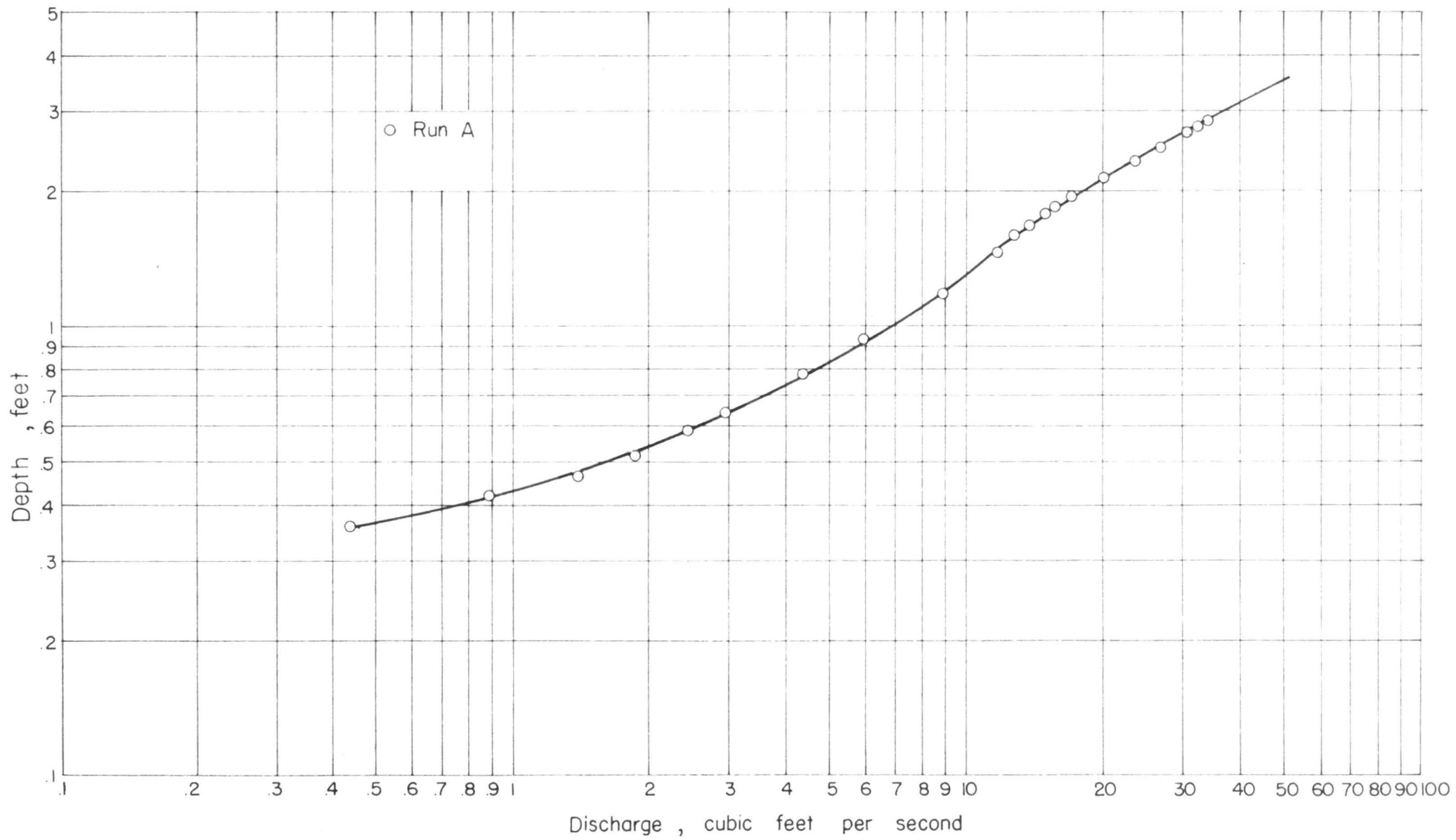

Figure 15. Depth-Discharge Relation for Cibecue Ridge No. 2 Control.

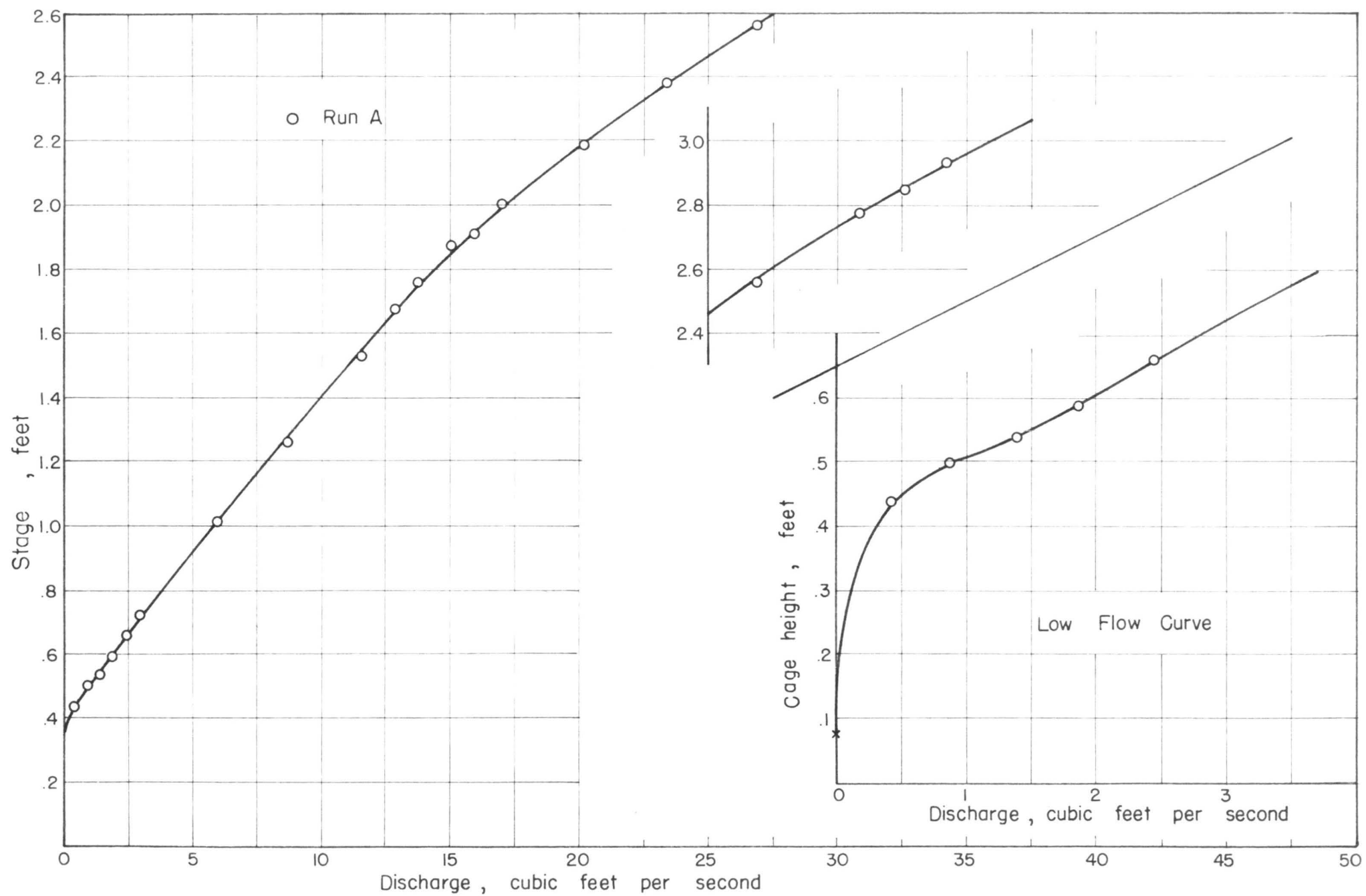
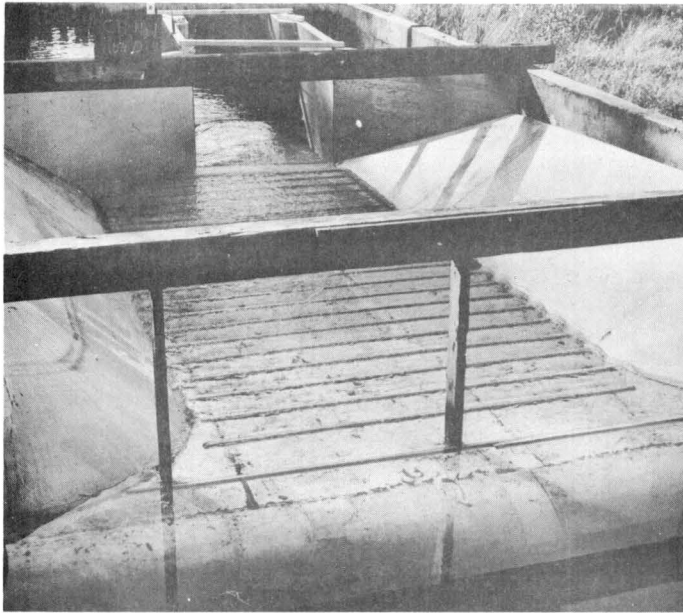
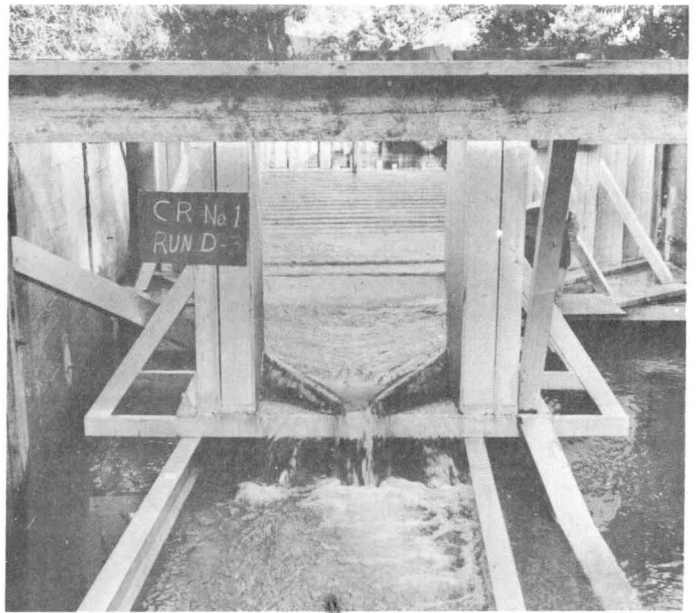

Figure 6. Stage-Discharge Relation for Cibecue Ridge No. 2 Control.



A. Downstream view of Run D-3
Discharge 0.60 cfs



B. Upstream view of Run D-3
Discharge 0.60 cfs

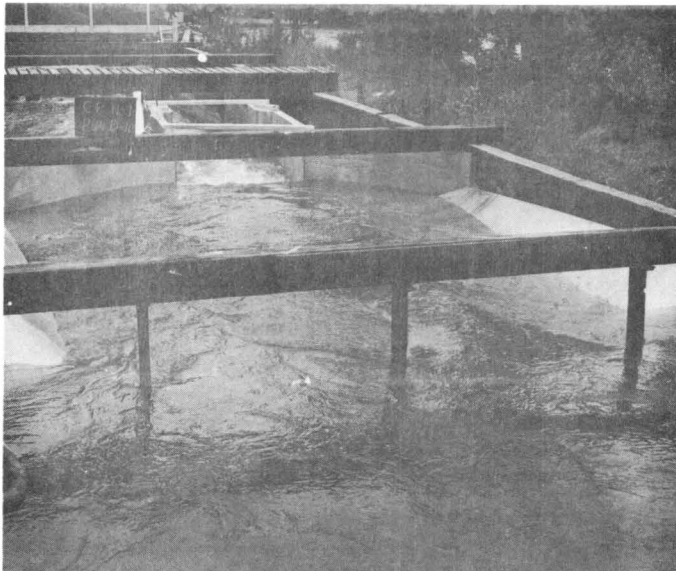

C. Downstream view of Run D-10
Discharge 37.3 cfs

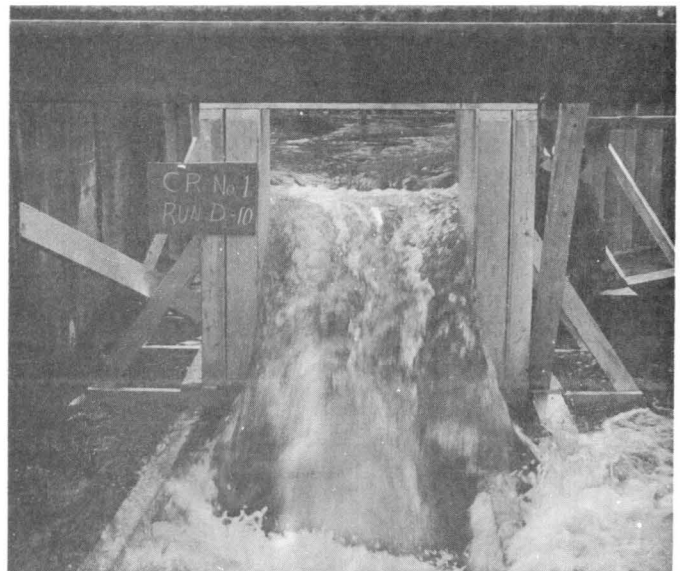

D. Upstream view of Run D-10
Discharge 37.3 cfs

Figure 17. Flow through model of Cibecue Ridge No. 1 control.



A. Downstream view of Run A-7
Discharge 0.89 cfs



B. Upstream view of Run A-7
Discharge 0.89 cfs



C. Upstream view of Run A-1
Discharge 11.7 cfs

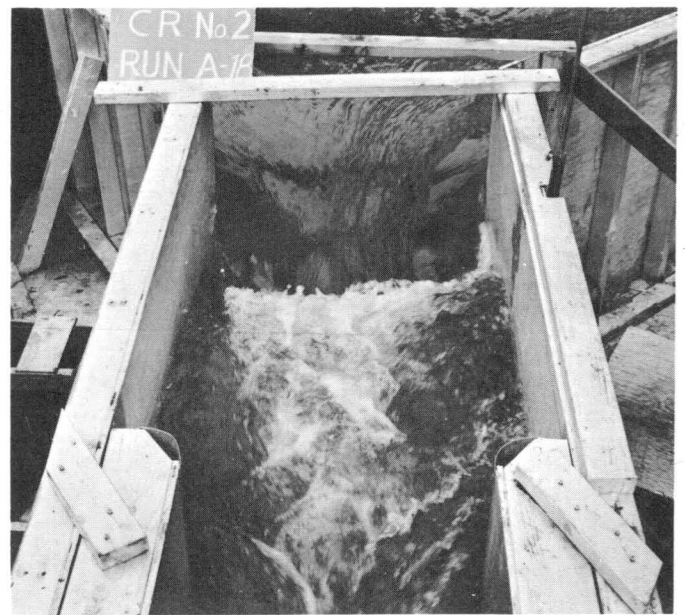

D. Upstream view of hydraulic jump
Run A-18, Discharge 34.2 cfs
(Point gage indicates location
of intake to stilling well)

Figure 18. Flow through model of Cibecue Ridge No. 2 control.

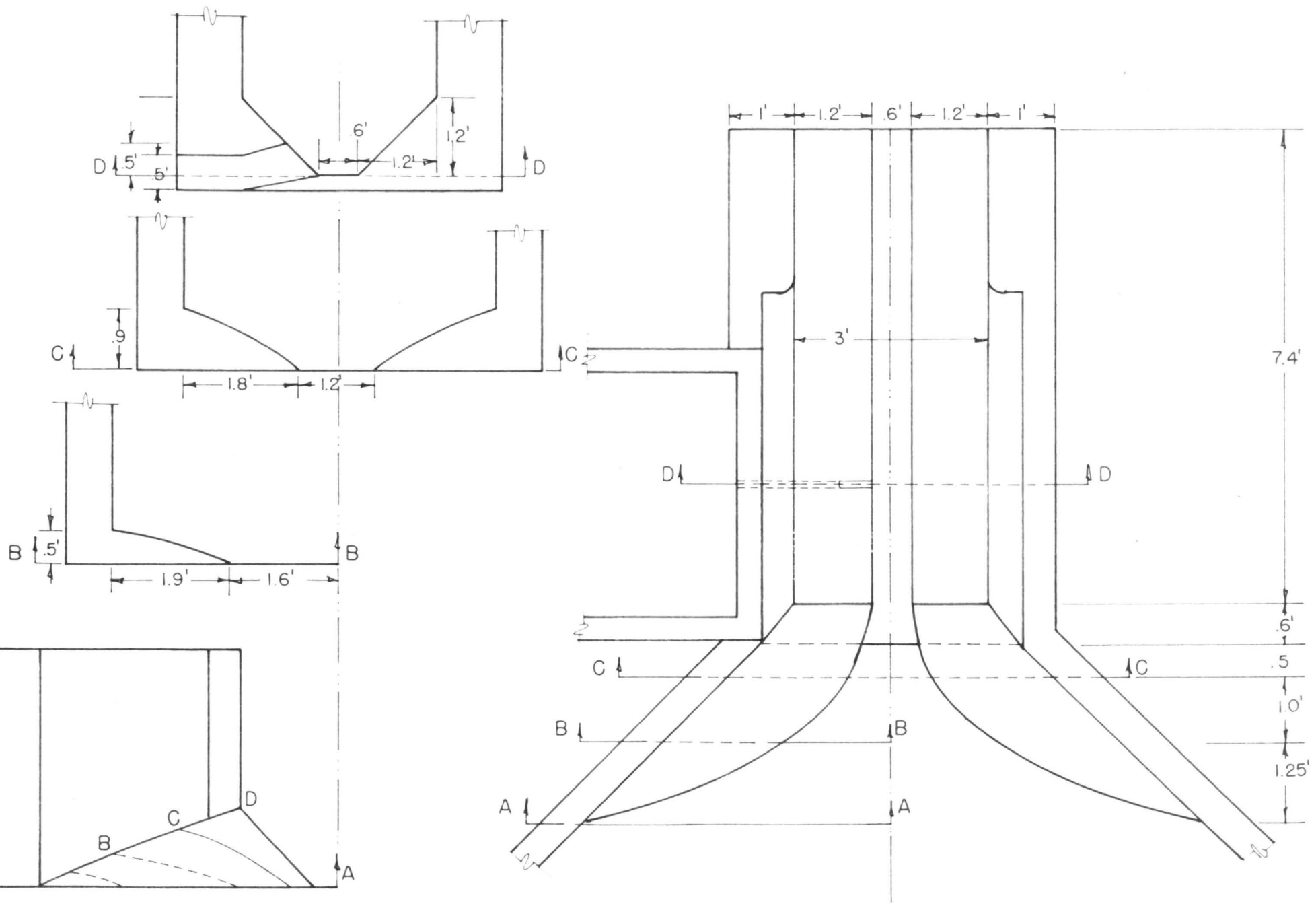

Figure 19. Plan and Cross Section of Modified Cibecue Ridge No. 1 Control. (Scale: 1"=2')

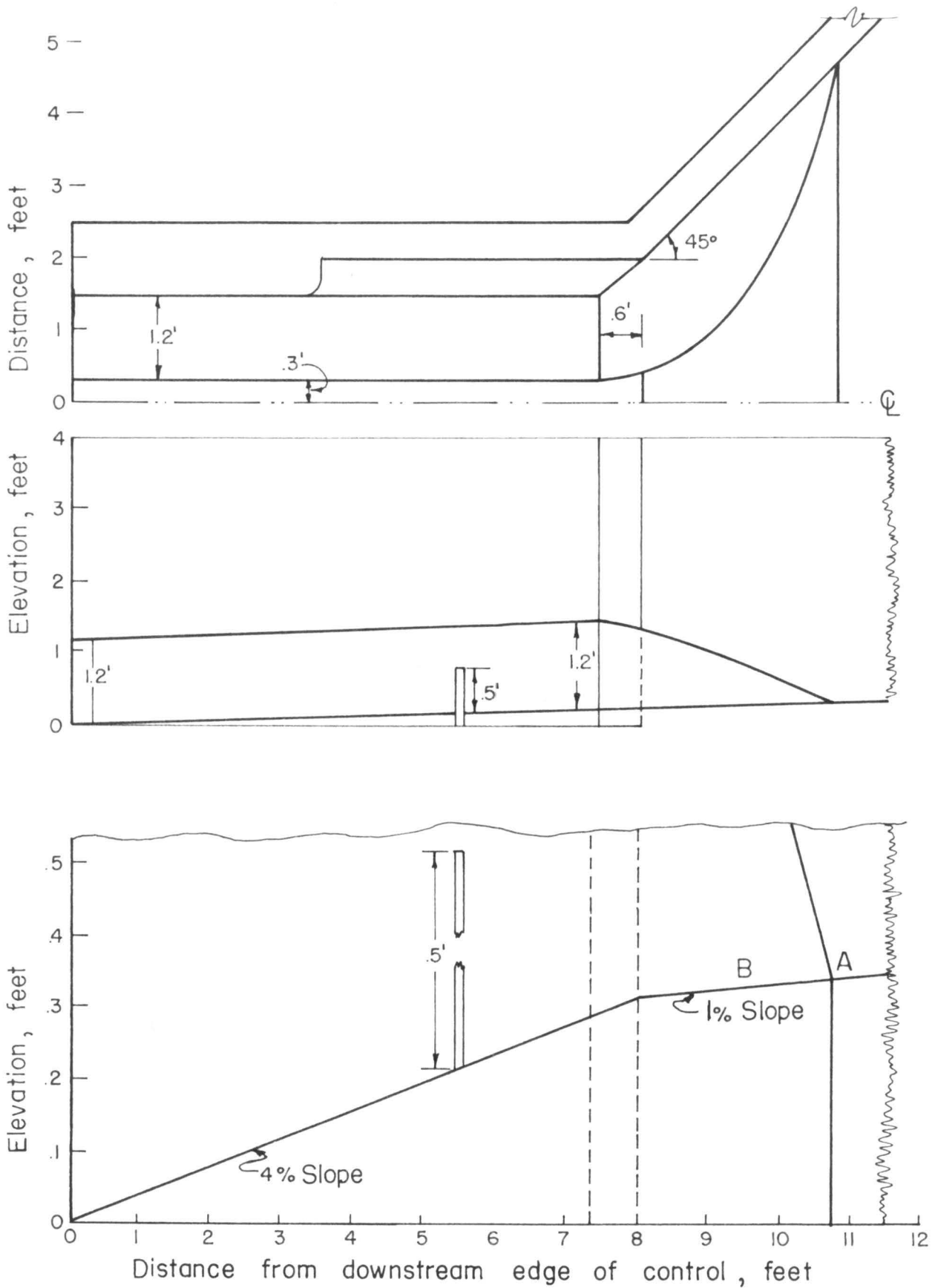

Figure 20. Plan and Profile of Modified Cibecue No. 1 Control.

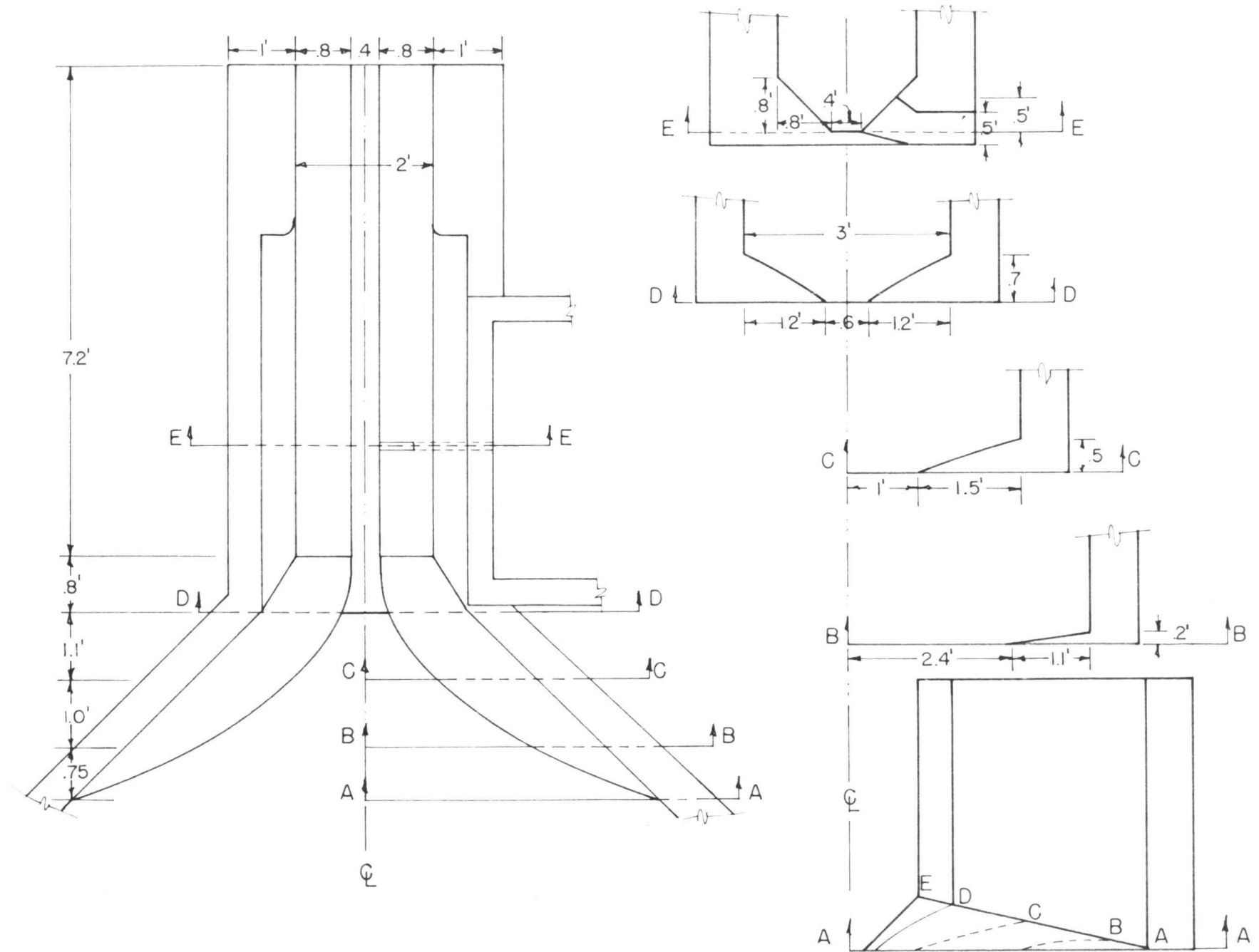

Figure 21. Plan and Cross Section of Modified Cibecue Ridge No. 2 Control. (Scale: 1"=2')

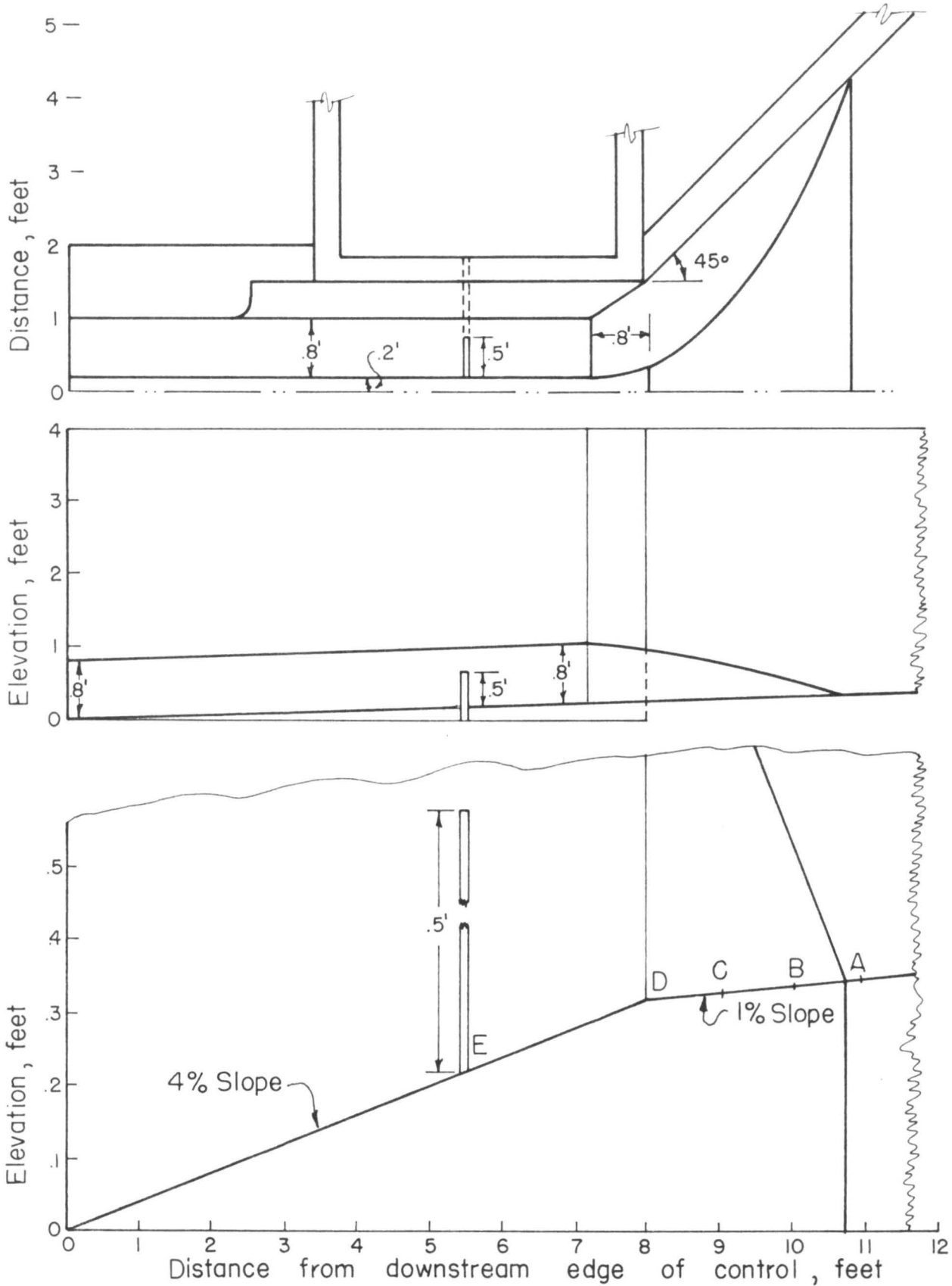
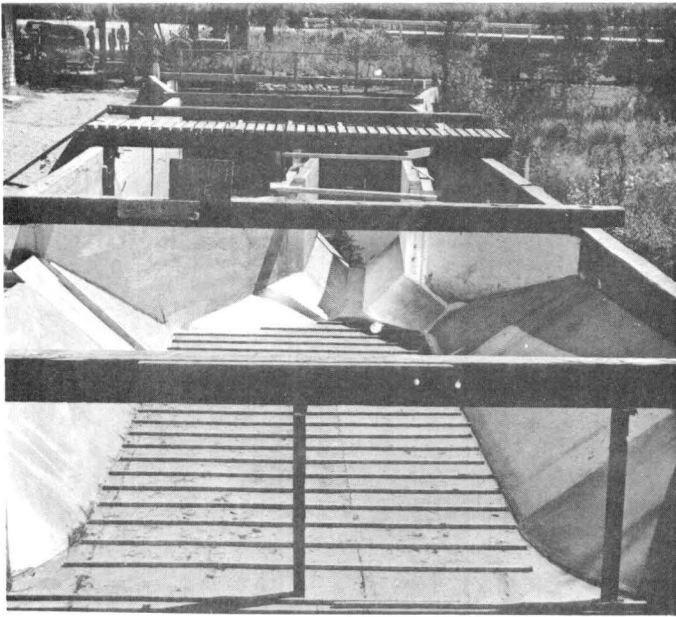
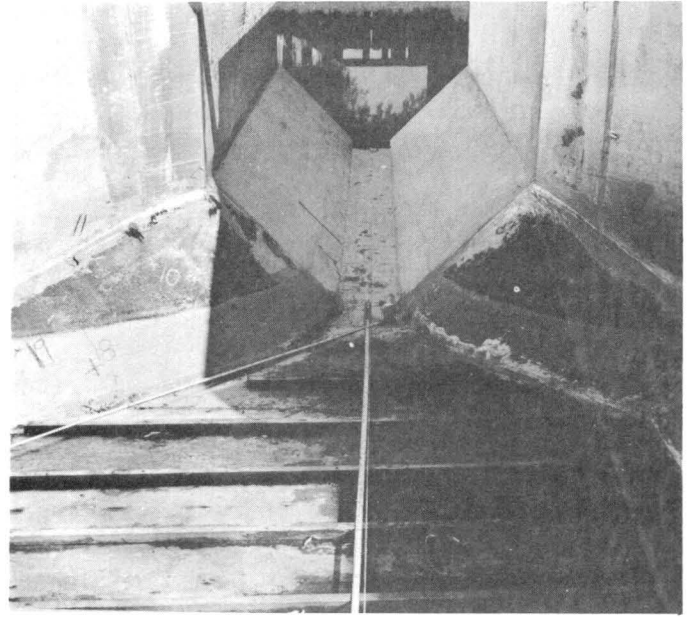

Figure 22. Plan and Profile of Modified Cibecue No. 2 Control



A. Downstream view



B. Downstream view

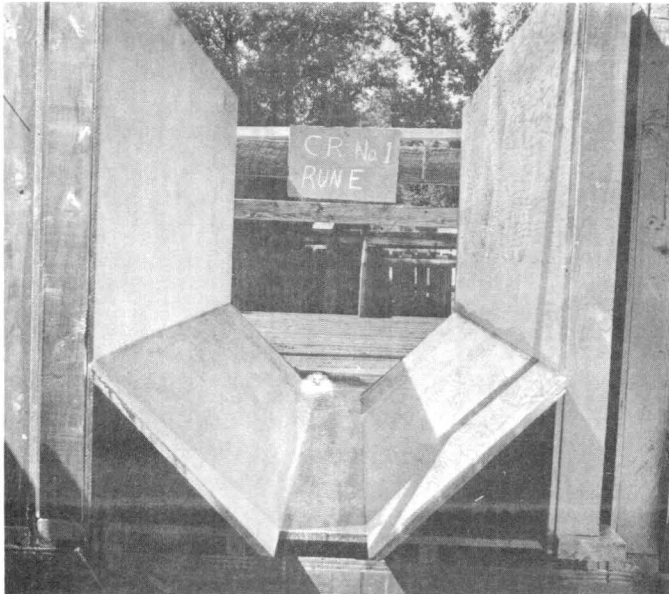

C. Upstream view

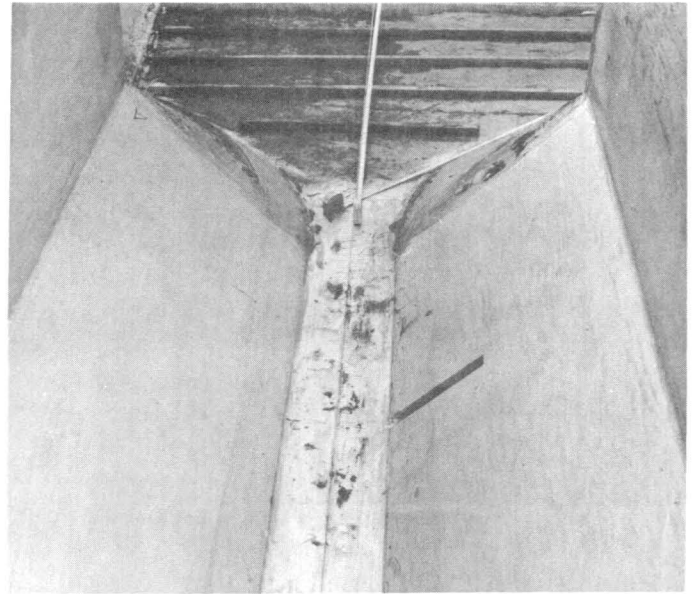

D. Upstream view

Figure 23. Modified model of the Cibecue No. 1 control.

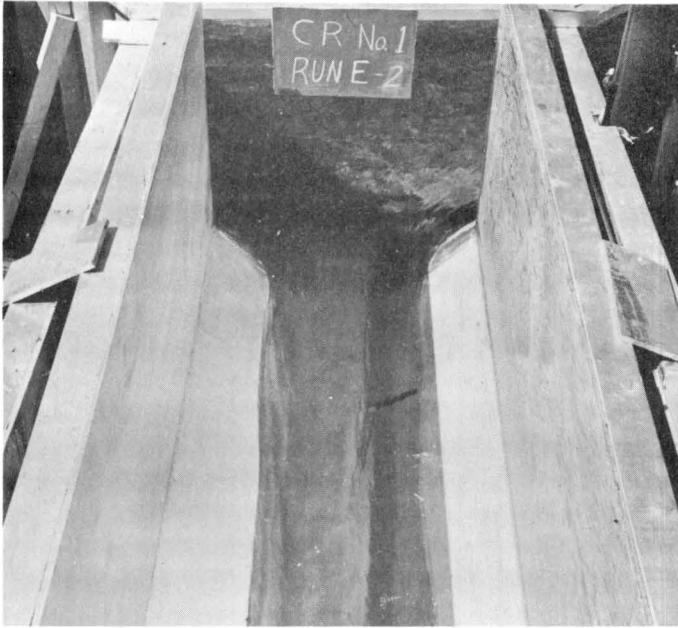

A. Upstream view of Run E-2
Discharge 2.95 cfs

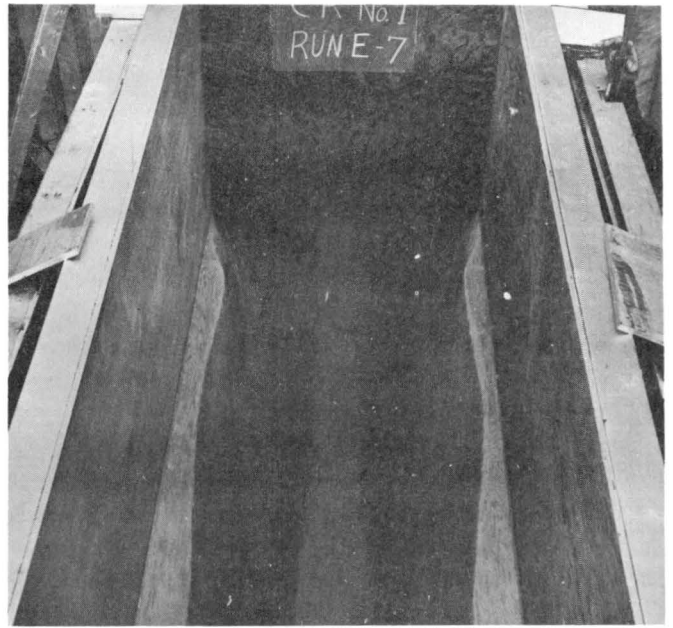

B. Upstream view of Run E-7
Discharge 9.38 cfs

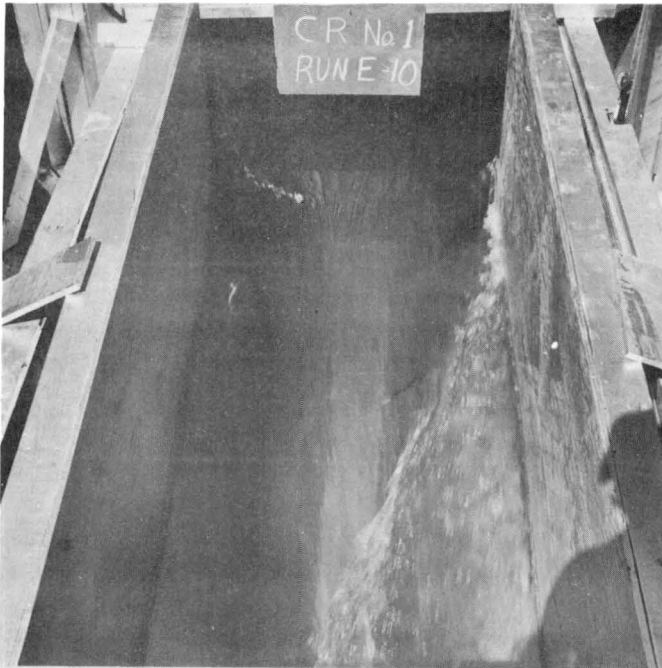

C. Upstream view of Run E-10
Discharge 22.1 cfs

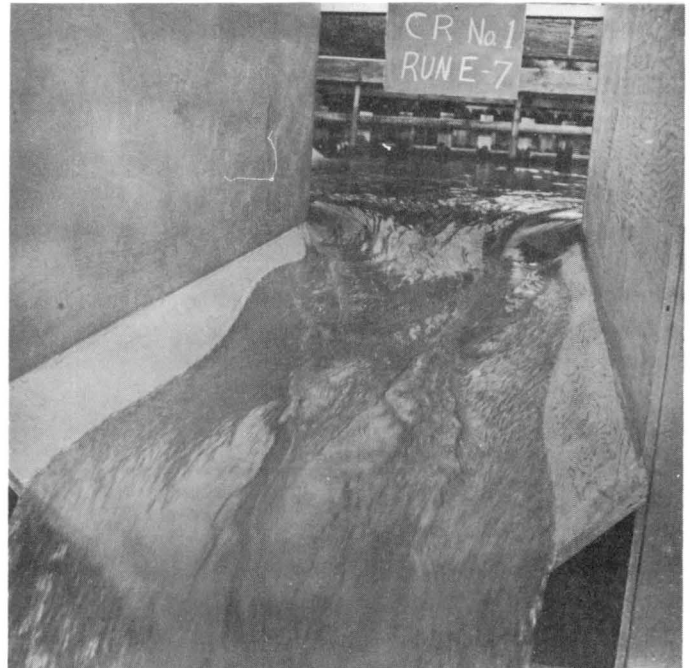

D. Upstream view of Run E-7
Discharge 9.38 cfs

Figure 24. Flow through the modified model of the Cibecue No. 1 control.

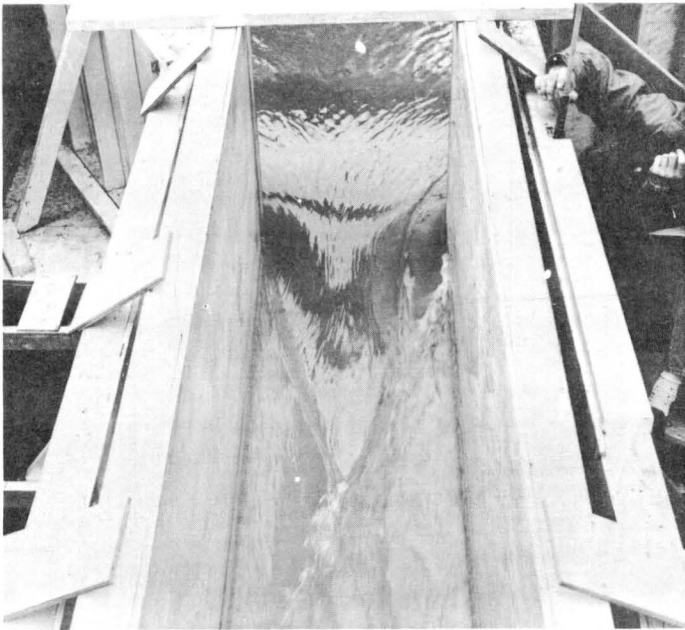

A. Upstream view of Run C-4
Discharge 9.42 cfs



B. Upstream view of Run C-4
Discharge 9.42 cfs

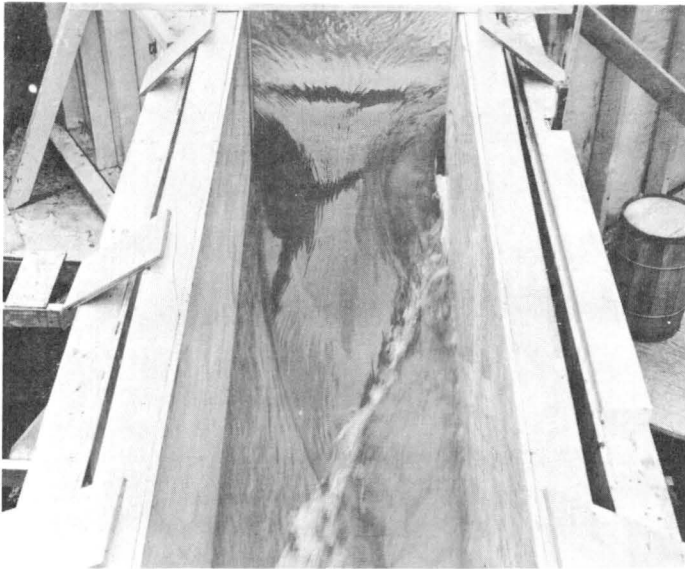

C. Upstream view of Run C-1
Discharge 21.5 cfs

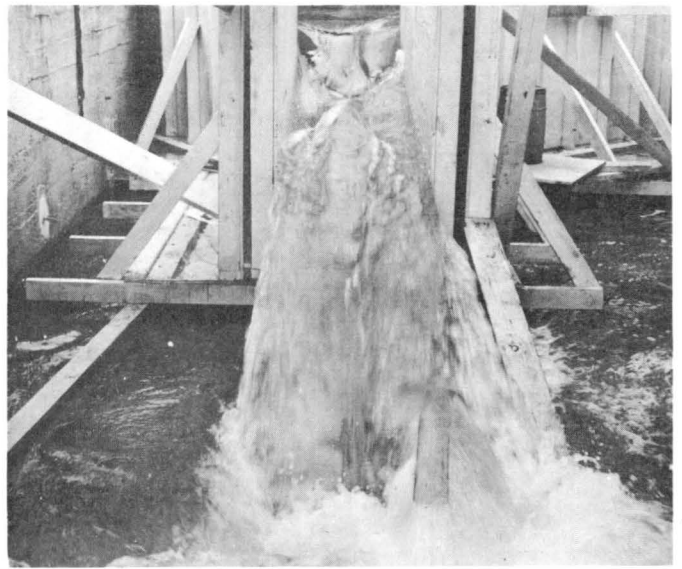

D. Upstream view of Run C-1
Discharge 21.5 cfs

Figure 25. Flow through the modified model of Cibecue Ridge No. 2 control.

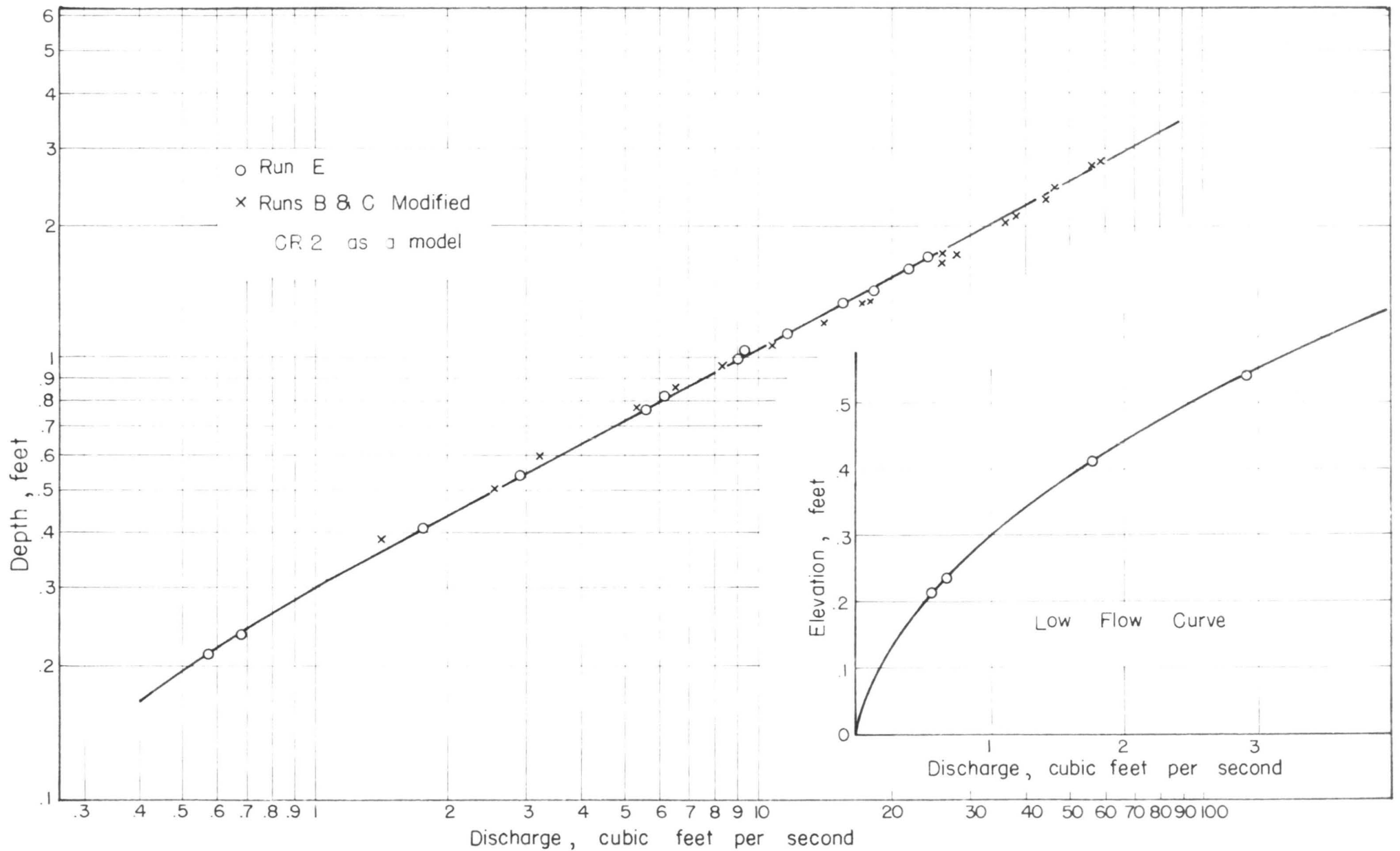

Figure 26, Depth-Discharge Relation for the Modified Cibecue Ridge No. 1 Control.

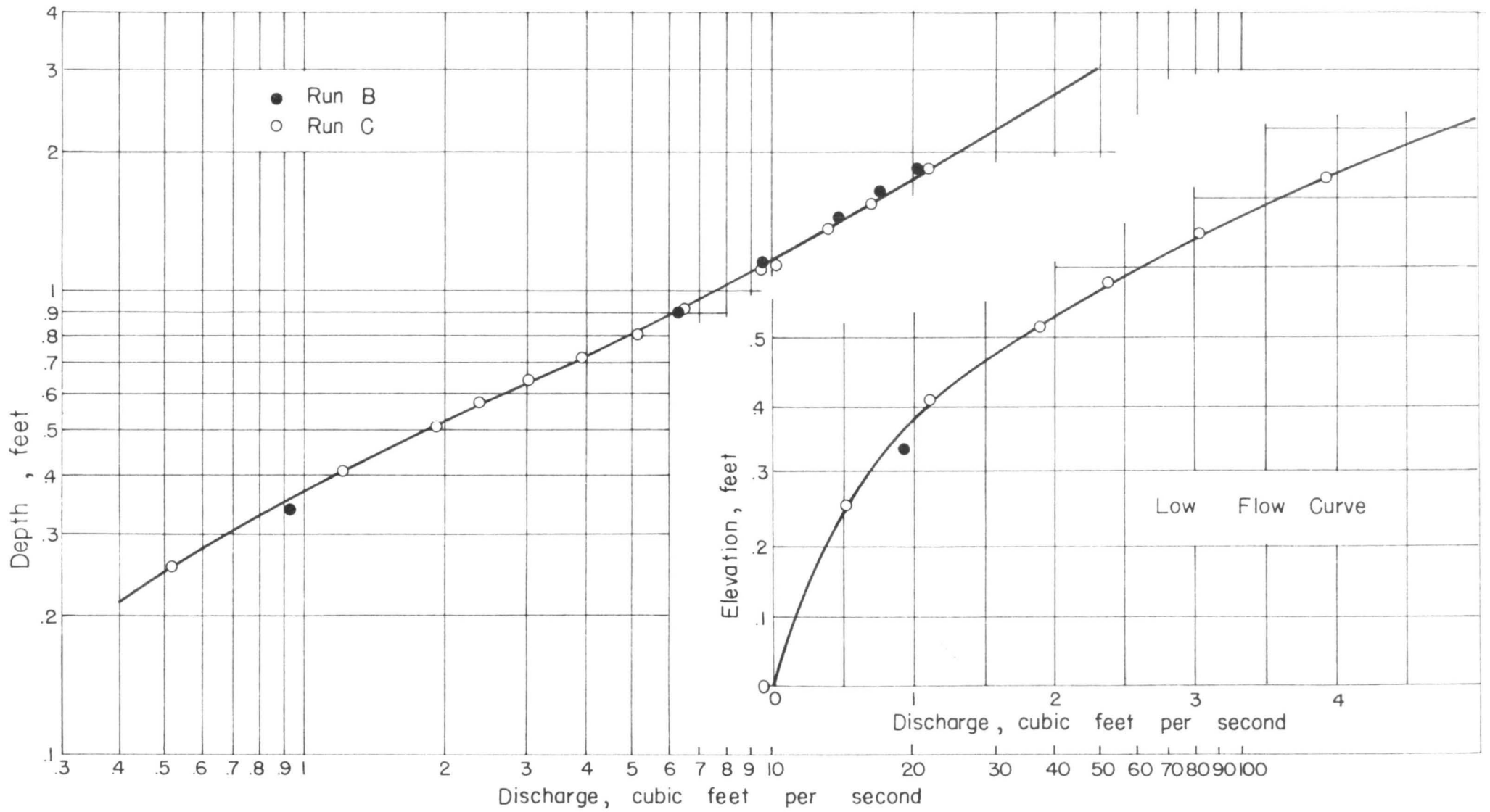

Figure 27. Depth-Discharge Relation for the Modified Cibecue Ridge No. 2 Control.

Table 1.--Data for Model Study of Cibecue No. 1 Control

Run	Weir		Discharge (cfs)	Control		
	Length (ft)	Head (ft)		Depth (ft)	Stage (ft)	
A - 3	4	0.131	0.62	0.424	0.64	
A - 4		.174	.94	.63		
A - 5		.418	3.44	.622	.84	
A - 2		.544	5.09	.678	.90	
A - 6		.673	7.00	.781	1.00	
A - 7		.876	10.4	.944	1.16	
A - 8		1.075	14.0	1.15	1.37	
A - 9		15	.344	9.75	.931	1.15
A - 10			.457	14.9	1.23	1.45
A - 16			.510	17.5	1.39	1.61
A - 11			.568	20.6	1.55	1.77
A - 15			.666	26.1	1.85	2.07
A - 14			.754	31.5	2.07	2.29
A - 13			.820	35.7	2.26	2.48
A - 12			.915	42.1	2.49	2.71
B - 7		15	0.336	9.43	0.912	1.13
B - 6	.442		14.2	1.19	1.41	
B - 5	.543		19.3	1.48	1.70	
B - 4	.632		24.2	1.76	1.98	
B - 3	.712		28.9	1.98	2.20	
B - 2	.804		34.6	2.22	2.44	
B - 1	.905		41.4	2.48	2.70	
B - 8	.905		41.4	2.48	2.70	
C - 3	15	0.367	10.7	1.00	1.22	
C - 2		.620	23.5	1.71	1.93	
C - 1		.830	36.4	2.23	2.45	
D - 3	4	0.128	0.60	0.418	0.64	
D - 4		.266	1.75	.513	.73	
D - 2		.433	3.63	.611	.83	
D - 5		.732	7.93	.855	1.08	
D - 6		15	.462	15.1	1.28	1.50
D - 8			.550	19.6	1.55	1.77
D - 7			.662	25.9	1.88	2.10
D - 9			.760	31.8	2.18	2.40
D - 10			.844	37.3	2.36	2.58

Table 2.--Data for model study of Cibecue Ridge No. 2 control

Run	Weir		Discharge (cfs)	Control		
	Length (ft)	Head (ft)		Depth (ft)	Stage (ft)	
A - 9	4	0.103	0.44	0.361	0.44	
A - 7		.167	.89	.420	.50	
A - 8		.228	1.40	.457	.54	
A - 5		.278	1.87	.506	.59	
A - 10		.333	2.45	.578	.66	
A - 6		.377	2.94	.641	.72	
A - 4		.491	4.37	.776	.86	
A - 3		.604	5.95	.929	1.01	
A - 2		.779	8.70	1.18	1.26	
A - 1		.947	11.7	1.45	1.53	
A - 20		15	0.415	12.91	1.60	1.68
A - 17			.433	13.8	1.68	1.76
A - 21			.460	15.0	1.80	1.87
A - 19			.478	15.9	1.83	1.91
A - 16			.500	17.0	1.94	2.02
A - 15			.561	20.2	2.11	2.19
A - 14			.619	23.4	2.30	2.38
A - 13	.680		27.0	2.48	2.56	
A - 11	.745		30.9	2.70	2.78	
A - 12	.771		32.5	2.77	2.85	
A - 18	.798	34.2	2.86	2.94		

Table 3.--Data for model study of modified Cibecue Ridge No. 1 control

Run	Weir		Discharge (cfs)	Control	
	Length (ft)	Head (ft)		Depth (ft)	Stage (ft)
E - 3	4	0.125	0.58	0.214	
E - 1		.141	.69	.237	
E - 4		.269	1.73	.416	
E - 2		.377	2.95	.546	
E - 5		.581	5.62	.765	
E - 6		.803	9.10	1.01	
E - 9	15	.254	6.24	.828	
E - 7		.335	9.38	1.04	
E - 12		.393	11.9	1.17	
E - 8		.474	15.7	1.34	
E - 11		.527	18.4	1.46	
E - 10		.595	22.1	1.61	
E - 13		.637	24.4	1.71	

Table 4.--Data for model study of modified Cibecue Ridge No. 2 control

Run	Weir		Discharge (cfs)	Control	
	Length (ft)	Head (ft)		Depth (ft)	Stage (ft)
B - 6	4	0.172	0.93	0.341	
B - 4		.384	3.03	.652	
B - 5		.627	6.29	.914	
B - 3	15	.338	9.51	1.16	
B - 2		.436	13.9	1.45	
B - 1		.500	17.0	1.65	
B - 7		.566	20.5	1.86	
C - 12	4	0.118	0.52	0.262	
C - 13		.207	1.21	.411	
C - 11		.282	1.91	.518	
C - 10		.548	5.14	.812	
C - 9		.866	10.2	1.15	
C - 7	15	.132	2.39	.583	
C - 6		.156	3.03	.653	
C - 8		.186	3.94	.731	
C - 5		.263	6.55	.925	
C - 4		.336	9.42	1.12	
C - 3		.429	13.2	1.39	
C - 2		.481	16.1	1.56	
C - 1		.585	21.5	1.88	