

THESIS

LARGE BORE NATURAL GAS ENGINE PERFORMANCE IMPROVEMENTS AND COMBUSTION  
STABILIZATION THROUGH REFORMED NATURAL GAS  
PRECOMBUSTION CHAMBER FUELING

Submitted by

Matthew D. Ruter

Department of Mechanical Engineering

In partial fulfillment of the requirements

for the Degree of Master of Science

Colorado State University

Fort Collins, Colorado

Fall 2010

Master's Committee:

Department Head: Susan P. James

Advisor: Daniel B. Olsen

Michael De Miranda  
Anthony J. Marchese

## ABSTRACT

### LARGE BORE NATURAL GAS ENGINE PERFORMANCE IMPROVEMENTS AND COMBUSTION STABILIZATION THROUGH REFORMED NATURAL GAS PRECOMBUSTION CHAMBER FUELING

Lean combustion is a standard approach used to reduce  $\text{NO}_x$  emissions in large bore natural gas engines. However, at lean operating points, combustion instabilities and misfires give rise to high total hydrocarbon (THC) and carbon monoxide (CO) emissions. To counteract this effect, precombustion chamber (PCC) technology is employed to allow engine operation at an overall lean equivalence ratio while mitigating the rise of THC and CO caused by combustion instability and partial and complete misfires. A PCC is a small chamber, typically 1-2% of the clearance volume. A separate fuel line supplies gaseous fuel to the PCC and a standard spark plug ignites the slightly rich mixture ( $1.1 < \Phi < 1.2$ ) in the PCC. The ignited PCC mixture enters the main combustion chamber as a high energy flame jet, igniting the lean mixture in the main chamber. Typically, natural gas fuels both the main cylinder and the PCC. In the current work reported herein, a mixture of reformed natural gas (syngas) and natural gas fuels the PCC. Syngas is a broad term that refers to a synthetic gaseous fuel. In this case, syngas specifically denotes a mixture of hydrogen, carbon monoxide, nitrogen, and methane generated in a natural gas reformer. Syngas has a faster flame speed and a wider equivalence ratio range of operation. Fueling the PCC with syngas reduces combustion instabilities and misfires. This extends the overall engine lean limit, enabling further  $\text{NO}_x$  reductions.

Research results presented are aimed at quantifying the benefits of syngas PCC fueling. A model is developed to predict the equivalence ratio in the PCC for different mixtures and flow rates of PCC fuel. An electronic injection valve is used to supply the PCC with syngas. The delivery pressure, injection timing, and flow rates are varied to optimize PCC equivalence ratio. The two syngas mixtures evaluated contain the same ratio of hydrogen to carbon monoxide but different levels of nitrogen diluent. The syngas with the higher nitrogen content is denoted syngas 1 while syngas 2 specifies the lower nitrogen content syngas.

Experimental results are presented for 80% syngas / 20% natural gas mixtures for each syngas PCC fueling scenario at 18" Hg intake manifold pressure. 80% syngas 1 / 20% natural gas PCC fueling resulted in an 18% reduction in NO<sub>x</sub> emission compared to natural gas fueling. Supplying the PCC with 80% syngas 2 / 20% natural gas improves combustion stability by 16% compared to natural gas PCC fueling. Increasing the intake manifold pressure to 22" Hg for 80% syngas 2 / 20% natural gas fueling provides an emission comparison at an equivalent combustion stability operating point. Comparing equivalent combustion stability operating points between syngas 2 and natural gas shows a 40% reduction in NO<sub>x</sub> emissions when fueling the PCC with 80% syngas 2 / 20% natural gas mixture compared to natural gas fueling.

Experimental results are presented for varying PCC fuel mixtures of syngas 2 and natural gas at 18" Hg intake manifold pressure. Results show dramatic increases in combustion stability are realized for high syngas 2 mixtures (greater than 80% syngas 2). Reducing intake manifold boost for natural gas PCC fueling to 8.5" Hg produces equivalent main cylinder combustion stability compared to 100% syngas 2 PCC fueling at 18" Hg intake manifold pressure. NO<sub>x</sub> emission increases by 780% for natural gas PCC fueling at the equivalent combustion stability operating point compared to syngas 2 PCC fueling at 18" Hg intake manifold pressure.

## ACKNOWLEDGEMENTS

A great deal of thanks and gratitude is due the numerous contributors to this work. I would like to begin by thanking my advisor, Dr. Daniel Olsen. Dr. Olsen provided countless hours of guidance and expertise towards this research. His patience, kindness, and technical expertise ensured not only that the research was conducted at the highest standard, but also that I developed as a professional in the field of natural gas engine research.

Additionally, the staff at the EECL spent many hours during testing lending their support and technical assistance. I would like specifically to thank Kirk Evans, Phillip Bacon and Cory Kreutzer for the work. Numerous graduate and under-graduate students also contributed to the project. They include Christian L'Orange, Adam Friss, Dan Lionberg, Casey Quinn, Roshan Joseph, and Nick Cirincione.

I also owe an immense amount of thanks towards my wife, Eileen, who has patiently and lovingly supported me throughout my graduate studies. She is an incredible woman, full of love and kindness. Of all the choices I've made in my life, choosing her to be my wife is beyond a doubt the best and most significant.

## TABLE OF CONTENTS

|  |      |
|--|------|
| ABSTRACT.....  | ii   |
| ACKNOWLEDGEMENTS.....                                | iv   |
| TABLE OF CONTENTS.....                               | v    |
| LIST OF FIGURES.....                                 | viii |
| LIST OF TABLES.....                                  | xii  |
| LIST OF ABBREVIATIONS .....                          | xiii |
| 1 INTRODUCTION AND BACKGROUND .....                  | 1    |
| 1.1 Natural Gas Engine Exhaust Emissions .....       | 2    |
| 1.2 PCC Technology.....                              | 4    |
| 1.3 Natural Gas Reforming.....                       | 8    |
| 1.3.1 Steam Reforming .....                          | 9    |
| 1.3.2 Catalytic Partial Oxidation Reforming.....     | 12   |
| 1.3.3 Autothermal Reforming .....                    | 14   |
| 1.4 Natural Gas vs. Syngas Fuel Characteristics..... | 15   |
| 1.4.1 Specific Energy Content .....                  | 15   |
| 1.4.2 Flammability Limits .....                      | 16   |
| 1.4.3 Flame Speed.....                               | 17   |

|       |   |    |
|-------|---|----|
| 2     | EXPERIMENTAL SETUP .....  | 23 |
| 2.1   | Test Engine.....  | 23 |
| 2.2   | PCC Fueling Setup .....   | 25 |
| 2.3   | Exhaust Emission Analyzers .....  | 28 |
| 2.4   | Experimental Procedure .....  | 32 |
| 3     | PCC EQUIVALENCE RATIO MODELING .....  | 37 |
| 3.1   | Two-Stroke Engine Sequence of Events.....                                   | 38 |
| 3.2   | PCC Fuel Metering and Fuel Retention Models .....                           | 42 |
| 3.2.1 | Perfect Displacement Model for Checkvalve Metering .....                    | 42 |
| 3.2.2 | Perfect Mixing Model for Checkvalve Metering .....                          | 45 |
| 3.2.3 | Perfect Mixing Model for Electronically Metered Fuel Injection (ePCC) ..... | 46 |
| 3.3   | PCC Equivalence Ratio Modeling Results.....                                 | 50 |
| 4     | TEST RESULTS AND DISCUSSION .....   | 54 |
| 4.1   | Preliminary Testing with Checkvalve and ePCC Fuel Metering .....            | 54 |
| 4.1.1 | Preliminary Checkvalve Fuel Metering Experimental Procedure .....           | 55 |
| 4.1.2 | Preliminary Checkvalve Fuel Metering Test Results and Discussion .....      | 56 |
| 4.1.3 | Preliminary ePCC Fuel Metering Test Results and Discussion .....            | 58 |
| 4.1.4 | Preliminary Checkvalve Fuel Metering Summary and Conclusions .....          | 63 |
| 4.2   | 80% Syngas 2 20% Natural Gas PCC Fueling Optimization .....                 | 63 |
| 4.2.1 | Syngas 2 PCC Fueling Experimental Procedure.....                            | 63 |

|       |  |     |
|-------|--|-----|
| 4.2.2 | Syngas 2 PCC Fueling Test Results and Discussion.....        | 64  |
| 4.3   | 80% Syngas 1 20% Natural Gas PCC Fueling Optimization .....  | 72  |
| 4.3.1 | Syngas 1 PCC Fueling Experimental Procedure.....             | 72  |
| 4.3.2 | Syngas 1 PCC Fueling Test Results and Discussion.....        | 73  |
| 4.4   | Percent Syngas 2 Fuel Sweep.....                             | 76  |
| 4.4.1 | Percent Syngas 2 Fuel Sweep Experimental Procedure.....      | 76  |
| 4.4.2 | Percent Syngas 2 Fuel Sweep Test Results and Discussion..... | 77  |
| 4.5   | PCC Fueling Scenario Comparison .....                        | 86  |
| 5     | SUMMARY AND CONCLUSION .....                                 | 88  |
| 6     | REFERENCES .....   | 94  |
|       | APPENDIX I – 5-GAS ANALYZER CALIBRATION LOG .....            | 96  |
|       | APPENDIX II – FTIR CALIBRATION LOG.....                      | 101 |
|       | APPENDIX III – BIAS CHECKS .....                             | 107 |
|       | APPENDIX IV – TEST DATA .....                                | 116 |

## LIST OF FIGURES

|   |    |
|---|----|
| Figure 1.1 - Crosshatch of PCC Installed in Cooper GMV-4TF Engine Cylinder Head Utilized for this Work .....  | 5  |
| Figure 1.2 - PCC Ignition Sequence and PCC NO <sub>x</sub> Formation Mechanism (10) .....   | 6  |
| Figure 1.3 - Lean PCC Flame Jet 9° aTDC (11) .....  | 7  |
| Figure 1.4 - Rich PCC Flame Jet 9° aTDC (11) .....  | 8  |
| Figure 1.5 - Nominal PCC Flame Jet 9° aTDC (11) .....   | 8  |
| Figure 1.6 - Natural Gas Steam Reforming Pathway (13) .....   | 11 |
| Figure 1.7 - Catalytic Partial Oxidation Product Composition vs. Temperature for Methane to Oxygen Ratio of 2:1 [reprinted from Gupta (12)].....  | 14 |
| Figure 1.8 - Autothermal Reforming Process (12) .....   | 15 |
| Figure 1.9 - Flammability Limits of Syngas and Methane in Air (14) .....  | 17 |
| Figure 1.10 - Unstretched Laminar Flame Speed vs. Equivalence Ratio at Various Hydrogen Fractions [Reprinted from Hung et al. (16)] .....   | 18 |
| Figure 1.11 - Turbulent Burning Velocity vs. Percent Hydrogen in Methane at Various Levels of Turbulence at a Stoichiometric Equivalence Ratio [Reprinted from Fairweather et al. (17)] ..... | 19 |
| Figure 1.12 – Laminar Flame Speed vs. Equivalence Ratio and H <sub>2</sub> to CO Mixture Percentage [Reprinted from Lieuwen et al. (18)].....   | 21 |
| Figure 1.13 - Flame Speed vs. Percent Dilution for 75% H <sub>2</sub> 25% CO Mixture in Air [Reprinted from Lieuwen et al. (18)] .....  | 22 |



|   |    |
|---|----|
| Figure 2.1 - Cooper Bessemer GMV-4TF.....   | 24 |
| Figure 2.2 - PCC Fuel Supply Schematic with Checkvalve or ePCC Fuel Metering and Rotameters<br>.....  | 26 |
| Figure 2.3 - PCC Fueling Schematic with ePCC Fuel Metering, Mass Flow Meters, and Needle<br>Valves .....                                      | 27 |
| Figure 2.4 - PCC Fuel Mixing Platform with Mass Flow Meters and Needle Valves .....   | 27 |
| Figure 2.5 - PCC Fueling with Hoerbiger ePCC Fuel Metering .....  | 28 |
| Figure 2.6 - 5-gas Emission Analyzer at the EECL.....   | 29 |
| Figure 2.7 - Nicolet Magna 560 Fourier Transform Infrared Spectrometer .....  | 30 |
| Figure 2.8 – Intake Manifold Boost vs. Main Cylinder Equivalence Ratio for the GMV-4TF .....  | 34 |
| Figure 2.9 - Intake Manifold Boost Level vs. Typical Brake Specific NO <sub>x</sub> Emission for the GMV-4TF<br>.....                         | 36 |
| Figure 3.1 - GMV-4TF Main Cylinder Pressure Trace and 2-Stroke Cycle Sequence of Events .....   | 38 |
| Figure 3.2 - GMV-4TF Cylinder Scavenging Loop .....   | 40 |
| Figure 3.3 - Fuel Metering and Fuel Retention Model Combinations .....  | 42 |
| Figure 3.4 - Empirical Fit Equation for Pressure Rise during Piston Compression.....  | 47 |
| Figure 3.5 - PCC Equivalence Ratio Flow Chart for Modified Perfect Mixing PCC Fueling and ePCC<br>Fuel Metering .....                         | 49 |
| Figure 3.6 – Comparison of the Perfect Mixing Model and the Perfect Displacement Model for<br>Checkvalve Fuel Metering with Natural Gas ..... | 50 |
| Figure 3.7 – Comparison of the Perfect Mixing Model and the Perfect Displacement Model for<br>Checkvalve Fuel Metering with Syngas 2 .....    | 51 |
| Figure 3.8 – Perfect Mixing Model of ePCC Fuel Injection for Natural Gas and Syngas 2 .....   | 52 |
| Figure 4.1 - Emission Comparison with Checkvalve Fuel Metering vs. PCC Fuel Type .....  | 57 |

|   |    |
|---|----|
| Figure 4.2 - $\text{NO}_x$ vs. $\text{COV}_{pp}$ with Checkvalve Fuel Metering .....  | 58 |
| Figure 4.3 – Measured $\text{COV}_{pp}$ and Objective Function vs. Calculated PCC $\phi$ with ePCC Fuel<br>Metering.....  | 59 |
| Figure 4.4 – $\text{NO}_x$ vs. $\text{COV}_{pp}$ with ePCC Fuel Metering for Natural Gas and 80% Syngas 2 / 20%<br>Natural Gas PCC Fuel Types.....  | 60 |
| Figure 4.5 - PCC Fuel Flow Comparison for Checkvalve and ePCC Fuel Metering for Natural Gas<br>and 80% Syngas 2 / 20% Natural Gas PCC Fuel Types.....   | 61 |
| Figure 4.6 – Emission Comparison of Natural Gas and 80% Syngas 2 / 20% Natural Gas for ePCC<br>Fuel Metering .....  | 62 |
| Figure 4.7 – $\text{COV}_{pp}$ and Thermal Efficiency of Natural Gas and 80% Syngas 2 / 20% Natural Gas<br>for ePCC Fuel Metering .....   | 62 |
| Figure 4.8 - Measured Main Cylinder $\text{COV}_{pp}$ vs. Calculated PCC Equivalence Ratio .....  | 65 |
| Figure 4.9 – Natural Gas vs. 80% Syngas 2 / 20 % Natural Gas PCC Fueling Brake Specific Emission<br>of THC and VOC at 18” Hg Boost.....   | 67 |
| Figure 4.10 - – Natural Gas vs. 80% Syngas 2 / 20 % Natural Gas PCC Fueling Brake Specific<br>Emission CO and $\text{CH}_2\text{O}$ at 18” Hg Boost .....   | 68 |
| Figure 4.11 - Natural Gas vs. 80% Syngas 2 / 20 % Natural Gas PCC Fueling Main Cylinder $\text{COV}_{pp}$<br>and Brake Specific $\text{NO}_x$ Emission at 18” Hg Boost.....   | 68 |
| Figure 4.12 – Main Cylinder $\text{COV}_{pp}$ and Brake Specific $\text{NO}_x$ Emission for Natural Gas vs. 80%<br>Syngas 2 / 20% Natural Gas PCC Fueling at Equivalent Intake Manifold Boost Points<br>and at Equivalent Combustion Stability Points ..... | 70 |
| Figure 4.13 - Natural Gas vs. 80% Syngas 2 / 20% Natural Gas PCC Fueling Brake Specific<br>Emission of CO and $\text{CH}_2\text{O}$ at Equivalent Combustion Stability Points.....  | 71 |

|  |    |
|--|----|
| Figure 4.14 - Natural Gas vs. 80% Syngas 2 / 20% Natural Gas PCC Fueling Brake Specific<br>Emission of THC and VOC at Equivalent Combustion Stability Points .....                               | 71 |
| Figure 4.15 – Natural Gas vs. 80% Syngas 1 / 20% Natural Gas PCC Fueling vs. Main Cylinder<br>COV <sub>pp</sub> and Brake Specific NO <sub>x</sub> Emission at 18” Hg Intake Manifold Boost..... | 74 |
| Figure 4.16 – Natural Gas vs. 80% Syngas 1 / 20% Natural Gas PCC Fueling vs. Brake Specific<br>Emission of CO and CH <sub>2</sub> O at 18” Intake Manifold Boost.....                            | 75 |
| Figure 4.17 - Natural Gas vs. 80% Syngas 1 / 20% Natural Gas PCC Fueling vs. Brake Specific<br>Emission of THC and VOC at 18” Hg Intake Manifold Boost .....                                     | 75 |
| Figure 4.18 - Percent Syngas 2 in PCC Fuel vs. COV <sub>pp</sub> , BS THC, BS CO, and BS VOC .....   | 78 |
| Figure 4.19 - PCC Fuel Type vs. Main Cylinder COV <sub>pp</sub> and Brake Specific NO <sub>x</sub> Emission at<br>Equivalent Combustion Stability Operating Points .....                         | 80 |
| Figure 4.20 - PCC Fuel Type vs. Brake Specific Emission of CO and CH <sub>2</sub> O at Equivalent<br>Combustion Stability Operating Points .....   | 81 |
| Figure 4.21 - PCC Fuel Type vs. Brake Specific Emission of VOC and THC at Equivalent<br>Combustion Stability Operating Points .....  | 82 |
| Figure 4.22 – Natural Gas Flow to PCC and/or Natural Gas Reformer vs. Percent Syngas in PCC<br>Fuel .....  | 84 |
| Figure 4.23 - Ignition Timing, Ignition Delay, Percent Reduction in Ignition Delay, and MFB 10%<br>vs. Percent Syngas 2 in PCC Fuel .....  | 86 |

## LIST OF TABLES

|   |    |
|---|----|
| Table 1.1 - Typical Natural Gas Constituents .....  | 9  |
| Table 1.2 – PCC Syngas Fuel Composition .....   | 15 |
| Table 1.3 - PCC Fuel Type vs. Specific Energy Content .....   | 16 |
| Table 2.1 - GMV-4TF Characteristics at Rated Load .....   | 24 |
| Table 2.2 - 5-gas Bench Instrumentation and Emissive Species Measured.....  | 29 |
| Table 2.3 - Suggested Manufacture's Accuracy Specification of 5-Gas Analyzers.....  | 32 |
| Table 4.1 - PCC Fuel Delivery Parameters at Optimized PCC Equivalence Ratio for 80% Syngas 2 /<br>20% Natural Gas Fueling ..... | 66 |
| Table 4.2 - PCC Fuel Delivery Parameters at Optimized PCC Equivalence Ratio for Syngas 1<br>Fueling .....                       | 73 |
| Table 4.3 - PCC Equivalence Ratio during Percent Syngas 2 Fuel Sweep.....   | 77 |
| Table 4.4 - PCC Fuel Injection Parameters vs. Percent Syngas in PCC Fuel .....  | 83 |
| Table 4.5 - Spark Ignition Timing and Mass Fraction Burned vs. Percent Syngas 2 in PCC Fuel....                                 | 85 |
| Table 4.6 - Optimal PCC Fueling Characteristics vs. PCC Fuel Type .....   | 87 |

## LIST OF ABBREVIATIONS

- °aTDC – Degrees After Top Dead Center
- °bTDC – Degrees Before Top Dead Center
- $A_{\text{eff}}$  – Effective Flow Area
- AFR – Air-to-Fuel Ratio
- $\text{Al}_2\text{O}_3$  – Aluminum Oxide
- BDC – Bottom Dead Center
- bhp – Brake Horsepower
- BS – Brake Specific
- $\text{C}_2\text{H}_4$  – Ethylene
- CAD – Crank Angle Degrees
- $C_d$  – Sonic Gaseous Flow Constant
- $\text{CH}_2\text{O}$  – Formaldehyde
- $\text{CH}_4$  – Methane
- CO – Carbon Monoxide
- $\text{CO}_2$  – Carbon Dioxide
- $\text{COV}_{\text{pp}}$  – Coefficient of Variance of Peak Pressure
- CPO – Catalytic Partial Oxidation Natural Gas Reformer
- CuO – Copper (III) Oxide
- EECL – Engines and Energy Conversion Laboratory
- EGR – Exhaust Gas Recirculation

EPA – United States Environmental Protection Agency

EPC – Exhaust Port Closes

ePCC – Electronically Controlled PCC Fueling Valve

EPO – Exhaust Port Opens

FID – Flame Ionization Detector

FTIR – Fourier Transform Infra-Red Spectrometer

GMV – Cooper-Bessemer GMV-4TF

H<sub>2</sub> – Hydrogen

H<sub>2</sub>O - Water

HAPs – Hazardous Air Pollutants

HC<sub>2</sub>H – Acetylene

IPC – Intake Port Closes

IPO – Intake Port Opens

k – Ratio of Specific Heat

MFB – Mass Fraction Burned

m<sub>ref</sub> – Reference Mass

$\dot{m}_{\text{sonic}}$  – Gaseous Sonic Mass Flow

m<sub>trapped</sub> – Mass of Fuel Trapped in PCC after PCC Fueling

MW<sub>air</sub> – Molecular Weight of Air

MW<sub>fuel</sub> – Molecular Weight of Fuel

NG – Natural Gas

NiO – Nickel Oxide

NO – Nitric Oxide

NO<sub>2</sub> – Nitrogen Dioxide

$\text{NO}_x$  – Oxides of Nitrogen, NO and  $\text{NO}_2$

OF – Objective Function

OH – Hydroxide Radical

PCC – Precombustion Chamber

$P_{\text{PCC}}$  – Pressure in PCC Fuel Line after Fuel Mixing

PPM – Parts Per Million

R – Specific Universal Gas Constant

SCFH – Standard Cubic Feet per Hour

SCR – Selective Catalytic Reduction

$\text{SG}_i$  – Specific Gravity of Fuel Species

$S_l$  – Unstretched Laminar Flame Speed

SLM – Standard Liters per Minute

TDC – Top Dead Center

THC – Total Hydrocarbons

$T_{\text{PCC}}$  – Temperature in PCC Fuel Line after Fuel Mixing

$u'$  – Root-Mean-Square (r.m.s.) Turbulent Velocity

$u_{\text{tr}}$  – Turbulent Burn Velocity

VOC – Volatile Organic Compounds

ZnO – Zinc Oxide

$\Phi$  – Equivalence Ratio

$\Lambda_{\text{PCC}}$  – Delivery Ratio

## **1 INTRODUCTION AND BACKGROUND**

Emissions from reciprocating stationary large bore natural gas engines are a significant source of air pollution. Stationary large bore natural gas engines are found throughout the United States and are used for a variety of applications. Two of the most prominent uses of large bore reciprocating natural gas fired engines are electrical power generation and natural gas compression. Many of the engines used in power generation and natural gas pipeline compression were manufactured decades ago prior to high levels of emission regulation. Subsequent changes in emission regulation over the years requires tighter control of pollutant emission necessitating older engines to be replaced with new low-emission engines or retrofitted to meet the current emission limits.

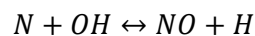
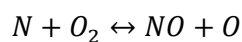
Replacing old large bore natural gas engines with new low-emission engines is cost prohibitive in many cases. Recent retrofit technologies show promise at reducing a variety of emissive species. For example, a great deal of work funded in the 1990's by gas pipeline companies demonstrated numerous retrofit technologies capable of reducing harmful emissions of oxides of nitrogen ( $\text{NO}_x$ ) by up to 80% (1). One such retrofit technology utilized to reduce emissions in large bore natural gas engines is precombustion chamber (PCC) ignition technology. This work specifically seeks to further investigate the advantages of PCC technology by fueling the PCC in a large bore natural gas engine with reformed natural gas. The objective of this work is the demonstration of a technology utilized to reduce the emission of  $\text{NO}_x$  from stationary large bore natural gas engines. Testing results reported herein quantify the effects of fueling the PCC of a large bore natural gas fired reciprocating engine with reformed natural gas.



## 1.1 Natural Gas Engine Exhaust Emissions

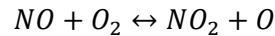
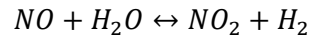
Specific regulated engine pollutants emitted from large bore natural gas engines reported herein include carbon monoxide (CO), total hydrocarbons (THC), volatile organic compounds (VOC), formaldehyde (CH<sub>2</sub>O), and oxides of nitrogen (NO<sub>x</sub>). Formation of each of these regulated species varies. CO, THC, VOC are products of incomplete or partial combustion. These species are formed when there is not enough oxygen present during combustion to fully convert the carbon and hydrogen in the fuel to carbon dioxide and water vapor (1). CH<sub>2</sub>O is an intermediate combustion product and trends similar to products of partial combustion. CH<sub>2</sub>O has carcinogenic effects and participates in formation of photochemical smog (2). Engine technologies that reduce the products of partial combustion include oxidation catalyst. Oxidation catalysts are very effective at removing the products of partial combustion and can do so at very high efficiencies (3), (4).

NO<sub>x</sub> formation occurs by one of three different mechanisms. NO<sub>x</sub> can be formed at the combustion flame front where extra energy is available or when the fuel used contains nitrogen bound to hydrocarbons. The most abundant source of NO<sub>x</sub> formation in natural gas engines, however, is thermal NO<sub>x</sub> (1). High post combustion temperatures inside the engine cylinder cause nitrogen and oxygen to react after initial combustion is complete creating thermal NO<sub>x</sub> (5). The Zeldovich mechanism given below describes the primary mechanism for thermal nitrogen oxide (NO) formation (1).



NO can continue to react to form nitrogen dioxide (NO<sub>2</sub>). NO<sub>x</sub> is the sum of NO and NO<sub>2</sub>.

The reactions listed below detail two of the main NO<sub>2</sub> formation mechanisms (6).



NO<sub>x</sub> emission is of critical interest for specific reasons. First, NO<sub>x</sub> is a major cause of photochemical smog. As levels of NO<sub>x</sub> emission in population centers increases, the visible air quality dramatically decreases (6). Additionally, NO<sub>x</sub> emission trends opposite products of partial combustion. Engine operating conditions aimed at mitigating NO<sub>x</sub> emission typically result in high products of incomplete combustion. One specific example is lean engine operation. Supplying an engine with significant quantities of excess air reduces combustion temperatures, lowering NO<sub>x</sub>. However, lean combustion gives rise to engine misfires and partial combustion. Complete misfires and partial combustion are characterized as incomplete combustion and dramatically increase the products of incomplete combustion to unacceptably high levels.

Oxidation catalysts cannot reduce NO<sub>x</sub> in lean-burn engine exhaust. A great deal of work is currently under way on exhaust aftertreatment such as Selective Catalytic Reduction (SCR) that reduces NO<sub>x</sub> in engine exhaust (7), (3). However, SCR requires a reagent that increases operating cost. Engine retrofit technologies capable of reducing engine-out NO<sub>x</sub> emission while maintaining acceptable levels of other harmful emissive species are extremely important.

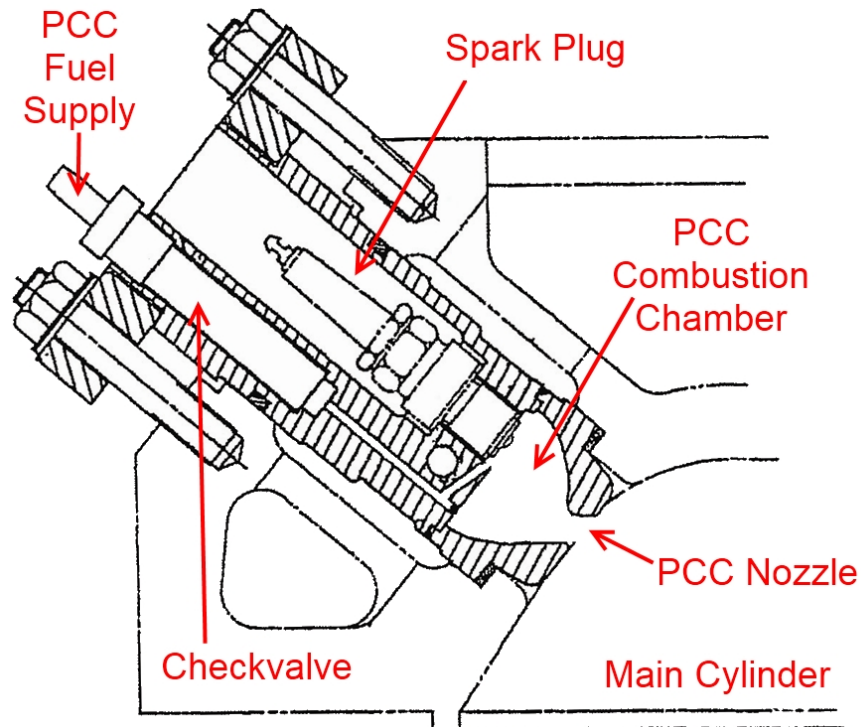
The United States Environmental Protection Agency (EPA) establishes regulatory limits for pollutant emission from stationary large bore natural gas engines (8). As regulatory limits are continually lowered, new emission reduction technology is required to meet the newly established standards. In addition to regulatory limits for new engines, the EPA also regulates

the emission of pollutants from existing engines currently in use. Older large bore natural gas engines may require retrofit technologies capable of reducing regulated emissive species in order to meet new regulations.

## **1.2 PCC Technology**

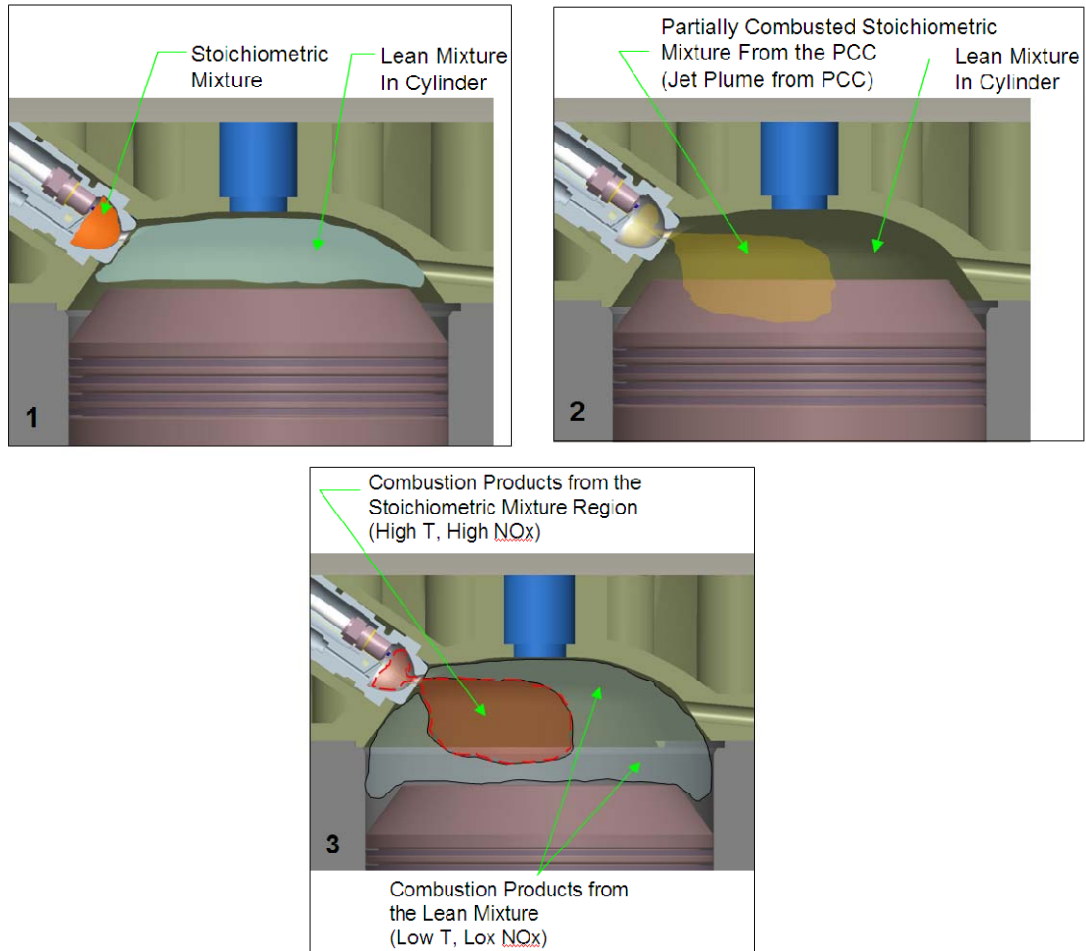
Several technologies exist that reduce the emission of NO<sub>x</sub> from stationary large bore natural gas engines. Lean combustion technology is a common method used to meet more stringent emission standards. Operating an engine lean reduces combustion temperatures. Reducing combustion temperatures reduces the NO<sub>x</sub> emission. At lean combustion operating points, unstable combustion and engine misfires give rise to high levels of CO, THC, and VOC emission. Precombustion chamber (PCC) ignition technology increases combustion stability in lean burn natural gas engines, mitigating emissions of CO, THC, and VOC emission (9). Effectively, PCC technology reduces NO<sub>x</sub> through lean operation while maintaining acceptable admittance levels of the products of partial combustion.

A PCC is a small chamber approximately 1% to 2% of the clearance volume of the engine. A separate fuel line supplies fuel to the PCC and a standard spark plug in the PCC ignites the slightly rich air-fuel mixture. A checkvalve meters fuel flow to the PCC under standard operating conditions. Figure 1.1 displays a cutaway drawing of the standard PCC installed in a Cooper-Bessemer GMV-4TF cylinder head. Notably, the PCC chamber is open to the main combustion chamber at all times. This affects PCC fuel retention during PCC fueling and supplies the PCC with combustion air from the main cylinder as the piston forces air and fuel from the main cylinder into the PCC as the piston travels upwards.



**Figure 1.1 - Crosshatch of PCC Installed in Cooper GMV-4TF Engine Cylinder Head Utilized for this Work**

After fuel ignition, the resulting combustion gas exits the PCC as a high energy flame jet seeding the main cylinder with distributed ignition sites. The flame jet exiting the PCC has ignition energy on the order of a million times that of a standard spark plug (9). This increase in ignition energy stabilizes combustion in the lean main cylinder. Figure 1.2 reprinted from (10) displays the orientation of the PCC in a GMV-4TF cylinder head and denotes the PCC ignition sequence. The sequence 1-2-3 shown corresponds to [1] just prior to ignition, [2] just after ignition as the PCC flame jet exits the PCC, and [3] post main chamber combustion. Figure 1.2 displays PCC  $\text{NO}_x$  formation in addition the ignition sequence for PCC ignition. PCC studies indicate PCC  $\text{NO}_x$  formation significantly impacts overall engine  $\text{NO}_x$  emission (10).

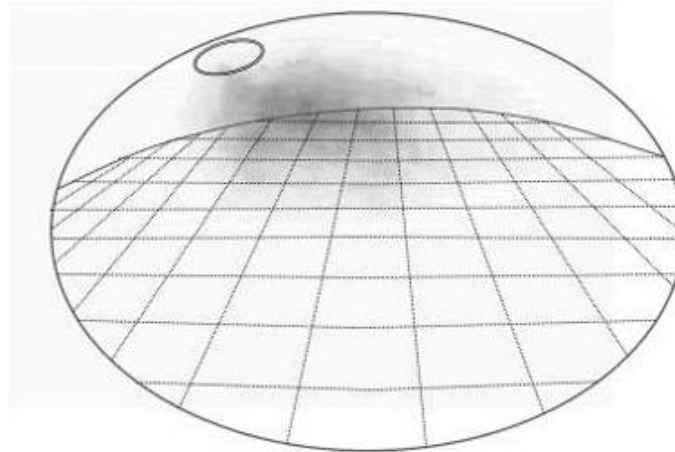


**Figure 1.2 - PCC Ignition Sequence and PCC NO<sub>x</sub> Formation Mechanism (10)**

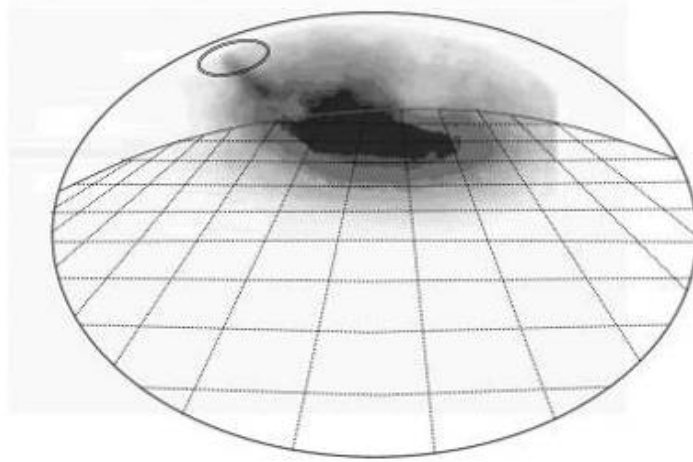
Olsen et al. (9) lists advantages of PCC ignition systems. Since the ignition volume produced by the PCC in the main chamber is large, the increase in ignition energy reduces the effect of main cylinder mixture heterogeneity. This produces more consistent combustion and less cycle-to-cycle combustion variation. Additionally, PCC flame jet spatial distribution and increased PCC ignition energy extend the lean limit of the engine. Effectively, PCC technology reduces NO<sub>x</sub> emission through lean limit extension due to lean combustion stabilization.

Optical PCC flame jet analysis performed by Lisowski (11) displayed in Figure 1.3 through Figure 1.5 on a prechambered GMV-4TF highlights the flame jet spatial distribution post flame

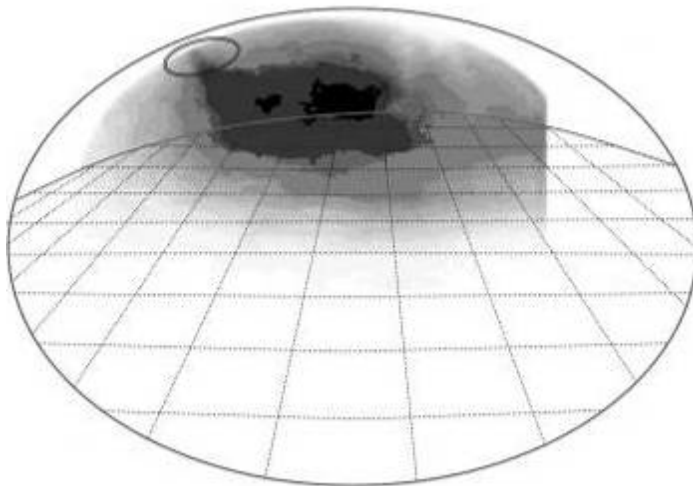
jet optical processing. Lisowski overlaid the flame jet on a grid to determine flame jet penetration. Dark regions presented in Figure 1.3 through Figure 1.5 indicate combustion and the circle in the upper left region of each figure represents the PCC nozzle. Lisowski concludes flame jet penetration and effectiveness to ignite the lean mixture in the main cylinder is dependent upon PCC equivalence ratio and ignition timing. As shown in Figure 1.3 through Figure 1.5, at  $9^\circ$  aTDC, nominal PCC fueling flame jet outperformed both lean and rich PCC fueling flame jets. Nominal PCC fueling at optimum conditions shown in Figure 1.5 displays more developed main cylinder combustion across the entire cylinder compared to either lean or rich PCC fueling. Optimal PCC flame jet is critical for consistent main cylinder combustion. Further discussion on PCC flame jet characteristics is found in (11).



**Figure 1.3 - Lean PCC Flame Jet  $9^\circ$  aTDC (11)**



**Figure 1.4 - Rich PCC Flame Jet 9° aTDC (11)**



**Figure 1.5 - Nominal PCC Flame Jet 9° aTDC (11)**

### **1.3 Natural Gas Reforming**

Natural gas consists of approximately 90% methane by mole. The remaining components in natural gas are mostly higher hydrocarbons ( $C_2+$ ) with a small amount of nitrogen and carbon dioxide diluents. Table 1.1 shows natural gas composition during GMV-4TF

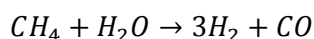
engine testing conducted during this work on three different test days. Though the molar percentages of the components can vary, the dominant constituent in natural gas is consistently methane. Natural gas reforming converts natural gas to synthesis gas (syngas) through a reforming process. The composition of syngas can vary greatly, but typically consists of hydrogen (H<sub>2</sub>), carbon monoxide (CO), and diluents (nitrogen and/or carbon dioxide). A great deal of research has been conducted for a wide range of natural gas reforming processes. The three main natural gas reforming processes most commonly employed are steam reforming, catalytic partial oxidation reforming, and autothermal reforming. Each reforming technology intakes a feedstock fuel (CH<sub>4</sub>) and oxygen and converts the methane and oxygen into H<sub>2</sub> and CO in the presence of a catalyst. Depending on the type of reformer, air, water, or carbon dioxide supplies the oxygen necessary for the reaction.

**Table 1.1 - Typical Natural Gas Constituents**

| Gaseous Species                          | Test Date |         |         |
|--|-----------|---------|---------|
|  | 4/13/10   | 1/19/10 | 9/22/09 |
| Methane (CH <sub>4</sub> )               | 93.1 %    | 96.6 %  | 87.1 %  |
| Ethane (C <sub>2</sub> H <sub>6</sub> )  | 1.0 %     | 0.8%    | 8.8 %   |
| Propane (C <sub>3</sub> H <sub>8</sub> ) | 0.5%      | 0.1 %   | 1.5 %   |
| Higher Hydrocarbons (C <sub>4</sub> +)   | 0.9 %     | 0.0 %   | 0.2 %   |
| Nitrogen (N <sub>2</sub> )               | 2.0 %     | 1.0 %   | 0.5 %   |
| Carbon Dioxide (CO <sub>2</sub> )        | 2.4 %     | 1.4 %   | 1.9 %   |

### 1.3.1 Steam Reforming

Steam reforming uses water as an oxygen source to convert methane to hydrogen and carbon monoxide in the presence of a catalyst material. The chemical reaction follows the formula below (12).



The reaction is highly endothermic, necessitating a thermal energy source. The energy required for the above reaction is 206 kJ/mole (12). The thermal energy source is the steam



generator, which converts liquid water to steam. The steam and methane pass over a catalyst where the reaction occurs. Steam reforming catalysts contain nickel (Ni) and a host of noble metals such as Ruthenium (Ru), Rhodium (Rh), Iridium (Ir), Platinum (Pt), and Palladium (Pd). Due mainly to cost, Ni is the most commonly employed catalyst material in steam reforming (12). Ni forms reactive nickel oxide (NiO) crystallite when deposited on the catalyst carrier substrate. Steam reforming catalysts must provide long term stability, tolerate high operating temperatures, withstand thermal stress associated with catalyst start-up and transient operation, and tolerate non-uniformity of feedstock (12).

A catalyst carrier offers the structural support for the catalyst material. A catalyst carrier must provide high crush strength, maximize the surface to volume ratio, resist thermal shock, minimize the pressure drop across the carrier, and transfer heat well to the endothermic reaction occurring on the catalytic surface of the carrier (13). Typical catalyst carrier materials include refractory alumina, ceramic magnesium aluminate, calcium aluminate, and calcium aluminate titanate. Refractory alumina and ceramic magnesium aluminate provide excellent crush strength. Calcium aluminate is a cement with adequate crush strength in lower pressure reactors but is not suited for high pressure environment due to crush strength degradation. Calcium aluminate titanate is costly but can withstand severe reactor environments. The specific surface area of the catalytic carrier is typically between 3.5 and 5 m<sup>2</sup>/g (13).

The surface of a catalyst provides a location site for the chemical reaction to occur, ultimately converting the methane and water into hydrogen and carbon monoxide. Figure 1.6 graphically depicts the reaction process (13). A methane molecule attaches to the catalyst surface freeing a hydrogen atom. The catalyst surface provides a reaction site for water to break down into a hydroxide (OH) radical, ultimately providing oxygen which recombines with carbon to form carbon monoxide. Free hydrogen atoms recombine as H<sub>2</sub>.

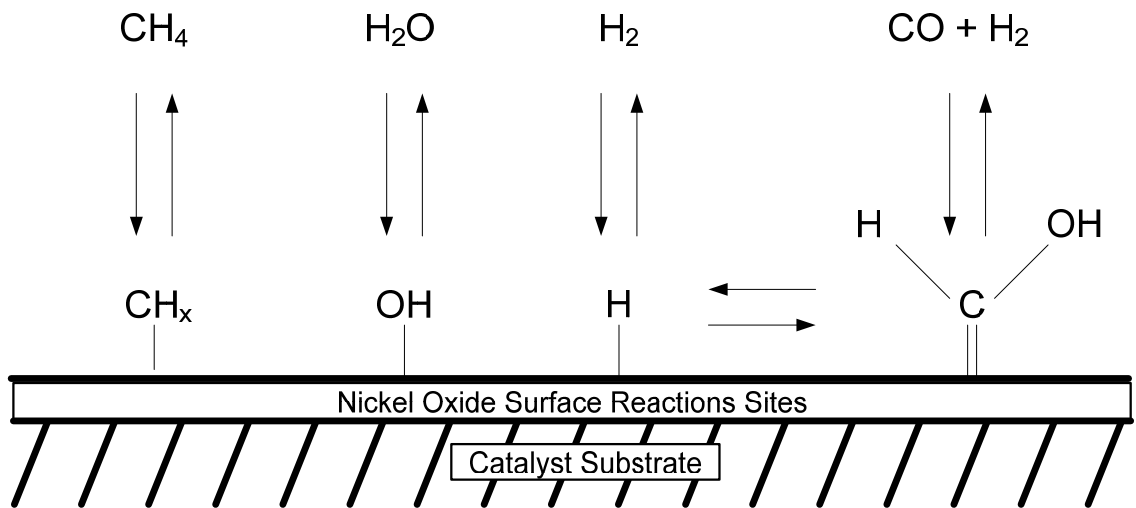
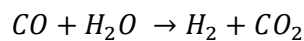


Figure 1.6 - Natural Gas Steam Reforming Pathway (13)

The inlet temperature of the reactor is typically 450°C – 650°C. Energy is added to the endothermic reaction resulting in an exit temperature of 700°C – 950°C (12). The design of the reactor must optimize the heat transfer through the system to ensure adequate energy is delivered to each catalytic reaction site. Varying the temperature within the reactor and the steam to carbon fuel ratio varies the output ratio of hydrogen to carbon monoxide from 1:1 to 2.8:1. Often in natural gas reforming hydrogen is the preferred fuel. A post-process water gas shift reaction converts the carbon monoxide present in the syngas to hydrogen through the following reaction. The slightly exothermic reaction releases 41.2 kJ/mol (12).



Water gas shift reactions occur in the presence of a catalyst. The type of catalyst material determines the required operating temperature. Iron chromium is a high temperature (~350°C) water gas shift catalyst. Low temperature (200°C – 300°C) catalysts are commonly a mixture of copper oxide (CuO 15%-30%), zinc oxide (ZnO 30%-60%), and aluminum oxide (Al<sub>2</sub>O<sub>3</sub> balance) (12).

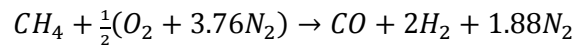
Correct operation of the natural gas steam reformer minimizes carbon formation, sintering, and catalyst poisoning. Carbon formation on the surface of the catalyst reduces the number of reactions sites present to convert methane to hydrogen and carbon monoxide. Typically, carbon deposits form as “needles” or “whiskers” on the surface of the catalyst. The mechanism of carbon formation occurs through carbon cracking where methane breaks down into elemental carbon and hydrogen instead of reacting with oxygen to form carbon monoxide. Since the reaction process depicted in Figure 1.6 consumes methane preferentially, supplying the reactor with an adequate quantity of steam mitigates elemental carbon deposit formation. An adequate supply of steam ensures sufficient oxygen to consume the carbon during the reaction (13).

Sintering occurs when the NiO crystallites grow in size due to surface diffusion at high temperatures ( $T > 800^{\circ}\text{C}$ ). Increasing the crystallite size reduces the overall effectiveness of the catalyst and lowers catalyst efficiency (13). Catalyst poisoning is a common problem with catalytic reactions. Chemicals such as sulfur, arsenic, chlorine, and alkali compounds absorb on the active catalyst surface and dramatically reduce catalytic activity. The process of catalyst regeneration works to remove carbon deposits and catalytic poisons such as sulfur. Both carbon and sulfur react with oxygen. Stopping the feed of methane fuel while continuing the flow of steam through the reactor oxidizes the carbon and sulfur, removing these elements from the surface of the catalyst. Typically, catalyst regeneration occurs at temperatures in excess of  $700^{\circ}\text{C}$  (13).

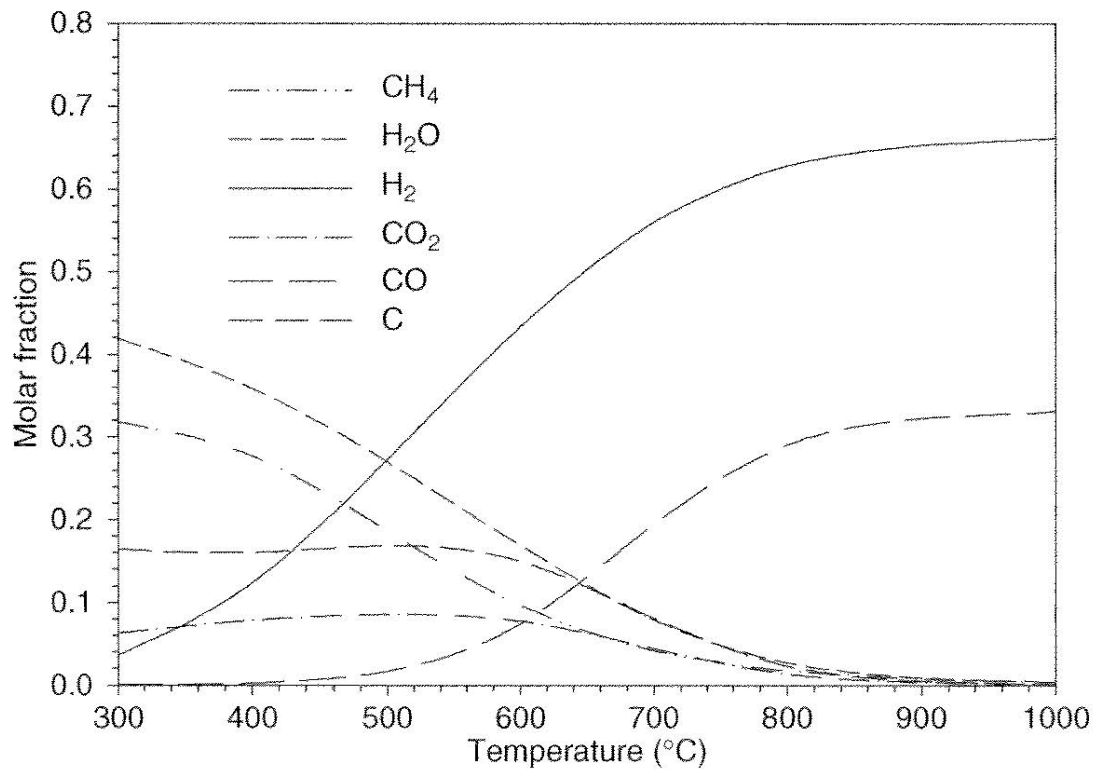
### **1.3.2 Catalytic Partial Oxidation Reforming**

Catalytic Partial Oxidation (CPO) natural gas reforming uses air as an oxygen source to convert methane to syngas. Using air as an oxygen source introduces nitrogen into the syngas

products. The following formula governs CPO natural gas reforming. The reaction is slightly exothermic, releasing 38 kJ/mol (12).



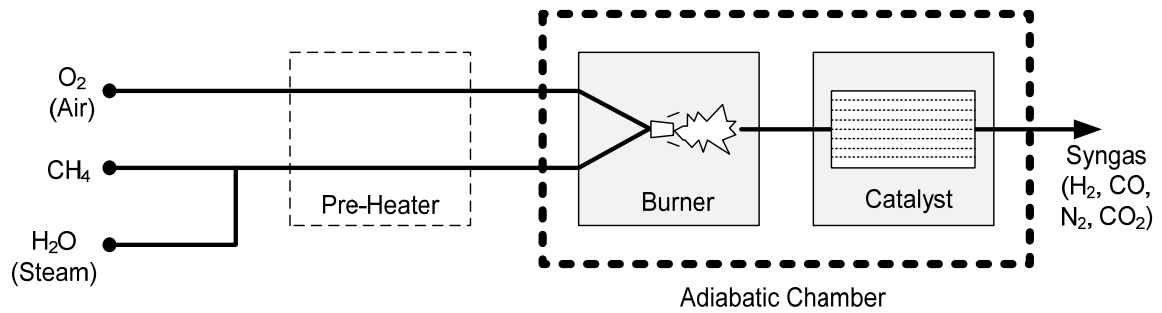
The most common CPO catalyst materials are Ni, Rh, Ru, Pd, Pt, Ir, and Rhenium (Re), of which Ni is most frequently utilized. A catalytic carrier substrate supports the catalyst material. The requirements for a CPO catalyst carrier are similar to the requirements listed for a steam reforming catalyst carrier. CPO reforming occurs at temperatures between 600°C and 900°C. Figure 1.7 reprinted from Gupta (12) shows the relationship between temperature and the molar percentages of the exiting gaseous species for methane to oxygen inlet ratio of 2:1. As the temperature of the reactor increases, the output of H<sub>2</sub> and CO increases and the output of CH<sub>4</sub> (slip), H<sub>2</sub>O, elemental C, and CO<sub>2</sub> decreases. However, elevated inlet temperatures increase the risk of methane combustion within the system. Careful control of the CPO reactor minimizes the risk of combustion (12).



**Figure 1.7 - Catalytic Partial Oxidation Product Composition vs. Temperature for Methane to Oxygen Ratio of 2:1 [reprinted from Gupta (12)]**

### 1.3.3 Autothermal Reforming

Autothermal natural gas reforming uses a combination of both steam reforming and partial oxidation reforming. In autothermal reforming, combustion of the feedstock fuel supplies the energy required for steam reforming reaction. Gupta (12) displays a process diagram depicted in Figure 1.8 showing the autothermal reforming process. Proper control of the ratio of CH<sub>4</sub> to air and CH<sub>4</sub> to H<sub>2</sub>O ensures the exothermic turbulent diffusion flame fuels the endothermic reaction in the catalyst zone. An adiabatic chamber surrounding the burner zone and catalyst zone works to improve efficiency, transferring as much energy as possible from the diffusion flame to the steam reforming catalytic site.



**Figure 1.8 - Autothermal Reforming Process (12)**

## 1.4 Natural Gas vs. Syngas Fuel Characteristics

Combustion is a complex event in which many different parameters affect the performance of a specific type of gas as a PCC fuel. An investigation into the specific energy content, flammability limits, and flame speed of syngas compared to natural gas reveals unique differences between the fuel types. These differences in part help explain the difference between the fuel types evaluated in the PCC equivalence ratio model (Chapter 3) and seen in the current engine testing reported herein (Chapter 4). Table 1.2 lists the molar percentages of the two different syngas blends evaluated.

**Table 1.2 – PCC Syngas Fuel Composition**

| PCC Syngas Fuel Blend | Molecular Constituents (%) |                |       |                |
|-----------------------|----------------------------|----------------|-------|----------------|
|                       | CH <sub>4</sub>            | H <sub>2</sub> | CO    | N <sub>2</sub> |
| Syngas 1              | 1.7%                       | 28.1%          | 15.6% | 54.6%          |
| Syngas 2              | 2.0%                       | 41.7%          | 23.1% | 33.2%          |

### 1.4.1 Specific Energy Content

Analysis of natural gas samples taken during engine testing provides a lower heating value for natural gas. The lower heating value of 100% syngas 1 and syngas 2 is calculated based on the molar percentages stated in Table 1.2 by converting the mole fractions into mass fractions

for each syngas fuel. Table 1.3 lists the specific energy content for each PCC fuel on a mass fraction basis.

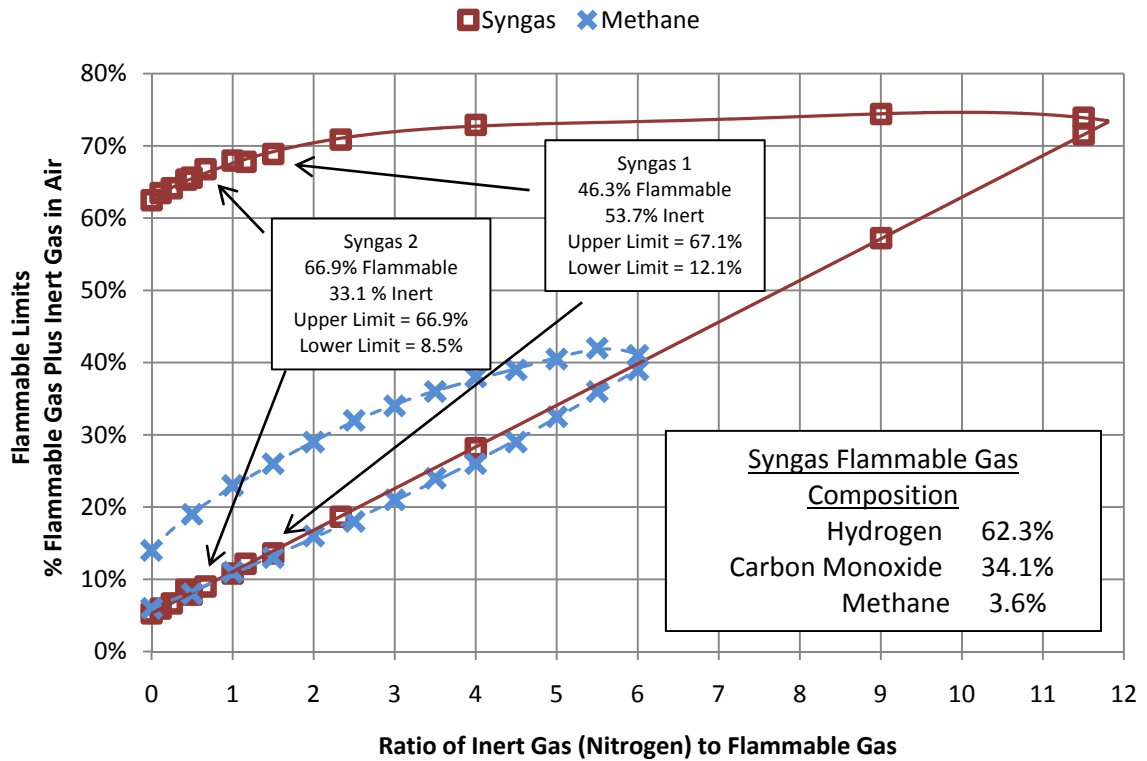
**Table 1.3 - PCC Fuel Type vs. Specific Energy Content**

| <b>PCC Fuel Type</b> | <b>Specific Energy Content (kJ/kg)</b> |
|----------------------|--|
| Natural Gas          | 43,480                                 |
| 100% Syngas 1        | 6,810                                  |
| 100% Syngas 2        | 11,740                                 |

The specific energy of natural gas is approximately 3½ times that of syngas 2 and 6½ times that of syngas 1. As such, the mass of syngas 1 or syngas 2 in the PCC must be increased to provide the necessary energy to promote stable main cylinder combustion.

#### **1.4.2 Flammability Limits**

In 1952 the United States Department of the Interior Bureau of Mines published a report detailing the flammability limits of numerous gaseous fuels (14). Figure 1.9 compares the flammability limits of syngas and methane using data from the Bureau of Mines investigation. To simplify the analysis, methane approximates natural gas in the current flammability limit comparison. Analysis of Figure 1.9 reveals syngas has a much greater flammability window than natural gas (methane). The equivalence ratio operating range will be wider for syngas PCC fueling compared to natural gas PCC fueling. The total effect of the increased flammability limit of syngas on PCC performance is unclear. However, the PCC system will likely be impacted less by variations in PCC fuel metering.



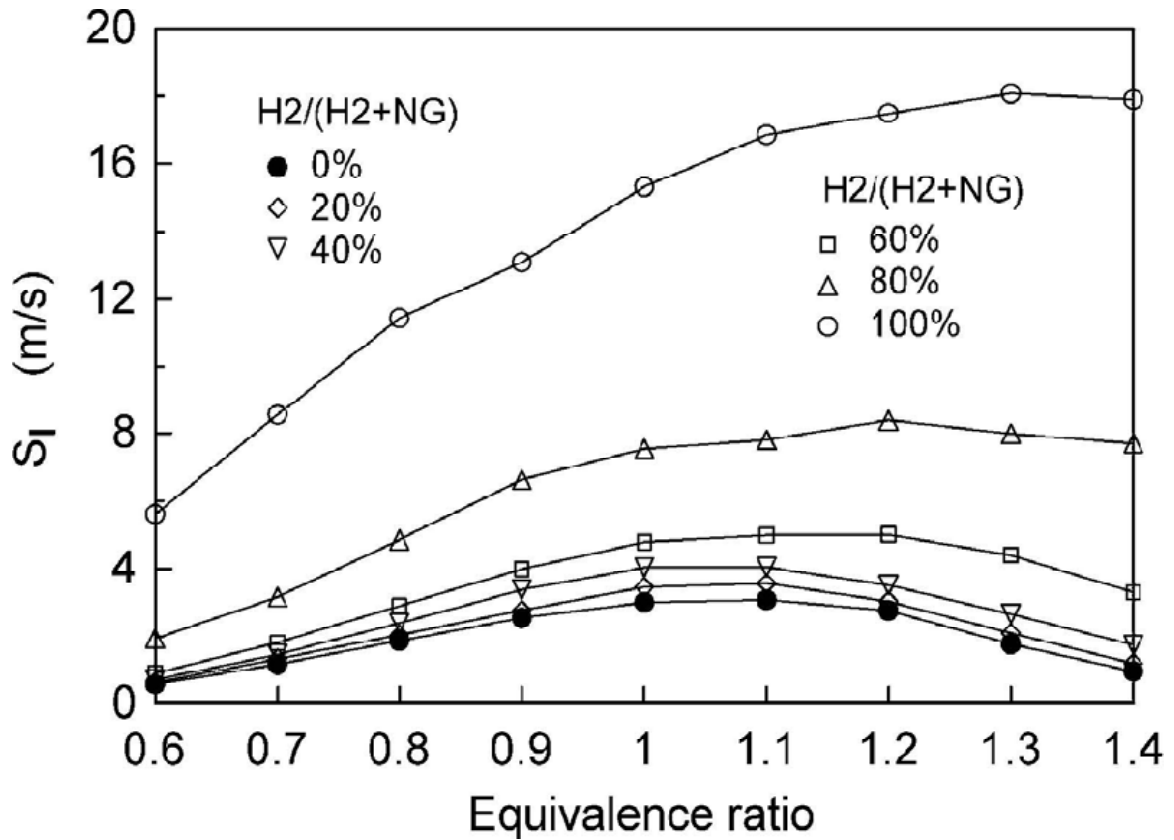
**Figure 1.9 - Flammability Limits of Syngas and Methane in Air (14)**

### 1.4.3 Flame Speed

Comparison of laminar flame speed and turbulent flame speed shows differences between hydrogen, carbon monoxide, and methane. Flame speed is defined as “the velocity that a planar flame front travels relative to the unburned gas in a direction normal to the flame surface” (15). Experimentation performed by Huang et al. (16) compares the laminar burning velocity in air of natural gas to hydrogen and to percent mixtures of hydrogen in natural gas. Huang et al. (16) concludes that for stoichiometric combustion, the laminar burning velocity of hydrogen is approximately 5½ times greater than natural gas. As the percent hydrogen increases from 0% hydrogen to 100% hydrogen, the laminar burning velocity increases exponentially. Figure 1.10 reprinted from Huang, et al. (16) displays the relationship showing

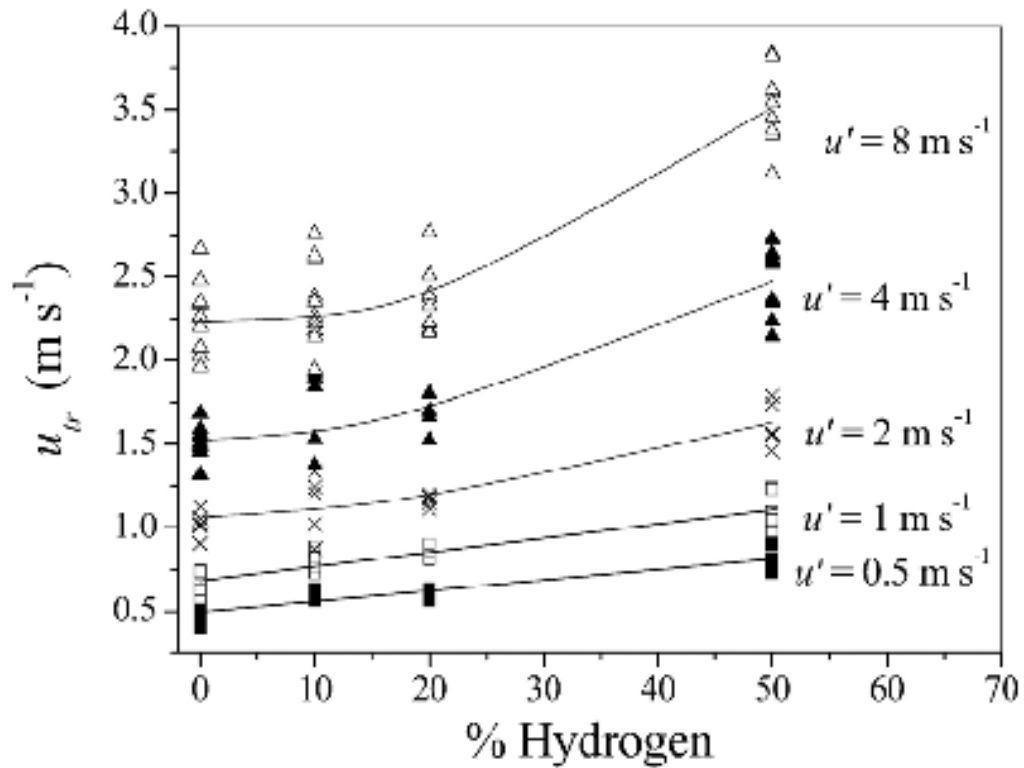


the dramatic increase in laminar flame speed for hydrogen compared to natural gas. The vertical axis labeled " $S_l$ " in Figure 1.10 denotes unstretched laminar flame speed and the horizontal axis indicates equivalence ratio for the fuel mixture in air.



**Figure 1.10 - Unstretched Laminar Flame Speed vs. Equivalence Ratio at Various Hydrogen Fractions [Reprinted from Hung et al. (16)]**

Experimentation by Fairweather et al. (17) analyzes the turbulent burning rates of methane and methane-hydrogen mixtures. Fairweather et al. (17) conclude the addition of hydrogen to methane significantly increase the turbulent burn velocity and increases the range of equivalence ratio operation for turbulent flame propagation. Figure 1.11 reprinted from (17) highlights the effects of the addition of hydrogen on the turbulent burn velocity. Burning velocity analysis reported is for stoichiometric combustion.



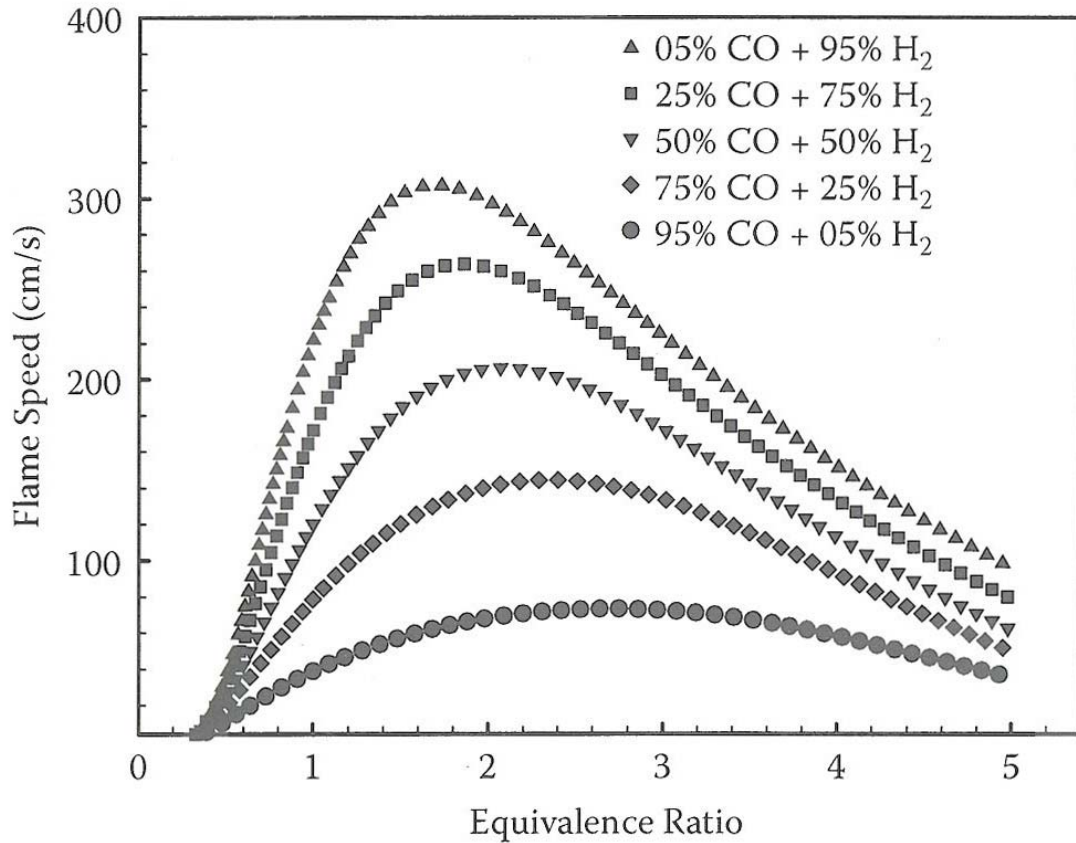
**Figure 1.11 - Turbulent Burning Velocity vs. Percent Hydrogen in Methane at Various Levels of Turbulence at a Stoichiometric Equivalence Ratio [Reprinted from Fairweather et al. (17)]**

The vertical axis in Figure 1.11 is turbulent burn velocity ( $u_{tr}$ ) in meters per second and the horizontal axis is the percent hydrogen added to methane. Figure 1.11 denotes the level of turbulence as  $u'$ , which is defined as root-mean-square (r.m.s.) turbulent velocity measured in meters per second. Analysis of Figure 1.11 shows the addition of hydrogen has a greater effect on turbulent burning velocity at higher levels of turbulence. As the turbulent level increases from  $u' = 0.5 \text{ m/s}$  to  $u' = 8 \text{ m/s}$ , a knee begins to develop at approximately 15% hydrogen addition. Figure 1.11 shows percent hydrogen addition below 15% has little impact on turbulent burning velocity while the addition of hydrogen above 15% has a significant impact on turbulent burning velocity at higher turbulent levels (17).

Further analysis by Fairweather et al. concludes the addition of hydrogen to methane affects the turbulent burning velocity at all equivalence ratios. For low percent hydrogen

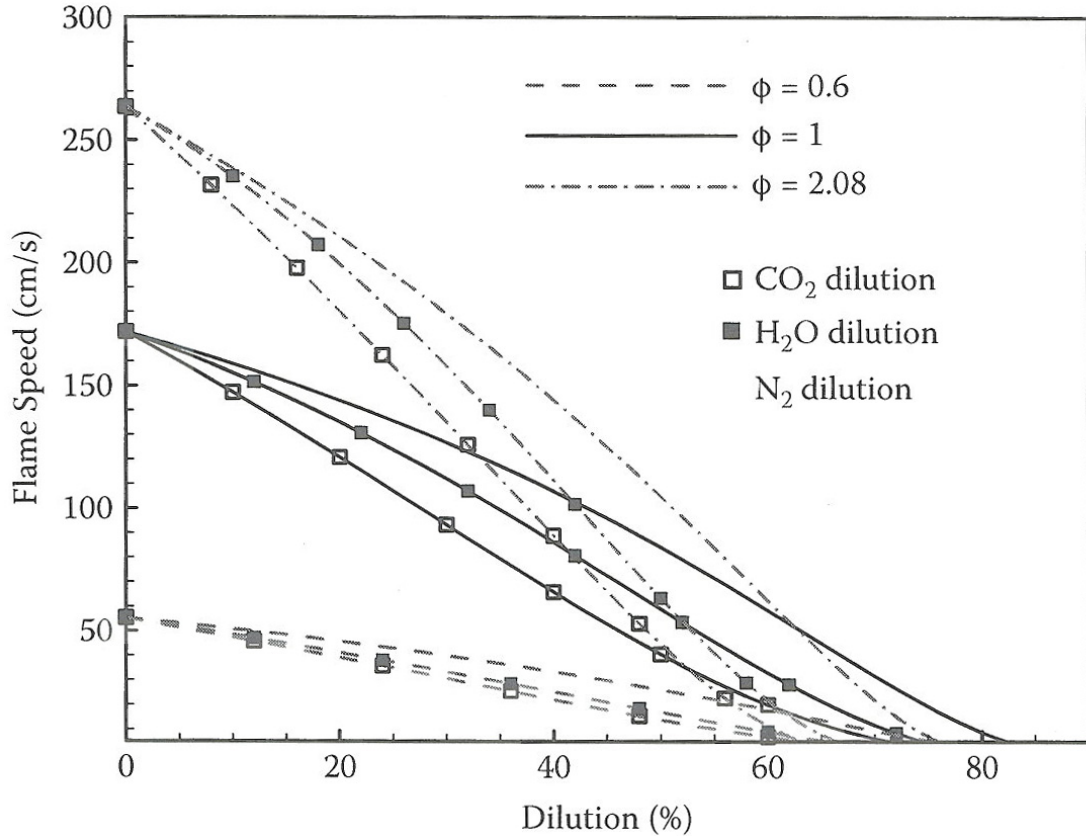
addition (less than 20%), turbulent burning velocity only increases for stoichiometric and lean combustion. Turbulent burning velocity appears unaffected for rich combustion at low percentage addition of hydrogen. However, Fairweather et al. concludes that for significant levels of hydrogen addition (approximately 50% hydrogen) turbulent burning velocity is increased for combustion at all equivalence ratios. Additionally, Fairweather et al. shows the addition of hydrogen extends the ignition limits compared to 100% methane (17).

While the addition of hydrogen to either methane or natural gas dramatically increases the laminar burning velocity and the turbulent burning velocity, syngas mixtures presented also include a significant fraction of CO and are diluted by nitrogen. Natarajan et al. (15) performed experimental analysis quantifying the effects of carbon monoxide and carbon dioxide diluent addition. Natarajan et al. varied the mixture of H<sub>2</sub> to CO concluding that higher fractions of H<sub>2</sub> increase the laminar flame speed compared to lower fractions of H<sub>2</sub>. The addition of diluents also impacts the laminar flame speed of the syngas. Diluents reduce adiabatic flame temperature and chemical kinetic rates, dramatically reducing the laminar flame speed (18). Analysis detailed in (18) agrees with work performed by Natarajan et al. (15). Figure 1.12 reprinted from (18) displays the relationship between the mixture percentage of hydrogen to carbon monoxide and flame speed. The flame speed increases as the percentage of hydrogen increases.



**Figure 1.12 – Laminar Flame Speed vs. Equivalence Ratio and H<sub>2</sub> to CO Mixture Percentage [Reprinted from Lieuwen et al. (18)]**

Figure 1.13 reprinted from (18) shows the effects of the addition of diluents. Figure 1.13 represents a 75% H<sub>2</sub> 25% CO mixture in air for three different equivalence ratios and three different diluents. As diluents are added to the fuel, the flame speed dramatically decreases until flammability limits are reached. Both Figure 1.12 and Figure 1.13 reveal the effect of equivalence ratio on flame speed. As equivalence ratio increases from 0.6 to approximately 2, flame speed dramatically increases (18).



**Figure 1.13 - Flame Speed vs. Percent Dilution for 75% H<sub>2</sub> 25% CO Mixture in Air [Reprinted from Lieuwen et al. (18)]**

The total combined effects of the discrepancies between flame speeds, specific energy content, and flammability limits presented on prechamber fuel selection are unclear. The hydrogen and carbon monoxide present in syngas increase both flame speed and flammability limits but reduce specific energy content compared to natural gas. Diluting the PCC fuel with nitrogen lowers the flame speed and narrows the flammability window. Additionally, optimal prechamber operation hinges upon the PCC flame jet's ability to ignite the lean mixture in the main cylinder. Clearly syngas exhibits different fundamental fuel characteristics compared to natural gas. Testing reported herein will quantify the effects of fueling the PCC with syngas compared to natural gas.

## 2 EXPERIMENTAL SETUP

### 2.1 Test Engine

Reformed natural gas PCC fueling tests were performed on a Copper-Bessemer GMV-4TF (GMV). The GMV is a large bore, four cylinder, two stroke cycle natural gas engine located at the Engines and Energy Conversion Laboratory (EECL) that utilizes a PCC to stabilize combustion at large air-fuel ratios. The common application for this engine is natural gas compression.

The engine is outfitted with an Altronic CPU-2000 ignition system, allowing independent control of ignition timing in each cylinder. In the current evaluation, all cylinder to cylinder ignition biases are set to zero and global ignition timing is adjusted to control average cylinder peak pressure location. The engine is highly instrumented, with over 100 different parameters recorded at each test point. Each cylinder is equipped with Kistler piezoelectric pressure transducers to measure main cylinder combustion pressure.

Combustion analysis provides crank angle resolved cylinder peak pressure, percent misfire, heat release, location of peak pressure, indicated mean effective pressure (IMEP), and cycle to cycle variations. A water brake dynamometer loads the engine and a computer controlled super charger in conjunction with a variable exhaust restriction provides pressurized air flow to the engine, simulating a turbocharger. The turbocharger simulator can mimic any turbocharger that would be integrated with a GMV series engine in the field. The humidity and temperature of the intake air flow to the engine is also controlled. Figure 2.1 displays a photograph of the engine and Table 2.1 provides specific engine characteristics at rated load.

All engine testing reported herein is performed at 100% rated load with a constant intake manifold to exhaust manifold pressure differential of 2.5" Hg. Detailed description of the test bed can also be found in various publications from the EECL (19), (11), (10), (9).



**Figure 2.1 - Cooper Bessemer GMV-4TF**

**Table 2.1 - GMV-4TF Characteristics at Rated Load**

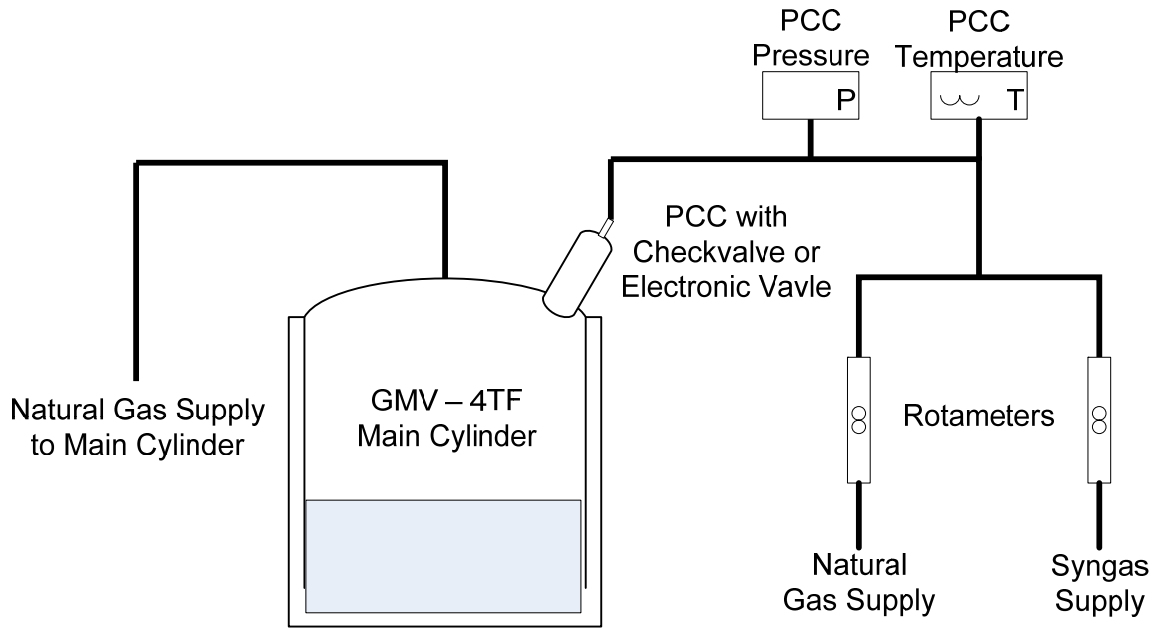
|                           |   |
|---------------------------|---|
| Rated Speed               | 300 RPM                                   |
| Rated Torque              | 7700 lbf-ft (5678 N-m)                    |
| Rated Power               | 440 bhp (330 kW)                          |
| Bore                      | 14 in (35.6 cm)                           |
| Stroke                    | 14 in (35.6 cm)                           |
| Location of Peak Pressure | 18° aTDC                                  |
| PCC Volume                | 3.3 in <sup>3</sup> (54 cm <sup>3</sup> ) |
| Cyl. Clearance Volume     | 194 in <sup>3</sup> (3.4 L)               |
| Total Displacement        | 8600 in <sup>3</sup> (140 L)              |

## 2.2 PCC Fueling Setup

The GMV-4TF is a lean burn engine utilizing precombustion chambers to extend lean limit operation. A PCC is a small chamber, typically 1% to 2% of the clearance volume. The volume of the PCC used in the current tests is 3.3 in<sup>3</sup> (54 cm<sup>3</sup>), or 1.6% of clearance volume. Ignition commences in the fuel rich PCC and the resulting PCC combustion gases enter the main cylinder as a high energy flame jet igniting the overall lean mixture. A centrally located gas admission valve supplies natural gas to the main cylinder. A separate fuel line delivers fuel to the PCC. Under standard operating conditions, the fuel supplied to both the main cylinder and the PCC is natural gas. The intent of the current study is to determine the benefits of supplying the PCC with a mixture of syngas and natural gas. Modifications to the PCC fuel supply line allow syngas to be blended with natural gas. Table 1.2 (shown earlier) lists the composition of the two different syngas mixtures utilized for testing. Bottled syngas supplies PCC syngas fuel in all testing reported herein. However, if the technology were to be implemented in the field a fuel reformer would be installed on site.

Figure 2.2 displays the PCC fuel supply schematic used for preliminary testing. The rotameters displayed in Figure 2.2 meter the flow of syngas and natural gas to a specified syngas/natural gas mixture. A pressure gauge and thermocouple record the pressure and temperature of the resulting fuel mixture, respectively. The rotameters depicted in Figure 2.2 limit PCC fuel pressure to 120 psi for preliminary testing. Section 4.1 discusses test results utilizing the PCC fuel supply schematic depicted in Figure 2.2.





**Figure 2.2 - PCC Fuel Supply Schematic with Checkvalve or ePCC Fuel Metering and Rotameters**

Subsequent sections discuss the need for electronic valve PCC fuel metering (ePCC) at PCC fuel injection pressures up to 230 psi. Test results reported in section 4.2, 4.3, and 4.4 utilize the PCC fueling schematic displayed in Figure 2.3. In Figure 2.3, a Hoerbiger electronically controlled valve meters PCC fuel flow into the prechamber during PCC fueling. Mass flow meters and needle valves replace the rotameters shown in Figure 2.2, controlling the mixture percent of syngas to natural gas. An Omega FMA-1843 mass flow meter measures the flow of syngas while an Omega FMA-2317 mass flow meter measures the flow of natural gas. Both Omega flow meters are hot wire anemometer instruments which automatically correct for pressure and temperature. The instrument manufacture provides gaseous species correction factors for both flow meters. The correction factor for natural gas is 0.72 and the correction factor for syngas is 0.99. An Altronic Hyper Fuel Valve System operates the ePCC, regulating injection duration and injection timing. Figure 2.4 and Figure 2.5 display photographs of the fuel delivery system depicted in Figure 2.3.

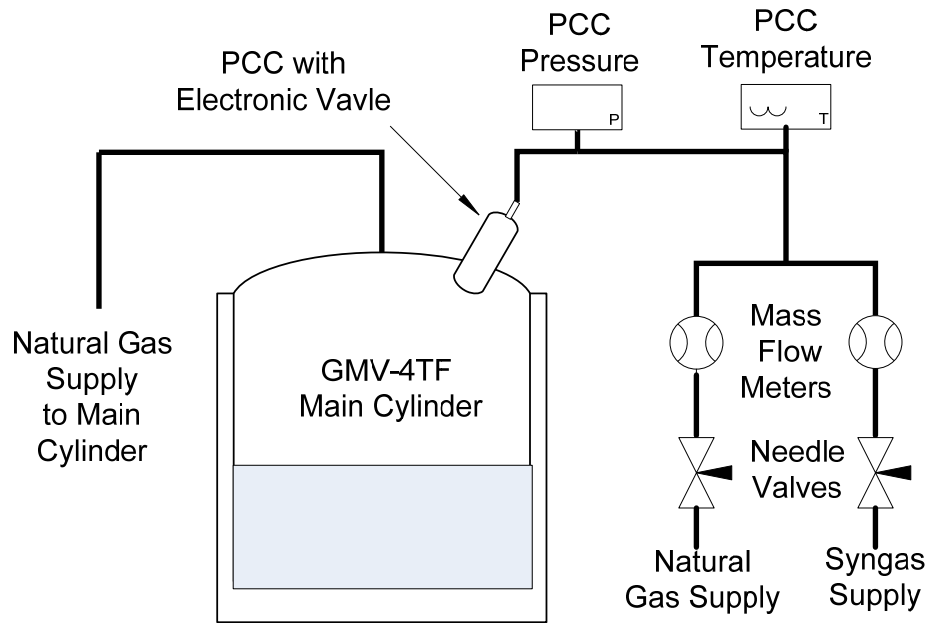


Figure 2.3 - PCC Fueling Schematic with ePCC Fuel Metering, Mass Flow Meters, and Needle Valves

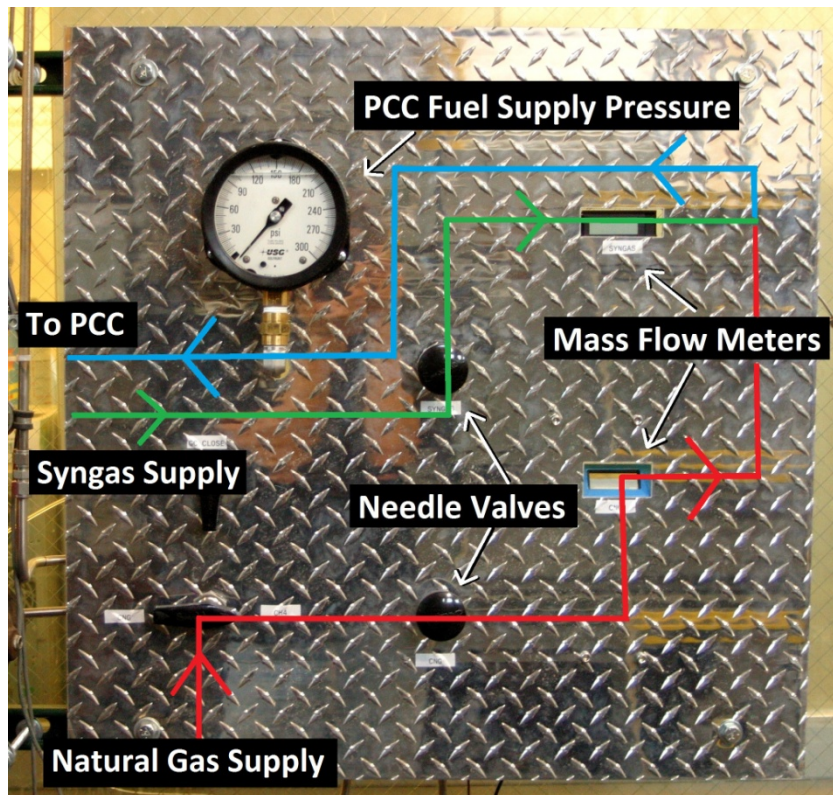


Figure 2.4 - PCC Fuel Mixing Platform with Mass Flow Meters and Needle Valves

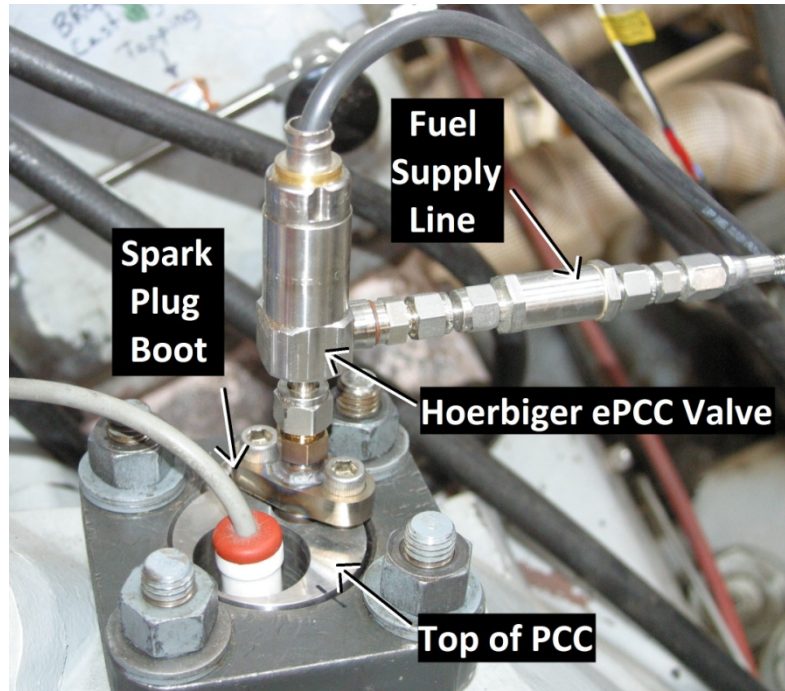


Figure 2.5 - PCC Fueling with Hoerbiger ePCC Fuel Metering

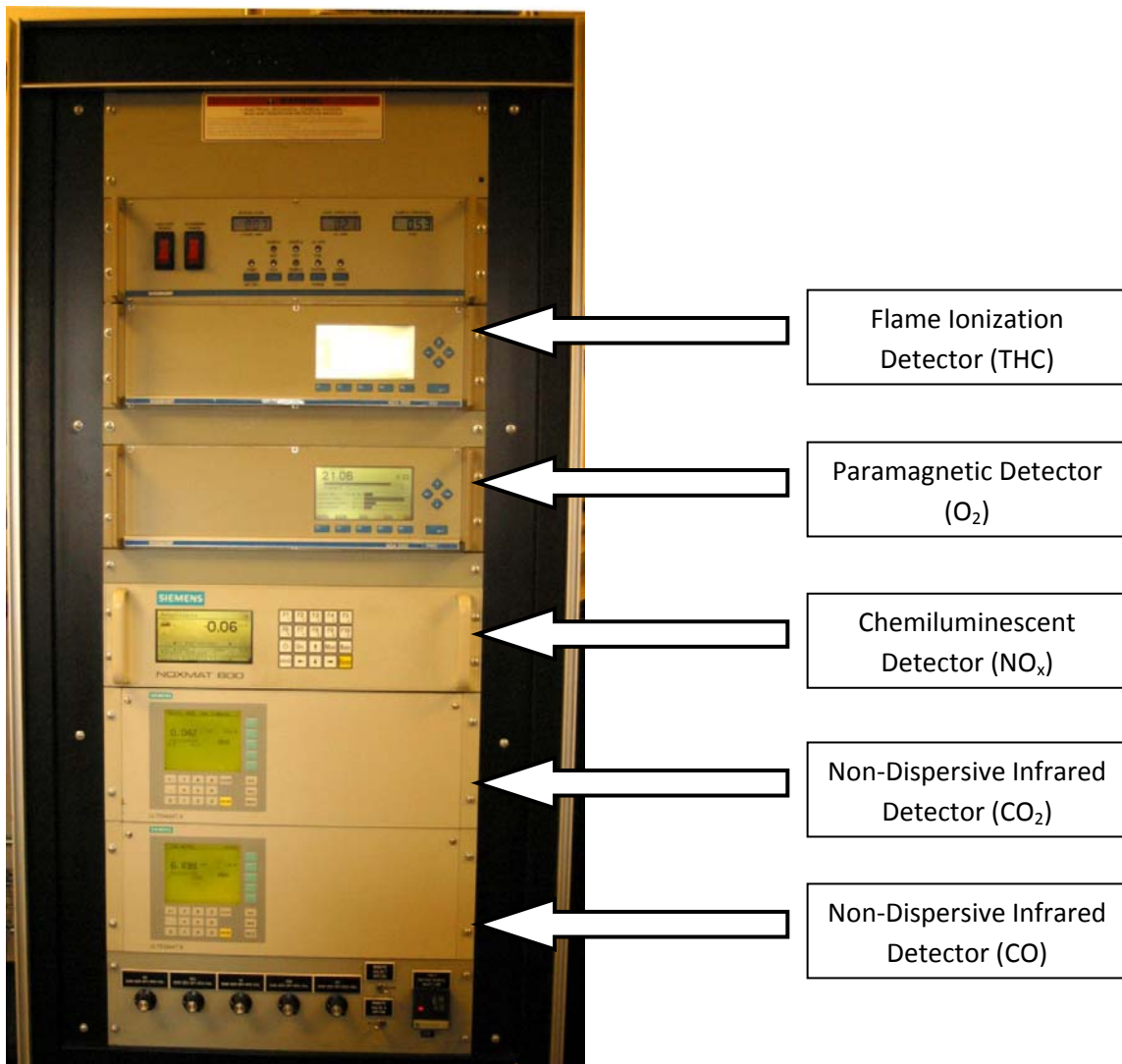
### 2.3 Exhaust Emission Analyzers

A 5-gas analyzer and a Nicolet Magna 560 Fourier Transform Infra-Red (FTIR) spectrometer measure exhaust pollutant emissions via a heated exhaust sample line. Water vapor is a product of hydrocarbon combustion. Liquid water inside the sample line can absorb various emissive species. Heating the sample line ensures the water vapor in the exhaust does not condense inside the sample line.

The 5-gas analyzer is a broad term comprising a number of specific emission detection instruments. Figure 2.6 displays the 5-gas analyzer bench and Table 2.2 denotes the emissions measured by each specific instrument of the 5-gas analyzer.

**Table 2.2 - 5-gas Bench Instrumentation and Emissive Species Measured**

| Emissive Species                        | Measurement Technique     | Instrument Manufacture | Model       |
|---|---------------------------|------------------------|-------------|
| NO <sub>x</sub> (NO + NO <sub>2</sub> ) | Chemiluminescent          | Siemens                | NOXMAT 600  |
| THC                                     | Flame Ionization Detector | Rosemount Analytical   | NGA 2000    |
| O <sub>2</sub>                          | Paramagnetic              | Rosemount Analytical   | NGA 2000    |
| CO                                      | Non-Dispersive Infrared   | Siemens                | ULTRAMAT 6E |
| CO <sub>2</sub>                         | Non-Dispersive Infrared   | Siemens                | ULTRAMAT 6E |



**Figure 2.6 - 5-gas Emission Analyzer at the EECL**

Figure 2.7 displays a photograph of the Nicolet Magna 560 FTIR. The FTIR measures over 20 different species including the same species as the 5-gas bench with the exception of oxygen. However, since the 5-gas bench instrumentation is specifically designed to measure each unique species respectively, where duplicate readings occur, the 5-gas bench measurements are used. In addition to the duplicate 5-gas bench measurements, the FTIR measures Hazardous Air Pollutants (HAPs) such as formaldehyde and ammonia in addition to species specific hydrocarbon components. The FTIR measures VOC emission in terms of an equivalent measurement from a Flame Ionization Detector (FID) calibrated with methane. The formula for VOC emission reported is shown below. The coefficient values of 3.01, 1.83, and 2.78 are the corresponding FID response factors for acetylene, ethylene, and propane, respectively. The equation below illustrates the VOC calculation.

$$VOC_{ppm} = 3.01 * Acetylene_{ppm} + 1.83 * Ethylene_{ppm} + 2.78 * Propane_{ppm}$$



**Figure 2.7 - Nicolet Magna 560 Fourier Transform Infrared Spectrometer**

The EPA specifies methods for each specific measurement technique. Testing is conducted in accordance to all pertinent EPA methods. Calibration of the emission measurement instruments is performed on a routine basis prior to each test day. Zero, span, and bias checks throughout the test day ensure proper accuracy of the 5-gas bench. Flowing high purity nitrogen to the 5-gas bench performs the zero check. If an instrument is outside specification, the instrument is re-zeroed. Supplying the 5-gas analyzer with known concentration calibration gases performs the span check. The analyzers are assumed to operate linearly between the zero point and the span point.

A bias check ensures the integrity of the exhaust sample line. Flowing the known calibration gases through the exhaust sample line to the 5-gas analyzer performs the bias check. Comparing the emission instrument reading from the span and zero check to the bias check ensures exhaust sample line integrity. The analyzers must respond within specification to the zero, span, and bias check. If an instrument is out of specification for the zero or span check, the instrument is re-calibrated. If the bias check is out of specification the sample line is inspected for leaks. Table 2.3 lists the manufacture's accuracy specifications for repeatability, drift, and linear deviation.

**Table 2.3 - Suggested Manufacture's Accuracy Specification of 5-Gas Analyzers**

| <b>Manufacture</b>   | <b>Model</b> | <b>Emissive Species</b> | <b>Repeatability</b>  | <b>Drift</b>                 | <b>Linear Deviation</b> |
|----------------------|--------------|-------------------------|-----------------------|------------------------------|-------------------------|
| Siemens              | NOXMAT 600   | NO <sub>x</sub>         | 0.5% full-scale       | 1% full-scale/24 hours       | 0.5% full-scale         |
| Rosemount Analytical | NGA 2000     | THC                     | ± 1% full scale       | 1% full-scale/24 hours       | ± 1% full scale         |
| Rosemount Analytical | NGA 2000     | O <sub>2</sub>          | ± 1% full scale       | 1% full-scale/24 hours       | ± 1% full scale         |
| Siemens              | ULTRAMAT 6E  | CO                      | 1% of measuring range | ± 1% of measuring range/week | 0.5% full-scale         |
| Siemens              | ULTRAMAT 6E  | CO <sub>2</sub>         | 1% of measuring range | ± 1% of measuring range/week | 0.5% full-scale         |

## 2.4 Experimental Procedure

The purpose of this investigation is to determine the effectiveness of fueling the PCC with syngas. Many different engine parameters can be used to quantify the effect of various PCC fueling parameters. In this work coefficient of variance of peak pressure ( $COV_{pp}$ ) and NO<sub>x</sub> emission were chosen.  $COV_{pp}$  serves as a measurement of combustion stability, relating the consistency of one combustion event to the next.  $COV_{pp}$  is calculated by dividing the standard deviation of the peak pressure by the average peak pressure. Combustion stability and  $COV_{pp}$  are inversely related. A high  $COV_{pp}$  indicates inconsistent and unstable combustion, whereas a low  $COV_{pp}$  represents consistent, stable combustion.

$COV_{pp}$  and NO<sub>x</sub> emission are highly dependent upon PCC equivalence ratio. During lean combustion, the fuel mixture is difficult to ignite, resulting in high  $COV_{pp}$  values. However, lower temperatures associated with lean combustion result in reduced NO<sub>x</sub> formation. During rich combustion the mixture is easy to ignite, driving  $COV_{pp}$  down though increased temperatures give rise to higher NO<sub>x</sub> emission. As such, the two offsetting parameters give an accurate representation of the potential benefit of fueling the PCC with syngas.

Previous work performed by Gingrich et. al (20) and Olsen and Lisowski (10) suggests that overall engine NO<sub>x</sub> emission is highly dependent upon PCC NO<sub>x</sub> formation. Consequently, an alternative PCC fuel that reduces NO<sub>x</sub> formation in the PCC will reduce overall engine NO<sub>x</sub> emission. A beneficial fuel will either produce lower NO<sub>x</sub> emission at a given COV<sub>pp</sub> or lower COV<sub>pp</sub> at a given NO<sub>x</sub> level. Due to the highly dependent nature of the test criteria on PCC equivalence ratio, a model was developed to calculate the equivalence ratio in the PCC at ignition. Chapter 3 details the PCC equivalence ratio model.

The baseline datapoint is taken by fueling the PCC with natural gas at 18" Hg intake manifold boost for comparison with both checkvalve fuel metering and ePCC fuel metering. A PCC equivalence ratio sweep is conducted by varying the flow of natural gas to the PCC. A two minute running average of main cylinder COV<sub>pp</sub> and NO<sub>x</sub> emission is calculated for each PCC fuel flow rate. A low COV<sub>pp</sub> represents optimal combustion stability for each PCC fueling scenario. At the optimum combustion stability operating point, a full five minute data point records complete engine and emission data providing baseline data to be used for comparison.

Experimental evaluation reported herein occurs in four main categories listed below. The section detailing the test results and discussion for each category is listed in parenthesis behind each category heading.

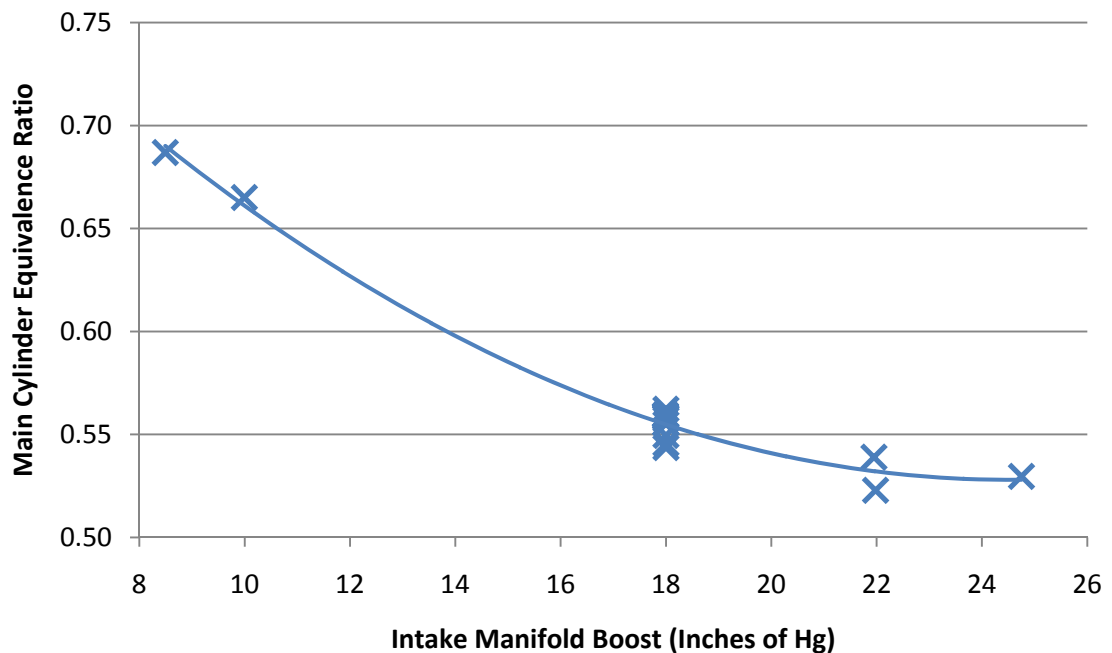
- Preliminary Testing with Checkvalve and ePCC Fuel Metering (Section 4.1)
- 80% Syngas 2 / 20% Natural Gas PCC Fueling with ePCC Fuel Metering (Section 4.2)
- 80% Syngas 1 / 20% Natural Gas PCC Fueling with ePCC Fuel Metering (Section 4.3)
- Percent Syngas 2 Fuel Sweep (Section 4.4)

The experimental procedure for each category varies and is specifically clarified within each respective test result section. For each test category, experimental evaluation occurs in a similar fashion as detailed for the natural gas baseline tests. The PCC equivalence ratio model



(Chapter 3) calculates the PCC fueling parameters for optimal combustion stability for each fueling scenario. A reduced range fuel sweep is conducted by varying the PCC fuel flow in which two minute data points are used to calculate  $COV_{pp}$  and  $NO_x$  emission. The fuel sweep validates the PCC equivalence ratio model calculation and ensures the optimal PCC fueling parameters for each fueling scenario. The minimum  $COV_{pp}$  occurs at the optimum PCC fueling parameter. A five minute data point records complete engine and emission data at the optimal PCC fueling parameter as defined by the PCC equivalence ratio calculation and the fuel sweep. Comparing the results of the five minute data point to the baseline natural gas data point details the combustion stability and pollutant emission difference for each PCC fueling scenario.

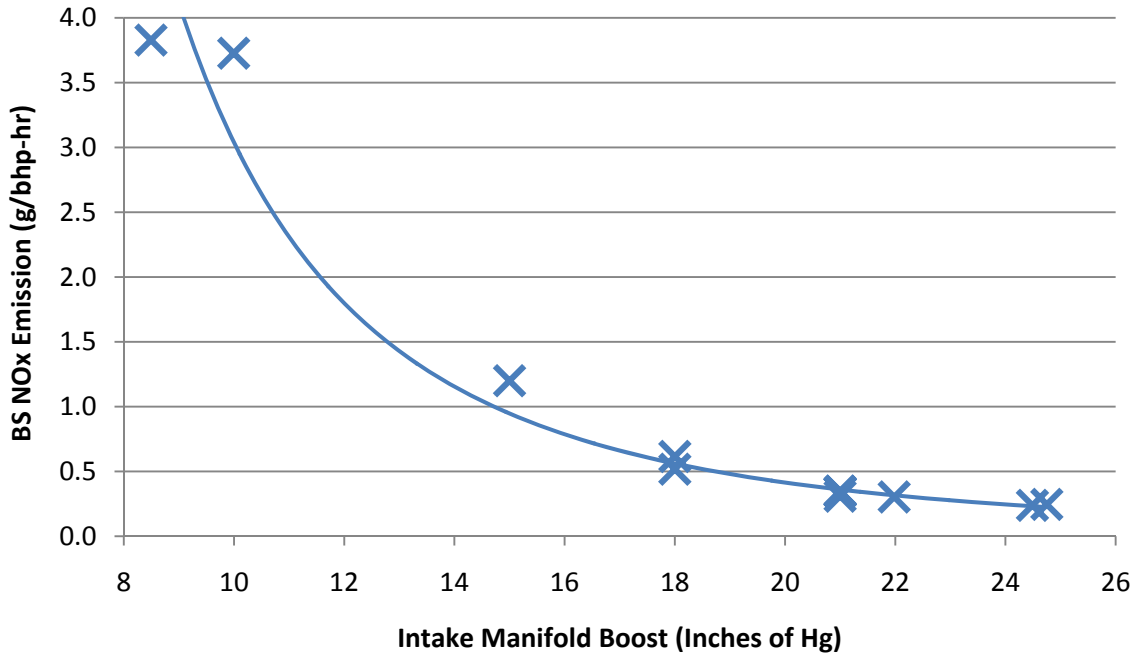
The equivalence ratio in the main cylinder is adjusted by varying the intake manifold boost level while maintaining a constant exhaust backpressure of 2.5" Hg. Figure 2.8 displays the non-linear relationship between intake manifold boost and main cylinder equivalence ratio.



**Figure 2.8 – Intake Manifold Boost vs. Main Cylinder Equivalence Ratio for the GMV-4TF**

Main cylinder equivalence ratio and combustion stability are closely related. As main cylinder equivalence ratio decreases combustion stability decreases (main cylinder  $COV_{pp}$  increases). PCC fuel type and fueling parameters significantly impact combustion stability. Syngas PCC fueling is compared to natural gas PCC fueling at an equivalent combustion stability operating point by adjusting the intake manifold boost level for each PCC fuel type. Further discussion on comparing PCC fueling scenarios at equivalent combustion stability operating points is found in subsequent sections.

Figure 2.9 displays the non-linear relationship between intake manifold boost level and  $NO_x$  emission for typical GMV-4TF engine operation using PCC technology. Figure 2.9 shows  $NO_x$  emission decreases as intake manifold boost level increases. A comparison of Figure 2.9 and Figure 2.8 shows  $NO_x$  emission decreases as the equivalence ratio in the main cylinder is reduced. This correlation between lean engine operation and  $NO_x$  emission is generally consistent across all engines. Lean operation reduces cylinder combustion temperature thereby reducing  $NO_x$ . A PCC fuel type that allows engine operation at lower main cylinder equivalence ratios than previously attainable extends the lean limit of the engine and results in a  $NO_x$  emission reduction.



**Figure 2.9 - Intake Manifold Boost Level vs. Typical Brake Specific NO<sub>x</sub> Emission for the GMV-4TF**

### 3 PCC EQUIVALENCE RATIO MODELING

Equivalence ratio ( $\Phi$ ) is an important factor in engine operation. Typical gaseous fuels are most readily ignitable at mixtures near stoichiometric ( $\Phi \approx 1$ ). However, due to the high temperatures associated with near stoichiometric combustion,  $\text{NO}_x$  formation is also high. To reduce  $\text{NO}_x$  emission, stationary large bore natural gas engines utilize PCC technology to operate at overall lean ( $\Phi < 0.7$ ) conditions in the main cylinders. At 18" Hg intake manifold pressure the equivalence ratio in the GMV main cylinder is approximately 0.57. A separate fuel line supplies fuel to the PCC where combustion commences in a slightly rich zone ( $1.1 < \Phi < 1.2$ ). The resulting combustion gases exit the PCC as a high energy flame jet seeding the main cylinder with multiple, distributed ignition sources.

In order to accurately predict how much alternative fuel will need to be fed into the PCC to obtain the required  $\Phi$ , a model calculates the equivalence ratio for a variety of gas compositions, mass flows, and fuel line pressures. Throughout the modeling process, the following engine operating parameters were assumed unless otherwise noted:

|                                       |                     |
|---------------------------------------|---------------------|
| Intake Manifold Boost:                | 18" Hg              |
| Engine Speed:                         | 300 RPM             |
| Engine Load:                          | 100%                |
| Engine Brake Power:                   | 440 bhp             |
| Main Cylinder $\Phi$ :                | 0.57                |
| Main Cylinder Trapped AF ratio:       | 27.2                |
| PCC Volume:                           | 54 cc               |
| PCC Pressure @ Scavenging:            | 139 kPa (absolute)  |
| PCC Pressure @ Ignition:              | 2330 kPa (absolute) |
| Jacket Water Temperature:             | 347 K               |
| Main Cylinder Mass Fraction Air:      | 0.778               |
| Main Cylinder Mass Fraction Fuel:     | 0.028               |
| Main Cylinder Mass Fraction Residual: | 0.194               |

### 3.1 Two-Stroke Engine Sequence of Events

The current modeling technique assumes PCC pressure closely tracks the main cylinder pressure. This assumption has been shown to be accurate with simultaneous main chamber and PCC pressure measurements (9). Figure 3.1 shows a typical GMV pressure trace and identifies the location of various events in the GMV 2-stroke cycle.

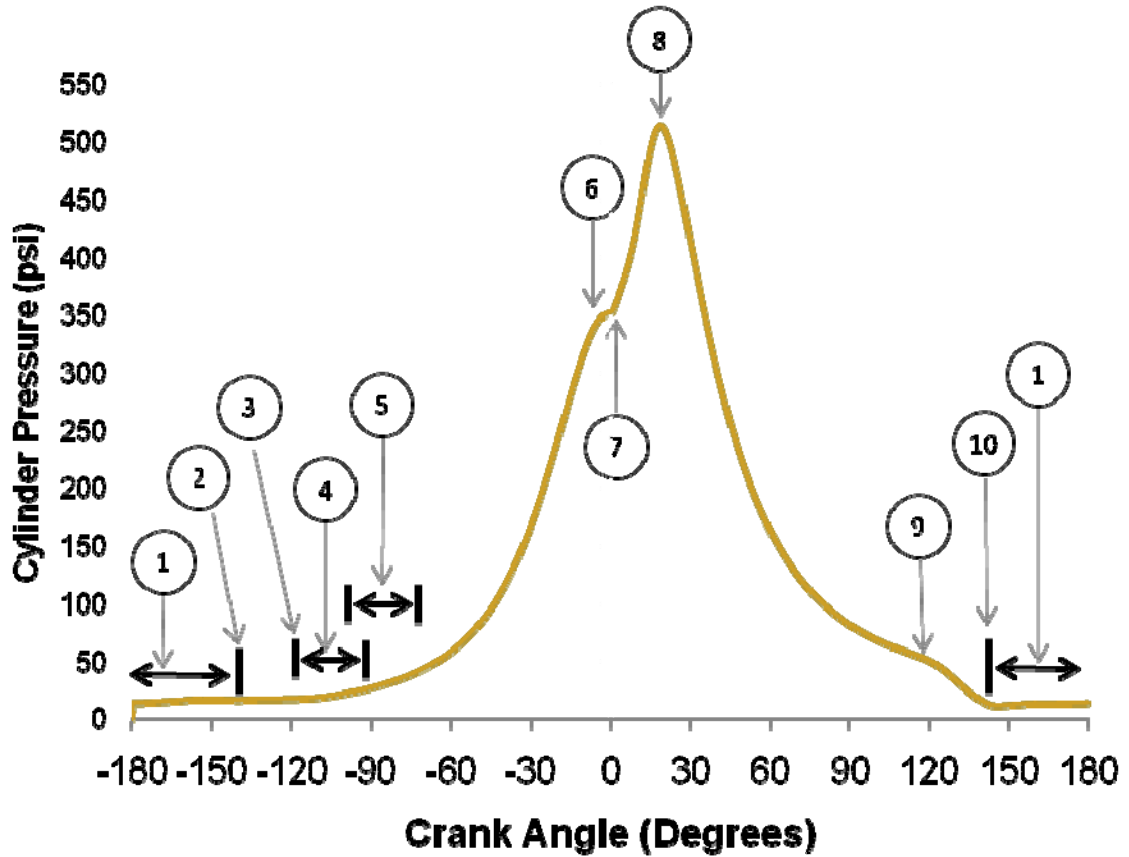


Figure 3.1 - GMV-4TF Main Cylinder Pressure Trace and 2-Stroke Cycle Sequence of Events

The events displayed in Figure 3.1 are:

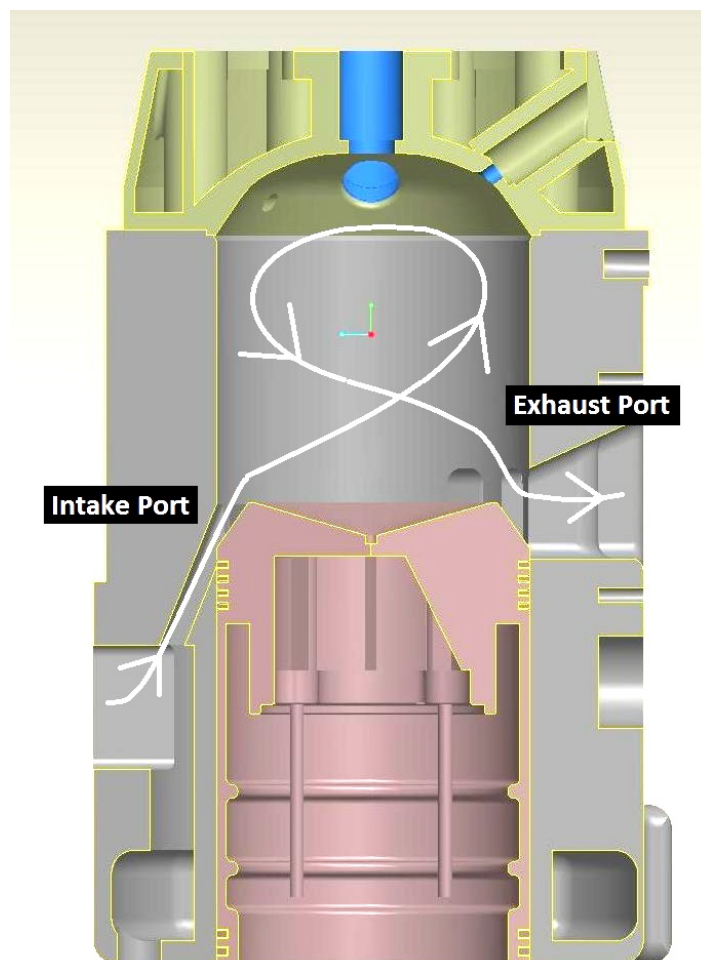
1. Main Cylinder Scavenging
2. Intake Port Closes (IPC)
3. Exhaust Port Closes (EPC)
4. Main Cylinder Fuel Admission
5. Electronic PCC Fuel Injection
6. Spark Plug Ignites Air-Fuel Mixture in PCC
7. PCC Flame Jet Ignites Main Cylinder Air-Fuel Mixture
8. Location of Peak Pressure
9. Exhaust Port Opens (EPO)
10. Intake Port Opens (IPO)

Figure 3.1 provides insight into the sequence of events in a two-stroke engine. At  $\pm 180^\circ$  the piston is at bottom dead center (BDC). At this point in the cycle, both the exhaust ports and the intake ports are open allowing air to flow through the cylinder (Figure 3.1 event #1). This process is called cylinder scavenging and works to remove the exhaust residual from the previous combustion cycle and fill the cylinder with air for the next combustion cycle. At 18" Hg intake manifold boost, the scavenging efficiency of the GMV is approximately 84%. This signifies the resulting charge in the cylinder for each combustion cycle at EPC is 84% air and 16% exhaust residual while operating at 18" Hg intake manifold boost level.

Figure 3.2 displays the scavenging process in the GMV. The white line draw in Figure 3.2 approximates the scavenging air pathway. The scavenging process in the GMV is a combination of cross-scavenging and Schnurle loop scavenging. The intake ports directly opposite the exhaust port are cross-scavenging ports. Incoming air entering the cylinder through the cross-scavenge ports is deflected upward and circulates orthogonal to the cylinder axis, which is

commonly referred to as “tumble.” Schnurle ports on opposite sides of the cylinder direct incoming air upward and away from the exhaust ports. The Schnurle ports are a type of loop scavenging ports and create two swirl vortices on the two cylinder halves. Further explanation of the scavenging process in a GMV engine is presented by Boyer et al. (21).

Both the exhaust ports and the intake ports are open in Figure 3.2. As the piston moves upward, the intake port close first (Figure 3.1 event #2) followed by the exhaust port (Figure 3.1 event #3) since the exhaust port is located higher on the cylinder wall.



**Figure 3.2 - GMV-4TF Cylinder Scavenging Loop**

As the piston moves upward closing both ports, the pressure in the cylinder rises quickly. Compression in the cylinder continues until the piston reaches top dead center (TDC).

Piston compression occurs between  $120^\circ$  bTDC and  $0^\circ$  in Figure 3.1. During piston compression, a gas admission valve located in the cylinder head supplies the main cylinder with fuel (Figure 3.1 event #4). Additionally, a separate fuel line and fuel admission system supplies the PCC with fuel (Figure 3.1 event #5). As the piston compresses the gasses in the main cylinder, a great deal of air-fuel mixture from the main cylinder is forced into the PCC through the PCC exhaust nozzle (See Figure 1.1). The PCC fuel admission event approximates a typical electronically controlled fuel valve admission sequence for natural gas PCC fueling. Checkvalve fuel admission occurs throughout main cylinder scavenging and is discussed in detail in subsequent sections.

As the piston nears TDC, a spark plug in the PCC ignites the PCC air-fuel mixture (Figure 3.1 event #6). Typical spark plug timing values for the GMV equipped with PCCs are between  $5.5^\circ$  bTDC and  $4^\circ$  bTDC. As the air-fuel mixture in the PCC burns, pressure in the PCC rises. The resulting combustion gases exit the PCC and enter the main cylinder as a high energy flame jet. The flame jet generates multiple ignition sources spatially distributed throughout the main cylinder (11) (Figure 3.1 event #7).

The pressure in the main cylinder rises quickly as the PCC flame jet ignites the main cylinder lean air-fuel mixture. Figure 3.1 shows the pressure spike associated with combustion centered on  $18^\circ$  aTDC (event #8). The high combustion pressure rise forces the piston back down, converting the thermal energy into mechanical energy. As the piston passes  $120^\circ$  aTDC the exhaust port opens (Figure 3.1 event #9) and exhaust blowdown occurs, where the remaining pressure in the cylinder is quickly released before the intake port is uncovered (Figure 3.1 event #10). The cylinder geometry design ensures the exhaust port will always open before the intake port safeguarding against hot exhaust gases traveling back into the intake manifold. Once the intake port opens, cylinder scavenging occurs, removing the products of combustion and introducing air for the subsequent cycle.



### 3.2 PCC Fuel Metering and Fuel Retention Models

The PCC equivalence ratio model calculates PCC  $\Phi$  for mechanical checkvalve fuel metering and electronic valve fuel metering (ePCC). The model utilizes either the perfect mixing model or the perfect displacement model to calculate PCC fuel retention during PCC fueling. Figure 3.3 displays the combinations of fuel metering and fuel retention models calculated by the PCC equivalence ratio model. The model calculates the PCC equivalence ratio for natural gas and two different syngas blends. Table 1.2 lists the composition of the two syngas gas blends.

|                      |                      | Fuel Metering Device |      |
|----------------------|----------------------|----------------------|------|
|                      |                      | Checkvalve           | ePCC |
| Fuel Retention Model | Perfect Displacement | X                    |      |
|                      | Perfect Mixing       | X                    | X    |

**Figure 3.3 - Fuel Metering and Fuel Retention Model Combinations**

#### 3.2.1 Perfect Displacement Model for Checkvalve Metering

The perfect displacement model assumes that all the fuel entering the PCC displaces the residual gas from the previous combustion cycle. The model is analogous to a piston forcing the PCC gas from the previous cycle into the main cylinder. Once the new gaseous charge fills the PCC volume, any excess charge entering the PCC flows out into the main cylinder. A mechanical checkvalve meters the charge allowing gas to flow into the PCC at any point during the cycle in which the pressure in the PCC is less than the pressure in the PCC fuel supply line. This occurs each cycle during the main cylinder scavenging process.

While metering fuel with a checkvalve, the rotameter readings provide the mass flow of natural gas and syngas into the PCC. The rotameter readings need to be corrected for temperature, pressure, and gaseous species. The flow correction calculation provided by the manufacture is:

$$SCFH_{actual} = SCFH_{measured} \sqrt{\frac{1.0 * 530 * (14.7 + P_{PCC})}{SG_i * (460 + T_{PCC}) * 14.7}}$$

In this equation  $P_{PCC}$  and  $T_{PCC}$  are the pressure and temperature, respectively, of the gas in the PCC fuel line after mixing (Figure 2.2).  $SG_i$  is the specific gravity of the gas flowing through the rotameter. The model calculates the specific gravity of each syngas blend based on gas composition, molecular weight, and gas density at atmospheric conditions. The ideal gas law converts the resulting standardized flow reading into mass flow.

The perfect displacement model assumes that the incoming gas charge dispels the residual charge in the PCC from the previous cycle without mixing. Operating under this assumption, the ideal gas law calculates the volume of the new charge using the standardized rotameter flow rates and the pressure and temperature of the delivered fuel. Dividing by the volume of the PCC computes the percent of the PCC occupied by the new gaseous charge. If the PCC is filled past 100% then the excess gas is assumed to flow into the main cylinder and the effects of this gas on overall performance of the engine is not accounted for and assumed negligible. The molecular weight of the gaseous charge determines the specific gas constant,  $R$ . The calculation of  $R$  is highly dependent upon the gas composition in the PCC when the checkvalve closes. If the PCC is filled to volumetric percent of 100% or greater, the model uses the molecular weight of the incoming gas. A weighted average calculates the molecular weight used to find the specific gas constant when the PCC is not completely filled. The weighted average calculation compares the molecular weight of the incoming gas charge against the molecular weight of the residual charge in the PCC. In all the modeling calculations performed, the model assumes the molecular weight of the residual charge is equivalent to the molecular weight of air. The ideal gas law determines the mass in the PCC when the exhaust port closes

using the calculated specific gas constant, fuel supply temperature, scavenging pressure, and PCC volume.

Once the exhaust port closes, the pressure in the cylinder, and thus in the PCC, rises rapidly as the piston moves toward TDC. Ignition in the PCC is initiated slightly before TDC as shown in Figure 3.1. During compression, the piston forces a significant amount of air and fuel from the main cylinder into the PCC. In each modeling scenario the model assumes all of the supplied PCC fuel in the PCC at exhaust port closure stays in the PCC during compression. The air and fuel from the main chamber adds to the total mass in the PCC throughout piston compression. The ideal gas law calculates the mass in the PCC at ignition using cylinder pressure at ignition, water jacket temperature, and a specific gas constant calculated from the mixture of air, fuel, and residual gas in the PCC.

The model calculates the mass entering the PCC from the main cylinder using the difference in the mass in the PCC at ignition and the mass in the PCC at exhaust port closure. Standard engine data analysis produces trapped air-fuel ratio and scavenging efficiency for the main chamber. Based on these parameters, the model returns the mass of air, natural gas, and residual from the main cylinder. Analyzing the ratio of mass flow of natural gas to specialty gas provides the composition of supplied fuel in the PCC at EPC. The model assumes the remaining mass is residual in the event the PCC is not completely filled during the fueling process.

Equivalence ratio is defined as the ratio of the stoichiometric air-fuel ratio (AFR) to the actual AFR (6). Since the mass of all the constituents in the PCC are known, the actual AFR is the ratio of the mass of air to the mass of all the fuel species in the PCC. The model utilizes thermochemistry techniques found in Pulkrabek (6) and the molecular formula of the resulting fuel composition to calculate the stoichiometric AFR. The atomic elements in the gas mixtures

used include carbon, hydrogen, oxygen, and nitrogen. Therefore, the resulting molecular formula is of the form shown below.

$$C_{C\#}H_{H\#}O_{O\#}N_{N\#}$$

The subscripts for the molecular formula for the gaseous mix are found using the equation

$$C\# = \frac{Y_{NG} * C\#_{NG} + Y_{syngas} * C\#_{syngas}}{Y_{NG} + Y_{syngas}}$$

where the Y values are mole fractions. This equation calculates the carbon number of the molecular formula. A similar technique determines the hydrogen, oxygen, and nitrogen numbers.

The model calculates the molecular weight of the resulting fuel molecule and evaluates the stoichiometric AFR using the following equation adapted and expanded upon from (5). Dividing the stoichiometric AFR by the actual AFR gives the equivalence ratio in the PCC.

$$AFR_{stoich} = \left( C\# + \frac{H\#}{4} - \frac{O\#}{2} \right) * 4.76 * \frac{MW_{air}}{MW_{fuel}}$$

### 3.2.2 Perfect Mixing Model for Checkvalve Metering

The perfect mixing model (5) assumes the incoming gaseous charge mixes instantaneously and perfectly with the resident gas. The incoming charge therefore displaces a continually changing mixture of residual gas and incoming gaseous fuel. The following equation gives the mass of delivered fuel trapped in the PCC after the exhaust port closes.

$$m_{trapped} = m_{ref} [1 - e^{-\Lambda_{PCC}}]$$

In this equation, the delivery ratio,  $\Lambda_{PCC}$ , is the ratio of delivered mass over a reference mass. The respective flow of each gaseous species and the duration the checkvalve is open determines the delivered mass. Corrected rotameter values provide mass flow as in the perfect displacement model. An empirical curve fit to the cylinder pressure trace returns the crank

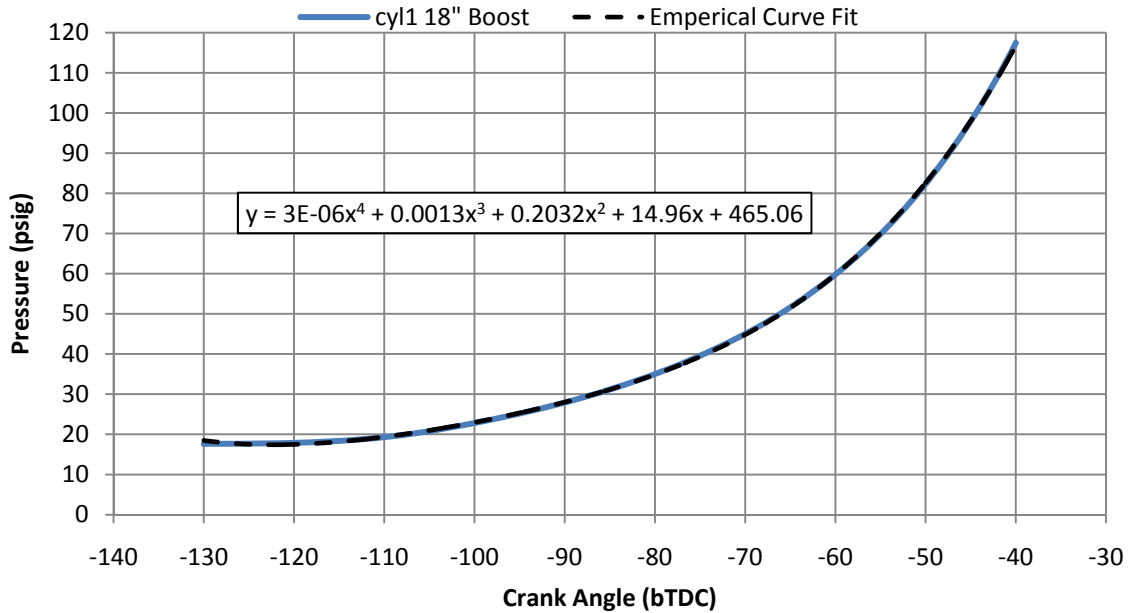
angle duration in which the pressure in the PCC fuel line is greater than the pressure in the PCC, thus allowing fuel to flow through the checkvalve. The ideal gas law is used to calculate the reference mass using scavenging pressure, fuel supply temperature, PCC volume, and the specific gas constant of the incoming fuel. Using the mass of trapped fuel at EPC (Figure 3.1 event #3), the model calculates the PCC  $\Phi$  using techniques described in the previous section.

### 3.2.3 Perfect Mixing Model for Electronically Metered Fuel Injection (ePCC)

Electronically metering the PCC fuel with the ePCC is a more controllable and reliable method than checkvalve fuel metering. Since the injection timing and duration are controlled electronically, many ePCC fuel injection scenarios exist. In all the ePCC situations modeled, the fuel supply pressure was significantly higher than the checkvalve case to ensure sonic flow through the ePCC during fueling and to allow fuel delivery to the PCC after EPC. After EPC, the pressure in the PCC rises quickly increasing the trapped mass in the PCC compared to checkvalve PCC fueling. An empirical curve fit equation relates cylinder pressure to crank angle. Figure 3.4 shows the empirical equation overlaid on the cylinder pressure trace from 130° to 40° bTDC.

For any gaseous flow, choked flow occurs whenever the ratio of PCC pressure to fuel supply pressure is less than the critical pressure ratio. The critical pressure ratio is 0.546 for a gas specific heat ratio of  $k = 1.3$ . The following equation is used to calculate the critical pressure ratio (5).

$$\frac{P_{PCC\ chamber}}{P_{Fuel\ Supply}} = \left( \frac{2}{k + 1} \right)^{\frac{k}{k-1}}$$



**Figure 3.4 - Empirical Fit Equation for Pressure Rise during Piston Compression**

Throughout modeling and testing, the pressure differential between supply pressure and PCC pressure during fueling is less than the critical pressure ratio resulting in sonic flow. This condition results in the largest fuel mass delivered for a given time duration. The equation below gives the sonic mass flow through an orifice (5) for choked flow.

$$\dot{m}_{sonic} = \frac{C_d A_{eff} P_{PCC}}{\sqrt{RT_{PCC}}} \sqrt{k} \left( \frac{2}{k+1} \right)^{\frac{(k+1)}{2(k-1)}}$$

In this case  $C_d A_{eff}$  is unknown. Using previous test data compiled at the EECL (9) while flowing only natural gas to the ePCC in which PCC  $\phi \approx 1.11$ ,  $C_d A_{eff}$  was calculated to be  $4.7 \times 10^{-6} \text{ m}^2$ . Multiplying the sonic mass flow by the duration of ePCC injection returns the delivered mass. The delivered mass calculated from the sonic flow equation agrees with mass flow inputs from the mass flow meters. The sonic flow equation is used to calculate mass flow for rotameter measurements during ePCC fuel metering. When utilizing mass flow meters, mass flow meter readings provide the delivered mass.

Preliminary testing shows correcting the trapped mass equation returns PCC  $\Phi$  for natural gas PCC fueling that agrees with previous work performed on the GMV by Simpson (22). In the following equation,  $C_1 = 0.9$  and  $C_2 = 1.55$  calibrate the perfect mixing model to (22). The pressure used to calculate the reference mass in the equation below is cylinder pressure at ePCC closure.

$$m_{trapped} = m_{ref} [1 - C_1 e^{-C_2 \Delta P_{PCC}}]$$

The model calculates the equivalence ratio in the PCC using the pressure in the PCC at the end of fuel injection and techniques described in previous sections. Figure 3.5 displays a flow chart for perfect mixing model PCC fueling and ePCC fuel metering. With the exception of preliminary testing which utilizes checkvalve fuel metering, all PCC equivalence ratio calculations follow the flow chart in Figure 3.5 utilizing the modified perfect mixing model stated above and ePCC fuel metering depicted in Figure 2.3.

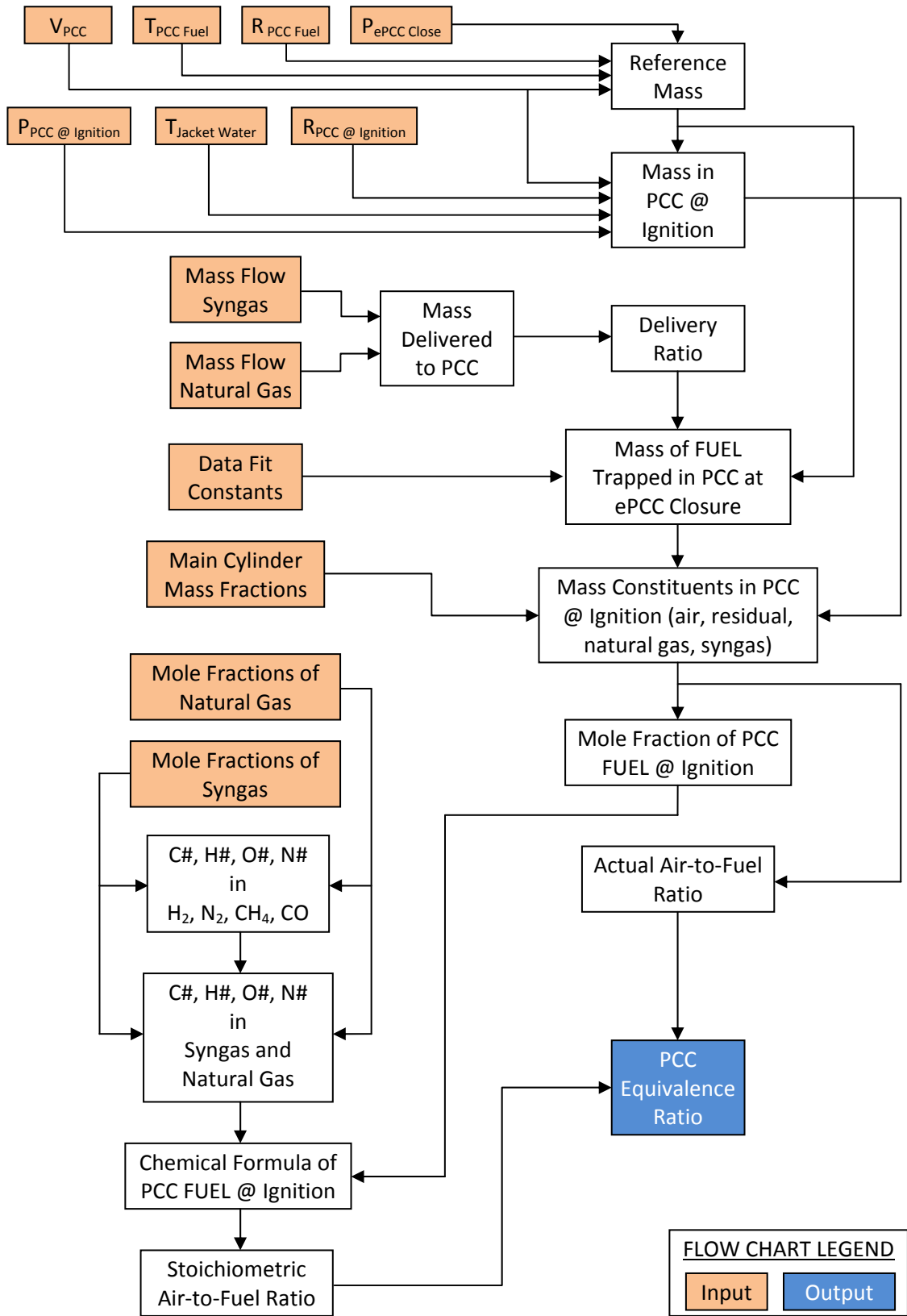
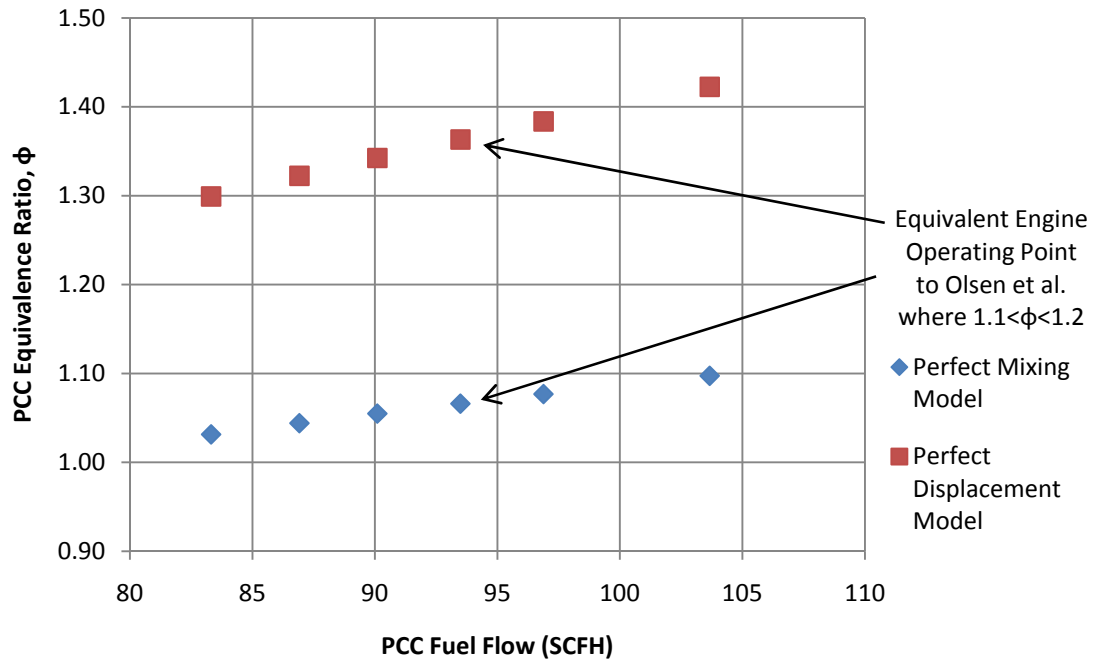


Figure 3.5 - PCC Equivalence Ratio Flow Chart for Modified Perfect Mixing PCC Fueling and ePCC Fuel Metering

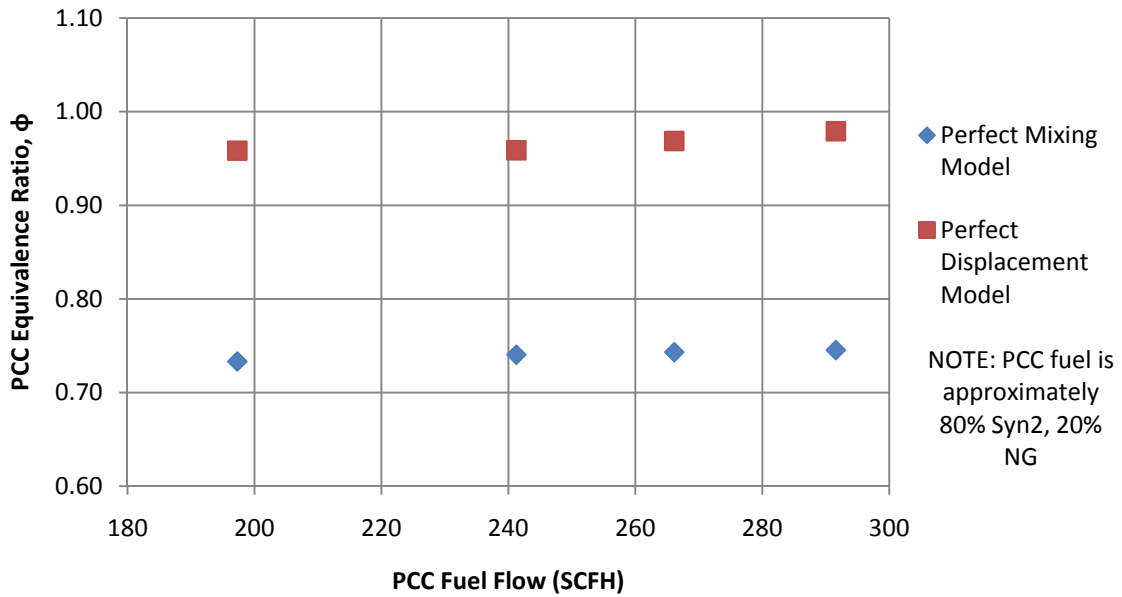


### 3.3 PCC Equivalence Ratio Modeling Results

Figure 3.6 and Figure 3.7 compare PCC  $\Phi$  with standard checkvalve fuel metering for the two fuel retention models for natural gas and syngas 2 respectively. Optimum main cylinder combustion stability occurs with a PCC equivalence ratio between 1.1 and 1.2 (9). A comparison of the calculated  $\Phi$  values in Figure 3.6 and the known  $\Phi$  values given by Olsen et al. (9) shows that the perfect displacement model slightly over predicts PCC  $\Phi$  while the perfect mixing model slightly under predicts PCC  $\Phi$ .



**Figure 3.6 – Comparison of the Perfect Mixing Model and the Perfect Displacement Model for Checkvalve Fuel Metering with Natural Gas**

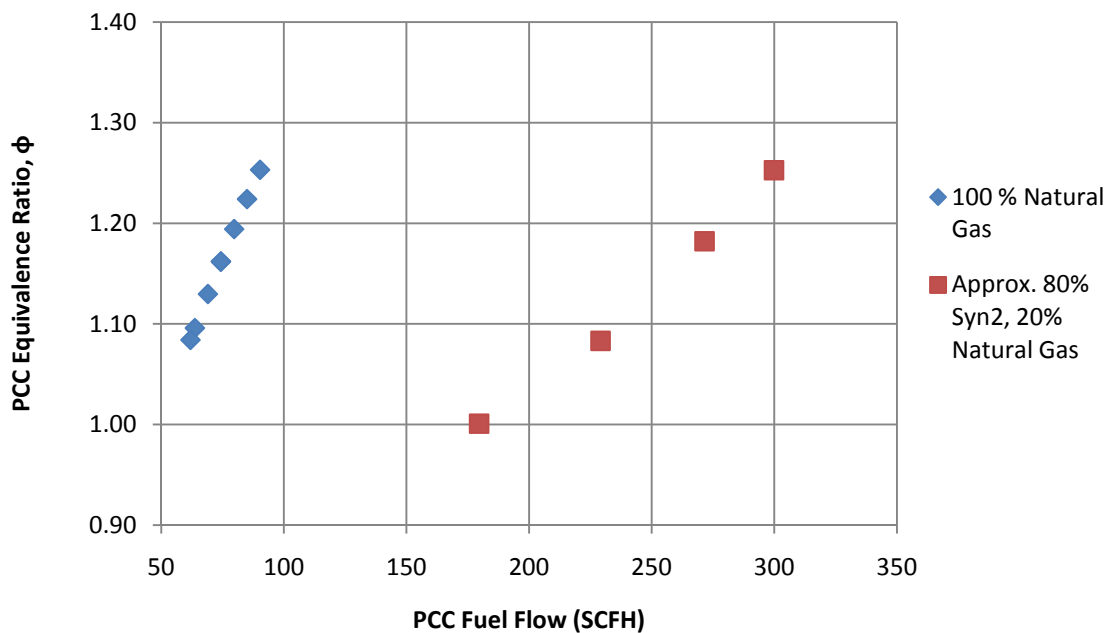


**Figure 3.7 – Comparison of the Perfect Mixing Model and the Perfect Displacement Model for Checkvalve Fuel Metering with Syngas 2**

Further analysis of Figure 3.7 shows that operating the GMV with a standard checkvalve to meter PCC fuel flow does not give an acceptable equivalence ratio for syngas 2 PCC fueling. This is consistent with engine performance seen during preliminary exploratory testing and lends validity to the equivalence ratio calculation for both gases. PCC  $\Phi$  appears to be insensitive to flow rate when operating with syngas 2 for standard checkvalve fuel metering. Increasing the flow rate with standard checkvalve metering results in overfilling the PCC, ultimately leaving the  $\Phi$  in the PCC unchanged.

Figure 3.8 plots PCC  $\Phi$  for 100% natural gas PCC fueling and 80% syngas 2 / 20% natural gas PCC fueling. Analysis of Figure 3.8 shows that the ePCC provides significantly greater control over PCC equivalence ratio compared checkvalve metering. The ePCC allows precise regulation over fuel delivery timing, duration, and pressure. The increased pressure in the PCC results in a greater overall mass in the PCC at the end of injection. Also, because the fuel is injected later in

the compression stroke (after EPC), the piston forces less mass from the main cylinder back into the PCC. The combination of these effects results in greater control over PCC  $\Phi$ . While using natural gas as a PCC fuel, an acceptable equivalence ratio is attainable using a standard checkvalve. However, when syngas 2 is used as a PCC fuel, the advantages of the ePCC are necessary in order to realize the required PCC  $\Phi$ . Modeling results for the ePCC are only presented for syngas 2; however, similar results are expected syngas 1.



**Figure 3.8 – Perfect Mixing Model of ePCC Fuel Injection for Natural Gas and Syngas 2**

Exploratory PCC equivalence ratio modeling for a checkvalve with a reduced orifice size shows favorable PCC equivalence ratio results. Reducing the orifice size in the checkvalve will reduce the flowrate through the valve. A checkvalve will allow fuel to flow at anytime in the cycle where the cylinder pressure is less than the pressure in the PCC fuel supply line. Since the flowrate through the orifice is reduced the PCC fuel supply system can be operated at a greater pressure. Increasing the pressure in the fuel supply system allows PCC fueling for a greater

duration, offsetting the reduced orifice size. The combination of these effects may provide an acceptable checkvalve fuel metering scenario for syngas PCC fueling. Results reported herein do not include reduced-orifice checkvalve testing.

## 4 TEST RESULTS AND DISCUSSION

### 4.1 Preliminary Testing with Checkvalve and ePCC Fuel Metering

The purpose of preliminary checkvalve fuel metering engine testing is a “proof of concept” test of syngas as a PCC fuel and the investigation of checkvalve fuel metering as an acceptable fuel metering technology for syngas. Model results indicate standard checkvalve fuel metering will not generate an acceptable PCC equivalence ratio for syngas PCC fueling. The results of preliminary testing determine the fuel metering device used in subsequent testing. Throughout preliminary checkvalve fuel metering testing, an objective function quantifies the benefits of the PCC fuel. The objective function established is:

$$OF = \frac{1}{2} \left[ \frac{NO_x}{NO_{xref}} + \frac{COV_{pp}}{COV_{ppref}} \right]$$

The purpose of this investigation is to determine the effectiveness of fueling the PCC with syngas. Specifically, preliminary testing focuses on establishing an acceptable fuel metering device for syngas PCC fueling. Many different engine parameters can be used to quantify the effect of various PCC fueling parameters.  $COV_{pp}$  and  $NO_x$  emission were chosen for the current evaluation as stated previously.  $COV_{pp}$  and  $NO_x$  emission are highly dependent upon PCC equivalence ratio. A beneficial fuel will either produce lower  $NO_x$  emission at a given  $COV_{pp}$  or lower  $COV_{pp}$  at a given  $NO_x$  level. The reference values for  $NO_x$  and  $COV_{pp}$  were arbitrarily selected from baseline data for the GMV-4TF.

#### 4.1.1 Preliminary Checkvalve Fuel Metering Experimental Procedure

Preliminary tests were conducted with the following engine parameters unless otherwise noted:

|                        |   |
|------------------------|---|
| Intake Manifold Boost: | 18" Hg  |
| Engine Speed:          | 300 RPM   |
| Engine Load:           | 100%  |
| Engine Brake Power:    | 440 bhp   |
| Engine Balance:        | Equivalent Cylinder to Cylinder $COV_{pp}$ ( $\pm 10\%$ of Average $COV_{pp}$ )<br>Location of Peak Pressure at<br>18° aTDC for All Cylinders ( $\pm 1^\circ$ ) |

The engine is balanced at the beginning of each test day by adjusting main cylinder gas admission valves and ignition timing. In general, engine rebalancing is not required for subsequent PCC fuel testing within the same test day. For each PCC fuel type, a fuel sweep is conducted by varying the amount of fuel delivered to the PCC. Rotameters control the PCC fuel flow while implementing checkvalve fuel metering. To provide comparison to checkvalve fuel metering, exploratory testing with ePCC fuel metering compares the two fuel metering technologies. When using the ePCC to meter fuel, injection duration and PCC fuel line pressure control choked fuel flow to the PCC when utilizing rotameters to evaluate gas flow. Mass flow through the ePCC is independent of cylinder pressure since an injection pressure ratio less than the critical ratio ensures choked flow throughout fuel delivery. All preliminary testing utilizes rotameter flow measurements. Subsequent testing implements mass flow meters to quantify fuel delivery to the PCC. As the fuel delivered to the PCC was varied, the following data was collected for each fuel flow rate:

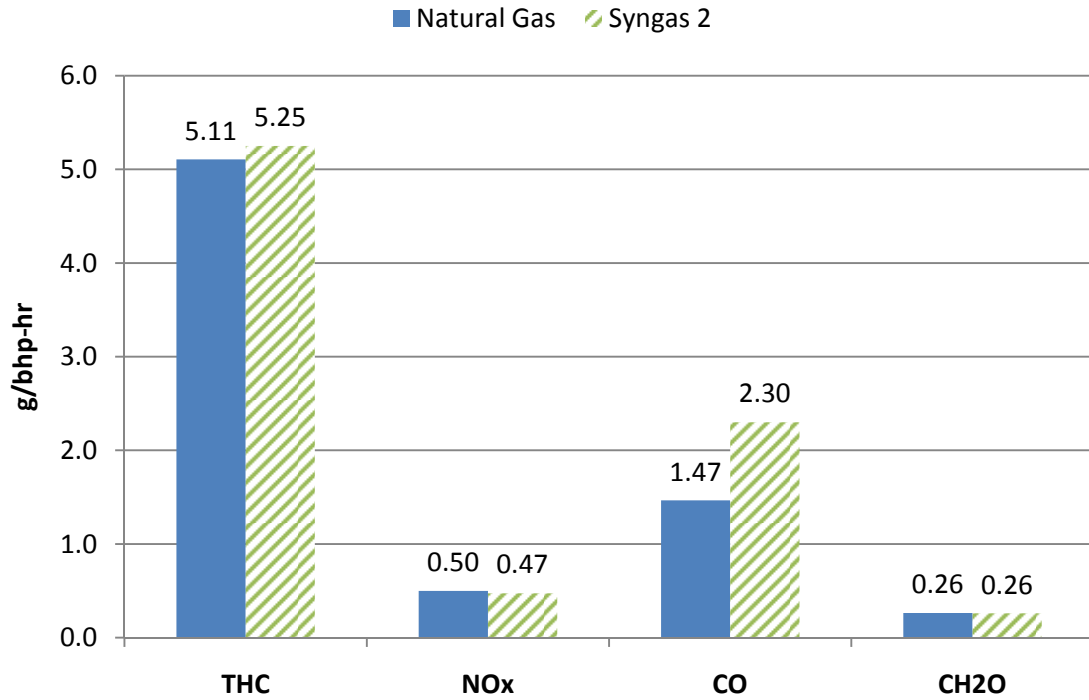
1.  $NO_x$  – 2 minute running average recorded using the Five-Gas analyzer
2.  $COV_{pp}$  – 2 minute running average recorded using the combustion analyzer
3. Rotameter Gas Flow

4. PCC Fuel Temperature
5. PCC Fuel Pressure
6. PCC Fuel Injection Timing (ePCC only)
7. PCC Fuel Injection Duration (ePCC only)
8. PCC Pressure at the End of Injection (ePCC only)
9. Ignition Timing

Varying PCC fuel supply minimizes the objective function, thereby establishing an optimum PCC fuel delivery rate for each PCC fuel type. At this optimum location for each PCC fuel type, three five minute data points are collected. A five minute data point includes comprehensive combustion and emissions data. The minimum objective function was only achieved with natural gas fueling during preliminary checkvalve testing due to problems achieving optimum PCC equivalence ratios for syngas.

#### **4.1.2 Preliminary Checkvalve Fuel Metering Test Results and Discussion**

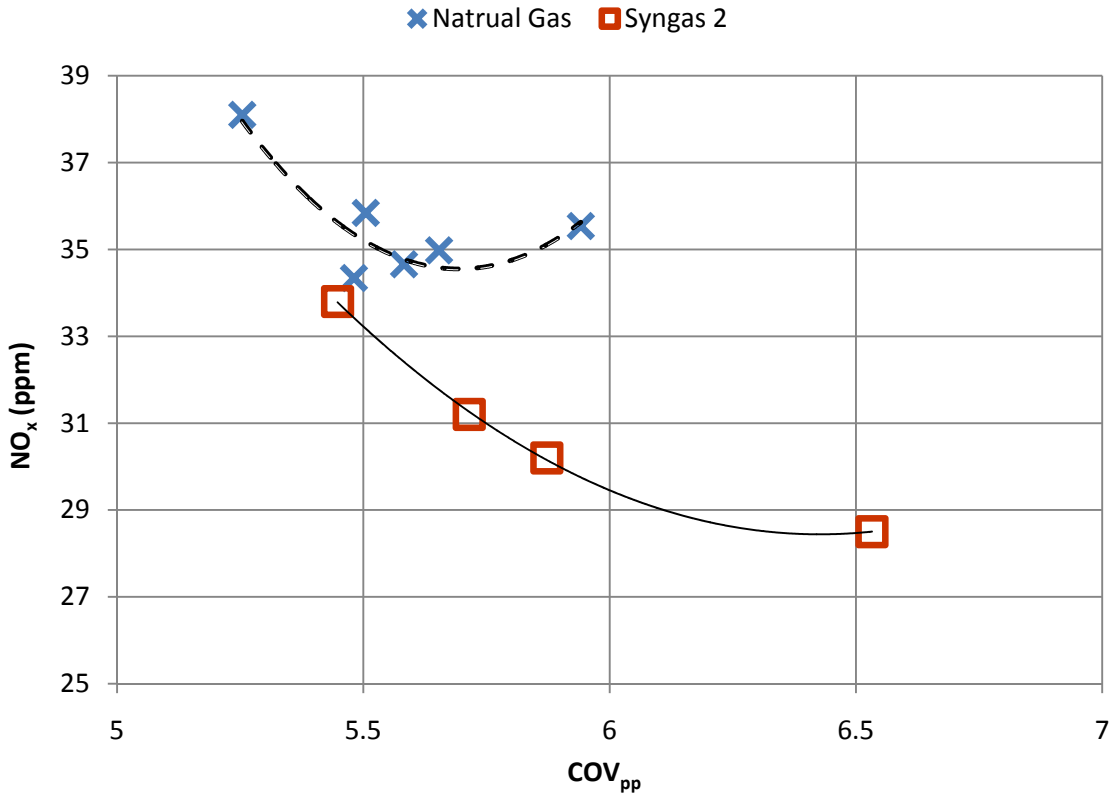
The checkvalve supplies the PCC with fuel whenever the pressure in the PCC is less than the pressure in the PCC fuel line. The PCC equivalence ratio model predicts standard checkvalve fuel metering will not attain an optimum PCC  $\Phi$  for syngas 1 or syngas 2. Therefore, little difference can be seen in engine performance and emission output for syngas fuels compared to natural gas while utilizing checkvalve PCC fuel metering. Figure 4.1 compares the emissions output of the engine for natural gas and syngas 2. While a slight reduction in  $\text{NO}_x$  is perceivable for syngas 2, the difference is insignificant.



**Figure 4.1 - Emission Comparison with Checkvalve Fuel Metering vs. PCC Fuel Type**

Figure 4.2 presents a cross plot of  $\text{NO}_x$  vs.  $\text{COV}_{pp}$ . The data show that for a given  $\text{COV}_{pp}$  value syngas 2 reduce  $\text{NO}_x$  emission. At a  $\text{COV}_{pp}$  value of approximately 5.5,  $\text{NO}_x$  emission for syngas 2 PCC fueling is approximately 5% lower than natural gas PCC fueling. This suggests PCC equivalence ratio optimization may generate a  $\text{NO}_x$  emission reduction at constant  $\text{COV}_{pp}$  for syngas 2 PCC fueling. Reduction in  $\text{COV}_{pp}$  enables main chamber equivalence ratio reduction by increasing intake manifold boost.  $\text{NO}_x$  emission is exponentially related to main cylinder equivalence ratio. Combustion modifications that enable decreases in main cylinder equivalence ratio generally provide the best path to  $\text{NO}_x$  reduction. Operation of the PCC on syngas did not produce  $\text{COV}_{pp}$  values lower than natural gas. This is due to lean PCC equivalence ratios during preliminary checkvalve syngas 2 PCC fueling.





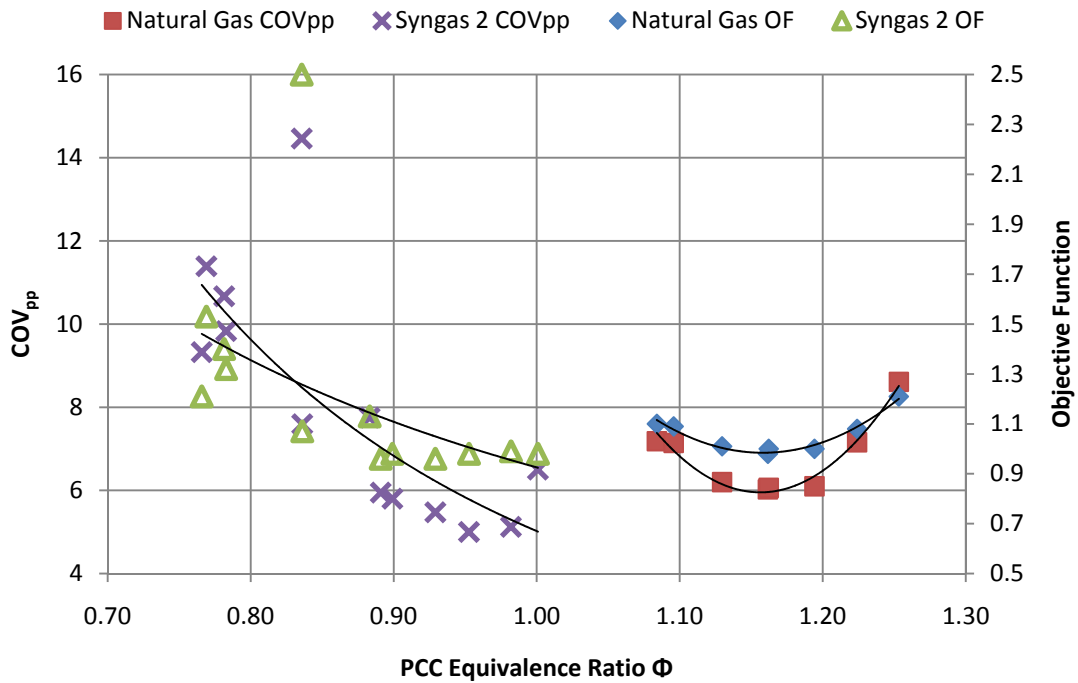
**Figure 4.2 - NO<sub>x</sub> vs. COV<sub>pp</sub> with Checkvalve Fuel Metering**

A series of tests was also conducted with the checkvalve at 25" Hg of intake manifold pressure. The results were similar to what can be seen in Figure 4.1 and Figure 4.2. At both 18" Hg and 25" Hg of boost, syngas 2 did not produce COV<sub>pp</sub> values lower than natural gas due to non-optimal PCC equivalence ratios less than 1.0.

#### **4.1.3 Preliminary ePCC Fuel Metering Test Results and Discussion**

Electronically controlling the fuel delivered to the PCC provides an advantage over checkvalve fuel metering. The modeling results demonstrate PCC equivalence ratio control over a larger range with ePCC fuel metering. Preliminary tests conducted with ePCC fuel metering provide a basis for comparison to checkvalve PCC fuel metering. Preliminary hardware limitations limit PCC injection duration to 30 ms and PCC injection pressure to 120 psig. Figure

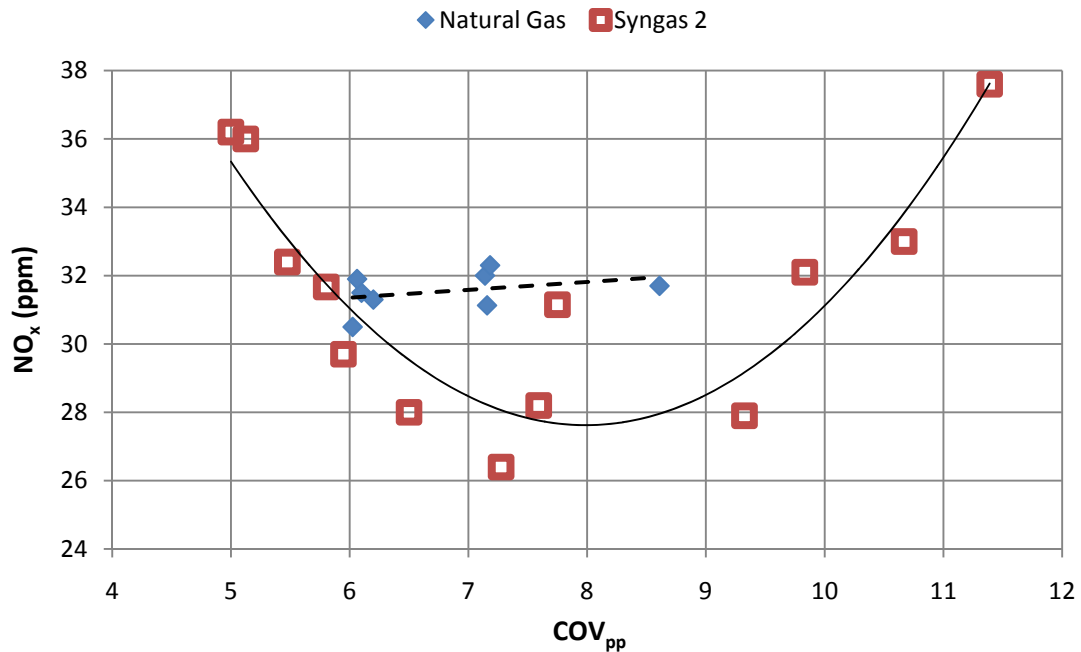
4.3 plots measured main cylinder  $COV_{pp}$  vs. calculated PCC equivalence ratio. Though PCC fueling hardware limits PCC  $\Phi$  for syngas PCC fueling, Figure 4.3 displays favorable results. Notably, syngas 2 PCC fueling generates a lower minimum  $COV_{pp}$  than natural gas PCC fueling. In addition, the trend line applied to  $COV_{pp}$  suggests PCC fueling system adaptations will further reduce  $COV_{pp}$  for syngas 2 PCC fueling through PCC  $\Phi$  optimization.



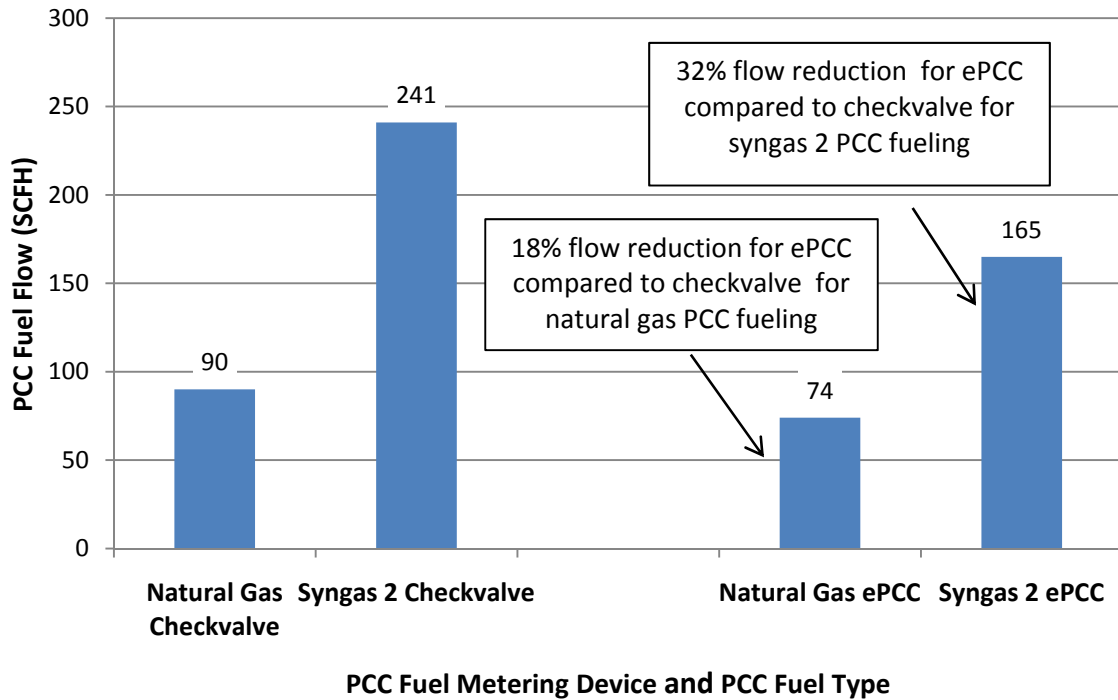
**Figure 4.3 – Measured  $COV_{pp}$  and Objective Function vs. Calculated PCC  $\phi$  with ePCC Fuel Metering**

Figure 4.4 displays a plot similar to Figure 4.2, where ePCC fuel metering is utilized in place of checkvalve fuel metering. Though there is considerable data scatter, the  $NO_x$ - $COV_{pp}$  trade-off appears favorable for syngas 2. Figure 4.5 displays another advantage of the ePCC fuel metering vs. checkvalve fuel metering. Figure 4.5 compares PCC fuel flow for each fueling scenario. The ePCC notably reduces the PCC fuel flow for both natural gas and syngas compared

to checkvalve fuel metering. Less prechamber fuel flows out of the PCC into the main chamber during PCC fueling when utilizing an ePCC to meter prechamber fuel. Checkvalve fuel metering allows fuel to flow into the PCC during the entire main cylinder scavenging process. Main cylinder scavenging occurs for approximately 70°. The ePCC does not fuel the prechamber during scavenging and only fuels the PCC for approximately 27° (natural gas PCC fueling). The reduction in fueling duration for ePCC fuel metering limits the quantity of prechamber fuel that flows out of the PCC into the main cylinder. Additionally, the ePCC fuels the prechamber during piston compression during which the pressure in the main cylinder is continually increasing. The reduction in fueling duration and the increase in cylinder pressure for ePCC fueling results in a reduction in prechamber fuel flow for ePCC fuel metering. Note that syngas 2 refers to an 80% syngas 2 / 20% natural gas mixture in Figure 4.1 through Figure 4.5.

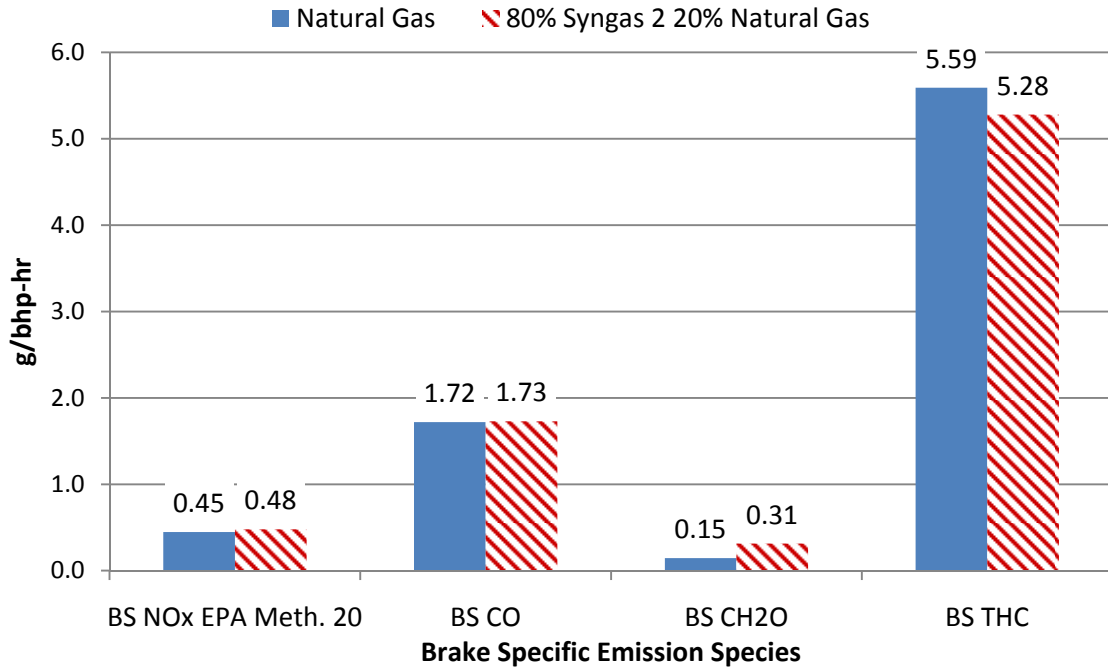


**Figure 4.4 – NO<sub>x</sub> vs. COV<sub>pp</sub> with ePCC Fuel Metering for Natural Gas and 80% Syngas 2 / 20% Natural Gas PCC Fuel Types**

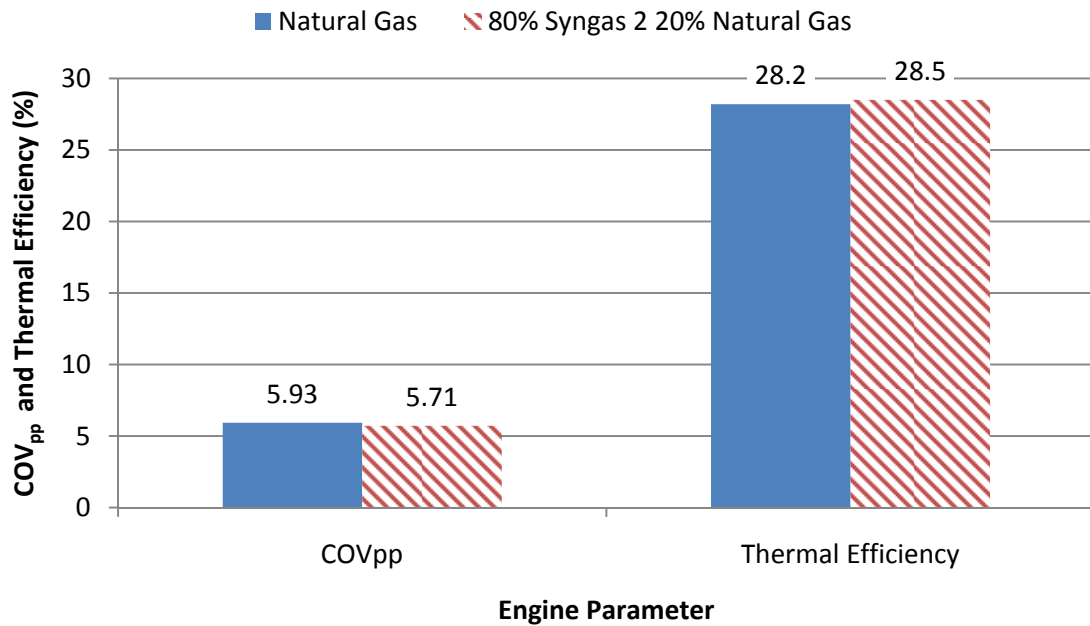


**Figure 4.5 - PCC Fuel Flow Comparison for Checkvalve and ePCC Fuel Metering for Natural Gas and 80% Syngas 2 / 20% Natural Gas PCC Fuel Types**

Figure 4.6 and Figure 4.7 display emissions and engine performance data for five minute data points. The five minute data points captured represent the best operating point for each PCC fuel during preliminary testing. Differences between the two cases are insignificant, with the exception of formaldehyde and main cylinder  $COV_{pp}$ . Syngas 2 PCC fueling shows a significant increase in formaldehyde emissions during preliminary testing. This increase is attributed to non-optimal PCC equivalence ratio for syngas 2. Figure 4.7 shows a slight decrease in main cylinder  $COV_{pp}$  for syngas 2 PCC fueling compared to natural gas fueling. Main cylinder  $COV_{pp}$  is expected to continue to decrease for syngas 2 PCC fueling upon fuel system modifications allowing for further optimization of PCC equivalence ratio for syngas 2 PCC fueling.



**Figure 4.6 – Emission Comparison of Natural Gas and 80% Syngas 2 / 20% Natural Gas for ePCC Fuel Metering**



**Figure 4.7 – COV<sub>pp</sub> and Thermal Efficiency of Natural Gas and 80% Syngas 2 / 20% Natural Gas for ePCC Fuel Metering**

#### **4.1.4 Preliminary Checkvalve Fuel Metering Summary and Conclusions**

Preliminary test results show standard checkvalve fuel metering does not produce optimal PCC equivalence ratios for syngas PCC fueling. ePCC fuel metering for syngas PCC fueling produces a small  $\text{NO}_x$  reduction at an equivalent combustion stability operating point. Testing with syngas 2 suggests that if syngas PCC fueling occurs at an optimized PCC equivalence ratio, main cylinder  $\text{COV}_{pp}$  will be reduced. PCC equivalence ratio model dictates syngas PCC fueling requires a higher injection pressure than natural gas. Fuel delivery system modifications for subsequent testing allow PCC fuel injection pressure up to 230 psi for ePCC fuel metering. All testing in subsequent sections utilizes ePCC fuel metering at appropriate PCC fuel injection pressures.

## **4.2 80% Syngas 2 20% Natural Gas PCC Fueling Optimization**

### **4.2.1 Syngas 2 PCC Fueling Experimental Procedure**

Tests conducted with natural gas PCC fueling at an engine intake manifold pressure of 18" Hg provide baseline data for subsequent syngas 2 PCC fueling tests. The ePCC meters PCC fuel and the modified perfect mixing model calculates PCC fuel retention. Mass flow meter readings provide fuel mass flow to the PCC. The equivalence ratio in the PCC is varied by increasing or decreasing the PCC fuel line pressure. A fuel sweep in collaboration with the PCC equivalence ratio model determines the optimum PCC equivalence ratio for each fueling scenario. Minimum  $\text{COV}_{pp}$  represents an optimum engine operating point. At the optimum operating point, a full data point is recorded. A full data point consists of combustion, 5-gas bench, and FTIR analysis.

In the current tests, syngas and natural gas are blended together. Needle valves shown in Figure 2.3 meter the flow of natural gas to provide a PCC fuel mixture consisting of 20% natural gas and 80% syngas by mass, as suggested by Hiltner and Willi. (23). PCC equivalence ratio sweep is conducted by varying the injection pressure and the injection duration. At the optimum point, a full data point records emission and combustion data for comparison to the optimum natural gas point. Increasing the intake manifold boost level increases the air-to-fuel ratio in the main cylinder and compares equivalent combustion stability operating points. Pollutant emission measurements at equivalent combustion stability operating points can then be analyzed.

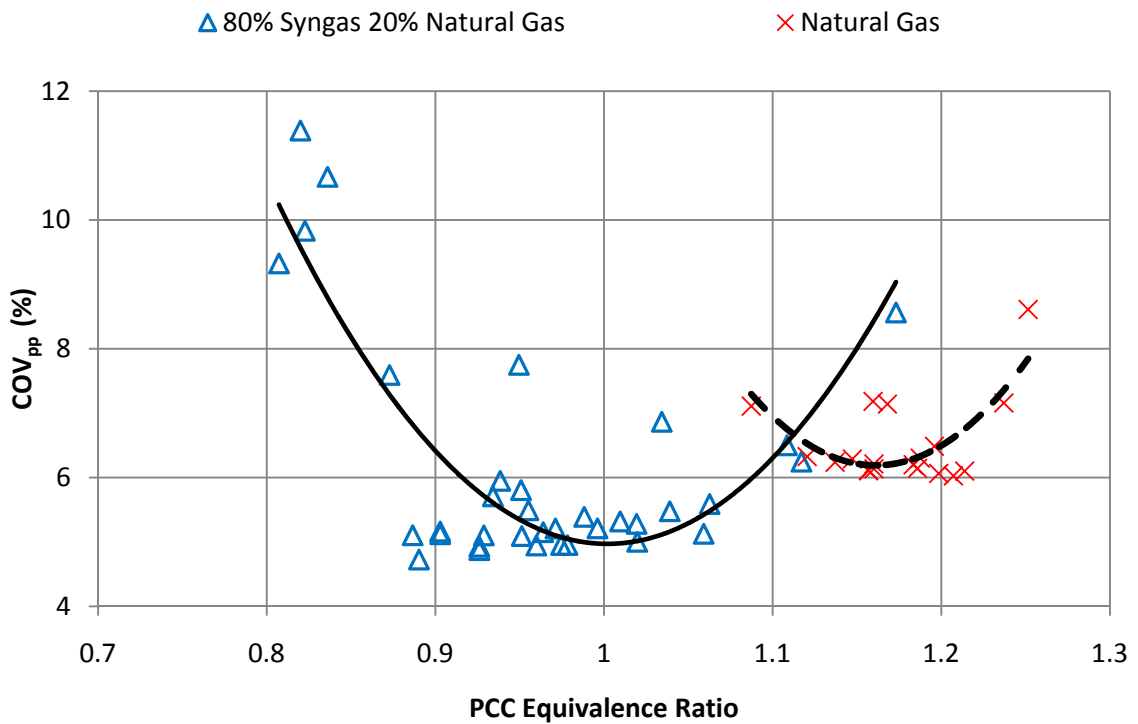
#### **4.2.2 Syngas 2 PCC Fueling Test Results and Discussion**

##### **4.2.2.1 Syngas 2 PCC Equivalence Ratio Optimization**

Figure 4.8 plots the measured main cylinder  $COV_{pp}$  versus the PCC equivalence ratio calculated from the model. The measured  $COV_{pp}$  values are two minute running average points. The mass flow of fuel to the PCC is incrementally varied to perform the equivalence ratio sweep. A calculated PCC  $\Phi$  between 1.1 and 1.2 for natural gas PCC fueling minimizes main cylinder  $COV_{pp}$ . At this minimized  $COV_{pp}$  location, combustion stability is optimized for natural gas PCC fueling. At the minimized  $COV_{pp}$  PCC fueling point, a full five minute engine data point records complete emission and engine operating data.

Fueling the PCC with a mixture of approximately 80% syngas 2 and 20% natural gas on a mass percent basis produces different results than natural gas PCC fueling. Subsequent references to syngas PCC fueling within Section 4.2 are for an 80%/20% syngas 2/natural gas blend unless specified otherwise. For syngas fueling, the PCC equivalence ratio model predicts that optimum combustion stability occurs near stoichiometric PCC equivalence ratios. At this

optimum  $COV_{pp}$  location, a full five minute data point records complete engine and emission data. The discrepancy between the optimum PCC  $\Phi$  for natural gas fueling and syngas fueling is unclear. Many different fuel characteristics work in concert determining the optimum equivalence ratio for each unique fuel. The scope of the current work does not include a full evaluation of the source or sources of this difference, though the discrepancy between flame speed, specific energy content, and flammability limits presented earlier provide plausible explanations.



**Figure 4.8 - Measured Main Cylinder  $COV_{pp}$  vs. Calculated PCC Equivalence Ratio**

Further analysis of Figure 4.8 shows main cylinder combustion is more stable for syngas PCC fueling than natural gas fueling. The lowest  $COV_{pp}$  reached with natural gas fueling was approximately 6%. However, syngas fueling enabled engine operation at a  $COV_{pp}$  value near 5%. Further discussion on the benefit of improved combustion stability is found in subsequent sections.



The objective function established for preliminary testing is a normalized average of main cylinder COVpp and NOx emission. Syngas fueling generated significant changes in main cylinder COVpp but minimal changes in NO<sub>x</sub> emission at an equivalent intake manifold pressure. Therefore, the use of objective function was limited to preliminary investigations. All subsequent testing utilizes minimized main cylinder COVpp as the definition of an optimal PCC fueling point.

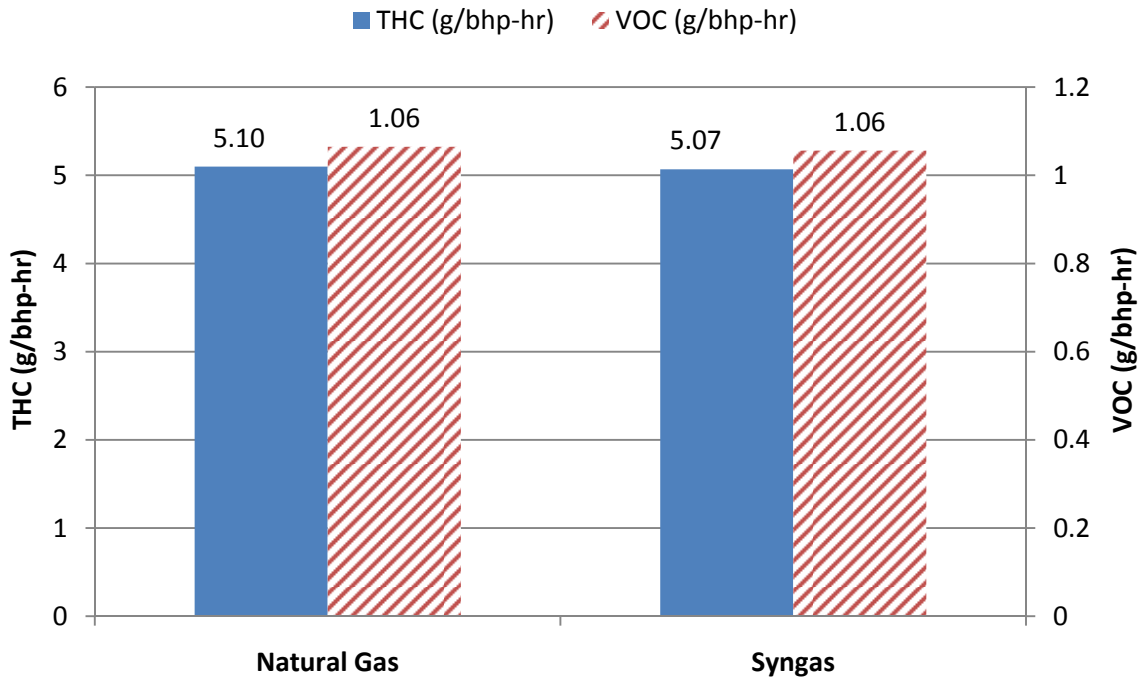
Table 4.1 provides the fuel delivery parameters at the optimized PCC equivalence ratio as determined by combustion stability for each fuel type. A significant difference exists between the delivery parameters required to optimize syngas PCC fueling compared to natural gas fueling. Test results revealed optimizing syngas PCC fueling requires a higher injection pressure and longer injection duration, increasing the total fuel flow delivered to the PCC. This is likely due to the difference in specific energy between syngas and natural gas. For both natural gas and syngas PCC fueling scenarios, combustion stability appeared to be relatively insensitive to small changes ( $\pm 10^\circ$ ) in crank angle location of injection.

**Table 4.1 - PCC Fuel Delivery Parameters at Optimized PCC Equivalence Ratio for 80% Syngas 2 / 20% Natural Gas Fueling**

| PCC Fuel Delivery Parameter             | PCC Fuel Type |                                |
|---|---------------|--------------------------------|
|   | Natural Gas   | 80% Syngas 2 / 20% Natural Gas |
| Location of Injection ( $^\circ$ bTDC)  | 100           | 98                             |
| Injection Duration (ms)                 | 15            | 20                             |
| PCC Fuel Pressure (psig)                | 90            | 165                            |
| Total PCC Fuel Flow (SLM)               | 33            | 70                             |
| Mass Percent of Natural Gas in PCC Fuel | 100%          | 20%                            |

**4.2.2.2 Emission Comparison at Equivalent Intake Manifold Pressure Operating Point**

Figure 4.9 – Figure 4.11 compare PCC fuel type versus combustion stability ( $COV_{pp}$ ) and the emission of CO,  $NO_x$ , THC, volatile organic compounds (VOC), and formaldehyde ( $CH_2O$ ) at an intake manifold pressure of 18” Hg. For brevity, Figure 4.9 - Figure 4.11 denote the 80% syngas 20% natural gas mixture as “Syngas.”



**Figure 4.9 – Natural Gas vs. 80% Syngas 2 / 20 % Natural Gas PCC Fueling Brake Specific Emission of THC and VOC at 18” Hg Boost**

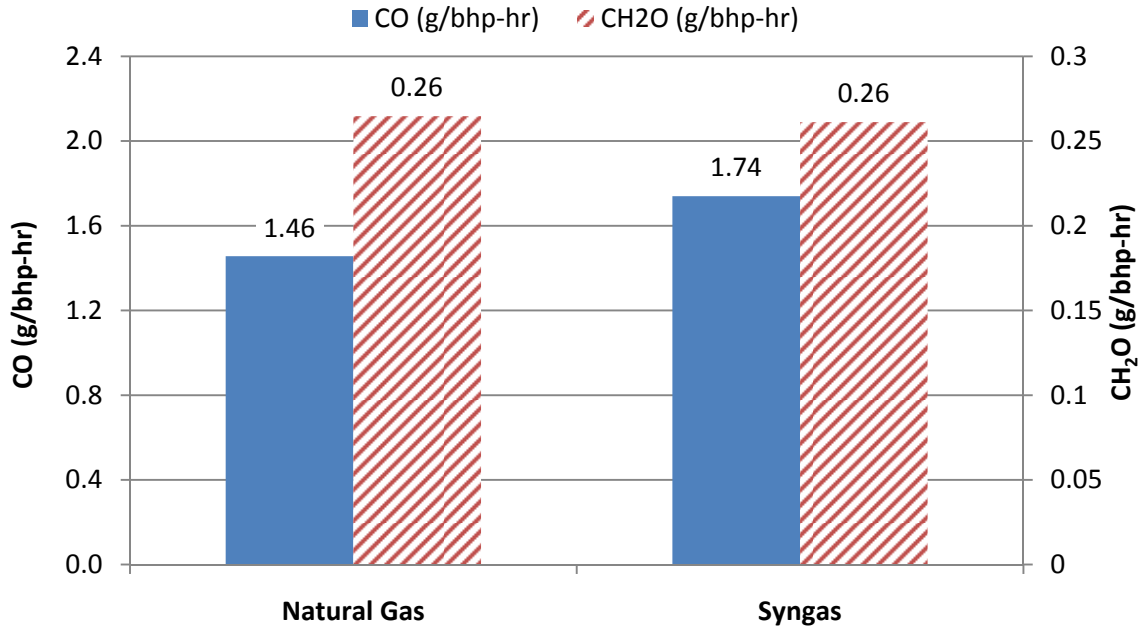


Figure 4.10 - - Natural Gas vs. 80% Syngas 2 / 20 % Natural Gas PCC Fueling Brake Specific Emission CO and CH<sub>2</sub>O at 18" Hg Boost

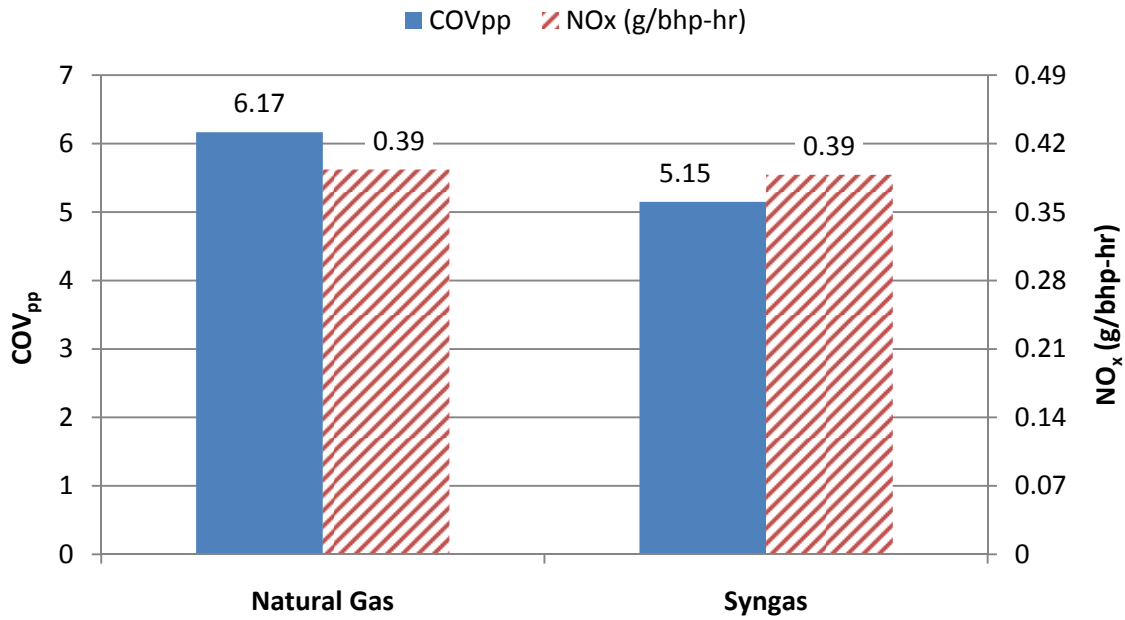


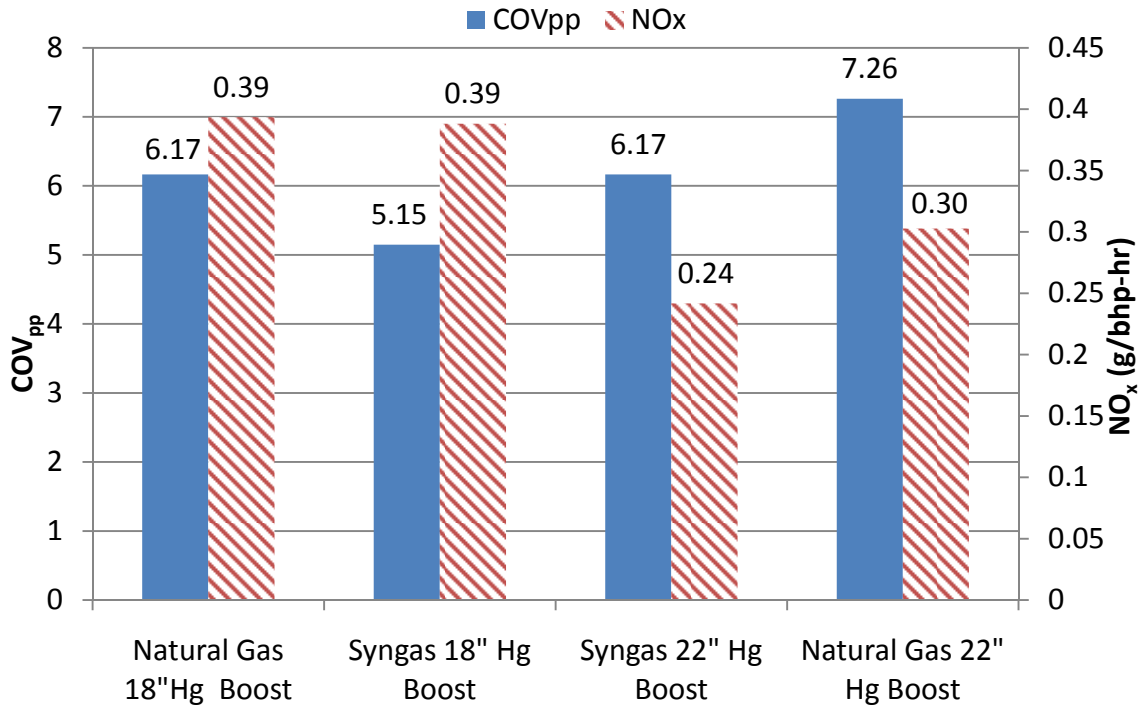
Figure 4.11 - Natural Gas vs. 80% Syngas 2 / 20 % Natural Gas PCC Fueling Main Cylinder COV<sub>pp</sub> and Brake Specific NO<sub>x</sub> Emission at 18" Hg Boost

Analysis of the emissions data shows that at an equivalent intake manifold pressure of 18" Hg CH<sub>2</sub>O, VOC, THC, and NO<sub>x</sub> emissions showed slight or no variation when comparing natural gas PCC fueling to syngas fueling. CO emission rose approximately 20% while fueling the PCC with syngas compared to natural gas. The increase in CO emission is potentially attributed to the CO present in syngas. COV<sub>pp</sub> for syngas PCC fueling decreased approximately 16% compared to natural gas fueling. This is a significant increase in combustion stability.

#### **4.2.2.3 Emission Comparison at Equivalent Combustion Stability Operating Point**

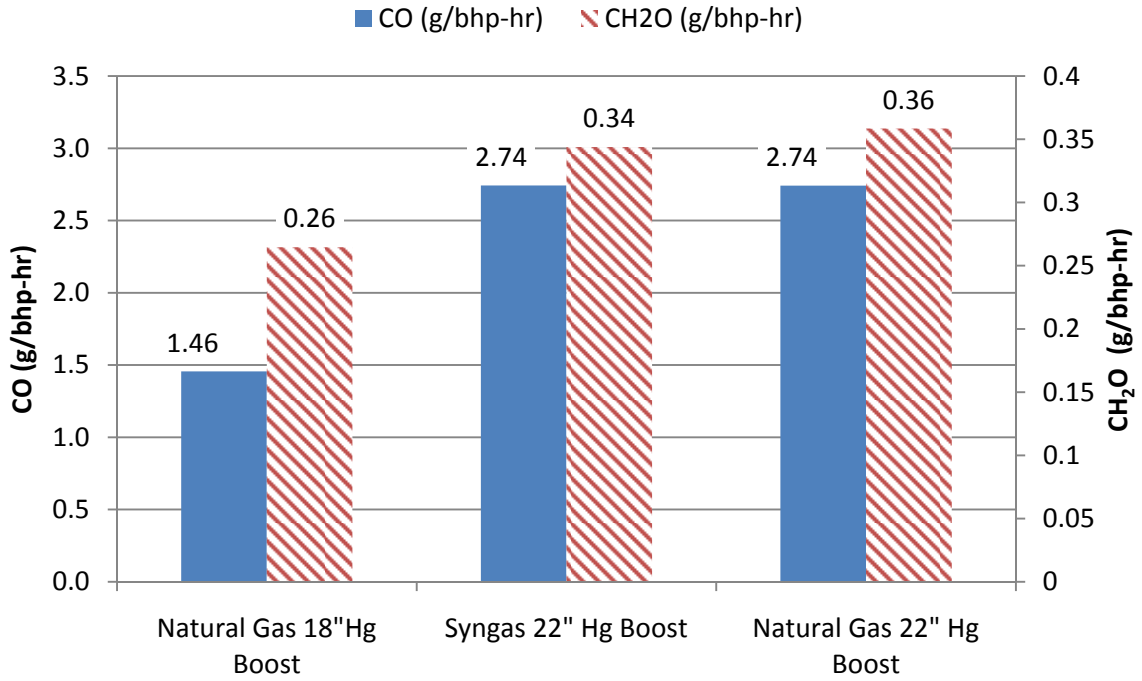
Fueling the PCC with syngas 2 produced a lower main cylinder COV<sub>pp</sub> compared to natural gas fueling (see Figure 4.8). The benefit of syngas 2 fueling can be seen by increasing intake manifold boost while fueling the PCC with syngas 2 to match the COV<sub>pp</sub> level of natural gas fueling at 18" Hg boost. As the intake manifold boost level increases, main cylinder equivalence ratio decreases. At 22" Hg boost, main cylinder trapped  $\Phi \approx 0.52$ . Engine pressure drop is maintained constant at 2.5" Hg. As boost increases from 18 to 22" Hg, the engine back pressure increases from 15.5 to 19.5" Hg.

Figure 4.12 compares PCC fuel type and intake manifold pressure versus main cylinder COV<sub>pp</sub> and NO<sub>x</sub> emission. Previous work by Olsen, et al. (9) concludes that NO<sub>x</sub> decreases exponentially as intake manifold boost increases due to the associated decrease in main chamber trapped equivalence ratio. This is consistent with results produced in the current work. For syngas 2 PCC fueling, increasing intake manifold boost by 22% resulted in a 20% increase in COV<sub>pp</sub> and a 40% reduction in NO<sub>x</sub> emission. Comparing natural gas PCC fueling at 18" Hg boost to syngas 2 PCC fueling at 22" Hg boost shows a 40% reduction in NO<sub>x</sub> emission at an equivalent combustion stability operating point. The 40% reduction in NO<sub>x</sub> results from a decrease in main chamber trapped equivalence ratio from 0.57 for 18"Hg/natural gas to 0.52 for 22"Hg/syngas 2.

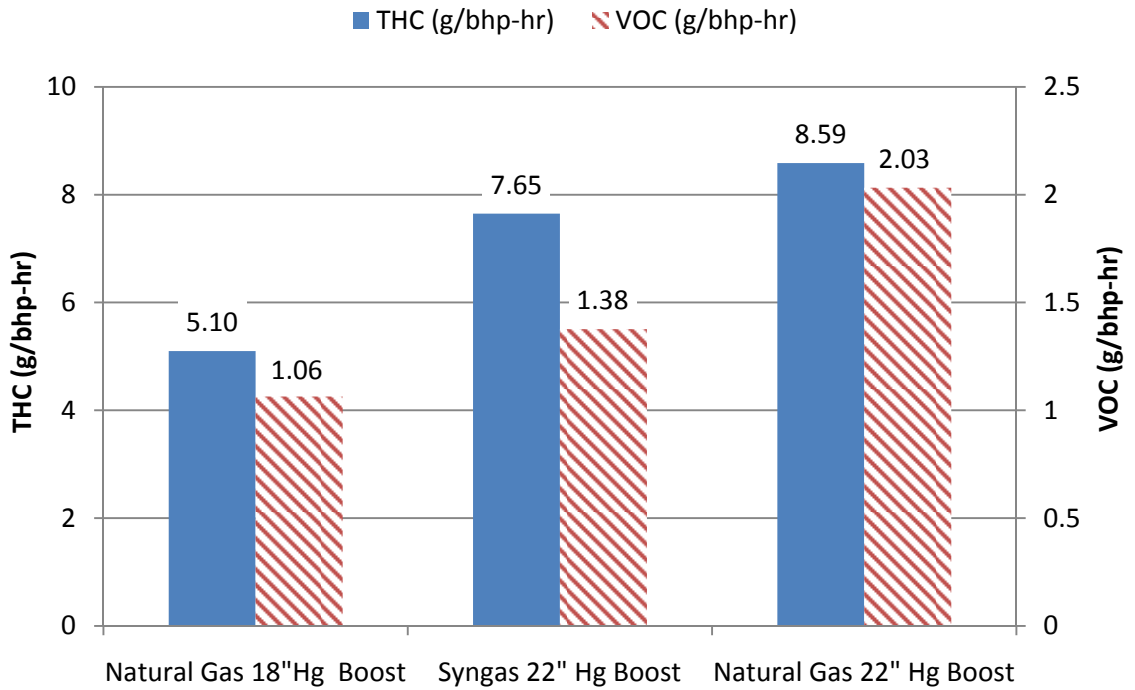


**Figure 4.12 – Main Cylinder COV<sub>pp</sub> and Brake Specific NO<sub>x</sub> Emission for Natural Gas vs. 80% Syngas 2 / 20% Natural Gas PCC Fueling at Equivalent Intake Manifold Boost Points and at Equivalent Combustion Stability Points**

Figure 4.13 and Figure 4.14 compare natural gas PCC fueling at 18" Hg boost to syngas 2 PCC fueling at 22" Hg versus the emission of CO, CH<sub>2</sub>O, VOC's, and THC. Though increasing intake manifold pressure while fueling the PCC with syngas 2 to match the COV<sub>pp</sub> of natural gas results in a decrease in NO<sub>x</sub> emission, the emission of CO, CH<sub>2</sub>O, VOC's and THC all increase. Relative to natural gas PCC fueling at 18" Hg, Figure 4.13 shows CO emission increased by 88% and CH<sub>2</sub>O emission increased by 30%. Figure 4.14 reveals a 50% increase in THC emission and a 29% increase in VOC emission. With the exception of CO, these increases are independent of PCC fuel type and are connected to the decrease in main cylinder trapped equivalence ratio. Products of partial combustion generally increase with a decrease in main chamber trapped equivalence ratio, the opposite trend of NO<sub>x</sub>. The increase in CO is from two effects, decreased main chamber trapped equivalence ratio and the CO present in syngas.



**Figure 4.13 - Natural Gas vs. 80% Syngas 2 / 20% Natural Gas PCC Fueling Brake Specific Emission of CO and CH<sub>2</sub>O at Equivalent Combustion Stability Points**



**Figure 4.14 - Natural Gas vs. 80% Syngas 2 / 20% Natural Gas PCC Fueling Brake Specific Emission of THC and VOC at Equivalent Combustion Stability Points**

Figure 4.12 – Figure 4.14 also compare natural gas PCC fueling to syngas 2 PCC fueling at 22” Hg intake manifold boost. At 22” Hg boost, the  $COV_{pp}$  of natural gas is greater than 7 and pollutant emissions are as great or greater than the 22” Hg boost syngas 2 fueling case. The greater increase in pollutant formation for the natural gas PCC fueling scenario compared to the syngas PCC fueling scenario is due to the effects of poor combustion. As the  $COV_{pp}$  value rises, the formation of the products of partial combustion increases disproportionately. The benefit of syngas 2 PCC fueling is realized through an increase in combustion stability and reliability at any given intake manifold boost. Effectively, syngas 2 PCC fueling increases the lean limit of the engine.

### **4.3 80% Syngas 1 20% Natural Gas PCC Fueling Optimization**

#### **4.3.1 Syngas 1 PCC Fueling Experimental Procedure**

Similar to the experimental procedure for syngas 2, the ePCC meters PCC fueling and the modified perfect mixing model calculates PCC fuel retention during syngas 1 PCC fueling. Mass flow meters provide fuel mass delivered to the prechamber during PCC fueling. Varying the fuel supply pressure and injection duration performs a fuel sweep for syngas 1 PCC fueling. Prior sections discussed the results of fueling the PCC with syngas 2, which has 33.2% nitrogen content by mole. The ratio of combustible gases in syngas 1 is similar to syngas 2 but syngas 1 contains 54.6% nitrogen by mole (See Table 1.2). The increase in diluent with syngas 1 affects combustion stability and pollutant emissions. A needle valve meters natural gas flow at a rate of 20% natural gas / 80% syngas 1 by mass. The PCC equivalence ratio model predicts the PCC equivalence ratio for each fuel type based on measured fuel supply parameters. Two minute running average data points near the calculated optimum PCC  $\Phi$  experimentally confirm the location of optimal syngas 1 PCC fueling scenario. A full five minute data point collects complete

combustion and emission data at the optimized PCC fueling parameters. PCC fueling scenarios tested for 80% syngas 1 / 20% natural gas are based on work performed by Hiltner and Willi (23).

#### 4.3.2 Syngas 1 PCC Fueling Test Results and Discussion

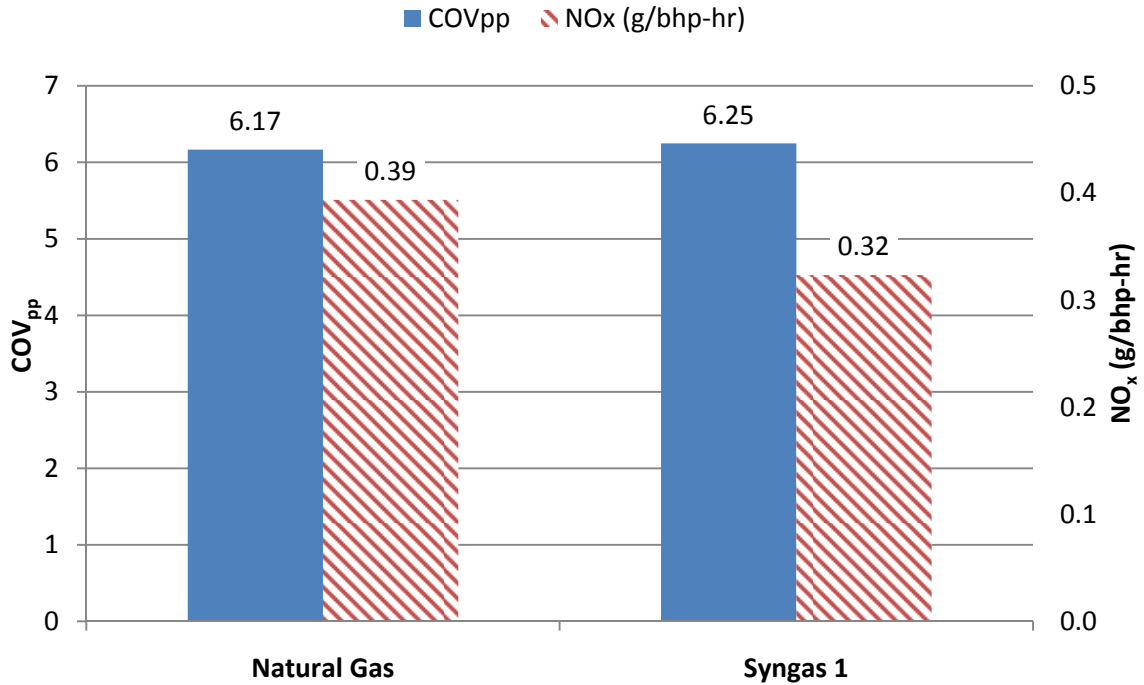
Table 4.2 compares the optimized PCC fueling parameters for 80% syngas 1 / 20% natural gas to 100% natural gas. Syngas 1 PCC fueling requires a significant increase in fuel supply pressure compared to both natural gas PCC fueling and syngas 2 PCC fueling. The increase in pressure is due to the increase in diluent present in syngas 1 compared to syngas 2. The PCC requires a specific quantity of flammable gaseous mass in the PCC fuel to promote good main cylinder combustion stability. As stated previously, the energy content in natural gas is approximately 6½ times the energy content in syngas 1, giving rise to the increase in fuel supply pressure for syngas 1.

**Table 4.2 - PCC Fuel Delivery Parameters at Optimized PCC Equivalence Ratio for Syngas 1 Fueling**

| PCC Fuel Delivery Parameter             | PCC Fuel Type |                                |
|---|---------------|--------------------------------|
|   | Natural Gas   | 80% Syngas 1 / 20% Natural Gas |
| Location of Injection (°bTDC)           | 100           | 81                             |
| Injection Duration (ms)                 | 15            | 20                             |
| PCC Fuel Pressure (psig)                | 90            | 225                            |
| Total PCC Fuel Flow (SLM)               | 33            | 92                             |
| Mass Percent of Natural Gas in PCC Fuel | 100%          | 20%                            |

Figure 4.15 through Figure 4.17 compare the results of fueling the PCC with 80% syngas 1 / 20% natural gas to 100% natural gas PCC fueling. Figure 4.15 plots main cylinder combustion stability and brake specific NO<sub>x</sub> emission vs. PCC fuel type. Syngas 1 PCC fueling results in an equivalent main cylinder COV<sub>pp</sub> and a 18% reduction in NO<sub>x</sub> emission.





**Figure 4.15 – Natural Gas vs. 80% Syngas 1 / 20% Natural Gas PCC Fueling vs. Main Cylinder COV<sub>pp</sub> and Brake Specific NO<sub>x</sub> Emission at 18” Hg Intake Manifold Boost**

Figure 4.16 plots PCC fuel type vs. brake specific emission of CO and CH<sub>2</sub>O. Analysis of Figure 4.16 shows that fueling the PCC with an 80%/20% blend of syngas 1 and natural gas results in a 19% increase in CO emission and equivalent emission of formaldehyde. Figure 4.17 plots the brake specific emission of THC and VOC vs. PCC fuel type. Syngas 1 PCC fueling produces equivalent THC and VOC emission compared to natural gas PCC fueling.

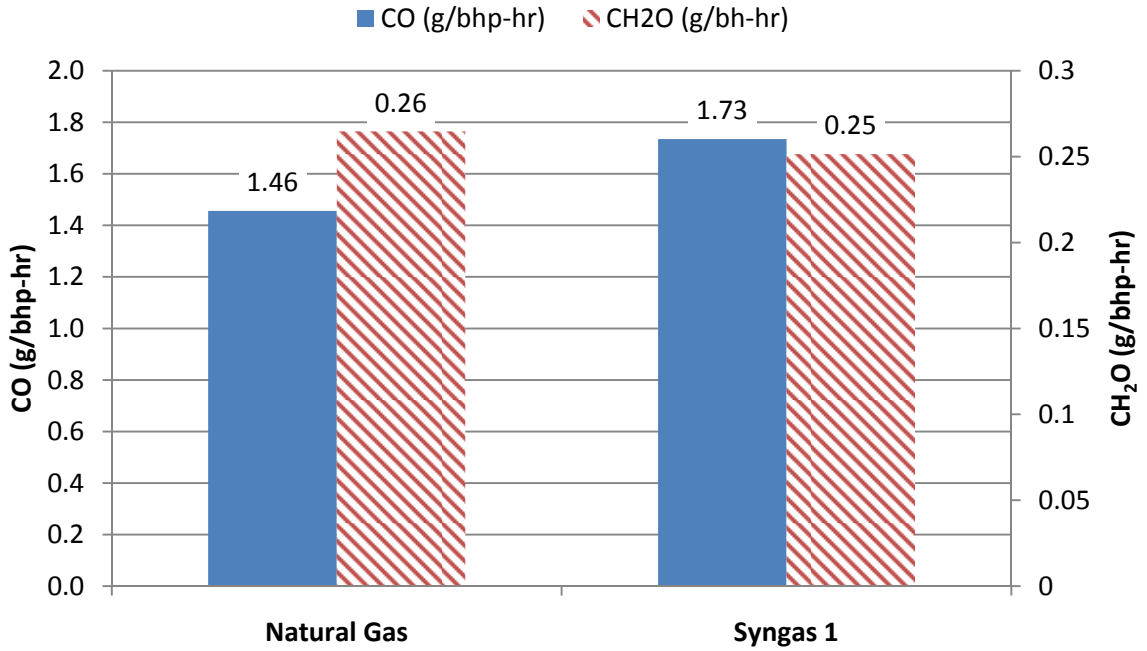


Figure 4.16 – Natural Gas vs. 80% Syngas 1 / 20% Natural Gas PCC Fueling vs. Brake Specific Emission of CO and CH<sub>2</sub>O at 18" Intake Manifold Boost

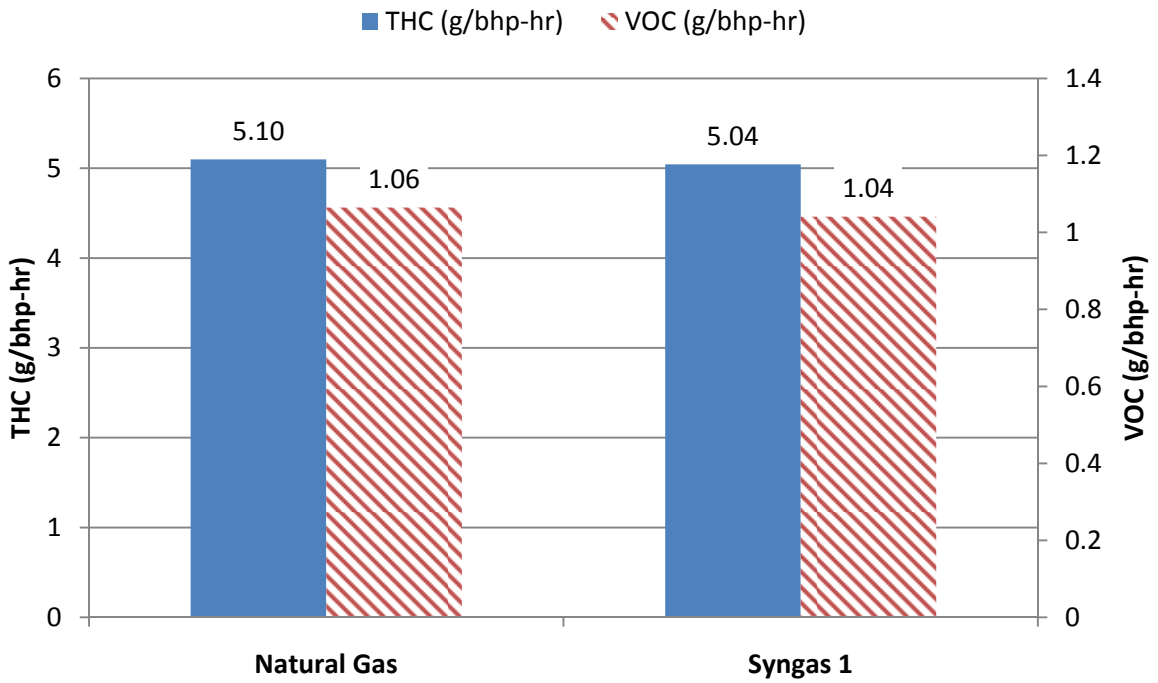


Figure 4.17 - Natural Gas vs. 80% Syngas 1 / 20% Natural Gas PCC Fueling vs. Brake Specific Emission of THC and VOC at 18" Hg Intake Manifold Boost

At 18" Hg intake manifold pressure fueling the PCC with an 80%/20% mixture of syngas 1 and natural gas produces differing results for syngas 1 compared to syngas 2. Syngas 2 PCC fueling generates a significant improvement in combustion stability compared to natural gas PCC fueling, while syngas 1 PCC fueling generates an equivalent main cylinder  $COV_{pp}$  compared to natural gas PCC fueling. Syngas 1 PCC fueling produces an increase in CO emission similar to syngas 2 PCC fueling when comparing either syngas composition to natural gas PCC fueling. Syngas 1 fueling reduced  $NO_x$  emission by 18% compared to natural gas fueling, while syngas 2 fueling  $NO_x$  emission is equivalent to natural gas PCC fueling when comparing equivalent intake manifold pressure operating points. Syngas 1 PCC fueling  $NO_x$  reduction is likely attributed to the increase levels of diluents in the PCC fuel. Similar to Exhaust Gas Recirculation (EGR) technology, increasing the diluents present during combustion lowers the combustion temperatures, reducing  $NO_x$  (6). Syngas 2 has a lower percentage of diluents and therefore does not directly reduce  $NO_x$  emission.  $NO_x$  emission can be reduced when fueling the PCC with syngas 2 by increasing the intake manifold pressure to match the  $COV_{pp}$  of natural gas.

## **4.4 Percent Syngas 2 Fuel Sweep**

### **4.4.1 Percent Syngas 2 Fuel Sweep Experimental Procedure**

Previous testing reported in Section 4.2 utilized an 80% syngas 2 / 20% natural gas PCC fuel mixture based on work performed by Hiltner and Willi (23). The current work optimizes the percent mixture of syngas 2 and natural gas. As shown previously in Figure 2.3, needle valves meter the flow of natural gas and syngas in the PCC fuel supply line and mass flow meters measure the quantity of natural gas and syngas, respectively. The percent syngas in the PCC fuel

is a mass percentage. Adjusting the needle valve varies the percent syngas in the PCC fuel at percent syngas 2 ratios of 0%, 20%, 40%, 60%, 80%, 90%, and 100%. The PCC equivalence ratio model calculates the required fuel delivery parameters for optimal PCC  $\Phi$  at each percent mixture point. A limited range PCC fuel sweep is conducted utilizing two minute running average data points at each percent mixture point to verify optimal PCC  $\Phi$ . Optimal PCC equivalence ratio is defined as the PCC fueling parameters that minimize main cylinder COV<sub>pp</sub>. Table 4.3 shows the PCC equivalence ratio values calculated by the model and the PCC equivalence ratio used during the tests based on the model values and the PCC fuel sweep. At the optimized operating point, a full five minute data point records complete combustion and emission data. Optimization of combustion stability was pursued so NO<sub>x</sub> reductions could be realized through increasing the intake manifold, further extending the lean limit of operation.

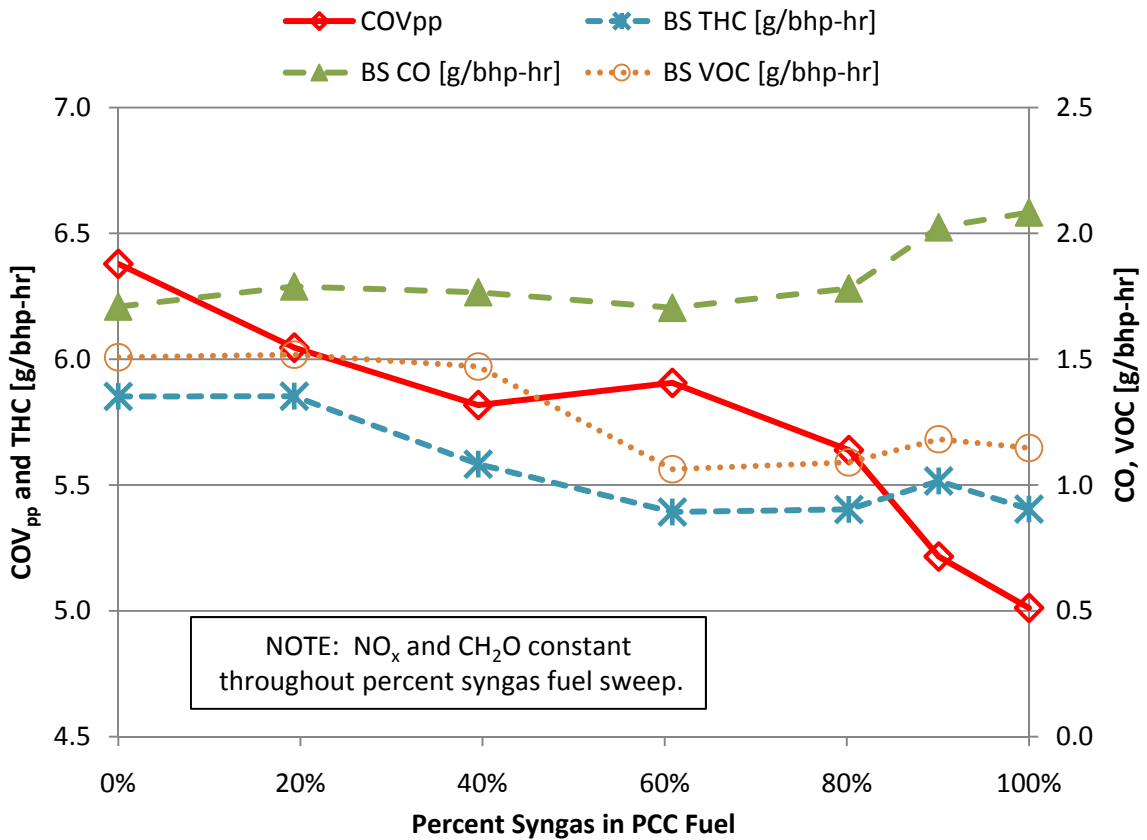
**Table 4.3 - PCC Equivalence Ratio during Percent Syngas 2 Fuel Sweep**

| <b>Percent Syngas in PCC Fuel</b>                               | <b>0%</b> | <b>20%</b> | <b>40%</b> | <b>60%</b> | <b>80%</b> | <b>90%</b> | <b>100%</b> |
|---|-----------|------------|------------|------------|------------|------------|-------------|
| <b>Calculated PCC <math>\Phi</math></b>                         | 1.15      | 1.11       | 1.07       | 1.03       | 0.99       | 0.97       | 0.95        |
| <b>Optimal PCC <math>\Phi</math> Verified by PCC Fuel Sweep</b> | 1.17      | 1.11       | 1.05       | 1.04       | 0.99       | 1.06       | 1.08        |

#### **4.4.2 Percent Syngas 2 Fuel Sweep Test Results and Discussion**

Figure 4.18 shows the relationship between the percent of syngas 2 in the PCC fuel and main cylinder combustion stability and critical pollutant emission. Each marker in Figure 4.18 represents a five-minute full engine data point in which complete combustion and emission data were recorded. Analysis of Figure 4.18 reveals a 21% reduction in main cylinder COV<sub>pp</sub> as the percent of syngas 2 in the PCC fuel increases from 0% to 100%. Fueling the PCC with 100% syngas 2 also reduced THC by 8% and VOC by 24% compared to natural gas fueling alone. The reduction of THC and VOC emission is likely attributed to the improvement in combustion

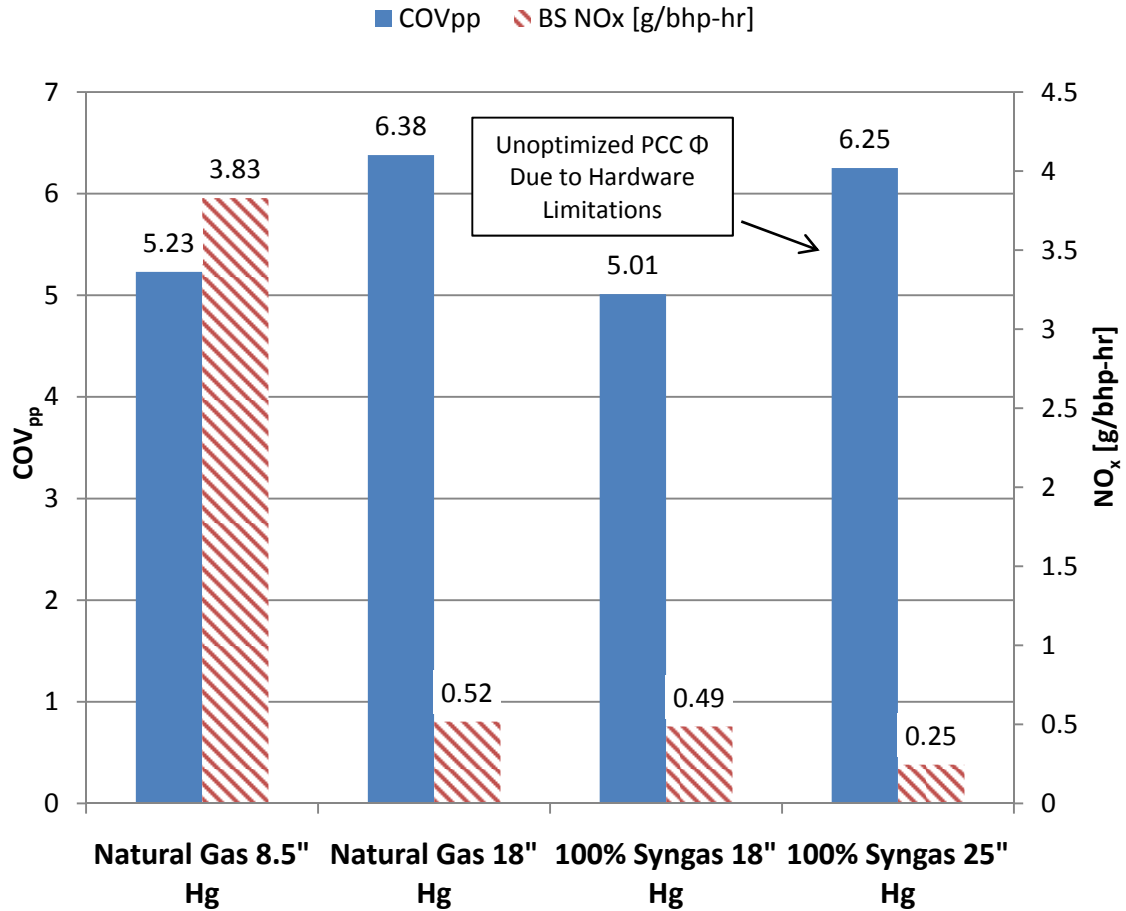
stability. The emission of CO rose by 22% as the percentage of syngas 2 increases from 0% to 100%. This increase is consistent with 80%/20% syngas 2/natural gas tests (Section 4.2) and likely a result of the CO present in the syngas fuel composition. The emissions of NO<sub>x</sub> and CH<sub>2</sub>O (not shown on plot) were constant throughout the percent syngas 2 PCC fuel sweep.



**Figure 4.18 - Percent Syngas 2 in PCC Fuel vs. COV<sub>pp</sub>, BS THC, BS CO, and BS VOC**

As shown in previously in Figure 4.11 for 80%/20% syngas 2/natural gas, 100% syngas 2 PCC fueling produces a significant decrease in main cylinder COV<sub>pp</sub>. The benefit of the combustion stability improvement for 100% syngas PCC fueling is shown through either increasing the intake manifold pressure for syngas PCC fueling or decreasing the intake manifold pressure for natural gas PCC fueling. Both fueling scenarios generate an equivalent combustion stability operating point. At the equivalent COV<sub>pp</sub> level, NO<sub>x</sub> emission is compared. Due to the

dramatic increase in combustion stability for 100% syngas 2 PCC fueling, hardware limitations at the EECL and fuel supply limitations prohibit increasing the boost for 100% syngas 2 PCC fueling to an equivalent combustion stability operating point compared to natural gas PCC fueling at 18" Hg boost. Figure 4.19 displays the results of reducing the intake manifold boost level for natural gas PCC fueling to match the main cylinder  $COV_{pp}$  of 100% syngas 2 PCC fueling. Figure 4.19 also displays the results of increasing the intake manifold pressure to 25" Hg for 100% syngas 2 PCC fueling. The PCC equivalence ratio is non-optimal for the 25" Hg boost point due to hardware limitations. Analysis of Figure 4.19 shows that natural gas PCC fueling at 8.5" Hg intake manifold pressure generates an equivalent main cylinder  $COV_{pp}$  compared to 100% syngas 2 PCC fueling at 18" Hg. However,  $NO_x$  emission for natural gas PCC fueling at 8.5" Hg intake manifold boost increases by 780% compared to 100% syngas 2 PCC fueling at 18" Hg intake manifold boost.



**Figure 4.19 - PCC Fuel Type vs. Main Cylinder COV<sub>pp</sub> and Brake Specific NO<sub>x</sub> Emission at Equivalent Combustion Stability Operating Points**

Figure 4.20 and Figure 4.21 display the brake specific emission of CO, CH<sub>2</sub>O, THC and VOC vs. PCC fuel type at equivalent combustion stability operating points. In Figure 4.20 and Figure 4.21, PCC equivalence ratio is non-optimal for 100% syngas 2 PCC fueling at 25" Hg intake manifold pressure due to hardware limitations. Analysis of Figure 4.20 and Figure 4.21 shows predictable results. All products of partial combustion increase as intake manifold boost level increases (main cylinder  $\Phi$  decreases). The trend of products of partial combustion is the inverse of the trend of NO<sub>x</sub>. As main cylinder  $\Phi$  decreases, NO<sub>x</sub> decreases while all other critical pollutant emission species increase. Figure 4.20 and Figure 4.21 also show that at an equivalent

intake manifold pressure, syngas 2 PCC fueling reduces THC and VOC emission and increases the emission of CO. The decrease in THC and VOC emission is attributed to the increase in combustion stability while the increase in CO is likely related to the CO present in syngas 2.

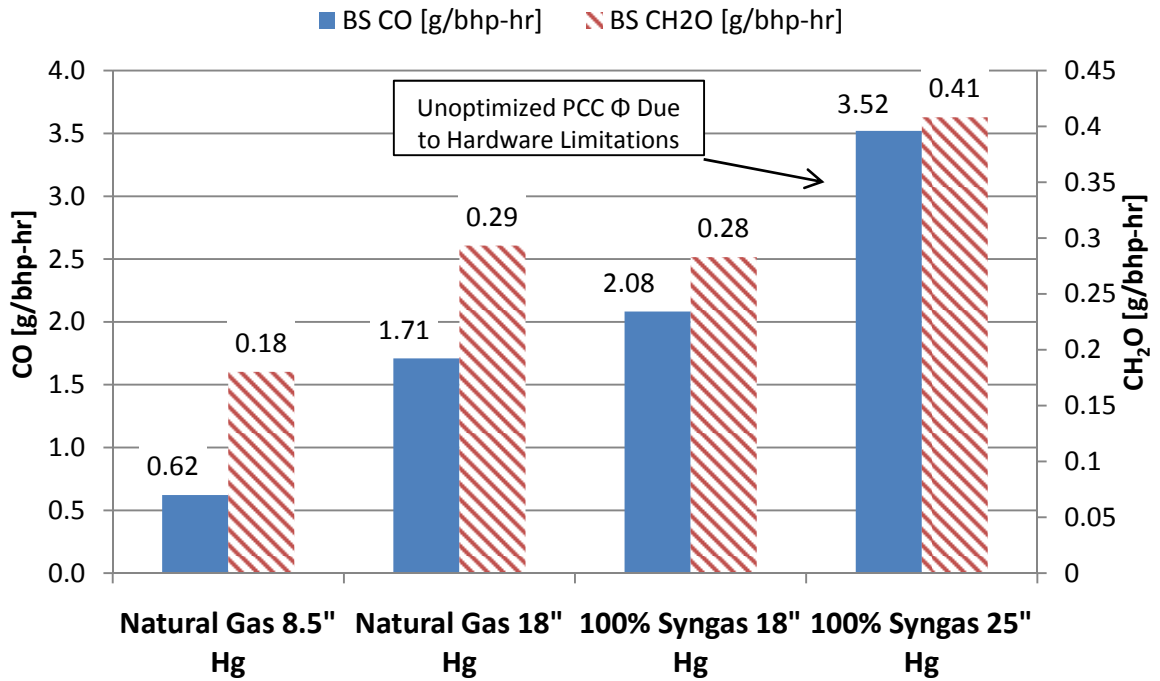
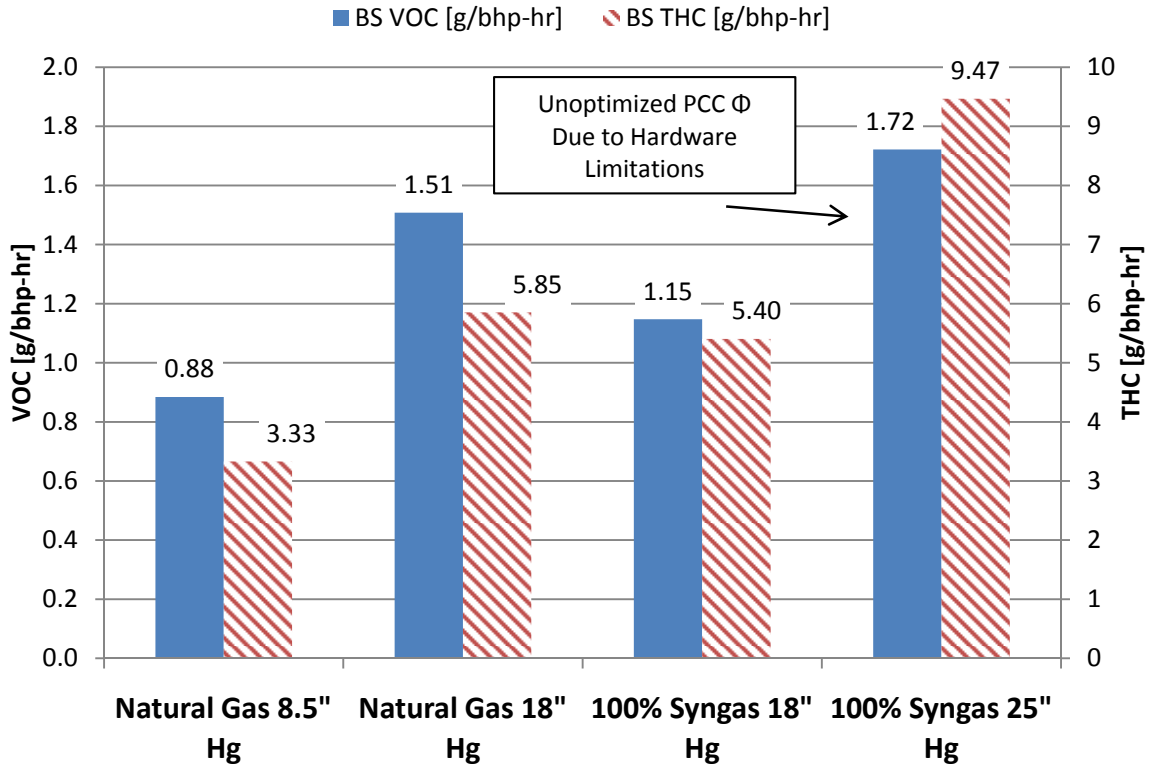


Figure 4.20 - PCC Fuel Type vs. Brake Specific Emission of CO and CH<sub>2</sub>O at Equivalent Combustion Stability Operating Points





**Figure 4.21 - PCC Fuel Type vs. Brake Specific Emission of VOC and THC at Equivalent Combustion Stability Operating Points**

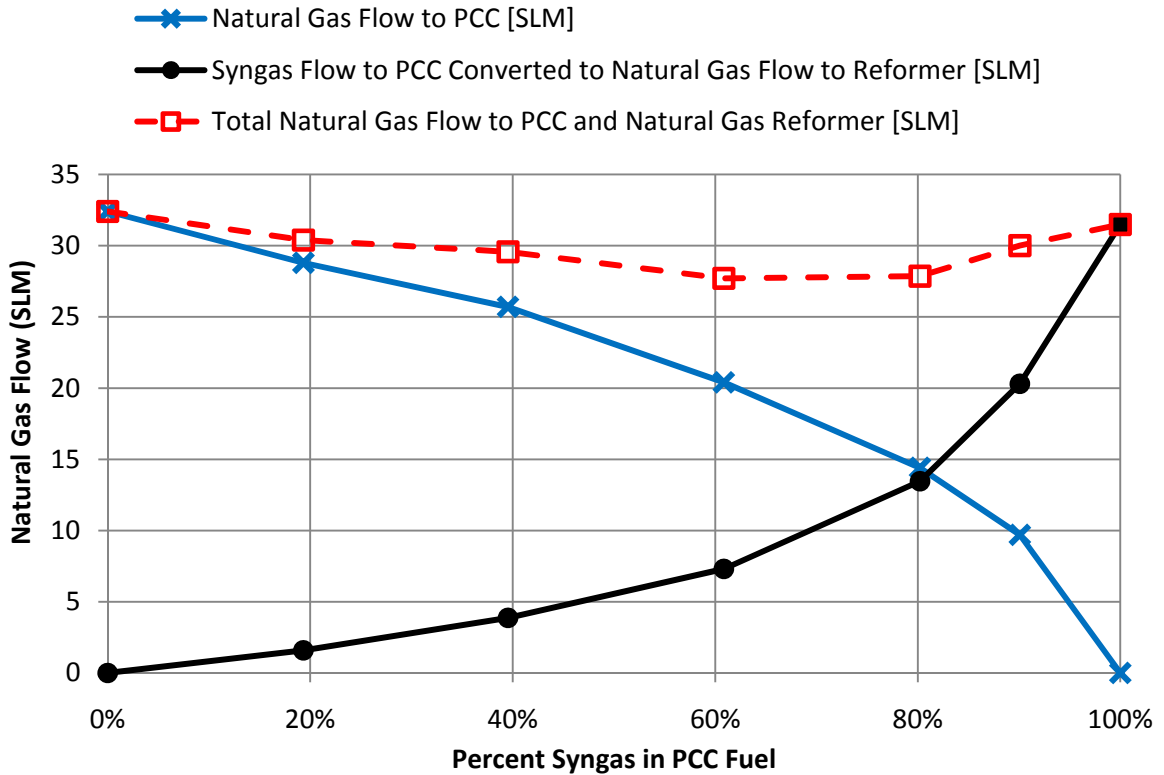
The mass of fuel in the PCC must increase as the percent of syngas in the PCC fuel increases due to the lower specific energy content in syngas. Table 4.4 displays the PCC fuel supply parameters associated with the data points displayed in Figure 4.18. The quantity of syngas 2 fuel required to optimize combustion stability dramatically increases as the percent syngas increases. The maximum fuel mass at the time of PCC ignition is trapped in the PCC by increasing PCC fuel supply pressure as the percentage of syngas 2 increases in addition to varying the location of injection. Increasing the fuel supply pressure also ensures sonic flow through the ePCC during fueling. Adjusting the fuel supply parameters is necessary to accommodate the required increase in fuel mass while supplying the PCC with syngas. Further analysis of Table 4.4 shows the supply pressure peaks near 230 psi for both the 90% and 100%

syngas data point. This peak is due to fuel hardware limitations. The optimum fuel supply pressure may be greater than 230 psig for 100% syngas.

**Table 4.4 - PCC Fuel Injection Parameters vs. Percent Syngas in PCC Fuel**

| <b>% Syngas 2 (mass %)</b>                      | <b>0%</b> | <b>19%</b> | <b>40%</b> | <b>61%</b> | <b>80%</b> | <b>90%</b> | <b>100%</b> |
|---|-----------|------------|------------|------------|------------|------------|-------------|
| Injection Pressure [psig]                       | 99        | 115        | 132        | 142        | 175        | 235        | 230         |
| Location of Injection (°bTDC)                   | 100.5     | 100.5      | 98         | 98         | 89         | 82.8       | 90.3        |
| Injection Duration (ms)                         | 15        | 15         | 17         | 18.3       | 20         | 20         | 30          |
| Natural Gas Flow [SLM]                          | 32.4      | 28.8       | 25.7       | 20.4       | 14.4       | 9.7        | 0           |
| Syngas Flow [SLM]                               | 0         | 6.9        | 16.8       | 31.7       | 58.4       | 88.1       | 136.6       |
| Syngas Flow Converted to Natural Gas Flow [SLM] | 0.0       | 1.6        | 3.9        | 7.3        | 13.5       | 20.3       | 31.5        |

Performing a carbon balance on the syngas flow through a natural gas reformer converts syngas flow to natural gas flow. Figure 4.22 displays the flow of natural gas to the PCC and to the natural gas reformer. As previously stated, the current test utilizes bottled syngas. The analysis performed in Figure 4.22 states the measured flow of syngas 2 from the compressed bottles in terms of the calculated natural gas flow to the natural gas reformer required to generate an equivalent syngas 2 supply. As the percent of syngas 2 fueling the PCC increases, the flow rate of natural gas to the reformer increases exponentially while the flow rate of natural gas to the PCC decreases exponentially. Figure 4.22 also plots the total combined natural gas flow to the natural gas reformer and to the PCC. Throughout the entire percent syngas fuel sweep, the total flow of natural gas to the system (PCC plus natural gas reformer) remained either constant or decreased compared to fueling the PCC with natural gas alone. There is no fuel penalty for syngas 2 PCC fueling.



**Figure 4.22 – Natural Gas Flow to PCC and/or Natural Gas Reformer vs. Percent Syngas in PCC Fuel**

Table 4.5 displays the ignition time and mass fraction burned (MFB) locations for the syngas 2 fuel sweep. Mass fraction burned locations are crank angle locations in which a set percentage of the fuel mass has been burned. MFB locations are used to characterize different stages of the combustion process. MFB 10% represents 10% of the fuel mass has burned and is the approximated crank angle location signifying when the flame front is fully developed and normal flame propagation commences. The crank angle resolved difference between ignition timing and MFB 10% is often called ignition delay. MFB 90% represents the end of the flame propagation process when the majority of the fuel mass has been consumed. MFB 90% is considered the end of the flame propagation process. The duration between MFB 10% and MFB 90% is considered the combustion duration. Further analysis of Table 4.5 shows the retardation

of ignition timing as the percent of syngas 2 increased in order to maintain the location of peak pressure at 18 °aTDC.

**Table 4.5 - Spark Ignition Timing and Mass Fraction Burned vs. Percent Syngas 2 in PCC Fuel**

| <b>% Syngas 2 (mass %)</b> | <b>0%</b> | <b>19%</b> | <b>40%</b> | <b>61%</b> | <b>80%</b> | <b>90%</b> | <b>100%</b> |
|----------------------------|-----------|------------|------------|------------|------------|------------|-------------|
| Ignition Timing (°bTDC)    | 5.0       | 5.0        | 5.0        | 5.0        | 4.4        | 3.9        | 2.8         |
| Location MFB 10%           | 4.4       | 4.2        | 4.0        | 4.1        | 4.4        | 4.6        | 4.9         |
| Location MFB 50%           | 13.3      | 13.0       | 12.8       | 13.1       | 13.4       | 13.6       | 13.8        |
| Location MFB 90%           | 26.4      | 25.9       | 25.7       | 26.4       | 26.6       | 26.9       | 27.2        |
| Ignition Delay (CAD)       | 9.4       | 9.2        | 9.0        | 9.1        | 8.7        | 8.5        | 7.8         |
| Combustion Duration (CAD)  | 22.0      | 21.8       | 21.7       | 22.4       | 22.2       | 22.3       | 22.2        |

Figure 4.23 plots the ignition timing, MFB 10%, ignition delay and the percent reduction in ignition delay as the percent syngas 2 increases from 0% to 100%. The percent reduction in ignition delay is the reduction in ignition delay compared to 100% natural gas PCC fueling. Analysis of Figure 4.23 shows the percent reduction in ignition delay is very large for high fractions of syngas 2 PCC fuel. 100% syngas 2 PCC fueling reduces the ignition delay by 18% compared to 100% natural gas PCC fueling.

As the fraction of syngas 2 increases, the flame speed of the PCC fuel increases due to the high fraction of hydrogen in syngas 2. The increase in flame speed of the PCC fuel supports an increase in PCC flame jet propagation and penetration into the main cylinder. Verification of the increase in PCC flame jet penetration requires optical analysis similar to analysis performed by Lisowski(11), which is beyond the scope of the current work. As shown in Figure 4.23, syngas 2 PCC fueling dramatically increased main cylinder combustion stability. Increases in combustion stability for syngas 2 PCC fueling lend validity to an increase in PCC flame jet propagation and penetration. Main cylinder flame development is stabilized as the PCC flame jet penetrates further into the main cylinder and distributes further across the cylinder main

cylinder. The increase in PCC flame jet characteristics increases combustion stability and decreasing ignition delay.

No significant trend exists in the MFB 90% and MFB 50% displayed in Table 4.5. Syngas 2 PCC fueling generates the reduction in ignition delay. Natural gas fuels the main cylinder through all testing reported herein. As such, the main cylinder flame speed and MFB 50% and 90% will change little when PCC fuel type is varied.

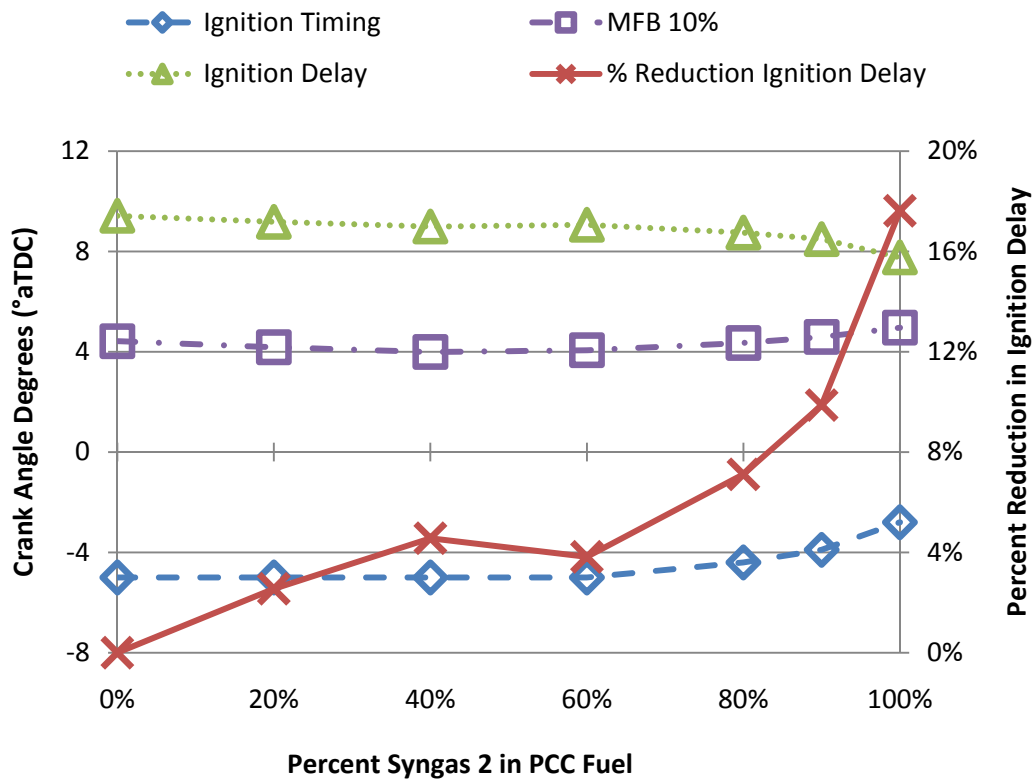


Figure 4.23 - Ignition Timing, Ignition Delay, Percent Reduction in Ignition Delay, and MFB 10% vs. Percent Syngas 2 in PCC Fuel

#### 4.5 PCC Fueling Scenario Comparison

Table 4.6 compares PCC fuel characteristics for the four different PCC fueling scenarios evaluated. The equivalence ratio model calculates the optimal PCC  $\Phi$ , fuel mass, and fuel energy in the PCC prior to ignition is based on empirical data and observations. The fuel mass

reported in Table 4.6 includes the mass of diluent present in the PCC fuel. Analysis of Table 4.6 shows optimal PCC  $\Phi$  for syngas 2 is less than the required  $\Phi$  for both syngas 1 and natural gas PCC fueling. Also, for all syngas fueling scenarios, the fuel energy in the PCC is less than the fuel energy for the natural gas case and the fuel mass is greater than the natural gas case. Though the fuel energy is less for each syngas fueling scenario, the fuel energy for each syngas fueling scenario is between 85% and 100% of the energy present in the natural gas fueling scenario. Syngas fuels contain high percentages of hydrogen and carbon monoxide in addition to nitrogen. As presented earlier, the flame speed and flammability limits for H<sub>2</sub>-CO mixtures are dramatically different than natural gas. The increase in flame speed and flammability limits potentially allows for the slight reduction in fuel energy realized for syngas fueling scenarios presented herein. The decisive factor for an increase in main cylinder combustion stability centers on the PCC flame jet's ability to ignite the lean main cylinder air-fuel mixture. The fundamental fuel characteristic advantages of hydrogen and carbon monoxide provide a pathway for main cylinder ignition at lower PCC energy values.

**Table 4.6 - Optimal PCC Fueling Characteristics vs. PCC Fuel Type**

| <b>PCC Fuel Type</b>           | <b>Optimal PCC <math>\Phi</math></b> | <b>Fuel Mass in PCC at Ignition (g)</b> | <b>Fuel Energy in PCC at Ignition (J)</b> |
|--------------------------------|--------------------------------------|---|---|
| Natural Gas                    | 1.17                                 | 0.066                                   | 2868                                      |
| 80% Syngas 1 / 20% Natural Gas | 1.19                                 | 0.130                                   | 2694                                      |
| 80% Syngas 2 / 20% Natural Gas | 0.99                                 | 0.093                                   | 2450                                      |
| 100% Syngas 2                  | 1.08                                 | 0.152                                   | 2651                                      |

## 5 SUMMARY AND CONCLUSION

Preliminary test results demonstrate the viability of syngas PCC fueling though results indicated standard checkvalve fuel metering does not generate acceptable equivalence ratios in the PCC for syngas PCC fueling. PCC equivalence ratio modeling results indicate that a reduced-orifice checkvalve may generate favorable syngas PCC fueling scenarios at high PCC fuel line pressures, though results reported herein do not include testing with a modified checkvalve. The current work utilizes ePCC fuel metering to provide acceptable PCC equivalence ratios for syngas PCC fueling. Subsequent testing utilizing ePCC fuel metering produced results listed below in three main categories.

### 1. 80% syngas 2 / 20% natural gas PCC fueling

Observations for syngas 2 PCC fueling scenarios conducted with an 80% syngas 2 / 20% natural gas blend at 18" Hg intake manifold boost include:

- The optimum calculated PCC equivalence ratio for syngas 2 PCC fueling was near stoichiometric compared to a slightly rich optimum PCC equivalence ratio for natural gas fueling.
- Syngas 2 PCC fueling requires a higher injection pressure and longer injection duration to optimize combustion stability compared to natural gas fueling.
- Syngas 2 PCC fueling increases main cylinder combustion stability by approximately 16% (i.e.  $COV_{pp}$  decreases by 16%) compared to natural gas fueling.
- Syngas 2 PCC fueling increased CO emission by 20% over natural gas fueling.

- Syngas 2 PCC fueling does not significantly affect NO<sub>x</sub>, THC, VOC, or CH<sub>2</sub>O emission compared to natural gas fueling.

Increasing the intake manifold boost to 22" Hg for 80%/20% syngas 2/natural gas PCC fueling produced the following results compared to natural gas PCC fueling at 18" Hg.

- Equivalent combustion stability
- 40% reduction in NO<sub>x</sub> emission
- Significant increase in all other measure emission parameters. The percent increases for the emission species are:
  - CO 80% Increase
  - THC 50% Increase
  - VOC 29% Increase
  - CH<sub>2</sub>O 30% Increase

The use of syngas 2 as a PCC fuel type generates greater combustion stability than fueling the PCC with natural gas alone. The increase in combustion stability can be translated to a reduction in NO<sub>x</sub> emission by increasing the intake manifold pressure. The reduction in NO<sub>x</sub> emission comes at the cost of an increase in all other pertinent emission parameters. The increase in other emissions parameters is expected. The increase in CO, THC, VOC and CH<sub>2</sub>O is as great or greater for natural gas PCC fueling at 22" Hg intake manifold boost compared to syngas 2 PCC fueling at 22" Hg boost.

## 2. 80% syngas 1 / 20% natural gas PCC fueling

Observations for syngas 1 PCC fueling scenarios conducted with an 80% syngas 1 / 20% natural gas blend at 18" Hg intake manifold boost include:

- Equivalent combustion stability



- 18% reduction in NO<sub>x</sub> emission
- 19% increase in CO emission
- Equivalent emission of THC, VOC, CH<sub>2</sub>O

Unlike syngas 2 PCC fueling, syngas 1 PCC fueling did not produce an increase in combustion stability. However, syngas 1 promotes a significant NO<sub>x</sub> reduction at an equivalent intake manifold boost level. This is likely due to the diluent present in the PCC fuel. The energy content in syngas 1 is 6½ less than natural gas. As such, the fuel supply pressure for syngas 1 PCC fueling is dramatically increased compared to natural gas fueling.

### 3. Percent syngas 2 fuel sweep

As the percent of syngas 2 PCC fueling varies from 0% to 100% at 18" Hg intake manifold boost the following observations compared to natural gas PCC fueling at 18" intake manifold boost include:

- 21% reduction in main cylinder COV<sub>pp</sub>
- 8% reduction in THC emission
- 24% reduction in VOC emission
- 22% increase in CO emission
- Equivalent emission of NO<sub>x</sub> and CH<sub>2</sub>O

The change in all parameters listed above is non-linear. The majority of change in combustion stability and pollutant emission occurs when syngas percentages are high (greater than 80%).

Reducing intake manifold boost for natural gas PCC fueling to 8.5" Hg produces equivalent main cylinder combustion stability compared to 100% syngas 2 PCC fueling at 18" Hg intake manifold pressure. NO<sub>x</sub> emission increases by 780% for natural gas PCC fueling at the

equivalent combustion stability operating point compared to 100% syngas 2 PCC fueling at 18” Hg intake manifold boost.

Converting syngas 2 PCC fuel flow to natural gas flow to a natural gas reformer shows the total natural gas flow for syngas 2 PCC fueling is equivalent or reduced compared natural gas PCC fueling alone. There is no fuel penalty for syngas 2 PCC fueling.

The hydrogen in syngas 2 generates a greater flame speed than natural gas. The increase in flame speed results in a reduction in ignition delay of 18% for 100% syngas 2 PCC fueling compared to natural gas PCC fueling.

#### PCC Fueling Summary

PCC fuel injection parameters vary a great deal for syngas 1, syngas 2 and natural gas PCC fueling scenarios. The optimal PCC  $\Phi$  for natural gas and syngas 1 PCC fueling is slightly rich compared to a near stoichiometric PCC  $\Phi$  for both syngas 2 fueling scenarios. The optimal PCC  $\Phi$  for each PCC fueling scenario is:

- Natural Gas 1.17
- 80% Syngas 1 / 20 % Natural Gas 1.19
- 80% Syngas 2 / 20% Natural Gas 0.99
- 100% Syngas 2 1.08

Though the start of injection varies for each PCC fuel type, engine performance varied little during testing for small changes in the location of the start of injection. The start of PCC fuel injection for each PCC fueling scenario is:

- Natural Gas 100 °bTDC
- 80% Syngas 1 / 20 % Natural Gas 81 °bTDC
- 80% Syngas 2 / 20% Natural Gas 98 °bTDC
- 100% Syngas 2 90 °bTDC

Syngas 1 and syngas 2 required greater injection durations compared to natural gas PCC fueling.

The duration of fuel injection for each PCC fueling scenario is:

- Natural Gas 15 ms
- 80% Syngas 1 / 20 % Natural Gas 20 ms
- 80% Syngas 2 / 20% Natural Gas 20 ms
- 100% Syngas 2 30 ms

The PCC injection pressure is much greater for all syngas fueling scenarios compared to natural gas. This discrepancy is likely attributed to the lower specific energy content of each syngas fuel. The energy in the PCC at ignition is only slightly lower for syngas PCC fueling. Each syngas PCC fueling scenario contains between 85% and 100% of the energy of natural gas PCC fueling. The similarity in total PCC energy at ignition between the fuel types is likely attributed to the PCC flame jet's ability to consistently ignite the lean main cylinder air-fuel mixture. If the energy in the PCC is too low, the flame jet will not consistently ignite the main cylinder. However, the dramatic increase in flame speed and flammability limits associated with syngas fueling may allow for a slight reduction in PCC energy at ignition while still maintaining consistent main cylinder combustion. The PCC fuel pressure for each PCC fueling scenario is:

- Natural Gas 90 psig
- 80% Syngas 1 / 20 % Natural Gas 225 psig
- 80% Syngas 2 / 20% Natural Gas 165 psig
- 100% Syngas 2 230 psig

At ignition the fuel mass and energy in the PCC for each PCC fueling scenario is:

- Natural Gas 0.066g / 2868J
- 80% Syngas 1 / 20 % Natural Gas 0.130g / 2694J
- 80% Syngas 2 / 20% Natural Gas 0.093g / 2450J

- 100% Syngas 2 0.152g / 2651J

An increase in main cylinder combustion stability is realized for each syngas 2 PCC fueling scenario utilizing ePCC fuel metering. The increase in main cylinder combustion stability translates into a reduction in NO<sub>x</sub> through increasing the intake manifold pressure. The products of partial combustion increase with an increase in intake manifold pressure. However, oxidation catalysts are able to effectively reduce engine out products of partial combustion but do not reduce NO<sub>x</sub> emission. Therefore ignition technology capable of reducing engine out NO<sub>x</sub> is important. Syngas 2 PCC fueling reduces engine out NO<sub>x</sub> emission through increasing the lean limit of a prechambered large bore natural gas engine via an increase in combustion stability.

## 6 REFERENCES

1. **Chapman, Kirby S. and Nuss-Warren, Sarah R.** *Phase I Report: Cost-Effective Reciprocating Engine Emissions Control and Monitoring for E&P Field and Gathering Engines*. National Gas Machinery Laboratory, Kansas State University. Springfield, VA : Department of Energy, 2007. Topical Report. DE-FC26-02NT1564.
2. **Olsen, D. B., et al.** Formaldehyde Characterization Utilizing In-Cylinder Sampling in a Large Bore Natural Gas Engine. *ASME Journal of Engineering for Gas Turbines and Power*. 2001, Vol. 123, pp. 669-676.
3. **Heck, Ronald M., Farrauto, Robert J. and Gulati, Suresh T.** *Cataytic Air Pollution Control: Commercial Technology, 2nd Ed.* New York : John Wiley & Sons, Inc., 2002. ISBN 0-471-43624-0.
4. **Olsen, Daniel B., Kohls, Morgan and Arney, Gregg.** Impact of Oxidation Catalysts on Exhasut NO<sub>2</sub>/NO<sub>x</sub> Ratio from Lean-Burn Natural Gas Engines. *Journal of Air & Waste Management Association*. 2010, Vol. 60, 7, pp. 867-874.
5. **Heywood, John B.** *Internal Combustion Engine Fundamentals*. New York : McGraw-Hill, 1988.
6. **Pulkrabek, Willard W.** *Engineering Fundamentals of Internal Combustion Engines, 2nd Ed.* New Jersey : Pearson Prentice-Hall, 2004.
7. **Schmitt, Joshua C.** Selective Catalytic Reduction: Testing, Numeric Modeling, and Control Strategies. *Master's Thesis*. Fort Collins, CO : Colorado State University, 2010.
8. **United States Environmental Protection Agency.** *Standards of Performance for Stationary Spark Ignited Internal Combustion Engines and National Emmission Standards for Hazardous Air Pollutants for Reciprocating Internal Combustion Engines*. Washington, DC : Federal Register, 2008. 40 CFR Parts 60, 603, 85, 90, 1048, 1065, & 1068.
9. **Olsen, Daniel B., Adair, Jessica and Willson, Bryan.** Precombustion Chamber Design and Performance Studies for a Large Bore Natural Gas Engine. *ASME ICE Spring Technical Conference*. 2005.
10. **Olsen, Daniel B. and Lisowski, Justin M.** Prechamber NO<sub>x</sub> Formation in Low BMEP 2-Stroke Cycle Natural Gas Engines. *Applied Thermal Engineering*. 2009, Vol. 29, 4, pp. 687-694.
11. **Lisowski, Justin M.** Diagnostic Techniques for Precombustion Chambers in Large Bore Lean Burn Natural Gas Engines. *Master's Thesis*. Fort Collins, CO : Colorado State University, 2007.

12. **Gupta, Ram B., [ed.].** *Hydrogen Fuel: Production, Transport, and Storage*. Boca Raton, FL : Taylor & Francis Group, LLC, 2009. 978-1-4200-4575-8.
13. **Rase, Howard F.** *Handbook of Commercial Catalyst: Heterogeneous Catalysts*. Boca Raton, FL : CRC Press LLC, 2000. 0-8493-9417-1.
14. **Coward, H. F. and G.W., Jones.** *Limits of Flammability of Gases and Vapors*. Washington D.C. : United States Department of the Interior Bureau of Mines, 1952.
15. **Natarajan, J., Lieuwen, T. and Seitzman, J.** Laminar Flame Speeds of H<sub>2</sub>/CO Mixtures: Effect of CO<sub>2</sub> Dilution, Preheat Temperature, and Pressure. *Combustion and Flame*. 2007, Vol. 151, pp. 104-119.
16. **Huang, Zuohua, et al.** Measurements of Laminar Burning Velocities for Natural Gas-Hydrogen-Air Mixtures. *Combustion and Flame*. 2006, Vol. 146, pp. 302-311.
17. **Fairweather, M., et al.** Turbulent Burning Rates of Methane and Methane-Hydrogen Mixtures. *Combustion and Flame*. 2009, Vol. 156, pp. 780-790.
18. **Lieuwen, Tim, Ed., Yang, Vigor and Yetter, Richard.** *Synthesis Gas Combustion: Fundamentals and Applications*. Boca Raton, FL : CRC Press Taylor & Francis Group, 2010. ISBN 978-1-4200-8534-1.
19. **Evans, Kirk, Olsen, Daniel B. and Willson, Bryan.** Fuel and Ignition Control Methodologies for Engines with Articulated Connecting Rods. *International Journal of Engine Research*. 2005, Vol. 6, 3, pp. 207-214.
20. **Gingrich, J.W., et al.** Precombustion Chamber NO<sub>x</sub> Emission Contribution to an Industrial Natural Gas Engine. *International Journal of Engine Research*. 2006, Vol. 7, 1, pp. 687-694.
21. **Boyer, R. L., Craig, D. R. and Miller, C. D.** A Photographic Study of Events in a 14-in. Two-Cycle Gas Engine Cylinder. *Transaction of the American Society of Mechanical Engineers*. 1954, Vol. 76, January, pp. 97-108.
22. **Simpson, Dean J.** Precombustion Chamber Design for Emission Reduction from Industrial Natural Gas Engines. *Master's Thesis*. Fort Collins, CO : Colorado State University, 2009.
23. **Hiltner, J.D. and Willi, M.L.** *Method and Apparatus for Providing a Hydrogen Enriched Fuel to Combustion Prechamber*. 6,739,289 United States, 2004. Patent.

## APPENDIX I – 5-GAS ANALYZER CALIBRATION LOG

Date 9/22/2009

| Time  | Description      | Comments/Notes | Initials |
|-------|------------------|----------------|----------|
| 7:55  | Warm up          |                | MK       |
| 9:47  | Zero/Span        |                | MK       |
| 9:58  | Pre bias checks  | Passed         | MK       |
| 14:30 | Rezero/Span THC  |                | MK       |
| 16:59 | Post Bias Checks |                | MK       |
| 17:08 | Shutdown         |                | MK       |

### Calibration Information

|          | THC (ppm) | O2 (ppm) | NOx (ppm) | CO2 (ppm) | CO (ppm) |
|----------|-----------|----------|-----------|-----------|----------|
| Ranges   | 0-2000    | 0-18     | 0-250     | 0-8       | 0-1000   |
| Span Gas | 1005      | 15       | 126       | 4.04      | 504      |

Date 10/8/2009

| Time  | Description     | Comments/Notes | Initials |
|-------|-----------------|----------------|----------|
| 8:10  | Warm up         |                | PCB      |
| 9:15  | Zero/Span       |                | PCB/CK   |
| 10:35 | Pre bias checks | Passed         | PCB/CK   |
| 10:35 | Rezero/Span THC |                | PCB/CK   |
| 1:30  | Shutdown        |                | PCB      |

### Calibration Information

|          | THC (ppm) | O2 (ppm) | NOx (ppm) | CO2 (ppm) | CO (ppm) |
|----------|-----------|----------|-----------|-----------|----------|
| Ranges   | 0-2000    | 0-25     | 0-250     | 0-8       | 0-1000   |
| Span Gas | 1005      | 15       | 126       | 4.04      | 504      |

Date 10/13/2009

| Time | Description      | Comments/Notes | Initials |
|------|------------------|----------------|----------|
| 7:50 | Warm up          |                | PCB      |
| 8:30 | Zero/Span        |                | PCB      |
| 9:30 | Pre bias checks  | Passed         | PCB/MK   |
| 9:30 | Rezero THC/CO    |                | PCB/MK   |
| 5:15 | Post bias checks | Passed         | PCB/MK   |
| 5:30 | Shutdown         |                | PCB      |

**Calibration Information**

|          | THC (ppm) | O2 (ppm) | NOx (ppm) | CO2 (ppm) | CO (ppm) |
|----------|-----------|----------|-----------|-----------|----------|
| Ranges   | 0-2000    | 0-25     | 0-250     | 0-8       | 0-1000   |
| Span Gas | 1005      | 15       | 126       | 4.04      | 504      |

Date 10/20/2009

| Time  | Description         | Comments/Notes | Initials |
|-------|---------------------|----------------|----------|
| 7:05  | Warm up             |                | MK       |
| 7:49  | Zero/Span           |                | MK       |
| 8:10  | Pre bias checks     | Passed         | MK       |
| 11:00 | THC Recalibrate     |                | MK       |
| 11:45 | THC Zero/Span check | OK             | PCB      |
| 17:20 | Post bias check     | Passed         | MK       |
| 17:31 | Shutdown            |                | MK       |

**Calibration Information**

|          | THC (ppm) | O2 (ppm) | NOx (ppm) | CO2 (ppm) | CO (ppm) |
|----------|-----------|----------|-----------|-----------|----------|
| Ranges   | 0-2000    | 0-25     | 0-250     | 0-8       | 0-1000   |
| Span Gas | 1005      | 15       | 126       | 4.04      | 504      |



Date 12/3/2009

| Time  | Description     | Comments/Notes | Initials |
|-------|-----------------|----------------|----------|
| 7:50  | Warm up         |                | PCB      |
| 8:45  | Zero/Span       |                | PCB      |
| 10:20 | Pre bias checks | Passed         | PCB      |
| 3:30  | THC Rezero/Span | OK             | PCB      |
| 5:15  | Post bias check | Passed         | PCB      |
| 5:45  | Shutdown        |                | PCB      |

**Calibration Information**

|          | THC (ppm) | O2 (ppm) | NOx (ppm) | CO2 (ppm) | CO (ppm) |
|----------|-----------|----------|-----------|-----------|----------|
| Ranges   | 0-2000    | 0-25     | 0-250     | 0-8       | 0-1000   |
| Span Gas | 1005      | 15       | 125       | 4.04      | 504      |

Date 1/19/2010

| Time  | Description     | Comments/Notes | Initials |
|-------|-----------------|----------------|----------|
| 8:10  | Warm up         |                | PCB      |
| 9:00  | Zero/Span       |                | PCB      |
| 10:40 | Pre bias checks | Passed         | PCB      |
| 1:15  | Check zero/span | OK             | PCB      |
| 5:24  | Post Bias Check | Passed         | PCB      |
| 5:30  | Shutdown        |                | PCB      |

**Calibration Information**

|          | THC (ppm) | O2 (ppm) | NOx (ppm) | CO2 (ppm) | CO (ppm) |
|----------|-----------|----------|-----------|-----------|----------|
| Ranges   | 0-2000    | 0-25     | 0-250     | 0-8       | 0-1000   |
| Span Gas | 1005      | 8.99     | 126       | 4.04      | 504      |

Date 2/23/2010

| Time  | Description     | Comments/Notes | Initials |
|-------|-----------------|----------------|----------|
| 8:00  | Warm up         |                | PCB      |
| 9:50  | Zero/Span       |                | PCB      |
| 10:00 | Pre bias checks | Passed         | PCB      |
| 12:30 | Shutdown        |                | PCB      |

**Calibration Information**

|          | THC (ppm) | O2 (ppm) | NOx (ppm) | CO2 (ppm) | CO (ppm) |
|----------|-----------|----------|-----------|-----------|----------|
| Ranges   | 0-2000    | 0-25     | 0-250     | 0-20      | 0-1000   |
| Span Gas | 1005      | 9.0      | 126       | 12        | 504      |

Date 2/25/2010

| Time  | Description                     | Comments/Notes | Initials |
|-------|---------------------------------|----------------|----------|
| 7:30  | Warm up                         |                | PCB      |
| 8:30  | Zero/Span                       |                | PCB      |
| 9:30  | Pre bias checks                 | Passed         | PCB      |
| 11:45 | Check THC Span - Respanned/Zero | OK             | PCB      |
| 2:37  | Zero/span check                 | Passed         | PCB      |
| 5:10  | Post bias check                 | Passed         | PCB      |
| 5:30  | Shutdown                        |                | PCB      |

**Calibration Information**

|          | THC (ppm) | O2 (ppm) | NOx (ppm) | CO2 (ppm) | CO (ppm) |
|----------|-----------|----------|-----------|-----------|----------|
| Ranges   | 0-2000    | 0-25     | 0-250     | 0-20      | 0-1000   |
| Span Gas | 1005      | 8.99     | 126       | 12        | 504      |

**Date** 4/13/2010

| <b>Time</b> | <b>Description</b> | <b>Comments/Notes</b> | <b>Initials</b> |
|-------------|--------------------|-----------------------|-----------------|
| 7:35        | Warm up            |                       | PCB             |
| 8:20        | Zero/Span          |                       | PCB             |
| 9:11        | Pre bias checks    | Passed                | PCB             |
| 10:55       | Zero/span check    | OK                    | PCB             |
| 5:25        | Post bias check    | Passed                | PCB             |
| 6:00        | Shutdown           |                       | PCB             |

**Calibration Information**

|             | <b>THC (ppm)</b> | <b>O2 (ppm)</b> | <b>NOx (ppm)</b> | <b>CO2 (ppm)</b> | <b>CO (ppm)</b> |
|-------------|------------------|-----------------|------------------|------------------|-----------------|
| Ranges      | 0-2000           | 0-25            | 0-250            | 0-8              | 0-1000          |
| Span<br>Gas | 1005             | 15              | 127              | 4.00             | 504             |

## APPENDIX II – FTIR CALIBRATION LOG

| Date  |                        | 9/22/2009        |          |
|-------|------------------------|------------------|----------|
| Time  | Description            | Comments/Notes   | Initials |
| 7:55  | Warm up, LN2, Purge N2 |                  | MK       |
| 8:45  | UHP N2                 |                  | MK       |
| 9:20  | Auto align             | 3.55, -2.05 1028 | MK       |
| 9:23  | Background             |                  | MK       |
| 9:25  | Zero                   |                  | MK       |
| 9:29  | Ethylene QA/QC 10      | 10.81            | MK       |
| 9:37  | CO QA/QC 494.3         | 482              | MK       |
| 14:37 | NG-01                  |                  | MK       |
| 14:54 | NG-02                  |                  | MK       |
| 15:05 | NG-03                  |                  | MK       |
| 15:35 | NG-04                  |                  | MK       |
| 15:47 | NG-05                  |                  | MK       |
| 16:01 | NG-06                  |                  | MK       |
| 16:11 | NG-07                  |                  | MK       |
| 16:20 | NG-08                  |                  | MK       |
| 17:01 | C2H4 Post              | Purge N2         | MK       |
| 17:08 | C2H4 Post              | 10.31            | MK       |
| 17:16 | CO Post                |                  | MK       |
| 17:21 | Purge N2               |                  | MK       |
| 17:26 | Shutdown               |                  | MK       |

Date 10/8/2009

| Time  | Description            | Comments/Notes                | Initials |
|-------|------------------------|-------------------------------|----------|
| 8:30  | Warm up, LN2, Purge N2 |                               | CK       |
| 9:15  | UHP N2                 |                               | CK       |
| 9:36  | Auto align             | 3.65, -2.11, 1028             | CK       |
| 9:45  | background             |                               | CK       |
| 9:55  | Zero                   |                               | CK       |
| 9:55  | Noise                  | PTP:0.004249<br>RMS:0.0002148 | CK       |
| 10:10 | Ethylene QA/QC         | 10.8896                       | CK       |
| 10:23 | CO QA/QC               | 467.8617                      | CK       |
| 10:32 | Sample line            |                               | CK       |
| 13:05 | Shutdown               |                               | CK       |

Date 10/13/2009

| Time  | Description            | Comments/Notes    | Initials |
|-------|------------------------|-------------------|----------|
| 8:00  | Warm up, LN2, Purge N2 |                   | MK       |
| 8:30  | GC Calibration         |                   | MK       |
| 8:46  | UHP N2                 |                   | MK       |
| 9:05  | Auto Align             | 3.55, -2.07, 1028 | MK       |
| 9:08  | Background             |                   | MK       |
| 9:16  | Zero 1                 |                   | MK       |
| 9:22  | QA/QC C2H4 10          | 10.30 (103%)      | MK       |
| 9:30  | QA/QC CO 494.3         | 491.9 (99.5%)     | MK       |
| 15:50 | H2-01                  |                   | MK       |
| 15:56 | H2-02                  |                   | MK       |
| 16:03 | H2-03                  |                   | MK       |
| 16:42 | Syn2-04                |                   | MK       |
| 16:54 | Syn2-05                |                   | MK       |
| 16:59 | Syn2-06                | 066 taken @ 1705  | MK       |
| 17:17 | QA/QC C2H4 10          | 10.06 (101%)      | MK       |
| 17:25 | QA/QC CO 494.3         | 487.7 (98.6%)     | MK       |
| 17:31 | Purge N2               |                   | MK       |
| 17:36 | Shutdown               |                   | MK       |

Date 10/20/2009

| Time  | Description            | Comments/Notes            | Initials |
|-------|------------------------|---------------------------|----------|
| 7:05  | Warm up, LN2, Purge N2 |                           | MK       |
| 8:00  | UHP N2                 |                           | MK       |
| 8:24  | Auto Align             | 3.67, -2.18, 1028         | MK       |
| 8:30  | Background             |                           | MK       |
| 8:37  | Zero 1                 |                           | MK       |
| 8:40  | Noise                  | PTP: 0.00275 RMS: 0.00014 | MK       |
| 8:43  | QA/QC C2H4 10          | 10.2                      | MK       |
| 8:50  | QA/QC CO 494.3         | 481                       | MK       |
| 11:56 | NG-01                  |                           | MK       |
| 13:31 | NG-02                  |                           | MK       |
| 13:38 | NG-03                  |                           | MK       |
| 13:44 | NG-04                  |                           | MK       |
| 13:50 | NG-05                  |                           | MK       |
| 16:57 | QA/QC CO 494.3         | 481.3                     | MK       |
| 17:05 | QA/QC C2H4 10          | 10.3                      | MK       |
| 17:10 | Purge N2               |                           | MK       |
| 17:15 | Shutdown               |                           | MK       |

Date 12/3/2009

| Time  | Description            | Comments/Notes                  | Initials |
|-------|------------------------|---------------------------------|----------|
| 7:29  | Warm up, LN2, Purge N2 |                                 | CK       |
| 8:55  | UHP N2                 |                                 | CK       |
| 9:22  | Auto align             | Max 4 Min -2.5, 1028            | CK       |
| 9:27  | background             |                                 | CK       |
| 9:36  | Zero                   |                                 | CK       |
| 9:40  | Noise                  | PTP: 0.003296, RMS:<br>0.000133 | CK       |
| 9:49  | Ethylene QA/QC         | 11.0004                         | CK       |
| 10:10 | QA/QC CO               | 524.57                          | CK       |
| 1:00  | PCCNG-01               |                                 | PCB      |
| 2:10  | PCCSyn2-02             |                                 | PCB      |
| 4:00  | PCCSyn2-03             |                                 | CK       |
| 4:30  | PCCSyn2-04             |                                 | CK       |
| 5:00  | PCCSyn2-05             |                                 | PCB      |

Date 1/19/2010

| Time  | Description            | Comments/Notes                 | Initials |
|-------|------------------------|--------------------------------|----------|
| 8:24  | Warm up, LN2, Purge N2 |                                | CK       |
| 9:15  | UHP N2                 |                                | CK       |
| 9:45  | Auto Align             | 2.03, -1.19 1029               | CK       |
| 9:49  | background             |                                | CK       |
| 9:58  | Zero                   | CO2 219 ppm, H2O 0             | CK       |
| 9:58  | Noise                  | PTP: 0.00541, RMS<br>0.0002703 | CK       |
| 10:11 | Ethylene QA/QC         | 10.84                          | CK       |
| 10:20 | CO QA/QC               | 518.54                         | CK       |
| 11:48 | NG-01                  |                                | KE       |
| 14:00 | Syn2-02                |                                | KE       |
| 16:10 | Syn2-03                |                                | PCB      |
| 16:25 | Syn2-04                |                                | PCB      |

Date 2/23/2010

| Time  | Description            | Comments/Notes                  | Initials |
|-------|------------------------|---------------------------------|----------|
| 8:00  | Warm up, LN2, Purge N2 |                                 | CCL      |
| 8:49  | UHP                    |                                 | CCL      |
| 9:13  | Align                  | 2.04, -1.2, 1028                | CCL      |
| 9:16  | Background             |                                 | CCL      |
| 9:26  | zero                   | Co: 0.1659, H2O 0               | CCL      |
| 9:26  | Noise                  | PTP: 0.004007, RMS:<br>0.000046 | CCL      |
| 9:36  | QA/QC Ethylene         | 10.7489                         | CCL      |
| 9:43  | QA/QC CO               | 507.9062                        | CCL      |
| 12:48 | Shutdown               |                                 | CCL      |

| Date      |                                    | 2/25/2010              |          |
|-----------|------------------------------------|------------------------|----------|
| Time      | Description                        | Comments/Notes         | Initials |
| 7:50      | Warm up, LN2, Purge N2             |                        | KE       |
| 10:29     | UHP                                |                        | KE       |
| 10:48     | Align                              |                        | KE       |
| 11:07     | Background                         |                        | KE       |
| 11:18     | Zero, Noise                        | PP: 0.158, RMS: 0.0955 | KE       |
| 11:35     | C2H4 QA/QC                         | 10.7                   | KE       |
| 11:43     | CO QA/QC                           | 508.4                  | KE       |
| 11:57     | CH4-01                             |                        | KE       |
| 12:16     | CNG-02                             |                        | CK       |
| 12:30     | CNG-03                             |                        | CK       |
| 12:58     | CNG-04                             |                        | CK       |
| 13:38     | Syn2-05                            |                        | KE       |
| 13:49     | Syn2-06                            |                        | KE       |
| 14:09     | Syn2-07                            |                        | PCB      |
| 14:50     | Syn2-08                            |                        | PCB      |
| 15:15     | Syn2-09                            |                        | KE       |
| 16:00     | Syn2-10                            |                        | PCB      |
| 16:15     | Syn2-11                            |                        | PCB      |
| 16:30     | Syn2-12                            |                        | PCB      |
| 16:50     | CNG-13                             |                        | PCB      |
| 2/26/2010 |                                    |                        |          |
| 8:20      | Quantify Spectra & Generate Report |                        | KE       |
| 8:34      | Generate 64 scan comparison        |                        | KE       |
|           | after overnite purge               |                        |          |



Date 4/13/2010

| Time  | Description            | Comments/Notes                 | Initials |
|-------|------------------------|--------------------------------|----------|
| 8:05  | Warm up, LN2, Purge N2 |                                | PCB      |
| 8:54  | Align                  | 2.1, -1.25 1028                | PCB      |
| 9:13  | UHP                    |                                | PCB      |
| 9:16  | Realign                | 2.05, -1.28 1028               | PCB      |
| 9:20  | Background             |                                | PCB      |
| 9:28  | Zero, Noise            | PP 0.009639, RMS:<br>0.0004987 | PCB      |
| 9:30  | QA/QC Ethylene         | 10.7 ppm                       | PCB      |
| 9:30  | QA/QC CO               | 505.4 ppm                      | PCB      |
| 10:20 | CH4-01                 |                                | PCB      |
| 10:45 | CNG-02                 |                                | PCB      |
| 11:16 | CNG-03                 |                                | PCB      |
| 11:50 | CNG-04                 |                                | PCB      |
| 12:15 | Syn20-05               |                                | PCB      |
| 12:46 | Syn40-06               |                                | PCB      |
| 13:17 | Syn40-07               |                                | PCB      |
| 13:40 | Syn60-08               |                                | PCB      |
| 14:15 | Syn80-09               |                                | PCB      |
| 14:45 | Syn90-10               |                                | PCB      |
| 15:05 | Syn100-11              |                                | PCB      |
| 15:10 | Syn100-12              |                                | PCB      |
| 15:35 | Syn100-13              |                                | PCB      |
| 15:45 | Syn100-14              |                                | PCB      |
| 16:31 | Syn100-15              |                                | PCB      |
| 16:55 | CNG-16                 |                                | PCB      |
| 17:10 | CNG-17                 |                                | PCB      |

### APPENDIX III – BIAS CHECKS

|                 |                     | Pre Daily Test |             |        |             | Post Daily Test     |             |         |        |     |
|-----------------|---------------------|----------------|-------------|--------|-------------|---------------------|-------------|---------|--------|-----|
| ZERO            | <b>0</b>            | SPAN           | %           | OK?    | <b>0</b>    | SPAN                | %           | OK?     |        |     |
|                 | ppm THC             | 0.65           | 1005        | 0.06%  | YES         | ppm THC             | 0.65        | 1005    | 0.06%  | YES |
|                 | % O <sub>2</sub>    | 0.04           | 15          | 0.27%  | YES         | % O <sub>2</sub>    | 0.1         | 15      | 0.67%  | YES |
|                 | ppm NO <sub>x</sub> | 0              | 126         | 0.00%  | YES         | ppm NO <sub>x</sub> | 0           | 126     | 0.00%  | YES |
|                 | % CO <sub>2</sub>   | 0.001          | 4.04        | 0.02%  | YES         | % CO <sub>2</sub>   | 0.001       | 4.04    | 0.02%  | YES |
|                 | vpm CO              | 2.309          | 504         | 0.46%  | YES         | vpm CO              | 2.309       | 504     | 0.46%  | YES |
| CO <sub>2</sub> | <b>4.04</b>         | SPAN           | %           | OK?    | <b>4.04</b> | SPAN                | %           | OK?     |        |     |
|                 | ppm THC             | 0.62           | 1005        | 0.06%  | YES         | ppm THC             | 0.37        | 1005    | 0.04%  | YES |
|                 | % O <sub>2</sub>    | 0.02           | 15          | 0.13%  | YES         | % O <sub>2</sub>    | 0.08        | 15      | 0.53%  | YES |
|                 | ppm NO <sub>x</sub> | 0              | 126         | 0.00%  | YES         | ppm NO <sub>x</sub> | 1.1         | 126     | 0.87%  | YES |
|                 | % CO <sub>2</sub>   | 4.02           | 4.04        | 99.50% | YES         | % CO <sub>2</sub>   | 3.999       | 4.04    | 98.99% | YES |
|                 | vpm CO              | 3.103          | 504         | 0.62%  | YES         | vpm CO              | 3.344       | 504     | 0.66%  | YES |
| NO <sub>x</sub> | <b>126</b>          | SPAN           | %           | OK?    | <b>126</b>  | SPAN                | %           | OK?     |        |     |
|                 | ppm THC             | 0.65           | 1005        | 0.06%  | YES         | ppm THC             | -0.01       | 1005    | 0.00%  | YES |
|                 | % O <sub>2</sub>    | 0.03           | 15          | 0.20%  | YES         | % O <sub>2</sub>    | 0.1         | 15      | 0.67%  | YES |
|                 | ppm NO <sub>x</sub> | 124.5          | 126         | 98.81% | YES         | ppm NO <sub>x</sub> | 123.6       | 126     | 98.10% | YES |
|                 | % CO <sub>2</sub>   | 0.004          | 4.04        | 0.10%  | YES         | % CO <sub>2</sub>   | 0.007       | 4.04    | 0.17%  | YES |
|                 | vpm CO              | 2.285          | 504         | 0.45%  | YES         | vpm CO              | 2.518       | 504     | 0.50%  | YES |
| O <sub>2</sub>  | <b>15</b>           | SPAN           | %           | OK?    | <b>15</b>   | SPAN                | %           | OK?     |        |     |
|                 | ppm THC             | -0.98          | 1005        | 0.10%  | YES         | ppm THC             | -1.24       | 1005    | 0.12%  | YES |
|                 | % O <sub>2</sub>    | 14.95          | 15          | 99.67% | YES         | % O <sub>2</sub>    | 14.95       | 15      | 99.67% | YES |
|                 | ppm NO <sub>x</sub> | 0.1            | 126         | 0.08%  | YES         | ppm NO <sub>x</sub> | 0.1         | 126     | 0.08%  | YES |
|                 | % CO <sub>2</sub>   | 0.001          | 4.04        | 0.02%  | YES         | % CO <sub>2</sub>   | 0.004       | 4.04    | 0.10%  | YES |
|                 | vpm CO              | 1.321          | 504         | 0.26%  | YES         | vpm CO              | 1.364       | 504     | 0.27%  | YES |
|                 | CO                  | 504            | <b>Pass</b> |        | CO          | 504                 | <b>Pass</b> |         |        |     |
|                 | THC                 | 1005           |             |        | THC         | 1005                | Date:       | 9/22/10 |        |     |

|                 |                     | Pre Daily Test |      |        |             | Post Daily Test     |       |      |        |     |
|-----------------|---------------------|----------------|------|--------|-------------|---------------------|-------|------|--------|-----|
| ZERO            | <b>0</b>            | SPAN           | %    | OK?    | <b>0</b>    | SPAN                | %     | OK?  |        |     |
|                 | ppm THC             | -0.19          | 1005 | 0.02%  | YES         | ppm THC             | 0.65  | 1005 | 0.06%  | YES |
|                 | % O <sub>2</sub>    | 0.02           | 15   | 0.13%  | YES         | % O <sub>2</sub>    | 0.1   | 15   | 0.67%  | YES |
|                 | ppm NO <sub>x</sub> | 0.2            | 126  | 0.16%  | YES         | ppm NO <sub>x</sub> | 0     | 126  | 0.00%  | YES |
|                 | % CO <sub>2</sub>   | 0.003          | 4.04 | 0.07%  | YES         | % CO <sub>2</sub>   | 0.001 | 4.04 | 0.02%  | YES |
|                 | vpm CO              | 2.4            | 504  | 0.48%  | YES         | vpm CO              | 2.309 | 504  | 0.46%  | YES |
| CO <sub>2</sub> | <b>4.04</b>         | SPAN           | %    | OK?    | <b>4.04</b> | SPAN                | %     | OK?  |        |     |
|                 | ppm THC             | -5.64          | 1005 | 0.56%  | YES         | ppm THC             | 0.37  | 1005 | 0.04%  | YES |
|                 | % O <sub>2</sub>    | 0              | 15   | 0.00%  | YES         | % O <sub>2</sub>    | 0.08  | 15   | 0.53%  | YES |
|                 | ppm NO <sub>x</sub> | 0.14           | 126  | 0.11%  | YES         | ppm NO <sub>x</sub> | 1.1   | 126  | 0.87%  | YES |
|                 | % CO <sub>2</sub>   | 4.022          | 4.04 | 99.55% | YES         | % CO <sub>2</sub>   | 3.999 | 4.04 | 98.99% | YES |
|                 | vpm CO              | 2.9            | 504  | 0.58%  | YES         | vpm CO              | 3.344 | 504  | 0.66%  | YES |
| NO <sub>x</sub> | <b>126</b>          | SPAN           | %    | OK?    | <b>126</b>  | SPAN                | %     | OK?  |        |     |
|                 | ppm THC             | -1.17          | 1005 | 0.12%  | YES         | ppm THC             | -0.01 | 1005 | 0.00%  | YES |
|                 | % O <sub>2</sub>    | 0.03           | 15   | 0.20%  | YES         | % O <sub>2</sub>    | 0.1   | 15   | 0.67%  | YES |
|                 | ppm NO <sub>x</sub> | 124.5          | 126  | 98.80% | YES         | ppm NO <sub>x</sub> | 123.6 | 126  | 98.10% | YES |
|                 | % CO <sub>2</sub>   | 0.005          | 4.04 | 0.12%  | YES         | % CO <sub>2</sub>   | 0.007 | 4.04 | 0.17%  | YES |
|                 | vpm CO              | 3.254          | 504  | 0.65%  | YES         | vpm CO              | 2.518 | 504  | 0.50%  | YES |
| O <sub>2</sub>  | <b>15</b>           | SPAN           | %    | OK?    | <b>15</b>   | SPAN                | %     | OK?  |        |     |
|                 | ppm THC             | -2             | 1005 | 0.20%  | YES         | ppm THC             | -1.24 | 1005 | 0.12%  | YES |
|                 | % O <sub>2</sub>    | 14.89          | 15   | 99.27% | YES         | % O <sub>2</sub>    | 14.95 | 15   | 99.67% | YES |
|                 | ppm NO <sub>x</sub> | 0.25           | 126  | 0.20%  | YES         | ppm NO <sub>x</sub> | 0.1   | 126  | 0.08%  | YES |
|                 | % CO <sub>2</sub>   | 0.003          | 4.04 | 0.07%  | YES         | % CO <sub>2</sub>   | 0.004 | 4.04 | 0.10%  | YES |
|                 | vpm CO              | 2.65           | 504  | 0.53%  | YES         | vpm CO              | 1.364 | 504  | 0.27%  | YES |

\* values allowed to stabilize for roughly 5 minutes

|     |      |
|-----|------|
| CO  | 504  |
| THC | 1005 |

Pass

|     |      |
|-----|------|
| CO  | 504  |
| THC | 1005 |

Pass

Date 10/8/2009

|                 |                     | Pre Daily Test |      |        |             | Post Daily Test     |       |      |        |     |
|-----------------|---------------------|----------------|------|--------|-------------|---------------------|-------|------|--------|-----|
| ZERO            | <b>0</b>            | SPAN           | %    | OK?    | <b>0</b>    | SPAN                | %     | OK?  |        |     |
|                 | ppm THC             | 0.87           | 1005 | 0.09%  | YES         | ppm THC             | -11.8 | 1005 | 1.17%  | YES |
|                 | % O <sub>2</sub>    | 0.03           | 15   | 0.20%  | YES         | % O <sub>2</sub>    | 0.02  | 15   | 0.13%  | YES |
|                 | ppm NO <sub>x</sub> | 0.11           | 126  | 0.09%  | YES         | ppm NO <sub>x</sub> | 1     | 126  | 0.79%  | YES |
|                 | % CO <sub>2</sub>   | 0.001          | 4.04 | 0.02%  | YES         | % CO <sub>2</sub>   | 0.005 | 4.04 | 0.12%  | YES |
|                 | vpm CO              | 0.994          | 504  | 0.20%  | YES         | vpm CO              | 2.2   | 504  | 0.44%  | YES |
| CO <sub>2</sub> | <b>4.04</b>         | SPAN           | %    | OK?    | <b>4.04</b> | SPAN                | %     | OK?  |        |     |
|                 | ppm THC             | 0.97           | 1005 | 0.10%  | YES         | ppm THC             | -12   | 1005 | 1.19%  | YES |
|                 | % O <sub>2</sub>    | 0.01           | 15   | 0.07%  | YES         | % O <sub>2</sub>    | 0.09  | 15   | 0.60%  | YES |
|                 | ppm NO <sub>x</sub> | 0.11           | 126  | 0.09%  | YES         | ppm NO <sub>x</sub> | 0.78  | 126  | 0.62%  | YES |
|                 | % CO <sub>2</sub>   | 4.031          | 4.04 | 99.78% | YES         | % CO <sub>2</sub>   | 3.971 | 4.04 | 98.29% | YES |
|                 | vpm CO              | 2.5            | 504  | 0.50%  | YES         | vpm CO              | 0.79  | 504  | 0.16%  | YES |
| NO <sub>x</sub> | <b>126</b>          | SPAN           | %    | OK?    | <b>126</b>  | SPAN                | %     | OK?  |        |     |
|                 | ppm THC             | 0.87           | 1005 | 0.09%  | YES         | ppm THC             | -12.5 | 1005 | 1.24%  | YES |
|                 | % O <sub>2</sub>    | 0.03           | 15   | 0.20%  | YES         | % O <sub>2</sub>    | 0.07  | 15   | 0.47%  | YES |
|                 | ppm NO <sub>x</sub> | 124.5          | 126  | 98.77% | YES         | ppm NO <sub>x</sub> | 123.8 | 126  | 98.25% | YES |
|                 | % CO <sub>2</sub>   | 0.004          | 4.04 | 0.10%  | YES         | % CO <sub>2</sub>   | 0.009 | 4.04 | 0.22%  | YES |
|                 | vpm CO              | 1.871          | 504  | 0.37%  | YES         | vpm CO              | 2     | 504  | 0.40%  | YES |
| O <sub>2</sub>  | <b>15</b>           | SPAN           | %    | OK?    | <b>15</b>   | SPAN                | %     | OK?  |        |     |
|                 | ppm THC             | 0.12           | 1005 | 0.01%  | YES         | ppm THC             | -13   | 1005 | 1.29%  | YES |
|                 | % O <sub>2</sub>    | 14.92          | 15   | 99.47% | YES         | % O <sub>2</sub>    | 14.85 | 15   | 99.00% | YES |
|                 | ppm NO <sub>x</sub> | 0.17           | 126  | 0.13%  | YES         | ppm NO <sub>x</sub> | 0.02  | 126  | 0.02%  | YES |
|                 | % CO <sub>2</sub>   | 0.001          | 4.04 | 0.02%  | YES         | % CO <sub>2</sub>   | 0.005 | 4.04 | 0.12%  | YES |
|                 | vpm CO              | 0.5            | 504  | 0.10%  | YES         | vpm CO              | 0.1   | 504  | 0.02%  | YES |

\* values allowed to stabilize for roughly 5 minutes

|     |      |
|-----|------|
| CO  | 504  |
| THC | 1005 |

Pass

|     |      |
|-----|------|
| CO  | 504  |
| THC | 1005 |

Pass

Date 10/13/2009

|                 |                     | Pre Daily Test |      |         |             | Post Daily Test     |       |      |        |     |
|-----------------|---------------------|----------------|------|---------|-------------|---------------------|-------|------|--------|-----|
| ZERO            | <b>0</b>            | SPAN           | %    | OK?     | <b>0</b>    | SPAN                | %     | OK?  |        |     |
|                 | ppm THC             | -2.12          | 1005 | 0.21%   | YES         | ppm THC             | -11.8 | 1005 | 1.17%  | YES |
|                 | % O <sub>2</sub>    | 0.125          | 15   | 0.83%   | YES         | % O <sub>2</sub>    | 0.02  | 15   | 0.13%  | YES |
|                 | ppm NO <sub>x</sub> | 0.19           | 126  | 0.15%   | YES         | ppm NO <sub>x</sub> | 1     | 126  | 0.79%  | YES |
|                 | % CO <sub>2</sub>   | 0.007          | 4.04 | 0.17%   | YES         | % CO <sub>2</sub>   | 0.005 | 4.04 | 0.12%  | YES |
|                 | vpm CO              | 1.847          | 504  | 0.37%   | YES         | vpm CO              | 2.2   | 504  | 0.44%  | YES |
| CO <sub>2</sub> | <b>4.04</b>         | SPAN           | %    | OK?     | <b>4.04</b> | SPAN                | %     | OK?  |        |     |
|                 | ppm THC             | 0.96           | 1005 | 0.10%   | YES         | ppm THC             | -12   | 1005 | 1.19%  | YES |
|                 | % O <sub>2</sub>    | 0.02           | 15   | 0.13%   | YES         | % O <sub>2</sub>    | 0.09  | 15   | 0.60%  | YES |
|                 | ppm NO <sub>x</sub> | 0.12           | 126  | 0.10%   | YES         | ppm NO <sub>x</sub> | 0.78  | 126  | 0.62%  | YES |
|                 | % CO <sub>2</sub>   | 4.024          | 4.04 | 99.60%  | YES         | % CO <sub>2</sub>   | 3.971 | 4.04 | 98.29% | YES |
|                 | vpm CO              | 2.428          | 504  | 0.48%   | YES         | vpm CO              | 0.79  | 504  | 0.16%  | YES |
| NO <sub>x</sub> | <b>126</b>          | SPAN           | %    | OK?     | <b>126</b>  | SPAN                | %     | OK?  |        |     |
|                 | ppm THC             | -0.4           | 1005 | 0.04%   | YES         | ppm THC             | -12.5 | 1005 | 1.24%  | YES |
|                 | % O <sub>2</sub>    | 0.02           | 15   | 0.13%   | YES         | % O <sub>2</sub>    | 0.07  | 15   | 0.47%  | YES |
|                 | ppm NO <sub>x</sub> | 124.8          | 126  | 99.07%  | YES         | ppm NO <sub>x</sub> | 123.8 | 126  | 98.25% | YES |
|                 | % CO <sub>2</sub>   | 0.003          | 4.04 | 0.07%   | YES         | % CO <sub>2</sub>   | 0.009 | 4.04 | 0.22%  | YES |
|                 | vpm CO              | 1.423          | 504  | 0.28%   | YES         | vpm CO              | 2     | 504  | 0.40%  | YES |
| O <sub>2</sub>  | <b>15</b>           | SPAN           | %    | OK?     | <b>15</b>   | SPAN                | %     | OK?  |        |     |
|                 | ppm THC             | -2.27          | 1005 | 0.23%   | YES         | ppm THC             | -13   | 1005 | 1.29%  | YES |
|                 | % O <sub>2</sub>    | 15.03          | 15   | 100.20% | YES         | % O <sub>2</sub>    | 14.85 | 15   | 99.00% | YES |
|                 | ppm NO <sub>x</sub> | 0.11           | 126  | 0.09%   | YES         | ppm NO <sub>x</sub> | 0.02  | 126  | 0.02%  | YES |
|                 | % CO <sub>2</sub>   | 0.002          | 4.04 | 0.05%   | YES         | % CO <sub>2</sub>   | 0.005 | 4.04 | 0.12%  | YES |
|                 | vpm CO              | 1.067          | 504  | 0.21%   | YES         | vpm CO              | 0.1   | 504  | 0.02%  | YES |

\* values allowed to stabilize for roughly 5 minutes

|     |      |
|-----|------|
| CO  | 504  |
| THC | 1005 |

**Pass**

|     |      |
|-----|------|
| CO  | 504  |
| THC | 1005 |

**Pass**

Date 10/20/2009

|                 |                     | Pre Daily Test |      |         |             | Post Daily Test     |       |      |        |     |
|-----------------|---------------------|----------------|------|---------|-------------|---------------------|-------|------|--------|-----|
| ZERO            | <b>0</b>            | SPAN           | %    | OK?     | <b>0</b>    | SPAN                | %     | OK?  |        |     |
|                 | ppm THC             | -0.15          | 1005 | 0.01%   | YES         | ppm THC             | 1.39  | 1005 | 0.14%  | YES |
|                 | % O <sub>2</sub>    | 0              | 15   | 0.00%   | YES         | % O <sub>2</sub>    | 0     | 15   | 0.00%  | YES |
|                 | ppm NO <sub>x</sub> | 0.02           | 126  | 0.02%   | YES         | ppm NO <sub>x</sub> | 0.02  | 126  | 0.02%  | YES |
|                 | % CO <sub>2</sub>   | 0              | 4.04 | 0.00%   | YES         | % CO <sub>2</sub>   | 0     | 4.04 | 0.00%  | YES |
|                 | vpm CO              | 1.305          | 504  | 0.26%   | YES         | vpm CO              | 1.305 | 504  | 0.26%  | YES |
| CO <sub>2</sub> | <b>4.04</b>         | SPAN           | %    | OK?     | <b>4.04</b> | SPAN                | %     | OK?  |        |     |
|                 | ppm THC             | -0.68          | 1005 | 0.07%   | YES         | ppm THC             | 1.08  | 1005 | 0.11%  | YES |
|                 | % O <sub>2</sub>    | 0              | 15   | 0.00%   | YES         | % O <sub>2</sub>    | 0     | 15   | 0.00%  | YES |
|                 | ppm NO <sub>x</sub> | 0.66           | 126  | 0.52%   | YES         | ppm NO <sub>x</sub> | 0.72  | 126  | 0.57%  | YES |
|                 | % CO <sub>2</sub>   | 4.059          | 4.04 | 100.47% | YES         | % CO <sub>2</sub>   | 4.01  | 4.04 | 99.26% | YES |
|                 | vpm CO              | 2.45           | 504  | 0.49%   | YES         | vpm CO              | 1.7   | 504  | 0.34%  | YES |
| NO <sub>x</sub> | <b>126</b>          | SPAN           | %    | OK?     | <b>126</b>  | SPAN                | %     | OK?  |        |     |
|                 | ppm THC             | -0.39          | 1005 | 0.04%   | YES         | ppm THC             | 0.75  | 1005 | 0.07%  | YES |
|                 | % O <sub>2</sub>    | 0.03           | 15   | 0.20%   | YES         | % O <sub>2</sub>    | 0.02  | 15   | 0.13%  | YES |
|                 | ppm NO <sub>x</sub> | 125.3          | 126  | 99.44%  | YES         | ppm NO <sub>x</sub> | 123   | 126  | 97.62% | YES |
|                 | % CO <sub>2</sub>   | 0.003          | 4.04 | 0.07%   | YES         | % CO <sub>2</sub>   | 0.008 | 4.04 | 0.20%  | YES |
|                 | vpm CO              | 0.107          | 504  | 0.02%   | YES         | vpm CO              | 0.8   | 504  | 0.16%  | YES |
| O <sub>2</sub>  | <b>15</b>           | SPAN           | %    | OK?     | <b>15</b>   | SPAN                | %     | OK?  |        |     |
|                 | ppm THC             | -1.19          | 1005 | 0.12%   | YES         | ppm THC             | 0.11  | 1005 | 0.01%  | YES |
|                 | % O <sub>2</sub>    | 14.95          | 15   | 99.67%  | YES         | % O <sub>2</sub>    | 14.86 | 15   | 99.07% | YES |
|                 | ppm NO <sub>x</sub> | 0.17           | 126  | 0.13%   | YES         | ppm NO <sub>x</sub> | 0.6   | 126  | 0.48%  | YES |
|                 | % CO <sub>2</sub>   | 0.001          | 4.04 | 0.02%   | YES         | % CO <sub>2</sub>   | 0.004 | 4.04 | 0.10%  | YES |
|                 | vpm CO              | 1              | 504  | 0.20%   | YES         | vpm CO              | 0.8   | 504  | 0.16%  | YES |

\* values allowed to stabilize for roughly 5 minutes

|     |      |
|-----|------|
| CO  | 504  |
| THC | 1005 |

Pass

|     |      |
|-----|------|
| CO  | 504  |
| THC | 1005 |

Pass

Date 12/3/2009

|                 |                     | Pre Daily Test |      |         |             | Post Daily Test     |       |      |        |     |
|-----------------|---------------------|----------------|------|---------|-------------|---------------------|-------|------|--------|-----|
| ZERO            | <b>0</b>            | SPAN           | %    | OK?     | <b>0</b>    | SPAN                | %     | OK?  |        |     |
|                 | ppm THC             | -6.2           | 1005 | 0.62%   | YES         | ppm THC             | -3.89 | 1005 | 0.39%  | YES |
|                 | % O <sub>2</sub>    | 0.03           | 8.99 | 0.33%   | YES         | % O <sub>2</sub>    | 0.02  | 8.99 | 0.22%  | YES |
|                 | ppm NO <sub>x</sub> | 0.33           | 126  | 0.26%   | YES         | ppm NO <sub>x</sub> | 0.35  | 126  | 0.28%  | YES |
|                 | % CO <sub>2</sub>   | 0              | 4.04 | 0.00%   | YES         | % CO <sub>2</sub>   | 0.004 | 4.04 | 0.10%  | YES |
|                 | vpm CO              | 1.1            | 504  | 0.22%   | YES         | vpm CO              | 1.6   | 504  | 0.32%  | YES |
| CO <sub>2</sub> | <b>4.04</b>         | SPAN           | %    | OK?     | <b>4.04</b> | SPAN                | %     | OK?  |        |     |
|                 | ppm THC             | -6.8           | 1005 | 0.68%   | YES         | ppm THC             | -3.66 | 1005 | 0.36%  | YES |
|                 | % O <sub>2</sub>    | 0.02           | 8.99 | 0.22%   | YES         | % O <sub>2</sub>    | 0     | 8.99 | 0.00%  | YES |
|                 | ppm NO <sub>x</sub> | 0.24           | 126  | 0.19%   | YES         | ppm NO <sub>x</sub> | 0.38  | 126  | 0.30%  | YES |
|                 | % CO <sub>2</sub>   | 4.04           | 4.04 | 100.00% | YES         | % CO <sub>2</sub>   | 3.944 | 4.04 | 97.62% | YES |
|                 | vpm CO              | 2.2            | 504  | 0.44%   | YES         | vpm CO              | 2.5   | 504  | 0.50%  | YES |
| NO <sub>x</sub> | <b>126</b>          | SPAN           | %    | OK?     | <b>126</b>  | SPAN                | %     | OK?  |        |     |
|                 | ppm THC             | -7.95          | 1005 | 0.79%   | YES         | ppm THC             | -3.87 | 1005 | 0.39%  | YES |
|                 | % O <sub>2</sub>    | 0.02           | 8.99 | 0.22%   | YES         | % O <sub>2</sub>    | 0.02  | 8.99 | 0.22%  | YES |
|                 | ppm NO <sub>x</sub> | 124.2          | 126  | 98.55%  | YES         | ppm NO <sub>x</sub> | 122.9 | 126  | 97.54% | YES |
|                 | % CO <sub>2</sub>   | 0.001          | 4.04 | 0.02%   | YES         | % CO <sub>2</sub>   | 0.004 | 4.04 | 0.10%  | YES |
|                 | vpm CO              | 1.202          | 504  | 0.24%   | YES         | vpm CO              | 2.2   | 504  | 0.44%  | YES |
| O <sub>2</sub>  | <b>8.99</b>         | SPAN           | %    | OK?     | <b>8.99</b> | SPAN                | %     | OK?  |        |     |
|                 | ppm THC             | -8.58          | 1005 | 0.85%   | YES         | ppm THC             | -4.02 | 1005 | 0.40%  | YES |
|                 | % O <sub>2</sub>    | 8.98           | 8.99 | 99.89%  | YES         | % O <sub>2</sub>    | 8.91  | 8.99 | 99.11% | YES |
|                 | ppm NO <sub>x</sub> | 0.14           | 126  | 0.11%   | YES         | ppm NO <sub>x</sub> | 0.37  | 126  | 0.29%  | YES |
|                 | % CO <sub>2</sub>   | 0.001          | 4.04 | 0.02%   | YES         | % CO <sub>2</sub>   | 0.003 | 4.04 | 0.07%  | YES |
|                 | vpm CO              | 0.614          | 504  | 0.12%   | YES         | vpm CO              | 2     | 504  | 0.40%  | YES |

\* values allowed to stabilize for roughly 5 minutes

|     |      |
|-----|------|
| CO  | 504  |
| THC | 1005 |

Pass

|     |      |
|-----|------|
| CO  | 504  |
| THC | 1005 |

Pass

Date 1/19/2010

|                 |                     | Pre Daily Test |      |         |             | Post Daily Test     |       |      |        |     |
|-----------------|---------------------|----------------|------|---------|-------------|---------------------|-------|------|--------|-----|
| ZERO            | <b>0</b>            | SPAN           | %    | OK?     | <b>0</b>    | SPAN                | %     | OK?  |        |     |
|                 | ppm THC             | -2.17          | 1005 | 0.22%   | YES         | ppm THC             | -3.89 | 1005 | 0.39%  | YES |
|                 | % O <sub>2</sub>    | 0              | 8.99 | 0.00%   | YES         | % O <sub>2</sub>    | 0.02  | 8.99 | 0.22%  | YES |
|                 | ppm NO <sub>x</sub> | 0.02           | 126  | 0.02%   | YES         | ppm NO <sub>x</sub> | 0.35  | 126  | 0.28%  | YES |
|                 | % CO <sub>2</sub>   | 0.001          | 12   | 0.01%   | YES         | % CO <sub>2</sub>   | 0.004 | 4.04 | 0.10%  | YES |
|                 | vpm CO              | 2.32           | 504  | 0.46%   | YES         | vpm CO              | 1.6   | 504  | 0.32%  | YES |
| CO <sub>2</sub> | <b>12</b>           | SPAN           | %    | OK?     | <b>4.04</b> | SPAN                | %     | OK?  |        |     |
|                 | ppm THC             | -2.33          | 1005 | 0.23%   | YES         | ppm THC             | -3.66 | 1005 | 0.36%  | YES |
|                 | % O <sub>2</sub>    | -0.02          | 8.99 | 0.22%   | YES         | % O <sub>2</sub>    | 0     | 8.99 | 0.00%  | YES |
|                 | ppm NO <sub>x</sub> | 0.03           | 126  | 0.02%   | YES         | ppm NO <sub>x</sub> | 0.38  | 126  | 0.30%  | YES |
|                 | % CO <sub>2</sub>   | 12.01          | 12   | 100.08% | YES         | % CO <sub>2</sub>   | 3.944 | 4.04 | 97.62% | YES |
|                 | vpm CO              | 3.8            | 504  | 0.75%   | YES         | vpm CO              | 2.5   | 504  | 0.50%  | YES |
| NO <sub>x</sub> | <b>126</b>          | SPAN           | %    | OK?     | <b>126</b>  | SPAN                | %     | OK?  |        |     |
|                 | ppm THC             | -2.4           | 1005 | 0.24%   | YES         | ppm THC             | -3.87 | 1005 | 0.39%  | YES |
|                 | % O <sub>2</sub>    | 0.01           | 8.99 | 0.11%   | YES         | % O <sub>2</sub>    | 0.02  | 8.99 | 0.22%  | YES |
|                 | ppm NO <sub>x</sub> | 125.6          | 126  | 99.69%  | YES         | ppm NO <sub>x</sub> | 122.9 | 126  | 97.54% | YES |
|                 | % CO <sub>2</sub>   | 0.004          | 12   | 0.03%   | YES         | % CO <sub>2</sub>   | 0.004 | 4.04 | 0.10%  | YES |
|                 | vpm CO              | 3              | 504  | 0.60%   | YES         | vpm CO              | 2.2   | 504  | 0.44%  | YES |
| O <sub>2</sub>  | <b>8.99</b>         | SPAN           | %    | OK?     | <b>8.99</b> | SPAN                | %     | OK?  |        |     |
|                 | ppm THC             | -2.75          | 1005 | 0.27%   | YES         | ppm THC             | -4.02 | 1005 | 0.40%  | YES |
|                 | % O <sub>2</sub>    | 8.99           | 8.99 | 100.00% | YES         | % O <sub>2</sub>    | 8.91  | 8.99 | 99.11% | YES |
|                 | ppm NO <sub>x</sub> | 0.05           | 126  | 0.04%   | YES         | ppm NO <sub>x</sub> | 0.37  | 126  | 0.29%  | YES |
|                 | % CO <sub>2</sub>   | 0.002          | 12   | 0.02%   | YES         | % CO <sub>2</sub>   | 0.003 | 4.04 | 0.07%  | YES |
|                 | vpm CO              | 2.5            | 504  | 0.50%   | YES         | vpm CO              | 2     | 504  | 0.40%  | YES |

\* values allowed to stabilize for roughly 5 minutes

|     |      |
|-----|------|
| CO  | 504  |
| THC | 1005 |

Pass

|     |      |
|-----|------|
| CO  | 504  |
| THC | 1005 |

Pass

Date 2/23/2010



|                 |                     | Pre Daily Test |      |        |             | Post Daily Test     |       |      |        |     |
|-----------------|---------------------|----------------|------|--------|-------------|---------------------|-------|------|--------|-----|
| ZERO            | <b>0</b>            | SPAN           | %    | OK?    | <b>0</b>    | SPAN                | %     | OK?  |        |     |
|                 | ppm THC             | -0.76          | 1005 | 0.08%  | YES         | ppm THC             | -5.07 | 1005 | 0.50%  | YES |
|                 | % O <sub>2</sub>    | 0.01           | 8.99 | 0.11%  | YES         | % O <sub>2</sub>    | 0.05  | 8.99 | 0.56%  | YES |
|                 | ppm NO <sub>x</sub> | 0.05           | 126  | 0.04%  | YES         | ppm NO <sub>x</sub> | 0.45  | 126  | 0.36%  | YES |
|                 | % CO <sub>2</sub>   | 0              | 12   | 0.00%  | YES         | % CO <sub>2</sub>   | 0.019 | 12   | 0.16%  | YES |
|                 | vpm CO              | 1.7            | 504  | 0.34%  | YES         | vpm CO              | 1.8   | 504  | 0.36%  | YES |
| CO <sub>2</sub> | <b>12</b>           | SPAN           | %    | OK?    | <b>12</b>   | SPAN                | %     | OK?  |        |     |
|                 | ppm THC             | -1.15          | 1005 | 0.11%  | YES         | ppm THC             | -4.94 | 1005 | 0.49%  | YES |
|                 | % O <sub>2</sub>    | -0.01          | 8.99 | 0.11%  | YES         | % O <sub>2</sub>    | 0     | 8.99 | 0.00%  | YES |
|                 | ppm NO <sub>x</sub> | 0.04           | 126  | 0.03%  | YES         | ppm NO <sub>x</sub> | 0.92  | 126  | 0.73%  | YES |
|                 | % CO <sub>2</sub>   | 11.96          | 12   | 99.67% | YES         | % CO <sub>2</sub>   | 11.77 | 12   | 98.08% | YES |
|                 | vpm CO              | 3.3            | 504  | 0.65%  | YES         | vpm CO              | 3.7   | 504  | 0.73%  | YES |
| NO <sub>x</sub> | <b>126</b>          | SPAN           | %    | OK?    | <b>126</b>  | SPAN                | %     | OK?  |        |     |
|                 | ppm THC             | -1.5           | 1005 | 0.15%  | YES         | ppm THC             | -4.65 | 1005 | 0.46%  | YES |
|                 | % O <sub>2</sub>    | 0.01           | 8.99 | 0.11%  | YES         | % O <sub>2</sub>    | 0.03  | 8.99 | 0.33%  | YES |
|                 | ppm NO <sub>x</sub> | 125            | 126  | 99.17% | YES         | ppm NO <sub>x</sub> | 124.1 | 126  | 98.49% | YES |
|                 | % CO <sub>2</sub>   | 0.007          | 12   | 0.06%  | YES         | % CO <sub>2</sub>   | 0.016 | 12   | 0.13%  | YES |
|                 | vpm CO              | 1.2            | 504  | 0.24%  | YES         | vpm CO              | 3     | 504  | 0.60%  | YES |
| O <sub>2</sub>  | <b>8.99</b>         | SPAN           | %    | OK?    | <b>8.99</b> | SPAN                | %     | OK?  |        |     |
|                 | ppm THC             | -2.22          | 1005 | 0.22%  | YES         | ppm THC             | -5.12 | 1005 | 0.51%  | YES |
|                 | % O <sub>2</sub>    | 8.97           | 8.99 | 99.78% | YES         | % O <sub>2</sub>    | 8.98  | 8.99 | 99.89% | YES |
|                 | ppm NO <sub>x</sub> | 0.12           | 126  | 0.10%  | YES         | ppm NO <sub>x</sub> | 0.34  | 126  | 0.27%  | YES |
|                 | % CO <sub>2</sub>   | 0.002          | 12   | 0.02%  | YES         | % CO <sub>2</sub>   | 0.008 | 12   | 0.07%  | YES |
|                 | vpm CO              | 0.34           | 504  | 0.07%  | YES         | vpm CO              | 0.992 | 504  | 0.20%  | YES |

\* values allowed to stabilize for roughly 5 minutes

|     |      |
|-----|------|
| CO  | 504  |
| THC | 1005 |

Pass

|     |      |
|-----|------|
| CO  | 504  |
| THC | 1005 |

Pass

Date 2/25/2010

|                 |                     | Pre Daily Test |      |        |            | Post Daily Test     |       |      |        |     |
|-----------------|---------------------|----------------|------|--------|------------|---------------------|-------|------|--------|-----|
| ZERO            | <b>0</b>            | SPAN           | %    | OK?    | <b>0</b>   | SPAN                | %     | OK?  |        |     |
|                 | ppm THC             | -0.39          | 1005 | 0.04%  | YES        | ppm THC             | -3.42 | 1005 | 0.34%  | YES |
|                 | % O <sub>2</sub>    | 0.03           | 15   | 0.20%  | YES        | % O <sub>2</sub>    | 0.02  | 15   | 0.13%  | YES |
|                 | ppm NO <sub>x</sub> | 0.14           | 127  | 0.11%  | YES        | ppm NO <sub>x</sub> | 1.5   | 127  | 1.18%  | YES |
|                 | % CO <sub>2</sub>   | 0.001          | 4    | 0.03%  | YES        | % CO <sub>2</sub>   | 0.005 | 4    | 0.13%  | YES |
|                 | vpm CO              | 2.51           | 504  | 0.50%  | YES        | vpm CO              | 1.441 | 504  | 0.29%  | YES |
| CO <sub>2</sub> | <b>4</b>            | SPAN           | %    | OK?    | <b>4</b>   | SPAN                | %     | OK?  |        |     |
|                 | ppm THC             | -0.03          | 1005 | 0.00%  | YES        | ppm THC             | -3.82 | 1005 | 0.38%  | YES |
|                 | % O <sub>2</sub>    | 0.02           | 15   | 0.13%  | YES        | % O <sub>2</sub>    | 0     | 15   | 0.00%  | YES |
|                 | ppm NO <sub>x</sub> | 0.15           | 127  | 0.12%  | YES        | ppm NO <sub>x</sub> | 1.06  | 127  | 0.83%  | YES |
|                 | % CO <sub>2</sub>   | 3.978          | 4    | 99.45% | YES        | % CO <sub>2</sub>   | 3.929 | 4    | 98.23% | YES |
|                 | vpm CO              | 1.51           | 504  | 0.30%  | YES        | vpm CO              | 2.32  | 504  | 0.46%  | YES |
| NO <sub>x</sub> | <b>127</b>          | SPAN           | %    | OK?    | <b>127</b> | SPAN                | %     | OK?  |        |     |
|                 | ppm THC             | -1.01          | 1005 | 0.10%  | YES        | ppm THC             | -4.12 | 1005 | 0.41%  | YES |
|                 | % O <sub>2</sub>    | 0.03           | 15   | 0.20%  | YES        | % O <sub>2</sub>    | 0.03  | 15   | 0.20%  | YES |
|                 | ppm NO <sub>x</sub> | 124.7          | 127  | 98.18% | YES        | ppm NO <sub>x</sub> | 124.5 | 127  | 98.05% | YES |
|                 | % CO <sub>2</sub>   | 0.002          | 4    | 0.05%  | YES        | % CO <sub>2</sub>   | 0.006 | 4    | 0.15%  | YES |
|                 | vpm CO              | 0.97           | 504  | 0.19%  | YES        | vpm CO              | 1.144 | 504  | 0.23%  | YES |
| O <sub>2</sub>  | <b>15</b>           | SPAN           | %    | OK?    | <b>15</b>  | SPAN                | %     | OK?  |        |     |
|                 | ppm THC             | -1.71          | 1005 | 0.17%  | YES        | ppm THC             | -4.55 | 1005 | 0.45%  | YES |
|                 | % O <sub>2</sub>    | 14.98          | 15   | 99.87% | YES        | % O <sub>2</sub>    | 14.97 | 15   | 99.80% | YES |
|                 | ppm NO <sub>x</sub> | 0.07           | 127  | 0.06%  | YES        | ppm NO <sub>x</sub> | 0.53  | 127  | 0.42%  | YES |
|                 | % CO <sub>2</sub>   | 0.001          | 4    | 0.03%  | YES        | % CO <sub>2</sub>   | 0.067 | 4    | 1.68%  | YES |
|                 | vpm CO              | 1.87           | 504  | 0.37%  | YES        | vpm CO              | 0.983 | 504  | 0.20%  | YES |

\* values allowed to stabilize for roughly 5 minutes

|     |      |
|-----|------|
| CO  | 504  |
| THC | 1005 |

Pass

|     |      |
|-----|------|
| CO  | 504  |
| THC | 1005 |

Pass

Date 4/13/2010

## APPENDIX IV – TEST DATA

| <b>Data Point Name</b>                     | <b>NG_01</b>       | <b>NG_02</b>     | <b>NG_03</b>     |
|--|--------------------|------------------|------------------|
| <b>Data Point Description (Checkvalve)</b> | <b>NG Baseline</b> |                  |                  |
| <b>Date</b>                                | <b>9/22/2009</b>   | <b>9/22/2009</b> | <b>9/22/2009</b> |
| Speed [rpm]                                | 3.00E+02           | 3.00E+02         | 3.00E+02         |
| Torque [lb-ft]                             | 7.71E+03           | 7.70E+03         | 7.71E+03         |
| Power [bhp]                                | 4.40E+02           | 4.40E+02         | 4.40E+02         |
| Fuel Flow [lb/hr]                          | 1.97E+02           | 1.97E+02         | 1.97E+02         |
| Eng Fuel Pres [psig]                       | 2.72E+01           | 2.71E+01         | 2.72E+01         |
| JW Out Temp [F]                            | 1.65E+02           | 1.65E+02         | 1.65E+02         |
| JW In Temp [F]                             | 1.62E+02           | 1.62E+02         | 1.62E+02         |
| IC Water Temp [F]                          | 3.51E+03           | 3.51E+03         | 3.51E+03         |
| IC Water In [F]                            | NaN                | NaN              | NaN              |
| DW Out [F]                                 | NaN                | NaN              | NaN              |
| DW In [F]                                  | NaN                | NaN              | NaN              |
| Inlet Air Pres [in Hg]                     | 1.80E+01           | 1.80E+01         | 1.80E+01         |
| Inlet Air Temp [F]                         | 1.11E+02           | 1.11E+02         | 1.12E+02         |
| Inlet Air Humidity [%]                     | 7.34E+00           | 7.94E+00         | 8.08E+00         |
| Engine Avg. Exhaust Port Temp [F]          | 6.84E+02           | 6.84E+02         | 6.85E+02         |
| Engine Hi Exhaust Port Temp [F] Cyl #2     | 7.38E+02           | 7.38E+02         | 7.39E+02         |
| Engine Lo Exhaust Port Temp [F] Cyl #1     | 6.45E+02           | 6.45E+02         | 6.46E+02         |
| Exh Back Pres [in Hg]                      | 1.55E+01           | 1.55E+01         | 1.55E+01         |
| Stack Temp [F]                             | 7.62E+01           | 7.63E+01         | 7.66E+01         |
| Stack Pressure [in H2O]                    | NaN                | NaN              | NaN              |
| PCC Fuel Flow [SLM]                        | 30.6               | 30.6             | 30.6             |
| <b>Emissions Data</b>                      |                    |                  |                  |
| THC [ppmd]                                 | 7.85E+02           | 7.84E+02         | 7.84E+02         |
| NOx [ppmd]                                 | 3.60E+01           | 3.58E+01         | 3.59E+01         |
| NO [ppmd]                                  | 1.20E+01           | 1.19E+01         | 1.25E+01         |
| NO2 [ppmd]                                 | 2.40E+01           | 2.39E+01         | 2.34E+01         |
| O2 [%d]                                    | 1.51E+01           | 1.51E+01         | 1.51E+01         |
| CO2 [%d]                                   | 3.35E+00           | 3.35E+00         | 3.35E+00         |
| CO [ppmd]                                  | 1.46E+02           | 1.46E+02         | 1.47E+02         |
| Formaldehyde                               | 2.15E+01           | 2.15E+01         | 2.15E+01         |

| <b>Data Point Name</b>                     | <b>NG_01</b>       | <b>NG_02</b>     | <b>NG_03</b>     |
|--|--------------------|------------------|------------------|
| <b>Data Point Description (Checkvalve)</b> | <b>NG Baseline</b> |                  |                  |
| <b>Date</b>                                | <b>9/22/2009</b>   | <b>9/22/2009</b> | <b>9/22/2009</b> |
| <b>Calculated Data</b>                     |                    |                  |                  |
| U & S A/F                                  | 0.00E+00           | 5.27E+01         | 5.27E+01         |
| Trapped A/F                                | 2.79E+01           | 2.79E+01         | 2.78E+01         |
| Phi Trapped                                | 6.09E-01           | 6.10E-01         | 6.11E-01         |
| Phi Total                                  | NaN                | 3.05E-01         | 3.05E-01         |
| BSFC [BTU/bhp-hr]                          | 9.00E+03           | 9.01E+03         | 9.00E+03         |
| BMEP [psi]                                 | 6.74E+01           | 6.74E+01         | 6.74E+01         |
| Thermal Eff.                               | 2.83E+01           | 2.82E+01         | 2.83E+01         |
| Methane [%]                                | 8.71E+01           | 8.68E+01         | 8.70E+01         |
| LHV [BTU/cf]                               | 9.76E+02           | 9.78E+02         | 9.78E+02         |
| Gas Density [lb/Mcf]                       | 5.13E+01           | 5.15E+01         | 5.14E+01         |
| BS THC [g/bhp-hr]                          | 5.07E+00           | 5.08E+00         | 5.07E+00         |
| BS NOx EPA Meth. 20 [g/bhp-hr]             | 5.59E-01           | 5.59E-01         | 5.55E-01         |
| BS CO [g/bhp-hr]                           | 1.48E+00           | 1.49E+00         | 1.49E+00         |
| BS CH2O [g/bhp-hr]                         | 2.69E-01           | 2.70E-01         | 2.69E-01         |
| BS VOC [g/bhp-hr]                          | 9.95E-01           | 1.01E+00         | 1.01E+00         |
| <b>Combustion Data</b>                     |                    |                  |                  |
| Engine Avg Peak Pressure[PSI]              | 5.01E+02           | 5.00E+02         | 5.01E+02         |
| Engine Avg Peak Pres Std Dev[PSI]          | 2.75E+01           | 2.79E+01         | 2.83E+01         |
| Engine Avg Peak Pres COV[%]                | 5.47E+00           | 5.56E+00         | 5.63E+00         |
| Engine Max Peak Pres COV Ch. #3[%]         | 5.98E+00           | 6.37E+00         | 6.19E+00         |
| Engine Min Peak Pres COV Ch. #4[%]         | 4.89E+00           | 4.91E+00         | 5.05E+00         |
| Engine Avg Peak Loc[*ATDC]                 | 1.83E+01           | 1.84E+01         | 1.83E+01         |
| Engine Avg IMEP[PSI]                       | 8.04E+01           | 8.03E+01         | 8.03E+01         |
| Engine Avg IMEP COV[%]                     | 2.25E+00           | 2.20E+00         | 2.17E+00         |
| Engine Max IMEP COV Ch. #2[%]              | 3.13E+00           | 2.88E+00         | 2.85E+00         |
| Engine Min IMEP COV Ch. #3[%]              | 1.65E+00           | 1.76E+00         | 1.72E+00         |

| <b>Data Point Name</b>                     | <b>H2-01</b>           | <b>H2-02</b> | <b>H2-03</b> |
|--|------------------------|--------------|--------------|
| <b>Data Point Description (Checkvalve)</b> | H2 non optimal PCC phi |              |              |
| <b>Date</b>                                | 10/13/2009             | 10/13/2009   | 10/13/2009   |
| <b>Engine Data</b>                         |                        |              |              |
| Speed [rpm]                                | 300                    | 300          | 300          |
| Torque [lb-ft]                             | 7724                   | 7713         | 7717         |
| Power [bhp]                                | 441                    | 440.4        | 440.6        |
| Fuel Flow [lb/hr]                          | 200.9                  | 200.9        | 201.2        |
| Eng Fuel Pres [psig]                       | 26.76                  | 26.76        | 26.81        |
| JW Out Temp [F]                            | 165                    | 165.1        | 164.7        |
| JW In Temp [F]                             | 161.7                  | 161.5        | 160.8        |
| IC Water Temp [F]                          | 3505                   | 3506         | 3506         |
| IC Water In [F]                            | NaN                    | NaN          | NaN          |
| DW Out [F]                                 | NaN                    | NaN          | NaN          |
| DW In [F]                                  | NaN                    | NaN          | NaN          |
| Inlet Air Pres [in Hg]                     | 18                     | 18           | 18           |
| Inlet Air Temp [F]                         | 109.1                  | 110          | 111          |
| Inlet Air Humidity [%]                     | 33.96                  | 34.06        | 34.18        |
| Engine Avg. Exhaust Port Temp [F]          | 688                    | 687.9        | 690.4        |
| Engine Hi Exhaust Port Temp [F] Cyl #2     | 739.4                  | 739.4        | 742.7        |
| Engine Lo Exhaust Port Temp [F] Cyl #1     | 648.6                  | 648.6        | 649.4        |
| Exh Back Pres [in Hg]                      | 15.49                  | 15.5         | 15.49        |
| Stack Temp [F]                             | 82.79                  | 82.45        | 82.18        |
| Stack Pressure [in H2O]                    | NaN                    | NaN          | NaN          |
| <b>PCC Fueling</b>                         |                        |              |              |
| NG Flow [SCFH]                             | 22                     | 22           | 22           |
| Specialty Flow [SCFH]                      | 263                    | 263          | 263          |
| % NG                                       | 7.7%                   | 7.7%         | 7.7%         |
| % Specialty                                | 92.3%                  | 92.3%        | 92.3%        |

| <b>Data Point Name</b>                     | <b>H2-01</b>           | <b>H2-02</b> | <b>H2-03</b> |
|--|------------------------|--------------|--------------|
| <b>Data Point Description (Checkvalve)</b> | H2 non optimal PCC phi |              |              |
| <b>Date</b>                                | 10/13/2009             | 10/13/2009   | 10/13/2009   |
| <b>Emissions Data</b>                      |                        |              |              |
| THC [ppmd]                                 | 823.3                  | 829          | 829.9        |
| NOx [ppmd]                                 | 31.18                  | 31.43        | 32.46        |
| NO [ppmd]                                  | 0                      | 0            | 0            |
| NO2 [ppmd]                                 | 0                      | 0            | 0            |
| O2 [%d]                                    | 14.89                  | 14.89        | 14.87        |
| CO2 [%d]                                   | 3.253                  | 3.254        | 3.271        |
| CO [ppmd]                                  | 135.5                  | 135.2        | 131.5        |
| Formaldehyde                               | 18.88                  | 18.84        | 18.73        |
| <b>Calculated Data</b>                     |                        |              |              |
| U & S A/F                                  | 51.5                   | 51.5         | 51.3         |
| Trapped A/F                                | 27.4                   | 27.4         | 27.3         |
| Phi Trapped                                | 0.628                  | 0.629        | 0.631        |
| Phi Total                                  | 0.312                  | 0.312        | 0.313        |
| BSFC [BTU/bhp-hr]                          | 9120                   | 9130         | 9150         |
| BMEP [psi]                                 | 67.5                   | 67.4         | 67.5         |
| Thermal Eff.                               | 27.9                   | 27.9         | 27.8         |
| Methane [%]                                | 95.6                   | 95.6         | 95.6         |
| LHV [BTU/cf]                               | 893                    | 892          | 894          |
| Gas Density [lb/Mcf]                       | 47.2                   | 47.2         | 47.2         |
| BS THC [g/bhp-hr]                          | 4.95                   | 4.98         | 4.98         |
| BS NOx EPA Meth. 20 [g/bhp-hr]             | 0.486                  | 0.491        | 0.5          |
| BS CO [g/bhp-hr]                           | 1.4                    | 1.4          | 1.36         |
| BS CH2O [g/bhp-hr]                         | 0.25                   | 0.249        | 0.247        |
| BS VOC [g/bhp-hr]                          | 0.786                  | 0.785        | 0.772        |

| <b>Data Point Name</b>                     | <b>H2-01</b>           | <b>H2-02</b> | <b>H2-03</b> |
|--|------------------------|--------------|--------------|
| <b>Data Point Description (Checkvalve)</b> | H2 non optimal PCC phi |              |              |
| <b>Date</b>                                | 10/13/2009             | 10/13/2009   | 10/13/2009   |
| <b>Combustion Data</b>                     |                        |              |              |
| Engine Avg Peak Pressure[]                 | 503                    | 503          | 501          |
| Engine Avg Peak Pres Std Dev[]             | 30.4                   | 29.8         | 30.4         |
| Engine Avg Peak Pres COV[]                 | 6.06                   | 5.94         | 6.07         |
| Engine Max Peak Pres COV Ch. #3[]          | 8.11                   | 8            | 7.91         |
| Engine Min Peak Pres COV Ch. #4[]          | 4.59                   | 4.52         | 4.87         |
| Engine Avg Peak Loc[]                      | 18.1                   | 18           | 18.2         |
| Engine Avg IMEP[]                          | 79.9                   | 79.8         | 80           |
| Engine Avg IMEP COV[]                      | 2.7                    | 3.44         | 3.1          |
| Engine Max IMEP COV Ch. #3[]               | 3.68                   | 5.14         | 5.07         |
| Engine Min IMEP COV Ch. #4[]               | 1.84                   | 1.84         | 1.93         |

| <b>Data Point Name</b>                     | <b>SYN2-04</b>           | <b>SYN2-05</b> | <b>SYN2-06</b> |
|--|--------------------------|----------------|----------------|
| <b>Data Point Description (Checkvalve)</b> | Syn2 non optimal PCC phi |                |                |
| <b>Date</b>                                | 10/13/2009               | 10/13/2009     | 10/13/2009     |
| <b>Engine Data</b>                         |                          |                |                |
| Speed [rpm]                                | 300                      | 300            | 300            |
| Torque [lb-ft]                             | 7706                     | 7706           | 7707           |
| Power [bhp]                                | 440.2                    | 440.2          | 440.2          |
| Fuel Flow [lb/hr]                          | 201.9                    | 202            | 202.1          |
| Eng Fuel Pres [psig]                       | 26.51                    | 26.53          | 26.53          |
| JW Out Temp [F]                            | 164.9                    | 165.1          | 164.7          |
| JW In Temp [F]                             | 161.2                    | 161.6          | 161.1          |
| IC Water Temp [F]                          | 3506                     | 3506           | 3505           |
| IC Water In [F]                            | NaN                      | NaN            | NaN            |
| DW Out [F]                                 | NaN                      | NaN            | NaN            |
| DW In [F]                                  | NaN                      | NaN            | NaN            |
| Inlet Air Pres [in Hg]                     | 18                       | 18             | 18             |
| Inlet Air Temp [F]                         | 110.7                    | 109.3          | 111.1          |
| Inlet Air Humidity [%]                     | 34.28                    | 34.31          | 34.19          |
| Engine Avg. Exhaust Port Temp [F]          | 686                      | 685.2          | 686.5          |
| Engine Hi Exhaust Port Temp [F] Cyl #2     | 736.1                    | 735.8          | 736.4          |
| Engine Lo Exhaust Port Temp [F] Cyl #1     | 641.3                    | 639.9          | 641.7          |
| Exh Back Pres [in Hg]                      | 15.49                    | 15.49          | 15.49          |
| Stack Temp [F]                             | 81.73                    | 81.78          | 82.16          |
| Stack Pressure [in H2O]                    | NaN                      | NaN            | NaN            |
| <b>PCC Fueling</b>                         |                          |                |                |
| NG Flow [SCFH]                             | 46                       | 46             | 46             |
| Specialty Flow [SCFH]                      | 190                      | 190            | 190            |
| % NG                                       | 19.5%                    | 19.5%          | 19.5%          |
| % Specialty                                | 80.5%                    | 80.5%          | 80.5%          |



| <b>Data Point Name</b>                     | <b>SYN2-04</b>           | <b>SYN2-05</b> | <b>SYN2-06</b> |
|--|--------------------------|----------------|----------------|
| <b>Data Point Description (Checkvalve)</b> | Syn2 non optimal PCC phi |                |                |
| <b>Date</b>                                | 10/13/2009               | 10/13/2009     | 10/13/2009     |
| <b>Emissions Data</b>                      |                          |                |                |
| THC [ppmd]                                 | 878.1                    | 885.5          | 877.3          |
| NOx [ppmd]                                 | 30.47                    | 29.68          | 30.71          |
| NO [ppmd]                                  | 0                        | 0              | 0              |
| NO2 [ppmd]                                 | 0                        | 0              | 0              |
| O2 [%d]                                    | 14.93                    | 14.94          | 14.94          |
| CO2 [%d]                                   | 3.267                    | 3.26           | 3.26           |
| CO [ppmd]                                  | 221.8                    | 224.1          | 224.4          |
| Formaldehyde                               | 19.61                    | 19.88          | 19.82          |
| <b>Calculated Data</b>                     |                          |                |                |
| U & S A/F                                  | 51                       | 51             | 51             |
| Trapped A/F                                | 27.3                     | 27.4           | 27.3           |
| Phi Trapped                                | 0.63                     | 0.629          | 0.63           |
| Phi Total                                  | 0.314                    | 0.314          | 0.314          |
| BSFC [BTU/bhp-hr]                          | 9160                     | 9160           | 9160           |
| BMEP [psi]                                 | 67.4                     | 67.4           | 67.4           |
| Thermal Eff.                               | 27.8                     | 27.8           | 27.8           |
| Methane [%]                                | 95.8                     | 95.8           | 95.8           |
| LHV [BTU/cf]                               | 888                      | 888            | 887            |
| Gas Density [lb/Mcf]                       | 47.1                     | 47.1           | 47.1           |
| BS THC [g/bhp-hr]                          | 5.23                     | 5.28           | 5.24           |
| BS NOx EPA Meth. 20 [g/bhp-hr]             | 0.473                    | 0.467          | 0.482          |
| BS CO [g/bhp-hr]                           | 2.28                     | 2.31           | 2.31           |
| BS CH2O [g/bhp-hr]                         | 0.257                    | 0.261          | 0.26           |
| BS VOC [g/bhp-hr]                          | 0.778                    | 0.784          | 0.775          |

| <b>Data Point Name</b>                     | <b>SYN2-04</b>           | <b>SYN2-05</b> | <b>SYN2-06</b> |
|--|--------------------------|----------------|----------------|
| <b>Data Point Description (Checkvalve)</b> | Syn2 non optimal PCC phi |                |                |
| <b>Date</b>                                | 10/13/2009               | 10/13/2009     | 10/13/2009     |
| <b>Combustion Data</b>                     |                          |                |                |
| Engine Avg Peak Pressure[]                 | 502                      | 501            | 500            |
| Engine Avg Peak Pres Std Dev[]             | 29.7                     | 29.5           | 30             |
| Engine Avg Peak Pres COV[]                 | 5.91                     | 5.87           | 5.97           |
| Engine Max Peak Pres COV Ch. #3[]          | 6.98                     | 6.75           | 7.04           |
| Engine Min Peak Pres COV Ch. #4[]          | 5.08                     | 5.11           | 5.04           |
| Engine Avg Peak Loc[]                      | 18.1                     | 18.1           | 18.1           |
| Engine Avg IMEP[]                          | 80                       | 79.9           | 79.9           |
| Engine Avg IMEP COV[]                      | 3.07                     | 2.8            | 2.84           |
| Engine Max IMEP COV Ch. #3[]               | 3.94                     | 4.02           | 3.96           |
| Engine Min IMEP COV Ch. #4[]               | 2.31                     | 1.83           | 1.89           |

| <b>Data Point Name</b>                     | <b>NG-02</b> | <b>NG-03</b> | <b>NG-05</b> |
|--|--------------|--------------|--------------|
| <b>Data Point Description (Checkvalve)</b> | Baseline     | Baseline     | Baseline     |
| <b>Date</b>                                | 10/20/2009   | 10/20/2009   | 10/20/2009   |
| <b>25" Hg Boost Data Points</b>            |              |              |              |
| Engine Data                                |              |              |              |
| Speed [rpm]                                | 300          | 300          | 300.1        |
| Torque [lb-ft]                             | 7711         | 7721         | 7713         |
| Power [bhp]                                | 440.5        | 441.1        | 440.6        |
| Fuel Flow [lb/hr]                          | 215.1        | 215.2        | 214.8        |
| Eng Fuel Pres [psig]                       | 30.92        | 30.92        | 30.92        |
| JW Out Temp [F]                            | 165          | 165.2        | 165.2        |
| JW In Temp [F]                             | 161.2        | 161.4        | 161.2        |
| IC Water Temp [F]                          | 3512         | 3512         | 3512         |
| IC Water In [F]                            | NaN          | NaN          | NaN          |
| DW Out [F]                                 | NaN          | NaN          | NaN          |
| DW In [F]                                  | NaN          | NaN          | NaN          |
| Inlet Air Pres [in Hg]                     | 25           | 25           | 25           |
| Inlet Air Temp [F]                         | 110.2        | 109.6        | 111          |
| Inlet Air Humidity [%]                     | 34.78        | 35.16        | 34.78        |
| Engine Avg. Exhaust Port Temp [F]          | 673.3        | 672.8        | 673.3        |
| Engine Hi Exhaust Port Temp [F] Cyl #2     | 736.4        | 735.6        | 736.5        |
| Engine Lo Exhaust Port Temp [F] Cyl #1     | 599          | 598.2        | 598.8        |
| Exh Back Pres [in Hg]                      | 22.51        | 22.5         | 22.5         |
| Stack Temp [F]                             | 86.93        | 87.05        | 87.18        |
| Stack Pressure [in H2O]                    | NaN          | NaN          | NaN          |
| PCC Flow [SCFH]                            | 90.6         | 90.6         | 90.6         |
| Emissions Data                             |              |              |              |
| THC [ppmd]                                 | 1732         | 1732         | 1720         |
| NOx [ppmd]                                 | 16.04        | 15.96        | 16.29        |
| NO [ppmd]                                  | 4.739        | 4.722        | 4.755        |
| NO2 [ppmd]                                 | 11.3         | 11.24        | 11.54        |
| O2 [%d]                                    | 15.45        | 15.45        | 15.46        |
| CO2 [%d]                                   | 3.043        | 3.046        | 3.567        |
| CO [ppmd]                                  | 312.6        | 311          | 309.7        |
| Formaldehyde                               | 34.73        | 34.68        | 34.52        |

| <b>Data Point Name</b>                     | <b>NG-02</b> | <b>NG-03</b> | <b>NG-05</b> |
|--|--------------|--------------|--------------|
| <b>Data Point Description (Checkvalve)</b> | Baseline     | Baseline     | Baseline     |
| <b>Date</b>                                | 10/20/2009   | 10/20/2009   | 10/20/2009   |
| <b>25" Hg Boost Data Points</b>            |              |              |              |
| Calculated Data                            |              |              |              |
| U & S A/F                                  | 53.3         | 53.2         | 47.9         |
| Trapped A/F                                | 29.7         | 29.7         | 28.7         |
| Phi Trapped                                | 0.58         | 0.58         | 0.6          |
| Phi Total                                  | 0.299        | 0.3          | 0.333        |
| BSFC [BTU/bhp-hr]                          | 9710         | 9700         | 9680         |
| BMEP [psi]                                 | 67.4         | 67.5         | 67.5         |
| Thermal Eff.                               | 26.2         | 26.2         | 26.3         |
| Methane [%]                                | 95.6         | 95.5         | 95.5         |
| LHV [BTU/cf]                               | 888          | 888          | 887          |
| Gas Density [lb/Mcf]                       | 47.3         | 47.3         | 47.3         |
| BS THC [g/bhp-hr]                          | 11.4         | 11.4         | 9.72         |
| BS NOx EPA Meth. 20 [g/bhp-hr]             | 0.275        | 0.272        | 0.239        |
| BS CO [g/bhp-hr]                           | 3.56         | 3.53         | 3.02         |
| BS CH2O [g/bhp-hr]                         | 0.497        | 0.496        | 0.424        |
| BS VOC [g/bhp-hr]                          | 1.66         | 1.65         | 1.41         |
| Combustion Data                            |              |              |              |
| Engine Avg Peak Pressure[]                 | 508          | 505          | 509          |
| Engine Avg Peak Pres Std Dev[]             | 39.2         | 35.9         | 39.5         |
| Engine Avg Peak Pres COV[]                 | 7.68         | 7.11         | 7.73         |
| Engine Max Peak Pres COV Ch. #2[]          | 8.23         | 7.92         | 8.55         |
| Engine Min Peak Pres COV Ch. #4[]          | 6.72         | 5.8          | 6.85         |
| Engine Avg Peak Loc[]                      | 18           | 17.5         | 18           |
| Engine Avg IMEP[]                          | 82.5         | 82.6         | 82.5         |
| Engine Avg IMEP COV[]                      | 4.3          | 4.26         | 4.31         |
| Engine Max IMEP COV Ch. #4[]               | 5.91         | 5.85         | 5.43         |
| Engine Min IMEP COV Ch. #3[]               | 2.95         | 2.99         | 2.87         |

| <b>Data Point Name</b>               | <b>PCCNG-01</b> | <b>PCCSYN2-03</b>     | <b>PCCSYN2-04</b>        | <b>PCCSYN2-05</b>     |
|--------------------------------------|-----------------|-----------------------|--------------------------|-----------------------|
| <b>Data Point Description (ePCC)</b> | NG baseline     | 80% syn2 lean PCC phi | 80% syn2 optimal PCC phi | 80% syn2 rich PCC phi |
| <b>Date</b>                          | 12/3/2009       | 12/3/2009             | 12/3/2009                | 12/3/2009             |
| Speed [rpm]                          | 300             | 300                   | 300                      | 300                   |
| Torque [lb-ft]                       | 7716            | 7740                  | 7740                     | 7748                  |
| Power [bhp]                          | 440.8           | 442.1                 | 442.1                    | 442.5                 |
| Load [%]                             | 99.84           | 100.2                 | 100.2                    | 100.3                 |
| Ambient Press [psia]                 | 12.33           | 12.33                 | 12.33                    | 12.34                 |
| Ambient Temp [F]                     | 40.87           | 51.19                 | 54.15                    | 59.72                 |
| Ambient Humidity [%]                 | 17.93           | 16.8                  | 16.62                    | 14.32                 |
| Inlet Air Pres [in Hg]               | 18              | 18                    | 18                       | 18                    |
| Inlet Air Temp [F]                   | 110.4           | 109.9                 | 109.4                    | 109.9                 |
| Inlet Air Humidity [%]               | 35.04           | 35.16                 | 35.26                    | 35.01                 |
| Inlet Air Flow [scfm]                | 2100            | 2084                  | 2078                     | 2080                  |
| IC Water Temp [F]                    | 3507            | 3508                  | 3509                     | 3509                  |
| Exh Back Pres [in Hg]                | 15.5            | 15.49                 | 15.5                     | 15.49                 |
| Exh Cyl 1 Temp [F]                   | 621.2           | 633.8                 | 619.8                    | 638.1                 |
| Exh Cyl 2 Temp [F]                   | 741.4           | 739.7                 | 729.6                    | 734.2                 |
| Exh Cyl 3 Temp [F]                   | 647.1           | 673.4                 | 662.5                    | 668.6                 |
| Exh Cyl 4 Temp [F]                   | 704.2           | 702.1                 | 689.4                    | 694.2                 |
| Avg Exh Temp [F]                     | 678.5           | 687.3                 | 675.3                    | 683.7                 |
| Stack Temp [F]                       | 75.29           | 77.71                 | 78.01                    | 78.46                 |
| Fuel Flow [lb/hr]                    | 198.6           | 201.1                 | 198.1                    | 199.9                 |
| Orifice Stat Pres [psia]             | 50.77           | 67.04                 | 68.09                    | 67.69                 |
| Orifice Diff Pres [in H2O]           | 0.0141          | 0.01369               | 0.0141                   | 0.0141                |
| Orifice Temp [F]                     | 68.08           | 66.06                 | 63.47                    | 59.9                  |
| Eng Fuel Pres [psig]                 | 25.69           | 25.55                 | 25.25                    | 25.34                 |
| Eng Fuel Temp [F]                    | 108             | 106.7                 | 106.1                    | 104.5                 |
| JW Out Temp [F]                      | 165             | 164.9                 | 164.9                    | 165.1                 |
| JW In Temp [F]                       | 161.7           | 161.8                 | 161.7                    | 161.8                 |
| JW Flow [gpm]                        | 474.3           | 473.5                 | 473.6                    | 471.4                 |
| Lube Press [psig]                    | 38.23           | 38.22                 | 38.09                    | 38.42                 |
| Lube In Temp [F]                     | 143             | 142.9                 | 143.8                    | 143.4                 |
| Lube Out Temp [F]                    | 154             | 154.4                 | 154.3                    | 154.6                 |
| THC [ppmd]                           | 932.2           | 899.7                 | 933.7                    | 869.7                 |
| NOx [ppmd]                           | 29.92           | 28.02                 | 34.02                    | 29                    |
| NO [ppmd]                            | 0               | 18.78                 | 16.92                    | 13.96                 |
| NO2 [ppmd]                           | 0               | 9.556                 | 17.1                     | 15.04                 |
| O2 [%d]                              | 15.13           | 14.79                 | 14.87                    | 14.86                 |
| CO2 [%d]                             | 3.218           | 3.416                 | 3.37                     | 3.382                 |
| CO [ppmd]                            | 167             | 158.9                 | 177.3                    | 168.3                 |

| <b>Data Point Name</b>               | <b>PCCNG-01</b> | <b>PCCSYN2-03</b>     | <b>PCCSYN2-04</b>        | <b>PCCSYN2-05</b>     |
|--------------------------------------|-----------------|-----------------------|--------------------------|-----------------------|
| <b>Data Point Description (ePCC)</b> | NG baseline     | 80% syn2 lean PCC phi | 80% syn2 optimal PCC phi | 80% syn2 rich PCC phi |
| Date                                 | 12/3/2009       | 12/3/2009             | 12/3/2009                | 12/3/2009             |
| <b>PCC Fueling Data</b>              |                 |                       |                          |                       |
| Injection Location [°bTDC]           | 90.2            | 120.4                 | 106.1                    | 109                   |
| Injection Duration [ms]              | 14              | 28                    | 22                       | 30                    |
| Injection Pressure [psig]            | 100             | 115                   | 115                      | 115                   |
| Natural Gas Flow [SCFH]              | 74.3            | 26.3                  | 41.3                     | 37.6                  |
| Syngas Flow [SCFH]                   | 0               | 154.8                 | 123.9                    | 170.3                 |
| % Natural Gas                        | 100%            | 15%                   | 25%                      | 18%                   |
| %Syngas                              | 0%              | 85%                   | 75%                      | 82%                   |
| Ignition Timing [°bTDC]              | 5               | 3.9                   | 5                        | 4.2                   |
| <b>FTIR Data</b>                     |                 |                       |                          |                       |
| Carbon Monoxide                      | 248.9           | 187                   | 237.2                    | 228.8                 |
| Carbon dioxide                       | 31210           | 26830                 | 30230                    | 30790                 |
| Nitric oxide                         | 11.12           | 14.86                 | 10.79                    | 7.144                 |
| Nitrogen dioxide                     | 22.39           | 68.56                 | 20.5                     | 21.21                 |
| Nitrous oxide                        | 0.8017          | 2.376                 | 1.327                    | 1.266                 |
| Methane                              | 1473            | 1092                  | 1310                     | 1234                  |
| Acetylene                            | 1.434           | 5.438                 | 2.72                     | 2.518                 |
| Ethylene                             | 6.458           | 5.245                 | 6.262                    | 5.767                 |
| Ethane                               | 7.162           | 6.56                  | 9.956                    | 8.26                  |
| Propylene                            | 1.603           | 6.425                 | 3.149                    | 2.943                 |
| Formaldehyde                         | 12.15           | 72.49                 | 25.82                    | 20.25                 |
| Water                                | 78450           | 287800                | 139700                   | 132500                |
| Propane                              | 6.419           | 7.91                  | 7.117                    | 6.713                 |
| Acrolein                             | 0.7226          | 36.85                 | 32.46                    | 30.11                 |
| Acetaldehyde                         | 2.061           | 7.195                 | 3.071                    | 2.606                 |
| IBTYL                                | 12.01           | 14.8                  | 13.32                    | 12.56                 |
| 13BUT                                | 0.7253          | 2.907                 | 1.425                    | 1.332                 |
| SF6                                  | 0.00628         | 0.02505               | 0.01256                  | 0.01179               |
| Methanol                             | 3.408           | 14.11                 | 7.012                    | 6.676                 |
| Hydrogen cyanide                     | 2.371           | 9.02                  | 4.547                    | 4.308                 |
| Ammonia                              | 0.4265          | 1.374                 | 0.6758                   | 0.6406                |
| Total Hydrocarbons                   | 1512            | 1128                  | 1361                     | 1279                  |
| Non Methane Hydrocarb                | 39.36           | 51.8                  | 50.43                    | 45.06                 |
| VOC's                                | 26.25           | 39.8                  | 32.21                    | 29.95                 |

| <b>Data Point Name</b>               | <b>PCCNG-01</b> | <b>PCCSYN2-03</b>     | <b>PCCSYN2-04</b>        | <b>PCCSYN2-05</b>     |
|--------------------------------------|-----------------|-----------------------|--------------------------|-----------------------|
| <b>Data Point Description (ePCC)</b> | NG baseline     | 80% syn2 lean PCC phi | 80% syn2 optimal PCC phi | 80% syn2 rich PCC phi |
| <b>Date</b>                          | 12/3/2009       | 12/3/2009             | 12/3/2009                | 12/3/2009             |
| <u>Calculated Data</u>               |                 |                       |                          |                       |
| Fuel Flow [SCFH]                     | 4441            | 4509                  | 4439                     | 4480                  |
| Fuel Flow [LB/HR]                    | 198.6           | 201.1                 | 198.1                    | 199.9                 |
| BSFC [BTU/bhp-hr]                    | 9011            | 9072                  | 8930                     | 8994                  |
| Stoich. A/F                          | 16.03           | 15.98                 | 15.98                    | 15.97                 |
| U & S A/F                            | 52.25           | 49.21                 | 49.75                    | 49.67                 |
| Trapped A/F                          | 28.35           | 26.36                 | 27.55                    | 27.45                 |
| Mass Flow A/F                        | 53.98           | 50.91                 | 51.46                    | 51.37                 |
| Air Flow [scfm]                      | 10720           | 10240                 | 10190                    | 10270                 |
| BMEP [psi]                           | 67.5            | 67.7                  | 67.71                    | 67.77                 |
| Thermal Eff.                         | 28.24           | 28.05                 | 28.49                    | 28.29                 |
| Wobbe Index                          | 1169            | 1165                  | 1165                     | 1163                  |
| Methane [%]                          | 95.32           | 95.61                 | 95.57                    | 95.64                 |
| LHV [BTU/cf]                         | 894.3           | 889.4                 | 889.6                    | 888.5                 |
| Gas Density [lb/Mcf]                 | 47.37           | 47.23                 | 47.26                    | 47.25                 |
| Water [%]                            | 7.845           | 28.78                 | 13.97                    | 13.25                 |
| Abs. Humidity                        | 0.01358         | 0.01343               | 0.01328                  | 0.01338               |
| NOx @ 15% O2 [ppmd]                  | 30.59           | 27.07                 | 33.27                    | 28.31                 |
| BS THC [g/bhp-hr]                    | 5.591           | 5.105                 | 5.28                     | 4.942                 |
| BS NOx Actual [g/bhp-hr]             | 0.506           | 0.4504                | 0.5447                   | 0.4671                |
| BS NOx EPA Meth. 20 [g/bhp-hr]       | 0.4476          | 0.4225                | 0.4794                   | 0.4262                |
| BS NOx FTIR [g/bhp-hr]               | 0               | 0                     | 0                        | 0                     |
| BS NO FTIR [g/bhp-hr]                | 0               | 0.1969                | 0.1767                   | 0.1467                |
| BS NO2 FTIR [g/bhp-hr]               | 0               | 0.1536                | 0.2739                   | 0.2422                |
| BS CO [g/bhp-hr]                     | 1.72            | 1.555                 | 1.729                    | 1.65                  |
| BS CH2O [g/bhp-hr]                   | 0.1457          | 1.068                 | 0.3139                   | 0.2455                |
| BS CO2 [g/bhp-hr]                    | 520.6           | 525.2                 | 516.2                    | 521.1                 |
| Phi Trapped                          | 0.6067          | 0.6528                | 0.6245                   | 0.627                 |
| H2O MF [scfm]                        | 544.8           | 542.3                 | 533.4                    | 539.4                 |
| Exh MF [scfm]                        | 10920           | 10440                 | 10390                    | 10470                 |
| BS O2 [g/bhp-hr]                     | 1780            | 1654                  | 1656                     | 1664                  |
| BS NMHC [g/bhp-hr]                   | 0.839           | 3.486                 | 1.931                    | 1.734                 |
| BS VOC [g/bhp-hr]                    | 0.7531          | 3.389                 | 1.81                     | 1.634                 |
| U&S AF Total                         | 0               | 0                     | 0                        | 0                     |
| Delivery Ratio                       | 1.621           | 1.675                 | 1.573                    | 1.581                 |
| Trapping Efficiency                  | 0.5005          | 0.4918                | 0.5083                   | 0.5069                |
| Scavenging Efficiency                | 0.8111          | 0.8237                | 0.7996                   | 0.8016                |

| <b>Data Point Name</b>                  | <b>PCCNG-01</b> | <b>PCCSYN2-03</b>        | <b>PCCSYN2-04</b>              | <b>PCCSYN2-05</b>        |
|---|-----------------|--------------------------|--------------------------------|--------------------------|
| <b>Data Point Description (ePCC)</b>    | NG<br>baseline  | 80% syn2 lean<br>PCC phi | 80% syn2<br>optimal PCC<br>phi | 80% syn2 rich<br>PCC phi |
| <b>Date</b>                             | 12/3/2009       | 12/3/2009                | 12/3/2009                      | 12/3/2009                |
| Combustion Data                         |                 |                          |                                |                          |
| Engine Avg Peak Pressure[%]             | 498.7           | 490.4                    | 513.1                          | 498.5                    |
| Engine Avg Peak Pres Std Dev[%]         | 29.64           | 37.82                    | 29.34                          | 35.06                    |
| Engine Avg Peak Pres COV[psi]           | 5.926           | 7.644                    | 5.706                          | 7.012                    |
| Engine Max Peak Pres COV Ch.<br>#3[psi] | 6.14            | 9.554                    | 6.314                          | 7.228                    |
| Engine Min Peak Pres COV Ch.<br>#4[psi] | 5.401           | 6.544                    | 5.199                          | 6.54                     |
| Engine Avg Peak Loc[psi]                | 379.7           | 352.2                    | 377.6                          | 350.9                    |
| Engine Avg IMEP[%]                      | 1.464           | 1.993                    | 1.457                          | 1.805                    |
| Engine Avg IMEP COV[psi]                | 80.87           | 82.17                    | 81.89                          | 81.92                    |
| Engine Max IMEP COV Ch. #3[psi]         | 91.78           | 95.62                    | 95.92                          | 95.38                    |
| Engine Min IMEP COV Ch. #4[psi]         | 71.74           | 69.81                    | 69.5                           | 69.11                    |



| <b>Data Point Name</b>                 | <b>NG-01</b>     | <b>SYN2-02</b>   | <b>SYN2-03</b>   |
|--|------------------|------------------|------------------|
| <b>Data Point Description (ePCC)</b>   | <b>NG</b>        | <b>80% syn2</b>  | <b>80% Syn2</b>  |
| <b>DATE</b>                            | <b>Baseline</b>  | <b>18"</b>       | <b>18"</b>       |
| <b>DATE</b>                            | <b>1/19/2010</b> | <b>1/19/2010</b> | <b>1/19/2010</b> |
| Speed [rpm]                            | 300              | 300              | 300              |
| Torque [lb-ft]                         | 7704             | 7733             | 7733             |
| Power [bhp]                            | 439.9            | 441.6            | 441.6            |
| Fuel Flow [lb/hr]                      | 195.1            | 195.4            | 195.4            |
| Eng Fuel Pres [psig]                   | 25               | 24.85            | 24.85            |
| JW Out Temp [F]                        | 165.1            | 164.9            | 164.9            |
| JW In Temp [F]                         | 161.8            | 161.4            | 161.4            |
| IC Water Temp [F]                      | 3506             | 3506             | 3506             |
| Inlet Air Pres [in Hg]                 | 18               | 18               | 18               |
| Inlet Air Temp [F]                     | 109.9            | 110.5            | 110.5            |
| Inlet Air Humidity [%]                 | 35.48            | 35.41            | 35.41            |
| Engine Avg. Exhaust Port Temp [F]      | 685.5            | 668.8            | 668.8            |
| Engine Hi Exhaust Port Temp [F] Cyl #2 | 731.6            | 715              | 715              |
| Engine Lo Exhaust Port Temp [F] Cyl #1 | 633              | 616.1            | 616.1            |
| Exh Back Pres [in Hg]                  | 15.49            | 15.49            | 15.49            |
| Stack Temp [F]                         | 72.2             | 75.38            | 75.38            |
| Stack Pressure [in H2O]                | NaN              | NaN              | NaN              |
| <b><u>PCC Fueling Data</u></b>         |                  |                  |                  |
| Injection Location [°bTDC]             | 90.1             | 109              | 98               |
| Injection Duration [ms]                | 14.1             | 20               | 20               |
| Injection Pressure [psig]              | 100              | 148              | 150              |
| Natural Gas Flow [SLM]                 | 22.8             | 10.6             | 10.4             |
| Syngas Flow [SLM]                      | 0                | 44.6             | 45.5             |
| % Natural Gas                          | 100%             | 19%              | 19%              |
| %Syngas                                | 0%               | 81%              | 81%              |
| Ignition Timing [°bTDC]                | 4.8              | 5.3              | 3.9              |
| <b><u>Emissions Data</u></b>           |                  |                  |                  |
| THC [ppmd]                             | 868.8            | 827.8            | 827.8            |
| NOx [ppmd]                             | 33.86            | 39.2             | 39.2             |
| NO [ppmd]                              | 16.7             | 24.93            | 24.93            |
| NO2 [ppmd]                             | 17.15            | 14.28            | 14.28            |
| O2 [%d]                                | 14.77            | 14.86            | 14.86            |
| CO2 [%d]                               | 3.389            | 3.31             | 3.31             |
| CO [ppmd]                              | 147.2            | 158.1            | 158.1            |
| Formaldehyde                           | 21.81            | 19.02            | 18.66            |

| <b>Data Point Name</b>               | <b>NG-01</b>     | <b>SYN2-02</b>   | <b>SYN2-03</b>   |
|--------------------------------------|------------------|------------------|------------------|
| <b>Data Point Description (ePCC)</b> | <b>NG</b>        | <b>80% syn2</b>  | <b>80% Syn2</b>  |
| <b>DATE</b>                          | <b>Baseline</b>  | <b>18"</b>       | <b>18"</b>       |
|                                      | <b>1/19/2010</b> | <b>1/19/2010</b> | <b>1/19/2010</b> |

---

Calculated Data

---

|                                |       |       |       |
|--------------------------------|-------|-------|-------|
| U & S A/F                      | 50.6  | 51.7  | 51.7  |
| Trapped A/F                    | 27.3  | 27.5  | 27.5  |
| Phi Trapped                    | 0.63  | 0.626 | 0.625 |
| Phi Total                      | 0.322 | 0.315 | 0.315 |
| BSFC [BTU/bhp-hr]              | 9000  | 8990  | 8980  |
| BMEP [psi]                     | 67.4  | 67.6  | 67.6  |
| Thermal Eff.                   | 28.3  | 28.3  | 28.3  |
| Methane [%]                    | 96.6  | 96.7  | 96.6  |
| LHV [BTU/cf]                   | 896   | 896   | 895   |
| Gas Density [lb/Mcf]           | 46.7  | 46.7  | 46.7  |
| BS THC [g/bhp-hr]              | 4.91  | 4.78  | 4.78  |
| BS NOx EPA Meth. 20 [g/bhp-hr] | 0.482 | 0.537 | 0.563 |
| BS CO [g/bhp-hr]               | 1.44  | 1.58  | 1.58  |
| BS CH2O [g/bhp-hr]             | 0.261 | 0.233 | 0.228 |
| BS VOC [g/bhp-hr]              | 0.958 | 0.93  | 0.905 |

---

Combustion Data

---

|                                      |      |      |      |
|--------------------------------------|------|------|------|
| Engine Avg Peak Pressure[%]          | 504  | 532  | 505  |
| Engine Avg Peak Pres Std Dev[%]      | 28.4 | 24.9 | 27.2 |
| Engine Avg Peak Pres COV[psi]        | 5.63 | 4.66 | 5.38 |
| Engine Max Peak Pres COV Ch. #2[psi] | 6.44 | 4.82 | 5.78 |
| Engine Min Peak Pres COV Ch. #4[psi] | 5.14 | 4.49 | 4.7  |
| Engine Avg Peak Loc[psi]             | 385  | 426  | 375  |
| Engine Avg IMEP[%]                   | 1.41 | 1.25 | 1.42 |
| Engine Avg IMEP COV[psi]             | 82.3 | 83.5 | 83.6 |
| Engine Max IMEP COV Ch. #3[psi]      | 94.5 | 94.1 | 93.8 |
| Engine Min IMEP COV Ch. #4[psi]      | 73.6 | 73.3 | 73.3 |

| Data Point Name                      | CH4-01A   | CNG-02    | CNG-03    | CNG-13    | CNG-04    |
|--------------------------------------|-----------|-----------|-----------|-----------|-----------|
| <b>Data Point Description (ePCC)</b> | CH4       | NG        | NG        | NG        | NG HP     |
|                                      | Baseline  | baseline  | baseline  | baseline  | inject    |
| <b>Date</b>                          | 2/22/2010 | 2/22/2010 | 2/22/2010 | 2/22/2010 | 2/22/2010 |
| Data Point                           | 7         | 8         | 9         | 24        | 10        |
| Speed [rpm]                          | 300       | 300       | 300       | 300       | 300       |
| Torque [lb-ft]                       | 7723      | 7741      | 7747      | 7728      | 7734      |
| Power [bhp]                          | 441.1     | 442.1     | 442.5     | 441.4     | 441.7     |
| Load [%]                             | 99.94     | 100.2     | 100.3     | 100       | 100.1     |
| Ambient Press [psia]                 | 12.24     | 12.24     | 12.24     | 12.27     | 12.24     |
| Ambient Temp [F]                     | 62.91     | 66.02     | 64.91     | 63.63     | 60.69     |
| Ambient Humidity [%]                 | 30.51     | 30.15     | 30.6      | 30.35     | 31.44     |
| Inlet Air Pres [in Hg]               | 18.0      | 18.0      | 18.0      | 18.0      | 18.0      |
| Inlet Air Temp [F]                   | 110.1     | 110.6     | 111       | 110.1     | 111.2     |
| Inlet Air Humidity [%]               | 35.37     | 35.34     | 34.82     | 35.15     | 34.96     |
| Inlet Air Flow [scfm]                | 2147      | 2143      | 2154      | 2187      | 2151      |
| IC Water Temp [F]                    | 3504      | 3504      | 3504      | 3507      | 3505      |
| Exh Back Pres [in Hg]                | 15.49     | 15.5      | 15.5      | 15.49     | 15.5      |
| Exh Cyl 1 Temp [F]                   | 611.2     | 613.2     | 610.7     | 614.5     | 609.8     |
| Exh Cyl 2 Temp [F]                   | 705.1     | 703.5     | 703.3     | 695.8     | 705.3     |
| Exh Cyl 3 Temp [F]                   | 664.2     | 664.6     | 662.7     | 653.1     | 660.3     |
| Exh Cyl 4 Temp [F]                   | 718.1     | 714.3     | 717.1     | 707.5     | 722.7     |
| Avg Exh Temp [F]                     | 674.7     | 673.9     | 673.4     | 667.7     | 674.5     |
| Stack Temp [F]                       | 79.26     | 79.09     | 77.4      | 82.93     | 80.34     |
| Fuel Flow [lb/hr]                    | 198.3     | 196.4     | 195.9     | 193.4     | 195.7     |
| Orifice Stat Pres [psia]             | 54.34     | 54.26     | 54.15     | 54.58     | 53.96     |
| Orifice Diff Pres [in H2O]           | 0.0141    | 0.0141    | 0.0141    | 0.0141    | 0.01431   |
| Orifice Temp [F]                     | 67.48     | 68.77     | 68.9      | 73.86     | 71.25     |
| Eng Fuel Pres [psig]                 | 25.02     | 25.04     | 25.02     | 24.84     | 25.04     |
| Eng Fuel Temp [F]                    | 112.6     | 113       | 112.9     | 115.3     | 113.2     |
| JW Out Temp [F]                      | 165       | 165       | 165.1     | 165.4     | 165.4     |
| JW In Temp [F]                       | 161.3     | 161.9     | 161.7     | 161.5     | 163       |
| JW Flow [gpm]                        | 471.9     | 472.3     | 472.6     | 473.2     | 475.7     |
| Lube In Temp [F]                     | 143.4     | 143.4     | 143.3     | 143       | 143       |
| Lube Out Temp [F]                    | 155.4     | 155.4     | 154.9     | 155.4     | 155.3     |
| THC [ppmd]                           | 849.4     | 841.8     | 846.9     | 850.6     | 857.2     |
| NOx [ppmd]                           | 27.16     | 26.68     | 27.47     | 22.75     | 26.51     |
| NO [ppmd]                            | 12.25     | 11.19     | 11.26     | 7.283     | 10.46     |
| NO2 [ppmd]                           | 14.92     | 15.49     | 16.2      | 15.47     | 16.05     |
| O2 [%d]                              | 15.27     | 15.29     | 15.31     | 15.45     | 15.29     |
| CO2 [%d]                             | 3.227     | 3.227     | 3.217     | 3.13      | 3.225     |
| CO [ppmd]                            | 143.4     | 141.4     | 142.6     | 145.1     | 145.7     |

| Data Point Name                      | CH4-01A         | CNG-02         | CNG-03         | CNG-13         | CNG-04          |
|--------------------------------------|-----------------|----------------|----------------|----------------|-----------------|
| <b>Data Point Description (ePCC)</b> | CH4<br>Baseline | NG<br>baseline | NG<br>baseline | NG<br>baseline | NG HP<br>inject |
| <b>Date</b>                          | 2/22/2010       | 2/22/2010      | 2/22/2010      | 2/22/2010      | 2/22/2010       |
| <u>PCC Fueling Data</u>              |                 |                |                |                |                 |
| Injection Location [°bTDC]           | 100.5           | 100.5          | 100            | 100            | 100.5           |
| Injection Duration [ms]              | 14.1            | 14.1           | 15             | 15             | 10.3            |
| Injection Pressure [psig]            | 90              | 90             | 90             | 90             | 140             |
| Natural Gas Flow [SLM]               | 31.5            | 31.5           | 33.1           | 33.1           | 33.1            |
| Syngas Flow [SLM]                    | 0               | 0              | 0              | 0              | 0               |
| % Natural Gas                        | 100%            | 100%           | 100%           | 100%           | 100%            |
| %Syngas                              | 0%              | 0%             | 0%             | 0%             | 0%              |
| Ignition Timing [°bTDC]              | 4.8             | 4.8            | 4.8            | 4.6            | 4.8             |
| <u>FTIR Data</u>                     |                 |                |                |                |                 |
| Carbon Monoxide                      | 204.2           | 199.8          | 201.9          | 205            | 206.8           |
| Carbon dioxide                       | 29710           | 29780          | 29790          | 29490          | 29870           |
| Nitric oxide                         | 6.702           | 6.761          | 6.744          | 6.533          | 6.684           |
| Nitrogen dioxide                     | 20.81           | 21.79          | 22.5           | 21.83          | 22.92           |
| Nitrous oxide                        | 1.221           | 1.237          | 1.217          | 1.214          | 1.212           |
| Methane                              | 1159            | 1146           | 1157           | 1159           | 1170            |
| Acetylene                            | 2.38            | 2.425          | 2.405          | 2.368          | 2.376           |
| Ethylene                             | 7.531           | 7.543          | 7.562          | 7.63           | 7.741           |
| Ethane                               | 18.22           | 19.3           | 19.57          | 19.91          | 19.88           |
| Propylene                            | 2.771           | 2.784          | 2.78           | 2.76           | 2.807           |
| Formaldehyde                         | 21.59           | 21.23          | 21.43          | 20.91          | 21.63           |
| Water                                | 125800          | 126100         | 126500         | 124800         | 126600          |
| Propane                              | 9.967           | 10.34          | 10.2           | 10.23          | 9.924           |
| Acrolein                             | 1.032           | 0.8832         | 0.845          | 0.7879         | 0.8217          |
| Acetaldehyde                         | 2.617           | 2.626          | 2.585          | 2.539          | 2.588           |
| IBTYL                                | 11.88           | 12.02          | 11.78          | 11.72          | 11.73           |
| 13BUT                                | 1.254           | 1.26           | 1.258          | 1.249          | 1.27            |
| SF6                                  | 0.01079         | 0.01066        | 0.01054        | 0.01039        | 0.01061         |
| Methanol                             | 6.381           | 6.021          | 5.854          | 5.71           | 5.882           |
| Hydrogen cyanide                     | 4.226           | 4.292          | 4.191          | 4.126          | 4.193           |
| Ammonia                              | 0.9909          | 0.8637         | 0.806          | 0.632          | 0.7156          |
| Total Hydrocarbons                   | 1234            | 1224           | 1235           | 1238           | 1248            |
| Non Methane Hydrocarb                | 75.18           | 77.88          | 78.02          | 78.85          | 78.23           |
| VOC's                                | 41.83           | 42.56          | 42.2           | 42.41          | 41.85           |

| Data Point Name                      | CH4-01A   | CNG-02    | CNG-03    | CNG-13    | CNG-04    |
|--------------------------------------|-----------|-----------|-----------|-----------|-----------|
| <b>Data Point Description (ePCC)</b> | CH4       | NG        | NG        | NG        | NG HP     |
|                                      | Baseline  | baseline  | baseline  | baseline  | inject    |
| <b>Date</b>                          | 2/22/2010 | 2/22/2010 | 2/22/2010 | 2/22/2010 | 2/22/2010 |
| Calculated Data                      |           |           |           |           |           |
| Fuel Flow [SCFH]                     | 4340      | 4297      | 4284      | 4239      | 4281      |
| Fuel Flow [LB/HR]                    | 198.3     | 196.4     | 195.9     | 193.4     | 195.7     |
| BSFC [BTU/bhp-hr]                    | 8887      | 8776      | 8742      | 8690      | 8752      |
| Stoich. A/F                          | 0         | 15.83     | 15.82     | 15.89     | 15.82     |
| U & S A/F                            | 0         | 52.43     | 52.54     | 54.15     | 52.54     |
| Trapped A/F                          | 28.33     | 28.49     | 28.56     | 29.1      | 28.52     |
| Mass Flow A/F                        | 53.83     | 53.82     | 53.94     | 55.53     | 53.8      |
| Air Flow [scfm]                      | 10670     | 10570     | 10560     | 10740     | 10530     |
| BMEP [psi]                           | 67.55     | 67.7      | 67.76     | 67.58     | 67.63     |
| Thermal Eff.                         | 28.63     | 28.99     | 29.11     | 29.28     | 29.07     |
| Wobbe Index                          | 1169      | 1168      | 1168      | 1172      | 1168      |
| Methane [%]                          | 93.78     | 93.74     | 93.72     | 93.89     | 93.71     |
| LHV [BTU/cf]                         | 903.4     | 903       | 902.9     | 904.8     | 903       |
| Gas Density [lb/Mcf]                 | 48.38     | 48.41     | 48.41     | 48.31     | 48.42     |
| Water [%]                            | 12.58     | 12.61     | 12.65     | 12.48     | 12.66     |
| Abs. Humidity                        | 0.01364   | 0.01384   | 0.01378   | 0.01357   | 0.01394   |
| NOx @ 15% O2 [ppmd]                  | 28.46     | 28.05     | 28.97     | 24.62     | 27.87     |
| BS THC [g/bhp-hr]                    | 5.147     | 5.041     | 5.065     | 5.189     | 5.12      |
| BS NOx Actual [g/bhp-hr]             | 0.4569    | 0.4434    | 0.4559    | 0.3852    | 0.4394    |
| BS NOx EPA Meth. 20 [g/bhp-hr]       | 0.4182    | 0.4069    | 0.4194    | 0.3543    | 0.4049    |
| BS NOx FTIR [g/bhp-hr]               | 0         | 0         | 0         | 0         | 0         |
| BS NO FTIR [g/bhp-hr]                | 0.1344    | 0.1213    | 0.1219    | 0.08043   | 0.1131    |
| BS NO2 FTIR [g/bhp-hr]               | 0.251     | 0.2574    | 0.2689    | 0.2618    | 0.266     |
| BS CO [g/bhp-hr]                     | 1.469     | 1.431     | 1.441     | 1.496     | 1.471     |
| BS CH2O [g/bhp-hr]                   | 0.2714    | 0.2637    | 0.2661    | 0.2642    | 0.2681    |
| BS CO2 [g/bhp-hr]                    | 519.3     | 513.1     | 510.9     | 507       | 511.4     |
| Phi Trapped                          | 0.61      | 0.60      | 0.60      | 0.59      | 0.60      |
| H2O MF [scfm]                        | 538.5     | 535.2     | 533.3     | 529.8     | 534       |
| Exh MF [scfm]                        | 10870     | 10770     | 10760     | 10930     | 10730     |
| BS O2 [g/bhp-hr]                     | 1786      | 1767      | 1767      | 1819      | 1762      |
| BS NMHC [g/bhp-hr]                   | 1.313     | 1.309     | 1.302     | 1.318     | 1.303     |
| BS VOC [g/bhp-hr]                    | 1.083     | 1.069     | 1.059     | 1.066     | 1.056     |
| U&S AF Total                         | 0         | 0         | 0         | 0         | 0         |
| Delivery Ratio                       | 1.648     | 1.634     | 1.635     | 1.656     | 1.63      |
| Trapping Efficiency                  | 0.496     | 0.4983    | 0.4982    | 0.4948    | 0.4989    |
| Scavenging Efficiency                | 0.8176    | 0.8143    | 0.8144    | 0.8193    | 0.8134    |

| Data Point Name                      | CH4-01A   | CNG-02      | CNG-03    | CNG-13      | CNG-04       |
|--------------------------------------|-----------|-------------|-----------|-------------|--------------|
| <b>Data Point Description (ePCC)</b> | CH4       |             | NG        |             |              |
|                                      | Baseline  | NG baseline | baseline  | NG baseline | NG HP inject |
| Date                                 | 2/22/2010 | 2/22/2010   | 2/22/2010 | 2/22/2010   | 2/22/2010    |
| Combustion Data                      |           |             |           |             |              |
| Engine Avg Peak Pressure[%]          | 496       | 496.6       | 497.2     | 485.5       | 492.2        |
| Engine Avg Peak Pres Std Dev[%]      | 30.55     | 30.35       | 29.84     | 31.03       | 32.68        |
| Engine Avg Peak Pres COV[psi]        | 6.188     | 6.087       | 6.022     | 6.389       | 6.742        |
| Engine Max Peak Pres COV Ch. #4[psi] | 6.745     | 7.117       | 6.402     | 6.562       | 8.847        |
| Engine Min Peak Pres COV Ch. #3[psi] | 5.418     | 5.063       | 5.431     | 6.288       | 5.341        |
| Engine Avg Peak Loc[psi]             | 358.2     | 360.8       | 357.7     | 347.7       | 355.8        |
| Engine Avg IMEP[%]                   | 1.572     | 1.564       | 1.592     | 1.603       | 2.007        |
| Engine Avg IMEP COV[psi]             | 81.13     | 81.09       | 81.52     | 82.03       | 81.67        |
| Engine Max IMEP COV Ch. #3[psi]      | 96.47     | 96.29       | 96.45     | 95.16       | 96.42        |
| Engine Min IMEP COV Ch. #4[psi]      | 74.02     | 74.49       | 74.32     | 73.39       | 73.37        |

| <b>Data Point Name</b>               | <b>CNG-03</b> | <b>CNG-04</b>  | <b>CNG-15</b>  | <b>CNG-16</b> | <b>CNG-17</b> |
|--------------------------------------|---------------|----------------|----------------|---------------|---------------|
| <b>Data Point Description (ePCC)</b> | NG 22" Hg     | NG<br>Baseline | NG<br>Baseline | NG 10" Hg     | NG 8.5" Hg    |
| <b>Date</b>                          | 4/13/2010     | 4/13/2010      | 4/13/2010      | 4/13/2010     | 4/13/2010     |
| Speed [rpm]                          | 300           | 300            | 300            | 300           | 300           |
| Torque [lb-ft]                       | 7733          | 7741           | 7748           | 7744          | 7749          |
| Power [bhp]                          | 441.8         | 442            | 442.5          | 442.3         | 442.6         |
| Load [%]                             | 100.1         | 100.2          | 100.3          | 100.2         | 100.3         |
| Ambient Press [psia]                 | 12.12         | 12.12          | 12.16          | 12.17         | 12.17         |
| Ambient Temp [F]                     | 22.65         | 23.11          | 32.21          | 33.9          | 31.53         |
| Ambient Humidity [%]                 | 45.01         | 44.49          | 41.3           | 40.52         | 40.21         |
| Inlet Air Pres [in Hg]               | 22.0          | 18.0           | 18.0           | 10.0          | 8.5           |
| Inlet Air Temp [F]                   | 110.3         | 111.4          | 109.8          | 111.2         | 110.3         |
| Inlet Air Humidity [%]               | 35.02         | 34.81          | 35.21          | 35.2          | 35.01         |
| Inlet Air Flow [scfm]                | 2314          | 2206           | 2206           | 1905          | 1850          |
| IC Water Temp [F]                    | 3504          | 3504           | 3504           | 3504          | 3504          |
| Exh Back Pres [in Hg]                | 19.5          | 15.49          | 15.49          | 7.502         | 5.995         |
| Exh Cyl 1 Temp [F]                   | 557.5         | 572.7          | 587.2          | 626.6         | 631.5         |
| Exh Cyl 2 Temp [F]                   | 673.2         | 671.3          | 676.1          | 695.2         | 697.7         |
| Exh Cyl 3 Temp [F]                   | 662.8         | 650.7          | 645.9          | 665.8         | 670.1         |
| Exh Cyl 4 Temp [F]                   | 745.6         | 732.4          | 736.3          | 757.4         | 755           |
| Avg Exh Temp [F]                     | 659.8         | 656.7          | 661.4          | 686.2         | 688.6         |
| Stack Temp [F]                       | 86.36         | 86.06          | 85.21          | 84.01         | 83.4          |
| Fuel Flow [lb/hr]                    | 197           | 192.3          | 187.5          | 187.3         | 190.7         |
| Orifice Stat Pres [psia]             | 48.95         | 50.25          | 44.27          | 43.96         | 46.09         |
| Orifice Diff Pres [in H2O]           | 0.0141        | 0.0141         | 0.0141         | 0.0141        | 0.0141        |
| Orifice Temp [F]                     | 73.91         | 75.36          | 76.31          | 76.31         | 76.31         |
| Eng Fuel Pres [psig]                 | 26.61         | 24.1           | 24.6           | 20.62         | 19.94         |
| Eng Fuel Temp [F]                    | 123.4         | 121.8          | 121.2          | 119.2         | 118.9         |
| JW Out Temp [F]                      | 164.9         | 165.2          | 165            | 165.1         | 164.9         |
| JW In Temp [F]                       | 161.2         | 161.2          | 160.8          | 161.8         | 161.7         |
| JW Flow [gpm]                        | 471.5         | 470.9          | 471.8          | 471.1         | 471.1         |
| Lube In Temp [F]                     | 142.7         | 143.3          | 142.7          | 142.2         | 142.1         |
| Lube Out Temp [F]                    | 155           | 155.5          | 155.2          | 156.1         | 155.8         |
| THC [ppmd]                           | 1182          | 831            | 863.3          | 575.1         | 566.1         |
| NOx [ppmd]                           | 18.19         | 32.53          | 29.28          | 345.9         | 367.6         |
| NO [ppmd]                            | 5.041         | 14.4           | 12.43          | 314.5         | 367.6         |
| NO2 [ppmd]                           | 13.15         | 18.13          | 16.85          | 31.42         | 0             |
| O2 [%d]                              | 15.65         | 15.54          | 15.56          | 14.91         | 14.77         |
| CO2 [%d]                             | 3.013         | 3.084          | 2.987          | 3.355         | 3.479         |
| CO [ppmd]                            | 248.6         | 159.9          | 149.6          | 75.88         | 65.56         |

| <b>Data Point Name</b>               | <b>CNG-03</b> | <b>CNG-04</b>  | <b>CNG-15</b>  | <b>CNG-16</b> | <b>CNG-17</b> |
|--------------------------------------|---------------|----------------|----------------|---------------|---------------|
| <b>Data Point Description (ePCC)</b> | NG 22" Hg     | NG<br>Baseline | NG<br>Baseline | NG 10" Hg     | NG 8.5" Hg    |
| <b>Date</b>                          | 4/13/2010     | 4/13/2010      | 4/13/2010      | 4/13/2010     | 4/13/2010     |
| <u>PCC Fueling Data</u>              |               |                |                |               |               |
| Injection Location [°bTDC]           | 100.5         | 100.5          | 100.5          | 115           | 115           |
| Injection Duration [ms]              | 15            | 15             | 15             | 15            | 15            |
| Injection Pressure [psig]            | 112           | 99             | 102            | 55            | 48            |
| Natural Gas Flow [SLM]               | 36.7          | 32.4           | 25.6           | 15.5          | 12.8          |
| Syngas Flow [SLM]                    | 0             | 0              | 0              | 0             | 0             |
| % Natural Gas                        | 100%          | 100%           | 100%           | 100%          | 100%          |
| %Syngas                              | 0%            | 0%             | 0%             | 0%            | 0%            |
| Ignition Timing [°bTDC]              | 5             | 5              | 5              | 3.5           | 3.5           |
| <u>FTIR Data</u>                     |               |                |                |               |               |
| Carbon Monoxide                      | 331.8         | 227.9          | 214.8          | 109.6         | 91.67         |
| Carbon dioxide                       | 29180         | 29910          | 28960          | 31770         | 32690         |
| Nitric oxide                         | 6.143         | 9.548          | 6.662          | 367.7         | 682           |
| Nitrogen dioxide                     | 20.17         | 25.46          | 24.33          | 30.02         | 33.75         |
| Nitrous oxide                        | 1.148         | 1.182          | 1.211          | 1.323         | 1.326         |
| Methane                              | 1374          | 957.5          | 1200           | 782           | 719.6         |
| Acetylene                            | 2.258         | 2.312          | 2.366          | 2.599         | 2.645         |
| Ethylene                             | 28.03         | 18.55          | 9.859          | 5.559         | 6.357         |
| Ethane                               | 116.7         | 86.57          | 35.49          | 20.36         | 38.06         |
| Propylene                            | 2.604         | 2.678          | 2.679          | 3.01          | 3.07          |
| Formaldehyde                         | 26.68         | 22.44          | 22.38          | 16.42         | 15.22         |
| Water                                | 119300        | 122600         | 124800         | 138700        | 140700        |
| Propane                              | 34.7          | 23.92          | 9.994          | 7.055         | 9.953         |
| Acrolein                             | 0.9231        | 0.749          | 0.8128         | 0.6578        | 0.6453        |
| Acetaldehyde                         | 3.397         | 2.639          | 2.697          | 1.945         | 1.841         |
| IBTYL                                | 14.53         | 11.39          | 12.45          | 10.2          | 10.19         |
| 13BUT                                | 1.178         | 1.212          | 1.212          | 1.362         | 1.389         |
| SF6                                  | 0.01093       | 0.01068        | 0.01044        | 0.01163       | 0.01188       |
| Methanol                             | 5.606         | 5.643          | 5.743          | 6.273         | 6.469         |
| Hydrogen cyanide                     | 3.842         | 3.982          | 4.161          | 4.546         | 4.587         |
| Ammonia                              | 1.182         | 0.9393         | 0.6614         | 0.5925        | 0.6014        |
| Total Hydrocarbons                   | 1737          | 1217           | 1311           | 849           | 828.6         |
| Non Methane Hydrocarb                | 362.9         | 259.8          | 110.8          | 67.04         | 108.9         |
| VOC's                                | 149.3         | 101.4          | 45.82          | 29.78         | 39.3          |



| Data Point Name                      | CNG-03    | CNG-04         | CNG-15         | CNG-16    | CNG-17     |
|--------------------------------------|-----------|----------------|----------------|-----------|------------|
| <b>Data Point Description (ePCC)</b> | NG 22" Hg | NG<br>Baseline | NG<br>Baseline | NG 10" Hg | NG 8.5" Hg |
| <b>Date</b>                          | 4/13/2010 | 4/13/2010      | 4/13/2010      | 4/13/2010 | 4/13/2010  |
| Calculated Data                      |           |                |                |           |            |
| Fuel Flow [SCFH]                     | 3914      | 3825           | 4148           | 4127      | 4049       |
| Fuel Flow [LB/HR]                    | 197       | 192.3          | 187.5          | 187.3     | 190.7      |
| BSFC [BTU/bhp-hr]                    | 8871      | 8680           | 8708           | 8691      | 8733       |
| Stoich. A/F                          | 15.88     | 15.93          | 16.46          | 16.44     | 16.21      |
| U & S A/F                            | 57.2      | 56.81          | 58.51          | 52.9      | 51.06      |
| Trapped A/F                          | 30.37     | 28.99          | 29.48          | 24.72     | 23.6       |
| Mass Flow A/F                        | 58.15     | 57.91          | 59.7           | 54.26     | 52.33      |
| Air Flow [scfm]                      | 11460     | 11140          | 11190          | 10160     | 9981       |
| BMEP [psi]                           | 67.65     | 67.68          | 67.76          | 67.74     | 67.78      |
| Thermal Eff.                         | 28.68     | 29.31          | 29.22          | 29.28     | 29.14      |
| Wobbe Index                          | 1234      | 1237           | 1208           | 1209      | 1216       |
| Methane [%]                          | 83.1      | 83.14          | 93.96          | 93.57     | 89.95      |
| LHV [BTU/cf]                         | 1001      | 1003           | 928.8          | 931.6     | 954.6      |
| Gas Density [lb/Mcf]                 | 53.31     | 53.25          | 47.87          | 48.06     | 49.88      |
| Water [%]                            | 11.93     | 12.26          | 12.48          | 13.87     | 14.07      |
| Abs. Humidity                        | 0.01249   | 0.01404        | 0.01352        | 0.01742   | 0.01767    |
| NOx @ 15% O2 [ppmd]                  | 20.44     | 35.8           | 32.34          | 341       | 353.9      |
| BS THC [g/bhp-hr]                    | 8.587     | 5.852          | 5.541          | 3.339     | 3.329      |
| BS NOx Actual [g/bhp-hr]             | 0.3296    | 0.5711         | 0.516          | 5.495     | 5.727      |
| BS NOx EPA Meth. 20 [g/bhp-hr]       | 0.3028    | 0.517          | 0.4774         | 3.728     | 3.829      |
| BS NOx FTIR [g/bhp-hr]               | 0         | 0              | 0              | 0         | 0          |
| BS NO FTIR [g/bhp-hr]                | 0.05956   | 0.1649         | 0.1428         | 3.258     | 3.735      |
| BS NO2 FTIR [g/bhp-hr]               | 0.2382    | 0.3184         | 0.2969         | 0.499     | 0          |
| BS CO [g/bhp-hr]                     | 2.742     | 1.709          | 1.605          | 0.7338    | 0.6219     |
| BS CH2O [g/bhp-hr]                   | 0.3585    | 0.2933         | 0.2943         | 0.1977    | 0.1802     |
| BS CO2 [g/bhp-hr]                    | 522.2     | 518            | 503.5          | 509.7     | 518.5      |
| Phi Trapped                          | 0.5571    | 0.5836         | 0.5812         | 0.6927    | 0.7226     |
| H2O MF [scfm]                        | 518.7     | 527.9          | 535.1          | 562.9     | 560.8      |
| Exh MF [scfm]                        | 11650     | 11330          | 11380          | 10350     | 10170      |
| BS O2 [g/bhp-hr]                     | 1972      | 1898           | 1907           | 1648      | 1601       |
| BS NMHC [g/bhp-hr]                   | 3.602     | 2.64           | 1.639          | 1.097     | 1.335      |
| BS VOC [g/bhp-hr]                    | 2.033     | 1.508          | 1.172          | 0.8514    | 0.8844     |
| U&S AF Total                         | 0         | 0              | 0              | 0         | 0          |
| Delivery Ratio                       | 1.615     | 1.732          | 1.734          | 1.979     | 2.036      |
| Trapping Efficiency                  | 0.5013    | 0.4828         | 0.4825         | 0.4473    | 0.4396     |
| Scavenging Efficiency                | 0.8099    | 0.8364         | 0.8369         | 0.8851    | 0.8952     |

| <b>Data Point Name</b>               | <b>CNG-03</b> | <b>CNG-04</b>  | <b>CNG-15</b>  | <b>CNG-16</b> | <b>CNG-17</b> |
|--------------------------------------|---------------|----------------|----------------|---------------|---------------|
| <b>Data Point Description (ePCC)</b> | NG 22" Hg     | NG<br>Baseline | NG<br>Baseline | NG 10" Hg     | NG 8.5" Hg    |
| Date                                 | 4/13/2010     | 4/13/2010      | 4/13/2010      | 4/13/2010     | 4/13/2010     |
| Combustion Data                      |               |                |                |               |               |
| Engine Avg Peak Pressure[%]          | 499.1         | 502.3          | 492.5          | 486.2         | 488.7         |
| Engine Avg Peak Pres Std Dev[%]      | 36.21         | 32.05          | 33.3           | 26.79         | 25.54         |
| Engine Avg Peak Pres COV[psi]        | 7.262         | 6.379          | 6.755          | 5.551         | 5.231         |
| Engine Max Peak Pres COV Ch. #1[psi] | 7.472         | 6.589          | 7.231          | 7.738         | 6.241         |
| Engine Min Peak Pres COV Ch. #3[psi] | 7.162         | 6.226          | 6.286          | 4.524         | 4.359         |
| Engine Avg Peak Loc[psi]             | 362.1         | 339.3          | 354.5          | 361.1         | 336.2         |
| Engine Avg IMEP[%]                   | 1.913         | 1.687          | 1.752          | 1.707         | 1.667         |
| Engine Avg IMEP COV[psi]             | 80.96         | 80.43          | 81.04          | 79.82         | 79.45         |
| Engine Max IMEP COV Ch. #3[psi]      | 98.26         | 96.45          | 94.32          | 92.59         | 92.32         |
| Engine Min IMEP COV Ch. #2[psi]      | 71.07         | 70.97          | 73.57          | 72.39         | 71.76         |

| Data Point Name                      | SYN20-05  | SYN40-07  | SYN60-08  | SYN80-09  | SYN90-10  |
|--------------------------------------|-----------|-----------|-----------|-----------|-----------|
| <b>Data Point Description (ePCC)</b> | 20% syn2  | 40%syn2   | 60% syn2  | 80% syn2  | 90% syn2  |
| <b>Date</b>                          | 4/13/2010 | 4/13/2010 | 4/13/2010 | 4/13/2010 | 4/13/2010 |
| Speed [rpm]                          | 300       | 300       | 300       | 300       | 300       |
| Torque [lb-ft]                       | 7747      | 7743      | 7749      | 7730      | 7708      |
| Power [bhp]                          | 442.5     | 442.3     | 442.6     | 441.6     | 440.4     |
| Load [%]                             | 100.2     | 100.2     | 100.3     | 100       | 99.74     |
| Ambient Press [psia]                 | 12.13     | 12.13     | 12.13     | 12.14     | 12.13     |
| Ambient Temp [F]                     | 23.51     | 26.05     | 21.65     | 20.68     | 15.32     |
| Ambient Humidity [%]                 | 44.94     | 43.11     | 43.95     | 44.95     | 45.8      |
| Inlet Air Pres [in Hg]               | 18.0      | 18.0      | 18.0      | 18.0      | 18.0      |
| Inlet Air Temp [F]                   | 109.9     | 110.9     | 111       | 111.4     | 109.7     |
| Inlet Air Humidity [%]               | 34.96     | 35.05     | 34.85     | 34.94     | 34.67     |
| Inlet Air Flow [scfm]                | 2202      | 2211      | 2200      | 2201      | 2206      |
| IC Water Temp [F]                    | 3504      | 3503      | 3504      | 3503      | 3503      |
| Exh Back Pres [in Hg]                | 15.5      | 15.5      | 15.5      | 15.49     | 15.5      |
| Exh Cyl 1 Temp [F]                   | 571.2     | 579       | 585.5     | 584.6     | 583.5     |
| Exh Cyl 2 Temp [F]                   | 667.3     | 665.7     | 670.5     | 670.4     | 667.4     |
| Exh Cyl 3 Temp [F]                   | 648.5     | 634.8     | 641.6     | 642.1     | 640.9     |
| Exh Cyl 4 Temp [F]                   | 728.4     | 725.8     | 727.5     | 728.1     | 725.9     |
| Avg Exh Temp [F]                     | 653.8     | 651.3     | 656.3     | 656.3     | 654.4     |
| Stack Temp [F]                       | 85.16     | 83.62     | 83.18     | 83.55     | 83.47     |
| Fuel Flow [lb/hr]                    | 192.3     | 191       | 184.7     | 185.7     | 186.5     |
| Orifice Stat Pres [psia]             | 50.48     | 50.54     | 41.91     | 42.95     | 44.38     |
| Orifice Diff Pres [in H2O]           | 0.0141    | 0.0141    | 0.0141    | 0.0141    | 0.0141    |
| Orifice Temp [F]                     | 75.93     | 76.11     | 76.12     | 76.12     | 76.12     |
| Eng Fuel Pres [psig]                 | 24.02     | 24.01     | 24.64     | 24.54     | 24.38     |
| Eng Fuel Temp [F]                    | 121       | 120.4     | 120       | 120.3     | 120.6     |
| JW Out Temp [F]                      | 165       | 164.8     | 165       | 165       | 165       |
| JW In Temp [F]                       | 161.5     | 161.3     | 161       | 160.7     | 161.4     |
| JW Flow [gpm]                        | 471       | 471.4     | 472.2     | 471.8     | 472.2     |
| Lube In Temp [F]                     | 143.5     | 143.4     | 143.5     | 143.6     | 143.6     |
| Lube Out Temp [F]                    | 155.3     | 155.6     | 155.9     | 155.7     | 155.9     |
| THC [ppmd]                           | 830.4     | 797.2     | 871.5     | 855.3     | 851.1     |
| NOx [ppmd]                           | 33.12     | 30.99     | 28.24     | 30.73     | 28.76     |
| NO [ppmd]                            | 14.57     | 12.35     | 14.33     | 13.28     | 11.64     |
| NO2 [ppmd]                           | 18.55     | 18.64     | 14.09     | 17.46     | 17.12     |
| O2 [%d]                              | 15.56     | 15.58     | 15.54     | 15.55     | 15.56     |
| CO2 [%d]                             | 3.075     | 3.053     | 2.952     | 2.967     | 2.974     |
| CO [ppmd]                            | 167.3     | 165       | 159.6     | 166.3     | 188.1     |

| <b>Data Point Name</b>               | <b>SYN20-05</b> | <b>SYN40-07</b> | <b>SYN60-08</b> | <b>SYN80-09</b> | <b>SYN90-10</b> |
|--------------------------------------|-----------------|-----------------|-----------------|-----------------|-----------------|
| <b>Data Point Description (ePCC)</b> | 20% syn2        | 40%syn2         | 60% syn2        | 80% syn2        | 90% syn2        |
| <b>Date</b>                          | 4/13/2010       | 4/13/2010       | 4/13/2010       | 4/13/2010       | 4/13/2010       |
| <u>PCC Fueling Data</u>              |                 |                 |                 |                 |                 |
| Injection Location [°bTDC]           | 100.5           | 98              | 98              | 98              | 82.8            |
| Injection Duration [ms]              | 15              | 17              | 18.3            | 20              | 20              |
| Injection Pressure [psig]            | 115             | 132             | 142             | 175             | 235             |
| Natural Gas Flow [SLM]               | 28.8            | 25.7            | 20.4            | 14.4            | 9.7             |
| Syngas Flow [SLM]                    | 6.9             | 16.8            | 31.7            | 58.4            | 88.1            |
| % Natural Gas                        | 81%             | 60%             | 39%             | 20%             | 10%             |
| %Syngas                              | 19%             | 40%             | 61%             | 80%             | 90%             |
| Ignition Timing [°bTDC]              | 5               | 5               | 5               | 4.4             | 3.9             |
| <u>FTIR Data</u>                     |                 |                 |                 |                 |                 |
| Carbon Monoxide                      | 237.8           | 234             | 225.9           | 235.8           | 260.3           |
| Carbon dioxide                       | 29640           | 29610           | 28730           | 28880           | 29000           |
| Nitric oxide                         | 9.174           | 7.067           | 9.146           | 8.303           | 6.535           |
| Nitrogen dioxide                     | 25.49           | 25.94           | 24.42           | 24.35           | 24.27           |
| Nitrous oxide                        | 1.175           | 1.19            | 1.201           | 1.191           | 1.189           |
| Methane                              | 946.6           | 926.9           | 1287            | 1221            | 1171            |
| Acetylene                            | 2.279           | 2.362           | 2.451           | 2.361           | 2.362           |
| Ethylene                             | 19.1            | 17.52           | 6.042           | 8.088           | 10.31           |
| Ethane                               | 87.68           | 80.97           | 10.09           | 24.22           | 37.95           |
| Propylene                            | 2.659           | 2.671           | 2.715           | 2.725           | 2.712           |
| Formaldehyde                         | 22.49           | 21.88           | 21.64           | 21.74           | 21.85           |
| Water                                | 121600          | 121600          | 126100          | 126700          | 123800          |
| Propane                              | 24.33           | 22.9            | 6.856           | 7.714           | 11.15           |
| Acrolein                             | 0.7456          | 0.7447          | 0.826           | 0.7955          | 0.7895          |
| Acetaldehyde                         | 2.639           | 2.623           | 2.674           | 2.554           | 2.597           |
| IBTYL                                | 11.31           | 11.41           | 12.83           | 12.22           | 12              |
| 13BUT                                | 1.203           | 1.209           | 1.229           | 1.233           | 1.227           |
| SF6                                  | 0.0106          | 0.01059         | 0.01055         | 0.01058         | 0.01059         |
| Methanol                             | 5.597           | 5.773           | 5.785           | 5.745           | 5.782           |
| Hydrogen cyanide                     | 3.926           | 4.015           | 4.112           | 3.974           | 4.022           |
| Ammonia                              | 0.8895          | 0.8917          | 0.6392          | 0.6544          | 0.6812          |
| Total Hydrocarbons                   | 1210            | 1171            | 1333            | 1302            | 1291            |
| Non Methane Hydrocarb                | 263.8           | 244.4           | 46.29           | 81.01           | 119.7           |
| VOC's                                | 103.4           | 96.25           | 27.82           | 36.69           | 50.24           |

| <b>Data Point Name</b>               | <b>SYN20-05</b> | <b>SYN40-07</b> | <b>SYN60-08</b> | <b>SYN80-09</b> | <b>SYN90-10</b> |
|--------------------------------------|-----------------|-----------------|-----------------|-----------------|-----------------|
| <b>Data Point Description (ePCC)</b> | 20% syn2        | 40%syn2         | 60% syn2        | 80% syn2        | 90% syn2        |
| <b>Date</b>                          | 4/13/2010       | 4/13/2010       | 4/13/2010       | 4/13/2010       | 4/13/2010       |
| Calculated Data                      |                 |                 |                 |                 |                 |
| Fuel Flow [SCFH]                     | 3815            | 3820            | 4238            | 4176            | 4096            |
| Fuel Flow [LB/HR]                    | 192.3           | 191             | 184.7           | 185.7           | 186.5           |
| BSFC [BTU/bhp-hr]                    | 8646            | 8604            | 8671            | 8682            | 8687            |
| Stoich. A/F                          | 15.88           | 15.91           | 16.66           | 16.54           | 16.42           |
| U & S A/F                            | 56.88           | 57.31           | 59.1            | 58.84           | 58.65           |
| Trapped A/F                          | 29.11           | 29.27           | 29.63           | 29.56           | 29.58           |
| Mass Flow A/F                        | 57.94           | 58.41           | 60.4            | 60.12           | 59.89           |
| Air Flow [scfm]                      | 11140           | 11160           | 11150           | 11160           | 11170           |
| BMEP [psi]                           | 67.76           | 67.73           | 67.78           | 67.63           | 67.43           |
| Thermal Eff.                         | 29.43           | 29.57           | 29.34           | 29.31           | 29.29           |
| Wobbe Index                          | 1235            | 1232            | 1200            | 1204            | 1211            |
| Methane [%]                          | 83              | 83.91           | 97.44           | 95.53           | 93.29           |
| LHV [BTU/cf]                         | 1003            | 996.3           | 905.6           | 918.1           | 933.9           |
| Gas Density [lb/Mcf]                 | 53.38           | 52.96           | 46.15           | 47.09           | 48.21           |
| Water [%]                            | 12.16           | 12.16           | 12.61           | 12.67           | 12.38           |
| Abs. Humidity                        | 0.0135          | 0.01392         | 0.01389         | 0.01407         | 0.01329         |
| NOx @ 15% O2 [ppmd]                  | 36.57           | 34.41           | 31.1            | 33.92           | 31.77           |
| BS THC [g/bhp-hr]                    | 5.853           | 5.583           | 5.393           | 5.403           | 5.516           |
| BS NOx Actual [g/bhp-hr]             | 0.5815          | 0.545           | 0.4954          | 0.5408          | 0.5083          |
| BS NOx EPA Meth. 20 [g/bhp-hr]       | 0.528           | 0.5044          | 0.4485          | 0.4929          | 0.4708          |
| BS NOx FTIR [g/bhp-hr]               | 0               | 0               | 0               | 0               | 0               |
| BS NO FTIR [g/bhp-hr]                | 0.1669          | 0.1417          | 0.164           | 0.1524          | 0.1342          |
| BS NO2 FTIR [g/bhp-hr]               | 0.3257          | 0.3278          | 0.2472          | 0.3072          | 0.3025          |
| BS CO [g/bhp-hr]                     | 1.789           | 1.766           | 1.704           | 1.781           | 2.024           |
| BS CH2O [g/bhp-hr]                   | 0.2937          | 0.2861          | 0.2838          | 0.286           | 0.2878          |
| BS CO2 [g/bhp-hr]                    | 516.5           | 513.5           | 495.4           | 499.3           | 502.8           |
| Phi Trapped                          | 0.581           | 0.5784          | 0.5809          | 0.5808          | 0.5786          |
| H2O MF [scfm]                        | 520.9           | 525             | 540.7           | 540.6           | 528.9           |
| Exh MF [scfm]                        | 11340           | 11350           | 11340           | 11350           | 11350           |
| BS O2 [g/bhp-hr]                     | 1900            | 1906            | 1896            | 1904            | 1912            |
| BS NMHC [g/bhp-hr]                   | 2.663           | 2.53            | 1.195           | 1.409           | 1.683           |
| BS VOC [g/bhp-hr]                    | 1.518           | 1.471           | 1.063           | 1.09            | 1.182           |
| U&S AF Total                         | 0               | 0               | 0               | 0               | 0               |
| Delivery Ratio                       | 1.727           | 1.732           | 1.735           | 1.737           | 1.732           |
| Trapping Efficiency                  | 0.4836          | 0.4828          | 0.4825          | 0.4821          | 0.4829          |
| Scavenging Efficiency                | 0.8354          | 0.8364          | 0.837           | 0.8375          | 0.8363          |

| <b>Data Point Name</b>               | <b>SYN20-05</b> | <b>SYN40-07</b> | <b>SYN60-08</b> | <b>SYN80-09</b> | <b>SYN90-10</b> |
|--------------------------------------|-----------------|-----------------|-----------------|-----------------|-----------------|
| <b>Data Point Description (ePCC)</b> | 20% syn2        | 40%syn2         | 60% syn2        | 80% syn2        | 90% syn2        |
| Date                                 | 4/13/2010       | 4/13/2010       | 4/13/2010       | 4/13/2010       | 4/13/2010       |
| <b>Combustion Data</b>               |                 |                 |                 |                 |                 |
| Engine Avg Peak Pressure[%]          | 506.8           | 509.3           | 505.9           | 503.1           | 499.9           |
| Engine Avg Peak Pres Std Dev[%]      | 30.65           | 29.61           | 29.85           | 28.35           | 26.08           |
| Engine Avg Peak Pres COV[psi]        | 6.046           | 5.818           | 5.906           | 5.639           | 5.216           |
| Engine Max Peak Pres COV Ch. #1[psi] | 6.845           | 6.066           | 6.264           | 6.037           | 5.791           |
| Engine Min Peak Pres COV Ch. #3[psi] | 5.371           | 5.557           | 5.346           | 5.07            | 4.344           |
| Engine Avg Peak Loc[psi]             | 369.3           | 375.4           | 362.8           | 384.8           | 396.1           |
| Engine Avg IMEP[%]                   | 1.575           | 1.514           | 1.524           | 1.425           | 1.344           |
| Engine Avg IMEP COV[psi]             | 80.41           | 80.04           | 80.12           | 80.01           | 80.38           |
| Engine Max IMEP COV Ch. #3[psi]      | 96.59           | 94.04           | 94.46           | 94.21           | 93.85           |
| Engine Min IMEP COV Ch. #2[psi]      | 70.78           | 70.16           | 70.08           | 70.13           | 72.61           |

| Data Point Name                      | Average   |           |                  |                  |                  |
|--------------------------------------|-----------|-----------|------------------|------------------|------------------|
|                                      | SYN100-11 | SYN100-12 | 100%             | SYN100-13        | SYN100-14        |
| <b>Data Point Description (ePCC)</b> | 100% syn2 | 100% syn2 | 100% syn2<br>ave | 100% syn2<br>22" | 100% syn2<br>25" |
| <b>Date</b>                          | 4/13/2010 | 4/13/2010 | 4/13/2010        | 4/13/2010        | 4/13/2010        |
| Speed [rpm]                          | 300       | 300       | 300              | 299.7            | 295.2            |
| Torque [lb-ft]                       | 7709      | 7708      | 7708.5           | 7711             | 7743             |
| Power [bhp]                          | 440.3     | 440.3     | 440.3            | 440.2            | 435.3            |
| Load [%]                             | 99.75     | 99.74     | 99.745           | 99.78            | 100.2            |
| Ambient Press [psia]                 | 12.13     | 12.13     | 12.13            | 12.13            | 12.13            |
| Ambient Temp [F]                     | 12.56     | 13.66     | 13.11            | 16.81            | 17               |
| Ambient Humidity [%]                 | 46.4      | 46.1      | 46.25            | 46.24            | 44.86            |
| Inlet Air Pres [in Hg]               | 18.0      | 18.0      | 17.995           | 22.0             | 24.8             |
| Inlet Air Temp [F]                   | 111.5     | 109.8     | 110.65           | 111              | 111.2            |
| Inlet Air Humidity [%]               | 34.59     | 34.93     | 34.76            | 34.92            | 35.34            |
| Inlet Air Flow [scfm]                | 2203      | 2205      | 2204             | 2312             | 2268             |
| IC Water Temp [F]                    | 3503      | 3503      | 3503             | 3503             | 3504             |
| Exh Back Pres [in Hg]                | 15.5      | 15.5      | 15.5             | 19.5             | 22.51            |
| Exh Cyl 1 Temp [F]                   | 588.8     | 588.5     | 588.65           | 581.5            | 592.2            |
| Exh Cyl 2 Temp [F]                   | 669.8     | 669.5     | 669.65           | 677.2            | 685.2            |
| Exh Cyl 3 Temp [F]                   | 644.3     | 644.3     | 644.3            | 662.1            | 687.8            |
| Exh Cyl 4 Temp [F]                   | 730.4     | 730.7     | 730.55           | 741.2            | 759.3            |
| Avg Exh Temp [F]                     | 658.3     | 658.3     | 658.3            | 665.5            | 681.1            |
| Stack Temp [F]                       | 83.34     | 83.21     | 83.275           | 85.02            | 83.7             |
| Fuel Flow [lb/hr]                    | 186.9     | 186.9     | 186.9            | 192.4            | 193.5            |
| Orifice Stat Pres [psia]             | 44.35     | 43.66     | 44.005           | 42.03            | 42.9             |
| Orifice Diff Pres [in H2O]           | 0.0141    | 0.0141    | 0.0141           | 0.0141           | 0.0141           |
| Orifice Temp [F]                     | 76.12     | 76.12     | 76.12            | 76.13            | 76.21            |
| Eng Fuel Pres [psig]                 | 24.47     | 24.52     | 24.495           | 27.23            | 29.05            |
| Eng Fuel Temp [F]                    | 120.3     | 120.1     | 120.2            | 121.6            | 123.4            |
| JW Out Temp [F]                      | 164.9     | 164.9     | 164.9            | 164.9            | 165              |
| JW In Temp [F]                       | 161.4     | 161.6     | 161.5            | 161.7            | 161.3            |
| JW Flow [gpm]                        | 471.1     | 471.7     | 471.4            | 471.5            | 471              |
| Lube In Temp [F]                     | 143.8     | 143.4     | 143.6            | 143              | 143.5            |
| Lube Out Temp [F]                    | 156       | 155.8     | 155.9            | 155.2            | 155.4            |
| THC [ppmd]                           | 836.8     | 849.5     | 843.15           | 1229             | 1437             |
| NOx [ppmd]                           | 30.23     | 29.97     | 30.1             | 17.33            | 15.07            |
| NO [ppmd]                            | 12.56     | 12.74     | 12.65            | 4.842            | 4.274            |
| NO2 [ppmd]                           | 17.67     | 17.23     | 17.45            | 12.48            | 10.79            |
| O2 [%d]                              | 15.53     | 15.54     | 15.535           | 15.61            | 15.48            |
| CO2 [%d]                             | 2.999     | 2.986     | 2.9925           | 2.936            | 3.015            |
| CO [ppmd]                            | 193.9     | 195       | 194.45           | 272              | 323.6            |

| Data Point Name                      | Average   |           |               |               |               |
|--------------------------------------|-----------|-----------|---------------|---------------|---------------|
|                                      | SYN100-11 | SYN100-12 | 100%          | SYN100-13     | SYN100-14     |
| <b>Data Point Description (ePCC)</b> | 100% syn2 | 100% syn2 | 100% syn2 ave | 100% syn2 22" | 100% syn2 25" |
| <b>Date</b>                          | 4/13/2010 | 4/13/2010 | 4/13/2010     | 4/13/2010     | 4/13/2010     |
| <u>PCC Fueling Data</u>              |           |           |               |               |               |
| Injection Location [°bTDC]           | 90.3      | 90.3      | 90.3          | 90.3          | 90.3          |
| Injection Duration [ms]              | 30        | 30        | 30            | 30            | 30            |
| Injection Pressure [psig]            | 230       | 230       | 230           | 230           | 230           |
| Natural Gas Flow [SLM]               | 0         | 0         | 0             | 0             | 0             |
| Syngas Flow [SLM]                    | 136.6     | 136.6     | 136.6         | 136.6         | 136.6         |
| % Natural Gas                        | 0%        | 0%        | 0%            | 0%            | 0%            |
| %Syngas                              | 100%      | 100%      | 100%          | 100%          | 100%          |
| Ignition Timing [°bTDC]              | 2.8       | 2.8       | 2.8           | 2.8           | 2.8           |
| FTIR Data                            |           |           |               |               |               |
| Carbon Monoxide                      | 267.1     | 268.5     | 267.8         | 351.7         | 404.4         |
| Carbon dioxide                       | 29180     | 28950     | 29065         | 28680         | 29450         |
| Nitric oxide                         | 7.28      | 7.498     | 7.389         | 6.271         | 6.232         |
| Nitrogen dioxide                     | 24.48     | 24.04     | 24.26         | 19.79         | 18.1          |
| Nitrous oxide                        | 1.203     | 1.203     | 1.203         | 1.194         | 1.191         |
| Methane                              | 1152      | 1186      | 1169          | 1731          | 1953          |
| Acetylene                            | 2.388     | 2.373     | 2.3805        | 2.343         | 2.278         |
| Ethylene                             | 9.936     | 9.249     | 9.5925        | 13.81         | 19.37         |
| Ethane                               | 36.91     | 32.06     | 34.485        | 46.63         | 70.06         |
| Propylene                            | 2.723     | 2.719     | 2.721         | 2.64          | 2.643         |
| Formaldehyde                         | 21.49     | 21.63     | 21.56         | 27.1          | 30.76         |
| Water                                | 124200    | 124500    | 124350        | 121100        | 120700        |
| Propane                              | 10.69     | 9.348     | 10.019        | 11.82         | 15.9          |
| Acrolein                             | 0.7913    | 0.7997    | 0.7955        | 1.032         | 1.147         |
| Acetaldehyde                         | 2.583     | 2.595     | 2.589         | 3.441         | 3.828         |
| IBTYL                                | 12.11     | 12.3      | 12.205        | 16.92         | 19.24         |
| 13BUT                                | 1.232     | 1.23      | 1.231         | 1.194         | 1.196         |
| SF6                                  | 0.01053   | 0.01058   | 0.010555      | 0.01049       | 0.01059       |
| Methanol                             | 5.668     | 5.735     | 5.7015        | 5.654         | 5.679         |
| Hydrogen cyanide                     | 4.09      | 4.074     | 4.082         | 3.985         | 3.898         |
| Ammonia                              | 0.6665    | 0.6058    | 0.63615       | 0.7632        | 0.9074        |
| Total Hydrocarbons                   | 1268      | 1288      | 1278          | 1875          | 2162          |
| Non Methane Hydrocarb                | 115.6     | 101.8     | 108.7         | 144.1         | 209.1         |
| VOC's                                | 48.03     | 43.08     | 45.555        | 58.74         | 80.87         |



| Data Point Name                      | Average   |           |             |           |           |
|--------------------------------------|-----------|-----------|-------------|-----------|-----------|
|                                      | SYN100-11 | SYN100-12 | 100%<br>ave | SYN100-13 | SYN100-14 |
| <b>Data Point Description (ePCC)</b> | 100% syn2 | 100% syn2 | 100% syn2   | 100% syn2 | 100% syn2 |
| <b>Date</b>                          | 4/13/2010 | 4/13/2010 | 4/13/2010   | 4/13/2010 | 4/13/2010 |
| Calculated Data                      |           |           |             |           |           |
| Fuel Flow [SCFH]                     | 4131      | 4134      | 4132.5      | 4284      | 4219      |
| Fuel Flow [LB/HR]                    | 186.9     | 186.9     | 186.9       | 192.4     | 193.5     |
| BSFC [BTU/bhp-hr]                    | 8716      | 8714      | 8715        | 8992      | 9087      |
| Stoich. A/F                          | 16.44     | 16.44     | 16.44       | 16.48     | 16.36     |
| U & S A/F                            | 58.22     | 58.36     | 58.29       | 58.5      | 56.6      |
| Trapped A/F                          | 29.4      | 29.5      | 29.45       | 30.58     | 30.89     |
| Mass Flow A/F                        | 59.45     | 59.6      | 59.525      | 59.61     | 57.61     |
| Air Flow [scfm]                      | 11110     | 11140     | 11125       | 11470     | 11150     |
| BMEP [psi]                           | 67.43     | 67.43     | 67.43       | 67.46     | 67.74     |
| Thermal Eff.                         | 29.19     | 29.2      |             | 28.3      | 28        |
| Wobbe Index                          | 1208      | 1207      | 1207.5      | 1206      | 1211      |
| Methane [%]                          | 93.89     | 93.98     | 93.935      | 94.6      | 92.59     |
| LHV [BTU/cf]                         | 929       | 928.1     | 928.55      | 924       | 937.4     |
| Gas Density [lb/Mcf]                 | 47.91     | 47.87     | 47.89       | 47.56     | 48.56     |
| Water [%]                            | 12.42     | 12.45     | 12.435      | 12.11     | 12.07     |
| Abs. Humidity                        | 0.01399   | 0.01342   | 0.013705    | 0.01272   | 0.01218   |
| NOx @ 15% O2 [ppmd]                  | 33.22     | 32.98     | 33.1        | 19.31     | 16.41     |
| BS THC [g/bhp-hr]                    | 5.358     | 5.451     | 5.4045      | 8.087     | 9.466     |
| BS NOx Actual [g/bhp-hr]             | 0.5311    | 0.528     | 0.52955     | 0.3149    | 0.2692    |
| BS NOx EPA Meth. 20 [g/bhp-hr]       | 0.4887    | 0.4844    | 0.48655     | 0.2886    | 0.2452    |
| BS NOx FTIR [g/bhp-hr]               | 0         | 0         | 0           | 0         | 0         |
| BS NO FTIR [g/bhp-hr]                | 0.1439    | 0.1464    | 0.14515     | 0.05739   | 0.04981   |
| BS NO2 FTIR [g/bhp-hr]               | 0.3104    | 0.3035    | 0.30695     | 0.2269    | 0.1928    |
| BS CO [g/bhp-hr]                     | 2.074     | 2.092     | 2.083       | 3.009     | 3.52      |
| BS CH2O [g/bhp-hr]                   | 0.2816    | 0.2844    | 0.283       | 0.3661    | 0.4082    |
| BS CO2 [g/bhp-hr]                    | 503.9     | 503.4     | 503.65      | 510.4     | 515.3     |
| Phi Trapped                          | 0.5827    | 0.5809    | 0.5818      | 0.5608    | 0.5537    |
| H2O MF [scfm]                        | 537.9     | 531.9     | 534.9       | 536.2     | 521.7     |
| Exh MF [scfm]                        | 11300     | 11320     | 11310       | 11660     | 11340     |
| BS O2 [g/bhp-hr]                     | 1898      | 1904      | 1901        | 1973      | 1924      |
| BS NMHC [g/bhp-hr]                   | 1.643     | 1.558     | 1.6005      | 2.114     | 2.652     |
| BS VOC [g/bhp-hr]                    | 1.159     | 1.136     | 1.1475      | 1.483     | 1.722     |
| U&S AF Total                         | 0         | 0         | 0           | 0         | 0         |
| Delivery Ratio                       | 1.729     | 1.728     | 1.7285      | 1.621     | 1.498     |
| Trapping Efficiency                  | 0.4833    | 0.4835    | 0.4834      | 0.5005    | 0.5211    |
| Scavenging Efficiency                | 0.8357    | 0.8355    | 0.8356      | 0.8111    | 0.7804    |

| Data Point Name                      | SYN100-11 | SYN100-12 | Average          | SYN100-13        | SYN100-14        |
|--------------------------------------|-----------|-----------|------------------|------------------|------------------|
|                                      |           |           | 100%             |                  |                  |
| <b>Data Point Description (ePCC)</b> | 100% syn2 | 100% syn2 | 100% syn2<br>ave | 100% syn2<br>22" | 100% syn2<br>25" |
| Date                                 | 4/13/2010 | 4/13/2010 | 4/13/2010        | 4/13/2010        | 4/13/2010        |
| Combustion Data                      |           |           |                  |                  |                  |
| Engine Avg Peak Pressure[%]          | 497.8     | 496.9     | 497.35           | 489.1            | 500.5            |
| Engine Avg Peak Pres Std Dev[%]      | 24.97     | 24.88     | 24.925           | 29.78            | 31.19            |
| Engine Avg Peak Pres COV[psi]        | 5.017     | 5.007     | 5.012            | 6.108            | 6.253            |
| Engine Max Peak Pres COV Ch. #1[psi] | 5.644     | 5.586     | 5.615            | 7.354            | 7.672            |
| Engine Min Peak Pres COV Ch. #3[psi] | 4.308     | 4.226     | 4.267            | 4.058            | 4.011            |
| Engine Avg Peak Loc[psi]             | 397.1     | 407.3     | 402.2            | 397.8            | 410              |
| Engine Avg IMEP[%]                   | 1.294     | 1.279     | 1.2865           | 1.674            | 1.996            |
| Engine Avg IMEP COV[psi]             | 80.56     | 80.46     | 80.51            | 80.82            | 81.35            |
| Engine Max IMEP COV Ch. #3[psi]      | 93.78     | 93.7      | 93.74            | 94.71            | 95.53            |
| Engine Min IMEP COV Ch. #2[psi]      | 73.65     | 73.16     | 73.405           | 72.88            | 72.47            |