

FOLIO  
TA 7  
C6  
1966  
no. 2  
cop. 2

West Pakistan  
Water and Power Development Authority

TARBELA DAM PROJECT  
POWER TUNNEL PENSTOCK MANIFOLD  
HYDRAULIC MODEL STUDY



CIVIL ENGINEERING DEPARTMENT

Engineering Research Center  
Colorado State University  
Fort Collins, Colorado

Prepared for  
Tippetts-Abbett-McCarthy-Stratton  
New York, New York

January 1966

CER66JFR-SSK2

LIBRARIES  
COLORADO STATE UNIVERSITY  
FORT COLLINS, COLORADO

FINAL REPORT  
OF  
HYDRAULIC MODEL STUDY  
OF  
POWER TUNNEL PENSTOCK MANIFOLD

TARBELA DAM PROJECT  
INDUS RIVER  
WEST PAKISTAN

Prepared for  
Tippetts - Abbett - McCarthy - Stratton  
New York, New York

*Consulting*

by

J. F. Ruff and S. Karaki

(8615)

Colorado State University  
Engineering Research Center  
Civil Engineering Department  
Fort Collins, Colorado  
January, 1966

LIBRARIES  
COLORADO STATE UNIVERSITY  
FORT COLLINS, COLORADO

## PREFACE

The Engineering Research Center at Colorado State University is located between two lakes, Horse-tooth Reservoir of the Colorado Big Thompson Project, and College Lake. The laboratories of the Center were strategically placed to utilize the high head, 250 feet, available from the reservoir and the storage capacity of the lakes. The Center is the focal point for research and graduate education.

There are five principal parts to the Center: the offices for staff and graduate students, the hydraulics laboratory, the fluid dynamics laboratory, the hydromechanical laboratory and the outdoor hydraulics - hydrology laboratory. The research activities of the center are fluid mechanics, hydraulics, hydrology, ground-water, soil mechanics, hydrobiology, geomorphology and environmental engineering.

The hydraulics laboratory includes 50,000 square feet of floor space in which basic and applied research activities are undertaken. The floor of the laboratory is constructed over a large sump system, having one acre foot capacity, which permits recirculation of water through the various research facilities. Generally, pumps are used for recirculation but the high head and large flow capacity from the reservoir can also be utilized.

The Center includes well equipped machine and woodwork shops. All research facilities of the Center are constructed on site and in the case of this model study, necessary metal work, carpentry, and nearly all the plastic work was done by personnel in the shops. The shop personnel are particularly well experienced in the art and skill of model construction.

This model study was undertaken by Colorado State University with close coordination with Tippetts-Abbett-McCarthy-Stratton (TAMS) of New York, for whom this work was done. The urgent need of hydraulic information for purposes of planning and design was recognized from the beginning and all information obtained from the model studies relevant to those purposes were transmitted to TAMS in advance of this report. Decisions affecting model construction tests or testing program, or time schedules were made with mutual consent through assessment of appropriate information and consideration and accord with project planning.

Grateful acknowledgment is hereby expressed by the writers to personnel at TAMS for their cooperation, to personnel of the shops for their ingenious contributions in solving model construction problems, particularly in the metal works, and to others contributing to the model study and the preparation of this report.

## CONTENTS

	<u>Page</u>
FIGURES . . . . .	iv
TABLES . . . . .	vi
SUMMARY . . . . .	viii
INTRODUCTION . . . . .	1
General Description of Project . . . . .	1
Description of Penstock Manifold . . . . .	1
Scope of the Model Study . . . . .	1
Model Criteria . . . . .	5
THE MODEL . . . . .	6
Model Construction . . . . .	6
Instrumentation . . . . .	6
Piezometer Readings . . . . .	6
Velocity Traverses . . . . .	6
MODEL TESTS AND RESULTS . . . . .	20
General . . . . .	20
Model Test Program . . . . .	20
Pressures and Velocities . . . . .	20
Form Loss Coefficients . . . . .	22
Branch Loss Coefficients . . . . .	26
Method A . . . . .	26
Method B . . . . .	27
Bypass Relief Valve . . . . .	28
Butterfly Valve . . . . .	28
CONCLUSIONS AND RECOMMENDATIONS . . . . .	32
REFERENCES . . . . .	33
APPENDICES	
A-1 PRESSURE HEADS ALONG MANIFOLD WALLS . . . . .	35
A-2 VELOCITY DISTRIBUTIONS WITHIN MANIFOLD . . . . .	43
B-1 PRESSURE HEADS ALONG MANIFOLD AND BYPASS RELIEF BRANCH WALLS . . . . .	61
B-2 VELOCITY DISTRIBUTIONS WITHIN MANIFOLD AND BYPASS RELIEF BRANCH . . . . .	65
C-1 PRESSURE HEADS ALONG MANIFOLD AND BYPASS RELIEF BRANCH WALLS WITH BUTTERFLY VALVE INSTALLED . . . . .	73
C-2 VELOCITY DISTRIBUTIONS WITHIN MANIFOLD AND BYPASS RELIEF BRANCH WITH BUTTERFLY VALVE INSTALLED . . . . .	75



FIGURES

<u>Figure</u>		<u>Page</u>
1	General plan of Tarbela Dam . . . . .	2
2	(a) Future power-tunnels 1 and 2 . . . . .	3
	(b) Future power-tunnels 1, 2 and 3 . . . . .	3
3	Details of the prototype manifold . . . . .	4
4	Friction factors for model and prototype operating ranges . . . . .	5
5	General limits of the model . . . . .	7
6	(a) Rolling a transition . . . . .	8
	(b) Fitting a branch connection . . . . .	8
	(c) Constructing reducing bend . . . . .	8
	(d) Alignment of model . . . . .	8
	(e) Installing piezometer taps . . . . .	8
7	Schematic drawing of the model . . . . .	9
8	Bypass relief branch . . . . .	10
9	Assembling the bypass valve . . . . .	10
10	Details of butterfly valve . . . . .	11
11	Photograph of completed model . . . . .	11
12	Velocity traverse and piezometer locations in penstock . . . . .	12
13	Velocity traverse and piezometer locations in branch connection 1 . . . . .	13
14	Velocity traverse and piezometer locations in branch connection 2 . . . . .	14
15	Velocity traverse and piezometer locations in branch connection 3 . . . . .	15
16	Piezometer locations in reducing bend . . . . .	16
17	Velocity traverse and piezometer locations in bypass relief branch connections . . . . .	17
18	Velocity traverse and piezometer locations in bypass relief branch . . . . .	18
19	Pressure data recording system . . . . .	19
20	Velocity traverse data recording system . . . . .	19
21	Pitot tube probe . . . . .	19
22	Velocity profiles at branch connection 3 . . . . .	21
23	Velocity profiles at locations 5, 6, 13 and 14 for Run 1A . . . . .	22

FIGURES - Continued

<u>Figures</u>		<u>Page</u>
24	(a) Hydraulic grade line - 4 branches open . . . . .	23
	(b) Hydraulic grade line - 2 branches open . . . . .	24
	(c) Hydraulic grade line - 1 branch open . . . . .	25
25	(a) Branch loss coefficients for branch 1 . . . . .	29
	(b) Branch loss coefficients for branch 2 . . . . .	29
	(c) Branch loss coefficients for branch 3 . . . . .	29
26	Branch loss coefficient . . . . .	30
27	Header loss coefficients . . . . .	30
28	Junction loss coefficients for the bypass relief valve . . . . .	31
29	Velocity profile downstream from open butterfly valve . . . . .	31

TABLES

<u>Table</u>		<u>Page</u>
I	Test Program for Tarbela Penstock Manifold Model . . . . .	20
II	Head Loss Coefficients . . . . .	27

## SUMMARY

A hydraulic model study of the Tarbela Dam penstock manifold was performed. Specifically, pressures and velocity distributions within the manifold were observed.

The manifold performed satisfactorily for a variety of discharge distributions representing the entire range of prototype operation. No abrupt pressure changes or unusual velocity distributions which would indicate poor flow characteristics in the prototype were observed. Form loss coefficients and junction loss coefficients were calculated for the manifold.

The bypass relief valve and branch exhibited satisfactory hydraulic performance. Branch loss coefficients were calculated for the bypass relief connection. Installation of a butterfly valve upstream from the bypass relief branch connection produced no adverse effects downstream with this valve leaf installed either vertically or horizontally.

The model construction, details of the tests performed, and method of calculating the coefficients are described in this report.

## INTRODUCTION

### General Description of Project

Tarbela Dam, proposed for construction on the upper Indus in West Pakistan, is a major feature in the system of works implementing the Indus Waters Treaty and the Indus Basin Development Fund Agreement of 1960. The dam site is some 29 miles upstream from the Attock bridge, which is about midway between Rawalpindi and Peshawar in the northern part of West Pakistan. The dam will be the first step in a long range plan to develop extensive off-channel storage. It will also make possible an ultimate installed hydroelectric generating capacity of 2,100,000 KW.

The dam, shown in Figure 1, consists of an embankment across the 9,000-foot width of the main river valley, a group of four tunnels to provide for power and irrigation releases in the right abutment, two saddle spillways cut through the rock of the left bank and discharging into a side valley, and two auxiliary embankment dams to close the upstream end of the side valley.

The Tarbela reservoir will have a gross storage capacity of 11.1 MAF (elevation 1550) and a capacity at the assumed minimum drawdown of 1.8 MAF (elevation 1300), providing a net usable capacity of 9.3 MAF. The assumed minimum level of drawdown, elevation 1300, will provide a depth of about 200 feet of water at the dam. The full reservoir depth will be approximately 450 feet.

The four tunnels will serve for river diversion during the final stages of construction and, ultimately, for power and irrigation releases. Tunnels 1 and 2, closest to the river channel, will be used first for diversion and then for power. Each tunnel will serve a group of four turbines and generators, each of 175,000 KW capacity, as shown in Figure 2(a). Tunnels 3 and 4 will be used for diversion during construction and later for irrigation releases. Tunnel 3 will eventually be converted to serve the third stage of power development, as shown in Figure 2(b).

### Description of Penstock Manifold

Details of the prototype manifold are shown in Figure 3. The manifold connects the 43.5-foot

diameter penstock with four 16-foot diameter turbine scroll case inlets. The header diameter is 36 feet, 31.0 feet, and 24.5 feet at branch connections 1<sup>1</sup>, 2 and 3, respectively. Downstream from branch connection 3, the header diameter reduces to 20 feet and subsequently from 20 feet to 16 feet at branch 4. Conical transitions with a 20° included angle are used at branch connections 1, 2 and 3 to reduce the diameter to 16 feet at the branch inlets. In plan, all branch centerlines intersect the header centerline at an angle of 70°.

### Scope of the Model Study

The purpose of the model study was to quantitatively as well as qualitatively evaluate the hydraulics of flow through the manifold for various discharges through the branches. The specific objectives are listed below:

1. Determine through pressure data and velocity profiles the flow characteristics within the manifold for different discharges through the branches.
2. Measure pressures and pressure fluctuations on the boundaries.
3. Calculate form loss coefficients at changes in cross-section of the manifold and junction loss coefficients for the manifold branch connections.
4. Determine the effects of the branch connection to the relief valve on velocity distributions approaching the turbines.
5. Determine the effect of a butterfly valve, installed upstream from the bypass relief branch connection, on pressures and velocities immediately downstream from the butterfly valve.

<sup>1</sup>

The branches are numbered 1, 2, 3 and 4 upstream to downstream. Reference to the various branches or branch connections, hereafter in this report, will be by the numbers, for example, as branch connection 1.

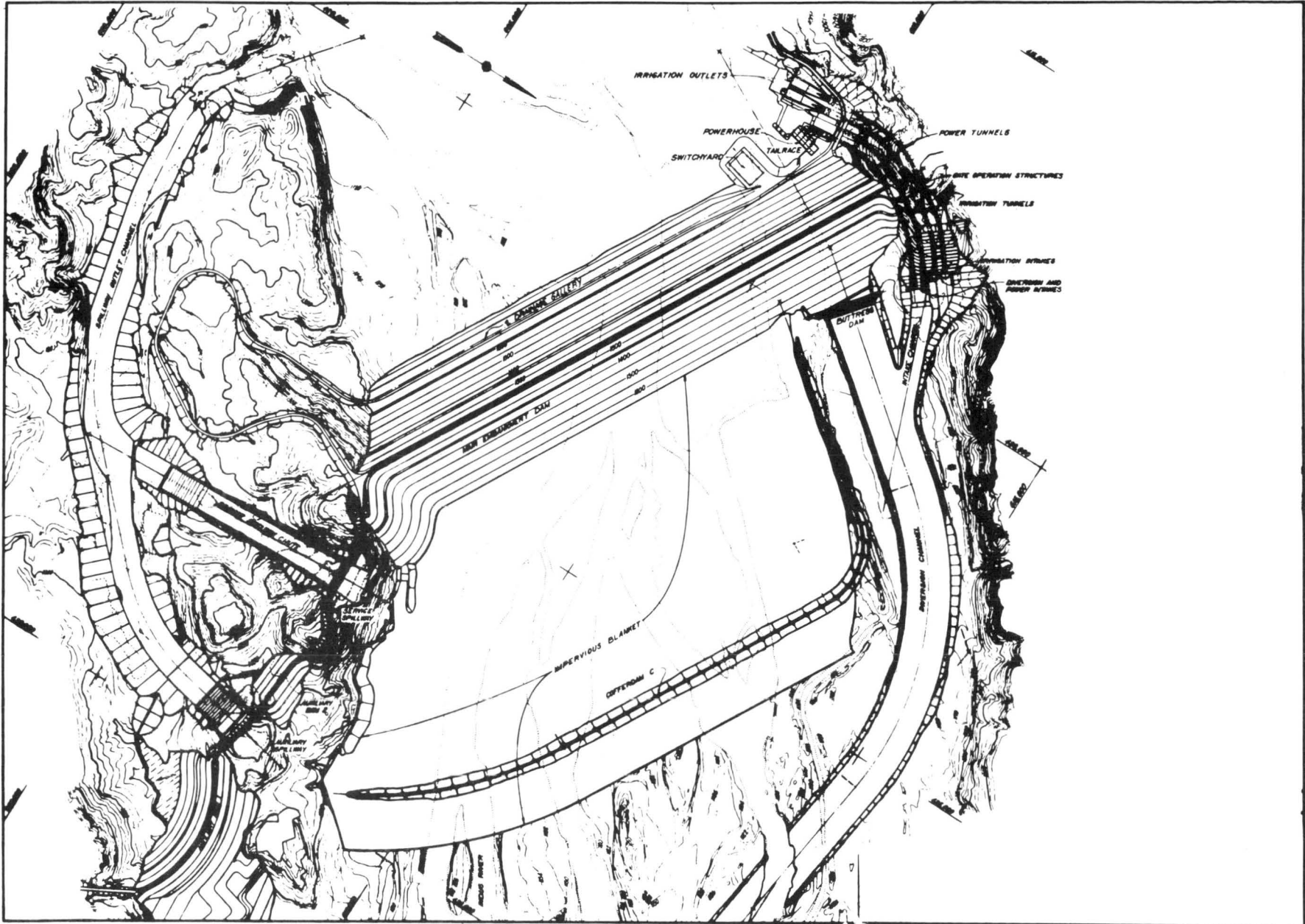

FIGURE 1 GENERAL PLAN OF TARBELA DAM



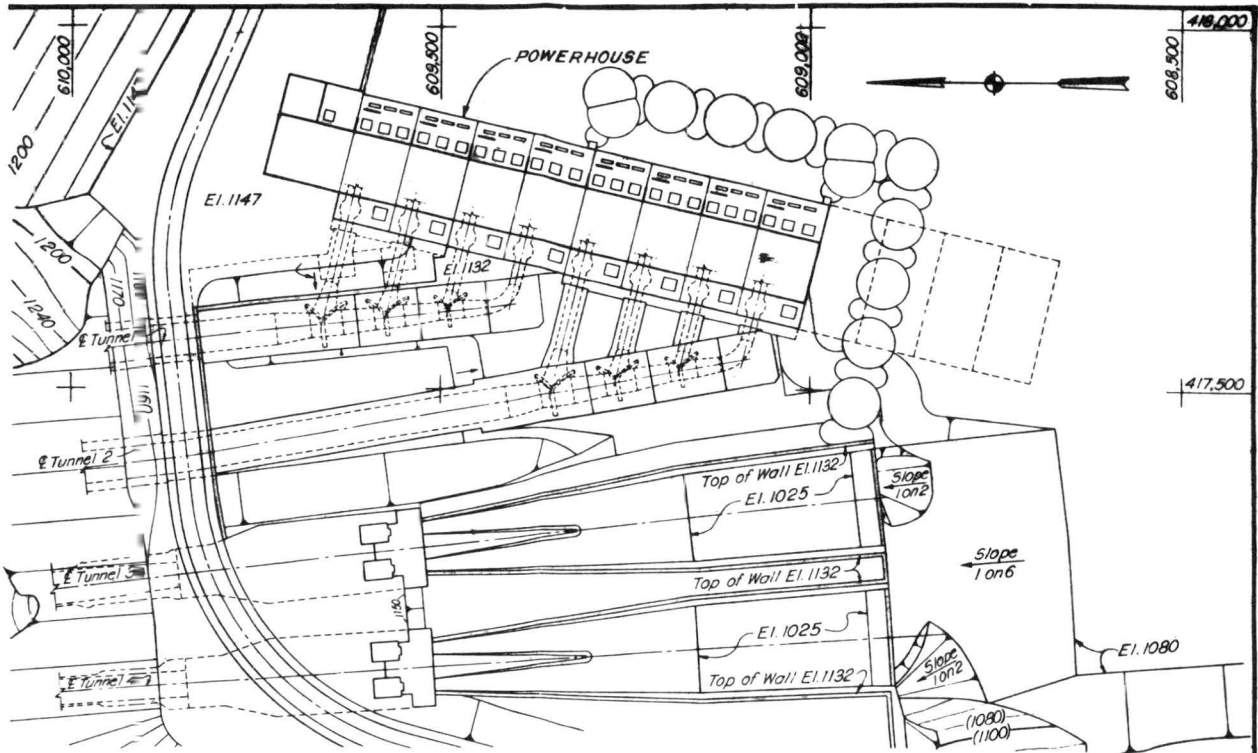

FIGURE 2 (a) FUTURE POWER - TUNNELS 1 & 2

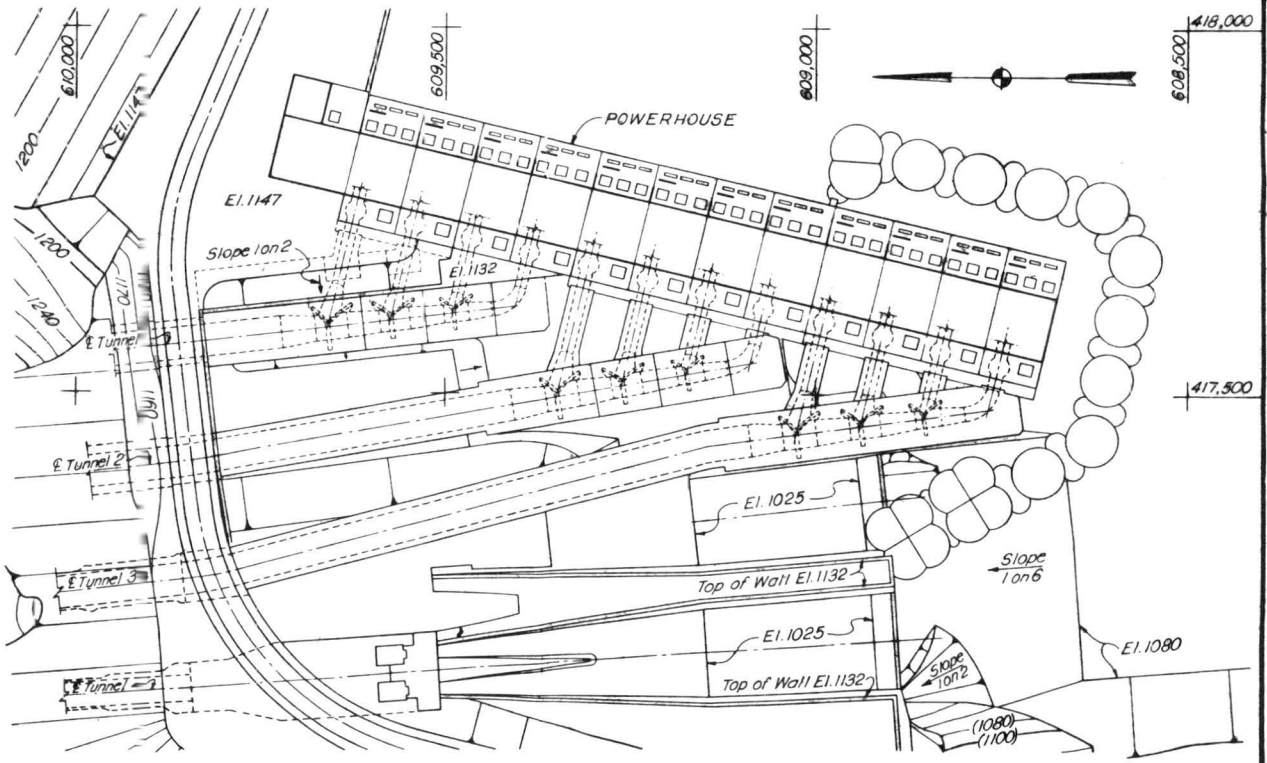

FIGURE 2 (b) FUTURE POWER - TUNNELS 1, 2 AND 3



## Model Criteria

The purpose of this model study is to predict prototype behavior. Therefore, the principles of similitude are applied to determine, in so far as possible, an indication of full scale phenomena based upon model tests. Dimensional analysis indicates that the Reynolds number ( $\frac{VD}{\mu}$ ) and Euler number ( $\frac{\Delta P}{\rho V^2}$ ) are significant in this case. It is known from fluid mechanics theory that the Reynolds number governs for friction losses in a closed conduit and that the geometry governs the form losses.

When working with hydraulic models, the Reynolds criteria can not be readily satisfied since it calls for almost prototype scale due to the characteristics of the water. Therefore, in such studies, the scale is made as large as possible in order to get the Reynolds number sufficiently large so that the friction becomes a function of the boundary roughness ( $e/D$ ) and essentially independent of the Reynolds number as indicated in Figure 4. Although the model and prototype operate at different Reynolds numbers and have different boundary roughness the friction losses in each case can be computed quite accurately. The Bureau of Reclamation's report "Friction Factors for Large Conduits Flowing Full"<sup>(2)</sup> gives friction factors measured in conduits approaching the size of the Tarbela penstock.

A geometric scale ratio of 1:24 was chosen to construct the model. This ratio was determined from an analysis of: ease of construction, construction tolerances, available facilities, and economy. A maximum discharge of about 4 cfs was provided through each branch. At this discharge the losses in the model could be accurately measured and the friction losses computed.

If the model and prototype are geometrically similar, then the form losses can be accurately determined from the model. Prototype form losses are determined by measuring the total losses in the model for various sections and then subtracting the friction losses computed for the model. Generally, the order of magnitude of the friction loss in the model compared to the form loss is about one to ten or greater.

Since geometric similitude exists between model and prototype, the form loss coefficients thus determined from the model can be used directly for the prototype to determine the form losses. The friction losses for the prototype can be computed as previously mentioned. The total losses in the prototype can thus be determined for any condition by adding the form and friction losses together.

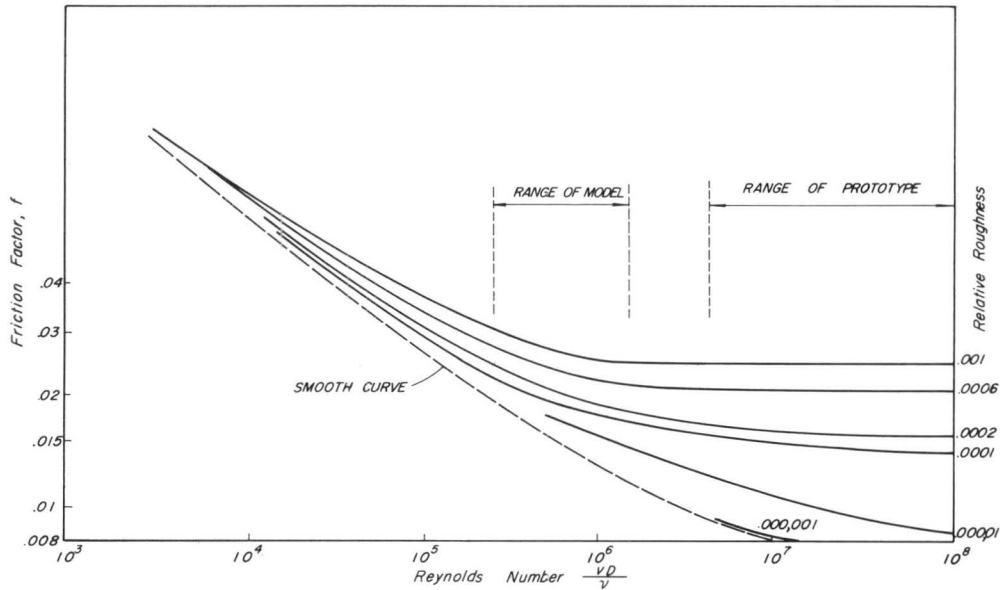

FIGURE 4 FRICTION FACTORS FOR MODEL & PROTOTYPE OPERATING RANGES

<sup>2</sup> Numbers in parenthesis refer to references cited in bibliography

## THE MODEL

### Model Construction

The geometric scale of the model manifold was 1:24. The particular manifold modeled is shown on a plan of the powerhouse area in Figure 5. The model was constructed of 3/16-inch welded steel plate. This thickness of steel was required to prevent warping of the model after welding, and with careful workmanship, this thickness was optimum for economy and accuracy of construction. The required tolerance was one percent. The maximum measured difference checked at many significant points was 0.3%. Bolted connections were used between sections to aid assembly. Filler material was placed in each joint and smoothed before assembling subsequent sections. Figure 6 shows photographs of the construction in process to illustrate the techniques involved. A portion of the model (described hereinafter) was formed in plastic to maintain control of model dimensions, particularly at the smaller diameters. Dimensions of the model facilities and actual laboratory arrangement are given in Figure 7.

The branch connection to the relief valve, the bypass relief valve and intermediate bend were constructed of Plexiglas and cast acrylic resin tubes, as shown in Figure 8. The transitions were milled from solid pieces of Plexiglas stock. The Howell-Bunger type relief valve was milled from Plexiglas stock with concentric tubes used for the body and sleeve. Figure 9 shows the bypass relief valve being assembled. The model was so constructed that the portion of the model containing the bypass relief branch connection and downstream piping could be interchanged among the four branches.

A valve leaf to represent a butterfly valve was constructed from Plexiglas stock and housed in a steel casing. The dimensions of the valve are shown in Figure 10. A photograph of the completed model is shown in Figure 11.

The locations of the many piezometers used to measure pressures at the boundaries and the points where velocity traverse were made are shown in the following figures:

- Figure 12 Velocity traverse and piezometer locations in penstock.
- Figure 13 Velocity traverse and piezometer locations in branch connection 1.
- Figure 14 Velocity traverse and piezometer locations in branch connection 2.
- Figure 15 Velocity traverse and piezometer locations in branch connection 3.

Figure 16 Piezometer locations in reducing bend.

Figure 17 Velocity traverse and piezometer locations in bypass relief branch connection.

Figure 18 Velocity traverse and piezometer locations in bypass relief branch.

Water was supplied by a 20-inch turbine pump. The discharge was regulated by a bypass valve at the pump and butterfly valves installed in each branch of the manifold. Calibrated orifice plates were installed in each branch to measure the discharge through the branches.

### Instrumentation

Piezometer Readings--Electronic instrumentation was employed to facilitate the reading of the many piezometers. The operation is shown in Figure 19. All piezometers were individually connected to a pressure transducer by manual manipulation of the tubes in the five piezometer banks.

The pressure from the piezometer and a reference pressure corresponding to a static head at the level of the header centerline were applied to the transducer. The pressure transducer transmitted an electrical signal that was proportional to the piezometric head. This signal was sent through an electronic averaging circuit and then into a digital voltmeter. The digital voltmeter displayed a voltage that was adjusted to give the direct reading of piezometric head. The output from the digital voltmeter was properly identified with the piezometer number and both were put on printed paper tape output.

Velocity Traverses--Electronic instrumentation was also utilized for directly recording the velocity profiles across the pipes. A sketch of the system is given in Figure 20. A pitot tube probe was inserted through the walls of manifold at the locations shown in Figures 12 and 18. A photograph of the pitot tube is shown in Figure 21. The differential pressure registered by the pitot tube was measured by a differential pressure transducer. The transducer output was a voltage directly proportional to the differential pressure. The square root of the transducer voltage was then taken and with a variable amplifier the scale adjusted to a present voltage directly proportional to the velocity. The position of the probe was registered by means of a rotary potentiometer attached to the probe. The velocity and position were then properly input to an x-y plotter and the velocity profiles were thus directly recorded.

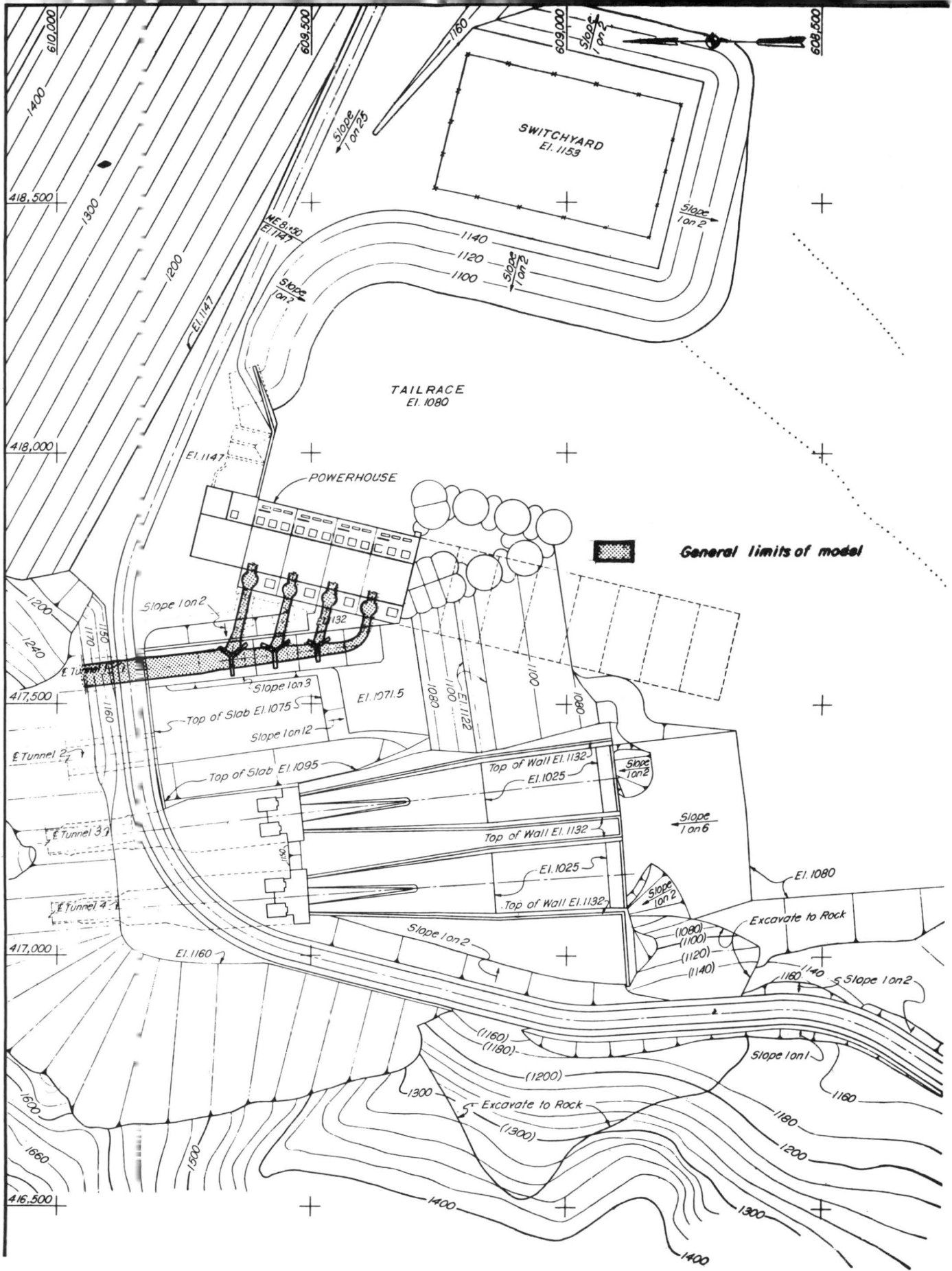

FIGURE 5 GENERAL LIMITS OF THE MODEL



Fig. 6(a) Rolling a transition



Fig. 6(b) Fitting a branch connection



Fig. 6(c) Constructing reducing bend

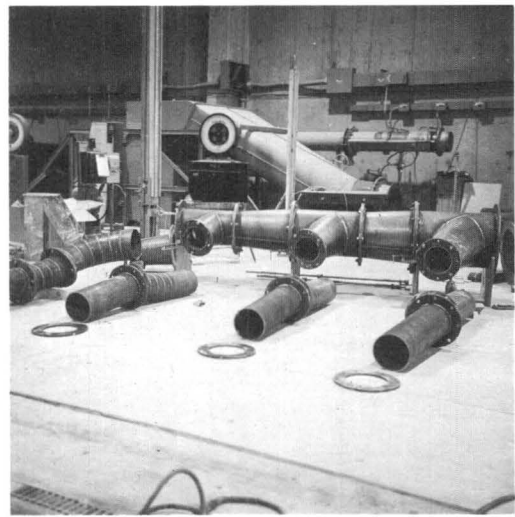

Fig. 6(d) Alignment of model

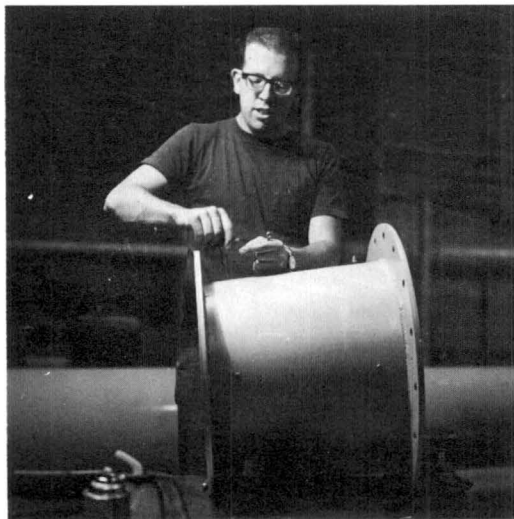

Fig. 6(e) Installing piezometer taps



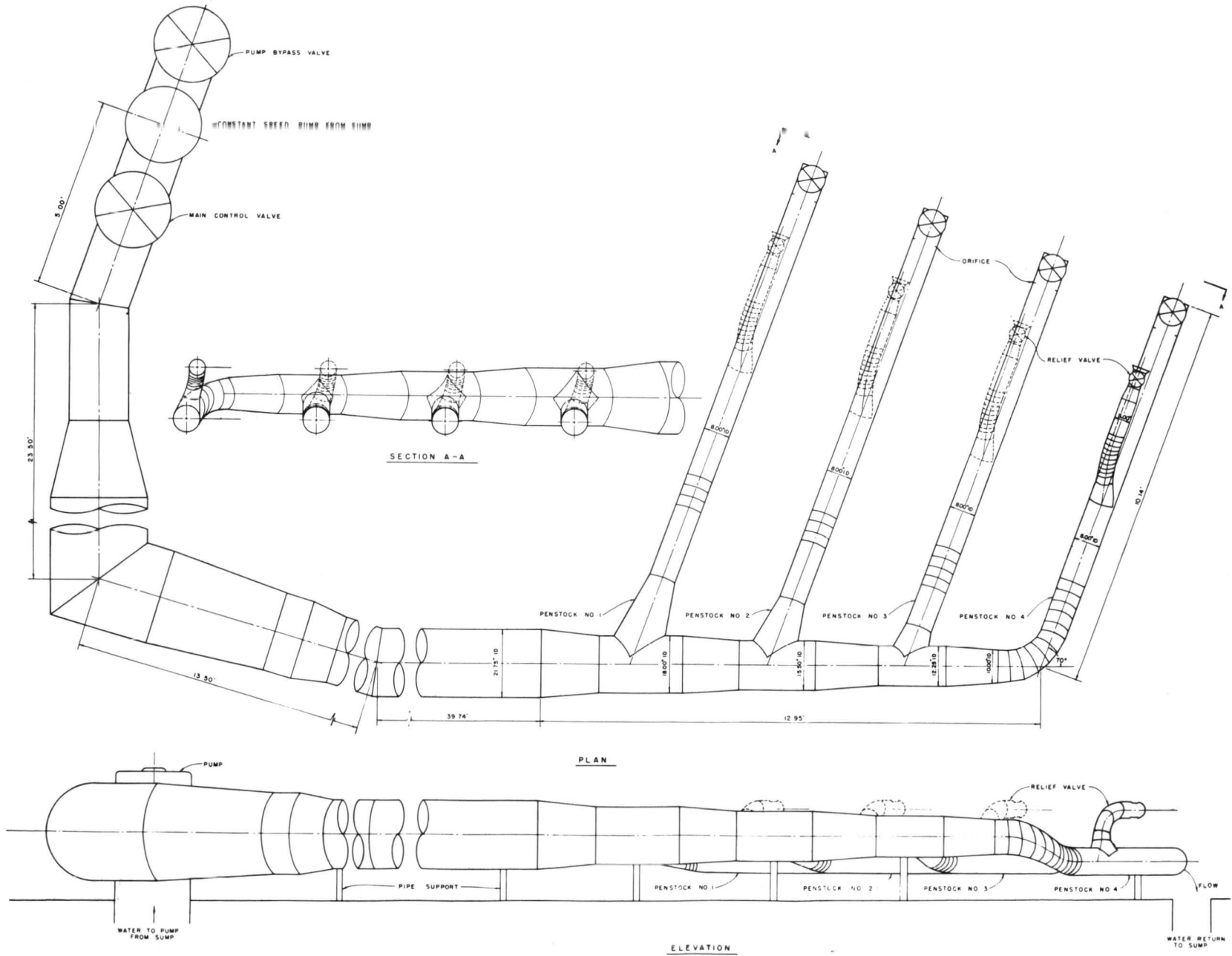

FIGURE 7 SCHEMATIC DRAWING OF THE MODEL

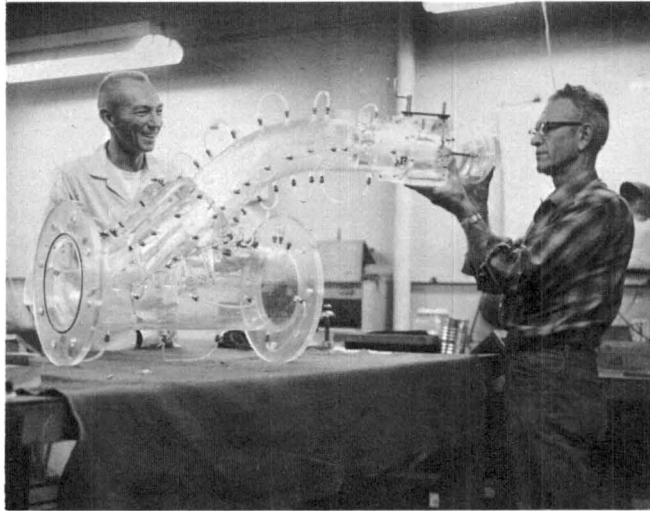

Fig. 8 Bypass relief branch

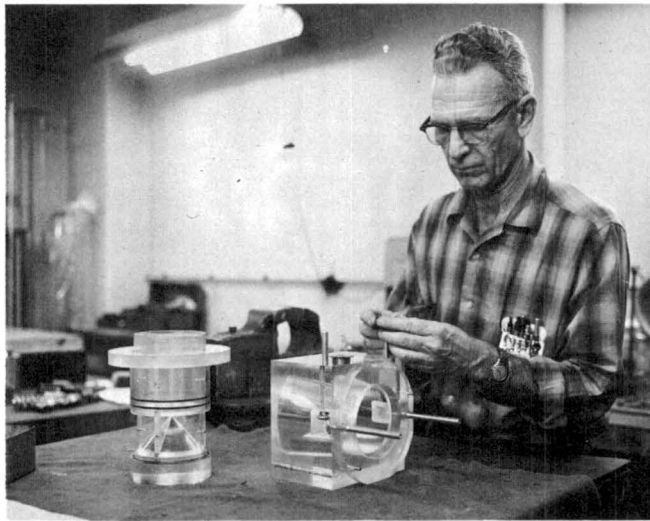

Fig. 9 Assembling the bypass valve

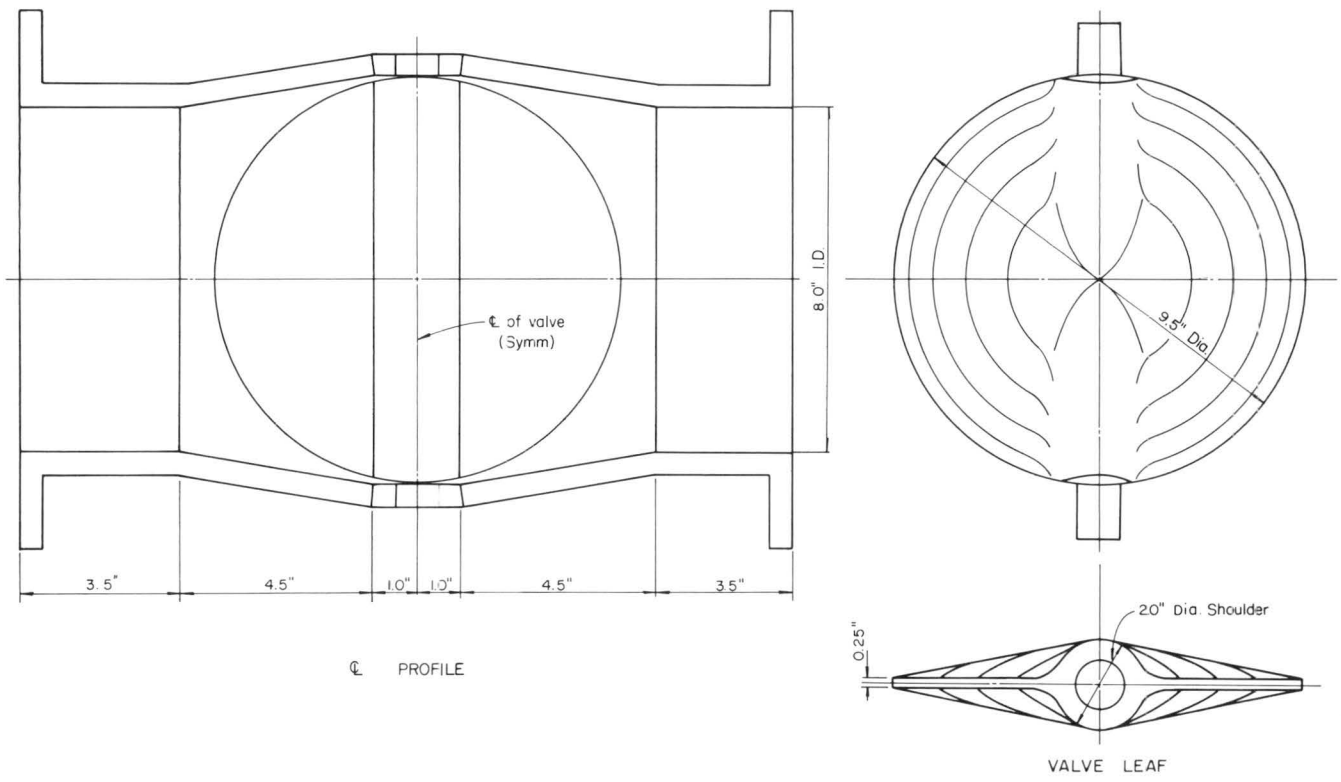

FIGURE 10 DETAILS OF BUTTERFLY VALVE

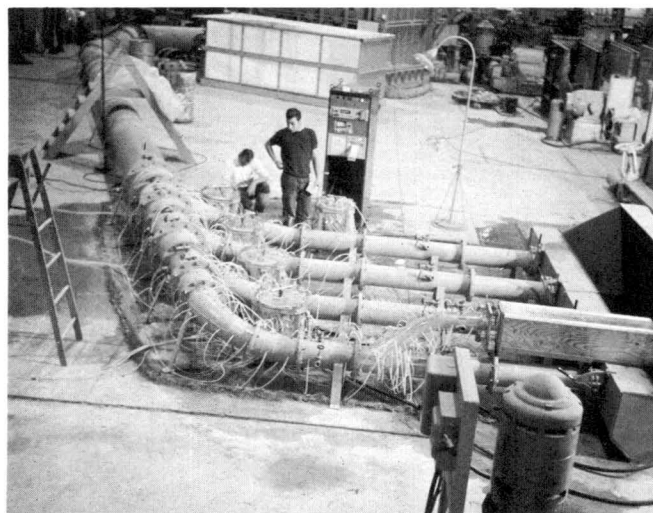

Fig. 11 Photograph of completed model

PIEZO. NO.	ELEV. IN FT.	PIEZO. NO.	ELEV. IN FT.	PIEZO. NO.	ELEV. IN FT.	PIEZO. NO.	ELEV. IN FT.	PIEZO. NO.	ELEV. IN FT.
1	101.16	89	100.25	195	99.35	260	99.63	316	99.31
2	100.25	79	99.52	196	99.68	261	99.92	317	99.64
3	99.34	71	100.25	197	99.93	262	99.59	318	99.92
4	100.25	72	100.91	198	99.60	263	99.25	319	99.59
5	101.16	73	100.25	199	99.26	264	99.59	320	99.26
6	100.25	74	99.59	200	99.60	265	99.92	321	99.59
7	99.34	75	100.24	201	99.97	266	99.58	322	99.92
8	100.25	113	100.87	202	99.58	267	99.25	323	99.58
9	101.16	114	100.25	203	99.25	268	99.58	324	99.25
10	100.25	115	99.61	204	99.58	269	99.92	325	99.58
11	99.34	116	100.25	205	99.92	270	99.58	326	99.92
12	100.25	117	100.78	206	99.58	271	99.25	327	99.58
13	101.16	118	100.25	207	99.25	272	99.58	328	99.25
14	100.25	119	99.72	208	99.58	306	100.20	329	99.58
15	99.34	120	100.25	249	100.20	307	99.87	330	100.24
16	100.25	157	100.71	250	99.87	308	99.55	338	99.92
17	101.13	158	100.25	251	99.53	309	99.87	339	99.55
18	100.25	159	99.76	252	99.87	310	100.03	340	99.92
19	99.37	160	100.25	253	100.01	311	99.70	361	100.08
20	100.25	161	100.88	254	99.68	312	99.37	362	99.75
21	101.03	162	100.25	255	99.35	313	99.70	363	99.42
22	100.25	163	99.81	256	99.68	314	99.97	364	99.73
23	99.47	164	100.25	257	99.96	315	99.64	365	100.92
24	100.25	193	100.00	258	99.63				
25	100.98	194	99.68	259	99.30				

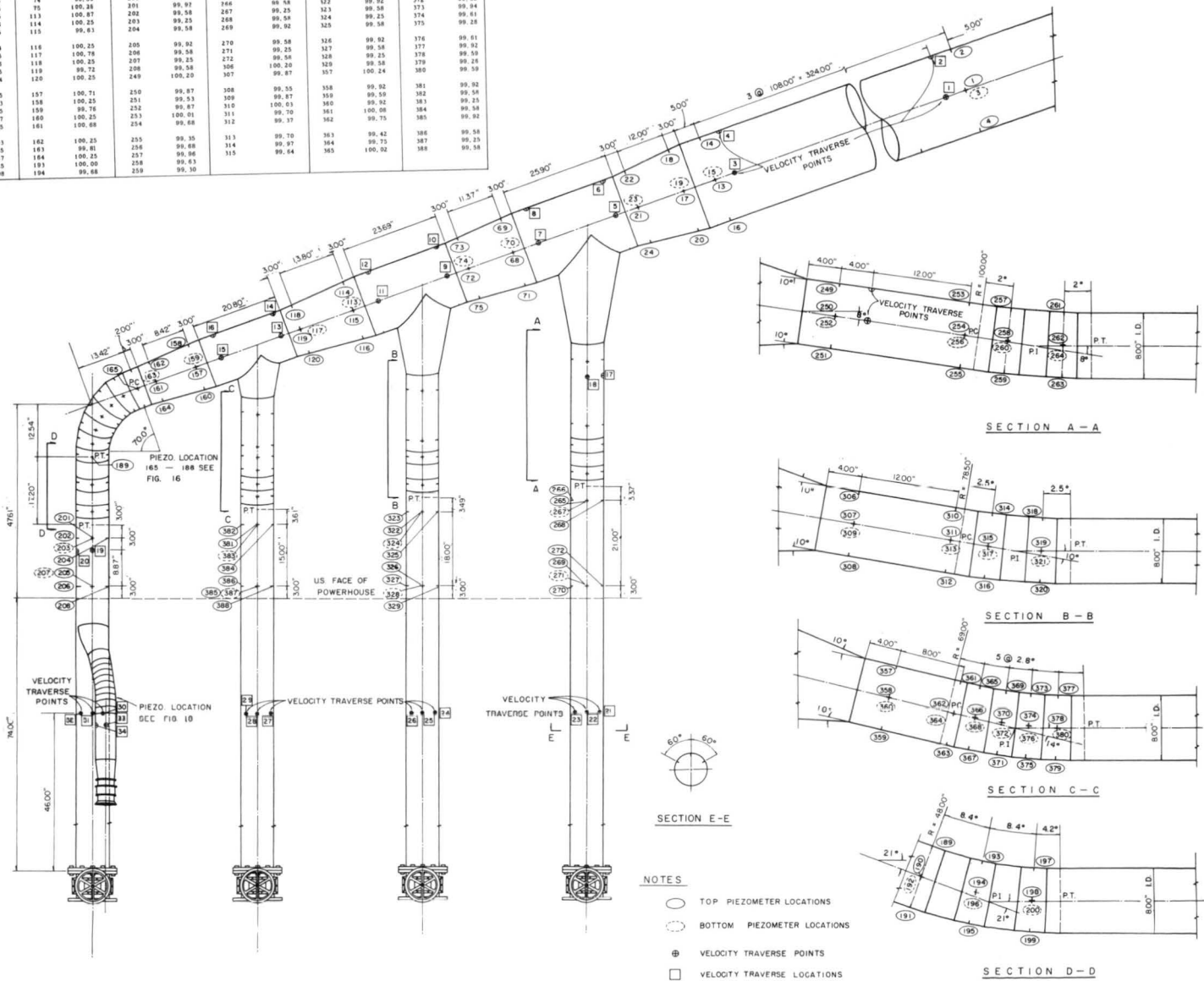
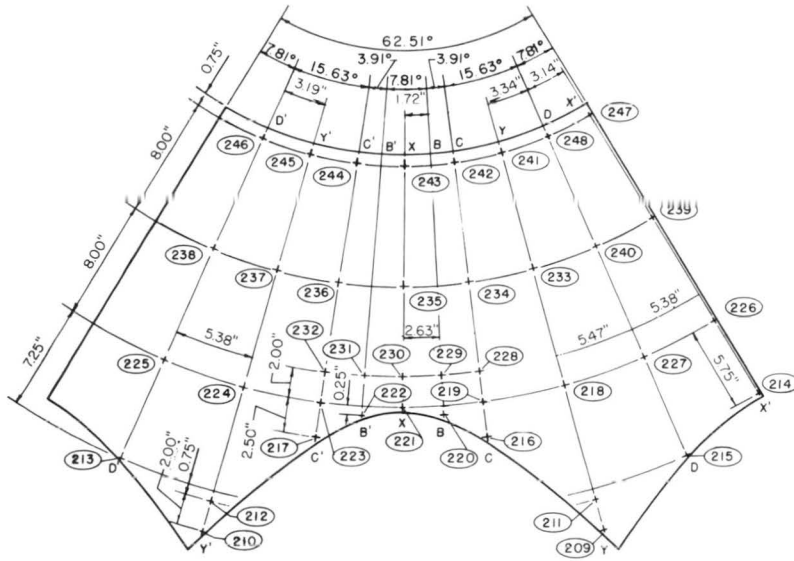
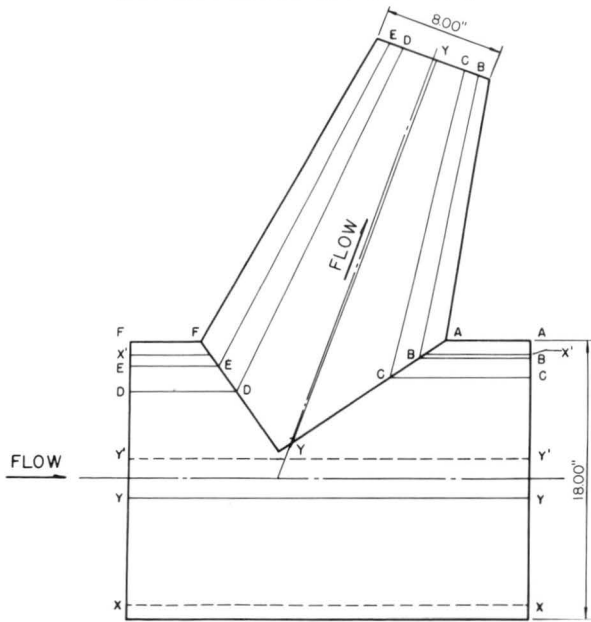

FIGURE 12 VELOCITY TRAVERSE AND PIEZOMETER LOCATIONS IN PENSTOCK



DEVELOPED VIEW OF CONE



BRANCH CONNECTION NO. 1  
(TRUE VIEW)

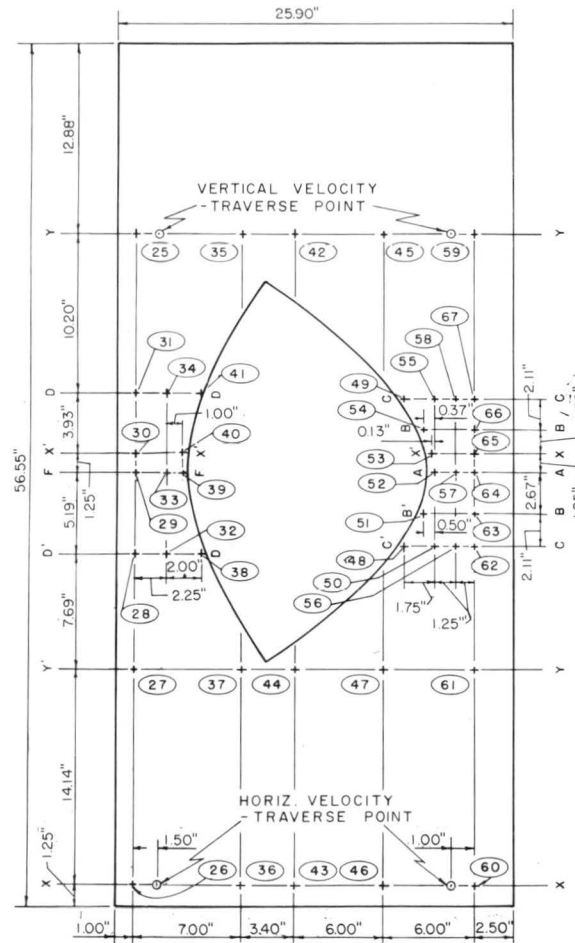

DEVELOPED VIEW OF CYLINDER

PIEZO. NO.	ELEV. IN FT.	PIEZO. NO.	ELEV. IN FT.
25	101.00	209	100.94
26	100.25	210	99.50
27	99.50	211	100.88
28	99.76	212	99.51
29	100.15	213	99.71
30	100.25	214	100.17
31	100.57	215	100.66
32	99.76	216	100.56
33	100.15	217	99.70
34	100.57	218	100.68
35	101.00	219	100.51
36	100.25	220	100.34
37	99.50	221	100.10
38	99.76	222	99.89
39	100.15	223	99.70
40	100.25	224	99.53
41	100.57	225	99.70
42	101.00	226	100.10
43	100.25	227	100.50
44	99.50	228	100.47
45	101.00	229	100.29
46	100.25	230	100.08
47	99.50	231	99.88
48	99.76	232	99.70
49	100.54	233	100.47
50	99.78	234	100.34
51	99.93	235	100.01
52	100.15	236	99.70
53	100.25	237	99.56
54	100.37	238	99.69
55	100.54	239	100.01
56	99.78	240	100.33
57	100.15	241	100.26
58	100.54	242	100.17
59	101.00	243	99.50
60	100.25	244	99.68
61	99.50	245	99.58
62	99.78	246	99.67
63	99.93	247	99.59
64	100.15	248	100.15
65	100.25		
66	100.37		
67	100.54		

FIGURE 13 VELOCITY TRAVERSE AND PIEZOMETER LOCATIONS IN BRANCH CONNECTION I

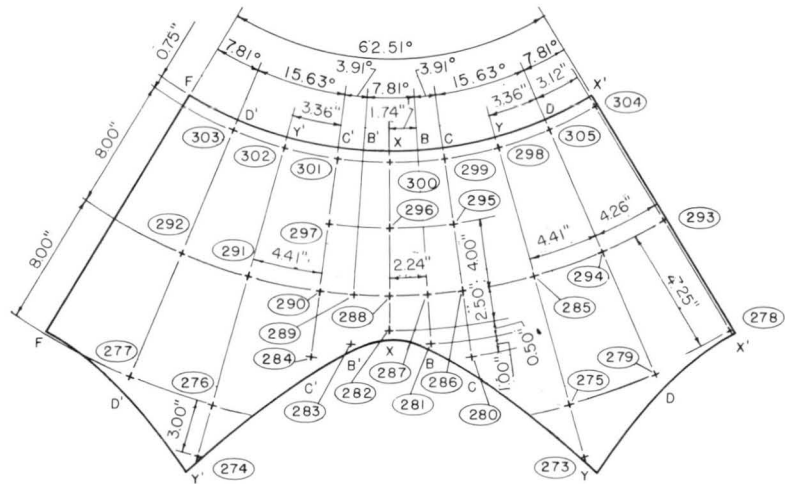

DEVELOPED VIEW OF CONE

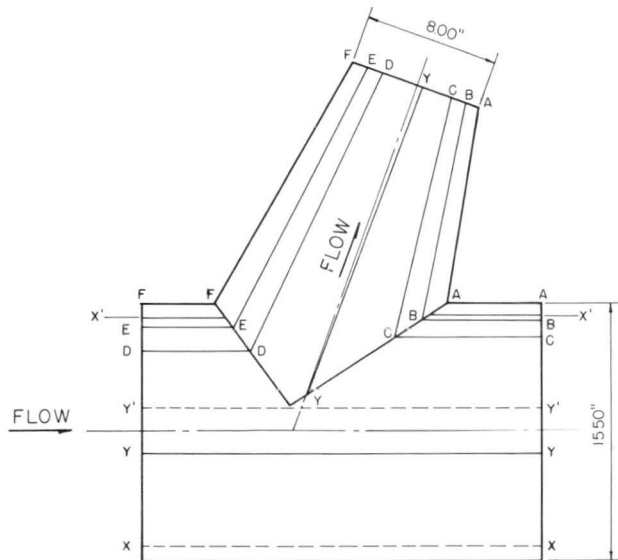

BRANCH CONNECTION NO. 2  
(TRUE VIEW)

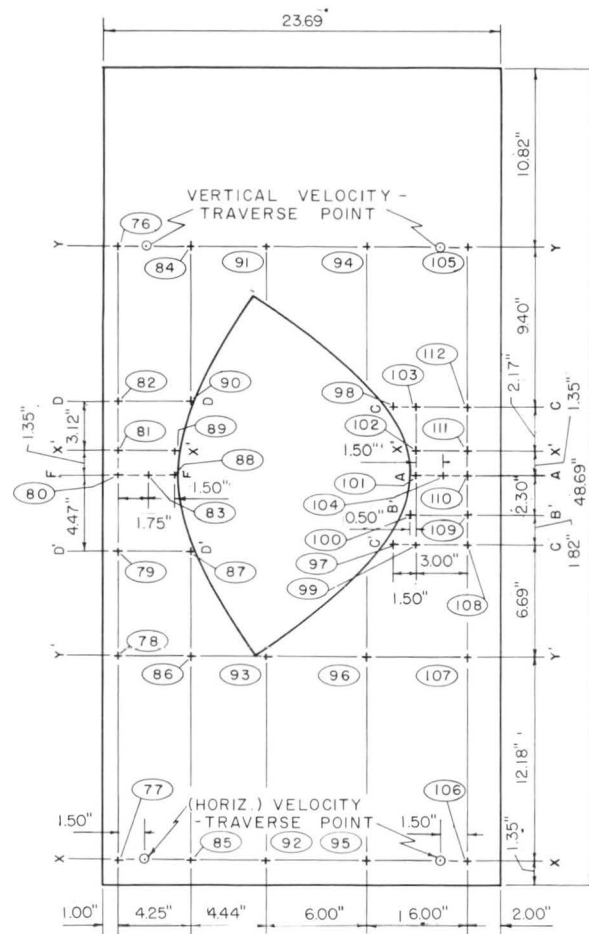

DEVELOPED VIEW OF CYLINDER

PIEZO. NO.	ELEV. IN FT.	PIEZO. NO.	ELEV. IN FT.
76	100.90	273	100.83
77	100.25	274	99.61
78	99.60	275	100.74
79	99.81	276	99.61
80	100.14	277	99.77
81	100.25	278	100.16
82	100.50	279	100.57
83	100.14	280	100.47
84	100.90	281	100.29
85	100.25	282	100.09
86	99.60	283	99.92
87	99.81	284	99.76
88	100.14	285	100.51
89	100.25	286	100.38
90	100.50	287	100.24
91	100.90	288	100.06
92	100.25	289	99.89
93	99.60	290	99.74
94	100.90	291	99.60
95	100.25	292	99.73
96	99.60	293	100.06
97	99.83	294	100.37
98	100.47	295	100.28
99	99.83	296	100.00
100	99.96	297	99.73
101	100.14	298	100.28
102	100.25	299	100.19
103	100.47	300	99.94
104	100.14	301	99.71
105	100.90	302	99.60
106	100.25	303	99.70
107	99.60	304	99.94
108	99.83	305	100.17
109	99.96		
110	100.14		
111	100.25		
112	100.47		

FIGURE 14 VELOCITY TRAVERSE AND PIEZOMETER LOCATIONS IN BRANCH CONNECTION 2



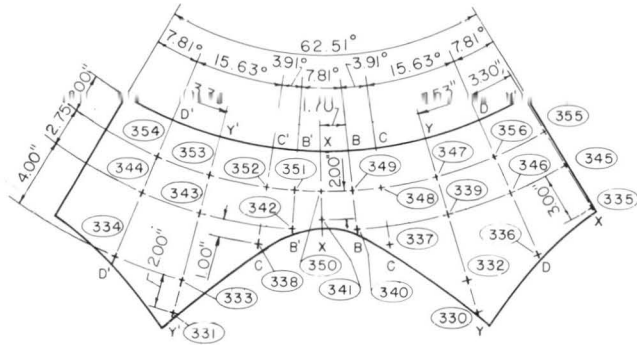

DEVELOPED VIEW OF CONE

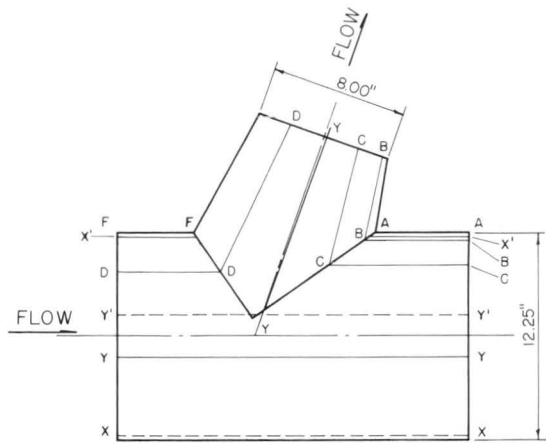

BRANCH CONNECTION NO 3  
(TRUE PICTURE)

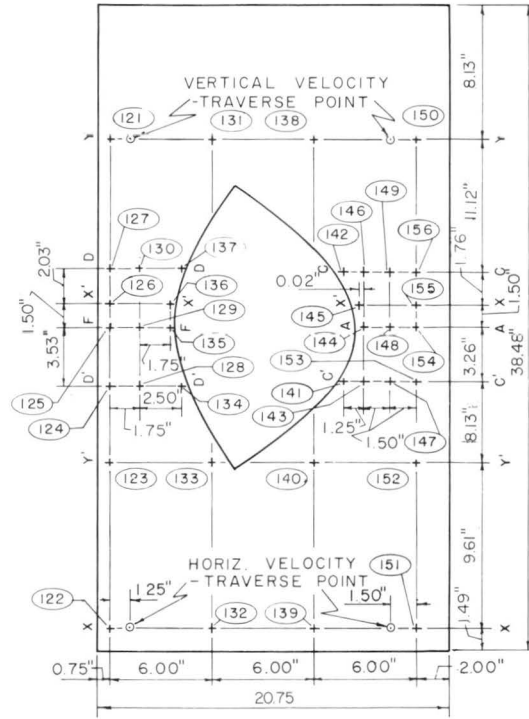

DEVELOPED VIEW OF CYLINDER

PIEZO. NO.	ELEV. IN FT.	PIEZO. NO.	ELEV. IN FT.
121	100.76	153	99.89
122	100.25	154	100.10
123	99.74	155	100.25
124	99.87	156	100.39
125	100.10		
126	100.25	330	100.68
127	100.42	331	99.73
128	99.87	332	101.99
129	100.10	333	99.72
130	100.42	334	99.86
131	100.76	335	100.15
132	100.25	336	100.48
133	99.74	337	100.40
134	99.87	338	99.83
135	100.10	339	100.48
136	100.25	340	100.24
137	100.42	341	100.08
138	100.76	342	99.95
139	100.25	343	99.70
140	99.74	344	99.81
141	99.89	345	100.09
142	100.39	346	100.43
143	99.89	347	100.39
144	100.10	348	100.29
145	100.25	349	100.18
146	100.39	350	100.04
147	99.89	351	99.73
148	100.10	352	99.80
149	100.39	353	99.68
150	100.76	354	99.79
151	100.25	355	100.04
152	99.74	356	100.28

FIGURE 15 VELOCITY TRAVERSE AND PIEZOMETER LOCATIONS IN BRANCH CONNECTION 3

PIEZO. NO.	ELEV. IN FT.	PIEZO. NO.	ELEV. IN FT.
165	100.67	179	99.78
166	100.25	180	100.06
167	99.83	181	100.39
168	100.25	182	100.10
169	100.64	183	99.72
170	100.28	184	100.00
171	99.82	185	100.28
172	100.19	186	100.01
173	100.59	187	99.64
174	100.24	188	99.89
175	99.80	189	100.16
176	100.14	190	99.85
177	100.50	191	99.54
178	100.19	192	99.85

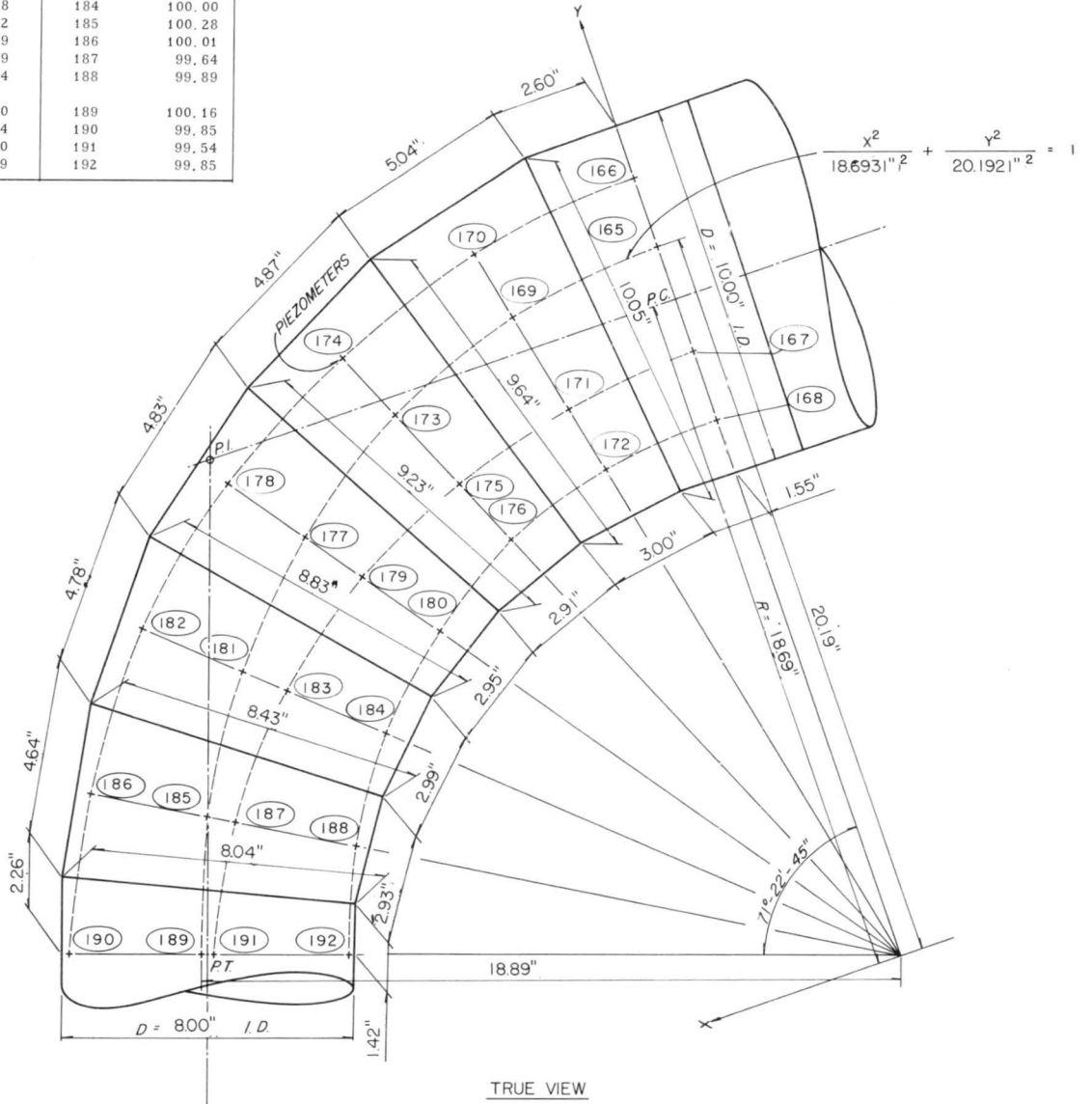

PENSTOCK NO. 4-REDUCING BEND

FIGURE 16 PIEZOMETER LOCATIONS IN REDUCING BEND

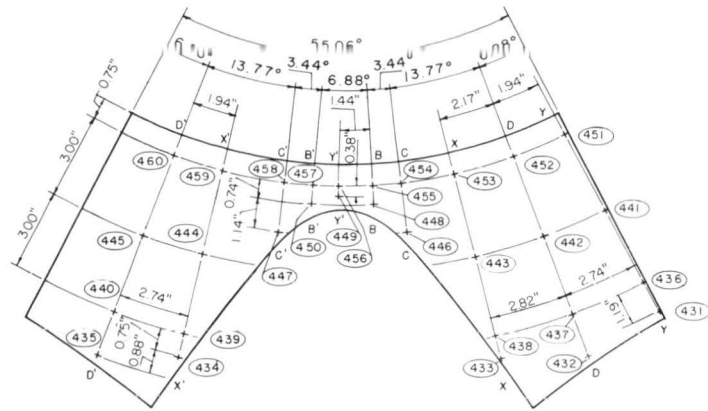

DEVELOPED VIEW OF CONE

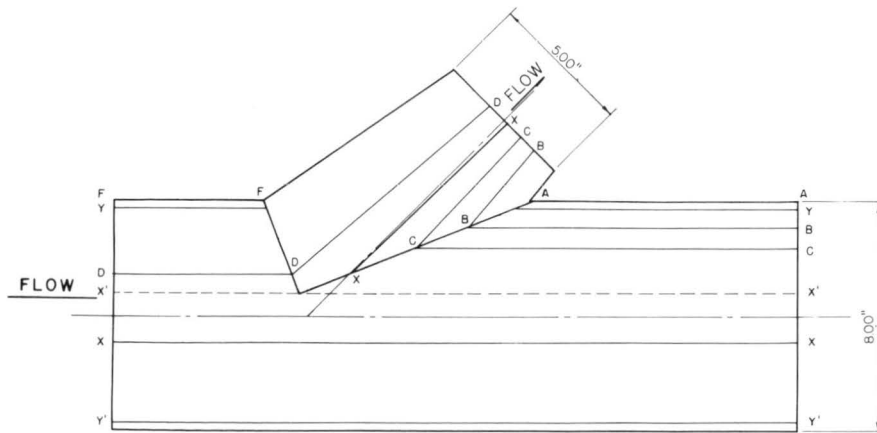

BRANCH CONNECTION TO RELIEF VALVE (TRUE VIEW)

PIEZO. NO.	ELEV. IN FT.	PIEZO. NO.	ELEV. IN FT.	PIEZO. NO.	ELEV. IN FT.	PIEZO. NO.	ELEV. IN FT.	PIEZO. NO.	ELEV. IN FT.
380	99.92	404	99.25	419	99.87	434	99.73	449	99.03
390	99.87	405	99.58	420	99.91	435	99.83	450	99.92
391	99.88	406	99.90	421	99.90	436	99.08	451	100.27
392	99.25	407	99.82	422	99.82	437	99.92	452	100.23
393	99.58	408	99.92	423	99.91	438	99.77	453	100.11
394	99.77	409	99.90	424	99.92	439	99.77	454	100.01
395	99.91	410	99.82	425	99.90	440	99.92	455	99.98
396	99.87	411	99.82	426	99.90	441	99.92	456	99.98
397	99.87	412	99.91	427	99.25	442	100.08	457	99.97
398	99.58	413	99.92	428	99.58	443	99.94	458	100.00
399	99.25	414	99.90	429	99.82	444	99.94	459	100.12
400	99.58	415	99.58	430	99.91	445	100.07	460	100.22
401	99.77	416	99.25	431	99.92	446	99.89		
402	99.91	417	99.58	432	99.84	447	99.88		
403	99.58	418	99.82	433	99.73	448	99.92		

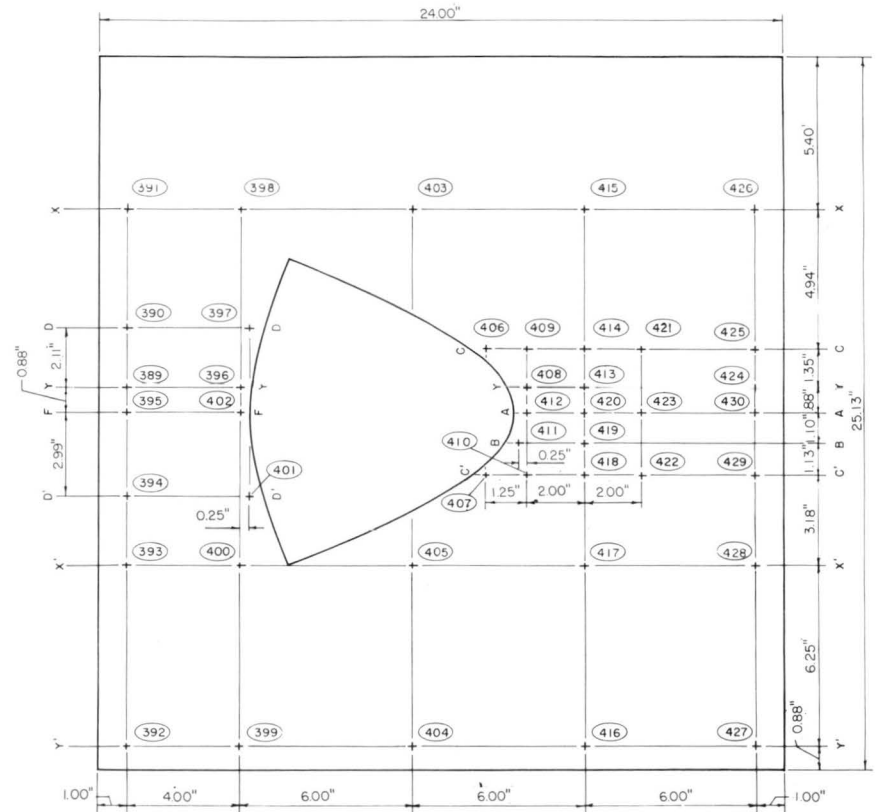

DEVELOPED VIEW OF CYLINDER

FIGURE 17 VELOCITY TRAVERSE AND PIEZOMETER LOCATIONS IN BYPASS RELIEF BRANCH CONNECTIONS

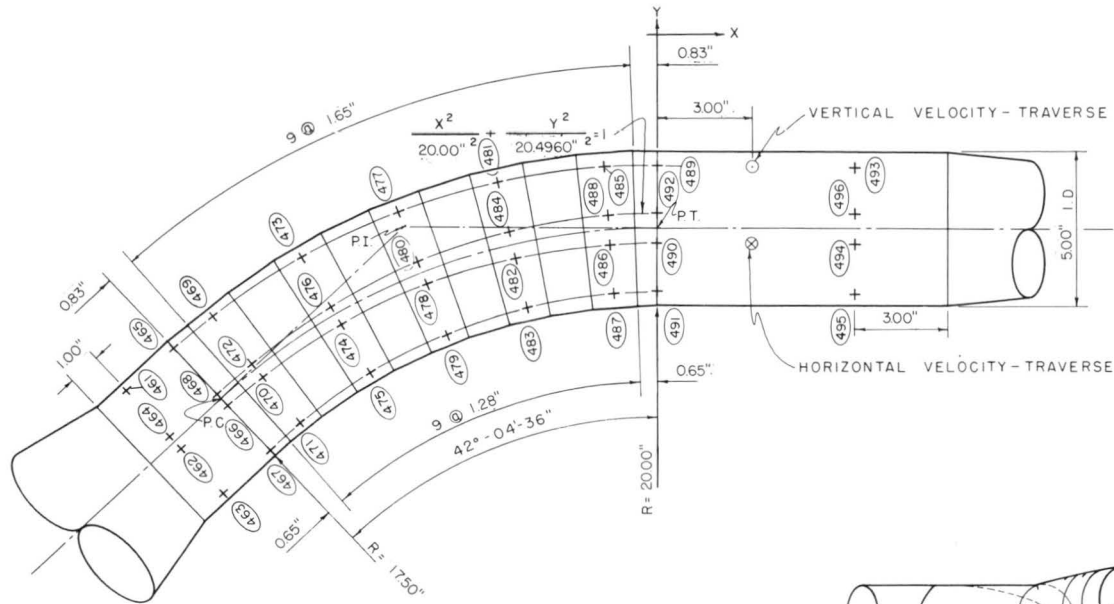

ELEVATION (TRUE VIEW)  
RELIEF VALVE

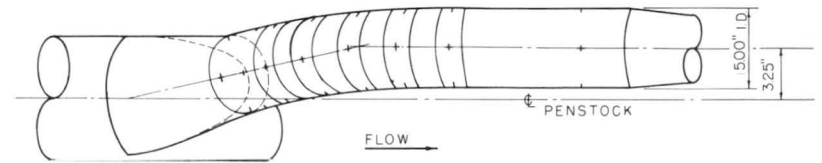

PLAN

PIEZO. NO.	ELEV. IN FT.	PIEZO. NO.	ELEV. IN FT.
461	100.37	479	100.50
462	100.22	480	100.68
463	100.07	481	100.97
464	100.22	482	100.77
465	100.50	483	100.57
466	100.35	484	100.77
467	100.37	485	101.03
468	100.35	486	100.81
469	104.58	487	100.62
470	100.43	488	100.81
471	100.31	489	101.03
472	100.43	490	100.83
473	100.72	491	100.62
474	100.58	492	100.83
475	100.40	493	101.06
476	100.58	494	100.85
477	100.88	495	100.65
478	100.68	496	100.85

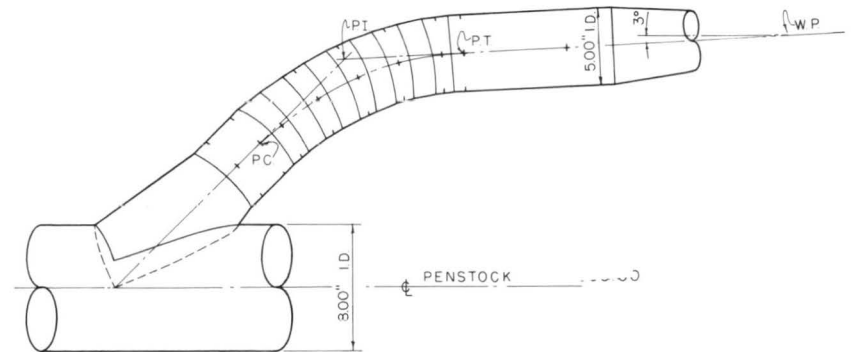

ELEVATION

FIGURE 18 VELOCITY TRAVERSE AND PIEZOMETER LOCATIONS IN BYPASS RELIEF BRANCH

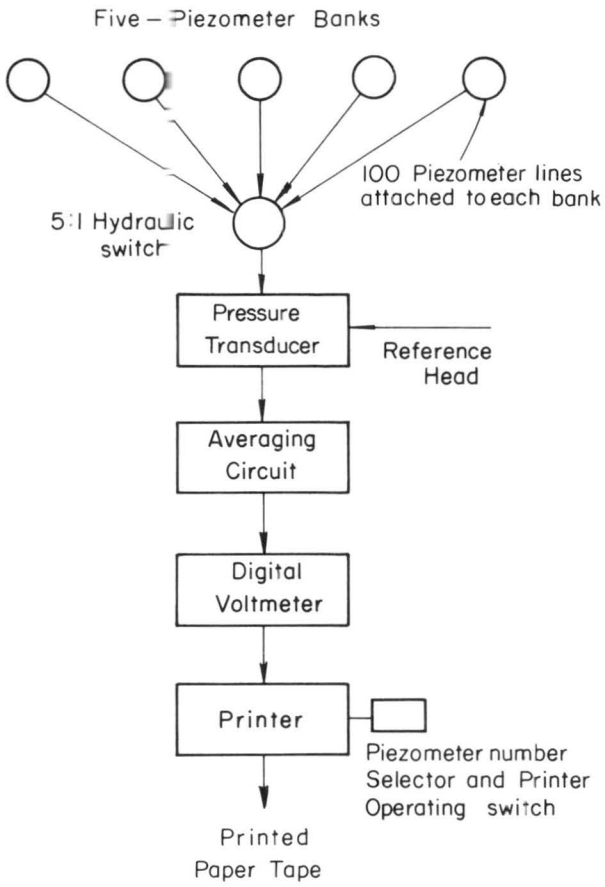

FIGURE 19 PRESSURE DATA RECORDING SYSTEM

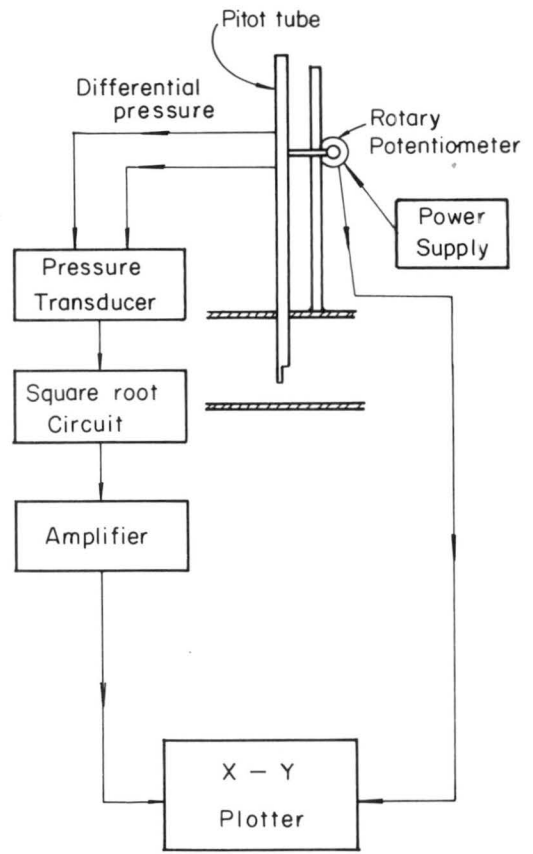

FIGURE 20 VELOCITY TRAVERSE DATA RECORDING SYSTEM

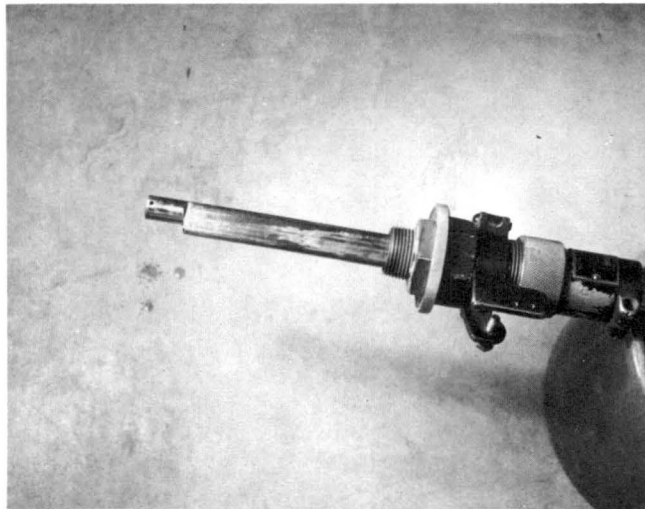

Fig. 21 Pitot tube probe

MODEL TESTS AND RESULTS

General

Model Test Program--The model test program is shown in Table 1. The program was designed to provide sufficient data to determine if the operating characteristics of the prototype would be satisfactory. Pressures, head losses, and velocity distributions were recorded for a wide range of operating conditions in the prototype structure. The effect of flow conditions at one branch on flow conditions at adjacent branches was observed. Branches 1, 2 and 3 were subjected to a test series in which 12.5, 25, 50, 75 and 100% of the approach flow to the branch was passed through that branch and the remainder passed out branch 4. Tests with the flow divided equally between the four branches and between two adjacent branches were also made.

A discharge on the order of 4 cfs was passed through the branch with the greater percentage of flow, in order to obtain measurable head losses through the branch connections. The discharge of 4 cfs was chosen since it could be provided when all branches were operating and because the magnitude

of the head losses (on the order of 0.2 to 0.3 feet) was such that accurate measurements could be obtained.

Tests were performed on the bypass relief branch connection similar to those described for the penstock branch connections. The flow approaching the bypass connection was divided with 20, 40, 60, 80 and 100% of the flow passing through the bypass valve. Tests were made with the bypass line installed in branches 1 and 4. Tests were also performed after the installation of the valve leaf and housing. Pressures and velocities downstream from the valve were measured with the valve leaf installed both vertically and horizontally.

Pressures and Velocities

Test runs were made for various discharge combinations through the branches as listed in Table 1. Pressures and velocities for each run were recorded. Pressure data for the runs are given in

TABLE I  
TEST PROGRAM FOR TARBELA PENSTOCK MANIFOLD MODEL

Test Number	<u>Percentage of Total Flow</u>			
	Branch 1	Branch 2	Branch 3	Branch 4
1A	25	25	25	25
2B	12.5	0	0	87.5
2C	25	0	0	75
2D	50	0	0	50
2E	75	0	0	25
2F	100	0	0	0
3B	0	12.5	0	87.5
3C	0	25	0	75
3D	0	50	0	50
3E	0	75	0	25
3F	0	100	0	0
4B	0	0	12.5	87.5
4C	0	0	25	75
4D	0	0	50	50
4E	0	0	75	25
4F	0	0	100	0
5F	0	0	0	100
6D	50	50	0	0
7D	0	50	50	0



Appendix A-1. Significant velocities for the runs are assembled in Appendix A-2.

To illustrate the flow conditions in a branch connection, velocity traverse data for several discharge conditions at branch 3 are shown in Figure 22. The profiles were made upstream and downstream from the reducing bend at traverse locations 13, 14, 15, 16, 19 and 20. (See Figure 12 for locations.) These particular profiles are given since the relative velocities observed in the model were greatest through the header at branch connection 3. Therefore, if any adverse conditions were to occur, they would be evident at the branch connection. Higher velocities were noted at the left<sup>3</sup> boundary of profile 14 as greater percentages of the total flow were passed through branch 3. This indicates an acceleration of the flow in this area. The pressure reduction along the left boundary associated with the acceleration of the flow was not excessive. The order of magnitude of the pressure variations observed during these test runs were similar to those noted in the following discussion.

The velocity distributions recorded at velocity traverse points 5, 6, 13 and 14 (see Figure 12 for traverse points) located on the header upstream from branches 1 and 3 are shown in Figure 23 for equal discharge through all branches. Horizontal velocity

profiles taken at points 6 and 14 show higher velocities occurred near the left boundary as mentioned previously.

Pressure reduction associated with acceleration of the flow were registered by piezometers located along the left boundary. Piezometers 30, 40, 214, 226 and 239 (see Figure 13 for piezometer locations) located along the longitudinal centerline of the left boundary of branch 1 registered pressures of 13.46, 13.00, 13.11, 13.18 and 13.75 feet of water, respectively, when all branches had equal discharges. For the same test run, similarly located piezometers 126, 136, 335, 345, and 355 in branch 3 (see Figure 15 for piezometer locations) registered pressures of 13.17, 11.86, 11.40, 11.50 and 12.56 feet of water, respectively. These pressures indicated the extent of pressure reduction that occurred in the branch connections.

The velocity profiles shown in Figures 22 and 23 indicated that a maximum velocity increase on the order of 20% to 30% above the mean velocity of the flow can be expected at the manifold branch connection. Therefore, a pressure reduction was expected in the region of the increasing velocity. The pressure variations as previously noted are not excessive but should be noted and taken into account in the structural design.

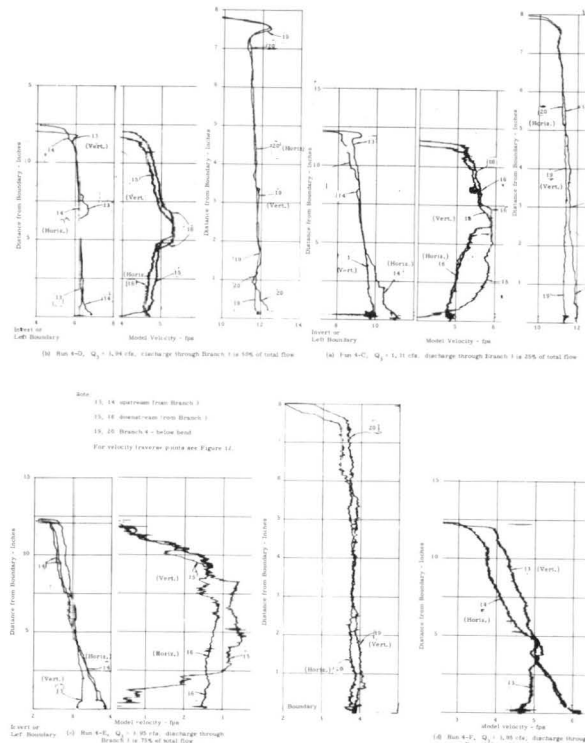

FIGURE 22 VELOCITY PROFILES AT BRANCH CONNECTION 3

<sup>3</sup> Left and right, as used in this report, refer to the observer's left and right looking downstream.

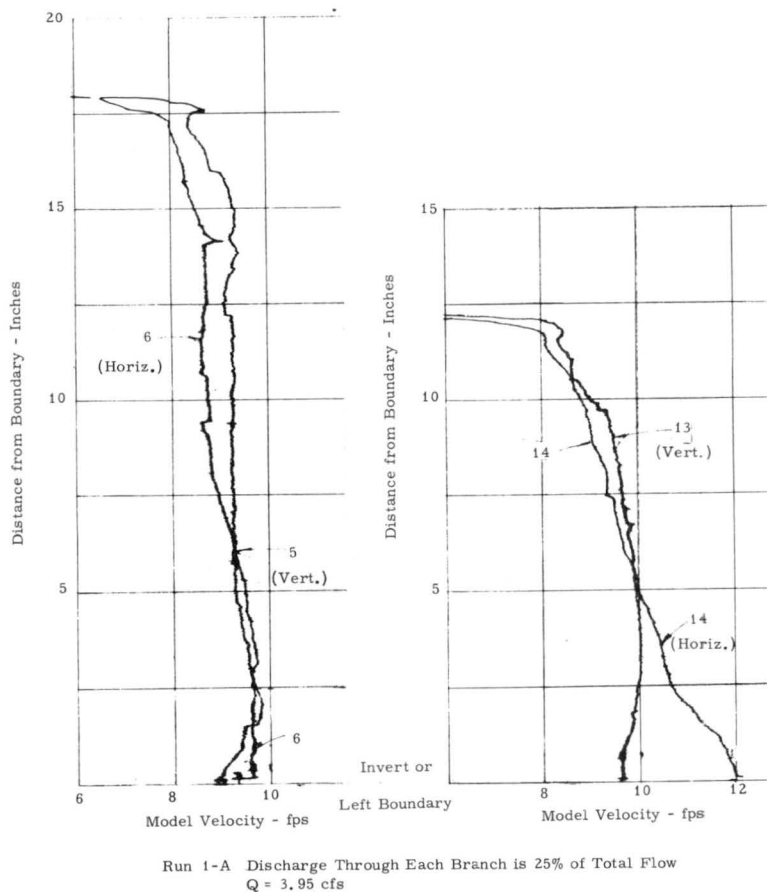

FIGURE 23 VELOCITY PROFILES AT LOCATIONS 5, 6, 13, & 14 FOR RUN 1A

Velocity traverses taken at the turbine scroll case, traverse points 21 to 32 (see Figure 12 for locations) were quite uniform across the diameter of the pipe. Velocity traverse data are given in Appendix A-2. The uniform velocity distributions indicate satisfactory flow conditions at these sections.

The discharges of several runs were calculated from the velocity profiles to verify the velocities measured. Discharges calculated were within 3% of the discharges measured at the orifices.

Piezometers 10, 22, 60, 77, 106, 122, 151, 192, 262 and 380 (see Figures 12 to 15 for locations) were monitored individually to determine the frequency and amplitude of pressure fluctuations at the boundaries. Irregular pressure fluctuations were noted with a frequency of the order of 0.5 to 1 cycle per second and an amplitude of  $\pm 0.1$  foot about the mean pressure. The fluctuations were attributed to pump surges. Higher frequency fluctuations were not detected in the model. These same piezometers were also attached to a manometer board in order to observe all of these piezometers simultaneously. The water levels in the manometer tubes fluctuated in

unison maintaining the same relative differences. This indicated a stable discharge distribution in the manifold.

#### Form Loss Coefficients

Piezometric data were recorded by printing out the registered pressures for a period of about 20 to 30 seconds in which a maximum and minimum were observed. The average of these readings was used to establish the hydraulic grade line. Hydraulic grade lines for three representative runs are shown in Figure 24.

Energy losses through the contractions between the branch connections were found in the following manner. First, the average differential piezometric head ( $\Delta h_p$ ) for the contractions was determined. This was accomplished by attaching the piezometers in the horizontal and vertical planes constituting a ring just upstream and downstream from the section to a differential pressure transducer. Connection of the piezometers in this manner gave an average pressure at each section and the transducer registered the average

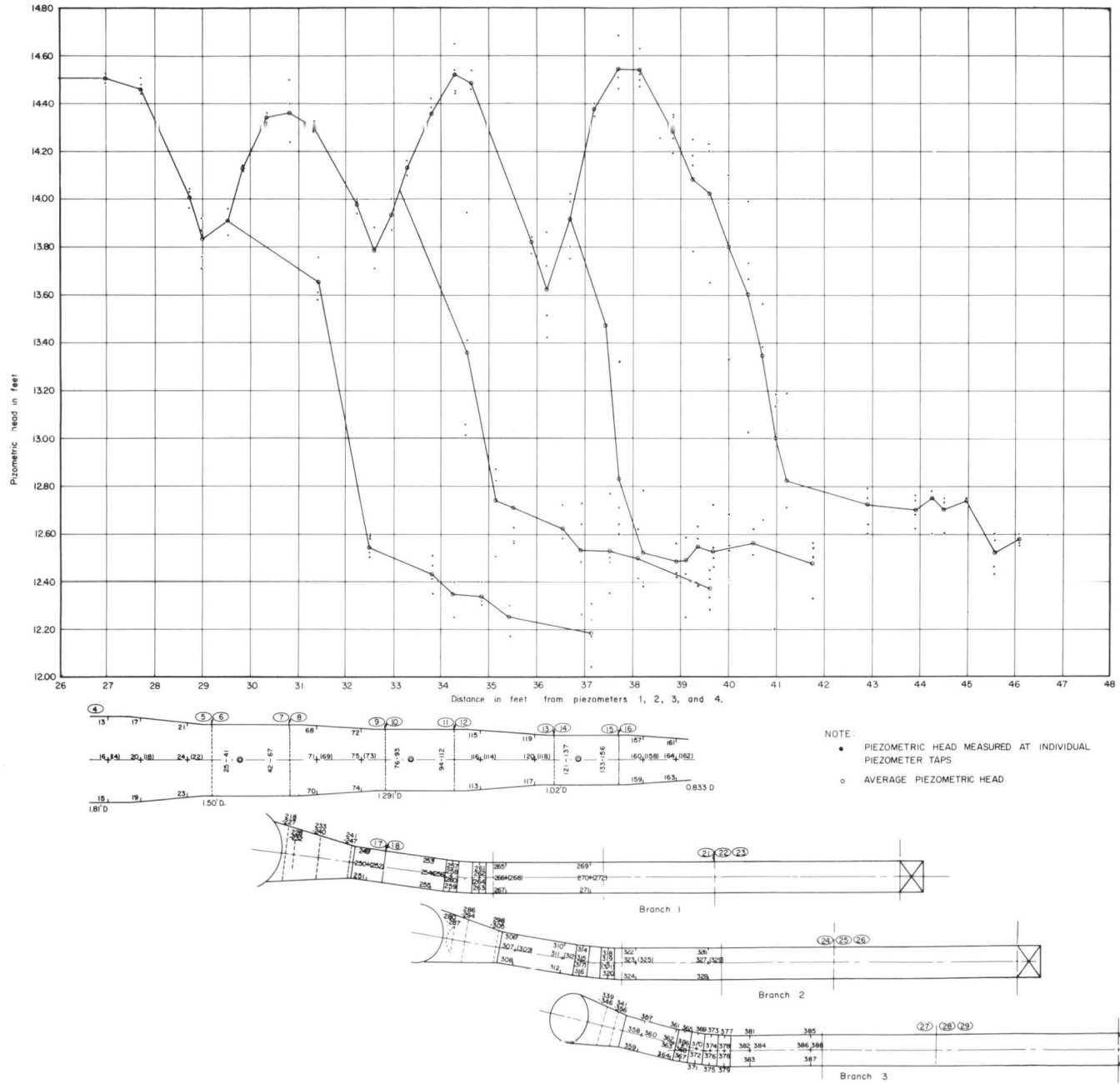
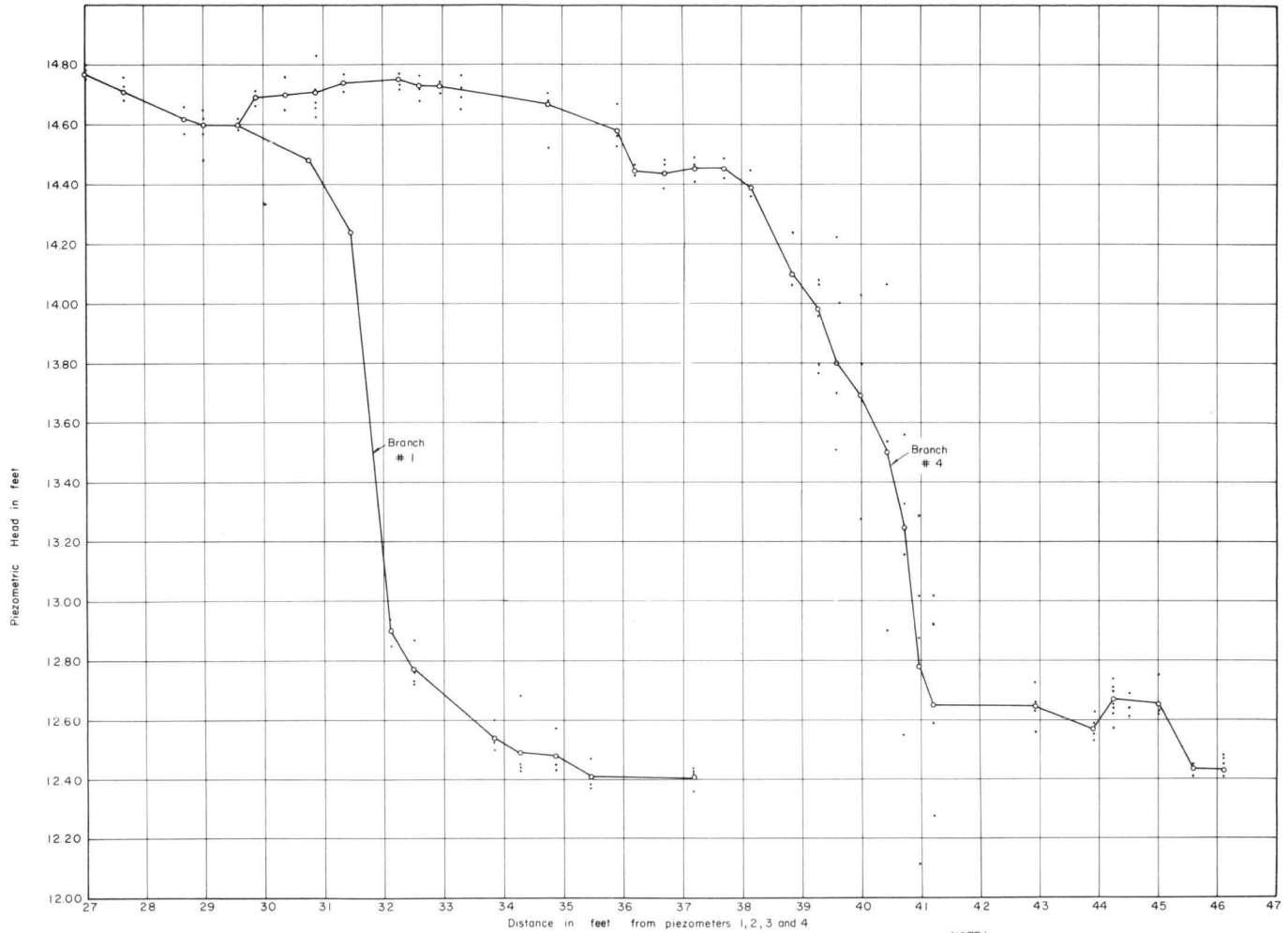

FIGURE 24 (a) HYDRAULIC GRADE LINE BRANCHES 1, 2, 3, AND 4 OPEN



NOTE:  
 ● PIEZOMETRIC HEAD MEASURED AT INDIVIDUAL PIEZOMETER TAPS.  
 ○ AVERAGE PIEZOMETRIC HEAD.

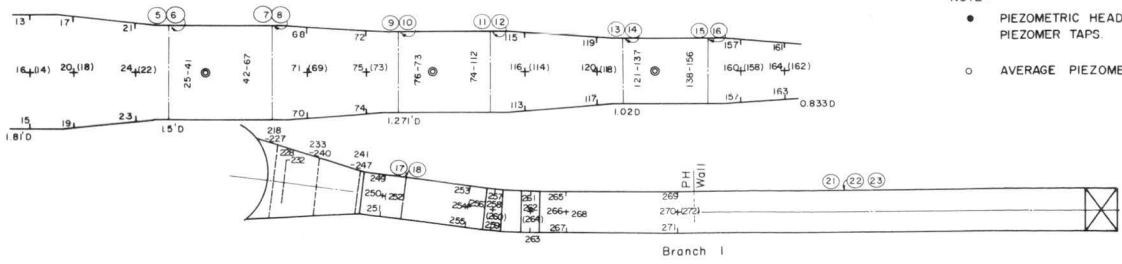

FIGURE. 24 (b) HYDRAULIC GRADE LINE BRANCHES 1 AND 4 OPEN

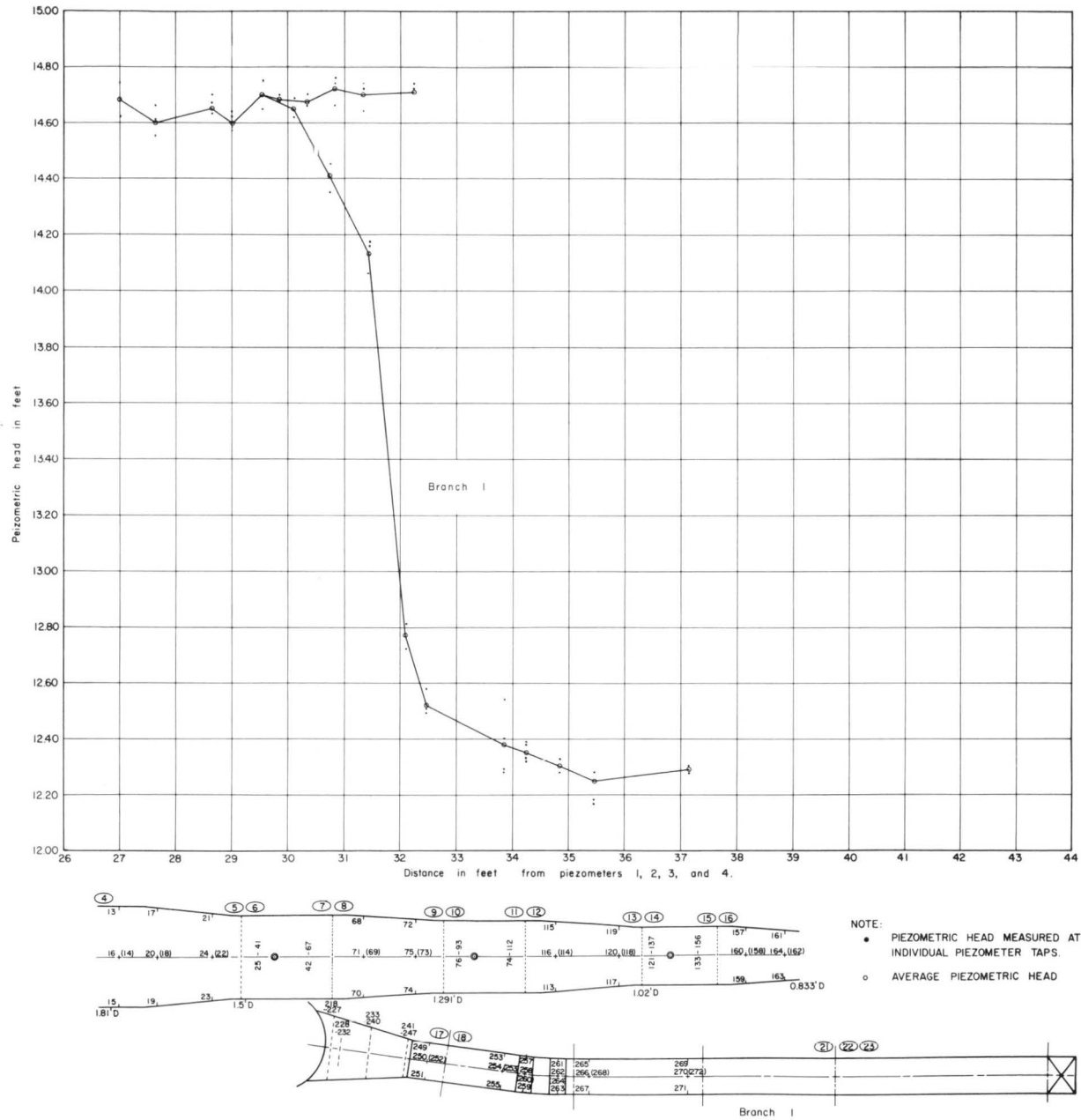

FIGURE 24 (c) HYDRAULIC GRADE LINE BRANCH I OPEN

differential head. The velocity heads upstream and downstream from a section were computed using the mean velocity and assuming a velocity distribution coefficient ( $\alpha$ ) equal to one. The differential velocity head ( $\Delta h_v$ ) and the head losses through a section were computed from the following formulas:

$$\Delta h_v = \frac{V_1^2 - V_2^2}{2g}$$

$$H_L = \Delta h_p + \Delta h_v$$

where:

- $H_L$  = head loss between upstream and downstream sections of the appropriate reach in feet.
- $\Delta h_p$  = differential piezometric head between upstream and downstream sections in feet.
- $\Delta h_v$  = differential velocity head between upstream and downstream sections in feet.
- $V_1$  = velocity at the upstream section in ft/sec.
- $V_2$  = velocity at the downstream section in ft/sec.

The order of magnitude of the head losses calculated for individual contractions in this manner was 0.02 feet or less. The accuracy of the equipment and readings of differential piezometric head can only be considered as  $\pm 0.01$  feet. Therefore, the inaccuracy of the head loss measurements due to the equipment was sufficient that calculation of the contraction loss coefficients for the individual sections was not justified.

In designing or calculating the head loss for these sections of the prototype, reference should be made to reports such as the Bureau of Reclamation's Boulder Canyon Project - Final Report, Part IV, Chapter II (8) and Engineering Monograph No. 7, pages 33 to 47 (2). The information given in these reports is based upon measurements of friction factors and head losses in prototype structures approaching the size of the Tarbela penstock.

#### Branch Loss Coefficients

Bifurcations and trifurcations have been studied by many researchers (1), (3), (4), (5), (6), (7). The loss coefficients for the branch connections were found in the following manner. The hydraulic grade line was established first. The length of conduit downstream was sufficient to insure that full

pressure recovery was accomplished. The energy lines are then calculated and projected upstream or downstream, as the case may be, to the intersection of branch and header. The difference in energy grade lines at the intersection is the loss chargeable to the branch connection.

The pressure recovery downstream from a branch connection, as observed previously, was also apparent in the model. Noticeably, branch 3, which has a short transition from header to branch inlet and a comparatively short conduit, has an increase in head on the order of 0.05 foot of water, from the piezometer ring composed of numbers 357, 358, 359 and 360 to a ring with numbers 381, 382, 383 and 384 as seen in Figure 24 (a), as discharges of about 4 cfs were diverted into the branch.

Two methods were used to determine the loss coefficients for the branches. The following discussion describes the two methods, referred to as methods A and B.

#### Method A

The junction loss coefficients were calculated from data collected in a similar manner to that collected for the form loss coefficients. For example, on branch number 1, differential piezometric heads were recorded between a ring of piezometers formed by piezometer numbers 25, 26, 27 and 31, and a ring of piezometer numbers 249, 250, 251 and 252, located just downstream from the branch connection. For the losses in the header at branch 1, the differential piezometric head was measured between a ring of piezometer numbers 25, 26, 27 and 31, and a ring of numbers 59, 60, 61 and 65. Similarly located piezometer rings were used to determine the differential piezometric heads for branches 2 and 3. Differential velocity heads were calculated using the mean velocity at the piezometer ring and a velocity distribution coefficient equal to one. The junction loss coefficients in the branch or header were calculated using:

$$H_{LB} = K_{Bi} \frac{V_d^2}{2g} \quad \text{and} \quad H_{LH} = K_{Hi} \frac{V_d^2}{2g}$$

where:

- $H_{LB}$  = head loss between section at header and section at branch.
- $H_{LH}$  = head loss between header sections.
- $V_d$  = velocity at downstream section in feet.
- $K_{Bi}$  = branch loss coefficient.

- $K_{Hi}$  = header loss coefficient.  
 $i$  = 1, 2, 3.  
 (1, 2 and 3 refers to branches 1, 2 and 3, respectively.)  
 $g$  = gravitational acceleration = 32.2 ft/sec<sup>2</sup>.

Head loss due to friction is included in the value of  $H_L$  used to calculate the branch and header loss coefficients. Junction loss coefficients for the branches computed for different test runs are given in Table II. This method considered the head loss due to friction as being negligible.

#### Method B

The head loss due to friction is taken into account in the calculation of the loss coefficients by method B. The data reduction for each test was accomplished in the following manner. A point on the energy grade line was established by adding the velocity head calculated using a velocity distribution coefficient equal to unity to the average piezometric head found for each ring of taps on the model. To establish the energy grade line in the branch, a line

with a slope equal to the calculated friction slope in the branch was fitted to experimental points. In fitting the calculated friction slope, greatest weight was given to points near the downstream end of the branch where full pressure recovery occurred.

To establish the energy grade line in the header, the total head loss in a section between junction points was approximated by the friction loss in a pipe the length of the section. The small form losses in the contraction and upstream junction losses were taken into account by using the smallest pipe diameter in the calculation of the pipe friction losses. The energy line through the header was determined by fitting a line with slope equivalent to the assumed losses to the experimental points.

The energy lines in the branch and header were projected upstream and downstream, respectively, to the junction. The losses attributed to the junction were found graphically. The junction loss coefficients were then determined from the equation previously defined:

$$H_{LB} = K_{Bi} \frac{V^2}{2g}$$

TABLE II  
BRANCH HEAD LOSS COEFFICIENT

Test Run	Branch No. 1 - $K_{B1}$			Branch No. 2 - $K_{B2}$			Branch No. 3 - $K_{B3}$		
	QB/QA x 100	Method A	Method B	QB/QA x 100	Method A	Method B	QB/QA x 100	Method A	Method B
1-A	25	0.238	0.280	33.3	0.214	0.17	50	0.297	0.146
2-B	12.2	1.091	0.770				0		
2-C	25	0.208	0.280				0		
2-D	50	0.086	0.080				0		
2-E	75	0.055	0.067				0		
2-F	100	0.049	0.060				0		
3-B				12.5	3.047	1.629			
3-C	0			25	0.493	1.040	0		
3-D	0			50	0.063	0.068	0		
3-E	0			75	0.018	0.020	0		
3-F	0			100	0.046	0.051	0		
4-B	0			0			12.5	11.091	9.200
4-C	0			0			25	2.205	1.510
4-D	0			0			50	0.320	0.171
4-E	0			0			75	0.203	0.091
4-F	0			0			100	0.162	0.048
5-E	0								
6-D	50	0.086	0.060	100	0.0124	-0.005	0		
7-D	0			50	0.120	0.086	100	0.189	0.045

The branch loss coefficients determined by method B are also given in Table II.

The branch loss coefficients found by methods A and B are plotted in Figure 25 for comparison. The coefficients found for branch connections 1 and 2 show close agreement and indicate friction losses are negligible through the branches. The coefficients determined for branch 3 by method A give greater values and indicate larger losses. These higher losses are discounted because full pressure recovery was accomplished only near the end of branch 3. The pressure measurements used in evaluating the coefficients by method A were made in an area of apparent low pressures associated with acceleration of the flow. Therefore, greater weight was given to the coefficients determined by method B for branch 3.

The three branch connections are quite close to being geometrically similar. The exception is in the angle of intersection of the branch and header. The angles for branches 1, 2 and 3 are  $70^{\circ} 37' 06''$ ,  $70^{\circ} 19' 01''$  and  $70^{\circ} 12' 19''$ , respectively. This angular difference was considered to be insignificant for purposes of this discussion. A comparison of all the form loss coefficients found for the branches is given in Figure 26. The three branch connections demonstrate that the form losses are dependent only upon the geometry and the ratio of discharge through the branch to the total discharge approaching the branch. Therefore, a suggested curve to be used for determining the form losses for any geometrically similar branch connection is also given in Figure 26.

Junction loss coefficients for the header were calculated by method A. Coefficients determined at branches 1, 2 and 3 are shown in Figure 27, along with a suggested curve to be used in determining losses in the header section for various operating conditions. As noted previously, in method B the junction losses in the header is taken into account by the manner in which the friction loss between junctions is calculated.

#### Bypass Relief Valve

The bypass relief valve was installed and tested on branches 1 and 4. Flow conditions through the bypass relief valve were satisfactory at all discharges when the valve was installed on both branches 1 and 4.

Pressure distributions similar to those described for the branch connections were found in the bypass relief branch connections. Pressures were satisfactorily positive at all piezometer locations. Pressure data are given in Appendix B-1.

Velocity profiles indicated that no unusual conditions exist. Velocity traverses data are given in Appendix B-2.

Junction loss coefficients were computed similarly to those described for branch connections 1, 2 and 3 by method A. The coefficients are shown in Figure 28 for the bypass relief branch connection.

Butterfly Valve--Upon completion of the initial tests of the bypass relief valve, a valve leaf and housing to simulate an open butterfly valve were installed upstream from the branch 4 bypass connection at the location shown in Figure 12. Details of the butterfly valve leaf and housing are given in Figure 10. Test runs were made with the valve leaf installed vertically and horizontally. Pressure data and velocity traverses were recorded downstream from the butterfly valve. No pressures or velocities were measured within the valve housing itself. There was no attempt made in this study to determine if the valve operated satisfactorily during closure.

The velocity traverses made at locations 19A and 20A (see Figure 11 for locations) gave the only indications of any effect due to installation of the open butterfly valve. When the valve was installed horizontally, the vertical velocity traverse taken at location 19A indicated a small, almost sinusoidal, increase and decrease of the mean velocity near the center of the traverse, as shown in Figure 29. With the butterfly valve placed vertically, the horizontal velocity traverse indicated a similar velocity distribution in the same relative area. The disturbance downstream of the butterfly valve is not severe enough to be cause for concern. Velocity traverse data are given in Appendix C-2.

Pressures at the bypass relief branch connection were satisfactorily positive with the butterfly valve leaf installed either vertically or horizontally. Pressures were similar to those registered without the valve installed. Pressure data for the test runs made with the butterfly valve installed are given in Appendix C-1.



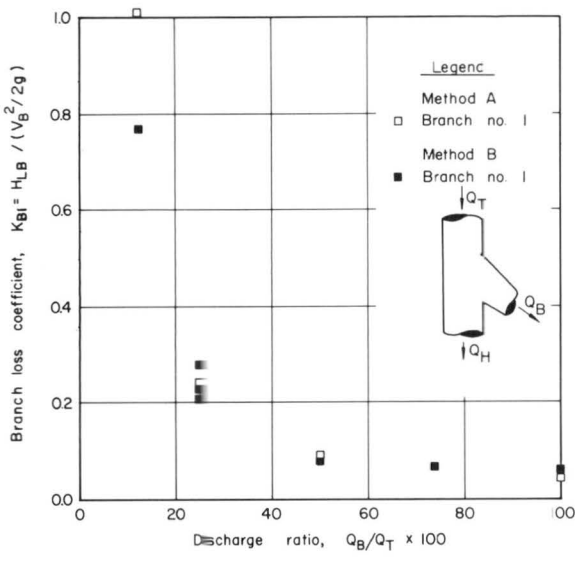

FIGURE 25 (A) BRANCH LOSS COEFFICIENTS FOR BRANCH 1.

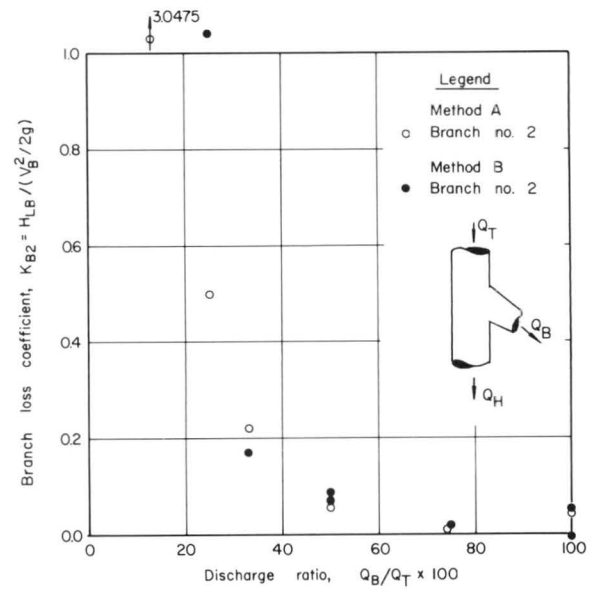

FIGURE 25 (B) BRANCH LOSS COEFFICIENTS FOR BRANCH 2.

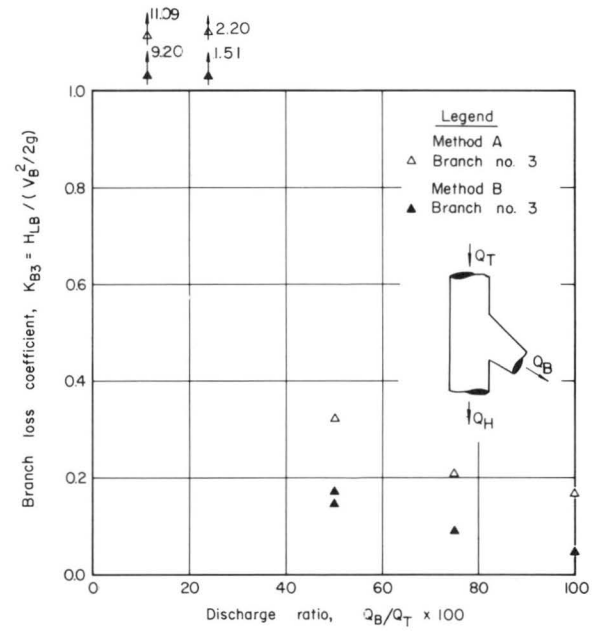

FIGURE 25 (C) BRANCH LOSS COEFFICIENTS FOR BRANCH 3.

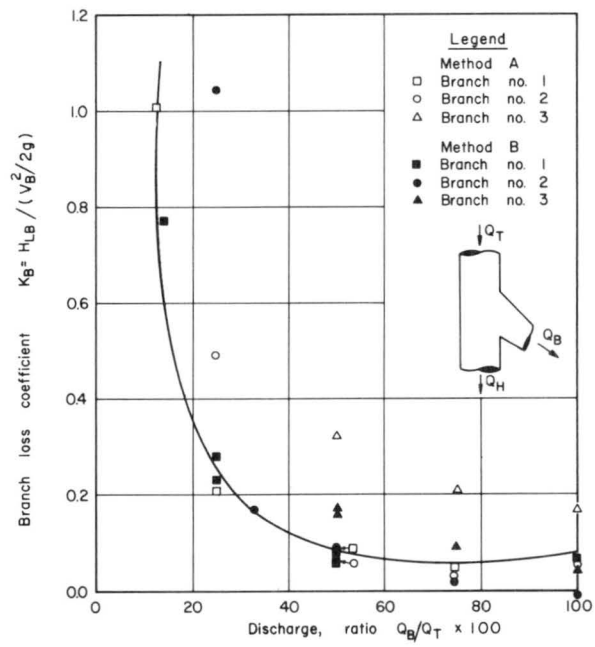

FIGURE 26 BRANCH LOSS COEFFICIENTS.

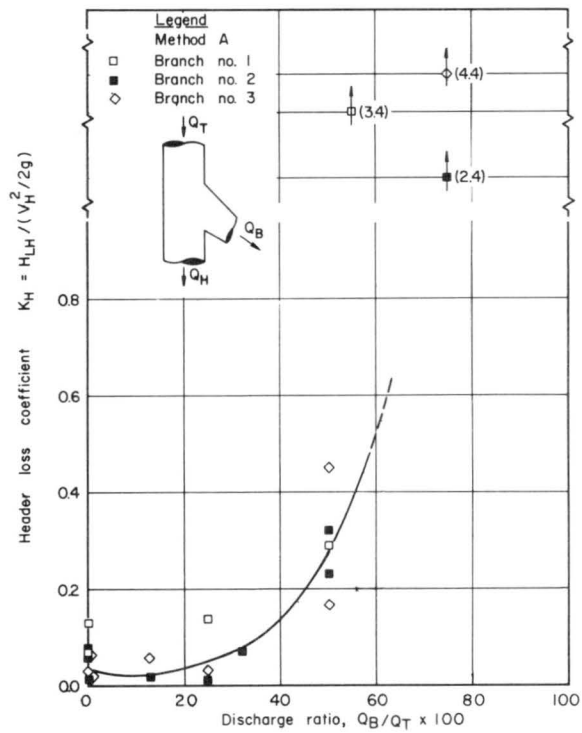

FIGURE 27 HEADER LOSS COEFFICIENTS.

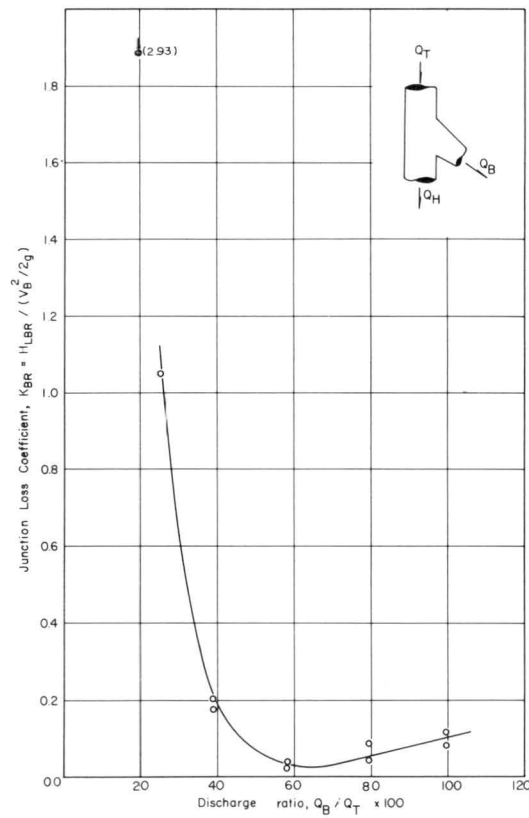

FIGURE 28 JUNCTION LOSS COEFFICIENT FOR THE BYPASS RELIEF BRANCH CONNECTION

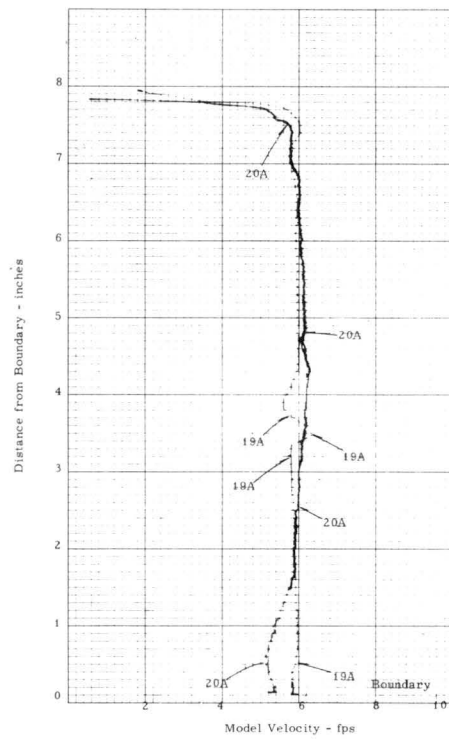

FIGURE 29 VELOCITY PROFILE DOWNSTREAM FROM BUTTERFLY VALVE.

## CONCLUSIONS AND RECOMMENDATIONS

The principal conclusion to be drawn from this model study is that the basic design of the manifold is satisfactory. Operation was satisfactory for all discharges through the branches. No vibration was evident in the model.

Pressure measurements recorded at the many piezometric taps indicated positive pressures at all locations within the manifold. A pressure reduction was observed along the left boundary of the junction of the header and a branch. This variation was not considered excessive but should be considered in the structural design. No pressure fluctuations other than those attributed to pump surge were detected in the model.

Velocity traverses made in conjunction with the pressure data indicated local acceleration of the flow near the left boundary of the header in the area where the pressure reduction was observed. The increase in velocity was on the order of 20 percent. This increase or local acceleration of velocity and the associated pressure reduction were not significant. Traverses made at other locations indicated no usual velocity distributions.

Velocity traverses taken at the turbine scroll case inlet showed uniform velocity profiles exist at these sections. The profiles give evidence of satisfactory flow conditions and satisfactory hydraulic operation.

Analysis of the pressure and velocity data showed that the branch connections were essentially independent of each other. That is, no effect was transmitted either upstream or downstream from a junction with either an open or closed branch.

The branch loss coefficients determined by methods A and B are in close agreement. Method A used the sum of friction and form losses in determining the coefficients. Method B established the losses through the branch connection by measuring the total losses and subtracting the computed friction losses in the model. Comparison of the two methods indicated that the friction losses were negligible in the model. A curve to be used for determining the form loss coefficients for the three branch connections was established. The curve is given in Figure 26.

Friction constitutes the principle loss at the contractions between branch connections. The losses at these sections were too small for accurate measurements. To determine the prototype losses at these sections, a look at the data collected by the Bureau of Reclamation (2) on conduits approaching the size of the Tarbela penstock will be helpful.

The bypass relief valve performed satisfactorily for all operational conditions and at all discharges. Junction loss coefficients including friction were calculated for the bypass relief branch connection. These coefficients are shown in Figure 28.

Installation of a butterfly valve upstream from the bypass relief connection causes no detrimental effects to the flow conditions. Pressure and velocity traverse data recorded downstream from the valve reflect no significant effect with the valve leaf installed either vertically or horizontally.

## REFERENCES

1. Bonnington S. T., Guide to the calculation of head losses in piping systems. The British Hydromechanics Research Association, Publication No. TN-445, January 1953.
2. Friction factors for large conduits flowing full. Engineering Monograph, No. 7, U. S. Department of the Interior, Bureau of Reclamation, September 1965.
3. Glaswell, John S. and E. Roy Tinney, Hydraulic studies of large penstock trifurcation. Journal of Power Division, Proceedings of the American Society of Civil Engineers, May 1955.
4. Grass, G. and E. Luth, Resistance to flow in branch pipes. Translation No. 1899, October 1960, by the Iron and Steel Institute, London, S. W., from Allgemeine Warmetechnik, 1958, 8, September, pp. 185-189.
5. Karaki, S. and J. F. Ruff, Diversion, power and irrigation tunnels, hydraulic model studies. Civil Engineering Department Report No. CER65-3SK-JFR6, Colorado State University, Fort Collins, Colorado, January 1965.
6. Kinne, E., Hydraulic losses in branching pipes. Bulletin 4, Munich Hydraulic Institute, 1934. Translation No. 323, U. S. Department of the Interior, Bureau of Reclamation.
7. Marchetti, M. and G. Nosida, Loss of head in symmetrical bifurcations of constant diameter in a pressure conduit, (Perdite di carico nelle biforcazioni simmetriche a diametro costante, delle condotte forzate). L'Encrigia Electrica No. 4, pp. 289-301, 1960. Translated from the Italian under contract by the U. S. Joint Publications Research Service, New York.
8. Penstocks and outlet pipes, Boulder Canyon Project, Final Reports, Part IV-Design and Construction, Bulletin 5, U. S. Department of the Interior, Bureau of Reclamation, 1949.
9. Hydraulic model studies of the Fontenelle Dam outlet works, Seedskafee Project, Wyoming. Hydraulic Lab. Report No. Hyd. 487, U. S. Department of the Interior, Bureau of Reclamation, Denver, Colorado, August 20, 1962.
10. Hydraulic model study of the Palisades Dam outlet works and spillway, Palisades Project-Idaho. Hydraulic Lab. Report No. Hyd. 350, U. S. Department of the Interior, Bureau of Reclamation, June 22, 1956.
11. Model Studies of penstocks and outlet works, Boulder Canyon Project, Final Reports, Part VI-Hydraulic Investigations, Bulletin 2, U. S. Department of the Interior, Bureau of Reclamation, 1938.

APPENDIX A-1

PRESSURE HEADS ALONG MANIFOLD WALLS

PRESSURE HEADS ALONG MANIFOLD WALLS

Pressure Heads in Feet of Water

Run #	1-A	2-B	2-C	2-D	2-E	2-F	3-B	3-C	3-D	3-E	3-F	4-B	4-C	4-D	4-E	4-F	5-F	6-D	7-D
Q	3.95	0.55	1.32	3.95	3.95	3.95	0	0	0	0	0	0	0	0	0	0	0	3.95	0
Br. 1	cfs	cfs	cfs	cfs	cfs	cfs													
Q	3.95	0	0	0	0	0	0.56	1.32	4.02	3.97	3.92	0	0	0	0	0	0	3.95	3.94
Br. 2	cfs						cfs	cfs	cfs	cfs	cfs							cfs	cfs
Q	3.95	0	0	0	0	0	0	0	0	0	0	0.56	1.31	3.94	3.94	3.95	0	0	3.94
Br. 3	cfs											cfs	cfs	cfs	cfs	cfs			cfs
Q	3.96	3.95	3.95	3.95	1.34	0	3.92	3.95	3.95	1.34	0	3.90	3.95	3.94	1.34	0	5.45	0	0
Br. 4	cfs	cfs	cfs	cfs	cfs		cfs	cfs	cfs	cfs		cfs	cfs	cfs	cfs		cfs		
Temp.	70°F	70°F	68°F	70°F	71°F	70°F	70°F	67°F	70°F	73°F	74°F	70°F	70°F	70°F	73°F	73°F	70°F	70°F	70°F
Piezo. No.	Pres. Head	Pres. Head	Pres. Head	Pres. Head	Pres. Head	Pres. Head	Pres. Head	Pres. Head	Pres. Head	Pres. Head	Pres. Head	Pres. Head	Pres. Head	Pres. Head	Pres. Head	Pres. Head	Pres. Head	Pres. Head	Pres. Head
1	13.41	13.26	13.38	13.44		13.41	13.23	13.37	13.29			13.21		13.28				13.48	13.35
2	14.30	14.31	14.29	14.47	14.18	14.36	14.23	14.28	14.15	14.29	14.11	14.17	14.39	14.36	14.22	14.25	15.13	14.33	14.31
3	15.16	15.21	15.21	15.30	15.02	15.21	15.19	15.25	15.06	15.23	15.06	15.08	15.28	15.28	15.16	15.18	16.02	15.19	15.29
4	14.26	14.29	14.30	14.51	14.10	14.27	14.18	14.36	14.12	14.29	14.13	14.15	14.35	14.33	14.25	14.23	15.12	14.30	14.40
5	13.34	13.44	13.20	13.55	13.15	13.46	13.26		13.23	13.39	13.18	13.27	13.43	13.44	13.26	13.34	14.18	13.36	13.45
6	14.29	14.29	14.29	14.35	14.08	14.35	14.17	14.36	14.19	14.27	14.13	14.15	14.32	14.38	14.22	14.27	15.15	14.31	14.36
7	15.16	15.24	15.18	15.29	15.02	15.22	15.18	15.28	15.04	15.15	15.04	15.11	15.24	15.24	15.08	15.19	16.02	15.19	15.30
8	14.25	14.30	14.26	14.39	14.07	14.34	14.27	14.36	14.15	14.27	14.17	14.21	14.35	14.31	14.26	15.13	14.33	14.37	
9	13.38	13.39	13.19	13.48		13.40	13.36		13.28	13.30	13.25	13.28	13.38	13.37	13.35	13.32	14.28	13.40	13.46
10	14.23	14.24	14.30	14.44	14.07	14.30	14.25	14.32	14.17	14.22	14.14	14.18	14.32	14.38	14.23	14.26	15.08	14.29	14.34
11	15.20	15.20	15.19	15.40	15.03	15.27	15.14	15.27	15.04	15.13	15.04	15.15	15.31	15.32	15.14	15.15	16.06	15.22	15.25
12	14.25	14.25	14.30	14.38	14.07	14.33	14.32	14.39	14.16	14.20	14.15	14.19	14.36	14.26	14.22	14.23	15.10	14.32	
13	13.37	13.42	13.42	13.62	13.25	13.56	13.37	13.45	13.26	13.33	13.24	13.32	13.46	13.46	13.33	13.31	14.21	13.38	13.45
14	14.26	14.36	14.33	14.52	14.16	14.37	14.28	14.39	14.14	14.24	14.15	14.26	14.37	14.34	14.26	14.38	15.17	14.32	14.34
15	15.16	15.25	15.28	15.45	15.03	15.33	15.13	15.25	15.06	15.14	15.04	15.22	15.30	15.24	13.14	15.18	16.02	15.20	15.26
16	14.24	14.26	14.35	14.50	14.17	14.49	14.22	14.43	14.12	14.28	14.12	14.22	14.33	14.41	14.25	14.22	15.17	14.29	14.30
17	13.32	13.37	13.45	13.45	13.17	13.46	13.30	13.57	13.30	13.38	13.12	13.31	13.34	13.45	13.41	13.35	14.33	13.43	13.41
18	14.26	14.30	14.42	14.48	14.05	14.36	14.27	14.34	14.16	14.22	14.19	14.16	14.34	14.37	14.25	14.21	15.23	14.32	14.28
19	15.07	15.21	15.11	15.33	14.89	15.18	15.11	15.27	14.97	15.14	14.98	15.06	15.23	15.27	15.09	15.08	16.03	15.19	15.13
20	14.23	14.29	14.38	14.51	14.06	14.41	14.24	14.39	14.15	14.23	14.10	14.14	14.33	14.43	14.23	14.18	15.14	14.28	14.28
21	12.98	13.45	13.47	13.63	13.27	13.64	13.41	13.60	13.30	13.40	13.33	13.36	13.58	13.59	13.33	13.44	14.41	13.46	13.46
22	13.78	14.22	14.29	14.37	14.11	14.40	14.24	14.34	14.08	14.22	14.08	14.15	14.36	14.36	14.18	14.17	15.09	14.18	14.24
23	14.57	15.02	15.11	15.19	14.84	15.23	15.06	15.13	14.87	14.95	14.87	14.96	15.11	15.11	15.01	15.01	15.87	14.91	14.99
24	13.71	14.24	14.34	14.32	13.97	14.38	14.23	14.37	14.06	14.21	14.07	14.20	14.31	14.36	14.17	14.18	15.12	14.15	14.28
25	12.76	13.51	13.54	13.62	13.28	13.58	13.47	13.58	13.26	13.43	13.34	13.40	13.62	13.44	13.31	13.48	14.35	13.36	13.40
26	13.67	14.25	14.27	14.32	14.06	14.39	14.20	14.35	13.99	14.19	14.08	14.18	14.28	14.21	14.14	14.20	15.07	14.09	14.18
27	14.37	14.97	15.04	15.12	14.73	15.12	14.91	15.06	14.78	14.95	14.83	14.97	15.04	14.96	14.89	14.92	15.05	14.85	14.91
28	13.94	14.64	14.77	14.81	14.47	14.83	14.72	14.46	14.67	14.59	14.66	14.72	14.70	14.70	14.70	15.57	14.56	14.63	
29	13.41	14.29	14.36	14.24	14.06	14.46	14.30	13.97	14.26	14.19	14.20	14.41	14.27	14.27	14.16	14.27	15.16	14.08	14.18
30	13.46	14.26	14.28	14.23	13.89	14.32	14.14	14.29	14.03	14.13	14.10	14.06	14.29	14.28	14.16	14.27	15.10	14.05	14.19
31	13.10	13.94	13.93	13.85	13.64	14.01	13.97	13.74	13.85	13.74	13.85	13.84	13.99	13.99	13.99	14.77	13.72	13.87	
32	13.90	14.69	14.77	14.70	14.39	14.78	14.70	14.59	14.70	14.70	14.70	14.69	14.69	14.76	14.76	14.76	14.56	14.68	
33	13.31	14.24	14.32	14.24	13.88	14.41	14.25	14.01	14.24	14.24	14.21	14.21	14.33	14.33	14.33	14.33	14.05	14.28	
34	12.92	13.86	13.93	13.81	13.58	13.98	13.83	13.67	13.87	13.67	13.87	13.77	13.92	13.92	13.92	13.92	13.63	13.85	
35	12.85	13.52	13.57	13.62	13.28	13.70	13.47	13.53	13.26	13.39	13.28	13.40	13.53	13.45	13.39	13.46	14.34	13.53	13.38
36	13.68	14.23	14.29	14.34	14.11	14.50	14.24	14.33	13.97	14.13	14.07	14.06	14.26	14.22	14.18	14.20	15.12	14.17	14.18
37	14.46	14.97	15.01	15.08	14.78	15.15	14.92	15.02	14.70	14.95	14.85	14.86	15.07	14.92	14.89	14.96	15.78	14.89	14.88
38	13.61	14.72	14.70	14.21	14.14	14.58	14.62	14.80	14.45	14.45	14.45	14.52	14.52	14.63	14.63	14.63	14.32	14.59	
39	13.02	14.36	14.34	13.97	13.72	14.18	14.32	14.07	14.07	14.07	14.07	14.18	14.18	14.28	14.28	14.28	13.88	14.21	
40	13.00	14.25	14.27	13.80	13.58	14.11	14.14	13.99	13.99	13.99	13.99	14.21	14.21	14.21	14.21	14.21	13.79	14.14	
41	12.72	13.91	13.91	13.61	13.37	13.79	13.84	13.69	13.22	13.44	13.34	13.76	13.49	13.82	13.43	13.41	13.47	14.31	13.63
42	13.14	13.40	13.56	13.71	13.28	13.68	13.45	13.22	13.44	13.34	13.36	13.56	13.49	13.43	13.41	13.47	14.31	13.55	13.40
43	13.87	14.27	14.24	14.41	14.06	14.42	14.21	14.30	13.97	14.16	14.13	14.13	14.28	14.23	14.13	14.18	15.01	14.31	14.17
44	14.63	15.04	15.04	15.19	14.87	15.20	14.86	15.08	14.76	14.89	14.85	14.86	15.02	15.01	14.87	14.91	15.81	15.01	14.92
45	13.35	13.50	13.51	13.65	13.37	13.67	13.40	13.46	13.27	13.46	13.35	13.38	13.53	13.43	13.40	13.44	14.31	13.65	13.39
46	14.07	14.17	14.31	14.51	14.10	14.45	14.17	14.35	14.04	14.22	14.09	14.09	14.18	14.21	14.14	14.17	15.06	14.31	14.21
47	14.86	15.01	15.03	15.20	14.81	15.16	14.93	15.00	14.72	14.94	14.84	14.84	14.97	14.90	14.93	14.97	15.61	15.11	14.88
48	14.73	14.83	14.85	15.09	14.58	14.77	14.65	14.40	14.40	14.40	14.40	14.61	14.61	14.64	14.64	14.64	14.89	14.63	
49	14.05	13.97	14.05	14.34	13.76	14.04	13.86	13.63	13.63	13.63	13.63	13.75	13.75	13.85	13.85	13.85	14.14	13.86	
50	14.68	14.69	14.80	15.04	14.59	14.86	14.65	14.46	14.46	14.46	14.46	14.61	14.61	14.64	14.64	14.64	14.86	14.64	
51	14.70	14.59	14.64	14.94	14.52	14.75	14.46	14.25	14.25	14.25	14.25	14.47	14.47	14.49	14.49	14.49	14.77	14.44	
52	14.52	14.37	14.49	14.67	14.26	14.50	14.24	14.09	14.09	14.09	14.09	14.20	14.20	14.27	14.27	14.27	14.56	14.21	
53	14.37	14.26	14.31	14.54	14.10	14.39	14.16	14.00	14.00	14.00	14.00	14.11	14.11	14.16					

Run #	1-A	2-B	2-C	2-D	2-E	2-F	3-B	3-C	3-D	3-E	3-F	4-B	4-C	4-D	4-E	4-F	5-F	6-D	7-D
Piezo. No.	Pres. Head	Pres. Head	Pres. Head	Pres. Head	Pres. Head	Pres. Head	Pres. Head	Pres. Head	Pres. Head	Pres. Head	Pres. Head	Pres. Head	Pres. Head	Pres. Head	Pres. Head	Pres. Head	Pres. Head	Pres. Head	Pres. Head
61	14.90	14.99	15.01	15.13	14.90	15.26	14.92	15.00	14.77	14.94	14.85	14.80	14.98	14.98	14.88	14.96	15.83	15.09	14.80
62	14.69	14.74	14.77	14.97	14.60	14.91	14.62		14.41			14.64	14.98				15.52	14.84	14.50
63	14.51	14.59	13.62	14.90	14.90	14.78	14.48		14.25			14.48					15.37	14.68	14.36
64	14.26	14.31	14.39	14.71	14.22	14.56	14.19		14.11			14.19			14.21		15.14	14.56	14.18
65	14.25	14.21	14.39	14.52	14.13	14.44	14.16	14.32	13.98	14.18	14.08	14.05	14.24	14.20		14.19	15.05	14.37	14.08
66	13.99	14.12	14.25	14.45	13.95	14.34	14.05		13.78			13.94					14.99	14.31	13.92
67	13.87	13.85	14.04	14.23	13.85	14.16	13.89		13.67			13.75					14.71	14.17	13.75
68	13.31	13.49	13.59	13.73	13.34	13.74	13.37	13.56	13.23	13.48	13.37	13.39	13.51	13.45	13.37	13.37	14.33	13.60	13.32
69	14.04	14.16	14.35	14.49	13.99	14.39	14.14	14.28	14.01	14.15	14.09	14.14	14.25	14.15	13.37	14.15	15.05	14.36	14.04
70	14.81	14.86	15.05	15.25	14.82	15.22	14.90	15.01	14.74	14.83	14.85	14.81	14.96	14.90	14.87	14.92	15.76	15.07	14.82
71	14.06	14.13	14.32	14.52	14.12	14.45	14.18	14.28	13.99	14.15	14.07	14.10	14.22	14.12	14.11	14.17	15.05	14.26	14.03
72	13.08	13.55	13.65	13.86	13.39	13.79	13.7	13.55	14.17	13.36	13.41	13.42	13.51	13.26	13.41	13.51	14.33	13.63	13.25
73	13.75	14.12	14.26	14.48	14.12	14.47	14.09	14.22	13.79	14.16	14.05	14.05	14.11	13.99	14.06	14.12	14.91	14.30	13.86
74	14.39	14.79	14.96	15.13	14.79	15.12	14.74	14.90	14.41	14.77	14.75	14.79	14.83	14.58	14.72	14.85	15.63	14.32	14.55
75	13.69	14.17	14.23	14.52	14.08	14.46		14.25	13.81	14.08	14.06	14.10	14.14	13.93	14.05	14.17	14.93	14.32	13.90
76	12.98	13.43	13.60	13.83	12.54		13.39	13.52	13.10	13.45	13.46	13.37	13.51	13.29	13.38	13.51	14.26	13.63	13.16
77	13.63	14.09	14.21	14.43	14.07		14.07	14.13	14.77	14.13	14.04	14.01	14.16	13.87	14.09	14.12	14.98	14.27	13.83
78	14.18	14.79	14.90	15.12	14.78		14.71	14.81	14.40	14.74	14.74	14.70	14.11	14.50	14.66	14.79	15.55	14.94	14.49
79	13.70	14.43		14.75					14.02	14.34	14.41	14.37					15.31	14.65	14.09
80	13.37	14.16	14.38	13.57			14.16	14.28	13.71	14.11	14.14	14.15			14.02		15.04	14.40	13.77
81	13.46	14.20		14.51	14.09		14.05	14.09	13.65	13.99	13.94	13.98	14.09	13.91	14.00	14.13	14.95	14.25	13.69
82	12.95	13.90		14.28			13.69	13.93	13.42	13.77	13.69	13.81					14.69	14.08	13.46
83	13.30	14.27		14.63			14.16	14.27	13.54	14.02	13.96							14.35	13.80
84	13.04	13.47	13.57	13.80	13.44		13.45	13.52	13.18	13.49	13.44	13.37	13.41	13.21	13.38	13.47	14.25	13.67	14.30
85	13.76	14.18	14.31	15.47	14.13		14.04	14.23	13.77	14.18	14.11	14.06	14.18	13.92	14.04	14.17	14.92	14.45	14.01
86	14.27	14.86	14.93	15.21	14.77		15.60	14.88	14.42	14.81	14.75	14.65	14.76	14.60	14.61	14.78	15.59	15.02	14.58
87	13.35	14.63		14.90			14.40	14.58	13.66	14.10	14.07							14.33	13.75
88	12.92	14.32		14.67			14.01	14.24	13.33	13.77	13.79							14.04	13.48
89	12.79	14.29		14.63			14.02	14.17	13.16	13.60	13.65							13.89	13.31
90	12.51	13.93		14.27			13.76	13.87	12.85	13.36	13.33							13.64	13.01
91	13.22	13.62	13.54	13.85	13.46		13.21	13.49	13.19	13.45	13.40	13.44	13.46	13.24	13.48	13.48	14.32	13.76	13.39
92	13.91	14.35	14.20	13.47	14.11		14.02	14.28	13.77	14.26	14.14	14.05	14.22	13.92	13.99	14.11	14.92	14.39	14.10
93	14.50	14.71	14.91	15.12	14.73		14.64	14.88	14.53	14.86	14.69	14.75	14.76	14.60	14.68	14.74	15.57	15.05	14.72
94	13.39	13.71	13.55	13.82	13.49		13.33	13.63	13.33	13.58	13.43	13.40	13.47	13.24	13.30	13.51	14.30	13.76	13.46
95	14.13	14.13	14.28	14.50	14.23		14.04	14.31	14.03	14.25	14.14	14.02	14.13	13.79	13.98	14.18	14.95	14.43	14.23
96	14.82	14.75	14.94	15.10	14.74		14.69	14.95	14.66	14.88	14.74	14.71	14.82	14.54	14.61	14.76	15.58	15.05	14.90
97	14.76	14.78		14.81			14.47	14.76	14.62	14.66	14.47							14.77	14.81
98	14.15	13.93		14.23			13.80	14.13	14.05	14.05	13.86							14.06	14.14
99	14.76	14.56		14.96			14.42	14.74	14.53	14.74	14.62							14.82	14.76
100	14.84	14.36		14.69			14.35	14.64	14.54	14.57	14.38							14.63	14.66
101	14.85	14.22	14.33	14.55			14.13	14.49	14.30	14.53	14.30							13.89	14.54
102			14.30	14.25			14.09	14.36	14.44	14.44	14.18							13.74	14.22
103	14.13	13.89	14.12	14.25			13.85	14.20	14.09	14.18	13.92							13.65	14.04
104	14.55	14.21	14.36	14.52			14.12	14.45	14.28	14.52	14.37							14.04	14.66
105	13.55	13.51	13.60	13.86	13.51		13.37	13.70	13.42	13.65	13.46	13.32	13.44	13.19	13.37	13.53	14.30	13.79	13.54
106	14.20	14.09	14.23	14.44	14.12		14.03	14.30	14.02	14.27	14.04	13.97	14.18	13.93	14.00	14.11	14.95	14.40	14.25
107	14.94	14.72	14.95	15.05	14.61		14.65	14.95	14.66	14.94	14.87	14.71	14.78	14.57	14.78	14.84	15.63	15.05	14.73
108	14.73	14.53	14.67	14.89			14.44	14.79	14.64	14.77	14.61							14.33	14.75
109	13.68	14.44	14.56	14.70			14.37	14.66	14.53	14.64	14.47							15.24	14.67
110	14.33	14.17	14.34	14.48			14.11	14.52	14.28	14.42	14.30						15.09	14.57	14.30
111	14.40	14.15	14.26	14.44	14.20		14.01	14.37	14.14	14.37	14.17	14.09	14.13	13.85	14.04	14.21	14.93	14.44	14.24
112	14.04	13.92	14.01	14.24			13.80	14.15	13.80	14.18	13.96							14.74	14.22
113	13.59	13.42	13.63	13.81	13.58		14.41	13.75	13.35	13.58	13.56	13.41	13.53	13.23	13.41	13.56	14.25	13.82	13.45
114	14.24	14.08	14.22	14.42	14.20		14.00	14.32	14.00	14.29	14.16	14.08	14.10	13.90	14.02	14.18	14.99	14.41	14.21
115	14.85	14.80	14.89	14.89	14.85		14.66	14.98	14.75	14.32	14.81	14.51	14.76	14.47	14.65	14.76	15.55	15.04	14.87
116	14.29	14.06	14.22	14.46	14.20		14.05	14.30	14.15	14.33	14.17	14.01	14.18	13.89	14.03	14.19	14.95	14.42	14.30
117	13.05	13.42	13.60	13.80	13.68		13.39	13.66	13.42	13.25	13.35	13.23	13.41	12.64	13.29	13.49	14.09	14.09	13.50
118	13.59	13.94	14.12	14.31	14.20		13.88	14.20	14.00	14.40	14.00	13.72	13.86	13.26	13.76	14.08	14.60	14.05	14.05
119	14.12	14.47	14.63	14.81	14.74		14.41	14.68	14.41	14.39	14.39	14.36	14.39	13.69	14.29	14.62	15.12	14.62	14.56
120	13.52	14.11	14.13	14.42	14.19		13.86	14.15	13.93	14.33	14.33	13.84	13.87	13.20	13.74	14.02	14.57	14.37	13.97
121	12.96	13.40	13.56	13.90	13.70		13.29	13.59	13.42	13.85		13.28	13.28	12.58	13.22	13.48	14.01	14.01	13.44
122	13.61	13.85	14.02	14.18	14.17		13.80	14.12	13.91	14.33		13.73	13.86	13.14	13.75	14.09	14.47	14.44	14.12
123	13.77	14.38	14.54	14.66			14.36	14.61	14.28	14.88		14.25	14.26	13.45	14.04	14.45	14.98	14.52	14.52
124	13.43	14.24		14.55			14.26		14.30			14.14	14.12	13.25	13.92	14.28	14.91	14.32	14.32
125	13.23	14.11		14.28			13.90		14.05			13.89	13.81	12.82	13.56	13.96	14.61	14.01	14.01
126	13.17	13.84		14.20	14.20		13.81	14.13	13.90	14.51		13.78	13.67	12.76	13.48	13.90	14.49	13.79	13.79
127	13.05	13.74		14.05			13.65		13.67			13.59	13.52	12.56	13.27				



Run #	1-A	2-B	2-C	2-D	2-E	2-F	3-B	3-C	3-D	3-E	3-F	4-B	4-C	4-D	4-E	4-F	5-F	6-D	7-D	
Piezo. No.	Pres. Head	Pres. Head	Pres. Head	Pres. Head	Pres. Head	Pres. Head	Pres. Head	Pres. Head	Pres. Head	Pres. Head	Pres. Head	Pres. Head	Pres. Head	Pres. Head	Pres. Head	Pres. Head	Pres. Head	Pres. Head	Pres. Head	
141	14.92	14.11		14.50					14.12					14.28	14.47	14.68	14.55	14.45		14.37
142	14.45	13.71		14.06					13.61					13.80	13.97	13.87	14.02	13.93		13.84
143	14.91	14.21		14.62					14.13					14.21	14.48	14.41	14.53	14.54		14.66
144	14.96	13.95		14.34					13.99					14.05	14.32	14.44	14.46	14.40		14.30
145	14.80	13.70		14.17					13.73					13.92	14.13	14.39	14.28	14.23		14.10
146	14.38	13.69		13.98					13.65					13.72	13.93	14.05	14.04	14.06		14.04
147	14.87	14.18		14.55					14.06					14.26	14.51	14.33	14.53	14.59		14.59
148	14.76	13.87		14.36					13.92					14.09	14.20	14.26	14.43	13.43		14.40
149	14.33	13.70		14.02					13.65					13.76	13.94	13.91	14.04	14.12		14.12
150	13.77	13.29	13.47	13.66	13.75				13.26	13.63	13.35	13.81		13.33	13.48	13.24	13.60	13.65	13.96	13.73
151	14.26	13.83	13.95	14.23	14.16				13.77	14.07	13.88	14.33		13.89	14.04	13.70	14.02	14.20	14.47	14.20
152	14.72	14.32	14.41	14.75	14.72				14.29	14.63	14.39	14.85		14.48	14.53	14.23	14.48	14.72	15.01	14.68
153	14.60	14.10		14.66					14.14		14.36			14.29	14.36	14.39	14.51	14.53	14.79	14.63
154	14.62	13.94		14.42					13.98		13.94			14.03	14.17	14.11	14.36	14.44	14.62	14.52
155	14.45	13.90	13.96	14.19	14.19				13.84		13.78	14.29		13.89	14.07	14.02	14.20	14.27		14.17
156	13.29	13.64		14.11					13.65		13.77			13.71	13.89	13.70	14.03	14.13	14.23	14.20
157	13.82	13.26	13.40	12.74	13.71				13.40	13.60	13.44	13.88		13.34	13.56	13.38	13.61	13.75	13.88	13.81
158	14.22	13.78	13.90	14.13	14.14				13.75	14.06	13.88	14.32		13.79	14.01	13.79	13.97	14.21	14.39	14.24
159	14.74	14.29	14.44	14.60	14.66				14.25	14.51	14.29	14.81		14.23	14.41	14.33	14.59	14.70	14.80	14.73
160	14.37	13.76	13.89	14.13	14.19				13.81	13.98	13.90	14.36		13.73	13.98	13.85	14.12	14.19	14.36	14.23
161	13.57	13.09	13.20	13.56	13.79				13.08	13.34	13.07	13.85		13.10	13.27	13.10	13.64			13.44
162	13.94	13.40	13.49	13.81	14.12				13.38	13.69	13.47	14.27		13.35	13.62	13.49	14.07			13.62
163	14.53	13.89	14.13	14.25	14.63				14.03	14.23	13.99	14.68		13.86	14.15	13.92	14.52			14.26
164	14.10	13.39	13.62	13.85	14.13				13.53	13.76	13.49	14.29		13.43	13.66	13.48	13.99			13.80
165	13.51	12.94	13.14	13.41	13.76				13.03	13.21	13.13	13.91		12.95	13.19	13.02	13.63			13.25
166	14.00	13.46	13.60	13.82	14.17				13.45	13.71	13.44	14.26		13.48	13.69	13.45	14.06			13.85
167	14.31	13.69	13.87	14.13	14.60				13.77	13.97	13.83	14.68		13.81	13.94	13.75	14.46			13.87
168	13.33	13.10	13.22	13.52	14.18				13.10	13.29	13.11	14.23		13.12	13.16	13.07	13.99			13.12
169	13.36	13.01	13.12	13.36	13.81				13.03	13.26	12.95	13.88		13.01	13.18	13.03	13.75			13.30
170	13.35	13.46	13.62	13.94	14.16				13.44	13.78	13.53	14.26		13.48	13.67	13.49	14.03			13.86
171	14.19	13.63	13.79	13.88	14.65				13.64	13.85	13.65	14.71		13.66	13.86	13.70	14.50			13.65
172	13.46	12.98	13.05	13.32	14.20				12.99	13.10	13.06	14.30		13.01	13.08	13.00	14.05			12.67
173	13.39	12.87	13.07	13.21	13.86				12.88	13.14	12.86	13.91		12.90	13.07	12.87	13.74			13.01
174	13.86	13.48	13.52	13.44	14.15				13.50	13.18	13.39	14.28		13.48	13.60	13.41	14.13			13.70
175	14.31	13.52	13.71	14.23	14.56				13.62	13.65	13.42	14.69		13.51	13.63	13.54	14.48			13.35
176	13.19	12.74	12.87	13.14	14.21				12.64	12.92	12.78	14.32		12.68	12.84	12.66	14.12			12.25
177	13.23	12.71	12.83	13.04	13.82				12.72	12.95	12.67	13.99		12.71	12.93	12.77	13.76			12.49
178	13.80	13.33	13.41	13.88	14.27				13.29	12.54	13.22	14.34		13.33	13.51	13.34	14.11			13.46
179	13.88	13.20	13.45	13.73	14.54				13.32	13.50	13.37	14.71		13.30	13.48	13.31	14.51			13.80
180	12.96	12.53	12.62	12.84	14.23				12.50	12.69	12.52	14.36		12.54	12.56	12.48	14.10			11.64
181	13.17	12.49	12.69	12.94	13.88				12.56	12.76	12.55	14.07		12.56	12.83	12.63	13.91			12.21
182	13.68	13.15	13.37	13.46	14.26				13.15	13.42	13.19	14.40		13.15	13.45	13.24	14.23			13.11
183	13.66	13.20	13.28	13.34	14.61				13.07	13.33	13.26	14.77		13.16	13.26	13.18	14.55			12.61
184	12.66	12.28	12.34	12.55	14.20				12.29	12.38	12.22	14.38		12.24	12.35	12.16	14.17			11.06
185	12.85	12.39	12.42	12.60	14.02				12.26	12.55	12.29	14.12		12.29	12.55	12.38	13.95			11.59
186	13.52	13.13	13.16	13.28	14.37				12.96	13.27	13.06	14.51		13.02	13.23	13.07	14.29			12.67
187	13.54	13.02	13.10	13.38	14.60				12.98	13.21	13.03	14.78		12.97	13.11	13.14	14.51			12.22
188	12.31	11.99	12.02	12.23	14.33				11.88	12.08	11.90	14.49		11.94	12.06	11.92	14.23			10.31
189	12.55	12.09	12.11	12.43	14.08				11.98	12.27	11.41	14.22		12.00	12.18	12.10	13.99			10.89
190	13.34	12.79	12.98	13.17	14.46				12.84	13.08	12.71	14.59		12.72	13.06	12.89	14.40			12.11
191	13.49	12.91	13.05	12.38	14.79				12.93	13.12	13.00	14.84		12.91	13.14	12.90	14.66			12.03
192	12.55	12.11	12.24	12.43	14.47				12.05	12.23	12.10	14.40		12.17	12.21	12.19	14.24			10.71
193	12.52	12.01	12.08	12.39	14.19				12.05	12.24	12.00	14.37		11.97	12.19	12.13	14.13			10.72
194	13.23	12.73	12.81	12.96	14.57				12.64	12.89	12.58	14.72		12.65	12.85	12.92	14.48			11.73
195	13.68	13.35	13.21	13.54	14.95				13.16	13.42	13.00	15.02		13.14	13.43	13.21	14.86			12.43
196	13.03	12.54	12.63	12.84	14.57				12.49	12.67	12.40	14.70		12.54	12.65	12.67	14.53			11.33
197	12.57	11.99	12.19	12.39	14.26				12.06	12.31	12.11	14.45		12.15	12.28	12.15	14.18			10.75
198	13.28	12.80	12.72	13.13	14.61				12.71	12.82	12.72	14.82		12.79	12.89	12.75	14.58			11.69
199	13.66	13.18	13.34	12.54	15.03				13.13	13.37	13.12	15.10		13.12	13.34	13.27	14.97			12.24
200	13.15	12.67	12.71	12.92	14.60				12.56	13.86	12.56	14.72		12.58	12.67	12.64	14.56			11.53
201	12.72	12.31	12.44	12.74	14.31				12.26	12.48	12.14	14.57		12.21	12.42	12.41	14.19			11.10
202	13.17	12.58	12.77	13.08	14.65				12.61	12.83	12.48	14.83		12.72	12.80	12.64	14.53			11.49
203	13.54	13.05	13.20	13.48	14.96				13.00	13.18	12.96	15.13		13.02	13.20	12.95	14.91			11.94
204	13.15	12.67	12.75	12.98	14.70				12.58	12.76	12.48	14.83		12.57	12.78	12.63	14.62			11.45
205	12.70	12.21	12.35	12.63	14.34				12.20	12.49	12.46	14.46		12.22	12.40	12.32	14.21			11.14
206	13.10	12.67	12.76	13.05	14.64				12.53	12.76	12.54	14.81		12.61	12.77	12.66	14.61			11.47
207	13.49	13.02	13.07	13.34	15.06				12.88	13.11	12.92	15.15		12.89	13.04	12.95	14.93			11.81
208	13.18	12.64	12.72	12.95	14.73				12.58	12.79	12.58	14.85		12.62	12.79	12.76	14.67			11.46
209	13.15	13.59	13.57	13.74	13.52	13.64			13.15	13.45	13.13	13.5								

Run #	1-A	2-B	2-C	2-D	2-E	2-F	3-B	3-C	3-D	3-E	3-F	4-B	4-C	4-D	4-E	4-F	5-F	6-D	7-D
Piezo. No.	Pres. Head	Pres. Head	Pres. Head	Pres. Head	Pres. Head	Pres. Head	Pres. Head	Pres. Head	Pres. Head	Pres. Head	Pres. Head	Pres. Head	Pres. Head	Pres. Head	Pres. Head	Pres. Head	Pres. Head	Pres. Head	Pres. Head
221	14.96	14.44	14.45	14.52	14.07	14.10	14.29		14.18	14.44	14.25	14.27		14.26		14.58		14.46	14.54
222	14.98	14.68	14.75	14.77	14.23	14.25	14.51		14.37		14.50	14.40		14.47	14.51	14.57		14.75	14.45
223	14.72	14.74	14.83	15.05	14.61	14.70	14.68	12.84	14.48			14.65	14.82	14.50				14.84	14.73
224	15.60	15.99																	
225	15.56	14.82	14.76	14.55	14.59	14.62	14.68		14.42	14.76		14.62		14.64	14.68			14.45	14.57
226	15.18	14.41	14.33	14.11	14.02	14.27	14.33		14.05	14.37		14.19		14.11	14.23			14.04	14.23
227	12.75	14.04	13.94	13.81	13.79	13.89	13.89		13.59			13.87		13.75				13.61	13.67
228	13.49	14.04	14.04	14.11	13.75	13.95	13.84		13.63					13.87				13.99	13.66
229	14.04	14.21	14.27	14.36	13.89	14.09	13.99		13.90					14.04				14.19	13.67
230	14.35	14.38	14.46	14.56	14.13	14.33	14.26		14.10					14.21				14.44	14.27
231	14.40	14.65	14.72	14.86	14.34	14.47	14.55											14.61	
232	14.28	14.83	14.87	14.83	14.50	14.64	14.68											14.73	
233	15.19	14.07	14.01	13.73	13.46	13.67		14.07			13.87	13.88	13.99			13.94	14.84	13.65	
234	15.24	14.11	14.18	13.86	13.62	13.84												13.84	
235	15.57	14.50	14.47	14.27	13.94	14.16		14.55			14.32	14.35	14.50			14.48	15.31	14.08	
236	15.84	14.74	14.80	14.46	14.22	14.42												14.37	
237	14.05	14.91	14.91	14.65	14.32	14.50		14.99			14.77	14.84	14.94			14.91	15.72	14.51	
238	15.82	14.74	14.81	14.53	14.21	14.42												14.41	
239	15.75	14.50	14.53	14.25	13.95	14.15		14.56			14.34	14.36	14.56			14.38	15.31	14.23	
240	15.27	14.09	14.20	13.95	13.57	13.74												13.77	
241	12.34	14.20	14.20	12.59	12.28	12.55												12.50	
242	12.47	14.33	14.24		12.52	12.68												12.63	
243	12.06	15.00	14.86		13.05	13.24												13.32	
244																			
245		14.88	14.77		12.72	12.92												13.10	
246			14.73															13.16	
247		14.89	14.82	13.35	12.92	13.13												13.16	
248		14.31	14.23	12.84	12.43	12.57												12.68	
249	12.39	14.32	14.18	12.56	12.32	12.32												12.39	
250	12.70	14.59	14.48	13.00	12.53	12.71												12.77	
251	12.99	14.90	14.87	13.19	12.80	12.98												13.01	
252	12.69	14.60	14.52	12.86	12.43	12.62												12.73	
253	12.39	14.47	14.39	12.49	12.14	12.28												12.38	
254	12.67	14.78	14.67	12.86	12.52	12.60												12.65	
255		15.17	15.03	13.18	13.00	13.19												13.29	
256	12.73	14.84	14.69	12.92	12.55	12.72												12.78	
257	12.29	14.48	14.40	12.47	12.04	12.36												12.38	
258	12.62	14.86	14.76	12.81	12.49	12.76												12.72	
259	13.10	15.19	15.07	13.38	12.87	13.08												13.12	
260	12.79	14.88	14.73	12.82	12.55	12.70												12.82	
261	12.38	14.61	14.45	12.65	12.16	12.36												12.41	
262	12.73	14.96	14.73	12.84	12.56													12.71	
263		15.31	15.15	12.35	12.78	13.04												12.97	
264	12.81	14.94	14.75	12.86	12.60	12.74												12.78	
265	12.33	13.97	14.42	12.46	12.14	12.25												12.24	
266	12.72	14.94	14.77	12.79	12.50	12.68												12.76	
267	13.05	15.23	15.12	13.15	12.85	13.03												13.05	
268	12.59	14.94	14.82	12.89	12.45	12.60												12.68	
269	12.39	14.58	14.44	12.50	12.17	12.38												12.45	
270	12.66	14.88	14.78	12.65	12.57	12.70												12.68	
271	12.79	15.24	15.07	13.11	12.71	12.71												12.79	
272	12.59	14.94	14.74	12.84	12.43	12.71												12.60	
273	13.34	13.62	13.71	13.86	13.63		13.50	13.74	13.17	13.65	13.45	13.50	13.50	13.17	13.47	13.51	14.36	13.74	13.33
274	14.45	14.87	14.93	15.17	14.83		14.66	14.86	14.57	14.77	14.66	15.12	14.67	14.47	14.72	14.78	15.59	14.88	14.70
275	13.44	13.64	13.73	13.93	13.68		13.51	13.80	13.26	13.61	13.46	13.55	13.73	13.36	13.53	13.67		13.81	13.34
276	14.55	14.8C	14.83	15.15	14.87		14.70	14.85	14.43	14.75	14.62	14.67	14.83	14.27	14.69	14.83		14.98	14.70
277	13.03	14.7E	14.77	15.01	14.70		14.55	14.56	13.22	13.61	14.84	14.41	14.24	14.49	14.64			13.97	13.57
278	12.74	14.2E	14.31	14.52			14.13	14.19	12.93	13.56	13.66	14.06	13.74	14.08	14.18			13.80	13.08
279	12.19	13.87	13.91	14.12			13.71	13.84	12.48	13.14	13.45	13.64	13.29	13.71	13.86			13.50	12.61
280	14.12	14.0C	14.02	14.36			13.83	14.13	13.66	13.77	13.52	13.93		13.54	13.85	13.98		13.62	13.77
281	14.49	14.17	14.24	14.65			14.20	14.32	13.86	13.65	13.27	14.05		13.85	14.01	14.07		13.60	14.02
282	14.63	14.3E	14.36	14.75	14.37		14.38	14.48	13.88	13.90	13.59	14.23		14.09	14.22	14.37		13.75	14.00
283	14.99	14.5E	14.58	14.89			14.56	14.73	14.19	13.96	13.60	14.47		14.23	14.41			13.94	14.37
284	14.87	14.7E		15.07			14.63	14.86	14.30	14.50	14.21	14.53		14.28		14.57		14.43	14.53
285	13.12	13.9E	13.98	14.25	13.94		13.77	13.88	13.13	13.42	13.36	13.90	13.90	13.53	13.77	13.83	14.65	13.58	13.33
286	13.55	14.0E		14.40			13.86	14.10	13.43	13.69	13.45			13.53				13.80	12.59
287	13.88	14.2E		14.56			14.12	14.26	13.49	13.77	13.59			13.69				13.50	13.50
288	14.10	14.3E	14.44	14.75	14.37		14.31	14.48	13.82	13.92	13.76	14.21	14.30	13.98	14.23	14.31	15.10	14.04	13.96
289	14.25	14.5E		14.85			14.49	14.85	13.90	14.16	13.98			14.14				14.16	14.05
290	14.20	14.6E		15.05			14.61	14.71	14.07	14.31	14.10			14.25				14.43	14.21
291	13.81		13.87		14.80		14.76	14.61	14.16	14.36	14.18	14.65	14.79	14.40	14.66	14.77	15.55	14.46	14.13
292	13.28						14.54	14.61	13.78	14.15	14.04			14.32				14.36	13.94
293	13.00		14.39		14.37		14.19	14.30	13.53	13.93	13.82	14.14	14.29	14.00	14.19	14.33	15.12	14.13	13.70
294	12.60						13.94	13.98	13.24	13.57	13.40			13.59				13.75	13.20
295	13.15						14.02	14.07	13.12	13.32	13.15							13.46	13.12
296	13.24						14.39	14.45	13.24	13.53	13.47							13.84	13.35
297	13.69						14.57	14.66	13.59	13.86	13.74							14.05	13.68
298	12.43						13.99	14.07	12.19	12.45	12.39							12.57	12.46
299	12.63						14.13	14.16	12.31	12.53	12.45							12.71	12.50
300	12.56						14.43	14.43	12.47	12.69	12.59							12.99	12.57

Run #	1-A	2-B	2-C	2-D	2-E	2-F	3-B	3-C	3-D	3-E	3-F	4-B	4-C	4-D	4-E	4-F	5-F	6-D	7-D
Piezo. No.	Pres. Head	Pres. Head	Pres. Head	Pres. Head	Pres. Head	Pres. Head	Pres. Head	Pres. Head	Pres. Head	Pres. Head	Pres. Head	Pres. Head	Pres. Head	Pres. Head	Pres. Head	Pres. Head	Pres. Head	Pres. Head	Pres. Head
301	12.60						14.53		12.76	12.76	13.05							12.97	12.58
302	12.88						14.65	14.67	12.62	12.72	12.66							12.99	12.80
303	13.17						14.62	14.65	12.75	12.91	12.68							13.03	12.92
304	14.22						14.35	14.49	12.60	12.48	13.34							12.59	12.66
305	12.86						14.14	14.28	12.25	12.53	12.31							12.72	12.69
306	12.37						14.07	14.13	11.93	12.19	12.07							12.38	12.22
307	12.69						14.40	14.48	12.32	12.65	12.54							12.78	12.48
308	13.08						14.72	14.87	12.74	12.88	12.81							13.05	12.96
309	12.92						14.45	14.50	12.48	12.68	12.51							12.81	12.60
310	12.08						14.35	14.26	11.80	11.88	11.83							12.09	11.97
311	12.88						14.69	14.56	12.43	12.70	12.58							12.83	12.75
312	13.35						15.03	14.97	12.90	13.12	12.99							13.27	13.18
313	12.88						14.68	14.63	12.51	12.62	12.50							12.83	12.66
314	12.27						14.43	14.36	11.92	12.11	11.94							12.25	12.34
315	13.00						14.70	14.65	12.58	12.83	12.60							13.05	12.86
316	13.40						15.05	15.04	13.02	13.09	12.99							13.43	13.27
317	12.84						14.73	14.74	12.55	12.70	12.56							12.90	12.66
318	12.58						14.48	14.41	12.22	12.29	12.06							12.51	12.31
319	13.18						14.76	14.76	12.57	12.84	12.62							13.07	12.72
320	13.22						15.13	15.11	12.95	13.06	12.89							13.28	13.08
321	12.76						14.77	14.77	12.55	12.69	12.52							12.86	12.66
322	12.49						14.43	14.37	12.21	12.41	12.17							12.56	12.44
323	12.90						14.78	14.73	12.57	12.68	12.54							12.89	12.73
324	13.22						15.10	15.03	12.90	13.09	12.93							13.29	13.02
325	13.04						14.82	14.73	12.58	12.77	12.58							13.10	12.76
326	12.53						14.44	14.34	12.20	12.36	12.22							12.62	12.34
327	12.83						14.73	14.72	12.42	12.64	12.49							12.88	12.70
328	13.08						15.06	15.04	12.75	12.89	12.67							13.03	12.96
329	12.70						14.69	14.75	12.36	12.57	12.37							12.74	12.62
330	13.32	13.54	13.62	13.83	13.62		13.48	13.62	13.43	13.85		13.28	13.33	12.47	13.25	13.47	14.02		13.63
331	14.33	14.38	14.57	14.80	14.70		14.43	14.55	14.34	14.85		14.22	14.36	13.83	14.22	14.49	15.04		14.69
332	12.01	12.24		12.63	12.40		12.14	12.26	12.13			12.08	12.18	11.55	11.77	12.05			12.30
333	14.18	14.44	14.54	14.98	14.74		14.38	14.55	14.44			14.29	14.42	13.72	14.04	14.24			14.38
334	11.96	14.32	14.39	14.71	14.54		14.25	14.22	14.22			14.06	13.53	11.17	11.59	14.69			12.90
335	11.40	14.00	14.11	14.45	14.29		13.99		14.04			13.77	13.59	11.18	11.94	12.53			12.55
336	10.75	13.66	13.70	14.10	13.97		13.58		13.67			13.44	13.22	10.41	10.95	11.86			11.58
337	13.90	13.84	13.90	14.35	14.02		13.76		13.80			13.96	14.06	13.25	13.18	12.84			13.08
338	14.55	14.50	14.53	14.80	14.61		14.31		14.29			14.54	14.66	13.95	13.68	13.32			13.21
339	12.99	13.79	13.80	14.10	13.98		13.63	13.87	13.75	14.05		13.46	13.50	12.46	12.74	12.96			13.02
340	14.10	14.06		14.36			13.90					14.09	14.35	13.42	12.68	11.97			12.36
341	14.15	14.19	14.23	14.65	14.37		14.10	14.30	14.19	14.49		14.30	14.96	13.13	12.59	12.32			12.44
342	14.17	14.37		14.68			14.23		14.25			14.42	14.65	13.51	13.12	12.42			12.44
343	13.77	14.41	14.57	14.84	14.63		14.42	14.59	14.34	14.84		14.20	14.24	13.20	13.54	13.62			13.84
344	12.23	14.35		14.78			14.33		14.35			13.99	13.55	11.75	13.06	13.44			13.55
345	11.50	14.05	14.14	14.55	14.30		13.02	14.23	14.01	14.50		13.91	13.64	11.35	12.33	12.90			12.95
346	11.01	13.61		14.15			13.71		13.68			13.53	13.28	10.81	12.31	12.66			12.77
347	12.32											13.62	13.39	11.98	12.36	12.46			12.70
348	12.71											13.75	13.78	12.37	12.66	12.64			12.82
349	13.00											13.79	13.27	12.47	12.66	12.75			12.97
350	13.28											13.88	14.01	12.71	12.94	12.86			13.06
351	13.45											14.35	14.32	12.85	13.12	13.29			13.35
352	13.36											14.20	14.17	12.84	13.14	13.20			13.26
353	12.96											14.21	14.05	12.57	13.04	13.17			13.27
354	12.55											14.09	13.94	12.34	12.81	13.00			13.14
355	12.56											13.81	13.72	12.17	12.89	13.08			13.26
356	12.04											13.53	13.41	11.66	12.47	12.60			12.75
357	12.16											13.66	13.64	11.68	11.89	12.00	14.47		12.25
358	11.89											13.79	14.02	12.44	11.80	11.95		14.78	12.18
359	12.79											14.21	14.09	12.20	12.46	12.58		15.13	12.72
360	12.86											13.96	13.51	12.11	12.33	12.33	14.80		12.46
361	12.34											14.00	13.85	11.87	12.11	12.14			12.35
362	12.82											14.26	14.25	12.20	12.52	12.52			12.76
363	13.02											14.57	14.64	12.36	12.73	12.79			13.00
364	12.75											14.28	14.27	12.34	12.48	12.48			12.79
365	12.23											13.97	14.02	11.81	11.95	12.07			12.09
366	12.74											14.34	14.34	12.33	12.39	12.42			12.62
367	13.33											14.64	14.77	12.87	13.01	13.12			13.26
368	12.90											14.31	14.36	12.47	12.39	12.56			12.66
369	12.40											13.99	14.04	11.98	11.94	12.17			12.17
370	12.94											14.41	14.38	12.50	12.47	12.64			12.84
371	13.31											14.70	14.72	12.86	12.94	13.04			13.23
372	12.93											14.29	14.48	12.46	12.52	12.69			12.76
373	12.51											14.10	14.14	11.98	12.04	12.17			12.36
374	12.89											14.45	14.50	12.49	12.47	12.66			12.82
375	13.44											14.79	14.80	13.08	13.00	13.15			13.35
376	12.93											14.39	14.43	12.41	12.53	12.46			12.78
377	12.48											14.12	14.14	11.96	12.02	12.14			12.30
378	12.94											14.45	14.43	12.59	12.55	12.64			12.83
379	13.42											14.76	14.84	13.03	13.03	13.07			13.31
380	12.96											14.48	14.42	12.43	12.47	12.65			12.75

Run #	1-A	2-B	2-C	2-D	2-E	2-F	3-B	3-C	3-D	3-E	3-F	4-B	4-C	4-D	4-E	4-F	5-F	6-D	7-D
Piezo. No.	Pres. Head	Pres. Head	Pres. Head	Pres. Head	Pres. Head	Pres. Head	Pres. Head	Pres. Head	Pres. Head	Pres. Head	Pres. Head	Pres. Head	Pres. Head	Pres. Head	Pres. Head	Pres. Head	Pres. Head	Pres. Head	Pres. Head
381	12.70											14.12	14.10	12.24	12.18	12.24			12.46
382	12.94											14.45	14.44	12.58	12.57	12.64			12.82
383	13.26											14.74	14.89	12.87	12.87	12.92			13.17
384	12.97											14.45	14.52	12.60	12.55	12.62			12.82
385	12.62											14.16	14.15	12.25	12.20	12.23			12.51
386	12.93											14.46	14.50	12.60	12.46	12.59			12.85
387	13.08											14.85	14.82		12.74	12.90			13.17
388	12.92											14.47	14.43		12.52	12.55			12.79
389	12.61	12.12	12.39	12.65	14.30		14.33	12.42	12.36	14.52		12.31	12.35	12.64			11.21		
390	12.59	12.26	12.41	12.78					12.31					12.63					
391	13.03	12.71	12.77	13.13	14.70		12.63	12.74	12.61	14.85		12.57	12.82	12.87			11.51		
392	13.48	13.07	12.16	13.49	14.99		13.03	13.10	13.04	15.16		12.85	13.16	13.27			11.91		
393	13.08	12.61	12.76	13.04	14.72		12.65	12.77	12.65	14.82		12.55	12.79	12.95			11.51		
394	12.77	12.34		12.93					12.34					12.65					
395	12.83	12.30		12.73					12.27					12.59					
396	12.73	12.27	12.39	12.69	14.44		12.28	12.48	12.24	14.41		12.16	12.44	12.54			11.10		
397	12.73	12.36		12.71					12.24					12.52					
398	12.98	12.62	12.68	13.02	14.65		12.55	12.71	12.57	14.80		12.59	12.69	12.89			11.37		
399	13.46	12.91	12.06	13.36	15.04		12.94	13.04	13.00	15.12		12.85	13.05	13.21			11.77		
400	13.10	12.65	12.72	13.10	14.69		12.57	12.74	12.65	14.81		12.54	12.85	12.87			11.42		
401	12.87	12.44		12.84					12.37					12.69					
402	12.84	12.40		12.78					12.30					12.57					
403	13.09	12.64	12.60	13.04	14.67		12.51	12.69	12.65	14.80		12.61	12.74	12.74			11.35		
404	13.32	12.99	12.97	13.38	15.02		12.96	13.01	12.98	15.13		12.82	12.98	13.17			11.68		
405	13.04	12.67	12.63	13.17	14.71		12.58	12.70	12.76	14.83		12.49	12.67	12.81			11.36		
406	12.49	12.28		12.50					12.12					12.25					
407	12.56	12.05		12.58					12.00					12.31					
408	12.44	12.02		12.49					11.90					12.36					
409	12.56	12.11		12.39					12.14					12.28					
410	12.55	12.12		12.47					12.05					12.35					
411	12.25	11.98		12.23					11.94					12.15					
412	12.28	12.07		12.35					11.85					12.16					
413	12.50	12.14	12.20	12.48	14.40		12.06	12.21	12.11	14.44		12.07	12.18	12.38			10.65		
414	12.42	12.22		12.54					12.10					12.38					
415	12.93	12.55	12.62	12.87	14.64		12.50	12.54	12.32	14.78		12.45	12.58	12.67			11.09		
416	13.26	12.88	12.92	13.18	15.06		12.76	12.97	12.75	15.13		12.77	12.94	13.01			11.50		
417	12.88	12.50	12.47	12.86	14.65		12.36	12.53	12.45	14.80		12.36	12.48	12.67			11.05		
418	12.60	12.24		12.60			12.24		12.18					12.40					
419	12.56	12.23		12.59					12.14					12.33					
420	12.55	12.10		12.42					12.08					12.35					
421	12.58	12.16		12.58					12.09					12.34					
422	12.68	12.22		13.56					12.28					12.45					
423	12.58	12.22		12.53					12.16					12.42					
424	12.59	12.12	12.18	12.48	14.35		12.13	12.26	12.13	14.45		12.03	12.18	12.36			10.75		
425	12.51	12.23		12.57					12.14					12.45					
426	13.01	12.67	12.51	12.85	14.61		12.47	12.64	12.56	14.76		12.45	12.59	12.67			11.10		
427	13.27	12.81	12.87	13.20	14.93		12.79	12.91	12.91	15.08		12.82	12.90	13.01					
428	12.92	12.52	12.52	12.86	14.66		12.47	12.54	12.48	14.79		12.45	12.54	12.69			11.12		
429	12.69	12.25		12.63					12.20					12.40					
430	12.58	12.27		12.57					12.18					12.29					
431	12.84	12.40		12.73					12.45					12.62					
432	12.83	12.38		12.83					12.40					12.40					
433	13.05	12.67		12.94					12.65					12.89					
434	13.05	12.73		12.94					12.64					12.74					
435	12.70	12.41		12.67					12.31					12.58					
436	12.60	12.33		12.65					12.26					12.48					
437	12.75	12.32		12.66					12.14					12.51					
438	13.09	12.71		13.06					12.65					12.88					
439	13.09	12.67		13.00					12.56					12.93					
440	12.78	12.27		12.70					12.33					12.57					
441	12.54	12.03		12.47					12.07					12.26					
442	12.53	12.09		12.56					12.02					12.33					
443	12.74	12.32		12.75					12.26					12.56					
444	12.71	12.26		12.63					12.15					12.43					
445	12.51	12.22		12.48					12.04					12.31					
446	12.90	12.54		12.93					12.57					12.61					
447	12.87	12.54		12.74					12.30					12.58					
448	12.99	12.62		12.98					12.46					12.67					
449	12.77	12.55		12.70					12.39					12.67					
450	12.78	12.30		12.71					12.40					12.51					
451	12.34	11.93		12.31					11.96					12.16					
452	12.33	12.00		12.36					12.00					12.20					
453	12.36	12.19		12.41					12.08					12.40					
454	12.68	12.16		12.53					12.02					12.40					
455														12.39					
456	12.80	12.37		12.72					12.25					12.65					
457	12.74	12.28		12.63					12.23					12.47					
458	12.64	12.30		12.54					12.14					12.49					
459	12.38	12.10		12.40					12.04					12.33					
460	12.33	12.02		12.41					12.06					12.23					

Run #	1-A	2-B	2-C	2-D	2-E	2-F	3-B	3-C	3-D	3-E	3-F	4-B	4-C	4-D	4-E	4-F	5-F	6-D	7-D
Piezo. No.	Pres. Head	Pres. Head	Pres. Head	Pres. Head	Pres. Head	Pres. Head	Pres. Head	Pres. Head	Pres. Head	Pres. Head	Pres. Head	Pres. Head	Pres. Head	Pres. Head	Pres. Head	Pres. Head	Pres. Head	Pres. Head	Pres. Head
461	12.35	11.89		12.26						11.87									12.08
462	12.42	12.05		12.40						12.01									12.23
463	12.67	12.22		12.63						12.18									12.45
464	12.53	12.04		12.48						12.14									12.25
465	12.20	11.80		12.17						11.84									11.96
466	12.35	11.91		12.39						12.03									12.11
467	12.39	11.95		12.32						11.95									12.11
468	12.35	11.97		12.31						11.80									12.16
469	12.25	11.64		12.20						11.79		11.64							11.89
470	12.34	11.86		12.43						11.86		11.87							12.02
471	12.46	11.97		12.37						11.97		11.93							12.13
472	12.31	11.97		12.30						11.93		11.87							12.08
473	12.06	11.71		12.06						11.62									11.94
474	12.28	11.86		12.18						11.75									12.02
475	12.40	11.96		12.34						11.95									12.20
476																			
477																			
478																			
479																			
480																			
481																			
482																			
483																			
484																			
485																			
486																			
487																			
488																			
489																			
490																			
491																			
492																			
493																			
494																			
495																			
496																			

APPENDIX A-2  
VELOCITY DISTRIBUTIONS WITHIN MANIFOLD

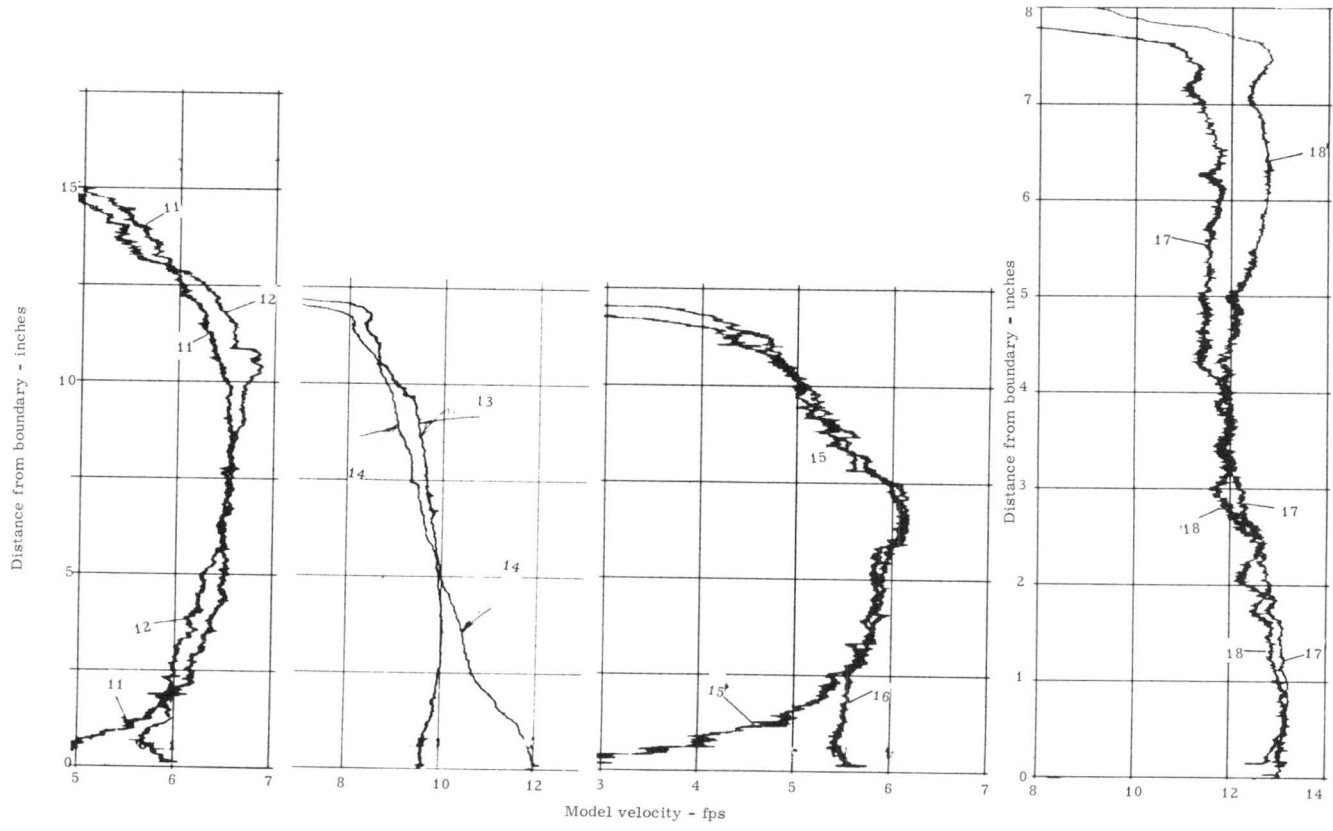
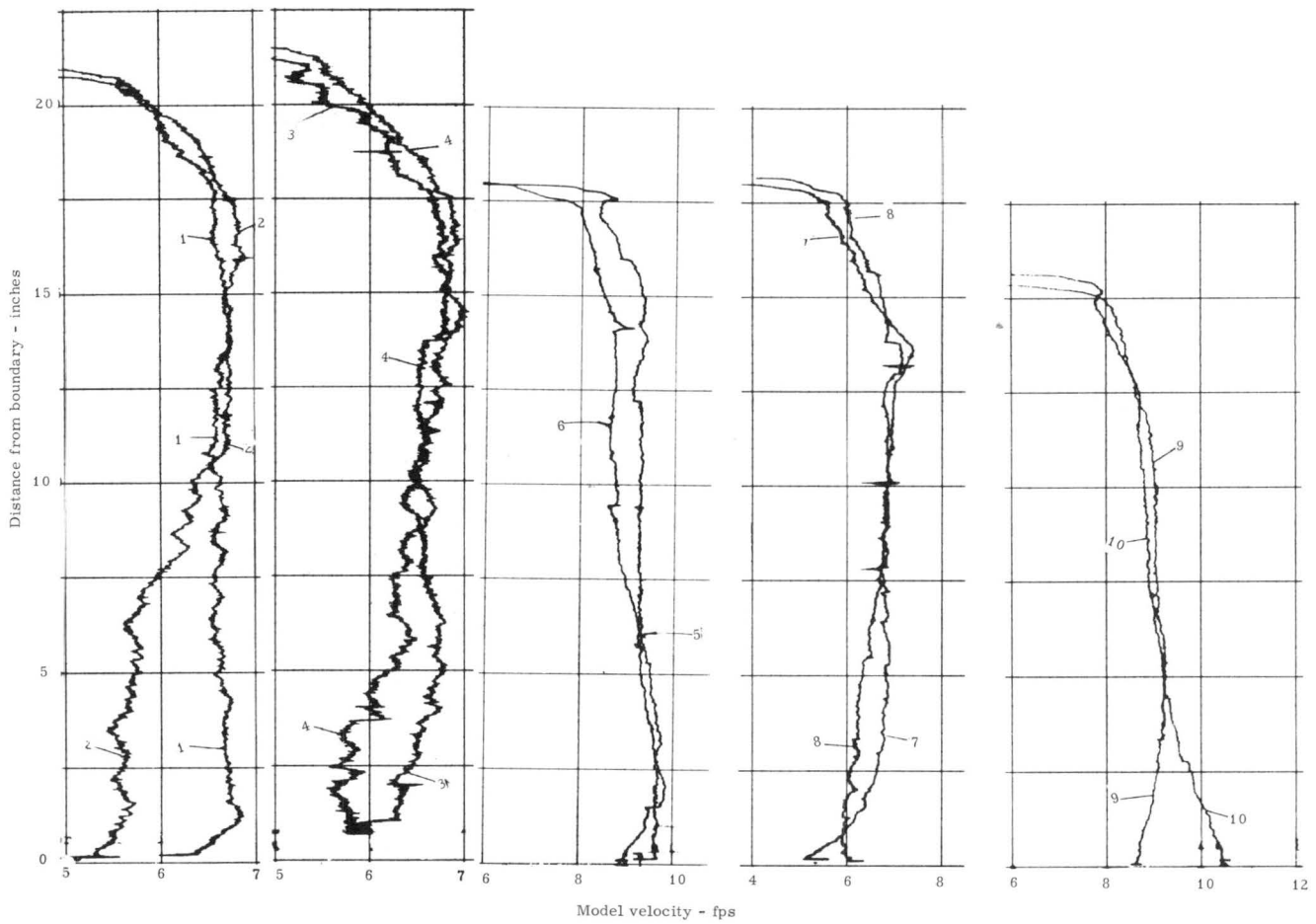

Run 1A,  $Q_1 = Q_2 = Q_3 = Q_4 = 3.95$  cfs, 25% of total discharge

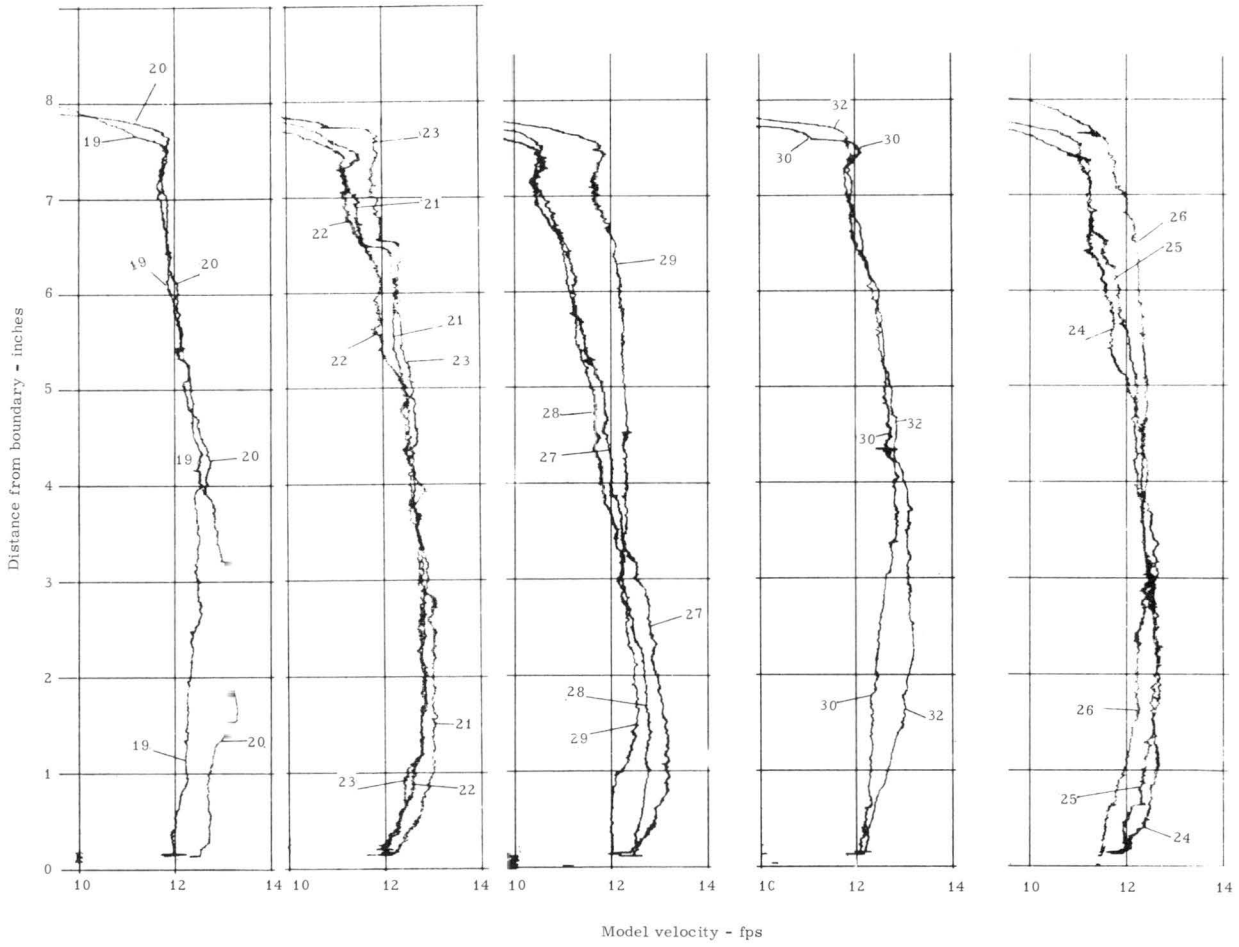

Run 1A,  $Q_1 = Q_2 = Q_3 = Q_4 = 3.95$  cfs, 25% of total discharge



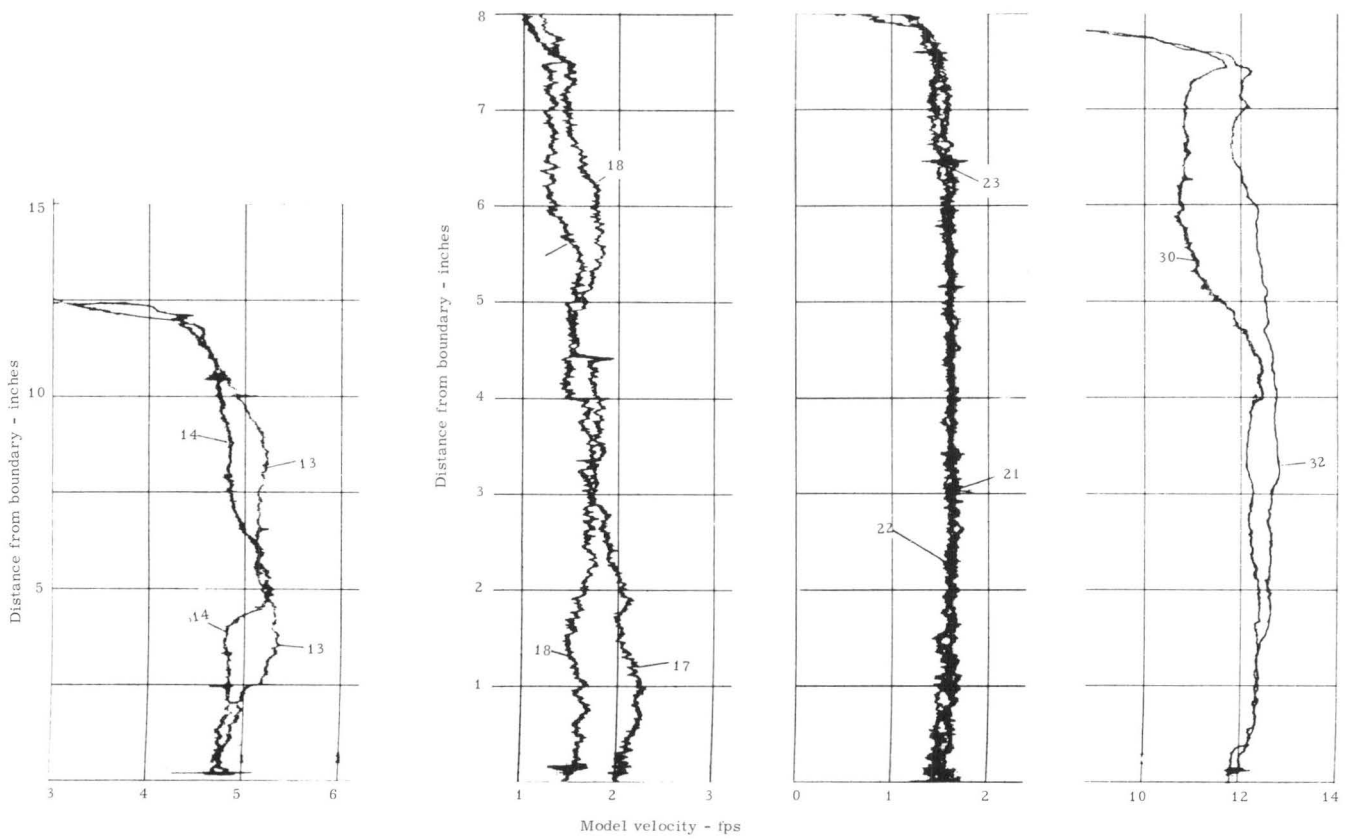
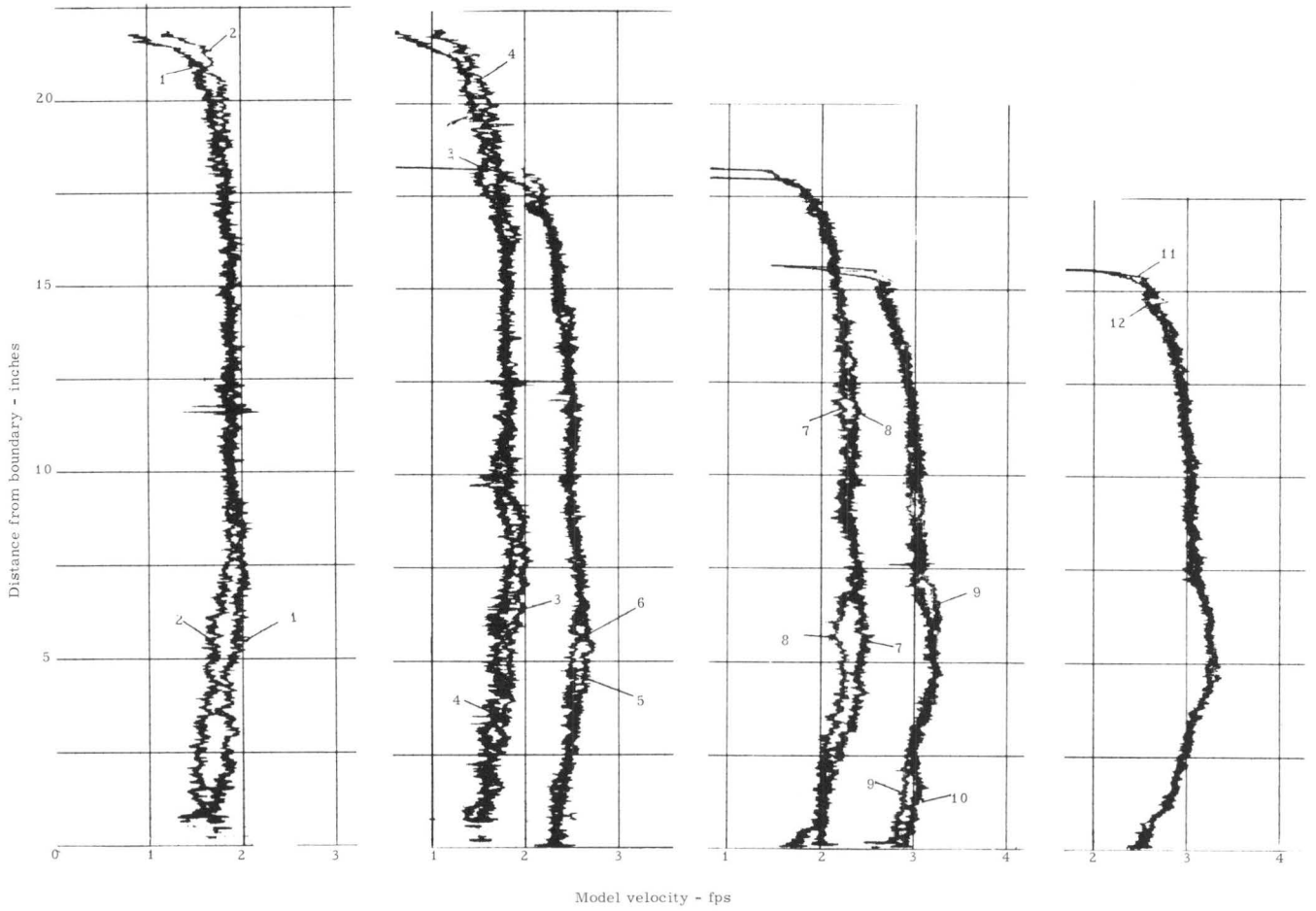

Run 2B,  $Q_1 = 0.55$  cfs, 12.22% of total discharge;  $Q_4 = 3.95$  cfs, 87.78% of total discharge

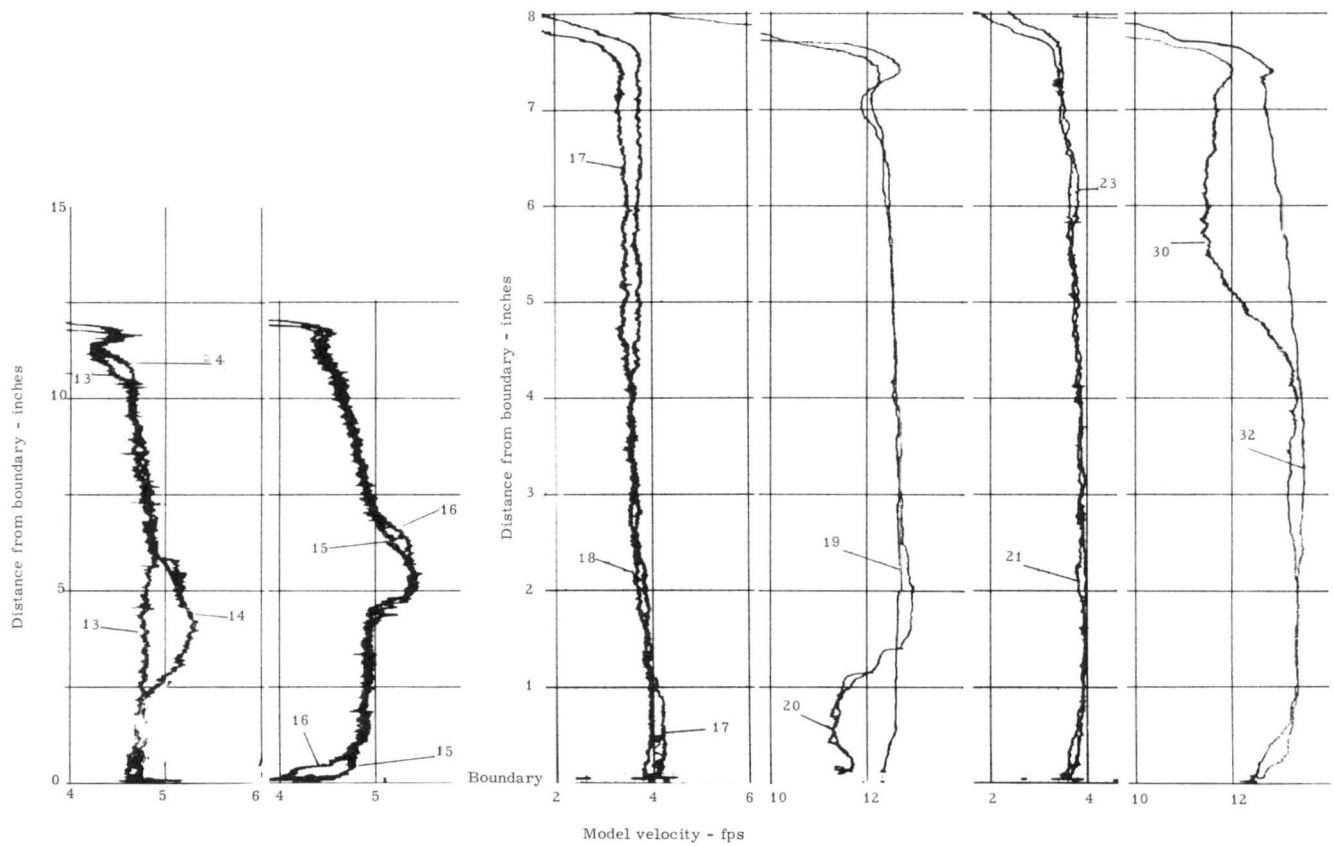
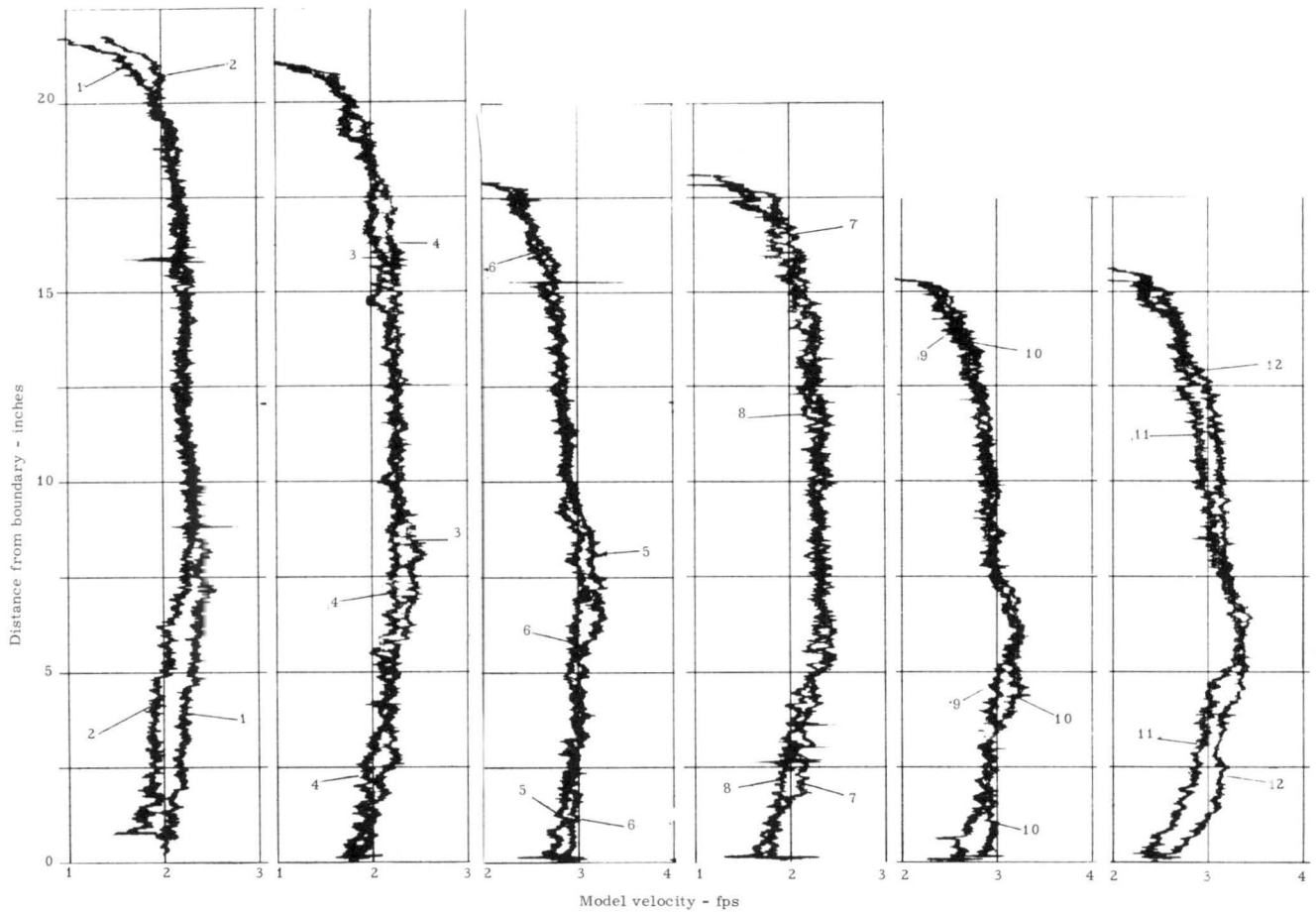

Run 2C,  $Q_1 = 1.32$  cfs, 25% of total discharge;  $Q_4 = 3.95$  cfs, 75% of total discharge

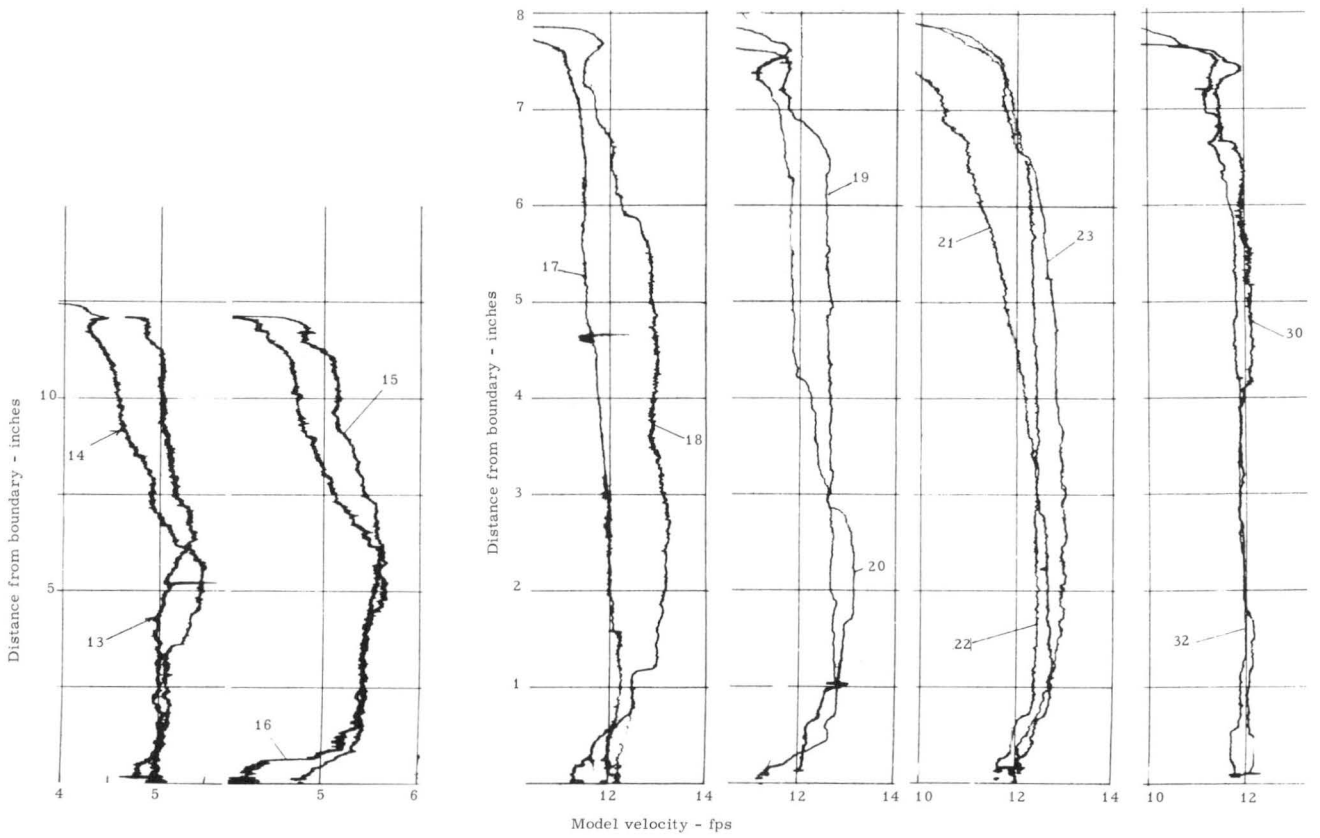
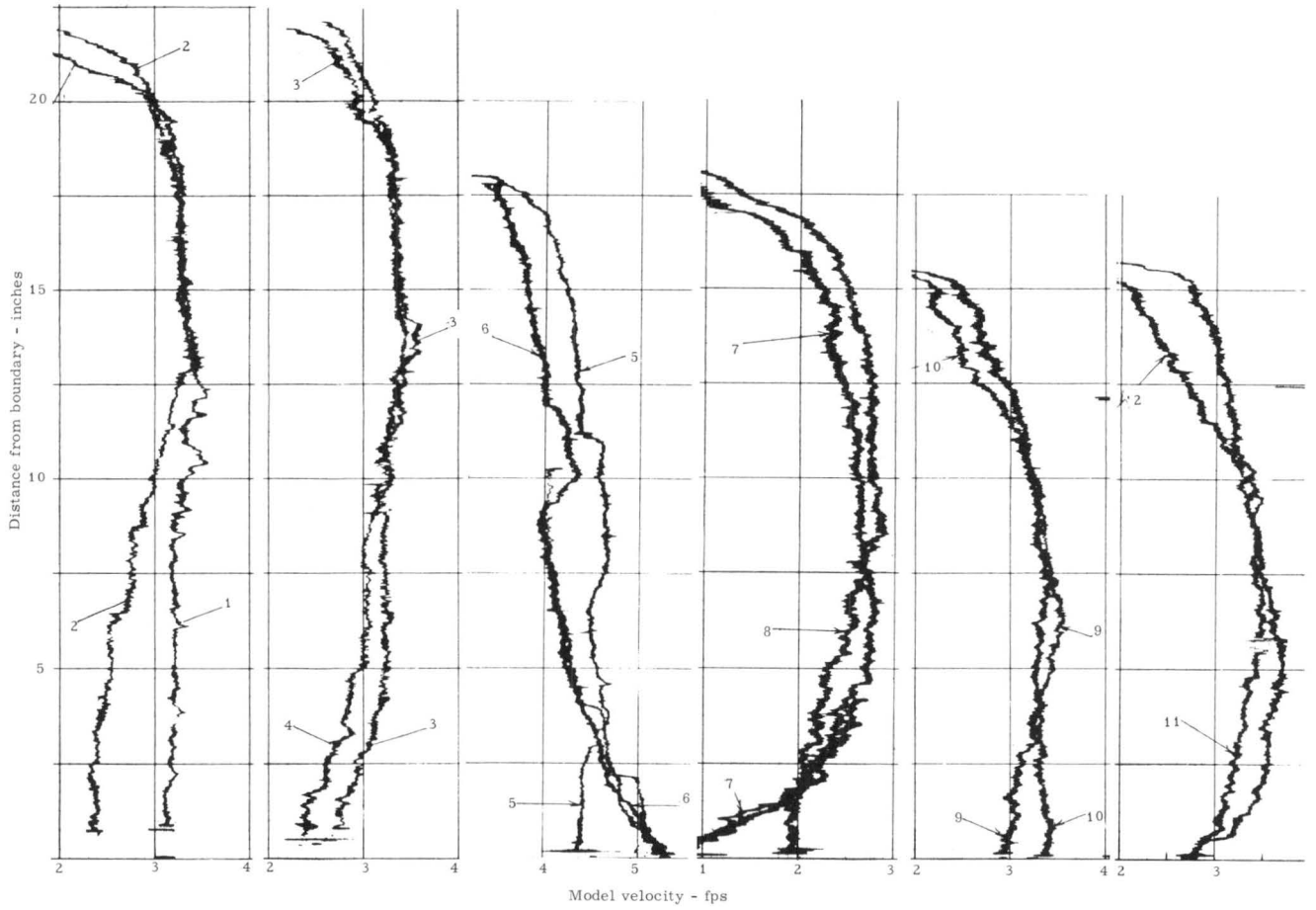

Run 2D,  $Q_1 = Q_4 = 3.95$  cfs, 50% of total discharge

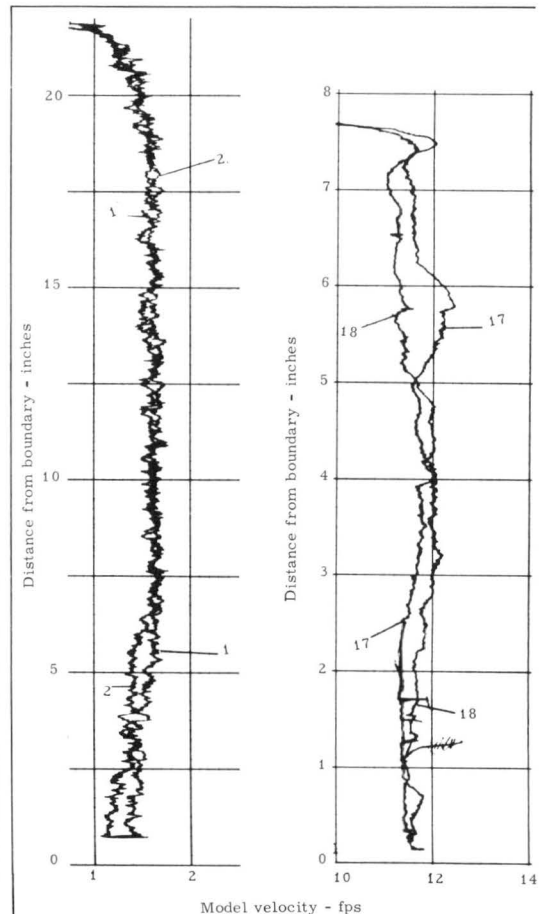
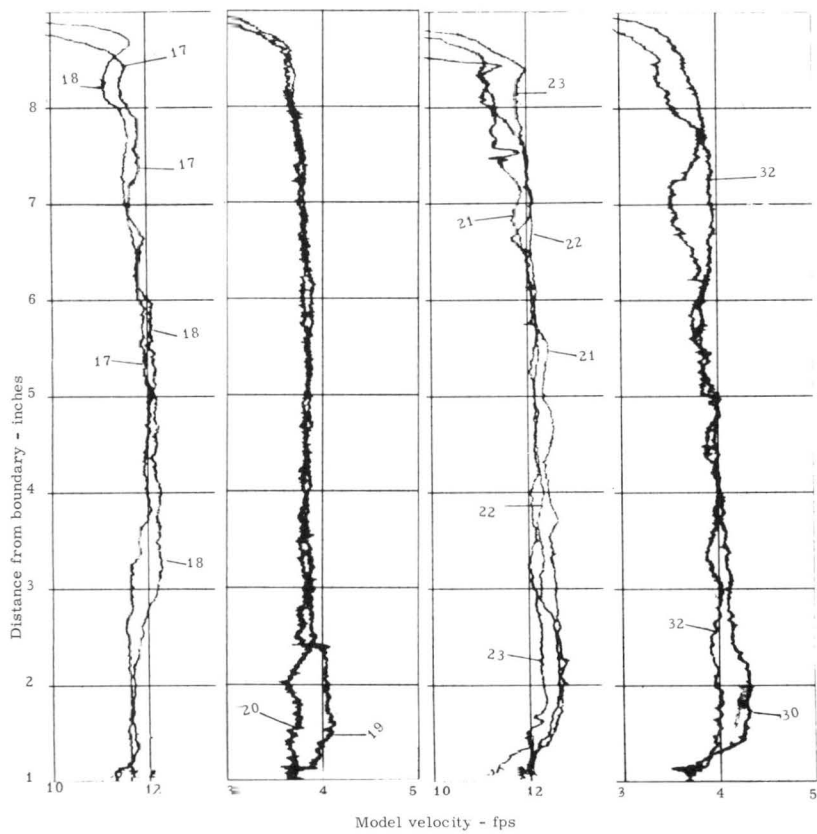
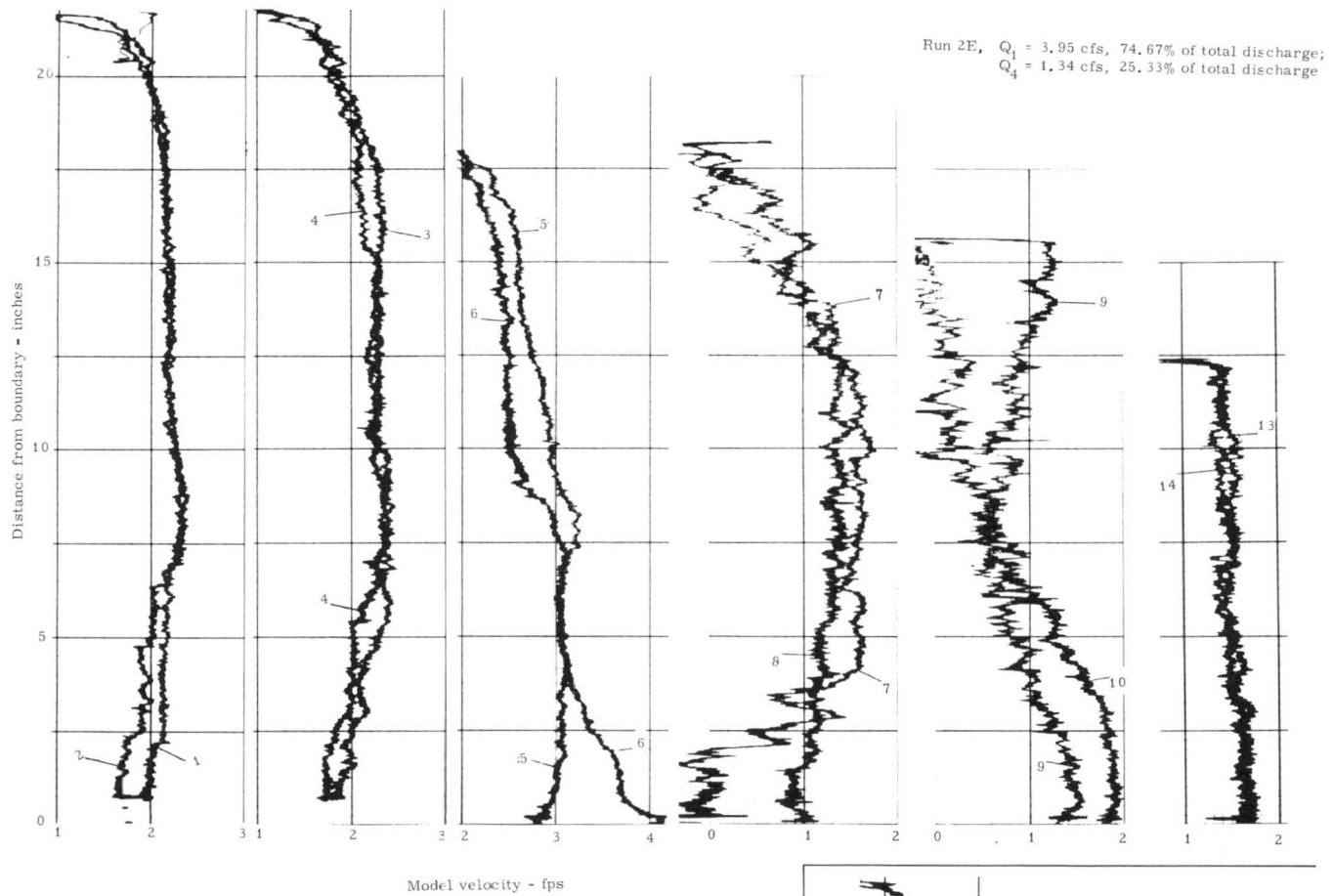

Run 2F,  $Q_1 = 3.95$  cfs, 100% of total discharge

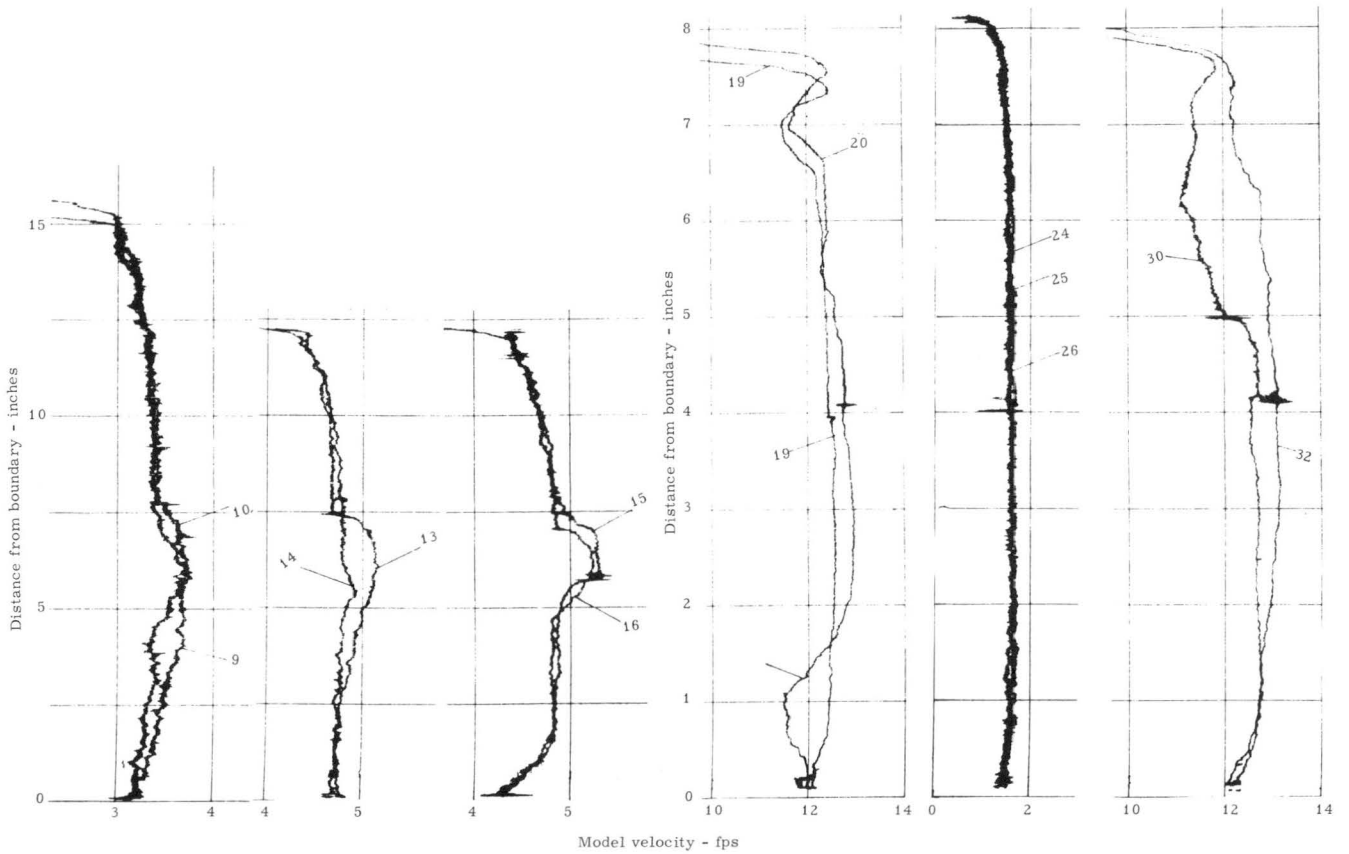
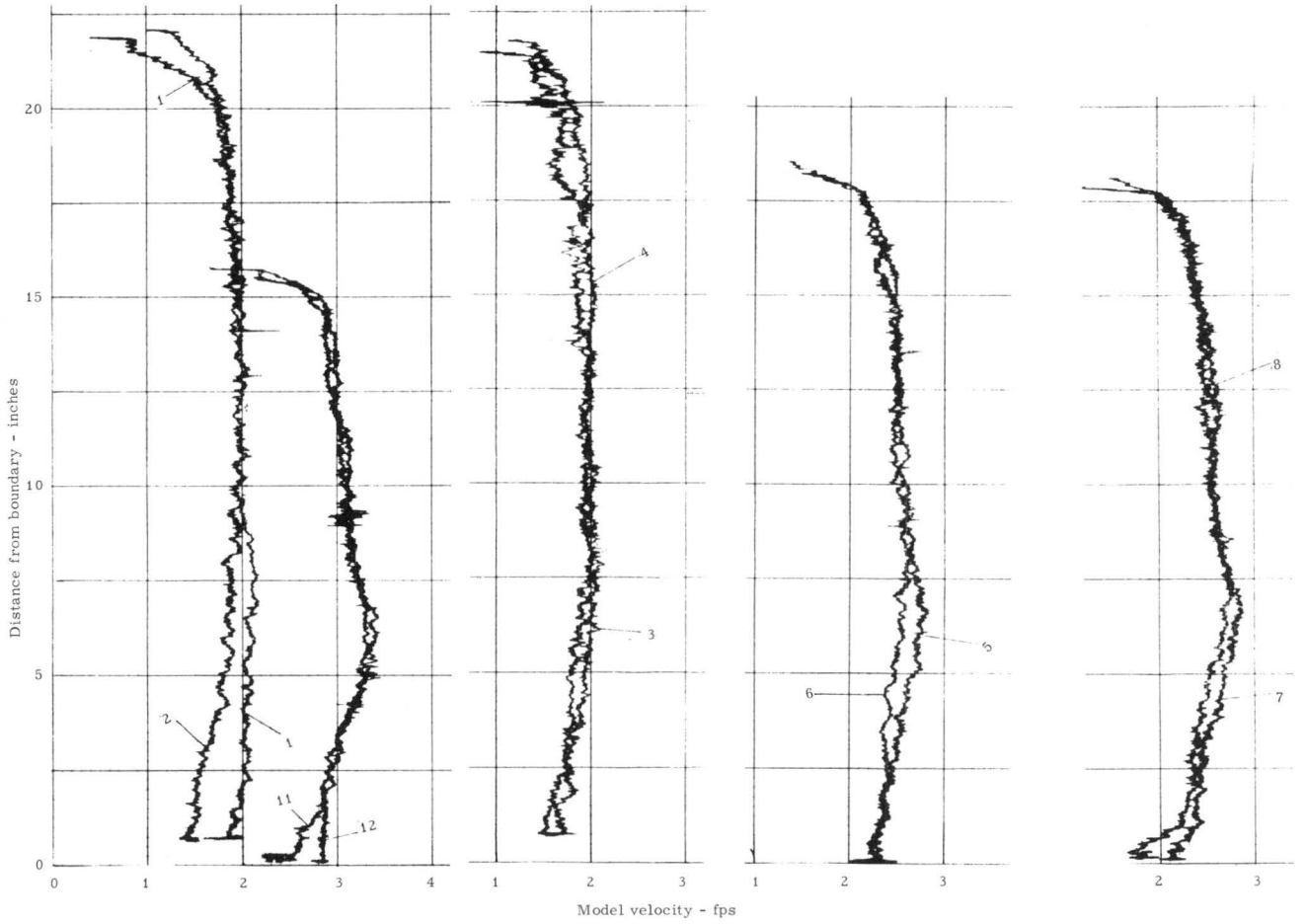

Run 3B,  $Q_2 = 0.56$  cfs, 12.5% of total discharge;  $Q_4 = 3.92$  cfs, 87.5% of total discharge

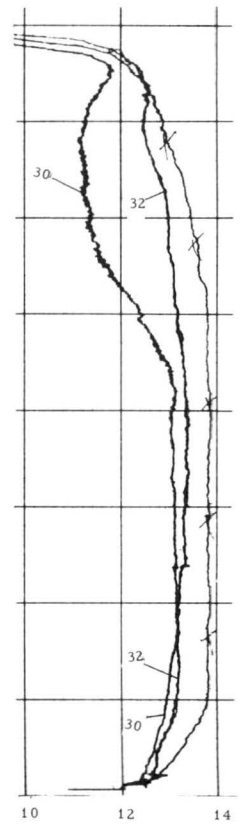
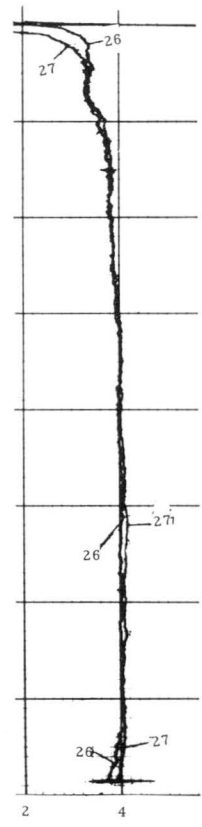
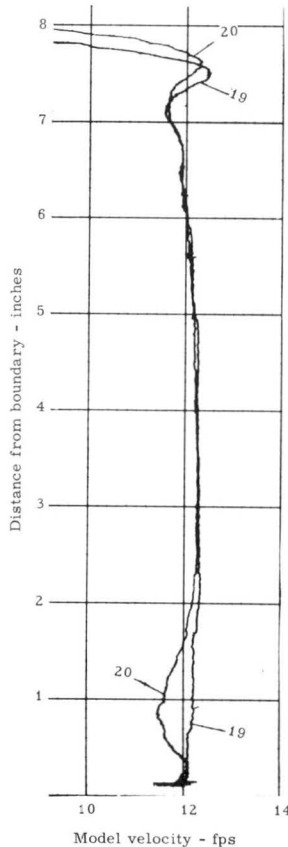
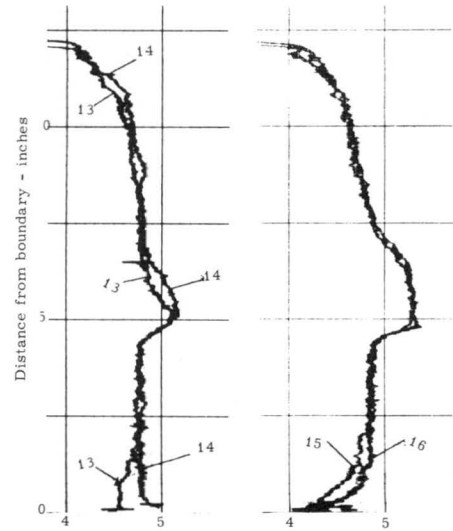
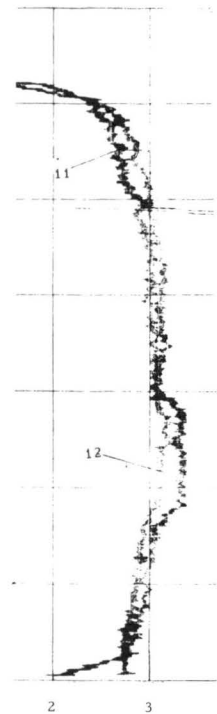
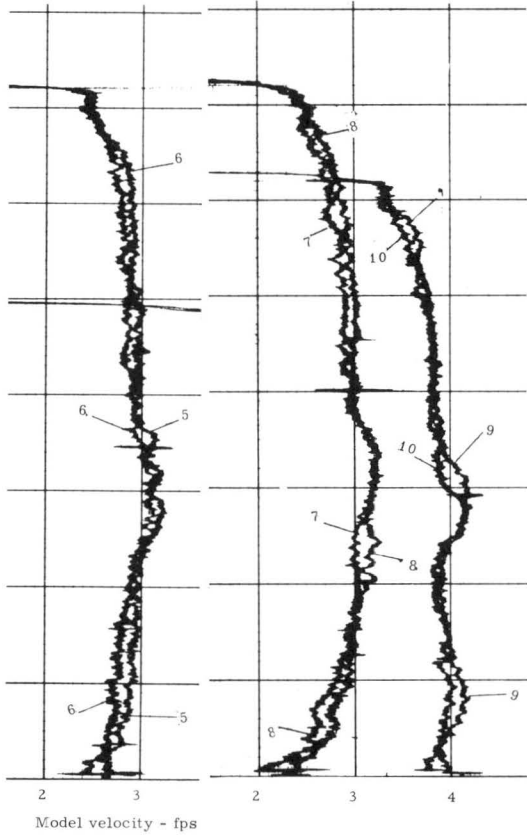
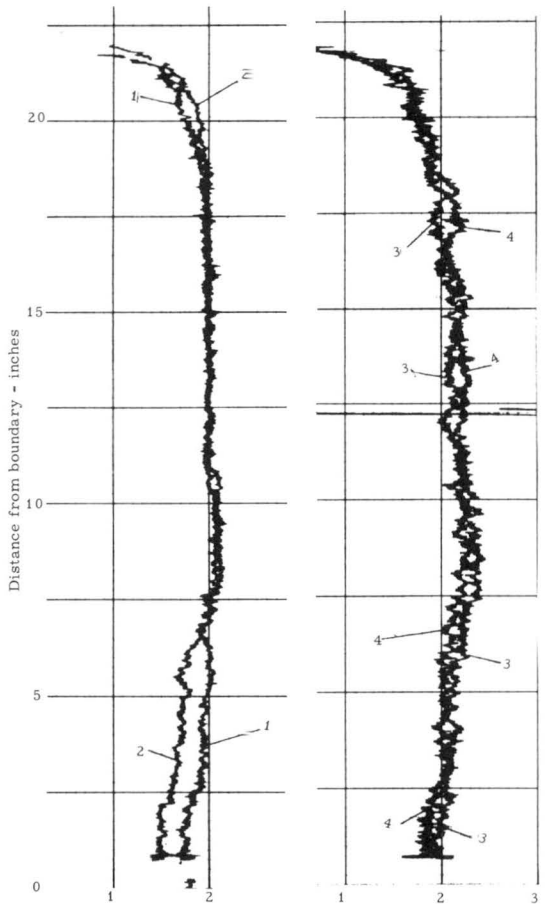

Run 3C,  $Q_2 = 1.32$  cfs, 25% of total discharge;  $Q_4 = 3.95$  cfs, 75% of total discharge

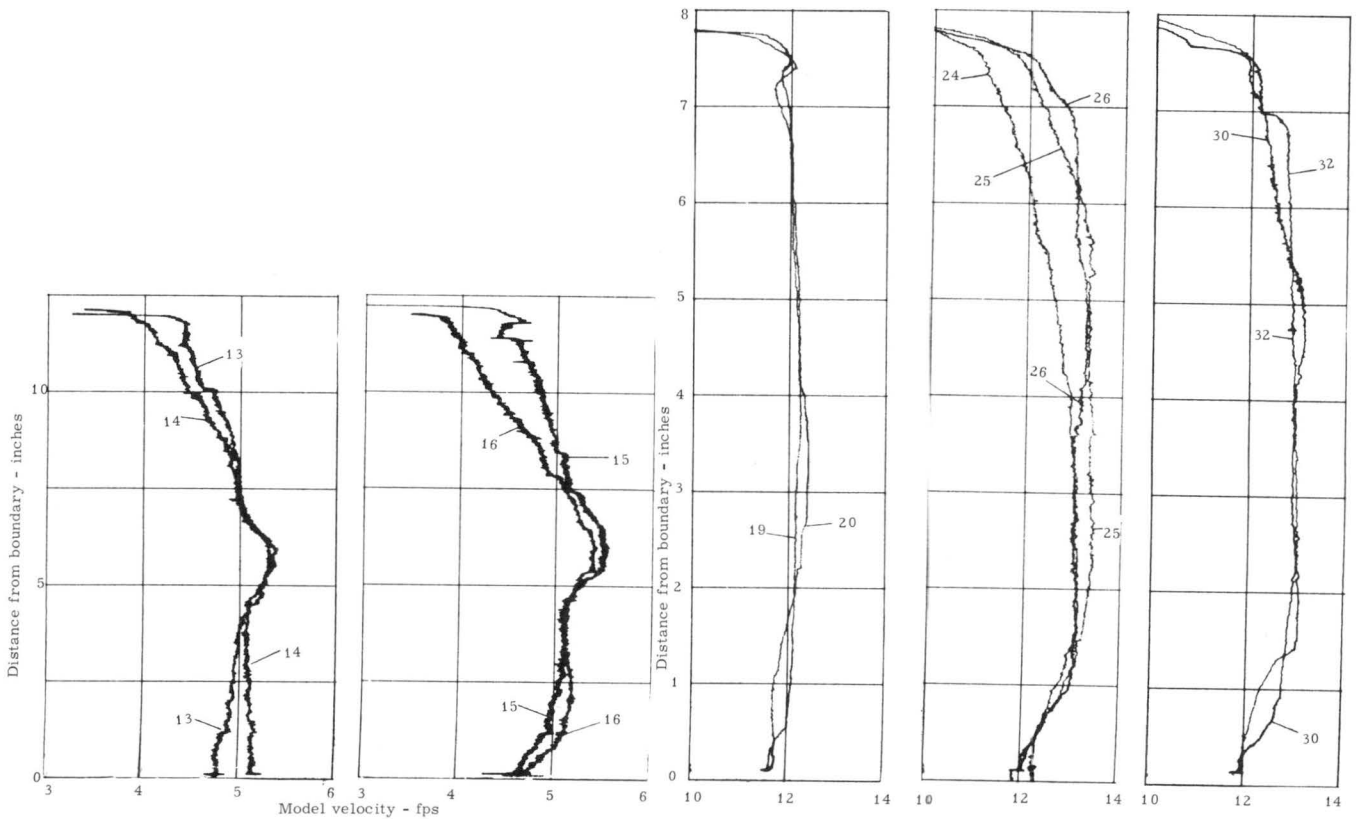
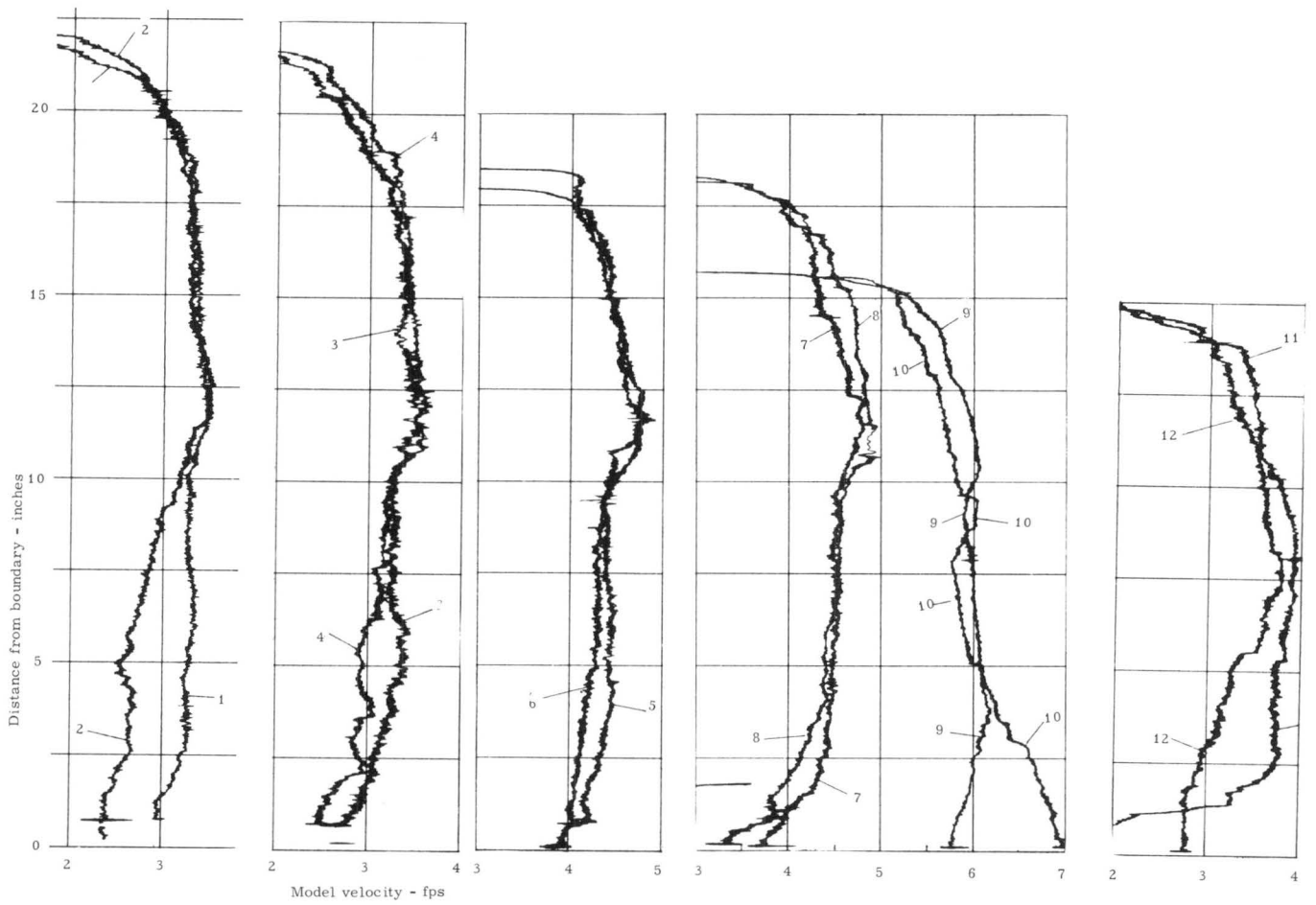

Run 3D,  $Q_2 = 4.02$  cfs, 50% of total discharge;  $Q_4 = 3.95$  cfs, 50% of total discharge

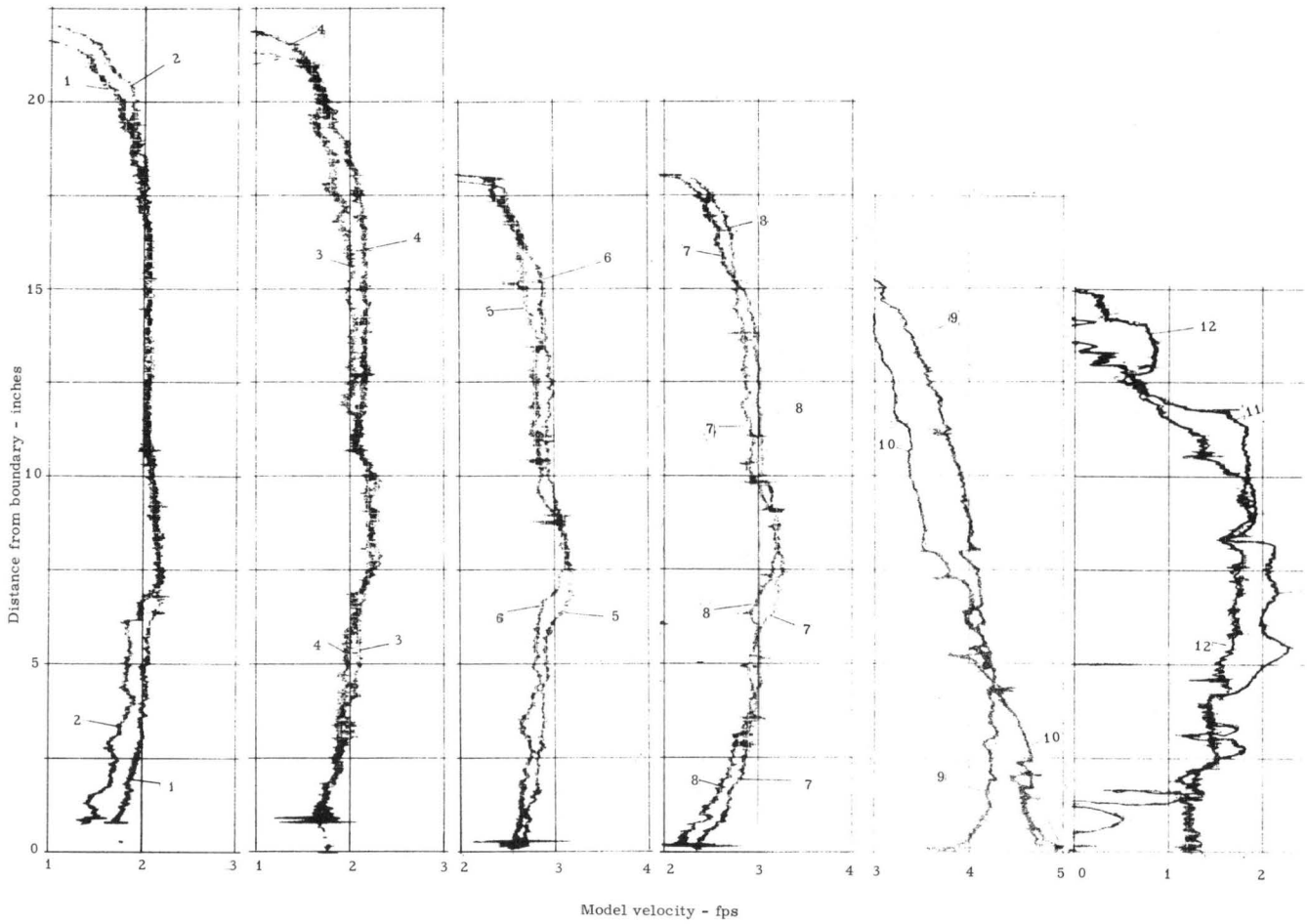

Model velocity - fps

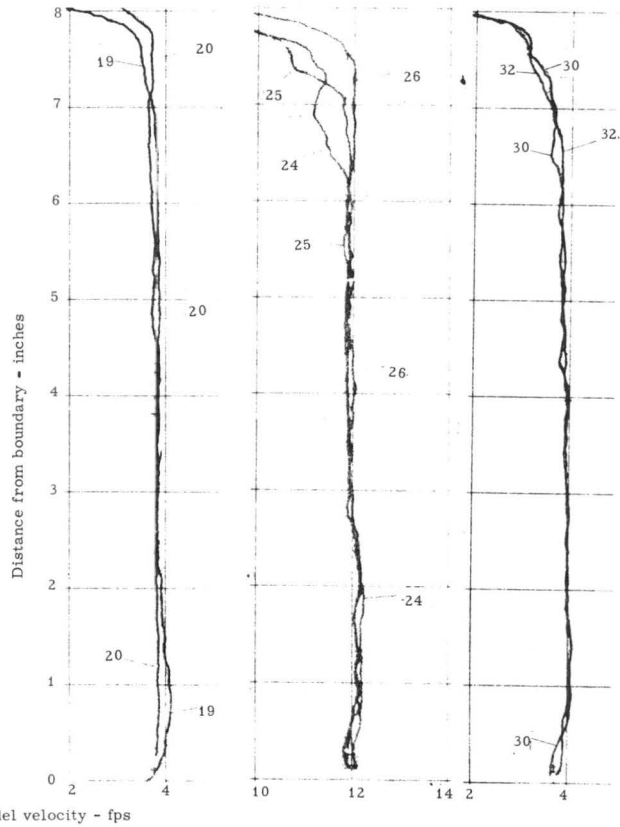
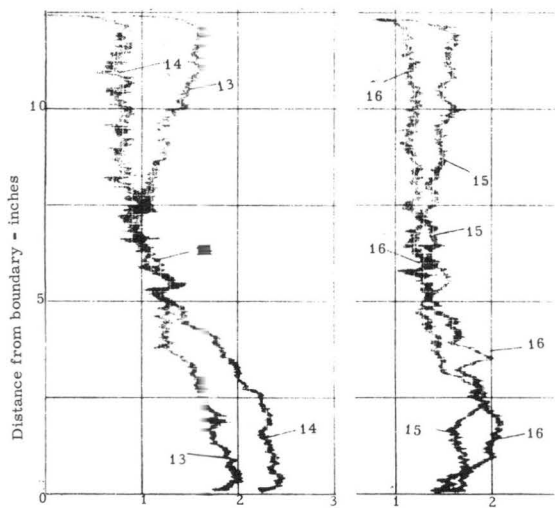

Run 3E,  $Q_2 = 3.97$  cfs, 74.76% of total discharge;  $Q_4 = 1.34$  cfs, 25.24% of total discharge



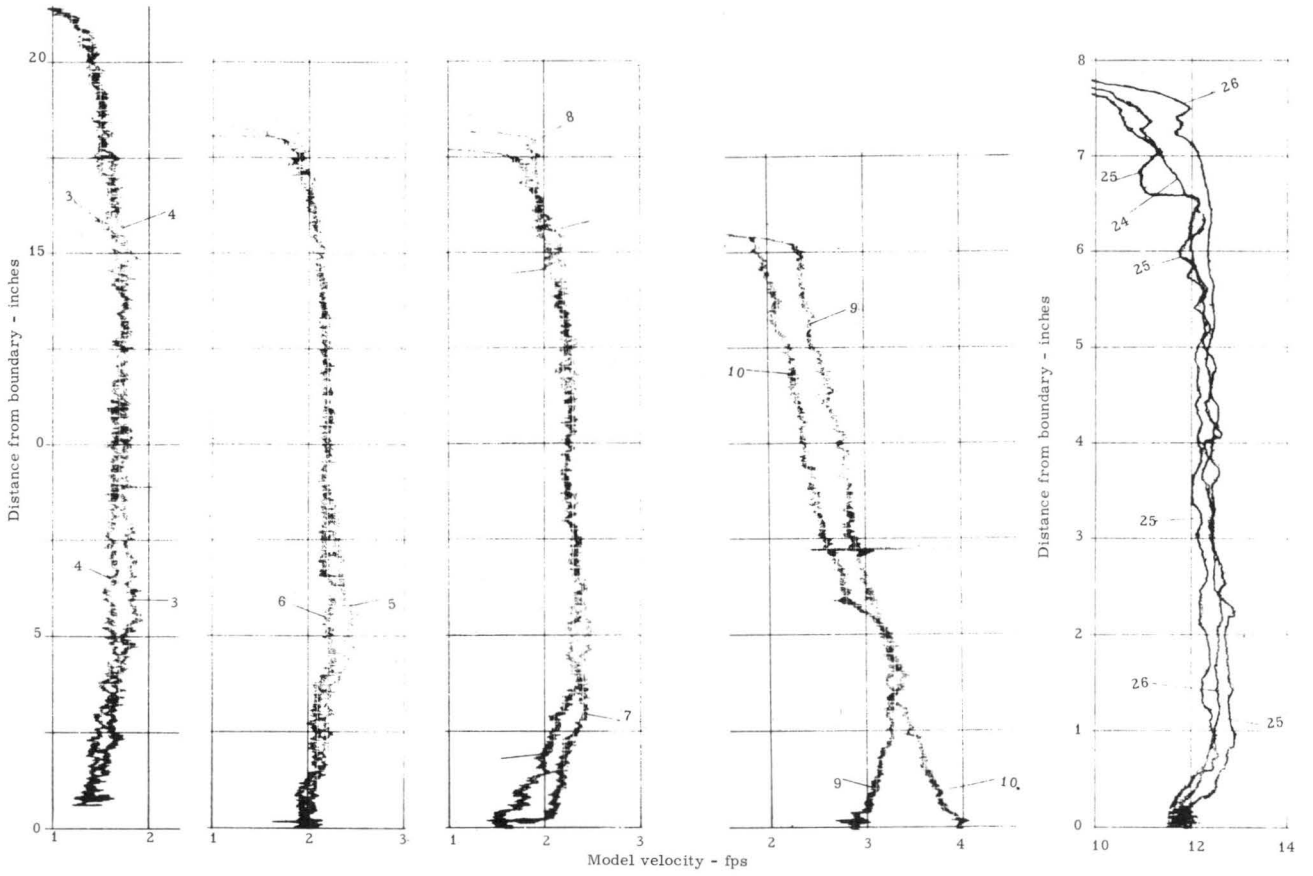

Run 3F,  $Q_2 = 3.92$ , 100% of total discharge

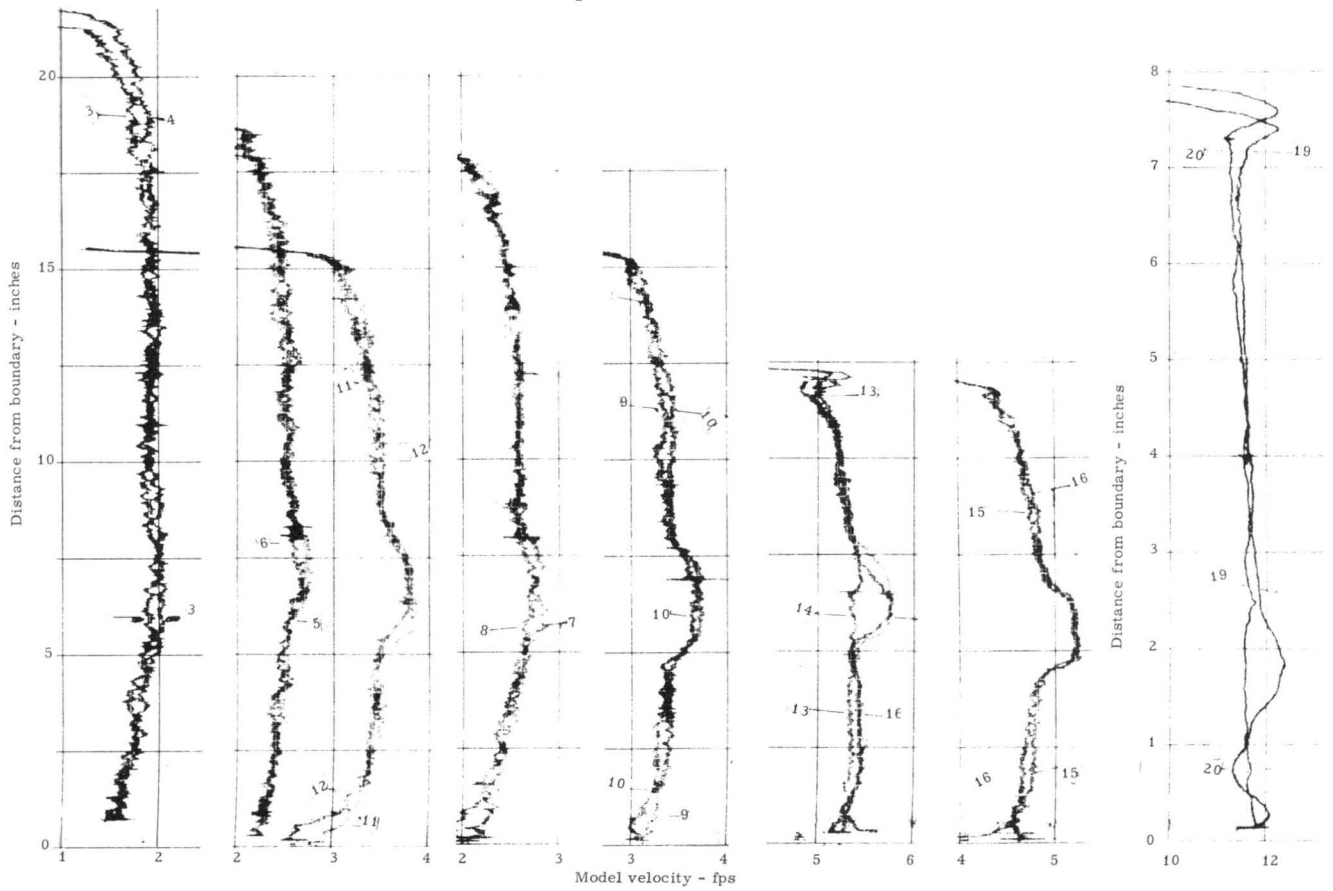

Run 4B,  $Q_3 = 0.56$  cfs, 12.65% of total discharge;  $Q_4 = 3.90$  cfs, 87.35% of total discharge

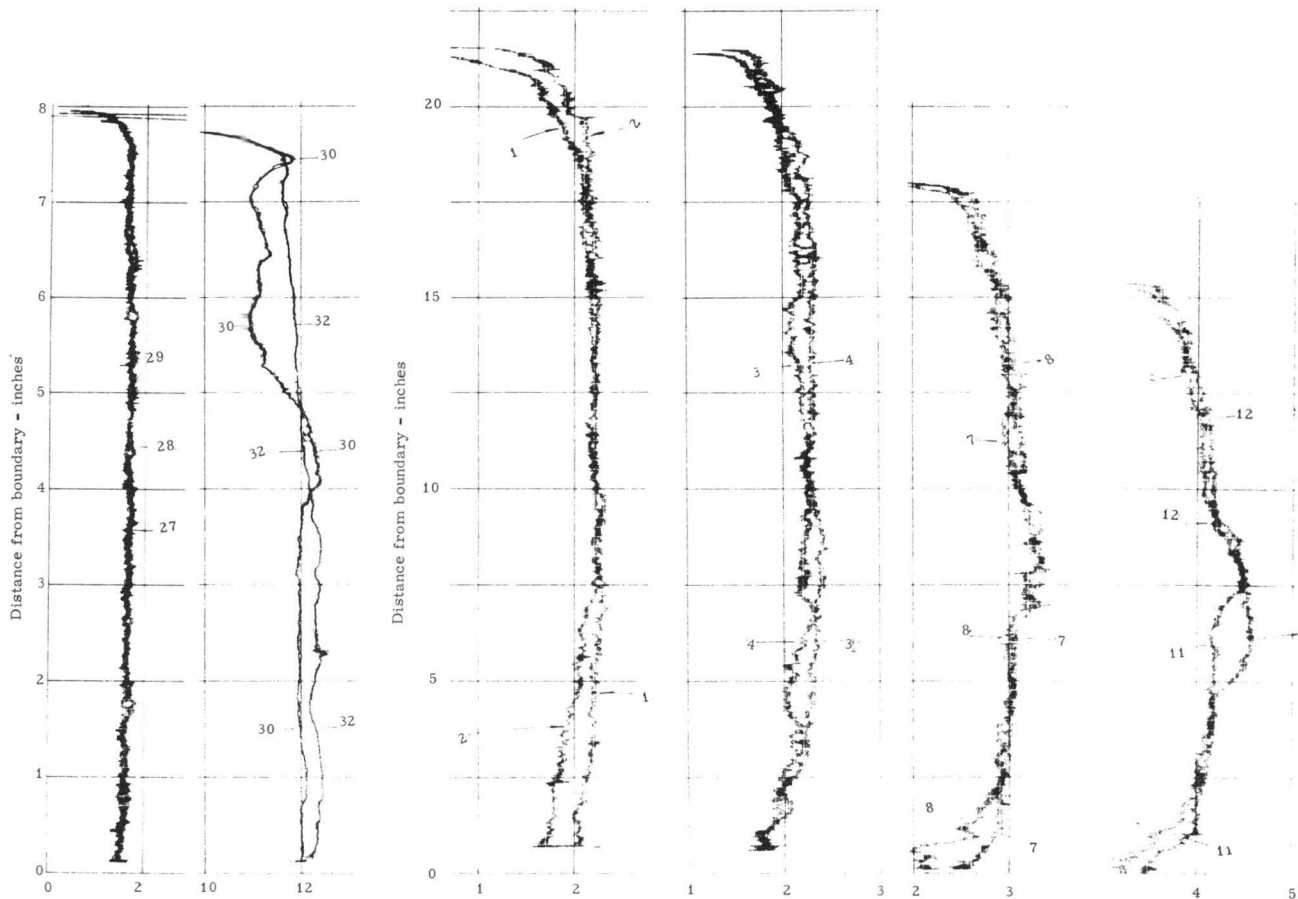

Model velocity - fps  
Run 4B

Model velocity - fps  
Run 4C

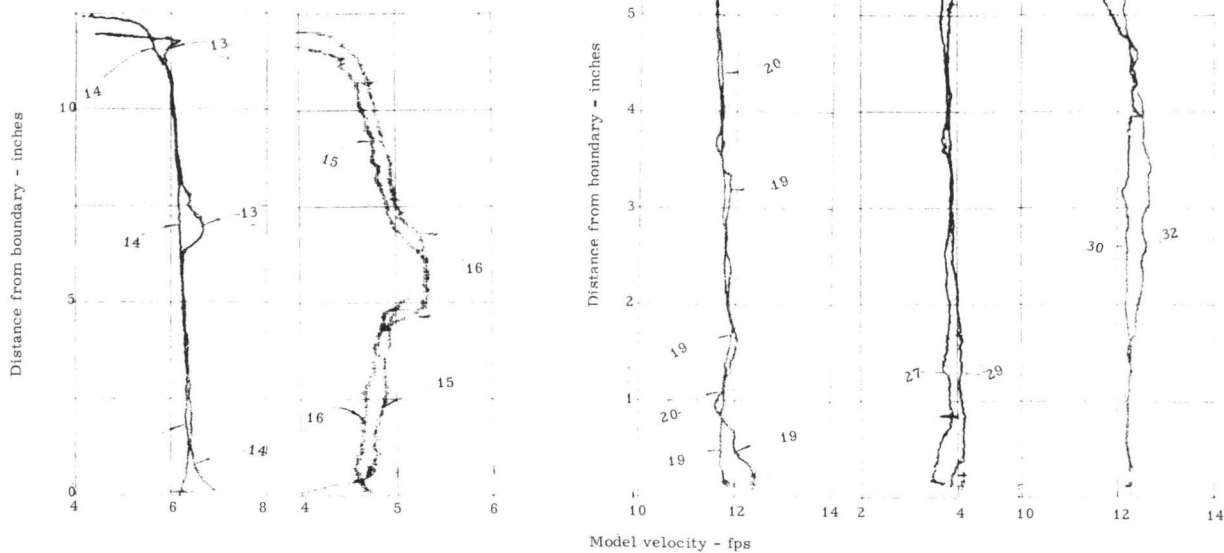

Run 4C,  $Q_3 = 1.31$  cfs, 25% of total discharge;  $Q_4 = 3.95$  cfs, 75% of total discharge

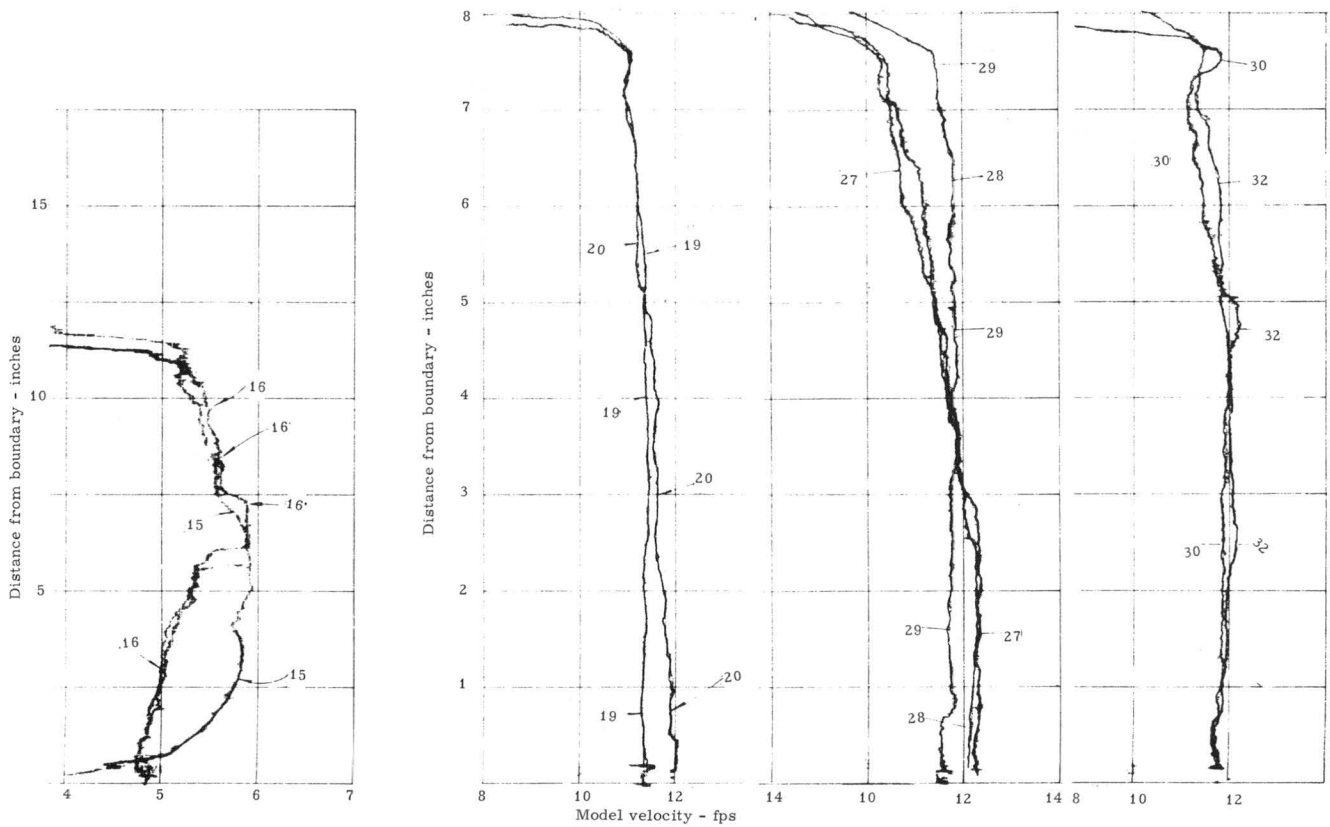
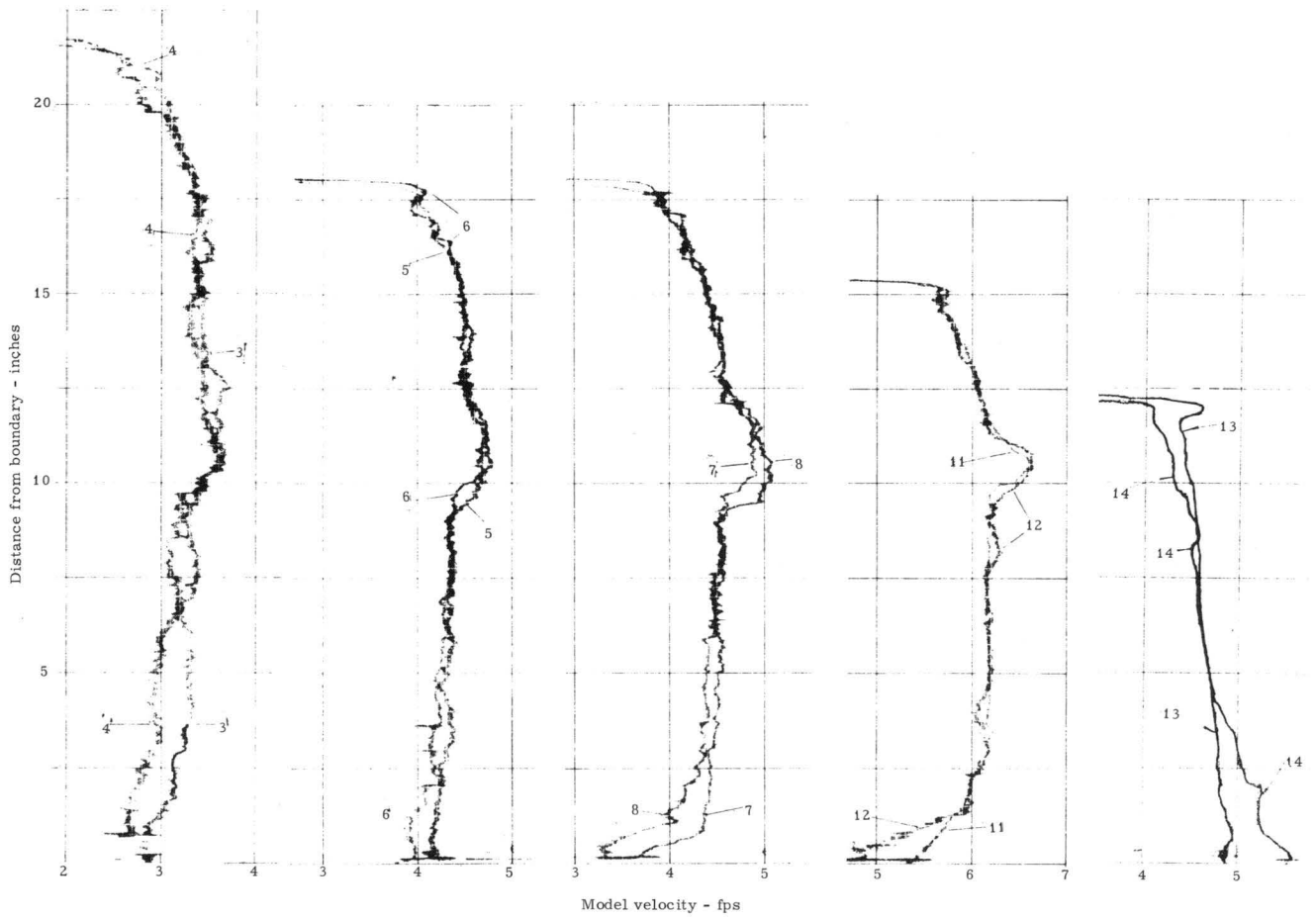

Run 4D,  $Q_3 = 3.94$  cfs, 50% of total discharge;  $Q_4 = 3.94$  cfs, 50% of total discharge

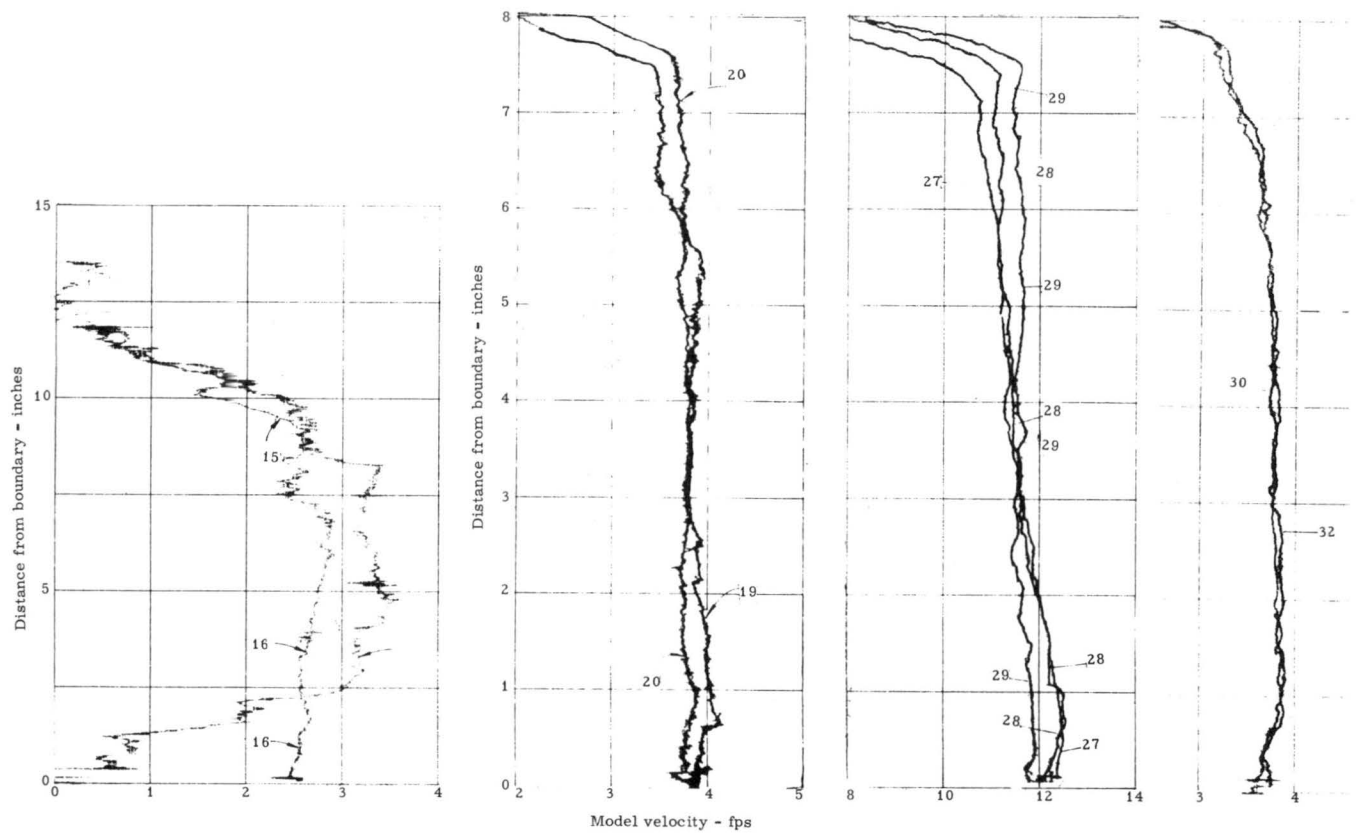
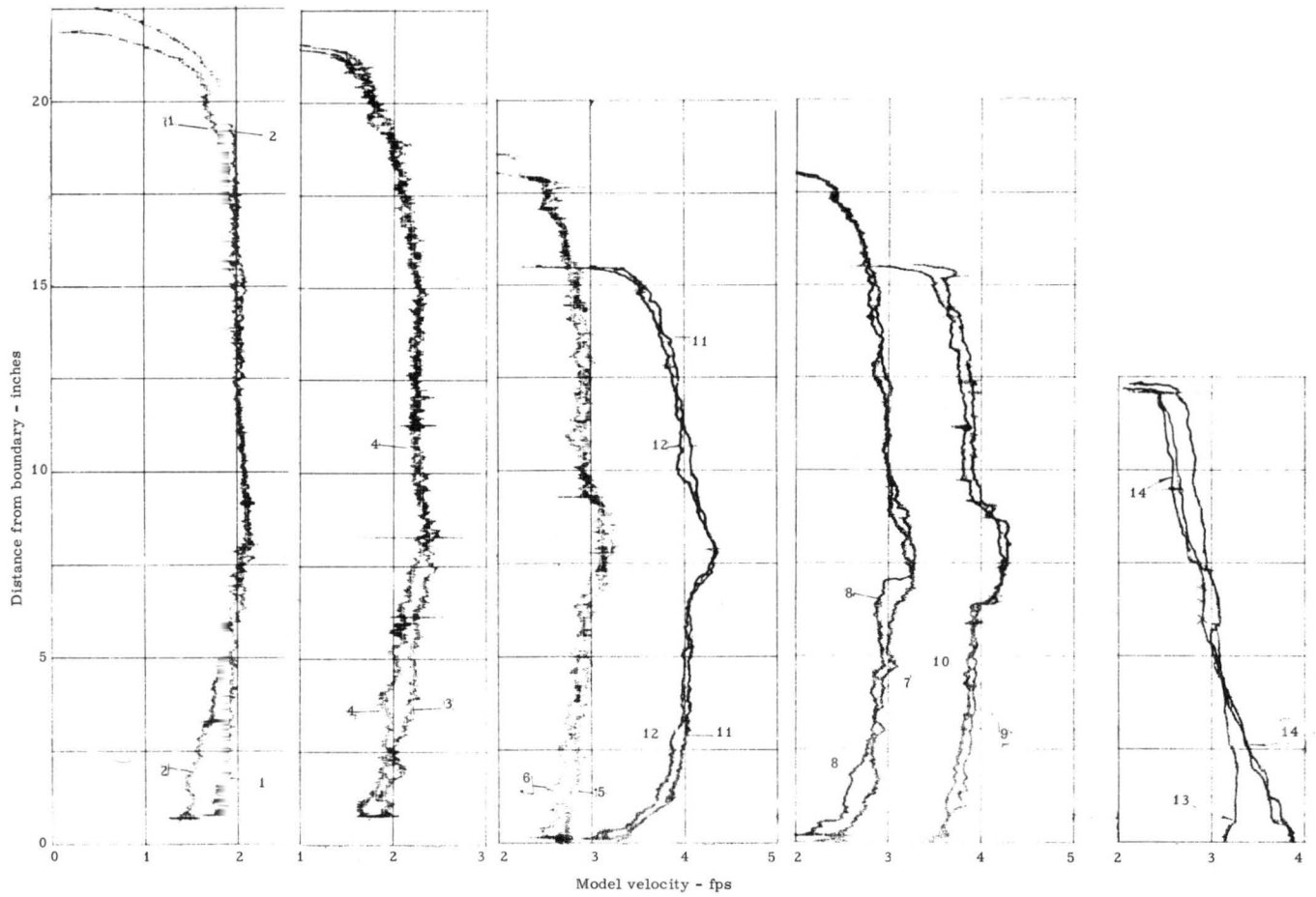

Run 4E,  $Q_3 = 3.94$  cfs, 75% of total discharge;  $Q_4 = 1.34$  cfs, 25% of total discharge

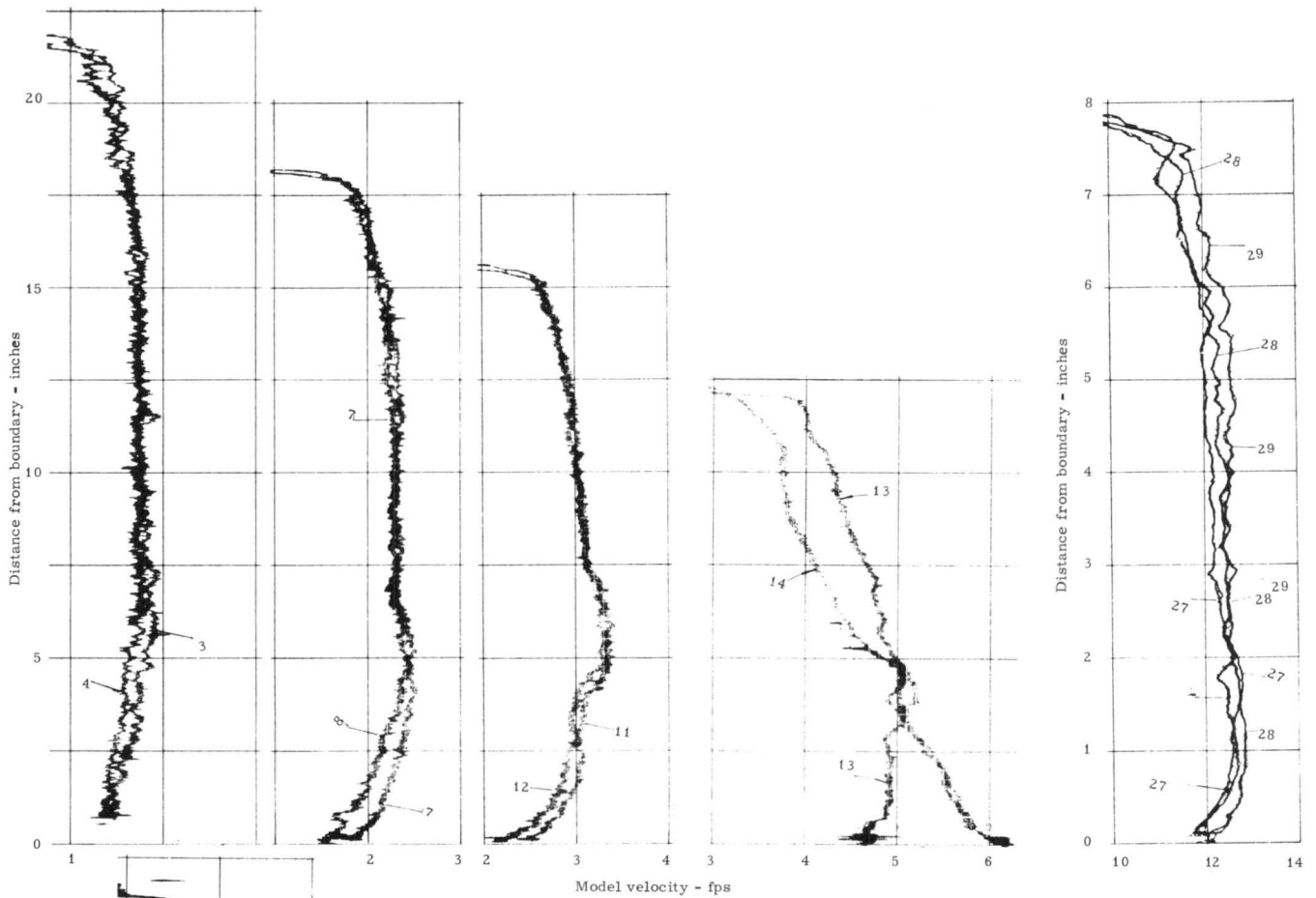

Run 4F,  $Q_3 = 3.95$  cfs, 100% of total discharge

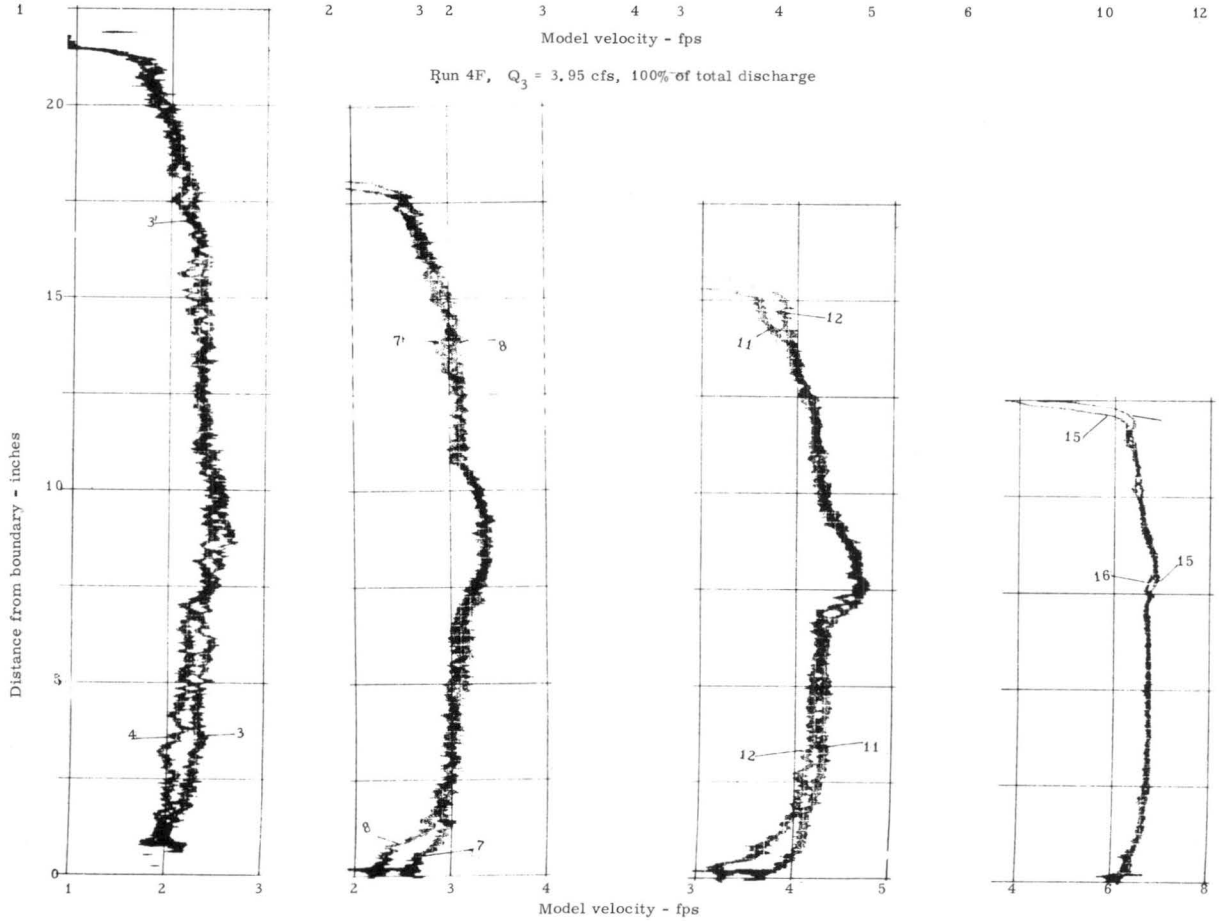

Run 5F,  $Q_4 = 5.45$  cfs, 100% of total discharge

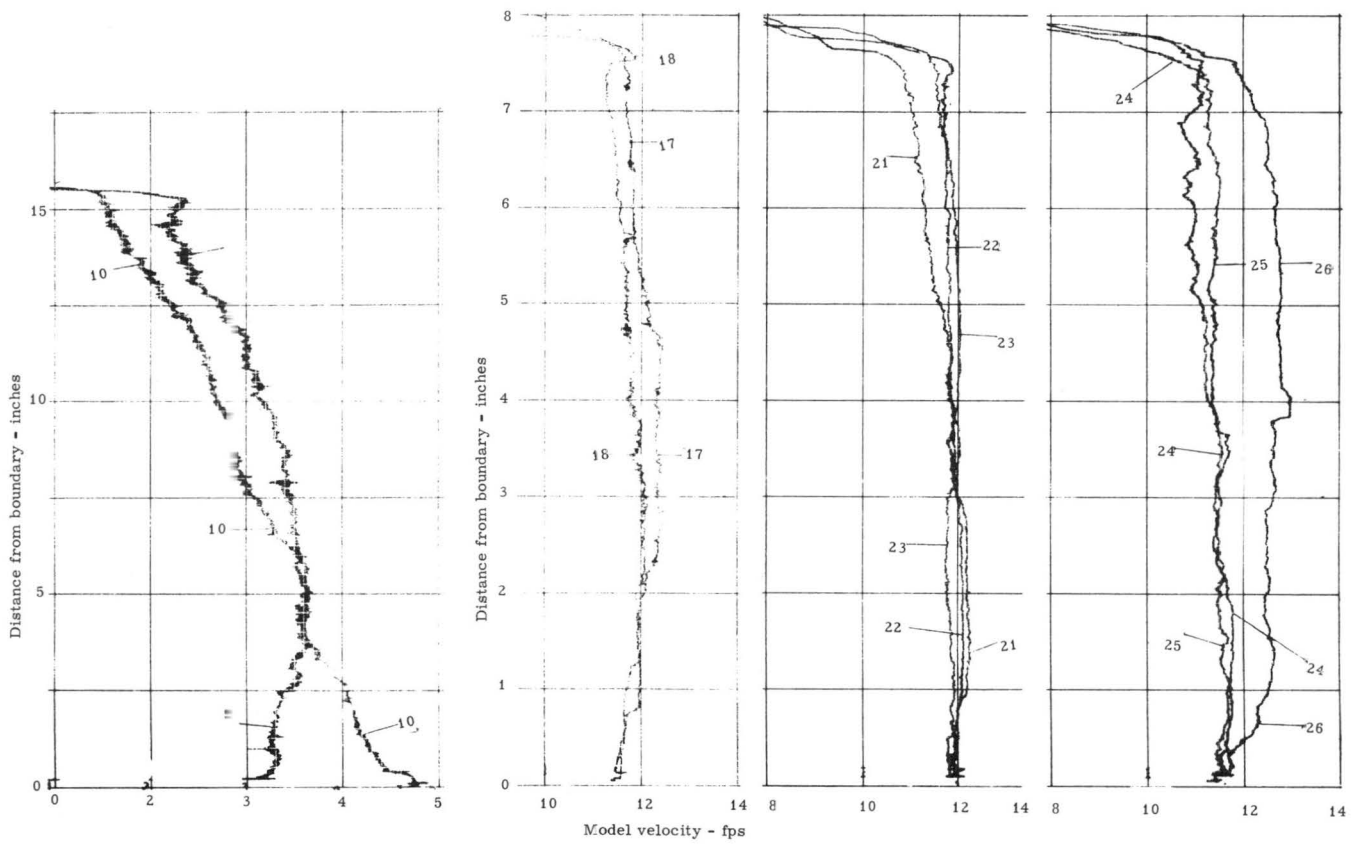
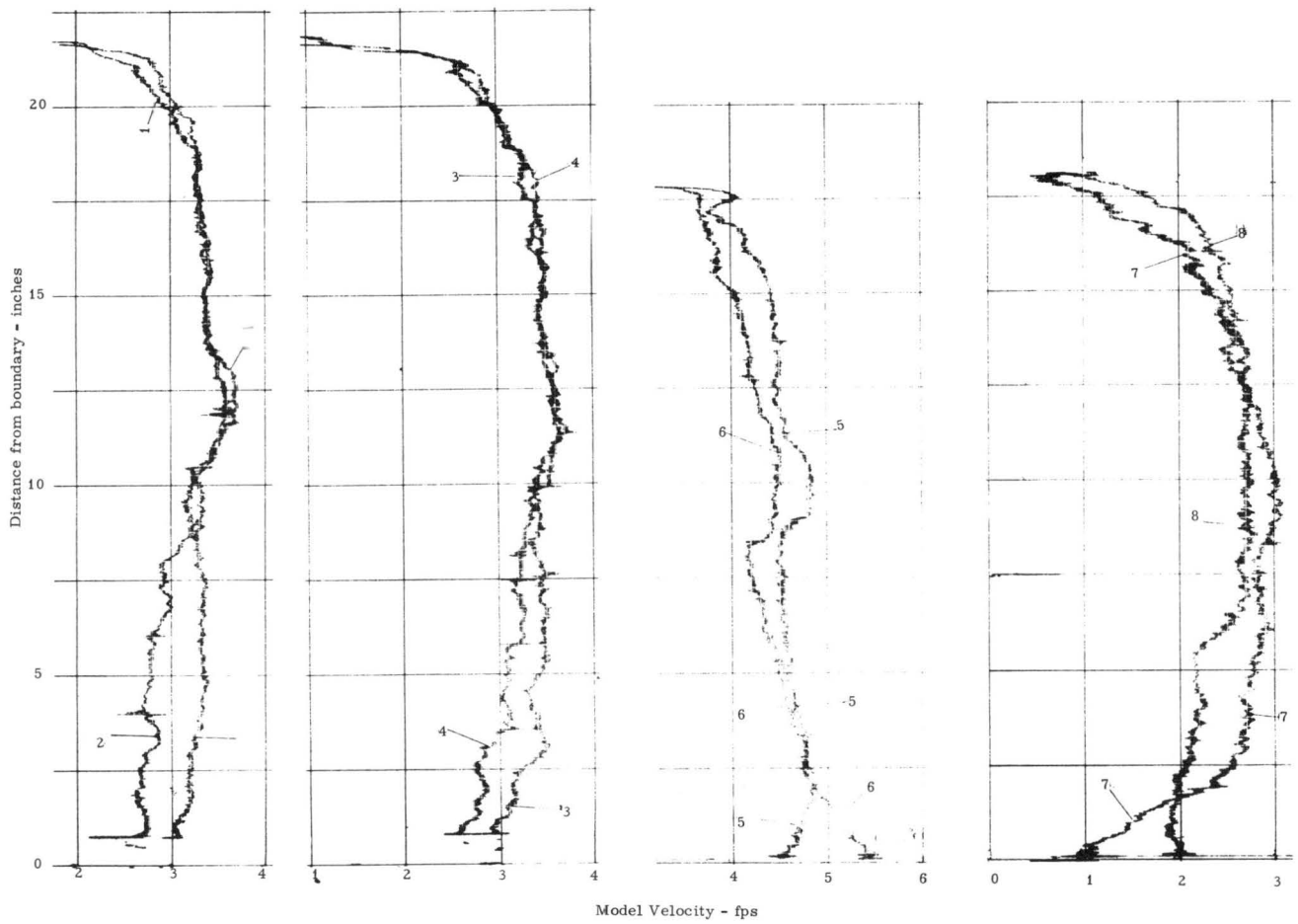

Run 6D,  $Q_1 = 3.95$  cfs, 50% of total discharge;  $Q_2 = 3.95$  cfs, 50% of total discharge

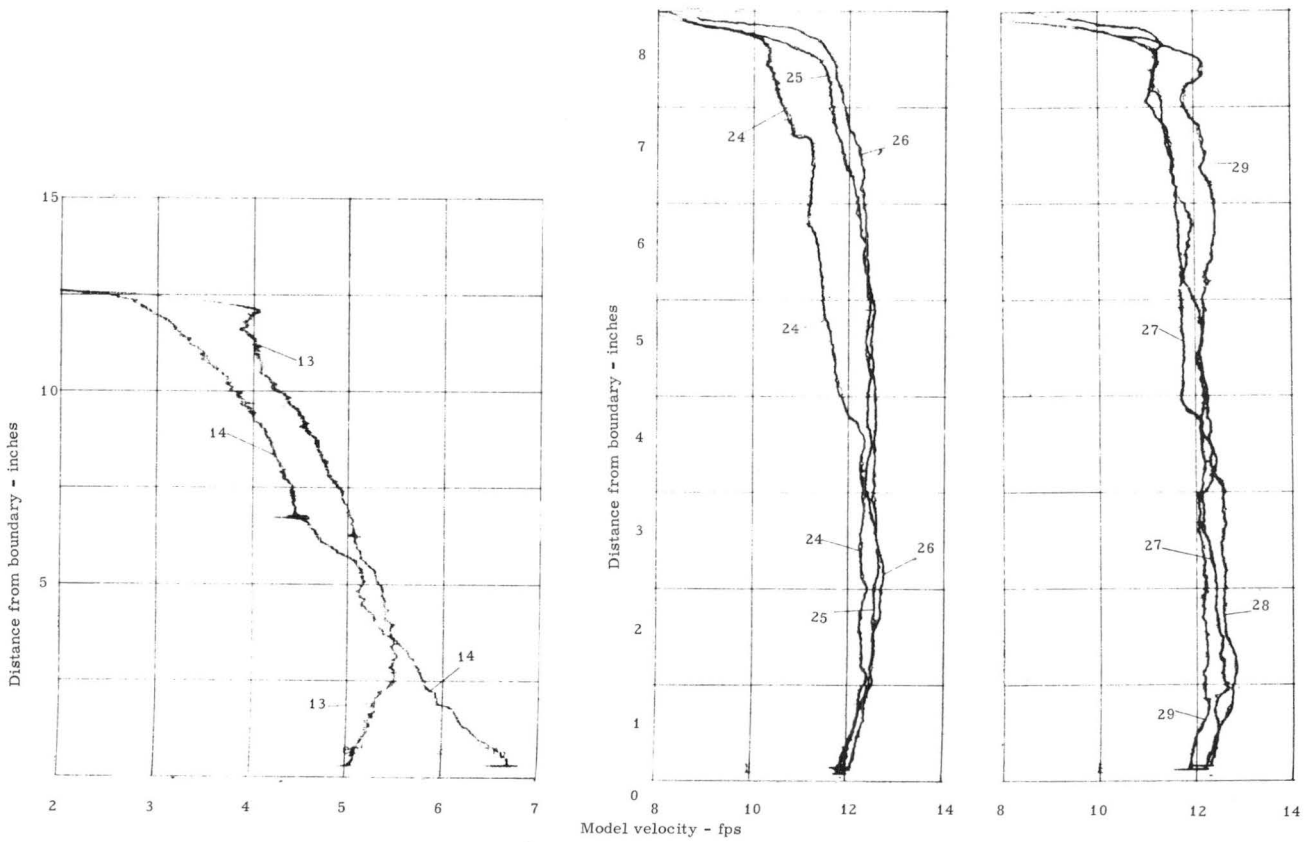
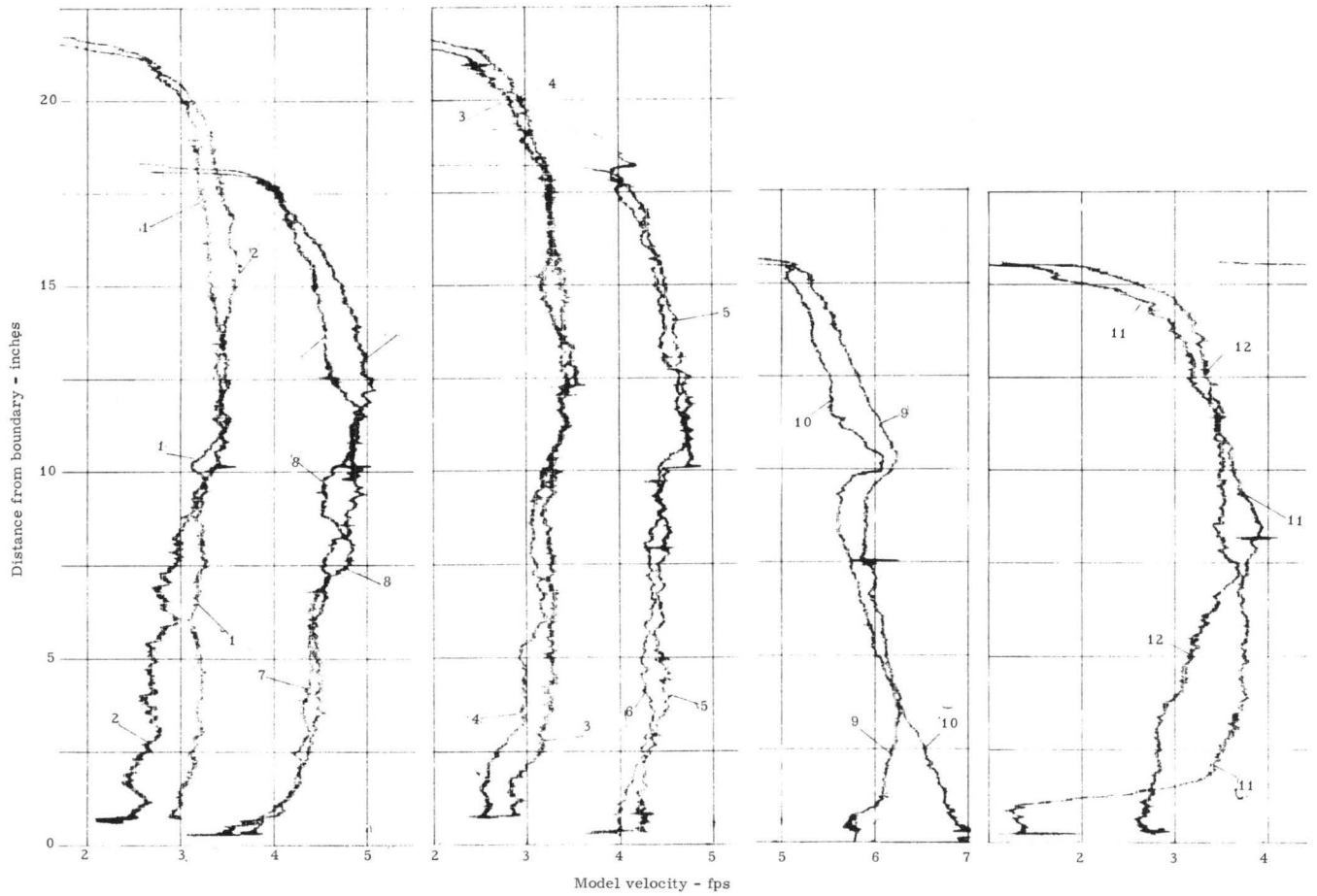

Run 7D,  $Q_2 = 3.94$  cfs, 50% of total discharge;  $Q_3 = 3.94$  cfs, 50% of total discharge

APPENDIX B-1

PRESSURE HEADS ALONG MANIFOLD AND BYPASS RELIEF BRANCH WALLS



PRESSURE HEAD ALONG MANIFOLD AND BYPASS RELIEF BRANCH WALLS

Run #	1-HB	2-HB	3-HB	4-HB	5-HB	6-HB	7-HB	8-HB	9-HB	10-HB
Q Br. 1	0	0	0	0	0	0	0.50 cfs	1.35 cfs	5.27 cfs	3.04 cfs
Q Br. 2	0	0	0	0	0	0	0	0	0	0
Q Br. 3	0	0	0	0	0	0	0	0	0	0
Q Br. 4	5.27 cfs	3.05 cfs	1.40 cfs	0.50 cfs	0	0	0	0	0	0
Q Relief Valve	1.83 cfs	2.00 cfs	1.97 cfs	2.00 cfs	2.10 cfs	2.00 cfs	2.05 cfs	2.00 cfs	1.30 cfs	2.00 cfs
Temp.	70°F	70°F	70°F	70°F	70°F	70°F	70°F	70°F	70°F	70°F
Piezo. No.	Pres. Head	Pres. Head	Pres. Head	Pres. Head	Pres. Head	Piezo. No.	Pres. Head	Pres. Head	Pres. Head	Pres. Head
165	11.33	13.45	14.16	14.41	14.54					
166	12.03	14.03	14.62	14.77	14.99	1	14.40	14.56	13.85	
167	11.88	14.17	14.88	15.23	15.39	2	15.30	15.47	14.79	14.26
168	10.77	13.42	14.33	14.70	14.99	3	16.30	16.40	15.68	15.21
169	11.30	13.47	14.21	14.44	14.59	4	15.39	15.46	14.76	14.26
170	12.11	14.09	14.64	14.77	14.97	5	14.45			13.20
171	11.53	13.98	14.82	15.17	15.35	6	15.29			14.24
172	10.17	13.16	14.18	14.64	14.94	7	16.21			15.18
173	10.93	13.32	14.07	14.42	14.62	8	15.38			14.28
174	11.88	13.99	14.61	14.82	15.06	9	14.51			
175	10.99	13.70	14.76	15.04	15.33	10	15.35			14.29
176	9.30	12.70	14.02	14.53	14.88	11	16.19			15.21
177	10.01	12.89	13.96	14.26	14.55	12	15.39			14.28
178	11.51	13.71	14.46	14.74	14.92	13	14.45	14.56	13.78	
179	11.37	13.41	14.62	15.01	15.18	14	15.27	15.46	14.79	14.29
180	8.33	12.27	13.86	14.51	14.86	15	16.31	16.32	15.67	15.15
181	9.44	12.65	13.90	14.35	14.70	16	15.38	15.45	14.77	14.27
182	10.85	13.14	14.43	14.78	15.05	17	14.46	14.65		15.12
183	9.72	13.13	14.45	14.98	15.36	18	15.33	15.50		14.30
184	7.26	11.71	13.68	14.42	14.90	19	16.23	16.35		15.15
185	8.33	12.14	13.75	14.29	14.70	20	15.35	15.48		14.26
186	9.99	13.13	14.31	14.80	15.05	21	14.53	14.70		
187	8.90	12.68	14.41	14.92	15.32	22	15.22	15.47		14.20
188	6.03	11.13	13.51	14.37	14.91	23	16.11	16.29		15.05
189	7.19	11.57	13.58	14.22	14.70	24	15.29	15.49		14.22
190	9.08	12.72	14.26	14.69	15.25	25	14.59	14.75	14.00	
191	8.72	12.64	14.39	14.99	15.50	26	15.41	15.46	14.75	14.21
192	6.63	11.46	13.62	14.43	14.95	27	16.13	16.27	15.46	14.95
193	6.78	11.46	13.61	14.32	14.78	28	15.83	15.98	15.16	14.47
194	8.25	12.37	14.17	14.77	15.26	29	15.36	15.53	14.78	14.18
195	9.17	13.00	14.66	15.15	15.73	30	15.31	15.43	14.64	14.06
196	7.63	12.04	14.08	14.75	15.26	31	14.96	15.12	14.40	13.70
197	6.79	11.49	13.64	14.44	14.90	32	15.76			14.50
198	8.21	12.31	14.20	14.88	15.25	33	15.45			13.98
199	8.94	12.91	14.61	15.24	15.71	34	14.99			13.60
200	7.81	12.16	14.12	14.78	15.22	35	14.56	14.74	14.03	13.50
201	7.52	11.84	13.74	14.44	15.07	36	15.33	15.54	14.80	14.27
202	7.84	12.18	14.11	14.84	15.43	37	16.12	16.28	15.48	15.07
203	8.36	12.58	14.47	15.17	15.75	38	15.73			13.96
204	7.75	12.12	14.17	14.80	15.41	39	15.44			13.48
205		11.80	13.85	14.46	14.96	40	15.22			13.39
206		12.19	14.16	14.80	15.47	41	14.89			13.14
207		12.53	14.66	15.04	15.73	42	14.57			13.50
208		12.25	14.28	14.78	15.44	43	15.32			14.30
389	7.34	11.57	13.72	14.41	15.05	44	16.12			15.04
390	7.54	11.79	13.83	14.47	15.10	45	14.55			13.48
391	7.94	12.14	14.26	14.87	15.36	46	15.28			14.33
392	8.41	12.56	14.74	15.22	15.73	47	16.07			14.92
393	7.85	12.07	14.33	14.83	15.42	48	15.83			14.61
394	7.39	11.72	13.99	14.56	15.21	49	15.03			13.79
395	7.42	11.70	13.87	14.40	15.09	50	15.55			14.84
396	6.73	11.19	13.35	13.95	14.57	51	15.58			14.52
397	6.57	11.19	13.40	13.99	14.74	52	15.39			14.38
398	7.86	12.40	14.32	14.98	15.44	53	15.30			14.26
399	8.56	12.93	14.88	15.36		54	15.18			14.15
400	7.74	12.20	14.30	14.95	15.41	55	15.00			14.01
401	6.36	11.00	13.40	14.13	14.95	56	15.67			14.84
402	6.77	11.13	13.30	14.00	14.66	57	15.31			14.41
403	9.58	13.60	15.13	15.31	15.60	58	15.06			14.07
404	9.79	13.87	15.39	15.71	16.05	59	14.53			13.47
405	9.66	13.64	15.05	15.27	15.56	60	15.25			14.30
406	10.88	14.14	14.94	14.90	15.04	61	16.09			15.04
407	11.15	14.26	14.96	14.95	15.10	62	15.83			14.82
408	11.63	14.73	15.40	15.50	15.37	63	15.63			14.70
409	10.84	14.26	15.18	15.25	15.49	64	15.45			
410	11.02	14.33	15.32	15.41	15.52	65	15.34			14.30

Run #	1-HB	2-HB	3-HB	4-HB	5-HB		6-HB	7-HB	8-HB	9-HB	10-HB
Piezo. No.	Pres. Head	Pres. Head	Pres. Head	Pres. Head	Pres. Head	Piezo. No.	Pres. Head	Pres. Head	Pres. Head	Pres. Head	Pres. Head
411	12.11	15.5	15.51	15.46	15.46	66	15.12				
412	12.09	14.3	15.58	15.49	15.52	67	15.60				
413	10.58	14.3	15.18	15.25	15.42	209	14.70	14.81	14.02	13.59	15.39
414	10.46	14.4	15.16	15.20	15.42	210	16.03	16.22	15.46	15.02	15.69
415	10.49	14.46	15.22	15.37	15.73						
416	10.75	14.6	15.57	15.77	15.88	211	14.67	14.81	14.11	13.50	14.42
417	10.59	14.0	15.26	15.44	15.71	212	15.99	16.24	15.45	14.86	15.82
418	10.63	14.3	15.18	15.31	15.49	213	14.71		14.99	13.50	14.83
419	10.65	14.8	15.26	15.23	15.49	214	15.21	15.33	14.58	13.40	14.66
420	10.68	14.6	15.20	15.19	15.29	215	15.36	14.87	14.01	12.60	14.00
421	10.29	13.8	15.07	15.11	15.40	216	14.92	15.09		12.92	14.24
422	10.42	14.5	15.15	15.25	15.44	217	16.79	15.96		13.91	
423	10.43	13.7	15.08	15.07	15.38	218	14.35	14.91		13.32	
424	10.27	13.2	15.02	15.14	15.36	219	14.96			13.42	
425	10.29	13.3	15.10	15.16	15.39	220	15.23	15.21		12.98	
426	10.57	14.2	15.28	15.41	15.70	221	15.32			13.25	
427	10.97	14.1	15.65	15.70	15.99	222	15.43	15.67		13.32	
428	10.61	14.3	15.40	15.44	15.71	223	15.78			14.31	
429	10.30	14.1	15.12	15.22	15.36	224		16.04			
430	10.32	13.5	15.01	15.15	15.33	225	15.79			14.25	
431	6.53	10.3	12.91	13.54	14.23	226	15.46			13.76	
432	6.48	10.3	12.79	13.86	14.55	227	14.36			13.39	
433	8.51	12.0	14.47	14.85	15.25	228	15.01			13.30	
434	8.47	12.0	14.47	14.88	15.07	229	15.14			13.53	
435	6.18	10.3	13.01	13.94	14.64	230	14.40			13.51	
436	6.40	10.3	12.76	13.48	14.09	231	15.61			13.93	
437	6.34	10.31	13.14	14.07	14.58	232	15.79			14.13	
438	8.49	12.3	14.36	14.72	15.06	233	14.92	14.97	14.21	12.72	14.09
439	8.42	12.3	14.44	14.69	15.08	234	15.03	15.18			
440	6.48	11.3	13.49	14.16	14.62	235	15.41	15.52	14.64	13.01	14.47
441	5.95	10.3	13.50	13.71	14.00	236	15.68	15.82			
442	5.97	10.30	13.49	13.71	14.00	237	15.80		15.10	13.56	14.97
443	7.28	12.1	13.88	13.96	14.23	238	15.66				
444	7.25	12.3	13.78	13.82	14.98	239	15.42		14.67	13.21	14.53
445	6.02	11.3	13.45	13.67	14.03	240	15.07				
446	9.99	12.3	13.11	11.97	11.13	241	14.82			19.38	
447	8.84	12.3	12.10	11.29	10.67	242	14.75				
448	9.50	12.1	11.45	9.39	9.53	243	15.58			10.42	
449	8.67	10.3	11.00	10.52	10.38	244	15.37				
450	8.19	11.3	10.02	9.12	9.23	245				9.39	
451	6.71	11.3	12.65	12.23	12.35	246	15.36				
452	6.86	11.3	12.30	12.15	12.20	247	15.53			9.01	
453	6.93	11.3	12.31	12.20	12.23	248	14.91				
454	7.05	11.3	12.15	12.00	12.06	249	14.80	14.71	13.46	9.02	11.89
455	7.69	11.3	12.26	11.13	10.35	250	15.11	15.02	13.75	9.45	12.24
456	7.97	10.3	11.20	10.72	10.48	251	15.41	15.32	14.00	9.65	12.53
457	7.61	11.3	12.04	11.11	10.38	252	15.12	15.03	13.62	9.20	12.15
458	6.95	11.3	12.24	12.00	12.06	253	14.94	14.72	13.49	8.64	11.77
459	6.68	10.3	12.21	12.09	12.06	254	15.29	15.06	13.80	9.05	12.17
460	6.80	11.3	12.24	12.06	12.13	255	15.64	15.49	14.20	9.85	12.76
461	7.42	11.3	11.62	11.37	11.43	256	15.30	15.11	13.83	9.20	12.27
462	7.22	10.3	11.48	11.30	11.20	257	14.96	14.75	13.44	8.59	11.78
463	7.01	10.3	11.65	11.26	11.01	258	15.28	14.08	13.89	9.06	12.17
464	7.32	10.3	11.58	11.33	11.29	259	15.62	15.50	14.11	9.38	12.42
465	7.74	10.3	11.71	11.59	11.40	260	15.29	15.10	13.74	9.20	12.22
466	7.75	10.3	11.42	11.31	11.21	261	15.01	14.82	13.48	8.68	11.78
467	7.29	10.3	11.23	11.03	11.01	262	15.35	15.09	13.83	9.20	12.24
468	7.70	10.3	11.47	11.29	11.23	263	15.69	15.50	14.13	9.19	12.34
469	7.89	10.3	11.79	11.59	11.53	264	15.41	15.16	13.86	9.12	12.22
470	7.70	10.3	11.31	11.18	10.99	265	15.04	14.79	13.41	8.17	11.68
471	6.97	9.81	10.89	10.77	10.79	266	15.32	15.13	13.81	9.13	12.21
472	7.81	10.3	11.44	11.21	11.15	267	15.62	15.46	14.13	9.54	12.53
473	8.01	10.3	11.75	11.61	11.53	268	15.35	15.10	13.69	8.72	11.98
474	7.72	10.3	11.09	10.89	10.86	269	14.99	14.80	13.41	8.48	11.70
475	7.04	9.61	10.59	10.44	10.44	270	15.38	15.16	13.80	8.82	12.09
476	7.86	10.3	11.31	11.14	11.08	271	15.72	15.48	14.14	9.28	12.54
477	8.09	10.3	11.52	11.40		272	15.33	15.19	13.74	8.92	12.09
478	7.76	10.3	10.97	10.85	10.71						
479	7.28	9.48	10.45	10.36		389	15.97	14.72	13.42	8.68	11.74
480	7.97	10.3	11.24	11.13	11.06	390	15.06	14.86	13.48	8.74	11.81
481	8.11	10.3	11.37	11.24	11.16	391	14.41	15.12	13.85	8.91	12.09
482	7.78	10.3	10.85	10.72	10.55	392	14.78	15.52	14.13	9.34	12.45
483	7.37	9.55	10.38	10.33	10.20	393	15.35	15.17	13.81	9.04	12.15
484	7.99	10.3	11.17	11.03	10.91	394	15.18	14.96	13.55	8.84	11.94
485	8.32	10.3	11.14	11.06	10.95	395	15.02	14.76	13.44	8.72	11.77
486	7.61	9.85	10.58	10.42	10.43	396	14.62	14.26	12.80	8.22	11.01
487	7.52	9.57	10.41	10.35	10.25	397	14.79	14.36	12.95	8.19	11.02
488	7.97	10.3	11.00	10.89	10.74	398	15.42	15.29	13.90	9.07	12.17
489	7.94	10.3	10.99	10.88	10.73	399	15.84	15.64	14.34	9.41	12.75
490	7.85	10.3	10.88	10.70	10.61	400	15.34	15.16	13.76	8.83	12.11
491	7.73	9.89	10.79	10.58	10.37	401	14.76	15.27	12.88	8.12	11.07
492	7.95	10.3	10.91	10.76	10.64	402	14.63	15.02	12.89	8.23	11.06
493	7.69	9.80	10.63	10.49	10.34	403	15.62	16.10	14.61	9.91	13.38
494	7.86	9.96	10.80	10.68	10.55	404	15.99	16.28	14.91	10.08	13.70
495	8.02	10.3	10.95	10.90	10.64	405	15.56	15.56	14.61	9.92	13.35
496	7.86	10.3	10.82	10.67	10.49	406	15.00	15.15	14.49	10.78	14.04
						407	15.12	15.28	14.46	10.79	13.82
						408	15.49	15.74	14.93	10.74	14.49
						409	15.42	15.54	14.71	10.63	13.96
						410	15.51	15.63	14.76	10.57	14.12

Run #	6-HB	7-HB	8-HB	9-HB	10-HB		6-HB	7-HB	8-HB	9-HB	10-HB
Piezo. No.	Fres. Head	Fres. Head	Fres. Head	Fres. Head	Fres. Head	Piezo. No.	Fres. Head	Fres. Head	Fres. Head	Fres. Head	Fres. Head
411	15.40	15.73	14.87	11.39	14.65	456	10.68	10.82	10.77	9.11	11.16
412	15.45	15.73	15.00	11.43	14.74	457	10.52	11.22	11.55	8.88	11.42
413	15.44	15.50	14.66	10.31	13.85	458	12.27	12.40	11.66	8.31	11.22
414	15.43	15.51	14.73	10.33	13.76	459	12.22	12.26	11.64	7.90	11.00
415	15.59	14.65	14.79	10.45	13.95	460	12.25	12.29	11.73	7.76	11.16
416	16.02	14.99	15.08	10.68	14.23	461	11.42	11.60	11.12	8.20	10.94
417	15.72	15.66	14.73	10.42	13.87	462	11.34	11.46	10.93	8.14	10.48
418	15.48	15.60	14.54	10.41	13.91	463	11.12	11.39	11.15	8.09	10.65
419	15.55	14.51	14.62	10.49	13.96	464	11.40	11.54	11.06	8.25	10.65
420		15.50	14.67	10.48	13.89	465	11.64	11.76	11.12	8.41	10.71
421	15.36	15.39	14.49	10.32	13.77	466	11.32	11.46	10.92		10.60
422	15.37	15.54	14.71	10.31	13.82	467	11.19	11.25	10.64	8.30	10.21
423	15.39	15.48	14.58	10.34	13.78	468	11.29	11.50	10.95	8.43	10.59
424	15.42	15.34	14.54	10.17	13.67	469	11.66	11.85	11.20	8.60	10.85
425	15.34	15.44	14.58	10.12	13.72	470	11.21	11.27	10.71	8.75	10.40
426	15.69	15.70	14.27	10.53	14.01	471	10.92	10.89	10.29	8.17	9.76
427	16.02	16.08	15.11	10.77	14.21	472	11.38	11.41	10.84	8.87	10.52
428	15.72	15.77	14.80	10.49	13.99	473	11.59	11.68	11.14	8.94	10.76
429	15.50	15.55	14.60	10.22	13.78	474	11.07	11.12	10.53	8.84	10.22
430	15.26	15.54	14.42	10.19	13.70	475	10.56	10.57	10.03	8.63	9.57
431	15.22	13.91	12.46	7.96	10.63	476	11.28	11.36	10.78	8.93	10.45
432	15.58	14.14	12.48	7.97	10.54	477	11.37		10.92	8.90	10.67
433	15.25	15.20	13.99	9.30	12.54	478	10.85	10.99	10.38	8.88	10.11
434	15.27	15.18	13.86	9.42	12.49	479	10.40		9.83	8.83	9.53
435	14.74	14.18	12.56	7.90	10.59	480	11.13	11.19	10.66	9.00	10.41
436	14.24	13.81	12.23	7.90	10.44	481	11.24	11.37	10.83	9.23	10.52
437	14.71	14.42	12.79	7.96	10.49	482	10.63	10.81	10.26	9.17	10.02
438	15.12	15.05	13.87	9.36	12.51	483	10.30	10.37	10.82	8.83	9.52
439	15.19	14.99	12.85	9.33	12.43	484	11.05	11.15	10.46	9.26	10.29
440	14.71	14.37	12.96	7.86	10.60	485	11.08	11.15	10.53	9.16	10.42
441	14.11	13.99	12.88	7.66	10.59	486	10.54	10.71	10.07	9.01	9.93
442	14.01	13.98	12.92	7.72	10.74	487	10.35	10.34	9.85	8.99	9.62
443	14.22	14.18	13.34	8.42	11.99	488	10.92	11.08	10.37	9.21	10.18
444	14.24	14.20	13.21	8.24	11.90	489	10.81	11.01	10.54	9.16	10.20
445	14.16	13.99	12.93	7.70	10.91	490	10.75	10.85	10.27	9.16	10.06
446	11.08	11.59	12.74	10.57	12.73	491	10.63	10.72	10.17	9.37	9.90
447	10.81	9.72	11.78	10.71	12.50	492	10.75	10.86	10.30	9.18	10.06
448	9.60	10.72	10.65	10.39	12.24	493	10.47	10.57	9.95	8.99	9.85
449	10.58		10.52	10.10	10.94	494	10.68	10.77		9.15	10.03
450	9.68	9.75	9.73		11.94	495	10.79	10.89	10.34	9.39	10.23
451	12.38	12.47	11.88		11.42						
452	12.35	12.39	11.76		11.16	496	10.55	10.80	9.20	9.22	9.99
453	12.38	12.49	11.83		11.12						
454	12.32	12.34	11.66		11.11						
455		11.47			11.34						

APPENDIX B-2

VELOCITY DISTRIBUTIONS WITHIN MANIFOLD AND BYPASS RELIEF BRANCH

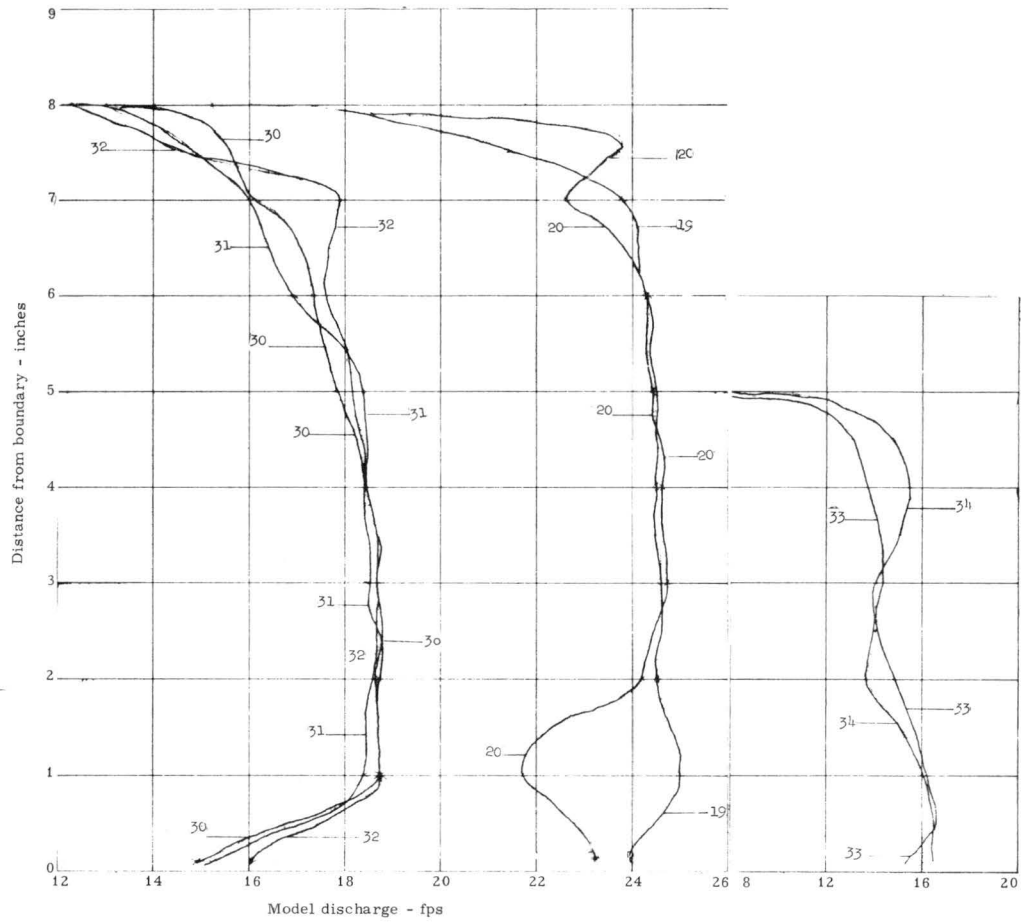
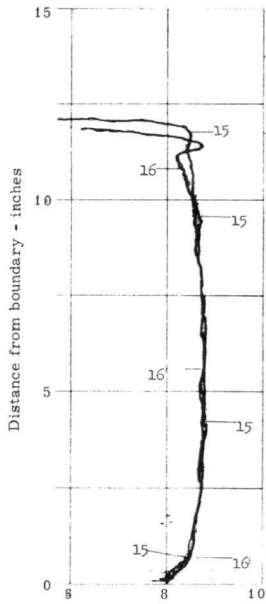

Run 1-HB,  $Q_4 = 5.27$  cfs, 75% of total discharge;  $Q_{\text{relief valve}} = 1.83$  cfs, 25% of total discharge

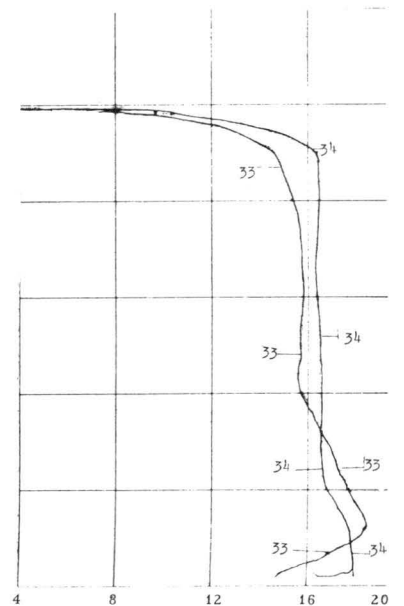
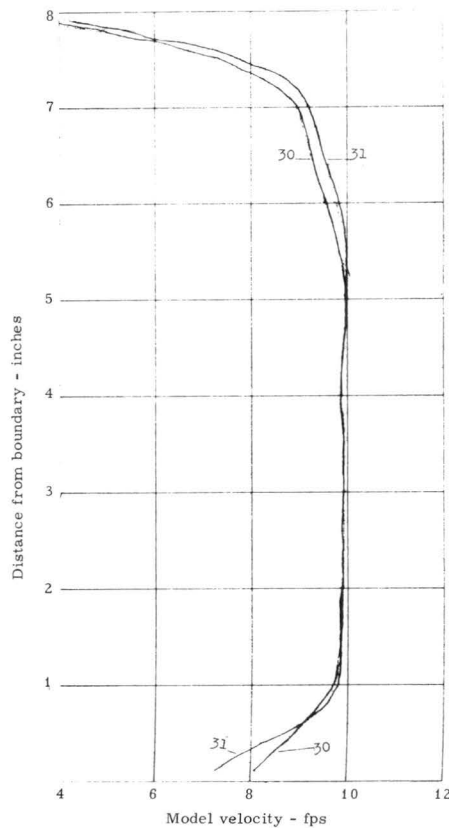
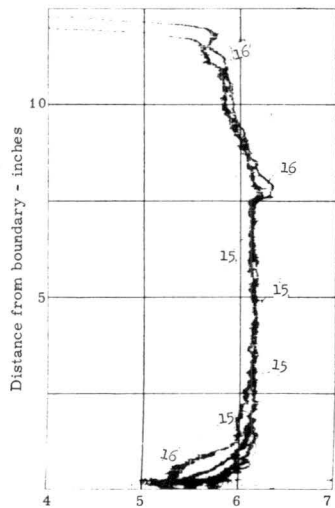

Run 2-HB,  $Q_4 = 3.05$  cfs, 60% of total discharge;  $Q_{\text{relief valve}} = 2.00$  cfs, 40% of total discharge

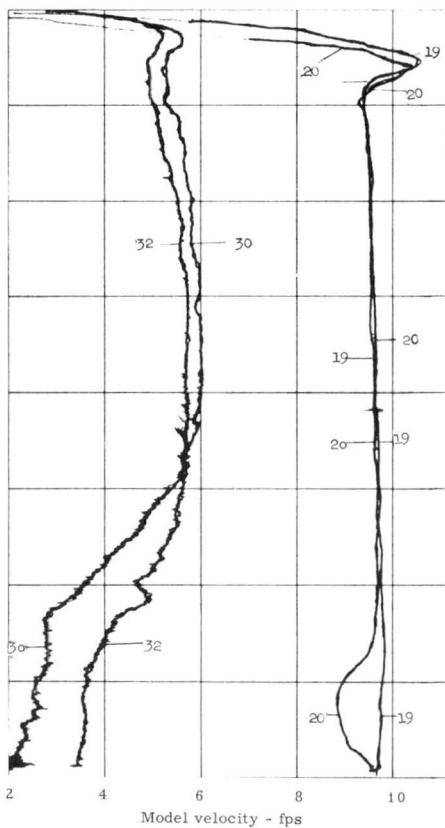
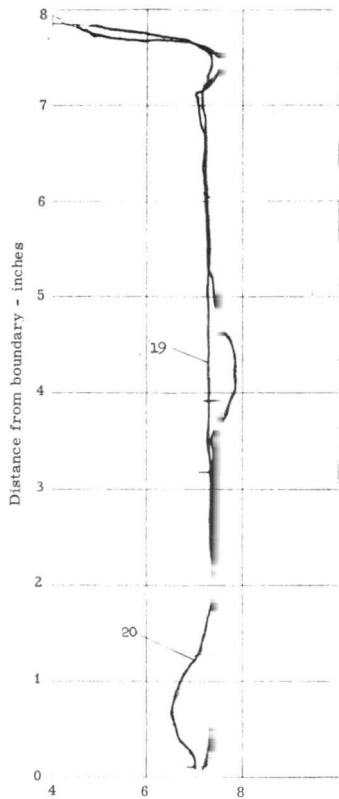

Run 3-HB  
 $Q_4 = 1.40$  cfs, 41% of total discharge;  
 $Q_{\text{relief valve}} = 1.97$  cfs, 59% of total discharge

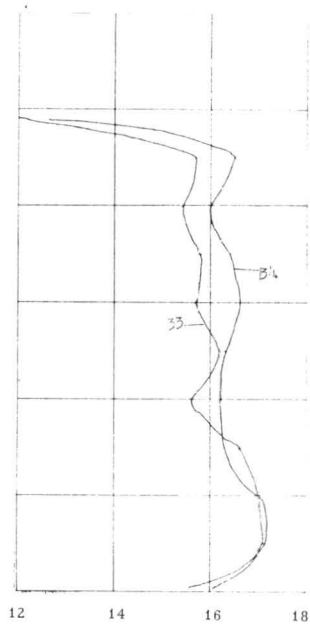

Run 4-HB

$Q_4 = 0.50$  cfs, 20% of total discharge;  
 $Q_{\text{relief valve}} = 2.00$  cfs = 80% of total discharge

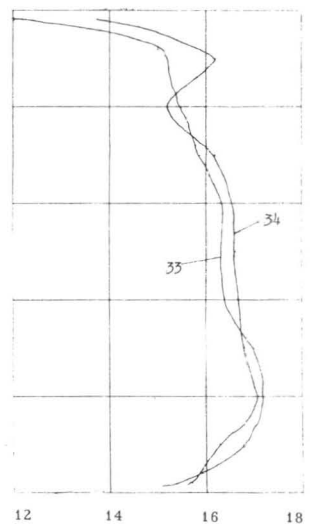
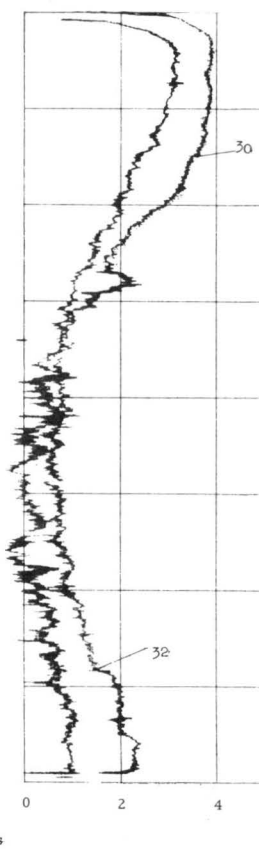
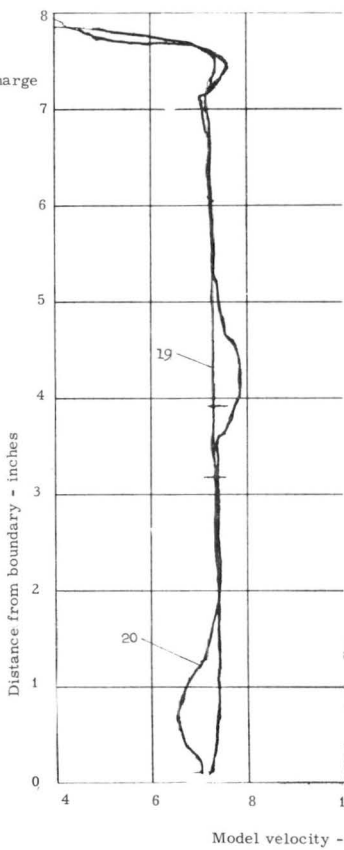
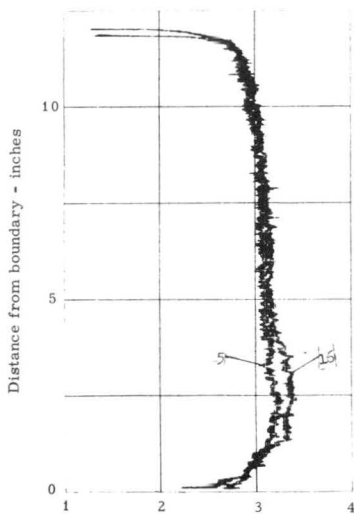

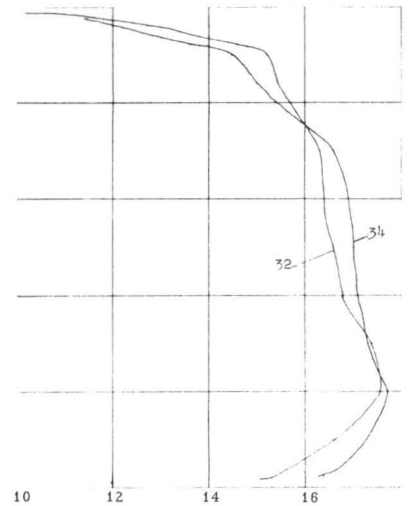
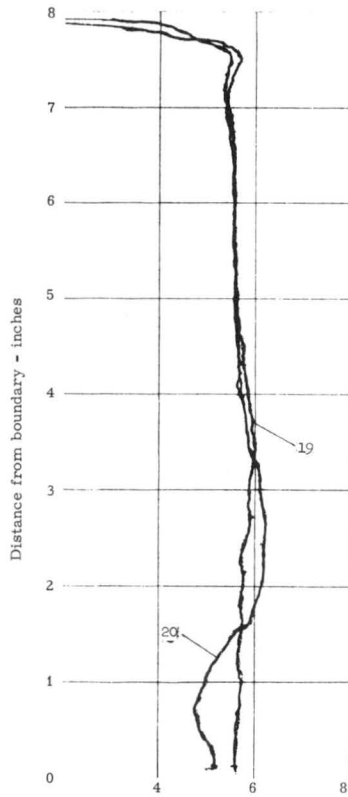
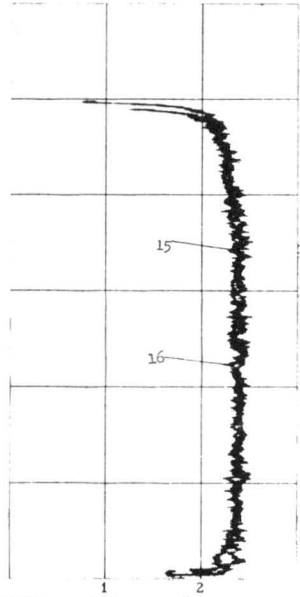
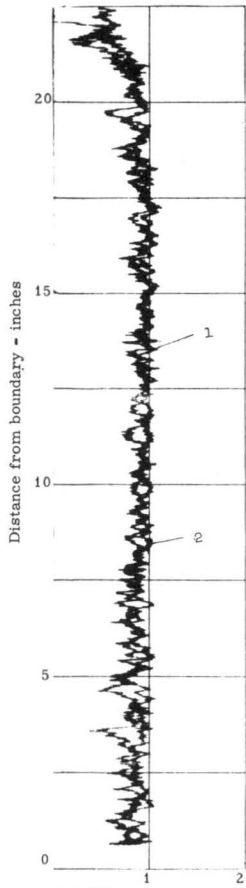

Model velocity - fps  
Run 5-HB,  $Q_4 = 0$ ;  $Q_{\text{relief valve}} = 2.10$  cfs, 100% of total discharge

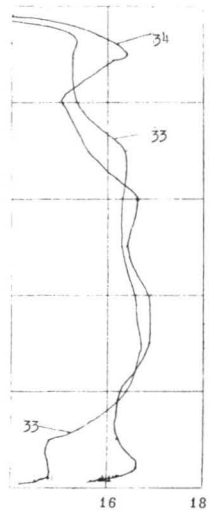
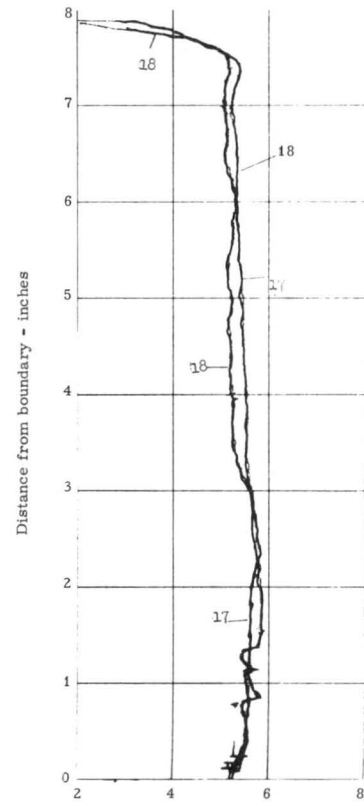
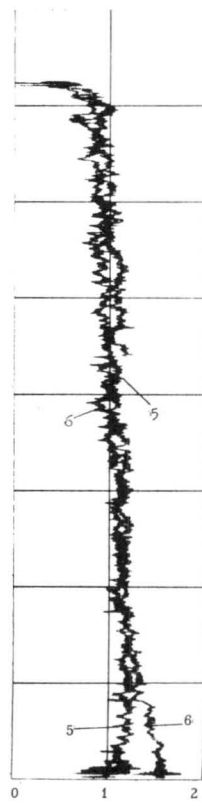
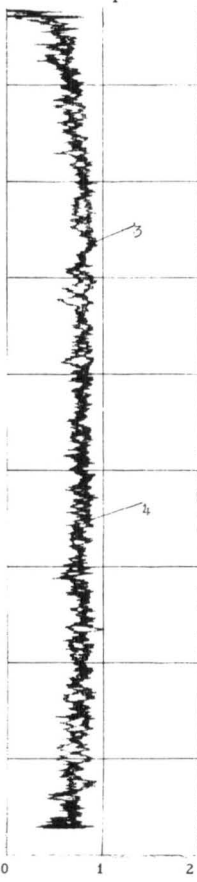
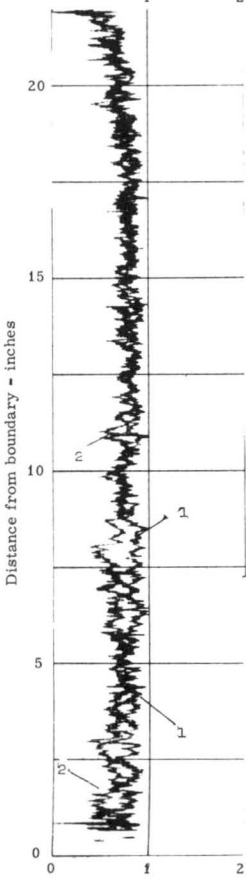

Model velocity - fps  
Run 6-HB,  $Q_1 = 0$ ;  $Q_{\text{relief valve}} = 2.00$  cfs, 100% of total discharge

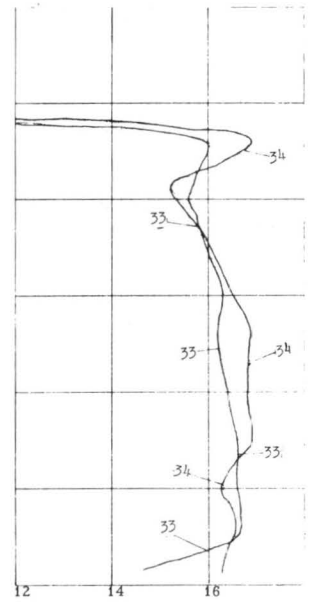
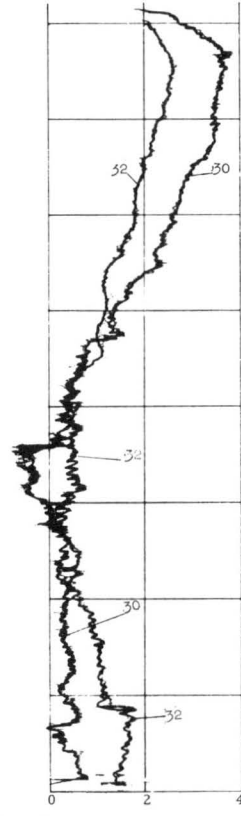
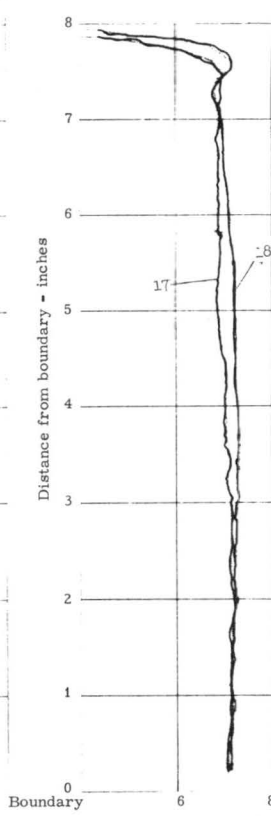
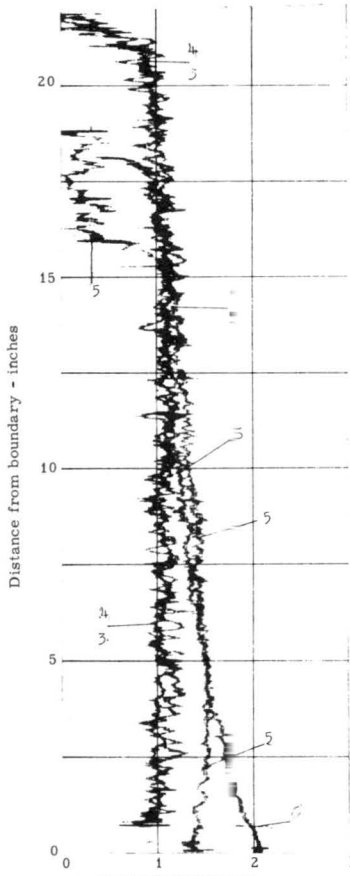

Model velocity - fps  
 Run 7-HB  $Q_1 = 0.50$  cfs, 20% of total discharge  
 $Q_{relief\ valve} = 2.05$  cfs, 80% of total discharge

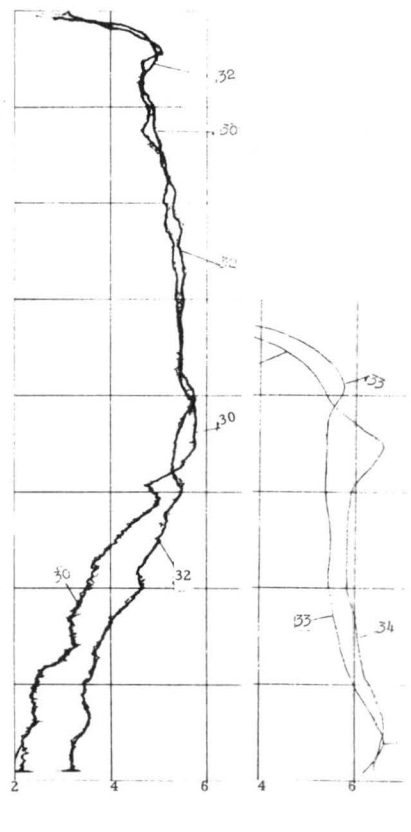
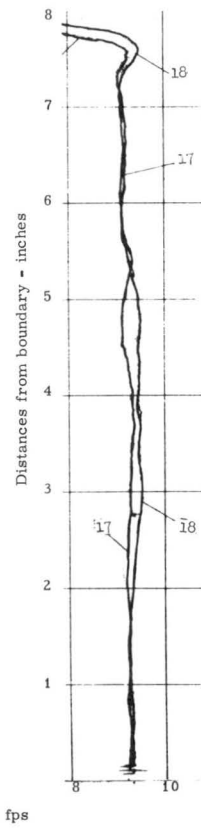
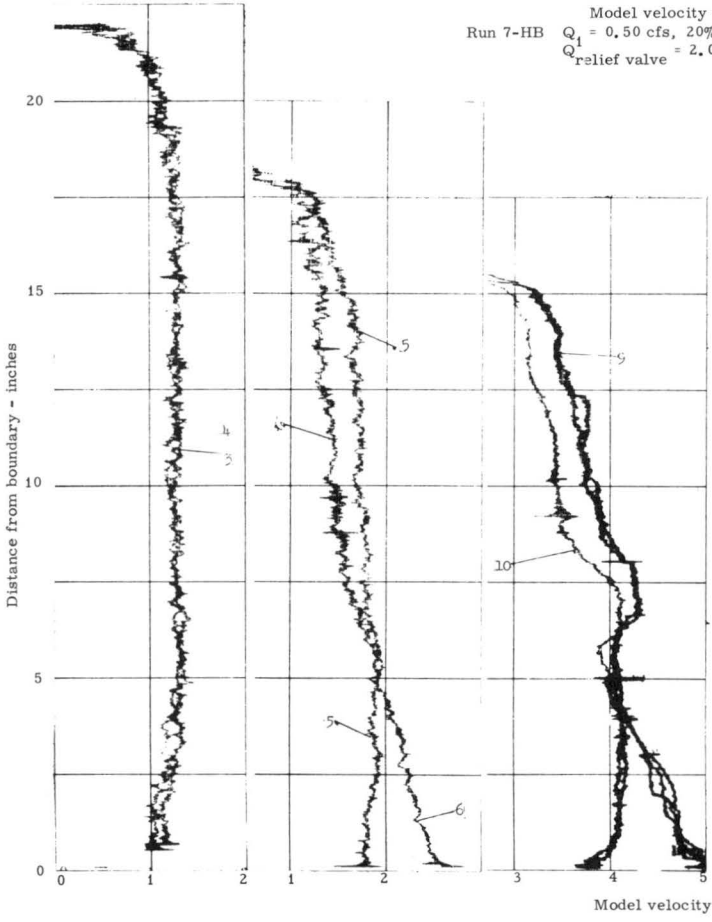

Model velocity - fps  
 Run 8-HB,  $Q_1 = 1.35$  cfs, 40% of total discharge;  $Q_{relief\ valve} = 2.00$  cfs, 60% of total discharge



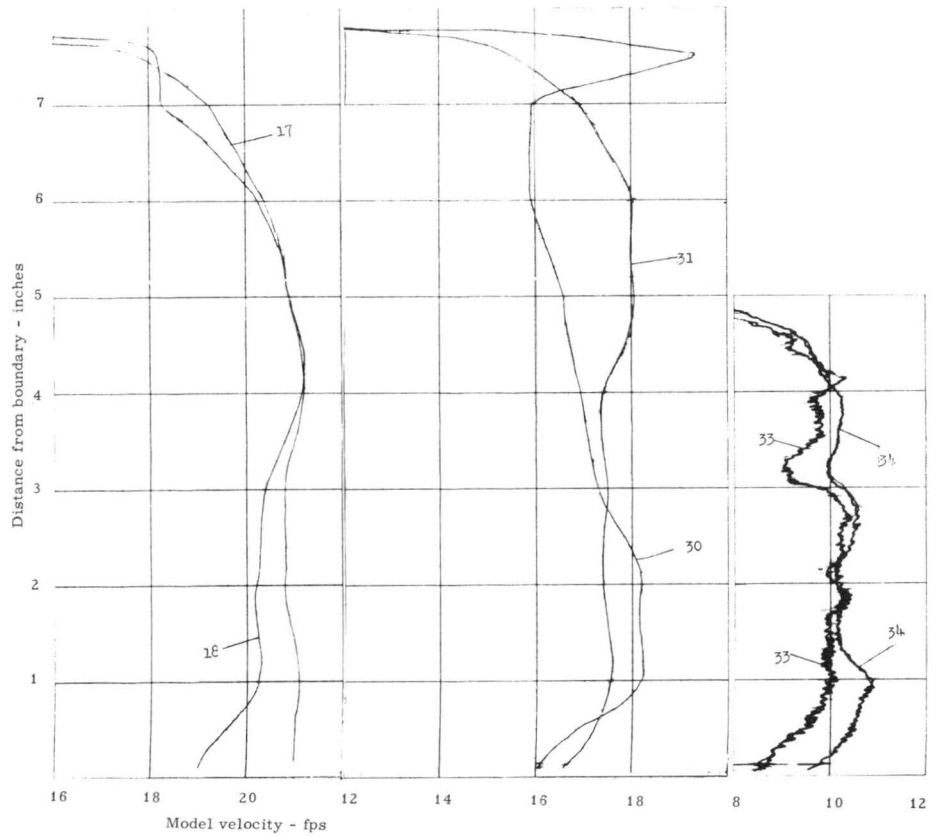
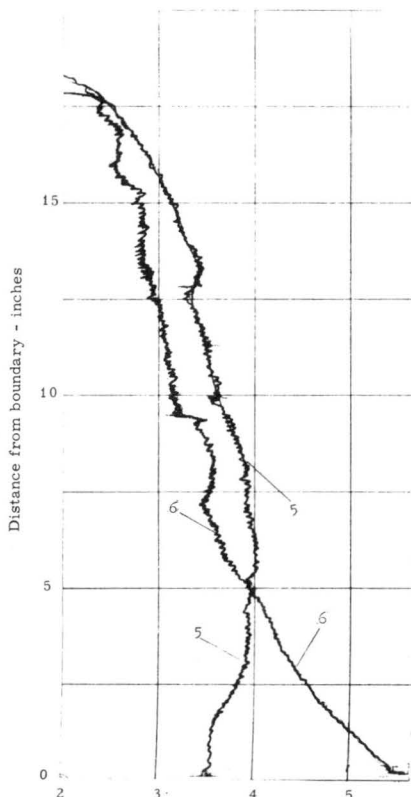
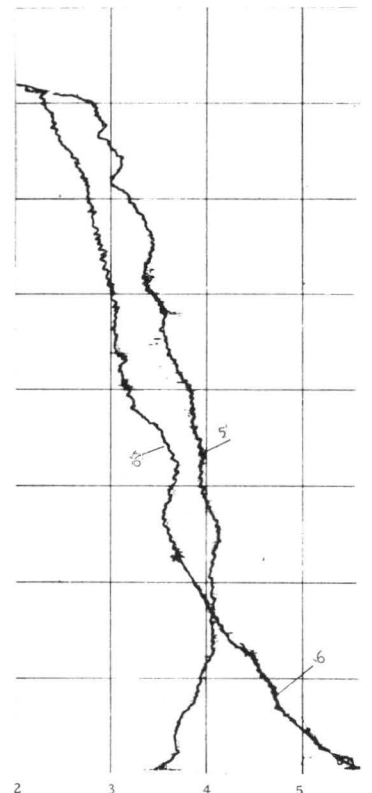
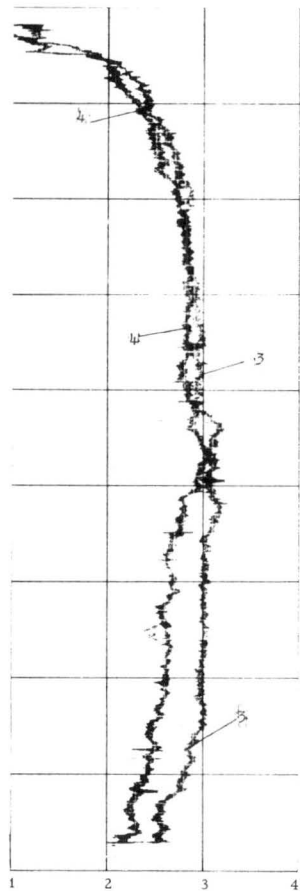
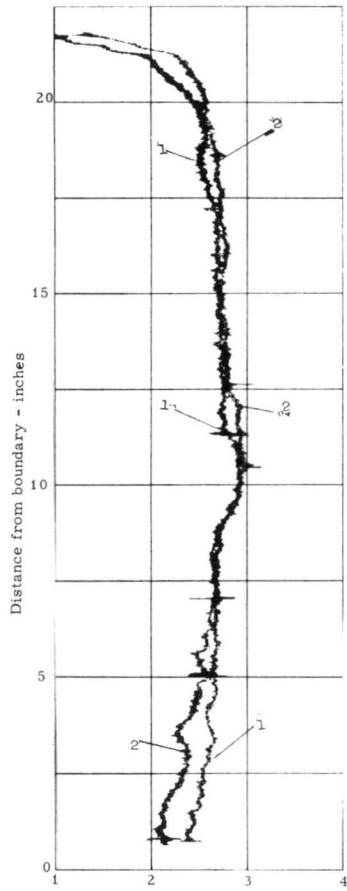

Run 9-HB,  $Q_1 = 5.27$  cfs, 80% of total discharge;  $Q_{\text{relief valve}} = 1.30$  cfs, 20% of total discharge

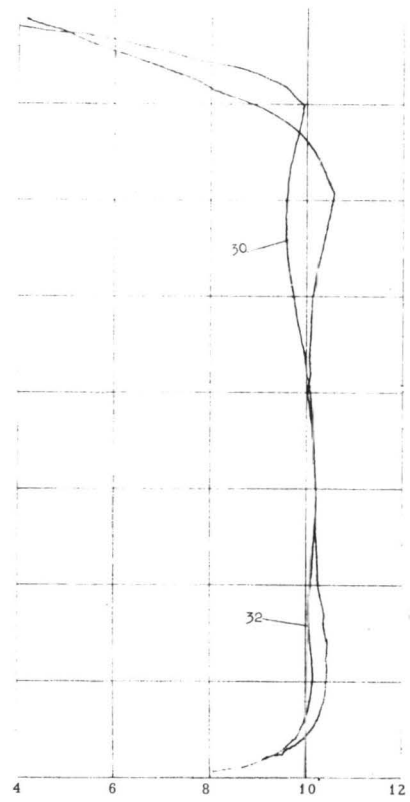
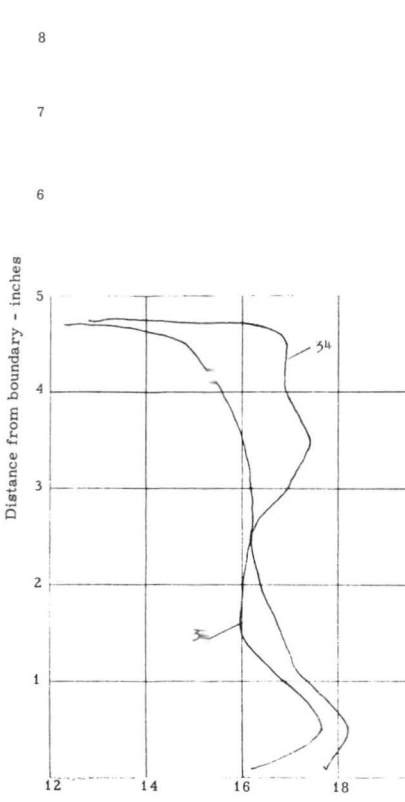
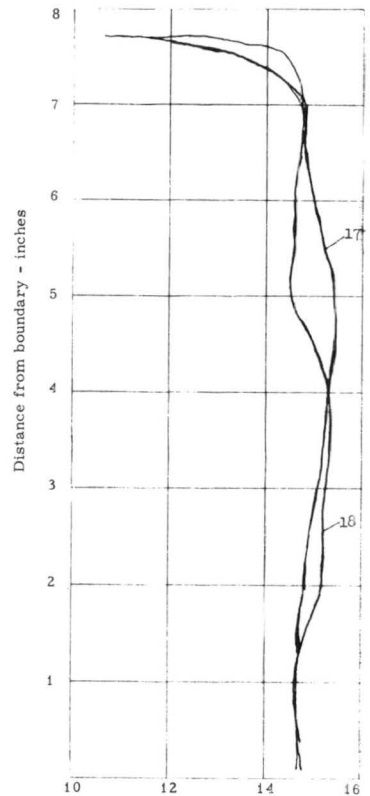
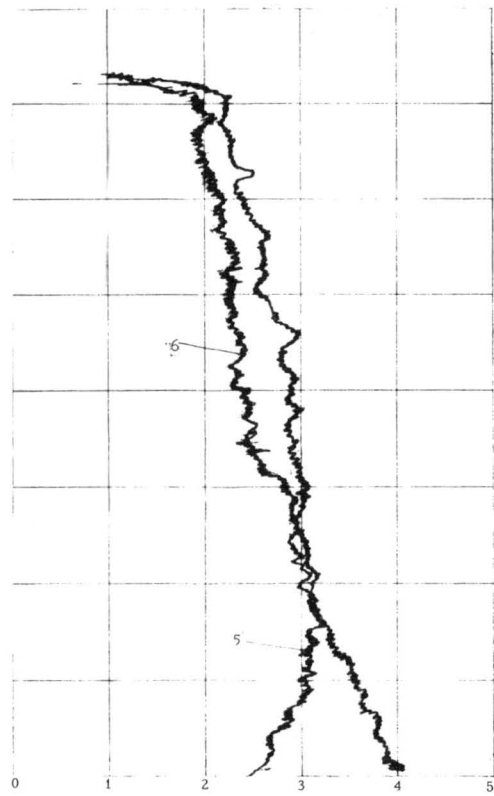
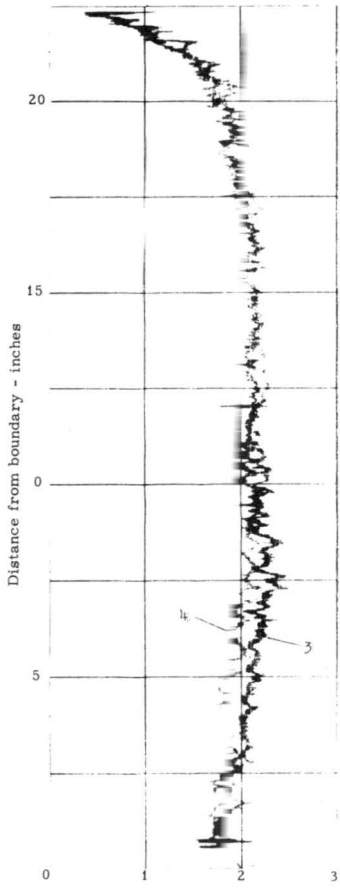

Run 10-HB,  $Q_1 = 3.04$  cfs, 60% of total discharge;  $Q_{\text{relief valve}} = 2.00$  cfs, 40% of total discharge

APPENDIX C-1

PRESSURE HEADS ALONG MANIFOLD AND BYPASS RELIEF BRANCH WALLS  
WITH BUTTERFLY VALVE INSTALLED

PRESSURE HEADS ALONG MANIFOLD AND BYPASS RELIEF BRANCH WALLS  
WITH BUTTERFLY VALVE INSTALLED

Run #	BF 1-V	BF 2-V	BF 3-V	BF 4-H	BF 5-H	BF 6-H		BF 1-V	BF 2-V	BF 3-V	BF 4-H	BF 5-H	BF 6-H	
Q Br. 4	5.25 cfs	2.97 cfs	0	5.22 cfs	3.00 cfs	0								
Q Relief Valve	1.30 cfs	1.92 cfs	2.00 cfs	1.30 cfs	2.06 cfs	2.05 cfs								
Temp.	64°F	70°F	70°F	70°F	70°F	70°F								
Piezo. No.	Pres. Head	Pres. Head	Pres. Head	Pres. Head	Pres. Head	Pres. Head		Piezo. No.	Pres. Head	Pres. Head	Pres. Head	Pres. Head	Pres. Head	
165	11.77	13.73	14.90	12.70	14.04	15.32		445		11.60	14.30	18.49	11.71	14.63
166	12.52	14.26	15.29	13.41	14.75	15.73		446		13.18	11.30	11.68	13.61	11.20
167	12.40	14.44	15.76	13.39	14.75	16.11		447		12.63	10.65	10.82	13.17	10.96
168	11.36	13.73	15.30	12.38	14.01	15.68		448		12.63	10.28	11.51	12.92	10.29
177	10.82	13.19	14.93	11.72	13.56	15.41		449		11.07	10.60	10.80	11.57	10.88
178	12.00	14.00	15.39	12.87	14.37	15.79		450		11.62	8.53	10.70	11.29	9.34
179	11.19	13.75	15.61	12.18	14.11	16.06		451	7.74	11.83	11.44	8.73	12.02	11.75
180	9.50	12.57	15.27	10.38	12.90	15.67		452	7.76	11.64	12.46	8.73	11.89	12.69
189	8.43	11.99	15.06	9.51	12.27	15.45		453	8.02	11.65	12.56	8.80	11.82	12.72
190	10.07	13.05	15.52	11.06	13.40	16.05		454	8.28	11.70	11.19	9.07	11.77	12.47
191	9.81	13.07	15.71	10.80	13.41	16.15		455	8.92		10.48	9.27	10.88	
192	8.09	11.93	15.27	9.08	12.14	15.67		456	9.08	11.38	10.57	10.14	11.68	10.89
193	8.17	11.89	15.20	9.20	12.23	15.56		457	8.87	11.75	11.50	9.71	11.95	10.24
194	9.42	12.73	15.52	10.40	13.05	15.99		458	8.34	11.63	12.28	9.13	11.72	12.60
195	10.24	13.39	15.87	11.23	13.58	16.35		459	7.99	11.43	12.41	8.75	11.52	12.53
196	8.96	12.49	15.52	9.89	12.76	15.93		460	7.91	11.55	12.26	8.65	11.62	12.64
197	8.10	11.98	15.20	9.23	12.22	15.64		461	8.35	11.27	11.52	9.11	11.45	11.80
198	9.44	12.73	15.72	10.43	13.09	16.02		462	8.26	10.99	11.41	9.15	11.09	11.56
199	10.08	13.38	15.95	11.20	13.69	16.43		463	8.32	11.09	11.15	9.14	11.16	11.48
200	9.07	12.61	15.57	10.14	12.90	16.01		464	8.45	11.09	11.53	9.18	11.23	11.76
389	8.54	12.16	15.23	9.52	12.43	15.52		465	8.55	11.13	11.67	9.54	11.36	11.99
390			15.27			15.72		466	8.70	11.01	11.40	9.60	11.12	11.55
391	9.06	12.53	15.64	9.89	12.92	16.08		467	8.42	10.65	11.29	9.38	10.77	11.48
392	9.38	12.94	16.04	10.30	13.16	16.40		468	8.67	11.04	11.48	9.56	11.09	11.66
393	8.94	12.50	15.59	9.98	12.92	16.04		469	8.81	11.17	11.79			12.08
396		11.53	14.81	9.14	11.75	15.21		470	8.85	10.87	10.30			11.43
398	8.69	12.61	15.81	9.95	12.99	16.10		471	8.32	10.30	10.86			11.21
399	9.41	13.10	16.10	10.24	13.46	16.53		472	8.84	10.81	10.47			11.66
400	8.69	12.47	15.65	9.80	12.76	16.01		473	8.90	11.03	11.75	9.92		12.00
403	9.84		15.82	10.86	13.97	16.19		474	8.88	10.61	11.20	9.80		11.35
404	10.18		16.32	10.07	14.31	16.60		475	8.57	10.04	10.64	9.59		10.83
405	9.91		15.84	10.91	14.09	16.22		476	8.93	10.90	10.41	9.92		11.65
413	10.46	14.20	15.64	11.29	14.52	16.10		477	8.61	10.87	11.55		10.16	11.85
415	10.50	14.30	15.88	11.41	14.59	16.28		478	8.99	10.46	11.02		10.62	11.20
416	10.83	14.63	16.21	11.72	14.91	16.63		479		9.93	10.53		10.03	10.68
417		14.42	15.96	11.42	14.55	16.28		480	8.91	10.70	11.32			11.48
424	10.60		15.69	11.06	14.40	15.93		481	8.95	10.84	11.34		10.84	11.62
426		14.08	15.69	11.06	14.40	15.93		482	8.91	10.32	10.87			11.12
427		14.44	16.00	11.46	14.70	16.38		483	8.71	9.94	10.40			10.58
428		14.75	16.26	11.78	15.02	16.62		484	9.08	10.66	10.18			11.36
		14.43	15.85	11.47	14.64	16.35								
430		14.02						485	8.91	10.67	11.18	10.05	10.82	11.46
431		11.15	14.39	8.88	11.18	14.81		486	8.92	10.33	10.72	9.97	10.29	11.01
432		11.04	14.77	8.82	11.19	15.12		487	8.76	10.03	10.48	9.95	10.02	10.69
433		12.85	15.44	10.18	13.23	15.88		488	9.03	10.59	11.05	10.12	10.73	11.31
434		12.88	15.41	10.37	13.24	15.88		489	9.02	10.53	11.02			11.29
435		10.96	14.78	8.86	11.08	15.22		490	8.99	10.40	10.76			11.12
436		10.96	14.42	8.87	11.13	14.77		491	8.97	10.30	10.72			10.89
437		11.00	14.94	8.79	11.18	15.21		492	9.00	10.45	10.90			11.13
438		12.83	15.41	10.13	13.16	15.76		493	8.85	10.21	10.58	10.94	10.29	10.82
439		12.84	15.32	10.24	13.18	15.73		494	9.02	10.38	10.81	10.02	10.46	11.02
440		11.16	14.73	8.81	11.25	15.23		495	9.20	10.58	10.99	10.23	10.64	11.16
441		11.25	14.34	8.43	11.22	14.62		496	8.97	10.37	10.82	10.02	10.47	11.02
442		11.51	14.29	8.52	11.38	14.61								
443		12.46	14.49	9.20	12.65	14.89								
444		12.27	14.48	9.17	12.54	14.77								

APPENDIX C-2

VELOCITY DISTRIBUTIONS WITHIN MANIFOLD AND BYPASS RELIEF BRANCH  
WITH BUTTERFLY VALVE INSTALLED

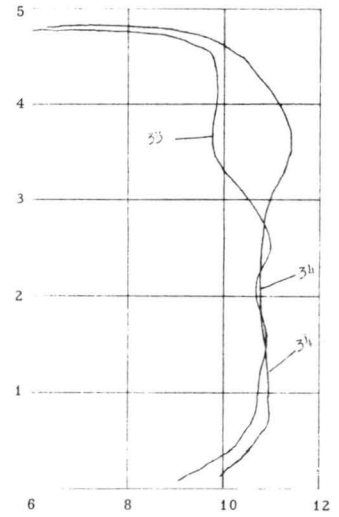
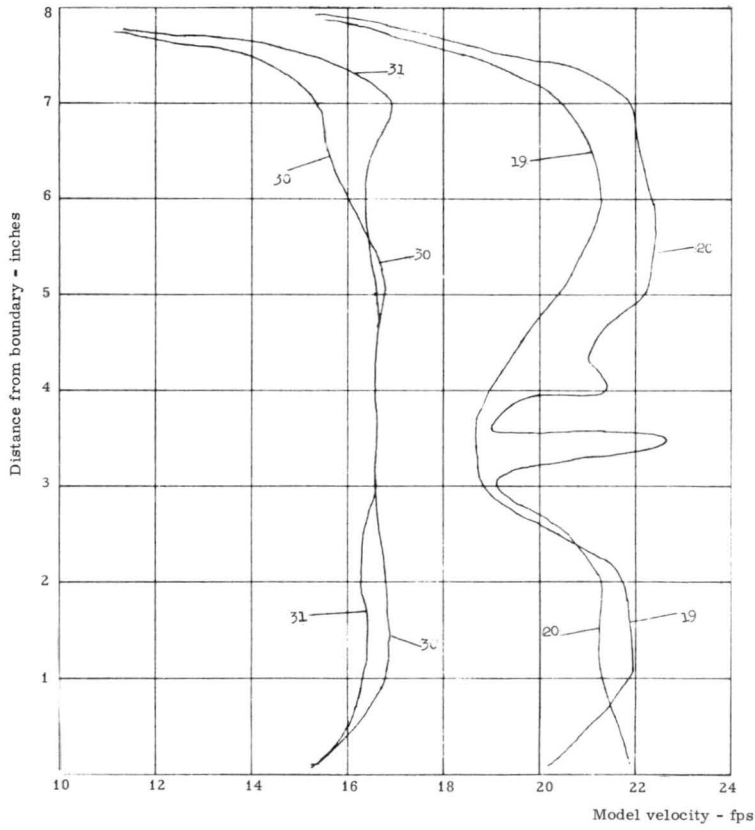

Run BF 1V,  $Q_4 = 5.25$  cfs, 80% of total discharge;  $Q_{\text{relief valve}} = 1.30$ , 20% of total discharge

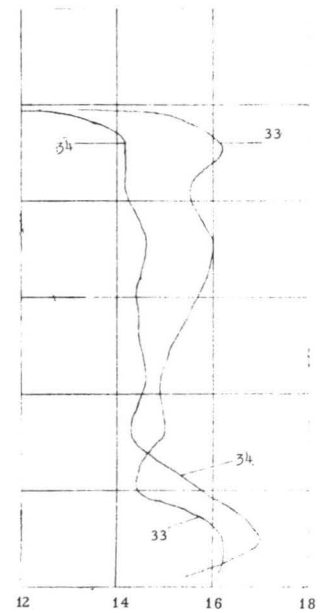
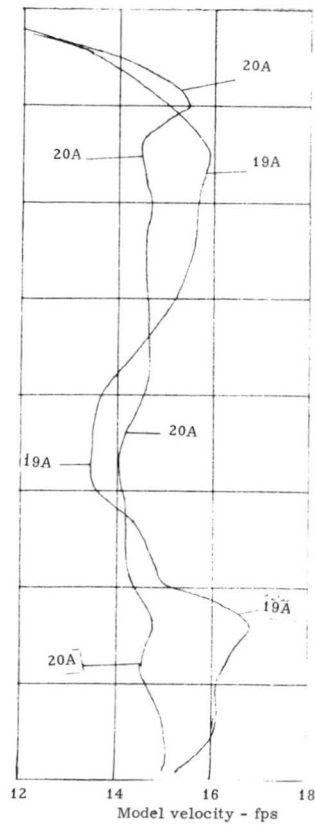
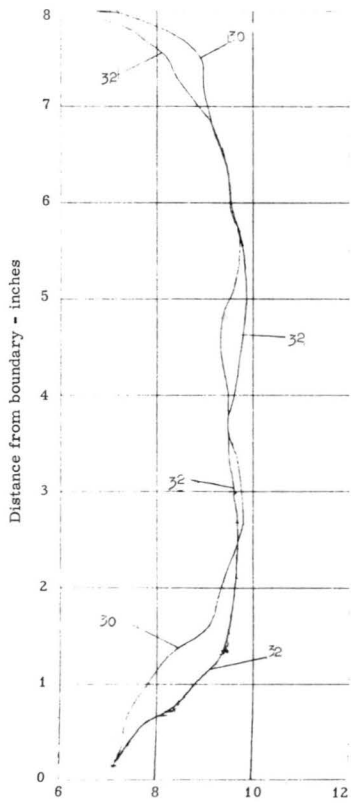

Run of BF 2V,  $Q_4 = 2.97$  cfs, 60% of total discharge;  $Q_{\text{relief valve}} = 1.92$  cfs, 40% of total discharge

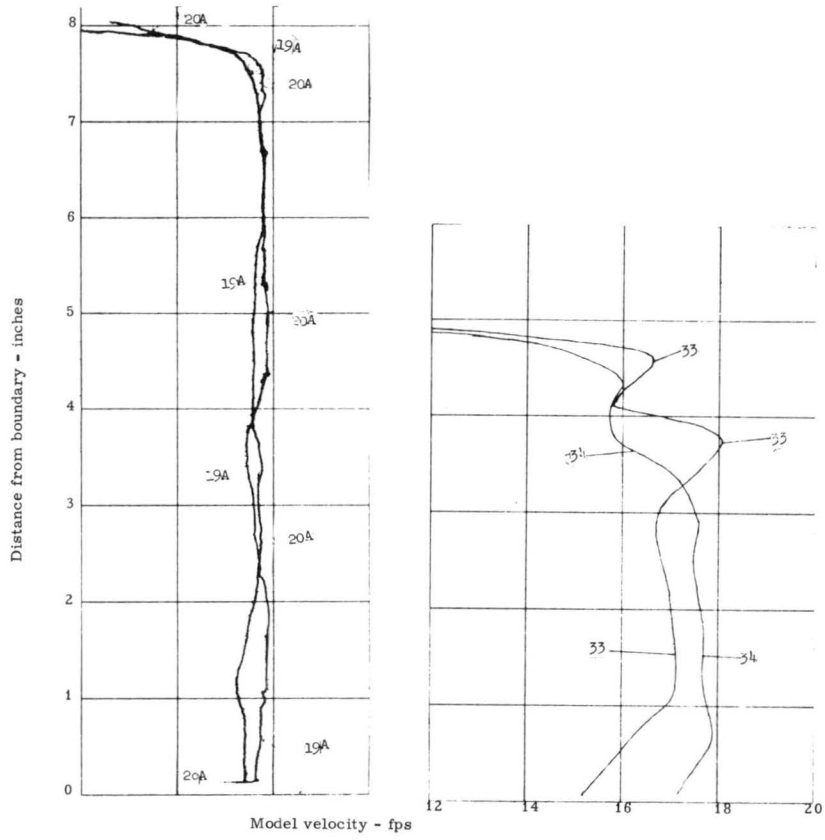

Run BF 3V,  $Q_{\text{relief valve}} = 2.00 \text{ cfs}$ , 100% of total discharge

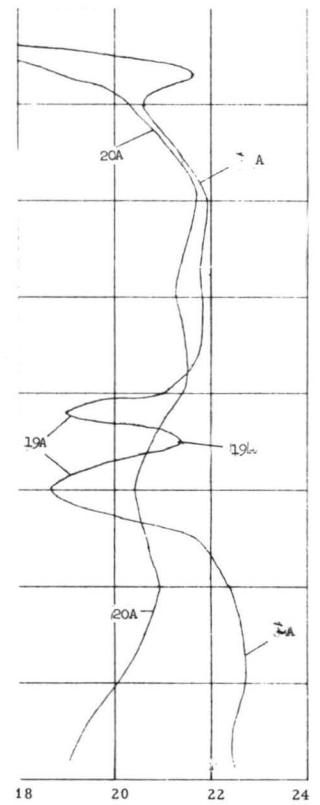
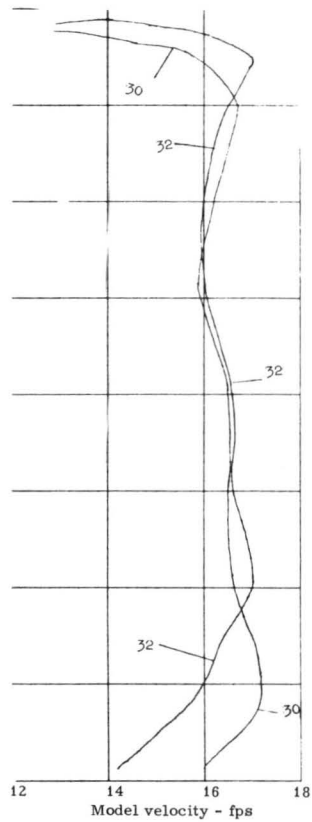
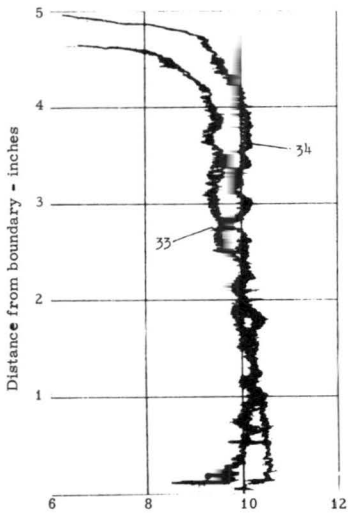

Run BF 4H,  $Q_4 = 5.22 \text{ cfs}$ , 80% of total discharge;  $Q_{\text{relief valve}} = 1.30$ , 20% of total discharge

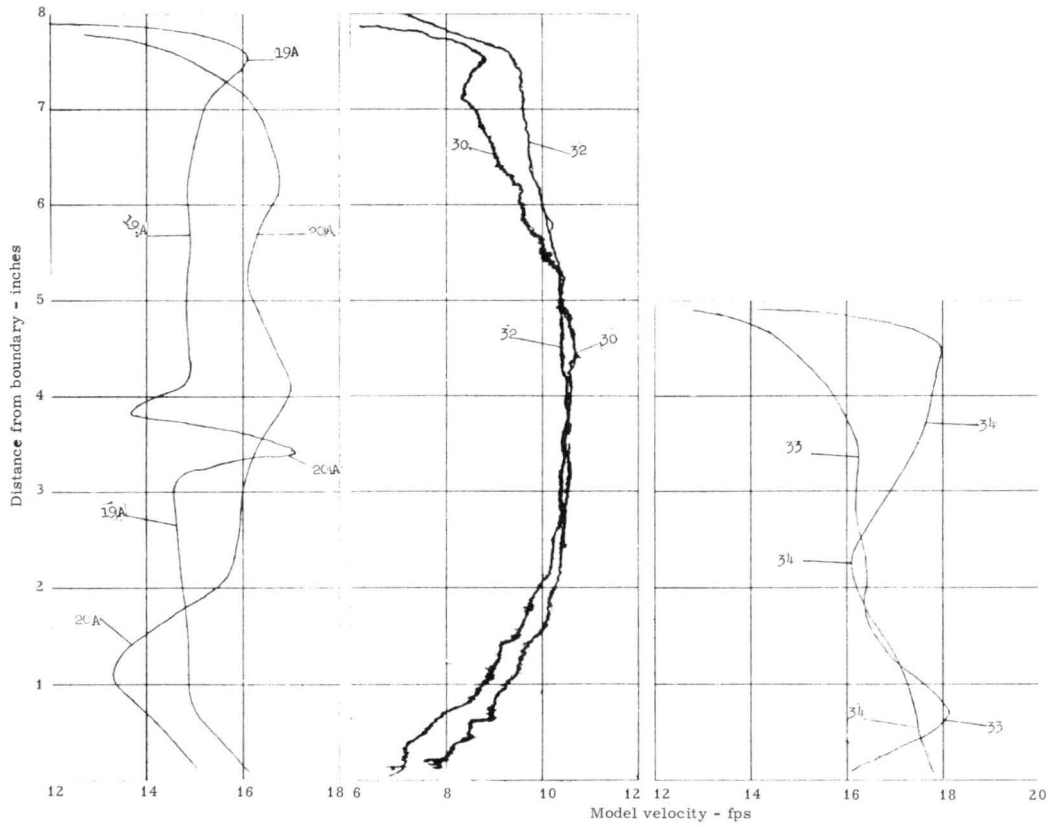

Run BF 5H,  $Q_4 = 3.00$  cfs, 60% of total discharge;  $Q_{\text{relief valve}} = 2.06$  cfs, 40% of total discharge

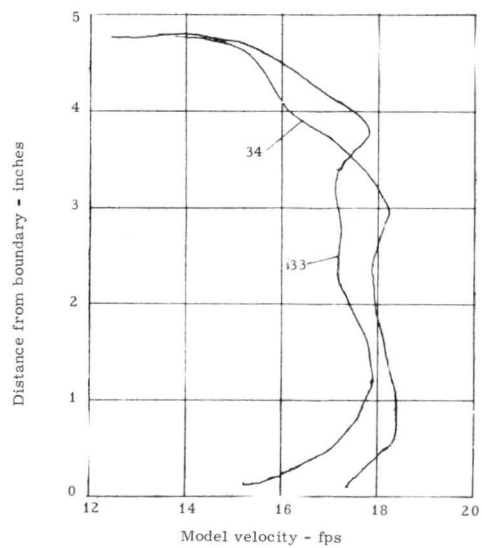

Run BF 6H,  $Q_{\text{relief valve}} = 2.05$  cfs, 100% of total discharge