

# The Development and Implementation of a Multimedia Messaging Service for an Enhanced Mobile Telemedicine System

*Andik Setyono, Multimedia University, Malaysia, and Dian Nuswantoro University, Semarang, Indonesia*

*Md. Jahangir Alam, Multimedia University, Malaysia*

*C. Eswaran, Multimedia University, Malaysia*

---

## ABSTRACT

*This paper presents an algorithm and architecture to enhance the performance of a mobile telemedicine system using the existing multimedia messaging service (MMS). With the proposed algorithm, the capacity of the MMS can be increased so that the mobile telemedicine system is able to send and receive a large content of multimedia messages using mobile phone devices which is not possible with the conventional MMS. This paper also presents the complete architecture of the mobile telemedicine system which can form the basis for building a practical mobile telemedicine system. The experimental results demonstrate that the proposed algorithm outperforms the conventional MMS with regard to the file size that can be transmitted without degrading the quality of the data which is important for medical diagnosis in a telemedicine environment.*

*Keywords: Compression, Mobile Telemedicine, Multimedia Message, Multimedia Messaging Service (MMS), Split and Merge*

---

## 1. INTRODUCTION

Multimedia Messaging Service (MMS) is a rich content and mobile message sending system that not only sends text messages but also sends image, animation, video and com-

bination of them. Theoretically, the MMS can transmit data up to 300 KB depending on the cellular service provider and MMS feature on mobile phone (Bodic, 2005). Almost all of the cellular service providers provide the MMS facilities. They use different bearer technology, such as network and system specification, which influence the capability of the MMS

DOI: 10.4018/jhisi.2012010102

to transfer data. Many service providers use general packet radio service (GPRS), which can transmit data up to 115 Kbps and some of them use universal mobile telecommunications system (UMTS) with a speed of 384 Kbps (Bodic, 2005; Setyono, Alam, & Al-Saqour, 2009). They also have different maximal data size for sending multimedia messages to mobile phone number and email server, and it is in the range of 50 – 100 KB (Setyono et al., 2009; Bodic, 2003). Currently, the MMS is widely used for exchanging greeting cards, audio and video recordings, exchanging photographs and so on. The MMS can also be used for developing mobile monitoring system, streaming audio and video (Bodic, 2003), mobile commerce (Daniel, 2004), information system (Jari, 2004), telemedicine system (Bernard et al., 2011), etc.

Telemedicine field is one of the research areas of biomedical engineering that needs multidisciplinary technologies such as, electronics, computer, telecommunications, transfer protocol, medical procedures, etc. (Yoke et al., 2006). The telemedicine is a part of telehealth, which relies on telecommunication systems to interact with and monitor patients at distance (Asadullah et al., 2008). A telemedicine system serves as an effective tool to enhance the quality of health care service remotely (Ashraf, 2008). The telemedicine system in general uses a high level of technology and therefore it requires a huge amount of money to provide the necessary hardware and software (Yoke et al., 2006).

Conventional telemedicine system using public switched telephone network (PSTN) land lines are already available to enable a doctor to monitor a patient remotely for home care or emergency applications. In recent years, many telemedicine applications are employing mobile technologies, such as mobile telemedicine using MMS (Asadullah, 2008; Ashraf, 2008), WAP (Kevin & Yuan, 2003), 3G network (Yuechun & Aura, 2004; Polley et al., 2006), etc. The telemedicine applications can also be developed using radio frequency identification (RFID) technologies and wireless sensor networks (WSNs) (Yang & Hui, 2008).

This paper presents a system to show how the existing MMS capacity can be increased to build a mobile telemedicine system (MTS) using Java 2 micro edition (J2ME) technology. This paper also presents the whole architecture, algorithm and application of the MMS for the MTS. The benefits of the proposed technique are: (i) It provides a viable solution to send large amount of data exceeding the limit which is currently not possible with the existing MMS technology. (ii) It preserves the quality of the image that is transmitted which is essential for medical diagnosis in a telemedicine environment. (iii) It provides a secured scheme to transmit medical data. (iv) It provides a basis for building a practical telemedicine system

The remaining part of the paper is organized as follows: Section 2 discusses methods of the research. Results of the research are presented in Section 3. Discussions are presented in Section 4 and conclusion and future work are presented in Section 5.

## 2. METHODS

### 2.1. Review of the Mobile Telemedicine System

There are several types of mobile telemedicine technologies, including wireless local networks (WLANs), mobile ad hoc networks (MANETs), wireless personal/patient networks (WPANs), third generation (3G) cellular phone technologies, radio frequency identification (RFID) technologies and wireless sensor networks (WSNs) (Yang & Hui, 2008). There exist different categories of the telemedicine systems such as teleconsultation, tediagnosis, telecare, remote clinical sessions and teleeducation, remote data access, telecardiology, home care and telemonitoring. The main objective of the telemedicine system is to enable remote health care support (Bernard et al., 2011), which gives access to existing information related to health, social care, and other general issues. In general, telemedicine offers the reduction of health-care cost, an easy way to access to health services,

an easy cooperation among health professionals and an improved quality of health care.

There are several advantages for using MMS technology compared to the current smart phones like iPhone and Google Android phones. Some of the advantages are as follows:

- (i) MMS uses GPRS network whereas smart phone require at least UMTS to connect to the internet (web-based services).
- (ii) MMS needs lower bandwidth compared to smart phones.
- (iii) MMS needs ordinary mobile phones with lower cost whereas smart phones are more expensive.
- (iv) MMS can cover remote areas using GPRS network whereas smart phones can access internet only very slowly using GPRS and it is impossible to upload large size files.
- (v) MMS uses prepaid service whereas smart phones require operator subscribed service.
- (vi) MMS is less expensive to send messages compared to smart phones.
- (vii) MMS data is more secured and also protected from unauthorized user compared to sending data through smart phones.
- (viii) Almost all of the existing mobile phones have MMS feature where MMS application can also be installed on the smart phone, so the data can be displayed by using wide screen.

We propose a complete architecture of the telemedicine system, an algorithm for sending large quantity of data and an application of MMS for a mobile telemedicine system. The existing MMS framework that is available in the market is using the resizing technique for sending large multimedia files (OMA, 2005; Nokia, 2007). The application of the system is built based on a modified MMS framework. The modification is essential because the existing MMS framework is unable to transfer a large amount of data to a physician for effective diagnosis. Resizing the data is a possible way to use the existing MMS framework but it is not useful for diagnosis purposes as it affects the quality of the data considerably. The standard of

a mobile phone service provider does not specify the maximum size of the multimedia message for the MMS. Nokia foresees initially that the MMS messages would be between 30 KB and 100 KB in size (Nokia, 2007). Actually, MMS can send multimedia packet data up to 300 KB (Bodic, 2005). However, this capacity also will not be sufficient for medical data transmission without any additional processing. To solve this problem, in the proposed method we implement compression and split techniques on the data on the client side and merging and decompression techniques on the server side.

## 2.2. Proposed Development

To develop a mobile telemedicine system, several problems need to be resolved. They are: sending multimedia message (MM) with larger data size, maintaining the quality of data during transmission, MM data retrieval (download) from a mobile phone and email server, receiving MM on computer server, storing MM data into the database server (MySQL), data security and finally, implementation of MMS framework for Internet application. The developed system uses open source software MySQL for database server. The advantages of MySQL are that it can be run on more than one operating system and it is also fast in executing Structured Query Language (SQL) commands. These problems will be solved in detail as the research works. We have performed research work to design mobile telemedicine system in previous work (Setyono, Alam, & Al-Saqour, 2010). We used split and merge techniques to solve the large data transmission on the mobile network with short discussion. In this research, we develop the proposed design using compression and splitting for pre-processing on the mobile phone then merging and decompression for post-processing on the computer server. Besides that, we implement the proposed design to prove algorithm and make evaluation in detail whether the system can be run well or not.

In this research, our first focus is how to perform data compression and splitting on a mobile device using J2ME and send it to the

Figure 1. Proposed architecture of the mobile telemedicine system

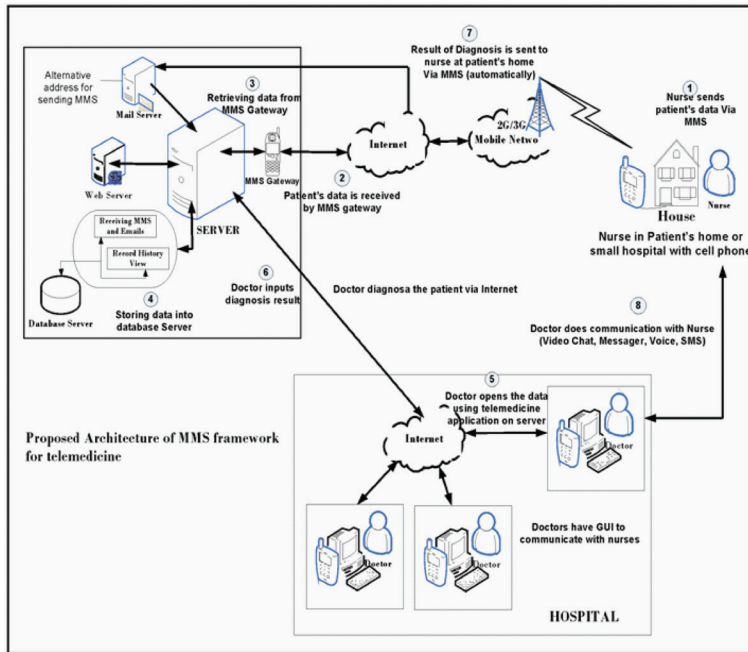

mobile phone and email server. Developing an application on micro devices is fairly a complex problem. We should have a clear idea about the standards used in MMS, as MMS allows only one delivery in a single package where there is a message header and content. If a split file is sent as different packets, the MMS center at the receiving side should be able to recognize the packets belonging to the same source file.

### 2.2.1. Architecture

The proposed architecture of the mobile telemedicine system is shown in Figure 1. This figure explains how the nurse at patient's home can send patient's information, such as symptoms of illness, picture of wound, voice or video of patient to the doctor in the hospital. The information can also be sent through email system in the form of multimedia content. The data obtained from the mobile phone number or from the email server is converted into a format which is suitable for storing in a database in the server. In this research, MySQL will be used.

It also updates the MM contents automatically. This database will be very useful as it can be used for diagnosis or for any research Internet application later. The developed system is appropriate to be implemented for a small hospital or clinic that has an independent database. All the patients' records are assumed to be stored on the database server.

After receiving the patient data from the server, the telemedicine system stores the data in the database. The doctor can analyze the patient's data for diagnosis. Once the diagnosis is completed, the database is updated with the results of the diagnosis which is subsequently stored in the MySQL database. The system will also automatically send the diagnostic results to the nurse at the patient's home through mobile phone number or email server based on the available communication system. The nurse, who is at the patient's home, can communicate and consult with the doctor for further clarification using SMS, phone, or chat facilities of GPRS/UMTS. The proposed architecture can be developed again like shown in Figure 2.

Figure 2. Proposed architecture of the mobile telemedicine system in detail

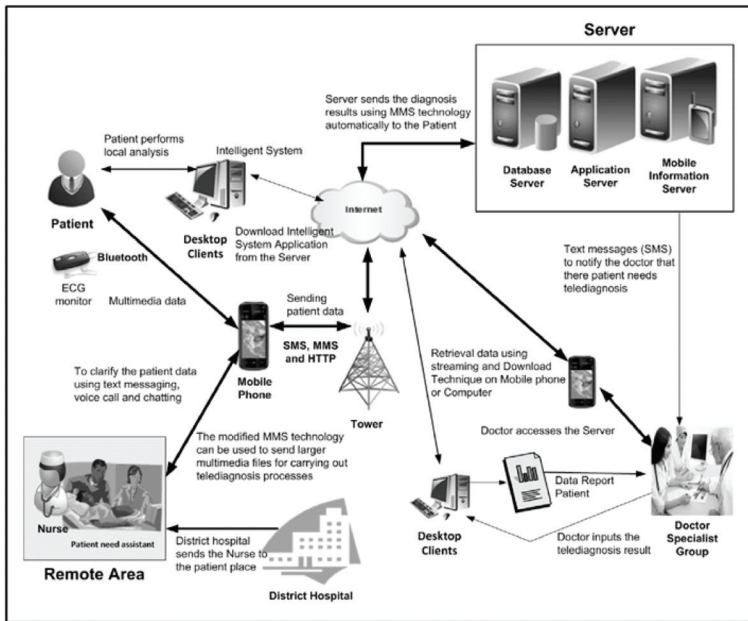

### 2.2.2. Algorithm

The main algorithm of the system is shown in Figure 3. From this figure we can see that there are two components of the system: one component is used for the client side and the other is used for the server side. The client is a form of mobile device (mobile phones, PDAs), where several stages of the process such as compression, splitting and sending a multimedia message are completed using the MMS technology. At the server side, a computer server is equipped with an email server and a mobile phone or a modem as a gateway to receive multimedia message from the client and several stages of the process such as downloading, merging, decompressing and storing of the data in the database server are performed.

Huffman's algorithm is a lossless compression algorithm. This algorithm is good for binary and multimedia files (Linawati, 2004; Mamta, 2010). From the literature review, we note that Huffman's algorithm gives nearly the same results for all data types (Mamta, 2010). Therefore, we choose Huffman coding algo-

rithm for developing the mobile telemedicine system because it is suitable for multimedia file. The flowchart of the algorithm for sending the multimedia messages is shown in Figure 4.

#### 2.2.2.1. Compression Technique

In general, a data compression technique consists of two major activities, namely modeling and coding. In Huffman coding, symbols that often appear will be transformed into a code with small number of bits, while the less frequent will be a code with large number of bits (Nelson & Gailly, 1996). Building a static Huffman table for each file to be compressed has its own advantages. Tables are uniquely adapted to the specific file, so that it can provide better compression than the universal table (Nelson & Gailly, 1996). Static Huffman coding is used in this research. The block diagram of the static Huffman model is shown in Figure 5.

#### 2.2.2.2. Split and Merge Techniques

Multimedia messages are structured as multipart messages which contain various media objects. The link between MMS client and the MMS

Figure 3. Transaction processes on the client and server sides

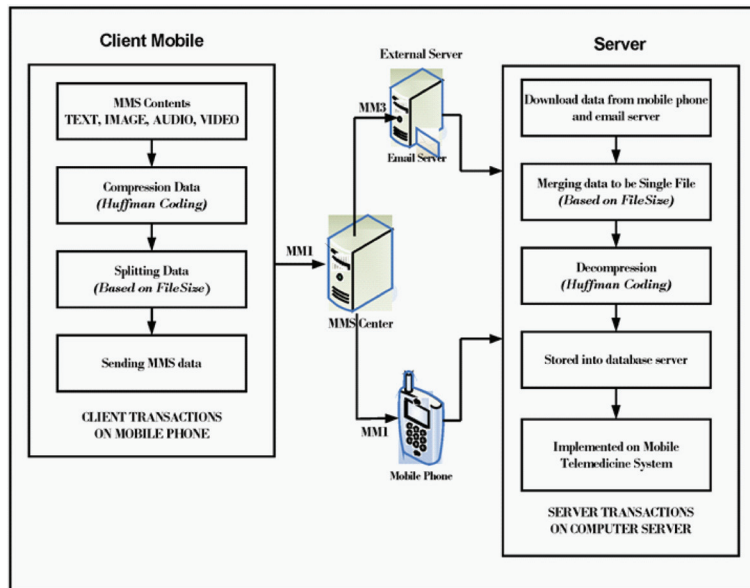

center often has bandwidth limit and therefore, multimedia messages are usually binary-encoded for efficient transfer over this link (Bodic, 2005). A multimedia message consists of an envelope also known as message header and message contents which are encapsulated in message body parts. The MMS protocol data units (PDUs) consist of MMS headers and message body coded with multipurpose internet mail extensions MIME multipart technique (Bodic, 2005). The body can contain any type of contents. The MMS headers contain MMS specific information about the message, mainly how the message will be transferred from the originator to the recipient (Simo et al., 2003). The wireless session protocol (WSP) content type application/vnd.wap.mms-message provides a good example to show how multimedia content and presentation information can be encapsulated to a single message (OMA, 2005). The fields on MMS header for a message delivery are: notification, retrieval, report and acknowledge. These are defined fully on multimedia messaging service encapsulation protocol document

(OMA, 2005). Message contents of MMS consists of texts (UTF-8, UTF-16), images (JPEG, GIF, WBMP, PNG), audio (AMR, MP3, MIDI) or video (3GP, MPEG-4) (Bodic, 2005).

A. Model Design: Though, theoretically, the MMS can send multimedia messages up to 300 KB, in the real world, almost all of the cellular service providers provide only 100 KB capacity (Setyono et al., 2009; Bodic, 2003). We have to face difficulties to send messages larger than this upper limit size. To solve this problem, we develop an algorithm to divide the original file into several smaller files. This method can be used to build a telemedicine system, where patient or nurse can send multimedia message to a doctor in the hospital and then the doctor can diagnose the patient's information. The basic idea of the algorithm is shown in Figure 6. Applying the same technique, similar kind of internet applications, like mobile commerce, mobile learning and mobile ticketing can be built.

Figure 4. Flowchart of the algorithm for sending MMS

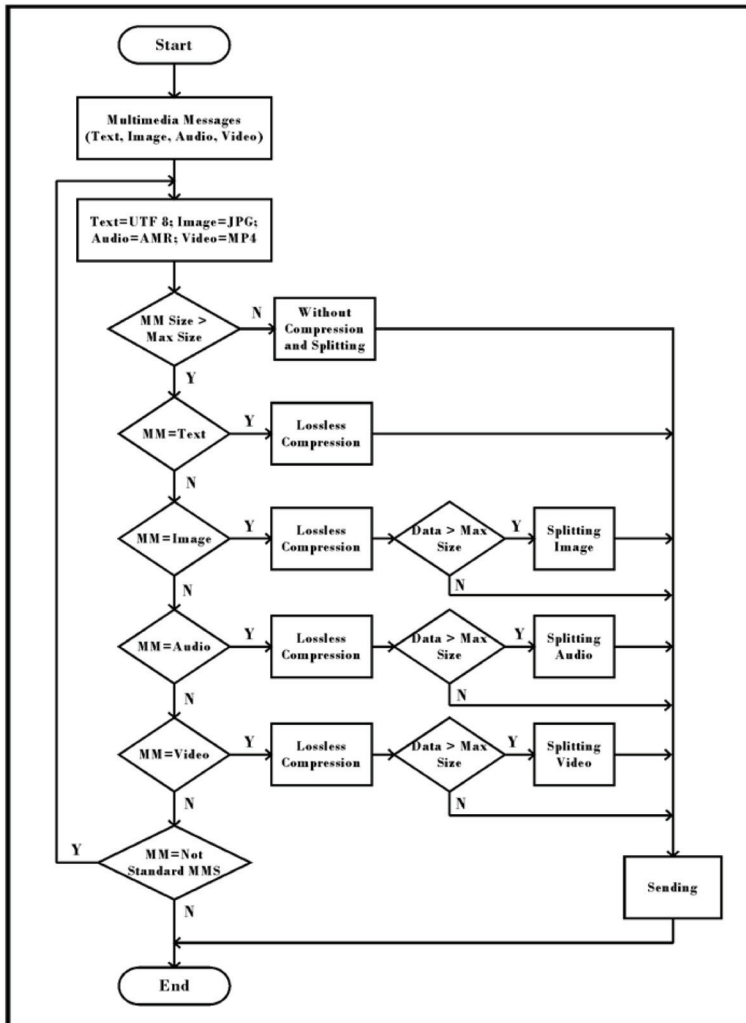

B. The Algorithm for Splitting and Merging Techniques: The MMS packages the message suitable for the MIME type and encodes to a binary message. Here, we split the original message file into several files in order to send a large message. The splitting method is employed if the original file size ( $OFS$ ) is larger than the maximum capacity ( $MC$ ) permitted. If  $M = OFS/MC$ , the number of split files  $N$  is given by

$$N = \begin{cases} M & \text{if } M \text{ is an integer} \\ \text{Integer}(M + 1) & \text{if } M \text{ is a fraction} \end{cases}$$

Let the original image be of size ( $w \times h$ ) where  $w$  and  $h$  denote the width and height of the image respectively. Then the size of each of the  $N$  split images will be equal to  $\{w \times (h / N)\}$ . The algorithm of the splitting technique is shown in Figure 7.

Figure 5. Static compression of Huffman coding (adapted from Nelson, 1996)

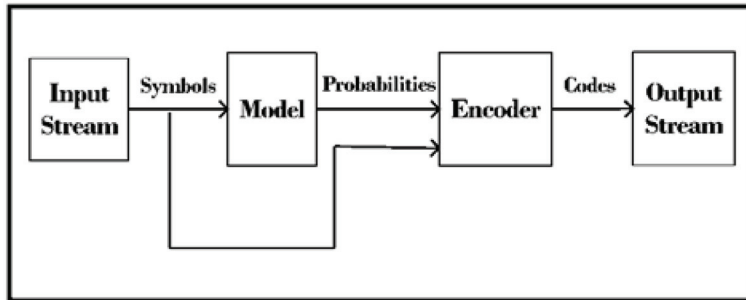

The downloaded messages are merged and decompressed on the server and stored into the database. The database can also be used for other types of internet applications. The first step of the merging process is reading data size of the original message. All the split files belonging to the same original message are stored with the same file identifier inside the database. When the total size of the stored split files is equal to the original data file size, all the split messages in the same folder will be merged into a single file and decompressed before storing into the database.

### 2.2.3. Application

#### 2.2.3.1. Client Applications

Mobile phones are used as mobile client devices and as the MMS gateway. The mobile client devices are used to send and receive multimedia messages. The MMS gateway is used to receive multimedia message from and to mobile client before reaching the server. To develop the mobile system using MMS technology, we use NetBeans 6.9 as editor and emulator. Java 2 Micro Edition (J2ME) is used for client application. In the client application, two techniques, compression and split, are used to reduce and decompose the multimedia message file before sending it to the server. To overcome the failure of delivery, the application notifies the user that the data transmission failed and should be repeated again. Similarly, if the data is sent successfully to the server and stored in the database, the system sends a notification that

the data is stored in the database successfully. This ensures that the doctor does not diagnose the patient with an incomplete information.

This application is developed to achieve the goal that the health services are provided at a longer distances from the hospital so that the load of the hospital is reduced. There are many benefits offered by the mobile telemedicine system to the patient. GRPS or UMTS network provided by the service provider is a pre-requisite to use this application. In developing this mobile telemedicine system, we integrate client and server applications. This will simplify the telemedicine process, and the doctor will get information using SMS that the message successfully sent and stored into database automatically.

#### 2.2.3.2. Server Applications

The mobile telemedicine system needs a server to connect with an internet network. Besides that the system needs an email server to receive the message. To develop applications on the server, we intend to use Java 2 Enterprise Edition (J2EE). These applications include data retrieval from the mobile phone and email server, storing the data into the database server and implementing a few telemedicine applications, such as data retrieval and information update by the doctor, sending an automatic message to the nurse/patient by the system, etc. The user interface of the existing applications on the server enables the doctor to perform diagnosis based on the patient's data received via mobile devices in the form of multimedia



Figure 6. Design algorithm for splitting and merging multimedia message (Setyono et al., 2010)

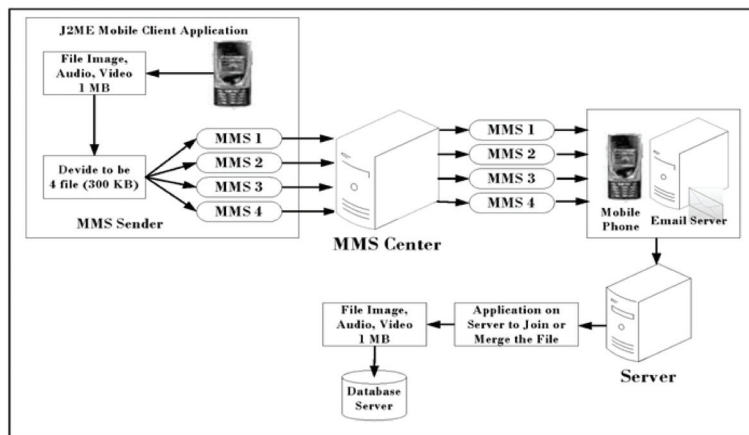

messages from the nurse in the remote location. User interface for the server application will be made as user friendly as possible. It is necessary that a doctor can use this system smoothly. There will be a notification system to notify the doctor that the information is incomplete. The incomplete information will not be stored into the database.

### 3. RESULTS

#### 3.1. Implementation

Our target is to implement the developed system in a hospital. It is also expected that the implemented system will have a broader scope, such as wide hospital network that can access the patients' history. Some other health related organizations will also be connected with this network. This part of the research work is under investigation. Figure 8 shows the basic architecture of the proposed mobile telemedicine system.

The steps involved in the basic architecture of the mobile telemedicine system (Figure 8) are explained below:

- (1) Sending multimedia message from mobile phone sender (user, nurse or patient).

to mobile phone or email server (on the receiving side).

- (2) Connecting mobile phone and email server with computer server using data cable or Bluetooth.
- (3) Downloading or retrieving multimedia data from mobile phone and email server using Object Exchange (OBEX).
- (4) Storing the downloaded data from mobile phone and email server receiver to the database server using SQL commands.
- (5) Retrieving data from database server for the use of internet applications (e.g., telemedicine).
- (6 - 8) Sending data from computer server to user by using internet applications.

#### 3.2. Simulation for Sending MMS

In this section we present the simulation results. It includes the process of sending multimedia message with a greater capacity than the existing ones. First we implement the lossless compression technique to reduce the file size, and then we apply the split technique to divide the large multimedia file into several files. The extension of each file is similar, for example, a large .jpg file is divided into several .jpg files.

Figure 9 shows the simulation results. We use Sony Ericsson K630i and J105i mobile phone devices to perform the simulation.

Figure 7. Algorithm of splitting message technique

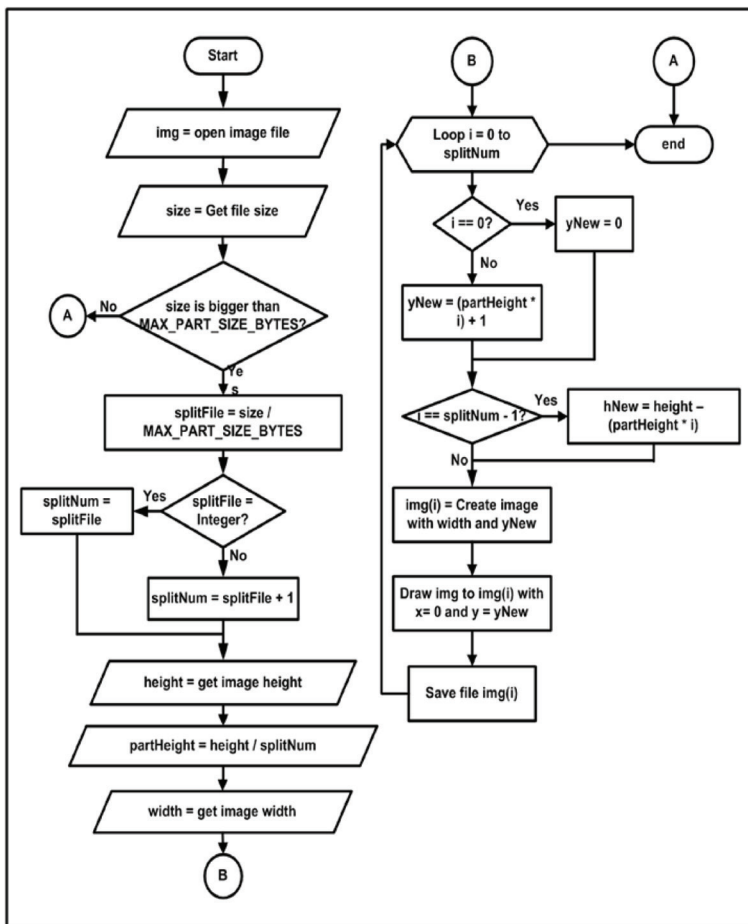

The clarification of the simulation results are given below:

- (a) Display for setting an inbox (storing the message on the mobile device).
- (b) User interface for sending MMS, there are subject, destination and messages.
- (c) File (image) that will be sent.
- (d) Selecting a file that will be sent.
- (e) The information in the form of notification that the file is more than 30 KB. We use 30 KB size limit because the MMS can send data of max 30 KB size only using the Java applications on a mobile phone. We are studying to overcome this problem.
- (f) Display the image before compressing and splitting.
- (g) Compressing files with a selected value of the quality factor.
- (h) Splitting of files (if the file size is larger than the maximum size, it will be split into several smaller files).
- (i) Determining the destination number (SIM Card) transmission.
- (j) Delivery process, where in one time multiple messages are sent sequentially.
- (k) Notification that the messages is ready to be sent and need the approval.
- (l) MMS inbox (sending the multimedia message successfully).

Figure 8. The basic architecture of mobile telemedicine system

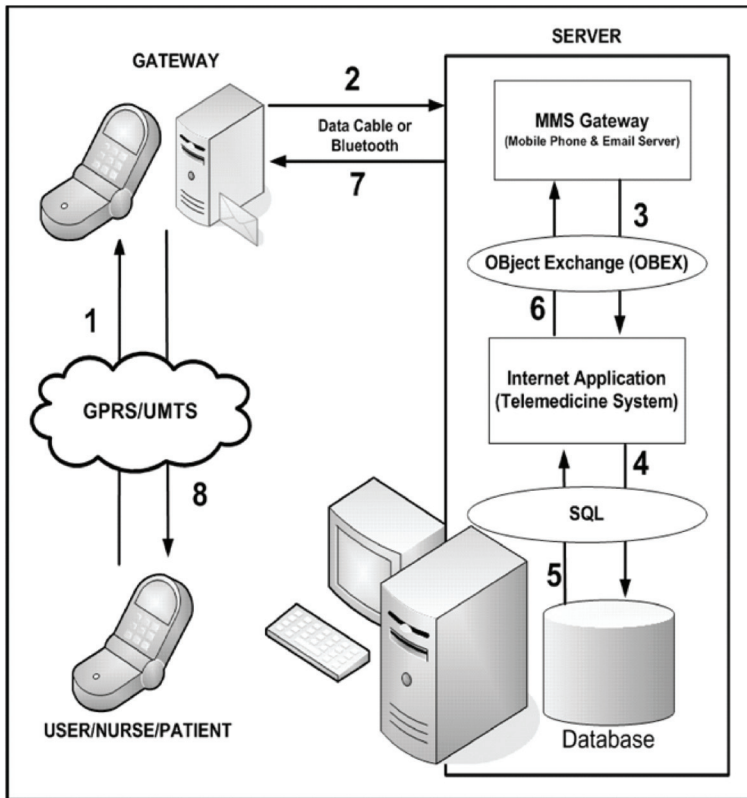

- (m) The first part of split image.
- (n) The second part of split image.
- (o) The third part of split image.
- (p) The split files are merged to be a single file before decompressing.

Figure 10 shows the implementation results of compression. We display the original file and compressed file.

### 3.3. State of the Art

In this research, we have developed the architecture, algorithm and application of MMS as a new framework to enhance the ability of MMS in message delivery. As we know that MMS is a mobile messaging system that has evolved from the development of short message service (SMS) and enhanced messaging services

(EMS). MMS will be developed continuously. Open Mobile Alliance (OMA) has been issuing releases regarding MMS updates. MMS version 1.3 was released on January 2008 which allows the MMS to transmit data up to 600 KB for every sending (OMA, 2008). Manufacturers of mobile phones are starting to use the MMS version 1.3 in the development of new mobile phone products. Along with the advancement in information technology and communications, MMS is being developed to help and facilitate the human needs. In implementing the mobile telemedicine system, security issues need greater attention. This is because of the fact that this system is a client-server application, with the client on the mobile network and server on the internet network. Both networks are connected to build an integrated mobile telemedicine system.

Figure 9. Simulation for sending multimedia messages

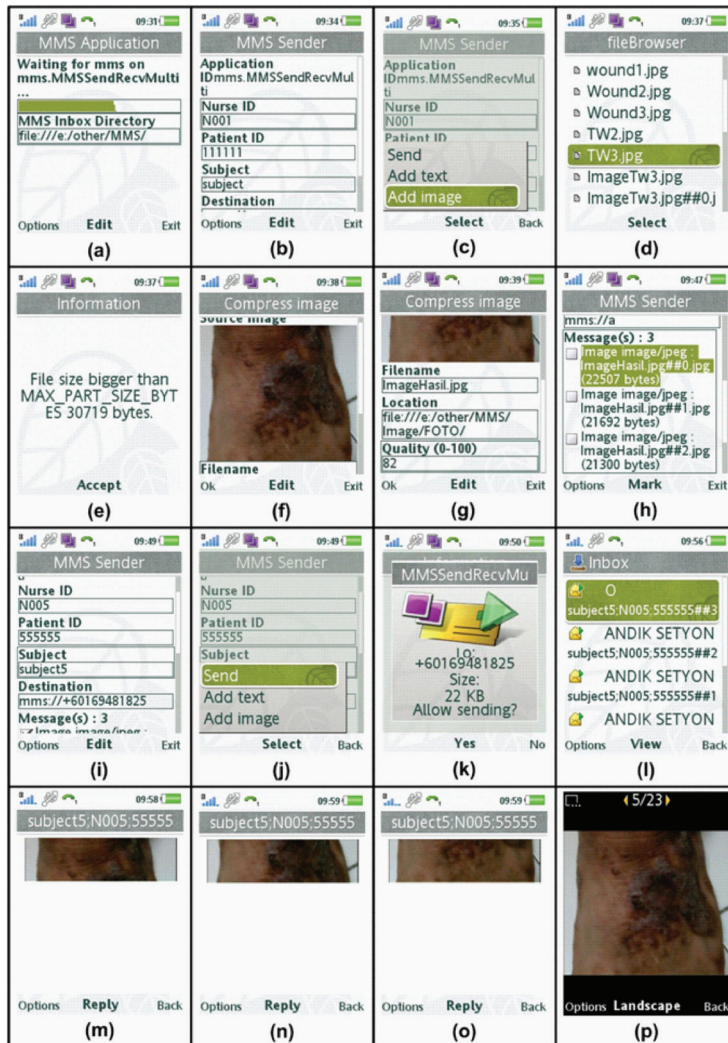

#### 4. DISCUSSION

This paper presents the MMS applications for a mobile telemedicine system using a mobile phone device. Through the research work, it is shown that how a mobile phone device with many limitations can be used to install an application on it. On the mobile phone device, the compression technique can run smoothly and it can also split data for multimedia message transmission. All these tasks are easy for a computer but not for a mobile phone device. As

already mentioned with the existing technology, the MMS cannot send data greater than 300 KB in size (Bodic, 2005). In majority of the Asian countries the maximum MMS capacity is still lower than this limit and it is around 100 KB only at a single delivery (Setyono et al., 2009). With this research, we expect that the modified and enhanced MMS can provide an alternative way for sending a large quantity of data, so that the recipient can receive the original large size data without any degradation in the quality. A comparison of the characteristics of the existing

Figure 10. The implementation results of Huffman compression

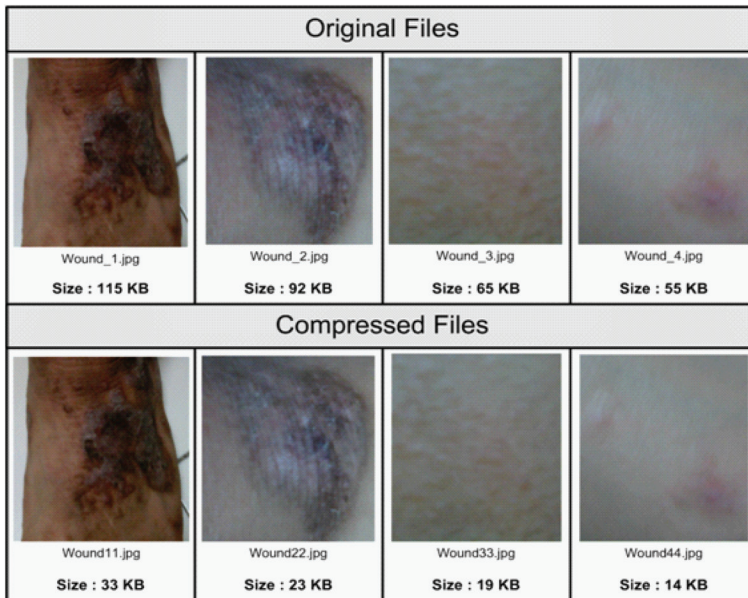
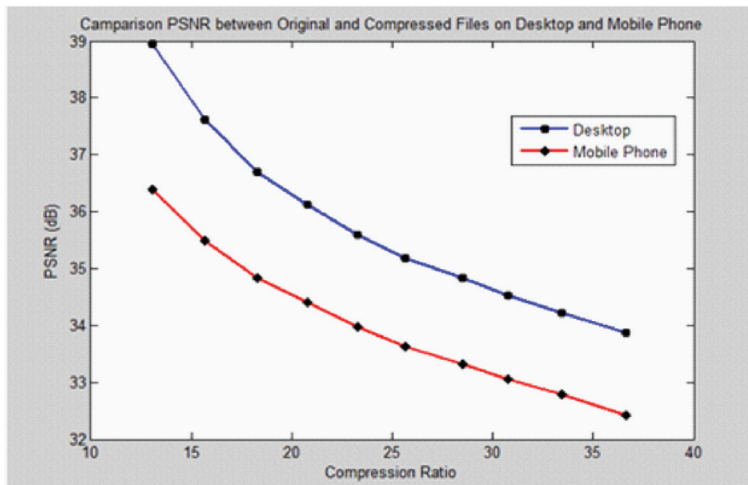

Figure 11. PSNR between source and compressed files



and the enhanced MMS applications is shown in Table 1.

The mobile applications have been developed using J2ME on the mobile devices, like mobile phones which have limitations in pro-

cessing the large data. Java libraries allow only 30 KB as maximum data to be sent in a single delivery. We have conducted several experiments to evaluate the compression and splitting performances on the mobile device. The image

Figure 12. Comparison between image source and compressed file on the mobile phone



Table 1. Comparison of the MMS applications

Item	Existing Method	Developed Method
Data Size	100 KB	> 100 KB
Resizing	Yes (smaller size)	No
Platform	Symbian C++	Java
Quality	Reduced	Preserved
Technique Time Cost	Resizing Average Low-cost	Compression and Split Average-High Moderate-High
Method	Single message every sending	Multiple messages in one sending
Strengths	Automatic resizing before sending	Can send data larger than 100 KB Quality is not reduced
Weakness	It cannot be modified It cannot send data larger than 100 KB Quality and size are reduced.	Risk of failure is still high since Large file is split to be several small files.

that is used as example is Lena.BMP (uncompressed file) which is often used in digital image processing. The image size is 512 x 512 pixels with file size 769 KB. The image is compressed in the form of JPEG image format. The experimental results are shown in Table 2.

In Table 2, column 1 gives the quality factor used for compression. Columns 2 and 3 give the times in ms for compression and decompression processes without using splitting technique. Columns 4 and 5 give the times (ms) when the combination of compression and splitting is adopted. Columns 6 and 7 give the times (ms) when the combination of splitting and compression

is adopted. It may be noted that columns 2, 4 and 6 represent the processes on the sender side and columns 3, 5 and 7 represent the processes on the receiver side.

We perform measurements of the image quality before and after transmission using peak signal to noise ratio (PSNR). We use the mobile communication network provided by the operator. PSNR is the most commonly used measure for determining the difference between the qualities of two images. The signal in this case is the original data, and the noise is the error introduced by compression. Figure 11 shows the PSNR between the source and compressed

Table 2. Speed of compression process on the mobile phone device

Speed of the compression process on the mobile phone in milli second (ms)						
Quality Factor	Compress Standard	Decompress Standard	Compress and Split	Merge and Decompress	Split and Compress	Decompress and Merge
85	15950	3896	35839	6063	32595	23011
80	16796	3716	35362	5921	31835	23302
75	15666	3697	35049	5380	31780	22638
70	15648	3748	35627	5421	32985	24604
65	15622	3810	16555	3810	31429	22390
60	15843	3777	16663	3777	31904	22895
55	16126	3745	18401	3745	33140	23511
50	15378	3776	16185	3776	31329	22210
45	15277	3760	15565	3760	31225	22249
40	15218	3843	16685	3843	31819	23013

files on desktop computer and mobile phone using JPEG compression standard.

We can see visually the compression result that has been done on the mobile phone. Figure 12 shows the actual images corresponding to the source and compressed files.

Figure 13 and Figure 14 show respectively the PSNR and the actual source and decompressed images. We note from Figure 13 that the PSNR value between the source and the decompressed files remains above +30 dB which is the threshold value for medical diagnosis applications. We make some experiments to measure the image quality (PSNR) without compression for single and split-files without compression and also cropping files before and after sending are IDENTICAL.

In the simulation section, it has been shown that the proposed MMS application can implement the compression and split processes on the mobile device for sending large sizes of multimedia messages. It should be noted here that the selection of the mobile phone device plays a vital role for the development of the MMS applications. This is because the proposed application has been developed using mobile information device profile (MIDP) 2.0, connected limited device configuration (CLDC) 1.0 and Java version JP 8\_4\_4, whereas many

mobile phones use different versions. So we must ensure that the mobile phones have these features.

In effect the proposed mobile telemedicine system will yield the following benefits: (i) with the developed system, a patient can consult with a doctor while living in a remote area, (ii) the doctor can diagnoses the patient's information using a better quality of data without visiting the patient physically, (iii) the system will also automatically send the diagnostic results to the nurse at the patient's home through mobile phone or email server based on the available communication system and (iv) the nurse, who is at the patient's home, can communicate and consult with the doctor for further clarification using SMS, phone, or chat facilities of GPRS/UMTS.

## 5. CONCLUSION AND FUTURE WORK

This paper has presented a novel technique to improve the ability of the existing MMS for sending and receiving a large quantity of multimedia message. This is achieved by implementing compression and split techniques on the mobile phone and merging and decom-

Figure 13. PSNR between source and decompressed files

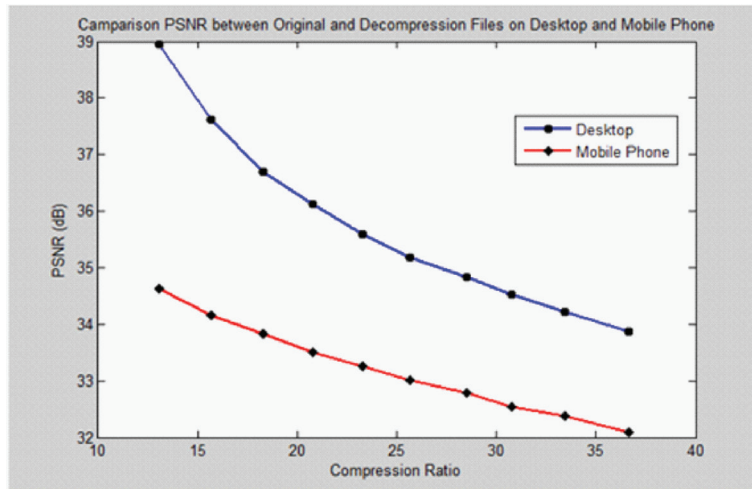

Figure 14. Comparison between the source and the decompressed images



pressing techniques on the server computer. The compression technique is used to reduce the file size and the splitting technique is used to break the original file into smaller files according to the limitation of the MMS. The simulation results show that the proposed method can be successfully implemented to send large amount of data using MMS application and also main-

tained quality of data between before and after transmission. It is proved by PSNR values are more than +30 dB. This feature is particularly useful for telemedicine applications. With the developed system, a patient can consult with a doctor while living in a remote area. The doctor also diagnoses the patient's information using a better quality of data without visiting



the patient physically. For future work, we will attempt to enhance the proposed MMS framework for mobile environment by implementing new techniques such as masking, cropping and streaming.

## REFERENCES

- Asadullah, S., Muhammad, M., & Muniba, S. M. (2008). *A system design for a telemedicine health care system* (pp. 295–305). Berlin, Germany: Springer-Verlag.
- Ashraf, A. T. (2008). Mobile personal electrocardiogram monitoring system and transmission using MMS. In *Proceedings of the International Caribbean Conference on Device, Circuits and Systems*.
- Bernard, F., Fong, A. C. M., & Li, C. K. (2011). *Telemedicine technologies: Information technologies in medicine and telehealth*. Chichester, UK: John Wiley & Sons.
- Bodic, G. L. (2003). *Multimedia messaging service: An engineering approach to MMS*. Chichester, UK: John Wiley & Sons. doi:10.1002/0470862521
- Bodic, G. L. (2005). *Mobile messaging technologies and services SMS, EMS, MMS* (2nd ed.). Chichester, UK: John Wiley & Sons. doi:10.1002/0470014520
- Daniel, R. (2004). *MMS: Technologies, usage and business model*. Chichester, UK: John Wiley & Sons.
- Jari, R. (2004). *MMS enabled web map dispatching solution for location enhanced fieldwork management*. Helsinki, Finland: Helsinki University of Technology.
- Kevin, H., & Yuan, T. Z. (2003). Implementation of WAP-based telemedicine system for patient monitoring. *IEEE Transactions on Information Technology in Biomedicine*, 7(2).
- Linawati, H. P. P. (2004). Perbandingan Kinerja Algoritma Kompresi Huffman, LZW dan DMC pada Berbagai Tipe File [Comparison of the Performance of Compression Algorithm among Huffman, LZW and DMC]. *Integral*, 9(1), 7-16. Retrieved from <http://home.unpar.ac.id/~integral/Volume%209/Integral%209%20No.%201/Perbandingan%20Kinerja%20Algoritma%20Kompresi.pdf>
- Mamta, S. (2010). Compression Using Huffman Coding. *International Journal of Computer Science and Network Security*, 10(2), 133–141.
- Nelson, M., & Gailly, J. L. (1996). *The data compression book* (2nd ed.). New York, NY: M&T Books.
- Nokia. (2007). *MMS FAQ*. Retrieved May 20, 2010, from <http://www.forum.nokia.com>
- Open Mobile Alliance (OMA). (2005). *Multimedia messaging service encapsulation protocol, approved version 1.2* (Tech. Rep. No. OMA-MMS-ENC-V1\_2-20050301-A). San Diego, CA: Author.
- Open Mobile Alliance (OMA). (2008). *Multimedia messaging service requirement candidate version, approved version 1.3* (Tech. Rep. No. OMA-MMS-ENC-V1\_3-20080128-C). San Diego, CA: Author.
- Polley, R. L., Max, Q. H. M., Fanny, F. L., Chen, X. J., & Peter, X. L. (2006). A 3G based network solution on the telehealthcare robotic system. In *Proceedings of the 6th World Congress on Intelligent Control and Automation* (pp. 381-384).
- Setyono, A., Alam, M. J., & Al-Saqour, R. A. (2009). Evaluation and analysis of multimedia messaging service (MMS) in message delivery. In *Proceedings of the 6th International Conference on IT in Asia, Serawak, Malaysia* (pp. 241-245).
- Setyono, A., Alam, M. J., & Al-Saqour, R. A. (2010). Design of multimedia messaging service for mobile telemedicine system. *International Journal of Network and Mobile Technologies*, 15-21.
- Simo, G., Janne, R., Jorma, Y., & Pekka, L. (2003). A multimedia messaging platform for content delivering. In *Proceedings of the 10th International Conference on Telecommunications* (pp. 431-435).
- Yang, X., & Hui, C. (2008). *Mobile telemedicine, a computing and networking perspective*. Boston, MA: Auerbach.
- Yoke, S. I., Allya, P. K., & Soegijardjo, S. (2006). Sistem Telemedika Berbasis ICT Dalam Pengelolaan Masalah Kesehatan Masyarakat [ICT-Based Telemedicine System in Management of Public Health Problems]. In *Proceedings of the Konferensi Nasional Teknologi Informasi & Komunikasi untuk Indonesia*, 223–226. Retrieved from <http://www.batan.go.id/sjk/eII2006/Page05/P05c.pdf>
- Yuechun, C., & Aura, G. (2004). A mobile teletrauma system Using 3G networks. *IEEE Transactions on Information Technology in Biomedicine*, 8(4).

*Andik Setyono was born in Indonesia, 12th February 1980. He received his bachelor and master degrees in computer science at Dian Nuswantoro University, Semarang, Indonesia, in 2003 and 2005, respectively. Currently he is working toward the PhD degree in the Faculty of Information Technology at Multimedia University, Cyberjaya, Malaysia. Since 2006 he has been with Nuswantoro University as a lecturer in the Faculty of Computer Science at Dian Nuswantoro University, Indonesia.*

*Md. Jahangir Alam received the BSc (Honours) and MSc degrees in physics from Jahangirnagar university, Dhaka, Bangladesh in 1989 and 1991, respectively. He received PhD in Information Technology from Osaka University, Osaka, Japan, in 2004. He worked as Assistant Professor in the Department of Electronics and Computer Science at Jahangirnagar University. Currently, he is working as a lecturer at Multimedia University, Cyberjaya, Malaysia.*

*C. Eswaran received his B.Tech, M.Tech and PhD degrees from the Indian Institute of Technology Madras, India, where he worked as a Professor in the Department of Electrical Engineering until January 2002. Currently he is working as a Professor in the Faculty of Information Technology, Multimedia University, Malaysia. He is also serving as the chairman of the research center, "Communication Infostructure" at this university. Dr. C. Eswaran served as a visiting faculty and research fellow in many international universities such as Ruhr University Bochum, Germany, Concordia University, Canada, University of Victoria, Canada, and Nanyang Technological University, Singapore. He has received two prestigious international fellowships: Humboldt-Fellowship (Germany) and Advanced Systems Institute Fellowship (British Columbia, Canada). He has supervised successfully more than 25 PhD/MS students in the areas of Information Systems, Communications, Digital signal Processing, Neural Networks, and Telemedicine. Prof. C. Eswaran is a senior member of IEEE.*