

*Retraining and updating of  
PC universities staff in AT*



TECHNISCHE  
UNIVERSITÄT  
WIEN  
Vienna University of Technology



## **Dust separation on bio mass combustion plants**



*Vineta Srebrenkoska  
Faculty of Technology  
University Goce Delcev - Stip*



*Course development workshop 1 - Ohrid, MK  
17th till 21st January 2011*



TECHNISCHE  
UNIVERSITÄT  
WIEN  
Vienna University of Technology

## Vienna University of Technology



The third training program was held at *TU Vienna*, Austria in period of 15-22, 11, 2010.

*The TU Vienna is among the most successful technical universities in Europe and is Austria's largest scientific-technical research and educational institution.*

Institute of Chemical Engineering



*During the retraining session in Vienna, Austria:*

- Air Pollution Control Techniques for Aerosol - and Dust emissions,
- Dust separators – types,
- Gasification of Biomass,
- Investigation of operating and engineering parameters of water spraying systems at figurative dust suppression,
- Standardized Filter Tests of Metal working fluid mist separators,
- Dust separation at biomass combustion plants. (was presented by Diominik Steiner from the company "Scheuch")

## BIOMASS

Biomass is material from vegetation, it can be used as a fuel in various boilers and combustor.

*The main components:* carbon, oxygen and hydrogen but it also contains nitrogen, sulphur, small amounts of chlorides and ash.

*The main part of the ash comprises:* Ca, K, Si, Mg, Mn, Al, Fe, P, Na and Zn.

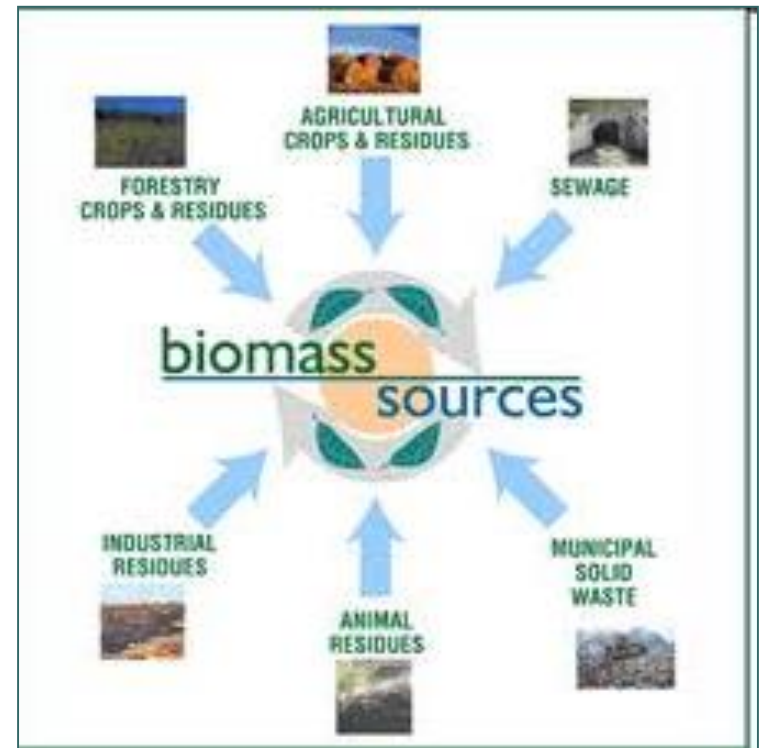

- *Biomass can be clean* (wood chip), which contains cellulose, hemicelluloses, lignin and ash.

- *Biomass can be contaminated*, which is the case with, for instance, demolition material which, also even after sorting, often contains sulphur from gypsum board, chlorine from PVC and ash, mortar, sand, etc. The amount and composition of the impurities varies.



## BIOMASS COMBUSTION

During combustion, various kinds of impurities are generated and some of them we find in the flue gas. Most of these are related to the composition of the biomass: particles from ash, NO<sub>x</sub> from nitrogen, SO<sub>2</sub> from sulphur, etc. We can also find impurities related to incomplete or bad combustion e.g. particles such as soot and unburned matter, carbon monoxide and other gaseous organic compounds such as dioxin.

(Dioxin are aromatic molecules in which chlorine replaces hydrogen. Dioxin is very toxic.)

*The impurities in the flue gas are harmful if they are emitted to the atmosphere.*

*Flue gas cleaning - must be installed !!! - eliminate or reduce this problem.*

The degree of cleaning depends on regional and local regulations, but regional and local authorities, organisations and individuals have often an opinion on an actual plant due to its size, location, etc.



## GAS CLEANING

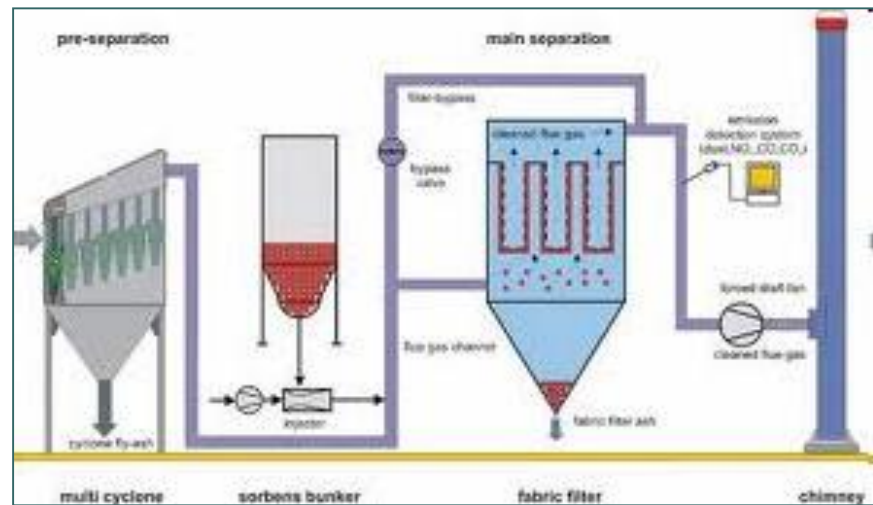

The gas cleaning systems can be divided as follows:

1. **Removal of particles or dust collection;**
2. Removal of water soluble gases: SO<sub>2</sub>, HCl, HF and NH<sub>3</sub>;
3. Removal of NO<sub>x</sub>, mainly NO;
4. **Removal of the very toxic substances: dioxin and mercury (Hg);**

One equipment or system can be specific for a certain pollutant or can, sometimes with some additions, take care of the whole gas cleaning.

There are often several possible solutions for an actual plant with respect to emission limits, performance, reliability, costs, etc.

## REMOVAL OF PARTICLES

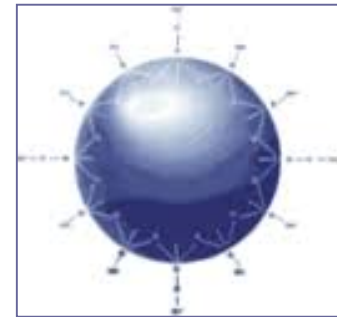

Particles in the atmosphere have a great influence on climate, weather, human health, corrosion, vegetation, etc. Particles smaller than some microns are particularly harmful for man as these small particles penetrate down to the smallest lung alveoli.

The properties of the particles in the flue gas and flue gas itself influence of course the behaviour of the particles during the particulate removal process.

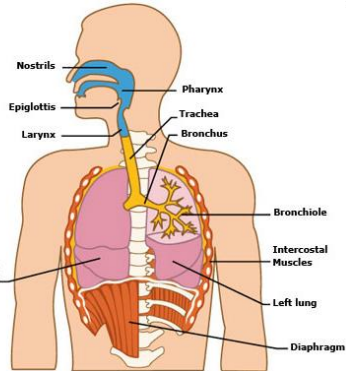

The most important parameters in the removal are:

### Particles

#### Physical properties

- Phase of particles – solid or liquid
- Particle size, particle size distribution and concentration
- Particle density and particle shape

#### Chemical properties

- Chemical composition
- Hygroscopicity, agglomeration properties.

#### Electrical properties

- Resistivity
- Electrical strength

### Flue gas

- Composition and temperature

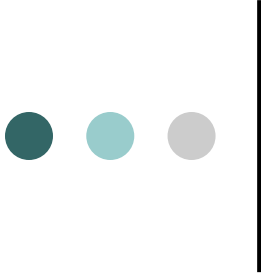

There are in principle three available forces for the separation of particles from a gas:

1. Mass or inertia force
2. Surface or adhesion force
3. Electrical force

*Cyclones and conventional wet scrubbers are typical mass force separators.*

*Fabric filter is a typical adhesion force separator.*

*Electrical is the dominant force in an electrostatic precipitator.*



## Cyclones

**Cyclones** are totally dependent on mass for the removal. Flue gas and particles are introduced tangentially into a cylinder so that a rotational movement is obtained. Centrifugal forces carry the particles toward the wall of the cylinder, to the vortex chamber and then to the dust collection chamber.

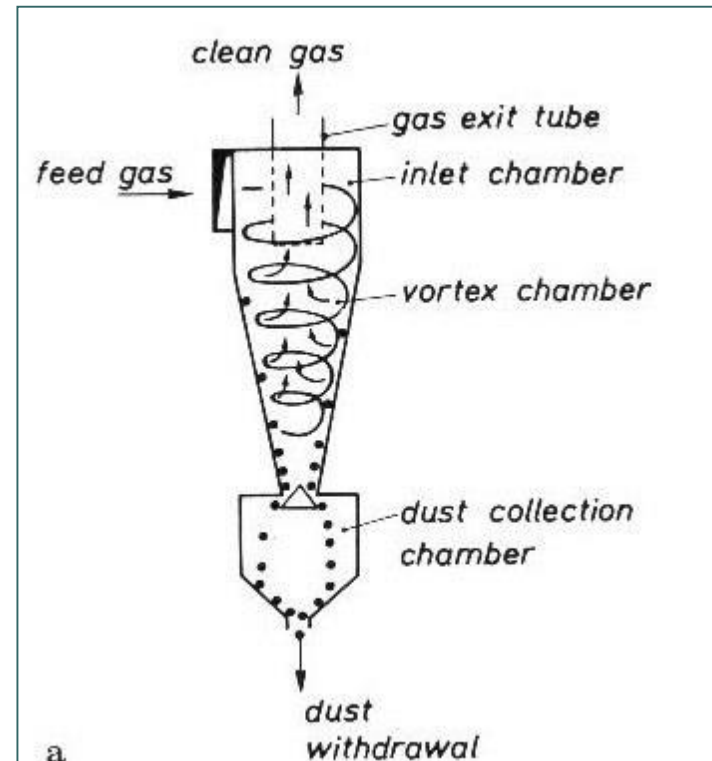

**Sand bed filters** also use mass forces for removal of particles.

When the particles are deflected during passage through the sand bed they stick on the surface and are collected. The particle cut diameter for a well designed sand bed filter is around one  $\mu\text{m}$  and it can then remove the main part of the coarse particles. By introducing electrostatic fields in the sand bed the removal of small harmful particles can be improved. A sand bed filter is robust and can stand extreme conditions.

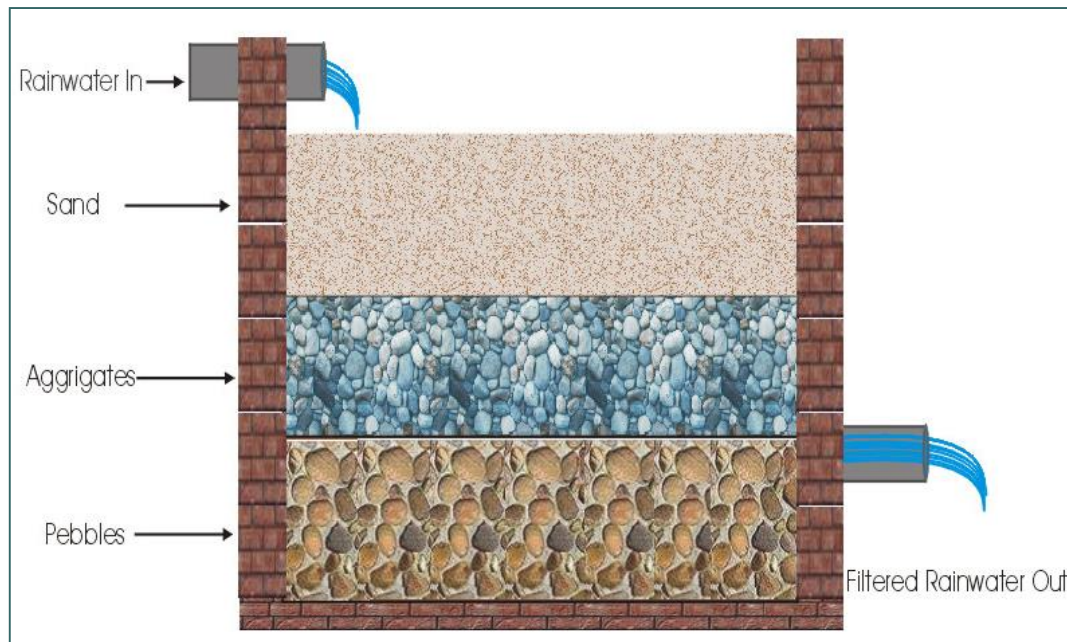

**Wet scrubbers** also rely on mass forces for the removal of particles.

The working principle is the same as for sand bed filters – instead of sand water droplets are used.

The particle cut diameter is very dependent on the velocity difference between droplets and particles. Higher velocity difference requires more power.

The removal of small particles can also be done using electrical forces, normally by charging particles and droplets with opposite charge.

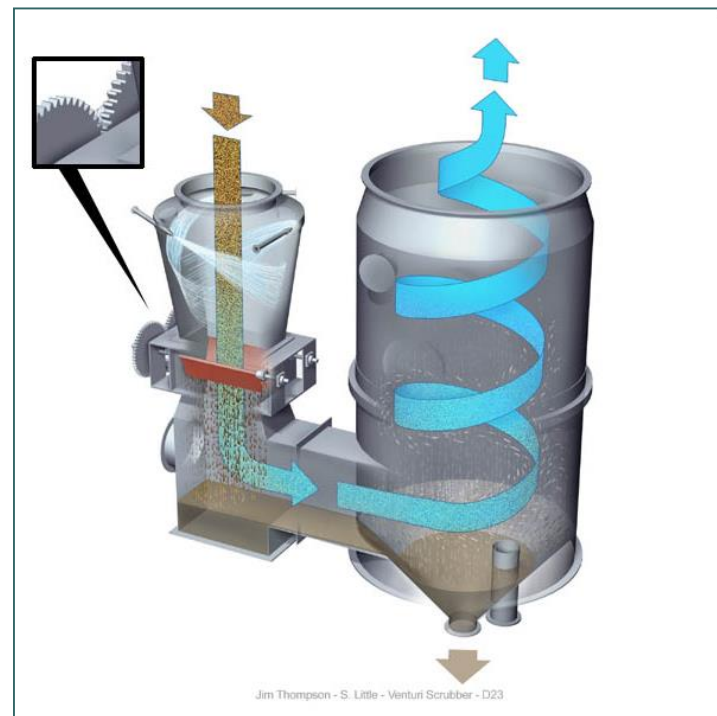
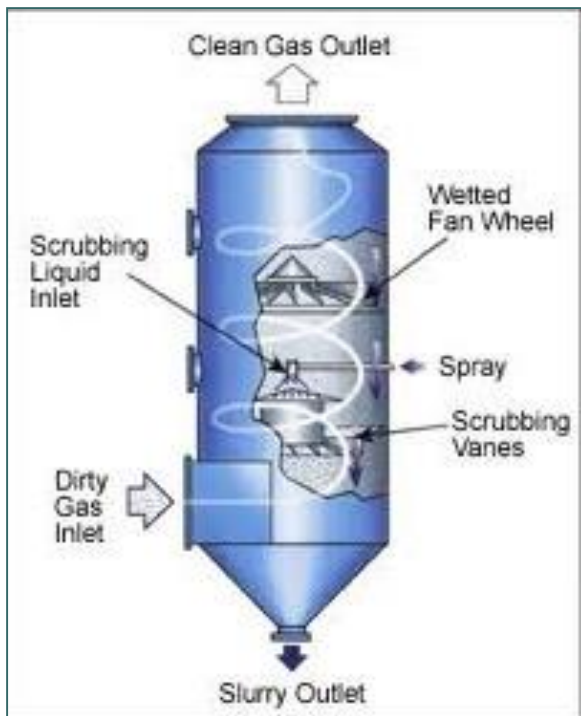

# Adhesion separators

**Fabric Filter (FF)** (Bag (house) filter, Fibrous filter, Textile filter)

- The most common adhesion separator.
- has a large area of woven or needled fabric which the flue gas has to flow through.

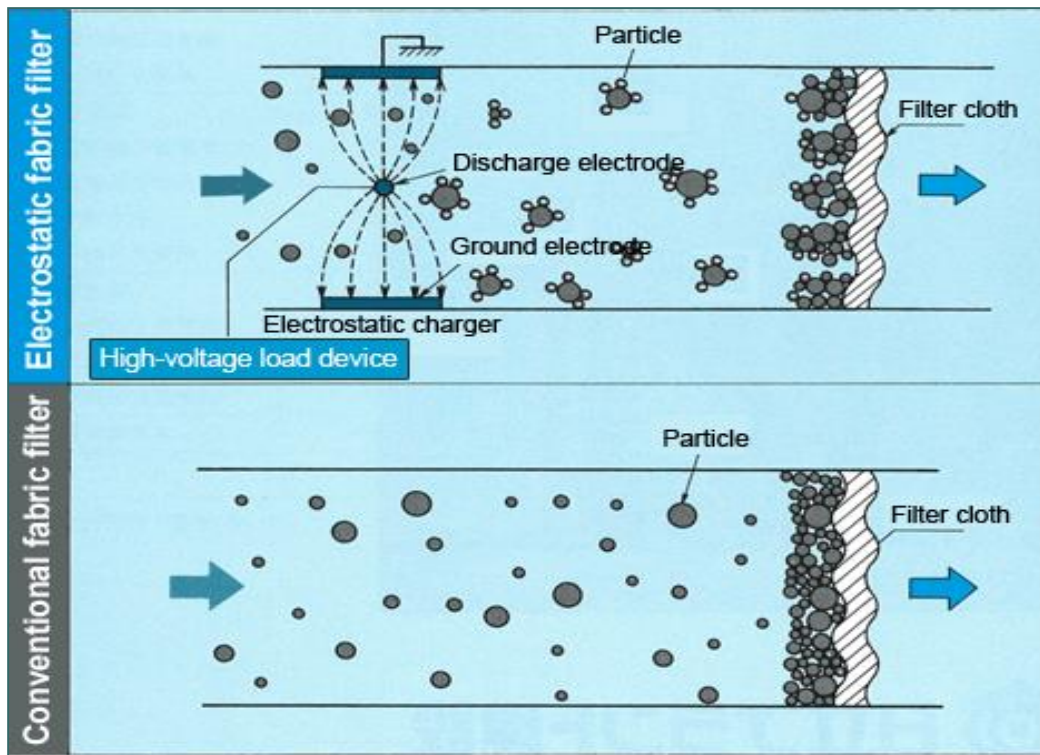

During passage, the particles are removed by deflection (mass forces), interception, diffusion (adhesion forces) and electrical forces.

*Fabric filters can operate up to 200 - 250 °C with common fabrics, higher temperatures require special material.*

*The dust cake which is formed on the fabric is regularly removed by shaking, pulsing, gas reversing, etc.*



*fabric filter*

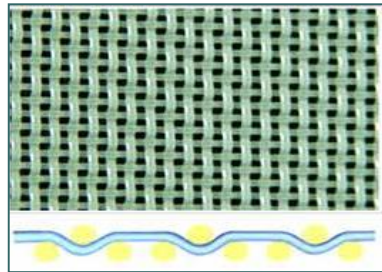

*Polyester filter fabric*



*Non Woven needle punched felt fabric for dust collection*

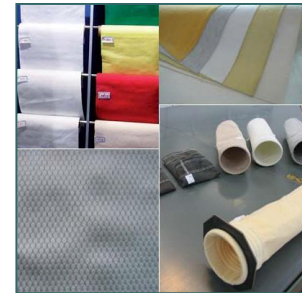

## Electrostatic precipitator ( ESP )

The principle of an electrostatic precipitator is very simple: charge the particles, separate them from the gas in an electrostatic field to a collector and remove the dust layer by *dry* or *wet* methods.

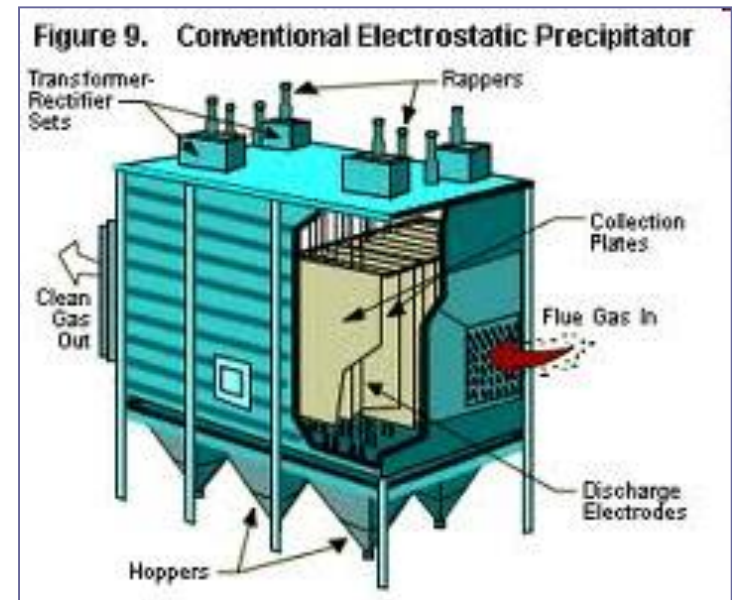
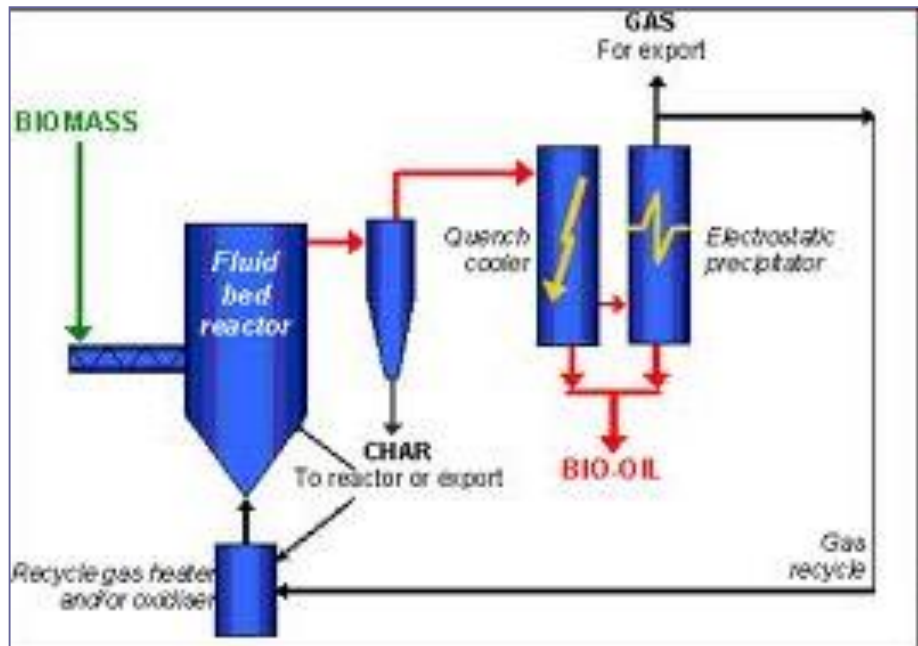

In principle, an ESP can be designed for very high removal efficiency for all particle sizes, simply by increasing the size. Construction material is mild steel and therefore DESP's can operate up to about 350 °C.

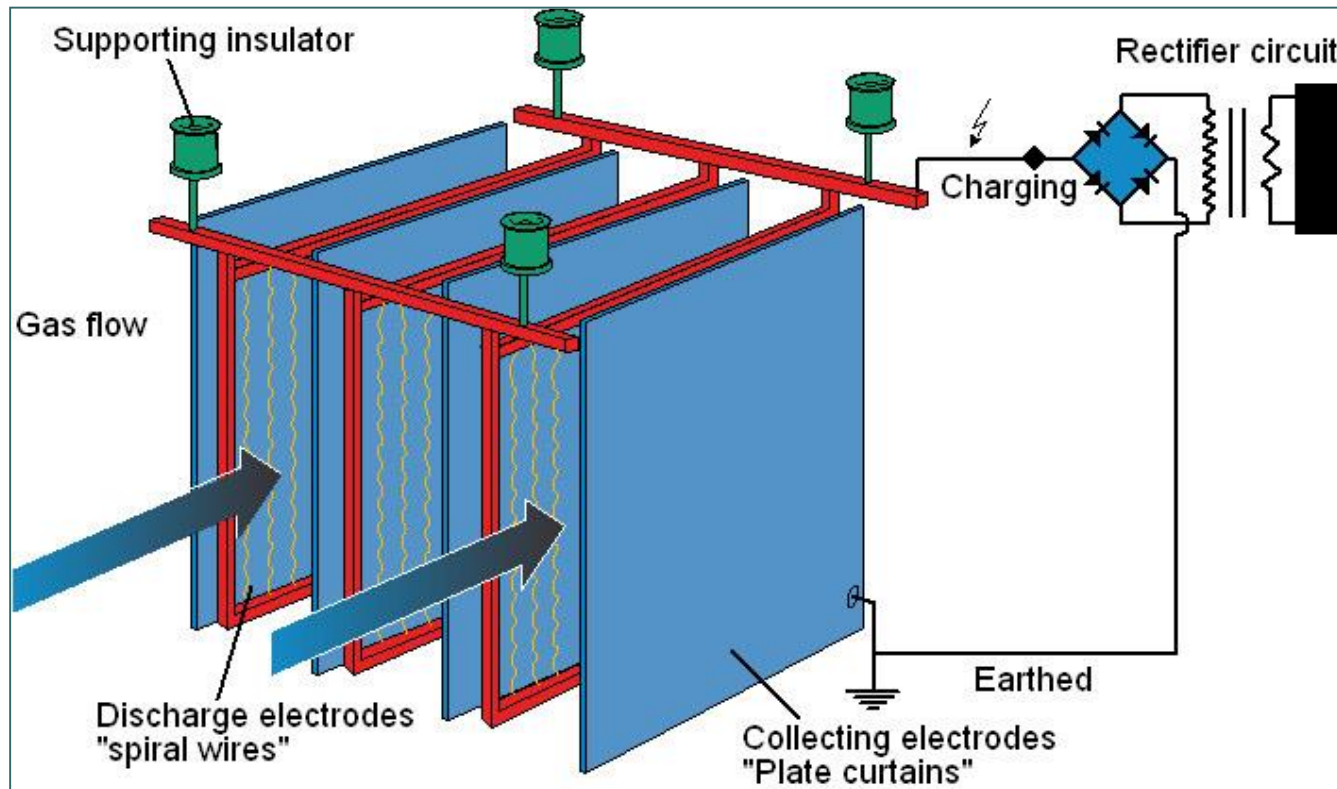

## Dust separation at biomass combustion plants



Diominik Steiner from the company "Scheuch" presented about innovative technologies and processes for clean air in the company.

The company have developed own product line-up, which includes:

*centrifugal separators,*

*fabric filters,*

*wet and dry electrostatic precipitators,*

*biological exhaust gas scrubbers,*

*a variety of cooling and heat extraction systems, as well as fans, rotary valves, discharge devices, valves and control systems or control devices.*

All components were completely compatible with each other and were optimized for the respective application.



The company "Scheuch" have five main business segments:



Wood processing industry



Wood based panel industry

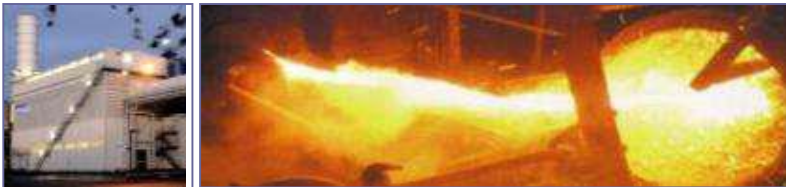

Metals industry



Industrial minerals



Energy industry

## Energy Industry - which included a range of innovative

Systems to dedust, reduce pollutants and recover heat from biomass fired heating plants and combined heating and power (CHP) plants for the energetic utilization of fossil fuels, scrap wood, residual materials and waste materials.

### Biomass combustion technologies

#### Fluidized bed combustion

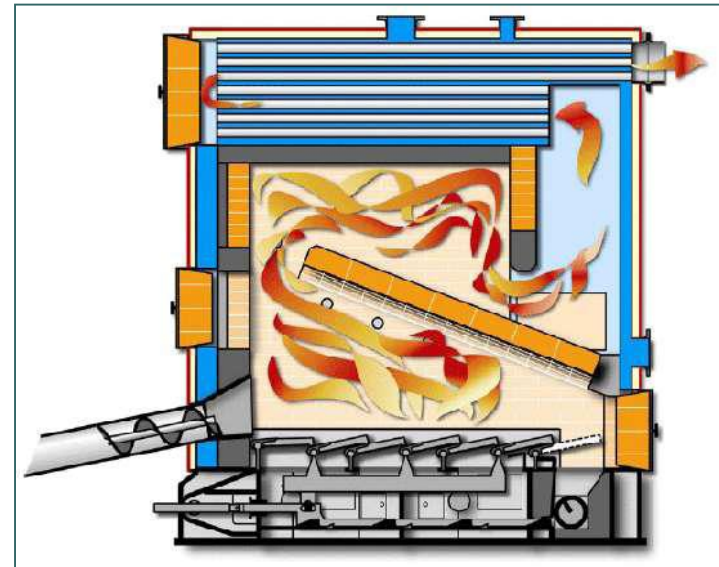
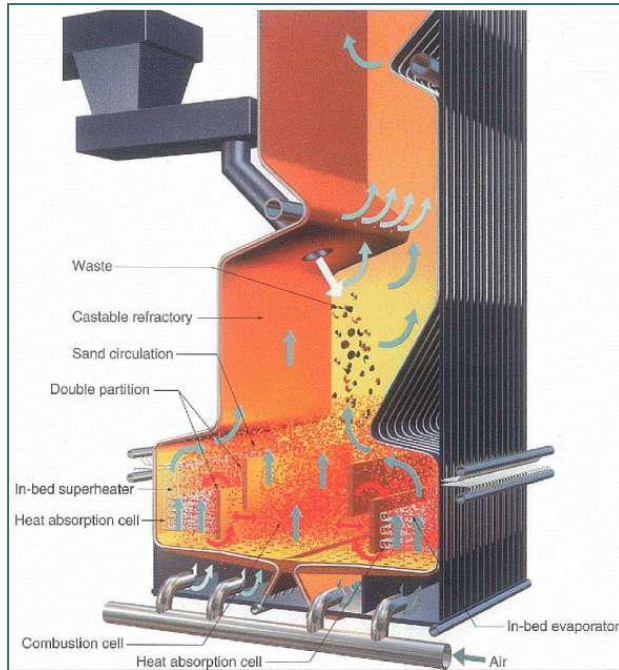

#### Grate combustion

## *Challenges for gas cleaning systems dependent on combustion system*

### 1. Native wood and wood pellets

- Wood chips
- Sawdust
- Pellets

### 2. Biomass with higher ash content

- Bark
- Straw
- Grass and hulls

### 3. Waste wood

- Categorie A1-A4





*Challenges for gas cleaning systems dependent on combustion system*

	<b>Fluidized bed combustion</b>	<b>Grate combustion</b>
Dust load	high	moderate
Gas properties	stable	changing
Dust properties	homegenous	varying
Combustion size	>30 MW	<50 MW

**Legal requirements and biomass dedusting technologies**

# Biomass dedusting technologies

Centrifugal separators (Cyclones and Multicyclones as pre-separator)

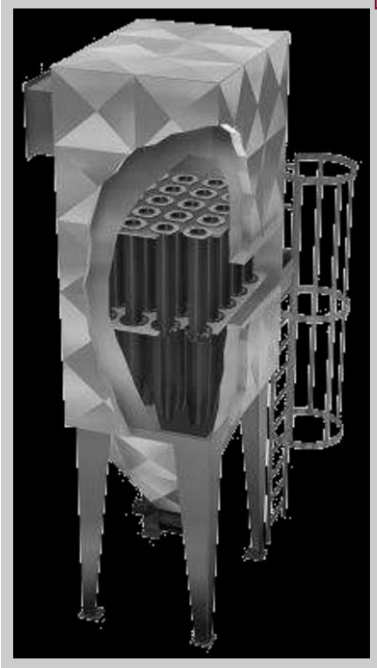

Electrostatic Precipitators ESPs

Fabric Filters





## Biomass dedusting technologies

Three main technologies:

1. **Effective dust separation** - for the separation of particles and centrifugal separators for pre-separation and dry electrostatic precipitators for final cleaning.
2. **The ERCS processes** (Energy-Recovery & Cleaning-System) which were developed and patented by "Scheuch" and offers dust and particle separation and highly efficient heat recovery and energy-optimized plume removal.
3. **Efficient removal of pollutants** - the bag filters.  
The fabric filter plants are extremely well suited for filtering fine dust and for use in combination with sorption processes to reduce pollutants.

## Centrifugal Separators - Multicyclones

- **Used as pre-separator**  
Clean Gas Dust Content  
 $\leq 150 \text{ mg/Nm}^3\text{dry}$

- **Incinerator Heat Power**  
from 0,2 to 100 MW

- **Gas Temperatures:**
  - $< 300 \text{ }^\circ\text{C}$  (Standard)
  - $> 300 \text{ }^\circ\text{C}$  (Optional)

### Functional principle

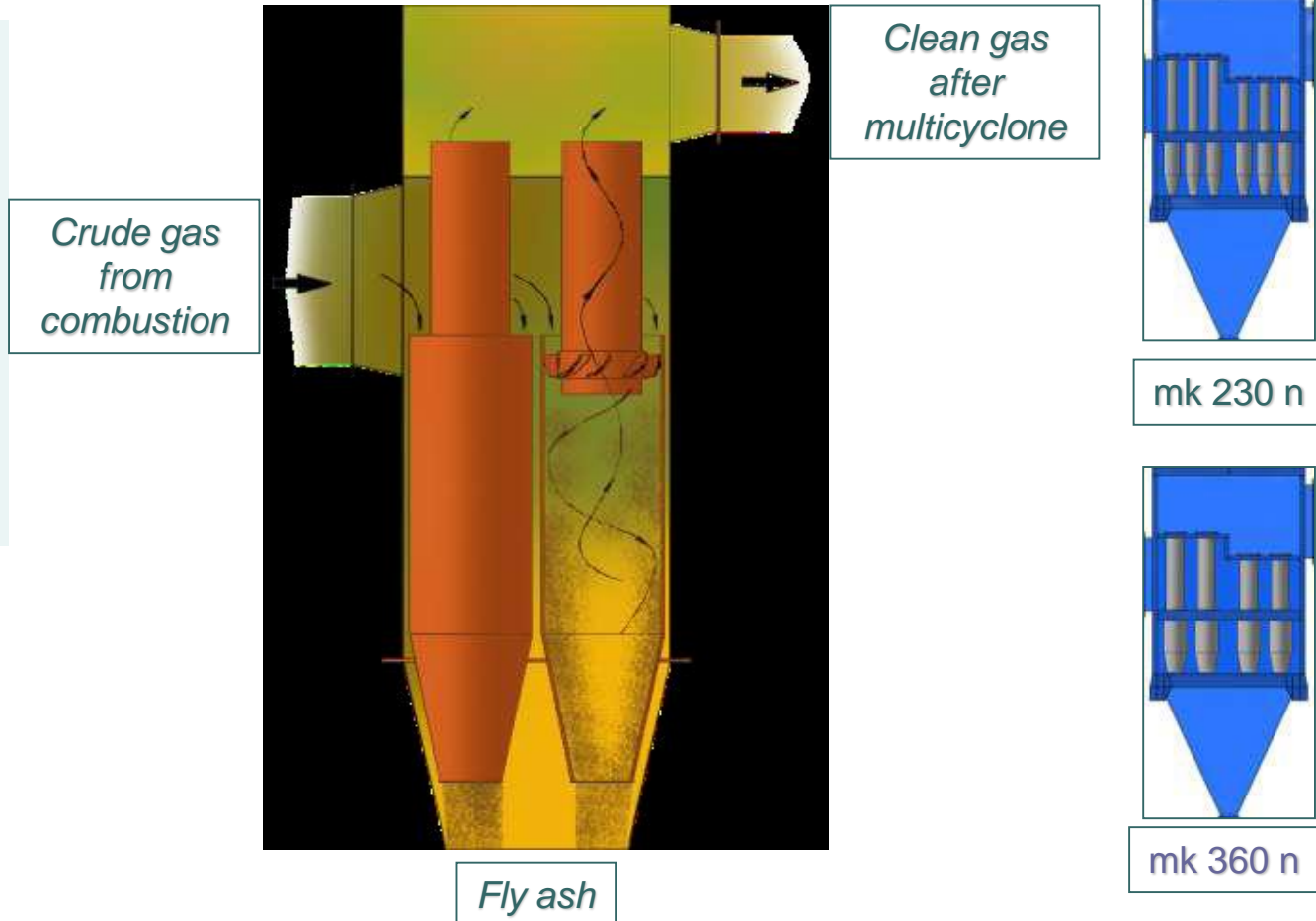

Multicyclone in operation  
Type mk 360n and mk 230n



24



TEMPUS - 158989 - 2009



Course development  
workshop 1 - Ohrid



## Electrostatic Precipitators – ESPs



-For Dedusting of Flue Gas  
Clean Gas Dust Content  $\leq 10 \text{ mg/Nm}^3\text{dry}$

- Incinerator Heat Power  
from 0,5 to 100 MW

- Gas Temperatures:  
•  $< 300 \text{ }^\circ\text{C}$  (Standard)  
•  $< 420 \text{ }^\circ\text{C}$  (Optional)

Dry ESP on Biomass Incinerators



## Single Compartment Filters

Plants < 10 MW / Single Compartment Filter



- **Clean Gas Dust Content**  
 $\leq 5 \text{ mg/Nm}^3\text{dry}$
- **Incinerator Heat Power**  
 $>0,2$  (suggested  $>5 \text{ MW}$ )
- **Gas Temperatures:**
  - $< 250 \text{ }^\circ\text{C}$  (dependent on fabric media)

Operating and cleaning principle

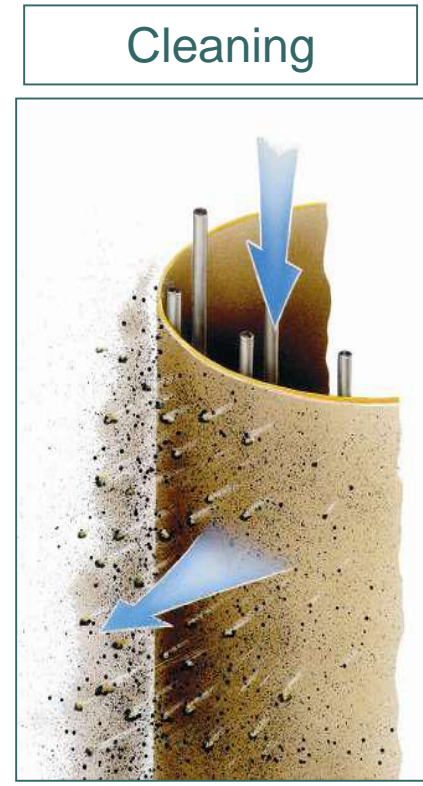
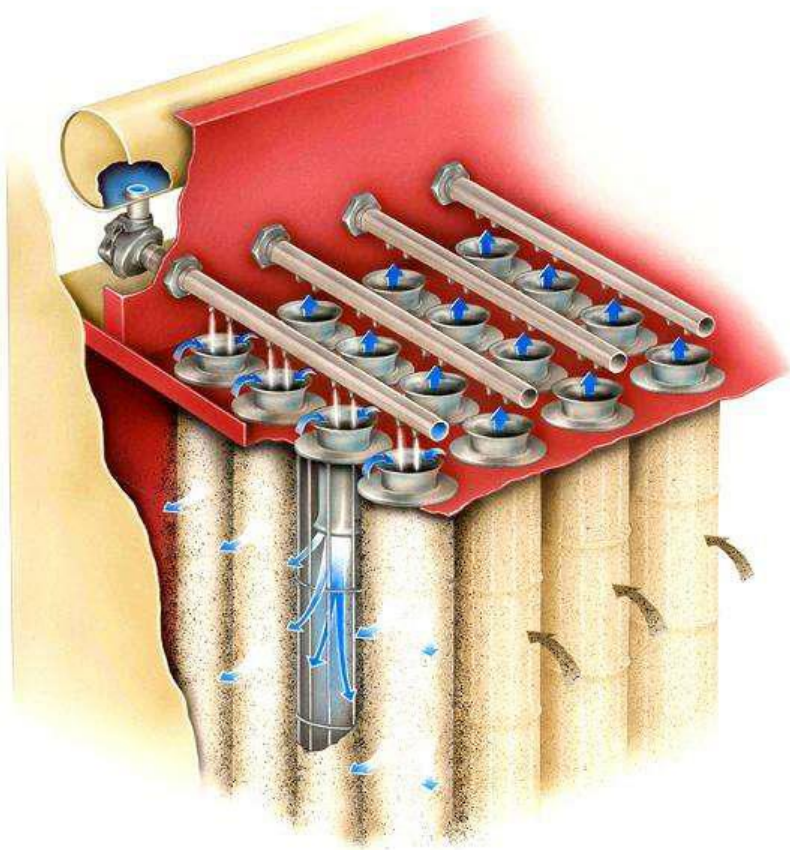

# Multi-Compartment Filters

Plants > 10 MW / Multi-Compartment Filter



# Multi-Compartment Filters

Plants > 10 MW / 1 Compartment in Maintenance

Remaining Compt.s  
in Filtration

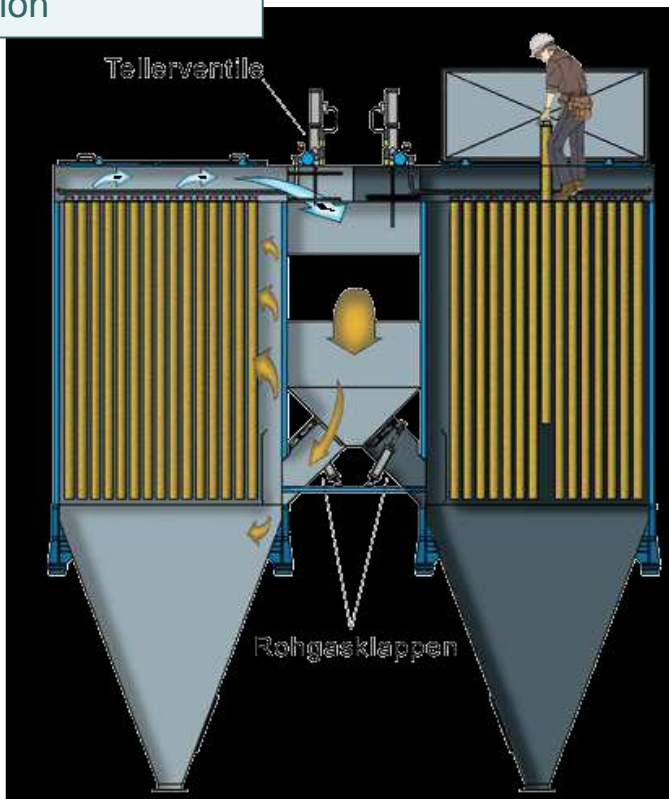

Compt. In  
Maintenance



Filter Bag Change during Operation  
(Availability)  
N2-Flushing of Compartments for Fire  
Prevention

Dust filter test equipment,  
laboratory at the  
Institute of Chemical Engineering



Lab-tour at the Institute of technology.

- **Particle size measurement techniques and dust filter test equipment.**

They have showed us the test equipment for measurement of clean gas concentration which consist two filters: membrane and polyamide filter.

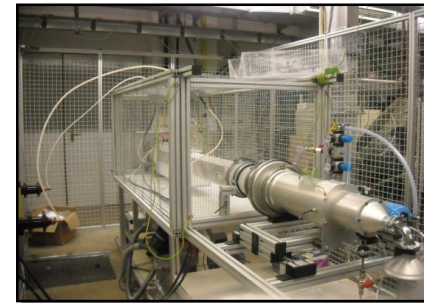
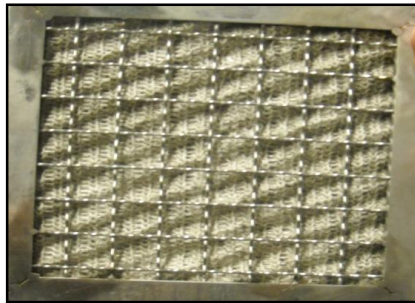
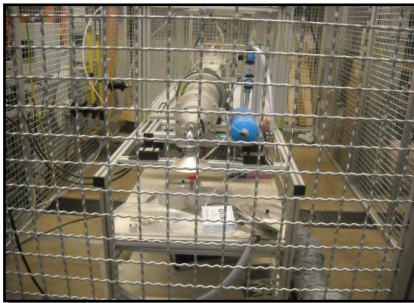

Vienna University of Technology  
laboratory at the  
Institute of Chemical Engineering



In the laboratory of the institute they work *according to standards*.  
By using white xenon they could note the particles size and count the number of particles which cross through the xenon light and they could make a short flash. The good filter should be cleaned after 20 minutes of work. The membrane filter was very thin and the clean gas concentration was about 0.5 mg on cubic meter. Because this filter was very thin the problem could occur if there is a mechanical damage, so all the particles in that case would be walk through the filter.





## Non – membrane vs. Membrane filter

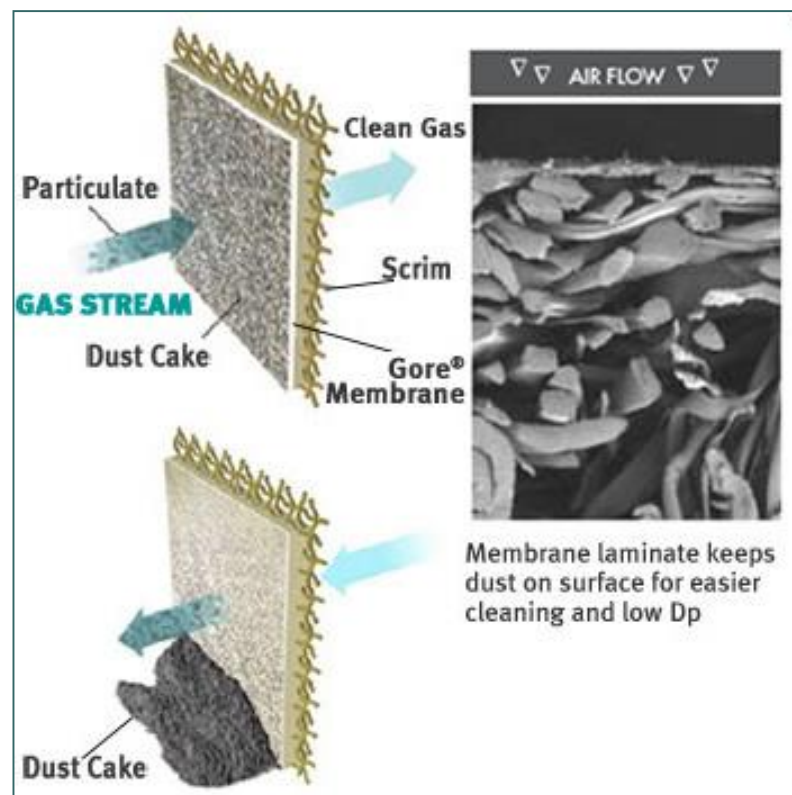
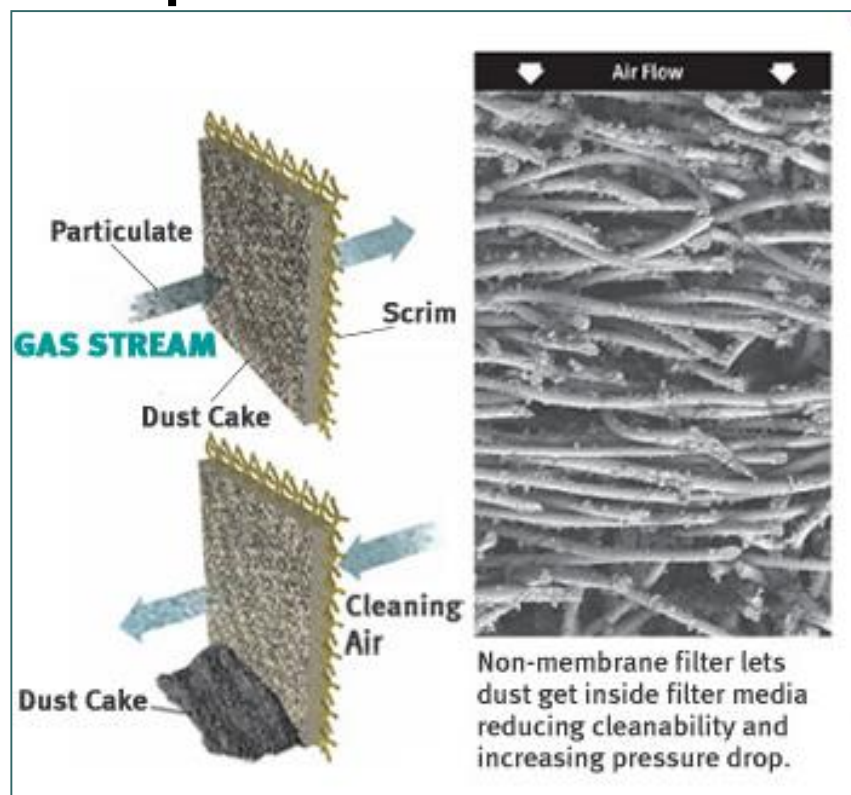

## Vienna University of Technology, laboratory equipment



By using the contemporary laboratory equipment they could classify the load of particles with using electrostatic field. They have produced special voltage of the electrostatic field so called mono dispersion which means that all the particles will have the same particle size. With this method they have got information about the particle size and their number concentration, so they could be calculate the particle size distribution. Particle size distribution has been very low starting with 4 or 5 nm up to 1000 nm. They could get the information in the time of 2 – 3 minutes. The scanning process was very quick.

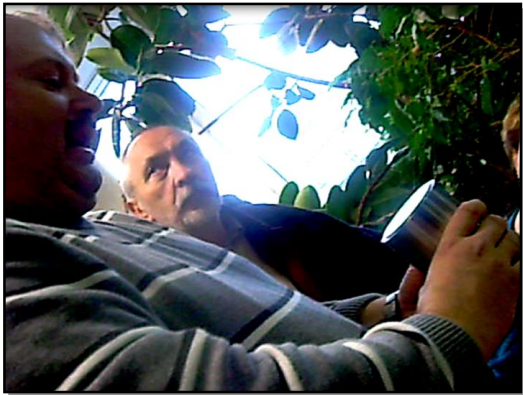



**Thank you for your attention !**