

Enabling Technologies for the Future of Chemical Synthesis

Daniel E. Fitzpatrick, Claudio Battilocchio, and Steven V. Ley*

Innovative Technology Centre, Department of Chemistry, University of Cambridge, Lensfield Road, Cambridge CB2 1EW, U.K.

ABSTRACT: Technology is evolving at breakneck pace, changing the way we communicate, travel, find out information, and live our lives. Yet chemistry as a science has been slower to adapt to this rapidly shifting world. In this Outlook we use highlights from recent literature reports to describe how progresses in enabling technologies are altering this trend, permitting chemists to incorporate new advances into their work at all levels of the chemistry development cycle. We discuss the benefits and challenges that have arisen, impacts on academic–industry relationships, and future trends in the area of chemical synthesis.



■ INTRODUCTION

Chemistry is a discipline that both underpins our modern society and drives innovation and change for the betterment of everyone.

As our science moves forward so does our need to properly harness all the new technologies and better integrate all disciplines and contributing knowledge generators. The principles of information management, engineering, micro-processing, and even how living cells manufacture chemical compounds are all important additional elements in enabling the future of chemical synthesis programs.

In recent reviews and publications,^{1–5} we have been making the case for why a more machine-assisted approach to the assembly of functional compounds is necessary to maximize the human resource, releasing precious time for more cerebral pursuits such as synthesis planning and the discovery of new chemical reactivity. These concepts are now gaining traction; however, while we were writing this outlook article it was interesting to revisit some of the futuristic and speculative statements made in our earlier accounts^{6–8} on the need for new tools and particularly new methods for synthesis. Indeed, our laboratory of today does reflect many of these changes in that much of what we do employs flow chemistry and continuous processing techniques involving a more holistic systems approach to multistep synthesis.⁹

We make extensive use of digital camera monitoring and information feedback to control reaction devices.¹⁰ In our open access review on this topic,¹¹ we conclude that computer-aided digital image capture and visualization techniques can improve laboratory safety, reduce time- and labor-consuming practices, and create opportunities beyond that of the human eye. We also anticipate these methods will help record comprehensive audit trails of our decisions during complex synthesis programs.

Given that we are increasingly using portable and wearable devices, cell phones, and tablets, we can expect much greater use of open source software^{12,13} and the incorporation of cheap, low-power computers such as the Raspberry Pi (Figure 1). These will all help to facilitate improved equipment management and communication through the “Internet of Chemical Things”.¹⁴

Currently many technology companies, such as Google and Microsoft, are investing heavily in the development of artificial intelligence and machine learning systems especially for “Big Data” analysis.¹⁵ We envisage that such methods will find great use in the chemical environment, challenging the dogmas of the past, by discovering new reactivity patterns from data anomalies captured by detector systems. Indeed, machine learning techniques have already found use in synthesis planning, with the Chematica system able to perform retrosynthetic analysis effectively, taking into account a variety of parameters including reagent cost and number of synthetic steps.¹⁶ Our fume hoods are also evolving to become more interactive and to accommodate a new style of working focused on being more flexible and energy efficient. These developments coincide with the general miniaturization of analytical equipment for IR, MS, Raman, conductivity, and NMR. Other synthesis laboratory developments are rapidly being assimilated such as 3D printing tools,^{17–19} head-up displays, and integrated screening methods.^{13,20}

This outlook article addresses a few key issues remaining where enabling methods of synthesis are impacting but where maybe a bolder vision is required to motivate new advances, affecting work carried out across the entire spectrum of development—from discovery right through to manufacturing.

■ MACHINES AS A DISCOVERY TOOL

The multistep preparation of any of society’s functional molecules still today relies on robust chemical processes that were often discovered decades ago. This contrasts sharply with other scientific disciplines where accelerated modern developments of computer-based technology drive the discovery process. While great strides in kinetic analysis^{21–24} and reaction prediction¹² are being made, there still exists a challenging task to discover new reactivity and invent new reactions that are of broad strategic value since these are key to the advancement of the subject.

Received: January 19, 2016

Published: February 24, 2016



Figure 1. New developments in small, low-cost computing devices such as the Raspberry Pi (pictured) are driving advances in reaction control strategies.

The multistep preparation of any of society's functional molecules still today relies on robust chemical processes that were often discovered decades ago.

Although machines and automation have contributed to the discovery of new reactions at a research and development level, particularly through the use of high throughput catalyst screening platforms,²⁵ this somewhat brute-force approach is in need of further innovation. A report in 2011 describes an accelerated discovery approach whereby compounds from a broad library of functionally diverse species were combined in 96-well reactor plates with varied catalyst systems.²⁶ The plates were then exposed to fluorescent light to facilitate new photoredox processes and hence discover new reactivity. A gas chromatography MS system monitored the formation of unexpected products which could be further optimized through new rounds of synthesis if desired. The concept has already proved its worth, leading to a new amine C–H arylation reaction. This approach greatly accelerates the number of trials that can be carried out by researchers within a fixed period of time, reducing the impact of developmental bottlenecks in traditional workflows.

Further machine-based reaction discovery has been realized through the exploration of novel processing windows,^{27–29} especially involving hazardous reactive intermediates.³⁰ For example, unstabilized aryl and vinyl diazo compounds are hazardous and toxic and are correspondingly very difficult to handle during classical batch processes. However, it is possible

to generate these unstable diazo compounds from hydrazones through the use of continuous flow chemistry equipment. They can then be translocated, without isolating, to a new chemical environment to explore new reactivity patterns (Figure 2).

A case in point shows that by reacting these species with boronic acids, a room temperature, non-metal catalyzed sp^2 – sp^3 cross-coupling can be achieved.³¹ These flow techniques for diazo generation (using MnO_2) and the translocation steps were also used for cyclopropanations³² and the generation of di- and trisubstituted allenes,³³ something that had been particularly difficult to achieve under batch conditions.

We were additionally able to show that these general concepts could be used in an iterative fashion to build molecular complexity rapidly by the sequential addition of different flow generated diazo species to homologate boronic acids (Figure 3).³⁴ Such a technique can be used to generate unusual backbone structures for possible new pharmaceutical molecules at the discovery level.

In a separate study, we extended the use of flow techniques to identify a reaction that reached completion with good yields under continuous conditions, but was not effective in batch mode.³⁵ We found that α -dibromoketones, which are useful synthetic building blocks, could be formed from ethyl esters when the reaction was conducted under carefully controlled processing conditions (Figure 4).

There are also other examples where flow chemistry and machine use has enabled reactivity over and above that possible in batch. The reader here is directed to the pioneering work by Yoshida,^{36–40} who has beautifully demonstrated the power of fast flow microreactor combinations to conduct sequential processing that is compatible with wide ranging chemical functionality (for example, Figure 5). These dynamic conditions cannot be achieved in batch-mode reactions.

Although it is fairly early days yet, it is clear that the developing machine-assisted approaches to discovering and exploiting new reactivity shows considerable promise. Through improved equipment advances and better integration of techniques, we can expect to see further enhancements, most notably through new purpose built facilities. These centers of innovation will involve the wider chemical community including engineers, informaticians, and business entrepreneurs.

■ MACHINE ASSISTANCE AND CONTINUOUS PROCESSING

By and large organic synthesis chemists are content with their hard earned experimental skill set. As a consequence, while the methods of synthesis continue to evolve rapidly, we see little in terms of a revolutionary change in the equipment used for synthesis. Indeed, the tools of synthesis have changed very little over time—we can still recognize glassware and tools such as distillation equipment, separation flasks, and chromatography

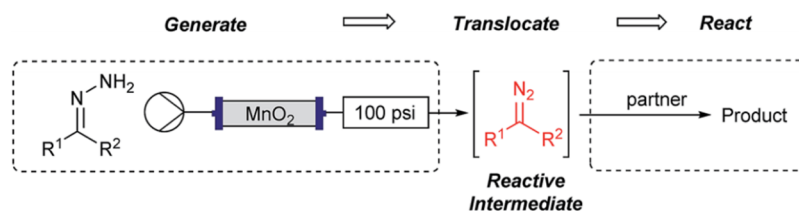

Figure 2. Flow chemistry techniques allow for the production and translocation of unstabilized diazo compounds from hydrazones. Reproduced from ref 31. Copyright 2015 Royal Society of Chemistry.

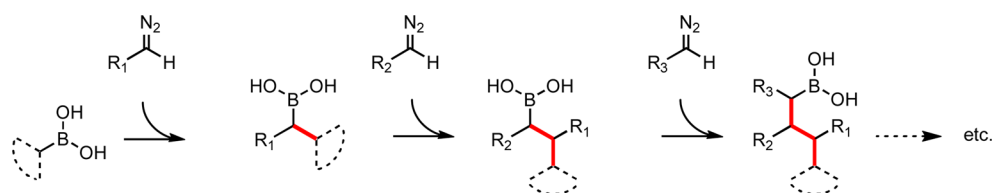

Figure 3. Molecules with unusual backbone structures could be formed by the iterative reaction of diazo species with boronic acids. Modified from ref 34.

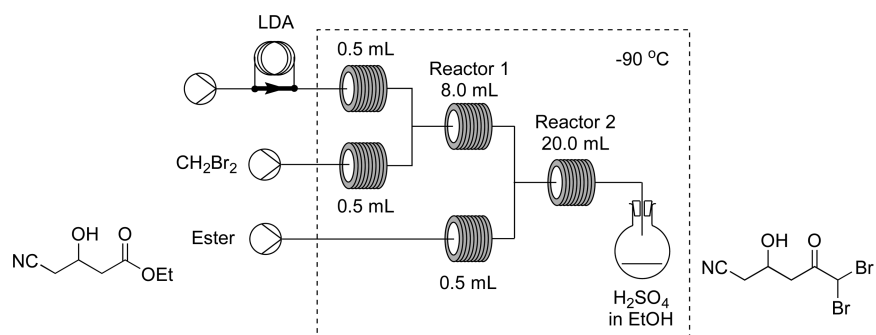

Figure 4. Equipment schematic for the flow production of α -dibromoketones, a reaction that was not effective in batch.

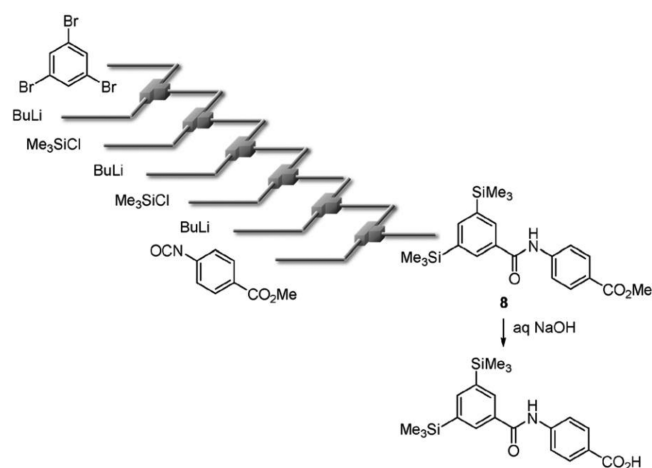

Figure 5. Fast flow reactions can only occur in flow-mode and are capable of working with a variety of functional groups. Reproduced from ref 36 with permission. Copyright 2013 The Royal Society of Chemistry.

methods that have remained substantially unchanged for a long period of time. This is in contrast to other areas of science where new systems are incorporated and used rapidly, soon after creation. One way of reducing this stagnation is to use machinery and methods of continuous improvement (optimization) to solve problems. Indeed, it surely makes sense that the routine, scale-up, and repetitive tasks of the past are better resolved by the use of new machinery.

If we understand the problem we can solve it and it is often an engineering problem as much as a chemistry problem that is faced by researchers. It is important therefore that there is greater continuity between the different working environments, from discovery to process development and on to full-scale manufacturing. Many of the concepts and tools used at scale have relevance also at the discovery level.

With all of this in mind, we need to evaluate the science with different criteria whereby the machine and other enabling

technologies of continuous processing and control are key design elements of the system in total.

The benefits that can be realized through the use of machine assistance need not be limited to a few specific opportunities, but rather a broader view across all synthesis environments is necessary. The use of machines to perform routine tasks is also common place in industry over virtually all sectors. The pharmaceutical and fine chemical society however has been slow to adopt continuous processing technologies, at least at the earlier stages of chemical production. Other industries on the other hand are more nimble and react to change based on consumer demand. The product development cycle in the chemical industry is not as compressed as other industries, consequently conservatism and a reliance on traditional methods dominate thinking.

Nevertheless, some players in the arena are adopting the use of these new enabling technologies to reduce the discovery-to-manufacturing time frame.⁴¹ It could be argued that historically high revenues, lack of competition, and commercial inertia have resulted in businesses not needing to change their methods. With increased levels of globalization and shrinking major markets, soon these companies will realize that change is necessary.

In our group we have recently demonstrated how full machine assistance enabled a single researcher to manage and control a continuous telescoped three-step synthesis process (with five intermediate downstream processing steps, Figure 6) to form a biologically active precursor.⁹ Although we have been

The benefits that can be realized through the use of machine assistance need not be limited to a few specific opportunities, but rather a broader view across all synthesis environments is necessary.

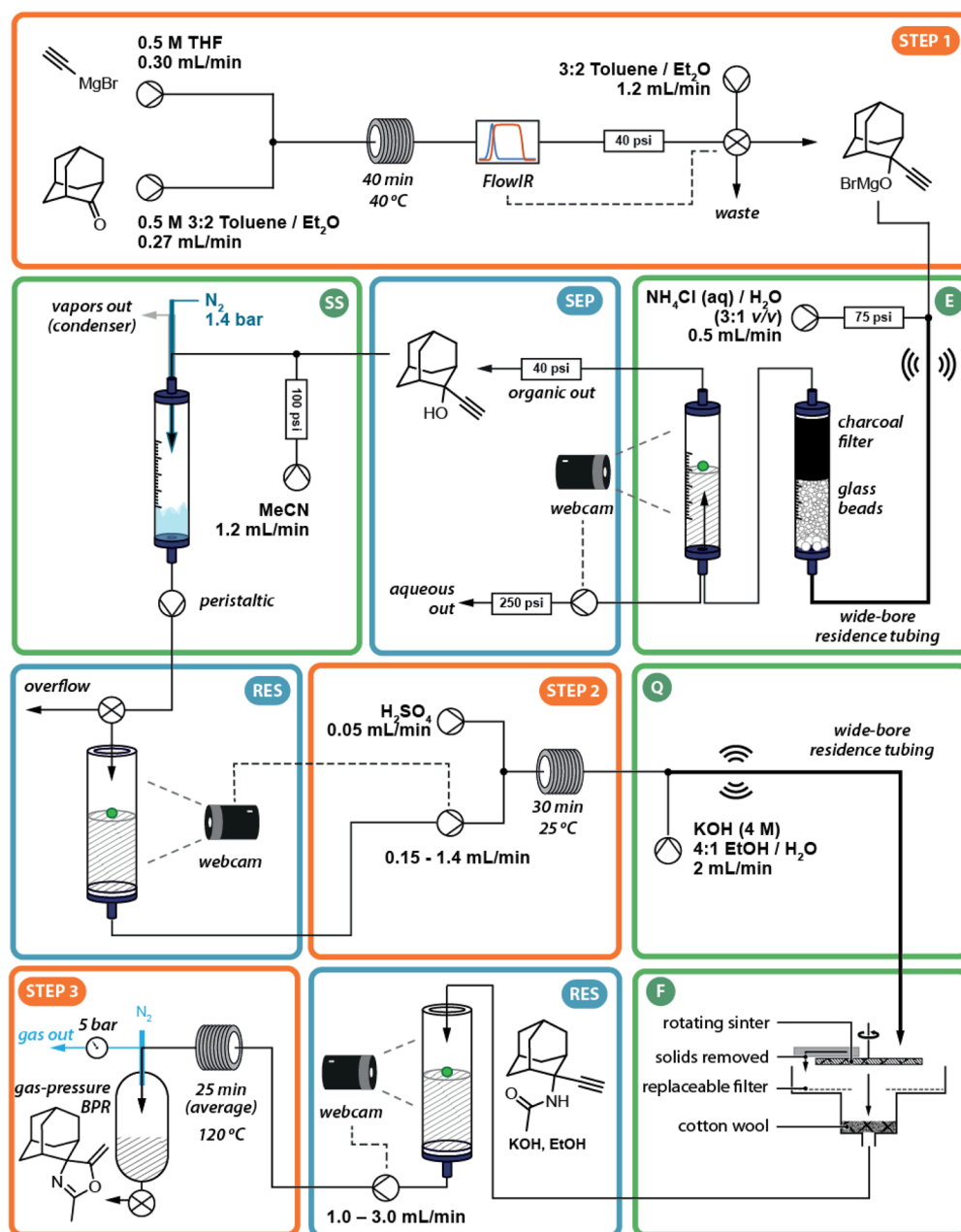

Figure 6. A fully telescoped, eight-step system was able to be managed by a single researcher through machine assistance and the use of low-cost computing devices.

using automated techniques for over a decade,⁴² recent advances in cheap computer control now greatly enhance experimental design and the setup of equipment. Through the adoption of machine assistance in this case, the number of researchers required to manage such a process was greatly reduced. Such an approach has the capability to liberate the scientific workforce to focus on more productive tasks both in academic settings but also in industrial laboratories.

Another illustration of the power of these methods was the machine-assisted preparation of the front-line drug tamoxifen for the treatment of breast cancer.⁴³ Using a simple experimental reactor system occupying only a small footprint (Figure 7), a production rate of over 220 g day⁻¹ of drug material was achieved, equating to 20 000 doses day⁻¹.

A team at MIT has also reported an impressive end-to-end continuous production of aliskiren from late-stage precursors.

This process involved two chemical steps with additional downstream processing to deliver material fully packaged into a tablet format.^{44,45}

Over the past decade, there has been a significant rise in the personal possession of electronic devices, particularly smartphones. Owing to the Internet-based nature of these systems, users can access information from wherever they might be located. As such this concept of “data at fingertips” is something we are very familiar with, yet its true potential in the laboratory has not been fully explored. The ability to access experimental data on-demand will shift the landscape of day-to-day work in chemical laboratories, with researchers’ ability to share and propagate results made greatly simpler. Equipment will be configured remotely, releasing workers from being tied to one location and enhancing workplace safety. We can expect to see

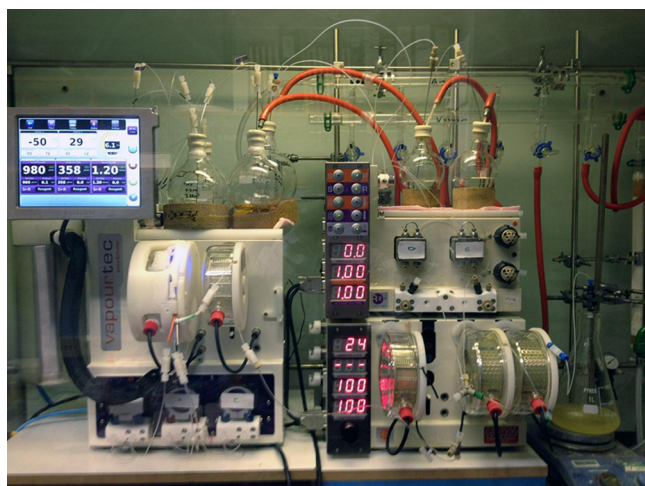

Figure 7. A simple equipment configuration enabled the production of 20 000 tamoxifen doses per day. Reproduced from 43. Copyright 2013 American Chemical Society.

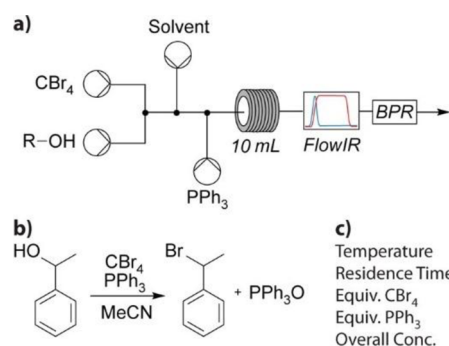

Figure 8. (a) The equipment layout used for the Appel reaction optimization; (b) the Appel reaction carried out; (c) the five parameters optimized by the control system. Partial reproduction from ref 46.

increases in collaboration arising from a more connected series of laboratories.

As a first step toward this ideal, we developed an Internet-based software platform which facilitates the monitoring and control of chemical reactions from anywhere in the world.⁴⁶ Flow Chemistry, by nature, is modular—researchers can mix-and-match reactor configurations and ancillary support tools at any time. Accordingly, the control system was built from the ground up so as to ensure full compatibility with the modular flow chemistry approach to problem solving. As the software was capable of setting reaction conditions and monitoring reactor outputs using detectors, we incorporated a self-optimization module into the system to explore the full benefits of machine assistance.

Using this module, a computer was able to optimize reactions (including a five-dimensional Appel reaction, Figure 8) with no input from a human. In these cases, the system was optimizing conditions from a fresh start—there were no experiments carried out by hand prior to the control system operating. Importantly, the system did not just optimize for yield but included additional terms such as throughput potential and cost considerations that would be taken into account by a chemist performing the procedure manually. Other such interesting examples of automated optimization have been described in recent reviews and publications.^{47–50}

■ BRIDGING ACADEMIA WITH INDUSTRY USING ENABLING TECHNOLOGIES

It is clear that traditional methods of making molecules have reached somewhat of a watershed in that there is a widespread belief that if we can design a functional molecule of interest we can make it and there is little new to discover.

Only those, however, who are fully engaged in the process truly understand just how wrong this idea is. Our chemistry today is just not good enough to deliver the products of the future. Our waste product streams, lack of robustness, and cost of materials all conspire to deliver unsustainable processes. Things must change. In particular, there is a disconnection between fundamental academic discoveries, the needs of a user industry, and our ability to deliver our chemistries on scale. Technology developments have a major role to play in bridging these different worlds.⁵¹

This need was recognized and discussed recently in a concept article, written by authors associated with large pharmaceutical companies (Merck, Pfizer, and Bristol Myers Squibb).⁵² They described the importance of precompetitive research, in which the outcomes from collaborations are released publically without traditional protections in an attempt to stimulate additional research in areas of common interest. The pharmaceutical industry has of course been historically adverse to this idea, largely owing to the highly competitive nature of their business. It is refreshing therefore to see this change in emphasis which can only be good for the science of synthesis.

Likewise, others have shared from the academic community. Baran has described how, in the realm of batch-based natural product synthesis, collaborations between industry and academia can lead to a symbiotic relationship.⁵³ Industry is able to, in effect, buy access to very specialized knowledge which would normally take many years to amass in-house at considerable expense, while academic groups are provided with much needed financial support for relevant research projects.⁵¹

Our group has benefited from such a relationship with industry, allowing us to shape some areas of our research program to better suit those sectors which find them most useful, such as the makers of pharmaceutical and agrochemical products. In particular, we have developed flow methods utilizing solid catalysts, with a particular focus on transformations that produce volatile byproducts.^{54–57} By applying a machine-assisted approach, we were able to drastically reduce the overall cost of processes, cutting the number of downstream operations required. In one particular example, we were able to define a laboratory scale process which would later pave the way to kilogram-scale production.⁵⁸

While supporting these sentiments, we would want to go further in promoting the interface between our high schools,

Industry is able to, in effect, buy access to very specialized knowledge which would normally take many years to amass in-house at considerable expense, while academic groups are provided with much needed financial support for relevant research projects.

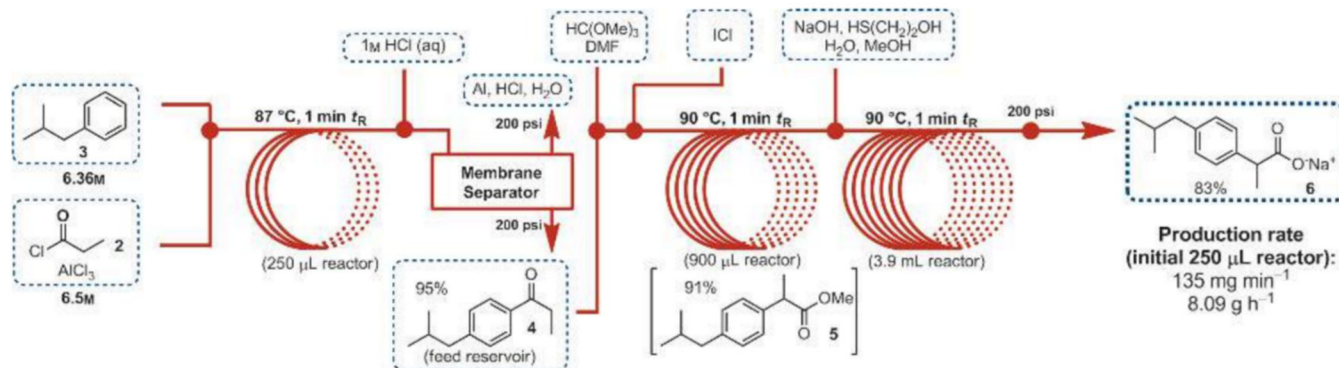

Figure 9. A three-step process was developed that enabled the rapid production of ibuprofen from a unit of very small size. Reproduced from ref 60 with permission. Copyright 2015 John Wiley and Sons.

universities, and industry. Open innovation, enterprise and technology transfer programs begin this process, but staff secondments, retraining programs, and overall greater flexibility in terms of concepts and philosophy will be necessary to transform where we are today to a new level of responsibility.

■ SYNTHESIS ON DEMAND

Accelerating the rate of work through contract research organizations (CRO) and parallel methods of synthesis is seen by some as financially attractive, yet it has done little to advance our subject. New understanding and development of knowledge only arise where unique and advanced skills are involved. Simply increasing the workforce constitutes little step-change in product outcome and virtually no gain in conceptual advancement. We must wake up and recognize a new approach is necessary.

Some initiatives are underway to address some of these issues, namely, the “Dial a Molecule” program in the UK and the DARPA sponsored project “Make it” in the USA. These research programs aim to develop an automated chemical synthesizer capable of delivering a push button approach to producing and purifying in-line a wide range of small, functional molecules on demand and at scale. These programs will go beyond the current equipment capabilities and will need to integrate up-front computational methods for synthesis planning and prediction. Furthermore, greatly improved hardware and software will be necessary to facilitate multistep autonomous control to incorporate all necessary downstream and intermediate processing and analysis.

A recent report described a system that goes some way to achieving this goal, focusing on the modularity benefits obtained through the use of flow chemistry techniques.⁵⁹ By changing reaction parameters, including starting materials and position of modules relative to others, it was possible for the system to produce molecules throughout a wide chemical space. The production of γ -lactams, β -amino acids, and γ -amino acids was reported.

In a separate study, a method to produce ibuprofen at a rate of 8 g h^{-1} using a very small system was described (its footprint was half the size of a standard fume hood).⁶⁰ This process consisted of three chemical transformation steps (Figure 9) and was capable of producing the active pharmaceutical ingredient (API) with a residence time of just 3 min.

■ FINAL COMMENTS

We conclude with a few final comments. Although our group can claim that over the years we have operated a very successful and wide ranging synthesis program, we are only too well aware of the current limitations of our science. Fortunately, our methods of synthesis are improving exponentially, but this cannot continue without equivalent advances in the tools of synthesis, particularly machine-assisted processes. This calls for more collaboration with engineers, informaticians, computational scientists, and robotics and software developers.

It might also suggest the fundamentally important 12 principles of green chemistry,⁶¹ which has been a journey and with us for over 20 years as a charter for life as a synthesis chemist, need to be revisited with today’s eyes. For example, we see a much greater need to protect the human resource from overuse, not just our materials. We need therefore to avoid many of the labor-intensive practices common to many of the synthesis programs today.⁶² We must address inefficiencies by avoiding the unit operations typically used in downstream processing. We must accept greater responsibility for our actions through leadership and management of our resources. Our precious metals footprint is as important as our carbon footprint, for example. All of this requires a shift in philosophy which implies that education and training need to evolve at a similar pace.

The chemistry community traditionally has been resistant to changes of this nature, resulting in general inertia. Yet we as humans are evolving rapidly in the way we process information and approach problems, so it is not a great surprise that our working regimes should change too. No longer is it practical or commercially viable for a workforce to use techniques that are many decades old. The future of chemical synthesis will be owned by a workforce combining historical literature experience with new ideas for finding and interpreting data, with practical work augmented by new machinery and tools. The sooner this philosophy is adopted, the sooner the benefits will accrue.

These are exciting times for our subject and we are looking forward to see what the future will bring.

We must accept greater responsibility for our actions through leadership and management of our resources.

■ AUTHOR INFORMATION

Corresponding Author

*E-mail: svl1000@cam.ac.uk.

Notes

The authors declare no competing financial interest.

■ ACKNOWLEDGMENTS

We are grateful to the Woolf Fisher Trust (D.E.F), Syngenta Crop Protection AG (C.B.), and EPSRC (S.V.L., Grant Codes EP/K009494/1, EP/M004120/1, and EP/K039520/1) for financial assistance.

■ REFERENCES

- (1) Ley, S. V.; Fitzpatrick, D. E.; Ingham, R. J.; Myers, R. M. Organic synthesis: march of the machines. *Angew. Chem., Int. Ed.* **2015**, *54*, 3449–3464.
- (2) Ley, S. V.; Fitzpatrick, D. E.; Myers, R. M.; Battilocchio, C.; Ingham, R. J. Machine-assisted organic synthesis. *Angew. Chem., Int. Ed.* **2015**, *54*, 10122–10136.
- (3) Myers, R. M.; Fitzpatrick, D. E.; Turner, R. M.; Ley, S. V. Flow chemistry meets advanced functional materials. *Chem. - Eur. J.* **2014**, *20*, 12348–12366.
- (4) Lau, S.-H.; Galván, A.; Merchant, R. R.; Battilocchio, C.; Souto, J. A.; Berry, M. B.; Ley, S. V. Machines vs malaria: a flow-based preparation of the drug candidate OZ439. *Org. Lett.* **2015**, *17*, 3218–3221.
- (5) Pastre, J. C.; Browne, D. L.; Ley, S. V. Flow chemistry syntheses of natural products. *Chem. Soc. Rev.* **2013**, *42*, 8849–8869.
- (6) Ley, S. V.; Baxendale, I. R.; Bream, R. N.; Jackson, P. S.; Leach, A. G.; Longbottom, D. A.; Nesi, M.; Scott, J. S.; Storer, R. I.; Taylor, S. J. Multi-step organic synthesis using solid-supported reagents and scavengers: a new paradigm in chemical library generation. *J. Chem. Soc., Perkin Trans. 1* **2000**, 3815–4195.
- (7) Ley, S. V.; Baxendale, I. R. Organic synthesis in a changing world. *Chem. Rec.* **2002**, *2*, 377–388.
- (8) Ley, S. V.; Baxendale, I. R. New tools and concepts for modern organic synthesis. *Nat. Rev. Drug Discovery* **2002**, *1*, 573–586.
- (9) Ingham, R. J.; Battilocchio, C.; Fitzpatrick, D. E.; Sliwinski, E.; Hawkins, J. M.; Ley, S. V. A systems approach towards an intelligent and self-controlling platform for integrated continuous reaction sequences. *Angew. Chem., Int. Ed.* **2015**, *54*, 144–148.
- (10) Ingham, R. J.; Battilocchio, C.; Hawkins, J. M.; Ley, S. V. Integration of enabling methods for the automated flow preparation of piperazine-2-carboxamide. *Beilstein J. Org. Chem.* **2014**, *10*, 641–652.
- (11) Ley, S. V.; Ingham, R. J.; O'Brien, M.; Browne, D. L. Camera-enabled techniques for organic synthesis. *Beilstein J. Org. Chem.* **2013**, *9*, 1051–1072.
- (12) Kabeshov, M. A.; Śliwiński, É.; Fitzpatrick, D. E.; Musio, B.; Newby, J. A.; Blaylock, W. D. W.; Ley, S. V. Development of a web-based platform for studying lithiation reactions in silico. *Chem. Commun.* **2015**, *51*, 7172–7175.
- (13) Guetzoian, L.; Ingham, R. J.; Nikbin, N.; Rossignol, J.; Wolling, M.; Baumert, M.; Burgess-Brown, N. A.; Strain-Damerell, C. M.; Shrestha, L.; Brennan, P. E.; Fedorov, O.; Knapp, S.; Ley, S. V. Machine-assisted synthesis of modulators of the histone reader BRD9 using flow methods of chemistry and frontal affinity chromatography. *MedChemComm* **2014**, *5*, 540–546.
- (14) Ley, S. V.; Fitzpatrick, D. E.; Ingham, R. J.; Nikbin, N. The Internet of Chemical Things. *Beilstein Mag.* **2015**, *1*, No. 2.
- (15) DeepMind: inside Google's super-brain. Accessed 13 January 2016, <http://www.wired.co.uk/magazine/archive/2015/07/features/deepmind/viewall>.
- (16) Kowalik, M.; Gothard, C. M.; Drews, A. M.; Gothard, N. A.; Weckiewicz, A.; Fuller, P. E.; Grzybowski, B. A.; Bishop, K. J. M. Parallel optimization of synthetic pathways within the network of organic chemistry. *Angew. Chem., Int. Ed.* **2012**, *51*, 7928–7932.
- (17) Kitson, P. J.; Marshall, R. J.; Long, D.; Forgan, R. S.; Cronin, L. 3D printed high-throughput hydrothermal reactionware for discovery, optimization, and scale-up. *Angew. Chem., Int. Ed.* **2014**, *53*, 12723–12728.
- (18) Symes, M. D.; Kitson, P. J.; Yan, J.; Richmond, C. J.; Cooper, G. J. T.; Bowman, R. W.; Vilbrandt, T.; Cronin, L. Integrated 3D-printed reactionware for chemical synthesis and analysis. *Nat. Chem.* **2012**, *4*, 349–354.
- (19) Dragone, V.; Sans, V.; Rosnes, M. H.; Kitson, P. J.; Cronin, L. 3D-printed devices for continuous-flow organic chemistry. *Beilstein J. Org. Chem.* **2013**, *9*, 951–959.
- (20) Guetzoian, L.; Nikbin, N.; Baxendale, I. R.; Ley, S. V. Flow chemistry synthesis of zolpidem, alpidem and other GABAA agonists and their biological evaluation through the use of in-line frontal affinity chromatography. *Chem. Sci.* **2013**, *4*, 764–769.
- (21) Desmet, G. B.; D'hooge, D. R.; Sabbe, M. K.; Marin, G. B.; Du Prez, F. E.; Espeel, P.; Reyniers, M.-F. Computational study and kinetic analysis of the aminolysis of thiolactones. *J. Org. Chem.* **2015**, *80*, 8520–8529.
- (22) Kanno, N.; Tani, H.; Daimon, Y.; Terashima, H.; Yoshikawa, N.; Koshi, M. Computational study of the rate coefficients for the reactions of NO₂ with CH₃NHNH, CH₃NNH₂, and CH₂NHNH₂. *J. Phys. Chem. A* **2015**, *119*, 7659–7667.
- (23) Gulzar, N.; Jones, K. M.; Konnerth, H.; Breugst, M.; Klusmann, M. Experimental and Computational Studies on the C-H Amination Mechanism of Tetrahydrocarbazoles via Hydroperoxides. *Chem. - Eur. J.* **2015**, *21*, 3367–3376.
- (24) Blackmond, D. G. Kinetic Profiling of Catalytic Organic Reactions as a Mechanistic Tool. *J. Am. Chem. Soc.* **2015**, *137*, 10852–10866.
- (25) Buitrago Santanilla, A.; Regalado, E. L.; Pereira, T.; Shevlin, M.; Bateman, K.; Campeau, L.-C.; Schneeweis, J.; Berritt, S.; Shi, Z.-C.; Nantermet, P.; Liu, Y.; Helmy, R.; Welch, C. J.; Vachal, P.; Davies, I. W.; Cernak, T.; Dreher, S. D. Organic chemistry. Nanomole-scale high-throughput chemistry for the synthesis of complex molecules. *Science* **2015**, *347*, 49–53.
- (26) McNally, A.; Prier, C. K.; MacMillan, D. W. C. Discovery of an α -amino C-H arylation reaction using the strategy of accelerated serendipity. *Science* **2011**, *334*, 1114–1117.
- (27) Hessel, V. Novel Process Windows – Gate to Maximizing Process Intensification via Flow Chemistry. *Chem. Eng. Technol.* **2009**, *32*, 1655–1681.
- (28) Hessel, V.; Kralisch, D.; Kockmann, N.; Noël, T.; Wang, Q. Novel process windows for enabling, accelerating, and uplifting flow chemistry. *ChemSusChem* **2013**, *6*, 746–789.
- (29) Gutmann, B.; Kappe, C. O. Forbidden chemistries go flow in API synthesis. *Chim. Oggi/Chem. Today* **2015**, *33*, 18–25.
- (30) For an early example of using azides as intermediates, refer to Baxendale, I. R.; Deeley, J.; Griffiths-Jones, C. M.; Ley, S. V.; Saaby, S.; Tranmer, G. K. A flow process for the multi-step synthesis of the alkaloid natural product oxomaritidine: a new paradigm for molecular assembly. *Chem. Commun.* **2006**, 2566–2568.
- (31) Tran, D. N.; Battilocchio, C.; Lou, S.-B.; Hawkins, J. M.; Ley, S. V. Flow chemistry as a discovery tool to access sp²–sp³ cross-coupling reactions via diazo compounds. *Chem. Sci.* **2015**, *6*, 1120–1125.
- (32) Roda, N. M.; Tran, D. N.; Battilocchio, C.; Labes, R.; Ingham, R. J.; Hawkins, J. M.; Ley, S. V. Cyclopropanation using flow-generated diazo compounds. *Org. Biomol. Chem.* **2015**, *13*, 2550–2554.
- (33) Poh, J.-S.; Tran, D. N.; Battilocchio, C.; Hawkins, J. M.; Ley, S. V. A versatile room-temperature route to di- and trisubstituted allenes using flow-generated diazo compounds. *Angew. Chem., Int. Ed.* **2015**, *54*, 7920–7923.
- (34) Battilocchio, C.; Feist, F.; Hafner, A.; Simon, M.; Tran, D. N.; Allwood, D. M.; Blakemore, D. C.; Ley, S. V. Iterative reactions of transient boronic acids enable sequential C-C bond formation. *Nat. Chem.* **2016**, [10.1038/NCHEM.2439](https://doi.org/10.1038/NCHEM.2439).
- (35) Hartwig, J.; Metternich, J. B.; Nikbin, N.; Kirschnig, A.; Ley, S. V. Continuous flow chemistry: a discovery tool for new chemical reactivity patterns. *Org. Biomol. Chem.* **2014**, *12*, 3611–3615.

- (36) Yoshida, J.; Takahashi, Y.; Nagaki, A. Flash chemistry: flow chemistry that cannot be done in batch. *Chem. Commun.* **2013**, *49*, 9896–9904.
- (37) Nagaki, A.; Takahashi, Y.; Yoshida, J. Extremely fast gas/liquid reactions in flow microreactors: carboxylation of short-lived organolithiums. *Chem. - Eur. J.* **2014**, *20*, 7931–7934.
- (38) Nagaki, A.; Tsuchihashi, Y.; Haraki, S.; Yoshida, J. Benzylolithiums bearing aldehyde carbonyl groups. A flash chemistry approach. *Org. Biomol. Chem.* **2015**, *13*, 7140–7145.
- (39) Nagaki, A.; Imai, K.; Ishiuchi, S.; Yoshida, J. Reactions of difunctional electrophiles with functionalized aryllithium compounds: remarkable chemoselectivity by flash chemistry. *Angew. Chem., Int. Ed.* **2015**, *54*, 1914–1918.
- (40) Yoshida, J. *Flash Chemistry: Fast Organic Synthesis in Microsystems*; John Wiley & Sons, Ltd: New York, 2008.
- (41) Baumann, M.; Baxendale, I. R. The synthesis of active pharmaceutical ingredients (APIs) using continuous flow chemistry. *Beilstein J. Org. Chem.* **2015**, *11*, 1194–1219.
- (42) Baxendale, I. R.; Griffiths-Jones, C. M.; Ley, S. V.; Tranmer, G. K. Preparation of the neolignan natural product grossamide by a continuous-flow process. *Synlett* **2006**, *3*, 427–430.
- (43) Murray, P. R. D.; Browne, D. L.; Pastre, J. C.; Butters, C.; Guthrie, D.; Ley, S. V. Continuous flow-processing of organometallic reagents using an advanced peristaltic pumping system and the telescoped flow synthesis of (E/Z)-Tamoxifen. *Org. Process Res. Dev.* **2013**, *17*, 1192–1208.
- (44) Heider, P. L.; Born, S. C.; Basak, S.; Benyahia, B.; Lakerveld, R.; Zhang, H.; Hogan, R.; Buchbinder, L.; Wolfe, A.; Mascia, S.; Evans, J. M. B.; Jamison, T. F.; Jensen, K. F. Development of a multi-step synthesis and workup sequence for an integrated, continuous manufacturing process of a pharmaceutical. *Org. Process Res. Dev.* **2014**, *18*, 402–409.
- (45) Mascia, S.; Heider, P. L.; Zhang, H.; Lakerveld, R.; Benyahia, B.; Barton, P. I.; Braatz, R. D.; Cooney, C. L.; Evans, J. M. B.; Jamison, T. F.; Jensen, K. F.; Myerson, A. S.; Trout, B. L. End-to-end continuous manufacturing of pharmaceuticals: integrated synthesis, purification, and final dosage formation. *Angew. Chem., Int. Ed.* **2013**, *52*, 12359–12363.
- (46) Fitzpatrick, D. E.; Battilocchio, C.; Ley, S. V. A novel internet-based reaction monitoring, control and autonomous self-optimization platform for chemical synthesis. *Org. Process Res. Dev.* **2016**, *20*, 386–394.
- (47) Fabry, D. C.; Sugiono, E.; Rueping, M. Self-optimizing reactor systems: algorithms, on-line analytics, setups, and strategies for accelerating continuous flow process optimization. *Isr. J. Chem.* **2014**, *54*, 341–350.
- (48) Fabry, D. C.; Sugiono, E.; Rueping, M. Online monitoring and analysis for autonomous continuous flow self-optimizing reactor systems. *React. Chem. Eng.* **2016**, [10.1039/C5RE00038F](https://doi.org/10.1039/C5RE00038F).
- (49) Skilton, R. A.; Bourne, R. A.; Amara, Z.; Horvath, R.; Jin, J.; Scully, M. J.; Streng, E.; Tang, S. L. Y.; Summers, P. A.; Wang, J.; Pérez, E.; Asfaw, N.; Aydos, G. L. P.; Dupont, J.; Comak, G.; George, M. W.; Poliakov, M. Remote-controlled experiments with cloud chemistry. *Nat. Chem.* **2015**, *7*, 1–5.
- (50) Parrott, A. J.; Bourne, R. A.; Akien, G. R.; Irvine, D. J.; Poliakov, M. Self-optimizing continuous reactions in supercritical carbon dioxide. *Angew. Chem., Int. Ed.* **2011**, *50*, 3788–3792.
- (51) Whitesides, G. M. Reinventing Chemistry. *Angew. Chem., Int. Ed.* **2015**, *54*, 3196–3209.
- (52) Welch, C. J.; Hawkins, J. M.; Tom, J. Precompetitive collaboration on enabling technologies for the pharmaceutical industry. *Org. Process Res. Dev.* **2014**, *18*, 481–487.
- (53) Michaudel, Q.; Ishihara, Y.; Baran, P. S. Academia-industry symbiosis in organic chemistry. *Acc. Chem. Res.* **2015**, *48*, 712–721.
- (54) Battilocchio, C.; Hawkins, J. M.; Ley, S. V. A mild and efficient flow procedure for the transfer hydrogenation of ketones and aldehydes using hydrous zirconia. *Org. Lett.* **2013**, *15*, 2278–2281.
- (55) Chorghade, R.; Battilocchio, C.; Hawkins, J. M.; Ley, S. V. Sustainable flow openauer oxidation of secondary benzylic alcohols with a heterogeneous zirconia catalyst. *Org. Lett.* **2013**, *15*, 5698–5701.
- (56) Battilocchio, C.; Hawkins, J. M.; Ley, S. V. Mild and selective heterogeneous catalytic hydration of nitriles to amides by flowing through manganese dioxide. *Org. Lett.* **2014**, *16*, 1060–1063.
- (57) For an industrial viewpoint, refer to Hawkins, J. M. Organic chemistry: streamlining drug synthesis. *Nature* **2015**, *520*, 302–303.
- (58) Ouchi, T.; Battilocchio, C.; Hawkins, J. M.; Ley, S. V. Process intensification for the continuous flow hydrogenation of ethyl nicotinate. *Org. Process Res. Dev.* **2014**, *18*, 1560–1566.
- (59) Ghislieri, D.; Gilmore, K.; Seeberger, P. H. Chemical assembly systems: layered control for divergent, continuous, multistep syntheses of active pharmaceutical ingredients. *Angew. Chem., Int. Ed.* **2015**, *54*, 678–682.
- (60) Snead, D. R.; Jamison, T. F. A three-minute synthesis and purification of ibuprofen: pushing the limits of continuous-flow processing. *Angew. Chem., Int. Ed.* **2015**, *54*, 983–987.
- (61) Anastas, P. T.; Warner, J. C. *Green Chemistry: Theory and Practice*; Oxford University Press: New York, 1998.
- (62) Ley, S. V. On Being Green: Can Flow Chemistry Help? *Chem. Rec.* **2012**, *12*, 378–390.