

DANIELE ZUDDAS

*BRANCHED COVERINGS  
AND 4-MANIFOLDS*

Tesi di perfezionamento

SCUOLA NORMALE SUPERIORE



# CONTENTS

PREFACE	5
1 PRELIMINARIES	9
1.1 Branched coverings . . . . .	9
1.2 Manifolds as branched covers . . . . .	13
1.3 Mapping class groups and braids . . . . .	20
1.4 Open book decompositions . . . . .	28
1.5 Lefschetz fibrations on $B^2$ . . . . .	30
2 DEHN TWISTS AND BRANCHED COVERS	35
2.1 Representation theorem . . . . .	35
2.2 Diagrams and moves . . . . .	38
2.3 Proof of Theorem 2.1.1 . . . . .	42
2.4 Final remarks and open questions . . . . .	54
3 UNIVERSAL SURFACE	59
3.1 Introduction . . . . .	59
3.2 Some covering moves . . . . .	61
3.3 Special covering presentations . . . . .	68
3.4 Getting the universal surface . . . . .	75
3.5 Concluding remarks and questions . . . . .	80
BIBLIOGRAPHY	85



## PREFACE

Recently the topology of branched covers and of Lefschetz fibrations has reached considerable importance, particularly in connection with contact geometry and the theory of Stein 4-manifolds.

Since classical algebraic geometry, Lefschetz fibrations and branched coverings have an important role in studying and representing manifolds. However, we treat the subject from a purely topological point of view (in the smooth category), and we consider also those Lefschetz fibrations with negative singular points. These more general Lefschetz fibrations (also said *achiral*) allow us to represent a large class of 4-manifolds. In particular, as showed by Harer in his Ph.D. thesis [16] (see also [12] for the original proof), every smooth oriented 4-manifold builded by handles of index  $\leq 2$  (2-handlebody) is an achiral Lefschetz fibration on  $B^2$  with bounded fiber (Loi and Piergallini give an alternative proof of this Harer's theorem, see Remark 3 of [32]).

In a more recent paper, Bobtcheva and Piergallini [8] consider an equivalence relation between handlebody structures: two oriented 4-dimensional 2-handlebodies  $\mathcal{H}_1$  and  $\mathcal{H}_2$  are *2-equivalent* iff they are related by the classical Kirby moves (addition/deletion of cancelling pairs of 1- and 2-handles, sliding of handles and isotopy). It is conjectured that this equivalence relation is different from diffeomorphism (which in principle requires also addition/deletion of cancelling pairs of 2- and 3-handles), but, although this conjecture seems to be reasonable, there is not a proof.

In Section 1.5 we will see the well known fact that a Lefschetz fibration induces a 2-handlebody decomposition. On the

other hand, it can be proved that every 2-equivalence class of 4-dimensional 2-handlebodies can be represented by a Lefschetz fibration on  $B^2$ , with bounded fiber. To do this, start from the special simple branched covering of  $B^2 \times B^2 \cong B^4$  constructed in Section 3.3, which represents a given 2-equivalence class, and then transform the branching surface in a 2-dimensional braid, see Section 1.3, with the Rudolph's algorithm [46]. The branched covering, composed with the projection on  $B^2$ , is a Lefschetz fibration which induces the given 2-equivalence class.

It is a remarkable fact that 4-dimensional 2-handlebodies bounded by  $\#_n(S^1 \times S^2)$  determine all smooth closed 4-manifolds (there is only one way to close a 2-handlebody with 3- and 4-handles [35]). Then the theory of Lefschetz fibrations for bounded manifolds should be useful in the closed case too. In particular, it would be advisable to have a complete set of (possibly local) moves relating any two Lefschetz fibrations representing 2-equivalent (perhaps diffeomorphic) 2-handlebodies. Of course, the Bobtcheva-Piergallini moves of [8] are a good starting point. These moves relate any two simple coverings of  $B^4$  branched over ribbon surfaces, representing 2-equivalent 4-dimensional 2-handlebodies.

A general relationship between branched coverings of  $B^4$  and Lefschetz fibrations is established in Corollary 2.1.3, as a consequence of the Representation Theorem 2.1.1. That corollary states that every Lefschetz fibration on  $B^2$  with bounded fiber, can be represented as a simple covering of  $B^2 \times B^2$  branched over a 2-dimensional braid (i.e. a surface whose projection on the first factor  $B^2$  is a simple branched covering). This generalizes Proposition 2 of [32]. On the other hand, any such a branched covering, composed with the projection on  $B^2$ , gives a Lefschetz fibration.

The Representation Theorem gives us an algorithmic way to represent Dehn twists in a surface, by means of simple branched coverings of  $B^2$ . Its proof is given in Section 2.3. This work appears in [51].

Another result given in this thesis is the construction of the first *universal surface* for oriented 4-dimensional 2-handlebodies.

This surface is contained in  $B^4$  and universal means that every oriented 2-handlebody of dimension four is a covering of  $B^4$  branched over that surface. In other words the term universal generalizes the notion of universal link introduced by Bill Thurston in the early eighties [48] (since this work many knots and links in  $S^3$  are known to be universal).

Our construction, published in [44], is given in Chapter 3. The basic idea is to start from a suitable presentation of a 2-handlebody as a simple branched covering of  $B^4$ , and then to symmetrize the branching surface by a set of covering moves (moves which change the branched covering, but not the diffeomorphism type of the covering manifold). After the symmetrization, we get the universal surface by the action of a rotation group of  $B^4$ . This action sends the symmetric branching surface onto itself, and the quotient induces a branched covering  $B^4 \rightarrow B^4$ . In the target  $B^4$ , we have the universal surface (which includes also the branching set of the symmetric branched covering  $B^4 \rightarrow B^4$ ).

**ACKNOWLEDGEMENTS.** This thesis has been realized in collaboration with Riccardo Piergallini, who is also my advisor. So I wish to express my gratitude to Riccardo for all the maths I learn from him and for the pleasure I have to work with him.

I am grateful to Andrea Loi of the University of Cagliari for many helpful conversations and encouragements.

I wish to thank Giuseppe Tomassini of Scuola Normale Superiore of Pisa for helpful conversations.

A special thank is for the Scuola Normale Superiore, for the excellent support given to my research.

I wish to be grateful to the University of Camerino for its hospitality.

Finally I thank my parents, for encouragement and support.





# CHAPTER 1

## BRANCHED COVERINGS, MAPPING CLASS GROUPS AND LEFSCHETZ FIBRATIONS

In this chapter we will give basic definitions and theorems on the subject. All the material here is well known and is given for completeness and to establish conventions and notations.

### 1.1 BRANCHED COVERINGS

Let  $M$  and  $N$  be compact smooth  $n$ -manifolds, with  $N$  connected. We recall that a map  $f : M \rightarrow N$  is said *proper* if  $f^{-1}(\text{Bd } N) = \text{Bd } M$ .

A *branched covering* is a smooth proper map  $p : M \rightarrow N$  such that:

- i) The singular set  $S_p \subset M$  coincides with the set of points at which  $p$  is not locally injective;
- ii) The branching set  $B_p = p(S_p)$  is a smooth embedded codimension two submanifold of  $N$ ;
- iii) The restriction  $p| : M - p^{-1}(B_p) \rightarrow N - B_p$  is an ordinary covering.

If  $M$  and  $N$  are oriented manifolds, we say that  $p$  is *oriented* if it is an orientation preserving local diffeomorphism at regular points. Usually we will consider only oriented branched coverings.

LOCAL MODEL. It is well-known that at a point  $x \in M$ , the branched covering is modelled on the map  $B^{n-2} \times B^2 \rightarrow B^{n-2} \times B^2$ ,  $(w, z) \mapsto (w, z^m)$ , where  $m = m_x \geq 1$  is the *local degree*, which is a topological invariant of the covering at  $x$ . It is clear that  $x \in S_p$  iff  $m_x \geq 2$  and that the local degree is locally constant on the singular set, and then it is constant on its connected components.

We also consider the *pseudo-singular set*  $L_p = p^{-1}(B_p) - S_p$ . By referring to the local model, we see that  $L_p$  is closed in  $M$  and also a codimension two submanifold, just as  $S_p$ .

For a regular value  $y \in N$ , the number  $d = \#p^{-1}(y)$  is the *degree* of  $p$ . If  $y$  is a singular value then we have  $d = \sum_x m_x$ , where  $x$  varies in  $p^{-1}(y)$ .

MONODROMY. The monodromy of  $p$  is that of the associated ordinary covering  $p| : M - p^{-1}(B_p) \rightarrow N - B_p$ . So it is a homomorphism  $\omega_p : \pi_1(N - B_p) \rightarrow \Sigma_d$ , where the choice of a base point  $* \in N - B_p$  and of a numbering of  $p^{-1}(*) \cong \{1, \dots, d\}$  are understood. The *monodromy group*  $\Omega(p)$  is the image of  $\omega_p$  in  $\Sigma_d$  and is defined, as  $\omega_p$ , up to an inner automorphism in  $\Sigma_d$ , which corresponds to a different numbering of  $p^{-1}(*)$ . A branched covering is connected iff  $\Omega(p)$  is transitive on  $\{1, \dots, d\}$ .

A *meridian* of the branching set  $B_p$  is an element  $\mu \in \pi_1(N - B_p)$  represented by the boundary of a regular disk in  $N$  which meets  $B_p$  transversely in a single point, say  $y$ .

The permutation  $\omega_p(\mu) = \tau_1 \cdots \tau_k$ , as a product of disjoint cycles, gives the local behavior of  $p$  at the singular points over  $y$ . In fact a cycle  $\tau_i$  corresponds to one of these singular points, say  $x_i$ , and its length is equal to the local degree of  $x_i$ .

We say that  $p$  is *simple* if  $\omega_p(\mu)$  is a transposition for any meridian  $\mu$ . This is equivalent to each of the following: 1)  $\#p^{-1}(y) \geq d - 1 \forall y \in N$ , and 2) all singular points have local degree two and  $p| : S_p \rightarrow B_p$  is 1-1. In most cases we consider simple branched coverings, but in Chapter 3 we widely use non-simple ones.

**REGULAR VS. IRREGULAR.** A branched covering is said to be *regular* if there is a finite group  $G$  of diffeomorphisms of  $M$  which acts freely on  $M - p^{-1}(B_p)$  s.t.  $M/G$  is homeomorphic to  $N$  and the projection  $\pi : M \rightarrow M/G$  is homeomorphic, as a map, to  $p$ .

In other words  $p$  is regular iff the deck transformations group, which is the group of all the diffeomorphisms  $f$  of  $M$  s.t.  $p = p \circ f$ , is transitive on a fiber (and then on all the fibers). Moreover it is not hard to show that  $p$  is regular iff  $p_*(\pi_1(M - p^{-1}(B_p))) = \ker \omega_p$  iff  $\Omega(p)$  acts freely on the set  $\{1, \dots, d\}$ . For a regular  $p$ ,  $\Omega(p)$  is isomorphic to the group of deck transformations.

A regular covering has no pseudo-singular points, and all the singular points with the same image have the same local structure, and so the same local degree. Therefore in the disjoint cycles decomposition  $\omega_p(\mu) = \tau_1 \cdots \tau_k$  for a meridian  $\mu$ , the  $\tau_i$ 's have all the same length  $l$  and  $kl = d$ . Note that 2-fold branched coverings are simple and regular and that there are no simple and regular coverings of degree  $> 2$ .

A branched covering which is not regular is said to be *irregular*. Irregular coverings are often more useful than regular ones, because the latter are very rigid, as it should be clear. In fact a regular covering can be approached with an irregular one, so the (simple) irregular coverings are generic. We will see examples in the next section.

It turns out that  $M$  and  $p$  are determined, up to diffeomorphisms, by  $N$ ,  $B_p$ , and  $\omega_p$ . We need a *splitting complex*, which is a compact subcomplex  $K \subset N$  of codimension one, with smooth cells, such that  $N - K$  is connected and the monodromy is trivial on  $N - K$ . A splitting complex does exist for any branching set (start from a triangulation of  $N$  s.t.  $B_p$  is a subcomplex, and look at the dual triangulation to choose the proper  $(n - 1)$ -cells to construct  $K$  in such a way  $N - K$  is contractible).

**RECOVERING FROM THE BRANCHING DATA.** Now we will show how to recover  $M$  and  $p$  from  $N$ ,  $B$  and  $\omega$ . First cut  $N$  along  $K$ , which means to remove from  $N$  the interior of a regular neighborhood of  $K$  relative to  $B$  (in such a way  $B$  is in the border of that neighborhood), and indicate with  $N'$  the cutted manifold.

Then each  $(n - 1)$ -cell  $c$  of  $K$  gives two  $(n - 1)$ -cells  $c'$  and  $c''$  of  $N'$ , and  $N$  can be recovered from  $N'$  by pasting  $c'$  and  $c''$ , with a smooth attaching map  $h_c : c' \rightarrow c''$ . For each  $c$  choose a meridian  $\mu_c$  which transversely meets  $c$  itself in a single point, oriented in such a way that the part of  $\mu_c$  contained in the cutting neighborhood of  $K$  points towards  $c''$ .

If the target of  $\omega$  is  $\Sigma_d$ , let  $\mathcal{M}$  be the topological union of  $d$  copies of  $N'$ , so  $\mathcal{M} = N'_1 \cup \dots \cup N'_d$ , and denote the corresponding cells with  $c'_i$  and  $c''_i$ . We have also a natural map  $P : \mathcal{M} \rightarrow N$ , given by the identifications on each  $N'_i$ , as a copy of  $N'$ , defined above.

Now, we past  $c'_i$  with  $c''_j$  if  $j = (\omega(\mu_c))(i)$ , with an attaching map modelled on  $h_c$ . After these identifications we get a quotient space  $M$  and a quotient continuous map  $p : M \rightarrow N$  (since  $P$  is compatible with the identifications on  $\mathcal{M}$ ). It is not hard to show that  $M$  is a topological  $n$ -manifold. Moreover, we can construct a smooth atlas on  $M$ , since any attaching map we use above is smooth. With respect to this differentiable structure  $p$  becomes a smooth branched covering.

The uniqueness of  $M$  and  $p$ , up to diffeomorphisms, follows from the uniqueness for unbranched coverings.

For a fixed splitting complex  $K$ , the *sheets* of  $p$  are the connected components of  $p^{-1}(N - K)$ . If the base point for the fundamental group is not in  $K$ , then a numbering of its preimage can be extended to a numbering of the sheets, and the monodromy group can be considered as acting on the sheets.

**STABILIZATIONS.** Let  $p : M \rightarrow N$  be a degree  $d$  branched covering map, with  $\text{Bd } N \neq \emptyset$ , and  $Q \subset N$  be a trivially properly embedded  $(n - 2)$ -ball, separated from  $B_p$ , so there is an  $(n - 1)$ -ball  $V$  s.t.  $Q \subset \text{Bd } V$ ,  $\text{Bd } V - Q \subset \text{Bd } N$  and  $V \cap B_p = \emptyset$ . We can construct a new branched covering  $\widehat{p} : \widehat{M} \rightarrow N$  of degree  $d + 1$  such that  $B_{\widehat{p}} = B_p \cup Q$ , and the monodromy is extended by assigning  $(i \ d + 1)$  to a meridian of  $Q$ , with  $i \in \{1, \dots, d\}$ . It is not hard to see that the new manifold  $\widehat{M}$  is diffeomorphic to the boundary connected sum  $M \#_b N$  (think to  $V$  as part of the

splitting complex). In particular, if  $N \cong B^n$ , then  $\widehat{M} \cong M$ . In this case  $\widehat{p}$  is called a *stabilization* of  $p$  and the new sheet added to  $p$  is said to be a *trivial sheet*.

In the closed case the stabilization is constructed by adding a trivial  $(n-2)$ -sphere  $S$  to the branching set. This sphere must be s.t. there is an  $(n-1)$ -ball  $V \subset N$  which is bounded by  $S$  and disjoint from  $B_p$ . Then we can make the covering  $\widehat{p}: \widehat{M} \rightarrow N$  of degree  $d+1$  with monodromy extended by assigning, as above,  $(i, d+1)$  to a meridian of  $S$ . It follows that  $\widehat{M} \cong M \# N$ , and then if  $N \cong S^n$  we get  $\widehat{M} \cong M$ .

For example, a branched covering of  $S^2$  can be stabilized by adding an  $S^0$  (so a pair of points) to the branching set. For a branched covering of  $B^2$  we add a single point. In the case of  $S^3$  we have to add an unknotted circle, which is also unlinked with the old branching set.

## 1.2 MANIFOLDS AS BRANCHED COVERS

Branched covers of  $S^n$  can be presented by a codimension two submanifold  $B$  of  $S^n$  together with a sequence of permutations corresponding to a finite set of generating meridians for  $\pi_1(S^n - B)$ .

At this point we can ask if every  $n$ -manifold is a branched covering of  $S^n$ . The first answer is due to Alexander, who in the early Twenties proved the following theorem.

**THEOREM 1.2.1.** *Every closed oriented PL  $n$ -manifold is a PL covering of  $S^n$ , branched over the  $(n-2)$ -skeleton of a standard  $n$ -simplex.*

Note that the branching set in this theorem is a submanifold only in dimension two (the 0-skeleton of a 2-simplex is a set of three points). Moreover the Alexander's theorem gives a *universal* branching set, the covering is not simple and there are no bounds on the degree. In low dimensions there are more precise and powerful results.

**DIMENSION 2.** We have a background with the theory of Riemann surfaces. We know that every Riemann surface is a simple analytic branched covering of the Riemann sphere.

The classical Riemann-Hurwitz formula for a  $d$ -fold branched covering  $p : M^2 \rightarrow N^2$  is the following:

$$\chi(M) = d\chi(N) - \sum_i (m_i - 1)$$

where the  $m_i$ 's are the local degrees at the singular points. This formula holds in every case (with or without boundary, orientable or non-orientable).

From the topological point of view, looking at the Figure 1.1 we see that the following proposition holds.

**PROPOSITION 1.2.2.** *A closed oriented surface of genus  $g$  is 2-fold covering of  $S^2$  branched over  $2g + 2$  points.*

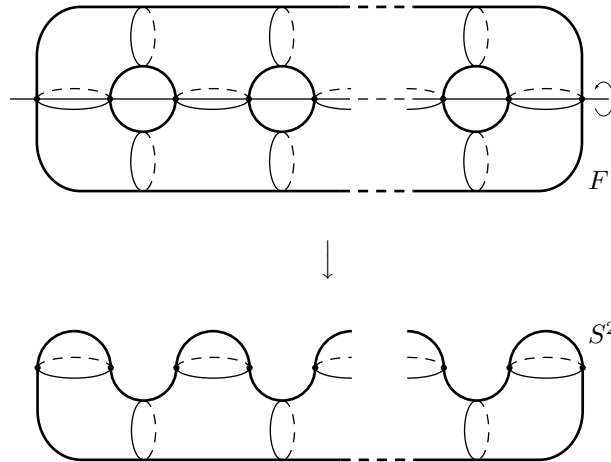

FIGURE 1.1.

The covering is generated by a  $180^\circ$ -rotation about the axis, and the singular points are the intersections of that axis with the surface  $F$ . The quotient space with respect to this action is  $S^2$ .

There is a classification of the simple branched coverings of  $S^2$ , and in fact the following theorem holds, see [4].

**THEOREM 1.2.3.** *Two simple branched coverings of  $S^2$  of the same degree  $d$  are equivalent.*

For recent results on the realizability of non-simple branched coverings with prescribed branch data see the nice preprint of Pervova and Petronio [42].

In the case with boundary, we can prove the following theorem.

**THEOREM 1.2.4.** *A compact, connected, orientable surface  $F$  with  $n$  boundary components is a simple branched covering of  $B^2$  of degree  $d = \max(2, n)$ .*

*Proof.* Let us consider a simple branched covering of  $B^2$ . As a splitting complex we choose a set of disjoint arcs each connecting a point in  $S^1$  with a branching point. Cutting  $B^2$  along these arcs, we still get  $B^2$ , and then each sheet is a copy of  $B^2$  too.

As in the general construction of the branched coverings, we have to paste the sheets according to the monodromy. So for a branching point with monodromy  $(i\ j)$  we have to paste an arc in the boundary at level  $i$  with one at level  $j$  or, which is the same, we attach a 1-handle from the  $i$ -th sheet to the  $j$ -th one. The sheets behave as 0-handles.

Therefore a branched covering of  $B^2$  induces a handle decomposition without 2-handles on the covering 2-manifold.

In Figure 1.2 is depicted a surface with  $m$  1-handles of genus  $\lfloor (m-1)/2 \rfloor$  and one boundary component if  $m$  is odd, or two if  $m$  is even. Then we get every compact connected oriented surface with 1 or 2 boundary components.

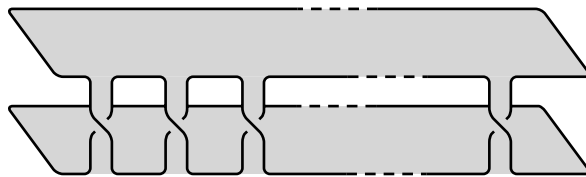

FIGURE 1.2.

It is now straightforward to get the branched covering  $p$  of  $B^2$  which induces the depicted handle decomposition. Simply take  $m$  branching points all with monodromy  $(1\ 2)$ .

To complete the proof we will show how to add more boundary components. Observe that if we have a branched covering of  $B^2$  of degree  $d$ , the addition a pair of branching points with monodromy  $(1\ d+1)$  does not change the genus and add a boundary component on the covering surface.

So if  $n > 2$  start from the  $p$  above to represent a surface of the same genus and two boundary components. Then add  $n - 2$  pairs of branching points  $b_1, b_2$  with monodromy  $(1\ 3)$ ,  $b_3, b_4$  with monodromy  $(1\ 4)$ ,  $\dots$ ,  $b_{2n-5}, b_{2n-4}$  with  $(1\ n)$ .  $\square$

In [40] Mulazzani and Piergallini proved that any other simple branched covering  $F \rightarrow B^2$  is, up to homeomorphisms, a (multi) stabilization of our covering.

Then every compact connected oriented 2-manifold is a simple oriented branched covering of  $S^2$  if it is closed, or of  $B^2$  if it is bounded. Moreover there is a bound on the degree which depends only on the number of boundary components.

**DIMENSION 3.** In the early Seventies Hilden, Hirsch and Montesinos independently proved the following theorem [23], [28], [33].

**THEOREM 1.2.5.** *Every closed oriented 3-manifold is a 3-fold simple oriented covering of  $S^3$  branched over a knot.*

We will outline a proof of this theorem in Section 1.5, based on the fact that every closed oriented 3-manifold is the boundary of a compact 4-manifold obtained from  $B^4$  by the addition of 2-handles. Since any such a 4-manifold is a branched covering of  $B^4$ , as we see later, we obtain the Hirsch-Hilden-Montesinos theorem by restricting that covering to the boundary. Theorem 1.2.5 follows also from the proof of the next theorem.

In the bounded case we have the following result.

**THEOREM 1.2.6.** *Any compact oriented connected 3-manifold with boundary is a simple covering of  $B^3$  branched over a non-singular curve. Moreover if the 3-manifold has connected boundary, then it is a simple branched covering of  $B^3$  of degree three.*



*Proof.* Let  $W$  be a connected 3-manifold with (not necessarily connected) boundary. Consider a handle decomposition relative to the boundary without 0-handles and a single 3-handle. Suppose also that the handles are ordered by their indices.

Start from a simple branched covering  $q : \text{Bd } W \rightarrow S^2$  of degree at least three and get the product with an interval  $p_0 = q \times \text{id}_I : \text{Bd } W \times I \rightarrow S^2 \times I$ . It is not hard to add 1-handles equivariantly to  $p_0$ . A 1-handle between the sheets  $i$  and  $j$  can be realized by the addition of a simple branching arc in  $S^2 \times I$  with monodromy  $(i \ j)$ . The simple arc must have the end points in the boundary component of  $S^2 \times I$  which goes to the interior of the manifold. After the addition of the 1-handles, we have a branched covering  $p_1 : W_1 \rightarrow S^2 \times I$ . Note that there is an obvious embedding  $W_1 \hookrightarrow W$  which sends a single boundary component of  $W_1$ , which we indicate  $\partial_1 W_1$ , to the interior of  $W$ .

Now we add the 2-handles. Since after the addition of the 2-handles it remains to add only a single 3-handle, it follows that the attaching curve of every 2-handle is non-separating in  $\partial_1 W_1$ .

Consider a 2-handle  $H^2$  attached along a curve  $C \subset \partial_1 W_1$ . This curve is isotopic in  $\partial_1 W_1$  to a curve which projects, through  $p_1$ , to an arc  $c \subset S^2$  with end points in the branching set of  $p_1$  (this can be obtained in degree at least three, see [4] and recall that a non-separating curve in a closed oriented surface is equivalent, up to an orientation-preserving diffeomorphism, to a standard curve).

This arc  $c$  can be pushed inside  $S^2 \times I$ , together with its end points, and smoothed with the branching set of  $p_1$ , to give a new bigger arc. Note that the monodromy can be extended to the new arc, coherently with that of  $p_1$ . Then we get a new branched covering  $p'_2 : W'_2 \rightarrow S^2 \times I$ , and it is straightforward to show that  $W'_2 \cong W_1 \cup H^2$ . We can repeat this argument to get a branched covering  $p_2 : W_2 \rightarrow S^2 \times I$ , where  $W_2 = W_1 \cup (\text{2-handles})$ .

It remains to add the 3-handle to the spherical boundary component  $\partial_1 W_2 \cong S^2$ . Since the branched covering  $p_{2|} : \partial_1 W_2 \rightarrow S^2$  is simple and of some degree  $d$ , it is equivalent, see [4], to the branched covering of  $S^2$  with  $2d - 2$  branching points

and monodromies  $(1\ 2)$ ,  $(1\ 2)$ ,  $(1\ 3)$ ,  $(1\ 3)$ ,  $\dots$ ,  $(1\ d)$ ,  $(1\ d)$ , which can be extended to a covering  $B^3 \rightarrow B^3$  branched over  $d - 1$  arcs. It follows that  $p_2$  can be extended, after the addition of a 3-handle in  $W_2$  and in  $S^2 \times I$ , to a branched covering  $p : W \rightarrow B^3$ . Observe that this covering  $p$  is simple and with branching set a disjoint union of arcs.

Note that since the degree of  $p$  is equal to that of the covering  $q$  we start from, then if  $W$  has connected boundary we get a 3-fold covering  $p$ , because in this case we can choose  $q$  of degree three.  $\square$

**DIMENSION 4.** In this dimension we have the following result of Iori and Piergallini [29].

**THEOREM 1.2.7.** *A closed oriented smooth 4-manifold is a 5-fold simple covering of  $S^4$  branched over an embedded smooth surface.*

The branching surface in this case can be non-orientable. In fact with orientable branching surfaces we get only bounding 4-manifolds with even Euler characteristic.

In the bounded case we need ribbon surfaces, see [47], [46] for a nice presentation.

**DEFINITION 1.2.8.** *A smooth oriented surface  $F \subset B^4$  is said in ribbon position if the distance from the origin restricts to a Morse function on  $F$  without critical points of index 2.  $F$  is ribbon if it is isotopic to a surface in ribbon position*

A ribbon surface can be isotoped in such a way that the projection on the standard  $\mathbb{R}^3 \subset S^3$  from the origin of  $B^4$  is an immersion whose singularities are of the type depicted in Figure 1.3 (ribbon singularities). On the other hand an immersed ribbon surface in  $\mathbb{R}^3$  can be pushed into  $B^4$  to give a regular ribbon surface (unique up to isotopy in  $B^4$  through ribbon surfaces).

In pictures of ribbon surfaces, we use brightness to represent the depth. So, a dark region is close to  $\mathbb{R}^3$  (the 0 depth), while

a bright one is pushed into  $B^4$  at a higher depth. In particular, something depicted in black is actually contained in  $\mathbb{R}^3$ .

So, ribbon surfaces have nice diagrams in  $\mathbb{R}^3$ . For example, in Figure 1.4 is depicted a ribbon disk, which is non-trivial, since it is bounded by the square knot (the connected sum of a trefoil knot and its mirror image).

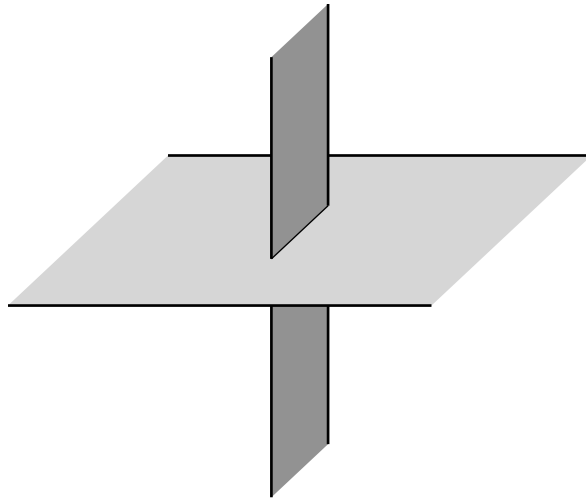

FIGURE 1.3.

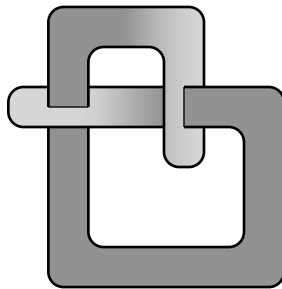

FIGURE 1.4.

**THEOREM 1.2.9.** *Every compact oriented 4-dimensional 2-handlebody is a 3-fold covering of  $B^4$  branched over a ribbon surface [8], [33].*

For a proof without a bound on the degree see Chapter 3. On the other hand in Section 1.5 we will see how branched coverings of  $B^4$  are related to the Lefschetz fibrations and then we conclude the proof of Theorem 1.2.9 with degree three.

### 1.3 MAPPING CLASS GROUPS AND BRAIDS

Let us consider a compact oriented surface  $F$  with (possibly empty) boundary, and fix a finite distinguished subset  $A \subset \text{Int } F$  (a so called pointed surface if  $A \neq \emptyset$ ). Let  $\mathcal{H}(F, A)$  be the group of the orientation preserving homeomorphisms  $\varphi : (F, A) \rightarrow (F, A)$  which are the identity on the boundary.  $\mathcal{H}(F, A)$  can be topologized with the compact open topology (which is the same as the uniform convergence topology with respect to a distance function on  $F$ ), and in this way  $\mathcal{H}(F, A)$  becomes a topological group which is Hausdorff and locally path connected. It is well-known that the connected component of the identity, which we indicate with  $\mathcal{H}_0(F, A)$ , is a closed normal subgroup, and then the quotient  $\mathcal{M}(F, A) = \mathcal{H}(F, A) / \mathcal{H}_0(F, A)$  is a discrete group called the *mapping class group* of  $(F, A)$ . When  $A = \emptyset$  we simply write  $\mathcal{H}(F)$  and  $\mathcal{M}(F)$ .

DEHN TWISTS. Consider a closed curve  $\gamma \subset \text{Int } F - A$  and a tubular neighborhood  $U \cong S^1 \times B^1$  of  $\gamma$  s.t.  $U \cap A = \emptyset$ . The identification between  $U$  and  $S^1 \times B^1$  is an orientation preserving homeomorphism s.t.  $\gamma$  corresponds to  $S^1 \times \{0\}$ .

The homeomorphism  $t : S^1 \times B^1 \rightarrow S^1 \times B^1$  with  $t(x, s) = (-x \cdot e^{s\pi i}, s)$ , where  $S^1$  is considered as the complexes of modulus one, is the identity on  $\text{Bd}(S^1 \times B^1)$  and then induces a homeomorphism of  $U$ , which can be extended to a  $t_\gamma : F \rightarrow F$  by the identity outside  $U$ . It follows that  $t_\gamma \in \mathcal{H}(F, A)$  and its class in  $\mathcal{M}(F, A)$  is denoted with  $t_\gamma$  too. That homeomorphism (or better its class) is what we mean for a *right-handed Dehn twist* around  $\gamma$ . It turns out that the mapping class  $t_\gamma$  depends only on the isotopy class of  $\gamma$  in  $F - A$ .

A right-handed Dehn twist is also called *positive*, while a *negative* one is a class of the type  $t_\gamma^{-1}$  (also called left-handed). This kind of positivity depends on the orientation of  $F$  (but not on that of  $\gamma$ ). So, if we reverse the orientation of  $F$ , positive Dehn twists become negative and vice versa.

If the curve is homotopic to zero (or, is the same, it bounds a disc in  $F - A$ ), then the corresponding Dehn twist is the identity (as a class). Otherwise it can be proved to be of infinity order in  $\mathcal{M}(F, A)$ . The Dehn twists we consider are always non-trivial.

The following question naturally arises: can a negative Dehn twist be equal to a positive one, possibly along a different curve?

The answer is not, in fact a Dehn twist determines its core curve up to isotopy. But for surfaces with boundary hold a more interesting fact.

**THEOREM 1.3.1.** *Let  $F$  be an oriented surface with non-empty boundary. Then a negative Dehn twist cannot be the product of positive Dehn twists.*

This theorem depends on the uniqueness of the Stein filling of  $S^3$  (which is  $B^4$ , as showed by Eliashberg [11]) and on a theorem of Loi and Piergallini [32] on Stein 4-manifolds with boundary as positive Lefschetz fibrations on  $B^2$  (see Section 1.5 for generalities on the subject).

Theorem 1.3.1 is related also to the existence of oriented not Stein-fillable 3-manifolds. In fact if there is a negative Dehn twist which is a product of positive twists in a genus  $g$  surface with boundary, then every class in  $\mathcal{M}(F)$  is the product of positive Dehn twists in any surface  $F$  of genus  $\geq g$  with connected non-empty boundary, and so every 3-manifold would be Stein-fillable.

But Etnyre and Honda proved in [13] that the Poincaré homology sphere with reversed orientation has no positive tight contact structures, and so it cannot be Stein-fillable.

On the other hand, on a closed surface every negative Dehn twist is a product of positive Dehn twists.

**HALF-TWISTS.** Let  $\alpha \subset \text{Int } F$  be a non-singular arc with end points in  $A$  and the interior disjoint from  $A$ . Consider a regular

neighborhood  $V$  of  $\alpha$  s.t.  $V \cap A = \text{Bd } \alpha$  and choose an orientation preserving identification  $(V, \alpha) \cong (B^2(2), B^1)$ , where  $B^2(r)$  is the disc of radius  $r$ . Consider the homeomorphism  $k : B^2(2) \rightarrow B^2(2)$  with  $k(\rho, \vartheta) = (\rho, \vartheta + \rho\pi)$ , in polar coordinates. The induced homeomorphism of  $V$  is the identity on the boundary and can be extended to a  $t_\alpha$  on all  $F$  with the identity outside  $V$ . Note that  $t_\alpha$  sends  $\alpha$  to itself exchanging the end points, so  $t_\alpha(A) = A$ . It follows that  $t_\alpha \in \mathcal{H}(F, A)$  and its class is called a *right-handed (or positive) half-twist*. As in the previous case, a left-handed (or negative) half-twist is a class of the type  $t_\alpha^{-1}$ .

**THEOREM 1.3.2.**  $\mathcal{M}(F, A)$  is finitely generated by Dehn twists and half-twists.

In fact we know more, since there are finite presentations of the mapping class groups in terms of half and Dehn twists, see [50], [14], [3], all based on the fundamental paper of Hatcher and Thurston [21].

Two non-separating curves on a surface  $F$  are equivalent up to an element of  $\mathcal{H}(F, A)$ , see for instance [31]. It follows that the corresponding Dehn twists are conjugated in  $\mathcal{M}(F, A)$ . Every two half-twists are conjugated because two arcs are always equivalent modulo  $\mathcal{H}(F, A)$ . Moreover, a conjugate of a right-handed Dehn (or half) twist is also a right-handed Dehn (resp. half) twist. The corresponding curves (resp. arcs) are related by the conjugating homeomorphism.

**BRAIDS.** The classical braid group is  $\mathcal{B}_n = \mathcal{M}(B^2, A_n)$ , where  $A_n \subset B^2$  is a fixed subset with  $n$  points and  $A_n \subset A_{n+1}$ ,  $\forall n \geq 1$ . In the following it is understood an identification  $A_n \cong \{1, \dots, n\}$ , compatible with the inclusion  $A_n \subset A_{n+1}$ .

So a braid is represented by a homeomorphism which sends a fixed finite subset onto itself. But the braid group can be defined also in a different way. Consider a curve whose connected components are  $n$  arcs in  $I \times B^2$  s.t. each arc connects a point in  $A_n \times \{0\}$  with a point in  $A_n \times \{1\}$  and project homeomorphically onto  $I$ . Such a curve is said a *geometric braid*, and two of these are considered equivalent if there is an isotopy through

geometric braids. In this case the number  $n$  is said the degree of the braid.

Two geometric braids can be composed by joining them together, and reparametrizing in such a way to stay in  $I \times B^2$ . Then the set of equivalence classes is a group which is isomorphic to  $\mathcal{B}_n$ .

The identity element is the trivial braid made of vertical straight arcs, and the inverse of a braid is its symmetric with respect to the plane  $\{1/2\} \times \mathbb{R}^2$ . It is simple to check that the structure of a group is well defined.

Roughly speaking, an isomorphism between  $\mathcal{B}_n$  and the group of geometric braids can be defined as follows: pick a homeomorphism  $h : (B^2, A_n) \rightarrow (B^2, A_n)$  and choose an isotopy  $H : I \times B^2 \rightarrow I \times B^2$  (rel Bd) from  $\text{id}_{B^2}$  to  $h$ . Then the curve which corresponds to  $h$  is  $H(I \times A_n)$ , so it follows the points in  $A_n$  during the isotopy.

It can be proved that this correspondence is well defined on isotopy classes and it induces the above-mentioned isomorphism.

The braid group  $\mathcal{B}_n$  has the following presentation: generators  $\sigma_1, \dots, \sigma_{n-1}$  and relations  $\sigma_i \sigma_j = \sigma_j \sigma_i$  if  $|i - j| > 1$  and  $\sigma_i \sigma_j \sigma_i = \sigma_j \sigma_i \sigma_j$  if  $|i - j| = 1$ , see [5] for a proof.

Each  $\sigma_i$  is a half-twist about the arc depicted in Figure 1.5 (a) and exchange the  $i$ -th and the  $(i+1)$ -th points of  $A_n$ . The corresponding geometric braid is that of Figure 1.5 (b). In particular  $\mathcal{B}_1$  is the trivial group,  $\mathcal{B}_2$  is infinite cyclic and  $\mathcal{B}_n$  is not abelian for  $n \geq 3$ .

Consider the homomorphism  $P : \mathcal{B}_n \rightarrow \Sigma_n$  which is the restriction of a braid (as a homeomorphism of  $B^2$ ) to the set  $A_n$  (which, as said above, is identified with the set  $\{1, \dots, n\}$ ). The normal subgroup  $\mathcal{P}_n = \ker P$  is said the *pure braid group*. For a finite presentation of  $\mathcal{P}_n$  see [5].

Another natural homomorphism is  $e : \mathcal{B}_n \rightarrow \mathbb{Z}$  such that  $e(\sigma_i) = 1, \forall i$ . This homomorphism is well defined because the defining relations for  $\mathcal{B}_n$  are homogeneous.

Given a geometric braid  $b \in \mathcal{B}_n$  we can construct a corresponding *closed braid* which is an oriented link in  $\mathbb{R}^3$ . Simply

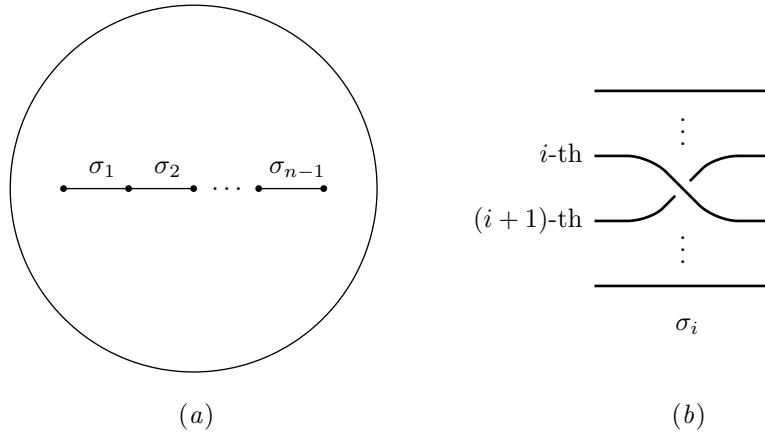

FIGURE 1.5.

consider the solid torus obtained from  $I \times B^2$  by identifying  $\{0\} \times B^2$  and  $\{1\} \times B^2$  with the identity, embedded in  $\mathbb{R}^3$  in a standard way. In this solid torus we have a link  $\hat{b}$  which is the result of  $b$  after the identification of  $\{0\} \times A_n$  and  $\{1\} \times A_n$ . Starting from a plane diagram of  $b$  we get  $\hat{b}$  by the addition of disjoint simple closing arcs as in Figure 1.6.

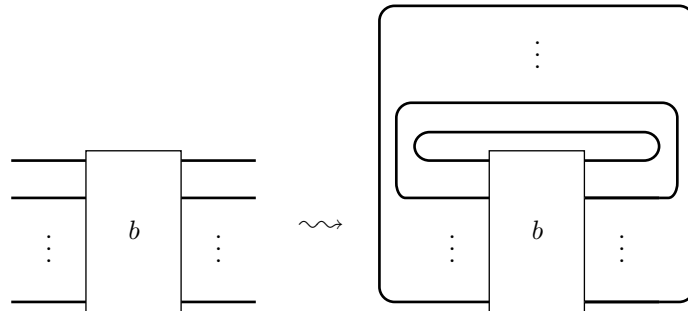

FIGURE 1.6.

Note that an oriented link  $L$  in  $\mathbb{R}^3$  is a closed braid iff the polar angle coordinate  $\vartheta : \mathbb{R}^3 - (z \text{ axis}) \rightarrow S^1$  restricts to an oriented covering map  $L \rightarrow S^1$ .

Vice versa, Alexander proved the following theorem.



**THEOREM 1.3.3.** *Every oriented link in  $\mathbb{R}^3$  is isotopic to a closed braid.*

For a proof see Birman [5], where the reader can find also the Markov moves which relates two braids representing isotopic links. Another nice constructive proof can be found in [46], where there is a more general algorithm which transforms a ribbon surface in a braided surface (see the next paragraph).

**TWO-DIMENSIONAL BRAIDS.** Let  $F \subset B^2 \times B^2$  be a compact oriented surface. We say that  $F$  is a two-dimensional braid, or a *braided surface*, if the projection on the first factor  $\pi_{1|} : F \rightarrow B^2$  is a simple oriented branched covering. In particular  $\text{Bd } F \subset \text{Bd } B^2 \times B^2 \subset S^3$  is a closed braid. The singular points of the branched covering are said *twist points* of  $F$ .

It turns out that twist points have an index  $\pm 1$ . If the orientation of the tangent plane  $\{\text{pt}\} \times B^2$  at a twist point  $x$  coincides with that of the surface, then we say that  $x$  is positive, otherwise is negative. If all the twist points are positive we say that the braided surface is positive.

Braided surfaces are ribbon, and in fact admit special diagrams in  $\mathbb{R}^3$  made of parallel discs joined by twisted bands. Discs corresponds to sheets of the branched covering, and each band correspond to a twist point. The band is left-handed if the twist point is positive, otherwise is right-handed. Here left or right-handed is referred to the longitudinal direction. For instance, in Figure 1.7 is depicted a positive (left-handed) band.

It is simple to show that each positive band gives in the boundary a piece of braid which can be represented by a conjugate of a standard generator  $\sigma_i$ . A negative (right-handed) band corresponds to a conjugate of  $\sigma_i^{-1}$ . Note also that the relations of the braid group imply that each  $\sigma_i$  is a conjugate of  $\sigma_1$ .

For a twist point  $x \in F$  there are local complex coordinates  $(z, w)$  in  $B^2 \times B^2$  centered at  $x$ , s.t. the local equation of  $F$  is  $z = w^2$ , and the map  $\pi_{1|F}$  is  $(w^2, w) \mapsto w^2$ . Moreover these coordinates can be chosen orientation preserving (resp. reversing) iff  $x$  is positive (resp. negative). The existence of these coordinates

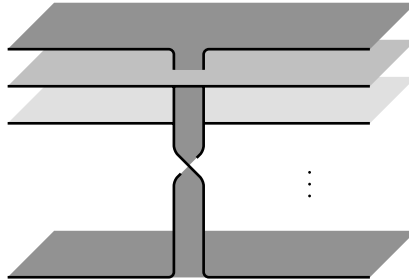

FIGURE 1.7.

is a straightforward consequence of the local model for branched coverings. Then near a positive twist point the surface looks like analytic. This local behavior is indeed global if every twist point is positive.

In [45] Rudolph proved that positive two-dimensional braids are isotopic to non-singular pieces of analytic curves (see also [9] for a proof of the converse in  $B^4$ , and also for a generalization to symplectic surfaces). Then this kind of positivity is powerful and deep.

Now we will see how the left-handed bands are those we want to call positive. Consider a positive twist point  $x \in F$ . Then, as said above, the local equation of  $F$  around  $x$  is given by  $z = w^2$ , with respect to local orientation-preserving complex coordinates  $(z, w)$ , defined on a bidisc  $B^2 \times B^2$  around  $x$ .

The disc of equation  $z = e^{it}$ ,  $t \in [0, 2\pi]$ , meets  $F$  at the two points  $(e^{it}, \pm e^{it/2})$  which, as  $t$  goes from 0 to  $2\pi$ , describe a positive generator  $\sigma_1$  on the starting disc  $z = 1$ , since the two points  $\pm e^{it/2} \in B^2$  rotate counterclockwise, as  $t$  varies. But this is only the local model. If we look at the full boundary braid, we will get a conjugate  $b\sigma_1 b^{-1}$ , for some  $b \in \mathcal{B}_n$ . It follows that in the longitudinal direction we see a left-handed twist. Of course, if we start from a right-handed (negative) band we will get  $b\sigma_1^{-1} b^{-1}$ .

LIFTING BRAIDS. Now we will see how branched coverings are useful to represent mapping classes.

Consider an element  $\varphi \in \mathcal{M}(F)$  (assume  $F$  with boundary). For a simple covering  $p : F \rightarrow B^2$  branched over the standard subset  $A_n$ , we say that  $\varphi$  is the lifting of a braid  $\beta \in \mathcal{B}_n$  iff  $p \circ \varphi = \beta \circ p$ .

Montesinos and Morton [38] proved the following theorem (a generalization of a degree-three version of Birman and Wajnryb [6]).

**THEOREM 1.3.4.** *Let  $p : F \rightarrow B^2$  be a simple branched covering of degree  $d \geq 3$ . Then each  $\varphi \in \mathcal{M}(F)$  is the lifting of a braid.*

To prove this theorem the authors show that every generator of  $\mathcal{M}(F)$  is a lifting, and this suffices since the lifting operation is a homomorphism  $\lambda : \mathcal{L}_p \rightarrow \mathcal{M}(F)$ , where  $\mathcal{L}_p < \mathcal{B}_n$  is the group of liftable braids. The elements of  $\mathcal{L}_p$  are characterized by the following property.

**PROPOSITION 1.3.5.** *A braid  $\beta \in \mathcal{B}_n$  is liftable with respect to  $p$  iff  $\omega_p = \omega_p \circ \beta_*$ , where  $\beta_* : \pi_1(B^2 - B_p) \rightarrow \pi_1(B^2 - B_p)$  is the induced automorphism. In particular, a half-twist  $t_\alpha$  is liftable iff  $p^{-1}(\alpha)$  contains a closed component  $\gamma$ . In this case, the lifting is a Dehn twist around  $\gamma$ .*

In [6] there is a set of generators for  $\mathcal{L}_p$  in degree 3. In [40] Mulazzani and Piergallini provide the generators for  $\mathcal{L}_p$  in any degree. In particular they show that  $\mathcal{L}_p$  is finitely generated by liftable powers of half-twists (if a half-twist  $t_\alpha$  is not liftable, then  $t_\alpha^2$  or  $t_\alpha^3$  is necessarily liftable).

In the proposition above we see that the lifting of a half-twist is a Dehn twist. But if we start from a Dehn twist, then Theorem 1.3.4 gives only a generic braid whose lifting is that Dehn twist. For many reasons is desirable to get a half-twist instead. We will see in Chapter 2 how to realize this, at least for a good class of Dehn twists which are those whose core curve is non-trivial in  $H_1(F)$ .

Note that a geometric braid related to a branched covering  $p : F \rightarrow B^2$  can be colored in  $I \times B^2$ , according to the initial colors of  $A_n \subset \{0\} \times B^2$ , to give a colored geometric braid in  $I \times B^2$ . The resulting branched covering of  $I \times B^2$  is a 3-manifold homeomorphic to  $I \times F$ . According to Proposition 1.3.5 a colored geometric braid is liftable (as homeomorphism) iff the initial and final colors match (*well-colored braid*).

## 1.4 OPEN BOOK DECOMPOSITIONS

Consider a link  $L$  in a 3-manifold  $M$  and suppose that the complement  $M - L$  is a fibre bundle over  $S^1$  s.t. the closure in  $M$  of any fibre is a Seifert surface for  $L$  (so it is a compact connected orientable surface with boundary  $L$ ). Then we say that  $L$  a *fibred link*. Note that not all the fibrations of the complement of  $L$  have the previous property, and a generic fibration may not give a fibred link. In fact the leaves can make multiple windings around the link.

**DEFINITION 1.4.1.** *An open book decomposition for  $M$  is a fibred link  $L$  with a fibration  $g : M - L \rightarrow S^1$  s.t. the closures of the leaves are Seifert surfaces for  $L$ .*

The closure of a leaf is called *page*, and  $L$  is the *binding* of the open book. The local model for an open book at the binding is  $\mathbb{R}^3$  as the union of all the half-planes through the  $z$  axis.

So an open book decomposition determines, up to conjugation and isotopy, a monodromy map  $\varphi : F \rightarrow F$ , where  $F$  is the page. Of course  $\varphi$  is the identity map on  $\text{Bd } F$ , and so its isotopy class stays in  $\mathcal{M}(F, \text{Bd } F)$ . If we orient  $M$ , the fibre  $F$  inherits an orientation compatible with the fibration. In what follows we always assume  $M$  and  $F$  compatibly oriented, and then the monodromy is orientation preserving. The following theorem is due to Alexander [1].

**THEOREM 1.4.2.** *Any closed oriented 3-manifold admits an open book decomposition.*

So the open book decompositions are a tool to present and study 3-manifolds, as showed in the following construction.

Let us consider an orientation preserving homeomorphism  $\varphi \in \mathcal{M}(F, \text{Bd } F)$ , and let

$$T_\varphi = \frac{I \times F}{(1, x) \sim (0, \varphi(x))}$$

be its mapping torus which is fibred over  $S^1$ . Since  $\varphi$  is the identity on  $\text{Bd } F$ , it follows that  $\text{Bd } T_\varphi$  is naturally parametrized by  $S^1 \times \text{Bd } F$  and then it is a disjoint union of tori. That parametrization is realized by the homeomorphism  $h : \text{Bd } T_\varphi \rightarrow S^1 \times \text{Bd } F \subset B^2 \times \text{Bd } F$  with  $h(t, x) = (e^{2\pi it}, y)$  for  $(t, y) \in I \times \text{Bd } F$ . Therefore we can construct a closed oriented 3-manifold

$$M_\varphi = T_\varphi \cup_h (B^2 \times \text{Bd } F)$$

in which we have the fibred link  $L = \{0\} \times \text{Bd } F \subset B^2 \times \text{Bd } F$ . Then  $M_\varphi$  is endowed with an open book decomposition.

In particular the page of  $M_\varphi$  is homeomorphic to  $F$ , and the monodromy is equivalent to  $\varphi$  up to this homeomorphism. Note that  $M_\varphi$  does depend up to orientation preserving homeomorphisms only on the conjugacy class of  $\varphi$  in  $\mathcal{M}(F, \text{Bd } F)$ .

A basic example is the standard open book of  $S^3$ , which is obtained from the decomposition of  $\mathbb{R}^3$  as union of half-planes through the  $z$ -axis by the one point compactification. So each half-plane becomes a disc and the binding becomes an unknotted circle. More precisely  $S^3 = M_{\text{id}}$ , where  $\text{id}$  is the identity map of  $B^2$ . Then this open book corresponds to the genus-one Heegaard splitting of  $S^3$ .

In [17] there is a complete set of moves needed to relate any two open book decompositions of the same 3-manifold.

**OPEN BOOKS AS BRANCHED COVERINGS.** Given an open book with monodromy  $\varphi$  we know from Theorem 1.3.4 that there exists a branched covering  $p : F \rightarrow B^2$  s.t.  $\varphi$  is the lifting of a braid  $\beta$ . The product branched covering  $\text{id} \times p : I \times F \rightarrow I \times B^2$

induces a covering of mapping tori  $\tilde{p} : T(\varphi) \rightarrow T(\beta) \cong I \times B^2$ . After we have filled the boundary we can extend  $\tilde{p}$  with an unbranched covering  $B^2 \times \text{Bd } F \rightarrow B^2 \times S^1$  to get a branched covering  $q : M(\varphi) \rightarrow M(\beta) \cong S^3$ . Since  $q$  has the same degree of  $p$ , we can find a  $q$  of degree  $d = \max(3, n)$ , where  $n = \#$  (boundary components of  $F$ ).

We note that the branching link of  $q$  is a braid around the binding of the standard open book of  $S^3$ . In particular every fibred link in a 3-manifold can be obtained in this way.

On the other hand, given a covering  $q : M \rightarrow S^3$  branched over a link  $L \subset S^3$ , we can change  $L$  into a closed braid  $\hat{\beta}$  by the Alexander's theorem 1.3.3. Then each page of the standard open book of  $S^3$  meets transversely that braid and the open book of  $S^3$  lifts to an open book of  $M$ . The monodromy is the lifting of  $\beta$  (which is liftable since it is well-colored).

In particular the Alexander existence theorem for open books 1.4.2 follows from Theorem 1.2.5. Moreover we can get an open book with connected binding with the first Harer move, see next section and also [17].

## 1.5 LEFSCHETZ FIBRATIONS ON $B^2$

A topological Lefschetz fibration on  $B^2$  is a smooth map  $f : V \rightarrow B^2$  defined on a compact oriented 4-manifold  $V$  s.t. the following hold:

- i) the singular set is finite and mapped injectively to a subset  $A \subset \text{Int } B^2$  (the branching set);
- ii) the restriction  $f|_1 : V - f^{-1}(A) \rightarrow B^2 - A$  is an oriented fibre bundle with fiber a connected surface  $F$ ;
- iii) the monodromy of a meridian of  $A$  is a Dehn twist on  $F$  (not necessarily positive).

So the bundle over a small regular loop around a branching point in  $B^2$  is the mapping torus of a Dehn twist on a curve in  $F$  said *vanishing cycle*.

A Lefschetz fibration is *allowable* if every vanishing cycle is non-zero in  $H_1(F)$ , and it is *positive* if every monodromial Dehn twist is positive.

It turns out that a Lefschetz fibration is determined, up to orientation preserving diffeomorphisms, by the branching set  $A$  and the monodromy homomorphism  $\omega : \pi_1(B^2 - A) \rightarrow \mathcal{M}(F)$ . The unique condition on  $\omega$  is that it must send meridians to Dehn twists. Since  $\pi_1(B^2 - A)$  is freely generated by meridians of  $A$ , if we fix standard generators for a standard  $A$ , we can associate to a finite sequence of Dehn twists  $(\delta_1^{\varepsilon_1}, \dots, \delta_n^{\varepsilon_n})$ ,  $\varepsilon_i = \pm 1$ , a unique class of Lefschetz fibrations with regular fiber  $F$ .

It can be proved that at a singular point  $x_i \in V$  there are suitable local complex coordinates s.t.  $f(z, w) = zw$  (a suitable complex coordinate in the target is understood). Moreover if  $x_i$  is positive (resp. negative) these coordinates are orientation preserving (resp. reversing). We also note that a singular fiber can be obtained from  $F$  by cutting it along a curve and capping the two new boundaries components with two discs meeting transversely at their centers. Such a curve is indeed a vanishing cycle and these oriented discs intersect positively (resp. negatively) if the singular point is positive (resp. negative).

Then a Lefschetz fibration is a complex Morse function and it induces a handlebody decomposition on  $V$ . Now we describe explicitly this handlebody structure.

First note that the local model at a singular point  $(z, w) \mapsto zw$  is equivalent, up to a linear changing of complex coordinates, to the map  $(z, w) = z^2 + w^2$ . The real part is then  $(x_1, y_1, x_2, y_2) \mapsto x_1^2 - y_1^2 + x_2^2 - y_2^2$ , where  $z = x_1 + iy_1$  and  $w = x_2 + iy_2$ . It follows that a singular point of  $f$  is an index 2 singular point of the real Morse function  $\text{Re } f$ , and so it corresponds to a 2-handle.

Suppose that  $\text{Bd } F \neq \emptyset$ . Consider a splitting complex of the branching set made of  $n$  disjoint arcs, and take a regular neighborhood  $U$  of it. Over  $\text{Cl}(B^2 - U) \cong B^2$  we have a trivial fibre bundle  $F \times B^2$  which is  $B^4 \cup 1$ -handles, since  $F \cong B^2 \cup 1$ -handles.

If we add  $U$  we get 2-handles  $H_1^2, \dots, H_n^2$ , and looking at the real local model above we see that the core and the cocore are respectively  $i\mathbb{R}^2$  and  $\mathbb{R}^2 \subset \mathbb{C}^2$ . Therefore the framing, which is the linking number of the core and belt spheres  $iS^1 \subset i\mathbb{R}^2$  and  $S^1 \subset \mathbb{R}^2$ , is  $-1$  if the corresponding singular point is *positive*, since the orientation given by the direct sum  $i\mathbb{R}^2 \oplus \mathbb{R}^2$  is opposite with respect to the natural orientation of  $\mathbb{C}^2$  (which, as we know, is equal to the orientation of the 4-manifold).

Otherwise, if the singular point is negative the framing is  $+1$ , because the orientation of  $i\mathbb{R} \oplus \mathbb{R}$  coincides with that of the 4-manifold. This framing can be computed with respect to the fiber, and the attaching curve can be identified with a vanishing cycle.

A typical Kirby diagram for a Lefschetz fibration on  $B^2$  with bounded fiber is depicted in Figure 1.8. Two intersecting curves can be taken into parallel copies of  $F \subset F \times B^2$ , in the same order as they appear in the monodromy sequence, and this gives a condition on the overpasses: two curves meet in the same order at every overpass in  $F$ . Vice versa a Kirby diagram relative to a surface  $F \subset \mathbb{R}^3$ , with a 1-handle for each 1-handle of  $F$ , and 2-handles attached along curves contained into parallel copies of  $F$  in  $\mathbb{R}^3$  with framings  $\pm 1$  with respect to  $F$ , represents a Lefschetz fibration with fiber  $F$  and monodromies given by Dehn twists (positive or negative) around the attaching curves of the 2-handles, taken in the order given by the overpasses.

It would be interesting to develop a Kirby calculus for Lefschetz fibrations. For instance if we add a 1-handle to the surface and also add a monodromy Dehn twist along a curve which goes once across that 1-handle, we obtain a new Lefschetz fibration which represent the same 4-manifold because in the Kirby diagram we simply add a cancelling pair of 4-dimensional 1- and 2-handles (in the boundary open book, see below, this corresponds to the first Harer move). In particular if there is a Lefschetz fibration with bounded fiber  $f : V \rightarrow B^2$  then there is also a Lefschetz fibration whose regular fiber has connected boundary. Moreover this operation can be realized by preserving the positiveness.



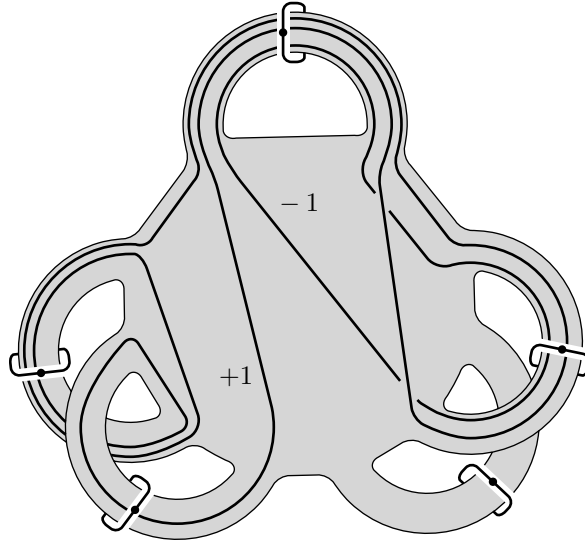

FIGURE 1.8.

If the fiber is a closed surface, the previous construction can be repeated with respect to the 4-manifold  $F \times B^2$ . In this case the Kirby diagram has another 2-handle  $D \times B^2$  which corresponds to a 2-handle of the fiber  $D \subset F$ . That 2-handle is attached along  $\text{Bd } D \subset \text{Cl}(F - D) \times B^2 \cong B^4 \cup 1\text{-handles}$  with framing 0 with respect to  $F$ .

In particular, for any Lefschetz fibration  $f : V \rightarrow B^2$  with fiber  $F$  and  $n$  branching points we have

$$\chi(V) = \chi(F) + n.$$

In Corollary 2.1.3 we will see that a Lefschetz fibration can be represented as a covering of  $B^2 \times B^2$  branched over a 2-dimensional braid. Moreover that braided surface is positive iff the Lefschetz fibration is positive too, see also [32].

**LEFSCHETZ FIBRATIONS AND OPEN BOOKS.** Let  $f : V \rightarrow B^2$  be a Lefschetz fibration with bounded regular fiber  $F$ . The 3-manifold  $M = \text{Bd } V$  can be decomposed as  $M = f^{-1}(S^1) \cup L \times B^2$ , where  $L = \text{Bd } F \cong \sqcup S^1$  and  $L \times B^2$  is given by the union of

the boundaries of all the fibers (this is in fact an  $L$ -bundle over  $B^2$  and then it is trivial).

The fibration  $f|_V : f^{-1}(S^1) \rightarrow S^1$  can be extended up to  $L \times (B^2 - \{0\})$  by first projecting onto  $B^2 - \{0\}$  and then to  $S^1$  in the obvious way. Then the link  $\text{Bd } f^{-1}(0) \subset M$  is fibered and we get an open book decomposition of  $M$ . Therefore a Lefschetz fibration  $f$  on  $V$  with bounded fiber induces an open book on  $M$  whose monodromy is the composition of all the monodromy Dehn twists of  $f$ , taken in the right order (the total monodromy of  $f$ ).

On the other hand an open book decomposition of a 3-manifold can be filled by a Lefschetz fibration with the same fiber and monodromy any sequence of Dehn twists whose product gives the monodromy of the open book.

Therefore there is a strong relation between: Lefschetz fibrations, branched coverings of  $B^2 \times B^2$ , 2-dimensional braids (as branching surfaces), open books, branched coverings of  $S^3$ , and braids (both as branching sets and liftable homeomorphisms).

# CHAPTER 2

## DEHN TWISTS AND BRANCHED COVERS

In this chapter we will show that any homologically non-trivial Dehn twist of a compact surface  $F$  with boundary, is the lifting of a half-twist in the braid group  $\mathcal{B}_n$ , with respect to a suitable branched covering  $p : F \rightarrow B^2$ . As a consequence, any allowable Lefschetz fibration on  $B^2$ , with bounded fiber, is a branched covering of  $B^2 \times B^2$ . The results of this chapter appear as a preprint in [51].

### 2.1 REPRESENTATION THEOREM

Let  $F$  be a compact, connected, oriented surface with boundary, and  $p : F \rightarrow B^2$  a simple branched covering of degree  $d$  with  $n$  branching points. If  $d \geq 3$ , then each element  $h$  in the mapping class group  $\mathcal{M}(F)$  is the lifting of a braid  $k \in \mathcal{B}_n$  [38]. So we have a commutative diagram

$$\begin{array}{ccc} F & \xrightarrow{h} & F \\ p \downarrow & & \downarrow p \\ B^2 & \xrightarrow[k]{} & B^2 \end{array}$$

Since  $\mathcal{M}(F)$  is generated by Dehn twists it is natural and interesting to get a braid  $k$  in some special form whose lift is a given Dehn twist  $h$ .

The aim of this chapter is to show that  $k$  can be chosen as a half-twist in  $\mathcal{B}_n$ , under the further assumptions that  $h$  is homologically non-trivial and by allowing the covering to be changed by stabilizations. More precisely we prove the following:

**THEOREM 2.1.1 (REPRESENTATION THEOREM).** *Let  $p : F \rightarrow B^2$  be a simple branched covering and  $\gamma \subset F$  be a closed curve. The Dehn twist  $t_\gamma$  along  $\gamma$  is the lifting of a half-twist in  $\mathcal{B}_n$ , up to stabilizations of  $p$ , iff  $[\gamma] \neq 0$  in  $H_1(F)$ .*

Actually, the proof of this theorem provides us with an effective algorithm based on suitable and well-understood moves on the diagram of  $\gamma$ , namely the labelled projection of  $\gamma$  in  $B^2$ , allowing us to determine the stabilizations needed and the half-twist whose lifting is  $t_\gamma$ .

Roughly speaking the proof goes as follows. As the first step, by stabilizing the covering, we eliminate the self-intersections of the diagram of  $\gamma$  without changing its isotopy class in  $F$ . Then we get a diagram which can be changed to one whose interior contains exactly two branch points of  $p$ . Then the proof is completed by the simple observation that the half-twist around an arc joining these two points and lying on the interior of the diagram lifts to the prescribed Dehn twist  $t_\gamma$ . The theorem is proved in Section 2.3. The next two corollaries are proved immediately, by assuming Theorem 2.1.1.

Two curves  $\gamma_1$  and  $\gamma_2$  in  $F$  are said to be equivalent if there is a diffeomorphism  $g : F \rightarrow F$ , fixing the boundary pointwise, such that  $g(\gamma_1) = \gamma_2$ . If each of  $\gamma_1$  and  $\gamma_2$  does not disconnect, then they are equivalent, see chapter 12 of [31]. Otherwise, they are equivalent iff their complements are diffeomorphic (of course that diffeomorphism must be the identity on the boundary). This implies that the set of equivalence classes is finite.

**COROLLARY 2.1.2.** *For any compact oriented surface  $F$  there exists a simple branched covering  $p_F : F \rightarrow B^2$ , such that any Dehn twist along a homologically non-trivial curve is the lifting of a half-twist with respect to  $p_F$ .*

*Proof.* Let  $\{\gamma_1, \dots, \gamma_m\}$  be a complete set of homologically non-trivial representatives of the previously defined equivalence classes.

We now construct a sequence of branched coverings, by induction. Start from a simple branched covering  $p_0 : F \rightarrow B^2$  of degree at least 3, and let  $p_i$ , for  $i = 1, \dots, m$ , be the branched covering obtained from  $p_{i-1}$  by Theorem 2.1.1 (and its proof), applied to  $t_{\gamma_i}$ . Therefore,  $t_{\gamma_i}$  is the lifting of a half-twist  $u_i$ , with respect to  $p_i$ . Since  $p_i$  is obtained from  $p_{i-1}$  by stabilizations, it follows that  $u_k$ , for  $k < i$ , still lifts to  $t_{\gamma_k}$ , with respect to  $p_i$  (the obvious embedding  $\mathcal{B}_{n_k} \hookrightarrow \mathcal{B}_{n_i}$  is understood). Then each  $t_{\gamma_i}$  is the lifting of the corresponding  $u_i$  with respect to  $p_m$ , and let  $p_F = p_m$ .

Any other Dehn twist  $t$ , along a homologically non-trivial curve, is conjugated to some  $t_{\gamma_i}$ , so  $t = g t_{\gamma_i} g^{-1}$ , for some  $g \in \mathcal{M}(F)$ . Since  $\deg(p_F) \geq 3$ , it follows that  $g$  is the lifting of a braid  $k \in \mathcal{B}_n$ , see [38]. Observing that the conjugated of a half-twist is also a half-twist, it follows that  $t$  is the lifting, with respect to  $p_F$ , of the half-twist  $k u_i k^{-1}$ .  $\square$

Another important consequence is the following corollary, which is an improvement of Proposition 2 of Loi and Piergallini [32]. They state and prove that proposition in the case where the Lefschetz fibration has fiber with connected boundary.

**COROLLARY 2.1.3.** *Let  $V$  be a 4-manifold, and  $f : V \rightarrow B^2$  be a Lefschetz fibration with regular fiber  $F$ , whose boundary is non-empty and not necessarily connected. Assume that any vanishing cycle is homologically non-trivial in  $F$ . Then there is a simple covering  $q : V \rightarrow B^2 \times B^2$ , branched over a braided surface, such that  $f = \pi_1 \circ q$ , where  $\pi_1$  is the projection on the first factor  $B^2$ .*

*Proof.*  $f$  is determined, up to isotopy, by the regular fiber and the monodromy sequence  $(t_1^{\varepsilon_1}, \dots, t_n^{\varepsilon_n})$ , where  $t_i$  is a Dehn twist along a homologically non-trivial curve, and  $\varepsilon_i = \pm 1$ .

Let  $p_F$  be the branched covering of Corollary 2.1.2. Then each  $t_i$  is the lifting, with respect to  $p_F$ , of a half-twist  $u_i$ .

We are then in the same situation of the proof of Proposition 2 in [32] to which we refer to complete the proof.  $\square$

Lefschetz fibrations with bounded fibers occur for instance when considering Lefschetz pencils on closed 4-manifolds, such as those arising in symplectic geometry, and discovered by Donaldson [10]. In fact, given a Lefschetz pencil, we can remove a 4-ball around each base point (those at which the fibration is not defined) to obtain a Lefschetz fibration on  $S^2$  whose fiber is a surface with possibly disconnected boundary.

The chapter is organized as follows. In the next section we present the diagrams of curves, their moves and some lemmas needed to get the Representation Theorem 2.1.1, which is then proved in Section 2.3. Finally, we state some remarks, and give some open problem.

In what follows, all manifolds are assumed to be smooth, compact, connected, oriented, and all maps proper and smooth, if not differently stated. Also, when considering mutually intersecting (immersed) submanifolds, we generally assume that the intersection is transverse.

## 2.2 DIAGRAMS AND MOVES

Let us consider a simple branched covering map  $p : F \rightarrow B^2$  of degree  $d \geq 2$  and a closed connected curve  $\gamma \subset \text{Int } F$ . By choosing a splitting complex  $K$ , we can speak about the sheets of  $p$ , labelled by the set  $\{1, \dots, d\}$ . These are the connected components of  $p^{-1}(B^2 - K)$ .

If not differently stated, the splitting complexes we refer to, are disjoint unions of arcs which connect  $B_p$  with  $\text{Bd } B^2$ . Of course,  $p$  can be presented by the splitting complex, to each arc of which is attached a transposition which is the monodromy of a loop going around to that arc. To be more precise we have to specify a base point  $*$  to compute  $\pi_1(B^2 - B_p, *)$ . In the chapter we represent  $B^2$  by a rectangle, and it is understood that the base

point is chosen in the lower horizontal edge. This makes sense, because the choice of the base point is made in a contractible subset of  $B^2 - B_p$ , so the fundamental group is uniquely determined.

Generically, the map  $p| : \gamma \rightarrow B^2$  is an immersion, and its image  $C = p(\gamma) \subset B^2 - B_p$  has only transverse double points as singularities. By labelling an open arc in  $C$ , disjoint from the splitting complex, with a number in  $\{1, \dots, d\}$ , we can recover  $\gamma$  as the unique lifting of  $C$  starting from the sheet specified by the label. We call the labelled immersed curve  $C$  a *diagram* of  $\gamma$ , and it represents also the twist  $t_\gamma$ . Note that the labelling can be uniquely extended to each component of  $C - K$ . At singular points of  $C$ , there are two different labels assigned to the intersecting arcs.

**REMARK 2.2.1.** *The diagram of the lifting of a half-twist  $u_\alpha$ , is the boundary of a regular neighborhood of  $\alpha$  in  $B^2 - (B_p - \alpha)$ .*

It is not hard to show that two diagrams of the same Dehn twist are related by the local moves  $\mathcal{T}_1, \mathcal{T}_2, \mathcal{T}_3$  and  $\mathcal{T}_4$  of Figure 2.1, their inverses, and isotopy in  $B^2 - B_p$  ( $i, j$  and  $k$  in that figure are pairwise distinct). In fact the moves correspond to critical levels of the projection in  $B^2$  of a generic isotopy of a curve in  $F$ . In  $\mathcal{T}_1$  the isotopy goes through a singular point of  $p$ , while in  $\mathcal{T}_2$  it goes through a pseudo-singular point. For a 3-dimensional analogue of the moves cf. Mulazzanti and Piergallini [39].

To be more explicit, we will use also the moves  $\mathcal{R}_1$  and  $\mathcal{R}_2$  of Figure 2.1, which represent the so called *labelled isotopy*. In this way, the diagrams of isotopic curves in  $F$  are related by moves  $\mathcal{T}_i, \mathcal{R}_i$  and isotopy in  $B^2$  leaving  $K$  invariant. Of course, only the moves  $\mathcal{T}_i$  change the topology of the diagram (rel  $B_p$ ).

**CLASSIFICATION OF MOVES.** By considering the action of the moves on a diagram  $C$ , we get the following classification of them. The moves  $\mathcal{T}_2, \mathcal{R}_1$ , and  $\mathcal{R}_2$  represent isotopy of  $C$  in  $B^2$ , liftable to isotopy of  $\gamma$  in  $F$ . The previous ones with  $\mathcal{T}_3$  and  $\mathcal{T}_4$

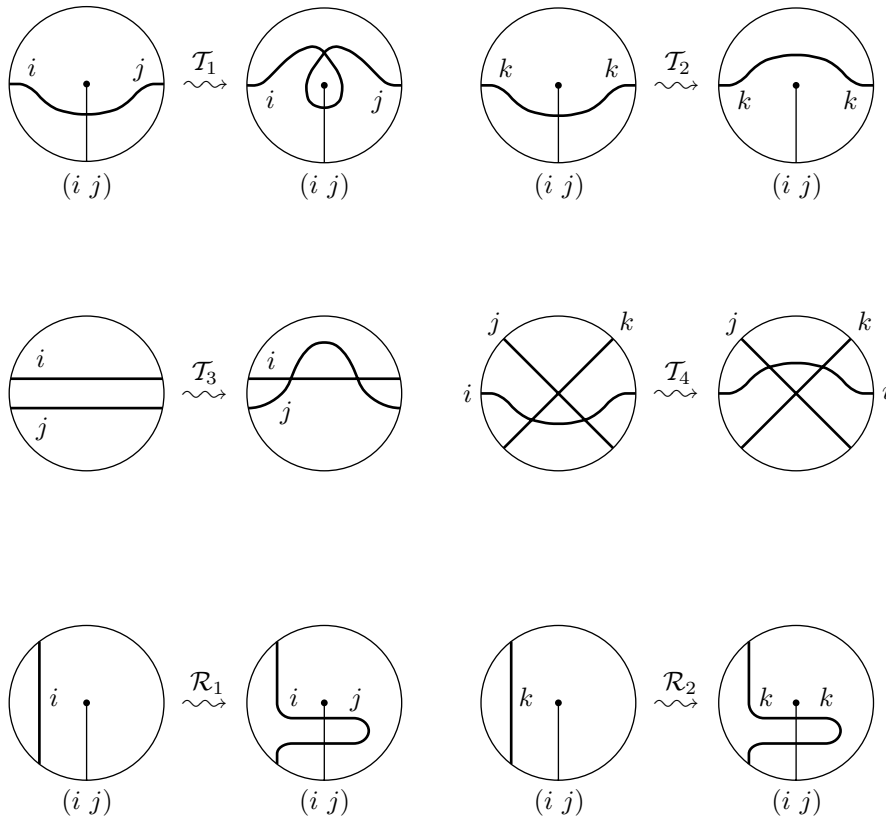

FIGURE 2.1.

give regular homotopy of  $C$  in  $B^2$ , liftable to isotopy. Finally, all the moves give homotopy in  $B^2$  liftable to isotopy. Moreover, the unlabelled versions of the moves give us respectively isotopy, regular homotopy, and homotopy in  $B^2$ . In Section 2.3 we will see how to realise a homotopy in  $B^2$  as a homotopy liftable to isotopy, by the addition of trivial sheets. We will use the argument to transform a singular diagram into a regular one.

**DEFINITION 2.2.2.** *Two subsets  $J, L \subset B^2$  are said to be separated iff there exists a properly embedded arc  $a \subset B^2 - (J \cup L)$ , such that  $\text{Cl } J$  and  $\text{Cl } L$  are contained in different components of  $B^2 - a$ .*



NOTATIONS. For a diagram  $C$ , a non-singular point  $y \in C - K$ , and a set  $D \subset B^2$ :

- $\lambda(y)$  is the label of  $y$ ;
- $\text{Sing}(C)$  is the set of singular points of  $C$ ;
- $\sigma(C) = \# \text{Sing}(C)$ ;
- $\beta(D) = \#(B_p \cap D)$ .

LEMMA 2.2.3. *Let  $p : F \rightarrow B^2$  be a simple connected branched covering, and  $x, y \in \text{Bd } F$  with  $p(x) \neq p(y)$ . There exists a properly embedded arc  $a \subset F$  such that  $\text{Bd } a = \{x, y\}$  and  $p|_a$  is one to one.*

*Proof.* We choose the splitting complex  $K$  in such a way that  $p(x)$  and  $p(y)$  are the end points of an arc in  $S^1$  disjoint from  $K$ . By our convention,  $K = a_1 \sqcup \dots \sqcup a_n$ , where the  $a_j$ 's are arcs. If we remove a regular open neighborhood of a suitable subset  $a_{i_1} \sqcup \dots \sqcup a_{i_{n-d+1}}$ , we obtain a new branched covering  $p' : B^2 \rightarrow B^2$ , which is contained in  $p$ .

By the well known classification of simple branched coverings  $B^2 \rightarrow B^2$  (see for instance [40]), we can assume that the monodromies are  $(1\ 2), \dots, (d-1\ d)$  as in Figure 2.2 (where only the relevant part is depicted). Look at the same figure to get the required arc, where  $i$  and  $j$  are the leaves at which  $x$  and  $y$  stay.  $\square$

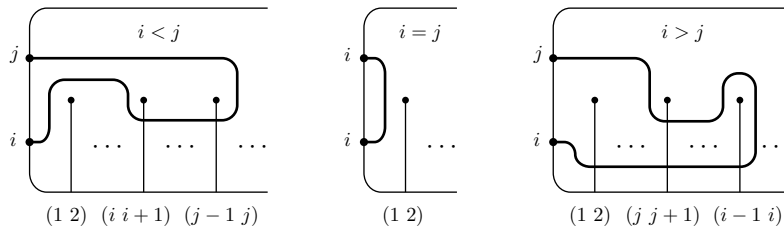

FIGURE 2.2.

### 2.3 PROOF OF THEOREM 2.1.1

Let us consider a diagram  $C \subset B^2$  of a closed simple curve  $\gamma \subset F$ . We first deal with the ‘only if’ part, which is immediate, then the rest of the section is dedicated to the ‘if’ part.

‘ONLY IF’. If we start from a half-twist  $u_\alpha$  whose lifting is the given Dehn twist  $t_\gamma$ , we can easily get a proper arc  $\beta \subset B^2$  which transversely meets  $\alpha$  in a single point. Then a suitable lifting of  $\beta$  gives an arc  $\tilde{\beta} \subset F$  which intersects  $\gamma$  in a single point. It follows that the homological intersection of  $[\gamma] \in H_1(F)$  with  $[\tilde{\beta}] \in H_1(F, \text{Bd } F)$  is non-trivial in  $H_0(F) \cong \mathbb{Z}$  (orientations may be chosen arbitrarily). So we have  $[\gamma] \neq 0$  in  $H_1(F)$ .

GETTING THE HALF-TWIST. Let us prove the ‘if’ part. We will consider three cases. In the first one, we deal with a non-singular diagram, and we will get the half-twist with a single stabilization. In the subsequent cases we will progressively adapt that argument to arbitrary diagrams.

CASE 1. Suppose that  $\sigma(C) = 0$ , which means that  $C$  is a Jordan curve in  $B^2$ .

In the example of Figure 2.3 we have only a particular case, but this is useful to give a concrete illustration of our method.

Let  $D$  be the disc in  $B^2$  bounded by  $C$ . If  $D$  contains exactly two branching points, then the component of the preimage of  $D$  containing  $\gamma$ , is a tubular neighborhood of  $\gamma$  itself, and the half-twist we are looking for is precisely that around an arc in  $D$  joining the two branching points, see Remark 2.2.1. Otherwise, if there are more branching points, so  $\beta(D) > 2$ , then we will reduce them (of course  $\beta(D)$  cannot be less than two, because  $[\gamma] \neq 0$ ).

So let us suppose  $\beta(D) > 2$ . We can also assume  $\beta(D)$  minimal up to moves  $\mathcal{T}_2$  (look at the pseudo-singular points in the preimage  $p^{-1}(D)$  in order to get the paths suitable for moves  $\mathcal{T}_2$ ).

Let  $s$  be an arc with an end point  $a \in C$  and the other, say it  $b$ , is in the exterior of  $C$ , such that  $s \cap D$  is an arc determining a

subdisc of  $D$  which contains exactly one branching point. Now, by extending the label  $\lambda(a)$  inherited from  $C$  to all of  $s$ , we get a label  $l = \lambda(b)$ . The assumptions above imply that the label of  $s$  at  $\text{Int } s \cap C$  is different from that of  $C$ , see Figure 2.3 (a).

We can now stabilize the covering by the addition of the branching point  $b$  with monodromy  $(l \ d + 1)$ . With a move  $\mathcal{T}_2$  along  $s$  the curve  $C$  goes through  $b$  as in Figure 2.3 (b), so the new branching point goes to the interior of the diagram.

Now we isotope  $C$  along  $s$  starting from  $a$ . As we approach to  $b$ , the label of  $C$  becomes  $l$  (1 in the example) because the labels of  $C$  and  $s$  coincide during the isotopy (they are subject to the same permutation of  $\{1, \dots, d\}$ ). Then we can turn around the branching point  $b$  to get an arc of  $C$  with label  $d + 1$  (we have to turn in the direction determined by the component of  $D - (s \cup k_b)$  containing the branching points we have to eliminate, where  $k_b$  is the new splitting arc relative to  $b$ ).

In fact we can now eliminate from  $D$  the exceeding branching points as in Figure 2.3 (c) by some subsequent applications of move  $\mathcal{T}_2$ . We obtain a diagram containing only two branching points in its interior, and then we get the half-twist as said above. In the example we get the half-twist around the thick arc in Figure 2.3 (d).

**CASE 2.** Suppose that  $\sigma(C) \geq 1$  and that for each point  $\tilde{a} \in \gamma$ , there is a proper embedded arc  $\tilde{s} \subset F$ , such that  $\tilde{s} \cap \gamma = \{\tilde{a}\}$  (the intersection is understood to be transverse), and that  $p|_{\tilde{s}}$  is one to one on both the subarcs  $\tilde{s}_1$  and  $\tilde{s}_2$  determined by  $\tilde{a}$  (so  $\tilde{s}_i$ 's are the closures of  $\tilde{s} - \tilde{a}$ ). Then, said  $s$ ,  $s_1$  and  $s_2$  respectively the images of  $\tilde{s}$ ,  $\tilde{s}_1$  and  $\tilde{s}_2$ , we have that the  $s_i$ 's are embedded arcs in  $B^2$ , and that the point  $a = p(\tilde{a})$  is the only one at which  $C$  and  $s$  intersect with the same label. Let us fix such an arc.

Consider a disc  $D \subset B^2$  such that  $a \in \text{Bd } D \subset C$  and  $\text{Int } D \cap C = \emptyset$ . Such a disc is an  $n$ -gone, where  $n = \#(\text{Sing}(C) \cap D)$ . Then one of the two subarcs of  $s$ , say  $s_1$ , is going inside  $D$  at  $a$  (so  $D \cap s_1$  is a neighborhood of  $a$  in  $s_1$ ). The disc  $D$  may contains branching points but, as we see later, we need a disc without them. The next two lemmas give us a way to get outside of  $D$

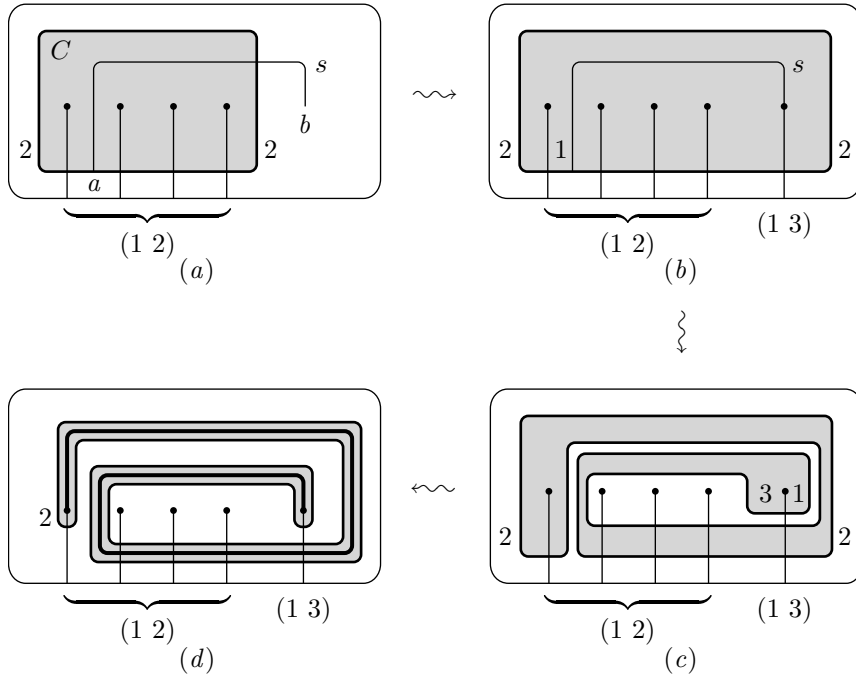

FIGURE 2.3.

these branching points. Now we assume that  $\beta(D) \geq 1$ , otherwise we leave  $C$  and  $s$  unchanged.

**LEMMA 2.3.1.** *If  $\beta(D)$  is minimal with respect to moves  $\mathcal{T}_2$ , then, starting from  $s_1$ , we can construct an arc  $s'_1$  with the same labelled end points of  $s_1$ , such that  $s'_1 \cap D$  is an arc.*

*Proof.* Let us start by proving the following claim: each component of the surface  $S = p^{-1}(D)$  cannot intersect simultaneously  $\gamma$  and the pseudo-singular set of  $p$ .

In fact, by the contrary, let  $S_1$  be such a connected component. Consider an arc in  $S_1$  which projects homeomorphically to an arc  $r$ , and which connects  $\gamma \cap S_1$  with a pseudo-singular point in  $S_1$ . Then we can use  $r$  to make a move  $\mathcal{T}_2$  along it. In this way we reduce  $\beta(D)$ , which is impossible by the minimality hypothesis, and so the claim must be true.

Now, let  $S_0$  be the connected component of  $S$  containing the point  $\tilde{a} = p^{-1}(a) \cap \gamma$ . So  $S_0 \cap \gamma \neq \emptyset$ , and then any other component of  $S$  cannot contain singular points of  $p$ , because to such a singular point would correspond a pseudo-singular point in  $S_0$ , which cannot exist by the claim.

It follows that the other components of  $S$  are discs projecting homeomorphically by  $p$ . Then the singular set of  $p|_S$ , which is not empty, since we are assuming  $\beta(D) > 0$ , is contained in  $S_0$ . This implies that any component of  $S - S_0$  contains pseudo-singular points (corresponding to singular points in  $S_0$ ). Therefore, by the claim, we have  $\gamma \cap S = \gamma \cap S_0$ .

Now, we can assume that the intersection between the lifting of  $s_1$  and  $S_0$  is connected. Otherwise, by Lemma 2.2.3 we can remove a subarc of  $s_1$  and replace it with a different one whose lifting is contained in  $S_0$ , to get a connected intersection.

Moreover, up to labelled isotopy we can also assume that the lifting of  $s_1$  does not meet the trivial components of  $S$ . We need some care in doing this, since we want as result an embedded arc in  $B^2$ . But this can be done, as depicted in Figure 2.4.

In that figure, the part of  $s_1$  coming from  $S_0$  is a well-behaved arc with respect to  $D$ , while the part of  $s_1$  coming from  $S - S_0$  is a set of disjoint arcs, possibly intersecting the previous one. The homotopy, liftable to isotopy, of  $s_1$  follows firstly the arc coming from  $S_0$  up to the point  $a$ , and then it simply sends outside  $D$  each arc coming from  $S - S_0$ .

The result of the operations above is an embedded arc  $s'_1$  whose intersection with  $D$  is connected.  $\square$

**REMARK 2.3.2.** *Note that in the previous lemma, the arcs  $s_1$  and  $\tilde{s}_1$  are not modified up to isotopy. Moreover, the proof depends only on the minimality of  $D$  up to moves  $\mathcal{T}_2$ , and the argument is localized only on  $D$ , apart from the rest of  $C$ .*

Let us push the end points  $b_1$  and  $b_2$  of  $s$  inside  $B^2$ , and let  $l_i = \lambda(b_i)$ . We need these two points later, when we use them as new branching points in a stabilization of  $p$ . The labels  $l_i$  become part of the monodromy transpositions.

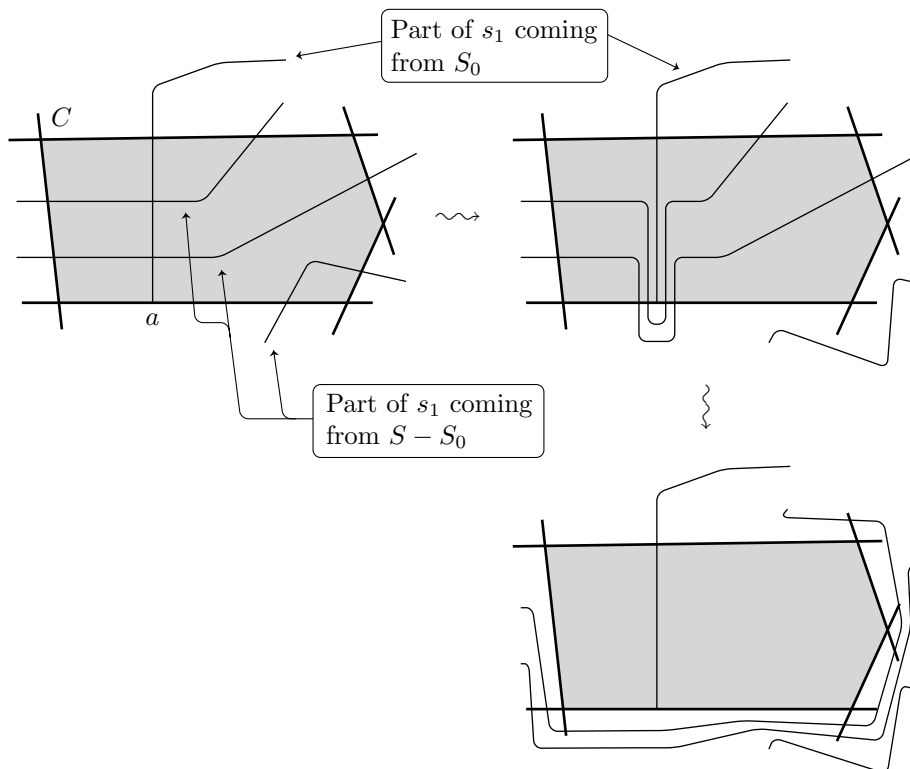

FIGURE 2.4.

LEMMA 2.3.3. *Up to stabilizations of  $p$ , we can find a diagram  $C'$ , obtained from  $C$  by liftable isotopy in  $B^2$ , such that the disc  $D'$ , corresponding to  $D$  through that isotopy, has  $\beta(D') = 1$  if  $D$  is a 1-gone, or  $\beta(D') = 0$  otherwise.*

*Proof.* We can assume that  $\beta(D)$  is minimal up to moves  $\mathcal{T}_2$ . If  $\beta(D) = 0$ , there is nothing to prove. If  $\beta(D) \geq 1$  consider the arc  $s'_1$  given by Lemma 2.3.1. The disc  $D$  is divided into two subdiscs  $D_1$  and  $D_2$  by  $s'_1$ , and suppose that  $D_1$  contains branching points. Let  $p_1$  be the stabilization of  $p$  given by the addition of a branching point at  $b_1$ , the free end of  $s'_1$ , with monodromy  $(l_1 d + 1)$ , where as said above  $l_1 = \lambda(b_1)$ , see Figure 2.5.

Now we use  $s'_1$  to isotope  $C$ , by an isotopy with support in a small regular neighborhood  $U$  of  $s'_1$ . Any arc in  $U \cap C$ , not

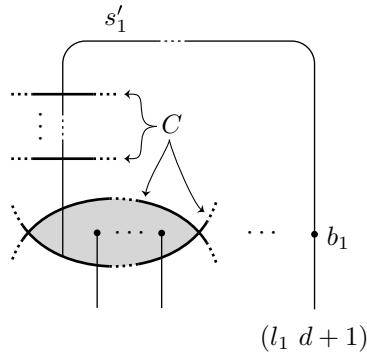

FIGURE 2.5.

containing  $a$ , meets  $s'_1$  with different label, so these arcs can be isotoped beyond  $b_1$  by move  $\mathcal{T}_2$ . The small arc of  $C$  containing  $a$  is isotoped in a different way, as in Figure 2.6 and in Figure 2.7, where  $s'_1$  is not showed.

So, this arc starts from  $D_2$ , goes up to  $b_1$ , turns around it and then goes back up to  $D_1$  (in Figure 2.5  $D_1$  is at the right of  $s'_1$ , while  $D_2$  is at its left). Since  $C$  and  $s'_1$  have the same label at  $a$ , they remain with the same label during the isotopy. Therefore the arc of  $C$  we are considering, arrives at  $b_1$  with label  $l_1$ , and so it goes back with label  $d + 1$ .

Then this arc arrives in  $D_1$  with label  $d + 1$ , as in Figure 2.8, and it can wind all the branching points by moves  $\mathcal{T}_2$ , since all of these have monodromies  $(i \ j)$  with  $i, j \leq d$ . The result is that the branching points in  $D_1$  go outside. Note that  $b_1$  is now inside  $D$ .

Moreover, if there is a singular point of  $C$  in the boundary of  $D_1$ , then we can get  $b_1$  outside  $D_1$  by a move  $\mathcal{T}_2$  as in Figure 2.9. This move is applied to a small arc found after the first singular point of  $C$  we get following the diagram from the point  $a$  along  $\text{Bd } D$ . That arc, isotoped up to  $b_1$ , takes a label different from  $l_1$  and  $d + 1$  and so the move  $\mathcal{T}_2$  does apply.

Now we have to remove the branching points in  $D_2$  (in the isotoped disc, of course). If  $\beta(D_2) > 0$  (after the  $\mathcal{T}_2$ -reduction) we need another stabilization. So, consider an arc  $s''_1$  obtained

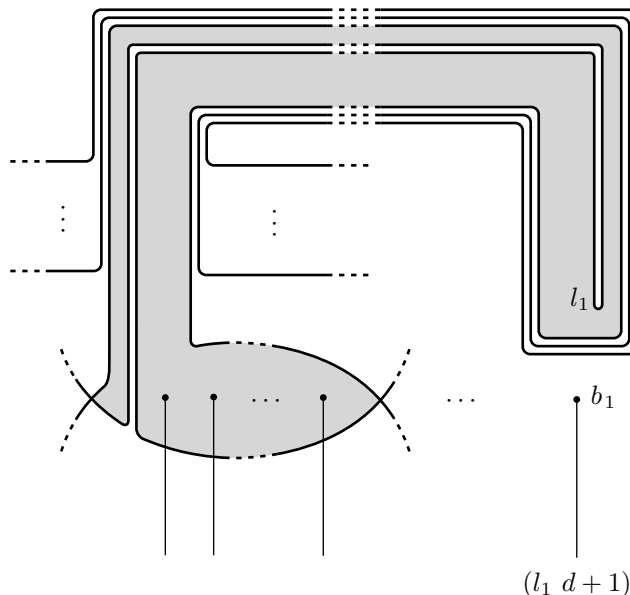

FIGURE 2.6.

from  $s'_1$ , as in Figure 2.10. Then we add a new branching point  $b_3$ , at the free end of  $s''_1$ , with monodromy  $(l_1 d + 2)$ .

We can now repeat the same argument above, to send outside the branching points of  $D_2$ , by using  $s''_1$  instead of  $s'_1$ . After that,  $b_3$  turns out to be inside  $D_2$ , and, as above, it can be sent outside if there are singular points of  $C$  in  $\text{Bd } D_2$ . Of course, at least one of the  $D_i$ 's contains singular points of the diagram, so at the end we get a disc with at most one branching point inside. If  $D$  is a 1-gone we end the proof, since in this case  $\beta(D) > 0$ .

Otherwise, if  $D$  is not a 1-gone, then we possibly need another stabilization, as in Figure 2.11. Here we consider a triangle, which is sufficient for our purposes, but the argument does work even for  $n$ -gons, with  $n \geq 3$ . If  $n = 2$  then we can arrange without stabilization by a move  $\mathcal{T}_2$  as in Figure 2.12. So, in any case we obtain a new diagram  $C'$  and a disc  $D'$  which satisfy the required properties.  $\square$

Note that in the proof we do not use the point  $b_2$ . But in principle this point can be used to stabilise the covering, if the



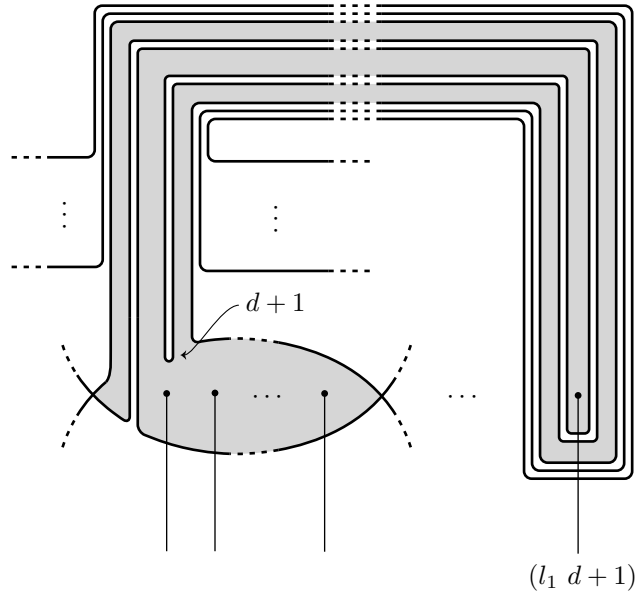

FIGURE 2.7.

arc needed to make the construction is  $s_2$ . In the following we apply Lemma 2.3.3 to each region containing branching points, and we will possibly use each of the  $s_i$ 's.

REMARK 2.3.4. *Note that Lemma 2.3.3 holds also if  $C$  is the diagram of a non-singular arc in  $F$ . This observation will be useful when considering the general case below.*

Now, we will proceed in the proof of Theorem 2.1.1. The idea is to reduce to Case 1, so we have to eliminate the double points of  $C$ .

Every generic immersion  $S^1 \looparrowright B^2$  is clearly homotopic to an embedding. Such homotopy can be realized as the composition of a finite sequence of the moves  $\mathcal{H}_1^{\pm 1}$ ,  $\mathcal{H}_3^{\pm 1}$ , and  $\mathcal{H}_4$  of Figure 2.14, and ambient isotopy in  $B^2$  (note that  $\mathcal{H}_4^{-1}$  coincides with  $\mathcal{H}_4$ ). These moves are the unlabelled versions of  $\mathcal{T}_1$ ,  $\mathcal{T}_3$ , and  $\mathcal{T}_4$  of Figure 2.1.

So, to conclude the proof in this case, it is sufficient to show that, up to stabilizations of  $p$ , each move  $\mathcal{H}_i^{\pm 1}$  can be realized

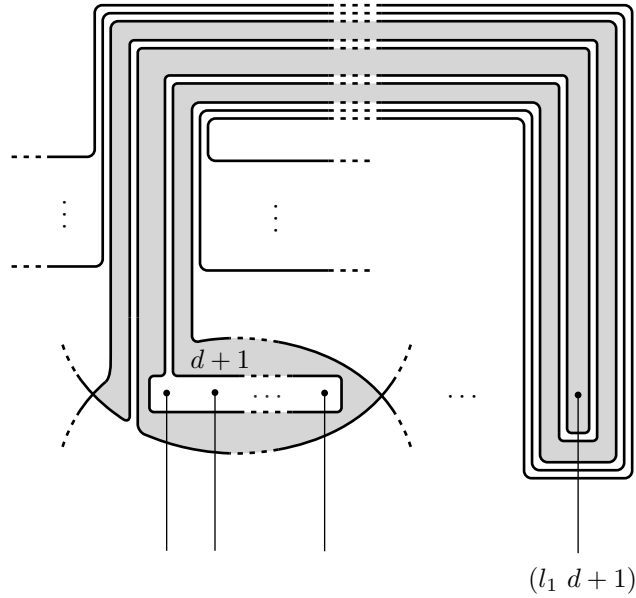

FIGURE 2.8.

in a liftable way. Actually, as we will see, the move  $\mathcal{H}_1^{-1}$  is not really needed, then we do not give a liftable realization of that.

It follows that a suitable generic homotopy from a singular diagram to a regular one, can be realized as a homotopy liftable to isotopy. Of course, also the ambient isotopy in  $B^2$  must be liftable, but this turns out to be implicit in the argument we are going to give.

In the preimage of  $\text{Sing}(C)$ , take an innermost pair of corresponding points, to get a disc  $D \subset B^2$  as the gray one in Figure 2.13, which is a 1-gone whose interior possibly intersects  $C$ , but does not contain other 1-gones.

Now, up to regular homotopy in  $B^2$ , we can make  $D$  smaller, in order to get a clean 1-gone, meaning that it does not meet other arcs of  $C$ . Of course, this can be done by the moves  $\mathcal{H}_3^{\pm 1}$  and  $\mathcal{H}_4$  of Figure 2.14, and ambient isotopy.

The application of the moves  $\mathcal{H}_3^{-1}$  and  $\mathcal{H}_4$  is obstructed by the branching points. By the Lemma 2.3.3, we get an isotopic diagram, with a region free of branching points. So we can realize

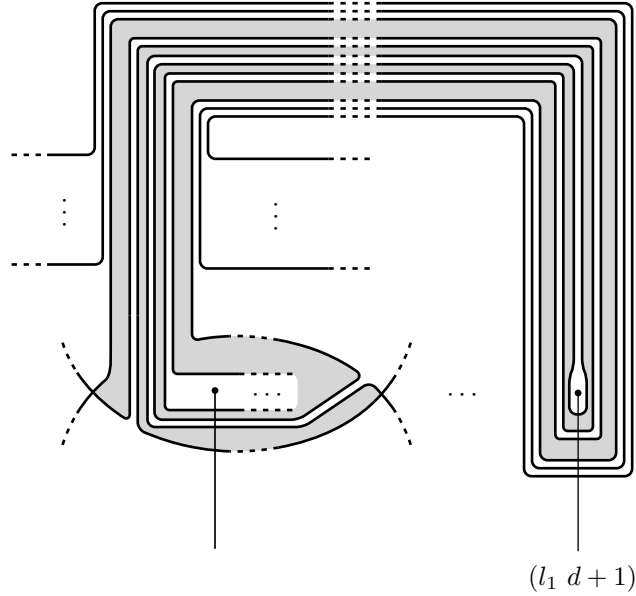

FIGURE 2.9.

$\mathcal{H}_3^{-1}$  and  $\mathcal{H}_4$  as the corresponding liftable versions  $\mathcal{T}_3^{-1}$  and  $\mathcal{T}_4$ , by this lemma applied to the corresponding 2 or 3-gone. Note that, after the application of Lemma 2.3.3, the labels involved in the 2 or 3-gone are, up to labelled isotopy, the right ones needed by  $\mathcal{T}_i$  moves, because the new diagram represents a curve isotopic to  $\gamma$  in  $F$ .

For move  $\mathcal{H}_3$ , we have troubles if the two arcs involved have the same label. In this case, we first apply an argument similar to that in the proof of Lemma 2.3.3, in order to get an arc with label  $d + 1$  in the relevant region, and then the prescribed move  $\mathcal{H}_3$  becomes equivalent to a  $\mathcal{T}_3$  and labelled isotopy.

After the cleaning operation of the 1-gone  $D$ , its interior turns out to be disjoint from  $C$ , and then it can be eliminated by the  $\mathcal{H}_1$  move. After another application of Lemma 2.3.3, we get a 1-gone with a single branching point inside. Then the move  $\mathcal{H}_1$  can be realized as a move  $\mathcal{T}_1^{-1}$ , obtaining a diagram with fewer 1-gones. In this way we can proceed by induction on the number of 1-gones, in order to eliminate the self-intersections of

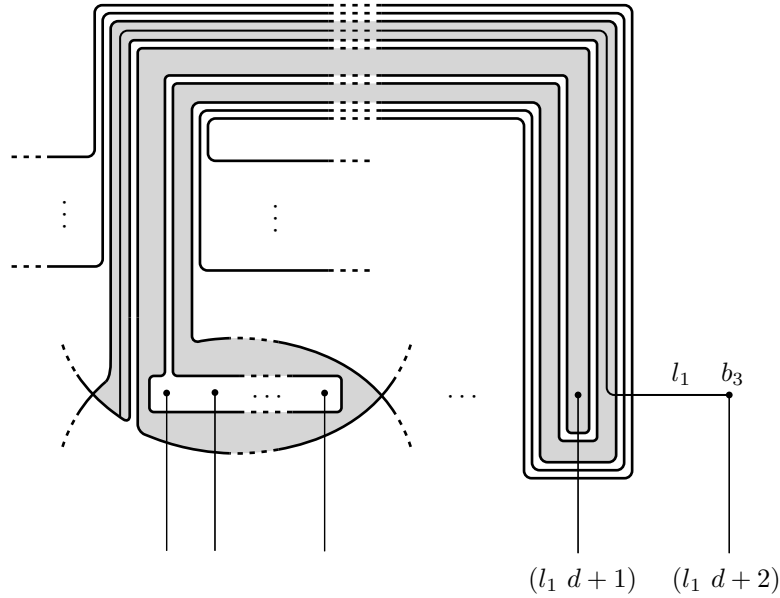

FIGURE 2.10.

the diagram, without using the move  $\mathcal{H}_1^{-1}$  at all. This concludes the proof in this case.

**GENERAL CASE.** We finally show how to treat the case when the subarcs  $s_1$  and  $s_2$  are not embedded.

Since  $\gamma$  is homologically non-trivial in  $F$ , there exists a properly embedded arc  $\tilde{s} \subset F$ , which meets  $\gamma$  in a given single point. Let us put  $s = p(\tilde{s})$ , and let  $s_1$  and  $s_2$  be the subarcs as above. If the  $s_i$ 's are singular, then we change them to embedded arcs by an argument similar to that of Case 2.

The idea is to treat  $s$  as a singular diagram and to remove the singular points by the reduction process we applied to  $C$  in Case 2. So we need the analogous of the arc  $s$  used above. As we see in Figure 2.15 that analogous is a subarc of  $s$  itself, shifted slightly and labelled in the same way.

In that figure we consider only the part of the arc relevant for the stabilization process (the part we have said  $s_1$  above). So, we start from the first 1-gone of  $s_1$  (or  $s_2$ ) that can be reached

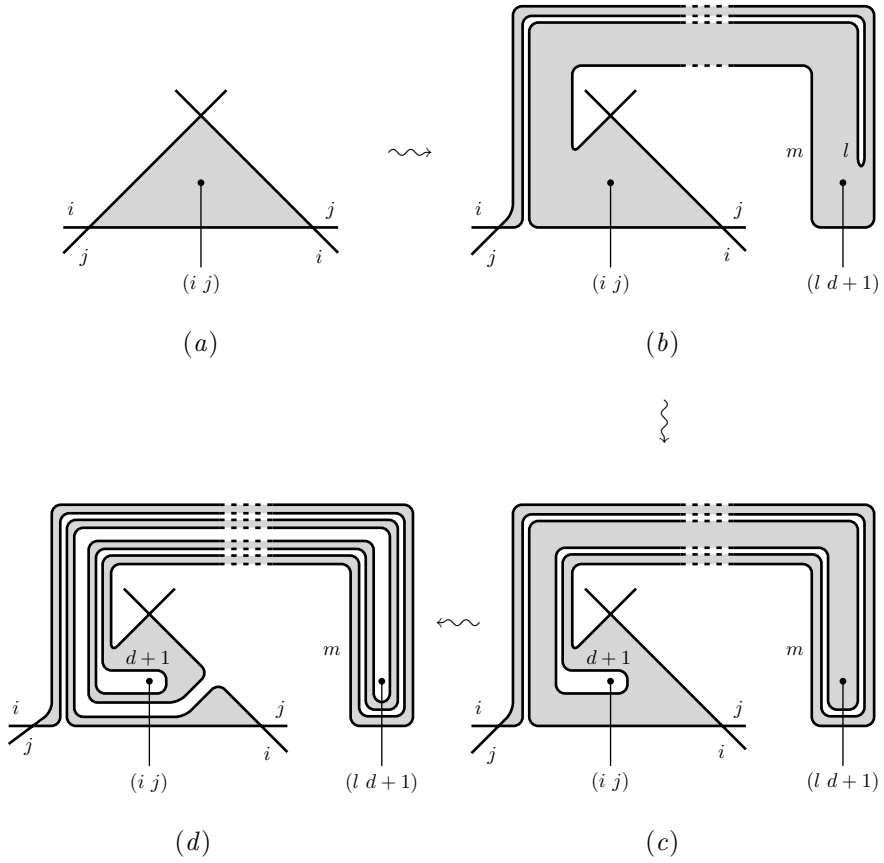

FIGURE 2.11.

from an end point, and repeat the same argument we apply to  $C$  in Case 2. In this way we get an immersed arc  $s$ , with  $s_1$  and  $s_2$  embedded.

So, for a given move  $\mathcal{H}_i$  of  $C$ , as in Case 2, we can choose a nice arc  $s$ , after some stabilizations of  $p$ , to represent that move as a move  $\mathcal{T}_i$ , then in a liftable way. This does suffice to complete the proof of Theorem 2.1.1.  $\square$

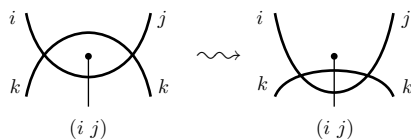

FIGURE 2.12.

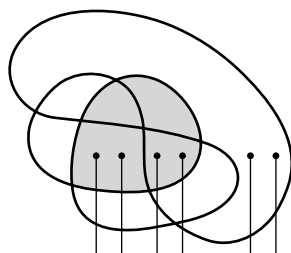

FIGURE 2.13.

## 2.4 FINAL REMARKS AND OPEN QUESTIONS

In the general case above, we cannot modify  $s$  by simply sliding its singular points outside  $B^2$ , and then cutting it and removing the useless components, because in this way we possibly get other intersections with  $C$  (with the same labels). But of course, in some special case this argument can work, and so with it we avoid some stabilizations.

Note that the number of stabilizations in the proof of Theorem 2.1.1, is at most three times the number of components of  $B^2 - C$ . Of course, the algorithm can be optimized to reduce the number of stabilizations.

**REMARK 2.4.1.** *The stabilizations in the statement of Theorem 2.1.1 are needed in most cases. Without them any Dehn twist is still the lifting of a braid, but in general not of a half-twist, as the next example shows.*

In fact, consider the covering  $p : F \rightarrow B^2$  of Figure 2.16, where  $F$  is a torus with two boundary components, one of these turning twice and the other once over  $S^1$ , and  $\gamma$  is a curve parallel to the boundary component of degree two. Since  $\deg(p) = 3$ ,  $t_\gamma$  is the lifting of a braid [38].

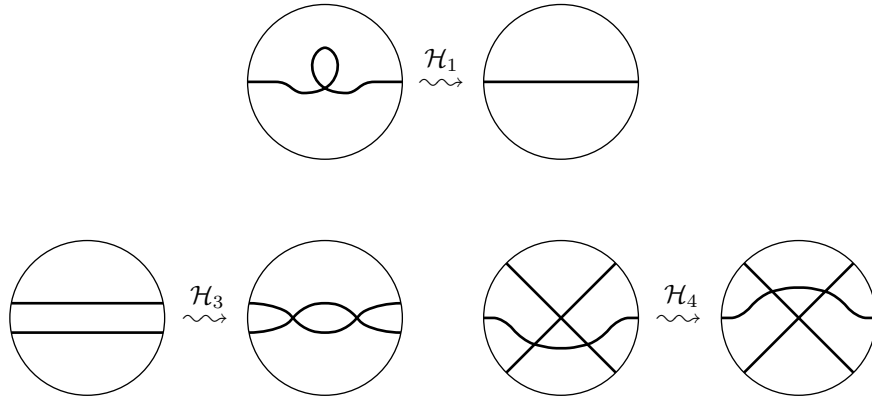

FIGURE 2.14.

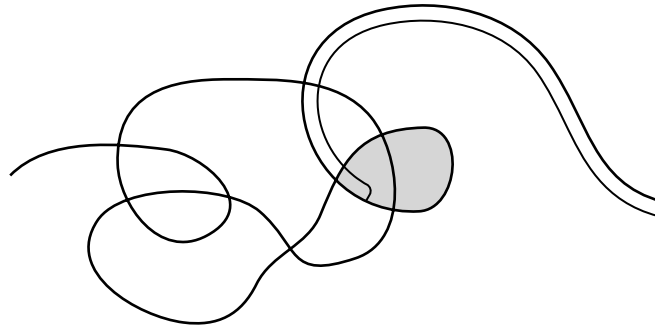

FIGURE 2.15.

If there is a half-twist representing  $t_\gamma$  with respect to  $p$ , then  $\gamma$  is isotopic to a curve  $\gamma'$  whose diagram  $C'$  is as in Remark 2.2.1, so as that depicted in the example of Figure 2.17. Then  $C' = p(\gamma')$  bounds a disc  $D$  containing two branching points.

Let  $H = \text{Cl}(B^2 - D)$ , and consider the branched covering  $p|_1 : p^{-1}(H) \rightarrow H$ . Observe that  $p^{-1}(D) = A \sqcup D'$ , where  $A$  is an annulus parallel to  $\text{Bd } F$  and  $D'$  is a trivial disc. Then  $\text{Cl}(F - A) = F' \sqcup A'$ , with  $F' \cong F$  and  $A' \cong A$ .

The disc  $D'$  is contained either in  $F'$  or in  $A'$ . But  $D' \subset F'$  is excluded, because this would imply that the covering  $p|_1 : A' \rightarrow H$  has degree two over a boundary component of  $H$ , and one over the other, which is impossible. So we have  $D' \subset A'$ , which implies

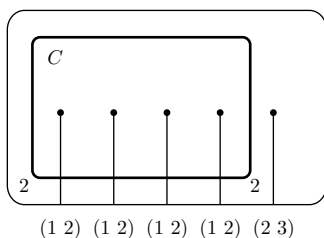

FIGURE 2.16.

that  $p^{-1}(H) \cong F' \sqcup S_{0,3}$ , where  $S_{0,3}$  is a genus 0 surface with three boundary components. It follows that  $p|_H$  has degree two on  $S_{0,3}$ , and one on  $F'$ . Then  $p|_H : F' \rightarrow H$  is a homeomorphism, which is impossible. The contradiction shows that  $\gamma$  cannot be represented as a half-twist.

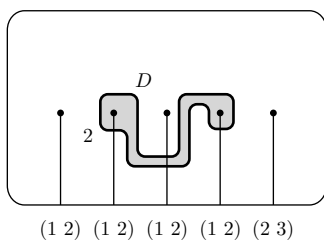

FIGURE 2.17.

**REMARK 2.4.2.** *If  $\text{Bd } F$  is connected, in Corollary 2.1.2 we can assume  $\deg(p) = 3$ . In fact in this case  $m = 1$ , and the result is well known.*

**REMARK 2.4.3.** *The branched covering  $q$  of Corollary 2.1.3 is deduced from the unique covering of Corollary 2.1.2. If we need an optimization on the degree, or even an effective construction, we can get  $q : V \rightarrow B^2 \times B^2$  starting from the vanishing cycles of  $f$ , and inductively applying the Representation Theorem 2.1.1 to them, avoiding to represent every class of curves as in Corollary 2.1.2 and to get the conjugating braid.*

For a homologically trivial curve  $\gamma \subset F$  it could exist a branched covering  $p : F \rightarrow B^2$  s.t.  $p(\gamma)$  is a non-singular



curve covered twice by  $\gamma$  and once by the other components of  $p^{-1}(p(\gamma))$ .

We conclude with some open questions.

**QUESTION 2.4.4.** *Given homologically non-trivial curves  $\gamma_1, \dots, \gamma_n \subset F$ , find a branched covering  $p : F \rightarrow B^2$  of minimal degree, respect to which  $t_{\gamma_i}$  is the lifting of a half-twist  $\forall i$ . In particular, determine  $p_F$  of minimal degree to optimize Corollary 2.1.2.*

**QUESTION 2.4.5.** *Given a branched covering  $p : F \rightarrow B^2$ , and a homologically non-trivial curve  $\gamma \subset F$ , understand if  $t_\gamma$  is the lifting of a half-twist with respect to  $p$ .*

In [8] Bobtcheva and Piergallini obtain a complete set of moves relating any two simple branched coverings of  $B^4$  representing 2-equivalent 4-dimensional 2-handlebodies (see also the Preface). In the light of Corollary 2.1.3, the Bobtcheva and Piergallini theorems can be useful in order to answer to the following question.

**QUESTION 2.4.6.** *Find a complete set of moves relating any two Lefschetz fibrations  $f_1, f_2 : V \rightarrow B^2$ .*



# CHAPTER 3

## UNIVERSAL SURFACE

In this chapter we construct an orientable ribbon surface in  $B^4$  s.t. any 2-handlebody of dimension four is a covering of  $B^4$  branched over that surface (which is said universal). The technique is a symmetrization process which starts from a suitable simple branched covering of  $B^4$ . The content of the chapter is a joint work with Riccardo Piergallini and has been published in [44].

### 3.1 INTRODUCTION

In the early seventies H.M. Hilden, U. Hirsch and J.M. Montesinos independently proved that any closed orientable 3-manifold can be represented as a 3-fold simple covering of  $S^3$  branched over a knot (cf. [28], [23] and [33]).

Ten years later, W. Thurston constructed the first universal link. He called a link  $L \subset S^3$  universal iff for any closed orientable 3-manifold there exists an  $n$ -fold (in general non-simple) covering  $M \rightarrow S^3$  branched over  $L$ . Subsequently, other universal links and knots were constructed by H.M. Hilden, M.T. Lozano, J.M. Montesinos and W.C. Whitten. The basic idea of these constructions is the following: symmetrize the branching links given by the Hilden-Hirsch-Montesinos representation theorem, making them sublinks of the preimage of a fixed link with

respect to a fixed branched covering  $S^3 \rightarrow S^3$  (cf. [48], [25], [24], [26], [22] and [36]).

More recently, M. Iori and R. Piergallini obtained a representation theorem of closed orientable smooth 4-manifolds as 5-fold simple covering of  $S^4$  branched over a smooth surface (cf. [43] and [29]). Then, it makes sense to look for a universal surface in  $S^4$ , satisfying a universal property analogous to that one of a universal link in the 3-dimensional case. But unfortunately, the symmetrization technique used for branching links in  $S^3$  seems hardly to be directly adaptable to branching surfaces in  $S^4$ .

In this chapter, we show how certain ribbon branching surfaces in  $B^4$  can be symmetrized, in order to get a universal orientable ribbon surface, for representing any compact bounded orientable 4-manifold  $M \cong B^4 \cup 1\text{-handles} \cup 2\text{-handles}$  as a branched cover of  $B^4$ . Such 4-manifolds turn out to be relevant for the presentation of all the closed orientable smooth 4-manifolds, making no difference how 3- and 4-handles are attached to them (cf. [30]). Hence, our result could be also useful in constructing a universal surface in  $S^4$ . Namely, we prove the following theorem.

**THEOREM 3.1.1.** *There exists an orientable ribbon surface  $F \subset B^4$ , such that any compact orientable 4-dimensional 2-handlebody is a cover of  $B^4$  branched over  $F$ .*

The chapter is entirely devoted to prove the theorem above. In particular, the symmetrization procedure is described in Section 3.4 and the universal surface  $F$  is depicted in Figure 3.26. Sections 3.3 and 3.2 are respectively aimed to show that any 4-manifold  $M$  as in the statement is a simple covering of  $B^4$  branched over a suitable ribbon surface and to introduce the covering moves needed for symmetrizing such a ribbon branching surface.

### 3.2 SOME COVERING MOVES

By a *covering move*, we mean any modification on a labelled surface determining a branched covering  $p : M \rightarrow B^4$ , that preserves the covering manifold  $M$  up to diffeomorphism. All the covering moves considered in this chapter are *local*, that is the modification takes place inside a cell and can be performed whatever is the rest of labelled branching surface outside. In the figures describing these moves, we will draw only the part of the labelled branching surface inside the relevant cell, assuming everything else to be fixed.

Of course, the notion of covering move makes sense for coverings between PL manifolds of any dimension  $m$  branched over arbitrary  $(m - 2)$ -dimensional subcomplexes of the range. Before of defining our moves, we roughly state two very general equivalence principles in this broader context and discuss some applications to our specific situation. Several special cases of these principles already appeared in the literature and we can think of them as belonging to the “folklore” of branched coverings.

**DISJOINT MONODROMIES CROSSING.** *Subcomplexes of the branching set of a covering that are labelled with disjoint permutations can be isotoped independently from each other without changing the covering manifold.*

The reason why this principle holds is quite simple. Namely, being the labelling of the considered subcomplexes disjoint, the sheets non-trivially involved by them do not interact, at least locally over the region where the isotopy take place. Hence, relative position of such subcomplexes is not relevant in determining the covering manifold.

In particular, this principle allows crossing changes in diagrams when the involved monodromies are disjoint. For example, this is the case of one of the well-known Montesinos moves (cf. [37], [43], [2] or [8]) for simple coverings of  $S^3$  branched over a link. Such crossing change has already been used in the construction of universal links (cf. [24] and [22]). In the same spirit, we specialize the above principle in our 4-dimensional context, by

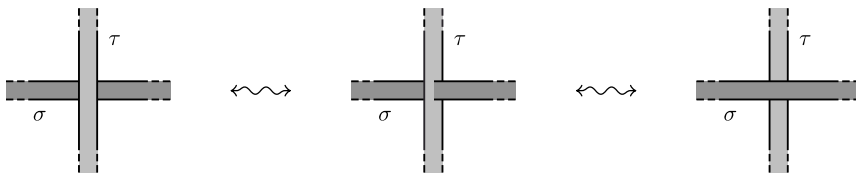

FIGURE 3.1.

considering the crossing change move described in Figure 3.1, where  $\sigma, \tau \in \Sigma_d$  are arbitrary disjoint permutations.

It is worth observing that, abandoning transversality, the disjoint monodromies crossing principle also gives the special case of the next one when the  $\sigma_i$ 's are disjoint and  $L$  is empty.

**COHERENT MONODROMIES MERGING.** *Let  $p : M \rightarrow N$  be any branched covering with branching set  $B_p$  and let  $\pi : E \rightarrow K$  be a connected disk bundle embedded in  $N$ , in such a way that: 1) there exists a (possibly empty) subcomplex  $L \subset K$  for which  $B_p \cap \pi^{-1}(L) = L$  and the restriction of  $\pi$  to  $B_p \cap \pi^{-1}(K - L)$  is an unbranched covering of  $K - L$ ; 2) the monodromies  $\sigma_1, \dots, \sigma_n$  relative to a fundamental system  $\omega_1, \dots, \omega_n$  for the restriction of  $p$  over a given disk  $D = \pi^{-1}(x)$ , with  $x \in K - L$ , are coherent in the sense that  $p^{-1}(D)$  is a disjoint union of disks. Then, by contracting the bundle  $E$  fiberwise to  $K$ , we get a new branched covering  $p' : M \rightarrow N$ , whose branching set  $B_{p'}$  is equivalent to  $B_p$ , except for the replacement of  $B_p \cap \pi^{-1}(K - L)$  by  $K - L$ , with the labelling uniquely defined by letting the monodromy of the meridian  $\omega = \omega_1 \dots \omega_n$  be  $\sigma = \sigma_1 \dots \sigma_n$ .*

We remark that, by connection and property 1), the coherence condition required in 2) actually holds for any  $x \in K$ . Then, we can prove that  $p$  and  $p'$  have the same covering manifold, by a straightforward fiberwise application of the Alexander's trick to the components of the bundle  $\pi \circ p : p^{-1}(E) \rightarrow K$ . A coherence criterion can be immediately derived from Section 1 of [40].

We will mainly apply the merging principle to “parallel” components of the branching surface with coherent monodromies, in order to control the number of such components

(cf. the below discussion of stabilization and Figures 3.5, 3.7, 3.8, 3.10).

However, this principle originated from a classical perturbation argument in algebraic geometry and appeared in the literature as a way to deform non-simple coverings between surfaces into simple ones, by going in the opposite direction from  $p'$  to  $p$  (cf. [4]). In dimension 3, it can be used in this direction, not only for achieving simplicity (cf. [8] or [18]), but also for removing singularities from the branching set (cf. [8]). Moreover, it has been used in the construction of universal links, for controlling the branching indices (cf. [22]).

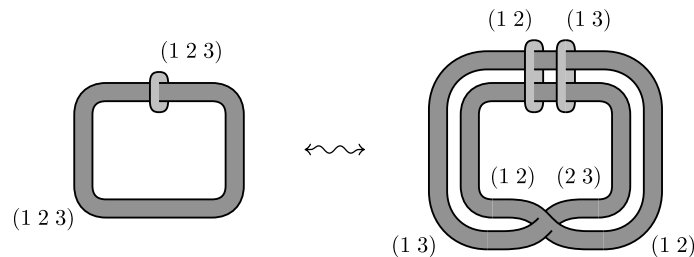

FIGURE 3.2.

Figure 3.2 shows an example of application of the merging principle to coverings of  $B^4$  branched over ribbon surfaces. Here, the absolute version (with  $L = \emptyset$ ) of the principle is applied in turn to both the components of the branching surface on the left side (letting  $K$  be a component and  $\pi : E \rightarrow K$  be its normal bundle). There is no obstruction to generalize this example, to show that any covering of  $B^4$  branched over a ribbon surface can be deformed into a simple one. For applications of the relative version of the principle (in both directions) see Figures 3.5 and 3.8.

Now, we pass to define our moves on labelled ribbon surfaces representing branched coverings of  $B^4$ . Concerning the assumptions on the monodromies, the definitions are given on a level of generality which is not the highest possible, but is still higher than needed for our present purposes. We made this choice because such moves are interesting in their own right. In the next

section we will use only stabilization and Moves 3 and 4. Moves 1 and 2 are used here to get the other ones. Let us start with some considerations about the well-known notion of stabilization.

**STABILIZATION.** The basic version consists in the addition of an extra trivial sheet, the  $(d+1)$ -th one, to a given  $d$ -fold branched covering. In terms of branching surface, this means to add a separate trivial disk with label  $(i\ d+1)$ , where  $1 \leq i \leq d$ . Now, we can iterate this process  $l$  times, by adding  $l$  trivial disks with labels  $(i_1\ d+1), \dots, (i_l\ d+1)$ , where  $1 \leq i_j \leq d+j-1$ . Of course, we can assume the disks to be parallel and it is easy to realize that their monodromies are coherent, whatever  $i_j$ 's we choose. Hence, we can merge all the disks into one. In particular, if all the  $i_j$ 's are distinct, the label of this disk is given by the product of  $l$  disjoint transposition  $(i_1\ d+1) \dots (i_l\ d+1)$ . We will refer to the addition of such a labelled disk as the *multi-stabilization* involving the sheets  $i_1, \dots, i_l$ .

**MOVE 1.** This move is described in Figure 3.3, where  $j_1, \dots, j_l$  and  $k_1, \dots, k_l$  are assumed to be all distinct (cf. [22] and [29] for the case of  $l = 1$ ). It can be obtained by a straightforward application of the main technique of [29], that is by extending the covering in the left side of the figure to certain cancelling 1- and 2- handles added to  $M$  and  $B^4$ , in such a way that the branching surface becomes as in the right side.



FIGURE 3.3.

Namely, we add to  $B^4$  a 1-handle  $H^1$ , connecting two small 3-balls around the tips of the tongues in the left side of the figure, and then a 2-handle  $H^2$  complementary to  $H^1$ , whose attaching loop  $\lambda$  meets  $B^4$  along a horizontal line avoiding the tongues. The covering instructions can be extended to these handles, by



assigning to  $\lambda$  the monodromy  $(j_1 k_1) \dots (j_l k_l)$  and by completing the branching surface with the cocore disk of  $H^2$  labelled with the same monodromy of  $\lambda$ . After cancelling  $H^1$  and  $H^2$ , the new branching surface and monodromy look like in the right side of Figure 3.3. We leave to the reader to check that, in the new covering manifold, there are  $d-l$  1-handles over  $H^1$  and the same number of 2-handle over  $H^2$  and that they cancel (non-trivially) to give back  $M$  again.

We remark that Move 1 could also be derived from the special case when  $l = 1$ , with an inductive argument analogous to the one used below for Move 3.

MOVE 2. Our second move is given by Figure 3.4. Here, the  $\sigma$  in the left side is any permutation in  $\Sigma_d$ , while the  $\sigma$  in the right side is the same permutation thought in  $\Sigma_{d'}$ , for a certain  $d' > d$ , and  $\rho \in \Sigma_{d'}$  is a product of disjoint transpositions which depends on  $\sigma$ . Differently from the previous one, this move changes the degree of the covering. In fact, we can transform the left side of Figure 3.4 into the right one, by performing a suitable multi-stabilization followed by a generalized version of our first move. Let  $\sigma = \gamma_1 \dots \gamma_h$  a decomposition of the given permutation  $\sigma$  into disjoint cycles. For the sake of exposition, we proceed by induction on  $h$ .

If  $h = 1$  we can write  $\sigma = (i j_1 \dots j_l)$ . In this case, we perform on the covering represented by the diagram on the left side of Figure 3.4 a multi-stabilization involving the sheets  $j_1, \dots, j_l$ . As a result, one trivial disk with label  $\rho = (j_1 d+1) \dots (j_l d+l)$  appears in the diagram. We stretch one of the two tongues to pass through such disk, so that its monodromy beyond it becomes  $\sigma^\rho = \rho^{-1}\sigma\rho = (i d+1 \dots d+l)$ . At this point, Move 1 immediately gives the diagram on the right side of the figure.



FIGURE 3.4.

The case of  $h > 1$  can be reduced to the inductive hypothesis by means of crossing changes and merging principle, as shown in Figure 3.5. Here,  $\sigma' = \gamma_1 \dots \gamma_{h-1}$ ,  $\sigma'' = \gamma_h$ ,  $\rho'$  (resp.  $\rho''$ ) is the product of disjoint transpositions resulting from applications of Move 1 to the tongues labelled with  $\sigma'$  (resp.  $\sigma''$ ), and  $\rho = \rho' \rho''$ . Starting from (a), we apply in sequence: merging principle to get (b); inductive hypothesis to get (c); crossing changes to get (d); merging principle again to get (e).

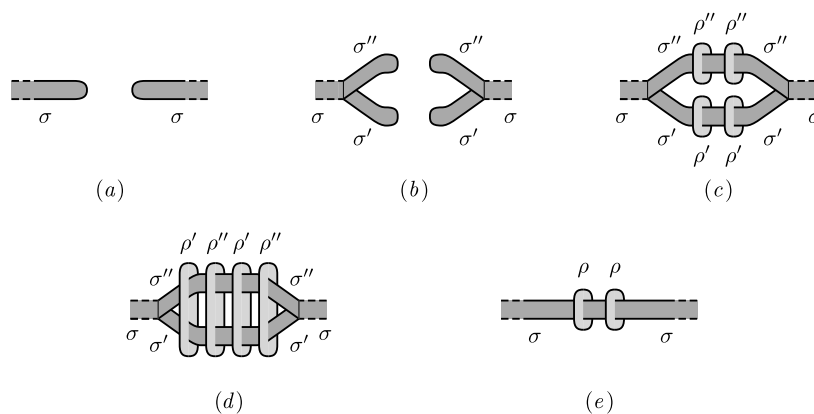

FIGURE 3.5.

MOVE 3. Our third move is the one of Figure 3.6, where the permutations  $\sigma$  and  $\rho$ , as well as covering degrees, are the same of Figure 3.4. We can limit ourselves to consider the case when  $\sigma$  is a cycle, since the general case can be derived by induction on the length of a cyclic decomposition of  $\sigma$ , with the same argument used for Move 2 (think of Figure 3.8 below, as if it were labelled analogously to Figure 3.5).



FIGURE 3.6.

So, we assume  $\sigma = (i \ j_1 \ \dots \ j_l)$  and proceed by induction on  $l$ . Figure 3.7 shows how to deal with the case of  $l = 1$ , when  $\sigma = (i \ j_1)$  and  $\rho = (j_1 \ d+1)$ . We observe that diagrams (c) and (d) represent isotopic surfaces, and same holds for diagrams (e), (f) and (g). Moreover: (b) is a stabilization of (a); (c) and (i) are obtained from the previous diagrams by Move 2 and its inverse; (e) and (h) by crossing changes. The inductive step is described in Figure 3.8. Here, the sequence of operations needed to get the various diagrams is the same of Figure 3.5.

MOVE 4. Differently from the previous ones, this move is defined only for simple monodromies, but it does not preserve simplicity. It is depicted in Figure 3.9, where  $\tau_1, \tau_2 \in \Sigma_d$  are arbitrary distinct transpositions and  $\tau_3 = \tau_1^{\tau_2} = \tau_2^{-1}\tau_1\tau_2$ , while each  $\rho_j$  is a product of two disjoint transpositions which depend on the  $\tau_i$ 's.

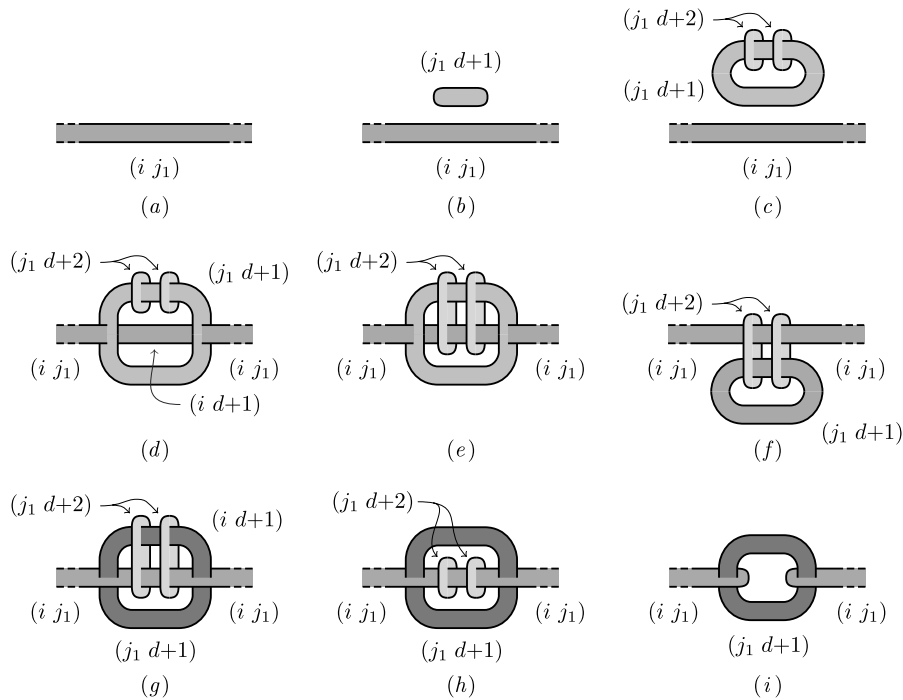

FIGURE 3.7.

The following Figure 3.10 tells us why this is a true covering move if  $\tau_1$  and  $\tau_2$  are not disjoint. Here, (b) and (c) are obtained by Move 3 (followed by isotopy in the former step), (d) by crossing change, and (e) by merging principle. We leave to the reader to adapt the monodromies of Figure 3.10 to the easier case of  $\tau_1$  and  $\tau_2$  disjoint.

### 3.3 SPECIAL COVERING PRESENTATIONS

Given a compact bounded orientable 4-manifold  $M$  as in the statement of our theorem, that is  $M \cong B^4 \cup 1\text{-handles} \cup 2\text{-handles}$ , we want to present it as a simple covering of  $B^4$  branched over a suitable orientable ribbon surface.

By Montesinos [34], we know that  $M$  is a 3-fold simple cover of  $B^4$  branched over a possibly non-orientable ribbon surface  $F \subset B^4$ . A variation of the Montesinos's argument actually shows that  $F$  can be chosen orientable. Alternatively, we can think of  $M$  as a topological Lefschetz fibration over  $B^2$  and represent it

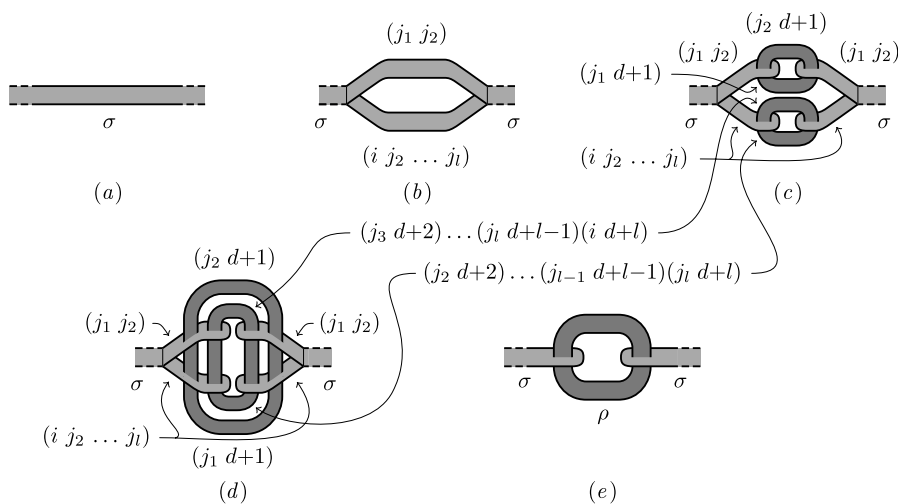

FIGURE 3.8.

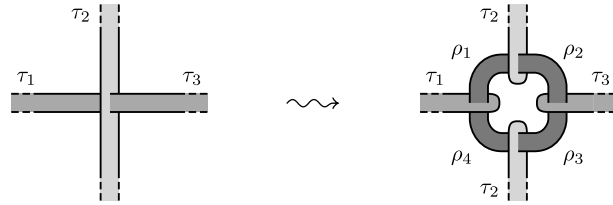

FIGURE 3.9.

as 3-fold simple cover of  $B^4$  branched over a braided surface (cf. Remark 3 of [32]).

However, we will construct a special covering presentation of  $M$  by a technique similar to one used in [32]. This choice, renouncing to control the degree of the covering, which is not relevant in this context, will eventually allows us to get a simpler universal surface. Nevertheless, it is worth observing that the symmetrization process described in the next section could

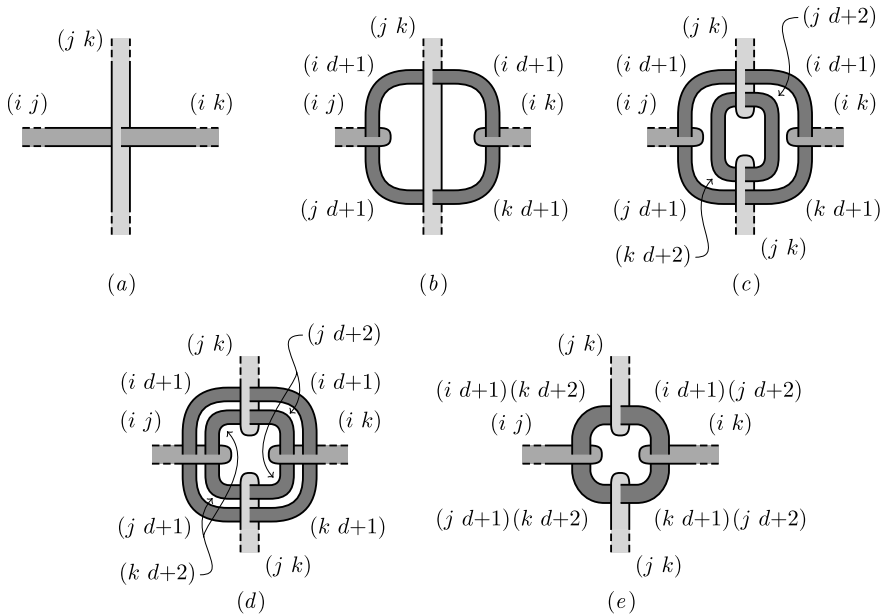

FIGURE 3.10.

be arranged to work starting from a generic ribbon branched surface.

Let the generic Kirby diagram of Figure 3.11 represent  $M$ . Here, as well as in Figure 3.12, the framings are assumed to coincide with the blackboard ones outside the box.

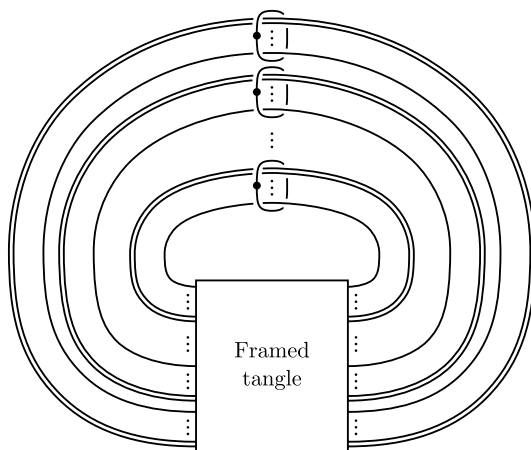

FIGURE 3.11.

By the classical Alexander's argument, we can modify this diagram in order to make the framed tangle inside the box into a framed braid. Moreover, by inserting a certain number of kinks and enlarging them to form new braid strings, we can assume that all the framings coincide with the blackboard ones. Figure 3.12 shows the resulting diagram cut open in the upper part, after the 1-handles have been isotoped to the lower part.

The rest of this section is devoted to show how the handle presentation of Figure 3.12 can be converted into a simple covering  $M \rightarrow B^4$  branched over an orientable ribbon surface. We need first to specify some more details of such handle presentation. Let  $m$  and  $n$  be respectively the number of 1-handles and 2-handles. We denote by  $K_1^1, \dots, K_m^1$  the vertical trivial loops representing the 1-handles in the diagram, indexed from left to right, and by  $K_1^2, \dots, K_n^2$  the braid components forming the attaching loops of the 2-handles, indexed according to their lowermost occurrence on the left, from bottom to top. We assume the

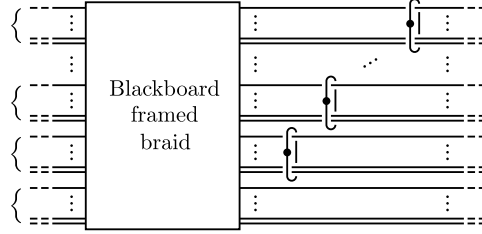

FIGURE 3.12.

$K_i^2$ 's counter-clockwise oriented. For any  $i = 1, \dots, n$ , we call  $s_i$  the number of strings of  $K_i^2$  and we put  $t_i = s_1 + \dots + s_i$ . As a notational convenience, we also put  $t_0 = 0$ . Moreover,  $H_j^i$  will indicate the  $i$ -handle corresponding to  $K_j^i$ .

To begin with, we consider the simple branched covering of  $B^4$  with  $t_n + m + 1$  sheets numbered from 0 to  $t_n + m$ , whose branching surface consists of the trivial family of disjoint disks  $D_1, \dots, D_{t_n+2m} \subset B^4$  and whose monodromy is given as follows: the disks  $D_{t_{i-1}+1}, D_{t_{i-1}+2}, \dots, D_{t_i}$ , that will be used for the 2-handle  $H_i^2$ , have respective monodromies  $(0 \ t_{i-1}+1), (t_{i-1}+1 \ t_{i-1}+2), \dots, (t_i-1 \ t_i)$ ; the disks  $D_{t_n+2j-1}$  and  $D_{t_n+2j}$ , corresponding to the 1-handle  $H_j^1$ , have the same monodromy  $(0 \ t_n+j)$ .

A diagram of these branching disks with their monodromies is shown in Figure 3.13. Here, the vertical lines stand for flat vertical disks, transversal to the closed braid of Figure 3.12 in the upper part, where we cut open it, so that each string meets all them once, from right to left in the order. There is no such vertical disk for the 2-handles  $H_i^2$  such that  $K_i^2$  consists of only one string, that this  $s_i = 1$  and  $t_{i-1} + 1 = t_i$ . Moreover, the disks representing  $D_{t_n+2j-1}$  and  $D_{t_n+2j}$  in the diagram are  $\varepsilon$ -displacements of the flat disk spanned by  $K_j^1$  in Figure 3.12, hence the  $K_i^2$ 's cross these three disks in the same way, for each  $j = 1, \dots, m$ . On the other hand,  $D_{t_{i-1}+1}$  is a 2-disk expansion of a small horizontal arc  $C_i \subset K_i^2$  placed at the beginning (on the left in Figure 3.12) of the lowermost string of  $K_i^2$ , for each  $i = 1, \dots, n$ .

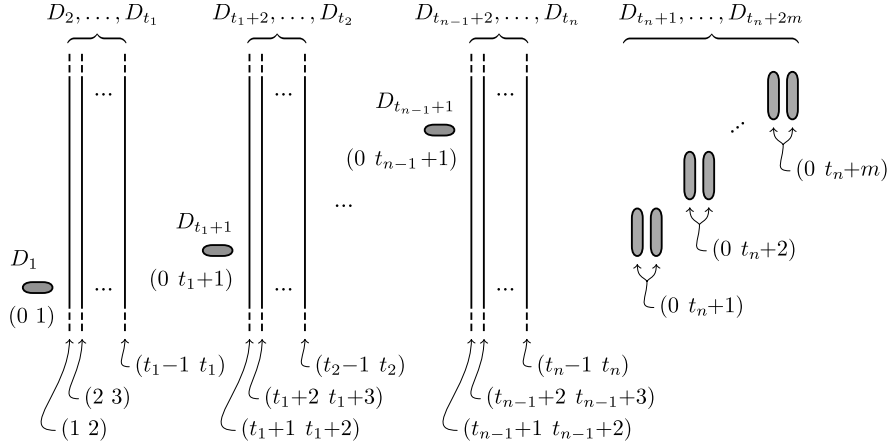

FIGURE 3.13.

The covering manifold  $M_1$  can be thought as  $B^4 \cup H_1^1 \cup \dots \cup H_m^1$ . In fact, the disks  $D_{t_n+2j-1}$  and  $D_{t_n+2j}$  give rise to the 1-handle  $H_j^1$  formed by the sheet  $t_n + j$ , for each  $j = 1, \dots, m$ . All the other branching disks induce stabilization by addition of trivial sheets. An outline of  $M_1$  (seen from the top) is drawn in Figure 3.14. We identify  $M_1$  with  $B^4 \cup H_1^1 \cup \dots \cup H_m^1$  in such a way that the blackboard framings relative to the Figures 3.12 and 3.14 coincide.

Now, we modify the above branched covering  $M_1 \rightarrow B^4$  to get the wanted simple branched covering  $M \cong M_1 \cup H_1^2 \cup \dots \cup H_n^2 \rightarrow B^4$ .

Following Montesinos [27] (see also [29]), we realize the addition of the 2-handles to  $M_1$ , by attaching an appropriate band  $B_i$  to the branching disk  $D_{t_{i-1}+1}$ , for each  $i = 1, \dots, m$ . Namely, we define  $B_i$  as a ribbon band representing the blackboard framing along the arc  $A_i = \text{Cl}(K_i^2 - C_i)$  in Figure 3.12.

This choice for the  $B_i$ 's works, since the following three properties are satisfied (cf. [27] or [29]): 1)  $A_i$  meets the branching disks only at its endpoints, that belong to  $\text{Bd } D_{t_{i-1}+1}$ ; 2) the counterimage of  $A_i$ , with respect to the covering, is the disjoint union of  $t_n + m - 1$  arcs and a simple loop  $L_i = A'_i \cup A''_i \subset \text{Bd } M_1$ , where  $A'_i$  and  $A''_i$  are the liftings of  $A_i$  respectively starting in



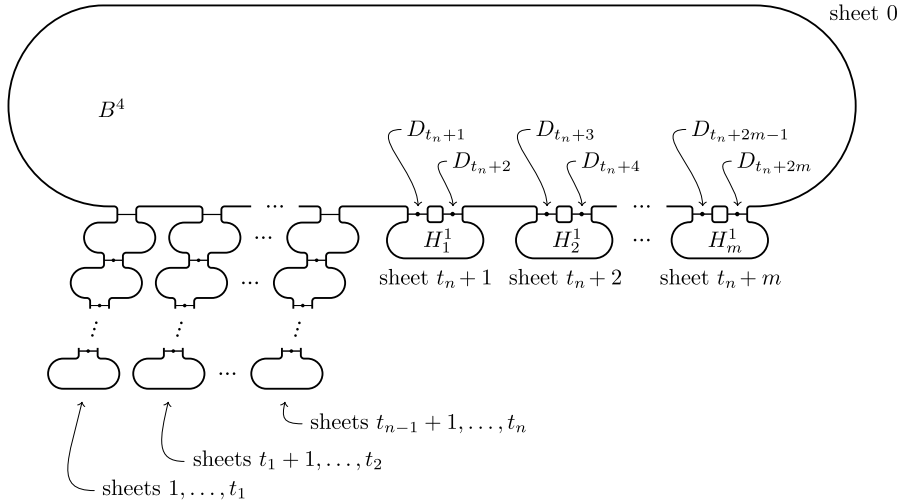

FIGURE 3.14.

the sheets 0 and  $t_{i-1} + 1$ ; 3) the link  $L_1 \cup \dots \cup L_n$  with the framings given by lifting the  $B_i$ 's is equivalent (in  $\text{Bd } M_1$ ) to the link  $K_1^2 \cup \dots \cup K_n^2$  with the blackboard framings of Figure 3.12.

Actually, property 1 holds by construction, while property 2 can be easily verified by inspection, after observing that the product of the monodromies associated to the vertical lines of Figure 3.13 taken from right to left is the permutation

$$\pi = (1 \ 2 \ \dots \ t_1)(t_1+1 \ t_1+2 \ \dots \ t_2) \dots (t_{n-1}+1 \ t_{n-1}+2 \ \dots \ t_n).$$

So, we are left with proving property 3. For the moment, we focus on a single braid component  $K_i^2$  disregarding the 1-handles. Figures 3.15 and 3.16 describe respectively the arc  $A_i$  and the loop  $L_i$  for a braid component  $K_i^2$  with four strings, omitting the non-relevant branching disks and sheets.

By considering again the permutation  $\pi$ , we immediately see that  $A'_i$  is a copy of  $A_i$  entirely contained in the sheet 0 of the covering, while  $A''_i$  is a trivial arc in the sheets  $t_{i-1} + 1, \dots, t_i$ , consisting of one string in each sheet (cf. Figure 3.16). Hence,  $L_i$  is isotopic to  $K_i^2$ .

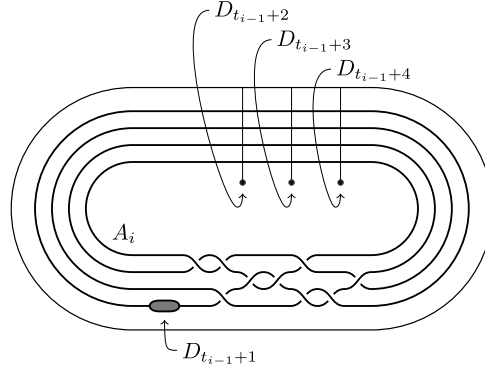

FIGURE 3.15.

Concerning the framing, we have that the blackboard framing along  $A_i$  in Figure 3.13 lifts to the blackboard framing along  $L_i$  in Figure 3.14 (cf. Figures 3.15 and 3.16), which in turn is equivalent to the blackboard framing of  $K_i^2$  in Figure 3.12. The last equivalence is due to the fact that the isotopy between  $L_i$  and  $K_i^2$  can be assumed to be regular with respect to the projection of figure 3.14.

At this point, we observe that all the  $K_i^2$ 's can be considered simultaneously, since the  $L_i$ 's interact only in the sheet 0. Hence  $L_1 \cup \dots \cup L_n$  and  $K_1^2 \cup \dots \cup K_n^2$  are isotopic as blackboard framed links.

Finally, let us take into account the 1-handles. Figure 3.17 shows how the crossings of the  $A_i$ 's with the projections of  $\text{Int } D_{t_n+2j-1}$  and  $\text{Int } D_{t_n+2j}$  lifts to passages of the  $A_i$ 's through the 1-handle  $H_j^1$ . In particular, we have that no extra twist is added neither in the link nor in the framings. Then, the presence of the 1-handles does not affect our reasoning in any way, except for the fact that the arcs  $A_i$  are no longer contained only in the sheet 0, but they traverse also the sheets  $t_n+1, \dots, t_n+m$  forming the 1-handles.

A diagram of the resulting branching surface (cut open as above) is outlined in Figure 3.18. Here, the framed braid is the same of Figure 3.12, while the vertical disks are the ones of Figure 3.13, apart from different order, due to the sliding of the  $D_k$ 's

with  $k \leq t_n$  from the upper part of the diagram (cf. Figure 3.15) to the lower one.

### 3.4 GETTING THE UNIVERSAL SURFACE

We begin this section, by explaining how the covering moves given in Section 3.2 can be used to symmetrize the branching surface of Figure 3.18.

Firstly, we modify any positive (resp. negative) crossing along the braid inside the box as described in the top (resp. bottom) part of Figure 3.19. In both cases, we perform eight Moves

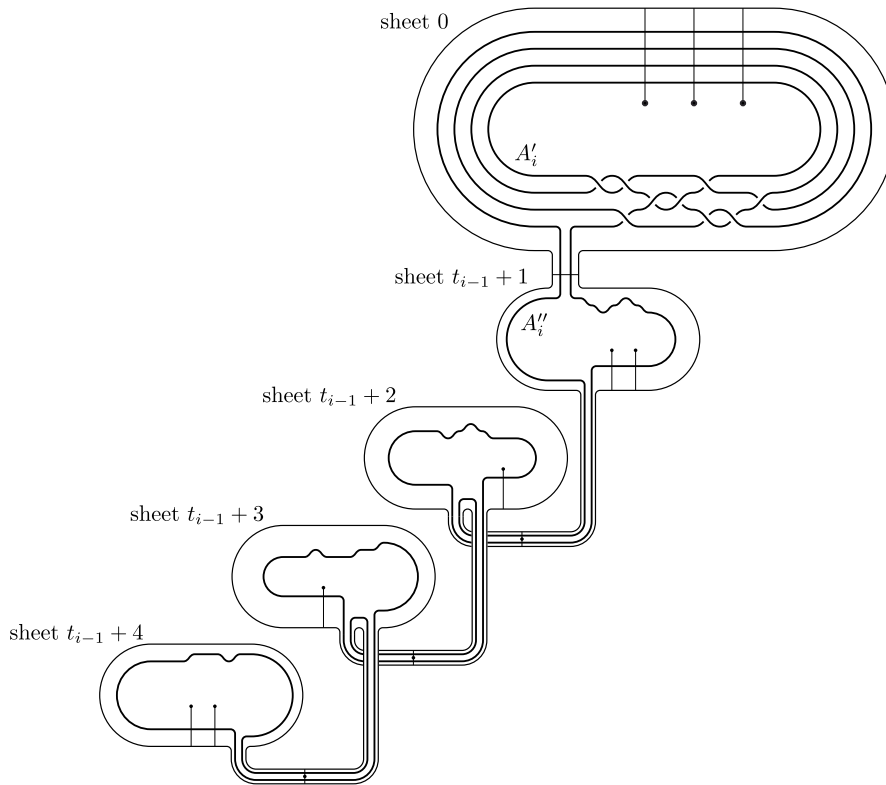

FIGURE 3.16.

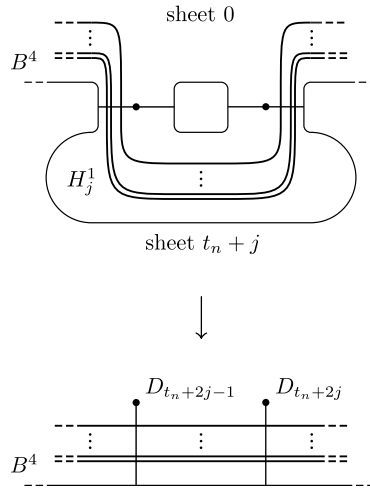

FIGURE 3.17.

3 (cf. Figure 3.6) and then we isotope some of the resulting vertical disks. Then, we make all such crossings into ribbon intersections, by stabilization (followed by suitable isotopy) and crossing change, as shown in Figure 3.20 (of course, the covering degree  $d$  must be dynamically updated after each stabilization). We leave to the reader to check that the monodromies of the two bands forming each crossing are really distinct but not disjoint, like in Figure 3.20.

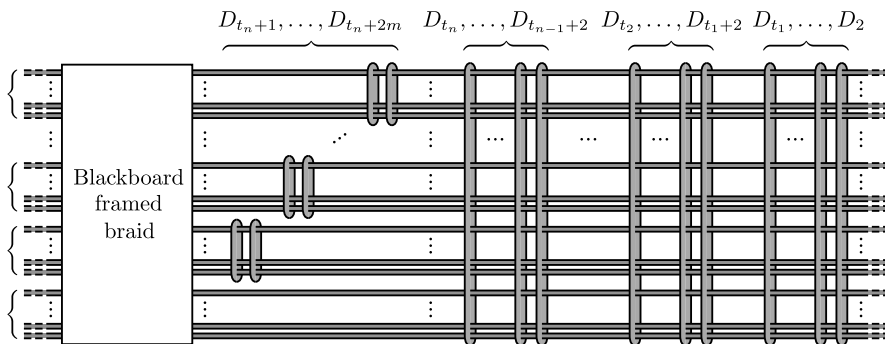

FIGURE 3.18.

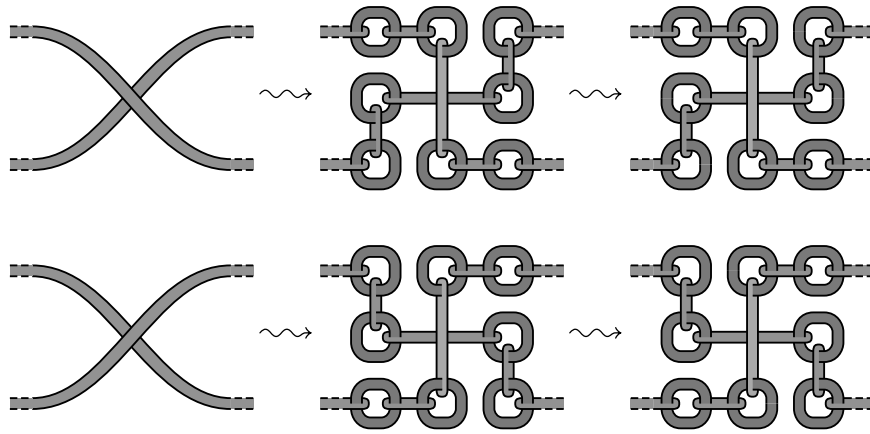

FIGURE 3.19.

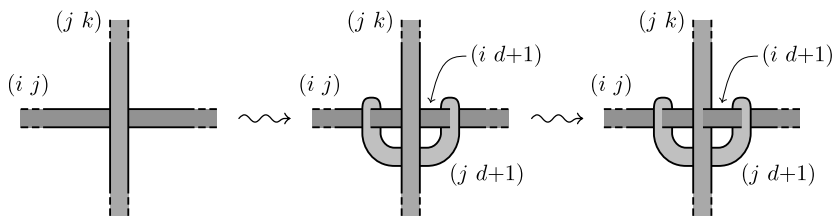

FIGURE 3.20.

Secondly, we apply our Move 4 (cf. Figure 3.9) to the ribbon intersections we have just obtained, apart from the ones formed by the stabilizing disks. Moreover, we do the same on all the ribbon intersections which appear in Figure 3.18 outside the box. Also in this case, we leave to the reader to verify that the involved monodromies are distinct.

At this point, our diagram consists of: small annuli centered at some vertices of a rectangular grid; a certain number of horizontal and vertical bands running along some edges of the same grid; small stabilizing disks as in Figure 3.20 around some of the annuli. We emphasize that the bands do not form any ribbon intersection or crossing with each other.

Such a diagram can be easily completed to get the one depicted in Figure 3.21, where top and bottom ends are assumed

to be trivially joined by bands passing in front of the ones already connecting left and right ends, and the pattern decorating the box has to be replicated at each potential crossing between the entering horizontal and vertical bands. Namely, it suffices to break the bands which take more than one grid edge, by using Move 3, and then to insert fake branching components (labelled with the identity) in the lacking places. Of course, top and bottom grid lines have to be considered as if they were adjacent.

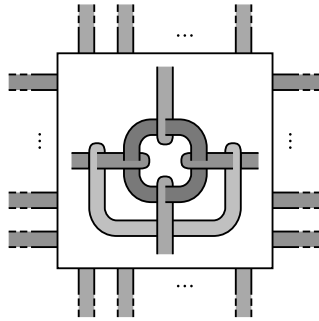

FIGURE 3.21.

Now, thinking of  $B^4$  as  $B^2 \times B^2 \subset \mathbb{C}^2$ , we place the diagram of Figure 3.21 in the torus  $S^1 \times S^1$ , in such a way that the rotations  $r_1 : (z_1, z_2) \mapsto (e^{2\pi i/n_1} z_1, z_2)$  and  $r_2 : (z_1, z_2) \mapsto (z_1, e^{2\pi i/n_2} z_2)$  permute respectively the rows and the columns of the  $n_1 \times n_2$  pattern matrix inside the box (cf. [48] and [22]).

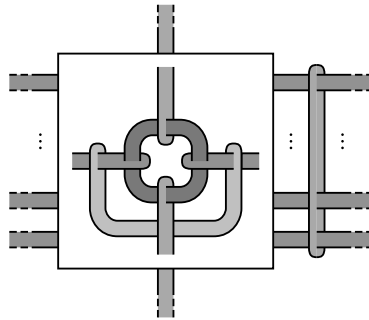

FIGURE 3.22.

Then, we compose the branched covering represented by the diagram with the quotient by the action of  $r_2$ , to get a new branched covering  $M \rightarrow B^4$ , whose branching surface is given in Figure 3.22. Here, the rightmost disk is the branching surface of the quotient, while the box contains a  $n_1 \times 1$  pattern matrix, which is the quotient of the one of Figure 3.21.

Breaking the rightmost disk into  $n_1$  disks, by Move 3 once again, and adding another fake branching annulus between top and bottom, we get the diagram of Figure 3.23, which can be still assumed  $r_1$ -invariant.

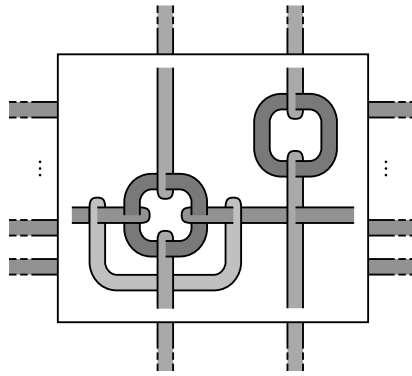

FIGURE 3.23.

Finally, we quotient by the action of  $r_1$ , in order to get the diagram of Figure 3.24, where the branching disk of this last quotient is the horizontal one. It is worth remarking that, by quotienting directly the diagram of Figure 3.22, one would get a singular point in the surface, due to the transversal intersection between the branching disks of the two quotients. This is the motivation for passing through the diagram of Figure 3.23.

Clearly, Figure 3.24 already represents a universal orientable ribbon surface. However, we conclude this section by simplifying a little bit such universal surface. The intermediate steps of this simplification are described in the following Figure 3.25.

We start with the surface in (a), which is isotopically equivalent to the one of Figure 3.24. Then, we add the two fake

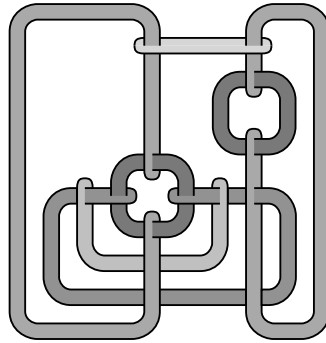

FIGURE 3.24.

branching components labelled with the identity in (b), in order to make the surface symmetric with respect to the center of the diagram (the disk marked with the asterisk can be thought of as the fixed point set of the symmetry). In (c) we see the branching surface of the composition of our branched covering with that symmetry. Of course, this surface is still universal, but it has two components less than before. The surfaces in (d), (e) and (f) are all obtained by isotopy.

The simplified universal surface is depicted in Figure 3.26. To get it, we isotoped once again the last surface of Figure 3.25 just for pictorial reasons.

### 3.5 CONCLUDING REMARKS AND QUESTIONS

First of all, we observe that the universal surface of Figure 3.26 consists of one annulus and four disks, all trivially embedded in  $B^4$ . Moreover, disregarding the annulus, the four disks can be separated and isotoped in a symmetric position, so that they are cyclically permuted by a rotation of  $\pi/2$  radians. Then, the quotient by the action of the rotation gives us a new universal ribbon surface with only three components, one annulus and two trivial disks. Unfortunately, the isotopy and the quotient force the annulus to wrap around the disks in a very unpleasant way



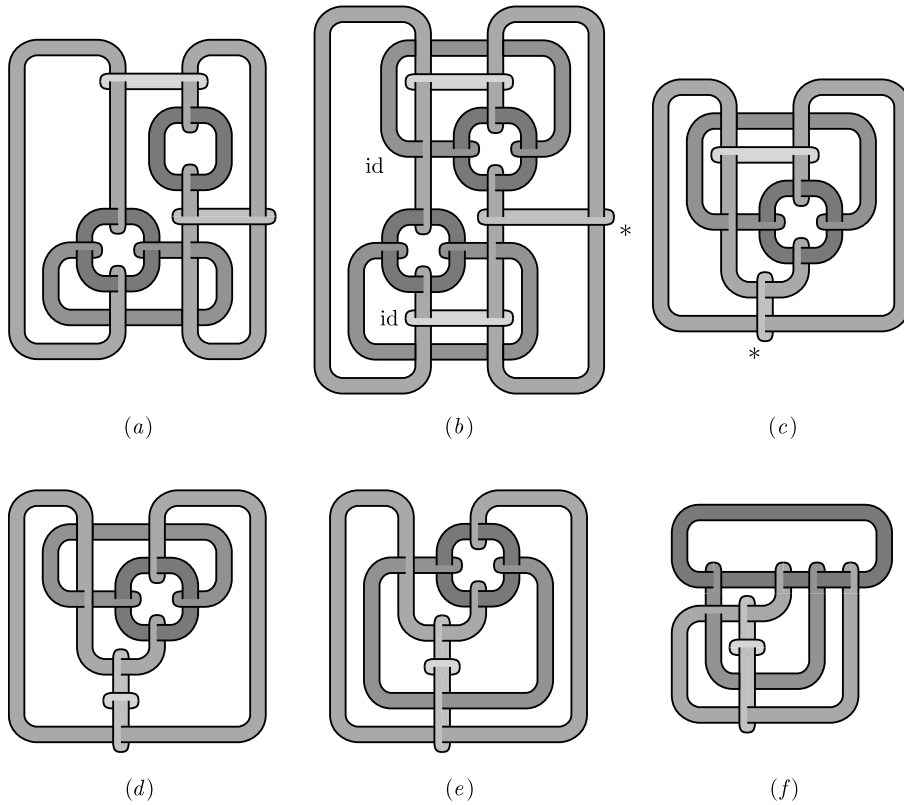

FIGURE 3.25.

and this makes resulting surface likely useless. Nevertheless, we know that the number of components can be reduced to three. However, the following question makes sense.

**QUESTION 3.5.1.** *Is there a ‘reasonable’ universal (possibly non-orientable) surface in  $B^4$  with less than five components?*

Even more, there is no reason to believe that three is the minimum number of components of a universal surface in  $B^4$ . In fact, it can be easily proved, by using signature, that there is no connected universal surface in  $S^4$  (cf. [49] and [29]), but the same argument does not work in  $B^4$ . So, here is our second question.

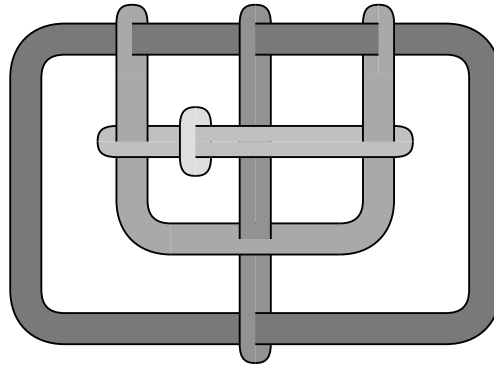

FIGURE 3.26.

QUESTION 3.5.2. *Does there exist any connected universal surface in  $B^4$ ?*

On the other hand, at the cost of some more components, one could modify the construction carried out in Section 3.4, in order to get a different universal surface, such that branched covering with all the branching indices equal to 2 would suffice for our representation theorem. The only branching indices bigger than 2 coming into that construction are indeed due to the rotations  $r_1$  and  $r_2$ . Namely, the branching indices over the two disks fixed by such rotations (cf. Figures 3.22 and 3.24) are respectively  $n_1$  and  $n_2$ . By the merging principle, each of these disks can be replaced by a pair of parallel disks labelled with suitable products of disjoint transpositions (the same argument used in [22] for the 3-dimensional case applies here). In this way, all the branching indices are reduced to 2.

Figure 3.27 (b) shows a braided version of our universal surface. It has been obtained by applying the Rudolph's braiding algorithm (cf. [46]) to the surface in the part (a) of the same figure, which is isotopic to the one of Figure 3.26.

Such way of seeing a universal surface is quite interesting, due to that fact that any covering  $M \rightarrow B^4$  branched over a braided surface naturally induces a topological Lefschetz fibration  $M \rightarrow B^2$  (cf. [32]). In particular, if the braided surface

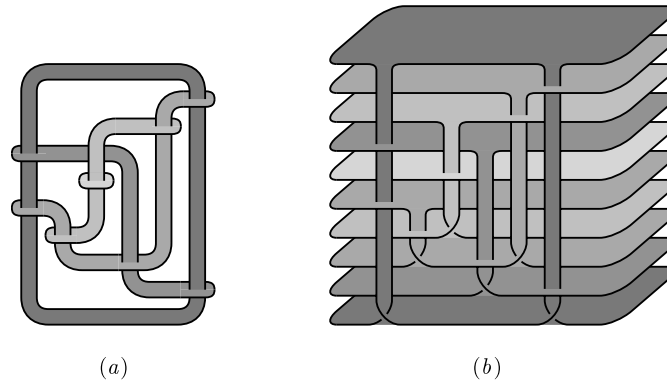

FIGURE 3.27.

is positive (quasi-positive in the Rudolph's terminology), that is all the bands between the sheets are positively twisted, then also the induced fibration is positive and  $M$  is a bounded Stein surface. One of the main ingredients in the proof of this fact is the Rudolph's theorem that positive braided surfaces are complex analytic (cf. [45]).

Since not all the 4-manifold considered here are Stein, no universal ribbon surface in  $B^4$  can be isotopically equivalent to a positive braided surface. In Figure 3.27 (b) we see that only three of the six bands are positively twisted.

However, it has been proved in [32] that any compact Stein surface with boundary is a covering of  $B^4$  branched over a positive braided surface. Then, the following question naturally arises.

**QUESTION 3.5.3.** *Does there exist a positive braided surface in  $B^4$  which is universal for compact Stein surfaces with boundary?*

Finally, some trivial remarks about universal links. Obviously, the boundary of any universal surface in  $B^4$  is a universal link in  $S^3$ . But, it is likely false that any universal link in  $S^3$  is the boundary of a universal surface in  $B^4$ . Actually, it is not clear at all whether any universal link bounds some surface in  $B^4$  allowing us to give a covering presentation of any closed orientable

3-manifold as the boundary of a 4-manifold. For example, we don't know what happens in the simplest case of the Borromean rings. So, we conclude with the following question.

QUESTION 3.5.4. *What universal links in  $S^3$  bound a universal surface in  $B^4$ ?*

## BIBLIOGRAPHY

- [1] J.W. Alexander, *A lemma on systems of knotted curves*, Proc. Nat. Acad. Sci. U.S.A. **9** (1923), 93–95.
- [2] N. Apostolakis, *On 4-fold covering moves*, Algebr. Geom. Topol. **3** (2003), 117–145.
- [3] S. Benvenuti, *Finite presentations for the mapping class group via the ordered complex of curves*, Adv. Geom. **1** (2001), no. 3, 291–321.
- [4] I. Bernstein, A.L. Edmonds, *On the construction of branched coverings of low-dimensional manifolds*, Trans. Amer. Math. Soc. **247** (1979), 87–124.
- [5] J.S. Birman, *Braids, links, and mapping class groups*, Princeton University Press, Princeton, N.J., 1974, Annals of Mathematics Studies, No. 82.
- [6] J.S. Birman, B. Wajnryb, *3-fold branched coverings and the mapping class group of a surface*, Lecture Notes in Math. vol. 1167, Springer, Berlin, 1985, 24–46.
- [7] J.S. Birman, B. Wajnryb, *Errata: 3-fold branched coverings and the mapping class group of a surface*, Israel J. Math. **88** 1-3 (1994), 425–427.
- [8] I. Bobtcheva, R. Piergallini, *Covering moves and Kirby calculus*, Preprint math.GT/0407032 (2004).
- [9] M. Boileau, S. Orevkov, *Quasi-positivité d’une courbe analytique dans une boule pseudo-convexe*, C. R. Acad. Sci. Paris Sér. I Math. **332** (2001), no. 9, 825–830.
- [10] S.K. Donaldson, *Lefschetz pencils on symplectic manifolds*, J. Differ. Geom. **53** (1999), no. 2, 205–236.

- [11] Y. Eliashberg, *Filling by holomorphic discs and its applications*, Lecture Note Ser. vol. 151, Cambridge Univ. Press, Cambridge, 1990, 45–67.
- [12] J. Etnyre, T. Fuller, *Realizing 4-manifolds as achiral Lefschetz fibrations*, Int. Math. Res. Not. (2006).
- [13] J. Etnyre, K. Honda, *On the nonexistence of tight contact structures*, Ann. of Math. **153** (2001), 749–766.
- [14] S. Gervais, *A finite presentation of the mapping class group of a punctured surface*, Topology **40** (2001), no. 4, 703–725.
- [15] R.E. Gompf, A.I. Stipsicz, *4-manifolds and Kirby calculus*, Graduate Studies in Mathematics 20, American Mathematical Society, 1999.
- [16] J. Harer, *Pencils of curves on 4-manifolds*, Ph.D. thesis, Univ. of California, Berkeley (1979).
- [17] J. Harer, *How to construct all fibered knots and links*, Topology **21** (1982), no. 3, 263–280.
- [18] F. Harou, *Description chirurgicale des revêtements ramifiés simples à quatre feuillets de la 3-sphère*, C. R., Math., Acad. Sci. Paris **336** (2003), no. 7, 597–600 (French).
- [19] J. Hass, P. Scott, *Insections of curves on surfaces*, Israel J. Math. **51** (1985), 90–120.
- [20] J. Hass, P. Scott, *Shortening curves on surfaces*, Topology **33** (1994), 25–43.
- [21] A. Hatcher, W. Thurston, *A presentation for the mapping class group of a closed orientable surface*, Topology **19** (1980), no. 3, 221–237.
- [22] H.M. Hilden et al. *On universal groups and three-manifolds*, Invent. Math. **87** (1987), no. 3, 441–456.
- [23] H.M. Hilden, *Every closed orientable 3-manifold is a 3-fold branched covering space of  $S^3$* , Bull. Amer. Math. Soc. **80** (1974), 1243–1244.
- [24] H.M. Hilden, M.T. Lozano, J.M. Montesinos, *Universal knots*, Lecture Notes in Math. vol. 1144, Springer, Berlin, 1985, 25–59.

- [25] H.M. Hilden, M.T. Lozano, J.M. Montesinos, *The Whitehead link, the Borromean rings and the knot  $9_{46}$  are universal*, Collect. Math. **34** (1983), no. 1, 19–28.
- [26] H.M. Hilden, M.T. Lozano, J.M. Montesinos, *On knots that are universal*, Topology **24** (1985), no. 4, 499–504.
- [27] H.M. Hilden, J.M. Montesinos, *Lifting surgeries to branched covering spaces*, Trans. Amer. Math. Soc. **259** (1980), no. 1, 157–165.
- [28] U. Hirsch, *Über offene Abbildungen auf die 3-Sphäre*, Math. Z. **140** (1974), 203–230.
- [29] M. Iori, R. Piergallini, *4-manifolds as covers of the 4-sphere branched over non-singular surfaces*, Geom. Topol. **6** (2002), 393–401 (electronic).
- [30] R.C. Kirby, *The topology of 4-manifolds*, Springer-Verlag, Berlin, 1989.
- [31] W.B.R. Lickorish, *An introduction to knot theory*, Springer, 1997, Graduate Texts in Mathematics, 175.
- [32] A. Loi, R. Piergallini, *Compact Stein surfaces with boundary as branched covers of  $B^4$* , Invent. Math. **143** (2001), no. 2, 325–348.
- [33] J.M. Montesinos, *A representation of closed orientable 3-manifolds as 3-fold branched coverings of  $S^3$* , Bull. Amer. Math. Soc. **80** (1974), 845–846.
- [34] J.M. Montesinos, *4-manifolds, 3-fold covering spaces and ribbons*, Trans. Amer. Math. Soc. **245** (1978), 453–467.
- [35] J.M. Montesinos, *Heegaard diagrams for closed 4-manifolds*, Geometric topology, Academic Press, New York, 1979, 219–237.
- [36] J.M. Montesinos, *Representing 3-manifolds by a universal branching set*, Math. Proc. Cambridge Philos. Soc. **94** (1983), no. 1, 109–123.
- [37] J.M. Montesinos, *A note on moves and on irregular coverings of  $S^4$* , Contemp. Math. vol. 44, Amer. Math. Soc., Providence, RI, 1985, 345–349.

- [38] J.M. Montesinos-Amilibia, H.R. Morton, *Fibred links from closed braids*, Proc. London Math. Soc. (3) **62** (1991), no. 1, 167–201.
- [39] M. Mulazzani, R. Piergallini, *Representing links in 3-manifolds by branched coverings of  $S^3$* , Manuscripta Math. **97** (1998), 1–14.
- [40] M. Mulazzani, R. Piergallini, *Lifting braids*, Rend. Istit. Mat. Univ. Trieste **32** (2001), no. suppl. 1, 193–219.
- [41] B. Ozbagci, A. Stipsicz, *Surgery on contact 3-manifolds and Stein surfaces*, Springer, Hungary, 2004.
- [42] E. Pervova, C. Petronio, *On the existence of branched coverings between surfaces with prescribed branch data I*, Algebr. Geom. Topol. **6** (2006), 1957–1985.
- [43] R. Piergallini, *Four-manifolds as 4-fold branched covers of  $S^4$* , Topology **34** (1995), no. 3, 497–508.
- [44] R. Piergallini, D. Zuddas, *A universal ribbon surface in  $B^4$* , Proc. London Math. Soc. (3) **90** (2005), no. 3, 763–782.
- [45] L. Rudolph, *Algebraic functions and closed braids*, Topology **22** (1983), no. 2, 191–202.
- [46] L. Rudolph, *Braided surfaces and Seifert ribbons for closed braids*, Comment. Math. Helv. **58** (1983), no. 1, 1–37.
- [47] L. Rudolph, *Special positions for surfaces bounded by closed braids*, Rev. Mat. Iberoamericana **1** (1985), no. 3, 93–133.
- [48] W. Thurston, *Universal links*, Preprint (1982).
- [49] O.Ya. Viro, *The signature of a branched covering*, Mat. Zametki **36** (1984), no. 4, 549–557.
- [50] B. Wajnryb, *A simple presentation for the mapping class group of an orientable surface*, Israel J. Math. **45** (1983), no. 2-3, 157–174.
- [51] D. Zuddas, *Representing Dehn twists with branched coverings*, Preprint arXiv:0710.0102 (2007).