



Vaasan yliopisto
UNIVERSITY OF VAASA

OSUVA Open
Science

This is a self-archived – parallel published version of this article in the publication archive of the University of Vaasa. It might differ from the original.

Thermal Response of Multiple Pipes and Fluids Using COMSOL for Geothermal Energy System Application

Author(s): Haq, Hafiz M.K.U.; Martinkauppi, Birgitta; Hiltunen, Erkki

Title: Thermal Response of Multiple Pipes and Fluids Using COMSOL for Geothermal Energy System Application

Year: 2014

Version: Published version

Copyright ©2014 NAUN.

Please cite the original version:

Haq, H.M.K.U., Martinkauppi, B. & Hiltunen, E. (2014). Thermal Response of Multiple Pipes and Fluids Using COMSOL for Geothermal Energy System Application. *International Journal of Energy and Environment* 8, 162-170.

<https://www.naun.org/main/NAUN/energyenvironment/2014/a042011-141.pdf>

Thermal response of multiple pipes and fluids using COMSOL for geothermal energy system application

Hafiz M K U Haq, Birgitta Martinkauppi, and Erkki Hiltunen
Faculty of Technology, University of Vaasa

Abstract—A geothermal system is modeled using COMSOL. The purpose is to study and evaluate the thermal response of the pipes and the fluids. The model is designed for a low energy network. A part of this network is used to collect energy from a sediment layer under water body. This model depicts a heating system in the low energy shallow network which brings out the thermal response and helps implementing an efficient geothermal system application. This model executes in COMSOL on a special pipe dedicated as a heat collector for the heating system, to study the heat transfer within the pipes and the fluids used as a heat carrier. It also presents the thermal response of multiple fluids and compares the simulated and the measured data of the actual working fluid within the system. The temperature distribution and the heat flux along the length of the pipe are also taken into account in multiple pipes.

Keywords— Heat transfer, Heat collector, Sediment energy, Pipe flow, Renewable energy.

I. INTRODUCTION

A sediment layer exists typically under a water body like river, lake or sea. The sediment layer has heat energy of which major part comes from the sun and minor part from geothermal sources. During winter, some of the heat energy is conveyed back to the sea water from the sediment and it keeps the bottom layer warm. Typically, water is densest around $+4^{\circ}\text{C}$ which limits heat conduction back to the water. To utilize this energy, a low energy network has been installed. As a part of this system, twelve heat collector pipes has been installed and spread in the sediment layer locating 3-5 m below sea bottom at Liito-oravankatu Street, Suvilahti (Vaasa) [3]. The temperature distribution analyses of these pipes with respect to the distance from the sea shore are an important factor in order to understand the heat transfer process and the prediction of the system on the time scale. This paper presents the simulated results of the temperature distribution along the size of the pipe and compares with the measured data taken by a method of Distributed Temperature Sensing (DTS). Furthermore, the thermal response of the different orientation of the pipes as a function of distance between the cold and hot region are discussed.

The rest of the text is organized in sections. The second section provides the background of the study including the material of the pipe, geometry of the pipe, fluid properties flowing inside the pipe and COMSOL software. The next section describes the method of implementation and variables used for the simulation. The results and discussions are followed by the comparison of simulated and measured data.

II. BACKGROUND

The Geological Survey of Finland has measured earlier the temperature of the seabed sediment which stayed stable at $+8-9^{\circ}\text{C}$ at the depth of 3-4 m [7]. Fig. 1 presents the temperature profile of the sediment in Suvilahti area in Vaasa from year 2006. To exploit the sediment energy, low energy network system has been installed and the energy is used in 42 houses [3]. Further information on distributed system in houses is very well explained in [9]. Later on, Geoenergy group (University of Vaasa) has monitored sediment temperatures using DTS measurements. The cable for DTS measurements was installed with the construction of the network.

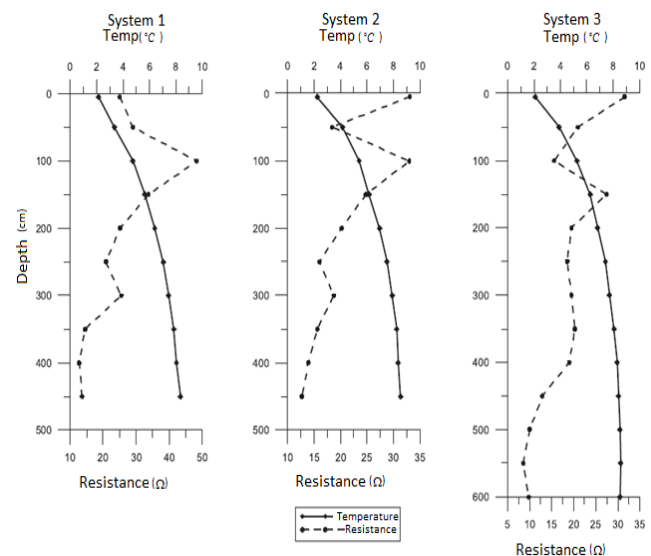

Fig.1 Temperature and resistance of the sediment (GTK Länsi-Suomen yksikkö: Valpola 2006 [14])

The heat collector pipes are placed inside the sediment layer to collect heat from the surrounding and enable the carrier fluid to increase the temperature by heat transfer. This fluid goes back to the storage tank of the heating system. The length of this pipe is important as compared to sediment temperature for heat exchange unless the fluid temperature is stabilized. In the heat collection well at Liito-oravankatu Street, the energy network is composed of 12 PE-pipes with a length of 300 m. The flowing fluid is called Altia's Naturet maalämpönestee (geothermal fluid) a mixture of ethanol and water with 1:1 ratio. The geometric model of the PE-Pipe is given in Fig. 2.

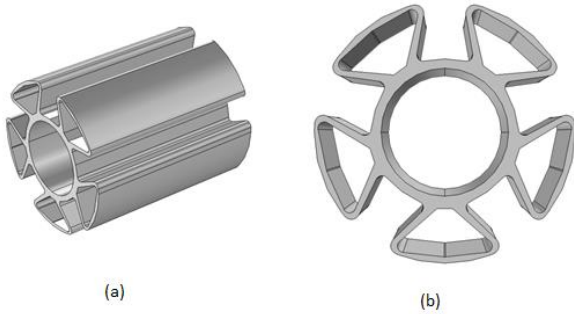

Fig. 2 Geometric model of the PE-Pipe created using COMSOL: a) 3D view and b) Front view

PE-Pipe named Refla energy pipe has five outer pipes each with area of 360 mm^2 to supply fluid (see Fig. 2b). The inner pipe is for returning fluid and has an area of 1194.6 mm^2 . Cooler water enters on the input pipes which flows across the length of the pipe and return back from the output pipe with the temperature change depending on sediment to pipe energy exchange. This warmer water is used in the heating system. The temperature difference between the inlet and outlet fluid is an important factor which reflects in the efficiency of the heating system.

COMSOL is utilized to present the evaluation of the 3D modeling (see [4], [8] and [10] for illustration) of pipe flow under the sediment layer. The 3D problem is solved using the average temperature of the sediment over months. The temperature distribution has been calculated using the thermal properties of the pipes and fluids.

III. METHODOLOGY

The focus of this study is to simulate the 3D model of the pipe and to evaluate the temperature distribution during pipe flow. COMSOL provides multiphysics functionality of the pipe flow:

$$F - f \frac{\rho}{2d} |u|u - \nabla P = 0 \quad (1)$$

$$\nabla \cdot (A\rho\mathbf{u}) = 0 \quad (2)$$

where $A \text{ (m}^2\text{)}$ is the cross sectional area of the pipe, $\rho \text{ (kg/m}^3\text{)}$ is the density of the pipe, $u \text{ (m/s)}$ is the fluid velocity flowing inside the pipe, $P \text{ (N/m}^2\text{)}$ is the pressure, d is the hydraulic diameter of the pipe, f is the Darcy friction factor and $F \text{ (N/m}^3\text{)}$ is the volumetric force.

The variation in the density is negligible in eq. (1) and the model is not pressure driven. The common practice of modeling dictates to exclude the gravity from the equation. Now, F represents the pressure variable as the reduced pressure. These assumptions significantly simplify the complexity of the equation [1]. The most important parameter in eq. (1) is Darcy friction factor which describes the friction loss in the pipe flow ([2] and [12] explain pipe flow in porous media).

Friction factor is a function of Reynolds number. Friction factor is directly proportional to the surface roughness of the pipe and inversely proportional to the hydraulic diameter of the pipe. Reynolds number basically predicts the pattern of the fluid flow (see [11] for multi-phase flow). The pattern of the fluid can be laminar, turbulent or in transition phase. In the transition region, fluid undergoes a shift from laminar to turbulent region. To solve the Darcy friction factor in all of these regions of the flow, a Churchill expression has been used [1].

$$f = 8 \left[\left(\frac{8}{R_e} \right)^{12} + (A + B)^{-1.5} \right]^{\frac{1}{12}} \quad (3)$$

$$A = \left[-2.457 \ln \left(\left(\frac{7}{R_e} \right)^{0.9} + 0.27 \left(\frac{e}{d} \right) \right) \right]^{16} \quad (4)$$

$$B = \left(\frac{37530}{R_e} \right)^{16} \quad (5)$$

The importance of the Reynolds number described in eqs. (1) - (3). Reynolds number depends on the properties of the fluid flowing inside the pipe. Dynamic viscosity and the hydraulic diameter of the pipe are important factors in order to understand the region of the fluid flow. Reynolds number usually defines as:

$$R_e = \frac{\rho v D_H}{\mu} \quad (6)$$

where $\rho \text{ (kg/m}^3\text{)}$ is the density, $v \text{ (m}^2\text{/s)}$ is kinematic viscosity of the fluid, $D_H \text{ (m)}$ is the hydraulic diameter of the pipe and $\mu \text{ (kg/(ms) = (Pas))}$ is the dynamic viscosity of the fluid.

Heat transfer from sediment layer to the pipe depends on two constraints, the wall (pipe) heat transfer function and the thermal conductivity of the sediment. Wall heat transfer function further depends on the temperature gradient and the coefficient of the heat transfer.

$$Q_{wall} = hZ(T_{ext} - T) \quad (7)$$

$$\rho A c_p \mathbf{u} \cdot \nabla T = \nabla \cdot A k \nabla T + f \frac{\rho}{2d_h} |u|^3 + Q_{wall} \quad (8)$$

where h is the coefficient of heat transfer, T_{ext} is the temperature of the sediment and Q_{wall} is the heat transfer between the pipe wall and the sediment layer. In case of several walls, the heat transfer coefficient will automatically be calculated considering the wall resistance and the external film resistance [1] and [6]. In this model, the thickness of the inner and outer wall is 4 mm and 3 mm respectively. The thermal conductivity of the pipe is 0.45 (W/mK) [5].

The measured temperature profile of the sediment calculated by the Geenergy research group provides the detail information characterized in months for 300 m of length of the pipe from the sea shore. It is evident that the temperature of the sediment is higher than +8 °C for the months of August, September and October. On the other hand, from November till February, the temperature of the sediment is measured to be less than +6 °C (Geenergy Group). In simulation, the important parameter is the average temperature of the sediment with respect to the length of the pipe round the year rather than individual months. But despite of this fact it has been noticed that the sediment temperature maintained to +9 °C [7].

Table I. Thermal properties of the pipe and fluid

Thermal Properties of the Fluid		Thermal Properties of the Pipe	
Density (kg/m ³)	960	Thermal conductivity (W/mK)	0.45
Dynamic viscosity (10 ⁻³ Pa*s)	2.12	Heat capacity (J/kgK)	2000
Heat capacity (J/kgK)	3250	Density (kg/m ³)	950
Thermal conductivity (W/mK)	0.29		

Table I presents the average thermal properties of the pipe and fluid flow. The density of the fluid has been taken from the online documentation of Altia company website for Naturet-maalämpönesteeet (Naturet -17 °C) at 20 °C temperature. Dynamic viscosity, heat capacity and thermal conductivity of the fluid are the average of seven values at temperatures (-30 – +30 °C) [5]. Thermal properties should be taken as an average value for the corresponding temperatures, the reason for this, is the consideration of fluctuation of the sediment temperature round the year and the steady state assumption. It should be clear that in winter, if sea surface is frozen and the surface temperature at this time can be as low as -4 °C. In this case, the thermal properties of the fluid changes which will cause an alteration in the heat transfer process. So to avoid these conditions, average values have been taken into account.

The heat transfer within the pipe in Fig. 2 can be simulated with the help of multiphysics functionality enhancing eq. (8). In this case, the equation is modified shown in eq. (9) in which

∇T is the temperature difference between the colder and the hotter region of the pipe.

$$\rho C_p \mathbf{u} \cdot \nabla T = \nabla \cdot (k \nabla T) + Q \quad (9)$$

Thermal response within the pipes has been evaluated for the multiple cases in which the distance between the inner and outer pipes are increased as well as an insulating material is introduced.

IV. RESULTS AND DISCUSSION

The velocity of the fluid and the temperature distribution of fluid flow are shown in Figs. 3 and 4 respectively. To visualize the temperature distribution, a section of 1 meter pipe has been considered. The reason is that the length of pipe is approximately 300 m and the distance between the inlet and the outlet pipes are 3 mm. The pipe flow model in COMSOL provides a platform to study both the steady state simulation and the transient (time – dependent) state simulation. This paper only focuses on the steady state process of the pipe flow to generate the temperature distribution across the pipe length.

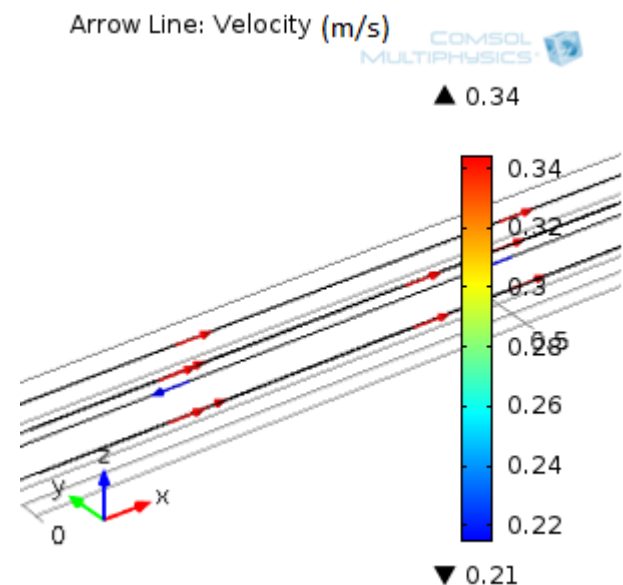

Fig. 3 Velocity of the fluid

In this case, the pipe is considered to be under the sediment layer and a section of only 1 meter. The maximum temperature is shown by the red color at the outlet in Fig. 4 and the rest of the pipe flow undergoes heat transfer process. It should be noted that the heat exchange process depend not only on the temperature of the sediment layer but also on the fluid velocity. The sediment temperature is considered to be +9 °C [7]. The volumetric flow rate is considered to be 0.0567 (l/s). The inlet temperature is +5 °C.

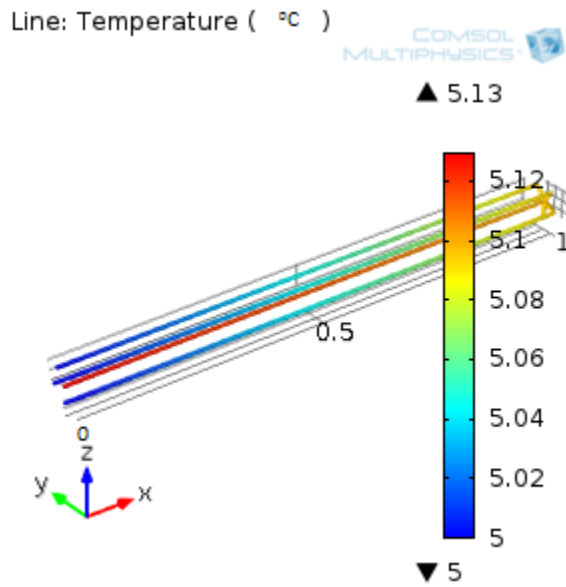

Fig. 4 Temperature distribution of fluid flow

The heat transfer within the pipe is presented in Fig. 5 in which the distance between the outer and inner pipes is 7 mm. The length of the pipe is considered to be 100 mm for the visual convenience. There is no insulation used in this case so a major part of the heat loss can be seen on both the end of the pipe. The input fluid temperature of cold pipe is considered to be +5 °C and the temperature of the hot pipe is considered to be +12 °C. The arrow lines in the Fig. 5 represent the heat flux and the direction of the heat transfer.

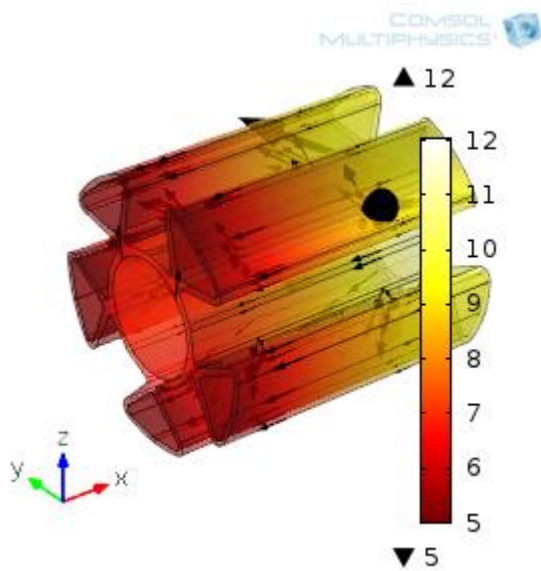

Fig. 5 Temperature distribution within the pipe

Isothermal contours are presented in Fig. 6 for a different case in which air insulation is introduced to analyze the heat transfer within the pipe. The input temperature of both cold and hot pipes remains the same to +5 and +12 °C respectively. Insulation between the inner and outer pipes decreases the heat loss at both the ends of the pipe which is important to extract the maximum energy from the sediment. The inner pipe at the first end maintained its temperature. The fluid flowing through, loose heat energy as it moves towards the cold end of the pipe. In this case, the external temperature is not taken into account in Fig. 6, hence a major heat loss. In practice, the pipe is surrounded by the sediment layer which provides resistance from the heat loss.

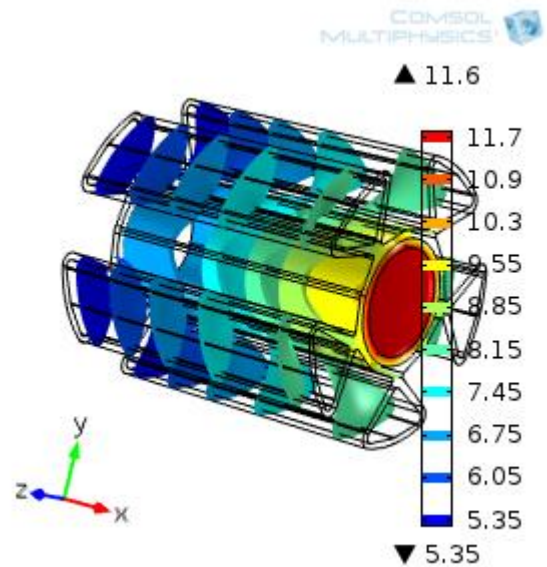

Fig. 6 Isothermal contours within the pipe (insulation introduced)

The temperature profile for 300 meter pipe is shown in Figs. 7 and 8. Since the distance between incoming and outgoing fluid is very small, it is not possible to see the 3D distribution. The incoming and outgoing fluid profile can be seen. At the beginning, there is a slight increase in the temperature for first 10 m of pipe length, but then it rapidly increases until 100 m. It can be seen that there is an abundant rise of temperature from almost 20 m to 100 m. After that point, the heat exchange process is fairly slow maintaining equilibrium until 300 m. In Fig. 8, thermal response of the different fluid type is presented, ethylene glycol has maximum temperature compared to rest of the fluid.

In a similar way, a model has been derived with 12 heat collector pipes of a cross section of 10 m. The temperature profile of the fluid flow is shown in Fig. 9. The inlet temperature is kept at +5 °C which is exchanged over +7 °C at the outlet. The transfer process is at peak at the 10 meter length of the pipe as it shows the maximum at that point. There is a slight temperature increase after 10 m.

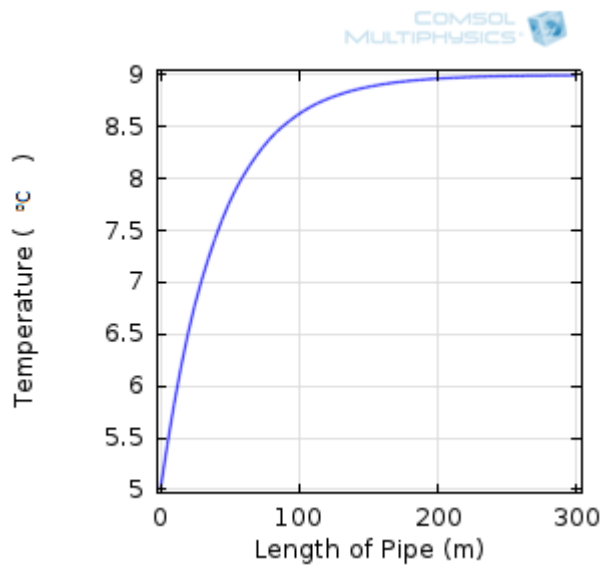

Fig. 7 Temperature of incoming fluid

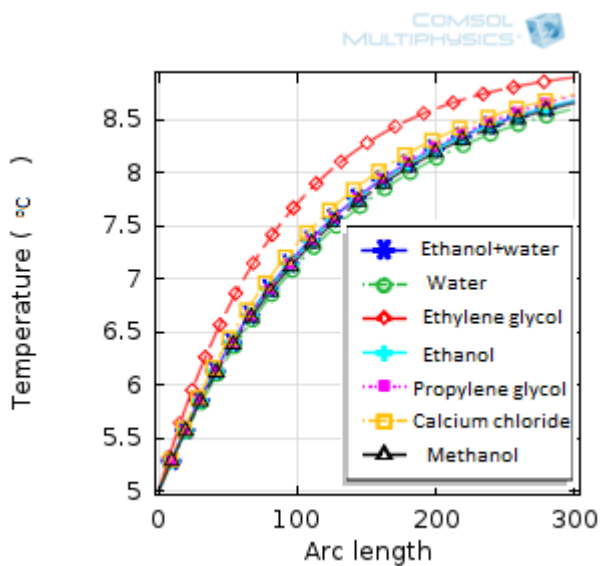

Fig. 8 Temperature response of different fluids VS. pipe length

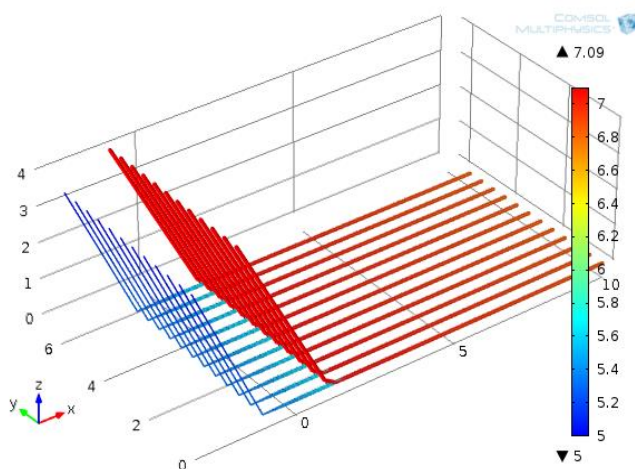

Fig. 9 Temperature distribution of fluid flow Comsol model of the system installed in Liito-oravankatu site

In Fig. 10, the distance between the inner and outer pipe is considered to be 3 mm. The starting point in graph is at 1 mm, cold water is allowed to pass through the pipe with the temperature of +5 °C shown with the dashed line along the length of the pipe. On the other hand, hot water; starts to flow from the 100 mm end of the pipe through to 1 mm point.

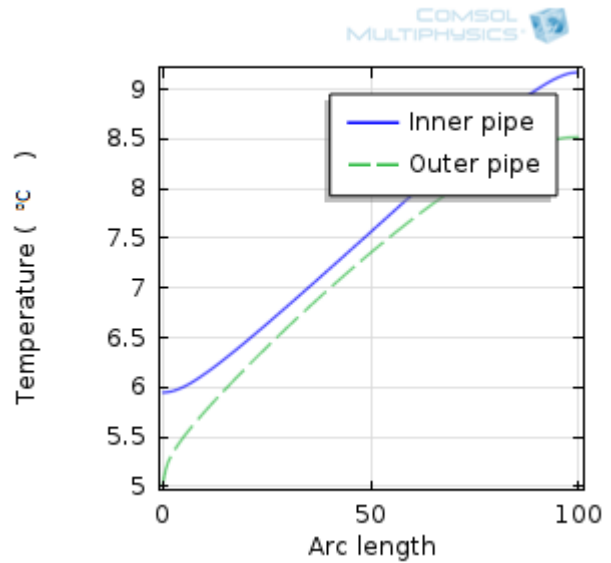

Fig. 10 Temperature distribution in pipe with 3 mm separation

The distance between the inner and outer pipes are now 7 mm. The temperature distribution in Fig. 11 shows a slight difference between the inner pipes compare to which presented in Fig. 10 allowing hot fluid to flow through increasing the input temperature of the inner pipe. There is no apparent change in the graph when the outer pipe is taken into consideration. Although, if the input temperature is kept constant in both of the case than there is no visual change in the simulated result.

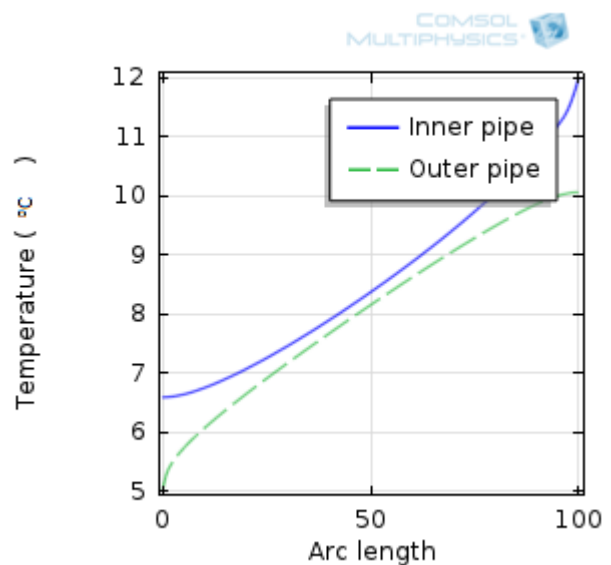

Fig. 11 Temperature distribution in pipe with 7 mm separation

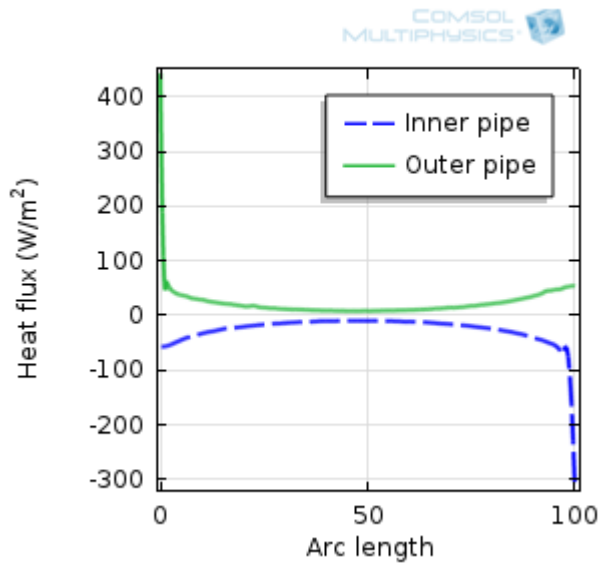

Fig. 12 Heat flux in 3 mm separation pipe

Heat flux is an interesting analogy when considering heat exchange to and from an object. There are three cases of heat transfer in three different types of the pipe. The first one is 3 mm distance between inner and outer pipe, 7 mm distance for the second case and an air insulation of 3 mm is introduced for the third case in 7 mm distance pipe. The first case is presented in Fig. 12 in which the heat flux in cold and hot region of the pipe can be seen. The fluid flowing in the inner pipe starts to lose the heat entering from the 100 mm length of the pipe and continues to do so until 1 mm length of the pipe. The outer pipe possesses the same inverted response. Fig. 13 points out the same response of the heat flux as for the case one with a slight change in the values.

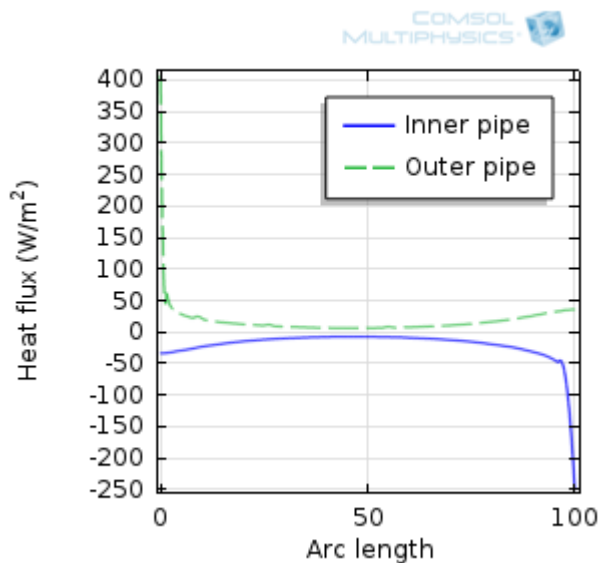

Fig. 13 Heat flux in 7 mm separation pipe

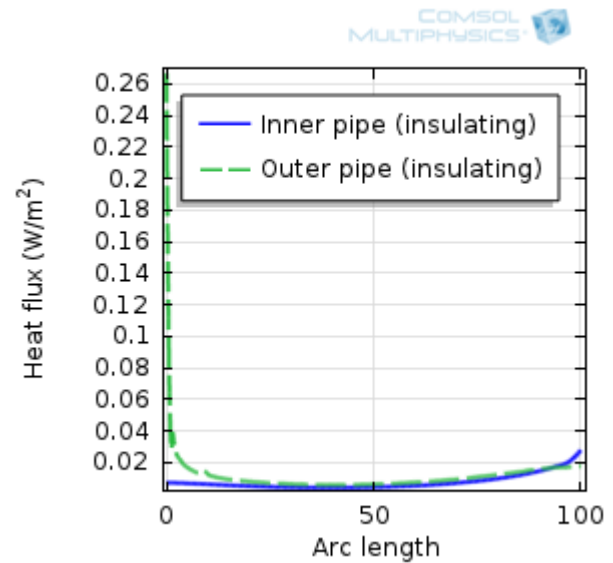





Fig. 14 Heat flux in 7 mm separation plus 3 mm insulation pipe

The third case presents a practical result as compared to the first and second case as seen in Fig. 14. An air insulation of 3 mm is introduced to the second case pipe in which heat loss is small. The separation between inner and outer pipe provides an efficient design of the pipe. The loss of heat is same in the cold and hot region of the pipe. The third case in Table II represents 3 mm insulation on a 7 mm separating pipe. The importance of insulation between the hot and cold fluid is apparent in Fig. 14. In simulation, the pipe model is not attached to any object or inserted in a material as in the practical case when it is surrounded by the sediment but rather to evaluate its own thermal response nothing is surrounding it. On the other hand, sediment layer surrounding the pipe has its own thermal properties which play an important part in the heat conduction from sediment to the pipe.

Sediment layer has a varying temperature depending on the stratification layer of the sea. The conduction process goes on as long as the pipe is surrounded by it. When there is a proper insulation between the hot and cold region of the pipe, the fluid flowing in the outer part of the pipe (see Fig. 2) gain the heat energy from the sediment. If the pipe is not insulated, the heat loss is high (see Fig. 12 and 13) as the fluid enters in the cold region as well as the hot region.

In Figs. 12, 13 and 14, the heat flux is taken along the length of the pipe for both outer and inner part and it is uniform because the heat transfer cancels the effect of the cold and hot region if not using the insulation between them. The hot region remains hot as fluid enters but suddenly it drops the temperature as no insulation used and vice versa for cold region. For a practical geothermal pipe, the insulation between the cold and hot region should be strong so the heat conduction between them is minimum.

Table II. Orientation of the pipe

Cases	Separation between inner and outer region	Pipe
Case. 1	3 mm	
Case. 2	7 mm	
Case. 3	7 + 3 mm	

V. COMPARISON

A comparison has been made in this section between the simulated result and the measured value of the outlet temperature. But before doing so, the input parameters of the system must be changed in order to present the actual values rather than the average results. For this, the temperature profile of the sediment will be taken into consideration for the alternating months of 2009 (Geoenergy research group).

The plain line in Fig. 15 represents the measured temperature value of the fluid in Liito-oravankatu in a period from January 2009 to November 2009. The corresponding line with diamond shaped marker indicates the simulated temperature of the fluid using COMSOL. The input surrounding temperature is the measured value of the sediment temperature taken by Geoenergy group from January 2009 to November 2009. The difference between the measured and the calculated values indicate the error caused by the simulation platform.

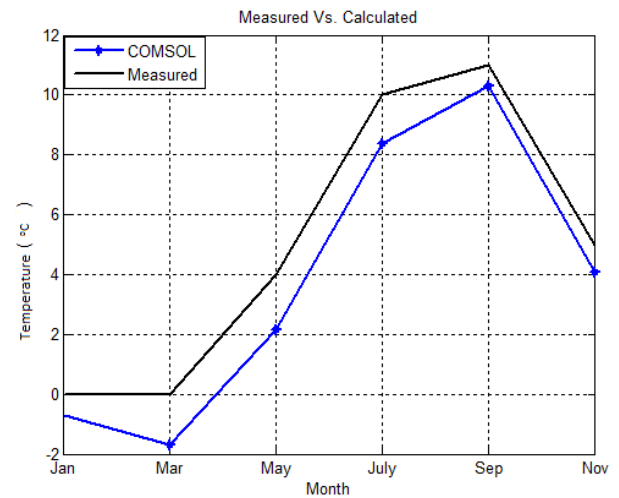

Fig. 15 Temperature distribution (measured Vs. Calculated) of different months

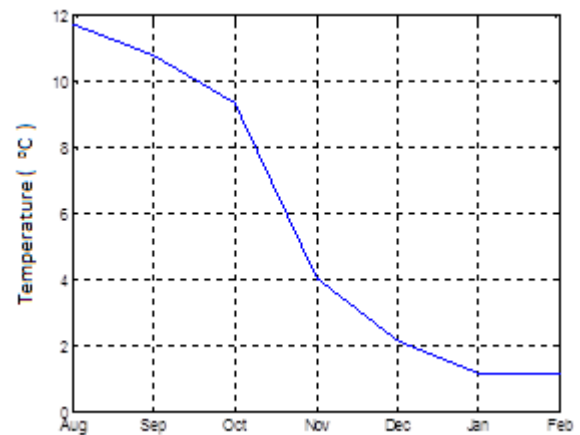

Fig. 16 Simulated temperature using Naturet solution

Figs. 16 and 17 show the temperature response of the flow when using different carrier fluids [13]. In Fig. 16 Naturet (fluid) has been used to calculate the resulting fluid temperature in °C. In Fig. 17, different fluids (including: Ethylene glycol, Propylene glycol, Calcium chloride, Methanol and Water) has been used to compare the temperature response. A minimal difference in the simulated temperature can be seen throughout the year by using different carrier fluid for heat transfer.

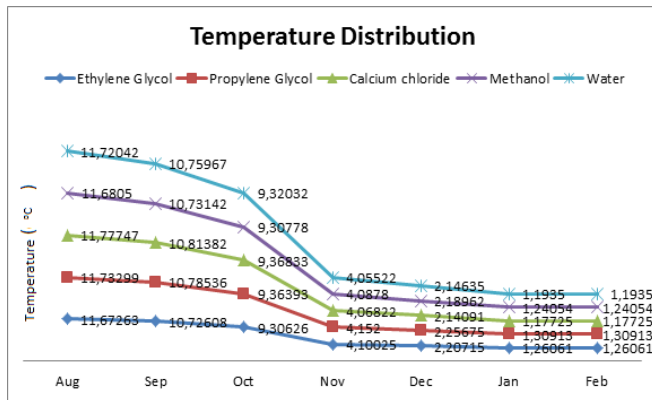

Fig. 17 Simulated temperature response using different fluids

The pipe models presented in Table. II are compared in Fig. 18 and 19. In these figures, the cold and hot channels are compared separately. Thermal response of first and second cases is similar to each other, hence one line representing both of them. The focus here is to compare between insulated and non-insulated pipes. The thermal response of non-insulated pipes is rapidly changing along the length of the pipe while an exponential response is seen for the insulated pipe. In the cold region, the temperature rises frequently in non-insulating pipe as compared to the insulated pipe (see Fig. 19).

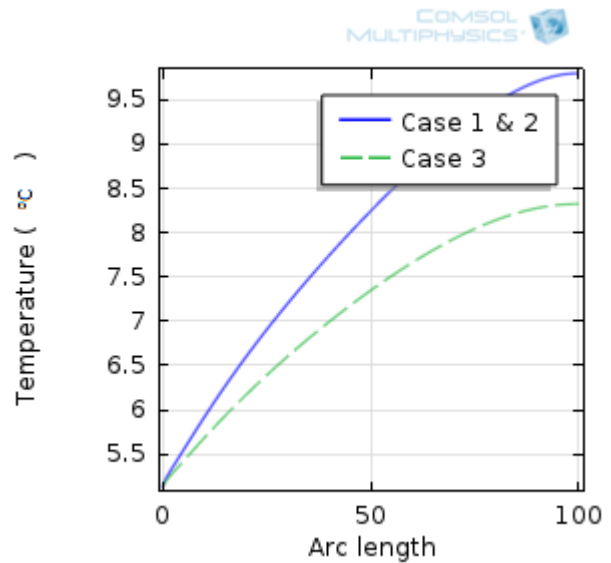

Fig. 19 Temperature distribution on cold region

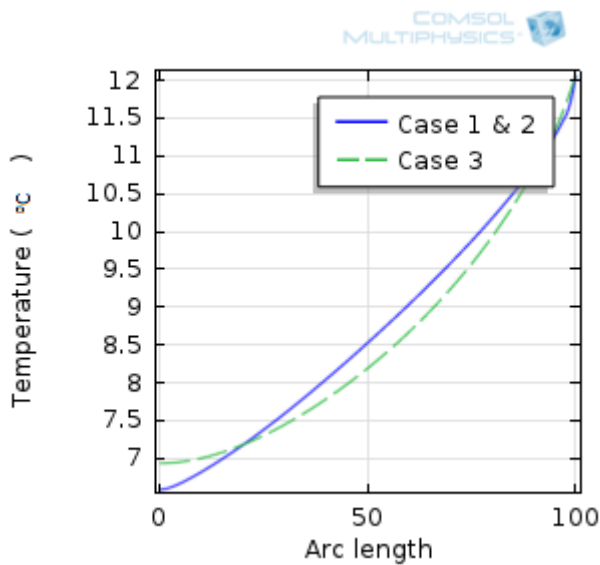

Fig. 18 Temperature distribution of hot region

VI. CONCLUSION

An acceptable model of the pipe flow considering all the parameters of the pipe including geometry, material of the fluid and the pipe, thermal response of the fluids and the pipes and the temperature profile of the sediment has been presented in this paper. An approximate value of the fluid coming out from the outlet has been obtained by simulation and compared to the measured value. The results indicate a good match between simulation values and real measurement. Simulation has been done using multi fluids having different thermal properties and the results have been presented which indicates a minimal difference in the temperature distribution. It is possible to change the configuration of the pipe to further evaluate the system with multiple pipes and to find the optimal accounts.

The response on the thermal ground has been evaluated for multiple orientation of the pipe. The arguments have been made on the basis of the thermal response. It has been noted that the insulation of the pipe is important that supposed to be used in a geothermal system application. A specific type of the pipe has been used for the evaluation in this paper but different pipe can be subjected to the test depending on the situation.

REFERENCES

- [1] COMSOL Pipe Flow Module (Model Library Manual). Version 4.4 2012.
- [2] Chamkha, Ali J. Heat and Mass Transfer of a Non-Newtonian Fluid Flow over a Permeable Wedge in Porous Media with Variable Wall Temperature and Concentration and Heat Source or Sink. WSEAS Transactions on Heat and Mass Transfer 2010. ISSN: 1790-5044.
- [3] Hiltunen, E, Martinkauppi, B, Zhu, L, Makiranta, A, Lieskoski, M and Rintaluoma, J. Renewable carbon-free heat production from urban and rural water areas. Manuscript to be submitted.
- [4] Johansson, Eric, Acuna, Jose and Palm, Bjorn. Use of Comsol as a tool in the design of an inclined multiple borehole exchanger 2012.
- [5] Kempainen, Joni. Lämpökaivojen Käyttö rakennuksen lämmityksessä (Terms of thermal wells for heating the building) 2012. Available at: <URL:http://www.theseus.fi/bitstream/handle/10024/51580/Kempainen_Joni.pdf?sequence=1>.
- [6] Lienhard, John H. A Heat Transfer Text Book. Phlogiston Press 2008. Available at: <URL: <http://web.mit.edu/lienhard/www/ahtt.html>>.
- [7] Martinkauppi, Ilkka. Sedimenttilämpömittaukset Pohjanmaalla ja Etelä-Pohjanmaalla (Sediment temperature measurements in Ostrobothnia and Southern Ostrobothnia) 2010. Available at: <URL: http://www.geoenergia.fi/pdf/L_Martinkauppi.pdf>.
- [8] Monzo, P, Acuna, J, Fossa, M and Palm, B. Numerical generation of the temperature response factors for a borehole heat exchangers field 2013.
- [9] Sarbu, Ioan. Energy analysis of low temperature heating systems. WSEAS Transactions on Heat and Mass Transfer 2010. ISSN: 1790-5044.
- [10] Schiavi, S. 3D simulation of the thermal response test in a U-tube borehole heat exchanger 2009.
- [11] Singarimbun, Alamta, Djamel, Mitra and Setyoko, Septian. Simulation of Production and Injection Process in Geothermal Reservoir Using Finite Difference Method. WSEAS Transactions on Heat and Mass Transfer 2012. E-ISSN: 2224-3461.
- [12] Sidik, Nor Awadi Che and Azmi, Mohd Irwan Mohd. Mesoscale Numerical Method for Prediction of Thermal Fluid Flow through Porous Media. WSEAS Transactions on Heat and Mass Transfer 2012. E-ISSN:2224-3461.
- [13] Stober, Ingrid and Bucher, Kurt. Geothermal Energy 2013. Page (70). ISBN 978-3-642-13352-7.
- [14] Valpola, Samu. Sedimentin lämpötilamittaukset Vaasan Suvilahden edustalla (Sediment temperature measurements in Suvilahti Vaasa) 2006. (Available in Finnish) Arkistoraportti P31.4.053. GTK Länsi-Suomenyksikkö.