



Vaasan yliopisto
UNIVERSITY OF VAASA

OSUVA Open
Science

This is a self-archived – parallel published version of this article in the publication archive of the University of Vaasa. It might differ from the original.

An enhanced contingency-based model for joint energy and reserve markets operation by considering wind and energy storage systems

Author(s): Habibi, Mahdi; Vahidinasab, Vahid; Pirayesh, Abolfazl; Shafie-khah, Miadreza; Catalão, Joao P. S.

Title: An enhanced contingency-based model for joint energy and reserve markets operation by considering wind and energy storage systems

Year: 2020

Version: Final draft (post print, aam, accepted manuscript)

Copyright ©2020 IEEE. Personal use of this material is permitted. Permission from IEEE must be obtained for all other uses, in any current or future media, including reprinting/republishing this material for advertising or promotional purposes, creating new collective works, for resale or redistribution to servers or lists, or reuse of any copyrighted component of this work in other works.

Please cite the original version:

Habibi, M., Vahidinasab, V., Pirayesh, A., Shafie-khah, M., & Catalão, J.P. S., (2020). An enhanced contingency-based model for joint energy and reserve markets operation by considering wind and energy storage systems. IEEE transactions on industrial informatics.
<https://doi.org/10.1109/TII.2020.3009105>

An Enhanced Contingency-based Model for Joint Energy and Reserve Markets Operation by Considering Wind and Energy Storage Systems

Mahdi Habibi, Vahid Vahidinasab, *Senior Member, IEEE*, Abolfazl Pirayesh, Miadreza Shafie-khah, *Senior Member, IEEE* and João P. S. Catalão, *Senior Member, IEEE*

Abstract—This paper presents a contingency-based stochastic security-constrained unit commitment to address the integration of wind power producers to the joint energy and reserve markets. The model considers ancillary services as a solution to cope with the uncertainties of the problem. In this regard, a comprehensive model is considered that maintains the profit of supplementary services. The contingency ranking is a popular method for reducing the computation burden of the unit commitment problem, but performing the contingency analysis changes the high-impact events in previous ranking methods. This paper employs an intelligent contingency ranking technique to address the above issue and to find the actual top-ranked outages based on the final solution. The proposed algorithm simultaneously clears the energy and reserve based on the mechanism of the day-ahead market. The main idea of this paper is to develop a framework for considering the most effective outages in the presence of the uncertainty of wind power without a heavy computation burden. Also, energy storage systems are considered to evaluate the impact of the scheduling of storage under uncertainties. Also, an accelerated Benders decomposition technique is applied to solve the problem. Numerical results on a six-bus and the IEEE 118-bus test systems show the effectiveness of the proposed approach. Furthermore, it shows that utilizing both wind farms and storage devices will reduce the total operational cost of the system, while the intelligent contingency ranking analysis and enough reserves ensure the security of power supply.

Index Terms—Intelligent contingency ranking, wind power intermittency, scheduling energy storage, accelerated Benders decomposition, stochastic security-constrained unit commitment.

NOMENCLATURE

Indices & Sets

b, B , slack Indices of buses, the base case, and slack bus.

The work of Miadreza Shafie-khah was supported by FLEXIMAR-Project (Novel Marketplace for Energy Flexibility), which has received funding from Business Finland Smart Energy Program, 2017-2021. The work of João P. S. Catalão was supported in part by FEDER funds through COMPETE 2020 and in part by the Portuguese funds through FCT, under POCI-010145-FEDER-029803 (02/SAICT/2017). Paper no. TII-20-1495. (*Corresponding authors: Vahid Vahidinasab; Miadreza Shafie-khah; João P. S. Catalão.*)

M. Habibi and A. Pirayesh are with the Abbaspour School of Engineering, Shahid Beheshti University, Tehran 16765-1719, Iran (e-mail: m_habibi@sbu.ac.ir; a_pirayesh@sbu.ac.ir).

V. Vahidinasab is with the Abbaspour School of Engineering, Shahid Beheshti University, Tehran 16765-1719, Iran, and also with the School of Engineering, Newcastle University, Newcastle upon Tyne NE1 7RU, United Kingdom, (e-mail: v_vahidinasab@sbu.ac.ir; vahid.vahidinasab@newcastle.ac.uk).

M. Shafie-Khah is with the School of Technology and Innovations, University of Vaasa, 65200 Vaasa, Finland (e-mail: mshafiek@univaasa.fi).

J. P. S. Catalão is with the Faculty of Engineering of the University of Porto, 4200-465 Porto, Portugal, and also with INESC TEC, 4200-465 Porto, Portugal (e-mail: catalao@fe.up.pt).

c, g, w Indices of storage, generator, and wind units.
 Co/Ge Indices of compression/generation modes.
 D, l, k Indices of load, generator blocks, and lines.
 e, s, t Indices of contingencies, scenarios, and time.
 \max/\min Indices of maximum/minimum values.
 U/D Indices of upward/downward reserves.
 $\Lambda, \gamma, \psi, \phi$ Sets of lines, generators, wind farms, and storage devices connected to bus b .

Parameters

K, X Base power [MW], reactance of lines [p.u].
 rc Realization price of reserve [\$/MWh].
 RC Cost of reserve capacity [\$/MW].
 RU, RD Ramp up/down limits of generators [MW].
 SRU, SRD Strat-up/shut-down ramp of generators [MW].
 SC, DC, NC Start-up, shut-down and no-load costs [\$/MWh].
 UE Binary status of units in contingencies.
 W, CW Available and curtailable wind power [MW].
 α Shift of lines' flow based on re-dispatches.
 Ω, η Scenarios' probability, storage efficiency [%].
 λ Incremental cost of units [\$/MWh].

Variables

CI Contingency impact variable (ranking index).
 I, J Generator, storage on/off binary variables.
 $S, S(1/2/3)$ Slack variables of load curtailment [MW].
 P, PL Dispatched power and lines' flow [MW].
 R, r Reserve capacity and its realization [MW].
 su, sd Start-up and shut-down binary variables.
 SE Stored energy of storage [MWh].
 T On/off duration of units [h].
 δ Voltage angle of different buses [rad].
 $\mu(1/\dots/7)$ Dual variables in subproblems.

I. INTRODUCTION

ECONOMY and safety are principal concerns of energy markets. The intermittency of renewable energy sources (RESs) and unscheduled outage of the components (UOCs) threaten the security cause many challenges for an optimal operation [1], [2]. Moreover, the near real-time horizon needs to introduce effective and straight methods to solve security-constrained unit commitment (SCUC) and incorporate such uncertainties. The operation under uncertainty has been investigated in many studies, but the complexity and computation burden are their consequences. Additionally, the SCUC problem becomes more complex while dealing with uncertainties

TABLE I
TAXONOMY OF PUBLICATIONS IN THE AREA

References	Model	Optimization Sys.	Uncertainty			Reserve				Storage	
			RES	Load	UOC	Check	RAC	RDC	ROC	Type	CSU
[1]	Stochastic	MOPSO	✓	✓	–	–	–	–	–	–	–
[2]	Robust	Benders	✓	–	–	–	–	–	–	–	–
[3]	Robust	CPLEX	–	–	✓	✓	✓	✓	–	–	–
[4]	Stochastic	CPLEX	–	–	Pre-selected	–	–	–	–	–	–
[5]	Economic Dispatch	Neural Network	–	–	Online Ranking	–	–	–	–	–	–
[6]	Stochastic	Decomposed Model	✓	✓	Pre-selected	✓	–	–	✓	–	–
[7]	Robust	Bi-level	–	✓	Ranking	–	–	–	–	–	–
[8]	Economic Dispatch	Ant colony	–	–	Online Ranking	–	–	–	–	–	–
[9]	Economic Dispatch	Gurobi MATLAB	–	–	Real-time	–	–	–	–	–	–
[10]	Stochastic	CPLEX	✓	–	✓	–	–	–	–	–	–
[11]	Robust	Decomposed Model	✓	–	–	✓	✓	✓	✓	ESS	✓
[12]	Robust	Benders	✓	✓	–	✓	✓	✓	✓	–	–
[13]	Robust-CCG	Benders	✓	✓	✓	–	✓	–	–	–	–
[14]	Deterministic	SPEA 2+	✓	✓	✓	✓	–	–	✓	–	–
[15]	Stochastic	ϵ -constraint	–	✓	✓	✓	–	–	–	–	–
[16]	Stochastic	Multi-objective	✓	–	–	✓	–	–	–	–	–
[17]	Stochastic	Benders	✓	–	–	✓	✓	✓	–	–	–
[18]	Deterministic	–	–	–	✓	✓	✓	✓	✓	–	–
[19]	Robust-CCG	Lagrangian	✓	–	✓	✓	✓	–	–	Battery	✓
[20]	Robust	CPLEX	–	–	–	–	–	–	–	PEVs	✓
[21]	Deterministic	Gurobi	–	–	–	✓	–	–	–	Battery	–
[22]	Deterministic	Benders	–	–	–	✓	–	–	–	CAES	–
[23]	Stochastic	Benders	✓	–	✓	✓	–	–	–	PEV	x
[24]	Stochastic	Benders	✓	✓	✓	✓	–	–	–	Battery	x
[25]	Stochastic	Multi-objective	✓	–	✓	✓	–	–	–	ESS	x
[26]	Stochastic	Decomposed Model	✓	✓	✓	✓	✓	✓	✓	Battery	✓
[27]	Robust	Benders	✓	✓	–	–	–	–	–	–	–
[28]	Stochastic	Benders	✓	–	✓	✓	✓	✓	✓	ESS	x
[29]	Stochastic	Benders	✓	✓	✓	✓	✓	✓	✓	–	–
[30]	Stochastic	Accelerated Benders	–	–	✓	–	–	–	–	Battery	✓
[31]	Stochastic	Accelerated Benders	✓	–	–	–	✓	✓	✓	–	–
This paper	CS-SCUC	ABD	✓	✓	ICRA	✓	✓	✓	✓	CAES	✓

at large-scale, and the solution time is a big issue for the comprehensive models. This paper proposed an exhaustive model considering the uncertainties of RESs and unscheduled outages, while the tailored framework guarantees the accuracy and maintains the solution time within a reasonable range. Also, the proposed framework enhances the robustness of the solution by finding the actual high-impact contingencies through the solving process. Furthermore, the model uses storage devices to improve the solutions under contingencies and in normal conditions.

A. Literature Survey

Generally, uncertainties from the operators' point of view can be divided into two categories. The first one is UOC, and the second one includes the stochastic behavior of RESs and loads. The markets usually consider outages of equipment through the contingency analysis (CA), and the scenario-based and RO models are regularly suggested for the second one.

Regarding the first, the $N-1$ contingency analysis is considered in [3] with an RO approach for a zonal reserve deployment. Considering all possible $N-1$ component outages impose a significant burden on the problem. To reduce the complexity, authors of [4] evaluate a set of possible line outages. Also, reference [6] uses a decomposed model to address pre-selected contingencies with reserve capability as the free capacity of generation. The machine learning methods are widely applied for selecting contingencies [5]. However, these methods use an

offline calculation based on historical dispatches of units, and they are not suitable for large systems. Reference [7] applies a contingency ranking analysis based on clustering outages of lines and transformers. The authors define subsets based on the potential danger of contingencies regarding the required preventive/corrective actions, and the solution is protected against the worsed case situation. A method for selecting high-impact contingencies near real-time is proposed in [8], which does not depend on large offline calculations. The main issue of the contingency ranking method is that after considering the selected events, the operation point of units may be changed by preventive actions; consequently, the high-impact events can be changed based on new dispatches. In this way, there is no guarantee that selected events provide acceptable security against possible outages. Reference [9] selects the top-ranked contingencies for the economic dispatch problem by solving the model within a loop in order to secure the final solution against the most important outages based on resulting dispatches. But, this method is not suitable for the SCUC problem because repetitive solving large scale systems will be a time-consuming process.

Regarding the second category, some of the studies introduce stochastic methods that consider scenarios for uncertainties [10]. The other popular method is robust optimization (RO) that chooses the worst case in a range for uncertainty [11], [12]. Although the RO approach addresses the uncertainties, even the advanced version has a challenge on the

distribution of uncertainty budgets. Reference [13] employs an RO approach considering the uncertainties of wind and load, but the model does not reflect the cost of ramping services for compensation. These services are used as a remedy to offset system uncertainties. The usage of ancillary services like spinning reserves lead to introduce joint energy and reserve market, that considers the explicit cost of reserves. Reference [14] presents a deterministic model for the joint energy and reserve market based on the operators point of view. A similar market with the explicit cost of energy and reserves is considered as a self-scheduling stochastic model in [15]. Similar to the uncertainty of RESs, load forecasting errors can be evaluated within scenarios. However, the magnitude of load fluctuations is low, and authors of [16] assume that the margin of deployed reserves is sufficient for the corresponding variations.

Based on the literature, the most important aspects of reserve deployments can represent with three features. The joint energy and reserve market considers the first one as reserve optimality check (ROC). Also, the reserve adequacy check (RAC) and reserve deliverability check (RDC) are the other important factors. The RAC means that the values of reserves should be wisely assigned to be enough at required situations. The RDC checks if the reserve values are deliverable through the network at the corresponding situations. Reference [17] suggests a Benders method for solving the stochastic model. The authors employ reserves to address wind uncertainties, but the cost of corrective actions (the ROC) is not considered. Reference [18] presents a deterministic model for considering the ROC, RAC, and RDC in deploying zonal reserves for first and second emergency outages. Reference [19] explores a Lagrangian-based RO with uncertainties of RESs and contingencies, where the proposed model performs the RAC.

One of the most attractive options for enhancement of operational efficiency is utility-scale energy storage systems (ESSs) [20], [21]. The scheduling reserve to alleviate wind uncertainty with considering bulk storage devices is proposed in [11]. Reference [22] presents a deterministic-based model using compressed air energy storage (CAES) units as one of the popular storage systems in the world. A similar model was investigated in [23] for the plug-in electric vehicles (PEVs). The model of [23], [24] considers the ancillary services for storage devices without checking the interdependency of storage dispatches between hours. It should be noted that any re-dispatches of the storage in different scenarios have an impact on its available energy level, and this case is ignored in their work. This concept can be defined as the commitment of storage under uncertainties (CSU). In [25], storage devices are used to address the forecasting error of wind power, but the sufficiency of their stored energy is not guaranteed in that work. Reference [26] evaluates the CSU with the definition of a feasible range for storage compensation over a 24 hours operation. However, the feasibility of the solution over a longer horizon is not guaranteed.

As expected, including different types of uncertainties impose an extra burden to the NP-hard SCUC problem, and it even gets worse in large-scale systems. In this regard, decomposition techniques are popular to reduce complexity [27]. Reference [24] studies a stochastic model for battery-based

energy storage transportation system with considering the uncertainty of the wind, load, and component outages. The complexity of the decomposed model increases when it considers the scenarios for different uncertainties. The scenarios of both component outages and wind power are considered as a probabilistic decomposed SCUC model in [28], but the solution time is significantly increased in that model. Reference [29] incorporates the scenarios of wind and load uncertainties and also $N-1$ contingencies in a Benders based decomposed model. However, the model became very complex and needed too much computing efforts. An accelerated Benders decomposition technique is suggested to reduce the computing time of the stochastic model of component outages in [30]. Authors of [31] consider acceleration techniques for a stochastic model of wind uncertainties.

The solution time is a big issue of the exhaustive models which deal with uncertainties of both RESs and UOCs. Also, the previous methods for contingency ranking faces the issue of missing the actual high-impact events by performing preventive actions. This paper covers the above gaps by introducing a well-tuned framework with low complexity, and it is secured against the actual high-impact UOCs based on the final solution, and wind power fluctuations will be addressed by deploying reserve services.

B. Contributions

Table I presents a taxonomy of existing approaches and reviews the previous researches. The last row of this table represents the specifications of this paper. In this study, we intended to develop a contingency-based stochastic security-constrained unit commitment (CS-SCUC) that addresses scenarios for wind power and different load levels. An intelligent contingency ranking analysis (ICRA) is developed to secure the CS-SCUC against the high-impact outages, and it does not impose a heavy computation burden while it is considered within the solving process. Unlike previous ranking methods that use pre-selected contingencies, the proposed technique uses the commitment of units of the final solution to calculate the ranking index and select the top-ranked outages. The model contains all concept of RAC, RDC, and ROC for reserve deployment to enhance the system security. Also, CAES units are employed as storage devices with considering the CSU concept. An accelerated Benders decomposition (ABD) method with some modifications is used to reduce the complexity. A six-bus and the IEEE 118-bus test systems have been evaluated to analyze the performance of the intended model. In brief, the main contributions of this paper can be recapitulated as follows:

- Proposing a comprehensive stochastic model with relatively low computation burden and high accuracy;
- Considering an intelligent contingency ranking analysis to address the actual high-impact contingencies calculated based on the resulting schedule.

Section II provides the wind speed model while the intelligent contingency ranking method presented in section III. The proposed CS-SCUC model is designated in section IV. Case studies and numerical results are given in section V, and section VI concludes the paper.

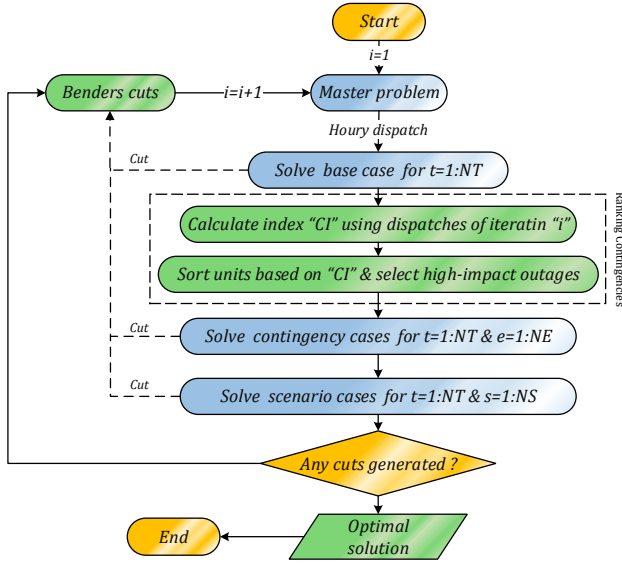

Fig. 1. Flowchart of solving decomposed CS-SCUC

II. SCENARIOS OF THE WIND SPEED

The output power of wind turbines varies with wind speed. Each turbine has an output power curve based on its manufacturing characteristic. Probability distribution functions are commonly used to address wind power uncertainties. For example, Weibull function in [23], and Beta function in [24] are considered as the distribution of wind speed. As expanding a new distribution model is beyond the scope of this paper, regular Weibull distribution is considered for the generation of wind speed scenarios.

In this article, the meteorological prediction of wind speed is used as the mean value [32], and the standard deviation increases from 1% to 20% through the operation period. First, 1000 samples with the above conditions are generated, and a scenario reduction method based on probability distance is used based on [33]. After this stage, the output power of a wind turbine is calculated by the power curve and is multiplied by the number of turbines to calculate a wind farm production.

This paper considers the stochastic behavior of wind power as a source of uncertainty to evaluate the performance of the model dealing with both contingencies and scenarios of variable resources. However, other types of renewable generations can be incorporated in the same way.

III. INTELLIGENT CONTINGENCY RANKING METHOD

As mentioned, a massive computation burden is forced to the CS-SCUC problem by performing $N-1$ contingency analysis. To reduce the model complexity, we employed an intelligent ranking method, in which the outages of generators are considered as contingencies. The proposed model evaluates the failure impact of dispatched generators on lines' congestion and prepares a priority list. First, the parameter " α_g^l " is calculated for all generators [33]. This parameter represents the change in line flows due to 1 MW change in the generation of units. By multiplying this parameter to normalized line flow and unit output power, the impact of outages on the loading

of lines can be obtained as $CI_{g,t}$ in (1). By sorting $CI_{g,t}$ of generators, we choose the top-ranking outages for ICRA.

$$CI_{g,t} = \sum_l (PL_l^t / PL_l^{\max}) \cdot \alpha_g^l \cdot \sum_k P_{g,t}^k. \quad (1)$$

The main difference of the intelligent contingency ranking method with the previous ranking method is that selected contingencies are calculated and updated using the last dispatches during the solving process, as it is illustrated in Fig. 1. Hence, the proposed method can ensure the selected high-rank contingencies are matched to the final solution because the algorithm terminates only if the solution is safe against the calculated contingencies.

IV. PROPOSED CS-SCUC FORMULATION

In this section, a CS-SCUC formulation is presented based on the Benders algorithm. The original problem is decomposed into a master problem and three subproblems. The subproblems check the master solution with the network constraints for each t , c , and s .

Fig. 1 shows the proposed algorithm. First, the master problem is solved. After that, the base case subproblem is solved with fixed values of the master's solution. After that, using the calculated power flow of the base case and dispatches of the master solution, the high ranked outages are selected. After that, the emergency case subproblem checks the feasibility of decision variables under top-ranked events. Finally, the scenario case subproblem checks the feasibility under different scenario realizations. In each case, the corresponding Benders cut is generated for infeasible subproblems. The subproblems are defined based on [31] to generate strong cuts. Also, the subproblems are independent and are solved in each loop from the beginning, and it will accelerate the convergence of the proposed algorithm. The algorithm will continue until any new cuts are not generated.

A. Master Problem

The objective function of master problem (2) is to minimize total operation costs including start-up and shut-down costs, no-load cost, reserve cost, regeneration cost of storage devices, the expected value of generation and lost opportunity costs. The lost opportunity cost (LOC) is a payment for contracted energy that is not utilized in operation. Also, the hourly cost of generators' production " $P_{g,t}^{k,s}$ " is considered in a stepwise form. The master problem constraints consist of (3)–(28).

$$\begin{aligned} \min_{I, P, Q} \sum_t \sum_g (SC_t st_{g,t} + DC_g sd_{g,t} + NC_g I_{g,t} + \\ RC_g^+ R_{g,t}^{+, \max} + RC_g^- R_{g,t}^{-, \max}) + \sum_t \sum_c (\lambda_c^{Ge} \zeta^t P_{c,t}^{Ge}) \\ + \sum_t \sum_s \sum_g \Omega_s (rc_g^- r_{g,t}^{-, s} + \sum_k \lambda_g^k P_{g,t}^{k,s}) \end{aligned} \quad (2)$$

s.t: (3)–(28)

The constraints of conventional generators are presented by (3)–(17). Constraint (3) indicate the start-up/shut-down variables, (4) and (5) check the minimum online and offline

durations, (7)–(10) are generation limits, and (11) and (12) are related to the ramp rate limits.

$$st_{g,t} - sd_{g,t} = I_{g,t} - I_{g,(t-1)} \quad (3)$$

$$st_{g,t} \leq I_{g,\tau} \quad \forall t \leq \tau \leq t + T_g^{\text{on,min}} - 1 \quad (4)$$

$$sd_{g,t} \leq 1 - I_{g,\tau} \quad \forall t \leq \tau \leq t + T_g^{\text{off,min}} - 1 \quad (5)$$

$$P_{g,t}^s = \sum_k P_{g,t}^{k,s} \quad (6)$$

$$P_{g,t}^{k,s} \leq P_g^{k,\max} I_{g,t} \quad (7)$$

$$P_{g,t} \leq P_g^{\max} I_{g,t} \quad (8)$$

$$P_{g,t} \geq P_g^{\min} I_{g,t} \quad (9)$$

$$P_{g,t}^s \geq P_g^{\min} I_{g,t} \quad (10)$$

$$P_{g,t} - P_{g,(t-1)} \leq RU_g I_{g,t} + SRU_g st_{g,t} \quad (11)$$

$$P_{g,(t-1)} - P_{g,t} \leq RD_g I_{g,t} + SRD_g sd_{g,t}. \quad (12)$$

The following constraints calculate the adequate reserves regarding the scenarios of wind power fluctuations.

$$P_{g,t}^s = P_{g,t} + r_{g,t}^{U,s} - r_{g,t}^{D,s} \quad (13)$$

$$R_{g,t}^{U,\max} \geq r_{g,t}^{U,s} \quad (14)$$

$$R_{g,t}^{D,\max} \geq r_{g,t}^{D,s} \quad (15)$$

$$r_{g,t}^{U,s} \leq RU_g I_{g,t} \quad (16)$$

$$r_{g,t}^{D,s} \leq RD_g I_{g,t}. \quad (17)$$

The wind generation is limited by available wind power as follows:

$$P_{w,t}^s \leq W_{w,t}^s \quad (18)$$

$$\sum_s \psi_s (W_{w,t}^s - P_{w,t}^s) \leq CW_{w,t}. \quad (19)$$

Constraints (20) and (21) represent total generation and consumption balance for base and scenario cases, respectively.

$$\sum_g P_{g,t}^s + \sum_c P_{c,t} + \sum_w P_{w,t}^s = \sum_b P_{b,t}^D \quad (20)$$

$$\sum_g P_{g,t} + \sum_c P_{c,t} + \sum_s \Omega_s \sum_w P_{w,t}^s = \sum_b P_{b,t}^D. \quad (21)$$

As stated, the CAES units are considered as storage devices, and the corresponding constraints are presented by (22)–(28). The efficiency of CAESs is 95% in the charging and discharging processes [22].

$$J_{c,t}^{Co} + J_{c,t}^{Ge} \leq 1 \quad (22)$$

$$SE_{c,(t+1)} = SE_{c,t} + P_{c,t}^{Co} \eta_c^{Co} - P_{c,t}^{Ge} / \eta_c^{Ge} \quad (23)$$

$$SE_{c,t}^{\min} \leq SE_{c,t} \leq SE_{c,t}^{\max} \quad (24)$$

$$SE_{c,t_0} = SE_{c,t_{24}} \quad (25)$$

$$P_{c,Ge}^{\min} J_{c,t}^{Ge} \leq P_{c,t}^{Ge} \leq P_{c,Ge}^{\max} J_{c,t}^{Ge} \quad (26)$$

$$P_{c,Co}^{\min} J_{c,t}^{Co} \leq P_{c,t}^{Co} \leq P_{c,Co}^{\max} J_{c,t}^{Co} \quad (27)$$

$$P_{c,t} = P_{c,t}^{Ge} - P_{c,t}^{Co}. \quad (28)$$

B. Base Case Subproblem

The base case includes the predicted scenario of wind power. This subproblem checks the solution if any violations come to the network constraints in the base case. The objective

function and the constraints are presented as (29)–(33). If the objective function gets a positive value, a Benders cut will be generated based on (34). Also, $\mu_{b,t}^1$ and $\mu_{b,t}^2$ are dual variables of (32) and (33), respectively.

$$\min S_B^t \quad (29)$$

$$\text{s.t: (30)–(33)}$$

$$-PL_l^{\max} \leq (PL_l^t = K(\delta_{\text{from}(l)}^t - \delta_{\text{to}(l)}^t) / X_l) \leq PL_l^{\max} \quad (30)$$

$$-\pi/2 \leq \delta_b^t \leq \pi/2 \quad ; \quad \delta_{b,\text{slack}}^t = 0 \quad (31)$$

$$\sum_{l \in \Lambda} PL_l^t + P_{b,t}^D - S_B^t \leq \sum_{g \in \gamma} \hat{P}_{g,t} + \sum_{c \in \phi} \hat{P}_{c,t} + \sum_s \Omega_s \sum_{w \in \psi} \hat{P}_{w,t}^s \quad (32)$$

$$\sum_{l \in \Lambda} PL_l^t + P_{b,t}^D + S_B^t \geq \sum_{g \in \gamma} \hat{P}_{g,t} + \sum_{c \in \phi} \hat{P}_{c,t} + \sum_s \Omega_s \sum_{w \in \psi} \hat{P}_{w,t}^s \quad (33)$$

$$S_B^t + \sum_b (\mu_{b,t}^1 - \mu_{b,t}^2) \left[\sum_{g \in \gamma} (P_{g,t} - \hat{P}_{g,t}) + \sum_{c \in \phi} (P_{c,t} - \hat{P}_{c,t}) + \sum_s \Omega_s \sum_{w \in \psi} (P_{w,t}^s - \hat{P}_{w,t}^s) \right] \leq 0. \quad (34)$$

C. Emergency Case Subproblem

This subproblem checks the master solution for NE top-ranked emergency outages with the priority list that calculated according to the base case lines flow. In each contingency, the binary multiplier of the corresponding generator “ $UE_{g,t}^e$ ” is set to zero by the model. The objective function and constraints of the subproblem are defined as (35)–(45). If the value of the objective function becomes positive, a Benders cut will be generated as (46). Here, $\mu_{g,t}^1, \dots, \mu_{g,t}^4, \mu_{b,t}^5, \mu_{b,t}^6$, and μ_{t}^7 are dual variables of (38)–(44), respectively.

$$\min (S_e^t = S1_e^t + S2_e^t + S3_e^t) \quad (35)$$

$$\text{s.t: (36)–(45)}$$

$$-PL_l^{\max} \leq (PL_l^{t,e} = K(\delta_{\text{from}(l)}^{t,e} - \delta_{\text{to}(l)}^{t,e}) / X_l) \leq PL_l^{\max} \quad (36)$$

$$-\pi/2 \leq \delta_b^{t,e} \leq \pi/2 \quad ; \quad \delta_{b,\text{slack}}^{t,e} = 0 \quad (37)$$

$$P_{g,t}^e - \hat{P}_{g,t} UE_{g,t}^e \leq RU_g \hat{I}_{g,t} UE_{g,t}^e \quad (38)$$

$$\hat{P}_{g,t} UE_{g,t}^e - P_{g,t}^e \leq RD_g \hat{I}_{g,t} UE_{g,t}^e \quad (39)$$

$$P_{g,t}^e \leq P_g^{\max} \hat{I}_{g,t} UE_{g,t}^e \quad (40)$$

$$P_{g,t}^e \geq P_g^{\min} \hat{I}_{g,t} UE_{g,t}^e \quad (41)$$

$$\sum_{l \in \Lambda} PL_l^{t,e} + P_{b,t}^D - S1_e^t \leq \sum_{g \in \gamma} P_{g,t}^e + \sum_{c \in \phi} \hat{P}_{c,t} + \sum_{w \in \psi} P_{w,t}^e \quad (42)$$

$$\sum_{l \in \Lambda} PL_l^{t,e} + P_{b,t}^D + S1_e^t \geq \sum_{g \in \gamma} P_{g,t}^e + \sum_{c \in \phi} \hat{P}_{c,t} + \sum_{w \in \psi} P_{w,t}^e \quad (43)$$

$$\sum_g P_{g,t}^e + \sum_w P_{w,t}^e + \sum_c \hat{P}_{c,t} + S2_e^t - S3_e^t = \sum_b P_{b,t}^D \quad (44)$$

$$P_{wt}^e \leq \sum_s \Omega_s W_{wt}^s \quad (45)$$

$$S_e^t + \sum_g UE_{g,t}^e \left[(\mu_{g,t}^1 - \mu_{g,t}^2) (P_{g,t} - \hat{P}_{g,t}) + (RU_g \mu_{g,t}^1 + RD_g \mu_{g,t}^2 + P_g^{\max} \mu_{g,t}^3 - P_g^{\min} \mu_{g,t}^4) (I_{g,t} - \hat{I}_{g,t}) \right] + \sum_b (\mu_{b,t}^5 - \mu_{b,t}^6) \sum_{c \in \phi} (P_{c,t} - \hat{P}_{c,t}) - \mu_{t}^7 \sum_c (P_{c,t} - \hat{P}_{c,t}) \leq 0. \quad (46)$$

D. Scenario Case Subproblem

The scenario check subproblem with objective function and constraints as (47)–(51) evaluates whether the master solution makes any violations in network buses for each scenario or not. It is to be noted here that, to reach a feasible CSU for storage, the power “ $\hat{P}_{c,t}$ ” has no index of scenarios. This case checks the power of generators “ $\hat{P}_{g,t}^s$ ” for different scenarios. This parameter includes the energy and reserves of the master problem. If the value of the objective function becomes positive, a Benders cut will be generated as (52). Here, $\mu 1_{b,t}^s$ and $\mu 2_{b,t}^s$ are dual variables of (50) and (51), respectively.

$$\min S_s^t \quad (47)$$

s.t: (48)-(51)

$$-PL_l^{\max} \leq (PL_l^{t,s} = K(\delta_{\text{from}(l)}^{t,s} - \delta_{\text{to}(l)}^{t,s})/X_l) \leq PL_l^{\max} \quad (48)$$

$$-\pi/2 \leq \delta_b^{t,s} \leq \pi/2 \quad ; \quad \delta_{b_{\text{slack}}}^{t,s} = 0 \quad (49)$$

$$\sum_{l \in \Lambda} PL_l^{t,s} + P_{b,t}^D - S_s^t \leq \sum_{g \in \gamma} \hat{P}_{g,t}^s + \sum_{c \in \phi} \hat{P}_{c,t} + \sum_{w \in \psi} \hat{P}_{w,t}^s \quad (50)$$

$$\sum_{l \in \Lambda} PL_l^{t,s} + P_{b,t}^D + S_s^t \geq \sum_{g \in \gamma} \hat{P}_{g,t}^s + \sum_{c \in \phi} \hat{P}_{c,t} + \sum_{w \in \psi} \hat{P}_{w,t}^s \quad (51)$$

$$S_s^t + \sum_b (\mu 1_{b,t}^s - \mu 2_{b,t}^s) \left[\sum_{g \in \gamma} (P_{g,t}^s - \hat{P}_{g,t}^s) + \sum_{c \in \phi} (P_{c,t} - \hat{P}_{c,t}) + \sum_{w \in \psi} (P_{w,t}^s - \hat{P}_{w,t}^s) \right] \leq 0. \quad (52)$$

V. COMPUTATIONAL RESULT

A six-bus and the IEEE 118-bus test systems are used to examine the proposed CS-SCUC model that considers wind speed uncertainties and unexpected outages. The algorithm performance is analyzed in the term of security in contingencies, and how wind and storage units affect system total cost and peak shaving. The solver duality gap for solving the master problem is set zero for the 6-bus test system, and we decrease it between 0.001 and 0.0001 to increase the speed in initial iterations for the IEEE 118-bus test system. All tests were implemented using CPLEX, on a laptop with Intel 7-core 2.4 GHz and 8 GB of RAM.

A. Six-bus Test System

The six-bus test system of Fig. 2 is used to analyze the proposed algorithm [34]. The system has three generators, one wind farm and one CAES unit that both are added to the bus number 4. The information of generators, lines, and

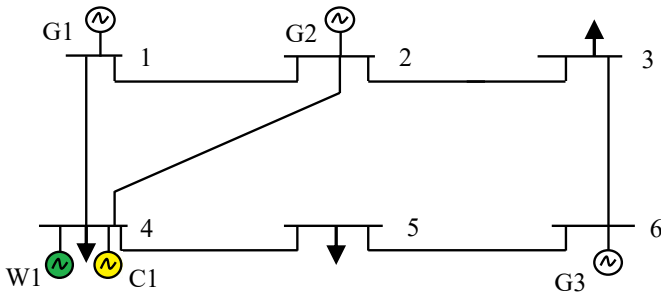

Fig. 2. Single line diagram of six-bus test system [34]

TABLE II
SPECIFICATIONS OF ESSs (MW) IN SIX-BUS TEST SYSTEM

CAES	$P_{c,Ge}^{\max}$	$P_{c,Ge}^{\min}$	$P_{c,Co}^{\max}$	$P_{c,Co}^{\min}$	SE_c^{\max}	SE_c^{\min}	SE_{ct_0}
C1	110	5	110	5	500	50	60

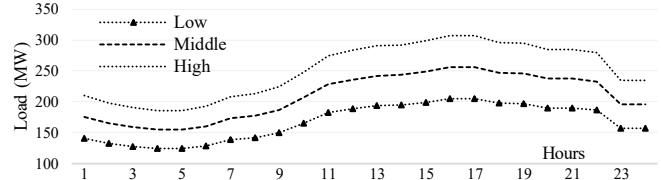

Fig. 3. Different load levels of six-bus test system

loads are given in [34]. In this study, the maximum permitted re-dispatches of generators are assumed to be the same as their ramp rate limits. The information of the applied CAES unit is listed in Table II. The real forecasted values of the wind speed on 27 November 2018 are used for modeling the wind. As Fig. 3 shows, three load levels are considered to address load variations. So, the system operator can choose the corresponding schedule based on actual load levels. Fig. 4 presents five scenarios that are obtained based on the scenario reduction method.

The power curve of the Lagerwey 750 KW wind turbine is used to calculate the output power according to [35]. In this case, 134 wind turbines of this type are considered for the wind farm. The parameter $CW_{w,t}$ is considered to be 90% of forecasted wind power in each hour. The multiplier “ ζ ” is the normalized inverse of the hourly load by the inverse value of the peak-load and multiplied to the storage cost to reach an optimized CSU. Two cases are defined for this test system.

Case 1: this case analyzes the result of the one-hour operation. Table III shows the generation, re-dispatch of units, the LOC, and the cost of different scenarios at hour 15. It can be seen that the corrective dispatch is prepared by G1, and the sum of production of generators and wind farms is equal to the constant value of 289.1 MW in different scenarios. The constant production of storage is 9.5 MW because it does not participate in scenarios. So, the total production will be 298.6 MW, which is equal to the load value at hour 15. Therefore, the generation/consumption is balanced at scenario-level, and the model successfully obtained decision variables.

Case 2: this case evaluates the 24-hour results of the proposed CS-SCUC model. Fig. 5 compares the cost of total operation in different conditions of the presence of the wind farm and CAES unit at the middle-load level. Adding the storage device to the basic SCUC reduces 4.3% of the total cost. The wind farm reduces 10.8% alone, and the simultaneous deployment of CAES unit and wind farm decrease more than 13% of the total cost, and it falls to \$97670.

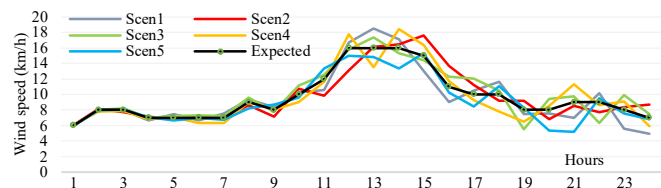

Fig. 4. Wind speed scenarios of wind farm

TABLE III
GENERATION DISPATCHES IN DIFFERENT SCENARIOS AT HIGH-LOAD

Parameter	Scen1	Scen2	Scen3	Scen4	Scen5	Base
Probability	0.208	0.173	0.238	0.212	0.169	1
G1 (MW)	203.2	180.1	191.4	180.1	182.4	188
G2 (MW)	33.4	33.4	33.4	33.4	33.4	33.4
G3 (MW)	20	20	20	20	20	20
W1 (MW)	32.5	55.6	44.3	55.6	53.2	47.7
Sum (MW)	289.1	289.1	289.1	289.1	289.1	289.1
$\Delta G1$ (MW)	15.2	-7.9	3.4	-7.9	-5.5	0
Curt-W1 (MW)	0	20.8	0	8.1	0	5.3
LOC (\$)	0	32.4	0	32.4	22.7	16.3
Gen. Cost (\$)	6377.4	5723	6043.2	5723	5789.8	5946.6

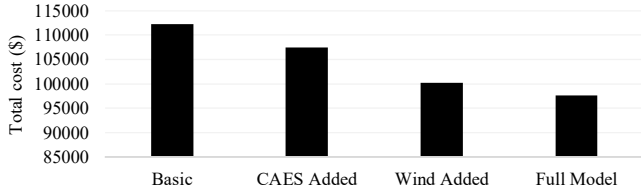

Fig. 5. Comparison of the operation cost in different conditions at middle-load

The CS-SCUC results with ICRA at high-load is presented in Fig. 6. The system generators supply the high-load, and the wind farm is dispatched over 90%. Also, the CAES unit is mainly charged at the off-load hours of 1 to 9, and it regenerates the power at peak-load hours of 15 to 22. The corresponding operational cost is \$137710. With considering both wind farm and CAES unit, the system peak-load is significantly reduced, and also the valley is filled at different load levels. The efficient pricing of storage leads to a flat curve for the operation of generators. The peak of generators' total production decreases 67.3 MW or 21.9% of initial peak-load.

The penetration of utilized wind power is expressed in Fig. 7. Wind energy penetration is the fraction of energy produced by wind compared to the total generation. It can be seen the wind penetration is about 20% in 4 hours. Fig. 8 shows sufficient hourly reserves for covering wind power fluctuations. The reserve's value is defined as the maximum of re-dispatches needed in scenarios. For example, at hour 15 the upward reserve is equal to 15.2 MW and the downward reserve is 7.9 MW, and they are sufficient to cover all scenarios based

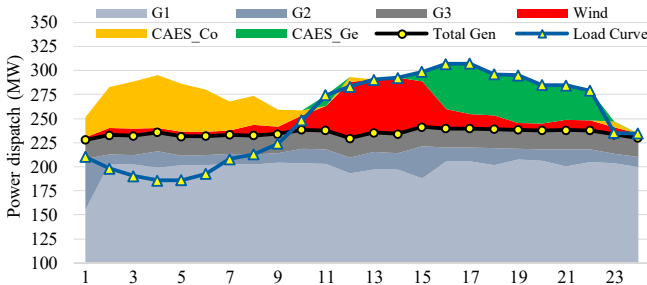

Fig. 6. Generation dispatch with ICRA at high-load

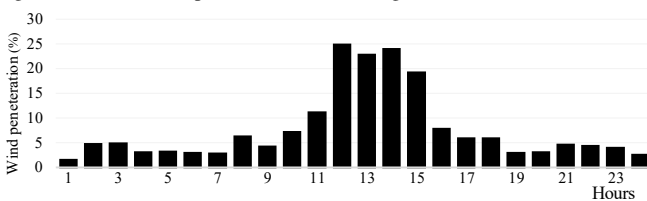

Fig. 7. Wind penetration in operation period with ICRA at middle-load

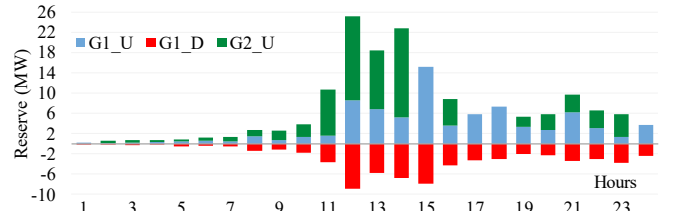

Fig. 8. Sufficient hourly reserve with ICRA at high-load

TABLE IV
ANALYSIS OF DIFFERENT LOAD LEVELS AND UNITS' COMBINATIONS

Load level	Low		Middle		High		
	ICRA	No	Yes	No	Yes	No	Yes
Basic		78252	78252	112285	INF	INF	INF
ESS added		77987	77987	107429	108218	149219	INF
Wind added		69881	69881	100159	INF	INF	INF
C&W added		69502	69502	97670	97851	134905	137710

*INF= problem is infeasible

on Table III. Hence, the result shows the RAC is checked for all scenarios. These reserves will be bought in the day-ahead market as capacities at a lower price compared to the energy prices. The realization cost of reserves as energy is settled in the clearing markets. With the intended model for reserves, the ROC is successfully guaranteed. Also, the scenario case subproblem performs the RDC for all scenarios, and all reserves are deliverable at the corresponding time and scenario.

Table IV represents values of the objective function in different combinations of adding wind farm and CAES unit to the basic SCUC to analyze the impact of considering ICRA and different load levels on total operational cost. At low-load, the ICRA has no impact on the operational cost in different conditions because the optimal solution for the base case is satisfying the constraints of contingencies. At middle-load without ESS, the operation is infeasible with ICRA. In this case, adding the wind farm is just lowering the total cost, and adding the storage device makes system operation feasible with ICRA. Although the CAES unit is not participating in contingencies, the corresponding extra capacity adds a preventive action capability to shift the base dispatches. At high-load, the additional cost of considering ICRA is \$2805 and about 2% compared to the non-secured case.

In this test system, the worst-case situation (NE=1) is considered for ICRA. This study assumes that only wind units and conventional generators participate in corrective actions for securing UOC, and storage devices have a fixed schedule. Table V represents the hourly emergency outages at high-load and the respective re-dispatch of generators. The result shows that the worst outage is G2 at hour 1 and hour 15, and G3 during the rest hours.

As stated, previous methods of selecting high-impact contingencies do not use the resulting dispatches of units, and this issue is shown in Table VI. As a test, the calculated high-ranked contingencies using the dispatches of units of the case without contingency analysis is used as selected events for contingency analysis. As can be seen, after performing contingency analysis, the high-ranked events are changed based on new dispatches. The reason is that preventive actions

TABLE V
 GENERATION RE-DISPATCHES (MW) WITH ICRA AT HIGH-LOAD

Hours	Outage	G1	G2	G3	W1
1	G2	+53.13	-53.15	0	+0.01
2	G3	-7.26	+34.86	-20	-7.6
3	G3	-7.05	+34.58	-20	-7.54
4	G3	-5.08	+29.66	-20	-4.58
5	G3	-1.94	+21.89	-20	+0.04
6	G3	-1.45	+21.29	-20	+0.16
7	G3	-4.57	+29.16	-20	-4.59
8	G3	+0.4	+19.33	-20	+0.27
9	G3	-0.45	+20.19	-20	+0.25
10	G3	+1.32	+17.79	-20	+0.89
11	G3	+6.06	+12.7	-20	+1.23
12	G3	+1.6	+50	-20	-31.6
13	G3	+19.13	-5.05	-20	+5.93
14	G3	+19.64	-4.62	-20	+4.98
15	G2	+28.05	-33.36	0	+5.3
16	G3	-6.25	+46.01	-20	-19.75
17	G3	+7.46	+10.9	-20	+1.65
18	G3	+9.91	+8.59	-20	+1.5
19	G3	-0.69	+27.61	-20	-6.92
20	G3	-1	+28.08	-20	-7.08
21	G3	+9.92	+9.05	-20	+1.02
22	G3	+4.91	+14.04	-20	+1.05
23	G3	+2.56	+16.61	-20	+0.83
24	G3	+4.61	+20.13	-20	-4.74

 TABLE VI
 COMPARISON OF SELECTED HIGH-RANKED CONTINGENCIES IN PREVIOUS METHOD AGAINST THE ICRA

Hours	Previous method			ICRA	Previous method			ICRA
	Befor CA	After CA	ICRA		Hours	Befor CA	After CA	
1	G2	G2	G2	G2	13	G3	G3	G3
2	G3	G3	G3	G3	14	G3	G3	G3
3	G3	G3	G3	G3	15	G3	G2	G2
4	G3	G3	G3	G3	16	G3	G2	G3
5	G3	G3	G3	G3	17	G3	G2	G3
6	G3	G3	G3	G3	18	G2	G3	G3
7	G3	G3	G3	G3	19	G2	G3	G3
8	G3	G3	G3	G3	20	G2	G3	G3
9	G3	G3	G3	G3	21	G2	G3	G3
10	G3	G3	G3	G3	22	G2	G3	G3
11	G3	G2	G3	G3	23	G3	G3	G3
12	G3	G3	G3	G3	24	G3	G3	G3

are performed, and the operation point is changed; consequently, the evaluated events no longer stand as top-ranked outages. The proposed ICRA cover this gap by performing the selection of contingencies based on the updating indices in each iteration. In this way, rather than considering different contingencies in each iteration, the selected events are top contingencies regarding the final solution.

A sensitivity analysis on different locations of the CAES unit is performed for different cases with considering ICRA in Table VII. It can be seen, the model is feasible only at B4 and B5 at high-load, and the best location for CAES is obtained besides the wind farm at B4.

The comparison of electricity price in different conditions of considering ICRA and the presence of CAES unit and wind farm at middle-load is shown in Fig. 9. As expected, consider-

 TABLE VII
 SENSITIVITY ANALYSIS ON LOCATION OF CAES UNITS

Load level	Electrical buses					
	B1	B2	B3	B4	B5	B6
Low	69502	69502	69502	69502	69502	69502
Middle	99860	98291	98195	97851	97904	98154
High	INF	INF	INF	137710	137780	INF

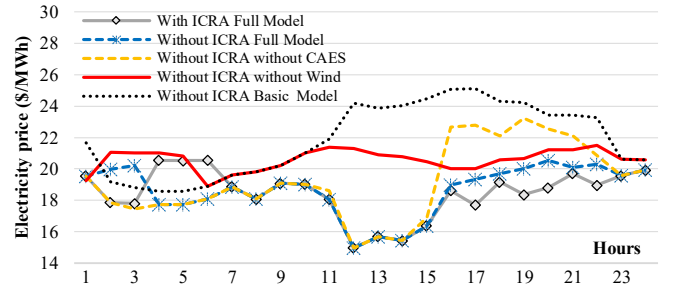

Fig. 9. Comparison of electricity prices at middle load

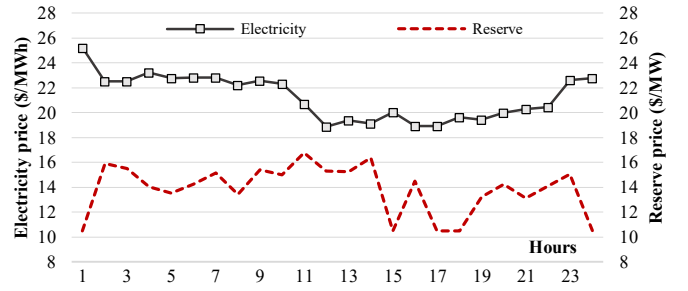

Fig. 10. Prices of electricity and reserve with ICRA at high load

ing wind farm (case without CAES) lowering electricity price, especially at windy hours of 11 to 15, but the prices are still high at peak-load hours. The CAES unit reduces the electricity price at peak-load, while it increases the price during low-load hours of 2 to 5. The full model presents the best performance, and the reason for lower electricity prices of the case with ICRA in peak-load hours is that storage discharging more energy in this case while the corresponding implicit cost of charging power was paid at hours of 4 to 6. The hourly prices of electricity and reserve at high-load is presented in Fig. 10, and we can see the highest reserve prices happen at hours with maximum available wind power at minimum electricity prices.

B. IEEE 118-bus Test System

The IEEE 118-bus test system [36] with 76 generators, 186 lines, and 91 loads is used to test the proposed model at large-scale. Detailed information of this test system is given in [36]. The peak of high-load is 7200 MW and occurs at hour 21. Also, the peak values of middle-load and low-load are 6000 MW and 4800 MW, respectively. As Fig. 11 shows, three wind farms with a capacity of 500 MW, 600 MW, and 500 MW are added to buses 15, 59, and 80, respectively. Also, next to each of the wind farms, a CAES unit is considered. The information of storage units is given in Table VIII. The same wind speed data is considered for calculating the power of wind farms.

Fig. 12 shows the CS-SCUC result at high-load. The CAES units store the extra energy of wind farms and cheap generators at low-load (valley filling) and generate at peak-load (peak-shaving). The wind farms and CAES units decrease 16.5% of

 TABLE VIII
 SPECIFICATIONS OF ESSs (MW) IN THE IEEE 118-BUS TEST SYSTEM

CAES	$P_{c,Ge}^{\max}$	$P_{c,Ge}^{\min}$	$P_{c,Co}^{\max}$	$P_{c,Co}^{\min}$	SE_c^{\max}	SE_c^{\min}	SE_{ct_0}
C1	300	10	300	10	1200	40	60
C2	400	20	400	20	1600	50	60
C3	300	10	300	10	1200	40	60

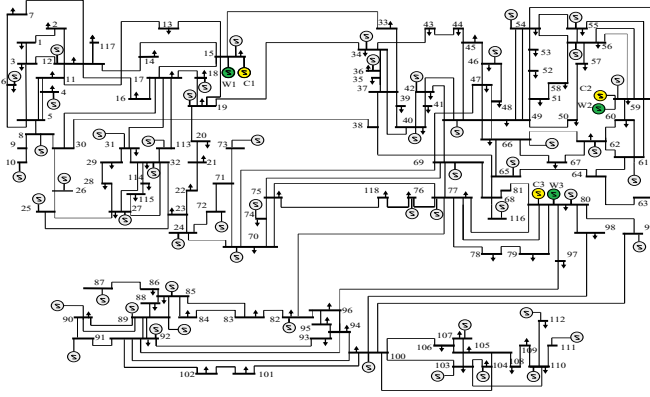

Fig. 11. Single line diagram of the IEEE 118-bus test system [36]

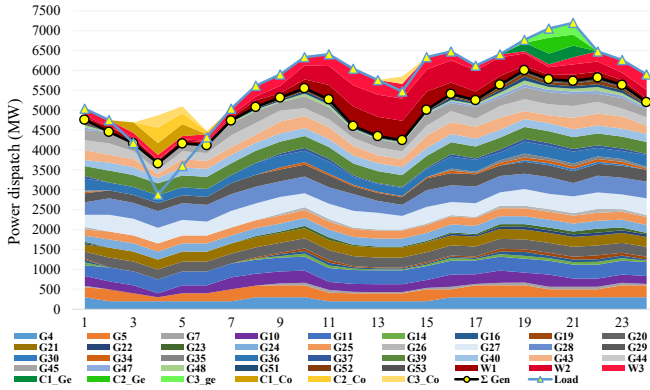

Fig. 12. Generation dispatches with ICRA at high-load

system peak-load, and the total generation of system generators reach to 6010 MW. The system minimum load increases 27% from 2880 MW to 3667 MW. The total operational cost at three load levels with and without considering ICRA are given in Table IX. In this test system, the solution is secured against the three high-impact outages (NE=3). Similar to the six-bus test system, the result shows that the ICRA has little impact at low-load. The same price of several groups of generators in this test system is the reason for small changes by considering contingency analysis. The obtained most dangerous contingency events based on the ICRA are reported in Table X.

Fig. 13 presents the value of reserves that the operator will require in the day-ahead market. The requirements for the operational reserve are increased with increasing penetration of wind power and the forecasting error through the operation horizon. Fig. 14 represents the penetration of wind power for 24 hours. The wind farms supply up to 30% of the total hourly load. Fig. 15 illustrates the amount of wind power curtailment. These values are lower than 10% during the operation period.

The hourly prices of the electricity and reserve for this test

Load level	ICRA=No	ICRA =Yes
Low	1034879	1034879
Middle	1407574	1407598
High	1820535	1820566

TABLE X
HIGH-IMPACT OUTAGES WITH ICRA AT MIDDLE-LOAD

	<i>E1</i>	<i>E2</i>	<i>E3</i>		<i>E1</i>	<i>E2</i>	<i>E3</i>
1	G39	G44	G45	13	G39	G27	G44
2	G39	G44	G45	14	G39	G27	G44
3	G39	G27	G28	15	G39	G43	G45
4	G39	G27	G28	16	G39	G44	G43
5	G39	G40	G27	17	G39	G43	G45
6	G39	G40	G43	18	G39	G44	G43
7	G39	G44	G45	19	G44	G45	G39
8	G39	G44	G45	20	G44	G39	G45
9	G39	G44	G43	21	G44	G39	G45
10	G39	G43	G45	22	G39	G44	G43
11	G39	G43	G45	23	G39	G43	G45
12	G39	G27	G28	24	G39	G27	G28

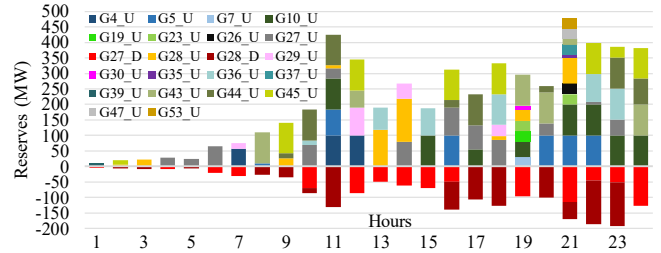

Fig. 13. Sufficient hourly reserve with ICRA at high-load

system at high-load and with considering ICRA is presented in Fig. 16. As can be seen, the curve of electricity prices follows the pattern of the total production of generators in Fig. 12, and the reserve price depends on available wind power and coincidence with peak-load hours.

Table XI compares the overall time in two conditions to evaluate the impact of the proposed method. In the six-bus test system with ICRA at high-load, the computing time with no acceleration was 79 seconds, and it converged in 12 iterations. After performing the proposed ABD, the final solution obtained in 7 iterations and 62 seconds. The computing time of the IEEE 118-bus is 595 seconds, while this time was 921 seconds with no acceleration techniques. The number of iterations was 25, and this number is reduced to 12 iterations by applying the proposed ABD method.

VI. CONCLUSION

This paper presents a contingency-based SCUC that is considering wind uncertainty. The model is analyzed at different load levels. An intelligent contingency ranking analysis is

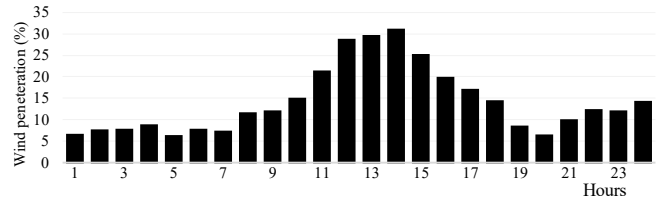

Fig. 14. Wind penetration in operation period with ICRA at high-load

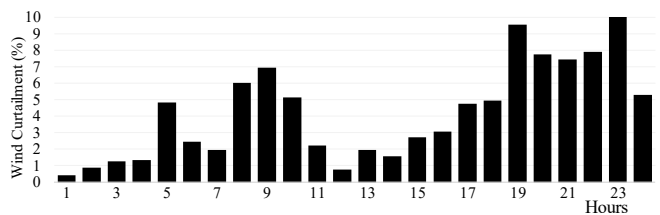

Fig. 15. Hourly wind generation curtailment with ICRA at high-load

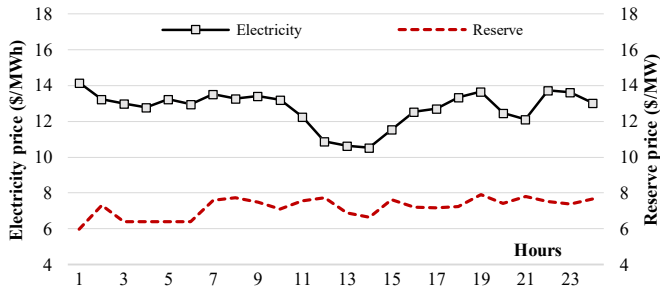

Fig. 16. Prices of electricity and reserve with ICRA at high load

TABLE XI
EVALUATION OF SOLUTION TIME

	Six-bus		IEEE 118-bus	
	ABD=No	ABD=Yes	ABD=No	ABD=Yes
Iterations	12	7	25	12
Time (sec)	79	62	921	595

adopted to address unpredicted outages. The model checks the adequacy, deliverability, and optimality for reserve deployments. Numerical results of this paper on a six-bus and the IEEE 118-bus test systems reveal the following conclusions:

- The deployed reserves are sufficient and deliverable to cover all scenarios. Also, the optimality of reserves is supported by considering both the expected value of LOC and generation cost and also the cost of ancillary services.
- The proposed model captured different sources of uncertainty, while a feasible solution for storage commitment is ensured through the stochastic framework. Considering storage beside the wind power reduce system peak-load up to 21%, while it reduces the operational cost.
- The intelligent contingency ranking method covers the gap of previous methods and successfully indicates that the high-impact outages are calculated based on the resulting commitment of units.
- Generators and wind farms successfully supplied the corrective dispatches, and storage units participate in preventive actions. The preventive dispatches of storage devices are more highlighted at high-load.
- Changes in prices of electricity and reserves happen in the opposite direction at windy hours, and they are both increased at high-load. Also, CAES units decrease prices at high-load and increase them at low-load hours.
- The acceleration techniques successfully reduced the computing time and iterations with high accuracy for solving the decomposed model.

Also, according to this study, the following question is of great interest in future: What is the best possible strategy for storage participation in emergency events?

REFERENCES

- [1] H. Arasteh, V. Vahidinasab, M. S. Sepasian, and J. G. Aghaei, "Stochastic system of systems architecture for adaptive expansion of smart distribution grids," *IEEE Transactions on Industrial Informatics*, 2018.
- [2] A. Nikoobakht, J. Aghaei, T. Niknam, V. Vahidinasab, H. Farahmand, and M. Korpås, "Towards robust opf solution strategy for the future ac/dc grids: case of vsc-hvdc-connected offshore wind farms," *IET Renewable Power Generation*, vol. 12, no. 6, pp. 691–701, 2018.
- [3] Y. Chen, P. Gribik, and J. Gardner, "Incorporating post zonal reserve deployment transmission constraints into energy and ancillary service co-optimization," *IEEE Transactions on Power Systems*, vol. 29, no. 2, pp. 537–549, 2014.
- [4] N. Amjadi and V. Vahidinasab, "Security-constrained self-scheduling of generation companies in day-ahead electricity markets considering financial risk," *Energy conversion and management*, vol. 65, pp. 164–172, 2013.
- [5] P. Sekhar and S. Mohanty, "An online power system static security assessment module using multi-layer perceptron and radial basis function network," *International Journal of Electrical Power & Energy Systems*, vol. 76, pp. 165–173, 2016.
- [6] H. Wu, M. Shahidehpour, Z. Li, and W. Tian, "Chance-constrained day-ahead scheduling in stochastic power system operation," *IEEE Transactions on Power Systems*, vol. 29, no. 4, pp. 1583–1591, 2014.
- [7] S. Fliscounakis, P. Panciatici, F. Capitanescu, and L. Wehenkel, "Contingency ranking with respect to overloads in very large power systems taking into account uncertainty, preventive, and corrective actions," *IEEE Transactions on Power Systems*, vol. 28, no. 4, pp. 4909–4917, 2013.
- [8] J. M. da Silva, I. Costa, J. V. C. dos Santos, J. L. V. Barbosa, T. Braun, and G. Pessin, "Toward a more reliable system for contingency selection in static security analysis of electric power systems," *IEEE Systems Journal*, 2019.
- [9] Y. Wang, L. Huang, M. Shahidehpour, L. L. Lai, and Y. Zhou, "Impact of cascading and common-cause outages on resilience-constrained optimal economic operation of power systems," *IEEE Transactions on Smart Grid*, vol. 11, no. 1, pp. 590–601, 2019.
- [10] A. Nikoobakht, J. Aghaei, M. Mardaneh, T. Niknam, and V. Vahidinasab, "Moving beyond the optimal transmission switching: stochastic linearised scuc for the integration of wind power generation and equipment failures uncertainties," *IET Generation, Transmission & Distribution*, 2017.
- [11] N. G. Cobos, J. M. Arroyo, N. Alguacil, and J. Wang, "Robust energy and reserve scheduling considering bulk energy storage units and wind uncertainty," *IEEE Transactions on Power Systems*, vol. 33, no. 5, pp. 5206–5216, 2018.
- [12] B. Hu, L. Wu, and M. Marwali, "On the robust solution to scuc with load and wind uncertainty correlations," *IEEE Transactions on Power Systems*, vol. 29, no. 6, pp. 2952–2964, 2014.
- [13] B. Hu and L. Wu, "Robust scuc considering continuous/discrete uncertainties and quick-start units: A two-stage robust optimization with mixed-integer recourse," *IEEE Transactions on Power Systems*, vol. 31, no. 2, pp. 1407–1419, 2016.
- [14] S. S. Reddy, P. Bijwe, and A. R. Abhyankar, "Joint energy and spinning reserve market clearing incorporating wind power and load forecast uncertainties," *IEEE Systems Journal*, vol. 9, no. 1, pp. 152–164, 2015.
- [15] V. Vahidinasab and S. Jadid, "Stochastic multiobjective self-scheduling of a power producer in joint energy and reserves markets," *Electric Power Systems Research*, vol. 80, no. 7, pp. 760–769, 2010.
- [16] M. S. Pinto, V. Miranda, and O. R. Saavedra, "Risk and unit commitment decisions in scenarios of wind power uncertainty," *Renewable Energy*, vol. 97, pp. 550–558, 2016.
- [17] J. Wang, M. Shahidehpour, and Z. Li, "Security-constrained unit commitment with volatile wind power generation," *IEEE Transactions on Power Systems*, vol. 23, no. 3, pp. 1319–1327, 2008.
- [18] T. Zheng and E. Litvinov, "Contingency-based zonal reserve modeling and pricing in a co-optimized energy and reserve market," *IEEE transactions on Power Systems*, vol. 23, no. 2, pp. 277–286, 2008.
- [19] H. Ye, Y. Ge, M. Shahidehpour, and Z. Li, "Uncertainty marginal price, transmission reserve, and day-ahead market clearing with robust unit commitment," *IEEE Transactions on Power Systems*, vol. 32, no. 3, pp. 1782–1795, 2017.
- [20] S. Pirouzi, J. Aghaei, V. Vahidinasab, T. Niknam, and A. Khodaei, "Robust linear architecture for active/reactive power scheduling of ev integrated smart distribution networks," *Electric Power Systems Research*, vol. 155, pp. 8–20, 2018.
- [21] Y. Sun, Z. Li, M. Shahidehpour, and B. Ai, "Battery-based energy storage transportation for enhancing power system economics and security," *IEEE Trans. Smart Grid*, vol. 6, no. 5, pp. 2395–2402, 2015.
- [22] H. Daneshi and A. Srivastava, "Security-constrained unit commitment with wind generation and compressed air energy storage," *IET Generation, Transmission & Distribution*, vol. 6, no. 2, pp. 167–175, 2012.
- [23] M. E. Khodayar, L. Wu, M. Shahidehpour et al., "Hourly coordination of electric vehicle operation and volatile wind power generation in scuc," *IEEE Trans. Smart Grid*, vol. 3, no. 3, pp. 1271–1279, 2012.
- [24] Y. Sun, J. Zhong, Z. Li, W. Tian, and M. Shahidehpour, "Stochastic scheduling of battery-based energy storage transportation system with

the penetration of wind power," *IEEE Transactions on Sustainable Energy*, vol. 8, no. 1, pp. 135–144, 2017.

- [25] R. Li, W. Wang, and M. Xia, "Cooperative planning of active distribution system with renewable energy sources and energy storage systems," *IEEE Access*, vol. 6, pp. 5916–5926, 2017.
- [26] C. E. Murillo-Sánchez, R. D. Zimmerman, C. L. Anderson, and R. J. Thomas, "Secure planning and operations of systems with stochastic sources, energy storage, and active demand," *IEEE Transactions on Smart Grid*, vol. 4, no. 4, pp. 2220–2229, 2013.
- [27] S. Pirouzi, J. Aghaei, T. Niknam, M. Shafie-Khah, V. Vahidinasab, and J. P. Catalão, "Two alternative robust optimization models for flexible power management of electric vehicles in distribution networks," *Energy*, vol. 141, pp. 635–651, 2017.
- [28] V. Guerrero-Mestre, Y. Dvorkin, R. Fernández-Blanco, M. A. Ortega-Vazquez, and J. Contreras, "Incorporating energy storage into probabilistic security-constrained unit commitment," *IET Generation, Transmission & Distribution*, vol. 12, no. 18, pp. 4206–4215, 2018.
- [29] C. Sahin, M. Shahidehpour, and I. Erkmén, "Allocation of hourly reserve versus demand response for security-constrained scheduling of stochastic wind energy," *IEEE Transactions on Sustainable Energy*, vol. 4, no. 1, pp. 219–228, 2013.
- [30] Y. Wen, C. Guo, H. Pandžić, and D. S. Kirschen, "Enhanced security-constrained unit commitment with emerging utility-scale energy storage," *IEEE Transactions on Power Systems*, vol. 31, no. 1, pp. 652–662, 2016.
- [31] L. Wu, M. Shahidehpour, and Z. Li, "Comparison of scenario-based and interval optimization approaches to stochastic secuc," *IEEE Transactions on Power Systems*, vol. 27, no. 2, pp. 913–921, 2012.
- [32] The Weather Company, LLC. (2018) Hourbyhour prediction of wind speed. [Online]. Available: <https://weather.com/weather/hourbyhour>
- [33] A. J. Conejo, M. Carrión, J. M. Morales *et al.*, *Decision making under uncertainty in electricity markets*. Springer, 2010, vol. 1.
- [34] Illinois Institute of Technolog. 6-bus, 3-unit, 24-hour system. [Online]. Available: http://motor.ece.iit.edu/data/IEAS_6bus.doc
- [35] Idaho National Laboratory. (2007) List of wind turbine power curves. [Online]. Available: http://www.wind-works.org/cms/Reports/Idaho_National_Laboratory_Power_Curves_2007.xls
- [36] Illinois Institute of Technolog. Ieee 118-bus, 54-unit, 24-hour system. [Online]. Available: http://motor.ece.iit.edu/data/IEAS_IEEE118.doc



Mahdi Habibi received the B.Sc. degree from the Babol Noshirvani University of Technology, Babol, Iran, in 2014, and the M.Sc. degree from Shahid Beheshti University of Technology, Tehran, Iran, in 2016 all in electrical engineering. He is currently studying Ph.D. in power system electrical engineering at the Shahid Beheshti University of Technology, Tehran, Iran. He is a member of the SOHA Smart Energy Systems Laboratory at SBU.

His research interests include the power system operation, system management under uncertainty, integration of renewable energy resources, provision of flexibility services, scheduling storage devices, and optimization models at transmission and distribution levels.



Vahid Vahidinasab (M'10-SM'17) received the PhD (High Distinction) degree in electrical engineering from Iran University of Science and Technology, Tehran, Iran, in 2010. Since 2010, he has been with the Department of Electrical Engineering, Shahid Beheshti University (SBU) as an Assistant Professor. He has also founded and managed SOHA Smart Energy Systems Laboratory at SBU. He has demonstrated a consistent track record of attracting external funds and managed several industrial projects and closely worked with several large and complex national/international projects. Since 2018 he is with the School of Engineering at Newcastle University and manages the inteGRIDy as an EU Horizon 2020 project. He is also a senior researcher of the EPSRC Active Building Centre (ABC) as a national centre of excellence with the vision of transforming the UK energy sectors through the deployment of active buildings contributing to more efficient energy use and decarbonisation and leads activities in the area of control and optimisation of active buildings.

His research interests are threefold: (1) Integrated Energy Systems Operation and Planning; (2) Energy Markets and Transactive Energy, (3) Energy Systems Integration. More specifically, he works with the focus on the whole system approach to energy with the aim of clean energy systems integration into the power systems, by considering flexibility and transactive energy as key elements. He has worked with international researchers on various interdisciplinary problems in power and energy systems, economics, optimization theory, and control theory.

Dr Vahidinasab is a research scientist with more than 15 years of experience in power systems studies, 150+ book chapters, technical reports and publications in top rank and peer-reviewed journals and conferences and 1100+ citations. He has served as a Thesis Supervisor/Advisor for 77 students in the Electric Power Engineering (including 11 PhD, 40 MSc and 26 BSc students).

He is a senior member of the IEEE, member of the IEEE Power and Energy Society (PES) as well as IEEE Smart Grid Community. He is also a Member of the Editorial Board and Associate Editor of the *IET Generation, Transmission & Distribution* as well as the *IET Smart Grid*. He is also the editor of the Springer book entitled "*Active Building Energy Systems: Operation and Control*".

He was considered as one of the Outstanding Reviewers of the IEEE TRANSACTIONS ON SUSTAINABLE ENERGY. He is also the winner of the Publons Top Peer Reviewer Award in two consecutive years of 2018 and 2019 and has been placed in Top 1% Reviewers of engineering in 2018 and engineering and cross-field in 2019.

Besides his research and education experiences, he has more than six years of management experiences in research and higher education institutes including Pro-Vice-Chancellor for Management and Resources Development and Member of the Executive Board, Niroo Research Institute (NRI), Deputy Pro-Vice-Chancellor for Research (NRI) and Secretary of Research Council, and Deputy Pro-Vice-Chancellor for Education and Secretary of Education Council at SBU. He also served as a Board Member and Head of Research and Education Committee of Iran Smart Grid Association.



Abolfazl Pirayesh received B.Sc. in electrical engineering and M.Sc. in electric power engineering from Sharif University of Technology, Tehran, Iran, in 1998 and 2000, respectively. He received his Ph.D. in electric power engineering from Sharif University with the collaboration of the Electrical Engineering Laboratory of the Institut National Polytechnique de Grenoble, France, in 2006. Since 2007 he has been with Shahid Beheshti University where he is currently an associate professor.

His main research interests are in the areas of power system operations and planning and electricity market issues.



Miadreza Shafie-khah (Senior Member, IEEE) received the M.Sc. and Ph.D. degrees in electrical engineering from Tarbiat Modares University, Tehran, Iran, in 2008 and 2012, respectively, the first Postdoctoral degree from the University of Beira Interior, Covilha, Portugal, in 2015, and the second Postdoctoral degree from the University of Salerno, Salerno, Italy, in 2016. He is currently a Tenure-Track Professor with the University of Vaasa, Vaasa, Finland. His research interests include power market simulation, market power monitoring, power system

optimization, demand response, electric vehicles, price forecasting, and smart grids. He is currently an Editor of the IEEE OPEN ACCESS JOURNAL OF POWER AND ENERGY and an Associate Editor of *IET Renewable Power Generation*. He was considered one of the Outstanding Reviewers of the IEEE TRANSACTIONS ON SUSTAINABLE ENERGY, in 2014 and 2017, one of the Best Reviewers of the IEEE TRANSACTIONS ON SMART GRID, in 2016 and 2017, and one of the Outstanding Reviewers of the IEEE TRANSACTIONS ON POWER SYSTEMS, in 2017 and 2018.



João P. S. Catalão (Senior Member, IEEE) received the M.Sc. degree from the Instituto Superior Técnico (IST), Lisbon, Portugal, in 2003, and the Ph.D. degree and Habilitation for Full Professor ("Agregação") from the University of Beira Interior (UBI), Covilha, Portugal, in 2007 and 2013, respectively. Currently, he is a Professor at the Faculty of Engineering of the University of Porto (FEUP), Porto, Portugal, and Research Coordinator at INESC TEC. He was also appointed as Visiting Professor by North China Electric Power University, Beijing, China. He was

the Primary Coordinator of the EU-funded FP7 project SiNGULAR ("Smart and Sustainable Insular Electricity Grids Under Large-Scale Renewable Integration"), a 5.2-million-euro project involving 11 industry partners. He has authored or coauthored more than 800 publications, including 350 journal papers (more than 100 IEEE Transactions/Journal papers), 390 conference proceedings papers, 5 books, 41 book chapters, and 14 technical reports, with an *h*-index of 60, an *i10*-index of 270, and over 13700 citations (according to Google Scholar), having supervised more than 85 post-docs, Ph.D. and M.Sc. students. He was the General Chair of SEST 2019 (2nd International Conference on Smart Energy Systems and Technologies), technically sponsored by IEEE PES and IEEE IES. He is the General Co-Chair of SEST 2020 (3rd International Conference on Smart Energy Systems and Technologies), technically sponsored by IEEE PES, IEEE IES and IEEE IAS. He is the Editor of the books entitled "*Electric Power Systems: Advanced Forecasting Techniques and Optimal Generation Scheduling*" and "*Smart and Sustainable Power Systems: Operations, Planning and Economics of Insular Electricity Grids*" (Boca Raton, FL, USA: CRC Press, 2012 and 2015, respectively). His research interests include power system operations and planning, hydro and thermal scheduling, wind and price forecasting, distributed renewable generation, demand response and smart grids.

Prof. Catalo is the Senior Editor of the IEEE TRANSACTIONS ON SMART GRID, the Promotion and Outreach Editor of the IEEE OPEN ACCESS JOURNAL OF POWER AND ENERGY, an Editor of the IEEE TRANSACTIONS ON POWER SYSTEMS, an Associate Editor of the IEEE TRANSACTIONS ON INDUSTRIAL INFORMATICS, an Associate Editor of the *IET Smart Grid*, and a Guest Editor for the Special Issue on "Challenges and New Solutions for Enhancing Ancillary Services and Grid Resiliency in Low Inertia Power Systems" of the *IET Generation, Transmission & Distribution*. From 2011 till 2018 he was an Editor of the IEEE TRANSACTIONS ON SUSTAINABLE ENERGY and an Associate Editor of the *IET Renewable Power Generation*. From 2013 till 2020 he was an Editor of the IEEE TRANSACTIONS ON SMART GRID. He was also a Subject Editor of the *IET Renewable Power Generation* from 2018 till 2019. He was the Guest Editor-in-Chief for the Special Section on "Real-Time Demand Response" of the IEEE TRANSACTIONS ON SMART GRID, published in December 2012, the Guest Editor-in-Chief for the Special Section on "Reserve and Flexibility for Handling Variability and Uncertainty of Renewable Generation" of the IEEE TRANSACTIONS ON SUSTAINABLE ENERGY, published in April 2016, the Corresponding Guest Editor for the Special Section on "Industrial and Commercial Demand Response" of the IEEE TRANSACTIONS ON INDUSTRIAL INFORMATICS, published in November 2018, and the Lead Guest Editor for the Special Issue on "Demand Side Management and Market Design for Renewable Energy Support and Integration" of the *IET Renewable Power Generation*, published in April 2019. He was the recipient of the 2011 Scientific Merit Award UBI-FE/Santander Universities, the 2012 Scientific Award UTL/Santander Totta, the 2016-2017-2018 FEUP Diplomas of Scientific Recognition, the 2017 Best INESC-ID Researcher Award, and the 2018 Scientific Award ULisboa/Santander Universities, in addition to an Honorable Mention in the 2017 Scientific Award ULisboa/Santander Universities. Moreover, he has won 4 Best Paper Awards at IEEE Conferences.