

**Adaptations of pyrophilous insects to burnt
habitats: Odor signals, infrared receptors and
behavior**

In partial fulfillment of the requirements for the degree of
Doctor of Philosophy (PhD)
of the Faculty of Forest Sciences and Forest Ecology,
University of Göttingen,
Germany

Submitted by
Thi Phuong Hoang
Born in Thanh Hoa, Vietnam
Göttingen, July 2019

1st reviewer: Prof. Dr. Carsten Mai

2nd reviewer: PD. Dr. Helmut Schmitz

Date of oral examination: 22.10.2019

Acknowledgements

I am deeply grateful to the KAAD, which provided the financial support for this study. My great thanks also go to my former supervisor Prof. Dr. Stefan Schütz and my new supervisors Prof. Dr. Carsten Mai, PD Dr. Helmut Schmitz and Dr. Gerrit Holighaus for their supervision, support and advice. Also, I would like to thank Prof. Dr. Michael Rostás for the evaluation of my oral examination. I am indebted to Andreas Teichmann for his help in constructing the infrared traps.

Further thanks go to all of the present and former staff of the department of forest zoology and forest protection, who helped me during my research. Thank you very much: Dr. Bernhard Weissbecker, Dr. Martin Gabriel, Christine Rachow, Sara Nicke, Ulrike Eisenwiener, Dr. Heinrich Lehmann-Danzinger, Yadanar Oo and Dr. Karthi Balakrishnan. Prof. Dr. Stefan Schütz provided ideas for the concept of the study. Further thanks go to specialists of the Department of Insect Systematics at the Institute of Biology and Ecological Resources, Hanoi, Vietnam for their identification of insects, and all of the Vietnamese students and workers who contributed to my work during field data collection in Vietnam.

I would like to thank my husband, Daniel Jestrzemeski for his help for the correction of the English-German translation and proofreading, establishing a figure in chapter 4 and his correction of the references of the whole thesis. Moreover, thanks to my husband, my son Nico Jestrzemeski, and my both German and Vietnamese families for giving sense to my life. Without their support, I would not have been able to finish my research.

Abstract

Pyrophilous insects are known to invade recently burnt habitats for food, mating and oviposition. They can approach fires due to their ability to recognize fire-specific volatile organic compounds (VOCs). Moreover, some of these insects also possess infrared (IR) receptors to detect fires and hot surfaces. The aim of this thesis is to examine recently burnt habitats for the presence of pyrophilous insects and identify cues suitable for them to find burnt habitats. This includes morphological and chemo-ecological studies unravelling the significance of IR receptors, IR radiation, volatile signals and behavior.

Three major questions were selected to investigate how pyrophilous insects approach fires: 1) identify fire-specific VOCs that are released by different Vietnamese plant species and are suitable cues for pyrophilous insects, 2) testing the behavioral responses of pyrophilous insects to volatile and heat (IR radiation) stimuli, and 3) identifying the sensory adaptation of the pyrophilous flat bug *Aradus candidatus* found to be active in recently burnt habitats. Volatile analysis (gas chromatography – mass spectrometry) was used to identify fire-specific VOCs to be subsequently tested in the field for their ability to influence insect behavior. Electroantennography (EAG) was used to examine the perception of pyrophilous insects to these VOCs. With a scanning electron microscope (SEM), pyrophilous insects were examined for presence of IR receptors. The results were used to conclude how pyrophilous insects are adapted to recently burnt habitats.

The trace analysis presented in chapter 3 of this thesis resulted in the detection of 55 VOCs that were released by four different Vietnamese plant species. Four of these VOCs identified as fire-specific were further tested in a behavioral field study. They derive from cellulose (hydroxyacetone, 5-methylfurfural) and lignin (guaiacol and 4-ethylguaiacol) degradation. Traps in a freshly burnt habitat baited with a mixture of these VOCs attracted 13 insect species belonging to the order Coleoptera that were not found in control traps positioned on adjacent unburnt land. Three of these were additionally found by hand collections, where another eight species of insects were found. The biodiversity of plant species seems to be associated with the chemo-diversity of fire-induced VOCs. This might play an important role for pyrophilous insects, thus linking plant diversity to the biodiversity of pyrophilous insects.

The attraction of pyrophilous insects to IR and volatile stimuli is investigated in chapter 4. A total of 26 insect species were recorded. The attraction of pyrophilous insects towards fire-specific VOCs, IR and combined stimuli was significantly higher when compared to the controls. One species (*Litochrus* sp. 1, Phalacridae, Coleoptera) was found in traps of all

combinations. Fungivorous insects were caught significantly more often in the IR traps, whereas VOC traps attracted carnivorous insects significantly more often. All traps attracted herbivorous insects. Eight insect species were caught in more than one trap. Among them, only one species was caught in all traps. Two species belonging to the family Cleridae (Coleoptera) were caught in different traps: while *Anthicoclerus* sp. 1 was recorded exclusively in the IR trap also containing the VOCs mixture, *Anthicoclerus* sp. 2 was trapped only in the IR trap without VOCs. These results hint at a complex evaluation of IR and olfactory stimuli for resource location by different members of the pyrophilous insect community.

The study on adaptation and behavior of *A. candidatus* in chapter 5 showed that *A. candidatus* elicits olfactory responses in electroantennograms (EAG) to hydroxyacetone, 5-methylfurfural, guaiacol, 4-methylguaiacol and 4-ethylguaiacol. Additionally, *A. candidatus* shows attraction to the traps baited with a mixture of fire-specific VOCs. *Aradus candidatus* also elicits a dose response to three other VOCs: Nonanal, 3-octanone and 2(5H)-furanone. In morphological studies, IR receptors were found in the propleural region of *A. candidatus*. These IR receptors have an outer shape similar to other species of the genus *Aradus*, including *A. albicornis*, *A. lugubris* and *A. fuscicornis*. The results of this chapter illustrate that pyrophilous insect species equipped with IR receptors show a highly pyrophilous behavior.

The results from these three studies show that pyrophilous insects can detect fire-specific VOCs, which helps them to approach fires. However, not all insects that are able to perceive a single fire-specific VOC are necessarily pyrophilous. A mixture of different fire-specific VOCs is recommended for testing the attraction of pyrophilous insects to fires. By attraction to both fire-specific VOCs and IR, some insect species revealed their distinct pyrophilous behavior. This was confirmed by demonstrating VOC and IR detection in *A. candidatus* on a morphological and physiological level.

Zusammenfassung

Feuerliebende Insekten besiedeln frisch niedergebrannte Lebensräume zur Nahrungsaufnahme, Fortpflanzung und Eiablage. Bei der Suche nach Brandflächen hilft ihnen ihre Fähigkeit, feuerspezifische, flüchtige organische Verbindungen (VOCs) wahrzunehmen. Manche Arten besitzen Infrarotrezeptoren, um Feuer und heiße Oberflächen aufzuspüren.

Das Ziel dieser Dissertation ist es, das Vorkommen von pyrophilen Insekten in kürzlich niedergebrannten Naturflächen in Vietnam zu untersuchen und Duftstoffe zu identifizieren, die ihnen helfen, diese zu finden. Die Arbeit umfasst eine morphologische und chemoökologische Studie, mit der die Bedeutung von Infrarotrezeptoren, Infrarotstrahlung und flüchtigen organischen Signalen und sowie des Verhaltens pyrophiler Insekten untersucht werden soll.

Hieraus ergeben sich drei grundlegende Forschungsziele:

- 1) Identifikation von feuerspezifischen VOCs, die von verschiedenen vietnamesischen Pflanzenarten emittiert werden und geeignete chemische Reize für feuerliebende Insekten darstellen.
- 2) Untersuchung der Verhaltensreaktion von feuerliebenden Insekten auf Stimuli von VOCs und Hitze (Infrarotstrahlung).
- 3) Untersuchung der sensorischen Adaption der feuerliebenden Rindenwanze *Aradus candidatus* an kürzlich niedergebrannte Lebensräume.

Die feuerspezifischen VOCs wurden mittels Gaschromatographie-Massenspektrometrie (GC-MS) analysiert. Anschließend wurde in Feldversuchen ihre Fähigkeit untersucht, das Flugverhalten von Insekten zu beeinflussen. Mittels Elektroantennographie (EAG) wurde die Wahrnehmung von VOCs durch pyrophile Insekten getestet, während das Vorhandensein von möglichen Infrarotrezeptoren auf den Insektenkörpern durch Rasterelektronenmikroskopie (REM) überprüft wurde. Aus den Ergebnissen wurden Schlussfolgerungen über die Anpassung von feuerliebenden Insekten an kürzlich niedergebrannte Habitate gezogen.

Durch die im dritten Kapitel präsentierte Spurenanalyse (GC-MS) wurden 55 feuerspezifische VOCs nachgewiesen, die von vier verschiedenen vietnamesischen Pflanzenarten emittiert werden. Vier dieser VOCs wurden als Stimuli im Feld im Rahmen einer Verhaltensstudie getestet. Die getesteten Duftstoffe basieren auf dem Abbau von Zellulose (Hydroxyaceton, 5-Methylfurfural) und Lignin (Guaiacol und 4-Ethylguaiacol) und wurden für die Feldversuche in Ködern in frisch niedergebranntem sowie intaktem Kontrollhabitat in Zentralvietnam während der Trockenzeit ausgehängt (2014 und 2015). Dreizehn Insektenarten in der Ordnung Coleoptera kamen ausschließlich in abgebranntem Habitat vor. Acht Arten wurden zudem auf

glimmenden Holzresten im gleichen Habitat nachgewiesen. Die Biodiversität von Pflanzenarten scheint in Verbindung mit der Chemodiversität von feuerinduzierten VOCs zu stehen, was auf eine Korrelation zwischen Pflanzendiversität und der Vielfalt von feuerliebenden Insekten schließen lässt.

In Kapitel 4 wird die Anziehung von pyrophilen Insekten zu volatilen und Infrarotstimuli untersucht. In den mit Infrarotstrahlung und feuerspezifischen VOCs bestückten Köderfallen wurden insgesamt 36 Insektenarten erfasst. Diese Köderfallen waren signifikant attraktiver für feuerliebende Insekten als die nicht bestückten Kontrollfallen.

Eine Insektenart (Coleoptera, Phalacridae, *Litrochus* sp. 1) wurde sowohl in den Köderfallen als auch in den Kontrollfallen auf verbranntem Gebiet gefangen. Pilzfressende Insekten wurden signifikant häufiger in den Infrarotfallen gefangen, während VOCs-Fallen signifikant attraktiver für fleischfressende Insekten waren. Alle Fallen waren attraktiv für herbivore Insekten. Acht Insektenarten wurden in mehr als einem Fallentyp gefangen.

Von diesen kam nur eine Insektenart in allen Fallen vor. Zwei Arten aus der Familie Cleridae (Coleoptera) zeigten unterschiedliche Fallenpräferenzen: während *Anthicoclerus* sp. 1 ausschließlich in der Infrarotfalle mit der VOCs-Beköderung auftauchte, fand sich *Anthicoclerus* sp. 2 stets nur in der Infrarotfalle ohne die VOCs-Beköderung. Diese Resultate lassen auf eine komplexe Wirkungsweise der olfaktorischen und Infrarotstimuli für das Lokalisieren von Nahrungsressourcen durch verschiedene Mitglieder der feuerliebenden Insektengemeinschaft schließen. Die Untersuchung von Adaption und Verhalten von *A. candidatus* mittels EAG (Kapitel 5) ergab, dass Hydroxyacetone, 5-Methylfurfural, Guaiacol, 4-Methylguaiacol und 4-Ethylguaiacol bei der Art eine olfaktorische Reaktion hervorrufen.

Zudem zeigt *A. candidatus* eine Anziehung hin zu einer Mischung aus verschiedenen feuerspezifischen VOCs. Drei weitere VOCs riefen bei den EAG-Versuchen ebenfalls eine olfaktorische Reaktion hervor: Nonanal, 3-Octanon und 2(5H)-Furanon.

In den morphologischen Studien wurden Infrarotrezeptoren in der propleuralen Region von *A. candidatus* nachgewiesen. Diese Rezeptoren ähneln in ihrer Form denen von anderen Arten der Gattung *Aradus*, darunter *A. albicornis*, *A. lugubris* und *A. fuscicornis*. Die Ergebnisse dieses Kapitels deuten darauf hin, dass feuerliebende Insekten mit Infrarotrezeptoren ein stark pyrophiles Verhalten aufweisen.

Die drei Studien zeigen, dass pyrophile Insekten feuerspezifische VOCs wahrnehmen können, was ihnen beim Lokalisieren und Anfliegen von Bränden hilft. Dennoch sind nicht alle Insekten, die einzelne feuerspezifische VOCs wahrnehmen können, zwingend pyrophil.

Daher sollte die Anziehung von pyrophilen Insekten zu Bränden mit Hilfe einer Mischung aus feuerspezifischen VOCs getestet werden. Einige Arten, die sowohl von feuerspezifischen

VOCs als auch von Infrarotstrahlung angezogen werden, zeigen ein deutlich pyrophiles Verhalten. Dies wird durch die Fähigkeit zur Detektion von VOCs und Infrarotstrahlung durch *A. candidatus* auf morphologischer als auch physiologischer Ebene bestätigt.

Table of contents

Acknowledgements.....	I
Abstract.....	II
Zusammenfassung.....	IV
Table of contents.....	VII
Chapter 1:	
Adaptation of pyrophilous insects to burnt habitats: General introduction	1
1.1 Introduction.....	1
1.2 Forest fires.....	2
1.3 Pyrophilous insects.....	5
1.4 Infrared receptors in insects.....	5
1.5 Volatile organic compounds.....	6
1.6 Roles of VOCs for insects.....	7
1.7 Formation of VOCs.....	8
1.8 Carbohydrate polymers.....	9
1.9 Cellulose.....	9
1.10 Lignin.....	10
1.11 Objectives of this thesis.....	11
1.12 References.....	13
Chapter 2:	
Pyrophilous insects in Vietnam Central Highlands.....	22
Abstract.....	23
2.1 Introduction.....	24
2.2 Study site and experimental design.....	25
2.3 Results.....	26
2.4 Discussion.....	27
2.5 Acknowledgements.....	30
2.6 References.....	31
Chapter 3:	
Do volatiles released upon heating of different species of Vietnamese woody plants attract pyrophilous insects?	34

Abstract	35
3.1 Introduction	36
3.2 Materials and methods	37
3.2.1 Wood samples	37
3.2.2 Chemicals	38
3.2.3 Sampling of volatiles	38
3.2.4 Trace analysis	38
3.2.5 Hand collection	39
3.2.6 Field tests	39
3.2.7 Statistical analysis	41
3.3 Results	41
3.3.1 Trace analysis	41
3.3.2 Field trial results	43
3.4 Discussion	45
3.4.1 Burnt wood volatiles	45
3.4.2 Field tests	46
3.4.3 Links between burnt wood volatiles and the biodiversity of pyrophilous insects	47
3.5 Conclusion	47
3.6 Acknowledgements	48
3.7 References	49
Chapter 4:	
Pyrophilous insects respond to different stimuli	51
Abstract	52
4.1 Introduction	53
4.2 Materials and methods	54
4.2.1 Trap construction	54
4.2.2 Estimation of the trapping radius of the trap emitting IR radiation	55
4.2.3 Estimation of the trapping radius of the trap baited VOCs	56

4.2.4 Chemicals.....	56
4.2.5 Study area and experimental design.....	56
4.2.6 Statistical tests.....	57
4.3 Results.....	57
4.4 Discussion.....	60
4.5 Conclusion.....	62
4.6 Acknowledgements.....	62
4.7 References.....	63

Chapter 5:

Behavioral and sensory adaptations of the flat bug <i>Aradus candidatus</i> to post-fire habitats in Vietnam.....	65
Abstract.....	66
5.1 Introduction.....	67
5.2 Materials and Methods.....	68
5.2.1 Insects.....	68
5.2.2 Chemicals.....	68
5.2.3 EAG experiments.....	69
5.2.4 Trap construction.....	69
5.2.5 Field traps.....	70
5.2.6 Scanning electron microscopy (SEM).....	71
5.2.7 Data analysis.....	71
5.3 Results.....	72
5.3.1 Attraction to different types of traps on burnt areas.....	72
5.3.2 EAG responses of <i>A. candidatus</i> antennae to fire-specific volatile organic compounds.....	73
5.3.3 Propleural IR receptors.....	74
5.4 Discussion.....	76
5.4.1 Attraction to a mixture of fire-specific VOCs.....	76
5.4.2 Structure and functions of IR receptors.....	78
5.5 Conclusion.....	79
5.6 Acknowledgements.....	80

5.7 References.....	81
Chapter 6:	
Adaptation of pyrophilous insects to burnt habitat: General discussion and conclusion.....	84
6.1 Presence of pyrophilous insects in Vietnam.....	84
6.2 Diversity of VOCs and insects in recently burnt habitats (chapter 3)	85
6.3 Are burnt wood VOCs a cue for pyrophilous insects to find burnt habitat?	86
6.4 Is infrared radiation a cue for pyrophilous insects to find burnt habitats? (Chapter 4)	87
6.5 Attraction of insects in recently burnt habitats to VOCs, infrared stimuli or both stimuli.....	88
6.6 Is multimodal sensing important for the behavior of pyrophilous insects? Hints from <i>A. candidatus</i> (chapter 5)	88
6.7 Conclusion.....	89
6.8 References.....	91
Publications by T. P. Hoang.....	94
Annex.....	95

Chapter 1

Adaptation of pyrophilous insects to burnt habitats: General introduction

1.1 Introduction

Natural fires have great impact on the human environment and ecological niches, altering the living conditions for plants, animals and fungi (Wikars 1997). Fire is a strong selective force for the best adaptation abilities to survive in these fire-altered habitats. Consequently, successfully adapted species become prevalent especially after fires and may also spread (Grimaldi & Engel 2005; Linksvayer et al., 2012). Some insect species are attracted to flames or smoke, which indicate fire and thus an availability of crucial resources for oviposition and food (New 2014). These species are defined as pyrophilous (Greek for fire-loving), since they significantly depend on forest fires for their reproduction. When a fire occurs, they approach and invade the burnt area immediately afterwards (Wikars 1997; Klocke et al., 2011). Since pyrophilous insects are primarily decomposers, they may profit from the increased nutrient availability after forest fires (Wikars 1997). However, it is unclear whether a warmer microclimate, reduced competition or fire-created substrates such as burnt wood are the crucial factor for their survival (Wikars 2002). Well-known pyrophilous insect species include members of the order Coleoptera (e.g., saproxylic species such as the buprestid beetle *Melanophila acuminata*), but also of other orders including Diptera (New 2014).

The adaptation of pyrophilous insects to a newly burnt habitat requires specially adapted motoric abilities such as crawling or flying. At the same time, the insects use olfactory and visual senses, in particular infrared (IR) perception, to detect smoke and find suitable food sources or mating partners while avoiding contact with hot surfaces remaining from fire (Nation 2001; Grimaldi & Engel 2005). Equipped with these abilities and sensory modalities, insects must decipher relevant cues to find a suitable habitat. This can be visual orientation toward a host plant species (Briscoe & Chittka 2001), acoustic and olfactory orientation towards a mating partner (Groot et al., 2010) and olfactory orientation towards a food source (Vogt & Riddiford 1981; Singh 1998). Many insect species rely on olfaction as an essential sense for orientation within and towards their ecological niches (Hansson 1999). Olfaction is based on the perception of Volatile Organic Compounds (VOCs) or VOC profiles to discriminate between healthy or damaged plants (Schütz et al., 1997a, 1997b; Schütz & Weißbecker 2003; Weißbecker 2004), to communicate with each other (Pelosi & Maida 1995), or in case of pyrophilous insects to find freshly burnt habitats (Schütz et al., 1999a, 1999b).

Volatile organic compounds are produced by different sources. For example, they can be by-products or end-products of the plant metabolism (Schütz et al., 1997b) or released intentionally by insect species (Vogt & Riddiford 1981). For example, plants release sesquiterpenes at room temperature ($23 \pm 2^\circ\text{C}$) (Manninen et al., 2002), due to drought stress or autooxidation (Choe and Min 2005) and may induce VOCs for defense (Schöning *et al.*, 1998; Thakeow et al., 2008). Besides organic matter, forest fires release high amounts of VOCs. During such fires, the degradation process of hemicellulose, cellulose and lignin, the essential compartments of a woody plant species, takes place.

For finding food sources, insects use olfaction both alone and in combination with other senses to maximize the efficiency (Schmitz et al., 2002; Heisswolf et al., 2007). Several pyrophilous insect species use the combination of senses for orientation towards newly burnt areas, including the beetle *Acanthocnemus nigricans* (Schmitz et al., 2002; Kreiss et al., 2007) and buprestid beetles of the genus *Melanophila* (Evans 1964; Schmitz et al., 1998; Schmitz et al., 2007). These pyrophilous insects are attracted to smoke produced by smoldering logs (Schütz et al., 1999a, 1999b; Paczkowski et al., 2013). Besides olfactory receptors, they possess also IR receptors (Schmitz et al., 2002; Kreiss et al., 2007). The interactions between olfaction and other types of perception in pyrophilous insects are complex. The question arises how pyrophilous insects can efficiently use visual, IR and olfactory perception for the detection of suitable habitats. This is a fundamental, yet unanswered question that should give occasion for studies on the behavior of pyrophilous insects in different regions of the world.

In large areas of Vietnam, forest fires take place very frequently (Le et al., 2014). They can be caused by natural events or anthropogenic actions (McNamara et al., 2006) and frequently attract pyrophilous insects (Hoang & Schütz 2015; Geiser 2016). Studies of pyrophilous insects in Vietnam are scarce. However, the presence of pyrophilous insects, their behavior and adaptation to recently burnt habitats in Vietnam are an important aspect for the understanding of tropical forest ecology and forest fire management. Hence, this gave rise to investigate the occurrence and adaptation of pyrophilous insects in the recently burnt habitats in Vietnam Central Highlands.

1.2 Forest fires

Forest fires are natural events which have a high impact on the ecological niches and forest fauna and flora. They impact the forest ecosystem both negatively and positively.

Fires in forests are usually more disastrous than those in other habitats because of the large volumes of burnt plant biomass and the rapid spread of the flames. Forest fires burn whole trees or some parts of the tree like the roots, bole or crown. This often leads to tree mortality

after fires (Swezy & Agee 1991). Therefore, Forest fires cause damage to the habitat and ecosystem and – initially – can be regarded as a threat to biodiversity (Swengel 2001).

On the other hand, forest fires positively impact the ecosystem and biodiversity by establishing between-patch heterogeneity (Levin & Paine 1974; Picket & White 1985) of the habitat after forest fires. This will increase the differences in stand structures and composition of tree species (Wright & Bailey 1982; Danks & Footit 1989; Esseen et al., 1992).

Moreover, fire affects the different layers (litter, herbs, shrubs and canopy) and forest types differentially (Prodon et al., 1987). Therefore, fires also alter the diversity of insect communities within these habitats. Effects of fires on the ecosystem and to the diversity of insects depend on the type of fires (e.g., wildfires) or fire management (e.g., prescribed burning). In 2010, Vietnam's forests covered 13,258,843 ha (39.1% of the total land area), of which 10,339,305 ha were natural forests (82.7%) and 2,919,538 ha of forest plantations (17.3%) (FPD Vietnam 2010). During the dry season, there are about six million hectares (ha) of forest with high potential of forest fire risk (about 50% of Vietnam's total forest area), located in 48 different provinces. Vegetation types particularly susceptible to fires include forest stands of pines, dipterocarps, casuarinas, eucalyptus and bamboo, as well as other types of land cover such as grass- and shrublands (Hoang 2007). In the face of global climatic changes, weather extremes in Vietnam are likely to become more severe and abundant, which could significantly increase the frequency of forest fires. With shortened rainy seasons, fires could take place throughout the year in different provinces, depending on the weather and climatic condition of each location.

Forest fires happen all over Vietnam during different annual periods (see Fig. 1). From December to April, regions with high forest-fire risk include North Vietnam, Southeastern Vietnam, Vietnam Central Highlands and the Mekong River Delta, whereas from April to June, forest fires occur in the coastal provinces of Central Vietnam. From June to August, hot and dry west winds cause forest fires in the north of Central Vietnam (Hoang 2007).

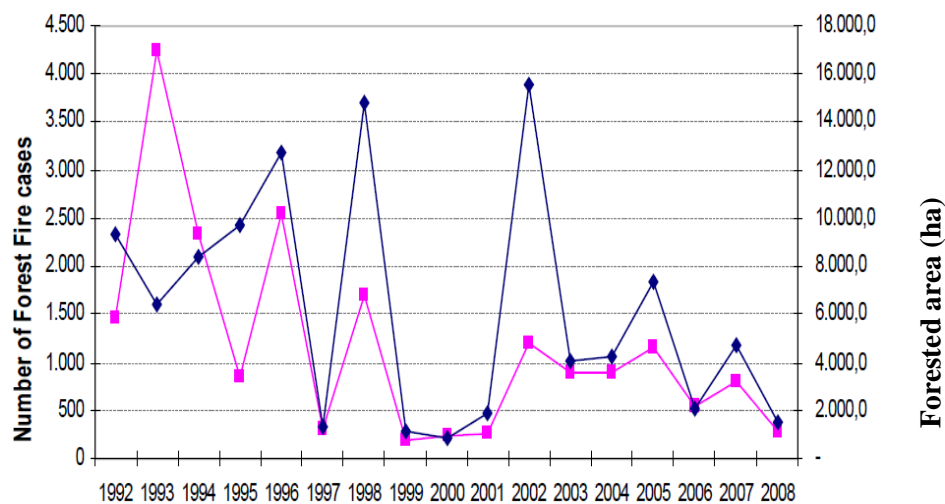

Figure 1: Forest fire data, pink: Forest fired cases and Lila: forest fire area (FPD Vietnam 2007).

There is a strong correlation between the number of forest fires in Vietnam and El Niño-Southern Oscillation (ENSO) activities. Vietnam Central Highlands are considered to be hotspots of forest fires, since they experience the longest dry season of any region in the country (from October to March). Provinces specifically affected by forest fires are Gia Lai, Dak Lak, Dak Nong, Kon Tum and Lam Dong (Fig. 2).

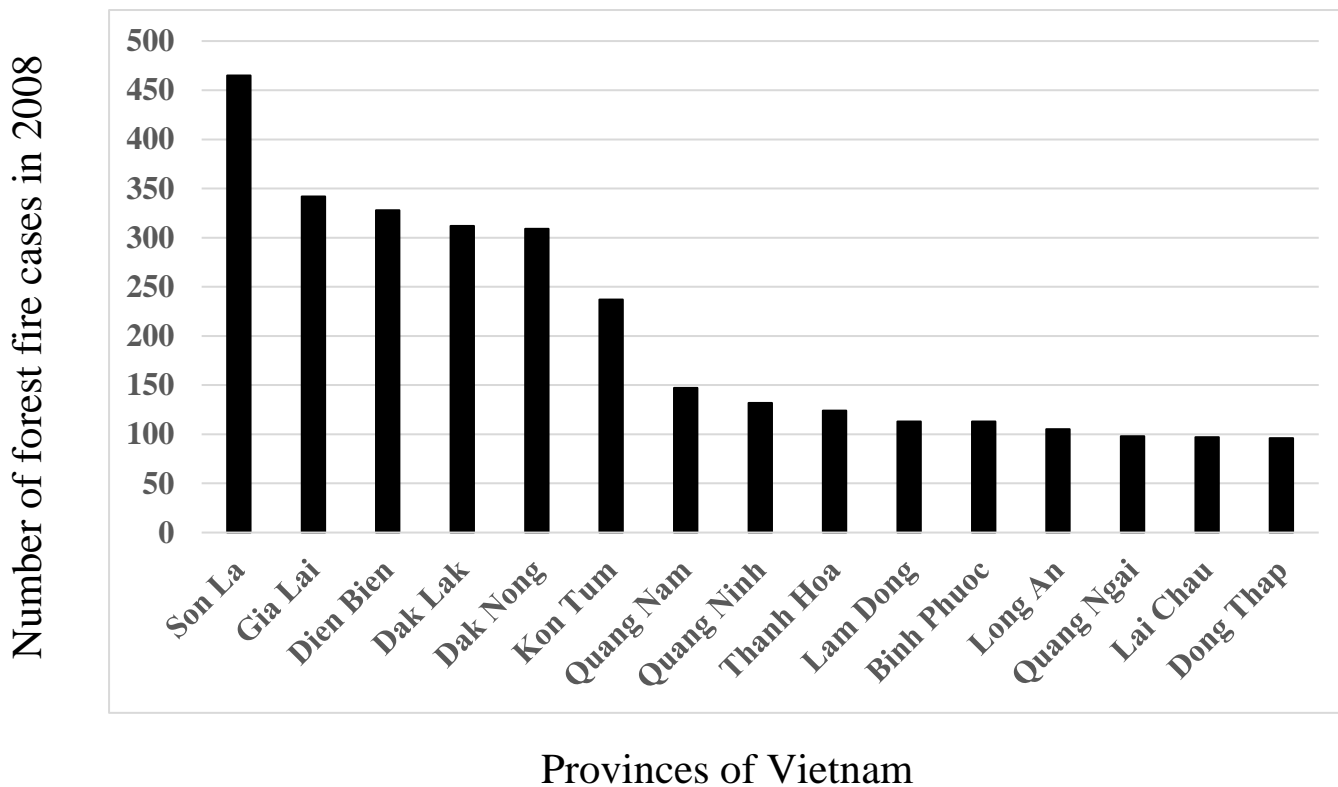

Figure 2: Forest fires in Vietnam Central Highlands (FPD Vietnam 2008).

1.3 Pyrophilous insects

Organisms which benefit from fire-affected forests as habitats or actively select such habitats are known as "pyrophilous" or "fire-loving". Pyrophilous organisms are known among plants, fungi, and animals, including numerous insects in the orders Hemiptera, Lepidoptera, Diptera and Coleoptera from at least 25 families (Klocke et al., 2011). In contrast to non-pyrophilous insects, populations of pyrophilous insects decline dramatically after fires, while their population richness immediately regains after a fire (Swengel 2001). Fire-loving insects need forest fires for their reproduction. Consequently, they approach fires and invade the burnt area immediately. In order to navigate towards a fire, as well as for orientation on the freshly burnt surface, pyrophilous insects use distinct sensors for burnt plant odor and maybe infrared (IR) radiation. Some beetles feature IR sensors underneath their wings (Schmitz et al., 1998), while others have antennae with smoke sensors perceiving the scent of smoke (Schütz et al., 1999a). Correlations between the biodiversity of pyrophilous insects and ecological disturbances such as fires have been studied extensively by researchers (Muona & Rutanen 1994; Wikars 1997). Recently, interest in the behavior of pyrophilous insects, their interaction with forest fires, and on the effects of fire on their population dynamics has grown. Also, military scientists have been focusing on the sensors of these insects and their ability to detect IR radiation. Forest fires can both result in decreased or increased insect damages to forest trees (Swengel 2001). However, the outcomes depend on the intensity of the fire as well as on the tree and insect species involved. For example, attacks of certain pest insects may cause such severe forest damages that large amounts of deadwood are produced, providing for combustibles that facilitate future fire outbreaks (Geiszler et al., 1980).

1.4 Infrared receptors in insects

Infrared radiation plays an important role for several living organisms. Besides the needs of long wave IR radiation for thermoregulation (Schmitz et al., 1997), some animals use high sensitivity IR receptors for effectively ambushing their prey, like in rattlesnakes and boid snakes (Bullock & Cowles 1952; Bullock & Fox 1957). Nocturnally active snakes use their IR receptors for detecting prey at night (Gamow & Harris 1973). IR receptors also are essential tools to help blood-sucking insects like Chagas bugs to detect and steer toward their preys (Lazzari & Nunez 1989).

Infrared receptors are found in some pyrophilous insects. It has been speculated that receptors are used for detecting forest fires. There is a strong evidence that buprestid beetles of the genus *Melanophila* approach forest fires (Champion 1909; Nicholson 1919; Linsley 1943; Evans 1962, 1964; Apel 1988, 1989). These beetles perceive IR radiation with their thoracic IR

receptors (Evans, 1964; Schmitz *et al.*, 2000). The Australian fire beetle *Merimna atrata* is known to detect fires from far distances (Poulton 1915; Schmitz *et al.*, 2002). This species has two pairs of IR organs on the ventrolateral sides of the abdomen (Schmitz *et al.*, 2000). The “Little Ash” beetle *Acanthocnemus nigricans* (family Acanthocnemidae) approaches forest fires (Champion 1922). *A. nigricans* possesses IR receptors on the prothorax (Schmitz *et al.*, 2002). Several species of flat bugs (Heteroptera: Aradidae) are found frequently at burnt sites (Hjältén *et al.*, 2006). Various *Aradus* species are attracted by the open fire, hot ash, or smoke such as *A. albicornis*, and *A. lugubris* (Wikars 1997). The IR receptors have been found in *A. albicornis* (Schmitz *et al.*, 2008), and also in *A. lugubris*, *A. flavicornis*, and *A. fuscicornis* (Schmitz *et al.*, 2010).

The IR receptors are located on different parts of the body in the mentioned insect species. In *Melanophila* beetles, one pair of IR pit organs are located on the metathorax adjacent to the coxae of the middle legs (Evans 1966). Two pairs of IR organs in *M. atrata* are situated ventrolaterally on the abdomen (Schmitz *et al.*, 2000). Differently, the first thoracic segment is the site where complex IR receptor organs in *A. nigricans* can be found. Unlike the three species above, IR receptors of several *Aradus* bugs (*A. lugubris*, *A. albicornis*, *A. flavicornis*, and *A. fuscicornis*) are located at the bases of the pro- and mesothoracic legs and on the lateral areas of the propleurae (Schmitz *et al.*, 2010).

The morphological similarities and differences of IR receptors in pyrophilous insects suggest similarities but also differences in the functions of these organs. Regarding the functional principle, the IR receptors of *Merimna atrata* have been described to be similar to the *A. nigricans* receptors (Schmitz *et al.*, 2002). Because of the similarity in morphology between the *Aradus* sensillum and the IR receptors of buprestid beetles in the genus *Melanophila*, it can be proposed that the function of IR receptors in these species are comparable (Schmitz *et al.*, 2007; Vondran *et al.*, 1995).

1.5 Volatile Organic Compounds

Volatile organic compounds (VOCs) are referred to as organic chemical compounds which have a vapor pressure of 1013 hPa at SATP (Standard Ambient Temperature and Pressure) conditions at 25°C. These SATP conditions are necessary to let organic chemical compounds evaporate into the gaseous phase. Volatiles can be classified into different levels such as very volatile like methane, volatile (reactive VOCs like isoprenes and terpenes), and semi-volatile (non-reactive VOCs). The classification of VOCs is based on their occurrence, reactivity, physical properties and boiling points. The volatiles can be released by natural processes or by anthropogenic origin. In nature, VOCs are produced by chemical reactions in plants (Feussner

et al., 1997), animals (Paczkowski 2013) or fungi (Thakeow et al., 2008), as well as by the burning of plant products during forest fires (Schütz et al., 1999a). Anthropogenically emitted VOCs can be produced by industrial processes (Graedel 1994) or by transport (Na 2006). VOCs are currently investigated in different research fields. These include atmospheric chemistry, as high concentrations of VOCs are harmful to humans (Granström 2002; Parkinson et al., 2008; Maleknia et al., 2009).

1.6 Roles of VOCs for insects

Insects use their antennal olfactory sensilla to recognize different VOCs. These play an important role for basic ecological purposes such as mating (Pelosi & Maida 1995), oviposition (Verheggen et al., 2008), finding food resources (Beck et al., 2012), and interspecific communication (Reyes-Vidal 2009). The specific roles of these VOCs are difficult to define due to their complex functions in the ecosystem (Nordlund et al., 1981). Chemicals used to exchange information and to mediate the interspecific or intraspecific interaction between organisms are so called semiochemicals. Intraspecific interaction refers to communications between different individuals of the same species within communities. Interspecific interactions refer to the communications between different species, mediated by allelochemicals.

Pheromones are defined as semiochemicals for intraspecific communication (Schaefer 2012). Pheromones play a critical role in the sexual communication of insects, for example in the lepidopteran species *Bombyx mori* (Maida et al., 1993; Sakurai et al., 2004) or *Lymantria dispar* (Plettner et al., 2000). Moreover, pheromones are used by many ants to direct recruit foragers to food sources (Gruter et al., 2012), alarming of a group (Vandermoten et al., 2012) and the selection of oviposition sites (Nufio & Papaj 2001). Apneumones are emitted by organic matter and can have both advantages and disadvantages for one insect species at the same time. As an advantage, apneumones attract one insect species to a food source. However, they also attract the predators of this species (Aak et al., 2010).

Allelochemicals arbitrate a beneficial relationship between sender and receiver (Ruther 2002). While kairomones provide a benefit for the receiver (e.g. by informing a predator about the location of its prey), allomones benefit the sender (Burger 1988; Ruther 2002; Schaefer 2012), for example by defense against predators. In contrast to kairomones and allomones, synomones mediate a benefit for both sender and receiver (Shepherd 2007). Thus, competition between two species is avoided.

1.7 Formation of VOCs

Volatile organic compounds are emitted by many different sources. Plants release VOCs as byproducts of their metabolic activities (Peñuelas & Llusà 2004). Woody material (e.g. tree trunks and deadwood) are another major source of plant-related VOC, as well as wood products. Fungi and fungus-infested wood also release VOCs (Holighaus 2012). Volatiles are further produced by the thermal oxidation of wood.

Wood consists of two main components: carbohydrate (hemicelluloses, cellulose) and lignin, as well as extractives (like waxes, fatty acids, resin acids, phenolic compounds, and terpenes of a tree). In general, softwood species have the same cellulose (40–45%) and lignin (26–34%) content in comparison to hardwood species (cellulose 38–49%, lignin 23–30%). However, the hemi-celluloses in general of softwood species is higher than their content in hardwood hemi-cellulose. According to Granström (2002), VOC emissions and degradation products of wood constituents differ between and among tree species and even on the same tree (see Kollmann 1982; Hyttinen et al., 2010). Especially, these differences are highly recognized between softwood and hardwood due their differences in cell types (Sjostrom 1993). The release of VOCs from wood varies with air temperature and thermal degradation of wood (Manninen et al., 2002; Hyttinen et al., 2010).

Released at ambient temperature, terpenes are the major important group of extractives (Englund & Nussbaum 2000; Banerjee 2001; Granström 2002; Manninen et al., 2002). The chemical reaction of terpenes can lead to the formation of new compounds (Neuenschwander et al., 2010).

Fatty acids are among the major group of wood extractives. They are distributed in vesicles and the phospholipid membranes of the parenchyma cells of wood (Sjostrom 1993). These membranes contain large amounts of linoleic and arachidonic acid (Frankel 1983). Fatty acids are degraded by the processes of thermal degradation (Paczkowski et al., 2011), autolysis or reactive oxygen species (Choe & Min 2005), and by microorganisms (Paczkowski et al., 2011). During these processes, some VOCs can be formed. For example, the aldehydes hexanal, heptanal, nonanal and decanal are formed during autolysis or oxidation by reactive oxygen species (Risholm-Sudman et al., 1998; Svedberg et al., 2004; Arshadi 2005; Roffael 2006). However, some early studies found that aldehydes can also be formed by thermal degradation processes (Arshadi 2005) and by the metabolism of fungi (Combet et al., 2006). The oxidation process of unsaturated fatty acids leads to the formation of hexanal (Risholm-Sundman et al., 1998). Nonetheless, little is still known about the formation of volatile products during the oxidation of lipid (Kionka & Kunau 1985; Heath et al., 2002; Combet et al., 2006).

1.8 Carbohydrate polymers

The major constituents of carbohydrates are composed of hemicellulose and cellulose polymers, with a small amount of sugar polymers like pectin and starch (Stamm 1964). Hemicelluloses are heteropolymers. Their structure includes different hexose and pentose sugars.

The polymerization of the most abundant pentose sugars D-xylose and L-arabinose with other sugars (like glucose, mannuronic acid and arabinose, see Sjoström 1993) results in the formation of arabinoxylan, glucuronoxylan, glucomannan, xylan and xyloglucan (Sjoström 1993). Hemicelluloses are very sensitive to heat, especially their sugar component xylan (pentosan) (Kotilainen 2000). Acetic acid is formed during the thermal deacetylation of hemicelluloses (Risholm-Sundman et al., 1998; Kotilainen 2000). The thermal degradation of pentoses and hexoses leads to the formation of hydroxyacetone and furanes such as 2-pentylfuran, furfural and methylated furfural (Fengel & Wegener 1984; Risholm-Sudman et al., 1998; Tjeerdsma et al., 1998; Oasmaa et al., 2003; Cheda et al., 2006; Roffael 2006).

1.9 Cellulose

Cellulose is a glucan polymer of D-glucopyranose units linked together by 1,4- β -glycosidic bonds. The number of glucose units in the cellulose molecule is referred to as degree of polymerization (DP). Wood cellulose has an average DP of at least 9,000–10,000 molecules and possibly as high as 15,000 molecules (Goring & Timell 1962). The subunits of cellulose polymers are connected with each other and molecule plane is turned by 180°. All these subunits together form linear cellulose chains (Fig. 3.1).

Cellulose is known to be more thermally stable than hemicelluloses (Kotilainen 2000). The cleavage of the 1,4- β -glycosidic bonds during the thermal degradation process leads to the formation of hydroxyacetone (Piskorz et al., 1986; Zhang et al., 2008), 5-methylfurfural (Oasmaa et al., 2003) and 3-methyl-2H-furo[2,3-c]pyran-2-one, also known as karrikinolide (Flematti et al., 2011) (Fig. 3.2). During the thermal degradation process of cellulose, levoglucosan is released at temperatures above 200°C, followed by the release of furan derivatives (Risholm-Sundman et al., 1998; Kotilainen 2000). Figure 3.3 shows that thermal degradation of cellulose leads to the formation of furan derivatives, mainly 2-furancarboxaldehyde (furfural).

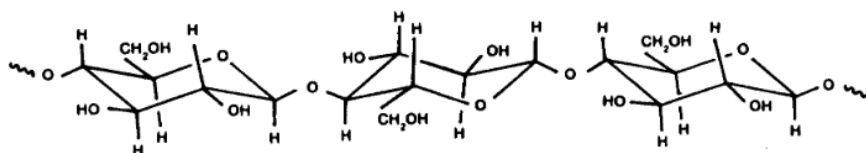

Figure 3.1: The partial molecular structure of cellulose [(C₆H₁₀O₅)] in the 1,4-β-D glucopyranose form.

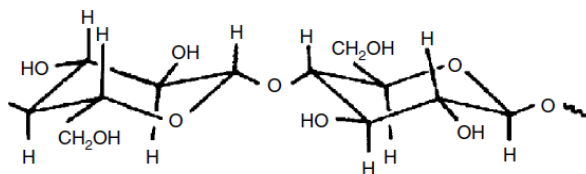

Figure 3.2: Chemical structure of cellobiose.

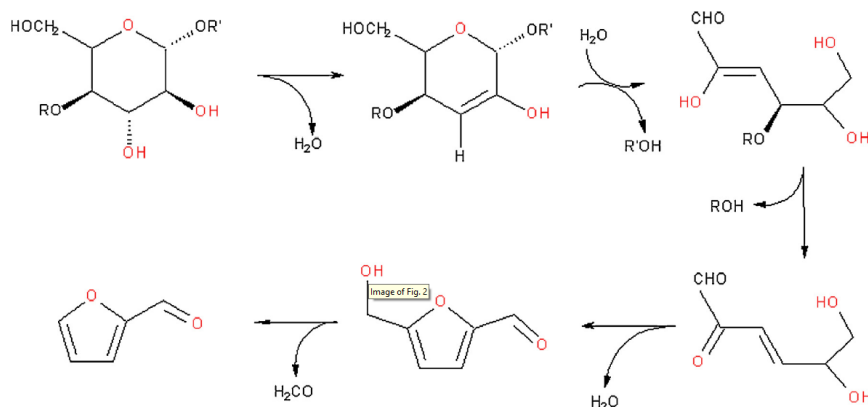

Figure 3.3: Proposed route to 5-methylfurfural and furfural from cellulose (Flematti et al., 2011).

1.10 Lignin

Lignin is a biopolymer consisting of different monomeric constituents and differs between hardwood and softwood. The main precursor of softwood lignin is synapylalcohol (Sjostrom 1993). Hardwood lignin mainly consists of the two biochemically polymerized phenylpropanoids coniferyl alcohol and sinapyl alcohol (Sjostrom 1993), which are mainly connected by the β-O-4 bond. Other bonds like biphenyl- or β-β-bonds (Higuchi 1990) are products of the biochemical radicalization of sinapyl or coniferyl alcohol. The lignin precursor (dimeric chinomethid) is therefore the product of this radicalization process. In plant growth, sinapyl or coniferyl alcohol is transformed into hardwood lignin molecules (Higuchi 1990; Sjostrom 1993) (Fig. 4).

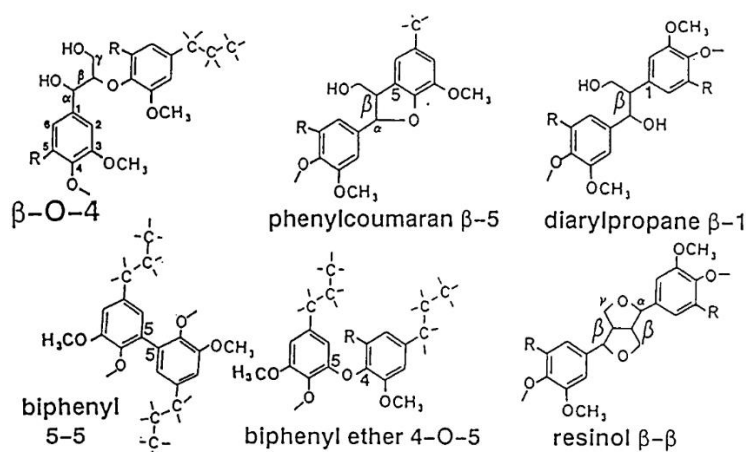

Figure 4: Principal bonding patterns between guaiacyl (R = H) and syringyl (R = OCH₃) units in hardwood lignins (Lapierre et al., 1994).

Under the physical influence of heat, the links between the polymerized coniferyl and sinapyl are broken down to their smaller components. The thermal oxidation of these components leads to the formation of guaiacol derivatives such as 4-methylguaiacol, 4-ethylguaiacol, eugenol and other compounds (Fig. 4) (Karagoz et al., 2005; Branca et al., 2006; Ingram et al., 2008 and Azeez et al., 2010). These compounds can also be formed during the oxidation process of lignin by white rot fungi (Oudia et al., 2008).

1.11 Objective of this thesis

At the beginning of this work, nothing was known about the presence of pyrophilous insects in Vietnam, although several pyrophilous insect species are known to occur in Europe, America, and Australia. Several studies have investigated the attraction of pyrophilous insects toward VOCs released upon heating up of wood (Schütz et al., 1999a; Paczkowski et al., 2013). Some other studies focus on the presence of IR receptors in pyrophilous insects (Evans 1964; Schmitz et al., 1997, 2000, 2002, 2008 and 2010). Forest fires are taking place very frequently in Vietnam (Le et al., 2014), suggesting the potential existence of fire-loving species in fire-prone regions (Hoang & Schütz 2015; Geiser 2016). Therefore, this study aimed to examine recently burnt habitats in Vietnam for the presence of pyrophilous insects and to identify cues suitable for them to find such habitats. This includes morphological and chemo-ecological studies unravelling the significance of IR receptors, IR radiation, volatile signals, and the respective behavior induced by such cues.

The experiments of the thesis are presented in four chapters (chapter 2 to chapter 5) representing manuscripts for publication on their own. Chapter 6 discusses the general outcome of this thesis. The presentation of experiments was subdivided according to 1) the presence of

pyrophilous insects in the Vietnam Central Highlands (chapter 2), 2) the attraction of insects in recently burnt habitat to common fire-specific VOCs released by different Vietnamese woody plant species upon heating (chapter 3), 3) the attraction of pyrophilous insects to fire-specific VOCs and IR radiation and combination of both stimuli (chapter 4), and 4) the behavior and sensory adaptation of the pyrophilous flat bug *Aradus candidatus* (chapter 5).

The respective chapters aim to address the following questions:

- 1) Are there pyrophilous insects in Vietnam?
(Chapters 2 and 5)
- 2) How does the diversity of VOCs correlate with the insect diversity in recently burnt habitats?
(Chapter 3)
- 3) Are burnt wood VOCs a cue for pyrophilous insects to find burnt habitats?
(Chapters 3 and 4 & 5)
- 4) Is infrared radiation a cue for pyrophilous insects to find burnt habitats?
(Chapter 4 & 5)
- 5) How does insect attraction to recently burnt habitats differ between VOCs, IR stimuli or both stimuli?
(Chapters 4 and 5)
- 6) Is multimodal sensing important for the behavior of pyrophilous insects?
(Chapter 5)

1.12 References

- Aak, A., Knudsen, G. K. and Soleng, A. (2010).** Wind tunnel behavioral response and field trapping of the blowfly *Calliphora vicina*. *Medical and Veterinary Entomology*, 24(3): 250-257.
- Apel, K. H. (1988).** Befallsverteilung von *Melunophila acuminata* DEG., *Phaenops cyanea* F. und *Ph. formnneki* JACOB (Col., Buprestidae) auf Waldbrandflächen. *Beiträge für Forstwirtschaft*, 22:45-48.
- Apel, K. H. (1989).** Zur Verbreitung von *Melunophilu acuminata* DEG. (Col., Buprestidae). *Entomol. Nach. Ber.* 33, 278-280.
- Arshadi, M. (2005).** Emission of volatile organic compounds from softwood pellets during storage. *Forest Products Journal*, 55(12): 132-135.
- Azeez, A. M., Meier, D., Odermatt, J. and Willner, T. (2010).** Fast pyrolysis of African and European lignocellulosic biomasses using Py-GC/MS and fluidized bed reactor. *Energy & Fuels*, 24(3): 2078-2085.
- Banerjee, S. (2001).** Mechanisms of terpene release during sawdust and flake drying. *Holzforschung*, 55(4): 413-416.
- Beck, J. J., Higbee, B. S., Light, D. M., Gee, W. S., Merrill, G. B. and Hayashi, J. M. (2012).** Hull split and damaged almond volatiles attract male and female navel orange worm moths. *Journal of Agricultural and Food Chemistry*, 60(33): 8090-8096.
- Branca, C., Di Blasi, C. and Elefante, R. (2006).** Devolatilization of conventional pyrolysis oils generated from biomass and cellulose. *Energy & Fuels*, 20(5): 2253-2261.
- Briscoe, A. D. and Chittka, L. (2001).** The evolution of colors vision in insects. *Annual Review of Entomology*, 46: 471-510.
- Bullock, H. T. and Cowles, B. R. (1952).** Physiology of an Infrared Receptor: The Facial Pit of Pit Vipers. *Science*, 115(2994): 541-543.
- Bullock, H. T. and Fox, W. (1957).** The Anatomy of the Infra-red Sense Organ in the Facial Pit of Pit Vipers. *Journal of Cell Science*, 3(98): 219-234.
- Burger, B. V., Munro, Z. M. and Visser, J. H. (1988).** Determination of plant volatiles 1: Analysis of the insect-attracting allomone of the parasitic plant *Hydnora africana* using Grob-Habich activated charcoal traps. *Journal of High Resolution Chromatography & Chromatography Communications*, 11(6): 496-499.
- Champion, G. C. (1909).** A buprestid and other Coleoptera on pine injured by "heath fires" in N.W. Surrey. *Entomologist's Monthly Magazine*, 45, 247-250.
- Champion, G.C., (1922).** The geographical distribution and synonymy of the dasytid-beetle *Acanthocnemus nigricans* HOPE (*Zciliatus* PERRIS). *Entomologist's Monthly Magazine (Series 3.8)*, 58: 77-79.
- Cheda, J. N., Roman-Leshkov, Y. and Dumesic, J.A. (2006).** Production of 5-hydroxymethylfurfural and furfural by dehydration of biomass-derived mono- and polysaccharides. *Green Chemistry*, 9(4): 342-350.

Choe, E. and Min, D. B. (2005). Chemistry and reactions of reactive oxygen species in foods chromatography. *Journal of Chromatography A*, 1216(10): 1607-1623.

Combet, E., Henderson, J., Eastwood, C. D. and Burton, K. S. (2006). Eight-carbon volatiles in mushrooms and fungi, properties, analysis, and biosynthesis. *Mycoscience*, 47(6): 317-326.

Danks, H. V. and Footitt, R. G. (1989). Insects of the boreal zone of Canada. *The Canadian Entomologist*, 121(8): 625-690.

Englund, F. and Nussbaum, R. M. (2000). Monoterpenes in Scots pine and Norway spruce and their emission during kiln drying. *Holzforschung*, 54(5): 449-456.

Esseen, P.-A., Ehnström, B., Ericson, L. and Sjöberg, K. (1992). Boreal forests – the focal habitats of Fennoscandia. Pp. 252-325 in: Hansson, L. (ed.): *Ecological Principles of Nature Conservation*. Elsevier, London, 436 pp.

Evans, W. G. (1962). Notes on the biology and dispersal of *Melanophilu* (Coleoptera: Buprestidae). *Pan-Pacific Entomology*, 38: 59-62.

Evans, W. G. (1964). Infrared receptors in *Melanophila acuminata* De Geer. *Nature (Lond.)* 202: 211.

Evans, W. G. (1966). Perception of infrared radiation from forest by *Melanophila acuminata* (Buprestidae, Coleoptera). *Ecology* 47: 1061-1065.

Fengel, D. and Wegener, G. (1984). *Wood, chemistry, ultrastructure, reactions*. De Gruyter Inc., Boston, USA.

Feussner, I., Kühn, H. and Wasternack, C. (1997). Do specific linoleate 13-lipoxygenases initiate β -oxidation? *FEBS Letters*, 406: 1-5.

Flematti, G. R., Scaffidi, A., Dixon, K. W., Smith, S. M. and Ghisalberti, E. L. (2011). Production of the seed germination stimulant karrikinolide from combustion of simple carbohydrates. *Journal of Agricultural and Food Chemistry*, 59(4): 1195-1198.

Forbes, S. L., Stuart, B. H. and Dent, B. B. (2002). The identification of adipocere in grave soils. *Forensic Science International*, 127(3): 225-230.

Forbes, S. L., Dent, B. B. and Stuart, B. H. (2005a). The effect of soil type on adipocere formation. *Forensic Science International*. 154(1): 35-43.

Forbes, S. L., Stuart, B. H. and Dent, B. B. (2005b). The effect of the burial environment on adipocere formation. *Forensic Science International*, 154(1): 24-34.

Forbes, S. L., Stuart, B. H. and Dent, B. B. (2005c). The effect of the method of burial on adipocere formation. *Forensic Science International*, 154(1): 44-52.

Frankel, E. N. (1983). Volatile lipid oxidation-products. *Progress in Lipid Research*, 22: 1-33.

- Gamow, R.I. & Harris, F.J. (1973).** The Infrared Receptors of Snakes. *Scientific American*, 228(5): 94-101.
- Geiser, M. (2016).** An update on the distribution of the pyrophilous beetle *Acanthocnemus nigricans* (Hope, 1845) (Coleoptera: Cleroidea: Acanthocnemidae), including new records from Laos. *Entomologica Basiliensia et Collectionis Frey*, 35: 429-432.
- Geiszler, D. R., Gara, R. I., Driver, C. H., Gallucci, V. F., and Martin, R. E. (1980).** Fire, fungi, and beetle influences on a lodgepole pine ecosystem of south-central Oregon. *Oecologia*, 46(2): 239–243.
- Goring, D. A. I. and Timell, T. E. (1962).** Molecular weight of native celluloses. *Tappi* 45: 454–460.
- Graedel, T. (1994).** Industrial ecology: definition and implementation. Pp. 23-43 in: Socolow, R., Andrews, C., Berkhout, F. and Thomas, V. (eds): *Industrial Ecology and Global Change*, Cambridge University Press, Cambridge, United Kingdom, 500 pp.
- Granström, K. (2002).** Emissions of monoterpenes and VOCs during drying of sawdust in a spouted bed. *Forest Products Journal*, 53(10): 48-55.
- Grimaldi, D. and Engel, M. S. (2005).** *Evolution of the insects*. Cambridge University Press, Cambridge, United Kingdom.
- Groot, M., Cokl, A. and Virant-Doberlet M. (2010).** Effects of heterospecific and conspecific vibrational signal overlap and signal-to-noise ratio on male responsiveness in *Nezara viridula* (L.). *Journal of Experimental Biology*, 213: 3213-3222.
- Gruter, C., Schurch, R., Czaczkes, T. J., Taylor, K., Durance, T., Jones, S. M., et al. (2012).** Negative feedback enables fast and flexible collective decision-making in ants. *PLoS ONE* 7(9): e44501. doi:10.1371/journal.pone.0044501.
- Hansson, B. S. (1999).** *Insect Olfaction*. Springer, New York, 458 pp.
- Heath, R. J., Jackowski, S. and Rock, C. O. (2002).** Fatty acid and phospholipid metabolism in prokaryotes. Pp. 59-96 in: Vance, D. E. and Vance, J. E. (eds.): *Biochemistry of lipids, lipoproteins and membranes*. Elsevier, San Francisco, USA, 612 pp.
- Heisswolf, A., Gabler, D., Obermaier, E. and Muller, C. (2007).** Olfactory versus contact cues in host plant recognition of a monophagous chrysomelid beetle. *Journal of Insect Behavior*, 20: 247-266.
- Higuchi, T. (1990).** Lignin biochemistry, Biosynthesis and biodegradation. *Wood Science and Technology*, 24(1): 23-63.
- Hjältén, J., Atlegrim, O., Sandström, F., Pettersson, R. and Røxstad, E. A. (2006).** Occurrence of flat bugs (Heteroptera: Aradidae) in burned and unburned forests. *Entomologica Fennica*, 17: 130-135.
- Hoang, M. D. (2007).** Ecology and Conservation Status of the Black-shanked Douc (*Pygathrix nigripes*) in Nui Chua and Phuoc Binh National Parks, Ninh Thuan Province, Vietnam. Ph.D.

Thesis, School of Natural & Rural Systems Management, The University of Queensland, Australia.

Hoang, T. P. and Schütz, S. (2015). Pyrophilous insects in Vietnam central highlands. *Mitteilungen Deutsche Gesellschaft für allgemeine und angewandte Entomologie*, 20: 133-138.

Holighaus, G. (2012). Odour signals relevant to beetles in deadwood habitats. PhD Thesis. Faculty of Forest Sciences and Forest Ecology. University of Göttingen, Germany.

Hyttinen, M., Masalin-Weijo, M., Kalliokoski, P., Pasanen, P. (2010). Comparison of VOC emissions between air-dried and heat-treated Norway spruce (*Picea abies*), Scots pine (*Pinus sylvestris*) and European aspen (*Populus tremula*) wood. *Atmospheric Environment*, 44(38): 5028-5033.

Ingram, L., Mohan, D., Bricka, M., Steele, P., Strobel, D., Crocker, D., et al. (2008). Pyrolysis of wood and bark in an auger reactor. Physical properties and chemical analysis of the produced bio-oils. *Energy & Fuels*, 22(1): 614-625.

Karagoz, S., Bhaskar, T., Muto, A. and Sakata, Y. (2005). Comparative studies of oil compositions produced from sawdust, rice husk, lignin and cellulose by hydrothermal treatment. *Fuel*, 84(7-8): 875-884.

Kionka, C. and Kunau, W. H. (1985). Inducible β -oxidation pathway in *Neurospora crassa*. *Journal of Bacteriology*, 161(1), 153-157.

Klocke, D., Schmitz, A., Soltner, H., Bousack, H. and Schmitz H. (2011). Infrared receptors in pyrophilous ("fire loving") insects as model for new un-cooled infrared sensors. *Beilstein Journal of Nanotechnology*, 2: 186-197.

Kollmann, F. (1982). *Technologie des Holzes und der Holzwerkstoffe, Anatomie und Pathologie, Chemie, Physik, Elastizität und Festigkeit.* Springer, Berlin, Germany, 1051 pp.

Kotilainen, R. A., Toivanen, T. J. and Alén, R. J. (2000). FTIR Monitoring of Chemical Changes in Softwood During Heating. *Journal of Wood Chemistry and Technology*, 20 (3): 307-320.

Kreiss, E., Schmitz, H. and Gebhardt, M. (2007). Electrophysiological characterization of the infrared organ of the Australian "little ash beetle" *Acanthocnemus nigricans* (Coleoptera, Acanthocnemidae). *Journal of Comparative Physiology*, 193(7): 729-739.

Lapierre, C., Monties, B., Meier, D. and Faix, O. (1994). Structural investigation of Kraft lignins transformed via oxo-ammoniation to potential nitrogenous fertilizers. *Holzforschung*, 48 (S1): 63-68.

Lazzari, C. R. and Nunez, J. A. (1989). The response to radiant heat and the estimation of the temperature of distant sources in *Triatoma infestans*. *Journal of Insect Physiology*, 35(6): 525-529.

Le, T. H., Thanh Nguyen, T. N., Lasko, K., Ilavajhala, S., Vadrevu, K. P. and Justice, C. (2014). Vegetation fires and air pollution in Vietnam. *Environmental Pollution*, 195: 267-275.

- Levin, S. A. and Paine, R. T., (1974).** Disturbance, patch formation, and community structure. *Proceedings of the National Academy of Sciences of the United States of America*, 71: 2744–2747.
- Linksvayer, T. A., Fewell, J. H., Gadau, J. and Laubichler, M. D. (2012).** Developmental evolution in social insects, regulatory networks from genes to society. *Journal of Experimental Zoology, B: Molecular and Developmental Evolution*, 318(3): 159-169.
- Linsley, E. G. (1943).** Attraction of *Melanophila* beetles by fire and smoke. *Journal of Economic Entomology*. 36, 341-342.
- Maida, R., Steinbrecht, A., Ziegelberger, G. and Pelosi, P. (1993).** The pheromone binding protein of *Bombyx mori*, purification, characterization and immunocytochemical localization. *Insect Biochemistry and Molecular Biology*, 23(2): 243-253.
- Maleknia, S. D., Bell, T. L. and Adams, M. A. (2009).** Eucalypt smoke and wildfires, temperature dependent emissions of biogenic volatile organic compounds. *International Journal of Mass Spectrometry*, 279(2-3): 126-133.
- Manninen, A. M., Pasanen, P. and Holopainen, J. K. (2002).** Comparing the VOC emissions between air-dried and heat-treated Scots pine wood. *Atmospheric Environment*, 36(11): 1763-1768.
- McNamara, S., Tinh, D. V., Erskine, P. D., Lamb, D., Yates, D., & Brown, S. (2006).** Rehabilitating degraded forest land in central Vietnam with mixed native species plantings. *Forest Ecology and Management*, 233(2-3): 358-365.
- Muona, J. and Rutanen, I. (1994).** The short-term impact of fire on the beetle fauna in boreal coniferous forest. *Annales Zoologici Fennici*, 31(1): 109-121.
- Na, K. (2006).** Determination of VOC source signature of vehicle exhaust in a traffic tunnel. *Journal of Environmental Management*, 81(4): 392-398.
- Nation, J. L. (2001).** *Insect physiology and biochemistry*. CRC Press, New York, USA, 560 pp.
- Neuenschwander, U., Guignard, F. and Hermans, I. (2010).** Mechanism of the aerobic oxidation of alpha-pinene. *ChemSusChem*, 3(1): 75-84.
- New, T. R. (2014).** *Insects, Fire and Conservation*. Springer, Basel, Switzerland, 208 pp.
- Nicholson, G. W. (1919).** *Melanophila acuminata* De Geer at a fire in June. *Entomologist's Monthly Magazine*, 55: 156-157.
- Nordlund, D. A., Jones, R. L. and Lewis, W. J. (1981).** *Semiochemicals. Their role in pest control*. Wiley VCH, New York, USA, 306 pp.
- Nufio, C. R. and Papaj, D. R. (2001).** Host marking behavior in phytophagous insects and parasitoids. *Entomologia Experimentalis et Applicata*, 99: 273-293.
- Oasmaa, A., Kuoppala, E. and Solantausta, Y. (2003).** Fast pyrolysis of forestry residue. 2. Physicochemical composition of product liquid. *Energy & Fuels*, 17(2): 433-443.

- Oudia, A., Queiroz, J. and Simoes, R. (2008).** Potential and limitation of *Trametes versicolor* laccase on biodegradation of *Eucalyptus globulus* and *Pinus pinaster* kraft pulp. *Enzyme and Microbial Technology*, 43(2): 144-148.
- Paczkowski, S., Sauerwald, T., Weiß, A., Bauer, M., Kohl, C.-D. and Schütz, S. (2011).** Biomimetic gas sensors for large-scale drying of wood particles. Martin-Palma, R. J. and Lakhtakia, A. 7975, 797505-797505-8. Conference Proceedings of the SPIE: Bioinspiration, Biomimetics, and Bioreplication, San Diego, USA.
- Paczkowski, S. (2013).** Insect olfaction as an information filter for chemo-analytical applications. PhD Thesis. Faculty of Forest Sciences and Forest Ecology. University of Göttingen, Germany.
- Paczkowski, S., Paczkowska, M., Dippel, S., Schulze, N., Schütz, S., Sauerwald, T., et al. (2013).** The olfaction of a fire beetle leads to new concepts for early fire warning systems. *Sensors and Actuators, B: Chemical*, 183: 273-282.
- Parkinson, P. R., Churchill, T. J. and Rolls, W. (2008).** Assessment of matrix effects on methyl benzoate, a potential biomarker for detection of outgassed semi-volatiles from mold in indoor building materials. *Bulletin of Environmental Contamination and Toxicology*. 81(5): 494-497.
- Pelosi, P. and Maida, R. (1995).** Odorant-binding proteins in insects. *Comparative Biochemistry and Physiology B-Biochemistry & Molecular Biology*, 111(3): 503-514.
- Peñuelas, J. and Llusà, J. (2004).** Plant VOC emissions: making use of the unavoidable. *Trends in Ecology & Evolution*, 19(8):402-404.
- Picket, S. T. A. and White, P. S. (1985).** The ecology of natural disturbance and patch dynamics. Academic Press, London, United Kingdom, 472 pp.
- Piskorz, J., Radlein, D. and Scott, D. S. (1986).** On the mechanism of the rapid pyrolysis of cellulose. *Journal of Analytical and Applied Pyrolysis*, 9(2): 121-137.
- Plettner, E., Lazar, J., Prestwich, E. G. and Prestwich, G. D. (2000).** Discrimination of pheromone enantiomers by two pheromone binding proteins from the gypsy moth *Lymantria dispar*. *Biochemistry*, 39(30): 8953-8962.
- Poulton, E. B., (1915).** The habits of the Australian buprestid “fire beetle”, *Merimna atrata*, Lap. et Gory. *Transactions of the Entomological Society of London*, Part 1: iii-iv.
- Prodon, R. (1987).** Fire, bird conservation and land management in the North-Mediterranean area. *Ecol Mediter* 13:127–133.
- Reyes-Vidal, Y. and de la Torre, M. (2009).** Emission, perception, and behavioral responses of entomopathogenic nematodes to semiochemicals. *Nematropica*, 39(2): 213-223.
- Risholm-Sudman, M., Lundgren, M., Vestin, E. and Herder, P. (1998).** Emissions of acetic acid and other volatile organic compounds from different species of solid wood. *Holz als Roh- und Werkstoff*, 56(2): 125-129.

Roffael, E. (2006). Volatile organic compounds and formaldehyde in nature, wood and wood-based panels. *Holz als Roh- und Werkstoff*, 64(2), 144-149.

Ruther, J., Meiners, T. and Steidle, J. L. M. (2002). Rich in phenomena-lacking in terms. A classification of kairomones. *Chemoecology*, 12: 161-167.

Sakurai, T., Nakagawa, T., Mitsuno, H., Mori, H., Endo, Y., Tanoue, S., et al. (2004). Identification and functional characterization of a sex pheromone receptor in the silkworm *Bombyx mori*. *Proceedings of the National Academy of Sciences of the United States of America*, 101(47): 16653-16658.

Schaefer, M. (2012). Wörterbuch der Ökologie. Spektrum Verlag, Heidelberg, Germany, 392 pp.

Schmitz, H. and Bleckmann, H. (1997). Fine structure and physiology of the infrared receptor of beetles of the genus *Melanophila* (Coleoptera: Buprestidae). *International Journal of Insect Morphology and Embryology*, 26(3-4): 205-215.

Schmitz, H. and Bleckmann, H. (1998). The photomechanic infrared receptor for the detection of forest fires in the beetle *Melanophila acuminata* (Coleoptera: Buprestidae). *Journal of Comparative Physiology*, 182(5): 647-657.

Schmitz, H., Schmitz, A. and Horst, B. (2000). New type of infrared organ in the Australian “fire-beetle” *Merimna atrata* (Coleoptera: Buprestidae). *Naturwissenschaften*, 87: 542-545.

Schmitz, H., Schmitz, A., Trenner, S. and Bleckmann, H. (2002). A new type of insect infrared organ of low thermal mass. *Naturwissenschaften*, 89(5): 226-229.

Schmitz, A., Sehrbrock, A. and Schmitz, H. (2007). The analysis of the mechanosensory origin of the infrared sensilla in *Melanophila acuminata* (Coleoptera; Buprestidae) adduces new insight into the transduction mechanism. *Arthropod Structure and Development*, 36(3), 291–303.

Schmitz, A., Gebhardt, M. and Schmitz, H. (2008). Microfluidic photomechanic infrared receptors in a pyrophilous flat bug. *Naturwissenschaften*, 95(5): 455-460.

Schmitz, A., Schätzel, H. and Schmitz, M. (2010). Distribution and functional morphology of photomechanic infrared sensilla in flat bugs of the genus *Aradus* (Heteroptera, Aradidae). *Arthropod structure & development* 39(1): 17-25.

Schöning, M. J., Schütz, S., Schroth, P., Weißbecker, B., Steffen, A., Kordos, P., et al. (1998). A BioFET on the basis of intact insect antennae. *Sensors and Actuators B: Chemical*, 47(1-3): 235-238.

Schütz, S., Weißbecker, B., Hummel, H. E., Schöning, M. J., Riemer, A., Kordos, P., et al. (1997a). Field effect transistor-insect antenna junction. *Naturwissenschaften*, 84: 86-88.

Schütz, S., Weißbecker, B., Klein, A. and Hummel, H. E. (1997b). Host plant selection of the Colorado potato beetle as influenced by damage induced volatiles of the potato plant. *Naturwissenschaften*, 84: 212-217.

- Schütz, S., Weißbecker, B., Hummel, H. E., Apel, K.-H., Schmitz, H. and Bleckmann, H. (1999a).** Insect antenna as a smoke detector. *Nature*, 398: 298-299.
- Schütz, S., Weißbecker, B., Koch, U. T. and Hummel, H. E. (1999b).** Detection of volatiles released by diseased potato tubers using a biosensor on the basis of intact insect antennae. *Biosensors and Bioelectronics*, 14(2): 221-228.
- Schütz, S. and Weißbecker, B. (2003).** Mechanismen duftvermittelter Pflanze-Insekt-Interaktionen. Vom Pflanzenstress zum Pflanzenfraß. *Nova Acta Leopoldina*, 87: 215-235.
- Shepherd, W. P., Huber, D. P. W., Seybold, S. J. and Fettig, C. J. (2007).** Antennal responses of the western pine beetle, *Dendroctonus brevicomis* (Coleoptera: Curculionidae), to stem volatiles of its primary host, *Pinus ponderosa*, and nine sympatric nonhost angiosperms and conifers. *Chemoecology*, 17(4): 209-221.
- Singh, R.N. (1998).** Neurobiology of the gustatory system of *Drosophila* and some terrestrial insects. *Microscopy Research and Technique*, 39(6): 547-563.
- Sjostrom, E. (1993).** *Wood Chemistry*, Second Edition, Elsevier, San Francisco, USA, 293 pp.
- Stamm, A. J. (1964).** *Wood and cellulose science*. Ronald Press Co. New York, USA.
- Svedberg, U. R. A., Högberg, H. E., Högberg, J. and Galle, B. (2004).** Emission of hexanal and carbon monoxide from storage of wood pellets, a potential occupational and domestic health hazard. *Annals of Occupational Hygiene*, 48(4): 339-349.
- Swengel, B. A. (2001).** A literature review of insect responses to fire, compared to other conservation managements of open habitat. *Biodiversity & Conservation*, 10(7): 1141–1169.
- Swezy, D. M. and Agee, J. K. (1991).** Prescribed-fire effects on fine-root and tree mortality in old-growth ponderosa pine. *Canadian Journal of Forest Research*, 21(5): 626-634.
- Thakeow, P., Angeli, S., Weißbecker, B. and Schütz, S. (2008).** Antennal and behavioral responses of *Cis boleti* to fungal odor of *Trametes gibbosa*. *Chemical Senses*, 33(4): 379-387.
- The Forest Protection Department (FPD) of Vietnam.** <http://www.flegt.org/web/vietnam-forest-protection-department>
- Tjeerdsma, B. F., Boonstra, M., Pizzi, A., Tekely, P. and Miltz, H. (1998).** Characterisation of thermally modified wood, molecular reasons for wood performance improvement. *Holz als Roh- und Werkstoff*, 56: 149-153.
- Vanderloten, S., Mescher, M. C., Francis, F., Haubruge, E. and Verheggen, F. J. (2012).** Aphid alarm pheromone: An overview of current knowledge on biosynthesis and functions. *Insect Biochemistry and Molecular Biology*, 42(3): 155-163.
- Verheggen, F. J., Arnaud, L., Bartram, S., Gohy, M. and Haubruge, E. (2008).** Aphid and plant volatiles induce oviposition in an aphidophagous hoverfly. *Journal of Chemical Ecology*. 34(3): 301-307.

Vogt, R. G. and Riddiford, L. M. (1981). Pheromone binding and inactivation by moth antennae. *Nature*, 293: 161-163.

Vondran, T., Apel, K.H. and Schmitz, H. (1995). The infrared receptor of *Melanophila acuminata* De Geer (Coleoptera: Buprestidae): ultrastructural study of a unique insect thermoreceptor and its possible descent from a hair mechanoreceptor. *Tissue and Cell*, 27(6): 645-658.

Weißbecker, B., Holighaus, G. and Schütz, S. (2004). Gas chromatography with mass spectrometric and electroantennographic detection, analysis of wood odorants by direct coupling of insect olfaction and mass spectrometry. *Journal of Chromatography A*, 1056(1-2): 209-216.

Wikars, L. O. (1997). Effects of forest fire and the ecology of fire-adapted insects. *Comprehensive Summaries of Uppsala Dissertations from the Faculty of Science and Technology 272*. Acta Universitatis Upsaliensis, Uppsala, Sweden, 272 pp.

Wikars, L. O. (2002). Dependence on fire in wood-living insects: An experiment with burned and unburned spruce and birch logs. *Journal of Insect Conservation* 6: 1-12.

Wright, H. A. and Bailey, A. W. (1982). Fire ecology, United States and southern Canada. John Wiley and Sons, New York, USA, 501 pp.

Zhang, B., Huang, H. J. and Ramaswamy, S. (2008). Reaction kinetics of the hydrothermal treatment of lignin. *Applied Biochemistry and Biotechnology*, 147(1-3): 119-131.

Chapter 2

Pyrophilous insects in Vietnam Central Highlands

Published as:

Hoang, T. P*, and Schütz, S. (2015). Pyrophilous Insects in Vietnam Central Highlands. *Mitteilungen Deutsche Gesellschaft für allgemeine und angewandte Entomologie*, 20: 133-138.

* I conducted all experiments and prepared the manuscript, for which I am the corresponding author.

Pyrophilous Insects in Vietnam Central Highlands

Thi Phuong Hoang, Stefan Schütz

Thi Phuong Hoang, Georg-August-Universität Göttingen, Abteilung für Forstzoologie und Waldschutz, Büsgenweg 3, DE-37077 Göttingen, Deutschland; E-Mail: phuongnfsgmail.com

Abstract

Pyrophile Insekten werden vom Feuer angezogen, insbesondere von Rauch und Hitze. Sie haben besondere Strategien entwickelt, um in Gebieten mit häufigen Bränden zu überleben. Diese Insekten wurden bereits in Europa, Amerika und Australien untersucht, aus Vietnam liegen bisher keine Daten vor. Informationen zu Verbreitung, Verhalten und zum Einfluss dieser Insekten auf biogeochemische Kreisläufe sind eine Voraussetzung, um die Bedeutung feuerliebender Insekten für die Ökosystemregeneration nach Buschfeuern und Waldbränden zu verstehen.

In dieser Studie soll das Vorkommen von pyrophilen Insekten in Gegenden mit hoher Waldbrandfrequenz untersucht werden. Die Untersuchung wurde während der Trockenperiode von November 2013 bis März 2014 in der Provinz Kon Tum (Zentralvietnam) durchgeführt. Zehn Plots wurden in jeweils drei unterschiedlichen Lebensräumen angelegt: Flächen ohne Feuer (Habitattyp I), frisch abgebrannte Flächen (Typ II) sowie Habitate, die ein Jahr zuvor abgebrannt waren (Typ III). Der Untersuchungszeitraum für jede Fläche betrug drei Wochen. Auf den Untersuchungsflächen wurden 45 Insektenarten nachgewiesen, darunter sechs Arten mit pyrophilem Habitus. Zwei pyrophile Käferarten wurde im Habitat-Typ II in noch warmer Asche nachgewiesen, umgeben von glimmenden Holzresten, eine andere Art (*Gonocephalum bilineatum*) ein bis zwei Tage nach Erlöschen der Glut am Rande eines Lagerfeuers. Drei weitere Arten (*Lanelater robustus*, *Ceropria laticollis* und *Promethis* sp. 1) wurden häufig und ausschließlich in den Habitat-Typen II und III gefunden.

Stichworte: Pyrophile Insekten, Waldbrände, Insektenfangmethoden, Kon Tum.

2.1 Introduction

Fires and insects are essential components of the forest ecosystem and often causally related. Insect outbreak may determine extent and intensity of subsequent fires by accumulation of fuels (Stocks 1987). Fires can affect insects by killing them directly or alter vital components of their habitat (McCullough et al., 1998). The abundance and spatial-temporal continuity of plant species during habitat recovery after fires are altered. This may later on specify the quality of plants in altered habitats as new hosts for immigrating herbivorous insect species (McCullough et al., 1998; Johansson et al., 2010). Some insect species, however, are attracted directly by fires for mating, oviposition, and re-colonizing. This might result in different communities of insects in this naturally cleared habitat. Fire cleared habitats provide favorable micro climate for these insects and create open space where insects can access easily and natural enemies are reduced (Wikars 1997; Esseen 1997; Boulanger et al., 2010; Klocke, 2011). These insects are called “pyrophilous insects” or “fire loving insects” which respond to smoke and heat generated by forest fires (Saint-Germain et al., 2005) and develop their own strategies in frequent fire areas for surviving or recolonizing (McCullough et al., 1998). They can be obligatory pyrophilous or facultative pyrophilous insects. The obligatory pyrophilous insects are specialized insect species which depend on frequent fires (Schütz et al. 1999; Suckling et al. 2001; Wikars 2001B; Schmitz et al. 2002; Allison et al. 2004; Evans 2010; Paczkowski et al. 2013, 2014) for reproduction and offspring, for example (*Melanophila acuminata*, *Acanthocnemus nigricans*). They colonize burnt trees and feed on heated wood (Evans, 1964; Schütz et al. 1999; Schmitz et al. 2002; Kreiss et al. 2007; Paczkowski et al. 2013, 2014) and fast-growing post-fire fungi (Heliövaara & Väisänen 1983; Coulianos 1989; Wikars 1992; Wikars 2001A) as specialists mostly without inter-specific competition. Facultative pyrophilous insects re-colonize freshly burnt areas as a new habitat for mating, ovipositing and reproducing in high numbers utilizing fire-debilitated trees (Saint-Germain et al., 2008; Boulanger et al. 2010) and can be found in the ashes and beneath the bark of fire debilitated trees acting as herbivores, fungivores, and as carnivores such as *Pterostichus adstrictus*, *Notiophilus biguttatus*, *Harpalus quadripunctatus*, and *Bembidion lampros* (Coleoptera: Carabidae) (Gongalsky et al. 2006). They can be attracted to the newly created habitat, but may not be obligatorily dependent on fires, because they also appear in unburnt habitats (Wikars 1997; Wikars & Schimmel 2001). Pyrophilous insects were observed amongst the Diptera, Lepidoptera, Coleoptera and Heteroptera (Wikars 1997). Up to now, 50 species of pyrophilous insects have been termed and can be seen more frequently after forest fires on the burnt areas than on neighboring unburnt areas (Wikars 1997). About 50% of the known pyrophilous

species so far appear while a fire is still burning and interpenetrate the freshly burnt area (Wikars 1997).

Fire-loving insects have been examined in Europe, America, and Australia. Data on these insects in Vietnam, however, are not available to us yet. Information on presence, behavior, and their effect on biogeochemical cycles are needed to assess their possible impacts on forest ecosystem recovery after natural and anthropogenic fires. These data are essential to address biodiversity aspects as their roles in re-establishing biodiversity in fire prone forest ecosystems. Besides, nature protection can use data on these insects to assess their ability to mitigate the destructive consequences of frequent anthropogenic fires. Research on fire-loving insects also reflects the effect of fires, positive and negative, on the overall insect community diversity.

2.2 Study site and experimental design

In order to examine pyrophilous insects in Vietnam, study sites were selected in secondary forested areas and *Pinus* plantations adjacent to secondary forest in Kon Tum province of Vietnam Central Highlands. Selected areas within Kon Tum province included the districts of Sa Thay, Ngoc Hoi (where Chu Mom Ray National Park is located), Dak Ha district, in the Ngoc Linh protected area, which is situated in the districts of Dak Glei, and in the Ngoc Reo commune. The study was implemented during the dry season from 20th of November 2013 to 28th of February 2014, when forests were usually burnt and frequent fires were taking place, both of natural and anthropogenic origin.

Ten plots were placed on each study site at three different habitats, including unburnt ones (habitat type I), freshly burnt ones (1-6 days, habitat type II) and habitats burnt one year ago (habitat type III) (Tab. 1). Each study site was sampled over three weeks. Selected sites had a central area of 140 m × 140 m and preferably larger, to allow space for a core circle of traps (Fig. 3). Habitat type I was selected to provide undisturbed reference areas for control samples. Habitat Type III was selected to check for the pyrophilous insects which were successfully developing in burnt logs, fire damaged trees, tree bark etc. Additionally, these areas attracted insects for re-colonization of re-growing plants. Habitat Type II was selected to check for the pyrophilous insects which were successfully attracted to the fire 1) for mating and ovipositing on plants and fungi, 2) scavenging and oviposition on carrion caused by animals not being able to escape the fire, and 3) predating or parasitizing on the former two groups. Approximately 43 different insect species were collected at these study sites during a period of three months using UV light trap, malaise traps and opportunistic search methods (search for presence on burnt logs, fresh ashes, and in smoke plumes).

Trapping was conducted in a randomized block design, with three blocks arranged in a north-south line according to wind direction. Block 1 was placed in the plot core circle using UV light trap. Block 2 situated in the furthest south using 1st malaise trap and block 3 located in the furthest north using malaise trap 2nd. Light trap was placed in the edge of the circle directed toward the center of the circle in order to attract insects from this site (Fig. 1). UV light traps were suspended 0.7 m above ground and used for all types of habitat. Canopy Malaise traps from Santee Traps (Lexington, KY) were used with or without color panels for habitat type II and III. Canopy Malaise traps differed from the traditional Malaise trap in that an insect could be caught from any direction and the traps had collecting containers at the top and bottom. The Malaise trap measured approximately 2.7 m in height and 1.2 m in width. Three-meter tall, metal conduit poles were used to suspend the traps. A 0.5 m length of pipe with a larger diameter than the conduit was inserted into the ground and the trap support poles were then inserted into the metal pipe to hold the trap in place. Collecting containers were filled approximately one-third full with a soapy (Company Clear, Vietnam) water solution. The colored Malaise traps had four panels (0.3 m² each) hung directly onto trees. Samples from malaise traps were immediately stored in 50% alcohol, sorted to morphologically similar groups and identified. Malaise traps were employed on one evening and 2 days at each study site and then transferred to other study sites. UV light trap was used over a 4 hours period primarily from 18 h to 22 h. This trapping setup was moved to other selected habitat every night. At the end of each trapping period UV-collected insects were transferred to plastic boxes, killed with ethyl acetate and stored in ethanol 50 %.

2.3 Results

The total of 45 species was found. Two species (Coleoptera, unidentified 1, 2) of the target beetles were found only in the habitat type II in the warm ashes close to smoldering logs and stumps in the freshly burnt habitat 150 m northeast of the Chu Mom Ray National Park and in the south of the *Pinus* plantation in C2 area of Sa Thay district. One species (*Gonocephalum bilineatum* Walker, 1858) (Coleoptera, Tenebrionidae) was captured one to two days after the forest fire in the ashes adjacent to smoldering logs and to cooking fires. This species was found only in habitat type II and III outside of the C2 *Pinus* plantation. Three other species (*Lanelater robustus* (Elateridae), *Ceropria laticollis* (Tenebrionidae) and *Promethis* sp. 1 (Tenebrionidae)) were frequently found in habitat type II and III.

Insect species caught by Malaise traps were mainly Coleoptera and Diptera in habitat burnt one year ago. These species were not caught by malaise traps in recently burnt habitats (Tab. 2).

All beetles of these species were kept in plastic containers (5 cm high, 6 cm diameter) with peanut and water diet at $(25 \pm 1) ^\circ\text{C}$, 40 % relative humidity and a 12/12 day/night period for 1 week. Forty-three species were caught in habitat type I and had been killed with ethyl acetate and stored in ethanol 50 %.

2.4 Discussion

About 600 beetles of each two species Coleoptera (*Acanthocnemus nigricans*) and (Coleoptera, unidentified 1) were found only in the warm ashes close to smoldering logs and stumps in the habitat type II. Three hundred and five *Gonocephalum bilineatum* were caught close to hot spots such as freshly charred wood and smoldering logs releasing smoke on freshly burnt areas. One hundred and fifteen *Gonocephalum bilineatum* together with 8 *Lanelater robustus*, 34 *Ceropria laticollis* and 63 *Promethis* sp.1, were found under the bark of the burnt trees on habitat burnt one year ago. Insects caught at the mentioned hot spots are considered as pyrophilous insects. Insects caught below the bark of the burnt trees were regarded as potentially pyrophilous insects. In order to rule out if the potential pyrophilous insects are attracted just by light, visible light traps and UV traps were examined. None of the pyrophilous beetles were caught in these traps. Moreover, none of the potentially pyrophilous insects were caught in visible light, UV traps, and Malaise traps. These beetles are probably attracted by more fire-specific stimuli like infrared radiation and fire-specific volatiles. Thus, developing suitable type of traps might be necessary to catch pyrophilous insects.



Figure 1: Malaise trap in habitat type III.



Figure 2: Burning logs in habitat II.

Table 1: Number of potentially pyrophilous insects caught in different habitat types.

	Habitat type I (Unburnt habitat)	Habitat type II (Freshly burnt habitat)	Habitat type III (Habitat burnt one year ago)
Coleoptera (<i>Acanthocnemus nigricans</i>)		600	
Coleoptera (unidentified 1)		600	
<i>Ceropria laticollis</i>			34
<i>Gonocephalum bilineatum</i>		305	115
<i>Lanelater robustus</i>			8
<i>Promethis</i> sp.1			63

Table 2: Insect species caught by Malaise traps in habitat burnt one year ago in Vietnam Central Highlands, 2015.

Order	Family	Species	Number of individual
Hymenoptera	Apidae	<i>Apis cerena</i> Fabricius, 1793	2
Hymenoptera	Apidae	<i>Trigona</i> sp.1	5
Hymenoptera	Ichneumonidae	<i>Lissopimpla basalis</i> (Vollenhoven, 1879)	2
Hymenoptera	Ichneumonidae	<i>Flavopimpla</i> sp.	1
Hymenoptera	Ichneumonidae	<i>Seticornuta</i> sp.	1
Hymenoptera	Ichneumonidae	<i>Syzeuctus</i> sp.	2
Hymenoptera	Ichneumonidae	<i>Enicospilus</i> sp.	1
Hymenoptera	Ichneumonidae	<i>Trathala flavoorbitalis</i> (Cameron, 1907)	1
Hymenoptera	Aulacidae	<i>Pristaulacus</i> sp.	2
Diptera	Agromyzidae	Agromyzid g. sp	9
Diptera	Calliphoridae	<i>Cosmina bicolor</i> (Walker, 1856)	1
Diptera	Calliphoridae	<i>Idiella mandarina</i> (Wiedemann, 1830)	1
Diptera	Calliphoridae	<i>Isomyia chrysoides</i> (Walker, 1856)	1
Diptera	Calliphoridae	<i>Rhinia apicalis</i> (Wiedemann, 1830)	9
Diptera	Calliphoridae	<i>Stomorhina discolor</i> (Fabricius, 1794)	15
Diptera	Calliphoridae	<i>Stomorhina siamensis</i> Kurahashi et Tumrasvin, 1992	1
Diptera	Chamaemyiidae	Chamaemyid g. sp.	1

Diptera	Conopidae	Conopid <i>g. sp</i>	1
Diptera	Culicidae	Culicid <i>g. sp.</i>	1
Diptera	Dolichopodidae	Dolichopodid <i>g. sp</i>	5
Diptera	Ephydriidae	Ephydrid <i>g. sp.</i>	1
Diptera	Lonchaeidae	Lonchaeid <i>g. sp.</i>	5
Diptera	Micropezidae	Micropezid <i>g. sp.</i>	1
Diptera	Milichidae	Milichid <i>g. sp.</i>	1
Diptera	Muscidae	<i>Atherigona biseta</i> Karl, 1939	16
Diptera	Muscidae	<i>Atherigona falcata</i> (Thomson, 1869)	4
Diptera	Muscidae	<i>Dichaetomyia bibax</i> (Wiedemann, 1830)	1
Diptera	Muscidae	<i>Myospila lenticeps</i> (Thomson, 1869)	1
Diptera	Muscidae	<i>Pygophora sp.3</i>	3
Diptera	Muscidae	<i>Stomoxys calcitrans</i> (Linnaeus, 1758)	2
Diptera	Muscidae	<i>Stomoxys indicus</i> Picard, 1908	1
Diptera	Phoridae	Phorid <i>g. sp.</i>	1
Diptera	Platystomatidae	Platystomatid <i>g. sp.</i>	1
Diptera	Sarcophagida	<i>Metopia sauteri</i> (Townsend, 1932)	2
Diptera	Sarcophagida	<i>Miltogramma angustifrons</i> (Townsend, 1933)	2
Diptera	Sarcophagida	<i>Pierretia globovesica</i> Ye, 1980	2
Diptera	Sarcophagida	<i>Taxigramma multipunctata</i> (Rondani, 1859)	1
Diptera	Sepsidae	Sepsid <i>g. sp.</i>	2
Diptera	Syrphidae	<i>Spheginobaccha demeijerei</i> Van Doesburg, 1968	3
Diptera	Tachinidae	Tabanid <i>g. sp.</i>	3
Diptera	Tephritidae	Tephritid <i>g. sp.</i>	2
Diptera	Tipulidae	Tipulid <i>g. sp.</i>	1

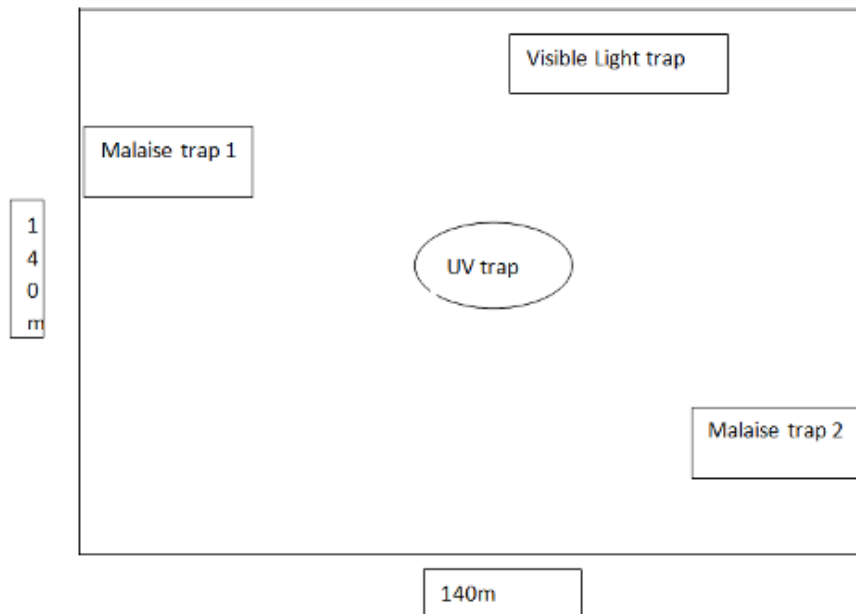

Figure 3: Study design.

It was demonstrated that some pyrophilous insects possess a special infrared organ (Evans 1964; Schmitz et al., 2000; Schmitz et al., 2008). Moreover, they may possess special adaptations in physiology and morphology of their antennae enabling them to perceive fire-specific volatile organic compounds via their olfactory system (Schütz et al. 1999; Paczkowski et al. 2013, 2014). To examine their adaptations to the need to track down remote forest fires, further experiments and studies on the sensory organs of these species need to be conducted employing methods as Electronantennography (EAG), Gas Chromatography with Mass Spectrometry (GC – MS), and Scanning Electron Microscopy (SEM).

2.5 Acknowledgements

Insects were identified by specialists of the Department of Insect Systematics at the Institute of Biology and Ecological Resources, Hanoi, Vietnam. Helpful corrections by an anonymous reviewer are gratefully acknowledged. TPH is supported by a stipend from the KAAD.

2.6 References

- Allison, J. D., Borden, J. H., Seybold, S. J. (2004).** A review of the chemical ecology of the Cerambycidae (Coleoptera). *Chemoecology*, 14(3-4): 123-150.
- Boulanger, Y., Sirois, L., Hébert, C. (2010).** Distribution of saproxylic beetles in a recently burnt landscape of the northern boreal forest of Québec. *Forest Ecology and Management*, 260(7): 1114-1123.
- Coulianos, C. C. (1989).** New provincial records of Swedish flatbugs and barkbugs (Hem. - Het., Aradidae) with *Aradus truncatus* FIEBER, 1861, new to Sweden. *Entomologisk tidskrift*, 110(1-2): 53-57.
- Esseen, P.-A., Ehnström, B., Ericsson and L., Sjöberg, K. (1997).** Boreal forests. *Ecology Bulletin* 46: 16-47.
- Evans, W. G. (1964).** Infrared receptors in *Melanophila acuminata* De Geer. *Nature (Lond.)* 202: 211.
- Evans, W.G. (2010).** Reproductive role of infrared radiation sensors of *Melanophila acuminata* (Coleoptera: Buprestidae) at forest fires. *Annals of the Entomological Society of America* 103: 823-826.
- Gongalsky, K.B., Midtgaard, F. and Overgaard, H.J. (2006).** Effects of prescribed forest burning on carabid beetles (Coleoptera: Carabidae): a case study in south-eastern Norway. *Entomologia Fennica* 17(3): 325-333.
- Heliövaara, K. and Väisänen, R. (1983).** Environmental changes and the flat bugs (Heteroptera, Aradidae and Aneuridae). *Annals Entomologia Fennica*, 49: 103-109.
- Johansson, T., Hjalten, J., Stenbacka, F. and Dynesius, M. (2010).** Responses of eight boreal flat bug (Heteroptera: Aradidae) species to clear-cutting and forest fire. *Journal of Insect Conservation*, 14: 3-9.
- Klocke, D. (2011).** Fire-Adaptation in *Hypocerides nearcticus* Borgmeier and *Anabarhynchus hyalipennis hyalipennis* Marquart and new notes about the Australian "Smoke Fly" *Microsania australis* Collart (Diptera: Phoridae, Therevidae and Platypezidae). *The Open Entomology Journal* 5: 10-14.
- Kreiss, E., Schmitz, H. and Gebhardt, M. (2007).** Electrophysiological characterization of the infrared organ of the Australian "little ash beetle" *Acanthocnemus nigricans* (Coleoptera, Acanthocnemidae). *Journal of Comparative Physiology*, 193(7): 729-739.
- McCullough, D.G., Werner, R.A., Neumann, D. (1998).** Fire and insects in northern and boreal forest ecosystems of North America. *Annual Reviews of Entomology*, 43: 107-127.
- Paczkowski, S., Paczkowska, M., Dippel, S., Schulze, N., Schütz, S., Sauerwald, T., et al. (2013).** The olfaction of a fire beetle leads to new concepts for early fire warning systems. *Sensors and Actuators, B: Chemical*, 183, 273-282.

- Paczkowski, S., Paczkowska, M., Dippel, S., Flematti, G. and Schütz, S. (2014).** Volatile combustion products of wood attract *Acanthocnemus nigricans* (Coleoptera: Acanthocnemidae). *Journal of Insect Behaviour*, 27: 228-238.
- Saint-Germain, M., Larrivé, M., Drapeau, P., Fahrig, L. and Buddle, C. M. (2005).** Short-term response of ground beetles (Coleoptera: Carabidae) to fire and logging in a spruce dominated boreal landscape. *Forest Ecology and Management*, 112(1-3): 118-126.
- Schmitz, H., Schmitz, A. and Horst, B. (2000).** New type of infrared organ in the Australian “fire-beetle” *Merimna atrata* (Coleoptera: Buprestidae). *Naturwissenschaften*, 87: 542-545.
- Schmitz, H., Schmitz, A., Trenner, S. and Bleckmann, H. (2002).** A new type of insect infrared organ of low thermal mass. *Naturwissenschaften*, 89(5): 226-229.
- Schmitz, A., Gebhardt, M. and Schmitz, H. (2008).** Microfluidic photomechanic infrared receptors in a pyrophilous flat bug. *Naturwissenschaften*, 95(5): 455-460.
- Schütz, S., Weißbecker, B., Hummel, H. E., Apel, K.-H., Schmitz, H. and Bleckmann, H. (1999a).** Insect antenna as a smoke detector. *Nature*, 398: 298-299.
- Stocks, B. J. (1987).** Fire potential in the spruce budworm-damaged forests of Ontario. *Forestry Chronicle*, 63(1): 8-14.
- Suckling, D. M., Gibb, A. R., Daly, J. M., Chen, X. and Brockerhoff, E. G. (2001).** Behavioral and electrophysiological responses of *Arophalus tristis* to burnt pine and other stimuli. *Journal of Chemical Ecology*, 27(6): 1091-1104.
- Wikars, L.O. (1992).** Skogsbränder och insekter. *Entomologisk Tidskrift*, 133(4): 1-11.
- Wikars, L.O. (1997).** Effects of forest fire and the ecology of fire-adapted insects. *Comprehensive Summaries of Uppsala Dissertations from the Faculty of Science and Technology 272*. Acta Universitatis Upsaliensis, Uppsala, Sweden, 272 pp.
- Wikars, L.-O. (2001a).** The wood-decaying fungus *Daldinia loculata* (Xylariaceae) as an indicator of fire-dependent insects. *Ecological Bulletins*, 49: 263-268.
- Wikars, L.-O. (2001b).** Dependence on fire in wood-living insects: An experiment with burned and unburned spruce and birch logs. *Journal of Insect Conservation*, 6: 1-12.
- Wikars, L.-O. and Schimmel, J. (2001).** Immediate effects of fire-severity on soil invertebrates in cut and uncut pine forests. *Forest Ecology and Management*, 141: 189-200.

Chapter 3

Do volatiles released upon heating of different species of Vietnamese woody plants attract pyrophilous insects?

This is a manuscript prepared for submission. I conducted all experiments and prepared the manuscript.

Abstract

Volatile organic compounds (VOCs) released by burnt wood of the three Vietnamese tree species *Pterocarpus macrocarpus*, *Lithocarpus ducampii* and *Parinari anamensis*, and by the bamboo species *Bambusa procera*, were investigated upon heating at temperatures of 25°C, 100°C, 150°C, 200°C, 250°C and 300°C. The responses of pyrophilous insects to a mixture of four VOCs (hydroxyacetone, 5-methylfurfural, guaiacol, and 4-ethylguaiacol) were investigated in the field with traps baited with the VOCs. A total of 55 VOCs were released in notable amounts by the four woody species within this temperature range. These VOCs consisted of terpenoids, ketones, esters, furanes, pyrans, anhydrosugars, phenols, guaiacols, syringols, methoxybenzenes and naphthalenes. Thirty-five of the 55 compounds were released by at least one species at one temperature. In contrast to the other species, *P. macrocarpus* released a broad variety of sesquiterpenes. Fifty-five VOCs were emitted by this species over the tested temperature range. The other species released VOCs in notable amounts only at 250°C and 300°C. *Lithocarpus ducampii* emitted 31 volatiles, while *P. anamensis* released 23 volatiles, and *B. procera* 14 volatiles. Field tests on burnt areas examining the attractiveness of traps baited with the VOCs resulted in 22 insect species belonging to the order of Coleoptera, of which only three species were caught by VOCs traps and hand collection. Ten insect species were captured only by VOC traps. Eight species were caught only by hand collection. The functional biodiversity of plant species seems to be associated with the chemo-diversity of fire-induced VOCs. This might play an essential role in the host plant selection of pyrophilous insects, thus linking plant diversity to the biodiversity of pyrophilous insects.

Keywords: *Pterocarpus macrocarpus*, *Lithocarpus ducampii*, *Parinari anamensis*, *Bambusa procera*, biodiversity, chemo-diversity, forest fires, burnt wood volatiles (VOCs), pyrophilous insects.

3.1 Introduction

Pyrophilous insects have received much attention in recent years due to their ability to approach fires or freshly burnt areas from a far distance. One way to approach fires is that pyrophilous insects use their olfactory receptors (Schütz et al., 1999) which enable them to perceive volatile organic compounds (VOCs) released by burning plants during a forest fire (Paczkowski et al. 2014). VOCs emitted by burning or smoldering wood, therefore, play an essential role in the survival of pyrophilous insects. To select the right place for feeding, mating, oviposition and development, pyrophilous insects have to rely on chemical signatures indicating suitable spots for larval development. Signals of interest can be the presence of VOCs released during heating of wood at a fire starting point, for example at 200° to 300°C. Recent studies document the volatiles released by heating of wood during the process of thermal degradation of lignin and cellulose. For example, hydroxyacetone is released by thermal degradation of cellulose and 5-methylfurfural is released by thermal degradation of hemi-celluloses (Mehmetli et al., 2008) and guaiacol and 4-ethylguaiacol released during thermal degradation of lignin. However, little attention has been paid to study the diversity of volatiles released during heating of different plant species.

Besides these studies on VOCs released during heating of wood, a few investigations focus on the olfactory perception of several burnt wood volatiles in pyrophilous insects such as the buprestid beetles *Melanophila accuminata* (Schütz et al., 1999), *Melanophila cuspidata* (Morimoto et al., 2006) and *Merimna atrata* (Paczkowski 2013). Furthermore, the perception and behavior of the (Geiser 2016) pyrophilous acanthocnemid beetle *Acanthocnemus nigricans* has been studied (Paczkowski et al. 2014). These studies showed that there are common burnt wood volatiles which are perceived by all insects and there are some burnt wood volatiles which are perceived only by one or 2 species of insects (Tab. 1). Therefore, the diversity of burnt wood volatiles might govern the chemo-diversity of pyrophilous insects. However, little evidence is available contributing to this.

Forest fires of anthropogenic origin took place in Vietnam with an average high number of 16,086 fires per year (2004 to 2012) where the Central Highlands are one of the most important fire hotspot (Le et al., 2014). The main causes of anthropogenic forest fires are shifting cultivation during illegal logging, and overexploitation of timber and non-timber forest products (McNamara et al., 2006). On the other hand, there is potential for a high diversity of pyrophilous insects in Vietnam (Hoang & Schütz 2015; Geiser 2016). However, to the best of our knowledge, there is no study about the impact of burnt plant volatiles on the biodiversity of pyrophilous insects in this region so far.

The main aims of this study are to examine the (potential) volatiles released by different Vietnamese woody species under controlled condition and to assess the interplay between the biodiversity of pyrophilous insects and burnt wood volatiles in the field by employing traps baited with fire-specific volatiles.

For the wood heating experiment, we selected three different tree species and a bamboo species because these woody species are present abundantly in Vietnam, especially in areas of fire hotspot in the Central Highlands of Vietnam (Le 1996). They have different wood properties and ecological traits. Moreover, logging of these tree species contributed to forest fires. These tree species include *Pterocarpus macrocarpus*, *Lithocarpus ducampii*, *Parinari anamensis*, and a bamboo species *Bambusa procera*. *Pterocarpus macrocarpus* has very strong, first-class wood properties. It is used in construction, cabinet work, high-class furniture, and fine art articles. It grows in the well-drained, light textured and low humidity soils (Le 1996). The wood is heavy and highly resistant to termites and insects (Morimoto et al., 2006). *Lithocarpus ducampii* has durable wood properties. It grows on clay and sandy-clay soil and can protect and ameliorate the soil (Le 1996). It is used in construction to make beds, shutters and to build boats and ships (Le 1996). *Lithocarpus ducampii* grows in wet sandy or rocky soil (Le 1996). It is classified as a less durable timber. It can be used for furniture and as interior construction wood (Le 1996). *L. ducampii* grows in all types of soil, even in soil with poor nutrients (Le 1996). It is used as construction material, as a biofuel, in pulp and paper making and for plywood. *Bambusa procera* is a woody grass and an important non-timber forest product species.

For the biodiversity assessment study, we employed two traps baited with burnt wood volatiles and two empty control traps. The volatiles included hydroxyacetone and 5-methylfurfural, as these are characteristic products of the thermal degradation of cellulose (Piskorz et al., 1986; Flematti et al., 2004), guaiacol and 4-ethylguaiacol. These compounds are typical products of the thermal degradation of lignin (Branca et al., 2006; Azeez et al., 2010).

3.2 Materials and methods

3.2.1 Wood samples

Five different trunks (20cm) of *Pterocarpus macrocarpus*, *Lithocarpus ducampii*, *Parinari anamensis* and *Bambusa procera* were sampled during the dry season in 2014 and 2015 in the Ngoc Reo forest, Kon Tum province, in the Central Highlands of Vietnam (Coordinates: *Pterocarpus macrocarpus*: N14°31'.912", E108°03'925"; *Lithocarpus ducampii*: N14°31'.930", E108°03'938"; *Parinari anamensis*: N14°31'.936", E108°03'927"; *Bambusa*

procera: N14°31'937", E108°03'929"). A permit for sampling was obtained from the provincial forest protection department of Kon Tum, Vietnam. Air-dried samples were collected from the middle part of xylem by slowly drilling with a wood driller ($\varnothing = 5$ mm).

3.2.2 Chemicals

All solvents used for cleaning and eluting (methanol, dichloromethane, trichloromethane, and pentane) were of analytical quality (p.a.; Merck, Darmstadt, Germany). Authentic standard compounds were of 95 to 99% purity and are listed in Tab. S1 (appendix).

3.2.3 Sampling of volatiles

To study the volatile emissions of wood heated to different temperatures, a gas chromatography (GC) oven (Fractovap series 4160, Carlo Erba Instrumentazione, Rodano, Italy) was used as a heating chamber for controlled wood heating experiments. A glass flask (250 ml Duran, Schott AG, Mainz, Germany) was placed into the GC oven. Synthetic air (20% O₂ in N₂, Alpha Gaz, Düsseldorf, Germany) was introduced into the flask at a pressure of 0.75 bar. The air was then removed from the flask using a rotary vane pump (Thomas Division, Sheboygan, USA) and pumped through a charcoal trap (1.8 mg Charcoal, CLSA Filter, Daumazan sur Arize, France) at a rate of 1.2 liters per minute (l/min). Before sampling of each volatile, a control sample of 0.6 liters of air from a clean flask maintained at 250°C for 30 min was collected using a charcoal trap for 30 seconds. Afterward, the flask was filled with a 1 g wood chip sample. After 10 min of conditioning at 25°C and an air flow of two liters per minute, the rotary vane pump removed 0.6 liters of a sample at a flow rate of 1.2 l/min through the charcoal trap. Afterward, the temperature was raised to 100°C and held for 10 min at an airflow of 2 l/min; then, the next charcoal trap was connected for 30 seconds to the rotary vane pump. A 0.6-liter sample was extracted at a flow rate of 1.2 l/min through the charcoal trap. This procedure was repeated at 150, 200, 250 and 300°C to collect the volatiles from wood chips heated to different temperatures.

3.2.4 Trace analysis

A mixture of 100 μ l of dichloromethane/methanol (2:1) was used to elute the charcoal traps. One microliter of the eluate was injected by a type 7163 auto sampler in the pulsed splitless mode (pulse pressure 150 kPa at 1.5 min) at a temperature of 250°C into a split/splitless injection port of a 6890N Network GC System with a 30 m \times 0.25 mm HP-5 MS (95% Dimethyl – 5% Diphenyl-Polysiloxane) nonpolar column (0.25 μ m film thickness), both from Agilent Technologies (Santa Clara, USA). The oven was programmed as follows: the initial

temperature was 40°C for 2.5 min, then increased at a rate of 6.2°C per min to 250°C and finally held for 10 min. Helium of 99.999% purity was used as the carrier gas. The carrier gas flow was adjusted to 1 ml/min resulting in a gas vector of 24 cm/s. A quadrupole mass spectrometer (type 5973, Agilent Technologies, Santa Clara, USA) with electron impact ionization (70 eV) linked to the GC by a transfer line at 250°C was operated in the scan mode in a detection range of $m/z = 20\text{--}354$ atomic mass unit (amu) with an acquisition time of 0.5 seconds.

Data acquisition was performed using MS ChemStation software (Agilent). Peaks were identified with the National Institute of Standards and Technology mass spectral library (NIST, Gaithersburg, USA), the MassFinder 2.1 software and the library “Terpenoids and Related Constituents of Essential Oils” (Hochmuth, König, Joulain, Hamburg, Germany). The linear retention index was calculated using straight-chain hydrocarbons (C7–C24). The co-elution of authentic standards was used to confirm the identity of the compounds.

For quantification purposes, a 100ng external standard was used for each class of wood degradation product utilizing a two point calibration curve. Furfural was used for polysaccharide degradation products, guaiacol was used for lignin degradation products, and α -humulene was used for sesquiterpenes (cf. Tab. S1). The release rate was calculated from the quantity in the sample, sampling time, and sample dry mass at the beginning of the experiment as the respective release rate equivalents. A compound was deemed present in the sample if it had a release rate equivalent greater than three ng/g*s (a notable amount) because this level is thought to represent the detection limit of pyrophilous insect antennae (Evans 1966).

3.2.5 Hand collection

Four people performed the searches for insects in the smoldering logs at different burnt habitats where the wood samples were found (the exact locations were mentioned in chapter 2.1). Insects approaching smoldering logs were count and collected every 5 minutes for 2 hours over 3 times per day. The hand collection was done from 1 to 6 days at each burnt habitats where the wooden logs were burning and smoking.

3.2.6 Field tests

The field experiment was carried out in secondary forested areas in Ngoc Reo forest, Pinus plantations, adjacent to the secondary forest of Chu Mom Ray National Park and inside the national park (Sa Thay district, Kon Tum province, Vietnam Central Highlands). Mean temperature (2015) at the study area was 21.8°C during the investigation period (from February to April). Field research was conducted during the dry season from 20 February to 14 April

2015, when forests were usually burnt and frequent fires were taking place, both of natural and anthropogenic origin.

Trap setup was placed on each study site at two different habitats, including unburnt and freshly burnt habitat (from 1 - 10 days after the fire).

An unburnt habitat was selected to provide an undisturbed reference area for control samples, whereas a freshly burnt habitat was chosen for investigating the presence of pyrophilous insects attracted to burnt wood. The trap setup was installed in a square block design, with three blocks arranged in a north-south line according to wind direction. The square had a central area of at least 300 m × 300 m to allow space between traps (Fig. 1). To prevent down-wind effects, the first VOC trap was placed in the furthest southeast, 50 m away from the edge. The second VOC trap was installed in the furthest southwest, also 50 m apart from the edge. These two VOC traps were filled with the total of 6.2 ml of a mixture of characteristic fire VOCs to test for behavioral activity including (2ml) Hydroxyacetone, (2ml) 5-methylfurfural, (2ml) guaiacol and (0,2 ml) 4-ethylguaiacol with the proportion of 1:1:1:1/10, respectively. Due to the limited amount, we could only provide the proportion of 4-ethylguaiacol 1/10ml on this mixture. The VOCs were renewed every day. Two control traps were set up in the furthest northeast and northwest respectively. These traps were suspended 1 m above ground and used in both habitat types. Each trap was active for 15 hours per day from 6:00 to 22:00 hours over 10 days resulting in a total of 11 replicates. After each day, the VOC mixture was renewed. Every second day traps were placed on a new site. Insects were monitored every three hours and captured specimens were transferred to plastic boxes. Insects were sorted to morphologically similar groups and killed with ethyl-acetate before being labeled and stored in 50% ethanol. Specimens from both traps and hand collection were sent to the Department of Insect Systematics at the Institute of Ecology and Biological Resources (IEBR) in Hanoi, Vietnam, for identification.

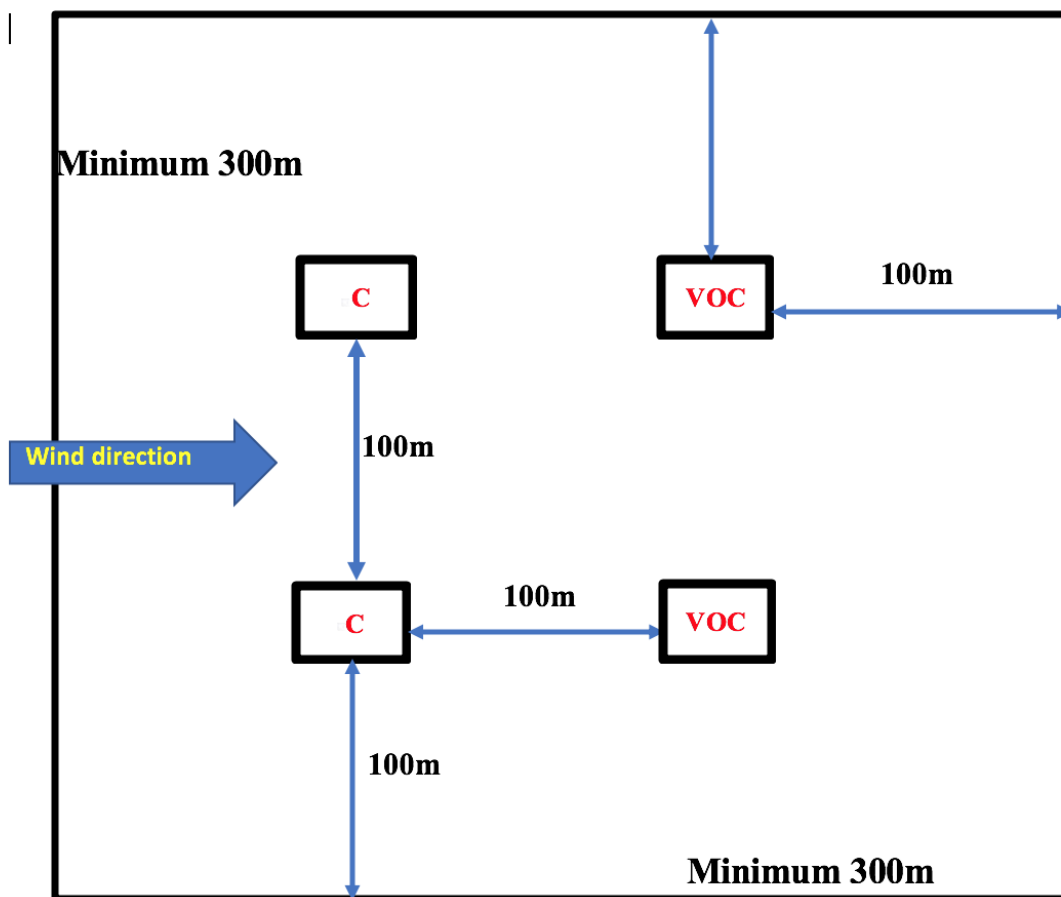

Figure 1: Symmetric drawing of the study design in the study areas in Vietnam central Highlands in 2015. C: Empty control traps. VOC: traps baited with a mixture of fire-specific volatile organic compounds.

3.2.7 Statistical analysis

The quantities of volatiles released by the woody plant species were tested for a normal distribution using the Shapiro-Wilk test. The data did not show a normal distribution. Therefore, the Wilcoxon rank sum test was used to test for significant differences in the emission rates of the volatiles. RStudio (version 3.2.0 [2015-04-16]) open source software was used for the statistical analysis. The significance level (P) was set at 95%.

3.3 Results

3.3.1 Trace analysis

A total of 65 compounds was identified to be released by the four woody species. Ten terpenoids were released only by *Pterocarpus macrocarpus* at a temperature range from 25°C to 200°C including α -copaene, α -cubebene, α -guaiene, β -selinene, α -muurolene, 1,2,4a,5,6,8a-hexahydro-4,7-dimethyl-1-(1-methylethyl)-naphthalene, guaia-1(10),11-diene (δ -guaiene), α -amorphene, γ -cadinene, tau-cadinol.

All four woody species released 55 compounds in notable amounts ($0.003\mu\text{g/g}\cdot\text{s}$) at 250°C and 300°C (Tab. S1 and Fig. 1) with different concentration (Fig. 2). α -caryophyllene, aromadendrene, and α -calacorene were emitted at all temperatures in *Pterocarpus macrocarpus* (Tab. 1). All other compounds were emitted at specific temperatures by each of the four woody species. These compounds belonged to 11 different structural groups, including terpenoids, ketones, esters, furanes, pyrans, anhydrosugars, phenols, guaiacols, syringols, methoxybenzenes and naphthalenes.

Five of 55 volatiles are commonly released reliably (minimum $>0\mu\text{g/g}\cdot\text{s}$) by all four woody species either at 250°C , at 300°C or both temperatures (Tab. 1). These volatiles included hydroxyacetone, furfural, 1-(2-furanyl)-ethanone, 5-methylfurfural, and levoglucosenone.

Thirty-four of 55 volatiles were found consistently with a quantity higher than 0 in at least one woody species at one temperature. These compounds were emitted during thermal degradation of cellulose and lignin or during the evaporation and thermal oxidation of sesquiterpenes (Fig. 2 and Tab. S1).

Twenty compounds were species-specific volatiles released only by *P. macrocarpus* at both temperatures including 2-cyclohexen-1-one, 3-methyl-2,5-furandione, 2-hydroxy-1-methoxyethylfuran, phenethyl ester acetic acid, 2-hydroxy-3-methyl-2-cyclopenten-1-one, 2-hydroxybenzaldehyde, 1-acetyl-(1H)-imidazole, α -caryophyllene (α -humulene), aromadendrene, cadina-1(10),6,8-triene, δ -cadinene, 4-hydroxy-3-methoxy-benzoic acid methylester, α -calacorene, unidentified compounds, tau-muurolol, 4-hydroxy-3,5-dimethoxy-benzaldehyde, cadalene, 10-nor-calamenen-10-one. Four volatiles were released specific by *L. ducampii* including 1-(acetyloxy)-2-propanone, butyrolactone, 2-methoxy-3-methyl-phenol, 1,5-dimethyl-naphthalene. Five volatiles were released specific by *P. annamensis*, including 4-methylphenol; 1,2,3,4-tetrahydro-1,5,7-trimethyl-naphthalene, 3-methoxy-5-methylphenol, 3-hydroxy-4-methoxybenzoic acid, and 3-(2-naphthyl)-1-butene.

Seven compounds showed temperature dependency. Two compounds were released only by *P. macrocarpus* at 250°C including γ -terpinene, and at 300°C including 2,2-dimethyl-1,3-cyclopentanedione. Three compounds were released only by *L. ducampii* at 250°C including 1,2-dihydro-1,1,6-trimethyl-naphthalene, 2,6-dimethyl-naphthalene, trans-isoeugenol. Two compounds were released only by *B. procera* at 300°C including 1-(2-furanyl)-ethanone, levoglucosenone (Fig. 2 and Tab. S1).

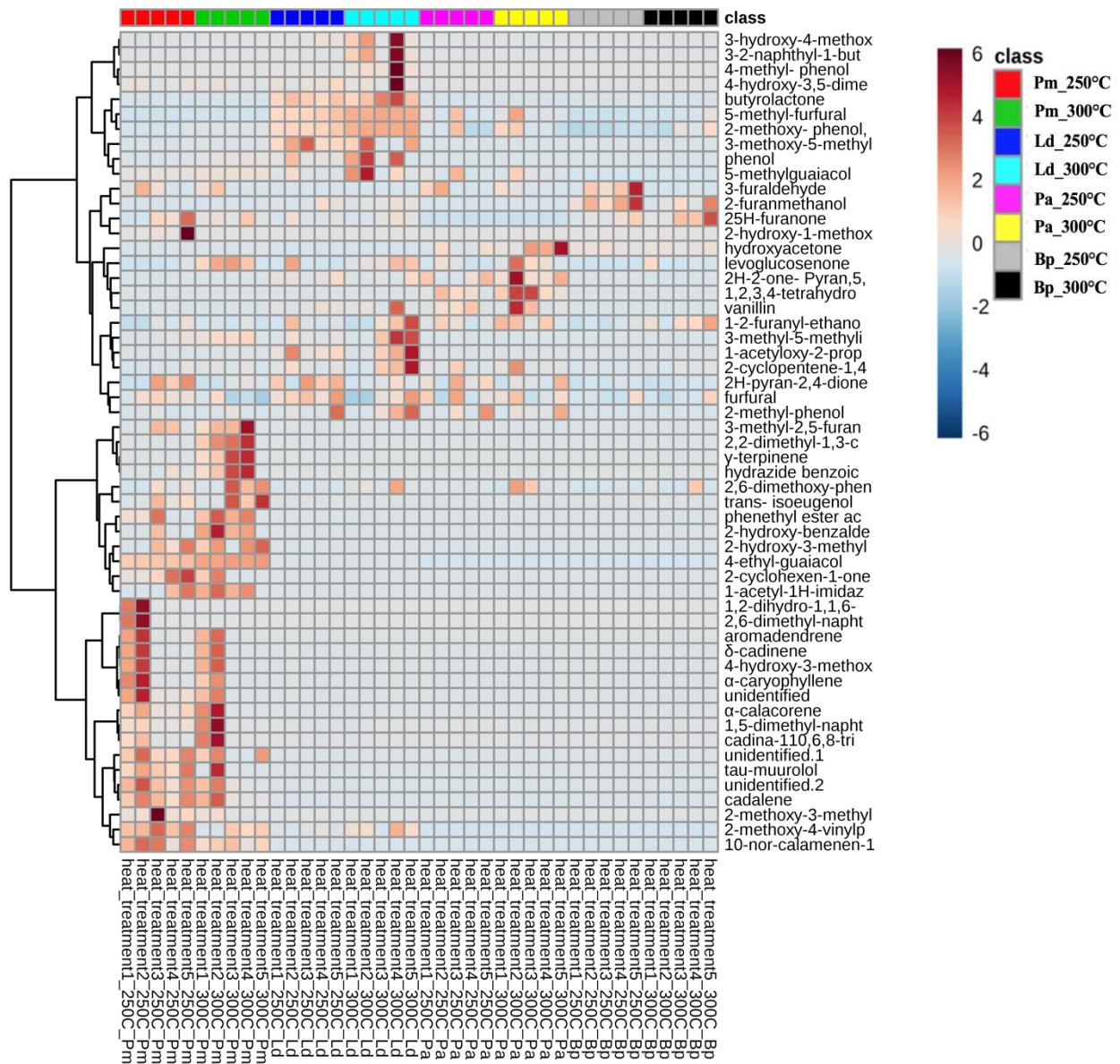

Figure 2: The heat map shows the concentration of VOCs released by all four woody species at 250°C and 300°C; Pm: *Pterocarpus macrocarpus*, Ld: *Lithocarpus ducampii*, Pa: *Parinari annamensis*, Bp: *Bambusa procera*. The full name of the compounds is shown in Tab. S1. Dark to light blue: these VOCs are not found in this temperature. Light red to dark red: VOCs are found from low to high concentration.

3.3.2. Field trial results

Twenty-two species belonging to the order Coleoptera were caught by both VOCs traps and at smoldering logs (Fig. 3). However, only two species were caught in both VOC traps as well as by searching in smoldering logs including *Apristus* sp. 1, and *Staphylinus* sp. 3.

Twelve of the 22 species were caught only by VOCs traps including *Anthicus* sp. 1, *Perissus rayus*, *Anthicoclerus* sp. 1, *Cartodere* sp. 1, *Litargus* sp. 1, *Litochrus* sp. 1, *Cryphalus* sp. 1, *Cryphalus* sp. 2, *Wallacellus denticulus*, *Eleusis humilis*, *Staphylinus* sp. 2 and *Anacypta* sp. 1. These species showed statistically significant differences between the VOCs trap and control trap (Fig. 3). None of the insects caught by other traps was found in the control traps. Equally,

the control traps in burnt habitats recorded insect species which were not found in other trap types such as *Salganea* sp. (Blattodea, Blattidae), *Catapiestus* sp. (Coleoptera, Tenebrionidae), *Xylocopa confusa* (Perez, 1901) (Hymenoptera, Apidae). Similarly, a different composition of insect species was recorded in these traps in unburnt habitat when compared to burnt habitat such as *Demonax bowringii* (Pascoe, 1859) (Coleoptera, Cerambycidae), *Chlorophorus quatuordecimmaculatus* (Chevrolat, 1863) (Coleoptera, Cerambycidae), *Laius* sp. (Coleoptera, Melyridae), *Anomala russiventris* (Fairmaire, 1893) (Coleoptera, Scarabaeidae), *Anomala* sp. (Coleoptera, Scarabaeidae) and *Apis cerena* (Fabricius, 1793) (Hymenoptera, Apidae). Eight of the 22 species were found only during searching in smoldering logs in freshly burnt habitat including *Acanthocnemus nigricans* (Hope, 1843), *Xylopsocus* sp. 1, *Monomma* sp. 1, *Hoshihananomia* sp. 1, *Elacatis* sp. 1, *Xyleborus exesus* Blandford, *Silvanus lewisi* and *Uleiota* sp. (Fig. 3).

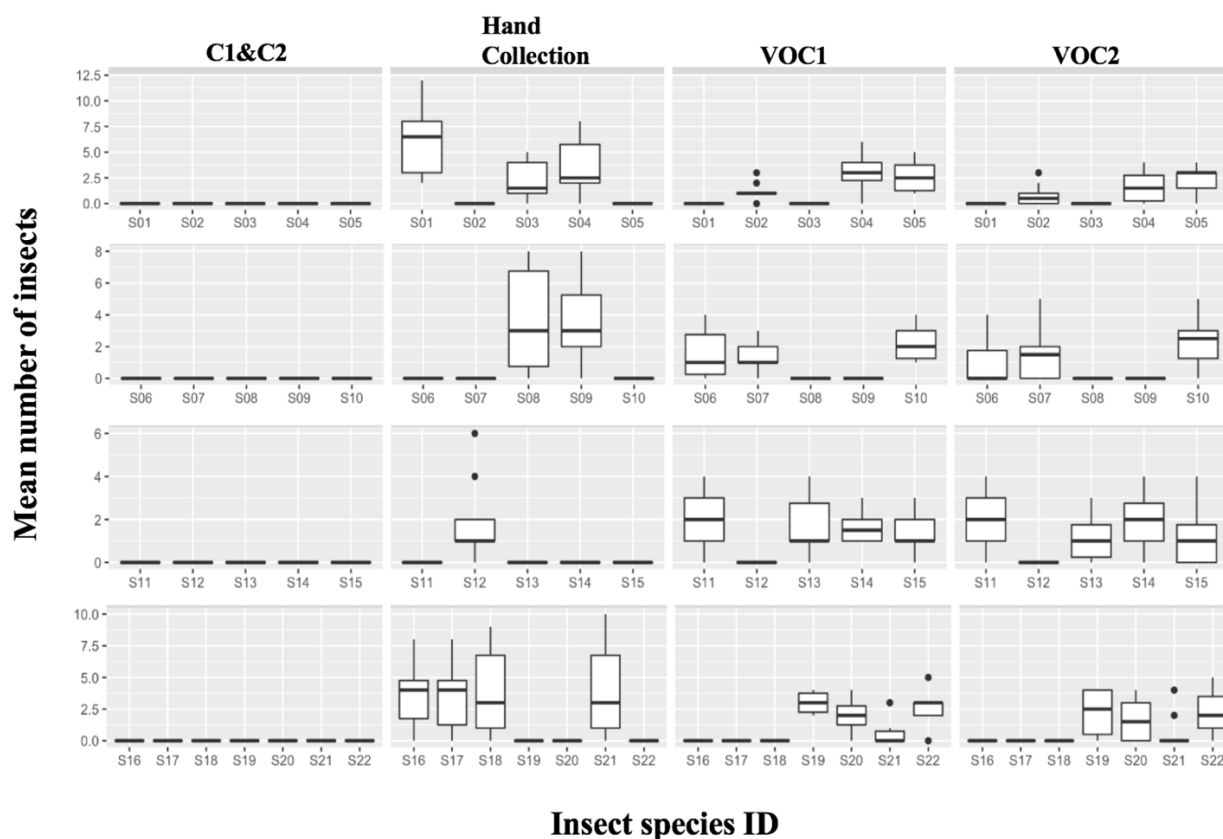

Figure 3: The mean number of insect species (Order Coleoptera) caught by different traps (n=10): **C1&C2:** control trap 1&2, **Hand collection:** insects caught by searching in smoldering logs on burnt sites. **VOC1:** volatile trap number 1, **VOC2:** volatile trap number 2. **Insect species ID:** the full name of the insect species (all Coleoptera) is given below:

S01: *Acanthocnemus nigricans* (Acanthocnemidae) (Hope, 1843), S02: *Anthicus* sp. 1 (Anthicidae), S03: *Xylopsocus* sp. 1 (Bostrichidae), S04: *Apristus* sp. 1 (Carabidae), S05: *Perissus rayus* (Cerambycidae), S06:

Anthicoclerus sp. 1 (Cleridae), S07: *Cartodere* sp. 1 (Lathridiidae), S08: *Monomma* sp. 1 (Monommidae), S09: *Hoshihananomia* sp. 1 (Mordellidae), S10: *Litargus* sp. 1 (Mycetophagidae), S11: *Litochrus* sp. 1 (Phalacridae), S12: *Elacatis* sp. 1 (Salpingidae), S13: *Cryphalus* sp. 1 (Scolytidae), S14: *Cryphalus* sp. 1 (Scolytidae), S15: *Wallacellus denticulus* (Scolytidae), S16: *Xyleborus exesus Blandford* (Scolytidae), S17: *Silvanus lewisi* (Silvanidae), S18: *Uleiota* sp. 1 (Silvanidae), S19: *Eleusis humilis* (Staphylinidae), S20: *Staphylinus* sp. 2 (Staphylinidae), S21: *Staphylinus* sp. 3 (Staphylinidae), and S22: *Anacypta* sp. 1 (Trogossitidae).

3.4 Discussion

3.4.1 Burnt wood volatiles

One of the primary goals of our study was to examine the volatiles released upon heating by wood samples of different Vietnamese tree species. As expected, our data demonstrates the diversity of the burnt wood volatiles released by different plant species. Besides the common volatiles released by all plant species in our study, we found that the specific release of sesquiterpene-derived and phenolic extractives by *Pterocarpus macrocarpus* is an outstanding feature in comparison with other woody species. Bamboo stands out because no extractive-derived compounds were released upon heating and it showed a comparatively low diversity of lignin breakdown products (Tab. 1 and Fig. 1).

The common burnt plant VOCs found in our study are in line with previous studies. Paczkowski et al. (2013), for example, described VOCs released during thermal degradation of wood chips, cellulose, and lignin of *P. sylvestris*. These VOCs are commonly released during thermal oxidation of hemicellulose, cellulose, and lignin at temperatures between 200°C and 300°C in our study.

Moreover, our results showed five volatiles released by all woody species upon heating (Tab. 1 and Fig. 1) which is consistent with results obtained in previous studies, namely that these volatiles are released during the thermal degradation of hemicellulose and cellulose (Del Río et al., 1978; Guillen et al., 2000; Noudogbessi & Yédomonhan 2008; De Simon et al., 2009; Paczkowski et al., 2013; Lourenço et al., 2015) including hydroxyacetone, furfural, 1-(2-furanyl)-ethanone, 5-methylfurfural, levoglucosenone.

As cellulose and lignin structure vary between and within tree species, and even within individuals, species-specific volatiles vary enormously for each tree species as well (Kollmann 1982), also including different eucalyptus species (Maleknia 2009). Depending on the temperature, the more complex structure of hemicellulose and lignin chains are broken into small molecules and different VOCs. Temperature-dependent VOCs were also found in several

eucalyptus species including *E. cinerea*, *E. citriodora*, *E. nicholii* and *E. sideroxylon* (Maleknia et al., 2009)

3.4.2 Field tests

One of the features of our research was to assess the local spectrum of pyrophilous insects. Our field tests demonstrate a certain diversity of insects caught by traps and by hand collection.

As expected, pyrophilous insects approached the recently burnt areas (Wikars 1997) by perceived fire-specific VOCs (Schütz et al., 1999). Three hand- caught insect species in our study (Fig. 3) are attracted by VOCs. Moreover, they are not caught by VOCs traps in unburnt habitat and by control traps in both habitats.

Ten trap- caught insect species could only be caught by VOCs traps in freshly burnt habitats (Fig. 3). These species are putative pyrophilous insects because they obviously were lured to the traps by the fire-specific VOCs (Schütz et al., 1999) after having approached the recently burnt habitat (Wikars 1997; Schmitz et al., 2008). Furthermore, they were not attracted by VOCs traps in unburnt habitats and the control traps in both habitats. These insects were not found by hand collection. However, it cannot be ruled out that these species had been overlooked.

Eight hand- caught insect species in our study (Fig. 3) showed pyrophilous behavior because they approached the freshly burnt habitat. However, they were not caught by our VOC traps. Prior studies (Schütz et al., 1999; Morimoto et al., 2006; Paczkowski et al., 2013, 2014; Geiser 2016) reported the perception of burnt wood volatiles by pyrophilous insects (cf. Tab. 1). VOCs in Tab. 1 were released consistently also by Vietnamese woody species upon heating. These data demonstrate that the preference for burnt wood volatiles obviously differs within pyrophilous insect species.

Table 1: Perception of burnt wood volatiles by pyrophilous insects according to the literature.

Compound	<i>Melanophila acuminata</i>	<i>Melanophila cuspidata</i>	<i>Merimna atrata</i>	<i>Acanthocnemus nigricans</i>
Hydroxyacetone		Paczkowski et al., 2013		Paczkowski et al., 2014
Furfural		Paczkowski et al., 2013	Paczkowski et al., 2013	
2-Furanmethanol		Paczkowski et al., 2013	Paczkowski et al., 2013	
5-methylfurfural		Paczkowski et al., 2013	Paczkowski et al., 2013	Paczkowski et al., 2014

Guaiacol	Schütz et al., 1999	Paczkowski et al., 2013	Paczkowski et al., 2013	Paczkowski et al., 2013
4-Methylguaiacol		Paczkowski et al., 2013		Paczkowski et al., 2014
4-Ethyl-guaiacol			Paczkowski et al., 2013	Paczkowski et al., 2014

3.4.3 Links between burnt wood volatiles and the biodiversity of pyrophilous insects

Our results show that there is a diversity of VOCs released upon heating wood and also a diversity of pyrophilous insects caught by VOC-baited traps and by hand collection. Prior studies (Schütz et al., 1999; Morimoto et al., 2006; Paczkowski et al., 2013, 2014; Geiser 2016) reported the perception of burnt wood volatiles by pyrophilous insects (Tab. 1). Data so far available show that guaiacol is perceived by all pyrophilous insects (Tab. 1) and the compound 5-methylfurfural is perceived by most pyrophilous beetles (Tab. 1). Our data suggest that guaiacol and 5-methylguaiacol are general fire VOCs which attract the pyrophilous insect species caught in our VOC traps. Because guaiacols are general indicators for the combustion of lignin, results indicate that the captured species belong to the group of general pyrophilous insects.

In contrast, eight insect species were caught close to smoldering logs but not by VOC traps. A possible explanation may be that these Vietnamese species are not attracted by the VOCs presented in the traps but by other fire-specific volatiles. These hitherto unknown compounds could, therefore, function as a fire-specific marker for specialized insects and govern host tree selection. This suggests the selective use of a general array of thermal degradation products from different plant species by a variety of pyrophilous insects, which demonstrates a link between the chemo-diversity of plant combustion products and the biodiversity of pyrophilous insects.

It would be also possible that insects found on freshly burnt habitats were not attracted by fire-specific VOCs. These non-pyrophilous insects might have been attracted by fire-weakened trees. Theoretically, this group of insects could perceive different volatiles emitted by dead wood or by dying trees suffering from water deficiency. Another group of potentially pyrophilous insects may use different cues to approach fires, for example, infrared radiation (Wikars 1992; Schütz et al., 1999; Schmitz et al., 2008, 2010).

3.5 Conclusion

In conclusion, the differences in the VOCs released by the thermal degradation of lignin and polysaccharides upon heating suggest that they are related to the properties of a certain plant

species. For example, these include wood properties such as a high extractive content and heartwood composition, or ecological traits such as a high defence status or special microhabitats, as exemplified by bamboo. Such functional biodiversity of plant species seems to be associated with the chemo-diversity of fire-induced VOCs. This might play an essential role in host plant selection and link plant diversity to the diversity of pyrophilous insects.

Several common VOCs, such as guaiacol and 5-methylfurfural, were released by all of the woody plant species tested in the temperature interval of 250°C and 300°C and might serve as candidate marker compounds for generalist pyrophilous insects. However, more specialized pyrophilous insects may also use these VOCs to detect a fire.

Several special VOCs and temperature-independent VOCs were also identified, allowing for the frequent and reliable separation of all of the tested plant species and serving as candidate marker compounds for specialized pyrophilous insects.

The field test revealed generalized pyrophilous insects as well as potentially specialized pyrophilous insects that may be attracted by the mentioned groups of VOCs. It can be suggested that these compounds mediate the diversity of insect assemblies and link plant biodiversity to the chemo-diversity of fire-induced VOCs and consequently to the biodiversity of pyrophilous insects at the biodiversity hotspot of the Central Highlands of Vietnam.

Our study, however, focused on the biodiversity of Vietnamese pyrophilous insects by testing a mixture of burnt wood volatiles. Future studies should, therefore, focus on the biodiversity of pyrophilous insects, which respond to different fire-relevant stimuli, for example, dealing with a broader spectrum of volatiles and infrared radiation. In this way the specific ecological niches of pyrophilous insect species on burnt areas can be described, including knowledge about the plants that have to be damaged by the fire.

3.6 Acknowledgments

TPH was supported by the Catholic Academic Exchange Service (KAAD - Katholischer Akademischer Ausländer-Dienst), Germany. Technical support from Ulrike Eisenwiener and Sara Nicke is gratefully acknowledged. Administrative support during sample collection in the Vietnam Central Highlands by the provincial Forest Protection Department of Kon Tum is also gratefully acknowledged.

3.7 References

- Azeez, A. M., Meier, D., Odermatt, J. and Willner, T. (2010).** Fast pyrolysis of African and European lignocellulosic biomasses using Py-GC/MS and fluidized bed reactor. *Energy & Fuels*, 24(3): 2078-2085.
- Branca, C., Di Blasi, C. and Elefante, R. (2006).** Devolatilization of conventional pyrolysis oils generated from biomass and cellulose. *Energy Fuels*, 20(5): 2253-2261.
- De Simon, B. F., Esteruelas, E., Muñoz, A. M., Cadahía, W. and Sanz, M. (2009).** Volatile compounds in acacia, chestnut, cherry, ash, and oak woods, with a view to their use in Cooperage. *Journal of Agricultural and Food Chemistry*, 57(8): 3217-3227.
- Del Río, J. C., Gutiérrez, A., Romero, J., Martínez, M. J. and Martínez, A.T. (2001).** Identification of residual lignin markers in eucalypt kraft pulps by Py-GC/MS. *Journal of Analytical and Applied Pyrolysis*, 58–59: 425-439.
- Evans, W. G. (1966).** Perception of infrared radiation from forest fires by *Melanophila acuminata* De Geer (Buprestidae, Coleoptera). *Ecology* 47(6): 1061-1065.
- Flematti, G. R., Ghisalberti, E. L., Dixon, K. W. and Trengove, R. D. (2004).** A compound from smoke that promotes seed germination. *Science*, 305(5686): 977.
- Geiser, M. (2016).** An update on the distribution of the pyrophilous beetle *Acanthocnemus nigricans* (Hope, 1845) (Coleoptera: Cleroidea: Acanthocnemidae), including new records from Laos. *Entomologica Basiliensia et Collectionis Frey*, 35: 429-432.
- Guillen, M. D., Sopolana, P., and Partearroyo, M. A. (2000).** Polycyclic aromatic hydrocarbons in liquid smoke flavorings obtained from different types of wood. Effect of storage in polyethylene flasks on their concentrations. *Journal of Agricultural and Food Chemistry*, 48(10): 5083-5087.
- Hoang, T. P. and Schütz, S. (2015).** Pyrophilous insects in Vietnam central highlands. *Mitteilungen Deutsche Gesellschaft für allgemeine und angewandte Entomologie*, 20: 133-138.
- Kollmann, F. (1982).** *Technologie des Holzes und der Holzwerkstoffe, Anatomie und Pathologie, Chemie, Physik, Elastizität und Festigkeit.* Springer, Berlin, Germany, 1051 pp.
- Le, S. (1996).** *Vietnam forest trees.* Agricultural Publishing House.
- Le, T. H., Thanh Nguyen, T. N., Lasko, K., Ilavajhala, S., Vadrevu, K. P. and Justice, C. (2014).** Vegetation fires and air pollution in Vietnam. *Environmental Pollution*, 195: 267-275.
- Lourenço, A., Neiva, D., Gominho, J., Marques, A. V. and Pereira, H. (2015).** Characterization of lignin in heartwood, sapwood and bark from *Tectona grandis* using Py–GC–MS/FID. *Wood Science and Technology*, 49(1): 159-175.
- Maleknia, S. D., Bell, T. L., and Adams, M. A. (2009).** Erratum to “Eucalypt smoke and wildfires: Temperature dependent emissions of biogenic volatile organic compounds”. *International Journal of Mass Spectrometry*, 279(2-3): 126-133.

- McNamara, S., Tinh, D. V., Erskine, P. D., Lamb, D., Yates, D., & Brown, S. (2006).** Rehabilitating degraded forest land in central Vietnam with mixed native species plantings. *Forest Ecology and Management*, 233(2-3): 358-365.
- Mehmetli, E., Dogan, Ö., Tiris, M., Kiran, N. C. and Matuschek, G. (2008).** Thermolysis product distribution of solid waste obtained from olive oil production. *CLEAN - Soil, Air, Water*, 36(3): 315-319.
- Morimoto, M., Fukumoto, H., Hiratani, M., Chavasiri, W. and Komai, K. (2006).** Insect antifeedants, pterocarpan and pterocarpol, in heartwood of *Pterocarpus macrocarpus* Kruz. *Bioscience, Biotechnology, and Biochemistry*, 70(8): 1864-1868.
- Noudogbessi, J.-P., Yédomonhan, P., Sohounhloúé, D., C., K., Chalchat J.-C. and Figuéredo, G. (2008).** Chemical composition of essential oil of *Syzygium guineense* (Willd.) DC. var. *guineense* (Myrtaceae) from Benin. *Records of Natural Products*, 2(2): 33-38.
- Paczkowski, S. (2013).** Insect olfaction as an information filter for chemo-analytical applications. PhD Thesis. Faculty of Forest Sciences and Forest Ecology. University of Göttingen, Germany.
- Paczkowski, S., Paczkowska, M., Dippel, S., Schulze, N., Schütz, S., Sauerwald, T., et al. (2013).** The olfaction of a fire beetle leads to new concepts for early fire warning systems. *Sensors and Actuators, B: Chemical*, 183: 273-282.
- Paczkowski, S., Paczkowska, M., Dippel, S., Flematti, G. and Schütz, S. (2014).** Volatile combustion products of wood attract *Acanthocnemus nigricans* (Coleoptera: Acanthocnemidae). *Journal of Insect Behaviour*, 27: 228-238.
- Piskorz, J., Radlein, D. and Scott, D. S. (1986).** On the mechanism of the rapid pyrolysis of cellulose. *Journal of Analytical and Applied Pyrolysis*, 9(2): 121-137.
- Schmitz, A., Gebhardt, M. and Schmitz, H. (2008).** Microfluidic photomechanic infrared receptors in a pyrophilous flat bug. *Naturwissenschaften*, 95(5): 455-60.
- Schmitz, A., Schätzel, H. and Schmitz, H. (2010).** Distribution and functional morphology of photomechanic infrared sensilla in flat bugs of the genus *Aradus* (Heteroptera, Aradidae). *Arthropod Structure & Development*, 39(1): 17-25.
- Schütz, S., Weißbecker, B., Hummel, H. E., Apel, K.-H., Schmitz, H. and Bleckmann, H. (1999).** Insect antenna as a smoke detector. *Nature*, 398: 298-299.
- Wikars, L.O. (1992).** Skogsbränder och insekter. *Entomologisk Tidskrift*, 133(4): 1-11.
- Wikars, L.O. (1997).** Effects of forest fire and the ecology of fire-adapted insects. *Comprehensive Summaries of Uppsala Dissertations from the Faculty of Science and Technology* 272. Acta Universitatis Upsaliensis, Uppsala, Sweden, 272 pp.

Chapter 4

Pyrophilous insects respond to different stimuli

This is a manuscript prepared for submission. I conducted all experiments and prepared the manuscript.

Abstract

Pyrophilous insects are attracted by fires, taking advantage from developing a part of their life cycle in freshly burnt habitats. They developed efficient senses for such an environment, responding to smoke and heat by using special receptors such as infrared (IR) organs and smoke-sensitive olfactory receptors on antennal sensilla. To disentangle how such sensory modalities contribute to behavior, we examined the reactions of insects in a freshly burnt habitat to traps equipped with IR stimuli or fire-specific volatile organic compounds (VOCs) or a combination of both in comparison to a control trap. Major fire-specific VOCs are thermal degradation products of cellulose, such as 5-methylfurfural, hydroxyacetone, and lignin (guaiacol, 4-ethyl-guaiacol). The primary aim of our study was that a newly developed IR trap attracts pyrophilous insects and to compare efficiency and species composition of insects caught by fire-specific VOCs and IR stimuli.

A total of 26 insect species were recorded. The attraction of pyrophilous insects towards fire-specific VOCs, IR and combined stimuli was significantly higher compared to the controls. Only one species (*Litochrus* sp. 1, Phalacridae, Coleoptera) was found in all three trap types. Insects considered to be fungivorous were caught significantly more often in the IR trap, whereas VOC traps attracted more carnivorous insects. All traps attracted a number of herbivorous insects.

Eight species were caught in more than one trap type. Two predatory beetles of the family Cleridae were caught in either IR trap or the IR combination with VOC mixture. These results hint at a complex evaluation of IR and olfactory stimuli for resource location by different members of the pyrophilous insect community.

Keywords: Pyrophilous insects, forest fires, infrared radiation, fire-specific volatiles, trapping methods.

4.1 Introduction

Pyrophilous insects depend on forest fires to varying degrees. Some xylophagous species among them approach forest fires for mating and oviposition, because their larvae can only develop in the wood of freshly burnt trees (Linsley 1943; Apel 1988). The well-known pyrophilous jewel beetles of the genus *Melanophila* (Buprestidae) are not only equipped with one pair of metathoracic infrared (IR) organs (Evans 1964; Vondran et al., 1995; Schmitz et al., 1997), but also with special antennal olfactory “smoke” receptors (Schütz et al., 1999). Earlier investigations showed that such specialized pyrophilous insects are attracted to volatile organic compounds released by thermal degradation of wood (Paczkowski et al., 2013, 2014). Other studies focus on the IR receptors (Schmitz et al., 2002; Kreiss et al., 2005, 2007; Schmitz et al., 2008, 2010). While all insects have olfactory senses, few pyrophilous insect species have evolved IR receptors independently and could detect fires using both VOC cues and IR cues. For example, *Acanthocnemus nigricans* (Cleroidea) uses a specialized IR sensory organ to detect the IR radiation emitted by hot surfaces (Schmitz et al., 2002; Kreiss et al., 2005, 2007). On the other hand, little attention was paid on the behavioral responses of pyrophilous insects towards IR radiation, or mixtures of fire-specific volatiles or combinations of both. Pyrophilous insects are often characterized by their occurrence in fire situations or the presence of morphological features such as IR receptors. However, no traps are available that imitate a fire by releasing fire-specific volatiles and/or IR radiation to attract insects with a pyrophilous lifestyle.

The aim of the present work was to develop a trap including a source of IR radiation to test whether we can attract particularly the pyrophilous insect species in the field. With the newly designed traps we tested and compared the attractiveness of IR radiation but also fire-specific volatiles, and the combination of both. For an explorative field study and a proof of principle we therefore constructed two traps capable of emitting IR radiation. Two traps of the same design released only a mixture of VOCs (VOC trap), a trap emitting IR radiation (IR trap), the other released additionally a fire-specific VOCs mixture (IRVOC trap), and two empty control traps of the same design. The chosen fire-specific volatiles included hydroxyacetone and 5-methylfurfural, as these are characteristic products of the thermal degradation of cellulose (Piskorz et al., 1986; Flematti et al., 2004), guaiacol and 4-ethylguaiacol. These compounds are typical products of the thermal degradation of lignin (Branca et al., 2006, Azeez et al., 2010). The study has been conducted in Vietnam, where forest fires are abundant and occur often over a long season (Hoang & Schütz 2015). While the contribution of IR and/or fire-specific VOCs to the attraction of pyrophilous insects has generally not been studied in detail, systematic

investigations of freshly burnt areas to characterize pyrophilous insects of Vietnam have not been carried out so far.

4.2 Material and methods

4.2.1 Trap construction

All traps used in this study were designed as X-pane flight interception traps made from two perpendicular panes of 40 cm width and 60 cm height, and were suspended at 1 m height above ground. Flight interception traps (type “Witaprall Ecco”, Witasek, Feldkirchen, Germany), made of black plastic boards, a black funnel, and a collection container were used as control trap and trap baited with VOCs (VOC traps). The IR traps were also designed as X-pane flight interception traps made from two perpendicular metal panes to resist the IR emitter heat. Panes were as well of 40 cm width and 60 cm height. The panels serve as reflectors for the IR emitter that extend from the upper end of the container to the upper end of the head plate (Fig. 1). The head plate has a hook which is used for the installation of the trap. Infrared traps comprised of four IR emitters. These 125-Watt IR emitters have a size of 60 × 60 mm. These IR emitters are fastened by bolts to the vertical support. The insects fall through a funnel into the trapping container, which has a throat and a plastic bottle (Vitlab, PFA 1000 ml) as a reservoir portion (Fig. 1). VOC traps and IR-VOC traps were provided with 8.2 ml VOCs mixture (2 ml hydroxyacetone, 2 ml guaiacol, 2 ml 5-methylfurfural and 0.2 ml 4-ethyl-guaiacol) in a 10 ml glass vial with an opening of 1 cm² in the center at the lower end of the panes.

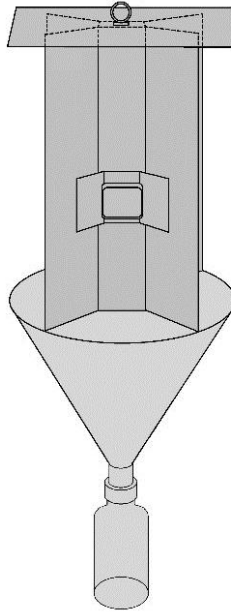

Figure 1: Infrared trap with four IR emitters to each direction at the middle of the metal reflectors.

4.2.2 Estimation of the trapping radius of the trap emitting IR radiation

We use a modified Stefan–Boltzmann formula according to Ebert & Westhoff (2006) to estimate the active trapping radius of the IR traps:

$$\text{Irradiance contrast (W/cm}^2\text{)} = \frac{\sigma A(T_2^4 - T_1^4)}{\pi D^2},$$

where σ is the Stefan–Boltzmann constant [$5.6522 \cdot 10^{-12} \text{ W / (cm}^2 \text{ K}^4\text{)}$]; A the radiating area ($6 \cdot 6 \text{ cm}^2$); T_2 , temperature ($^{\circ}\text{K}$) of IR emitters ($486^{\circ}\text{C} = 759^{\circ}\text{K}$); T_1 , temperature ($^{\circ}\text{K}$) of the panes ($35^{\circ}\text{C} = 308.15^{\circ}\text{K}$). Thus, the temperature difference between the IR source and the panes ($T_2 - T_1$) as well as the radiating area (A) of the IR source determines the trapping radius distance (D) (Ebert & Westhoff 2006). If a sensitivity of an insect IR receptor of $60 - 100 \mu\text{W/m}^2$ is assumed (corresponding to the reported sensitivity of the thoracic IR organs of *Melanophila* beetles, Evans 1966) the trapping radius of our IR traps was 5 m (IR radiation intensity $83 \mu\text{W/cm}^2$). However, in a theoretical simulation study a much higher sensitivity of the *Melanophila* IR sensilla of 1.3 nW/cm^2 has been postulated (Schmitz & Bousack 2012). In this theoretical case a trapping radius of more than 1 km would result (IR radiation intensity at a distance of 1 km: 2 nW/cm^2).

4.2.3 Estimation of the trapping radius of the trap baited VOCs

To estimate the active trapping radius of a VOC trap, emission rates of guaiacol from the vial (2 ml/day) were used to calculate a distance-dependent dilution factor at given wind velocities (Bossert et al., 1963). We compared this factor to the detection limit of *Melanophila acuminata* (Schütz et al., 1999) at 10 ng/ml (of 10 ng / cm³). Assuming a wind speed of 30 cm per second, the active trapping radius of the VOC trap would be around 50 m.

4.2.4 Chemicals

Hydroxyacetone was obtained from Aldrich Co. (St. Louis, Missouri, USA), 5-methylfurfural from Acros Co. (Belgium, Wisconsin, USA), guaiacol from Fluka (Buchs, Switzerland) and 4-ethylguaiacol from SAFC Co. (St. Louis, Missouri, USA). Compounds (> 97% purity) were of analytical quality.

4.2.5 Study area and experimental design

The experiments were carried out in forested areas in Ngoc Reo Forest, inside pine (*Pinus* sp.) plantations, adjacent to the secondary forest of Chu Mom Ray National Park and inside the national park (Sa Thay district, Kon Tum province, Vietnam Central Highlands). Mean (day and night) temperature (2015) at the study area was 22.2°C during the sample period (from February to April). Field research was conducted during the dry season from 16 February to 10 April 2015, when forests are usually burnt, and frequent fires took place in the research area. Traps were set up in two different types of habitats, including unburnt and freshly burnt areas (from 1 -10 days after the fire). The unburnt habitat was selected to provide an undisturbed reference of control samples, whereas freshly burnt habitats were chosen for investigating the presence of pyrophilous insects. The trap setup was installed in a block design, with three blocks arranged in a north-south line alongside wind direction. The designed block had an open canopy in the center of at least 300 m × 400 m to allow space for a core circle with traps (Fig. 2). With the wind direction from north-south, the first VOC trap was placed in the furthest southeast, 100 m away from the square edge. The second VOC trap was installed in the furthest southwest, likewise. The IR trap with VOCs (IRVOC trap) was set up 100 m away from the first VOC trap in the northeast, whereas the IR trap was placed in parallel with the IRVOC trap and was installed 100 m away from the second VOC trap in the northwest. Two control traps were set up in the furthest northeast and northwest respectively. All traps were suspended 1 m above ground and applied to both habitat types. Each trap was active for 15 hours per day from 6:00 to 22:00 hours over 10 days. After each day, the VOC mixture was renewed. Every second day,

the traps were placed on a new site. Insects were collected every three hours and kept in plastic boxes. Trap catches were sorted to morphologically similar groups and killed with ethyl-acetate before being labeled and stored in 50% ethanol. Specimens collected from traps were sent to the Department of Insect Systematics at the Institute of Ecology and Biological Resources (IEBR) in Hanoi, Vietnam, for identification.

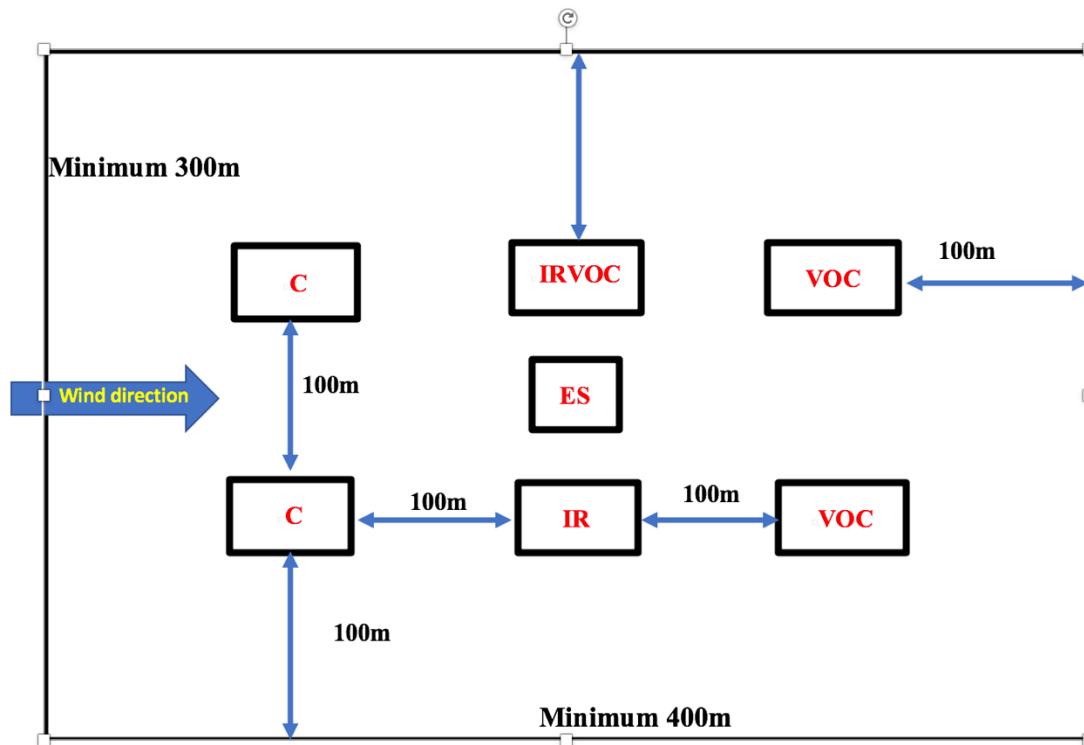

Figure 2: Symmetric drawing of the study design in Vietnam Central Highlands in 2015. C: Empty control traps. IR: traps emitting IR radiation. IRVOC: traps emitting IR radiation and containing a mixture of fire-specific volatile organic compounds. VOC: traps baited with a mixture of fire-specific volatile organic compounds. ES: electric supplier.

4.2.6 Statistical tests

Because the total insect species caught by each trap type in freshly burnt areas were smaller than 20 ($n < 20$), Wilcoxon rank-sum test was used to test for significant differences in the distribution of insect species between all traps, and significant differences between insect taxa caught in each trap. The significance level (P) was set at 95%.

4.3 Results

A total of 1,246 insects belonging to 26 species were caught on the freshly burnt areas. Of these, 338 beetles (27%) belonging to nine species were found in IR traps and 270 beetles (22%) of 14 species in VOC traps. The VOC1 and VOC2 traps yielded 226 insects (18%) in total, belonging to 14 species, while the trap combining IR with volatiles (IRVOC) yielded 412

individuals (33%) of 12 species. The abundance of insects caught by the three trap types (VOC1, VOC2, IR, and IRVOC) showed statistically significant differences with the beetles caught by the control traps ($P = 0.000053, 0.000053, 0.000053$ and 0.000053 respectively) (Fig. 3). The number of species caught in the IRVOC trap was significantly different from the volatile traps ($P = 0.0028$ and 0.0019 respectively) (Fig. 3). There were no significant differences in the number of insect species caught by both VOC traps (VOC1 and VOC2). None of the insect species recorded by the other trap types was found in control traps. Equally, control traps in burnt habitats yielded other insect species which were not found in other traps such as: *Salganea* sp. (Blattodea, Blattidae), *Catapiestus* sp. (Coleoptera, Tenebrionidae), *Xylocopa confusa* (Perez, 1901) (Hymenoptera, Apidae). A different insect species composition was recorded in these traps in unburnt habitat when compared to burnt habitat. The species included *Demonax bowringii* (Pascoe, 1859) (Coleoptera, Cerambycidae), *Chlorophorus quatuordecimmaculatus* (Chevrolat, 1863) (Coleoptera, Cerambycidae), *Laius* sp. (Coleoptera, Melyridae), *Anomala russiventris* (Fairmaire, 1893) (Coleoptera, Scarabaeidae), *Anomala* sp. (Coleoptera, Scarabaeidae), *Apis cerana* (Fabricius, 1793) (Hymenoptera, Apidae) and *Syzeuctus* sp. (Hymenoptera, Ichneumonidae).

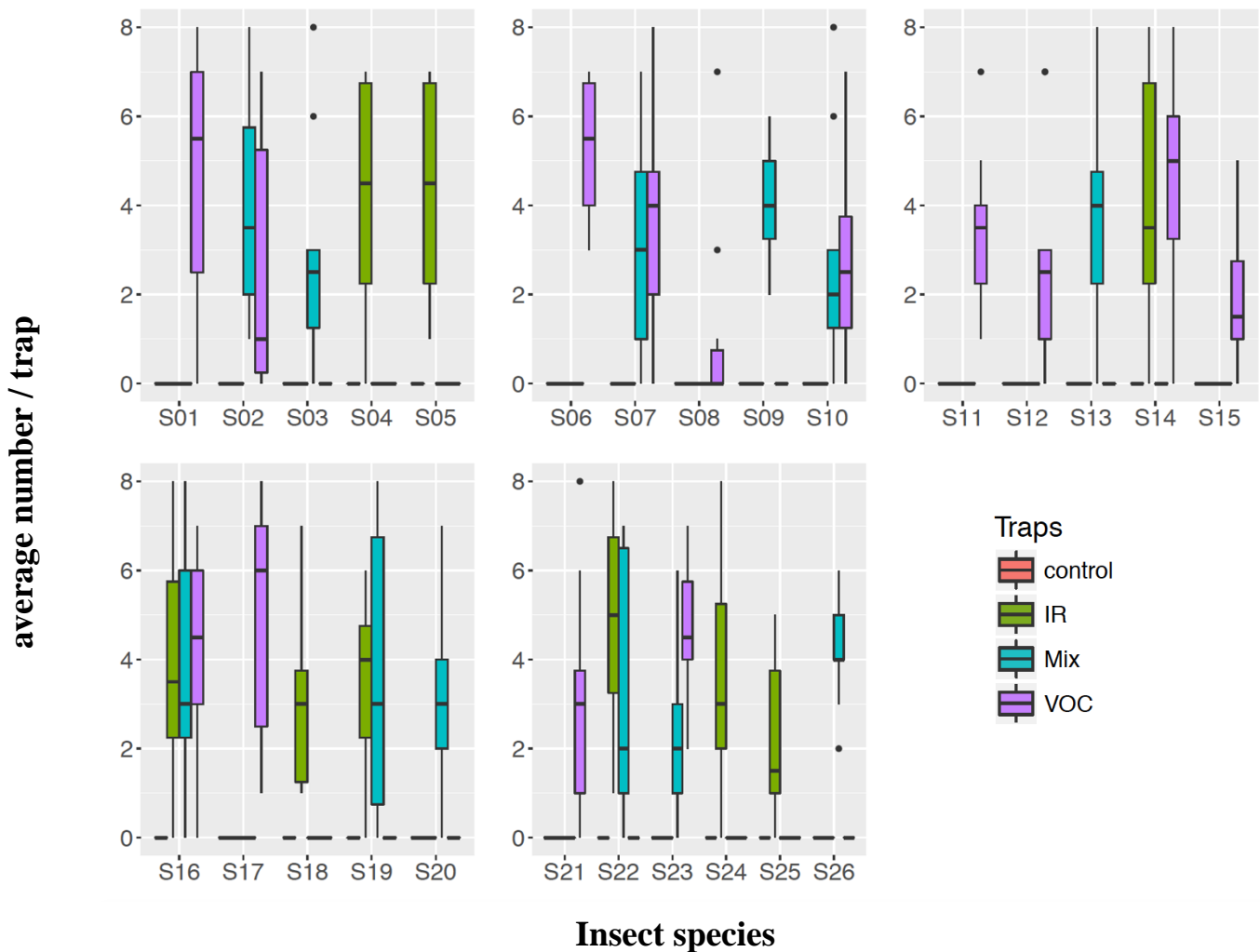

Figure 3: Mean numbers of beetles captured on freshly burnt areas. Bars and whiskers display the median, upper and lower quartiles and maxima and minima. The sum shows the overall number of pyrophilous insects caught in each trap type. None of these insect species were caught by these trap types on unburnt areas and in habitats burnt one year ago. No species of insect listed in the figure was caught by control traps. VOC = trap baited with a mixture of VOCs; IR = trap emitting IR radiation; IRVOC(Mix) = combined trap releasing VOCs and emitting IR radiation.

S01-S26: Insect species 1 to 26, all belonging to Coleoptera; S01-S08: Carnivorous insect species; S01: *Apristus* sp. 1 (Carabidae), S02: *Anthicoclerus* sp. 1 (Cleridae), S03: *Anthicoclerus* sp. 1 (Cleridae), S04: *Nephus boninensis* (Coccinellidae), S05: *Pseudoplectus* sp. 1 (Pselaphidae), S06: *Eleusis humilis* (Staphylinidae), S07: *Staphylinus* sp. 2 (Staphylinidae), S08: *Staphylinus* sp. 3 (Staphylinidae).

S09-S20: Herbivorous insect species; S09: *Colobicus* sp. 1 (Colydiidae), S10: *Cryphalus* sp. 1 (Scolytidae), S11: *Cryphalus* sp. 2 (Scolytidae), S12: *Wallacellus denticulus* (Scolytidae), S13: *Scolytus* g. sp. 1 (Scolytidae), S14: *Anacypta* sp. 1 (Trogossitidae), S15: *Anthicus* sp. 1 (Anthicidae), S16: *Litochrus* sp. 1 (Phalacridae), S17: *Perissus rayus* (Cerambycidae), S18: *Cryptolestes ferrugineus* (Cucujidae), *Monomma* sp. 1 (Monommidae), S20: *Elacatis* sp. 1 (Salpingidae).

S21-S26: Fungivorous insect species; S21: *Cartodere* sp. 1 (Lathridiidae), S22: *Corticaria gibbosa* (Lathridiidae), S23: *Litargus* sp. 1 (Mycetophagidae), S24: *Psammoecus* sp. 1 (Silvanidae), S25: *Cathartus* sp. 1 (Silvanidae), S26: *Silvanus bidentatus* (Silvanidae).

Overall more species were caught in traps releasing VOCs alone (13) than in traps emitting only IR or in combination with VOCs (8). Surprisingly, only five species were attracted by IRVOC traps but not by other trap types (Fig. 3)

Regarding feeding guilds, the overall number of carnivorous insect species caught by VOC1 and VOC2 traps was significantly lower than that caught by IRVOC traps ($P = 0.0043$ and 0.00017 ; VOC1 and VOC2 respectively). Numbers of herbivorous insect species caught by VOC, IR and IRVOCs were not statistically different from each other in a pairwise comparison. The numbers of fungivorous insect species in IR traps significantly differed from VOC1, VOC2 and IRVOC traps ($P = 0.007$, 0.0048 and 0.00037 respectively). The number of fungivorous insect species in the VOC1 and VOC2 traps was significantly higher in comparison with those in IRVOC traps ($P = 0.0015$ and 0.0016 respectively) (Fig. 4).

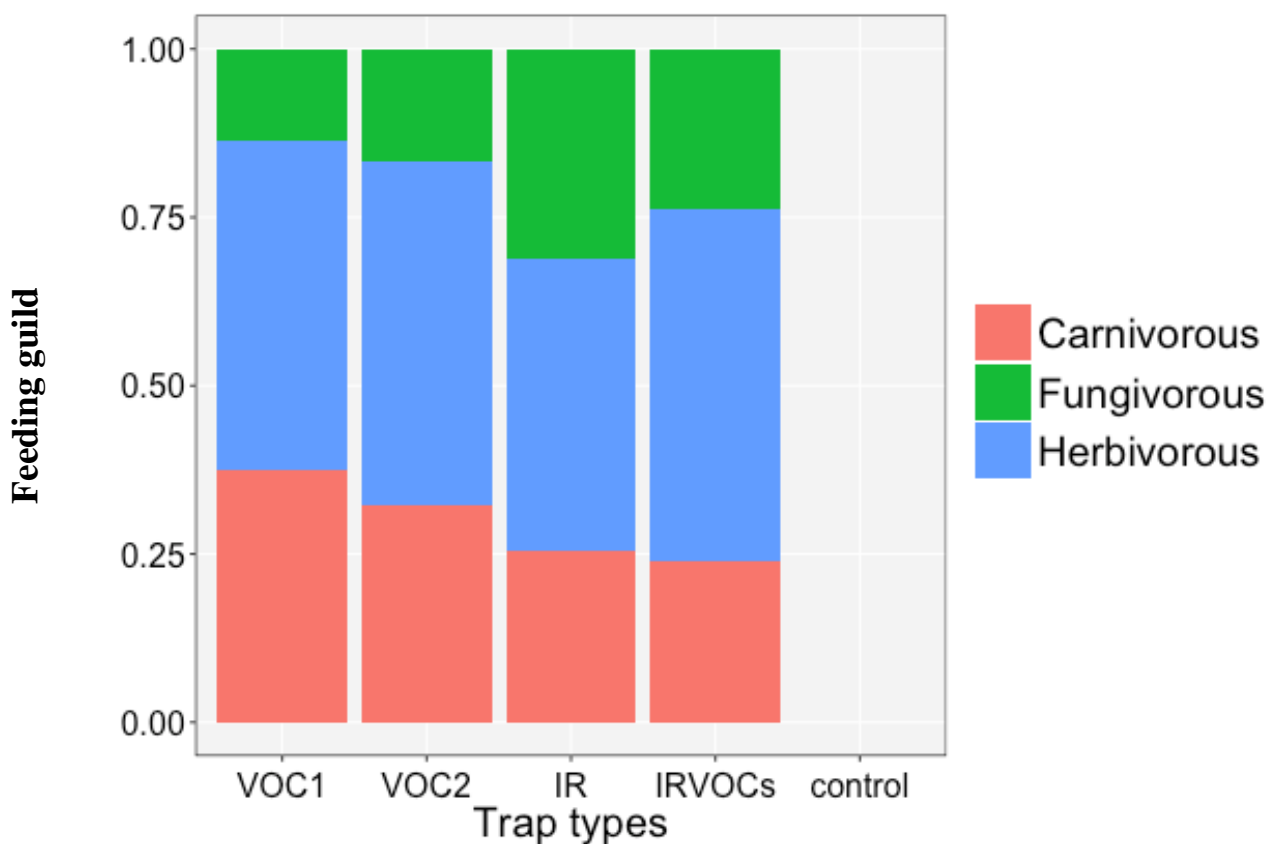

Figure 4: Mean number of insects caught by traps releasing different types of fire-specific cues. Insects were grouped together as feeding guilds (carnivorous, fungivorous and herbivorous) according to literature knowledge. VOC = trap baited with the mixture of VOCs; IR = trap emitting IR radiation; IRVOCs = combined traps releasing VOCs and IR radiation.

4.4 Discussion

The main aim of our study was to test the attractiveness for pyrophilous insects of a newly constructed trap emitting major fire-specific cues such as IR radiation and fire-specific volatiles. In comparison to control traps, our numerous trap catches from recently burnt habitats demonstrate that our newly developed trap emitting either IR radiation, fire-specific VOCs or a combination of both effectively attracted insects likely having a pyrophilous lifestyle. In

detail, differences in their attraction according to different fire-relevant stimuli tested became apparent suggesting that IR radiation alone might be capable of attracting pyrophilous insects, while fire-specific VOCs or their combination with IR radiation seemed to play a major role for their attraction in recently burnt forests. Similarly, the number of species occurring in VOC traps alone exceeded the number of those found in IR traps only. Due to a very limited number of custom-made traps capable of emitting IR radiation, results should be interpreted cautiously. Results, however might indicate that certain species of pyrophilous insects rely either on IR or on VOC stimuli, but are not susceptible to both stimuli, while the majority combines both informations. There is also no clear tendency that IR radiation increases or decreases the attractivity of VOCs alone.

The attraction of pyrophilous insects to traps emitting IR radiation might be expected because a few species of pyrophilous beetles possess IR receptors (Schmitz et al., 2002; Kreiss et al., 2005, 2007; Paczkowski et al., 2014) to detect hot surfaces, for example, *A. nigricans*, *Merimna atrata*, and *Melanophila acuminata*. Our study indicates that nine species of insects are attracted to pure IR traps. However, these beetles neither have been described as pyrophilous nor reported to have IR receptors in early studies. A search for IR receptors, therefore, may be rewarding.

The majority of the species was found in traps containing fire-specific volatiles. VOCs play an important role in host-finding in herbivorous insects (Bernays & Chapman 1994), saproxylic and fungivorous insects (Holighaus 2012), or also in pyrophilous insects (Schütz et al., 1999). However, instead of truly smoke volatiles like 4-ethylguaiacol, guaiacol is also produced by deadwood or maybe by microorganisms (Holighaus 2006). Similarly, hydroxyacetone is found in the fermentation product of wood sap (Ômura et al., 2000), and 5-methylfurfural is a part of the containing fermentation/vinegar related compounds which was used to lure a non-pyrophilous fruit fly *Drosophila melanogaster* (Becher et al., 2010). Therefore, the insects attracted by such a single component are not necessarily pyrophilous. To increase fire specificity of VOC lures we used baits containing a mixture of fire-specific VOCs. It is, therefore, very important to confirm the responses of these insects by other additional examinations such as Electroantennography (EAG) experiments or a search for IR receptors. Surprisingly, only five insect species were caught only by IRVOC traps but not by the other traps. This disproves our expectation that the IRVOC trap would attract the same species found in the VOC and IR traps. The reason for this is not apparent. Further experiments are required to clarify this point.

Several fungivorous insect species (33 %) were attracted by our mixture of fire-specific VOCs.

As expected, these saproxylic species (*Cartodere* sp. (Lathridiidae)) and *Litargus* sp. (Mycetophagidae) (Cocciufa et al., 2014) might be attracted to guaiacol because this compound is also produced by deadwood (Holighaus 2006). In contrast, 33% of other saproxylic species fungivorous insect species (*Corticicara gibbosa* (Lathridiidae), *Psammoecus* sp. (Silvanidae) (Cocciufa et al., 2014) were attracted by the IR trap stronger than expected. A search for the IR receptors is recommended for further interpretation.

4.5 Conclusion

With the limited number of replicants and without further confirmation by EAG experiments and IR examination, we could not be able to conclude the attraction response of insects to a trap emitting IR radiation when positioned on freshly burned areas. However, with several numbers of insect species caught by the IR trap, the trap can, therefore, be used for further studies on the appearance and behavior of pyrophilous insects. Our study revealed the complexity in stimuli selection by different species of pyrophilous insects. The preference to certain stimuli or to all stimuli by an insect species and a search for IR receptors in several insect species attracted to IR traps would be a starting point for further studies.

4.6 Acknowledgements

TPH was supported by the Catholic Academic Exchange Service (KAAD - Katholischer Akademischer Ausländer-Dienst), Germany. Technical support from Andreas Teichmann, Ulrike Eisenwiener and Sara Nicke is gratefully acknowledged. Thanks to Daniel Jestrzanski for his help with establishing the figure. Administrative support during sample collection in the Vietnam Central Highlands by the provincial forest protection department of Kon Tum is also gratefully acknowledged.

4.7 References

- Apel, K.-H. (1988).** Befallsverteilung von *Melanophila acuminata* Deg, *Phaenops cyanea* F und *Ph. formaneki* Jacob (Col., Buprestidae) auf Waldbrandflächen. Beiträge für die Forstwirtschaft, 22(2): 45-48.
- Azeez, A. M., Meier, D., Odermatt, J. and Willner, T. (2010).** Fast pyrolysis of African and European lignocellulosic biomasses using Py-GC/MS and fluidized bed reactor. Energy & Fuels, 24(3): 2078-2085.
- Becher, P. G., Bengtsson, M., Hansson, B. S. and Witzgall, P. (2010).** Flying the fly: long-range flight behavior of *Drosophila melanogaster* to attractive odors. Journal of Chemical Ecology, 36(6): 599-607.
- Bernays, E. A. and Chapman, R. F. (1994).** Host-plant selection by phytophagous insects. Chapman & Hall, New York, USA, 312 pp.
- Bossert, W. H. & Wilson, E. O. (1963).** The analysis of olfactory communication among animals. Journal of Theoretical Biology, 5(3):443-469.
- Branca, C., Di Blasi, C. and Elefante, R. (2006).** Devolatilization of conventional pyrolysis oils generated from biomass and cellulose. Energy Fuels, 20(5): 2253-2261.
- Cocciufa, C., Gerth, W., Luiselli, L., Redolfi De Zan, L., Pierfilippo Cerretti P. and Carpaneto, G.M. (2014).** Survey of saproxylic beetle assemblages at different forest plots in central Italy. Bulletin of Insectology 67 (2): 295-306.
- Ebert, J. and Westhoff, G. (2006).** Behavioural examination of the infrared sensitivity of rattlesnakes (*Crotalus atrox*). Journal of Comparative Physiology, 192(9): 941-947.
- Evans, G. (1964).** Infra-red receptors in *Melanophila acuminata* DeGeer. Nature, 202: 211.
- Evans, W. G. (1966).** Perception of infrared radiation from forest fires by *Melanophila acuminata* De Geer (Buprestidae, Coleoptera). Ecology 47(6): 1061-1065.
- Flematti, G. R., Ghisalberti, E. L., Dixon, K. W. and Trengove, R. D. (2004).** A compound from smoke that promotes seed germination. Science, 305(5686): 977.
- Hoang, T. P. and Schütz, S. (2015).** Pyrophilous insects in Vietnam central highlands. Mitteilungen Deutsche Gesellschaft für allgemeine und angewandte Entomologie, 20: 133-138.
- Holighaus, G. and Schütz, S. (2006).** Odours of wood decay as semiochemicals for *Trypodendron domesticum* L. (Col., Scolytidae). Mitteilungen Deutsche Gesellschaft für allgemeine und angewandte Entomologie, 15: 161-165.
- Holighaus, G. (2012).** Odour signals relevant to beetles in deadwood habitats. PhD Thesis. Faculty of Forest Sciences and Forest Ecology. University of Göttingen, Germany.
- Kreiss, E.-J., Schmitz, A. and Schmitz, H. (2005).** Morphology of the prothoracic discs and associated sensilla of *Acanthocnemus nigricans* (Coleoptera, Acanthocnemidae). Arthropod Structure and Development, 34(4): 419-428.

- Kreiss, E., Schmitz, H. and Gebhardt, M. (2007).** Electrophysiological characterisation of the infrared organ of the Australian “little ash beetle” *Acanthocnemus nigricans* (Coleoptera, Acanthocnemidae). *Journal of Comparative Physiology*, 193(7): 729-739.
- Linsley, G. E. (1943).** Attraction of *Melanophila* beetles by fire and smoke. *Journal of Economic Entomology*, 36(2): 341-342.
- Ômura, H., Honda, K. and Hayashi, N. (2000).** Identification of feeding attractants in oak sap for adults of two nymphalid butterflies, *Kaniska canace* and *Vanessa indica*. *Physiological Entomology*, 25(3): 281-287.
- Paczkowski, S., Paczkowska, M., Dippel, S., Schulze, N., Schütz, S., Sauerwald, T., et al. (2013).** The olfaction of a fire beetle leads to new concepts for early fire warning systems. *Sensors and Actuators, B: Chemical*, 183, 273-282.
- Paczkowski, S., Paczkowska, M., Dippel, S., Flematti, G. and Schütz, S. (2014).** Volatile combustion products of wood attract *Acanthocnemus nigricans* (Coleoptera: Acanthocnemidae). *Journal of Insect Behaviour*, 27: 228-238.
- Piskorz, J., Radlein, D. and Scott, D. S. (1986).** On the mechanism of the rapid pyrolysis of cellulose. *Journal of Analytical and Applied Pyrolysis*, 9(2): 121-137.
- Schmitz, H., Bleckmann, H. and Mürtz, M. (1997).** Infrared detection in a beetle. *Nature*, 386: 773-774.
- Schmitz, H., Schmitz, A., Trenner, S. and Bleckmann, H. (2002).** A new type of insect infrared organ of low thermal mass. *Naturwissenschaften*, 89: 226-229.
- Schmitz, A., Gebhardt, M. and Schmitz, H. (2008).** Microfluidic photomechanic infrared receptors in a pyrophilous flat bug. *Naturwissenschaften*, 95(5): 455-460.
- Schmitz, A., Schätzel, H. and Schmitz, H. (2010).** Distribution and functional morphology of photomechanic infrared sensilla in flat bugs of the genus *Aradus* (Heteroptera, Aradidae). *Arthropod structure & development* 39(1): 17-25.
- Schmitz, H. and Bousack, H. (2012).** Modelling a historic oil-tank fire allows an estimation of the sensitivity of the infrared receptors in pyrophilous *Melanophila* beetles. *PLoS One*, 7(5): e37627. doi: 10.1371/journal.pone.0037627.
- Schütz, S., Weißbecker, B., Klein, A. and Hummel, H. E. (1997).** Host plant selection of the colorado potato beetle as influenced by damage induced volatiles of the potato plant. *Naturwissenschaften*, 84(5): 212-217.
- Schütz, S., Weissbecker, B., Hummel, H. E., Apel, K.-H., Schmitz, H. and Bleckmann, H. (1999).** Insect antenna as a smoke detector. *Nature*, 398(6725): 298-299.
- Vondran, T., Apel, K. H. and Schmitz, H. (1995).** The infrared receptor of *Melanophila acuminata* De Geer (Coleoptera: Buprestidae): ultrastructural study of a unique insect thermoreceptor and its possible descent from a hair mechanoreceptor. *Tissue and Cell*, 27(6): 645-658.

Chapter 5

Behavioral and sensory adaptations of the flat bug *Aradus candidatus* to post-fire habitats in Vietnam

This is a manuscript prepared for submission. T. P. Hoang conducted all experiments and prepared the manuscript. Helmut Schmitz conducted the scanning electron microscope (SEM) part, contributed to the discussion and review of the manuscript.

Abstract

The pyrophilous flat bug *Aradus candidatus* can be found in recently burnt habitats in Vietnam. Pyrophilous insects are known to approach these freshly burnt areas using fire-specific stimuli like the smell of smoldering logs and IR radiation. Recently, the response of pyrophilous insects to fire-specific volatile organic compounds (VOCs) has received increased scientific attention. Moreover, infrared (IR) receptors have been described in a few pyrophilous flat bug species of the genus *Aradus*. In our study, we investigated the responses of antennal olfactory receptors to fire-specific VOCs and the presence of infrared receptors in this species. The electro-antennogram of the *A. candidatus* antenna clearly revealed its perception toward hydroxyacetone, 5-methylfurfural, guaiacol, 4-methylguaiacol, and 4-ethylguaiacol. In field experiments, *A. candidatus* was attracted to traps baited with a mixture of these fire-specific VOCs. EAG responses also revealed a dose response to three other VOCs like nonanal, 3-octanone and 2(5H)-furanone. Moreover, IR receptors were found on the thoracic propleural region of *A. candidatus*. These IR receptors have an outer shape similar to other pyrophilous *Aradus* species like *A. albicornis*, *A. lugubris* and *A. fuscicornis*. The attraction of *A. candidatus* to fire-specific VOCs, the presence of IR receptors, and the observed behavior to approach recently burnt habitats illustrate a highly pyrophilous behavior in this Vietnamese flat bug species.

Keywords: burnt wood volatiles, *Aradus candidatus*, burnt habitat, IR receptors, flat bugs, forest fires, pyrophilous insects, photomechanic IR receptors

5.1 Introduction

The ability to approach fires even from far distances and colonize freshly burnt areas in about 50 species of so-called pyrophilous insects is well known (Wikars 1997; Schmitz et al., 2008). Pyrophilous insects use fire-specific stimuli such as the smell of burning logs and probably also infrared (IR) radiation (Evans 1964; Wikars 1992; Schütz et al. 1999; Schmitz et al., 2008, 2010) as cues to approach fires.

Responses of antennal olfactory sensilla in pyrophilous insects to fire-specific volatile organic compounds (VOCs) measured by electro-antennographic (EAG) recording techniques have received increased attention in recent years (Paczkowski et al., 2013, 2014). These VOCs are released upon thermal degradation of cellulose, hemicellulose and lignin from plants during forest fires. There are several studies dealing with the EAG responses of pyrophilous insects to fire-specific VOCs such as *Melanophila accuminata* (Schütz et al., 1999), *M. cuspidata* (Paczkowski et al., 2013), *Merimna atrata* (Paczkowski 2013), and *Acanthocnemus nigricans* (Paczkowski et al., 2014). Moreover, several studies on the sensory adaptation of pyrophilous insects exist (Kreiss et al., 2005; Schmitz et al., 2008, 2010). The 12 species of the pyrophilous beetle genus *Melanophila* are equipped with IR receptors. Infrared receptors are located directly behind the coxae of the mesothoracic legs (Vondran et al., 1995; Schmitz et al., 2010). As a special feature, the IR sensilla of *Melanophila* beetles are innervated as mechanoreceptors and, therefore, have been termed photomechanic (Schmitz & Bleckmann 1998). Astonishingly, photomechanic IR receptors strongly resembling IR sensilla in *Melanophila* beetles have also been found in flat bugs of the genus *Aradus*. In some pyrophilous *Aradus* species, IR receptors are distributed on the propleural region as in *A. albicornis*, *A. lugubris* and *A. fuscicornis* (Schmitz et al., 2008, 2010). This *Aradus candidatus* has been found on freshly burnt areas in Vietnam Central Highlands during our study conducted from February to April, 2017. This bug species was found on an independent field trip that is not part of the studies presented in the chapters. However, to the best of our knowledge, there is no study about pyrophilous behavior and fire-specific sensory adaptations of *A. candidatus* so far. Therefore, it is reasonable to examine the responses of antennal olfactory receptors to fire-specific volatiles and the presence of IR receptors in this species.

In electrophysiological investigations, we examined the EAG response of *A. candidatus* to VOCs including 3-octanone, nonanal, 2(5H)-furanone, guaiacol, 4-ethyl-guaiacol, hydroxyacetone and 5-methylfurfural. These VOCs have different functions and are used by pyrophilous insects for detecting wood fires. 3-octanone is also a volatile released typically by fungi (Holighaus et al., 2014). Nonanal is present in decaying material (Paczkowski et al., 2013). Guaiacol is released

by the incomplete combustion of lignin (Sagebiel & Seiber 1993; Schütz et al., 1999) and also known as an atmospheric marker for wood smoke (Schütz et al., 1999). Thus, it is a very important substance for pyrophilous insects. 2(5H)-furanone is known as VOC released by heated meat (Ansorena 2001; Ozkara et al., 2019). 4-ethyl-guaiacol is also released by the incomplete combustion of lignin (Piskorz et al., 1986; Flematti et al., 2004). Hydroxyacetone and 5-methylfurfural are products of the thermal degradation of cellulose and hemi-celluloses (Branca et al., 2006; Azeez et al., 2010). They play an important role in attracting pyrophilous insects (Paczkowski et al., 2013) and, therefore, are of interest to test the sense of smell of an insect to establish a potential pyrophilous biology. For the field test, we use the volatile mixtures of six compounds for the traps baited with VOCs including hydroxyacetone, 5-methylfurfural, guaiacol, 4-methylguaiacol, 4-ethylguaiacol and 2(5H)-furanone. We also built IR traps as described in Chapter 4 by Hoang et al., (manuscript, 14 pp) to show the importance of IR stimuli in *A. candidatus*. Finally, we examined the ventrolateral regions of the thorax and the abdomen of *A. candidatus* for putative IR receptors.

5.2 Material and Methods

5.2.1 Insects

Adult *Aradus candidatus* bugs were caught after fires on burnt forested areas in February to April 2017 in Kontum province, Vietnam. The live insects were stored in perforated boxes and transported to Germany. They were kept alive for two months in small plastic boxes filled with burnt logs naturally infested with post-fire fungi. The dead specimens were used for scanning electron microscopy. Some bugs were further sent to E. Heiss (Innsbruck, Austria) for identification to species level.

5.2.2 Chemicals

Eight chemical compounds hydroxyacetone, guaiacol, nonanal, 5-methylfurfural, 2(5H)-furanone, 4-methylguaiacol, 4 ethylguaiacol and 3-octanone were diluted in silicon oil M 200 (w/w) (Carl Roth GmbH + Co. KG, Germany) for the EAG experiments. Six chemical compounds (>97% purity) were used for traps baited with VOCs in the field including: hydroxyacetone, guaiacol, 5-methylfurfural, 2(5H)-furanone, 4-methylguaiacol and 4-ethylguaiacol. All of these compounds were obtained from commercial suppliers. Hydroxyacetone, 3-octanone and 2(5H)-furanone were obtained from Sigma-Aldrich Co. (St. Louis, Missouri, USA), 5-methylfurfural from Acros Co. (Belgium, Wisconsin, USA), guaiacol

from Fluka (Buchs, Switzerland) and 4-ethylguaiacol from SAFC Co. (St. Louis, Missouri, USA). All concentrates (> 97% purity) were of analytical quality.

5.2.3 EAG experiments

Two drops of a diluted VOC were soaked onto a 2 cm² filter paper for each dilution step. The soaked filter paper was placed into a 10 ml glass syringe. The dose responses of the antennal sensilla were measured in an electro-antennographic (EAG) setup. This setup was described in detail by (Weißbecker et al., 2004). Before starting the experiments, an amplification factor of 10 was adjusted, resulting in a total amplification factor of 100. A corner frequency of the EAG signal was set to pass filtered at 10 Hz. The corner frequency is set to a cutoff frequency. The low frequency at 1 Hz and the high frequency at 50 Hz was adjusted to pass filtered.

Shortly before a series of measurements, two wells of the antenna holder were filled with haemolymph Ringer solution (Kaissling & Thorson 1980; Schütz et al., 1997). The excised antenna which was freshly removed from the bug, was mounted onto a canal bridge of the antenna holder. Then, the two ends of this antenna were contacted in the Ringer solution of the antenna holder's wells, so that the antenna formed a bridge between the two wells of the antennae holder.

Each EAG experiment was started by puffing 2.5 ml of air from an empty glass syringe into a stream of humidified air (500 ml/min, 23°C, 80% relative humidity) (Paczkowski et al., 2013) passing over the antenna in the antenna holder. Afterwards, air from a glass syringe loaded with a filter paper containing paraffin oil was puffed in the same way over the antenna. In order to test the ability of the antennae to respond to the different compounds, air from a glass syringe loaded with the respective VOC at a concentration of 10⁻⁵ (mg) was puffed into the air stream. These concentrations are diluted in silicone oil. If responses could be elicited, air loaded with concentrations of 10⁻⁴, and 10⁻³ mg of the tested compounds was applied. This was repeated three times for each dilution step, leaving two minutes of resting time between each single puff. The procedure was repeated with the same dilution steps of the six compounds listed above. With different insect antennae, the different orders of compounds were used for each antenna. Thus, depending on the range of the dilution steps, the total number of sample injections per antenna ranged from 27 to 30. The signals were recorded and analyzed by the Agilent Chemstation software.

5.2.4 Trap construction

The construction of IR traps and VOC traps are described in chapter III of this thesis.

5.2.5 Field traps

The experiments were carried out in secondary forest areas in Ngoc Reo forest, pine plantations (*Pinus* sp.), adjacent to the secondary forest of Chu Mom Ray National Park and inside the national park (Sa Thay district, Kon Tum province, Vietnam Central Highlands). The mean temperature at the study area was 21.8°C during the sample period (from February to April 2017). Field research was conducted during the dry season from 20 February to 14 April 2017, when frequent fires of natural and anthropogenic origin took place in the survey area.

Traps were set up in two different habitats, including unburnt and freshly burnt areas (from 1 - 10 days after the fire). The unburnt habitat was selected to provide an undisturbed reference of control samples. Whereas freshly burnt habitats were chosen for investigating the presence of the following groups of pyrophilous insects: 1) mating and oviposition on plants and fungi, 2) scavenging and oviposition on carrions of animals not being able to escape from the fire, and 3) preying or parasitizing on the former two groups. The trap setups were installed in a block design (Fig. 1), with three blocks arranged in a north-south line according to wind direction. The design was placed over a central area of at least 300 m × 400 m to allow for space between the traps. To prevent down-wind effects, the first VOC trap was placed in the furthest southeast, 50 m away from the edge. The second VOC trap was installed in the furthest southwest, also 50 m from the edge. The IR trap with VOCs (mixed trap) was set up 100 m away from the first VOC trap in the northeast, whereas the IR trap was placed in parallel with the IRVOC trap and was installed 100 m away from the second VOC trap in the northwest. The design, construction and performance of the IR traps were described in detail by Hoang et al. (manuscript, 14 pp). Two control traps were set up in the furthest northeast and northwest respectively. These traps were suspended 1 m above ground. They were used in both unburnt and freshly burnt habitats. Each trap was active for 15 hours per day from 6:00 to 22:00 hours over 10 days resulting in total of 11 replicates. After each day, the VOC mixture was renewed. Every second day, traps were placed on a new site. Insects were monitored every three hours and contents of the traps were transferred to plastic boxes. Captured insects were sorted to morphologically similar groups and killed with ethyl-acetate before being labeled and stored in 50% ethanol. Specimens from both traps were sent to the Department of Insect Systematics at the Institute of Ecology and Biological Resources (IEBR) in Hanoi, Vietnam, for identification.

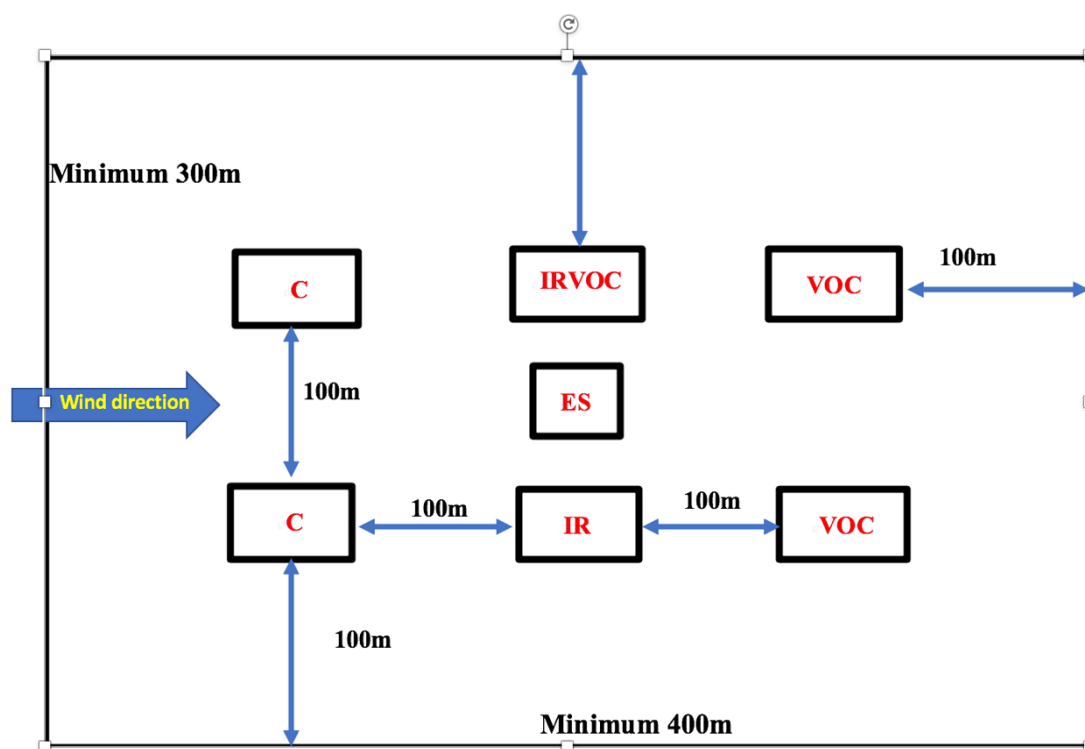

Figure 1: Symmetric drawing of the study design in Vietnam Central Highlands in 2017. C: Empty control traps. IR: Traps emitting IR radiation. IRVOC: Traps emitting IR radiation and contained a mixture of fire-specific volatile organic compounds. VOC: Traps baited with a mixture of fire-specific volatile organic compounds. ES: Electric supplier.

5.2.6 Scanning electron microscopy (SEM)

Bugs fixed in 70% ethanol were cleaned by sonication in a mixture of chloroform and ethanol (2:1) for 2 min. After drying in air, specimens were glued onto holders with carbon glue (Leit-C, Fa. Neubauer), sputtered with gold, and examined in a LEO 440i (Leica, Bensheim, Germany) scanning electron microscope (SEM).

5.2.7 Data analysis

The EAG responses to fire-specific VOCs were normalized by comparing them to the EAD responses of the silicon oil control. We subtracted the mean of the blank responses before and after the measurements which were elicited by the antennae to the control stimuli (silicone).

The EAG-responses to selected compounds were checked for significant differences between the tested concentrations at dilutions of 10^{-3} , 10^{-4} and 10^{-5} by Kruskal–Wallis ANOVA test, because data did not show a normal distribution. Dunn's test was used as a post hoc procedure following rejection of a Kruskal–Wallis test (R studio, version 1.1.463). The Wilcoxon rank-

sum test was used to check for significant differences between numbers of insects caught in each trap. The significance level (P value) was set at 5%.

5.3 Results

5.3.1 Attraction to different types of traps on burnt areas

A total of 68 individuals of *A. candidatus* were caught by all traps, whereas only one *A. candidatus* was captured by the control traps. Two volatile traps yielded 25 individuals of *A. candidatus*, the two IR traps 18 individuals and the IRVOC traps 25 individuals. No significant differences between numbers of bugs caught in these three traps exist (Fig. 2). However, the numbers of bugs caught by VOC, IR and IRVOC traps were significantly different from the number of bugs (1) caught in the control traps ($P = 0.003465$, 0.002654 and 0.001843 respectively, Wilcoxon rank sum test).

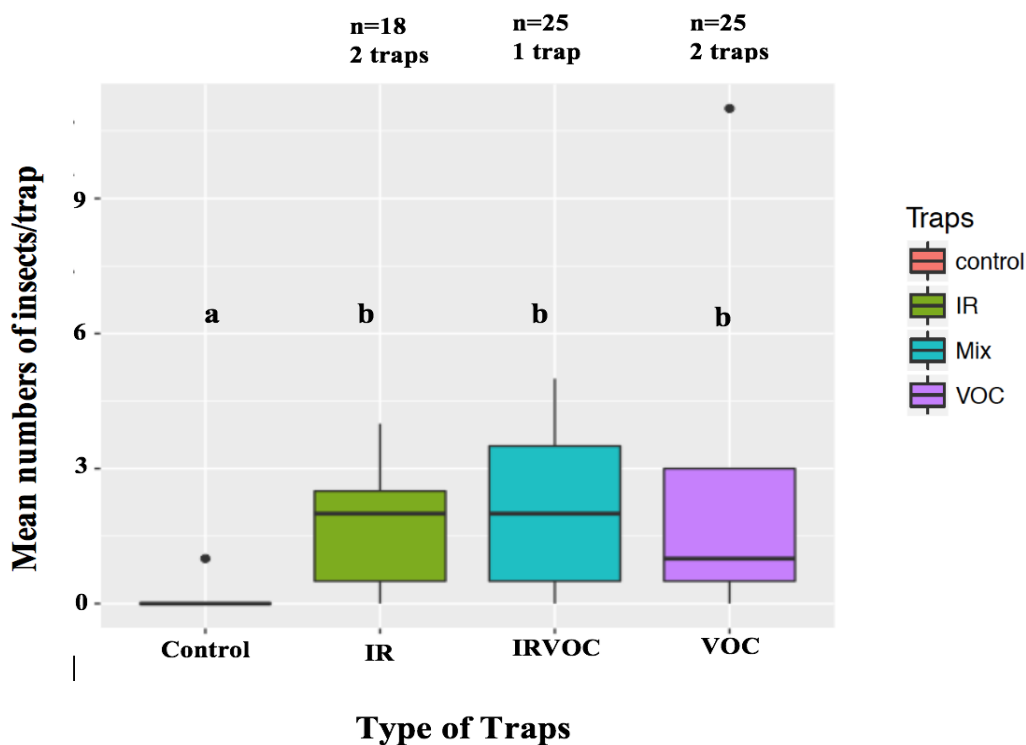

Figure 2: *Aradus candidatus* caught by different types of traps: Control: control traps, IR: traps emitting IR radiation, VOCs: traps baited with a mixture of fire-specific volatile organic compounds. IRVOCs: traps emitting IR radiation and containing a mixture of fire-specific volatile organic compounds. Bars and whiskers display the median, upper and lower quartiles, as well as maxima and minima. The dots display outliers representing an abnormal number of *A. candidatus* caught by these traps. Different letters indicate significant differences among insects caught by each type of trap ($P < 0.05$, Wilcoxon rank sum test).

5.3.2 EAG responses of *A. candidatus* antennae to fire-specific volatile organic compounds

The normalized EAG responses of the *A. candidatus* antennae to hydroxyacetone, guaiacol, nonanal, 5-methylfurfural, 2(5H)-furanone, 4-methylguaiacol, 4-ethylguaiacol and 3-octanone at three doses (10^{-5} to 10^{-3} diluted in silicon oil (mg)) are shown in Fig. 3. Hydroxyacetone, guaiacol, nonanal, 5-methylfurfural, and 2(5H)-furanone showed clear dose responses down to the 10^{-5} dilution. 4-methylguaiacol showed a clear dose response between 10^{-4} and 10^{-3} doses. 4-ethylguaiacol and 3-octanone elicited very high dose responses between 10^{-5} and 10^{-4} dose (Fig. 3).

When comparing the normalized EAG responses of *A. candidatus* of all eight volatile compounds at the three doses tested (10^{-3} , 10^{-4} and 10^{-5}) the highest response to 3-octanone and 4-methylguaiacol respectively was recorded at a dose of 10^{-3} . These compounds showed significantly higher responses than 4-ethyl-guaiacol ($P < 0.05$, Dunn test). At a dose of 10^{-4} , significantly higher EAG response amplitudes of 3-octanone, 4-methylguaiacol, hydroxyacetone and 5-methylfurfural in comparison to 4-ethyl-guaiacol and 2(5H)-furanone were measured ($P < 0.05$, Dunn test). At a dose of 10^{-5} , the highest EAG response amplitudes to 3-octanone, 4-methylguaiacol and hydroxyacetone occurred. These compounds were significantly more effective than 4-ethylguaiacol ($P < 0.05$, Dunn test). The EAG response amplitudes of the *A. candidatus* antenna to 4-ethyl-guaiacol at 10^{-3} and 10^{-5} dilutions were the lowest of all compounds (Fig.3). The EAG response amplitudes to 2(5H)-furanone at 10^{-4} were the lowest of all compounds.

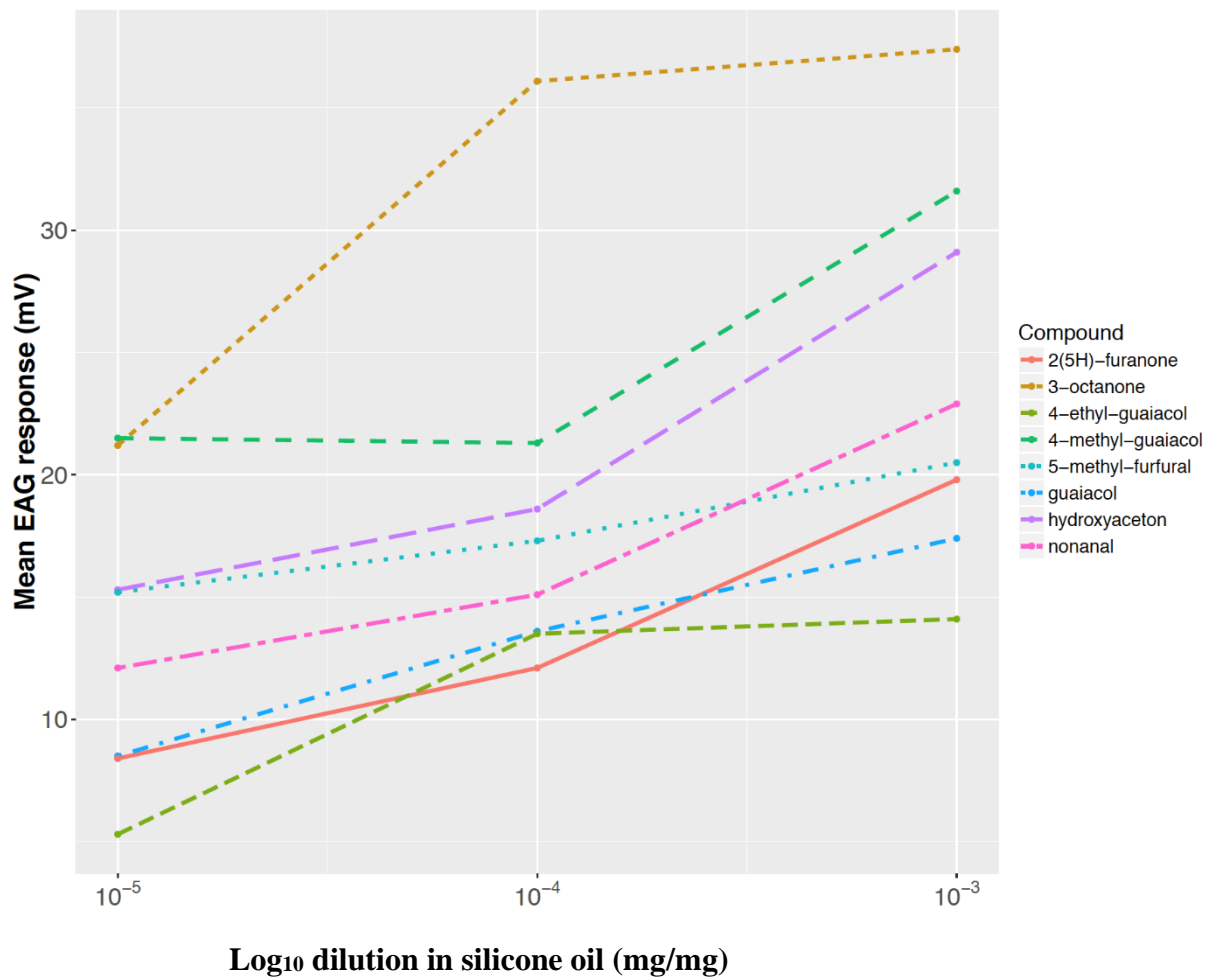

Figure 3: EAG responses of *A. candidatus* to selected fire-specific VOCs.

5.3.3 Propleural IR receptors

A low number of presumed IR sensilla were found on the lateral regions of the prothorax (the propleurae). IR receptors are distributed between the hair mechanoreceptors which exhibit bollard-like bases and a short lateral peg (Fig. 4A overview image). The outer cuticular apparatus of an IR sensillum consists of a dome-shaped hemisphere and a small apical recess (Fig. 4B image with details). The distribution and outer shape of IR sensilla in *A. candidatus* are similar to the IR sensilla found in other pyrophilous *Aradus* species (Schmitz et al., 2010).

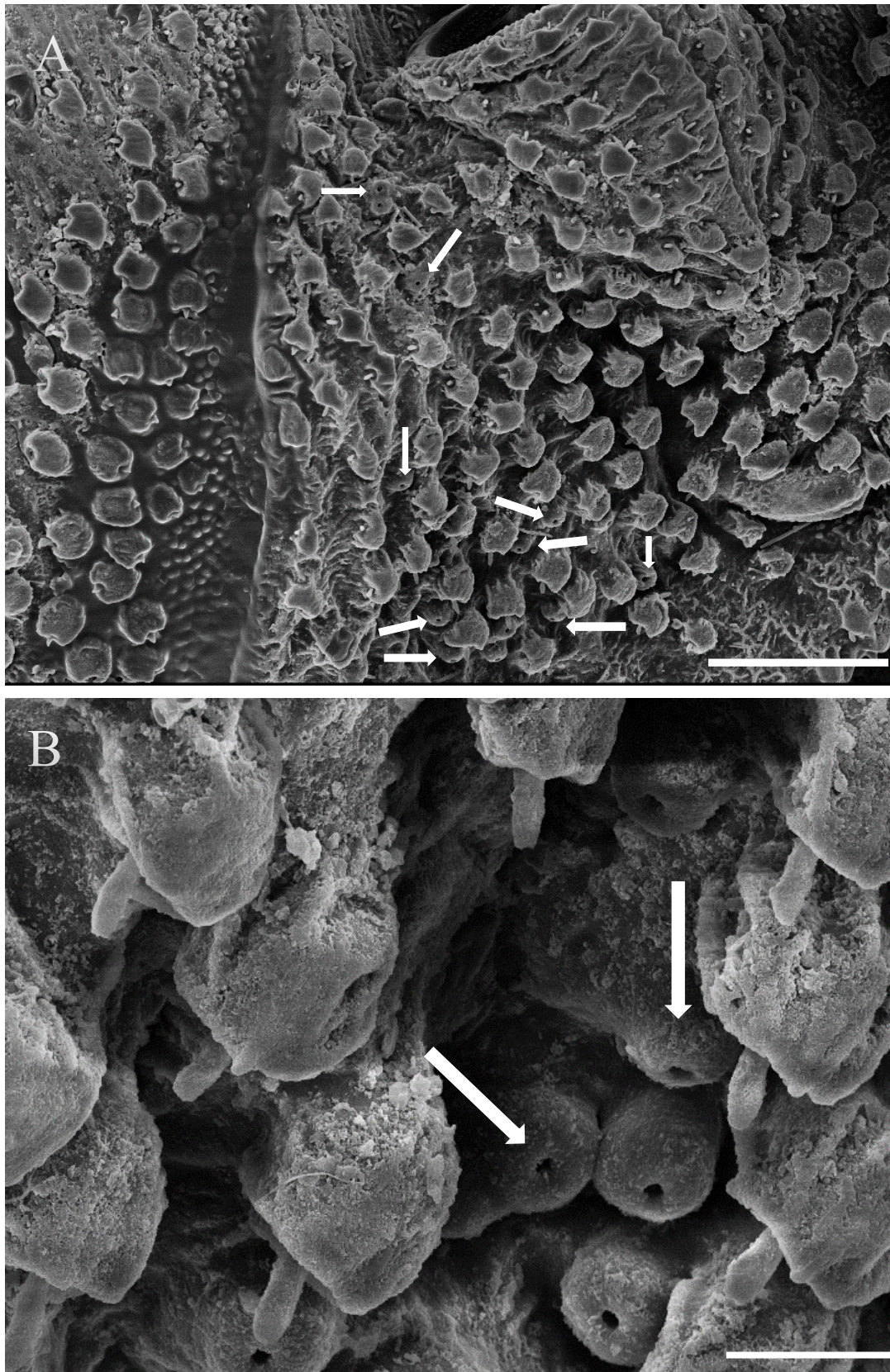

Figure 4: (A) View of the propleural region of *Aradus candidatus* with some IR sensilla on the area directly posterior to the base of the left prothoracic leg, bar 100 μm . (B) grouped IR sensilla surrounded by mechanoreceptors. Bar 20 μm . White arrows mark some IR sensilla.

5.4 Discussion

A major aspect of this study was to examine the presumed pyrophilous behavior and the corresponding sensory adaptations of *A. candidatus* in Vietnam. EAG responses of isolated antennae and field traps set up on freshly burnt areas were used to find evidence for a pyrophilous biology. Moreover, *A. candidatus* obviously possesses IR sensilla in the propleural region. Altogether, this demonstrates the highly pyrophilous behavior of *A. candidatus*.

5.4.1 Attraction to a mixture of fire-specific VOCs

We were able to confirm that the fire-specific VOCs hydroxyacetone, 5-methylfurfural, guaiacol, 4-methylguaiacol, and 4-ethylguaiacol can be perceived dose-dependent. The attraction of *A. candidatus* towards these compounds is confirmed by our field studies with traps baited with mixtures of fire-specific VOCs. Also other pyrophilous insects are attracted by the tested VOCs, e. g. *Melanophila cuspidata* (except for 4-ethyl-guaiacol) and *Acanthocnemus nigricans* (except for guaiacol), which has been confirmed by lab and field tests in previous studies (Tab. 1). Moreover, it was demonstrated that the pyrophilous beetle *Merimna atrata* perceived 5-methylfurfural, guaiacol and 4-ethylguaiacol as shown by (Paczkowski, 2013) (Tab. 1). The EAG response of the pyrophilous beetle *Melanophila accuminata* to guaiacol was investigated by (Schütz et al., 1999) (Tab. 1).

Table 1: Response of pyrophilous insect species to different compounds according to the literature. References: A: Paczkowski et al., 2013; B: Paczkowski 2013; C: Paczkowski et al., 2014; D: Schütz et al., 1999. GC-MS/EAD: gas chromatography - mass spectrometry/ electroantennographic detector. EAG: electroantennography.

Compound	<i>Melanophila accuminata</i>	<i>Melanophila cuspidata</i>	<i>Merimna atrata</i>	<i>Acanthocnemus nigricans</i>
Hydroxyacetone		A		C
Furfural		A	B	
2-Furanmethanol		A	B	
5-methylfurfural		A	B	C
Guaiacol	D	A	B	
4-Methylguaiacol		A		C
4-Ethylguaiacol			B	C
Syringol	D			
Lab test	EAG (B)	GC-MS/EAD, EAG (A), Behavior confirmation using olfactometer (A)	EAG (B)	Olfactometer (A)
Field test				Behavior confirmation using traps baited with VOCs (C)

As shown in Tab. 1, fire-specific VOCs are not known to be perceived by all pyrophilous insects. Instead, non-pyrophilous insects may respond to the fire-specific VOCs too. For example, *Nauphoeta cinerea* use 4-methylguaiacol as a sex pheromone in male insects (Abed et al., 1993). This shows that not every insect perceiving fire-typical compounds has necessarily to be pyrophilous. This is the reason why we tested the responses of pyrophilous insects with a mixture of more than one fire-specific compound.

Our EAG results demonstrated that olfactory sensillae on the antennae of *A. candidatus* can perceive dose-response volatiles emitted by decaying material like nonanal (Paczkowski et al., 2012) and the fungal volatiles 3-octanone (Holighaus et al., 2014). Further experiments are needed to test the attraction of *A. candidatus* to these compounds. However, it is reasonable to

suppose that *A. candidatus* is attracted to 3-octanone because *A. candidatus* colonizes the burnt trees and presumably feeds on fast-growing post-fire fungi (Heliövaara and Väisänen 1983; Coulianos 1989; Wikars 1992). Therefore, the fungal volatile 3-octanone may play an important role for them to find their food sources. Additionally, for the first time, a dose-dependent EAG response of an *A. candidatus* antenna to the heated meat VOC 2(5H)-furanone (Ansorena et al., 2001; Ozkara et al., 2019) could be shown in our study. Because carnivorous pyrophilous insects might be attracted to the heated meat volatiles, therefore this compound was used.

The attraction of *A. candidatus* to our mixture of fire-specific VOCs containing 2(5H)-furanone is confirmed. Further studies are needed to reveal the behavior of *A. candidatus* toward 2(5H)-furanone.

Our results demonstrate that the number of *A. candidatus* caught by traps with a combined stimulus (i. e., VOCs and IR radiation) was higher than in traps baited only with VOCs or IR radiation. A possible explanation may be that *A. candidatus* is also equipped with IR receptors and, therefore, more fire-specific receptors are stimulated resulting in a stronger behavioral response. Additionally, it can be postulated that *A. candidatus* uses its IR receptors for a safe landing near hot spots (Schmitz et al., 2008, 2010). Furthermore, our study demonstrates an attraction of *A. candidatus* to IR radiation alone and a combined IRVOCs stimulus for the first time. The attraction of the pyrophilous beetle *A. nigricans* to several fire-specific VOCs had been previously studied by (Paczkowski et al., 2014) also demonstrating the attraction to fire-specific VOCs (Tab. 1). Although *A. nigricans* has been found in the investigated area in Vietnam (Hoang & Schütz 2015; Hoang et al., manuscript (21 pp.), Geiser 2016) we could not capture this pyrophilous species with our traps. A possible reason may be, that our VOC mixture contained some VOCs different from the mixtures used by Paczkowski *et al.* (2014) in former field tests. This may suggest that *A. nigricans* may be repelled by one of our compounds. Further experiments are needed to confirm this speculation.

5.4.2 Structure and functions of IR receptors

The presence of IR receptors on the thorax of *A. candidatus* could explain why the bug is attracted by traps emitting IR radiation (alone or in combination with VOCs). Similar thoracic IR receptors have been found in three other aradid bugs including *A. albicornis* (Schmitz et al., 2008), *A. lugubris* and *A. fuscicornis* (Schmitz et al., 2010). This suggests that IR sensilla of *A. candidatus* might have a similar function like in other pyrophilous *Aradus* species (Schmitz et al., 2008, 2010).

The ultrastructure of the IR sensilla in *A. candidatus* has not been examined in our study. However, based on the similarity of the cuticular apparatus to the IR receptors found in *Aradus albicornis* (Schmitz et al., 2008), *A. lugubris* and *A. fuscicornis* (Schmitz et al., 2010), a so-called photomechanic function can be proposed. Interestingly, the structure and function of the IR receptors in pyrophilous *Aradus* species is highly reminiscent to the IR receptors found in the thoracic pit organs of pyrophilous *Melanophila* beetles (Schmitz & Bleckmann 1997). In contrast, the IR sensilla of *Aradus* bugs are not confined in a pit but are interspersed between hair mechanoreceptors (Schmitz et al., 2008, 2010).

Some of our data gathered in the field from 2014-2017 (not published) showed that there are a number of insects with a presumed pyrophilous way of life which have been caught in small numbers in the trap baited with the combination of IR and fire-specific VOCs. This may be in line with previous studies that not all pyrophilous species have IR receptors (Schmitz et al., 2010). These pyrophilous species may use their olfactory abilities to detect the fire from far distances. Instead, IR receptors have been found in some species that have not been described as pyrophilous insects (Schmitz et al., 2010). What may drive the spectacular morphological and physiological development of hitherto non-pyrophilous insects into pyrophilous species? This question could serve as a starting-point for further studies.

5.5 Conclusion

We could demonstrate that *A. candidatus* elicits responses towards our mixtures of fire-specific VOCs including hydroxyacetone, 5-methylfurfural, guaiacol, 4-methylguaiacol, 4-ethylguaiacol what has been confirmed by EAG recordings from isolated antennae and field experiments. IR receptors are found on the propleural region of *A. candidatus*. These IR receptors have an outer shape similar to those found in other *Aradus* species like *A. albicornis*, *A. lugubris* and *A. fuscicornis*. The response of *A. candidatus* to fire-specific VOCs, the presence of IR receptors, and the species' occurrence at recently burnt habitats, immediately after fire, illustrate a highly pyrophilous behavior of this bug species.

The perception of fire-specific VOCs and IR receptors in pyrophilous insects are subject of current studies for their role in fire detection and orientation on freshly burnt areas. Further studies might reveal the interaction of different senses used to perceive fire-specific VOCs (olfaction) and IR radiation in pyrophilous insects. Moreover, the selective forces responsible for the remarkable morphological and physiological development of hitherto non-pyrophilous insects into pyrophilous species should be studied further.

5.6 Acknowledgements

We would like to thank Sara Nicke, Urike Eisenwiener, Karthi Balakrishnan and Andreas Teichmann for helpful technical support during our lab tests. We would like to thank all Vietnamese students and workers who help us during collection of field data in Vietnam. We are grateful to the forest protection department of Kon Tum province to give the permission to our work and for the transport of living insects to Germany. We are indebted to E. Heiss (Innsbruck, Austria) for the determination of *A. candidatus*. Prof. Dr. Stefan Schütz contributed his ideas to this study. The work of Thi Phuong Hoang was kindly supported by KAAD (Katholischer Akademischer Ausländer-Dienst).

5.7 References

- Abed, D., Brossut, R. and Farine, J.-P. (1993).** Evidence for sex pheromones produced by males and females in *Blatta orientalis* (Dictyoptera, Blattidae). *Journal of Chemical Ecology*, 19(12): 2831-2853.
- Ansorena, D., Gimeno, O., Astiasarán, I. and Bello, J. (2001).** Analysis of volatile compounds by GC-MS of a dry fermented sausage: chorizo de Pamplona. *Food Research International*, 34(1): 67-75.
- Azeez, A. M., Meier, D., Odermatt, J. and Willner, T. (2010).** Fast pyrolysis of African and European lignocellulosic biomasses using Py-GC/MS and fluidized bed reactor. *Energy & Fuels*, 24(3): 2078-2085.
- Branca, C., Di Blasi, C. and Elefante, R. (2006).** Devolatilization of conventional pyrolysis oils generated from biomass and cellulose. *Energy & Fuels*, 20(5): 2253-2261.
- Coulianos, C. C. (1989).** New provincial records of Swedish flatbugs and barkbugs (Hem. - Het., Aradidae) with *Aradus truncatus* FIEBER, 1861, new to Sweden. *Entomologisk tidskrift*, 110(1-2): 53-57.
- Evans, G. (1964).** Infra-red receptors in *Melanophila acuminata* DeGeer. *Nature*, 202: 211.
- Flematti, G. R., Ghisalberti, E. L., Dixon, K. W. and Trengove, R. D. (2004).** A compound from smoke that promotes seed germination. *Science*, 305(5686): 977.
- Geiser, M. (2016).** An update on the distribution of the pyrophilous beetle *Acanthocnemus nigricans* (Hope, 1845) (Coleoptera: Cleroidea: Acanthocnemidae), including new records from Laos. *Entomologica Basiliensia et Collectionis Frey*, 35: 429-432.
- Heliövaara, K. and Väisänen, R. (1983).** Environmental changes and the flat bugs (Heteroptera, Aradidae and Aneuridae). Distribution and abundance in Eastern Fennoscandia. *Annales Entomologici Fennici*, 49(4): 103-109.
- Hoang, T. P. and Schütz, S. (2015).** Pyrophilous Insects in Vietnam Central Highlands. *Mitteilungen Deutsche Gesellschaft für allgemeine und angewandte Entomologie*, 20: 133-138.
- Hoang, T. P., Holighaus, G., and Schmitz, H. (Manuscript).** Pyrophilous insects response to different stimuli. 14 pp.
- Hoang, T.P., Schmitz, H., Holighaus, G. (Manuscript).** Do volatiles released upon heating of different species of Vietnamese woody plants attract pyrophilous insects? 21 pp.
- Holighaus, G., Weißbecker, B., von Fragstein, M. and Schütz, S. (2014).** Ubiquitous eight-carbon volatiles of fungi are infochemicals for a specialist fungivore. *Chemoecology*, 24(2): 57-66.
- Kaissling, K. and Thorson, J. (1980).** Insect olfactory sensilla: structural, chemical and electrical aspects of the functional organisation. Pp. 261-282 in: Sattelle. D. B., Hall, L. M. and

Hildebrand, J. G. (eds): Receptors for neurotransmitters, hormones and pheromones in insects. Amsterdam, Elsevier/North-Holland, 310 pp.

Kreiss, E.-J., Schmitz, A. and Schmitz, H. (2005). Morphology of the prothoracic discs and associated sensilla of *Acanthocnemus nigricans* (Coleoptera, Acanthocnemidae). *Arthropod Structure and Development*, 34(4): 419-428.

Ozkara, K. T., Amanpour, A., Guclu, G., Kelebek, H. and Selli, S. (2019). GC-MS-Olfactometric differentiation of aroma-active compounds in Turkish heat-treated sausages by application of aroma extract dilution analysis. *Food Analytical Methods*, 12(3): 729-741.

Paczkowski, S., Paczkowska, M., Maibaum, F. and Schütz, S. (2012). Decaying mouse volatiles perceived by *Calliphora vicina* Rob.-Desv. *Journal of Forensic Sciences*. 57(6): 1497-1506.

Paczkowski, S. (2013). Insect olfaction as an information filter for chemo-analytical applications. PhD Thesis. Faculty of Forest Sciences and Forest Ecology. University of Göttingen, Germany.

Paczkowski, S., Paczkowska, M., Dippel, S., Schulze, N., Schütz, S., Sauerwald, T., et al. (2013). The olfaction of a fire beetle leads to new concepts for early fire warning systems. *Sensors and Actuators, B: Chemical*, 183: 273-282.

Paczkowski, S., Paczkowska, M., Dippel, S., Flematti, G. and Schütz, S. (2014). Volatile combustion products of wood attract *Acanthocnemus nigricans* (Coleoptera: Acanthocnemidae). *Journal of Insect Behaviour*, 27(2): 228-238.

Piskorz, J., Radlein, D. and Scott, D. S. (1986). On the mechanism of the rapid pyrolysis of cellulose. *Journal of Analytical and Applied Pyrolysis*, 9(2): 121-137.

Sagebiel, J. C. and Seiber, J. N. (1993). Studies on the occurrence and distribution of wood smoke marker compounds in foggy atmospheres. *Environmental Toxicology and Chemistry*, 12(5): 813-822.

Schmitz, H. and Bleckmann, H. (1997). Fine structure and physiology of the infrared receptor of beetles of the genus *Melanophila* (Coleoptera: Buprestidae). *International Journal of Insect Morphology and Embryology*, 26(3-4): 205-215.

Schmitz, H. and Bleckmann, H. (1998). The photomechanic infrared receptor for the detection of forest fires in the beetle *Melanophila acuminata* (Coleoptera: Buprestidae). *Journal of Comparative Physiology*, 182(5): 647-657.

Schmitz, A., Gebhardt, M. and Schmitz, H. (2008). Microfluidic photomechanic infrared receptors in a pyrophilous flat bug. *Naturwissenschaften*, 95(5): 455-460.

Schmitz, A., Schätzel, H. and Schmitz, M. (2010). Distribution and functional morphology of photomechanic infrared sensilla in flat bugs of the genus *Aradus* (Heteroptera, Aradidae). *Arthropod structure & development* 39(1): 17-25.

Schütz, S., Weißbecker, B., Hummel, H. E., Schöning, M. J., Riemer, A., Kordos, P., et al., (1997a). Field effect transistor-insect antenna junction. *Naturwissenschaften*, 84: 86-88.

Schütz, S., Weißbecker, B., Klein, A. and Hummel, H. E. (1997b). Host plant selection of the Colorado potato beetle as influenced by damage induced volatiles of the potato plant. *Naturwissenschaften*, 84: 212-217.

Schütz, S., Weißbecker, B., Hummel, H. E., Apel, K.-H., Schmitz, H. and Bleckmann, H. (1999). Insect antenna as a smoke detector. *Nature*, 398: 298-299.

Vondran, T., Apel, K.-H. and Schmitz, H. (1995). The infrared receptor of *Melanophila acuminata* De Geer (Coleoptera: Buprestidae): ultrastructural study of a unique insect thermoreceptor and its possible descent from a hair mechanoreceptor. *Tissue and Cell*, 27(6): 645-658.

Weißbecker, B., Holighaus, G. and Schütz, S. (2004). Gas chromatography with mass spectrometric and electroantennographic detection, analysis of wood odorants by direct coupling of insect olfaction and mass spectrometry. *Journal of Chromatography A*, 1056(1-2): 209-216.

Wikars, L.O. (1992). Skogsbränder och insekter. *Entomologisk Tidskrift*, 133(4): 1-11.

Wikars, L.O. (1997). Effects of forest fire and the ecology of fire-adapted insects. Comprehensive Summaries of Uppsala Dissertations from the Faculty of Science and Technology 272. *Acta Universitatis Upsaliensis*, Uppsala, Sweden, 272 pp.

Chapter 6

Adaptation of pyrophilous insects to burnt habitat:

General discussion and conclusion

6.1 Presence of pyrophilous insects in Vietnam

By hand collection in the smoldering logs, we could collect hundreds of specimens of several beetle species. The question arises whether those are pyrophilous? Pyrophilous species are distributed worldwide, for example in Europe, North America, and Australia. We surprisingly caught *Acanthocnemus nigricans* (Acanthocnemidae) a pyrophilous beetle that was thought to be restricted to the Australian continent in our study area in Vietnam (chapter 2 and 3). This is in line with a recent study of the presence and distribution of *A. nigricans* in Southeast Asia (Geiser 2016) that speculates about the benefits of slash-and-burn agricultural practice for pyrophilous species. While for Vietnam museal records of *A. nigricans* trace back to the years 1909 and 1912 (Geiser 2016), surprisingly, this species has not yet been caught by traps baited with a mixture of fire-specific VOCs or by traps emitting IR radiation. However, this species is known to be attracted by traps baited with VOCs in Australia (Paczkowski et al., 2013), and it is also known that it possesses IR receptors (Schmitz et al., 2002).

For the first time, the pyrophilous nature of the flat bug species *Aradus candidatus* is confirmed through this study (chapter 5). Like other pyrophilous insect species, *A. candidatus* immediately approaches open flames (own observation). Moreover, the EAG dose-response relationships indicates an olfactory response of *A. candidatus* to several fire-specific VOCs (chapter 5), including hydroxyacetone, guaiacol, 5-methylfurfural, 4 methylguaiacol, 4-ethylguaiacol, and 2(5H)-furanone. Field experiments confirmed that *A. candidatus* is attracted by traps baited with a mixture of such fire-specific VOCs. Another factor that contributed to conclusively demonstrate the pyrophilous nature of *A. candidatus* is the presence of IR receptors on the thorax. This is especially supported by the observation that *A. candidatus* was lured to traps emitting IR radiation (alone or in combination with VOCs) (chapter 5). While the attractiveness of IR radiation has never been tested, it has been demonstrated that other pyrophilous insect species such as *A. nigricans*, *Merimna atrata* and *Melanophila acuminata* showed the same behavior towards smoldering logs and fire-specific VOCs (Paczkowski et al., 2013). Likewise, these pyrophilous insect species also possess IR receptors (Schmitz et al., 2000, 2002, 2007). The observed IR receptors in *A. candidatus* are similar to the thoracic IR receptors in three other

aradid bugs including *A. albicornis* (Schmitz et al., 2008), *A. lugubris* and *A. fuscicornis* (Schmitz et al., 2010), supporting their proposed function and a pyrophilous lifestyle.

6.2 Diversity of VOCs and insects in recently burnt habitats (chapter 3)

Volatile organic compounds play an important role for basic needs of insects such as mating (Pelosi & Maida 1995), oviposition (Verheggen et al., 2008), finding food resources (Beck et al., 2012), or interspecific communication (Reyes-Vidal 2009). Many volatile compounds are emitted from different sources, while sharing similar chemical bases such as fundamental metabolisms (Bruce et al., 2005; Schoonhoven et al., 2005; Kües & Navarro-Gonzales 2009). Volatile organic compound emissions and degradation products of wood constituents differ between and among tree species, and even within the same tree (Kollmann 1982; Hyttinen et al., 2010). Burning adds another source of variability, that results in a diversity of burnt wood VOCs and also typical species-specific chemical profiles (chapter 3). Burnt wood VOCs are, therefore, classified according to species and temperature in chapter 3 as 1), a group of common VOCs released by all four woody species. 2), a group of VOCs released only at certain temperatures (at 250°C or 300°C), and 3), a group of VOCs released only by a specific tree species. Volatile organic compounds play an important role for pyrophilous insects to orient themselves toward fires (Schütz et al., 1999). Therefore, the diversity of insects in burnt habitats might be associated with the diversity of burnt wood VOCs. This specificity is emphasized by the attraction responses of insects on burnt habitats to the VOC-baited traps described in chapter 3. According to the literature, guaiacol and 5-methylfurfural are perceived by several pyrophilous insect species like the beetles *Melanophila cuspidata*, *Merimna atrata* and *A. nigricans* (Schütz et al., 1999; Paczkowski et al., 2013, 2014). Guaiacol is also perceived by *Melanophila acuminata* (Paczkowski et al., 2013). Furthermore, insect species in this study were also attracted by a VOC mixture containing guaiacol (chapters 3, 4 and 5). This suggests that guaiacol and 5-methylfurfural may play a role as general VOCs for insects to detect and fly towards burnt habitats. Therefore, insect species attracted to our mixture containing guaiacol and 5-methylfurfural might be generalistic pyrophilous insects. In contrast, hydroxyacetone and 4-ethyl-guaiacol are only perceived by certain species. For example, *M. cuspidata* and *A. nigricans* perceive hydroxyacetone (Paczkowski et al., 2013, 2014), while *M. atrata* and *A. nigricans* perceive 4-ethylguaiacol (Paczkowski et al., 2013, 2014). Although released by burnt wood (chapter 3), hydroxyacetone is found in the fermentation product of wood sap (Ômura et al., 2000). Guaiacol is also produced by deadwood or maybe by microorganisms (Holighaus 2006). Similarly, 5-methylfurfural is a fermentation/vinegar related compounds used to lure the

non-pyrophilous fruit fly *Drosophila melanogaster* (Becher et al., 2010). As it has not been known to be emitted by other sources, 4-ethyl-guaiacol is considered as a true smoke volatile, which can be also perceived by human olfaction. This compound could function as fire-specific marker for specialized insects and govern the burnt host-tree selection. Other insects may benefit from increased microbial activity and an increased amount of deadwood in burnt areas, characterized by the former compounds (Holighaus 2006). The perception of burnt wood VOCs by a variety of insect species in burnt habitat suggests a link between the chemo-diversity of plant combustion products and the biodiversity of insects. The diversity of insects found in burnt habitats may also be related to their feeding habits: several saproxylic fungivorous insect species were attracted by our mixture of fire-specific VOCs. As expected, these taxa (*Cartodere* sp. (Lathridiidae) and *Litargus species* (Mycetophagidae) (Cocciufa et al., 2014) (chapters 3 and 4)) might be attracted to guaiacol because this compound is also produced by deadwood (Holighaus 2006). Hydroxyacetone is found in the fermentation products of wood sap (Ômura et al., 2000). Therefore, this compound alone is not fire-specific. Hence, the pyrophilous behavior of insects in burnt habitat based on their VOCs perception should be interpreted with care.

6.3 Are burnt wood VOCs a cue for pyrophilous insects to find burnt habitat?

The attraction response of the pyrophilous flat bug *A. candidatus* to burnt wood VOCs such as hydroxyacetone, 5-methylfurfural, guaiacol and 4-ethylguaiacol has been emphasized (chapter 5). There is strong evidence that pyrophilous insects like *Merimna atrata* and *A. nigricans* (Paczkowski et al., 2013, 2014), as well as *Melanophila cuspidata* (Schütz et al., 1999; Paczkowski et al., 2013, 2014) showed attraction responses to these VOCs. VOCs also play an important role in host-finding in herbivorous insects (Bernays & Chapman 1994), saproxylic and fungivorous insects (Holighaus 2012), or also in pyrophilous insects (Schütz et al., 1999). There are evidences that VOCs released during the thermal degradation of cellulose and lignin in this study, come from different sources as well. For example, these so-called fire-specific VOCs can also be perceived by insect species with non-pyrophilous behavior (Bohbot & Dickens 2012; Holighaus 2012). Moreover, some of these VOCs are known to be released by other sources such as guaiacol (Holighaus 2006), hydroxyacetone (Ômura et al., 2000), and 5-methylfurfural (Becher et al., 2010, for more detail see chapter 6.2). Therefore, not all insects which can perceive these single burnt wood VOCs are necessarily pyrophilous. This is also the reason why we used the traps baited with a mixture of fire-specific VOCs. In order to conclude the behavior of insects in burnt habitats, the sensory capabilities of potentially pyrophilous

insects should be investigated by EAG recordings and the presence of IR receptors should be confirmed.

6.4 Is infrared radiation a cue for pyrophilous insects to find burnt habitats? (Chapter 4)

Infrared receptors are found in some pyrophilous insects. It has been speculated that receptors are used for detecting forest fires. The pyrophilous bug *A. candidatus* approaches open flames (own observation) and possesses IR receptors (chapter 5). There is strong evidence that buprestid beetles of the genus *Melanophila* approach forest fires (Champion 1909; Nicholson 1919; Linsley 1943; Evans 1962, 1964; Apel 1988, 1989). These beetles perceive IR radiation with their thoracic IR receptors (Evans 1964; Schmitz et al., 2000). The Australian fire beetle *M. atrata* is known to detect fires from far distances (Poulton 1915; Schmitz et al., 2002). This species has two pairs of IR organs on the ventrolateral sides of the abdomen (Schmitz et al., 2000). However, IR receptors are obviously only used for the orientation on freshly burnt areas (Hinz et al. 2018). The “Little Ash Beetle” *A. nigricans* (family Acanthocnemidae) approaches forest fires (Champion 1922). *Acanthocnemus nigricans* possesses IR receptors on the prothorax (Schmitz et al., 2002). Several species of flat bugs (Heteroptera: Aradidae) are found frequently at burnt sites (Hjältén et al., 2006) whereas *Aradus* species are often attracted by the open fire, hot ashes or smoke, such as *A. albicornis* and *A. lugubris* (Wikars 1997). IR receptors have been found in *A. albicornis* (Schmitz et al., 2008), and also in *A. lugubris*, *A. flavicornis*, and *A. fuscicornis* (Schmitz et al., 2010).

On the other hand, several insect species were attracted only to traps having an IR source in this study (chapter 4). They may use only IR receptors to detect fires (Schmitz et al., 2002; Kreiss et al., 2005, 2007; Heisswolf et al., 2007; Paczkowski et al., 2014). Therefore, IR may play an important role for these insect species to find forest fires. If IR receptors are considered to have evolved only in the context of forest fires, we conclude that insects attracted by IR traps alone can be considered as pyrophilous. However, random landing, while sensing the warm surface of the trap might also contribute to the results and should be considered as an alternative explanation for insects that might not be pyrophilous but prefer warm surfaces. A search for efficient thermoreceptors, therefore, may be reasonable.

6.5 Attraction of insects in recently burnt habitats to VOCs, infrared stimuli or both stimuli

For the first time, the preference of insects in recently burnt habitats for different fire-relevant stimuli was tested (chapters 4 and 5). Compared to control traps and exposure of all types of traps in unburnt forest areas, our numerous trap catches from recently burnt habitats demonstrate that our newly developed traps emitting either IR radiation, fire-specific VOCs or a combination of both, effectively attracted insects likely having a pyrophilous lifestyle. In detail, differences in their attraction according to different fire-relevant stimuli became apparent. This suggests that IR radiation alone might be capable of attracting pyrophilous insects, while fire-specific VOCs or their combination with IR radiation seems to play an important role for their attraction to burnt areas. Similarly, the number of insect species occurring in VOC traps alone exceeds that of those that were found in IR traps only. This might be also due to a repellent effect of the IR radiation to certain species that are otherwise attracted to fire-specific VOCs. Due to a very limited number of custom-made traps capable of emitting IR radiation, the results should be interpreted cautiously. However, our findings might indicate that certain species of pyrophilous insects rely either on IR or on VOC stimuli, but might not be susceptible to both stimuli, while the majority combines both information. There is also no clear tendency that IR radiation increases or decreases the attractivity of VOCs alone.

In the special case of *A. candidatus* (chapter 5), no clear tendency preference towards VOCs or IR stimuli has been found, probably due to low catch numbers. More detailed explanations are presented in chapter 6.1.

6.6 Is multimodal sensing important for the behavior of pyrophilous insects? Hints from *A. candidatus* (chapter 5)

It has been postulated that *A. candidatus* uses different cues (olfactory and IR) for fire and heat detection (chapter 5). As some pyrophilous insects typically show strong preferences towards open flames, *A. candidatus* also shows an attraction response to both burnt wood VOCs and IR radiation. The number of *A. candidatus* individuals caught by traps with a combined stimulus was slightly higher than in traps baited only with VOCs or IR radiation. A possible explanation may be that *A. candidatus* integrates the information of IR receptors and fire-specific olfactory receptors, resulting in a stronger behavioral response. However, although less *A. candidatus* were trapped in VOC traps than in the traps combining IR and VOCs, it still might be true that *A. candidatus* uses its IR receptors for a safe landing near hot spots (Schmitz et al., 2008, 2010). At least the presence of IR radiation as provided in our traps does not reduce the attractivity of

the fire-specific VOCs. Thus, the testability of exact landing behavior might not be possible in our traps and needs more sophisticated behavioral studies and observations. In contrast, *A. nigricans* (chapter 3) has been found to show a strong preference for approaching smoldering logs (Champion 1922) and possesses IR receptors on the prothorax (Schmitz et al., 2002). However, these pyrophilous insect species were not attracted by our traps. There were a few insect species attracted only by the traps combining IR and VOCs, but not by other traps (chapter 4). This might disprove the idea that traps combining IR and VOCs would also attract those species found in either VOC traps or IR traps. Further studies should be conducted to clarify this situation.

6.7 Conclusion

This work has demonstrated the presence of two pyrophilous insect species in Vietnam: *Aradus candidatus* and *Acanthocnemus nigricans*. Associated with the diversity of burnt wood VOCs, different insect species were found in burnt habitats, including herbivores, carnivores and fungivores. It has been emphasized that there are various insect species which colonize recently burnt habitats in Vietnam. However, they are not necessarily pyrophilous. Similarly, the confirmed attraction of insects to burnt wood VOCs (chapter 3 and 4) could not let us finally conclude about a fire-loving biology of these species, because some of the fire-specific VOCs tested in our study are also emitted by other sources (Bruce et al., 2005; Schoonhoven et al., 2005; Kües & Navarro-Gonzales 2009). Moreover, certain fire-specific volatiles (e.g., guaiacol) are also perceived by other insect species which do not show pyrophilous behavior (Bohbot & Dickens 2012; Holighaus 2012). Therefore, the combination of both VOCs and IR provided the strongest evidence for a pyrophilous biology in some insect species. However, it should be considered that the attraction responses towards burnt wood VOCs and IR radiation observed in pyrophilous insects vary between insect species. They are found in the case of *A. candidatus* and the well-known pyrophilous beetle *A. nigricans*. The pyrophilous flat bug species showed a strongly pyrophilous behavior, appearing immediately at burnt sites with a significant attraction response towards a mixture of burnt wood VOCs and IR radiation, as well as by a combination of both. In addition, IR receptors of *A. candidatus* were found on the thorax. In contrast, *A. nigricans* is attracted to smoldering logs and possesses IR receptors (Schmitz et al., 2002), showing EAG responses to burnt wood VOCs (Paczkowski et al., 2013). However, no individual of *A. nigricans* was attracted by any of our traps.

This pioneer study on the adaptation of pyrophilous insects in burnt habitats in Vietnam brought out manifold results about the relevance of odor signals, IR reception, and attraction behavior

of pyrophilous insects of Vietnam. Consequently, new trendsetting ideas on the biology and ecological function of pyrophilous insects and other insect species recolonizing burnt habitats as well as new points of view regarding the impact of different forest fire management regimes on pyrophilous species could follow. These ideas are to be addressed in future research.

6.8 References

- Apel, K.H. (1988).** Befallsverteilung von *Melanophila acuminata* DEG., *Phaenops cyanea* F. und *Ph. formnneki* JACOB (Col., Buprestidae) auf Waldbrandflächen. Beiträge für Forstwirtschaft, 22:45-48.
- Apel, K.H. (1989).** Zur Verbreitung von *Melanophilu acuminata* DEG. (Col., Buprestidae). Entomol. Nach. Ber. 33, 278-280.
- Becher, P. G., Bengtsson, M., Hansson, B. S. and Witzgall, P. (2010).** Flying the fly: long-range flight behavior of *Drosophila melanogaster* to attractive odors. Journal of Chemical Ecology, 36(6): 599-607.
- Beck, J. J., Mahoney, N. E., Cook, D. and Gee, W. S. (2012).** Generation of the volatile spiroketals conophthorin and chalcogran by fungal spores on polyunsaturated fatty acids common to almonds and pistachios. Journal of Agricultural and Food Chemistry, 60(48): 11869-11876.
- Bohbot, J. D. and Dickens, J. C. (2012).** Odorant receptor modulation: Ternary paradigm for mode of action of insect repellents. Neuropharmacology, 62(5-6): 2086–2095.
- Bruce, T. J. A., Wadhams, L. J. and Woodcock, C. M. (2005).** Insect host location: a volatile situation. Trends in Plant Science, 10(6): 269-274.
- Champion, G. C. (1909).** A buprestid and other Coleoptera on pine injured by “heath fires” in N.W. Surrey. Entomologist's Monthly Magazine, 45, 247-250.
- Champion, G. (1922).** The Geographical Distribution and Synonymy of the Dasytid-Beetle *Acanthocnemus nigricans* Hope (=ciliatus Perris). Entomologist's Monthly Magazine, 58(4): 77-79.
- Cocciufa, C., Gerth, W., Luiselli, L., De Zan, L. R., Cerretti, P. and Carpaneto, G. M (2014).** Survey of saproxylic beetle assemblage sat different forest plots in central Italy. Bulletin of Insectology, 67(2): 295-306.
- Evans, W. G. (1962).** Notes on the biology and dispersal of *Melanophilu* (Coleoptera: Buprestidae). Pan-Pacific Entomology, 38: 59-62.
- Evans, G. (1964).** Infra-red receptors in *Melanophila acuminata* DeGeer. Nature, 202: 211.
- Geiser, M. (2016).** An update on the distribution of the pyrophilous beetle *Acanthocnemus nigricans* (Hope, 1845) (Coleoptera: Cleroidea: Acanthocnemidae), including new records from Laos. Entomologica Basiliensia et Collectionis Frey, 35: 429-432.
- Heisswolf, A., Gabler, D., Obermaier, E. and Muller, C. (2007).** Olfactory versus contact cues in host plant recognition of a monophagous chrysomelid beetle. Journal of Insect Behavior, 20: 247-266.
- Hinz, M., Klein, A., Schmitz, A. and Schmitz, H. (2018).** The impact of infrared radiation in flight control in the Australian “firebeetle” *Merimna atrata*. PLoS One, 13(2): e0192865.

Hjältén, J., Atlegrim, O., Sandström, F., Pettersson, R. and Rexstad, E.A. (2006). Occurrence of flat bugs (Heteroptera: Aradidae) in burned and unburned forests. *Entomologica Fennica*, 17: 130-135.

Holighaus, G. and Schütz, S. (2006). Odours of wood decay as semiochemicals for *Trypodendron domesticum* L. (Col., Scolytidae). *Mitteilungen Deutsche Gesellschaft für allgemeine und angewandte Entomologie*, 15: 161-165.

Holighaus, G. (2012). Odour signals relevant to beetles in deadwood habitats. PhD Thesis. Faculty of Forest Sciences and Forest Ecology. University of Göttingen, Germany.

Hyttinen, M., Masalin-Weijo, M., Kalliokoski, P. and Pasanen, P. (2010). Comparison of VOC emissions between air-dried and heat-treated Norway spruce (*Picea abies*), Scots pine (*Pinus sylvestris*) and European aspen (*Populus tremula*) wood. *Atmospheric Environment*, 44(38): 5028-5033.

Kollmann, F. (1982). Technologie des Holzes und der Holzwerkstoffe, Anatomie und Pathologie, Chemie, Physik, Elastizität und Festigkeit. Springer, Berlin, Germany, 1051 pp.

Kreiss, E.-J., Schmitz, A. and Schmitz, H. (2005). Morphology of the prothoracic discs and associated sensilla of *Acanthocnemus nigricans* (Coleoptera, Acanthocnemidae). *Arthropod Structure and Development*, 34(4): 419-428.

Kreiss, E., Schmitz, H. and Gebhardt, M. (2007). Electrophysiological characterization of the infrared organ of the Australian "little ash beetle" *Acanthocnemus nigricans* (Coleoptera, Acanthocnemidae). *Journal of Comparative Physiology*, 193(7): 729-739.

Kües, U. and Navarro-González, M. (2009). Communication of Fungi on Individual, Species, Kingdom, and Above Kingdom Levels. Pp. 79-106 in: Anke, T., and Weber, D. (eds): *The Mycota XV. Physiology and genetics*. Springer, Berlin Heidelberg New York.

Linsley, G. E. (1943). Attraction of *Melanophila* beetles by fire and smoke. *Journal of Economic Entomology*, 36(2): 341-342.

Nicholson, G. W. (1919). *Melanophila acuminata* De Geer at a fire in June. *Entomologist's Monthly Magazine*, 55: 156-157.

Ômura, H., Honda, K. and Hayashi, N. (2000). Identification of feeding attractants in oak sap for adults of two nymphalid butterflies, *Kaniska canace* and *Vanessa indica*. *Physiological Entomology*, 25(3): 281-287.

Paczkowski, S., Paczkowska, M., Dippel, S., Schulze, N., Schütz, S., Sauerwald, T., et al. (2013). The olfaction of a fire beetle leads to new concepts for early fire warning systems. *Sensors and Actuators, B: Chemical*, 183: 273-282.

Paczkowski, S., Paczkowska, M., Dippel, S., Flematti, G. and Schütz, S. (2014). Volatile Combustion Products of Wood Attract *Acanthocnemus nigricans* (Coleoptera: Acanthocnemidae). *Journal of Insect Behaviour*, 27(2): 228-238.

- Pelosi, P. and Maida, R. (1995).** Odorant-binding proteins in insects. *Comparative Biochemistry and Physiology B-Biochemistry & Molecular Biology*, 111(3): 503-514.
- Poulton, E. B. (1915).** The habits of the Australian buprestid “fire beetle,” *Merimna atrata* Lap., et Gory. *Transactions of the Entomological Society of London*. Part 1: iii-iV.
- Reyes-Vidal, Y. and De la Torre, M. (2009).** Emission, perception, and behavioral responses of entomopathogenic nematodes to semiochemicals. *Nematropica*, 39(2): 213-223.
- Schmitz, H., Bleckmann, H. and Schmitz, A. (2000).** A new type of infrared organ in the Australian “fire-beetle” *Merimna atrata* (Coleoptera: Buprestidae). *Naturwissenschaften*, 87(12): 542–545.
- Schmitz, H., Schmitz, A., Trenner, S. and Bleckmann, H. (2002).** A new type of insect infrared organ of low thermal mass. *Naturwissenschaften*, 89(5): 226-229.
- Schmitz, A., Sehrbrock, A. and Schmitz, H. (2007).** The analysis of the mechanosensory origin of the infrared sensilla in *Melanophila acuminata* (Coleoptera; Buprestidae) adduces new insight into the transduction mechanism. *Arthropod Structure and Development*, 36(3), 291–303.
- Schmitz, A., Gebhardt, M. and Schmitz, H. (2008).** Microfluidic photomechanic infrared receptors in a pyrophilous flat bug. *Naturwissenschaften*, 95(5): 455-60.
- Schmitz, A., Schätzel, H. and Schmitz, M. (2010).** Distribution and functional morphology of photomechanic infrared sensilla in flat bugs of the genus *Aradus* (Heteroptera, Aradidae). *Arthropod structure & development* 39(1): 17-25.
- Schoonhoven, L. M., Van Loon, J. J. A. and Dicke, M. (2005).** *Insect-plant biology*. Oxford University Press, Oxford, United Kingdom, 421 pp.
- Schütz, S., Weißbecker, B., Hummel, H. E., Apel, K.-H., Schmitz, H. and Bleckmann, H. (1999).** Insect antenna as a smoke detector. *Nature*, 398: 298-299.
- Verheggen, F. J., Arnaud, L., Bartram, S., Gohy, M. and Haubruge, E. (2008).** Aphid and plant volatiles induce oviposition in an aphidophagous hoverfly. *Journal of Chemical Ecology*. 34(3): 301-307.
- Wikars, L.O. (1997).** Effects of forest fire and the ecology of fire-adapted insects. *Comprehensive Summaries of Uppsala Dissertations from the Faculty of Science and Technology* 272. Acta Universitatis Upsaliensis, Uppsala, Sweden, 272 pp.

Publications by T. P. Hoang

Refereed publication:

Hoang, T. P., and Schütz, S. (2015). Pyrophilous Insects in Vietnam Central Highlands. *Mitteilungen Deutsche Gesellschaft für allgemeine und angewandte Entomologie*, 20: 133-138.

Manuscripts prepared for publication:

Hoang, T. P., Schmitz, H., Holighaus, G. (Manuscript). Do volatiles released upon heating of different species of Vietnamese woody plants attract pyrophilous insects? 21 pp.

Hoang, T. P., Holighaus, G., and Schmitz, H. (Manuscript). Pyrophilous insects response to different stimuli. 14 pp.

Hoang, T. P., Holighaus, G., and Schmitz, H. (Manuscript). Behavioral and sensory adaptations of the flat bug *Aradus candidatus* to post-fire habitats in Vietnam. 19pp.

Annex

Table S1: Emission rates ($\mu\text{g/g}\cdot\text{s}$) in furfural-equivalents (furanes, pyrans, esters, ketones, anhydrosugars), guaiacol-equivalents (phenols, guaiacols, syringols), and α -humulene-equivalents (naphthalenes, terpenoids). The values of the emission rate are displayed in the following order: minima, lower quartile, median, upper quartile, minima, and maxima. A minimum above 0 ($\mu\text{g/g}\cdot\text{s}$) shows a reliable emission of the compound at this temperature step.

The statistical significantly different results were obtained in column 1:

- # Significant difference between WSP1 and WSP2 at (\downarrow)250°C or at (\uparrow)300°C or at both temperatures ($\downarrow\uparrow$);
- † Significant difference between WSP1 and WSP3 at (\downarrow)250°C or at (\uparrow)300°C or at both temperatures ($\downarrow\uparrow$);
- ∅ Significant difference between WSP1 and WSP4 at (\downarrow)250°C or at (\uparrow)300°C or at both temperatures ($\downarrow\uparrow$);
- ¥ Significant difference between WSP2 and WSP3 at (\downarrow)250°C or at (\uparrow)300°C or at both temperatures ($\downarrow\uparrow$);
- ¢ Significant difference between WSP2 and WSP4 at (\downarrow)250°C or at (\uparrow)300°C or at both temperatures ($\downarrow\uparrow$);
- ⊠ Significant difference between WSP3 and WSP4 at (\downarrow)250°C or at (\uparrow)300°C or at both temperatures ($\downarrow\uparrow$).

Each volatile was characterized by three primary constituents: polysaccharide, lignin, and extractive. ST= sesquiterpene.

^{a,b,c}. Identification confirmed by a. Co-elution of authentic standard, b. LRI /HP-5MS +LRI /INNOWAX+ mass spectrum library, c. LRI and/or Mass spectrum library.

ID	Compound	LRI HP-5MS measured	Functional group	LRI HP-5MS literature	LRI INNOWAX literature	Emission rates ($\mu\text{g/g}\cdot\text{s}$)								Products of	Authentic standard factors		
						250°C				300°C					CAS No.	Compa- ny	Pu- rity
						WSP1	WSP2	WSP3	WSP4	WSP1	WSP2	WSP3	WSP4				
C1 ^b #†∅↑	hydroxyacetone	< 800	Ketone	< 800		0.1, 0.2, 0.2, 0.2, 0.2	0.2, 0.2, 0.2, 0.3, 0.3	0.1, 0.1, 0.1, 0.1, 0.1	0.1, 0.1, 0.1, 0.1	0.2, 0.2, 0.3, 0.9, 1.2	0.5, 0.5, 2.2, 2.5, 5.1	5.4, 6.5, 7.7, 8.9, 11.1	4.8, 5.9, 8.3, 8.4, 9.5	Cellulose + Hemi-cellulose			
C2 ^a †↑	3-furaldehyde	838	Furane	837* (801- 837)	1441*	0, 0, 0, 0.1, 0.2	0, 0, 0, 0.1, 0.2	0	0	0, 0, 0, 0.1, 0.3	0.1	0, 1.3, 2.4, 2.4, 7.2	0	Pentosan	498- 60-2	Aldrich	97%
C3 ^a ∅¢↓	furfural	853	Furane	860***	1482***	22, 30.1, 30.8, 34.3, 42.8	36.3, 36.5, 46.5, 55.7, 71.6	8.5, 15, 26.8, 44.2, 62.3	308.6, 318, 373.6, 470.4, 841.1	0.1, 6.1, 14.9, 27.7, 37.2	0.3, 0.3, 30.7, 37.3, 72.3	12.1, 22.2, 31.1, 36.7, 49.8	218, 368.4, 408.7, 427.4, 961	Pentosan	98-01- 1	Acros	99%
C4 ^a #¥↓ †¥↑	2-furanmethanol	873	Furane	877***	1564	0.8, 1.4, 1.6, 1.6, 2.7	4.2, 4.4, 6.1, 25.7, 44.8	0	128.4, 217, 399.3, 444.9, 852.3	0.5, 1.3, 1.4, 1.5, 2.8	9.7, 14.1, 19.1, 27, 38	0	0, 44.5, 63.4, 214, 567.9	Cellulose	98-00- 0	Merck	99%

ID	Compound	LRI HP-5MS measured	Functional group	LRI HP-5MS literature	LRI INNOWAX literature	Emission rates (µg/g)								Products of	Authentic standard factors		
						250°C				300°C					CAS No.	Compa- ny	Pu- rity
						WSP1	WSP2	WSP3	WSP4	WSP1	WSP2	WSP3	WSP4				
C5 ^a ↕↓	1-(acetyloxy)-2-propanone	887	Ester	867** (821-867)	1476 ** (1464-1484)	0	8.2, 8.6, 13.4, 24.2, 67	0	0	0	0, 0, 29.5, 48.6, 116	0	0	Cellulose	592-20-1	Aldrich	98%
C6 ^b ↕↓	2-cyclopentene-1,4-dione	898	Ketone	882** (836-911)	1191** (1535-1605)	0, 2.7, 4.8, 9, 24.6	7.5, 16.4, 17.7, 18.4, 47.3	3.9, 10.4, 10.9, 19.3, 61.9	0, 1.3, 2.8, 5.6, 6.5	0, 9.5, 16.3, 20.8, 24.6	0, 1.2, 62.4, 78, 210.6	11.2, 12.5, 18.7, 22.3, 116.4	1.9, 7.5, 7.7, 9.9, 10.7	Cellulose			
C7 ^b	1-(2-furanyl)-ethanone	924	Furane	892* (881-929)	1475* (1475-1538)	0, 2.9, 33, 58, 93	26.6, 30.7, 51.3, 62.8, 204.3	24.5, 58.7, 59.8, 97.9, 163.1	9.6, 12.5, 29.1, 35.5, 58.8	19.3, 25.8, 34.4, 59.1, 93	5.4, 6.2, 110.3, 190.9, 401.1	47.5, 64.4, 170.5, 195.5, 206.2	27.4, 96.9, 123, 143.1, 250.9				
C8 ^a ↕↕↓↑	2(5H)-furanone	927	Furane	924***	1602***	1.7, 3.7, 33, 46.4, 118.1	8.2, 11, 12.1, 15.4, 32	0	1.1, 1.5, 2.3, 3.9, 6.1	14, 19, 25.9, 50.1, 118.1	7.6, 10.1, 20.1, 21.9, 32.5	0	1.8, 2, 7.1, 7.4, 15.7	Glucosan	497-23-4	Aldrich	98%
C9 ^a #↕↕↓↑	butyrolactone	933	Furane	928** (861-928)	(1592-1650) **	0	30.6, 32.5, 39.1, 44.9, 49	0	0	0	33.4, 45.7, 46.7, 84, 112.3	0	0	Cellulose + Hemi-cellulose	96-48-0	Fluka	99%
C10 ^b #†Ø↓	2-cyclohexen-1-one	942	Pyran	927* (910-957)	1838**	0.7, 0.9, 2.1, 6, 7.6	0	0	0	0, 0, 1.2, 4.8, 7.6	0	0	0				
C11 ^a #↕↓ ↕↑	2H-2-one-Pyran,5,6 dihydro		Pyran			0	0, 2.2, 2.8, 3.5, 5.6	0, 0, 0.7, 1.5, 6	0	0	0, 0, 4.3, 10.5, 12.5	4.8, 5.4, 5.7, 14.1, 36.3	0				
C12 ^a #†Ø↑	3-methyl-2,5-furandione		Furane			0, 0, 0, 3.9, 4.7	0	0	0	0, 0.5, 3.3, 4.7, 13.2	0	0	0				
C13 ^a #†Ø↓	2-hydroxy-1-methoxy-ethylfuran		Furane			0, 5.4, 76.9, 236, 4606.3	0	0	0	0, 0, 4, 28.5, 4606.3	0	0	0				

ID	Compound	LRI HP-5MS measured	Functional group	LRI HP-5MS literature	LRI INNOWAX literature	Emission rates (µg/g)								Products of	Authentic standard factors		
						250°C				300°C					CAS No.	Compa- ny	Pu- rity
						WSP1	WSP2	WSP3	WSP4	WSP1	WSP2	WSP3	WSP4				
C14 ^a #†Ø↑	phenethyl ester acetic acid		acid			0, 0, 0.6, 0.7, 2.8	0	0	0	0, 0.3, 1.6, 2.4, 3.2	0	0					
C15 ^a øα↓↑ †↓	5-methylfurfural	972	Furane	985***	1591***	0.5, 0.5, 0.5, 0.5, 0.5	7.6, 8.1, 8.3, 9.2, 10.6	1, 1.5, 1.5, 4, 10.8	0.1, 0.2, 0.3, 0.3, 0.7	0.5, 0.7, 0.7, 0.7, 0.7	13.1, 13.2, 13.3, 13.5, 13.9	1.9, 2.3, 2.9, 3.4, 14.5	0.4, 0.8, 1.2, 1.6, 4.1	Cellulose + Hemi- cellulose	620- 02-0	Acros	98%
C16 ^b †Ø¥øα↓ ¥ø↑	3-methyl-5- methyliden-2(5H)- furanone	984	Furane	989 *	1718*	0, 0.1, 0.1, 0.1, 0.3	0, 0.3, 0.4, 0.5, 0.7	0	0	0.1, 0.1, 0.1, 0.2, 0.4	0, 0, 0.9, 2.3, 2.6	0	0				
C17 ^a #øα↓ †Ø¥ø↑	phenol	994	Phenol	981** (943- 1002)	2008** (1947- 2009)	0, 0, 0, 0, 1.8	3.3, 4, 4.1, 4.4, 20.7	0	0	1.8, 2.5, 3.5, 4.4, 5.2	0, 2.7, 28.7, 45.7, 53.3	0	0	H-lignin	87-66- 1	Aldrich	99%
C18 ^c øα↑	2H-pyran-2,4-dione	1006	Pyran			0, 0, 5169, 8391.6, 9232.3	0, 5315.7, 5395.4, 7112.7, 8656.5	0, 1822.5, 3013.1, 4571, 7670.6	0, 200.4, 520.7, 730, 983.2	50.1, 327.2, 1218.5, 1818.4, 9232.3	382.1, 812, 954.5, 1453.6, 3805.8	69.4, 595, 1137.7, 1996.4, 6796.4	0, 0, 497.8, 524.3, 720.2	Cellulose			
C19 ^b #†Ø↓↑	2-hydroxy-3- methyl-2- cyclopenten-1-one	1035	Ketone	1036* (1000- 1036)	1838* (1824- 1839)	0, 0, 1.5, 3.2, 5.5	0	0	0	0, 3, 4.6, 5.3, 6.2	0	0	0				
C20 ^a #†Ø↑	2-hydroxy- benzaldehyde	1048	Phenol	1044** (1013- 1074)	1699** (1628- 1702)	0, 0, 0, 0, 4.6	0	0	0	0, 1.4, 6, 6.6, 13.5	0	0	0	G-lignin	90-02- 8	Alfa Aesar	99%
C21 ^b Øøα↓ α↑	2-methyl-phenol	1061	Phenol	1052* (1029- 1068)	1022* (1995- 2022)	0, 1.1, 0, 3.2, 9.5	1.7, 4.8, 5.7, 13.9, 130.3	0, 1.9, 3.2, 37.1, 102.5	0	0, 0.3, 1.5, 4.3, 19	0, 0, 26.8, 77.9, 134.8	0, 9.6, 11.3, 21, 83.9	0				
C22 ^c #†Ø↑	1-acetyl-(1H)- imidazole	1065	Imidazole	1054**		0, 0, 0, 8.7, 16.2	0	0	0	0, 10.2, 12.2, 15.6, 17.4	0	0	0				
C23 ^c	γ-terpinene	1068	Terpenoid	1065* (1031- 1082)	1239* (1200- 1274)	0	0	0	0	0, 0.5, 3, 9.2, 12.4	0	0	0				

ID	Compound	LRI HP-5MS measured	Functional group	LRI HP-5MS literature	LRI INNOWAX literature	Emission rates (µg/gS)								Products of	Authentic standard factors			
						250°C				300°C					CAS No.	Compa- ny	Pu- rity	
						WSP1	WSP2	WSP3	WSP4	WSP1	WSP2	WSP3	WSP4					
C24 ^b #¥¢↑	4-methyl-phenol	1088	Phenol	1085* (1051- 0198)	2076** (2037- 2117)	0	0	0, 0, 0, 24.5, 26.5	0	0	0	97.1, 135.4, 183.2, 190.7, 1955.6	0					
C25 ^a #Ø¢↓ #¥¢↑	2-methoxy-phenol, (guaiacol)	1094	Guaiacol	1105***	1880***	6639.8, 736.7, 771.7, 772, 838.9	1879.4, 2027.3, 2056.2, 2117.4, 2372.4	190.5, 294.6, 745.8, 945.5, 2578.9	32, 138.1, 146.2, 395, 424.4	838.9, 1010.8, 1023.4, 1045.9, 1058.9	2934.5, 3067.5, 3087.2, 3129.2, 3211.4	339.2, 716.4, 832, 2026, 2270	237.6, 378.4, 876.2, 1283.2, 1867.6	G-lignin	90-05- 1	Fluka	98%	
C26 ^a	2,2-dimethyl-1,3- cyclopentanedione		Ketone			0	0,	0	0	0, 0.5, 2.8, 4.2, 5.8	0	0	0					
C27 ^a	hydrazide benzoic acid		acid			0, 0, 0, 0, 3	0	0	0	0, 1.1, 6.4, 18.8, 25.7	0	0	0					
C28 ^c Ø¢↓	levoglucosenone	1119	Anhydrosugar	1123***		0, 0, 0.1, 0.3, 1.9	0.1, 0.5, 0.5, 0.8, 9.7	0, 0.1, 0.6, 2.1, 3.6	0	0.4, 2.8, 6.1, 8.7, 10.4	1.4, 2.5, 3, 7, 8	0.6, 2.1, 3.4, 5.2, 13.8	0.3, 0.3, 0.6, 1.1, 5.2	Cellulose + Hemi- cellulose				
C29 ^b #†↓	2-methoxy-3- methyl-phenol	1185	Guaiacol	1178*	2021*	22.6, 3.4, 4.1, 6.9, 43.9		0	0	0, 0, 1.3, 4.4, 6.9	0	0	0					
C30 ^a Ø¢↓	5-methylguaiacol	1196	Guaiacol	1194** (1177- 1202)	1789**	1.53, 1.7, 1.8, 1.8, 1.9	0.7, 0.8, 0.9, 1.2, 3.1	0.4, 0.5, 0.5, 1.8, 6.6	0	1.9, 2.5, 2.6, 2.6, 2.7	0.5, 1.2, 4.1, 8.9, 15.6	0.5, 0.9, 0.9, 1.6, 4.7	0	G-lignin	1195- 09-1	Aldrich	98%	
C31 ^b #†Ø¥¢↓	4-ethyl-guaiacol	1285	Guaiacol	1282* (1243- 1285)	2055* (2002- 2055)	0.5, 0.6, 0, 0.6, 0.7	0.1, 0.1, 0.1, 0.1, 0.1	0	0	0.7, 0.9, 0.9, 0.9, 0.9	0.1, 0.1, 0.1, 0.1, 0.1	0	0	G-lignin				
C32 ^b	1,2,3,4-tetrahydro- 1,5,7-trimethyl- naphthalene	1289	Naphthalene	1310*	1462**	0	0	0, 0.1, 0.2, 0.4, 0.7	0	0	0	0.2, 0.4, 0.5, 1.6, 1.6	0	Extractives				

ID	Compound	LRI HP-5MS measured	Functional group	LRI HP-5MS literature	LRI INNOWAX literature	Emission rates (µg/g)								Products of	Authentic standard factors		
						250°C				300°C					CAS No.	Compa- ny	Pu- rity
						WSP1	WSP2	WSP3	WSP4	WSP1	WSP2	WSP3	WSP4				
C33 ^b #†∅ ¥¢↓	2-methoxy-4- vinylphenol	1318	Guaiacol	1313** (1272- 1313)	2138** (2138- 2205)	197.6, 202.3, 225.9, 347.1, 403.2	13.4, 22.3, 33.9, 40.6, 64.8	0	0	12.8, 51.1, 156.7, 176.5, 347.1	6.5, 87.4, 119.5, 121.8, 242	0	0	G-lignin	7786- 61-0	SAFC	98%
C34 ^b #¥¢↓	3-methoxy-5- methylphenol	1330	Guaiacol	1317** (1317- 1342)	2524** (2524- 2535)	0	0	0.01, 0.02, 0.02, 0.03, 0.04	0	0	0	0	0, 0, 0.02, 0.03, 0.04				
C35 ^a	1,2-dihydro-1,1,6- trimethyl- naphthalene	1353	Naphthalene	1332** (1313- 1332)	1724* (1712- 1724)	0, 0, 0, 0.6, 1.1	0	0	0	0	0	0	0				
C36 ^a ¢∅↓ ∅↑	2,6-dimethoxy- phenol, (syringol)	1357	Syringol	1347** (1304- 1347)	2269** (2251- 2307)	0, 0, 4.6, 10.8, 16.2	0.4, 0.5, 0.9, 1.4	0.4, 0.7, 3.4, 3.5, 3.8	0, 0, 0, 1.3	1.3, 4.2, 20.3, 40.4, 60	1.2, 3.8, 4.5, 8.4, 37.5	0.7, 1, 1.6, 24.3, 39.5	0, 0.3, 0.9, 6.3, 25.3	S-lignin	91-10- 1	Aldrich	98%
C37 ^a †∅¢∅↓ #¢↑	vanillin	1406	Guaiacol	1403** (1348- 1403)	2566** (2540- 2610)	0, 0.3, 8.6, 31.9, 86.4	0, 0.3, 0.4, 0.5, 0.9	0, 0.2, 1.1, 1.4, 2.4	0	0, 5.6, 93.4, 135.2, 292.9	0.1, 0.2, 0.3, 0.6, 5.7	0, 0, 0.3, 2.7, 7.3	0	G-lignin	121- 33-5	Aldrich	99%
C38 ^a	2,6-dimethyl- naphthalene	1429	Naphthalene	1425* (1409- 1425)	2038* (2012- 2038)	0, 0, 0, 9.2, 16.1	0	0	0	0	0	0	0	Break down product of ST	581- 42-0	Aldrich	98%
C39 ^b	1,5-dimethyl- naphthalene	1429	Naphthalene	1425* (1325- 1450)	2048*	0, 0.1, 0.2, 0.2, 0.4	0	0	0	0, 0, 0.1, 0.8, 2.1	0	0	0				
C40 ^a	trans-isoeugenol	1455	Guaiacol	1410* (1410- 1499)		0, 0, 31.8, 76.2, 142.8	0	0	0	3.1, 22.7, 93.4, 249.1, 345.7	0	0	0	G-lignin (Phenolic extractive)	5932- 68-3	Aldrich	98%
C41 ^a #↑	3-hydroxy-4- methoxybenzoic acid		Acid			0	0	0, 0.3, 0.4, 0.7, 1.1	0	0	0	0.2, 0.8, 2.8, 5.4, 12.6	0				

ID	Compound	LRI HP-5MS measured	Functional group	LRI HP-5MS literature	LRI INNOWAX literature	Emission rates (µg/g*s)								Products of	Authentic standard factors		
						250°C				300°C					CAS No.	Compa- ny	Pu- rity
						WSP1	WSP2	WSP3	WSP4	WSP1	WSP2	WSP3	WSP4				
C42 ^a	α-caryophyllene (a-humulene)	1461	Terpenoid	1456* (1417- 1469)	1705* (1624- 1705)	0, 0, 0, 4.7, 8.1	0	0	0	0, 0, 0, 1.7, 4.6	0	0	0	ST extractive	6753- 98-6	Aldrich	96%
C43 ^b #†↓	aromadendrene	1469	Terpenoid	1455**	1637** (1622- 1637)	0, 0.1, 0.3, 3.7, 7	0	0	0	0, 0, 0.2, 2.3, 5.4	0	0	0	ST extractive	489- 39-4	Aldrich	97%
C44 ^b	cadina-1(10),6,8- triene	1525	Terpenoid	1519** (1512- 1519)	1834** (1807- 1876)	0, 0, 0, 0.2, 0.3	0	0	0	0, 0, 0, 0.4, 0.9	0	0	0				
C45 ^c	3-(2-naphthyl)-1- butene	1530	Naphthalene			0	0	0, 0, 0, 0, 0.1	0	0	0	0.1, 0.2, 0.6, 1.2, 3.1	0				
C46 ^b	δ-cadinene	1530	Terpenoid	1520***	1774*	0, 0, 87.2, 45710.8, 86998.2	0	0	0	0, 0, 0, 27997.9, 72491.7	0	0	0	ST extractive (cadalenes)	1460- 97-5	BOC sciences	99%
C47 ^a	4-hydroxy-3- methoxy- benzoicacid methylester	1535	Guaiacol	1540***		14.2, 15.2, 38, 985.8, 1855.5	0	0	0	3.5, 4.4, 22.1, 637.7, 1571.7	0	0	0	G- lignin(Phenolic extractive)	15964- 80-4	Aldrich	98%
C48 ^c	α-calacorene	1551	Terpenoid	1527***		0.3, 0.4, 1, 1, 1.8	0	0	0	0, 0, 0.5, 2, 4.1	0	0	0	ST extractive (cadalenes)			
C49 ^c	unidentified	1572	Naphthalene			0.2, 0.2, 0.5, 1.8, 3.6	0	0	0	0, 0, 0.3, 1.1, 2.3	0	0	0				
C50 ^c	unidentified	1592	Guaiacol			0.4, 0.4, 0.5, 0.9, 1	0	0	0	0, 0.1, 0.6, 0.8, 0.9	0	0	0				
C51 ^c	unidentified	1625	Terpenoid			0.3, 0.6, 0.7, 0.9, 1.3	0	0	0	0, 0.1, 0.4, 0.8, 1	0	0	0				
C52 ^b	tau-muurolol	1650	Terpenoid	1633** (1608- 1649)	2179** (2143 - 2209)	0.7, 0.8, 1.1, 1.7, 2.4	0	0	0	0, 0, 0, 1.8, 3.5	0	0	0				
C53 ^c	4-hydroxy-3,5- dimethoxy- benzaldehyde	1663	Terpenoid	1663***		0, 0.5, 0.8, 1.6, 1.7	0	0	0	0, 0, 0.5, 1.4, 1.8	0	0	0	S- lignin(Phenolic extractive)	134- 96-3	Aldrich	98%

ID	Compound	LRI HP-5MS measured	Functional group	LRI HP-5MS literature	LRI INNOWAX literature	Emission rates ($\mu\text{g/g}^*\text{s}$)								Products of	Authentic standard factors		
						250°C				300°C					CAS No.	Compa- ny	Pu- rity
						WSP1	WSP2	WSP3	WSP4	WSP1	WSP2	WSP3	WSP4				
C54 ^b	cadalene	1684	Terpenoid	1684* (1645- 1684)	2242* (2196- 2242)	4.1, 7.3, 9.4, 14.6, 14.8	0	0	0	0.9, 1.8, 6.1, 13.4, 18.62	0	0	0	ST extractive (cadalenes)			
C55 ^b	10-nor-calamenen- 10-one	1714	Terpenoid	1700** (1671- 1700)	2419**	2.7, 9.6, 13.7, 15.6, 16.6	0	0	0	1.8, 5, 6.4, 7.9, 13.7	0	0	0	Oxidized ST (cadalenes)			

Companies: Aldrich Co. (St. Louis, Missouri, USA), Acros Co. (Belgium, Wisconsin, USA), Alfa Aesar (Karlsruhe, Germany), BOC sciences (New York, USA), Merck (Darmstadt, Germany), Fluka (Buchs, Switzerland), SAFC Co. (St. Louis, Missouri, USA), SCB Santa Cruz Biotech (Heidelberg, Germany).