

Yale University

## EliScholar – A Digital Platform for Scholarly Publishing at Yale

---

Cowles Foundation Discussion Papers

Cowles Foundation

---

2-1-1975

### The Solution of Systems of Piecewise Linear Equations

B. Curtis Eaves

Herbert E. Scarf

Follow this and additional works at: <https://elischolar.library.yale.edu/cowles-discussion-paper-series>



Part of the [Economics Commons](#)

---

#### Recommended Citation

Eaves, B. Curtis and Scarf, Herbert E., "The Solution of Systems of Piecewise Linear Equations" (1975). *Cowles Foundation Discussion Papers*. 623.

<https://elischolar.library.yale.edu/cowles-discussion-paper-series/623>

This Discussion Paper is brought to you for free and open access by the Cowles Foundation at EliScholar – A Digital Platform for Scholarly Publishing at Yale. It has been accepted for inclusion in Cowles Foundation Discussion Papers by an authorized administrator of EliScholar – A Digital Platform for Scholarly Publishing at Yale. For more information, please contact [elischolar@yale.edu](mailto:elischolar@yale.edu).

**COWLES FOUNDATION FOR RESEARCH IN ECONOMICS**

**AT YALE UNIVERSITY**

**Box 2125, Yale Station  
New Haven, Connecticut 06520**

**COWLES FOUNDATION DISCUSSION PAPER NO. 390**

**Note:** Cowles Foundation Discussion Papers are preliminary materials circulated to stimulate discussion and critical comment. Requests for single copies of a Paper will be filled by the Cowles Foundation within the limits of the supply. References in publications to Discussion Papers (other than mere acknowledgment by a writer that he has access to such unpublished material) should be cleared with the author to protect the tentative character of these papers.

**THE SOLUTION OF SYSTEMS OF PIECEWISE LINEAR EQUATIONS**

**B. Curtis Eaves and Herbert Scarf**

**February 27, 1975**

# THE SOLUTION OF SYSTEMS OF PIECEWISE LINEAR EQUATIONS\*

by

B. Curtis Eaves and Herbert Scarf

## 1. Introduction

In this paper we study, from a geometrical point of view, the solutions of systems of piecewise linear equations involving one more variable than equation. As our examples will indicate, virtually all of the fixed point and complementary pivot algorithms, as well as a number of related techniques which have been developed over the last decade can be cast in this framework (Lemke and Howson [15], Lemke [16], Scarf [20, 21], Scarf and Hansen [22], Kuhn [13, 14], Eaves [4, 6, 8], Shapley [24], Merrill [18], Katzenelson [12], Fujisawa and Kuh [10], and Chein and Kuh [1]). This geometrical setting leads naturally to an index theory--analogous to that of differential topology--which is of considerable importance in the study of uniqueness and monotonicity of these algorithms. Examples of the use of index theory in computation have recently been given by Kuhn [14], Shapley [23] and Lemke [17].

In the development of our ideas we have been strongly influenced by the lucid exposition of differential topology presented by Milnor [18], and by a number of stimulating conversations with Stephen Smale. Other important sources are the exposition of index theory on discrete structures

---

\*The research described in this paper was carried out under grants from the National Science Foundation, the Ford Foundation, and Army Research Office at Durham.

given by Fan [9], and the constructive proof of the piecewise linear non retraction theorem of Hirsch [11].

In the interests of simplicity we have avoided the most general presentation and restricted our attention to a small number of well known applications. For example, the domain on which our equations are defined will be the union of a finite number of compact convex polyhedra. With some cost in simplicity the domain could equally well have been a non-compact oriented piecewise linear manifold. We have also omitted from the paper applications such as the non-linear complementarity problem in which index theory is extremely useful. These will be described in subsequent publications.

## 2. Piecewise Linear Mappings of Polyhedra

We shall be concerned with a set of points  $P$  in  $R^{n+1}$  which is the union of a finite number of compact convex polyhedra,  $P_1, P_2, \dots, P_k$  each of which is assumed to be of dimension  $(n+1)$ , and no two of which have an interior point in common. The term polyhedron, with the adjective "convex" omitted, will be used to describe such a set. The convex polyhedra used in constructing  $P$  will be referred to as the pieces of the polyhedron.

Figure 1 represents a somewhat extreme example of such a polyhedron. As the figure illustrates, the polyhedron  $P$  need not be convex even though it is composed of convex pieces. It need not be connected or for that matter simply connected, and moreover the intersection of two adjacent pieces of  $P$  need not be a full face of either polyhedron as they are assumed to be in a simplicial subdivision.

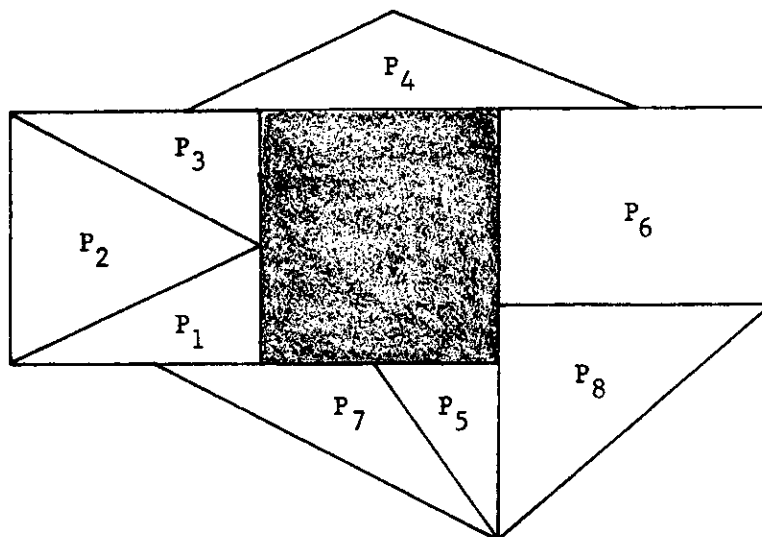

FIGURE 1

An example which is more typical of those arising in the application of our techniques is given in Figure 2. In this example the polyhedron

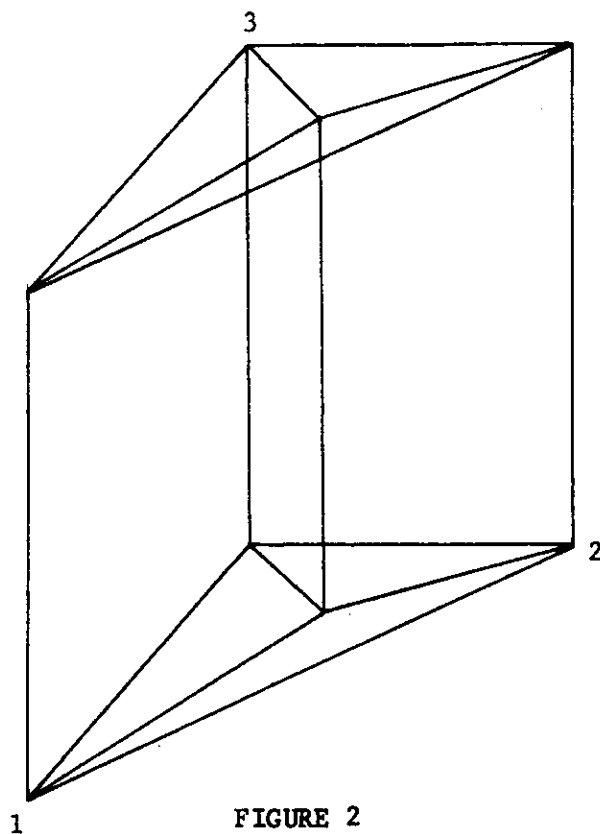

FIGURE 2

$P$  is the product of an interval with the simplex  $S = \{(x_1, x_2) \mid x_1 \geq 0, x_1 + x_2 \leq 1\}$ . The pieces  $\{P_i\}$  are obtained by taking the product of this interval with each  $n$ -simplex in a simplicial subdivision of  $S$ .

We consider now a mapping  $F$  of the polyhedron  $P$  into Euclidian space  $R^n$ , which is assumed to be linear ( $F(\alpha x + (1-\alpha)x') = \alpha F(x) + (1-\alpha)F(x')$ ) in each piece  $P_i$  and continuous in  $P$ . In each of our applications the polyhedron  $P$  and the mapping  $F$  will be defined by the nature of the problem and we shall be concerned with solutions to the system of equations

$$F(x) = c$$

for a specific vector  $c$  in  $R^n$ .

In order to motivate the subsequent arguments let us begin with a few intuitive and not quite rigorous remarks about the character of the set of solutions to such a system. In each piece of linearity  $P_i$  the mapping  $F(x)$  is linear with a maximal rank of  $n$ , since the mapping is into  $R^n$ . If the mapping is, in fact, of rank  $n$  in a given piece of linearity then the intersection

$$F^{-1}(c) \cap P_i,$$

if it is not empty, is generally a straight line segment touching two distinct faces of  $P_i$  of dimension  $n$ .

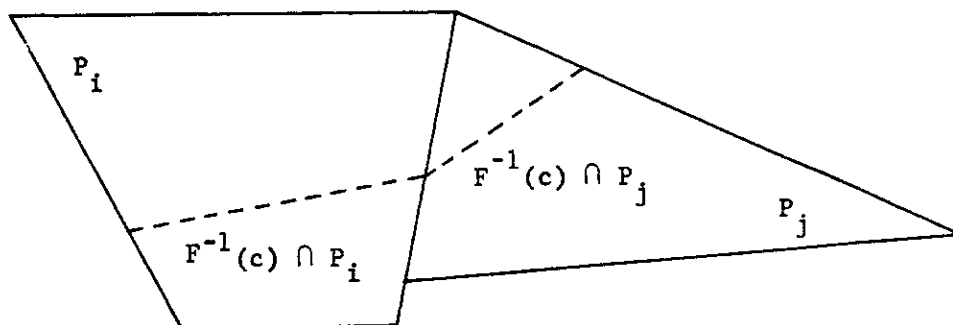

FIGURE 3

Consider an adjacent piece of linearity  $P_j$  whose intersection with  $P_i$  contains a single point of  $F^{-1}(c)$ . Since the mapping is continuous on the common boundary of  $P_i$  and  $P_j$  we expect in general that

$$F^{-1}(c) \cap P_j$$

will be a straight line segment in the piece of linearity  $P_j$  which fits together continuously with the corresponding segment in  $P_i$ . We shall see shortly what technical points must be examined in detail in order to make this type of argument precise. For the moment, however, these remarks seem to suggest that the set of solutions  $F^{-1}(c)$  can be obtained by traversing a series of straight line segments from one piece of linearity  $P_i$  to an adjacent one.

Since the polyhedron is composed of a finite number of bounded pieces, there are essentially two types of curves (by a curve we mean a homeomorph of closed bounded interval or a circle) that can arise in this

fashion. One possibility is that the process of moving from one piece of linearity to an adjacent piece will terminate by reaching the boundary of the polyhedron  $P$ . Since movement is possible in two directions this would imply a curve touching the boundary of  $P$  in two distinct points; we shall call such a curve a path. This case is illustrated in Figure 4, in which the dashed line represents  $F^{-1}(c)$ .

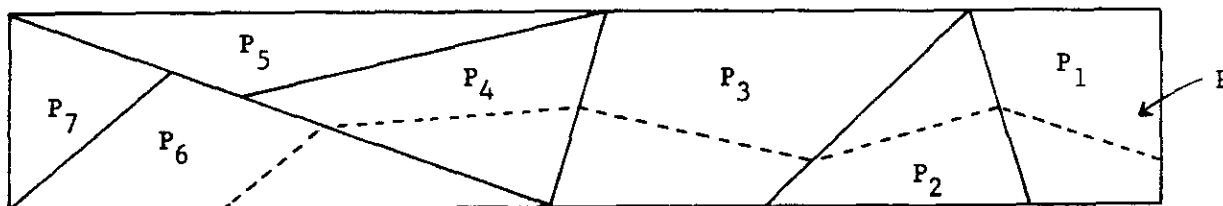

FIGURE 4

Another possibility that may arise by continuing the straight line segments is the generation of a closed curve or loop which has no intersection with the boundary of  $P$ . Figure 5 illustrates a possibility in

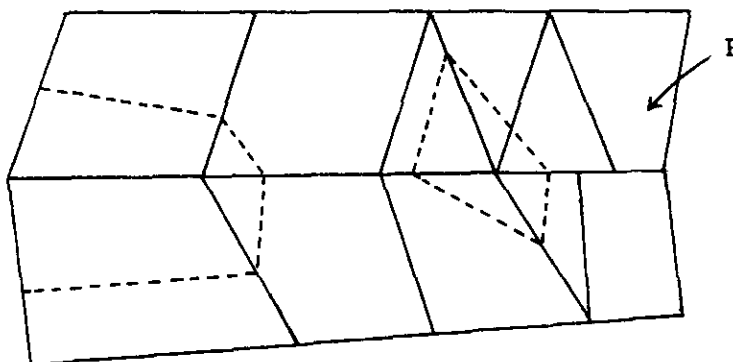

FIGURE 5

which the set of solutions  $F^{-1}(c)$  contains such a loop in addition to a path terminating in a pair of boundary points of  $P$ .

These rough arguments suggest that the set of solutions to  $F(x) = c$  will either be empty or be a disjoint union of a finite number of paths



and loops. As we shall see, this important conclusion will generally be correct. However, the problem may occasionally become degenerate for specific choices of the function  $F$  and vector  $c$  and produce a set of solutions more complex than that described above.

For example, we may be working in a piece of linearity  $P_i$  in which the rank of  $F(x)$  is less than  $n$ . In such a region the solutions of  $F(x) = c$  may very well form a set of dimension strictly larger than one. Another illustration of difficulty arises if for some piece of linearity  $P_i$  the set  $P_i \cap F^{-1}(c)$  lies fully in the boundary of  $P_i$ .

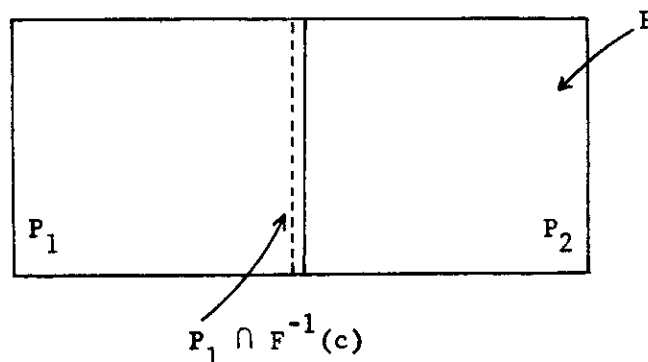

FIGURE 6

A final example occurs when the set  $F^{-1}(c)$  intersects the boundary of a piece of linearity  $P_i$  in some face of dimension less than  $n$ . As Figure 7 illustrates, this case may produce a bifurcation of the path in two different directions. The common feature of these examples,

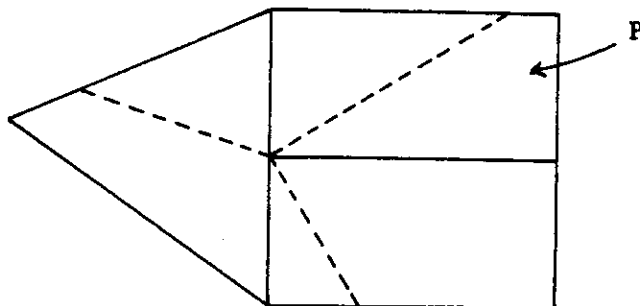

FIGURE 7

and in fact all difficulties caused by degeneracy is, the fact that  $F(x) = c$  has a solution on some face of dimension less than  $n$ , of a piece of linearity.

In the next section we shall use this idea to impose a condition on the basic problem which avoids degeneracy and permits us to establish the main theorem characterizing the set of solutions to  $F(x) = c$ .

It may be appropriate at this point to provide a formal definition of the terms "path" and "loop," which have been used in the previous discussion.

2.1. [Definition] A path is a curve in  $P$  with two endpoints, each of which lies in the boundary of  $P$  and whose intersection with each piece of linearity is either empty or a straight line segment. A loop is a closed curve with no endpoints whose intersection with each piece of linearity is either empty or a straight line segment.

Figures 4 and 5 illustrate paths and loops; Figure 6 a path but of the type we shall avoid, and in Figure 7 the dotted set is neither a path nor a loop.

### 3. The Main Theorem

We are given a polyhedron  $P$  in  $R^{n+1}$  and a piecewise linear mapping  $F$  which carries  $P$  into  $R^n$ . The following definition employs a modification, which is suitable to our purposes, of well known terminology used in differential topology.

3.1. [Definition] A vector  $c$  in  $R^n$  is a degenerate value of  $F : P \rightarrow R^n$  if there is an  $x$  in  $P$  lying in a face of dimension less than  $n$  of some piece of linearity  $P_1$ , for which  $F(x) = c$ .

A vector  $c$  which is not a degenerate value is called a regular value of the mapping.

Consider the following simple illustration of this definition.

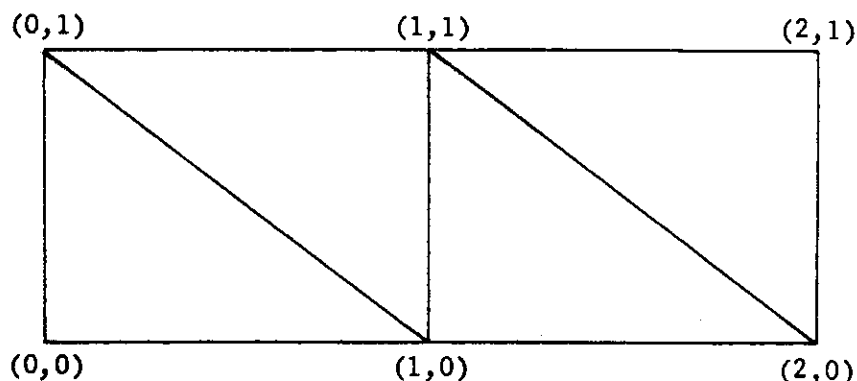

FIGURE 8

The polyhedron  $P$  is composed of four triangles in  $R^2$ . The mapping into  $R^1$  is given by  $F(x_1, x_2) = x_1 + x_2$ . According to the definition the degenerate values are those taken on at the six 0-dimensional faces (vertices), and are therefore given by  $(0,1,2,3)$ . The regular values of the mapping consist therefore of all points in  $R^1$  other than these four values--illustrating the fact that vectors in  $R^n$  which are not assumed by  $F$  are considered to be regular values. We also see that degenerate values can be assumed on faces of higher dimension; for example, the value 1 is assumed by  $F$  on the entire face connecting  $(0,1)$  and  $(1,0)$ .

We shall now provide a complete description of the set of solutions to  $F(x) = c$ , when  $c$  is a regular value of the map. We shall organize the argument by demonstrating the following preliminary lemma.

3.2. [lemma] Let  $P_i$  be a piece of linearity, let  $c$  be a regular value of  $F$ , and assume that  $P_i \cap F^{-1}(c)$  is not empty. Then

$P_i \cap F^{-1}(c)$  consists of a single straight line segment whose endpoints are interior to two distinct faces of dimension  $n$  of  $P_i$ .

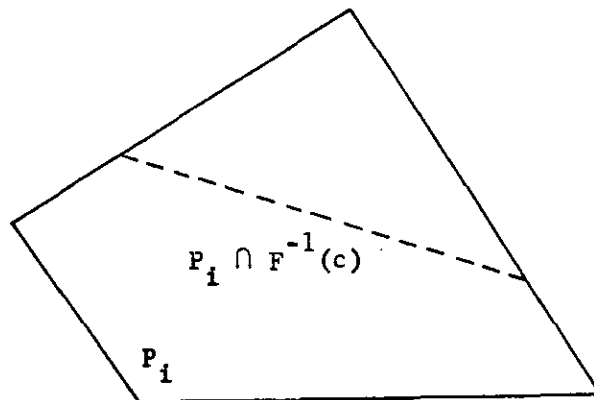

FIGURE 9

In order to demonstrate this lemma let us assume that  $F(x) = Ax + b$  in  $P_i$  with  $A$  an  $n \times (n+1)$  matrix. First of all let us remark that the matrix  $A$  has rank  $n$ . Otherwise the value  $c$  is assumed on a face of dimension  $n-1$  of  $P_i$ , contradicting the assumption that  $c$  is a regular value.

Since  $A$  is of rank  $n$  the solutions to  $Ax + b = c$  in  $P_i$  form a straight line segment. The line segment cannot be fully contained in any face of dimension  $n$  of  $P_i$ , since extending it would then enable us to reach a face of dimension  $n-1$ . Its endpoints must therefore be contained in the interiors of two distinct faces of  $P_i$ . This demonstrates the lemma.

We are now prepared to prove the major theorem characterizing the set of solutions to  $F(x) = c$ , where  $c$  is a regular value.

3.3. [Theorem] Let  $F : P \rightarrow \mathbb{R}^n$  be continuous and linear in each piece  $P_i$ , and let  $c$  be a regular value. Then the set of solutions

of  $F(x) = c$  is a finite disjoint union of paths, each of which intersects the boundary of  $P$  in precisely two points, and loops, which have no intersection with the boundary of  $P$ .

The proof of Theorem 3.3 is, of course, an immediate consequence of the arguments of the previous section combined with Lemma 3.2. If  $F^{-1}(c)$  has a non-empty intersection with a piece  $P_i$ , then this intersection will consist of a straight line segment touching two faces of dimension  $n$  of  $P_i$ , and no lower dimensional face either of  $P_i$  or of any adjacent piece of linearity. If either endpoint of this line segment is not on the boundary of  $P$  it will be contained in precisely one other piece of linearity, say  $P_j$ . (The fact that this endpoint is contained in at most one other piece of linearity is the feature which assures that paths do not bifurcate as in Figure 7.) But then  $P_j \cap F^{-1}(c)$  will not be empty and will consist of a similar straight line segment.

This process will either produce a path which intersects the boundary of  $P$  in two distinct points, or a path which returns to itself and is therefore a loop. This provides us with one component of the set of solutions to  $F(x) = c$ . If there is another piece of linearity which intersects  $F^{-1}(c)$  we continue by constructing an additional component. Since there are a finite number of such pieces of process of constructing paths and loops will ultimately terminate. This demonstrates Theorem 3.3.

This characterization of the set of solutions to  $F(x) = c$  is valid only if  $c$  is a regular value of the mapping; if  $c$  is degenerate the corresponding set may be considerably more complex. In applying Theorem 3.3 it will be necessary to avoid degenerate values, which, as the following theorem indicates, form a negligible subset of  $R^n$ .

3.4. [Theorem] The set of degenerate values is a closed subset of  $R^n$ , contained in a finite union of  $(n-1)$  dimensional hyperplanes.

This theorem, analogous to Sard's theorem in the case of differentiable manifolds, is an immediate consequence of the definition of a degenerate value to be the image of a point  $x$  lying in an  $n-1$  dimensional face of some piece of linearity. There are a finite number of such faces, each of which is carried by  $F$  into a closed subset of an  $n-1$  dimensional hyperplane in  $R^n$ .

Theorem 3.4, in the form stated above, is not quite suitable for most of our applications since a value  $c$  is considered to be a regular value whenever  $F^{-1}(c)$  is empty. While the degenerate values form a small subset of  $R^n$ , they need not form a small subset of the image of  $P$  under  $F$ . For example, if  $F$  maps all of  $P$  onto the same vector then all values for which  $F^{-1}(c)$  is not empty, will be degenerate. The following theorem is a sharpening of Theorem 3.4, which is more appropriate for our purposes.

3.5. [Theorem] Let  $Q$  be a face of dimension  $n$  of a piece  $P_i$ , and let  $x$  be interior to this face. Assume that the image of  $Q$  under the mapping  $F$  is of dimension  $n$ . Then any relative neighborhood of  $x$  on the face  $Q$ , contains points  $x'$  for which  $c' = F(x')$  is regular.

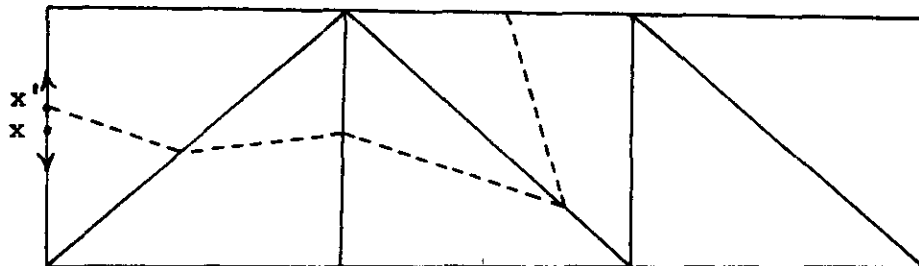

FIGURE 10

The hypothesis of Theorem 3.5 imply that any neighborhood of  $x$ , on  $Q$ , will be mapped into a set of dimension  $n$  by the linear transformation obtained by restricting  $F$  to  $Q$ . Since the set of degenerate values of  $F$  is a set of dimension  $n-1$  or less, there will be many values of  $x'$  in this neighborhood, whose image is a regular value of  $F$ .

Theorem 3.5 permits us to treat degeneracy by a slight perturbation of the vector  $c$ , as is customary in linear programming. (See any standard reference which discusses the resolution of degeneracy in linear programming.)

#### 4. Examples of the General Method

In the present section we shall illustrate the significance of our characterization of the set of solutions to  $F(x) = c$  by applying this result to a series of examples which have played an important role in the development of fixed point computational techniques. There are many other examples which we have chosen not to discuss in this paper.

##### Example I

Our first example is that of "integer labelling," one of the earliest techniques for the numerical approximation of a fixed point of a continuous mapping of the simplex into itself. For simplicity of exposition we shall take the particular form of this method described in Chapter 7 of [16]. (Also see Cohen [2] and Eaves [4, 5].)

Consider a simplicial subdivision of the simplex  $S = \{x = (x_1, \dots, x_m) \mid x_i \geq 0, \sum_1^n x_i \leq 1\}$  which is arbitrary, aside from the assumption that the only vertices of the subdivision lying on the boundary of  $S$  are

$$\begin{aligned}
 v^0 &= (0, 0, \dots, 0) \\
 v^1 &= (1, 0, \dots, 0) \\
 v^2 &= (0, 1, \dots, 0) \\
 &\vdots \\
 v^n &= (0, 0, \dots, 1) .
 \end{aligned}$$

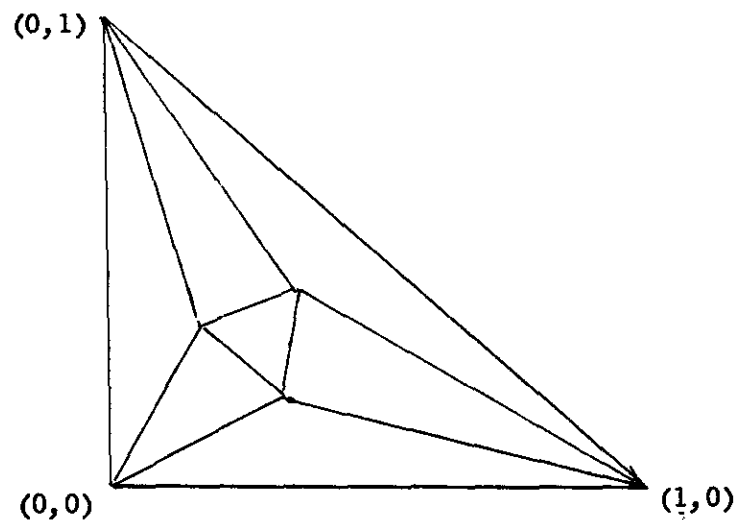

FIGURE 11

Let every vertex  $v$  of this subdivision be given an integer label  $\ell(v)$  selected from the set  $(0, 1, \dots, n)$ . The label associated with a given vertex will typically be assigned on the basis of some underlying mapping of the simplex into itself. For our purposes, however, the labelling can be considered to be arbitrary, aside from the proviso that  $v^i$  receive the label  $i$ , for  $i = 0, 1, \dots, n$ .

We shall show that Theorem 3.3 can be employed, in the present context, to demonstrate the existence of at least one simplex in the subdivision all of whose labels are distinct. This conclusion can be viewed, of course, as a simplified form of Sperner's lemma.

The conventional computational procedure for determining such a



simplex starts out with the unique simplex in the subdivision containing the vertices  $v^1, \dots, v^n$  and the additional vertex  $v^j$ . If the label associated with  $v^j$  is 0, the process terminates. Otherwise we remove that vertex of the simplex say  $v^k$  whose label agrees with that of  $v^j$ . A new vertex  $v^l$  is introduced, where the vertices  $v^1, \dots, v^n, v^j, v^l$ , with  $v^k$  omitted, form a simplex in the subdivision. If the label associated with  $v^l$  is 0 the process terminates; otherwise we continue by removing the vertex whose label agrees with that of  $v^l$ .

At each iteration we are presented with a simplex whose vertices bear the labels 1, 2, ..., n. Of the two vertices with the same label, we remove the one which has not just been introduced. The argument that the algorithm does not cycle and must terminate with a simplex of the desired type may be found in the previously cited reference.

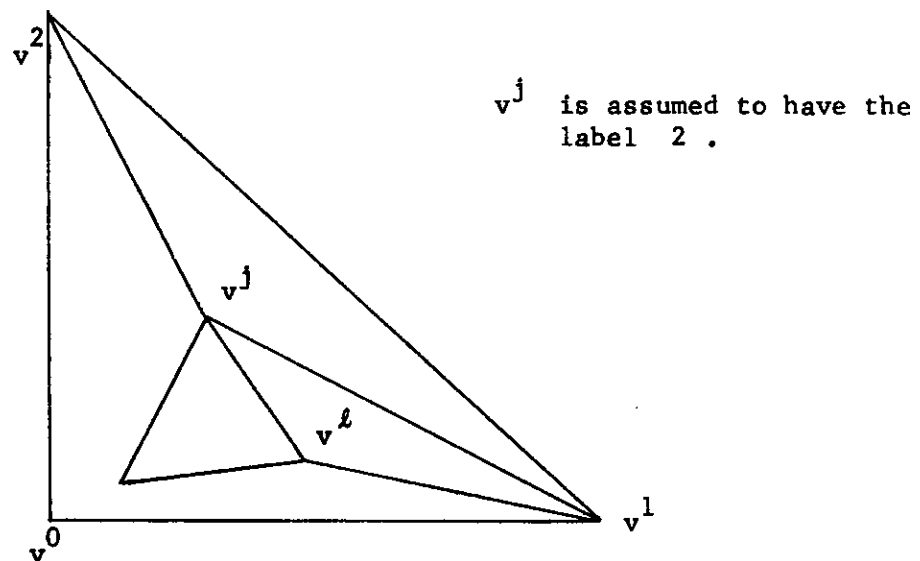

FIGURE 12

In order to place the problem in our context we make the following definition.

4.1. [Definition] Define a continuous map  $f : S \rightarrow S$  of the simplex into itself as follows:

1. Let  $v$  be any vertex of the simplicial subdivision, and let  $\ell(v) = i$  be the integer label associated with  $v$ . We then define  $f(v)$  to be  $v^i$ .

2. We extend the definition of  $f$  to the entire simplex by requiring  $f$  to be linear in each simplex of the subdivision of  $S$ .

With this definition the function  $f$  is piecewise linear in  $S$ , and because of the special structure of the subdivision it is easy to see that  $f(x)$  is the identity map ( $f(x) \equiv x$ ) on the boundary of  $S$ . In order to demonstrate the existence of at least one completely labelled simplex it is clearly sufficient to show that for any vector  $c$ , interior to the simplex  $S$  there will exist a vector  $x$ , for which

$$f(x) = c.$$

The vertices of that simplex in the subdivision which contains  $x$  will certainly bear distinct labels. For if the label  $i$  is omitted, then the image of each vertex in the simplex will be on that face of  $S$  whose  $i^{\text{th}}$  coordinate is zero (or on the face  $\sum_{i=1}^n x_i = 1$ , if  $i = 0$ ).  $f(x)$  will therefore lie on the boundary of  $S$ , contradicting the assumption that  $c$  is an interior point. Conversely, if the vertices of a particular simplex in the subdivision bear distinct labels then it is easy to see that the system of equations,  $f(x) = c$ , has a solution contained in that simplex.

We begin by defining a polyhedron  $P$  in  $R^{n+1}$ .

4.2. [Definition] The polyhedron  $P$  is defined to be the product of the simplex  $S$  with the closed interval  $[0,1]$ , i.e.

$$\{(x_1, \dots, x_n, x_{n+1}) \mid x_i \geq 0, \sum_{i=1}^n x_i \leq 1, \text{ and } x_{n+1} \leq 1\}.$$

The pieces  $P_1, P_2, \dots, P_k$  of  $P$  are obtained by taking the product of an arbitrary  $n$ -simplex in the subdivision of  $S$  with the same closed interval  $[0,1]$ .

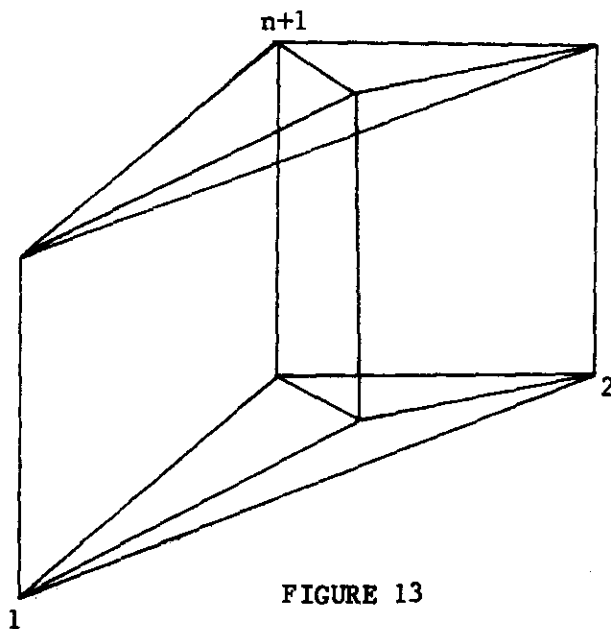

FIGURE 13

The following definition will provide us with a function  $F(x_1, \dots, x_n, x_{n+1})$  to which Theorem 3.3 can be applied.

4.3. [Definition] Let  $d$  be that vector in  $R^n$  all of whose coordinates are unity. We define

$$F(x_1, \dots, x_n, x_{n+1}) \equiv f(x_1, \dots, x_n) - x_{n+1} d.$$

$F$  is a continuous map of  $P$  into  $R^n$  which is linear in each piece of the polyhedron  $P$ . Our purpose is to show that for an arbitrary vector  $c$ , interior to the simplex  $S$ ,  $F^{-1}(c)$  will intersect that face of  $P$  on which  $x_{n+1} = 0$ .

Let  $c$  be a vector interior to  $S$  and let us examine the intersection of  $F^{-1}(c)$  with the other faces of  $P$ . First of all we remark that  $F^{-1}(c)$  cannot intersect that face of  $P$  on which  $x_{n+1} = 1$ . This would imply that

$$f(x_1, \dots, x_n) - d = c,$$

which is impossible, since  $f_i(x) \leq 1$ ,  $d = (1, 1, \dots, 1)$  and  $c_i > 0$  for all  $i$ .

On the remaining faces of  $P$ , other than the two ends of the prism, we know that  $f(x) \equiv x$ . A vector  $x$  in  $F^{-1}(c)$  which is on such a face will therefore satisfy

$$x - x_{n+1}d = c,$$

the unique solution of which is given by

$$(x_1^*, \dots, x_n^*) = c + \frac{(1 - \sum_1^n c_i)d}{n},$$

$$x_{n+1}^* = \frac{(1 - \sum_1^n c_i)}{n}.$$

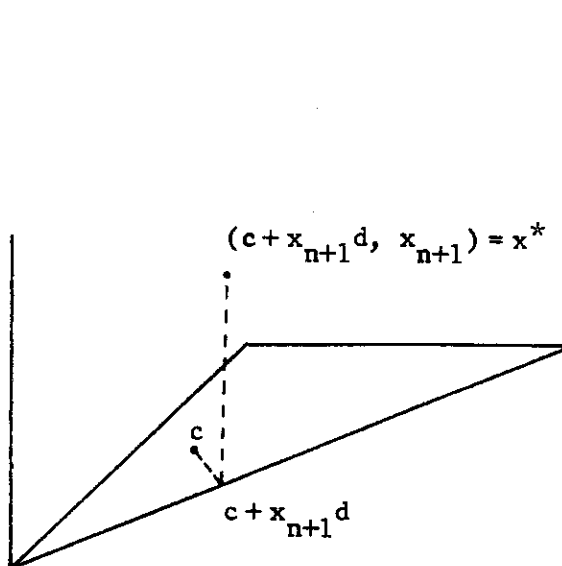

FIGURE 14

We have therefore demonstrated the important conclusion that if  $c$  is interior to  $S$ , the equations  $F(x) = c$  have precisely one solution on the boundary of  $P$  other than on that face where  $x_{n+1} = 0$ . But if  $c$  is a regular value of the mapping  $F$ , Theorem 3.3 can be invoked to produce a path starting from  $x^*$ . Since the path must terminate at some other boundary point of  $P$ , there must be a vector on the bottom face of  $P$  for which  $F(x) = c$ . As we have already seen, this demonstrates the existence of a completely labelled simplex.

In order for this argument to be complete we need only show that there exists at least one vector  $c$ , interior to  $S$ , which is a regular value of the mapping  $F$ . But this follows immediately from Theorem 3.5 and the observation that  $F$  maps the face of  $P$  on which  $\sum_{i=1}^n x_i = 1$  onto an  $n$ -dimensional subset of  $R^n$ .

Let us examine the path generated from  $x^*$  and terminating with a solution to the problem in somewhat greater detail. Since  $c$  is a regular value this path will move from one piece of linearity to an adjacent one by passing through the interior of their common face  $Q$ .

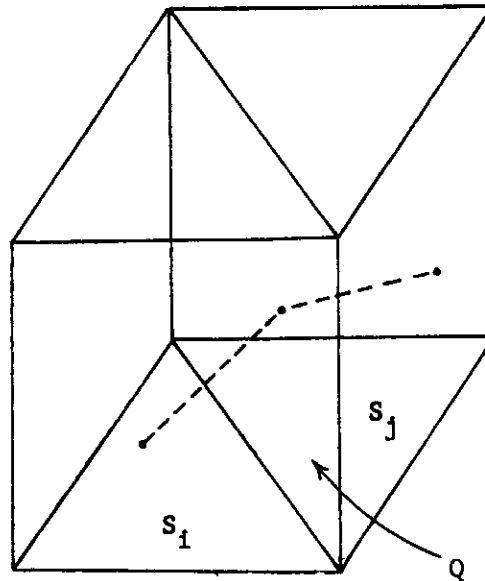

FIGURE 15

The face  $Q$  is the product of the interval  $[0,1]$  with the intersection of two adjacent simplices in the simplicial subdivision of  $S$ , say  $S_i$  and  $S_j$ . It is easy to see, however, that the  $n$  vertices common to  $S_i$  and  $S_j$  must together bear all of the labels  $1, 2, \dots, n$ . For if the  $i^{\text{th}}$  such label were missing it would follow that  $f_i(x) = 0$  on this common intersection, which contradicts

$$f(x_1, \dots, x_n) - x_{n+1}^d = c.$$

We see, therefore, that the projection of our path to the lower face of  $P$  moves through simplices each of which has vertices which together bear all the labels  $1, 2, \dots, n$ , and which do not bear the label zero until the process terminates. Each such simplex must have a single duplicated label belonging to that vertex which is being removed in passing to the next simplex. The sequence of simplices is therefore identical with that produced by the conventional algorithm, described at the beginning of the example.



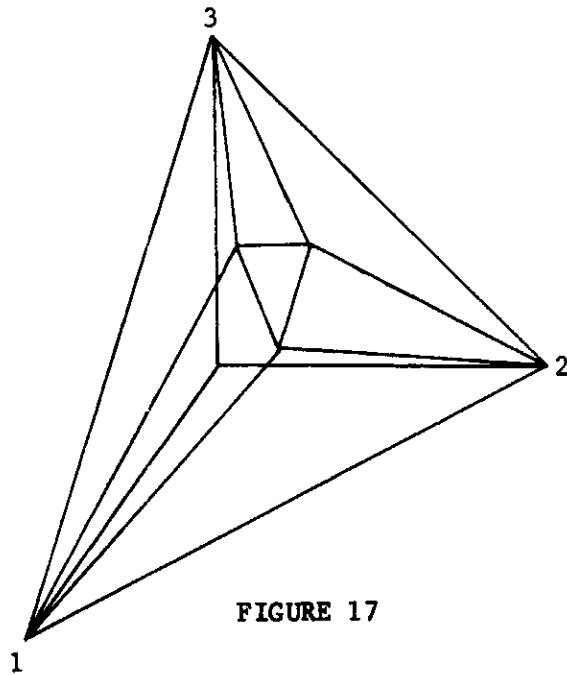

FIGURE 17

Let the vertices of the subdivision be denoted by  $v^1, v^2, \dots, v^n, v^{n+1}, \dots, v^k$ , where

$$v^1 = (1, 0, \dots, 0)$$

$$v^2 = (0, 1, \dots, 0)$$

$$\vdots$$

$$v^n = (0, 0, \dots, 1) .$$

For simplicity of exposition we make the assumption that no vertices of this subdivision, other than the first  $n$  vertices, lie on the boundary of  $S$  .

Each vertex  $v^j$  will have associated with it a vector  $f(v^j)$  contained in  $R^n$  . In practice this association is determined by the particular problem being solved; for our purposes, however, we may consider the vector labels to be completely arbitrary aside from the assumption that



$$f(v^i) = v^i, \text{ for } i = 1, 2, \dots, n.$$

In addition to this assignment of vector labels a specific positive vector  $c$  in  $R^n$  is given.

By a solution to this problem we mean the determination of a particular simplex in the subdivision, with vertices  $v^{j_1}, v^{j_2}, \dots, v^{j_n}$ , such that the equations

$$\alpha_{j_1} f(v^{j_1}) + \alpha_{j_2} f(v^{j_2}) + \dots + \alpha_{j_n} f(v^{j_n}) = c,$$

have a non-negative solution  $(\alpha_{j_1}, \alpha_{j_2}, \dots, \alpha_{j_n})$ . In order to guarantee that such a solution does indeed exist it is sufficient to make the following assumption.

4.4. [Assumption] Let  $\alpha = (\alpha_1, \alpha_2, \dots, \alpha_k)$  be non-negative and satisfy

$$\sum_1^k \alpha_j f(v^j) \leq 0.$$

Then  $\alpha = 0$ .

To cast this problem in our general form we begin by defining a function  $f(x)$  taking the non-negative orthant of  $R^n$  into  $R^n$ , as follows:

1.  $f(v^j) =$  the vector label associated with  $v^j$  for any vertex of the subdivision;
2.  $f(x)$  is linear in each simplex of the subdivision  $S$ , and
3.  $f(x)$  is homogeneous of degree 1, i.e.  $f(\lambda x) = \lambda f(x)$  for any  $\lambda \geq 0$ .

According to this definition,  $f(x)$  is therefore linear in each cone with vertex at the origin whose half-rays pass through a particular simplex in the subdivision of  $S$ . Because of the special assignment of vector labels to the vertices  $v^1, \dots, v^n$ , the function is the identity ( $f(x) \equiv x$ ) on the boundary of the non-negative orthant of  $R^n$ . Moreover, assumption 4.4 implies that for no non-negative vector  $x$ , other than the zero vector, will  $f(x)$  be  $\leq 0$ .

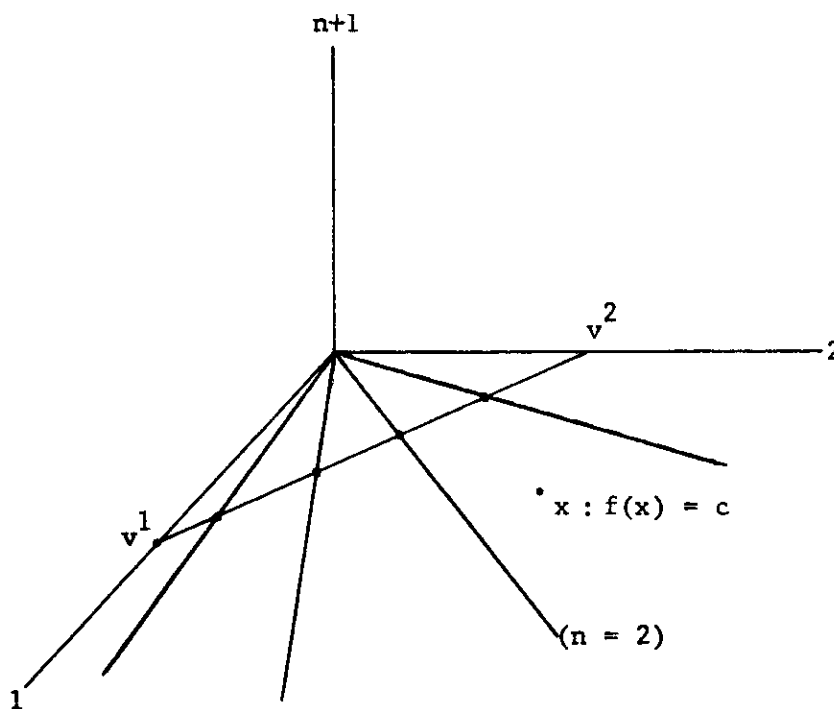

FIGURE 18

It should be clear that solving the vector labelling problem is simply equivalent to the determination of a non-negative vector  $x$  for which

$$f(x) = c .$$

The particular simplex in the subdivision involved in the solution is

then obtained by intersecting the ray from the origin through  $x$  with the simplex  $S$ .

In order to define an appropriate polyhedron  $P$  we begin by remarking that assumption 4.4 implies that the set of non-negative  $x$  for which  $f(x) \leq c$ , is bounded. For if there were a sequence  $x^1, x^2, \dots$  tending to infinity with  $f(x^j) \leq c$ , then any limit point of the sequence

$$(x^j / \|x^j\|)$$

would be non-negative, different from zero and map into a vector all of whose coordinates were less than or equal to 0. For specificity let us assume that there is a positive constant  $M$ , such that  $x \geq 0$ , and  $f(x) < c$  implies that

$$\sum_1^m x_i < M.$$

4.5. [Definition] The polyhedron  $P$  is defined to be the product of the closed unit interval  $0 \leq x_{n+1} \leq 1$  with the set  $\{(x_1, \dots, x_n) \mid x_i \geq 0, \sum_1^n x_i \leq M\}$ . Each piece  $P_i$  is determined by a particular simplex of the subdivision,  $S_i$ , and consists of all  $(x_1, \dots, x_n, x_{n+1})$  with

1.  $0 \leq x_{n+1} \leq 1$
2.  $\sum_1^n x_i \leq M$ , and
3.  $(x_1, \dots, x_n) / \sum_1^n x_i$  contained in  $S_i$ .

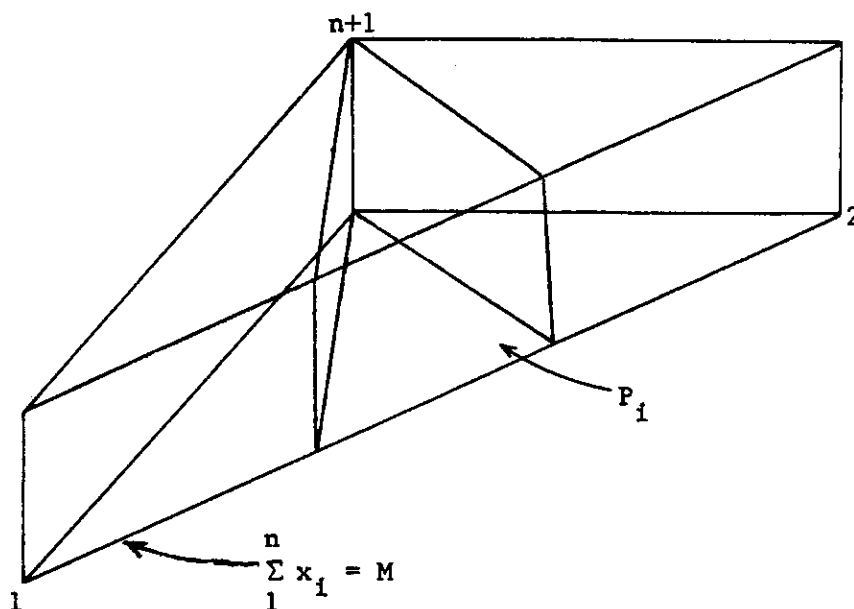

FIGURE 19

We also define the function  $F(x_1, \dots, x_n, x_{n+1})$  in the following way.

4.6. [Definition] Let  $d$  be a vector in  $\mathbb{R}^n$  which is strictly larger than  $c$ , and assume--for definiteness--that

$$\frac{c_j}{d_j} > \frac{c_1}{d_1} \text{ for } j = 2, \dots, n.$$

We then define

$$F(x_1, \dots, x_n, x_{n+1}) = f(x_1, \dots, x_n) + x_{n+1}d.$$

With this definition a solution to the vector labelling problem will be obtained by finding a vector  $(x_1, \dots, x_n, x_{n+1})$  in  $F^{-1}(c)$  with  $x_{n+1} = 0$ . In order to argue that such a vector does indeed exist let us examine the intersection of  $F^{-1}(c)$  with those boundary faces of  $P$  other than that face with  $x_{n+1} = 0$ .

1. The upper face  $x_{n+1} = 1$  .

An intersection on this face would satisfy  $f(x_1, \dots, x_n) + d = c$  ,  
which is ruled out by assumption 4.4 since  $d > c$  .

2. The face  $\sum_{i=1}^n x_i = M$  ,  $x_{n+1} > 0$  .

Such an intersection would satisfy  $f(x_1, \dots, x_n) < c$  and  $\sum_{i=1}^n x_i = M$  ,  
which is again impossible by the implications of assumption 4.4.

3. The face  $x_i = 0$  , for  $i = 1, \dots, n$  .

On any such face the function  $f(x)$  is the identity, and the system of equations  $F(x) = c$  may therefore be written as  $x + dx_{n+1} = c$  or

$$x = c - dx_{n+1} .$$

Given our assumption however that  $c_1/d_1 < c_j/d_j$  for  $j = 2, \dots, n$  ,  
it is easy to see that the only such intersection is the vector  
 $x^* = (c - (c_1/d_1)d, c_1/d_1)$  , on the face  $x_1 = 0$  .

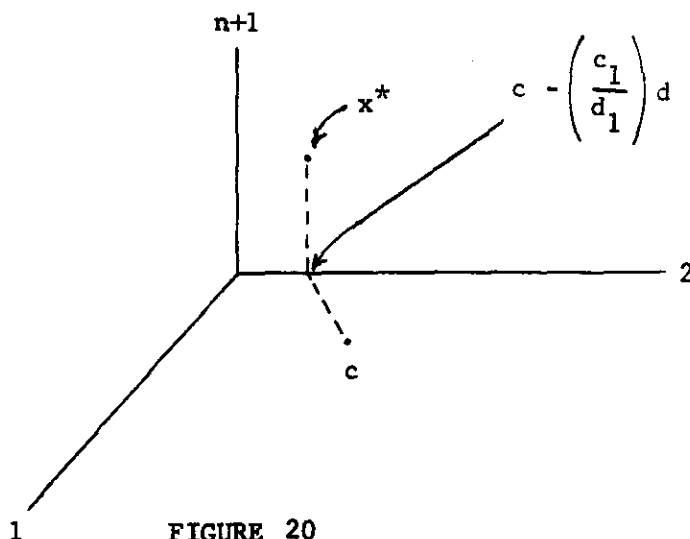

FIGURE 20

We have reached the important conclusion that  $F^{-1}(c)$  intersects  
the boundary of  $P$  , other than that part of boundary where  $x_{n+1} = 0$  ,  
in a single point. If  $c$  is a regular value of the mapping this completes

our argument, since the path beginning at  $x^*$  must reach a second boundary point of  $P$  which necessarily lies in the face  $x_{n+1} = 0$ . If  $c$  is not a regular value of the mapping we appeal to Theorem 5.3. The image of the face  $x_1 = 0$ , under  $F$ , is clearly of dimension  $n$  (since  $f$  is the identity on that face) and we therefore conclude that there are values of  $x'$ , lying on that same face and arbitrarily close to  $x^*$ , for which  $c' = F(x')$  is regular. The system of equations  $f(x) = c'$  will therefore have solutions, and by passing to the limit, so will the original system.

It may be useful, as a final remark, to show that the path generated above--when  $c$  is a regular value--moves through a sequence of simplices which is identical to that generated by the algorithm described in Scarf and Hansen [22]. Consider two adjacent pieces of linearity  $P_1$  and  $P_2$  whose common face  $Q$  is traversed by the path. Since  $c$  is a regular

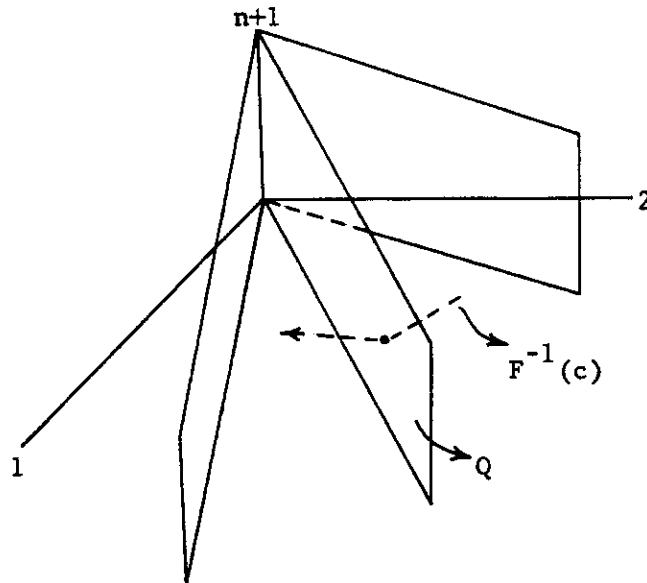

FIGURE 21

value the mapping  $F$  must take  $Q$  into a subset of  $\mathbb{R}^n$  of full dimension, for otherwise a component of  $F^{-1}(c)$  would be fully in this face.

Let us express the action of  $F$  on  $Q$  as follows. The piece  $P_1$  is generated by a simplex in the subdivision with vertices  $v^{j_1}, v^{j_2}, \dots, v^{j_n}$  and  $P_2$  by the simplex, say, in which  $v^{j_1}$  is replaced by  $v'$ . Any  $(x_1, \dots, x_n, x_{n+1})$  on the face  $Q$  can therefore be written as

$$(x_1, \dots, x_n) = \alpha_{j_2} v^{j_2} + \dots + \alpha_{j_n} v^{j_n}, \text{ so that}$$

$$F(x_1, \dots, x_n, x_{n+1}) = \alpha_{j_2} f(v^{j_2}) + \dots + \alpha_{j_n} f(v^{j_n}) + x_{n+1} d.$$

Since this mapping has full rank, it follows that the matrix

$$A = \begin{bmatrix} d_1 & f_1(v^{j_2}) & \dots & f_1(v^{j_n}) \\ \vdots & \vdots & & \vdots \\ \vdots & \vdots & & \vdots \\ d_n & f_n(v^{j_2}) & \dots & f_n(v^{j_n}) \end{bmatrix}$$

has a non-singular determinant. Since  $A(x_{n+1}, \alpha_{j_2}, \dots, \alpha_{j_n})' = c$  at the point of intersection of the path and  $Q$ , it follows that the columns of  $A$  form a feasible basis whose columns correspond to the vertices of the simplex defining  $P_1$  --with the single exception that the column  $d$  has replaced the image  $f(v^{j_1})$ . This is precisely the general position of the conventional almost complementary algorithm.

Example III

The general arguments of this paper are very similar in spirit to the homotopy methods introduced by Eaves [6, 8] and Eaves and Saigal [7] for the approximation of fixed points of a continuous mapping of the simplex into itself. The present example will illustrate this similarity in some detail.

Let  $S$  be the simplex  $\{x = (x_1, \dots, x_n) \mid x_i \geq 0, \sum_{i=1}^n x_i \leq 1\}$ , and  $P$  the polyhedron obtained by taking the product of  $S$  with the closed unit interval  $\{t \mid 0 \leq t \leq 1\}$ .

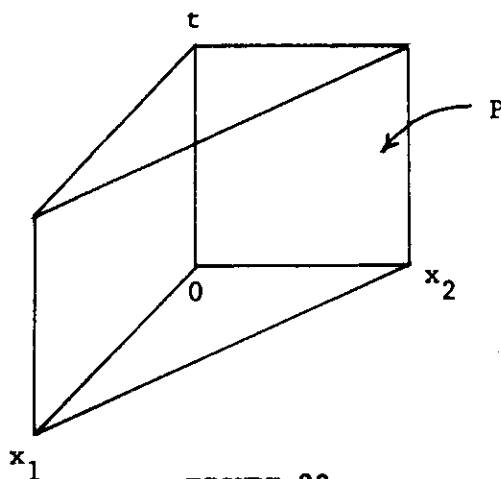

FIGURE 22

Let  $f(x)$  be the continuous mapping of the simplex  $S$  into itself, whose fixed point we wish to approximate. We interpret this mapping as carrying the lower face of  $P$  (where  $t = 0$ ) into  $S$  and on the upper face (where  $t = 1$ ) we construct some simple mapping whose fixed point is unique and easy to determine. For example the mapping on the upper simplex may carry every point into the same vector  $b$ .

A homotopy between these two mappings is a continuous mapping  $f(x,t)$  of  $P$  into  $S$  such that



$$f(x,0) \equiv f(x) , \quad \text{and}$$

$$f(x,1) \equiv b .$$

Such a homotopy may arise quite naturally in some applications in which a parameter  $t$  varies continuously in a closed interval or it may be constructed directly by assuming for example that

$$f(x,t) = t \cdot b + (1-t)f(x) .$$

We shall make the simplifying assumption--which can easily be brought about by embedding  $S$  in a larger simplex--that for each  $t$  ,  $f(x,t)$  maps the boundary of  $S$  into its interior.

The basic idea of the homotopy method is to trace a path of fixed points from the face  $t = 1$  , where the fixed point is given by  $x = b$  , until the path intersects the face  $t = 0$  . In order to carry this out in a piece-wise linear framework we assume that the polyhedron  $P$  is given a subdivision with vertices  $\{v^j = (x^j, t^j)\}$  . The subdivision may be quite arbitrary, but if we are concerned with an accurate estimate, the derived subdivision on the face  $t = 0$  should have a fine mesh.

We define the piecewise linear mapping of  $P$  into  $R^n$  by defining it first on the vertices of the subdivision and then extending the mapping linearly in each simplex of the subdivision. On a vertex  $(x^j, t^j)$  , we simply require that

$$F(x^j, t^j) = x^j - f(x^j, t^j) .$$

In order to evaluate  $F$  at a point  $(x,t)$  on the boundary of  $P$  we locate this point in a face of dimension  $n$  of some simplex of the subdivision, evaluate  $F$  on the  $(n+1)$  vertices of the face and

extend the definition linearly. Since every vertex on the face where  $t = 1$  is mapped by  $f(x,1)$  to  $b$ , we see that  $F(x,1) = x-b$ . A vertex  $(x,t)$  on the face where  $x_i = 0$  is carried into the interior of the simplex, so that  $f_i(x,t) > 0$  and therefore  $F_i(x,t) < 0$ . It follows that aside from the face of  $P$  on which  $t = 0$ , there is precisely one boundary point of  $P$  contained in  $F^{-1}(0)$ , i.e.  $x^* = (b,1)$ .

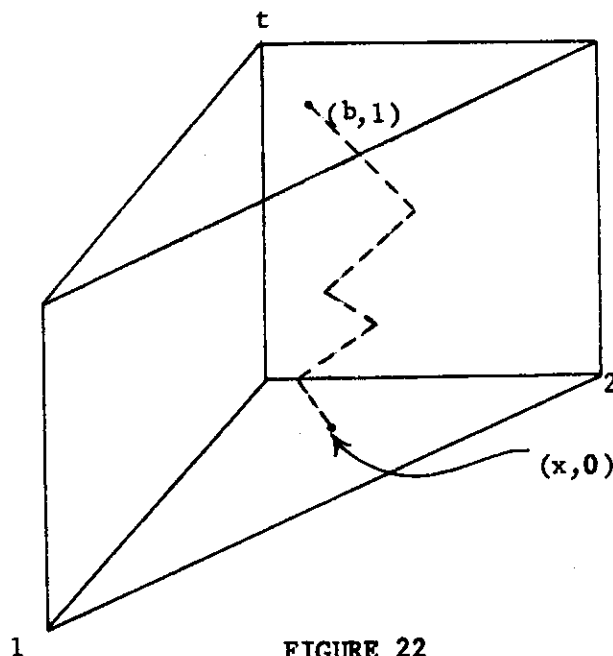

FIGURE 22

If  $0$  is a regular value of  $F$ , the path in  $F^{-1}(0)$  beginning at  $(b,1)$  must ultimately penetrate the face where  $t = 0$ , say at the point  $(x,0)$ . Let  $x$  be contained in a simplex in the derived subdivision on this face, with vertices  $v^1, v^2, \dots, v^n$  so that

$$x = \alpha_1 v^1 + \dots + \alpha_n v^n,$$

with  $\alpha_i \geq 0$  and  $\sum_1^n \alpha_i = 1$ . Then

$$0 = F(x,0) = - \sum_1^n \alpha_i f(v^i) + x.$$

If the subdivision is sufficiently fine on this face,  $f(v^i)$  will be approximately equal to  $f(x)$ , for all  $i$ , and  $x$  will serve as an approximate fixed point of the mapping. If, on the other hand  $0$  is not a regular value of  $F$ , Theorem 3.5 may be called upon to provide starting points on the face where  $t = 1$ , which are as close as we wish to  $(b,1)$ .

It is important to remark that the cylinder  $P$  can be continued below the face  $t = 0$ , and be given a simplicial subdivision which becomes increasingly fine. This permits the computational procedure to be prolonged until an approximate fixed point is reached, with an arbitrary accuracy which has been specified in advance.

#### Example IV

Our fourth example of the general methods of this paper will be the linear complementarity problem as treated by Lemke [16]. Consider a square  $n \times n$  matrix  $C$  and a vector  $c$  in  $R_n$ . A solution to the linear complementarity problem is a non-negative vector  $x$ , satisfying the system of linear inequalities

$$\sum_{j=1}^n c_{ij} x_j \geq c_i, \quad \text{for } i = 1, \dots, n,$$

with the additional proviso that  $x_i = 0$  for any index  $i$  with  $\sum_{j=1}^n c_{ij} x_j > c_i$ .

In order to place this problem in our setting we begin by defining  $n$  functions  $g^j(x_j)$ , each mapping  $R^1$  into  $R^n$ .

1. If  $x_j \geq 0$ ,

$$g^j(x_j) = \begin{pmatrix} c_j \\ \vdots \\ c_{nj} \end{pmatrix} x_j$$

2. If  $x_j \leq 0$ , then

$$g^j(x_j) = \begin{pmatrix} 0 \\ \vdots \\ 1 \\ \vdots \\ 0 \end{pmatrix} x_j,$$

with the single 1 appearing in the  $j^{\text{th}}$  entry of this vector.

We then define the piecewise linear function  $f(x_1, \dots, x_n)$ , mapping  $\mathbb{R}^n$  into  $\mathbb{R}^n$ , by

$$f(x_1, \dots, x_n) = \sum_{j=1}^n g^j(x_j).$$

It should be clear that a solution to the linear complementarity problem is obtained simply by finding a vector  $x$  for which  $f(x) = c$ . To see this we introduce the following notation. Let  $x = (x_1, \dots, x_n)$  be an arbitrary vector in  $\mathbb{R}^n$ . Then

$$x^+ = (\max(0, x_1), \dots, \max(0, x_n)) \text{ and}$$

$$x^- = (\min(0, x_1), \dots, \min(0, x_n)).$$

With this notation the equations  $f(x) = c$  become

$$Ix^- + Cx^+ = c.$$

Since  $x_i^+ \cdot x_i^- = 0$  for all  $i$ , the vector  $x^+$  is a solution to the linear complementarity problem.

The natural definition of the polyhedron  $P$  in  $R^{n+1}$  is the product of the half line  $[0, \infty)$  with  $R^n$ .  $F$  is then defined by

$$F(x_1, \dots, x_n, x_{n+1}) = f(x_1, \dots, x_n) + dx_{n+1}$$

with  $d$  a positive vector, strictly larger than  $c$  in all coordinates.

However, in order to avoid unbounded pieces of linearity we shall restrict

$P$  to be the bounded polyhedron

$$-M \leq x_i \leq M, \quad i = 1, \dots, n, \quad \text{and}$$

$$0 \leq x_{n+1} \leq 1,$$

for some large constant  $M$ . There are  $2^n$  pieces of linearity obtained by selecting an arbitrary subset of the coordinates greater than or equal to zero, with the complementary subset less than or equal to zero.

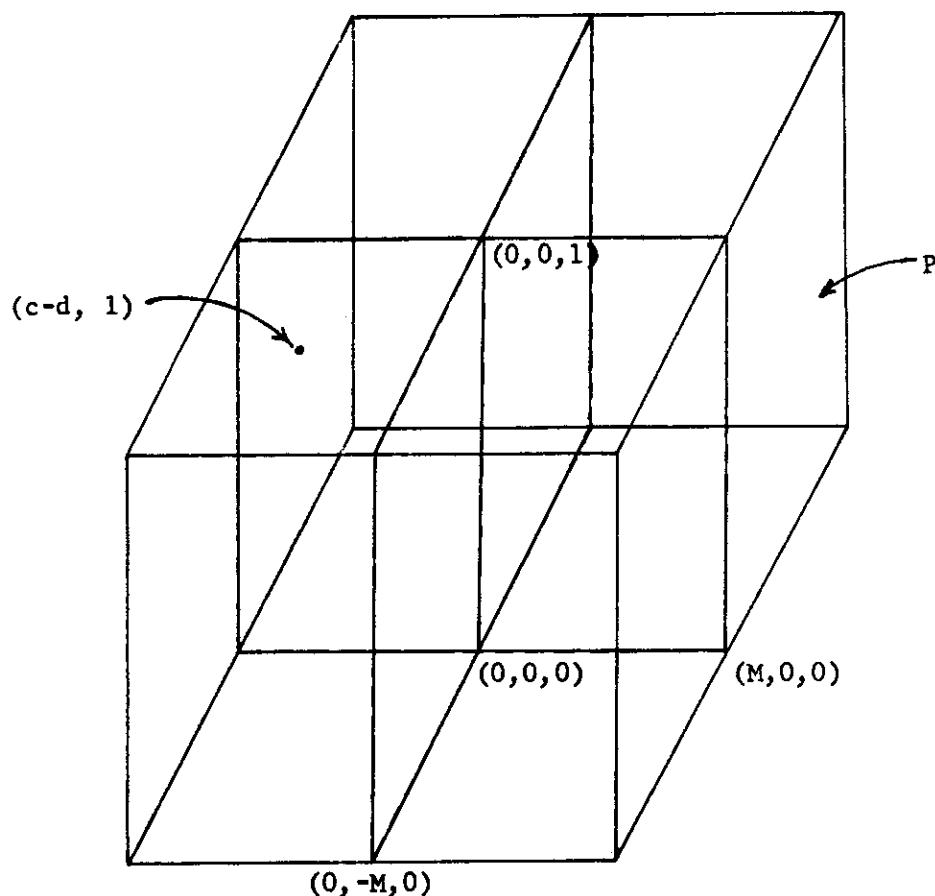

FIGURE 24

In order to solve the linear complementarity problem we find a boundary point of  $P$  in  $F^{-1}(c)$  and follow the piecewise linear path from this boundary point until it intersects the face  $x_{n+1} = 0$ , a procedure identical with that originally suggested by Lemke. One such vector is given by  $x = (c_1 - d_1, \dots, c_n - d_n, 1)$ . In general, there may be more than one boundary point of  $P$ , with  $x_{n+1} > 0$ , contained in  $F^{-1}(c)$ , and the path may exit from  $P$  without reaching the plane  $x_{n+1} = 0$ .

The literature contains a variety of different conditions which may be placed on the problem and which have the effect of implying that  $F^{-1}(c)$  intersects the boundary of  $P$  at a unique point with  $x_{n+1} > 0$ . One such condition is the following:

4.6. [Assumption] The matrix  $C$  will be assumed to have the property that if  $x \geq 0$ , and  $xCx \leq 0$ , then  $x = 0$ .

The condition of this assumption is known as "strict copositivity" as discussed by Lemke. It may equally well be stated as  $x \geq 0$ ,  $xf(x) \leq 0$  implies  $x = 0$ , a condition on the function  $f$  which is also known as "strict copositivity."

The equations  $F(x, x_{n+1}) = c$  may be written as

$$\begin{bmatrix} 1 & \dots & 0 \\ 0 & & 0 \\ \vdots & & \vdots \\ 0 & \dots & 1 \end{bmatrix} x^- + \begin{bmatrix} c_{11} & \dots & c_{1n} \\ \vdots & & \vdots \\ c_{n1} & \dots & c_{nn} \end{bmatrix} x^+ = c - x_{n+1}^d,$$

or

$$Cx^+ \geq c - x_{n+1}^d.$$

If we multiply these equations by  $x^+$ , and use the fact that  $x_i^+ \cdot x_i^- = 0$  for all  $i$ , we obtain

$$x^+ Cx^+ = c \cdot x^+ - x_{n+1}^d x^+.$$

Now let us examine the boundary points of  $P$  which lie in  $F^{-1}(c)$ .

1. The face  $x_{n+1} = 1$ .

Since  $d > c$  we see that on this face  $c \cdot x^+ - x_{n+1}^d x^+ \leq 0$ , so that  $x^+ Cx^+ \leq 0$ . From assumption 4.6 this implies that  $x^+ = 0$ , and the equations  $F(x, x_{n+1}) = c$  become

$$\begin{bmatrix} 1 & \dots & 0 \\ 0 & & 0 \\ \vdots & & \vdots \\ 0 & & 1 \end{bmatrix} x^- = c - d ,$$

yielding the unique solution on the upper face which we have previously remarked upon.

2. The remaining faces other than  $x_{n+1}^- = 0$ .

As we shall see, assumption 4.6 implies that there are no solutions of  $F(x) = c$  on these faces, for sufficiently large  $M$ . Let us assume, to the contrary, that as  $M \rightarrow \infty$ , there exist solutions  $x(M)$ , lying on these boundary faces and as a consequence having at least one of its coordinates tending to infinity.

Consider, as the first subcase, the possibility that one of the coordinates of  $x^+(M)$  tends to  $+\infty$ . But then, if  $y(M) = x^+(M)/\|x^+(M)\|$ , we have

$$y(M)Cy(M) = (c \cdot y(M) - x_{n+1}^+(M)dy(M))/\|x^+(M)\| .$$

If  $y$  is any limit point of the sequence  $y(M)$ , then  $\|y\| = 1$ , and from the above equation,  $yCy = 0$ . This contradicts assumption 4.6, and implies that  $x^+(M)$  is bounded.

We are therefore lead to the second subcase, namely  $x^+(M)$  is bounded and some component of  $x^-(M)$  tends to  $-\infty$ . But this is an immediate contradiction of the equations

$$Ix^-(M) + Cx^+(M) = c - x_{n+1}^-(M) \cdot d ,$$

since both  $Cx^+(M)$  and  $x_{n+1}^-(M)$  remain bounded.



We have therefore verified, that aside from the boundary face where  $x_{n+1} = 0$ , there is a unique point in  $F^{-1}(c)$  lying on the boundary of  $P$ . If  $c$  is a regular value of  $F$ , the path emanating from this point must terminate with a solution to  $f(x) = c$ . If  $c$  is not a regular value we simply perturb the boundary point in order to initiate the path.

### 5. The Index of a Solution

As the previous sections have shown, virtually all of our computational techniques for approximating fixed points can be viewed as following a piecewise linear path, contained in  $F^{-1}(c)$ , from one boundary point of the polyhedron  $P$  until a second boundary point is reached. By introducing the concepts of index theory it is possible to obtain a considerable increase in our understanding of such paths and consequently of solutions. As we shall see, each solution to  $F(x) = c$ , on the boundary of  $P$ , has associated with it an index which is either  $+1$  or  $-1$ . The index may be calculated entirely in terms of the local data specifying the solution, independently of the path which has been traversed. The important global theorem connecting these locally determined indices states that the sum of the indices over all solutions to  $F(x) = c$ , lying on the boundary of  $P$ , is zero.

We begin with a few general remarks about the concept of orientation. A set of  $n$  linearly independent vectors  $b^1, b^2, \dots, b^n$  in an  $n$  dimensional vector space determine a basis for this space. Any two such bases  $(b^1, b^2, \dots, b^n)$  and  $(\hat{b}^1, \hat{b}^2, \dots, \hat{b}^n)$  are said to have the same orientation if the determinant of the linear transformation carrying  $b$  into  $\hat{b}$  is positive. If the determinant is negative the

two bases have an opposite orientation. It is frequently useful to select a specific basis for a vector space and to describe its orientation as being positive. Any other basis for the same vector space will have a positive or negative orientation depending on whether its orientation agrees or disagrees with that of the standard basis.

A non-singular linear mapping  $T$  from one  $n$  dimensional vector space into another will have an index of  $+1$  if it maps positive bases into positive bases; in the contrary case the index is defined to be  $-1$ . In the special case in which the standard bases for both vector spaces are given by

$$\begin{aligned} b^1 &= (1, 0, \dots, 0) \\ b^2 &= (0, 1, \dots, 0) \\ &\vdots \\ b^n &= (0, 0, \dots, 1) \end{aligned}$$

the index is  $+1$  if the determinant of the linear transformation  $T$  is positive, and  $-1$  if the determinant is negative.

Such linear mappings arise naturally in the context of our problem. Let  $P$  be an  $n+1$  polyhedron,  $F$  a piecewise linear map into  $R^n$  and  $c$  a regular value of this map. Theorem 3.3 tells us that the set  $F^{-1}(c)$  is a finite union of paths, each of which touches the boundary of  $P$  at two points, and loops which have no intersection with the boundary of  $P$ . We shall assume that each path and loop in  $F^{-1}(c)$  is given a specific orientation. For a given path this means that the directions in each piece of linearity intersecting  $F^{-1}(c)$  are selected to be consistent with movement along the path from one endpoint to another; and for a loop, to be consistent with cyclic movement.

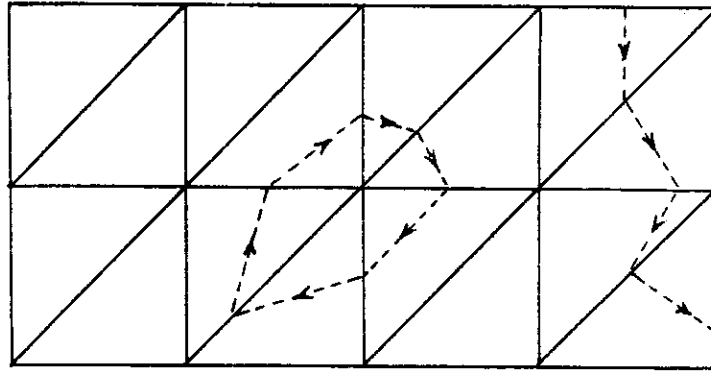

FIGURE 25

Now let us consider a piece of linearity  $P_i$  which has a non-empty intersection with a particular path or loop in  $F^{-1}(c)$  --an intersection which is a straight line segment connecting two distinct faces of dimension  $n$  of  $P_i$ . Assuming that the path begins at one such face and terminates at the other, its direction numbers will be given by a specific vector  $q$  in  $R^{n+1}$ , normalized in some conventional fashion. The reverse direction will, of course, be described by the vector  $-q$ .

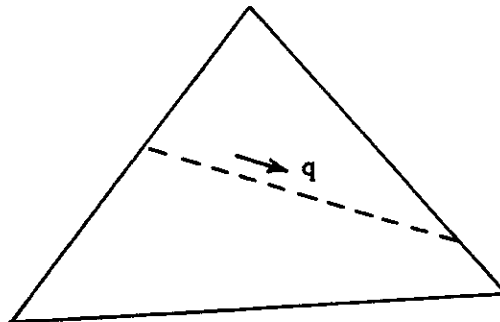

FIGURE 26

Now consider any hyperplane  $H$  of dimension  $n$  which intersects the straight line segment at a single point  $x$  in  $P_i$ , i.e.  $H$  is transversal to the path at  $x$ . The set of vectors  $(y-x)$ , for

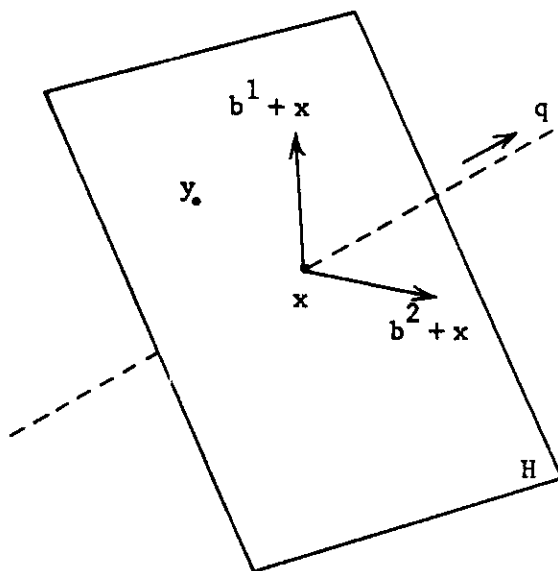

FIGURE 27

$y$  in  $H$ , form an  $n$  dimensional vector space which we shall denote by  $V_H$ .

We shall adopt the convention that a linearly independent set of vectors  $b^1, \dots, b^n$  in  $V_H$  has a positive orientation if the determinant

$$(5.1) \quad \det \begin{bmatrix} b_1^1 & b_1^2 & \dots & b_1^n & q_1 \\ b_2^1 & b_2^2 & \dots & b_2^n & q_2 \\ \vdots & \vdots & & \vdots & \vdots \\ b_{n+1}^1 & b_{n+1}^2 & \dots & b_{n+1}^n & q_{n+1} \end{bmatrix}$$

is positive, and has a negative orientation otherwise. This is equivalent to deriving the orientation of a basis in  $V_H$  from a standard orientation of the enveloping space,  $R^{n+1}$  and a given direction  $q$ , transversal to the plane  $H$ .

The mapping  $F$ , which is linear in  $P_i$  (and non-singular since  $c$  is a regular value) can be extended to a non-singular linear map of  $V_H$  into  $R^n$ . More specifically let  $F(x) = Ax + a$  in  $P_i$ , with  $A$  an  $n \times (n+1)$  matrix. Then vectors  $(y-x)$  in  $V_H$  are mapped into  $R^n$  by  $A(y-x)$ .

In order to determine the index of this map, we endow the target space  $R^n$  with the standard orientation, and consider a basis  $b^1, b^2, \dots, b^n$  of  $V_H$ . The index of the map is determined by comparing the orientation of  $b^1, \dots, b^n$  in  $V_H$  with the orientation of its image  $Ab^1, \dots, Ab^n$  in  $R^n$ . In other words we compare the sign of (5.1) with the sign of

$$(5.2) \quad \det(Ab^1, Ab^2, \dots, Ab^n) .$$

If the two determinants have the same sign the index is  $+1$ , if not  $-1$ .

The importance of this definition is displayed in the following lemma.

5.3. [Lemma] The index of the map from  $V_H$  to  $R^n$  is the same for all  $n$ -dimensional hyperplanes  $H$  which intersect the segment  $P_i \cap F^{-1}(c)$  in a single point.

The basic geometric idea behind this result is that the orientation of the various vector spaces  $V_H$  are all determined by the same direction  $q$  and the orientation of  $R^{n+1}$ . In order to give a formal proof, we shall simply demonstrate that the index is identical in sign to the determinant

$$\det \begin{bmatrix} a_{11} & a_{12} & \cdots & a_{1,n+1} \\ \vdots & \vdots & & \vdots \\ a_{n1} & a_{n2} & \cdots & a_{n,n+1} \\ q_1 & q_2 & \cdots & q_{n+1} \end{bmatrix} = \det \begin{bmatrix} A \\ q \end{bmatrix},$$

which is itself independent of the hyperplane  $H$ , and the point of intersection  $x$ .

We have

$$\begin{bmatrix} a_{11} & a_{12} & \cdots & a_{1,n+1} \\ \vdots & \vdots & & \vdots \\ a_{n1} & a_{n2} & \cdots & a_{n,n+1} \\ q_1 & q_2 & \cdots & q_{n+1} \end{bmatrix} \begin{bmatrix} b_1^1 & b_1^2 & \cdots & b_1^n & q_1 \\ \vdots & \vdots & & \vdots & \vdots \\ b_{n+1}^1 & b_{n+1}^2 & \cdots & b_{n+1}^n & q_{n+1} \end{bmatrix} \\ = \begin{bmatrix} \vdots & \vdots & & \vdots & 0 \\ Ab^1 & Ab^2 & \cdots & Ab^n & \vdots \\ \vdots & \vdots & & \vdots & 0 \\ \hline q \cdot b^1 & q \cdot b^2 & \cdots & q \cdot b^n & \|q\|^2 \end{bmatrix} = \|q\|^2 \det(Ab^1, \dots, Ab^n),$$

where we have used the fact that  $Aq = 0$ , since the function  $F$  is constant along the path with direction  $q$ . This concludes the proof of Lemma 5.3.

The index of the mapping from  $V_H$  to  $R^n$  is independent of the hyperplane  $H$  and the point of intersection  $x$  on the straight line segment  $P_i \cap F^{-1}(c)$ . In particular  $x$  may be selected to be either of the two endpoints of this line segment and  $H$  to be the  $n$  face of  $P_i$  through which the path enters or leaves this piece of linearity.

Calculating the index in this fashion also permits us to relate the index in two adjacent pieces of linearity containing parts of the same path or loop in  $F^{-1}(c)$ .

5.4. [Theorem] The index is identical for any two points of the same oriented path or loop in  $F^{-1}(c)$ , if  $c$  is a regular value of the mapping.

In order to demonstrate 5.4 we need only show that the index is unchanged when calculated in either of the two possible ways at a point  $x^*$  contained in a common  $n$  face  $H$  of two adjacent pieces of linearity  $P_1$  and  $P_2$ . Let  $x^*+b^1, x^*+b^2, \dots, x^*+b^n$  be a set of linearly independent vectors on this face, and let

$$F(x) = A^i x + a^i \quad \text{in } P_i, \quad \text{for } i = 1, 2.$$

The direction of the path in  $P_1$  is given by  $q^1$  and in  $P_2$  by  $q^2$ .

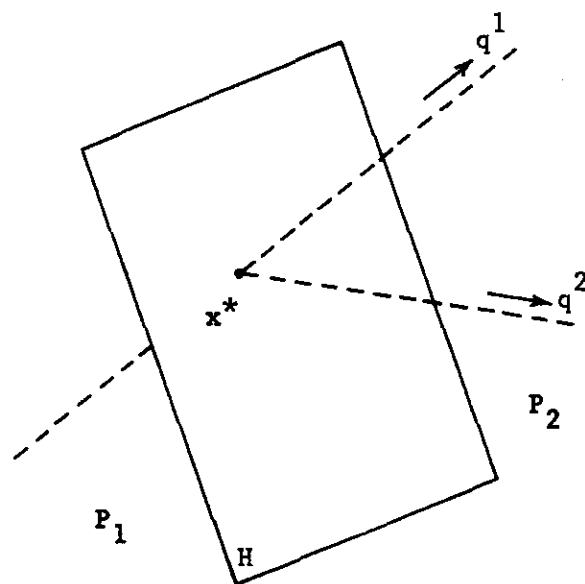

FIGURE 28

Since  $q^1$  and  $q^2$  point to the same side of  $H$ , we have

$$q^2 = \sum_1^n \alpha_j b^j + \theta q^1 \quad \text{with } \theta > 0 .$$

The two determinants

$$\det \begin{bmatrix} b_1^1 & \dots & b_1^n & q_1^i \\ b_2^1 & \dots & b_2^n & q_2^i \\ \vdots & & \vdots & \vdots \\ b_{n+1}^1 & \dots & b_{n+1}^n & q_{n+1}^i \end{bmatrix}$$

used in calculating the index in each of the two adjacent pieces of linearity will therefore have the same sign.

Since  $A^1 x + a^1 = A^2 x + a^2$  for all  $x$  in  $H$  we also see that

$$A^1(x^* + b^j) + a^1 = A^2(x^* + b^j) + a^2 ,$$

and therefore  $A^1 b^j = A^2 b^j$  for all  $j$  . It follows that the two determinants

$$\det(A^1 b^1, A^1 b^2, \dots, A^1 b^n)$$

are identical in each of the two computations. This demonstrates Theorem 5.4.

The index we have been discussing so far should be thought of as being defined at each point of an oriented path or loop in  $F^{-1}(c)$  . A more cumbersome but appropriate title would be "oriented curve index." The major conclusion of Theorem 5.4 is that this oriented curve index is identical at the two endpoints of a path contained in  $F^{-1}(c)$  .





FIGURE 29

At such an endpoint, however, it is appropriate to define the index in the following way, which is independent of orientation. Such an index might be thought of as a "boundary" index.

5.5. [Definition] Let  $x^*$  be a boundary point of  $F^{-1}(c)$ , contained in the relative interior of an  $n$  face  $H$  of some piece of linearity in which  $F(x) = Ax + a$ . Let  $x+b^1, x+b^2, \dots, x+b^n$  be a set of linearly independent vectors in  $H$ , and let  $q$  be an arbitrary direction pointing into  $P$  at  $x^*$ . The index of  $x^*$  is defined to be  $+1$  if the two determinants

$\det(Ab^1, Ab^2, \dots, Ab^n)$ , and

$$\det \begin{bmatrix} b_1^1 & \dots & b_1^n & q_1 \\ b_2^1 & \dots & b_2^n & q_2 \\ \vdots & & \vdots & \vdots \\ b_{n+1}^1 & \dots & b_{n+1}^n & q_{n+1} \end{bmatrix}$$

agree in sign, and  $-1$  otherwise.

In this definition the direction  $q$  is an arbitrary direction pointing into  $P$  at  $x^*$ , rather than the specific vector associated with the direction of the path in  $F^{-1}(c)$  which starts from  $x^*$ . This more general choice is possible since the sign of the second determinant

in definition 5.5 is the same for all directions pointing into  $P$ , by an argument identical with that used in the proof of Theorem 5.4.

With this definition the following theorem is an immediate consequence of our previous arguments.

5.6. [Theorem] Let  $c$  be a regular value of the piecewise linear map taking  $P$  into  $R^n$ . Then

$$\sum \text{index}(x) = 0,$$

with the summation taken over all  $x$  in  $F^{-1}(c)$  which also lie on the boundary of  $P$ .

## 6. Several Applications of Index Theory

In order to appreciate the additional information provided by index theory, we shall apply the results of the previous section to the examples studied earlier in this paper.

### Example I

We are given a simplicial subdivision of  $S = \{x = (x_1, \dots, x_n) \mid x_i \geq 0, \sum_{i=1}^n x_i \leq 1\}$  with vertices  $v^0, v^1, \dots, v^n, \dots, v^k$ , and with the property that

$$\begin{aligned} v^0 &= (0, 0, \dots, 0) \\ v^1 &= (1, 0, \dots, 0) \\ &\vdots \\ v^n &= (0, 0, \dots, 1), \end{aligned}$$

are the only vertices of the subdivision lying on the boundary of  $S$ .

Each vertex  $v$  is given an integer label  $l(v)$ , selected arbitrarily from the set  $(0, 1, \dots, n)$  except for the proviso that  $l(v^j) = j$  for  $j = 0, \dots, n$ .

The function  $f(x_1, \dots, x_n)$ , mapping  $S$  into itself, is defined to be linear in each simplex and equal to  $v^{l(x)}$  for each vertex  $x$  of the subdivision. The determination of a simplex with distinct labels is then equivalent to finding a vector  $x$  for which  $c = f(x)$  is interior to  $S$ .

The function  $f$  was then extended to the product of  $S$  and the closed unit interval by defining

$$F(x_1, \dots, x_n, x_{n+1}) = f(x_1, \dots, x_n) - dx_{n+1},$$

with  $d$  a vector all of whose coordinates are unity. A solution to the original problem is then obtained by finding a point  $(x_1, \dots, x_n, x_{n+1})$  in  $F^{-1}(c)$  lying on the face  $x_{n+1} = 0$

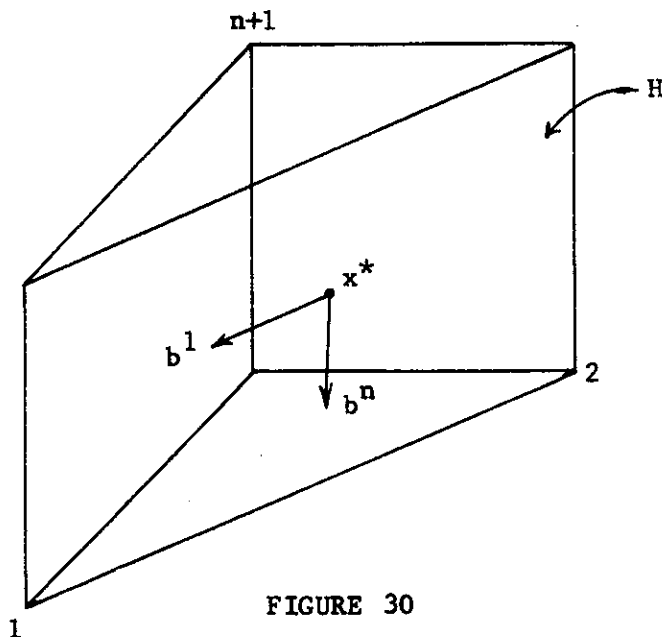

FIGURE 30

In our previous study of this example we argued that there was a unique point in  $F^{-1}(c)$  lying on some boundary face of  $P$  other than  $x_{n+1} = 0$ . In particular the point  $x^*$  lies on the face  $H$  defined by

$$\sum_{j=1}^n x_j = 1.$$

Let us select a basis  $b^1, \dots, b^n$  for the vector space  $H - x^*$ . The direction  $q$ , pointing into the polyhedron  $P$  at  $x^*$ , will be taken as

$$q = (-1, -1, \dots, -1).$$

The determinant

$$\det \begin{bmatrix} b_1^1 & \dots & b_1^n & -1 \\ b_2^1 & \dots & b_2^n & -1 \\ \vdots & & \vdots & \vdots \\ b_{n+1}^1 & \dots & b_{n+1}^n & -1 \end{bmatrix}$$

may therefore be written as

$$-\det \begin{bmatrix} b_1^1 - b_{n+1}^1 & \dots & b_1^n - b_{n+1}^n \\ \vdots & & \vdots \\ b_n^1 - b_{n+1}^1 & \dots & b_n^n - b_{n+1}^n \end{bmatrix}.$$

On the face  $\sum_{j=1}^n x_j = 1$ , the mapping  $F$  is given by

$$F(x_1, \dots, x_{n+1}) = \begin{cases} x_1 - x_{n+1} \\ \vdots \\ x_n - x_{n+1} \end{cases},$$

so that a basis vector  $(b_1^j, \dots, b_{n+1}^j)'$  is carried into  $(b_1^j - b_{n+1}^j, \dots, b_n^j - b_{n+1}^j)'$ . The two determinants used in evaluating the index at  $x^*$  are therefore opposite in sign, and the index of  $x^*$  equals  $-1$ .

We obtain the important conclusion that the sum of the indices associated with points in  $F^{-1}(c)$  for which  $x_{n+1} = 0$  (the solutions to our original problem) equals  $+1$ . Let us attempt to determine the index for such a solution  $x$ , lying in a completely labelled simplex with vertices  $v^{j_0}, \dots, v^{j_n}$ . For definiteness we assume that  $v^{j_0}$  bears the label  $0$ ,  $v^{j_1}$  the label  $1$ , etc.

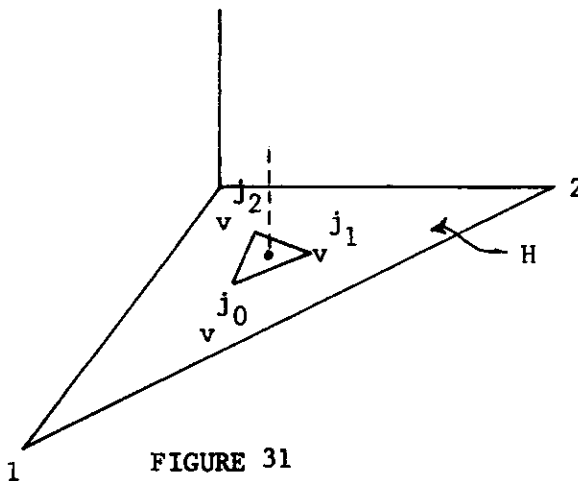

FIGURE 31

A basis for the hyperplane  $x_{n+1} = 0$  may be obtained by selecting  $b^i = v^{j_i} - v^{j_0}$  for  $i = 1, \dots, n$ , and the direction  $q$  as  $(0, 0, \dots, 0, 1)$ . The first determinant used in evaluating the index at  $x$  is therefore given by

$$\det \begin{bmatrix} v_1^{j_1} - v_1^{j_0} & \dots & v_1^{j_n} - v_1^{j_0} & 0 \\ \vdots & & \vdots & \vdots \\ v_n^{j_1} - v_n^{j_0} & \dots & v_n^{j_n} - v_n^{j_0} & 0 \\ 0 & & 0 & 1 \end{bmatrix}$$

$$= \det \begin{bmatrix} v_1^{j_1} - v_1^{j_0} & \dots & v_1^{j_n} - v_1^{j_0} \\ \vdots & & \vdots \\ v_n^{j_1} - v_n^{j_0} & \dots & v_n^{j_n} - v_n^{j_0} \end{bmatrix} .$$

In order to evaluate the second determinant we remark that  $F$  maps the basis vector  $v^{j_i} - v^{j_0}$  into the  $i^{\text{th}}$  unit vector in  $\mathbb{R}^n$ . The second determinant is therefore equal to unity. We have the following theorem.

6.1. [Theorem] Let  $v^{j_0}, v^{j_1}, \dots, v^{j_n}$  be the vertices of an arbitrary completely labelled simplex, and assume that  $v^{j_i}$  bears the label  $i$ . We define the index of the solution to be equal to  $+1$  if the determinant

$$\det \begin{bmatrix} v_1^{j_1} - v_1^{j_0} & \dots & v_1^{j_n} - v_1^{j_0} \\ \vdots & & \vdots \\ v_n^{j_1} - v_n^{j_0} & \dots & v_n^{j_n} - v_n^{j_0} \end{bmatrix}$$

is positive and  $-1$  if the determinant is negative. Then the sum of the indices over all completely labelled simplices is  $+1$ . Moreover a so-

lution obtained by initiating the algorithm on the boundary with  $x_{n+1} > 0$  will have an index of  $+1$ .

### Example II

We begin with a simplicial subdivision of the simplex

$S = \{(x = (x_1, \dots, x_n) | x_i \geq 0, \sum_{i=1}^n x_i = 1\}$ , with vertices  $v^1, v^2, \dots, v^n, v^{n+1}, \dots, v^k$ , where

$$\begin{aligned} v^1 &= (1, 0, \dots, 0) \\ &\vdots \\ v^n &= (0, 0, \dots, 1), \end{aligned}$$

and the remaining vertices interior to  $S$ . Each vertex has associated with it a vector label  $f(v^j)$ , arbitrary aside from the requirement that  $f(v^i) = v^i$  for  $i = 1, \dots, n$ . A specific non-negative vector  $c$  is given and we are concerned with finding a simplex in the subdivision, with vertices  $v^{j_1}, v^{j_2}, \dots, v^{j_n}$ , such that the equations

$$\alpha_1 f(v^{j_1}) + \alpha_2 f(v^{j_2}) + \dots + \alpha_n f(v^{j_n}) = c,$$

have a non-negative solution  $\alpha$ .

As we have previously seen, the procedure for converting this problem to the solution of a system of piecewise linear equations is to define the function  $f(x_1, \dots, x_n)$  in  $R_+^n$  by the conditions:

1.  $f(v^j)$  equals the vector label associated with the vertex  $v^j$  of the subdivision,
2.  $f$  is linear in each simplex of the subdivision, and
3.  $f$  is homogeneous of degree 1.

The problem is then equivalent to finding a vector  $x$  for which  $f(x) = c$ .

The polyhedron  $P$  is given by the product of the closed unit interval  $[0,1]$  with the set  $\{x = (x_1, \dots, x_n) \mid x_i \geq 0, \sum_1^n x_i \leq M\}$ , and the function  $F$  by

$$F(x_1, \dots, x_n, x_{n+1}) = f(x_1, \dots, x_n) - x_{n+1}^d.$$

In our earlier discussion we saw that  $d$  could be selected so that  $F^{-1}(c)$  contains a unique vector  $x^*$  on the boundary of  $P$ , with  $x_{n+1} > 0$ . The path emanating from this point must therefore reach the face  $x_{n+1} = 0$ , and provide us with a solution to  $f(x) = c$ .

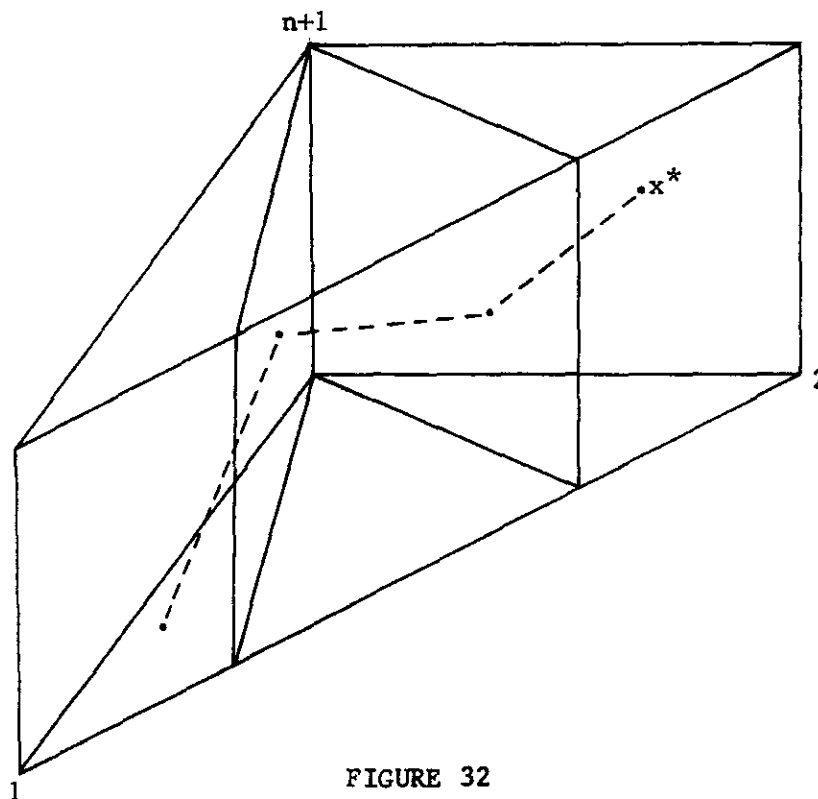

FIGURE 32

It is a routine matter to verify that the index associated with the point  $x^*$  is  $-1$ . The sum of the indices associated with the solutions lying on the face  $x_{n+1} = 0$  is therefore  $+1$ . Rather than



calculating this index directly let us take a slightly different approach and examine the index along the path traversed by the computational procedure.

In general, if the function  $F = Ax + a$  in some piece of linearity  $P_i$ , and if the direction of the path is given by the vector  $q$  in  $P_i$ , then the index along the path has the same sign as the determinant

$$\det \begin{bmatrix} a_{11} & a_{12} & \cdots & a_{1,n+1} \\ \vdots & \vdots & & \vdots \\ a_{n1} & a_{n2} & \cdots & a_{n,n+1} \\ q_1 & q_2 & \cdots & q_{n+1} \end{bmatrix} .$$

We may use the fact that  $Aq = 0$  to express the index in a different form. Assuming that  $q_{n+1} \neq 0$  we multiply the  $j^{\text{th}}$  column of this matrix by  $q_j/q_{n+1}$  and add it to the last column, for  $j = 1, \dots, n$ , obtaining

$$\det \begin{bmatrix} a_{11} & a_{12} & \cdots & \sum_1^{n+1} a_{1j} q_j / q_{n+1} \\ \vdots & \vdots & & \vdots \\ a_{n1} & a_{n2} & \cdots & \sum_1^n a_{nj} q_j / q_{n+1} \\ q_1 & q_2 & & \sum_1^n q_j^2 / q_{n+1} \end{bmatrix} .$$

Every entry in the last column of this matrix is zero, other than the diagonal entry, and we see that the index along the path has the same sign as

$$q_{n+1} \det \begin{bmatrix} a_{11} & \cdots & a_{1n} \\ \vdots & & \vdots \\ a_{n1} & \cdots & a_{nn} \end{bmatrix} .$$

Moreover, if  $q_{n+1} \neq 0$ , it follows that this determinant is different from zero. On the other hand, if  $q_{n+1} = 0$ , then it is easy to verify that the corresponding determinant is zero.

Let us attempt to calculate this matrix for the general vector labelling problem. A specific simplex in the subdivision with vertices  $v^{j_1}, \dots, v^{j_n}$  will define the piece of linearity consisting of all vectors  $(x_1, \dots, x_n, x_{n+1})$  with

$$(x_1, \dots, x_n) = \alpha_1 v^{j_1} + \dots + \alpha_n v^{j_n} ,$$

for  $\alpha_i \geq 0$ ,  $\sum_1^n x_j \leq M$ , and  $0 \leq x_{n+1} \leq 1$ . In this piece of linearity

$$F(x_1, \dots, x_n, x_{n+1}) = \alpha_1 f(v^{j_1}) + \dots + \alpha_n f(v^{j_n}) - x_{n+1} d .$$

If we define the two  $n \times n$  matrices

$$U = \begin{bmatrix} f_1(v^{j_1}) & \cdots & f_1(v^{j_n}) \\ \vdots & & \vdots \\ f_n(v^{j_1}) & \cdots & f_n(v^{j_n}) \end{bmatrix} , \text{ and}$$

$$V = \begin{bmatrix} j_1 & \dots & j_n \\ v_1 & \dots & v_n \\ \vdots & & \vdots \\ j_1 & \dots & j_n \\ v_n & \dots & v_n \end{bmatrix},$$

then the linear representation of  $F$  in this piece of linearity takes the form  $F(x_1, \dots, x_{n+1}) = UV^{-1}(x_1, \dots, x_n)' - x_{n+1}^d$ . We obtain the important conclusion that the index along the path, which must be equal to  $-1$ , is identical in sign with

$$q_{n+1} \det(UV^{-1}).$$

The quantity  $q_{n+1}$  has a specific interpretation. If it is positive the coordinate  $x_{n+1}$  is increasing in this piece of linearity and the path is therefore moving away from the plane  $x_{n+1} = 0$ . On the other hand if  $q_{n+1} < 0$  the path is approaching the plane  $x_{n+1} = 0$  and if  $q_{n+1} = 0$  the path is moving parallel to this plane. But from the index theorem the sign of  $q_{n+1}$  must be opposite to that of  $\det(UV^{-1})$  if this determinant is not zero. If the determinant is zero, then  $q_{n+1} = 0$ . This demonstrates the following theorem:

6.2. [Theorem] The path generated by the algorithm will be moving towards the plane  $x_{n+1} = 0$  in any piece of linearity in which  $\det(UV^{-1}) > 0$ , away from the plane if  $\det(UV^{-1}) < 0$ , and parallel to the plane if  $\det(UV^{-1}) = 0$ .

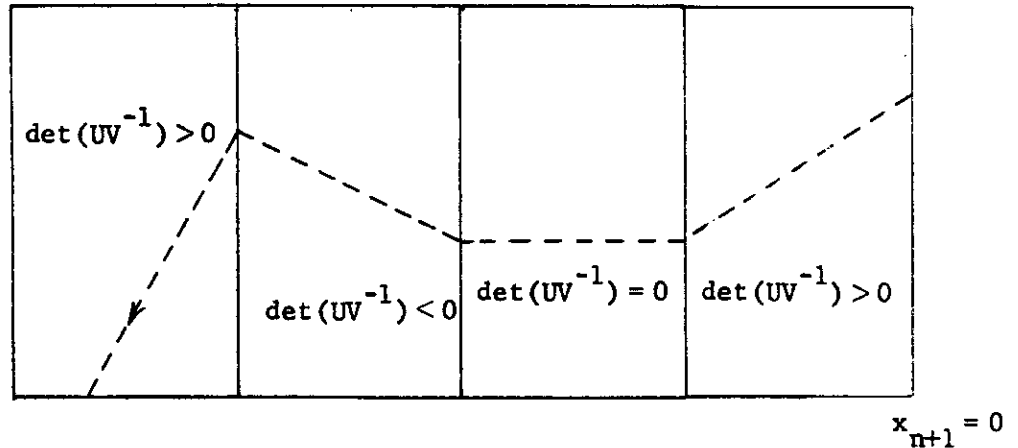

FIGURE 33

This result is significant in revealing the lack of monotonicity in approach to a solution which is characteristic of fixed point methods. In any two adjacent regions in which the determinants  $\det(UV^{-1})$  are different in sign the rate of change of  $x_{n+1}$  will differ in sign. In order to guarantee monotonicity of convergence it is necessary to require that  $\det(UV^{-1})$  have the same sign in every simplex of the subdivision, a property which holds only for rather special problems.

Of course,  $x_{n+1}$  must be decreasing in the final piece of linearity in which the determinant will therefore be positive. We have, in fact, the following theorem which characterizes the index of a solution on the plane  $x_{n+1} = 0$  in terms of the determinants  $\det(UV^{-1})$ .

6.3. [Theorem] Let  $v^{j_1}, \dots, v^{j_n}$  be the vertices of a completely labelled simplex, i.e. one for which  $U\alpha = c$  has a non-negative solution. The index of this solution, based on a direction pointing into  $P$ , is equal in sign to  $\det(UV^{-1})$ . The index sum over all completely labelled simplices is equal to  $+1$ .

The proof of Theorem 6.3 follows the same arguments which we have just presented and need not be given explicitly. It is appropriate to

remark, however, that the solution will be unique if it can be shown that  $\det(UV^{-1}) > 0$  for every simplex in the subdivision. For then each solution will have a positive index and there will, of necessity, be only one such solution. There are a number of important problems (for example the convex programming problem, and the non-linear complementarity problem when the Jacobian is a P-matrix) whose solutions can be shown to be unique, for sufficiently fine subdivisions, by this argument.

### Example III

In our third example the polyhedron  $P$  is given by the product of the closed unit interval  $[0,1]$  and the simplex  $S = \{x = (x_1, \dots, x_n) \mid x_i \geq 0, \sum_1^n x_i \leq 1\}$ . A continuous map  $f(x,t)$  from  $P$  into the interior of the simplex  $S$  is given with the property that  $f(x,1)$  maps the upper face  $t = 1$ , into a constant  $b$ .

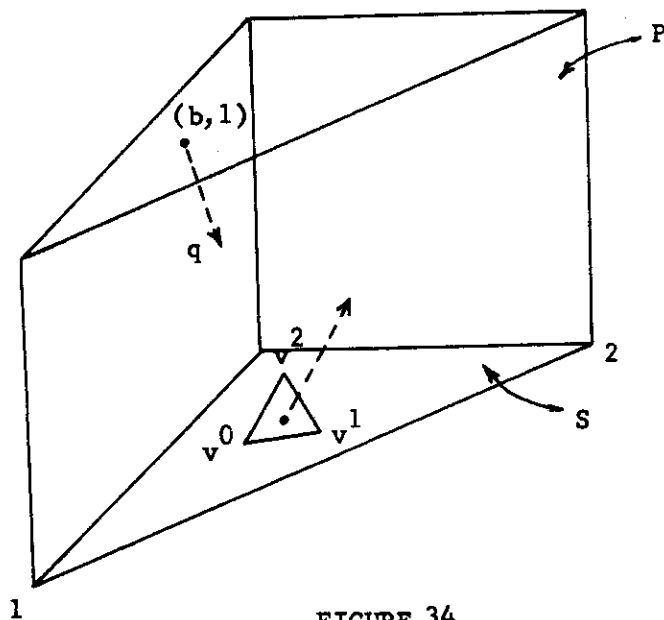

FIGURE 34

In order to approximate a fixed point of the mapping  $f(x,0)$ , of  $S$  into itself, we take a fine simplicial subdivision of  $P$ , with vertices  $\{(v^j, t^j)\}$ . For each such vertex we define

$$F(v^j, t^j) = v^j - f(v^j, t^j),$$

and extend the definition linearly in the interior of each simplex. An approximate fixed point of the mapping  $f(x,0)$  will be provided by a vector  $(x,0)$  in  $F^{-1}(0)$ .

As we have previously argued the vector  $(b,1)$  is the unique boundary point in  $F^{-1}(0)$ , with  $x_{n+1} > 0$ . In order to determine the index at this point we remark that  $F(x_1, \dots, x_n, t) = A(x_1, \dots, x_n, t)^t + a$ , in the piece of linearity containing  $(c,1)$ , with

$$A = \begin{bmatrix} +1 & \dots & 0 & a_{1,n+1} \\ 0 & \dots & 0 & a_{2,n+1} \\ \vdots & & \vdots & \vdots \\ 0 & & +1 & a_{n,n+1} \end{bmatrix}.$$

If  $q = (q_1, \dots, q_n, q_{n+1})$  is the direction of the path emerging from  $(0,1)$ , then as before the index has the same sign as

$$q_{n+1} \det \begin{bmatrix} +1 & \dots & 0 \\ 0 & & 0 \\ \vdots & & \vdots \\ 0 & & +1 \end{bmatrix}.$$

Since  $q_{n+1} < 0$ , this index is equal to  $-1$ .

The sum of the indices associated with the approximate fixed points of  $f(x,0)$  is therefore equal to  $+1$ . Consider a particular  $(x,0) \in F^{-1}(0)$ , and let  $x$  be contained in a simplex on the face  $t = 0$ , with vertices  $v^0, v^1, \dots, v^n$ . The index of  $x$  then has the same sign as  $\det B$  if

$$F(x,0) = Bx + a$$

within this particular simplex.

Let  $x = \sum_1^n \alpha_j v^j$ , with  $\alpha_j \geq 0$  and  $\sum_0^n \alpha_j = 1$ , or alternatively

$$x = v^0 + \sum_1^n \alpha_j (v^j - v^0).$$

If we define

$$V = \begin{bmatrix} v_1^1 - v_1^0 & \dots & v_1^n - v_1^0 \\ \vdots & & \vdots \\ v_n^1 - v_n^0 & \dots & v_n^n - v_n^0 \end{bmatrix}$$

then  $(\alpha_1, \dots, \alpha_n)' = V^{-1}(x - v^0)$ .

With this representation for  $x$ , we have  $F(x,0) = F(v^0, 0) + \sum_1^n \alpha_j (F(v^j, 0) - F(v^0, 0))$ , so that if

$$U = \begin{bmatrix} F_1(v^1, 0) - F_1(v^0, 0) & \dots & F_1(v^n, 0) - F_1(v^0, 0) \\ \vdots & & \vdots \\ F_n(v^1, 0) - F_n(v^0, 0) & \dots & F_n(v^n, 0) - F_n(v^0, 0) \end{bmatrix}$$

it will be correct that

$$F(x, 0) = F(v^0, 0) + UV^{-1}(x - v^0) .$$

The index of the solution is therefore identical in sign with  $\det UV^{-1}$  .

#### Example IV

In order to study the linear complementarity problem

$$\sum_{j=1}^n c_{ij} x_j \geq c_i , \quad \text{for } i = 1, \dots, n$$

with  $x = (x_1, \dots, x_n) \geq 0$  ( $x_i = 0$  if  $\sum_{j=1}^n c_{ij} x_j > c_i$ ), we introduced the function  $f(x_1, \dots, x_n)$ , defined for all vectors in  $R^n$ , as follows:

$$f(x) = Ix^- + Ax^+ .$$

The polyhedron  $P$ , in  $R^{n+1}$ , is the cube

$$-M \leq x_i \leq M , \quad \text{for } i = 1, \dots, n ,$$

$$0 \leq x_{n+1} \leq 1 ,$$

and the piecewise linear function  $F$  is given by

$$F(x_1, \dots, x_n, x_{n+1}) = f(x_1, \dots, x_n) + x_{n+1}^d ,$$

with  $d$  a positive vector strictly larger than  $c$  .



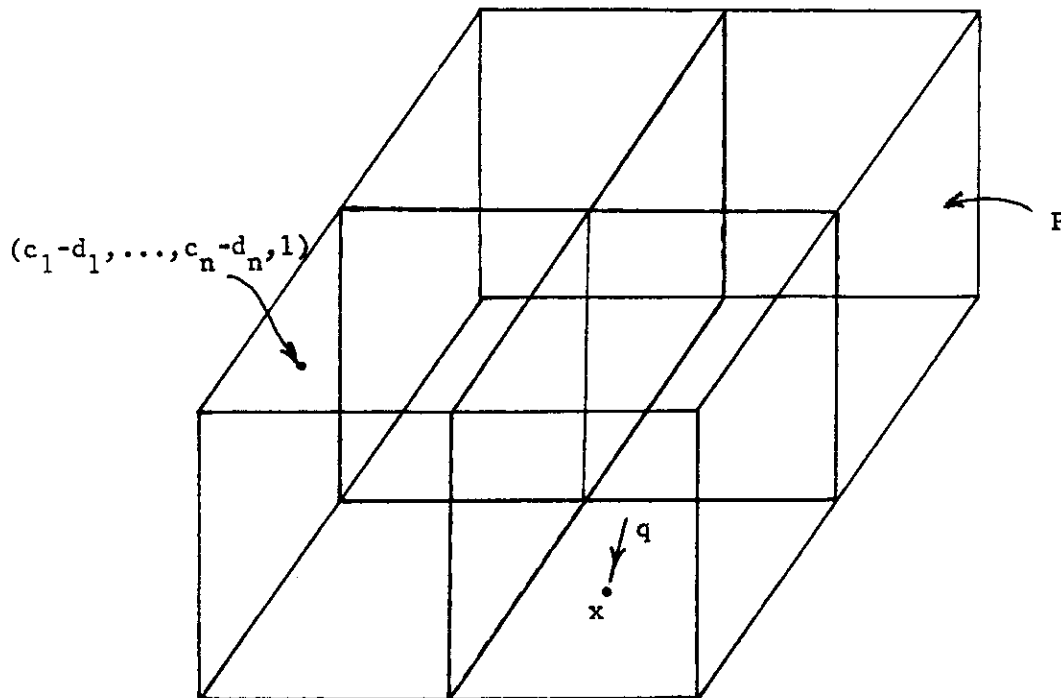

FIGURE 35

The polyhedron  $P$  is naturally divided into  $2^n$  pieces of linearity, each obtained by selecting a specific subset  $S$  of the integers  $(1, \dots, n)$  for which the coordinates  $x_i$ , for  $i \in S$ , are non-negative.

The linear complementarity problem is solved by finding a vector  $(x_1, \dots, x_{n+1})$  in  $F^{-1}(c)$ , for which  $x_{n+1} = 0$ . In our previous study of the problem we demonstrated that under certain assumptions on the matrix  $C$ , there would be a unique boundary point of  $P$  in  $F^{-1}(c)$ , on those faces of  $P$  other than the face  $x_{n+1} = 0$ . The specific boundary point is given by  $(c_1 - d_1, \dots, c_n - d_n, 1)$ .

It is a trivial matter to verify that the index associated with this boundary point is  $-1$ . Assuming it to be the unique boundary point in  $F^{-1}(c)$  lying above the face  $x_{n+1} = 0$ , we conclude that the sum of the indices associated with solutions to the original linear comple-

mentarity problem is unity. Let us calculate the index associated with a solution  $x$  on the lower face of  $P$ .

Let  $x$  be contained in a piece of linearity defined by the index set  $S$ . In other words  $x_i \geq 0$  for  $i \in S$  and  $\leq 0$  for  $i \notin S$ . Let  $(q_1, \dots, q_n, q_{n+1})$  be the direction of the path terminating at  $x$ , and observe that  $q_{n+1} < 0$ . As in Example II the index along the path (which must be  $-1$ , since that is its value at the beginning of the path) agrees in sign with

$$q_{n+1} \det \begin{bmatrix} a_{11} & \dots & a_{1n} \\ \vdots & & \vdots \\ a_{n1} & \dots & a_{nn} \end{bmatrix},$$

where  $F(x) = Ax + a$  in this piece of linearity.

This latter determinant is very easy to evaluate. For  $j \in S$ , its  $j^{\text{th}}$  column is given by

$$(c_{1j}, c_{2j}, \dots, c_{nj})',$$

and for  $j \notin S$  its  $j^{\text{th}}$  column consists of 0's and a single 1 appearing in row  $j$ . We see that the index of a solution is given by the sign of the determinant of that principal minor of

$$C = \begin{bmatrix} c_{11} & \dots & c_{1n} \\ \vdots & & \vdots \\ c_{n1} & \dots & c_{nn} \end{bmatrix},$$

whose rows and columns have indices belonging to  $S$ .

Just as in Example II, these observations provide us with considerable information along the path. Each piece of linearity will have associated with it a principal minor of  $C$  obtained by striking out those rows and columns of  $C$  corresponding to indices  $j$  for which  $x_j < 0$  in this piece of linearity. If the determinant of this principal minor is positive, then  $q_{n+1} < 0$  and the path is approaching the plane  $x_{n+1} = 0$ . Conversely if the determinant is negative the path is moving along from a solution in this piece of linearity. It follows that monotonicity of the path can only be guaranteed if the matrix  $C$  has all of its principal minors positive, i.e. if  $C$  is a P-matrix. Similar conclusions may also be obtained for the non-linear complementarity problem in which the functions  $\sum_j c_{ij} x_j$  are replaced by non-linear functions defined in  $R_+^n$ .

The algorithm described and studied by Katzenelson, Fujisawa and Kuh and others is in a setting somewhat more general than that of Lemke. Let  $f : R^n \rightarrow R^n$  be piecewise linear and consider the problem of solving  $f(x) = y$ . Let  $x_0$  be an estimate of the solution, let  $y_0 = f(x_0)$  and let

$$F(x,t) = f(x) - ty_0 - (1-t)y.$$

Katzenelson's algorithm, as extended by Chien and Kuh consists of generating a path in  $F^{-1}(0)$ , beginning with the point  $(x_0, 1)$ , in order to find a point  $(x, 0) \in F^{-1}(0)$ . Convergence of the algorithm is established by these authors under a variety of assumptions on the Jacobian of the mapping; these results can equally well be obtained by the use of index theory as described in this paper.

## BIBLIOGRAPHY

- [1] Chien, M. J. and E. S. Kuh. "Solving Piecewise-Linear Equations for Resistive Networks," Memorandum No. ERL-M471, 10 Sept. 1974, College of Engineering, University of California, Berkeley.
- [2] Cohen, D. I. A. "On the Sperner Lemma," Journal of Combinatorial Theory, Vol. 2 (1967), 585-587.
- [3] Cottle, R. W. and G. B. Dantzig. "A Generalization of the Linear Complementarity Problem," Jour. Combinatorial Th., 8, 1 (1970), 79-90.
- [4] Eaves, B. C. "An Odd Theorem," Proceedings of A.M.S., 26, 3 (November, 1970), 509-513.
- [5] \_\_\_\_\_. "Computing Kakutani Fixed Points," SIAM J. Appl. Math., 21, 2 (September, 1971), 236-244.
- [6] \_\_\_\_\_. "Homotopies for Computation of Fixed Points," Mathematical Programming, 3, 1 (August, 1972), 1-22.
- [7] \_\_\_\_\_ and R. Saigal. "Homotopies for Computation of Fixed Points on Unbounded Regions," Math. Prog., 3, 2 (October, 1972), 225-237.
- [8] Eaves, B. C. "Solving Piecewise Linear Convex Equations," Mathematical Programming, Study 1 (November, 1974), 96-119.
- [9] Fan, K. "Simplicial Maps from an Orientable n-Pseudomanifold into  $S^m$  with the Octahedral Triangulation," Jour. of Combinatorial Th., 2, 4 (June, 1967), 588-602.
- [10] Fujisawa, T. and E. S. Kuh. "Piecewise-Linear Theory of Nonlinear Networks," SIAM J. Appl. Math., 22, 2 (March, 1972), 307-328.
- [11] Hirsch, M. W. "A Proof of the Nonretractibility of a Cell onto Its Boundary," Proceedings of A.M.S., 14 (1963), 364-365.
- [12] Katzenelson, J. "An Algorithm for Solving Nonlinear Resistor Networks," Bell Telephone Tech. Journal, 44 (1965), 1605-1620.
- [13] Kuhn, H. W. "Simplicial Approximation of Fixed Points," Proceedings of the National Academy of Sciences, U.S.A., 61 (1968), 1238-42.
- [14] \_\_\_\_\_. "A New Proof of the Fundamental Theorem of Algebra," Mathematical Programming, Study 1 (November, 1974), 148-158.
- [15] Lemke, C. E. and J. T. Howson, Jr., "Equilibrium Points of Bimatrix Games," J. Soc. Indust. Appl. Math., 12(2) (June, 1964).

- [16] Lemke, C. E. "Bimatrix Equilibrium Points and Mathematical Programming," Management Science, 11, 7 (1965), 681-689.
- [17] \_\_\_\_\_. "On Generalizing Shapley's Index Theory," Troy, New York, Rensselaer Polytechnical Institute, Interim Report, October, 1974.
- [18] Merrill, Orin H. Applications and Extensions of an Algorithm That Computes Fixed Points of Certain Non-Empty Convex Upper Semi-Continuous Point to Set Mappings, Ph.D. Dissertation, University of Michigan, 1971.
- [19] Milnor, J. W. Topology from the Differentiable Viewpoint. Charlottesville, Va.: The University Press of Virginia, 1965.
- [20] Scarf, Herbert E. "The Approximation of Fixed Points of a Continuous Mapping," SIAM Journal of Applied Math, 15 (1967), 1328-42.
- [21] \_\_\_\_\_. "The Core of an N Person Game," Econometrica, 37 50-69.
- [22] \_\_\_\_\_. The Computation of Economic Equilibria (in collaboration with T. Hansen). New Haven: Yale University Press, 1973.
- [23] Shapley, L. S. "A Note on the Lemke-Howson Algorithm," Mathematical Programming, Study 1 (November, 1974), 175-189.
- [24] \_\_\_\_\_. "On Balanced Games without Side Payments," Mathematical Programming, ed. by T. C. Hu and S. M. Robinson, New York: Academic Press, 1973.