

INFORMATION TO USERS

This material was produced from a microfilm copy of the original document. While the most advanced technological means to photograph and reproduce this document have been used, the quality is heavily dependent upon the quality of the original submitted.

The following explanation of techniques is provided to help you understand markings or patterns which may appear on this reproduction.

1. The sign or "target" for pages apparently lacking from the document photographed is "Missing Page(s)". If it was possible to obtain the missing page(s) or section, they are spliced into the film along with adjacent pages. This may have necessitated cutting thru an image and duplicating adjacent pages to insure you complete continuity.
2. When an image on the film is obliterated with a large round black mark, it is an indication that the photographer suspected that the copy may have moved during exposure and thus cause a blurred image. You will find a good image of the page in the adjacent frame.
3. When a map, drawing or chart, etc., was part of the material being photographed the photographer followed a definite method in "sectioning" the material. It is customary to begin photoing at the upper left hand corner of a large sheet and to continue photoing from left to right in equal sections with a small overlap. If necessary, sectioning is continued again — beginning below the first row and continuing on until complete.
4. The majority of users indicate that the textual content is of greatest value, however, a somewhat higher quality reproduction could be made from "photographs" if essential to the understanding of the dissertation. Silver prints of "photographs" may be ordered at additional charge by writing the Order Department, giving the catalog number, title, author and specific pages you wish reproduced.
5. PLEASE NOTE: Some pages may have indistinct print. Filmed as received.

University Microfilms International

300 North Zeeb Road
Ann Arbor, Michigan 48106 USA
St. John's Road, Tyler's Green
High Wycombe, Bucks, England HP10 8HR

77-13,408

WETHERINGTON, Cora Lee, 1947-
SOME EFFECTS OF THE INTERFOOD INTERVAL ON
SCHEDULE-INDUCED DRINKING.

The University of North Carolina at
Greensboro, Ph.D., 1976
Psychology, experimental

Xerox University Microfilms, Ann Arbor, Michigan 48106

SOME EFFECTS OF THE INTERFOOD INTERVAL
ON SCHEDULE-INDUCED DRINKING

by

Cora Lee Wetherington

A Dissertation Submitted to
the Faculty of the Graduate School at
The University of North Carolina at Greensboro
in Partial Fulfillment
of the Requirements for the Degree
Doctor of Philosophy

Greensboro
1976

Approved by

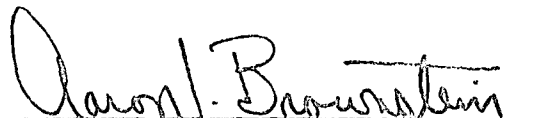
Dissertation Adviser

APPROVAL PAGE

This dissertation has been approved by the following committee of the Faculty of the Graduate School at the University of North Carolina at Greensboro.

Dissertation Adviser

Aaron J. Eisenstein

Committee Members

Robert L. Shurt

Richard T. Whitlock

Robert J. Casper

Leslie Smith

June 22, 1976
Date of Acceptance by Committee

WETHERINGTON, CORA LEE. Some Effects of the Interfood Interval on Schedule-Induced Drinking. (1976) Directed by: Dr. Aaron J. Brownstein. Pp. 225

Schedule-induced drinking was studied in four male albino rats when food was presented at regular intervals ranging from 15 to 480 secs. Water was available at all times during the course of the experiment.

Several measures of schedule-induced drinking were examined as a function of the interfood interval. The measures were referred to as reflecting either the strength of drinking or its temporal location. The temporal location was assessed by determining the frequency distribution of both time between pellet delivery and the first lick (initiation time) and time between pellet delivery and the last lick (termination time).

As the interfood interval value was manipulated, regularities were observed in several measures of the strength of drinking. First, the inverted U-shaped function reported in previous studies regarding the number of licks, volume, and time spent drinking was observed. Second, the overall lick rate, ingestion rate, and relative time, each computed with respect to session time, were well described as negative power functions of the interfood interval. Third, the corresponding local measures, obtained by using only the time provided by the number of intervals with a lick, provided a better fit to a power function. This fit was further improved by subtracting a time constant representing some minimum

delay between pellet delivery and the first lick. The significance of this computation was discussed with reference to explication of the bitonic functions, and also with reference to some other schedule-induced behavior.

The frequency distributions of initiations were extremely skewed to the right. The means and medians were well described by power functions with exponents less than 1.00. The medians indicated that 50 percent of the initiations were usually less than 30 secs. Examination of the frequency distribution within the first 30 secs. after food revealed that the probability of drinking rose quickly after food, reached a prominent peak, and quickly declined. This peak became less prominent and the functions fell more slowly as the interfood interval increased. The means and medians of the initiation distributions for the first 30 secs. after food were increasing functions of the interfood interval.

The frequency distributions of terminations were extremely skewed to the left. The means and medians were well described by power functions with exponents less than 1.00. Correction of the termination distributions for the opportunities for a termination revealed trends for the distribution to shift to the left as the interfood interval increased.

The time between the occurrence of the first lick and the last lick in an interval was referred to as the "drinking state." Examination of this time period revealed the following relationships: (1) A small, significant negative correlation occurred between the time of onset of the drinking state

and its duration. (2) The probability of being in the drinking state was an inverted U-shaped function of the proportion of the interfood interval. (3) The time at which the probability of being in the drinking state was maximal was a power function of the interfood interval with an exponent less than 1.00. (4) The duration of the drinking state increased as a function of the interfood interval, but occupied proportionately less of the interval as the interfood interval increased. Several of these findings were discussed in reference to data reported by Killeen (1975).

ACKNOWLEDGMENTS

Sincere appreciation is extended to the members of my Doctoral Committee, Drs. Richard L. Shull, Kendon L. Smith, Robert G. Eason, and Richard L. Whitlock, for their interest, critical reading of the manuscript, and helpful suggestions. Special gratitude belongs to Dr. Aaron J. Brownstein, Dissertation Adviser, for his valuable assistance and encouragement in the preparation of this dissertation.

TABLE OF CONTENTS

	Page
APPROVAL PAGE	ii
ACKNOWLEDGMENTS	iii
LIST OF TABLES	v
LIST OF FIGURES	vi
CHAPTER	
I. INTRODUCTION	1
II. METHOD	6
Subjects	6
Apparatus	6
Procedure	7
III. RESULTS	9
Molar and Molecular Measures of Schedule-	
Induced Drinking	9
Molar Measures	9
Molecular Measures	26
Summary of the Molar and Molecular Measures	41
Distributions of the Initiation and Termina-	
tion of Schedule-Induced Drinking	41
Analysis of the Initiation Distribution	44
Analysis of the Termination Distribution	137
The Relation between the Initiation and	
Termination Distributions	177
IV. DISCUSSION	203
The Strength of Schedule-Induced Drinking	203
The Temporal Location of Adjunctive Behavior	212
V. SUMMARY	221
BIBLIOGRAPHY	223

LIST OF TABLES

Table	Page
1 Order of Experimental Conditions and Number of Sessions in Parentheses for Each Rat.	8
2 Equations for Best-Fit Line, \bar{r} and \bar{r}^2 for Overall Lick Rate, Overall Ingestion Rate, and Relative Time for Each Rat.	25
3 Equations for Best-Fit Line, \bar{r} , and \bar{r}^2 for Local Lick Rate, Local Ingestion Rate, and Local Relative Time for Each Rat.	33
4 Equations for Best-Fit Line, \bar{r} , and \bar{r}^2 for Mean, Median, and Mode of Initiation Distribution for Each Rat.	51
5 Equations for Best-Fit Line, \bar{r} , and \bar{r}^2 for Means and Medians of Drinking Initiations in the First 30 Secs. after Food for Each Rat.	136
6 Equations for Best-Fit Line, \bar{r} , and \bar{r}^2 for the Mean, Median, and Mode of Termination Distribution for Each Rat	144
7 Correlation between Initiation Time and Duration of Drinking State for Each Rat for Each Condition. Significance Level Indicated in Parentheses	178
8 Equations for Best-Fit Line, \bar{r} , and \bar{r}^2 for \bar{t} at Maximal Probability of Being in Drinking State for Each Rat.	193
9 Equations for Best-Fit Line, \bar{r} , and \bar{r}^2 for Corrected Overall Lick Rate, Overall Ingestion Rate, and Relative Time for Each Rat.	208
10 Equations for Best-Fit Line, \bar{r} , and \bar{r}^2 for Corrected Local Lick Rate, Local Ingestion Rate, and Relative Time for Each Rat.	210

LIST OF FIGURES

Figure	Page
1. Number of licks, plotted as a function of the FT value	10
2. Water volume (ml), plotted as a function of the FT value	12
3. Time spent drinking, plotted as a function of the FT value	14
4. Number of interfood intervals with a lick, plotted as a function of the FT value.	16
5. Overall lick rate, plotted as a function of the FT value	19
6. Overall ingestion rate, plotted as a function of the FT value.	21
7. Overall relative time spent drinking, plotted as a function of the FT value.	23
8. Local lick rate, plotted as a function of the FT value	27
9. Local ingestion rate, plotted as a function of the FT value	29
10. Local relative time spent drinking, plotted as a function of the FT value	31
11. Licking tempo, plotted as a function of the FT value.	35
12. Ingestion tempo, plotted as a function of the FT value	37
13. Volume per lick, plotted as a function of the FT value	39
14. Schematic of an interfood interval, showing initiation time and termination time	42
15a. Mean, mode, and median of frequency distribution of initiations for Rat J-7, plotted as a function of the FT value	45

Figure	Page
15b. Mean, mode, and median of frequency distribution of initiations for Rats J-10 and J-11, plotted as a function of the FT value	47
15c. Mean, mode, and median of frequency distribution of initiations for Rat J-12, plotted as a function of the FT value	49
16a. Simple probability of an initiation, for Rat J-7, first determination, plotted as a function of proportions of the FT	54
16b. Simple probability of an initiation, for Rat J-7, second determination, plotted as a function of proportions of the FT	56
16c. Simple probability of an initiation, for Rat J-10, plotted as a function of proportions of the FT	58
16d. Simple probability of an initiation, for Rat J-11, plotted as a function of proportions of the FT	60
16e. Simple probability of an initiation, for Rat J-12, plotted as a function of proportions of the FT	62
17a. Relative frequency of initiations, for Rat J-7, first determination, plotted as a function of proportions of the FT	64
17b. Relative frequency of initiations, for Rat J-7, second determination, plotted as a function of proportions of the FT.	66
17c. Relative frequency of initiations, for Rat J-10, plotted as a function of proportions of the FT.	68
17d. Relative frequency of initiations, for Rat J-11, plotted as a function of proportions of the FT.	70
17e. Relative frequency of initiations, for Rat J-12, plotted as a function of proportions of the FT.	72

Figure	Page
18a. Probability of an initiation per opportunity, for Rat J-7, first determination, plotted as a function of proportions of the FT . . .	75
18b. Probability of an initiation per opportunity, for Rat J-7, second determination, plotted as a function of proportions of the FT . . .	77
18c. Probability of an initiation per opportunity, for Rat J-10, plotted as a function of proportions of the FT	79
18d. Probability of an initiation per opportunity, for Rat J-11, plotted as a function of proportions of the FT	81
18e. Probability of an initiation per opportunity, for Rat J-12, plotted as a function of proportions of the FT	83
19a. <u>Left-hand panel.</u> Probability an initiation has occurred at given proportions of the FT, for Rat J-7, first determination	86
<u>Right-hand panel.</u> Probability a termination has not occurred at given proportions of the FT, for Rat J-7, first determination . .	86
19b. <u>Left-hand panel.</u> Probability an initiation has occurred at given proportions of the FT, for Rat J-7, second determination.	88
<u>Right-hand panel.</u> Probability a termination has not occurred at given proportions of the FT, for Rat J-7 (2), second determination. .	88
19c. <u>Left-hand panel.</u> Probability an initiation has occurred at given proportions of the FT, for Rat J-10	90
<u>Right-hand panel.</u> Probability a termination has not occurred at given proportions of the FT, for Rat J-10	90
19d. <u>Left-hand panel.</u> Probability an initiation has occurred at given proportions of the FT, for Rat J-11	92
<u>Right-hand panel.</u> Probability a termination has not occurred at given proportions of the FT, for Rat J-11	92

Figure	Page
19e. <u>Left-hand panel</u> . Probability an initiation has occurred at given proportions of the FT, for Rat J-12	94
<u>Right-hand panel</u> . Probability a termination has not occurred at given proportions of the FT, for Rat J-12	94
20a. Simple probability of an initiation for Rat J-7, first determination, plotted as a function of consecutive 2-sec time periods after food	97
20b. Simple probability of an initiation for Rat J-7, second determination, plotted as a function of consecutive 2-sec time periods after food	99
20c. Simple probability of an initiation for Rat J-10, plotted as a function of consecutive 2-sec time periods after food	101
20d. Simple probability of an initiation for Rat J-11, plotted as a function of consecutive 2-sec time periods after food	103
20e. Simple probability of an initiation for Rat J-12, plotted as a function of consecutive 2-sec time periods after food	105
21a. Relative frequency of initiations for Rat J-7, first determination, plotted as a function of consecutive 2-sec time periods after food	108
21b. Relative frequency of initiations for Rat J-7, second determination, plotted as a function of consecutive 2-sec time periods after food	110
21c. Relative frequency of initiations for Rat J-10, plotted as a function of consecutive 2-sec time periods after food.	112
21d. Relative frequency of initiations for Rat J-11, plotted as a function of consecutive 2-sec time periods after food.	114
21e. Relative frequency of initiations for Rat J-12, plotted as a function of consecutive 2-sec time periods after food.	116

Figure	Page
22a. Probability of an initiation per opportunity, for Rat J-7, first determination, plotted as a function of consecutive 2-sec time periods after food	118
22b. Probability of an initiation per opportunity, for Rat J-7, second determination, plotted as a function of consecutive 2-sec time periods after food	120
22c. Probability of an initiation per opportunity, for Rat J-10, plotted as a function of consecutive 2-sec time periods after food . . .	122
22d. Probability of an initiation per opportunity, for Rat J-11, plotted as a function of consecutive 2-sec time periods after food . . .	124
22e. Probability of an initiation per opportunity, for Rat J-12, plotted as a function of consecutive 2-sec time periods after food . . .	126
23a. Time at the maximal simple probability of an initiation and time at the maximal conditional probability of an initiation during consecutive 2-sec time periods after food, for Rat J-7, plotted as a function of the FT value	129
23b. Time at the maximal simple probability of an initiation and time at the maximal conditional probability of an initiation during consecutive 2-sec time periods after food, for Rats J-10, J-11, and J-12, plotted as a function of the FT value	131
24. Mean and median time of initiations in the first 30 secs after food, plotted as a function of the FT value	134
25a. Mean, mode, and median of frequency distribution of terminations for Rat J-7, plotted as a function of the FT value.	138
25b. Mean, mode, and median of frequency distribution of terminations for Rats J-10 and J-11, plotted as a function of the FT value. . . .	140
25c. Mean, mode, and median of frequency distribution of terminations for Rat J-12, plotted as a function of the FT value.	142

Figure	Page
26a. Simple probability of a termination, for Rat J-7, first determination, function of proportions of the FT	145
26b. Simple probability of a termination, for Rat J-7, second determination, function of proportions of the FT.	147
26c. Simple probability of a termination, for Rat J-10, function of proportions of the FT . .	149
26d. Simple probability of a termination, for Rat J-11, function of proportions of the FT . .	151
26e. Simple probability of a termination, for Rat J-12, function of proportions of the FT . .	153
27a. Relative frequency of terminations, for Rat J-7, first determination, plotted as a function of proportions of the FT.	156
27b. Relative frequency of terminations, for Rat J-7, second determination, plotted as a function of proportions of the FT.	158
27c. Relative frequency of terminations, for Rat J-10, plotted as a function of proportions of the FT	160
27d. Relative frequency of terminations, for Rat J-11, plotted as a function of proportions of the FT	162
27e. Relative frequency of terminations, for Rat J-12, plotted as a function of proportions of the FT	164
28a. Probability of a termination per opportunity, for Rat J-7, first determination, plotted as a function of proportions of the FT	166
28b. Probability of a termination per opportunity, for Rat J-7, second determination, plotted as a function of proportions of the FT	168
28c. Probability of a termination per opportunity, for Rat J-10, plotted as a function of pro- portions of the FT.	170
28d. Probability of a termination per opportunity, for Rat J-11, plotted as a function of pro- portions of the FT.	172

Figure	Page
28e. Probability of a termination per opportunity, for Rat J-12, plotted as a function of proportions of the FT.	174
29a. Probability of being in the drinking state, for Rat J-7, first determination, plotted as a function of the FT value.	181
29b. Probability of being in the drinking state, for Rat J-7, second determination, plotted as a function of the FT value.	183
29c. Probability of being in the drinking state, for Rat J-10, plotted as a function of the FT value	185
29d. Probability of being in the drinking state, for Rat J-11, plotted as a function of the FT value	187
29e. Probability of being in the drinking state, for Rat J-12, plotted as a function of the FT value	189
30. Absolute time at which being in the drinking state is most probable.	191
31a. Mean, mode, median, and first quartile of the frequency distribution of time between the initiation lick and termination lick, for Rat J-7, plotted as a function of the FT value	194
31b. Mean, mode, median, and first quartile of the frequency distribution of time between the initiation lick and termination lick, for Rats J-10 and J-11, plotted as a function of the FT value	196
31c. Mean, mode, median, and first quartile of the frequency distribution of time between the initiation lick and termination lick, for Rat J-12, plotted as a function of the FT value	198
32. Mean and median proportion of interfood interval spent in drinking state, plotted as a function of the FT value.	201

CHAPTER I
INTRODUCTION

Falk, in 1961, reported that rats exposed to 3.17-hr daily sessions of a variable-interval schedule of food presentation, during which water was freely available, consumed 3.43 times their pre-experimental daily water intake. He called this phenomenon "schedule-induced polydipsia." Since then much research effort has been devoted to studying this excessive intake of water generated by a schedule of food reinforcement.

Initial attempts at understanding schedule-induced drinking were in terms of physiological mechanisms. When these were found lacking, attempts were made on the behavioral level to explain schedule-induced drinking as either an unconditioned respondent or an adventitiously reinforced operant. However, these attempted explanations were also inadequate (see Falk, 1969, for review). Although schedule-induced drinking appears to be neither a respondent nor an operant, Falk (1966) observed that such drinking does have reinforcing properties. Rats will acquire an operant consequence by the opportunity to engage in drinking which is schedule-induced. Falk (1966) described schedule-induced drinking as a new class of behavioral effect resulting from schedule control. He suggested the term "adjunctive behavior"

to describe responses which are neither operant nor respondent but have reinforcing properties derived from schedule control.

Other responses were subsequently shown to be induced by the intermittent delivery of food. Some of these include attack (Azrin, Hutchinson, & Hake, 1966; Gentry, 1968; Hutchinson, Azrin, & Hunt, 1968), pica (Villareal, 1967), air-licking (Mendelson & Chillag, 1970, Taylor & Lester, 1969), wheel running (Levitsky & Collier, 1968), and escape (Azrin, 1961; Thompson, 1964).

Falk (1971) has argued that all these responses are members of a class of adjunctive behavior because they have in common certain dynamic properties and are a function of the same variables. Several such correspondencies are as follows: (1) Their probability of occurrence is an inverted U-shaped function of the interreinforcement time. (2) Their probability of occurrence is a decreasing function of the animal's percent free-feeding body weight. (3) Each is a postreinforcement phenomenon in that it occurs immediately after reinforcement. (4) Each has persistent and excessive aspects. (5) A response contingency is not required in order to generate the behavior. (6) The behavior can sustain operant behavior.

The present experiment focused upon the description of schedule-induced drinking as a postfood phenomenon. Currently, there are two studies in the literature which question this characterization. Killeen (1975) examined the rate of bar-pressing, maintained by the opportunity to engage in

schedule-induced drinking, during several interfood intervals. He reported that the rate of bar-pressing was very low immediately after food, increased to a maximum approximately midway in the interfood interval, then declined late in the interval. A best-fit normal curve accounted for 94 percent of the variance in response rates.

Although Killeen's data showed that the maximal rate of drinking occurred midway in the interval, schedule-induced drinking might still be considered a postfood phenomenon if drinking onset is temporally proximal to food delivery. Indeed this was the finding that originally prompted the description of schedule-induced drinking as a postfood event. If schedule-induced drinking is a postfood event, then the latency of licking measured from food delivery should be unaffected by the interfood interval. Segal, Oden, and Deadwyler (1965) examined the mean latency of the first lick when food was presented to two rats at regular intervals ranging from 60 to 480 secs. They reported that the mean latency of the first lick was an increasing function of the interfood interval. For one rat the mean latency increased from approximately 5 to 196 secs., and for the other rat it increased from approximately 10 to 108 secs. When expressed as a proportion of the interfood interval, drinking did not begin until a third or half of the interval had elapsed. These results appear to indicate that the onset of licking is not at all a postfood event but rather is modulated by

the interfood interval. These results, however, may be misleading, for at the longer interfood intervals there is opportunity to exhibit longer latencies than are possible at shorter interfood intervals. It is possible that the majority of the latencies are invariant with respect to the interfood interval. The occurrence of a few long latencies at the longer interfood intervals would generate a mean latency that increases as a function of the interfood interval.

The two studies just described fail to support the characterization of schedule-induced drinking as a postfood event. Killeen's (1975) data suggest that with respect to rate of drinking, schedule-induced drinking is maximal midway in the interfood interval. The Segal et al. (1965) data suggest that onset of drinking is not restricted to the beginning of the interval. Inasmuch as the occurrence of schedule-induced drinking and other schedule-induced or "interim" (Staddon & Simmelhag, 1971) behavior have recently been topics of theoretical concern, it would appear appropriate to obtain a precise quantitative description of exactly where in the interfood interval drinking occurs.

One strategy for examining the location of drinking within the interfood interval is to examine the entire distribution of lick latencies rather than the average latency; and, additionally, to examine the entire distribution of lick terminations. This procedure permits an assessment of whether or not these distributions are relatively stable across

interfood intervals, or whether changes in the interfood interval generate a major shift in these distributions, as suggested by the Segal et al. (1965) data. In addition, it permits assessment of the control of these distributions by relative time since food.

CHAPTER II

METHOD

Subjects

Subjects were four male albino rats maintained at 80 percent of their free-feeding body weight. The rats were approximately eight months old at the start of the experiment. Their experimental history consisted of receiving food delivered according to various FT schedules which generated schedule-induced drinking. Rat J-12 died after his sixth experimental condition, and J-11 died after his seventh experimental condition in the present study.

Apparatus

A standard, commercial, rodent operant conditioning chamber 23 cm long, 20.2 cm wide, and 19.4 cm high served as the experimental chamber. Chamber illumination was provided by a light (#1829, 28 V.) which was located 3 cm to the right of the pellet dispenser and 6.5 cm above the grid floor. A water bottle with a drinking tube was mounted outside the chamber on a wall adjacent to the one containing the food hopper. The tube was recessed 0.2 cm behind the 0.5 cm thick wall. Access to the tube was provided by an aperture 1.2 cm in diameter located 6 cm above the grid floor and 3.3 cm from the edge of the wall adjacent to the one containing the food hopper. White noise masked extraneous sounds.

Procedure

Each rat was exposed to at least six interfood intervals, ranging from 15 to 480 secs. These interfood intervals are referred to as fixed-time (FT) schedules. Daily experimental sessions consisted of the delivery of 41 food pellets with one exception. During the FT 480 condition, sessions for J-11 consisted of the delivery of 27 pellets. Conditions were changed when there was little day-to-day variability in the number of licks per session, the number of interfood intervals containing a lick, and the distribution of lick onset times.

Table 1 lists the experimental conditions for each rat in the order of exposure and the number of sessions per condition. The asterisk listed by some experimental conditions indicates that an experimental manipulation, irrelevant to the present experiment, intervened between that condition and the subsequent condition.

During the entire experiment water was freely available at all times.

Table 1
 Order of Experimental Conditions and
 Number of Sessions in Parentheses for Each Rat

J-7	J-10	J-11	J-12
FT 60 (16)	*FT 240 (17)	*FT 240 (16)	FT 240 (38)
FT 120 (19)	*FT 135 (28)	FT 480 (69)	FT 60 (10)
FT 240 (12)	*FT 135 (44)	*FT 30 (34)	FT 30 (10)
FT 480 (10)	FT 30 (33)	FT 120 (37)	FT 480 (20)
FT 30 (21)	FT 240 (39)	FT 60 (20)	FT 120 (32)
FT 60 (32)	FT 480 (47)	FT 240 (46)	FT 15 (32)
FT 240 (52)	FT 120 (24)	FT 15 (19)	Deceased
FT 120 (28)	FT 15 (56)	Deceased	
FT 15 (26)	FT 120 (30)		
FT 480 (29)			

CHAPTER III

RESULTS

All the results reported in this experiment were obtained during the last 10 sessions of each experimental condition. Since Rat J-7 was exposed to several redeterminations after the first five conditions, the first five conditions and all subsequent ones were considered separately for clarity of presentation. Results from Rat J-11's FT 480 condition, in which only 26 food pellets were delivered, have been adjusted where appropriate to estimate results based on 40 pellet deliveries.

Molar and Molecular Measures of Schedule-Induced DrinkingMolar Measures

Schedule-induced drinking is usually measured in terms of the amount of licking engaged in, the volume ingested, time spent drinking, and the number of food deliveries followed by drinking. These measures from the present study are shown in Figures 1-4. Unconnected data points in these figures, and in subsequent figures, are redetermination values. Licks, water volume, and the time spent drinking are generally inverted U- or V-shaped functions, though there are several inversions. For a given rat the location of the maximal value, or peak, is constant across these three measures. For Rat J-7 it occurred at FT 120 and FT 60 during the first and second determinations, respectively. For

Figure 1. Number of licks, plotted as a function of the FT value.

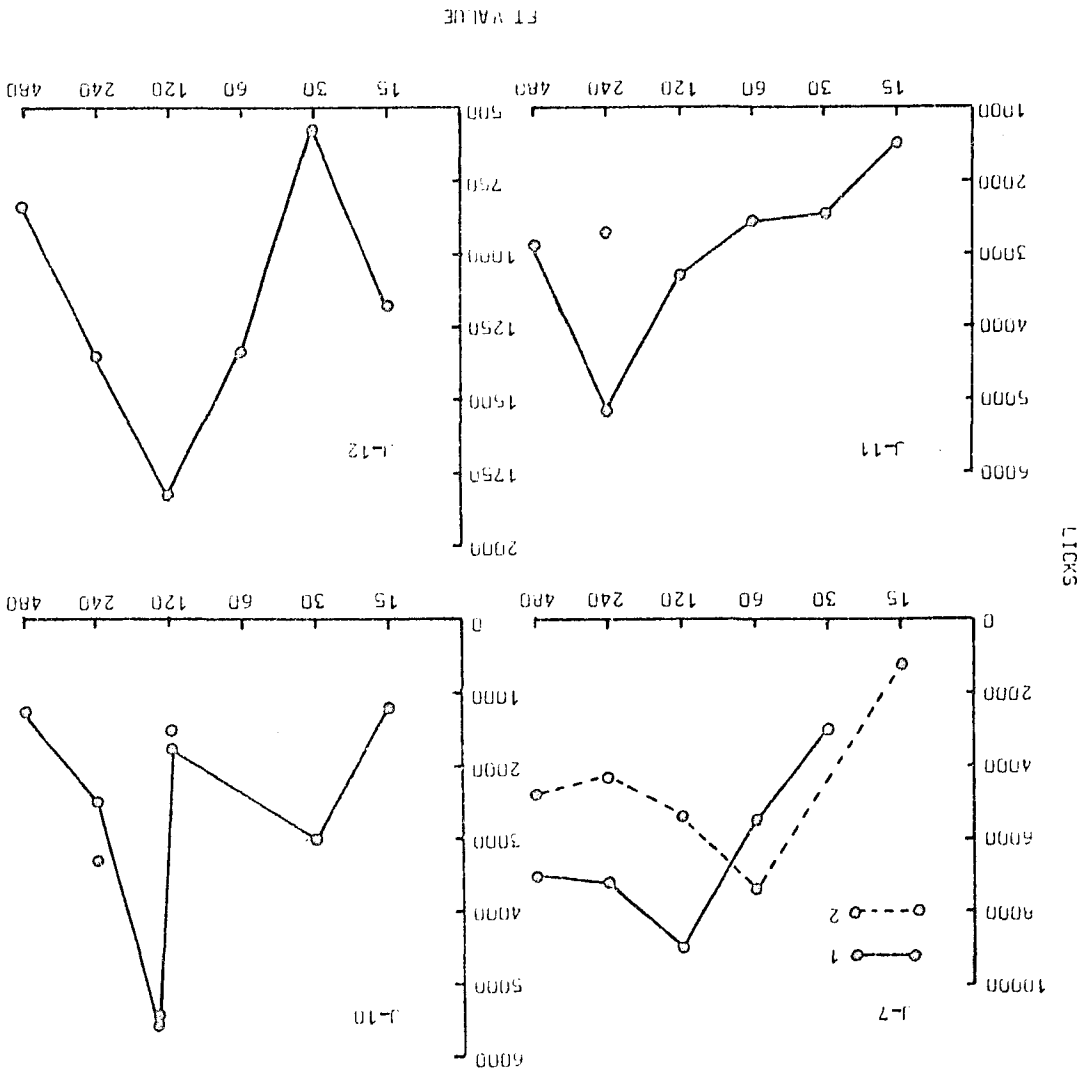

Figure 2. Water volume (ml), plotted as a function of the FT value.

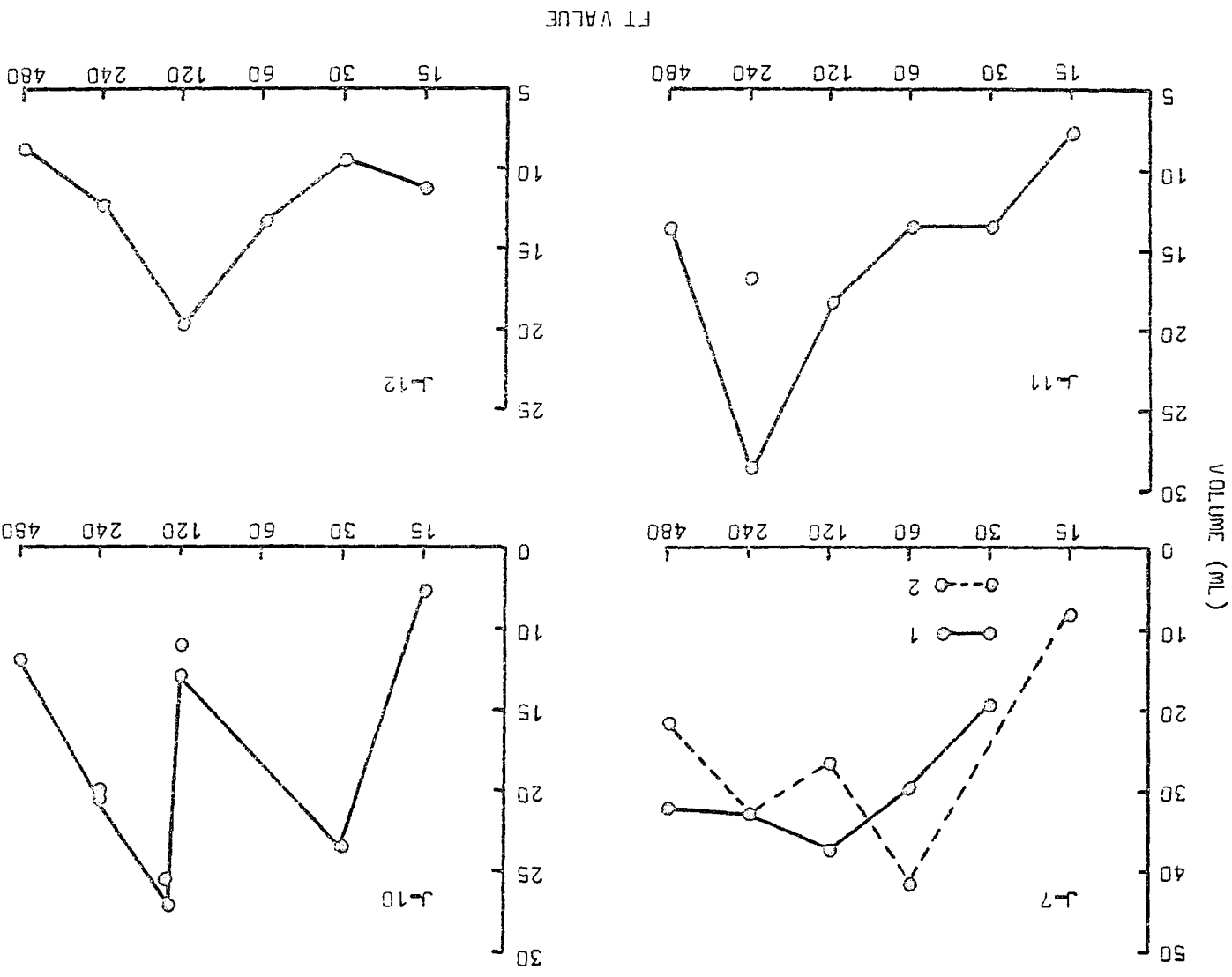
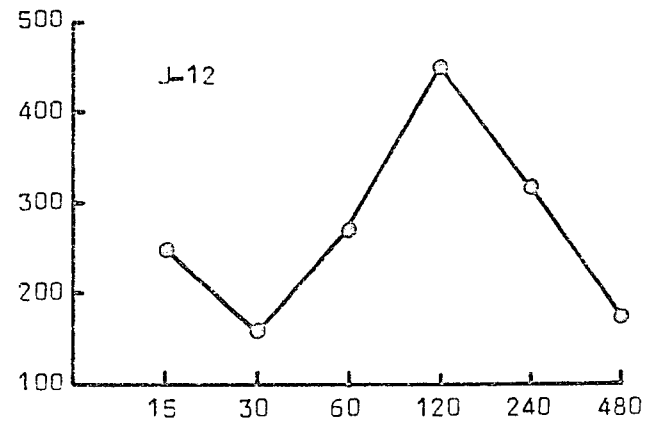
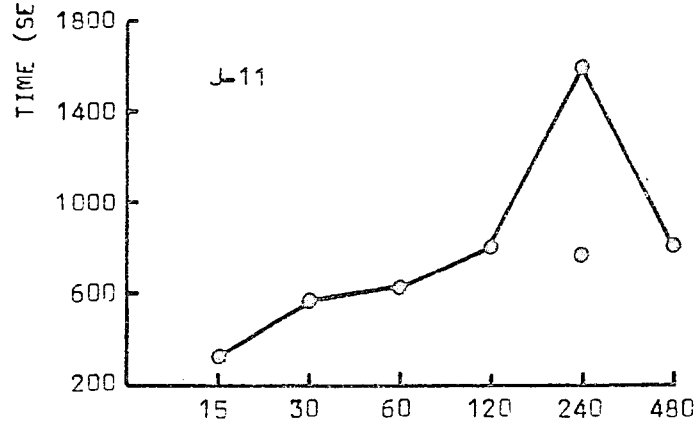
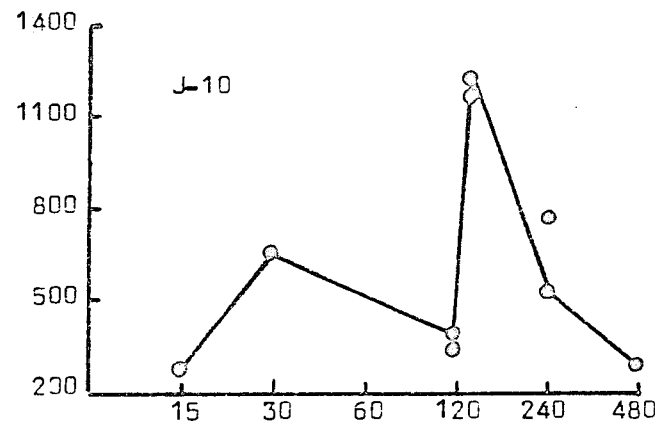
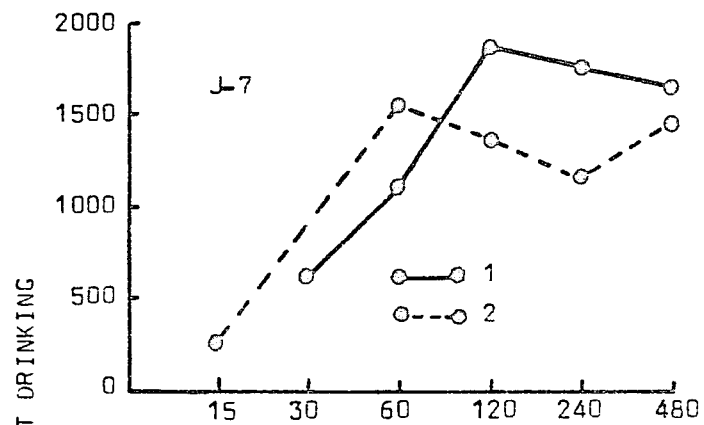

Figure 3. Time spent drinking, plotted as a function of the FT value.



FT VALUE

Figure 4. Number of interfood intervals with a lick, plotted as a function of the FT value.

INTERVALS WITH A LICK

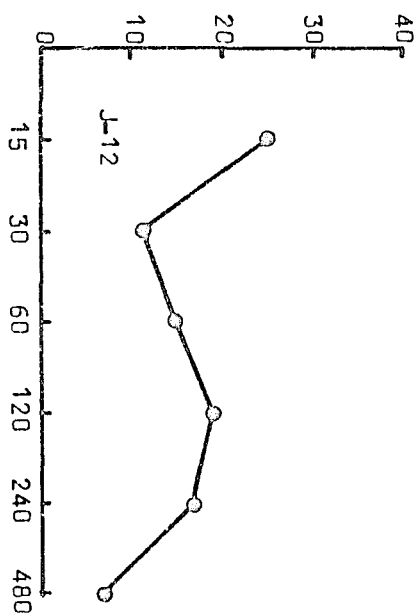
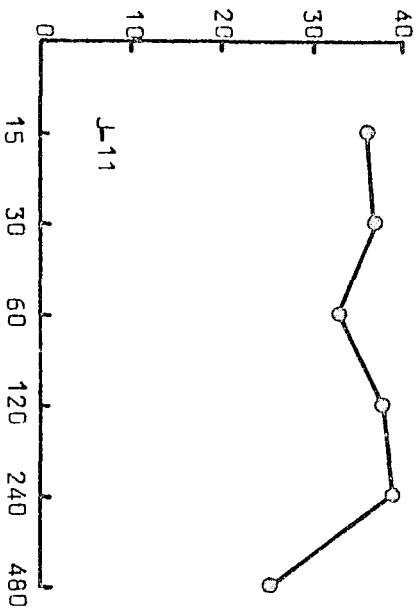
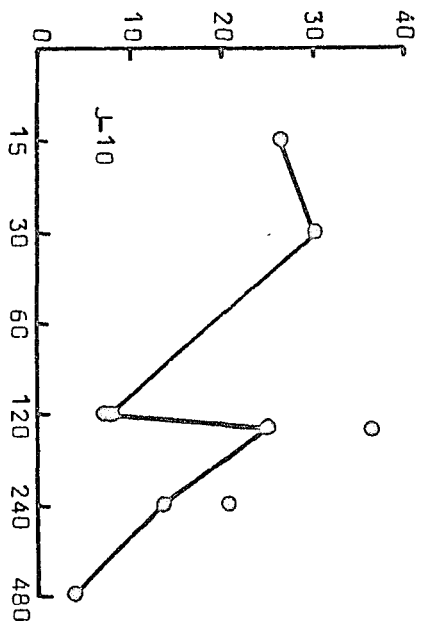
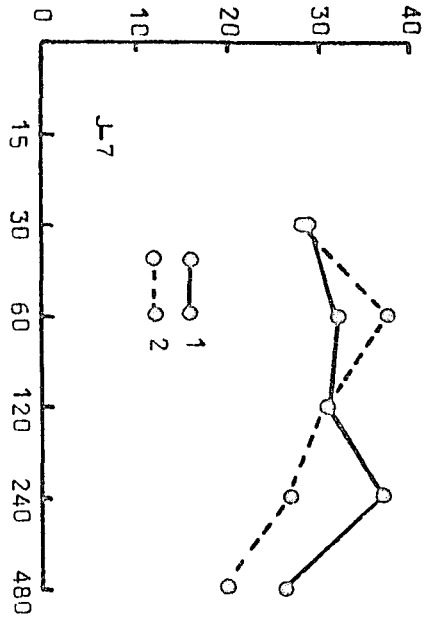

FT VALUE

Rats J-10, J-11, and J-12, the peaks were located at FT 135, FT 240, and FT 120, respectively. The number of intervals containing drinking, shown in Figure 4, did not vary systematically as a function of the FT.

The measures of schedule-induced drinking in Figures 1-3 were obtained from sessions of varying lengths. This raises the possibility that changes in these measures merely reflect differential availability of time. When behavioral measures are subject to this concern, it is conventional to express measures either in terms of rates or relative time. Overall lick rate, overall ingestion rate, and overall relative time were therefore obtained by dividing the number of licks, volume, and time spent drinking, by the session time. These measures are shown in Figures 5-7 on log-log coordinates. For each rat, the measures are generally linearly decreasing though there is a tendency for the functions to show some curvature at the smaller FT values. The equations for the least squares best-fit line for each function is listed in Table 2, Column 1. The Pearson product-moment correlation, \underline{r} , is shown in Column 2. The square of the correlation, \underline{r}^2 , provides an estimate of the proportion of the variability accounted for by the best-fit lines. This is shown in Column 3. The correlation coefficients in Column 2 suggest that overall lick rates, overall ingestion rates, and overall relative time drinking are reasonably well described as power functions of the FT value. The proportion of variability accounted for by the best-fit lines for the overall lick rate

Figure 5. Overall lick rate, plotted as a function of the FT value.

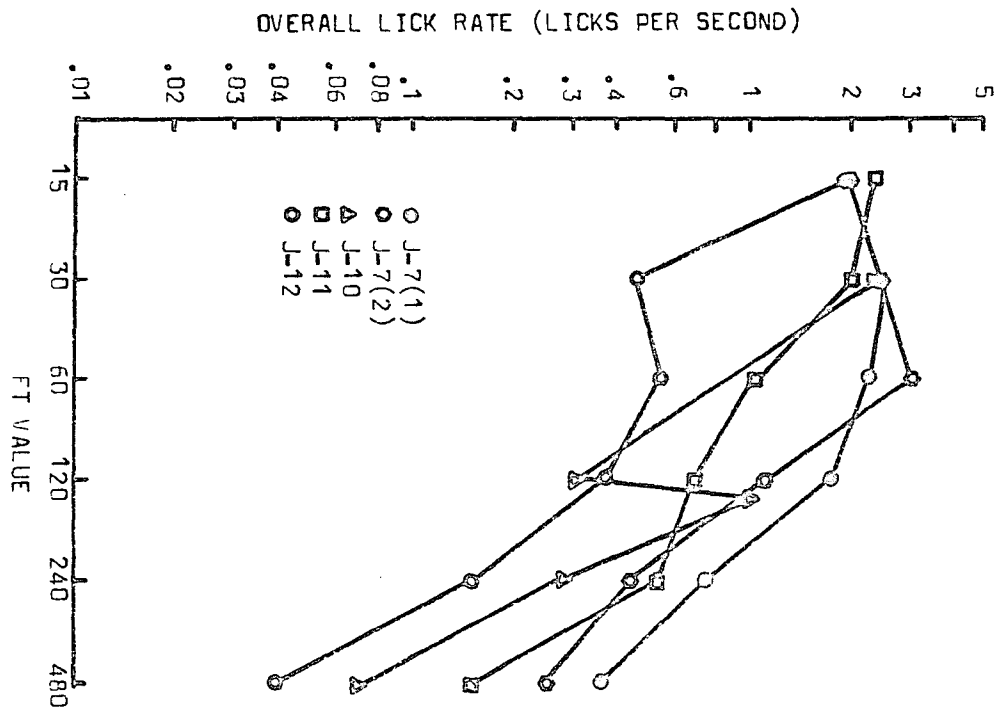

Figure 6. Overall ingestion rate, plotted as a function of the FT value.

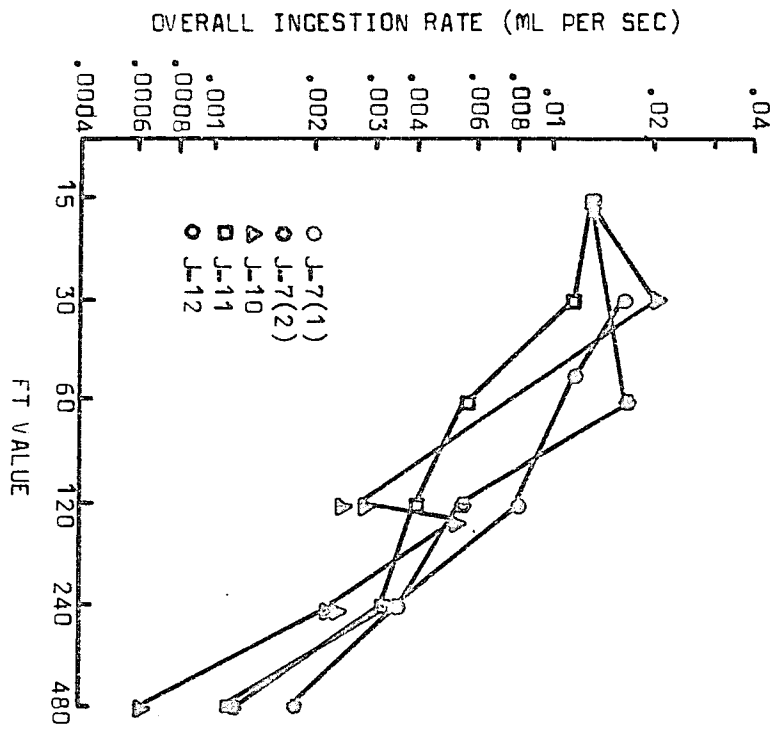

Figure 7. Overall relative time spent drinking, plotted as a function of the FT value.

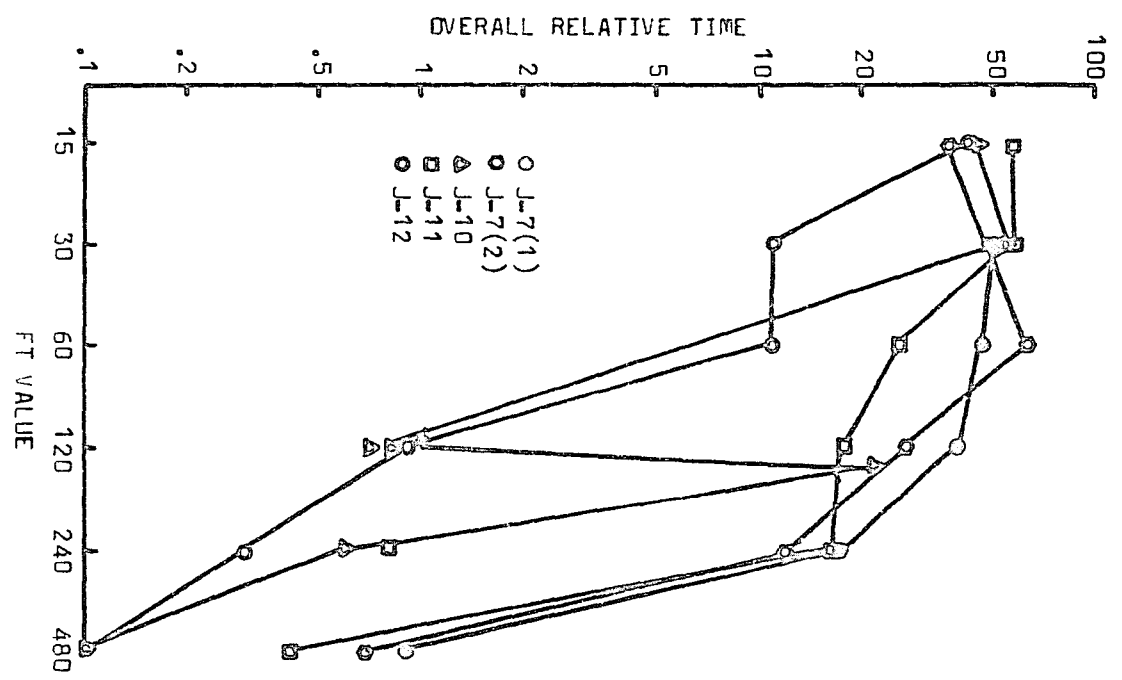

Table 2

Equations for Best-Fit Line, \underline{r} and \underline{r}^2 for Overall Lick Rate,
Overall Ingestion Rate, and Relative Time for Each Rat

Rat	Equation	\underline{r}	\underline{r}^2
<u>Overall Lick Rate</u>			
J-7(1)	$\underline{y} = -.71\underline{x} + 1.58$	-.94	.88
J-7(2)	$\underline{y} = -.67\underline{x} + 1.32$	-.86	.74
J-10	$\underline{y} = -.94\underline{x} + 1.63$	-.90	.81
J-11	$\underline{y} = -.71\underline{x} + 1.29$	-.99	.98
J-12	$\underline{y} = -.97\underline{x} + 1.37$	-.95	.90
<u>Overall Ingestion Rate</u>			
J-7(1)	$\underline{y} = -.83\underline{x} - .48$	-.98	.96
J-7(2)	$\underline{y} = -.73\underline{x} - .79$	-.88	.77
J-10	$\underline{y} = -.91\underline{x} - .59$	-.93	.86
J-11	$\underline{y} = -.71\underline{x} - .97$	-.99	.98
J-12	$\underline{y} = -.98\underline{x} - .56$	-.98	.96
<u>Relative Time</u>			
J-7(1)	$\underline{y} = -.63\underline{x} + .74$	-.94	.88
J-7(2)	$\underline{y} = -.54\underline{x} + .43$	-.81	.66
J-10	$\underline{y} = -1.02\underline{x} + 1.11$	-.89	.79
J-11	$\underline{y} = -.72\underline{x} + .70$	-.97	.94
J-12	$\underline{y} = -.93\underline{x} + .66$	-.95	.90

ranged from .74 to .98. For the overall ingestion rate, the proportion ranged from .77 to .98, and for relative time, it ranged from .66 to .94.

Molecular Measures

The measures of schedule-induced drinking described above may be regarded as molar inasmuch as they involve gross measurement of behavior during the entire session time. A more molecular analysis is provided by examining local measures of drinking computed only with respect to those intervals in which drinking occurred. Whereas overall measures are computed by using the entire session time as the time base, local measures use only the time provided by the intervals actually containing drinking. Thus, the local lick rate, local ingestion rate, and local relative time are obtained by dividing licks, volume, and time spent drinking by the number of interfood intervals containing a lick multiplied by the FT value. These measures, shown in Figures 8, 9, and 10, in log-log plots, decrease linearly as a function of the FT. The equations for the best-fit line, \underline{r} , and \underline{r}^2 are shown in Table 3. The proportion of variability accounted for by the best-fit lines for local lick rate varied from .81 to .98. For local ingestion rate, the proportion varied from .72 to .98. For local relative time the proportion varied from .72 to .98. Comparison of these \underline{r}^2 s with those in Table 2 indicates that in 11 of the 15 cases, a power function provides a better fit for the local measures than for the overall measures. Of the remaining four cases, three of the proportions were equal.

Figure 8. Local lick rate, plotted as a function of the FT value.

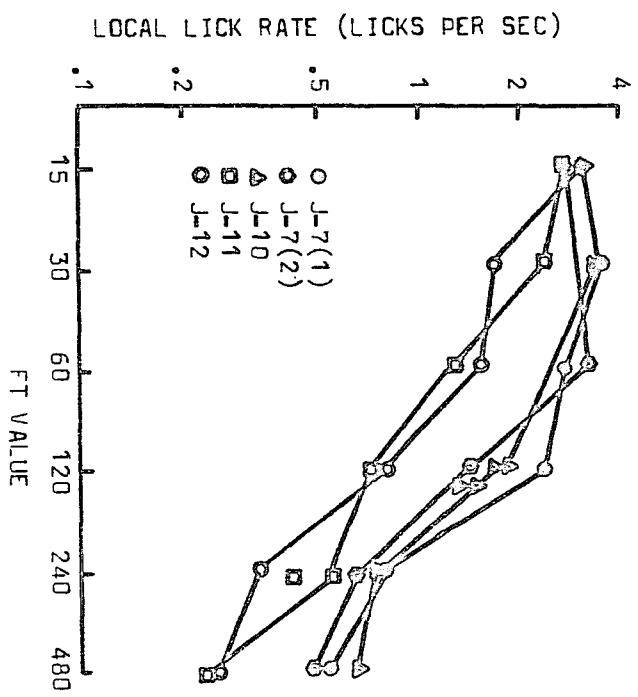

Figure 9. Local ingestion rate, plotted as a function of the FT value.

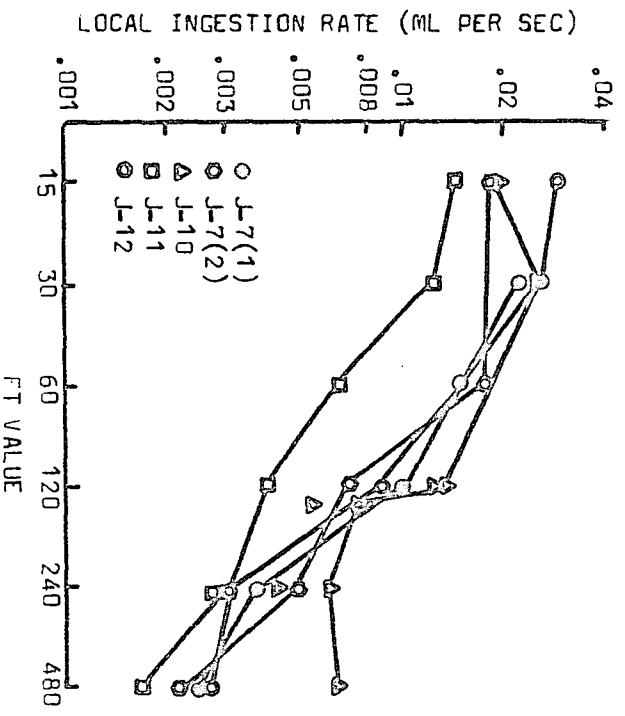

Figure 10. Local relative time spent drinking, plotted as a function of the FT value.

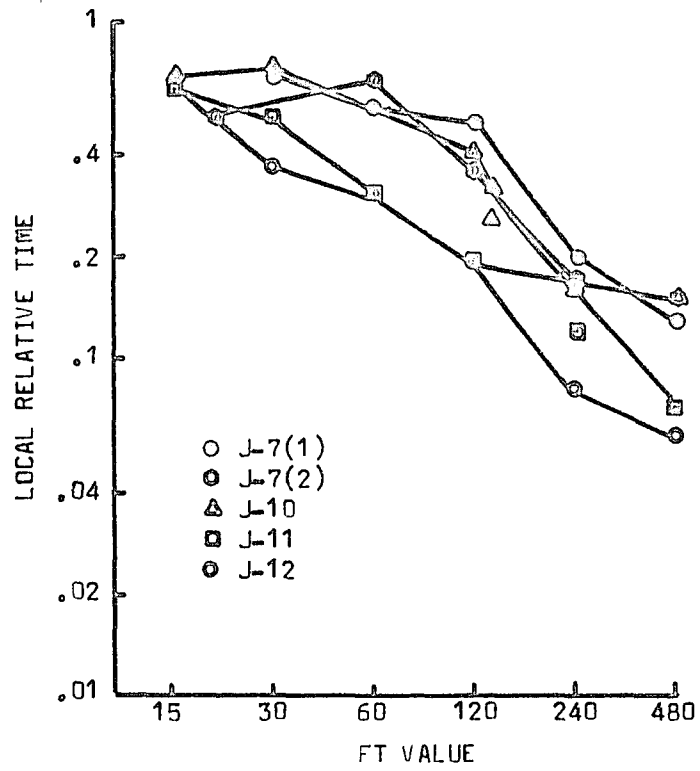

Table 3

Equations for Best-Fit Line, \underline{r} , and \underline{r}^2 for Local Lick Rate,
Local Ingestion Rate, and Local Relative Time for Each Rat

Rat	Equation	\underline{r}	\underline{r}^2
<u>Local Lick Rate</u>			
J-7(1)	$\underline{y} = -.71\underline{x} + 1.68$	-.95	.90
J-7(2)	$\underline{y} = -.57\underline{x} + 1.27$	-.90	.81
J-10	$\underline{y} = -.52\underline{x} + 1.50$	-.93	.86
J-11	$\underline{y} = -.72\underline{x} - .72$	-.99	.98
J-12	$\underline{y} = -.74\underline{x} + 1.39$	-.98	.96
<u>Local Ingestion Rate</u>			
J-7(1)	$\underline{y} = -.83\underline{x} - .38$	-.98	.96
J-7(2)	$\underline{y} = -.63\underline{x} - .85$	-.93	.86
J-10	$\underline{y} = -.44\underline{x} - 1.10$	-.85	.72
J-11	$\underline{y} = -.64\underline{x} - 1.03$	-.99	.98
J-12	$\underline{y} = -.74\underline{x} - .61$	-.95	.90
<u>Local Relative Time</u>			
J-7(1)	$\underline{y} = -.63\underline{x} + .85$	-.95	.90
J-7(2)	$\underline{y} = -.42\underline{x} + .36$	-.85	.72
J-10	$\underline{y} = -.50\underline{x} + .51$	-.95	.90
J-11	$\underline{y} = -.64\underline{x} + .61$	-.99	.98
J-12	$\underline{y} = -.71\underline{x} + .67$	-.99	.98

A finer analysis of drinking is provided by examining drinking only when it is occurring. These measures are shown in Figures 11-13 in log-log plots. The "tempo" of licking, shown in Figure 11, was obtained by dividing the number of licks by the time spent drinking. For Rats J-10 and J-12, this measure was unsystematically related to the FT, varying from 4 to 5 licks per sec. For Rat J-11 this measure decreased slightly, varying from 3-4 licks per sec. For Rat J-7 it decreased during the second determination, varying from approximately 3.5 to 5.5 licks per sec. These decreases in lick rate could have been an artifact of the method of measuring time spent licking. In order to measure time spent licking, time was accumulated in secs. via a relay which latched for one sec. each time a lick occurred. This method would selectively deflate measures of tempo when there was a tendency for occasional single licks to occur or any time a train of licking had interruptions greater than one sec.

The ingestion "tempo," obtained by dividing the total session water volume by the total time spent drinking is shown in Figure 12. For each rat this measure is approximately constant across FT values.

To the extent that both the local lick tempo and the local ingestion tempo are constant across FT values, the mean volume per lick should also be constant. This measure is shown in Figure 13 and does appear to be approximately constant across FT values.

Figure 11. Licking tempo, plotted as a function of the FT value.

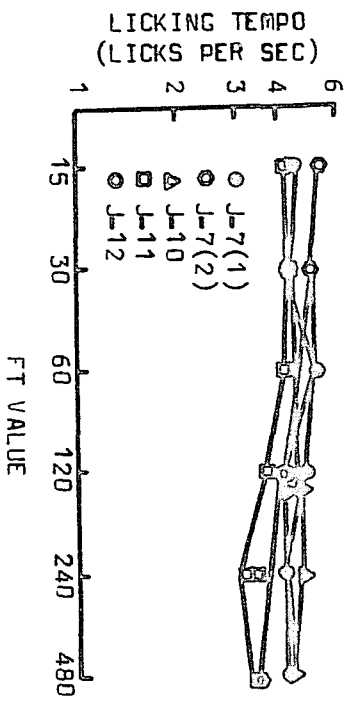

Figure 12. Ingestion tempo, plotted as a function of the FT value.

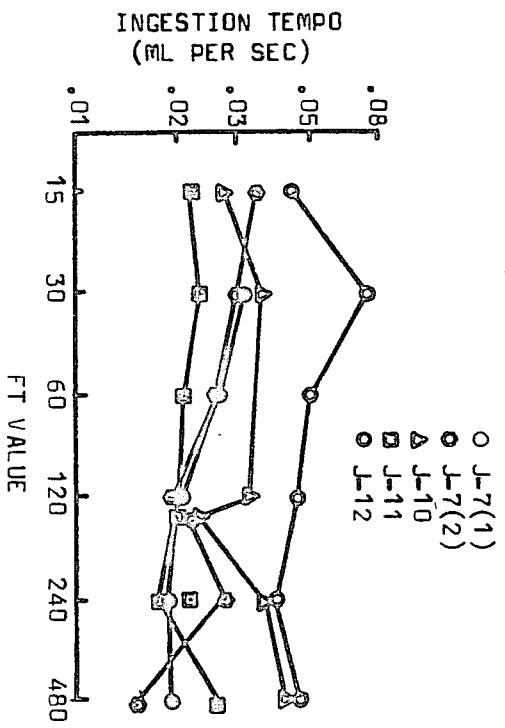
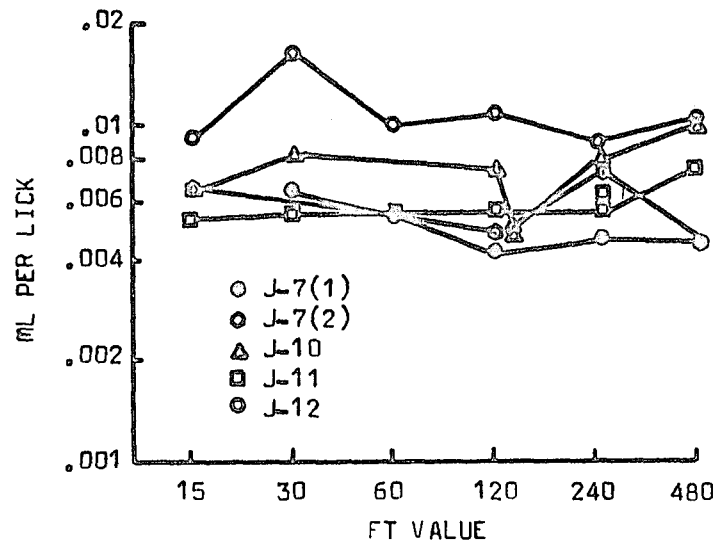

Figure 13. Volume per lick, plotted as a function of the FT value.



Summary of the Molar and Molecular Measures

Figures 1-4 above show the number of licks, water volume, time spent drinking, and the number of interfood intervals containing drinking. The first three measures are inverted U- or V-shaped functions of the FT, while the latter measure varies unsystematically as a function of the FT. All the subsequent measures of drinking result from transformations on the first four. When licks, volume, and licking time are divided by session time to determine overall measures, negative power functions are obtained (Figures 5-7, Table 2). When licks, volume, and licking time are divided by the time provided by the number of intervals containing drinking, the resulting local measures are also negative power functions of the FT value (Figures 8-10, Table 3). Dividing both the number of licks and the volume by time spent drinking reveals a constancy in lick and ingestion tempo (Figures 11 and 12) as a function of the FT and, necessarily, a constancy in volume per lick (Figure 13) as a function of the FT.

Distributions of the Initiation and Termination of Schedule-Induced Drinking

For each FT value for each rat the time between pellet delivery and the first lick was measured, and the time between pellet delivery and the last lick was measured. These two time periods are schematized in Figure 14. The term initiation will alternately be used to refer to either the time

Figure 14. Schematic of an interfood interval, showing initiation time and termination time.

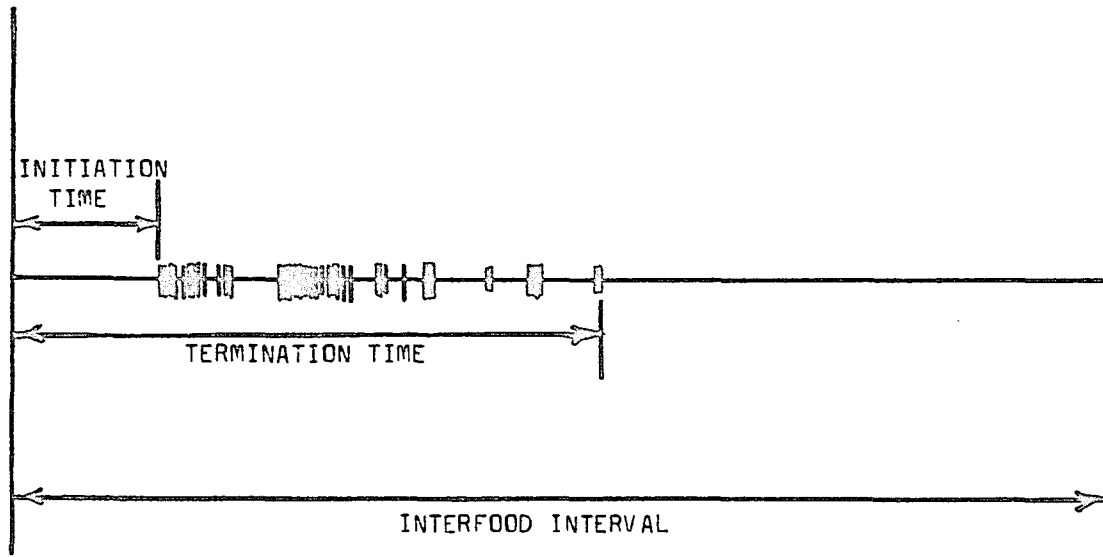

until the first lick or the occurrence of the first lick, depending upon context. Termination will likewise be used to refer to either the time until the last lick or the occurrence of the last lick. Often drinking did not terminate before pellet delivery. Instead, the pellet delivery terminated drinking. In some analyses of termination data such terminations are excluded from analysis because of the bias they introduce. When exclusion occurs, it will be noted.

This section of the paper consists of three parts. First, an analysis of the frequency distribution of initiations will be presented. Second, an analysis of the frequency distribution of terminations will be presented. Finally, some relations between the two will be considered.

Analysis of the Initiation Distribution

The frequency distributions of the initiation times were positively skewed. The mean, median, and mode of these distributions for each rat are shown in Figure 15. For each rat the mean yielded the highest values, the mode yielded the smallest values, and the median, intermediate values. The greatest absolute changes occurred in the means and the smallest absolute changes occurred in the modes as the FT value was manipulated. The equations for the best-fit lines for these functions, \bar{x} , and \bar{x}^2 , are listed in Table 4. For each rat a power function provides a reasonable fit between both the mean and the median initiation time and the FT value.

Figure 15a. Mean, mode, and median of frequency distribution of initiations for Rat J-7, plotted as a function of the FT value.

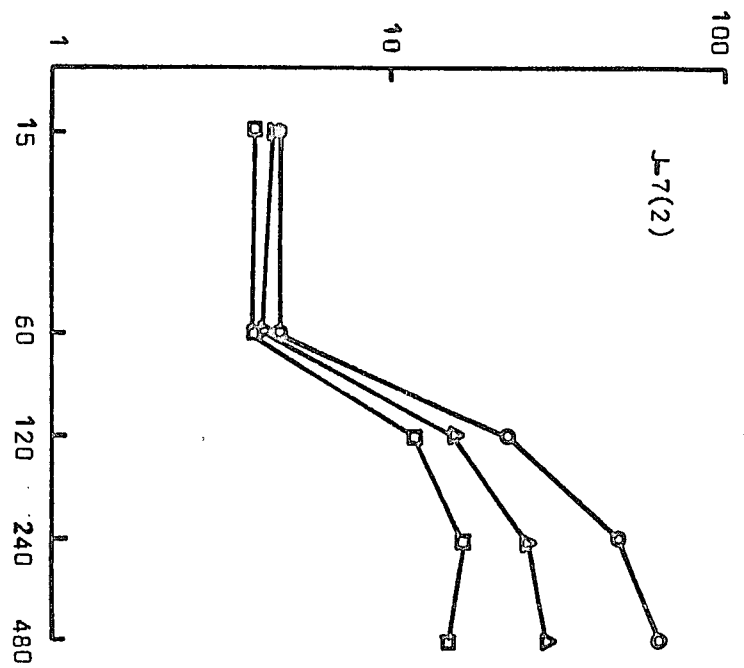
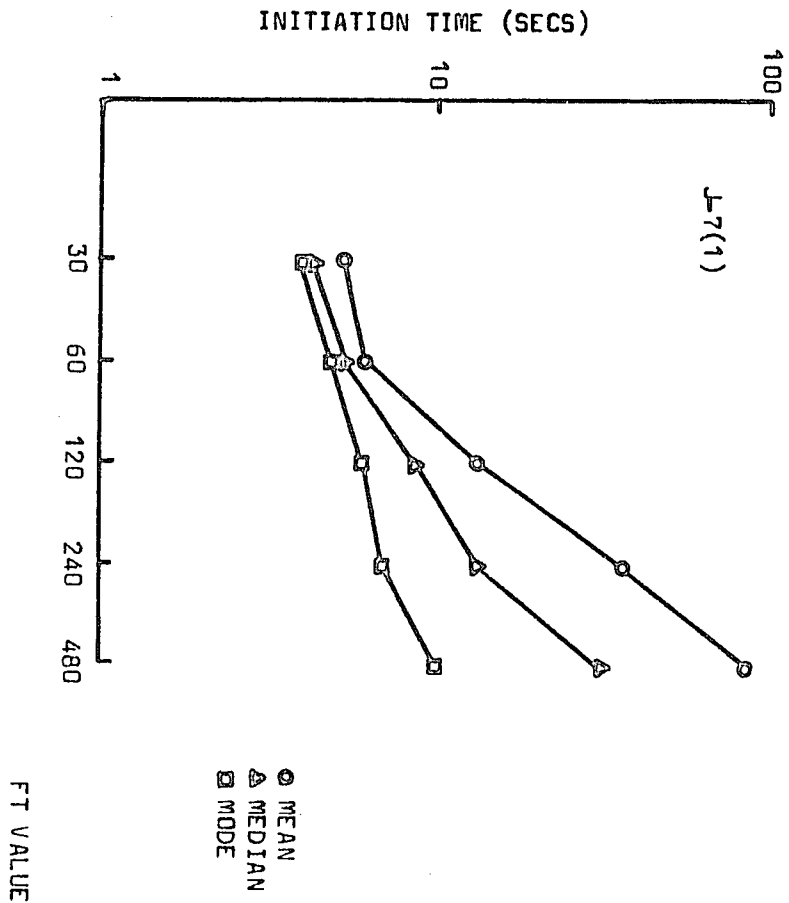

Figure 15b. Mean, mode, and median of frequency distribution of initiations for Rats J-10 and J-11, plotted as a function of the FT value.

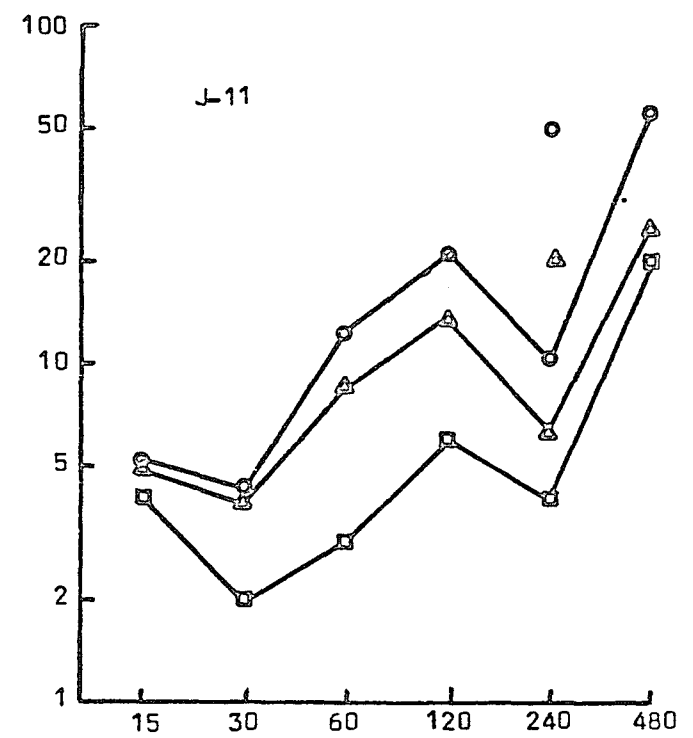
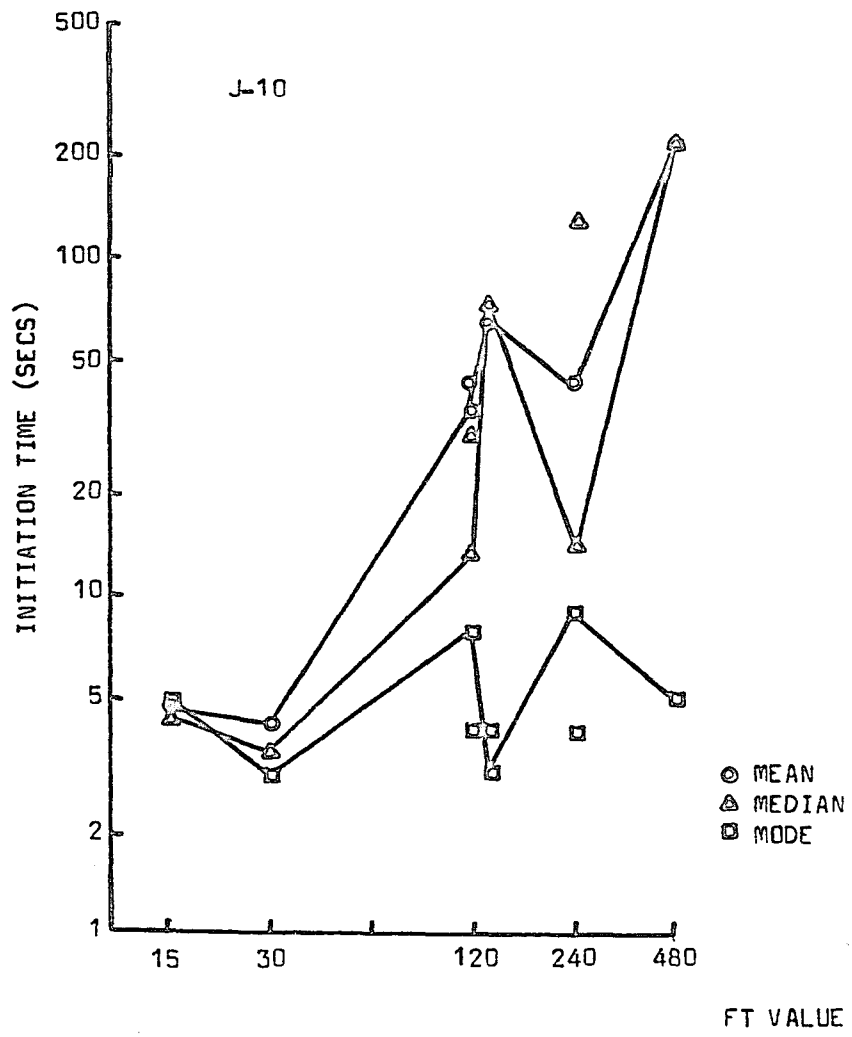

Figure 15c. Mean, mode, and median of frequency distribution of initiations for Rat J-12, plotted as a function of the FT value.

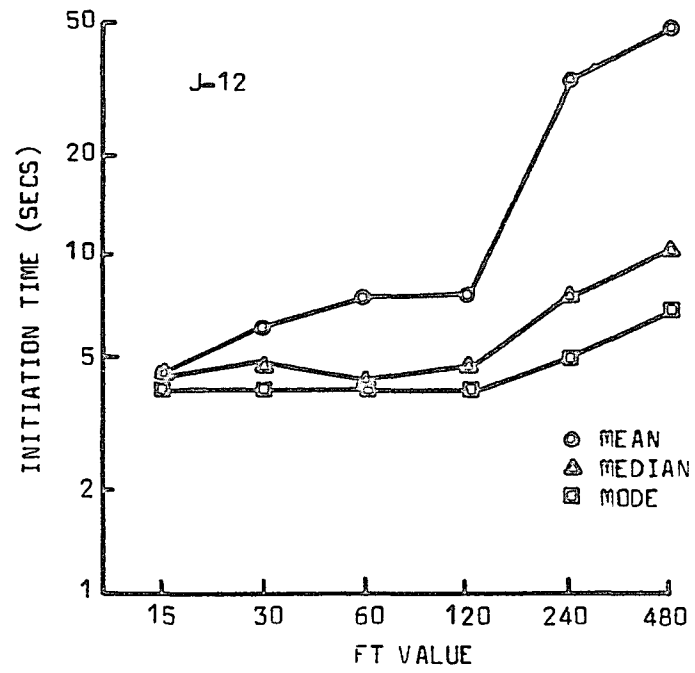

Table 4

Equations for Best-Fit Line, \underline{r} , and \underline{r}^2 for Mean, Median, and Mode of Initiation Distribution for Each Rat

Rat	Equation	\underline{r}	\underline{r}^2
<u>Mean</u>			
J-7(1)	$\underline{y} = 1.07\underline{x} - .98$.98	.96
J-7(2)	$\underline{y} = .86\underline{x} - .50$.92	.85
J-10	$\underline{y} = 1.22\underline{x} - .93$.98	.96
J-11	$\underline{y} = .75\underline{x} - .29$.97	.94
J-12	$\underline{y} = .70\underline{x} - .28$.92	.85
<u>Median</u>			
J-7(1)	$\underline{y} = .72\underline{x} - .50$.97	.94
J-7(2)	$\underline{y} = .62\underline{x} - .17$.90	.81
J-10	$\underline{y} = 1.22\underline{x} - .98$.95	.90
J-11	$\underline{y} = .51\underline{x} - .01$.94	.88
J-12	$\underline{y} = .24\underline{x} - .29$.86	.74
<u>Mode</u>			
J-7(1)	$\underline{y} = .31\underline{x} + .13$.99	.98
J-7(2)	$\underline{y} = .47\underline{x} - .02$.88	.77
J-10	$\underline{y} = .09\underline{x} + .49$.39	.15
J-11	$\underline{y} = .46\underline{x} - .20$.73	.53
J-12	$\underline{y} = .70\underline{x} - .28$.85	.72

The proportion of variance accounted for by the respective power functions for the means ranged from .85 to .96; for the medians, it ranged from .74 to .94. For each rat the means are slightly better fitted by a power function than are the medians. For all rats except Rat J-7, first determination, the power function for the mode accounted for less variability than did the power function for the means and median. The r^2 s for these functions ranged from .15 to .98.

A closer examination of the distribution of initiations is provided by Figure 16, which shows the simple probability of an initiation as a function of the proportion of the FT. The probability was computed by dividing the number of initiations occurring at a given proportion of the FT by the total number of possible initiations. In this figure, as well as in subsequent figures, when data points converge, symbols have been omitted for clarity. For each animal the maximal probability occurs during the first one-third of the FT. By mid-interval most of the functions have become flattened. All animals evidence a trend for the maximal probabilities of the longer FT values to occur at smaller proportions of the FT.

As Figure 4 showed, drinking was not generated by every pellet delivery; therefore, comparisons of the simple probability of an initiation across FT values at a given proportion of the FT reflect differences in the number of intervals containing drinking. It would be of interest, then, to examine the probability of an initiation among only those intervals in which drinking occurred. These relative

frequency functions are shown in Figure 17. Because the denominator of the relative frequency computation is smaller than that in the simple probability computation, the relative frequency probabilities are larger than the respective simple probabilities. Because this elevation reflects the number of intervals containing drinking, the rank-ordering of the FT values with respect to their probability at a given proportion of the FT value may not be the same using these two computations. Comparison of Figures 16 and 17 shows that in most instances the ordering is actually the same, though there are a few exceptions.

Both the simple probability and relative frequency measures of probability assume that the number of opportunities for licking to be initiated is constant at each time in the interfood interval. When the initial lick occurs at time \underline{t} , however, this fact precludes the occurrence of an initial lick at time $\underline{t} + 1$. The opportunity to initiate drinking at \underline{t} is inversely related, therefore, to the number of initiations prior to \underline{t} . Under such conditions, a probability measure that has been employed is the conditional probability, or probability per opportunity. This statistic, described by Anger (1956) with respect to inter-response times (IRTs), is computed by dividing the frequency of the IRT of duration \underline{x} by the frequencies of the IRTs of durations greater than and equal to \underline{x} . The corresponding statistic was applied to the distribution of initiations as a function of the proportion of the FT and the results are

Figure 16a. Simple probability of an initiation, for Rat J-7, first determination, plotted as a function of proportions of the FT.

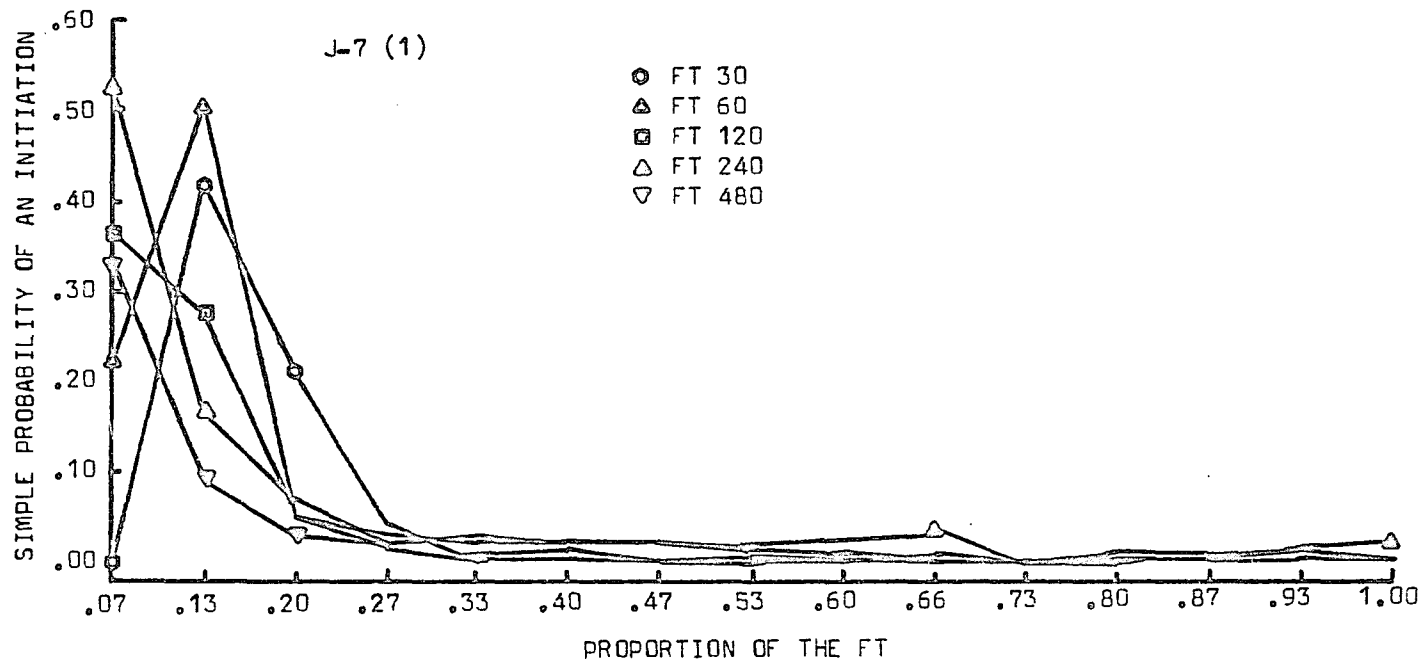

Figure 16b. Simple probability of an initiation, for Rat J-7, second determination, plotted as a function of proportions of the FT.

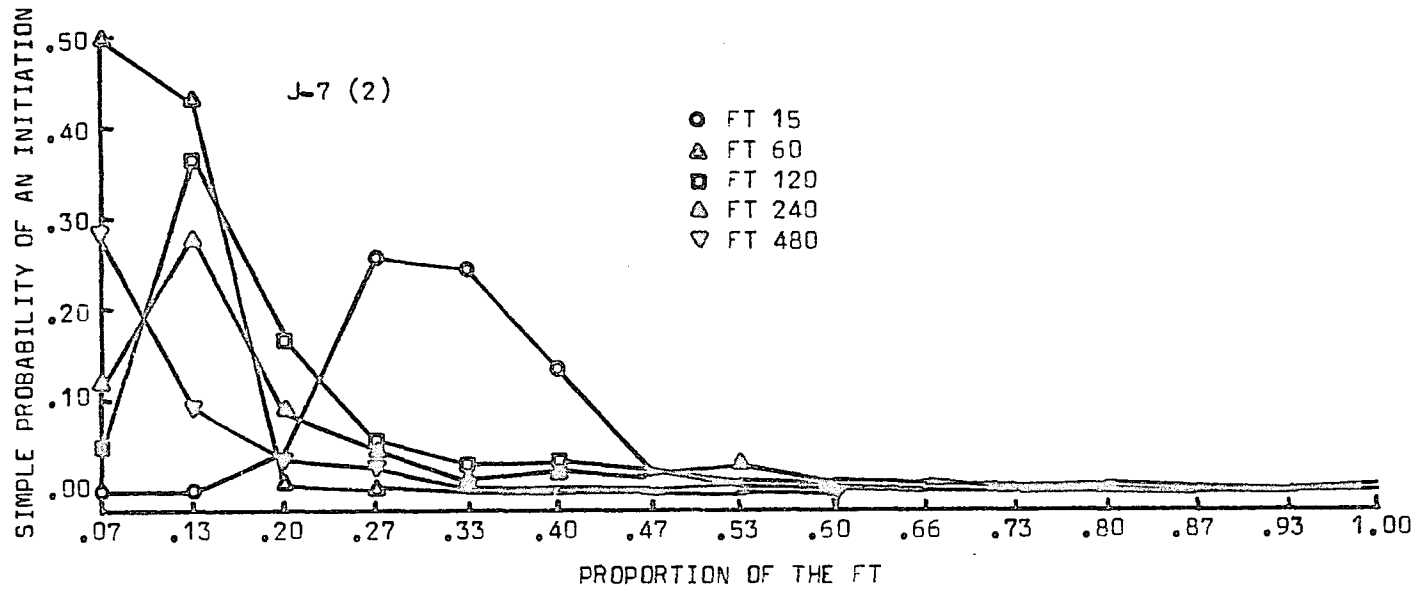

Figure 16c. Simple probability of an initiation, for Rat J-10, plotted as a function of proportions of the FT.

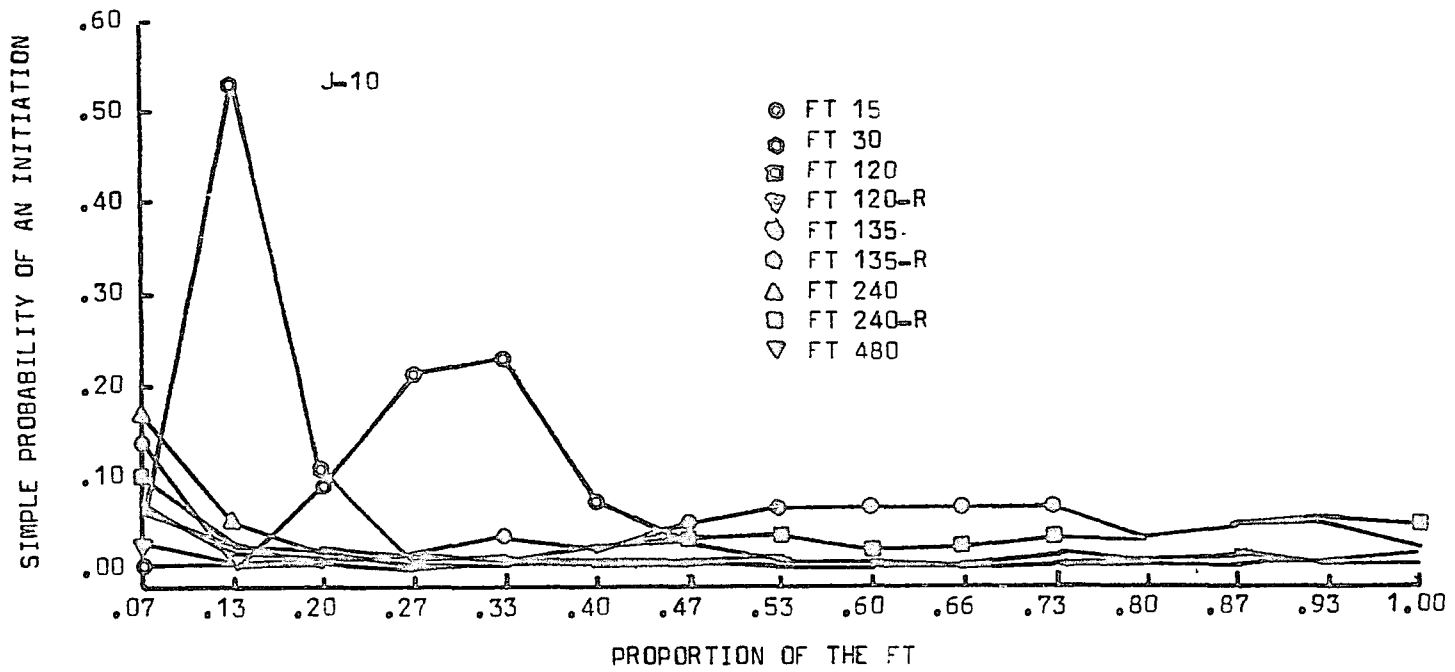

Figure 16d. Simple probability of an initiation, for Rat J-11, plotted as a function of proportions of the FT.

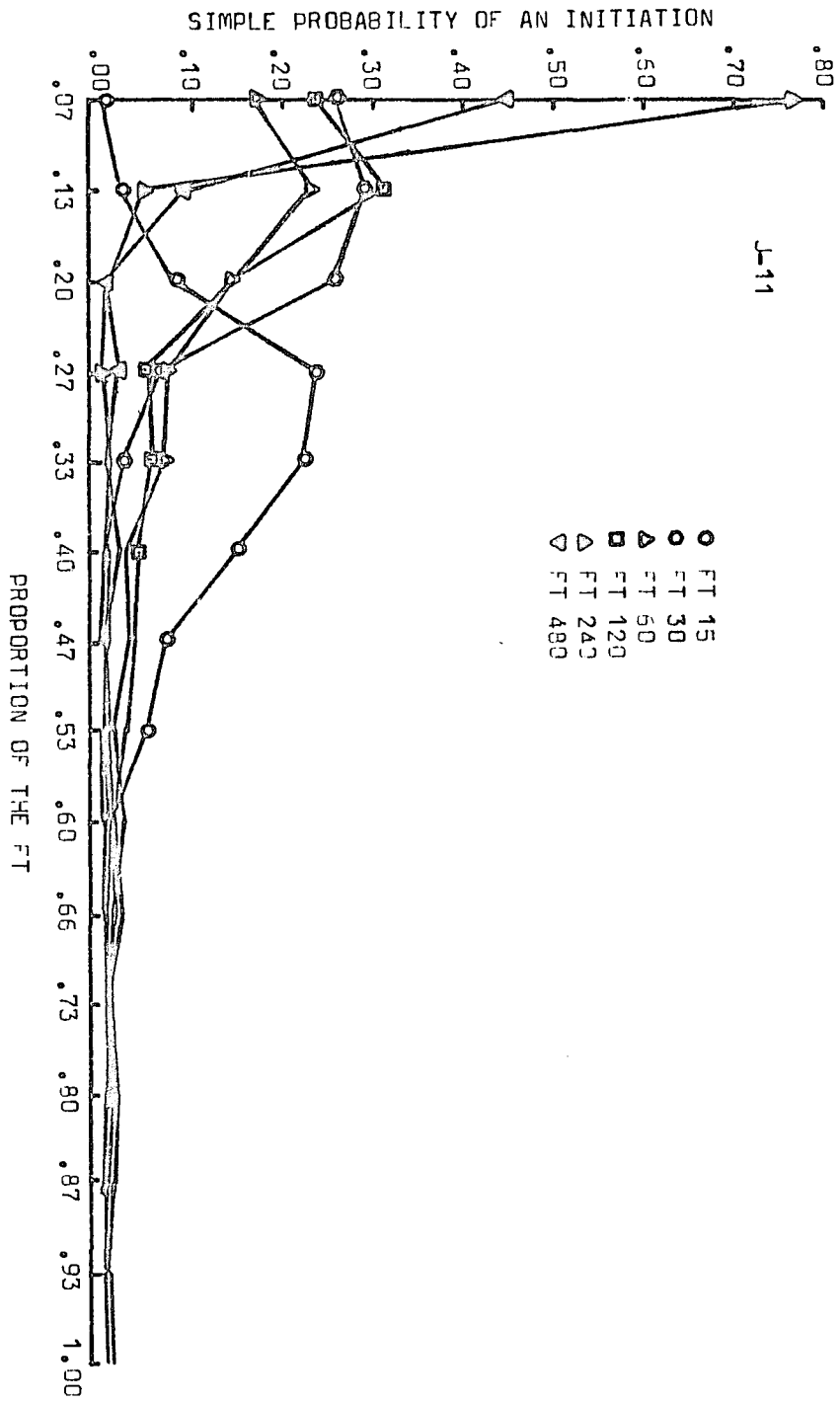

Figure 16e. Simple probability of an initiation, for Rat J-12, plotted as a function of proportions of the FT.

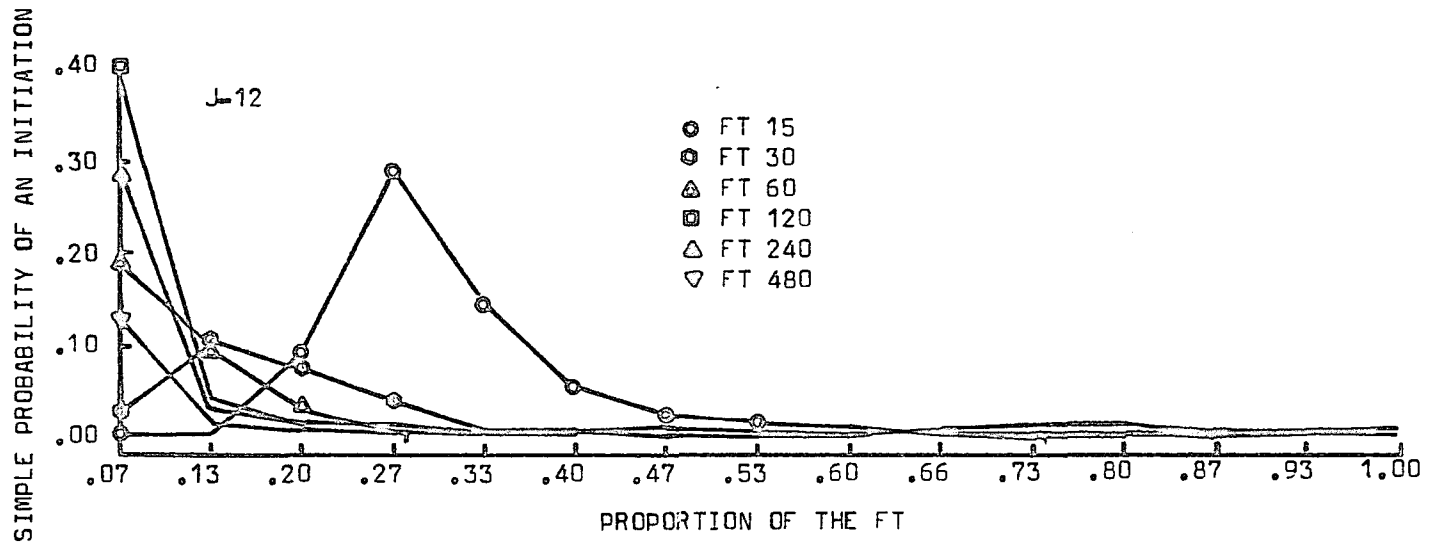

Figure 17a. Relative frequency of initiations, for Rat J-7, first determination, plotted as a function of proportions of the FT.

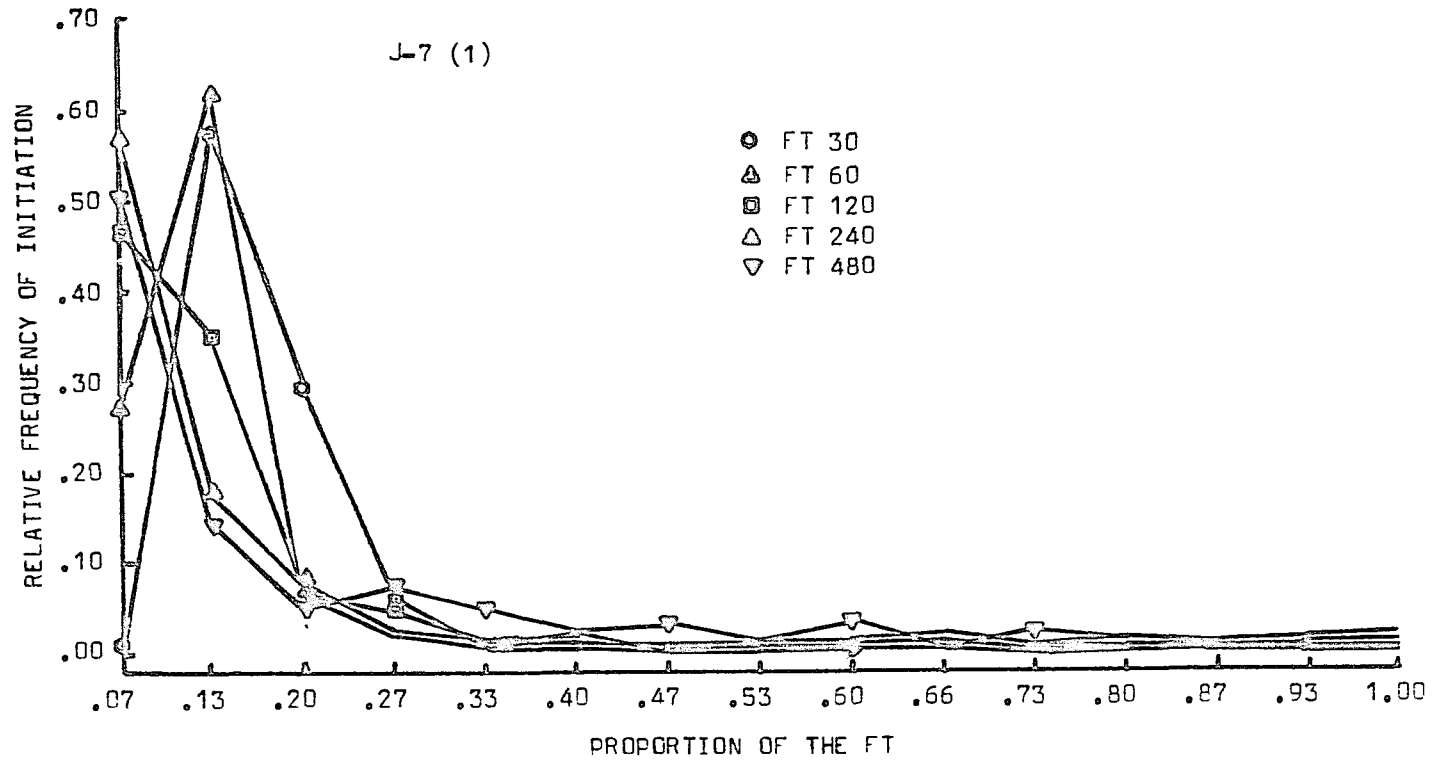

Figure 17b. Relative frequency of initiations, for Rat J-7, second determination, plotted as a function of proportions of the FT.

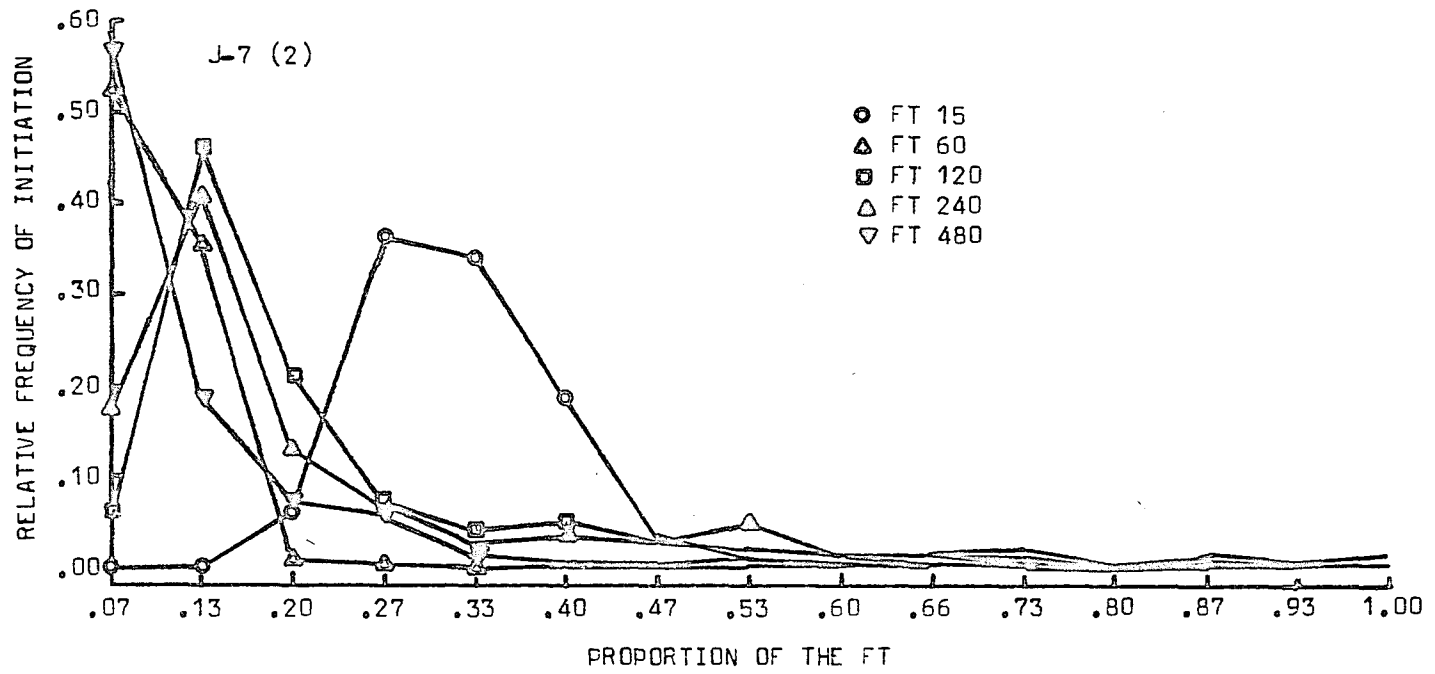

Figure 17c. Relative frequency of initiations, for Rat J-10, plotted as a function of proportions of the FT.

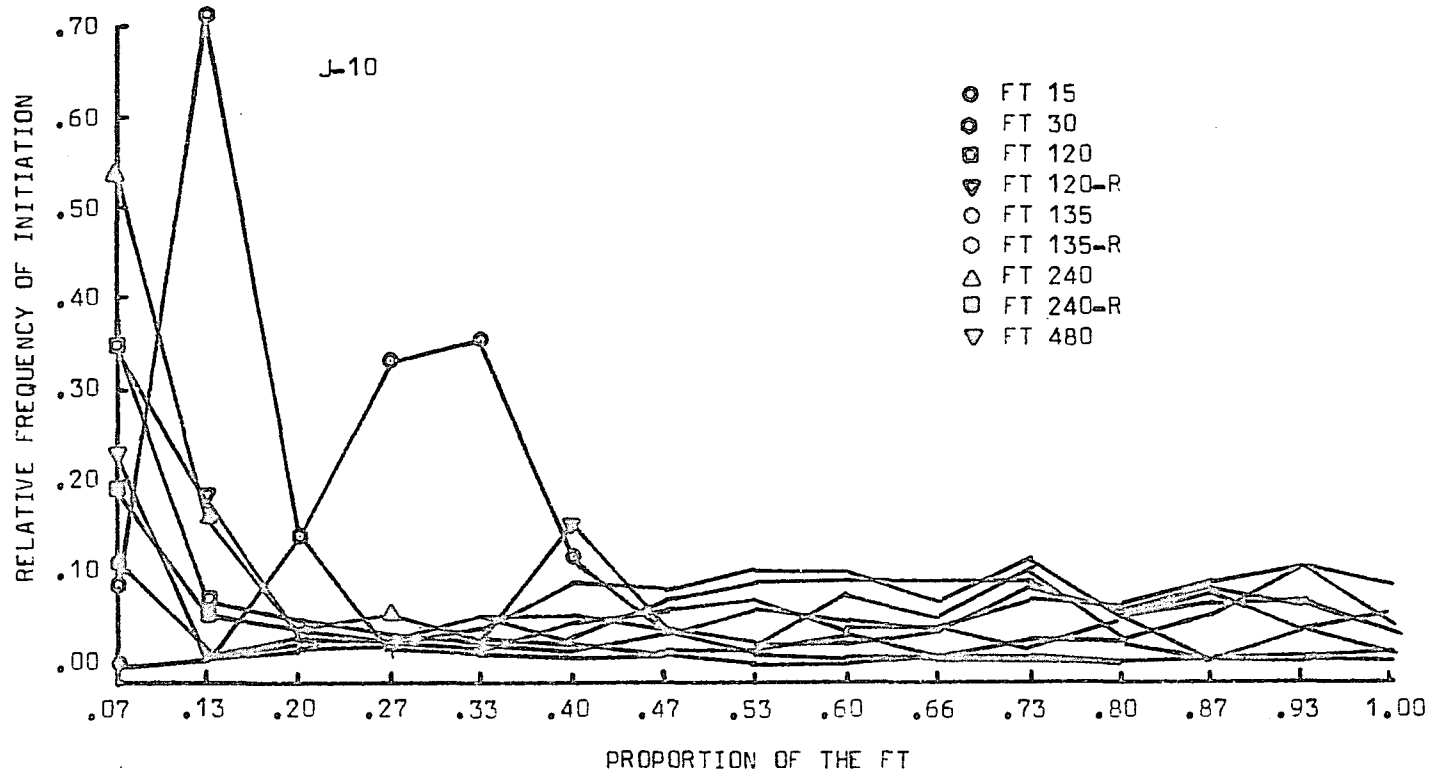

Figure 17d. Relative frequency of initiations, for Rat J-11, plotted as a function of proportions of the FT.

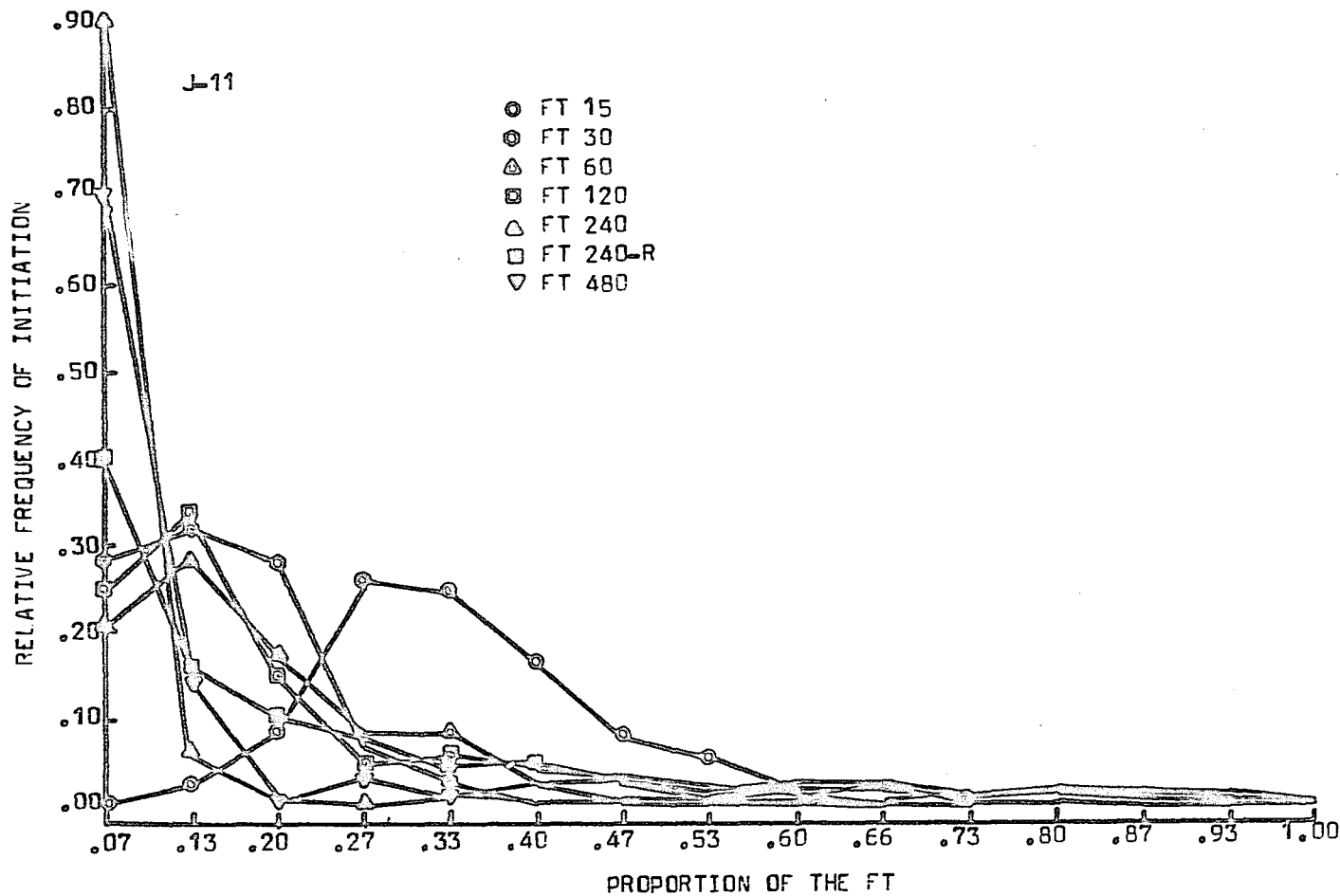
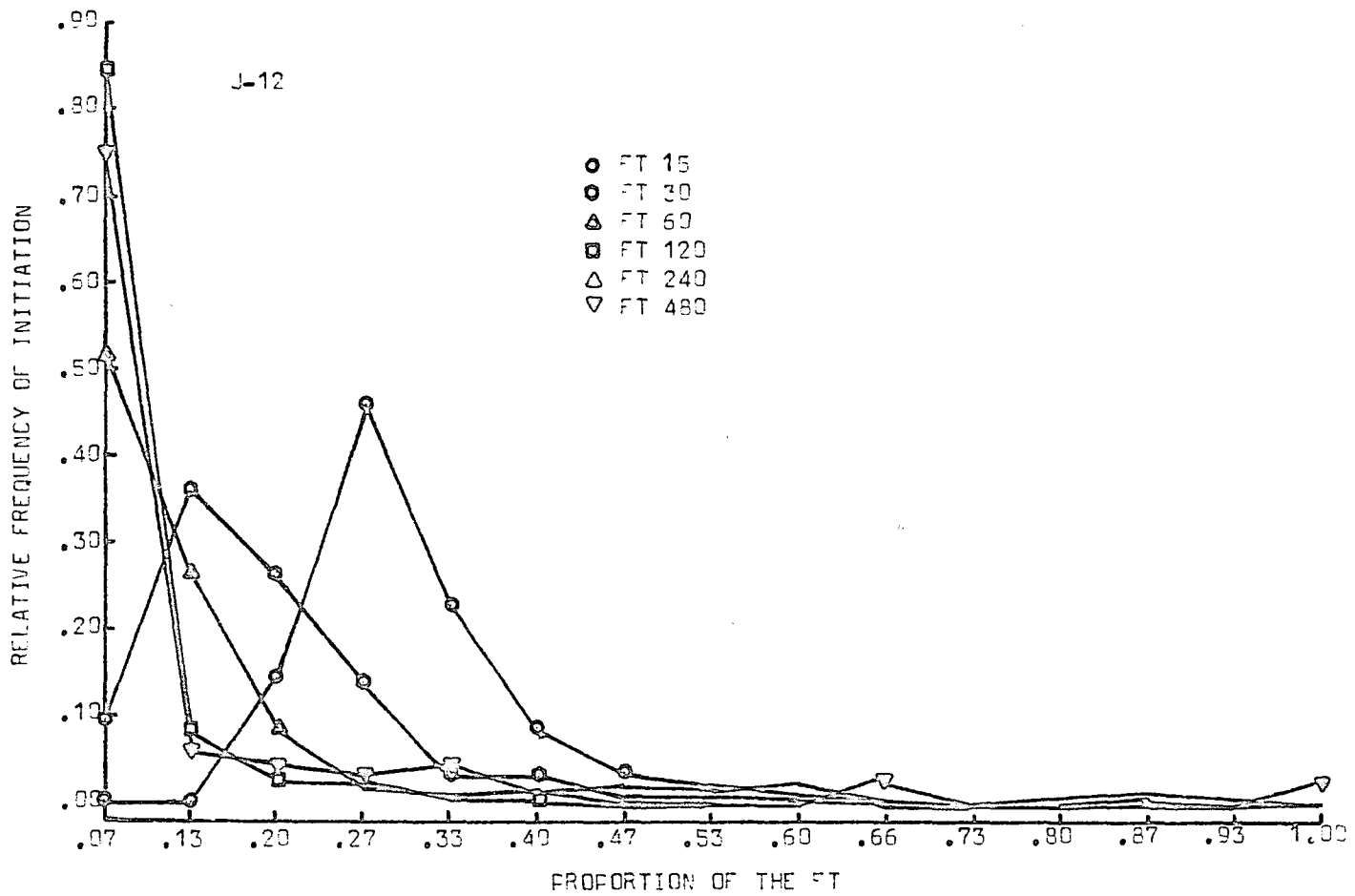

Figure 17e. Relative frequency of initiations, for Rat J-12, plotted as a function of proportions of the FT.



shown in Figure 18. These initiation-per-opportunity functions resemble the functions of Figure 17, but exhibit several differences. First, for Rats J-10 and J-12 the maximal probabilities occur at the same proportions in both figures; however, for Rats J-7 and J-11 at some FT values the maximal probabilities occur at higher proportions in Figure 18 than in Figure 17. For Rat J-7 the shifts occurred at FT 120 (first determination) and at FT 15 and FT 60 (second determination). For Rat J-11, shifts occurred at FT 15, FT 30, and FT 240. Secondly, with the exception of Rat J-12, the conditional probabilities are higher in the latter half of the FT relative to the first half than are the relative frequencies. This effect is most dramatic for Rat J-11. Thirdly, some conditional probability functions decline continuously during most of the FT, whereas the relative frequency functions become flattened in the latter half of the FT. Also, some of the conditional probability functions rise in the latter part of the FT, e.g., Rat J-7 during FT 240 (first determination), Rat J-10 during FT 480 and both determinations of FT 135, and Rat J-11 during FT 480. This examination of the probability of an initiation corrected for opportunities indicates that drinking is less confined to the early portion of the interval than is suggested by an examination of the relative frequencies. But despite these changes in the probabilities, drinking may still be characterized as being more probable in the early portion of the interval.

Figure 18a. Probability of an initiation per opportunity, for Rat J-7, first determination, plotted as a function of proportions of the FT.

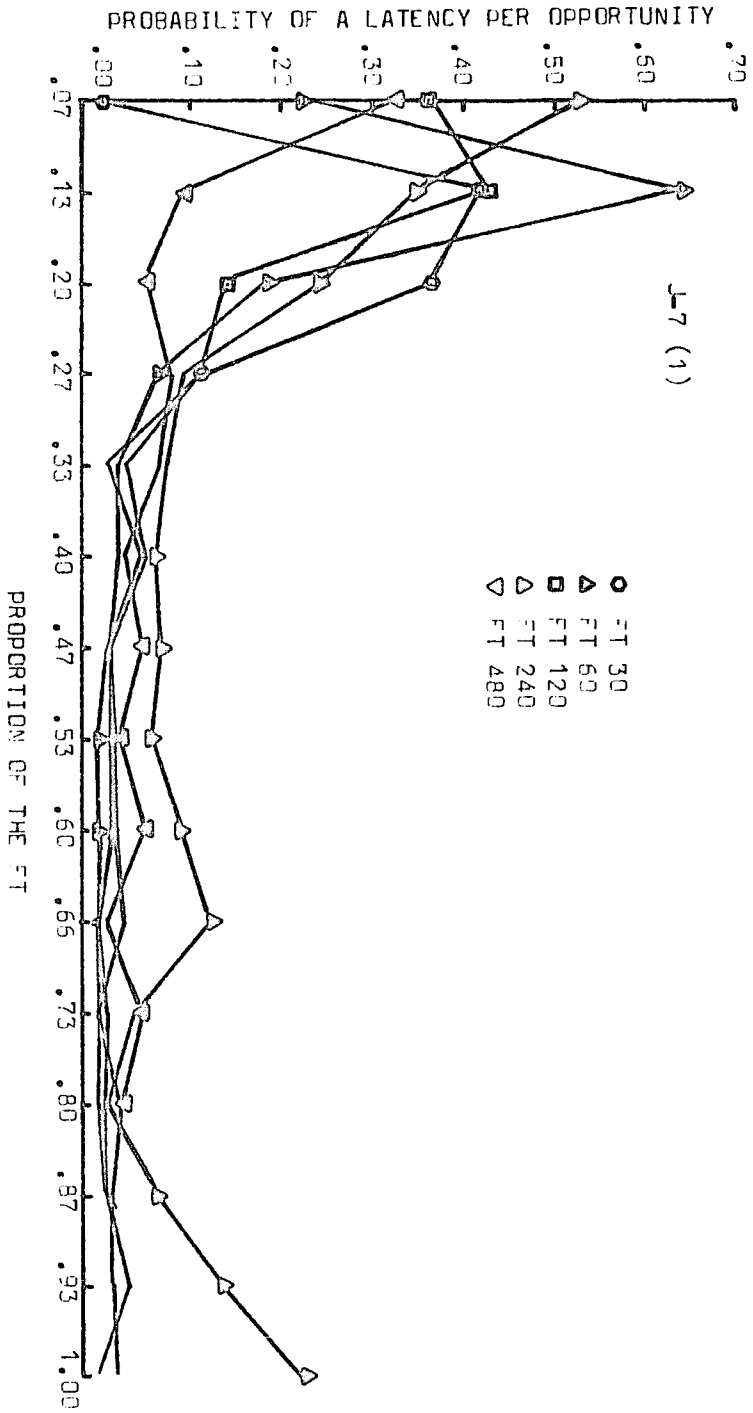

Figure 18b. Probability of an initiation per opportunity, for Rat J-7, second determination, plotted as a function of proportions of the FT.

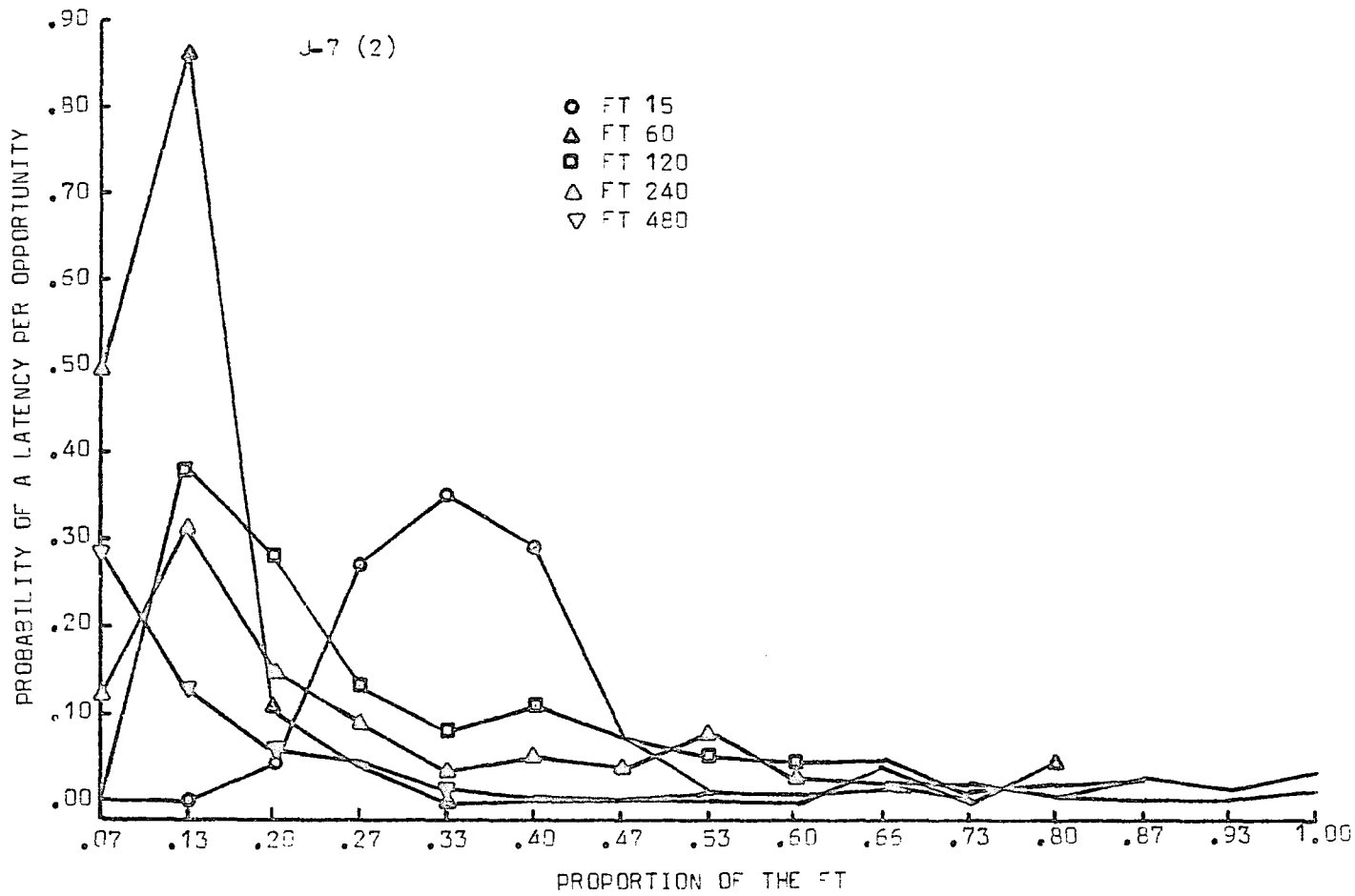

Figure 18c. Probability of an initiation per opportunity, for Rat J-10, plotted as a function of proportions of the FT.

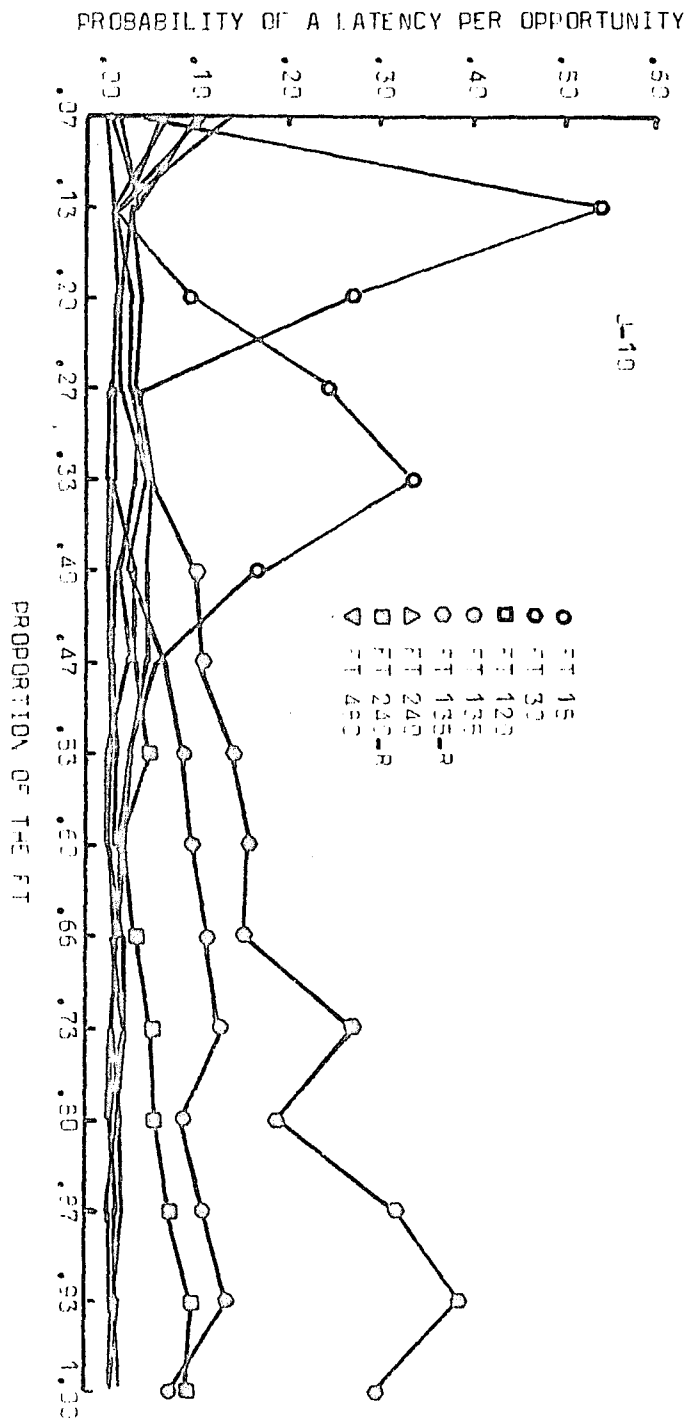

Figure 18d. Probability of an initiation per opportunity, for Rat J-11, plotted as a function of proportions of the FT.

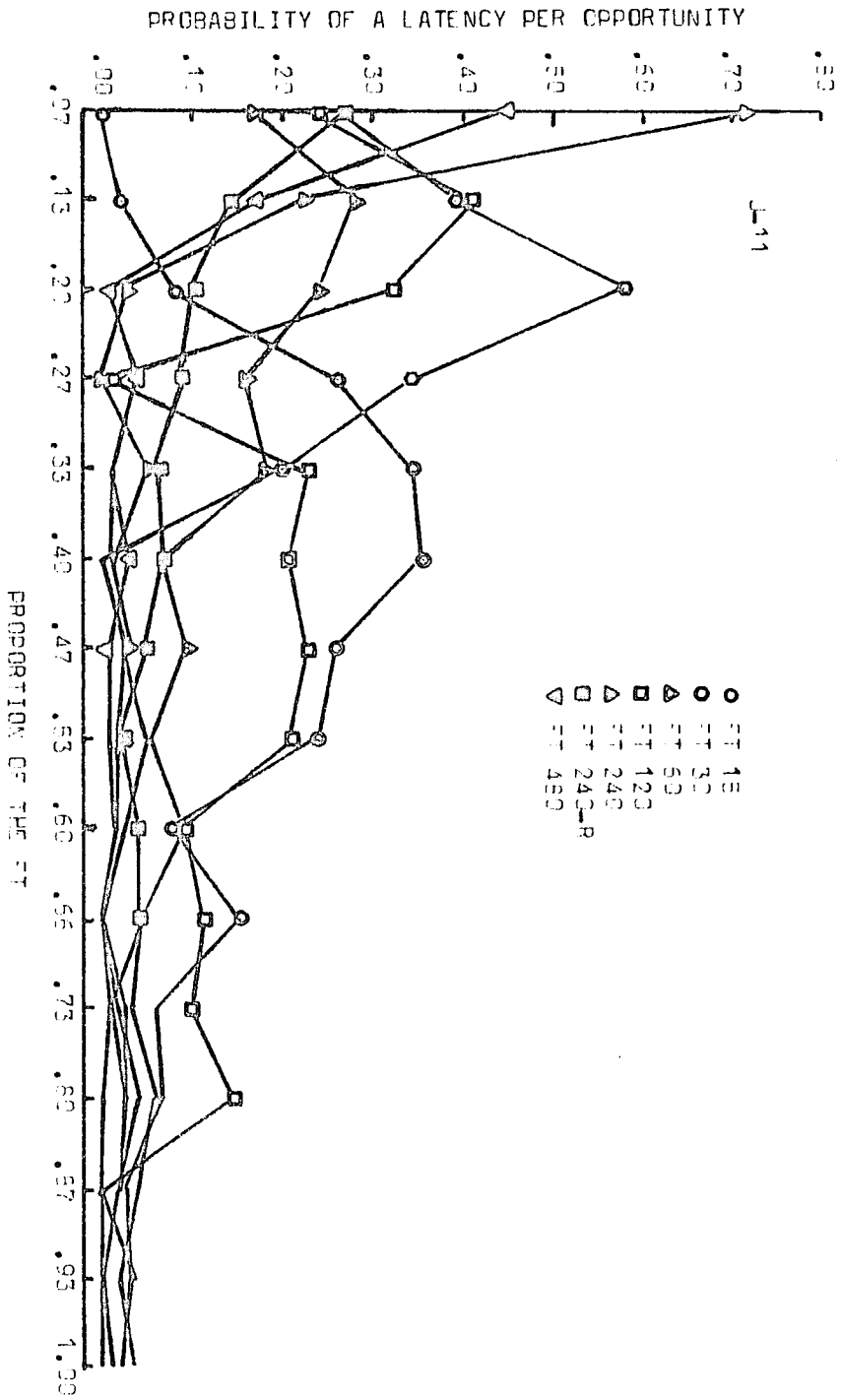
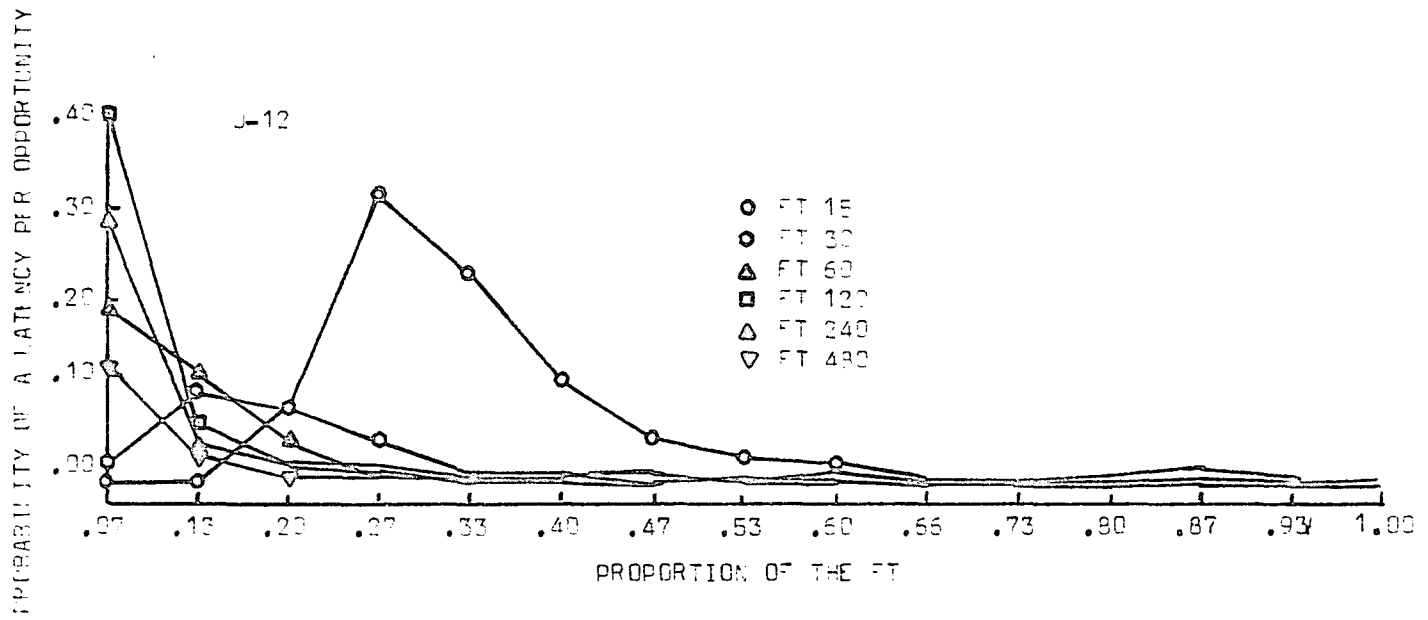

Figure 18e. Probability of an initiation per opportunity, for Rat J-12, plotted as a function of proportions of the FT.



The three measures of initiation probability described above each reflect the probability that an initiation will occur at some discrete time \underline{t} . An alternate representation of the probability of drinking, which will be useful later in the paper, is the probability that an initiation has occurred at any time prior to and including \underline{t} . This probability is equal to the cumulative simple probability of initiations at \underline{t} . These probabilities are shown in the left-hand panels of Figure 19. Since the probability that licking will have been initiated at \underline{t} is equal to the sum of the simple probabilities through \underline{t} , the value at the final proportion of the FT equals the proportion of the intervals containing licking. For Rats J-7, J-11, and J-12 all these functions are negatively accelerated, with a tendency for the initial rise to become less steep at longer FT values. The changes in shape correspond to the changes in the peakedness of the probability functions in Figures 16 and 17. Curves for Rat J-10 exhibit not only negative acceleration but also positive acceleration and linearity. The positively accelerated functions correspond to the FT values which exhibit an increasing probability per opportunity in Figure 18.

Whether the probability of drinking is expressed in terms of simple probability or conditional probability or cumulative relative frequency, the maximal probability of drinking initiation appears to be confined to a period of time early in the interfood interval. In fact, in Figure 15,

Figure 19a. Left-hand panel. Probability an initiation has occurred at given proportions of the FT, for Rat J-7, first determination.

Right-hand panel. Probability a termination has not occurred at given proportions of the FT, for Rat J-7, first determination.

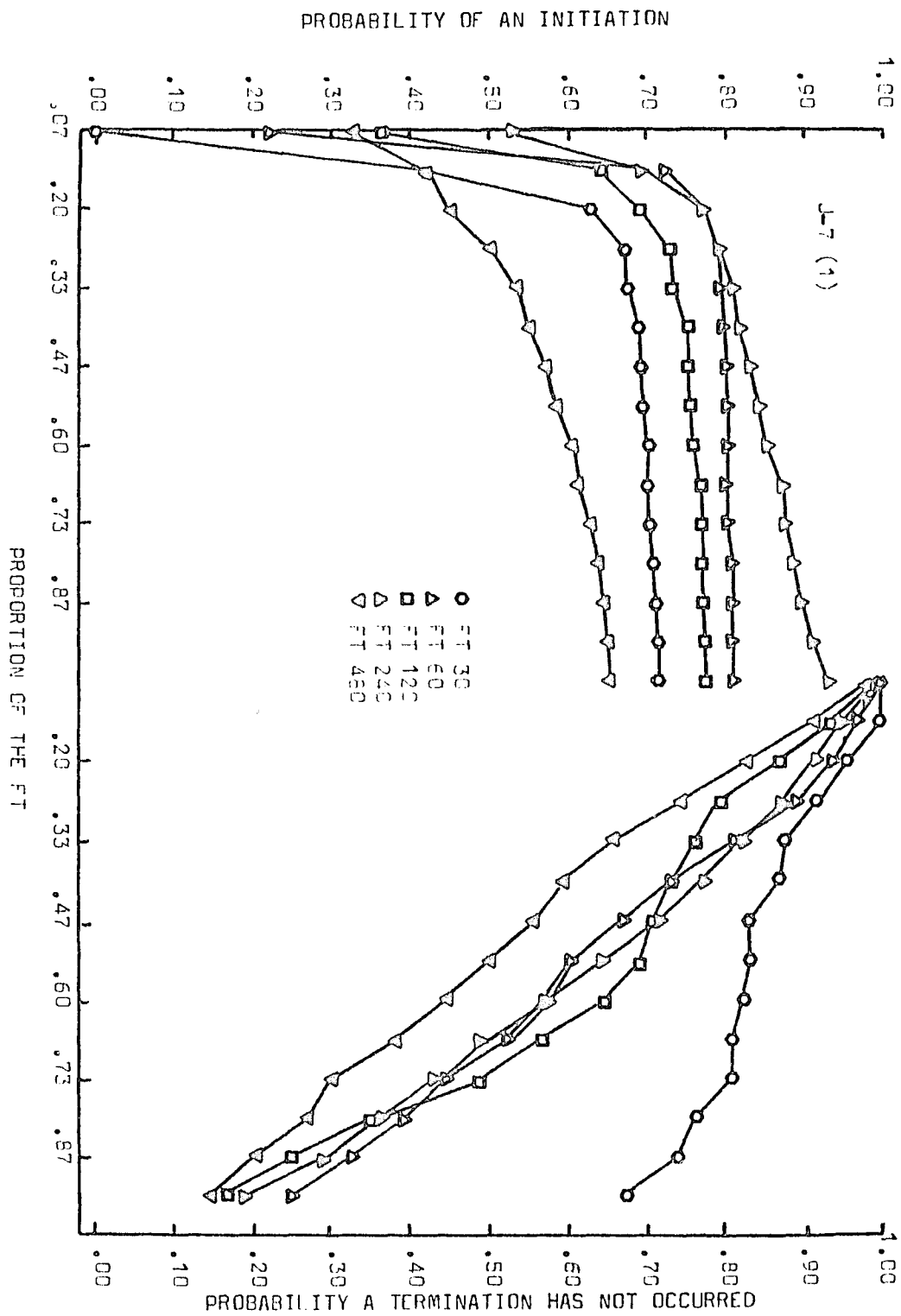

Figure 19b. Left-hand panel. Probability an initiation has occurred at given proportions of the FT, for Rat J-7, second determination.

Right-hand panel. Probability a termination has not occurred at given proportions of the FT, for Rat J-7 (2), second determination.

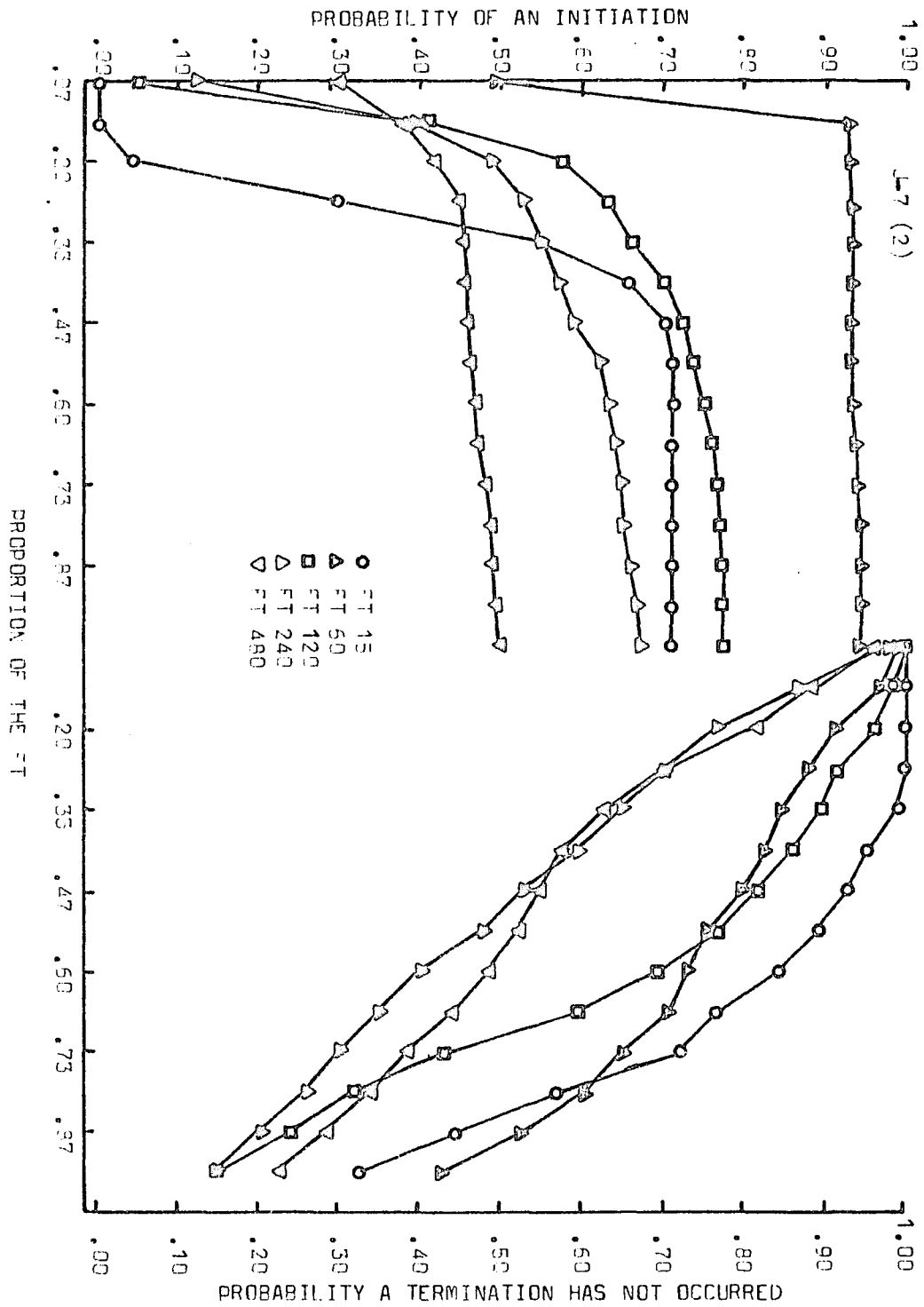

Figure 19c. Left-hand panel. Probability an initiation has occurred at given proportions of the FT, for Rat J-10.

Right-hand panel. Probability a termination has not occurred at given proportions of the FT, for Rat J-10.

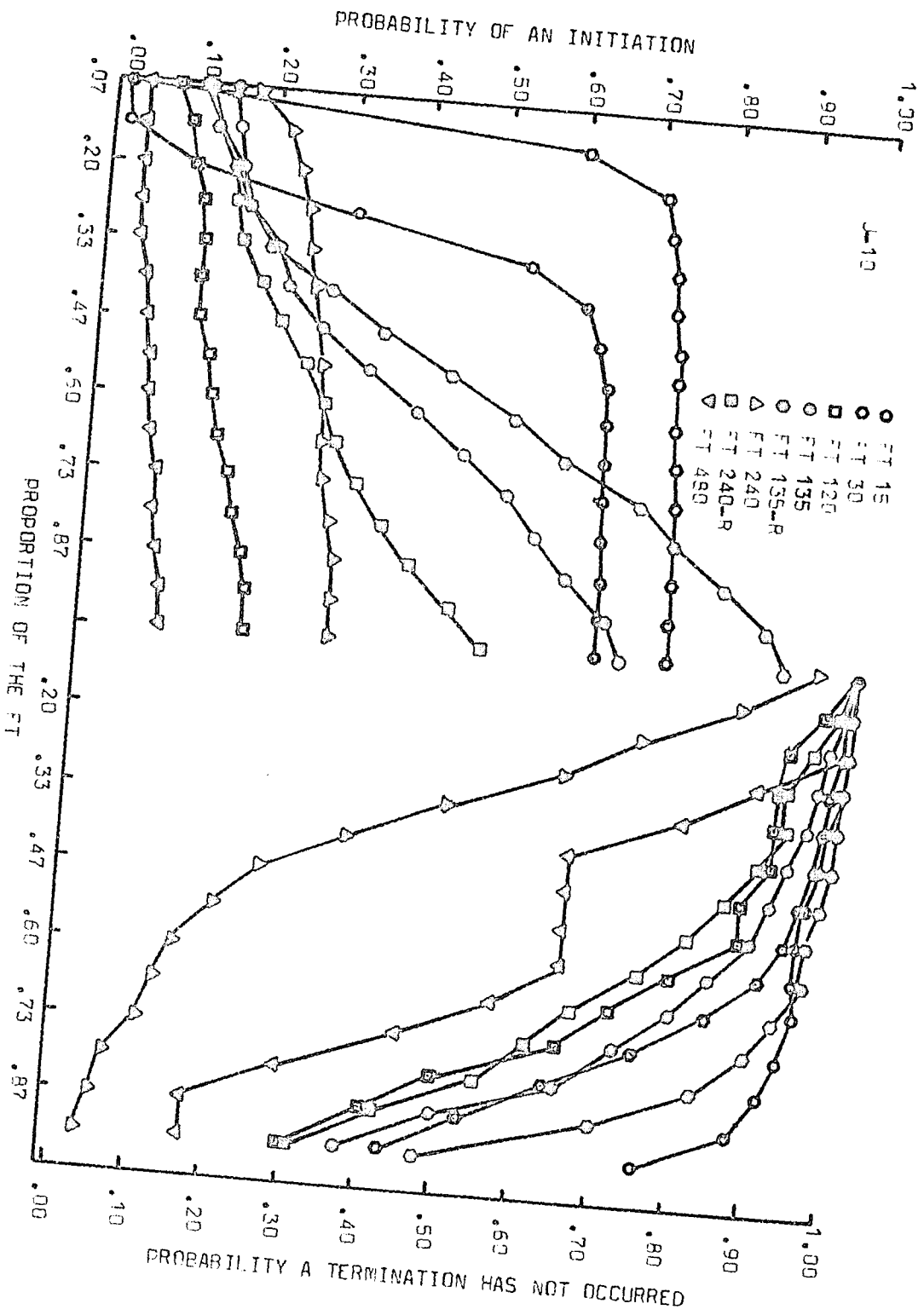

Figure 19d. Left-hand panel. Probability an initiation has occurred at given proportions of the FT, for Rat J-11.

Right-hand panel. Probability a termination has not occurred at given proportions of the FT, for Rat J-11.

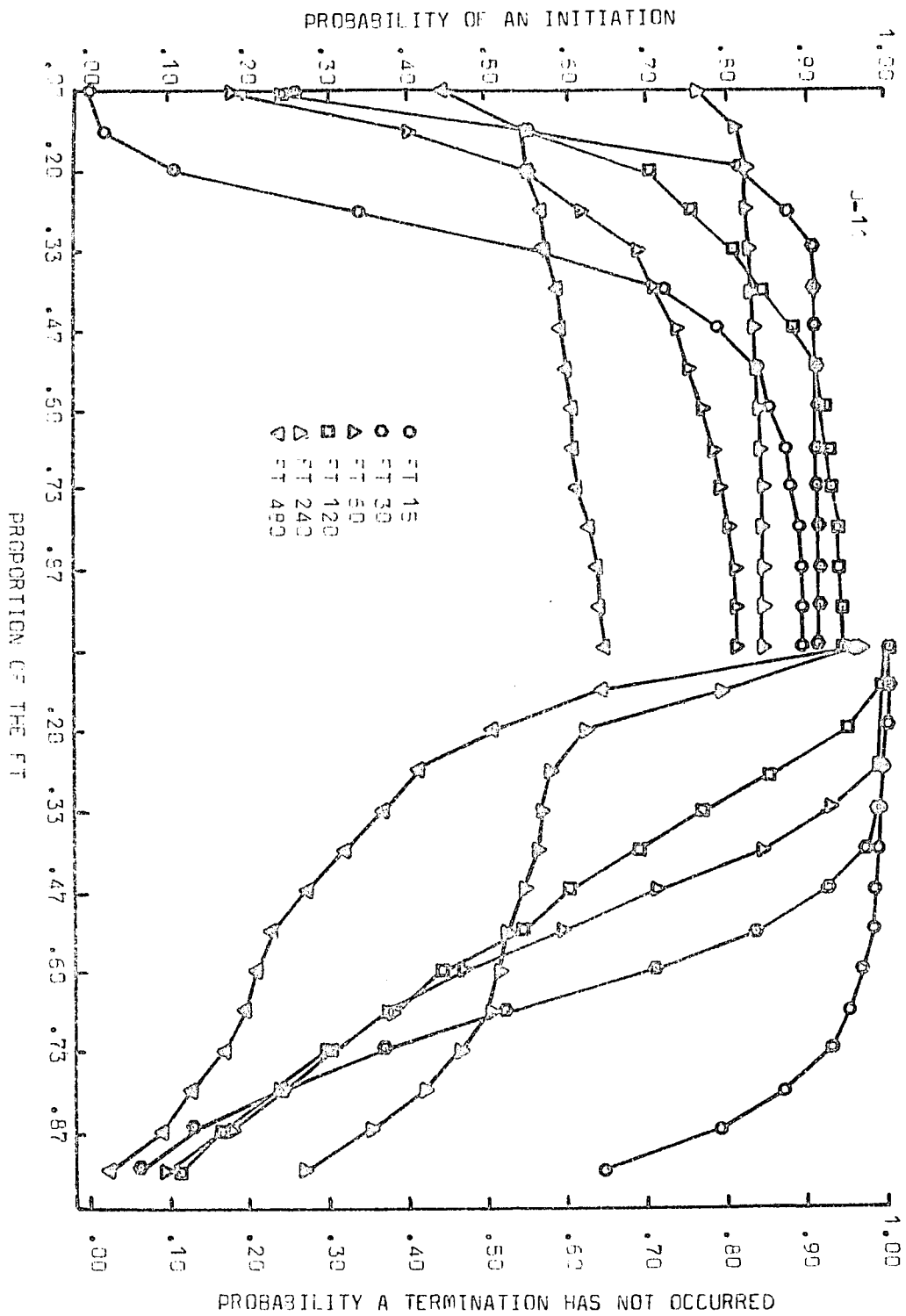
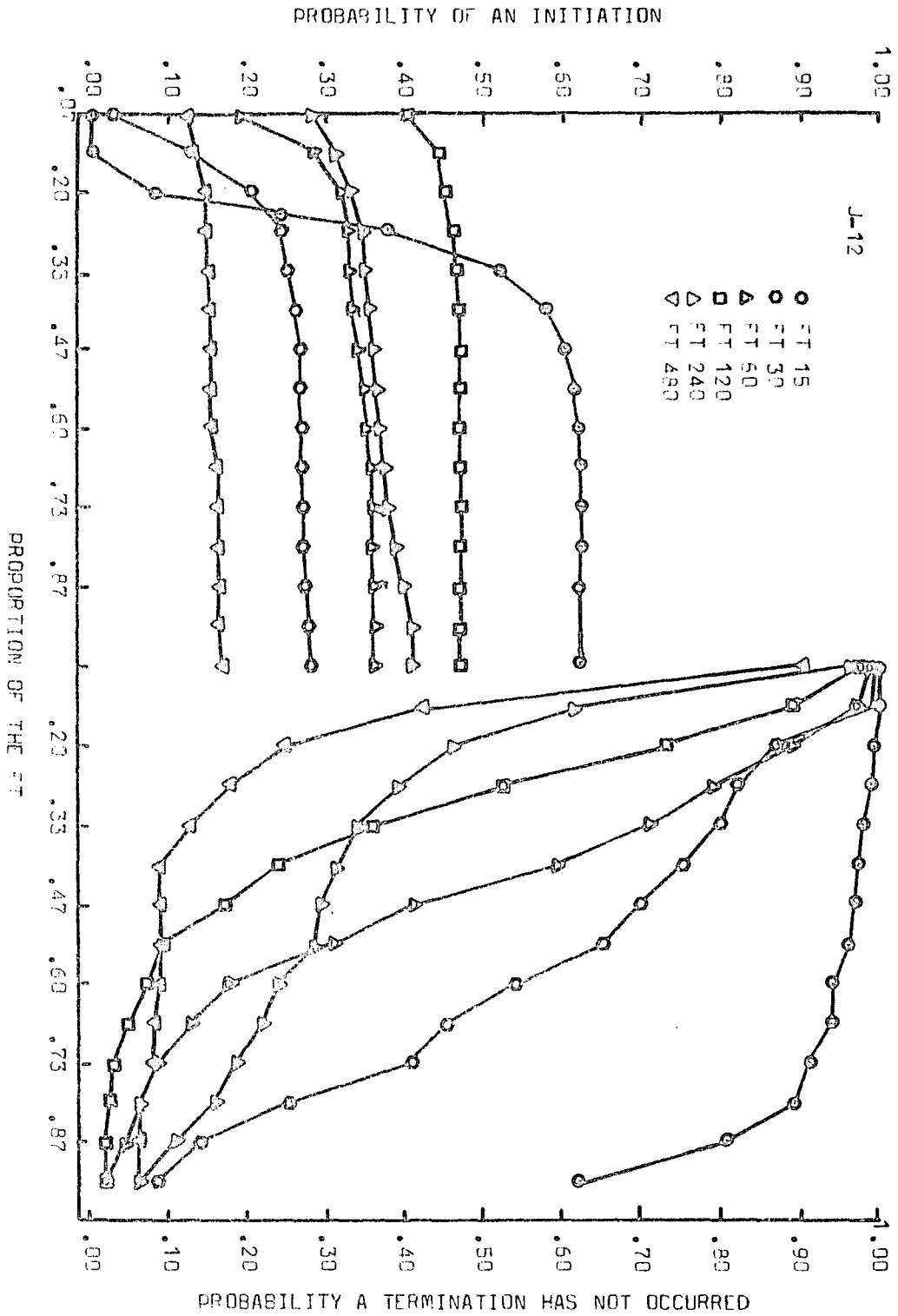

Figure 19e. Left-hand panel. Probability an initiation has occurred at given proportions of the FT, for Rat J-12.

Right-hand panel. Probability a termination has not occurred at given proportions of the FT, for Rat J-12.



the functions relating the median initiation value to the FT reveal that for 27 of the 32 data points, 50 percent of the initiations fall within the first 30 secs. of the interfood interval. Although the medians are constrained for FT 15 and FT 30, they are not constrained for the other FT values. Since so much of the drinking occurs within the first 30 secs., the probability of drinking within this time period has been further analyzed.

Figure 20 shows the simple probability of an initiation as a function of time since food, collapsed into two-sec. blocks. An examination of these functions between rats reveals two striking similarities. First, at the shorter FT values the probabilities rise very quickly to a sharp peak, then quickly decline to near zero probabilities by 8 to 10 secs. Secondly, as the FT value increases, the probability associated with these peaks becomes smaller, and the functions are less peaked. The extent to which the location of the peak changes as a function of the FT varies between rats. The values are approximately equal to the modal values of the distribution of all initiations, less than perfect correspondence being due to averaging over two-sec. blocks. Note that for J-7, first determination, by 16 secs. after food the probability of an initiation across all FT values was less than 0.05. During the second determination, the distribution shifted to the right, requiring 28 secs. for all probabilities to decline below .05. With

Figure 20a. Simple probability of an initiation for Rat J-7, first determination, plotted as a function of consecutive 2-sec time periods after food.

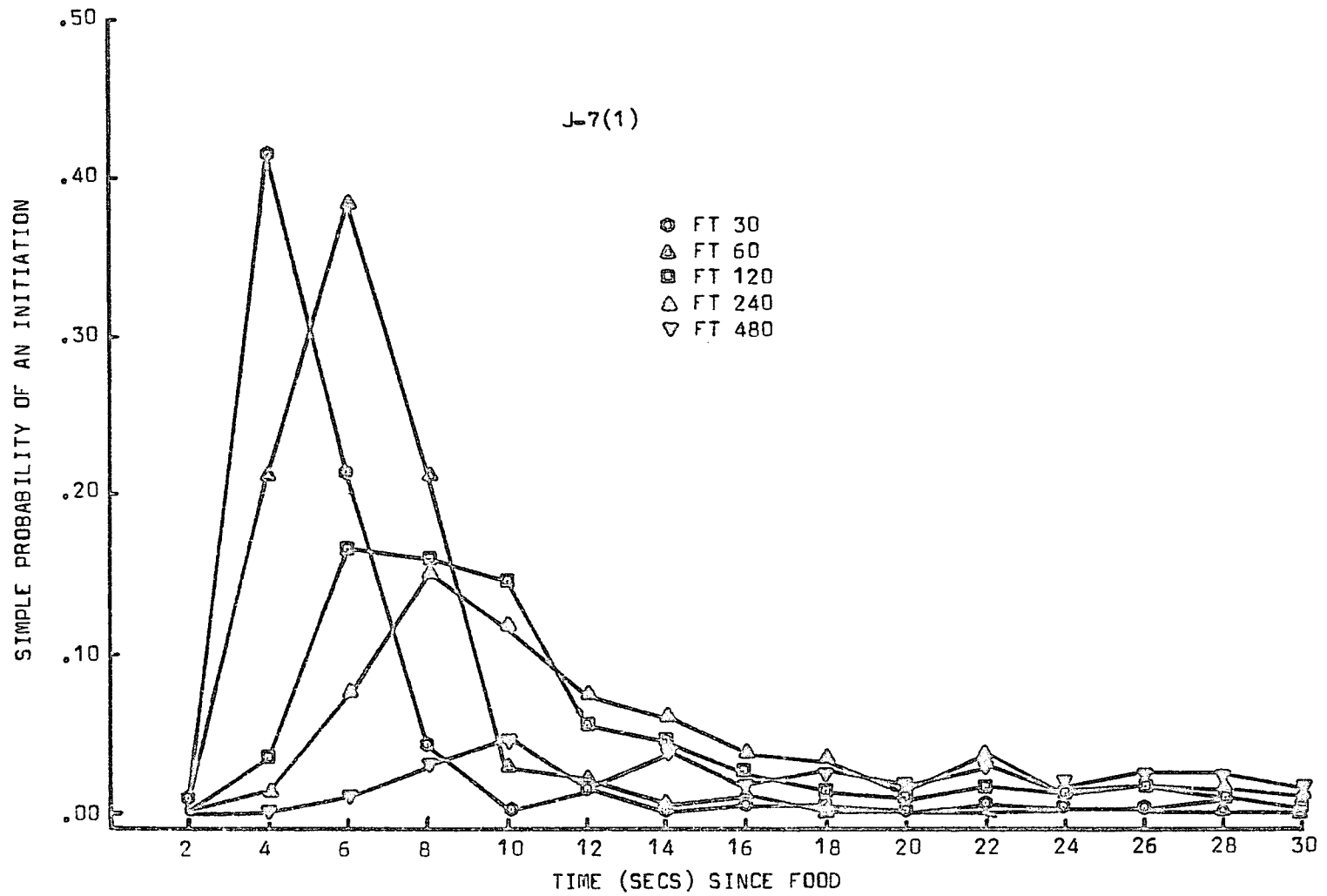

Figure 20b. Simple probability of an initiation for Rat J-7, second determination, plotted as a function of consecutive 2-sec time periods after food.

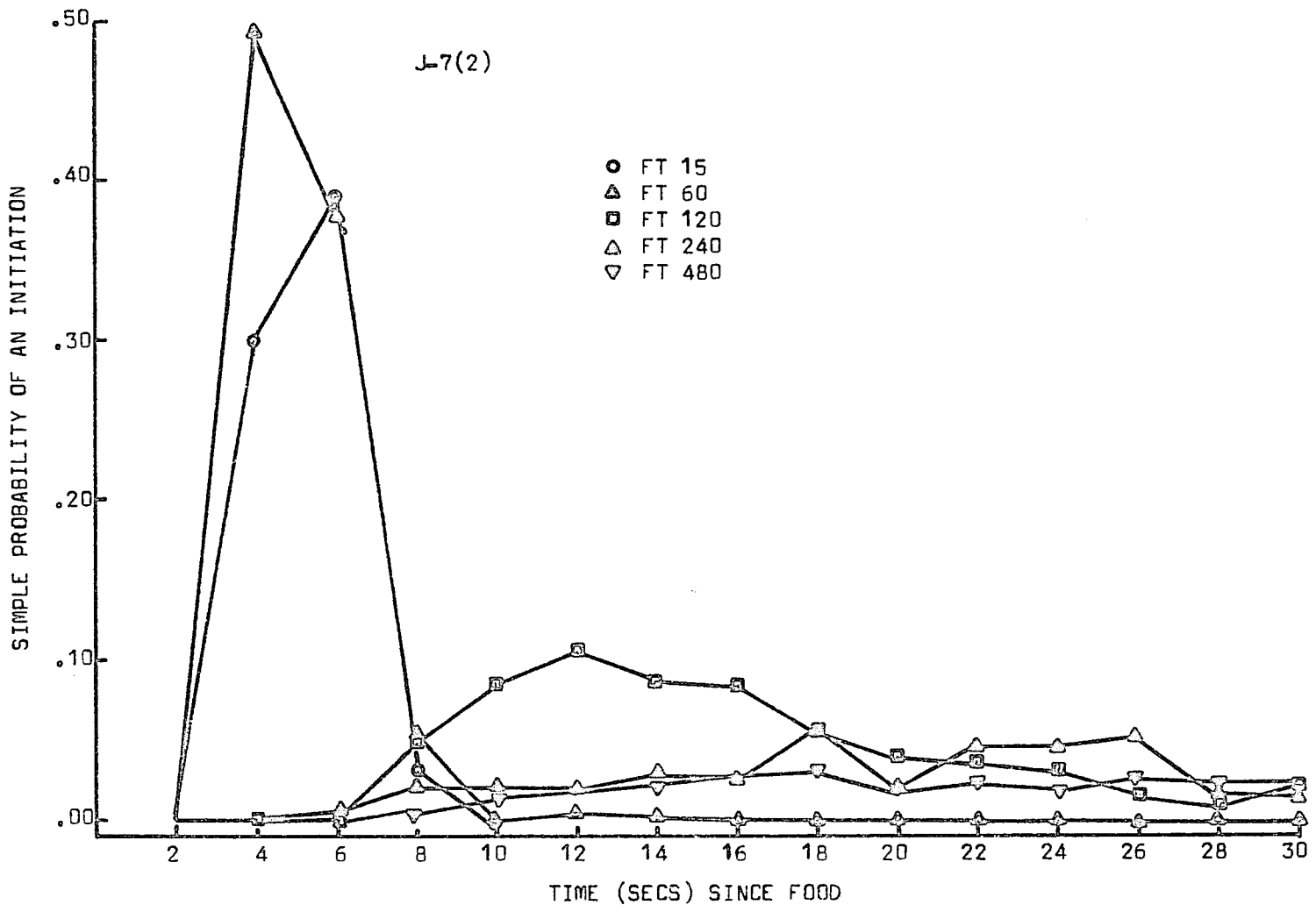

Figure 20c. Simple probability of an initiation for Rat J-10, plotted as a function of consecutive 2-sec time periods after food.

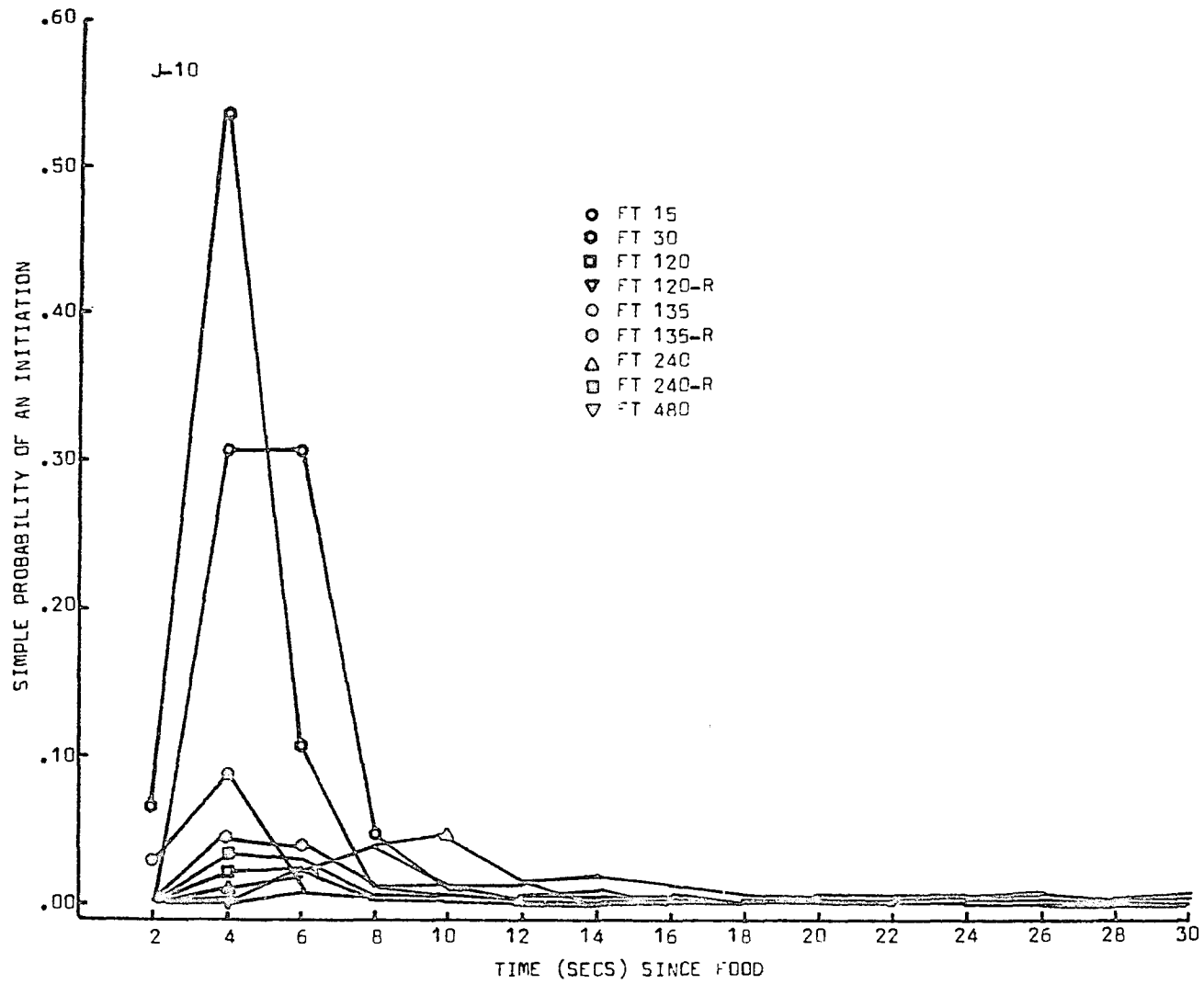

Figure 20d. Simple probability of an initiation for Rat J-11, plotted as a function of consecutive 2-sec time periods after food.

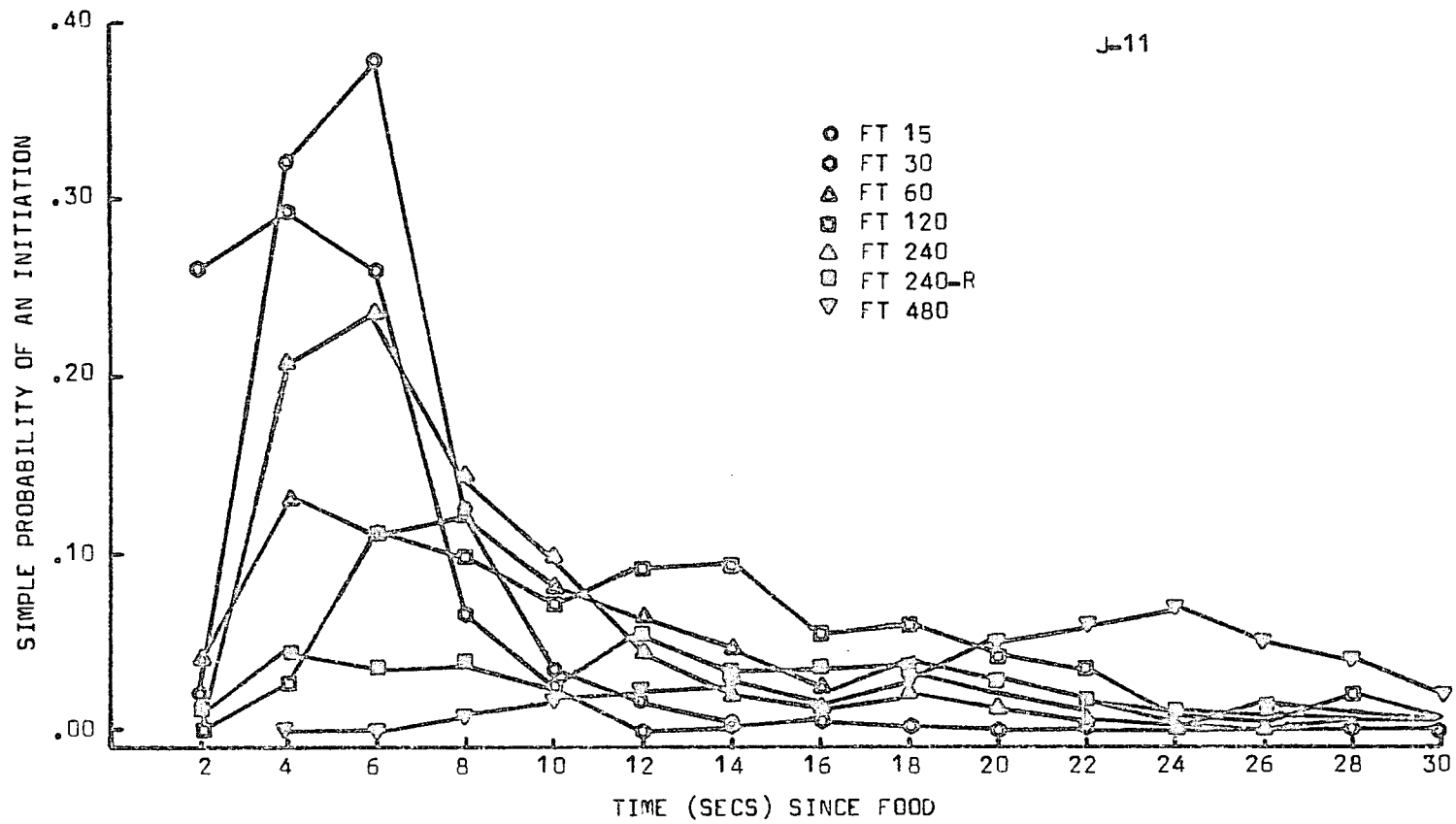
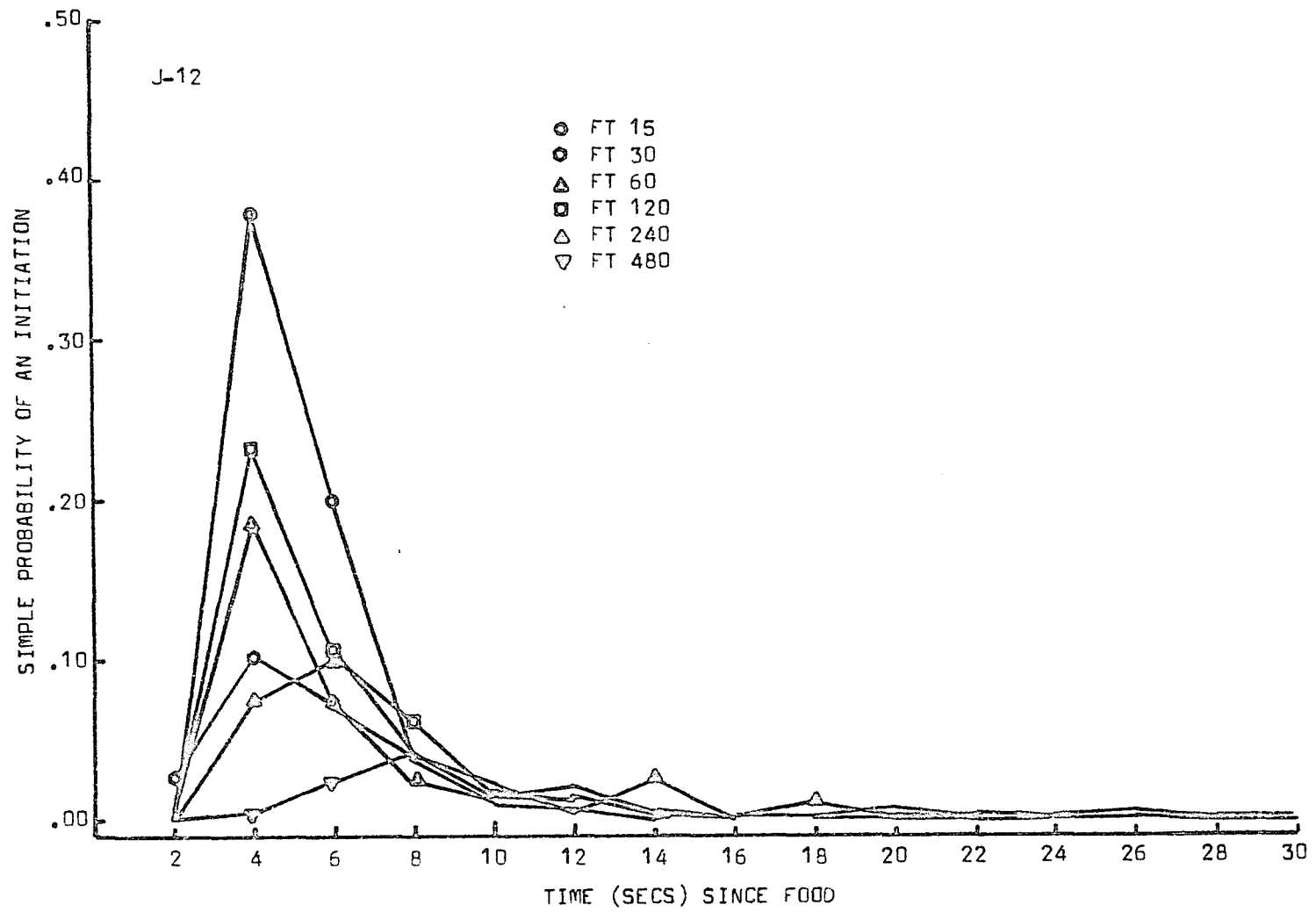

Figure 20e. Simple probability of an initiation for Rat J-12, plotted as a function of consecutive 2-sec time periods after food.



the exception of FT 240, these probabilities had been attained at 20 secs. For Rat J-10 all the probabilities had declined below 0.05 by 8 secs. For Rat J-11, the decline occurred at 14 secs. for all FT values except FT 120 and FT 480. For FT 120 probabilities less than 0.05 were attained at 20 secs. The FT 480 function did not peak until 24 secs. For Rat J-12 the probabilities had all declined below 0.05 by 10 secs.

Because the simple probability of an initiation is affected by the number of intervals containing drinking, it would be of interest to compare initiation probabilities across FT values, examining only those intervals containing drinking. These relative frequency probabilities are shown in Figure 21. Of special interest is the rank-ordering of the FT values with respect to the probabilities associated with the peak. Comparison of Figure 20 and 21 reveals only two reversals. For J-7, second determination, the rank-ordering of the FT 15 and FT 60 was reversed, and for Rat J-12, FT 60 and FT 120 was reversed.

Figures 20 and 21 indicate that the maximal probabilities of an initiation are attained early in the first 30 secs. after food delivery. Because the opportunities for initiations are changing, however, the probability per opportunity statistic was applied to the frequency distribution. The resulting functions are shown in Figure 22. They strongly resemble those in Figures 20 and 21 in showing a quick rise and decline in probability at low FT values and a less rapid

Figure 21a. Relative frequency of initiations for Rat J-7, first determination, plotted as a function of consecutive 2-sec time periods after food.

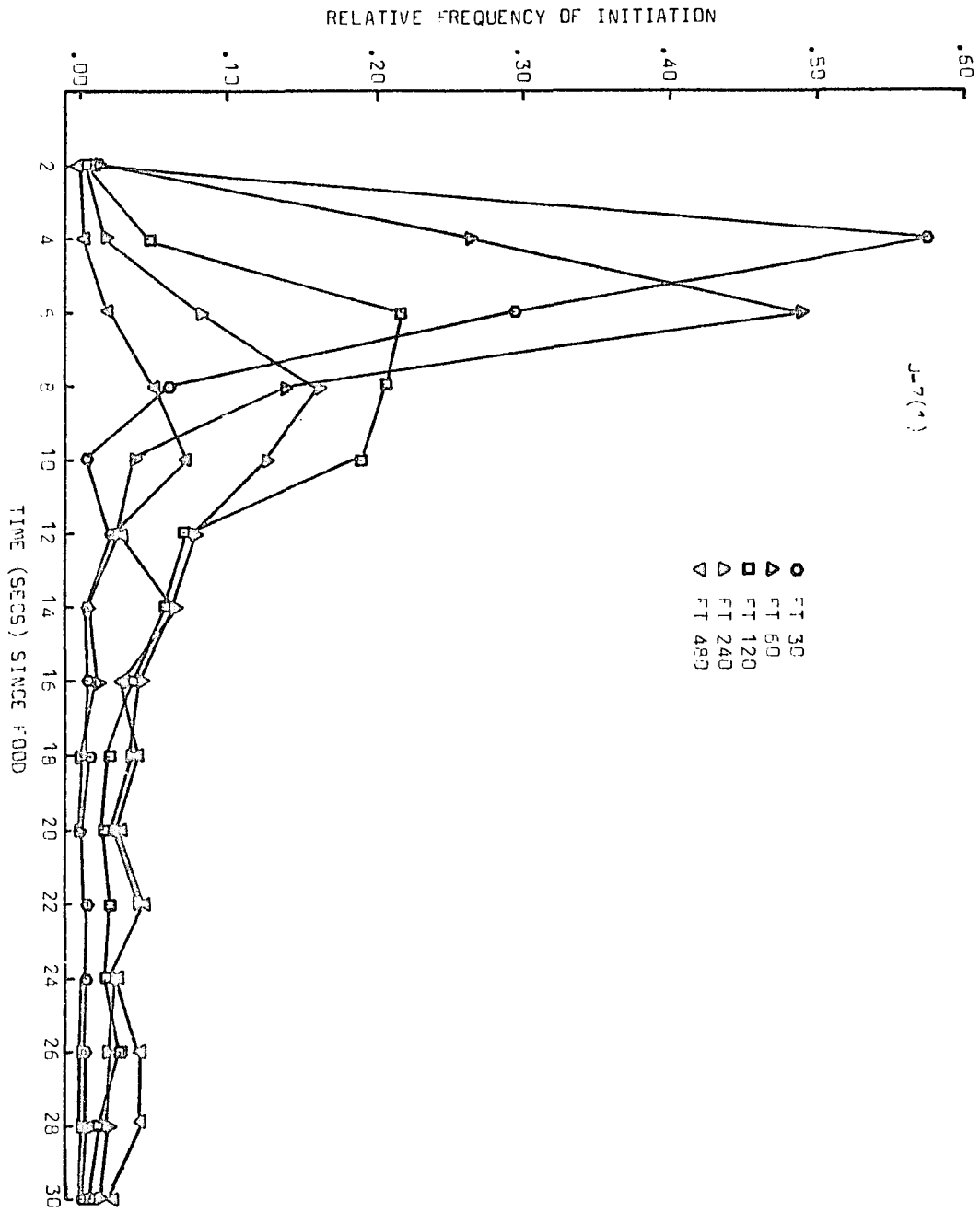

- FT 30
- ◻ FT 60
- ◄ FT 120
- ◃ FT 240
- ◂ FT 480

Figure 21b. Relative frequency of initiations for Rat J-7, second determination, plotted as a function of consecutive 2-sec time periods after food.

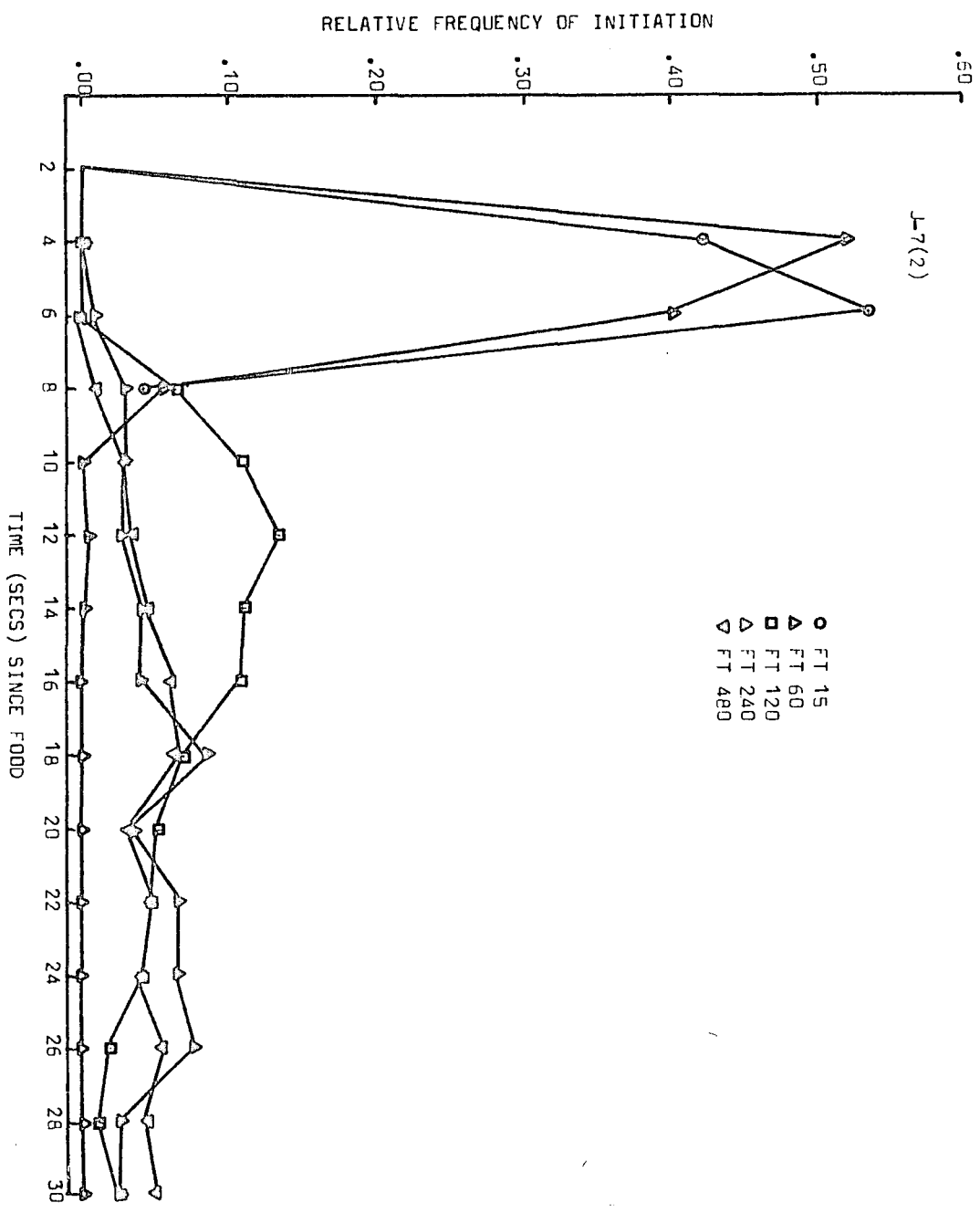

- FT 15
- △ FT 60
- FT 120
- ▽ FT 240
- ◇ FT 480

Figure 21c. Relative frequency of initiations for Rat J-10, plotted as a function of consecutive 2-sec time periods after food.

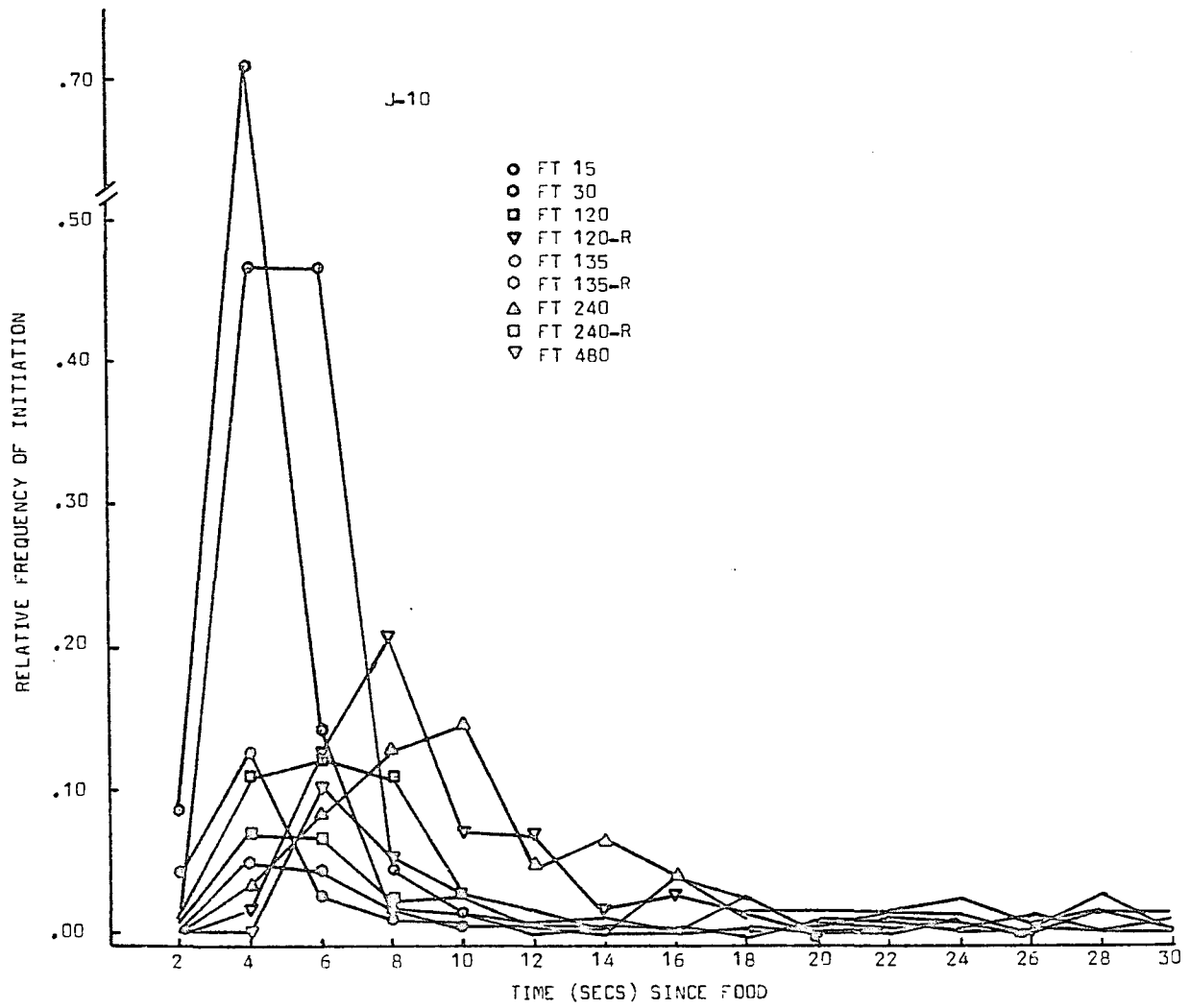

Figure 2ld. Relative frequency of initiations for Rat J-11, plotted as a function of consecutive 2-sec time periods after food.

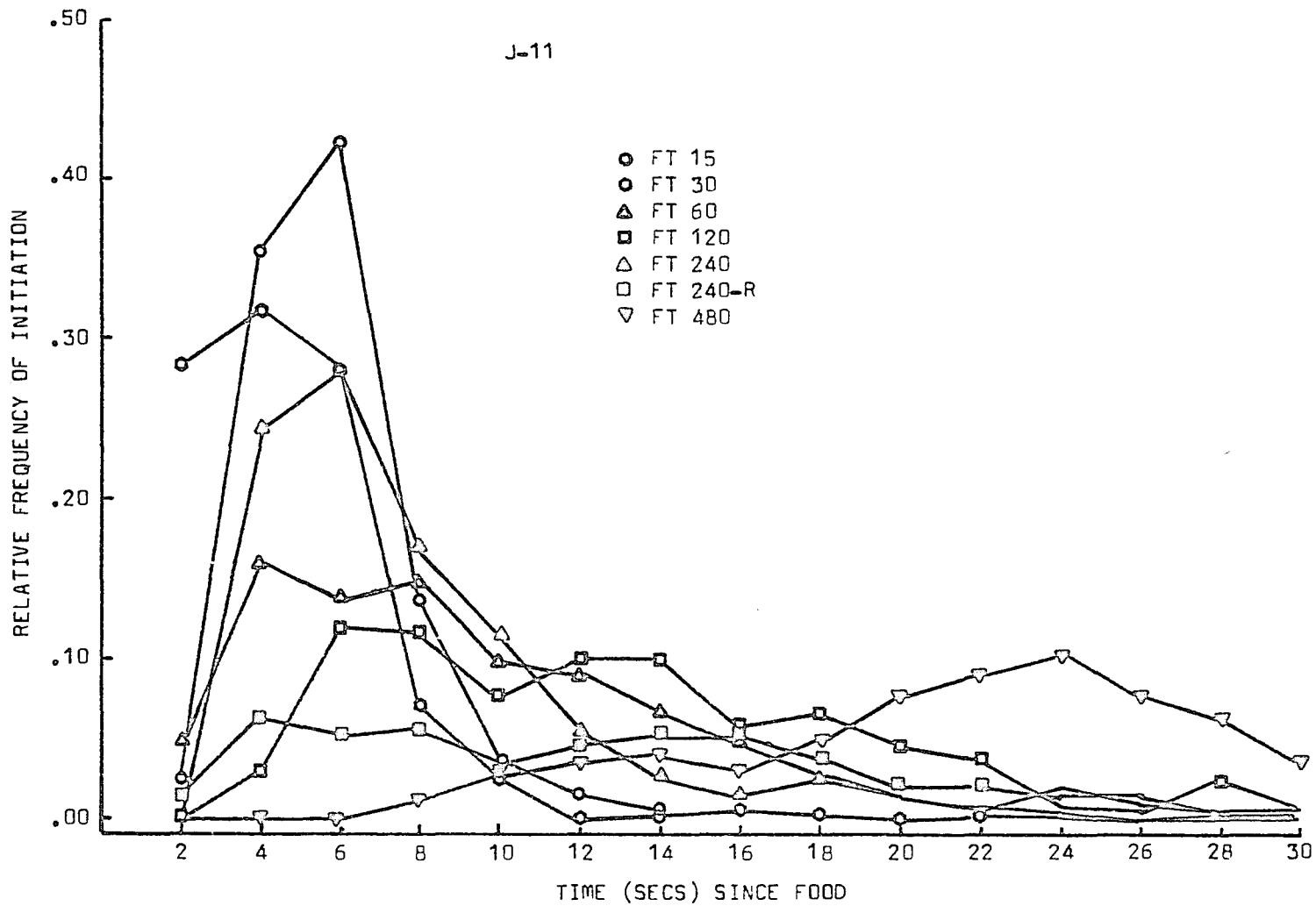

Figure 21e. Relative frequency of initiations for Rat J-12, plotted as a function of consecutive 2-sec time periods after food.

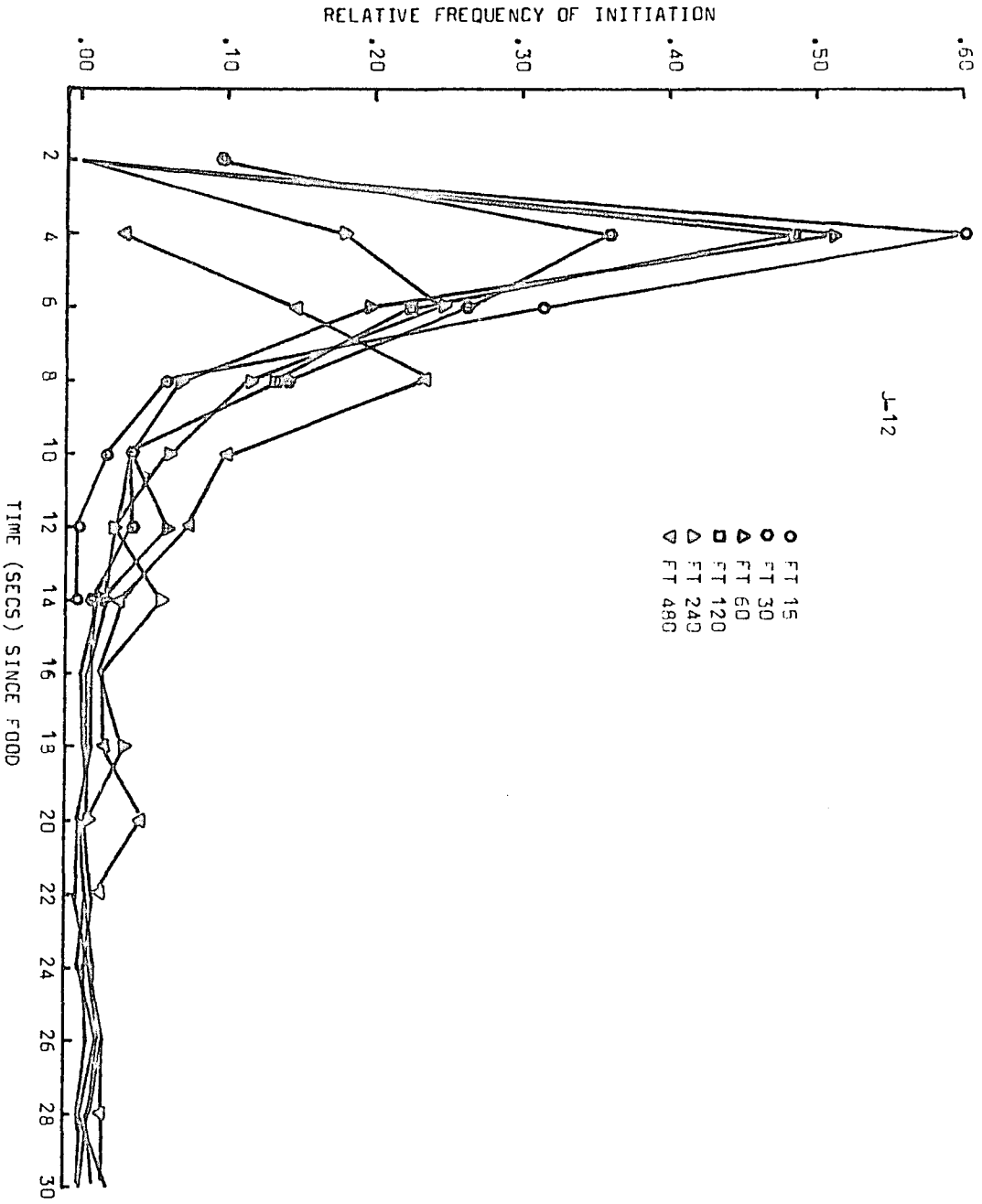

Figure 22a. Probability of an initiation per opportunity, for Rat J-7, first determination, plotted as a function of consecutive 2-sec time periods after food.

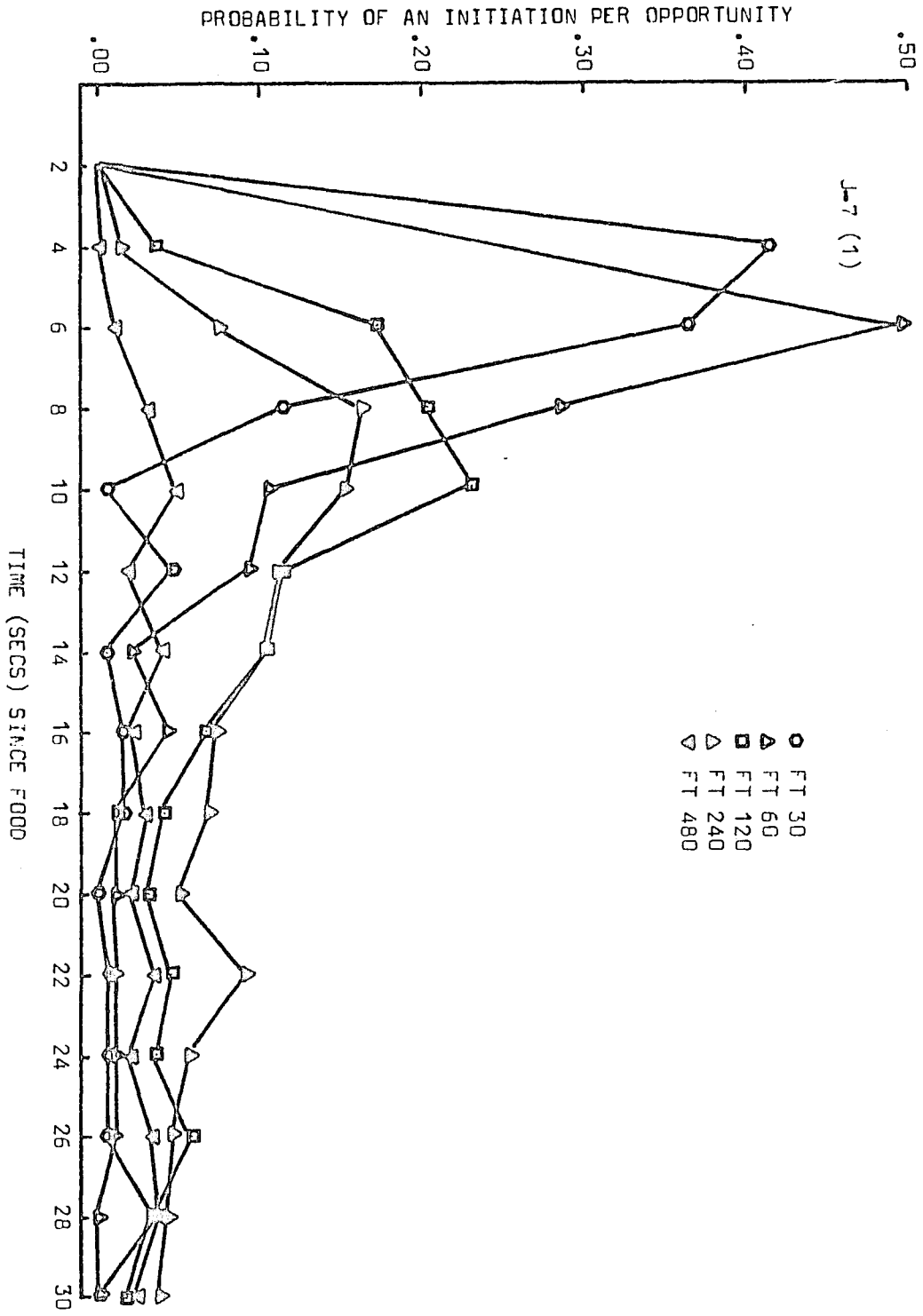

Figure 22b. Probability of an initiation per opportunity, for Rat J-7, second determination, plotted as a function of consecutive 2-sec time periods after food.

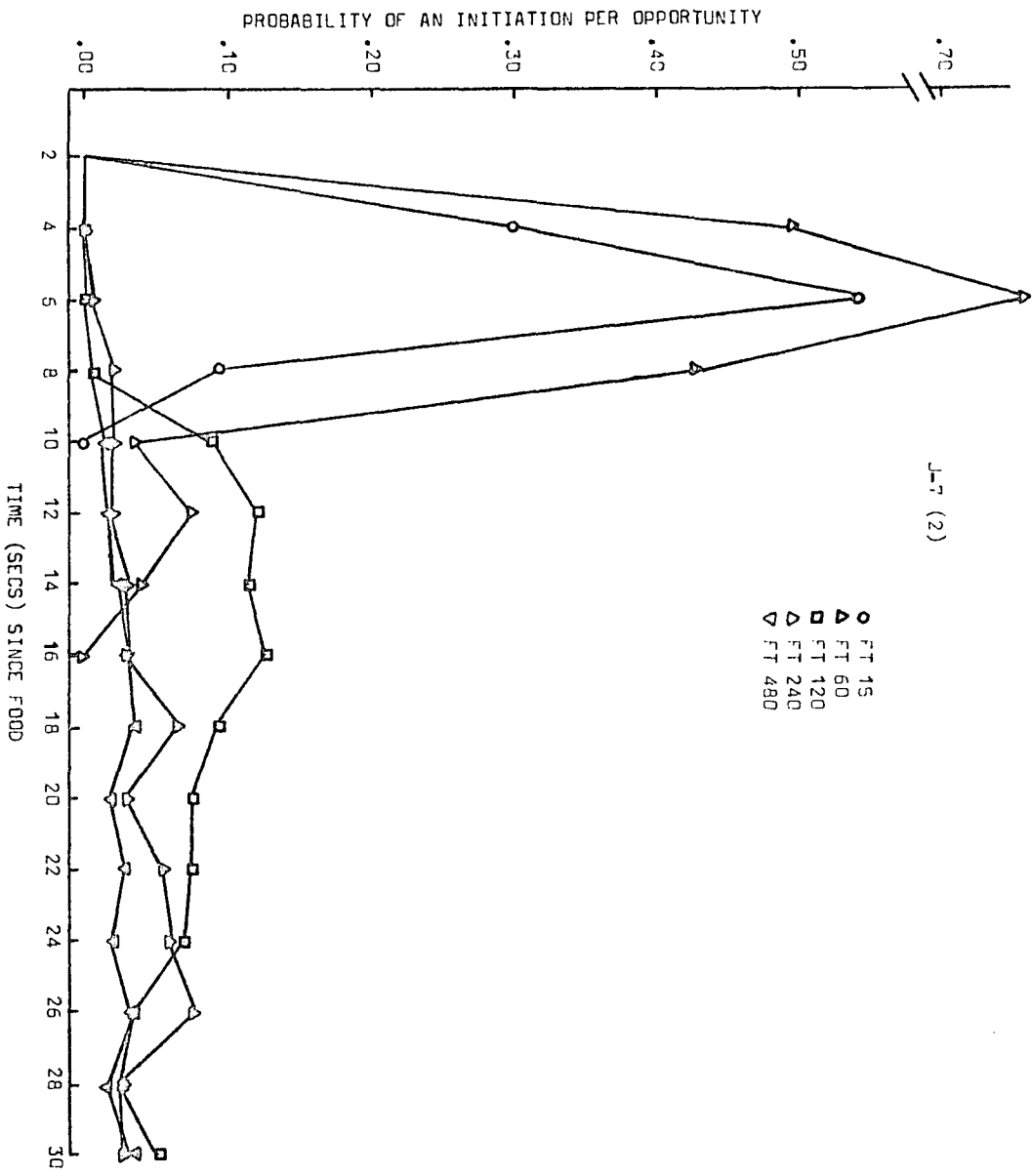

Figure 22c. Probability of an initiation per opportunity, for Rat J-10, plotted as a function of consecutive 2-sec time periods after food.

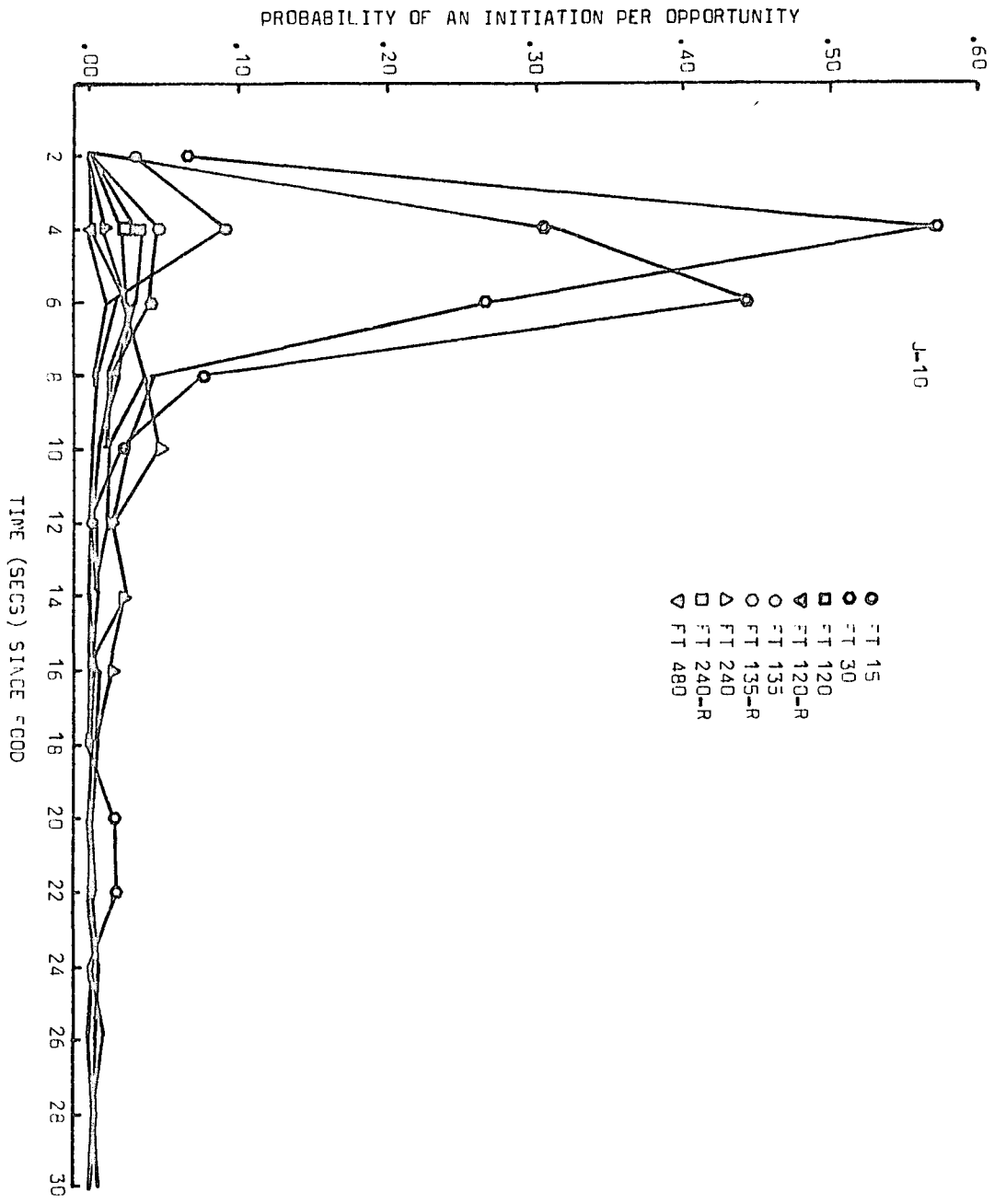
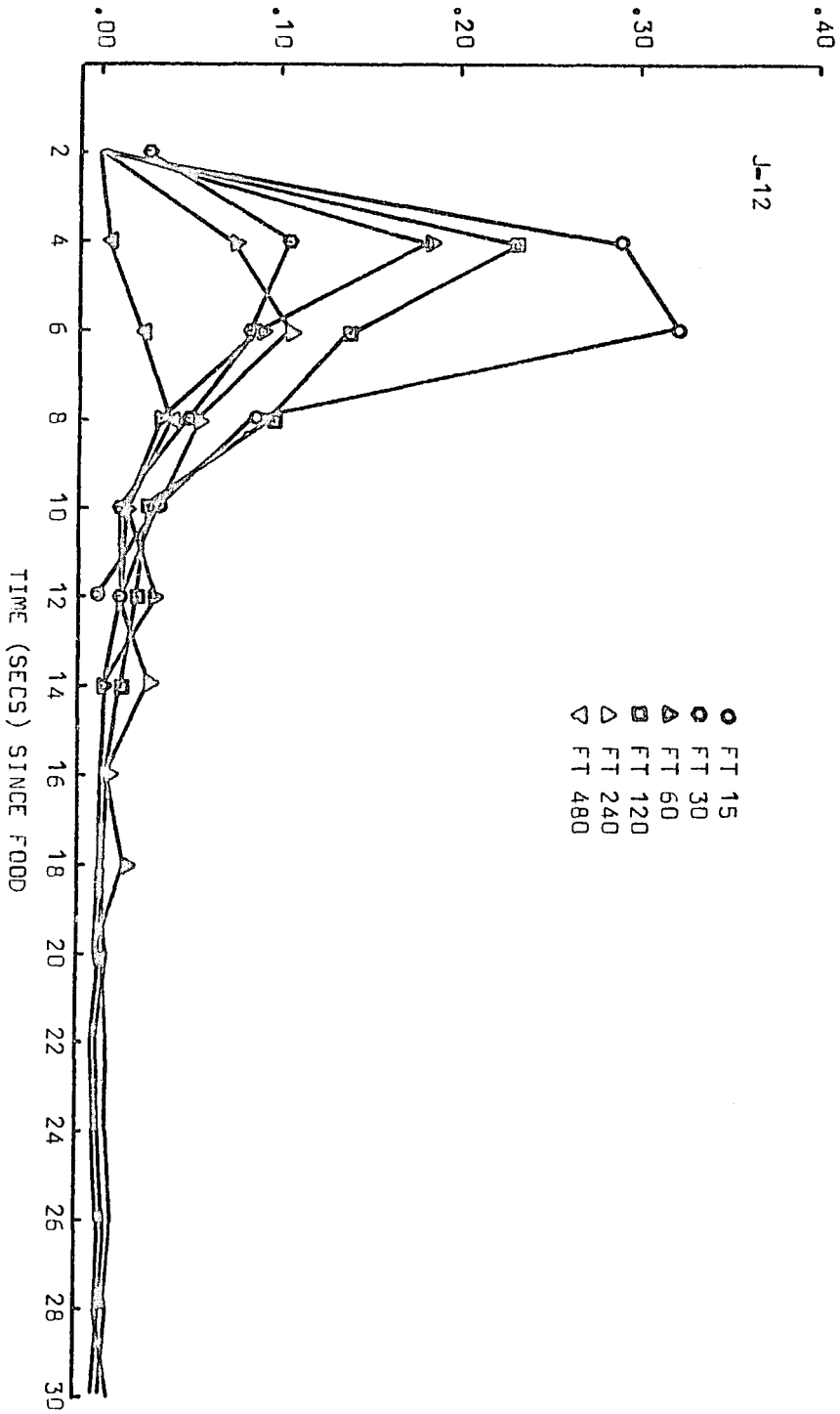

Figure 22d. Probability of an initiation per opportunity, for Rat J-11, plotted as a function of consecutive 2-sec time periods after food.

Figure 22e. Probability of an initiation per opportunity, for Rat J-12, plotted as a function of consecutive 2-sec time periods after food.

PROBABILITY OF AN INITIATION PER OPPORTUNITY



rise and decline at higher FT values. There are several shifts in the location of the peaks. These are plotted in Figure 23 as a function of the FT. For comparison, the location of the peak probabilities from Figure 20 are also plotted. In conditions with redeterminations, the mean of the two points is plotted.

The measures of probability of drinking initiation described above reveal the following two regularities. First, in most cases the maximal probability of drinking occurs within a few seconds after food delivery. Secondly, the maximal probability of drinking initiation is sensitive to the FT value since the functions become less peaked as the FT increases. It is not clear, however, whether the location of the peak is sensitive to the FT value. Figure 23 indicates that for Rats J-7, J-11, and J-12 these locations increase only slightly as a function of the FT; for Rat J-10 the functions appear flat.

Does this outcome indicate that the location of the maximal probability of drinking is largely insensitive to the FT value? Perhaps the modal initiation probability is not the most informative statistic regarding the location of drinking, especially since the measures of drinking probability just described show that the distributions of drinking probability become more shallow as the FT value increases; and Figure 5 indicates that the median and mean initiation time do change dramatically as a function of the FT. Unfortunately, the mean initiation time does not provide a good

Figure 23a. Time at the maximal simple probability of an initiation and time at the maximal conditional probability of an initiation during consecutive 2-sec time periods after food, for Rat J-7, plotted as a function of the FT value.

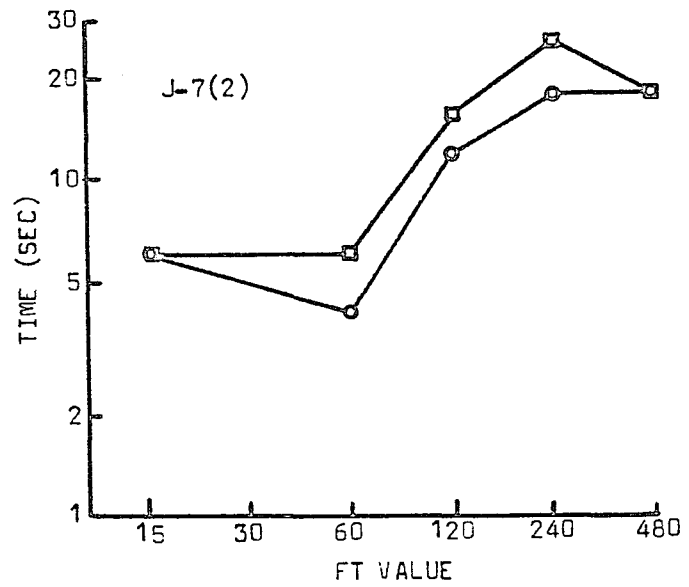
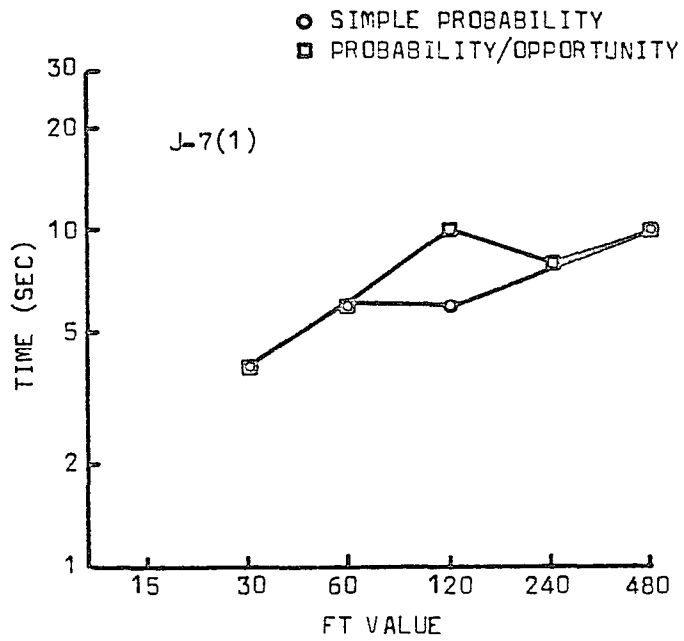
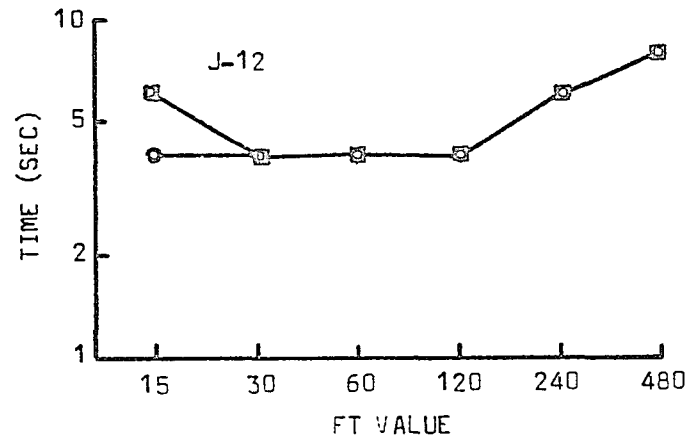
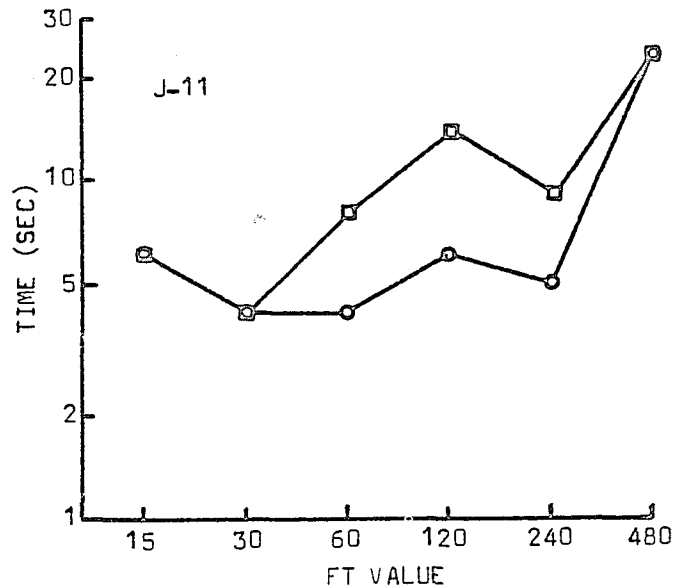
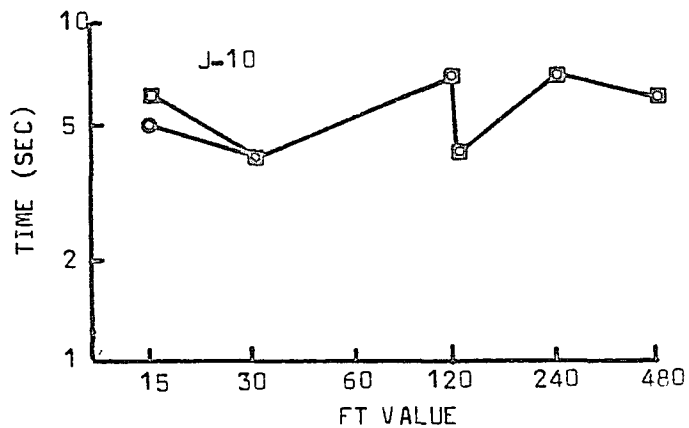

Figure 23b. Time at the maximal simple probability of an initiation and time at the maximal conditional probability of an initiation during consecutive 2-sec time periods after food, for Rats J-10, J-11, and J-12, plotted as a function of the FT value.



○ SIMPLE PROBABILITY
 □ PROBABILITY/OPPORTUNITY

measure of sensitivity to FT value for it is very sensitive to extreme values: it can be inflated by the occurrence of a few random long initiation times. The median is less sensitive to extreme values, but nonetheless still sensitive. Inasmuch as the mean and median are increasing functions of the FT value, there arises the question of the extent to which they are largely due to random occurrences of longer initiations with increases in the FT value. This possibility can be assessed by examining mean and median initiation times over time periods that are equal for the various FT values, and therefore not differentially affected by a few extreme initiations. Figure 15 indicates that the median initiation time was less than 30 secs. in 27 of the 32 points; accordingly, analysis of the mean and median initiation times during this period should provide a good basis for assessing the sensitivity of the location of drinking to FT value. The mean of the initiations occurring during the first 30 secs. of the inter-food interval is shown in the upper graph of Figure 24 as a function of the FT. The median of this distribution is shown in the lower graph. (The FT 15 condition has been excluded since 30 secs. is unavailable.) These functions are not flat, but rather tend to increase, indicating that initiation times in the first 30 secs. after food are differentially affected by the FT. The equation for the best-fit line for these functions, the correlation coefficient, and \underline{r}^2 are provided in Table 5. In general, these functions are not as

Figure 24. Mean and median time of initiations in the first 30 secs after food, plotted as a function of the FT value.

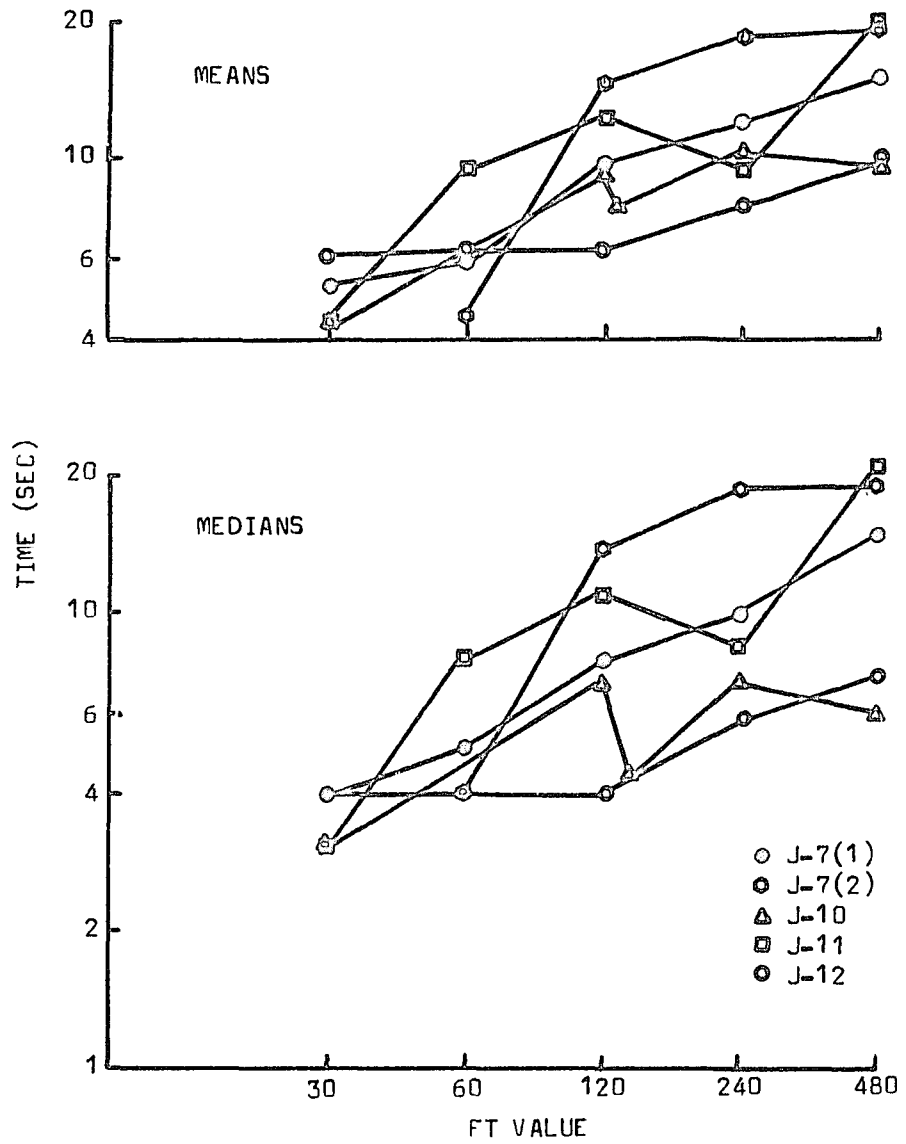

Table 5

Equations for Best-Fit Line, \underline{r} , and \underline{r}^2 for Means and Medians of Drinking Initiations in the First 30 Secs. after Food for Each Rat

Rat	Equation	\underline{r}	\underline{r}^2
<u>Means</u>			
J-7(1)	$y = .41x + .24$.98	.96
J-7(2)	$y = .66x - .86$.87	.76
J-10	$y = .17x + 1.17$.63	.40
J-11	$y = .45x + .14$.87	.76
J-12	$y = .19x + 1.09$.88	.77
<u>Medians</u>			
J-7(1)	$y = .48x - .12$.99	.98
J-7(2)	$y = .72x - .53$.87	.76
J-10	$y = .27x + .14$.77	.59
J-11	$y = .57x - .25$.89	.79
J-12	$y = .22x + .23$.89	.79

well described by a power function as are the corresponding functions for the entire distribution; nevertheless, the \underline{r} s found are substantial.

In summary, the various analyses of the initiation distribution indicate that drinking onset time occurs early in the interfood interval, with the mean and median onset times well described by fractional power functions.

Analysis of Termination Distribution

The mean, median, and mode of the termination distribution is shown in Figure 25. The bold diagonal line indicates ordinate values that equal the abscissa values. For Rats J-7 and J-10 the modal termination times closely approximated the FT value, as they did at several FT values for J-11, and at FT 15 for Rat J-12. The remaining points for J-12 exhibited large discrepancies between the modal value and the FT value. Table 6 shows the equation for the best-fit line, \underline{r} , and \underline{r}^2 for the mean, median, and mode for each rat. The proportion of the variability accounted for by the equation for the means and medians ranged from .96 to .98, indicating that these data are well described by power functions. Best-fit lines for the modes are informative only for Rats J-11 and J-12, whose modal values did not approximate the FT. The proportion of variability accounted for by the lines for Rats J-11 and J-12 is .59 and .43, respectively.

The simple probability of a termination is shown in Figure 26 as a function of the proportion of the FT. For

Figure 25a. Mean, mode, and median of frequency distribution of terminations for Rat J-7, plotted as a function of the FT value.

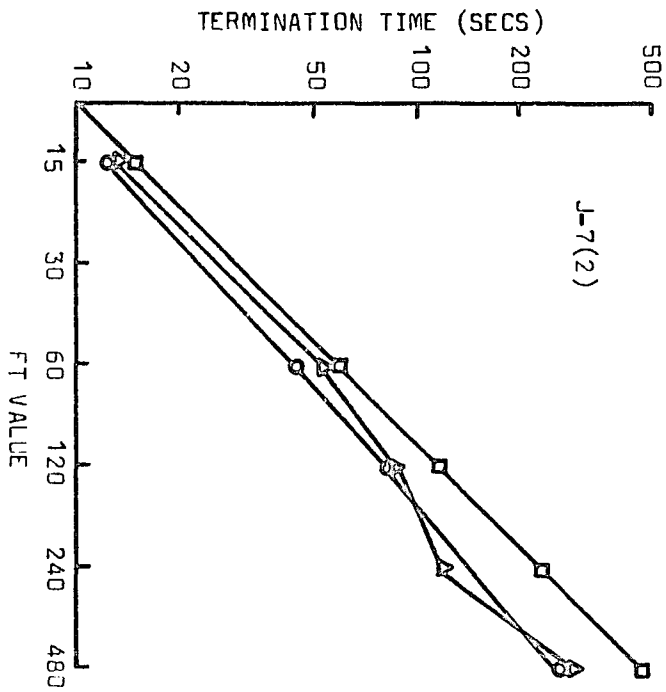
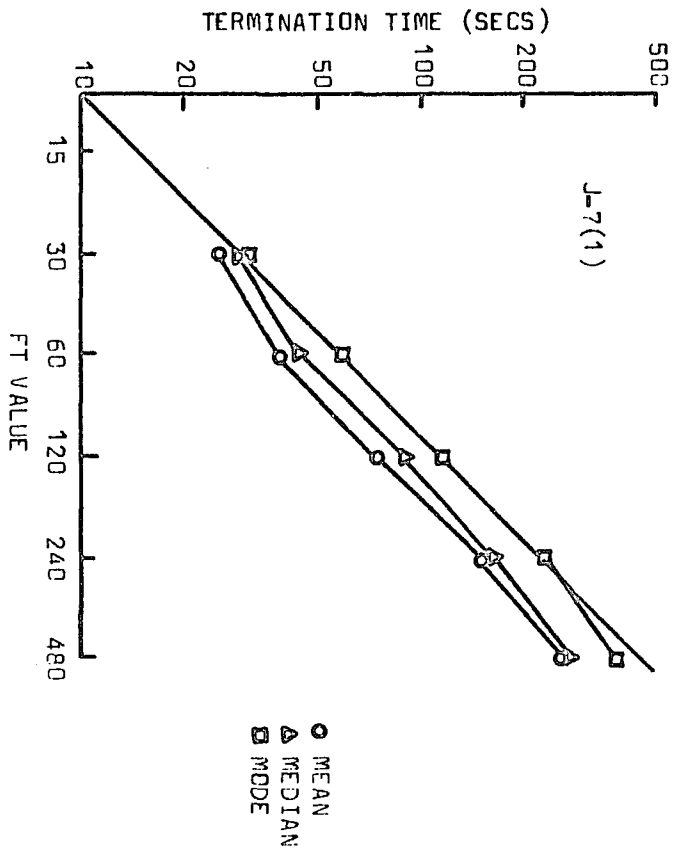
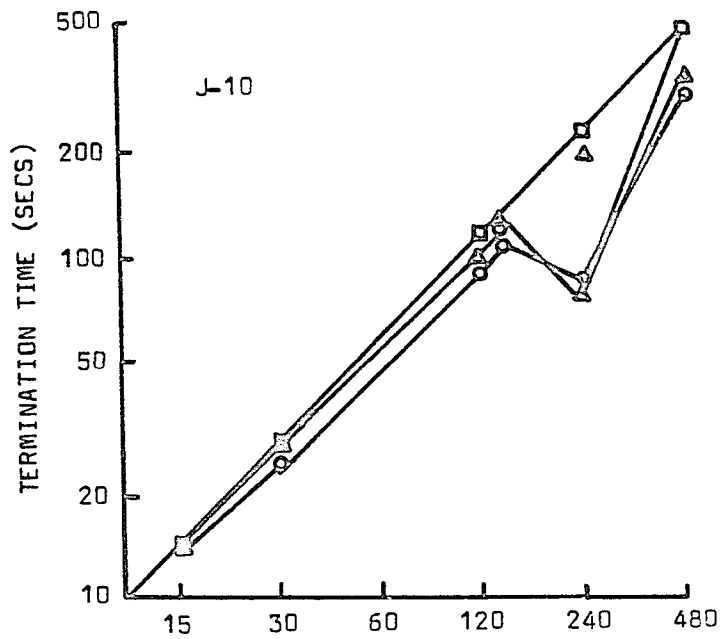

Figure 25b. Mean, mode, and median of frequency distribution of terminations for Rats J-10 and J-11, plotted as a function of the FT value.



○ MEAN
 △ MEDIAN
 □ MODE

FT VALUE

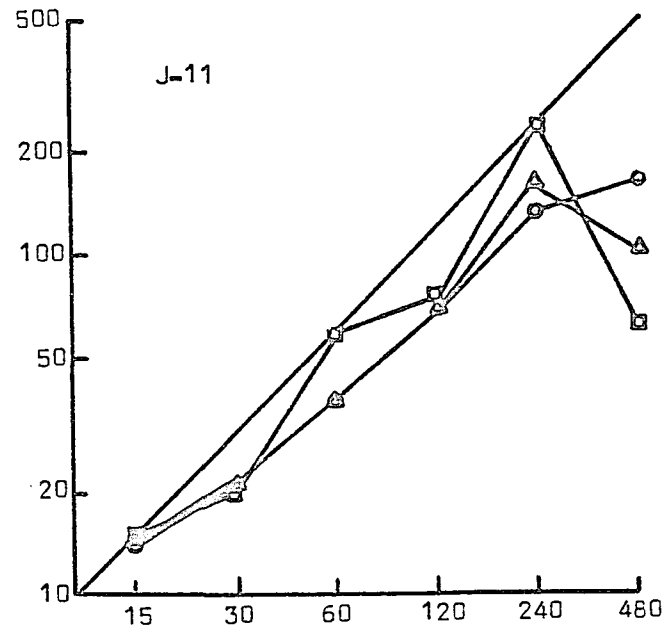

Figure 25c. Mean, mode, and median of frequency distribution of terminations for Rat J-12, plotted as a function of the FT value.

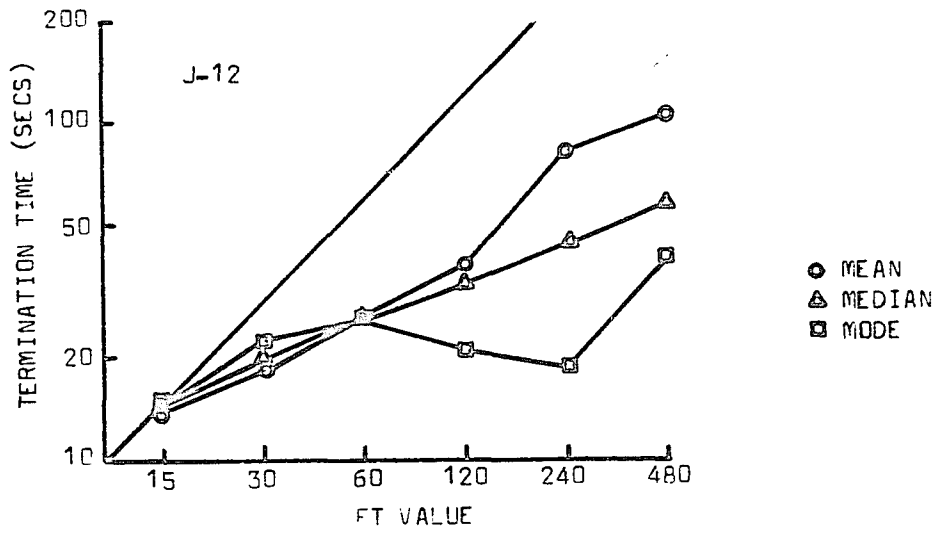

Table 6

Equations for Best-Fit Line, \underline{r} , and \underline{r}^2 for the Mean, Median, and Mode of Termination Distribution for Each Rat

Rat	Equation	\underline{r}	\underline{r}^2
J-7(1)	$y = .86x + .09$.99	.98
J-7(2)	$y = .86x + .09$.99	.98
J-10	$y = .85x + .15$.99	.98
J-11	$y = .72x + .28$.99	.98
J-12	$y = .60x + .39$.98	.96
<u>Median</u>			
J-7(1)	$y = .82x + .22$.99	.98
J-7(2)	$y = .84x + .15$.99	.98
J-10	$y = .87x + .14$.99	.98
J-11	$y = .65x + .40$.94	.88
J-12	$y = .38x + .72$.99	.98
<u>Mode</u>			
J-7(1)	$y = 1.21x - .44$.99	.98
J-7(2)	$y = 1.00x$	1.00	1.00
J-10	$y = .95x + .04$.99	.98
J-11	$y = .63x + .52$.77	.59
J-12	$y = .16x + 1.03$.66	.43

Figure 26a. Simple probability of a termination, for Rat J-7, first determination, function of proportions of the FT.

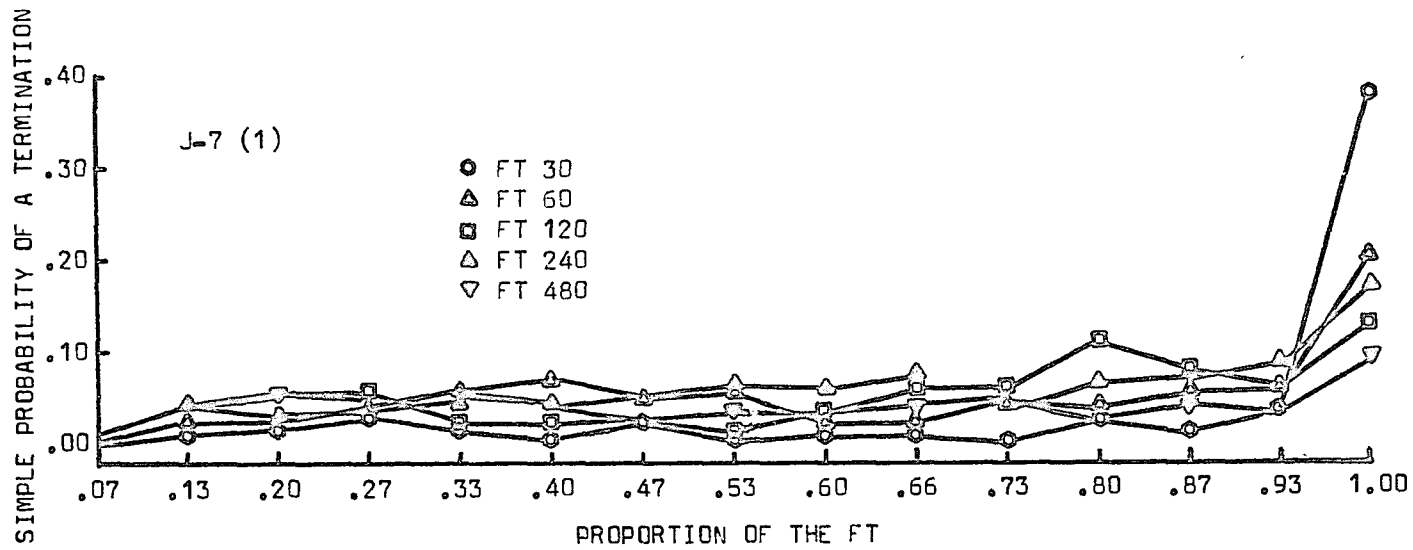

Figure 26b. Simple probability of a termination, for Rat J-7, second determination, function of proportions of the FT.

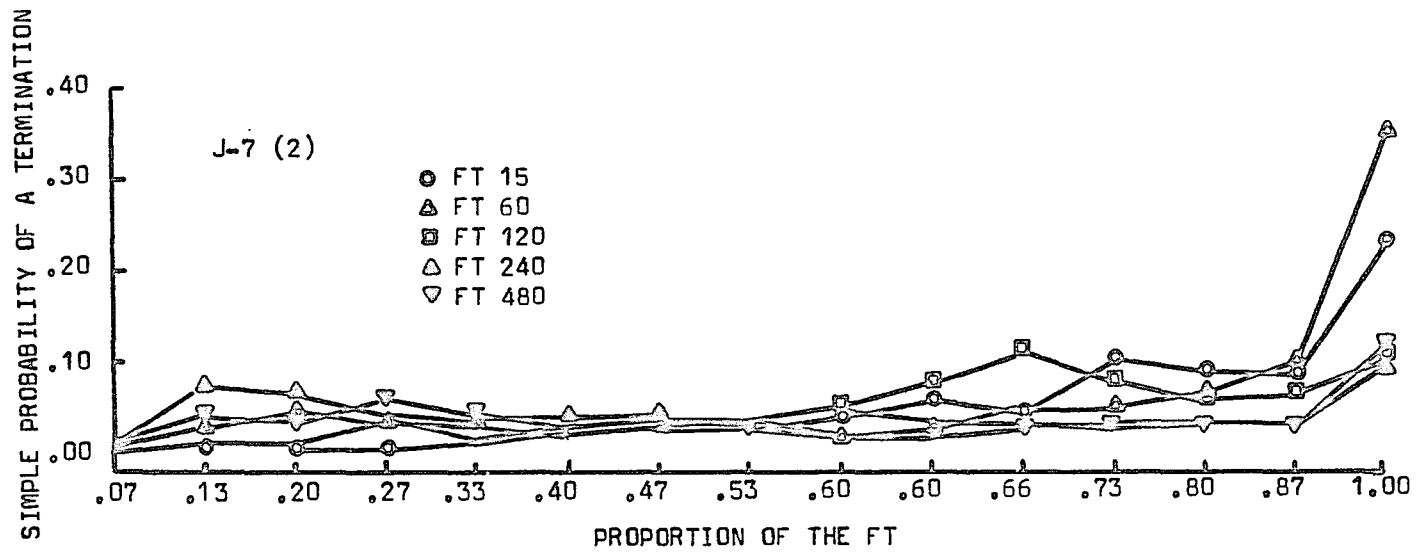

Figure 26c. Simple probability of a termination, for
Rat J-10, function of proportions of the FT.

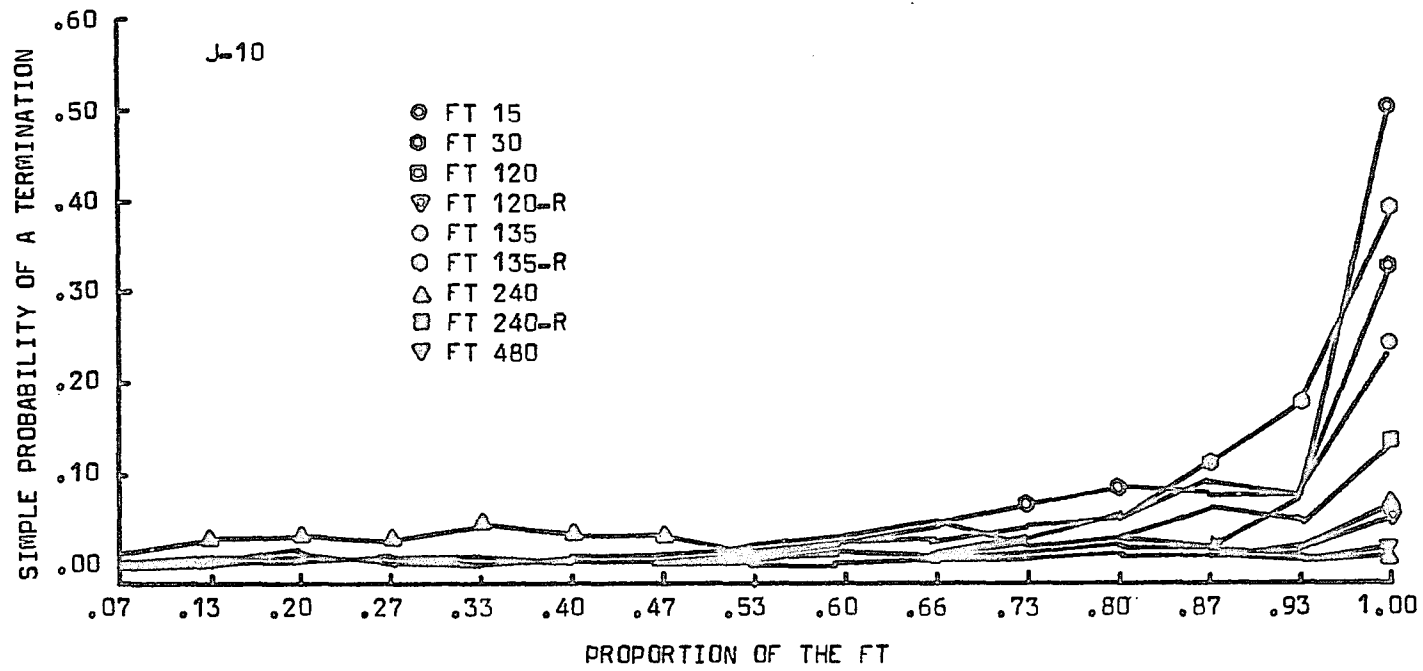

Figure 26d. Simple probability of a termination, for
Rat J-11, function of proportions of the FT.

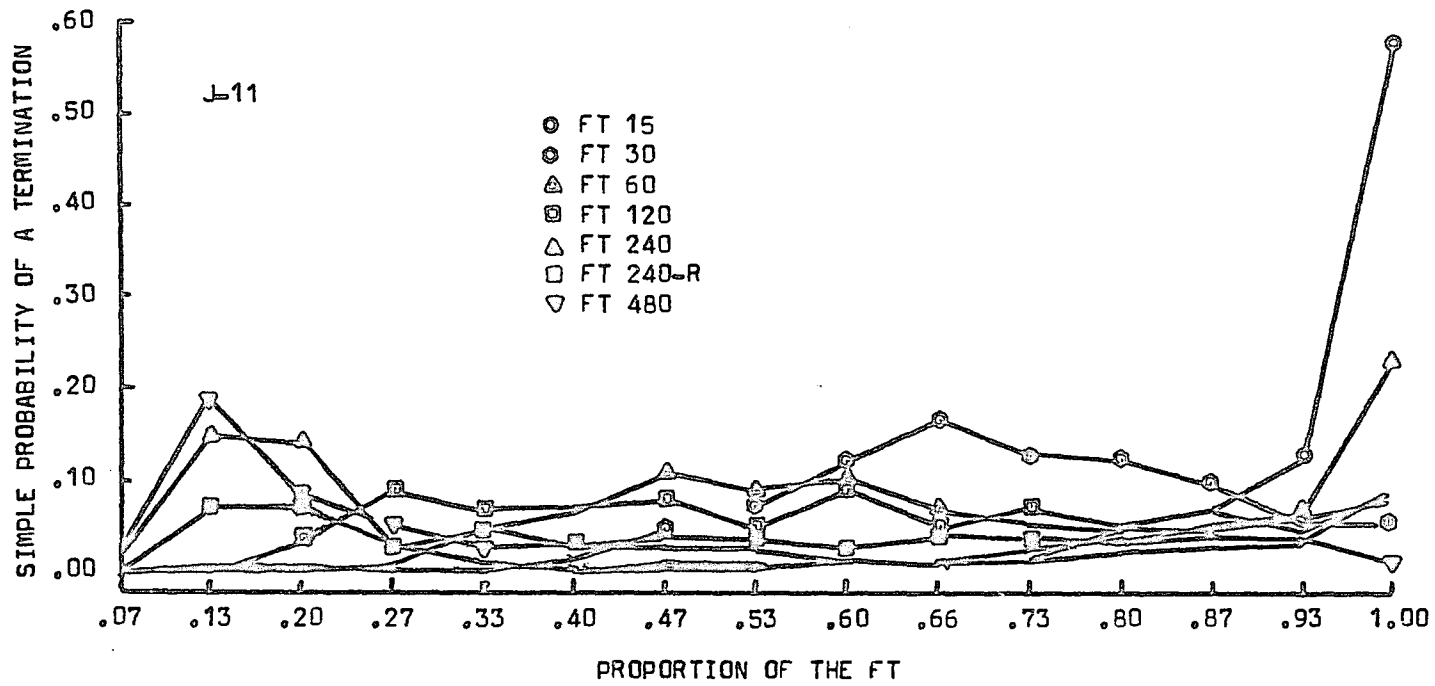
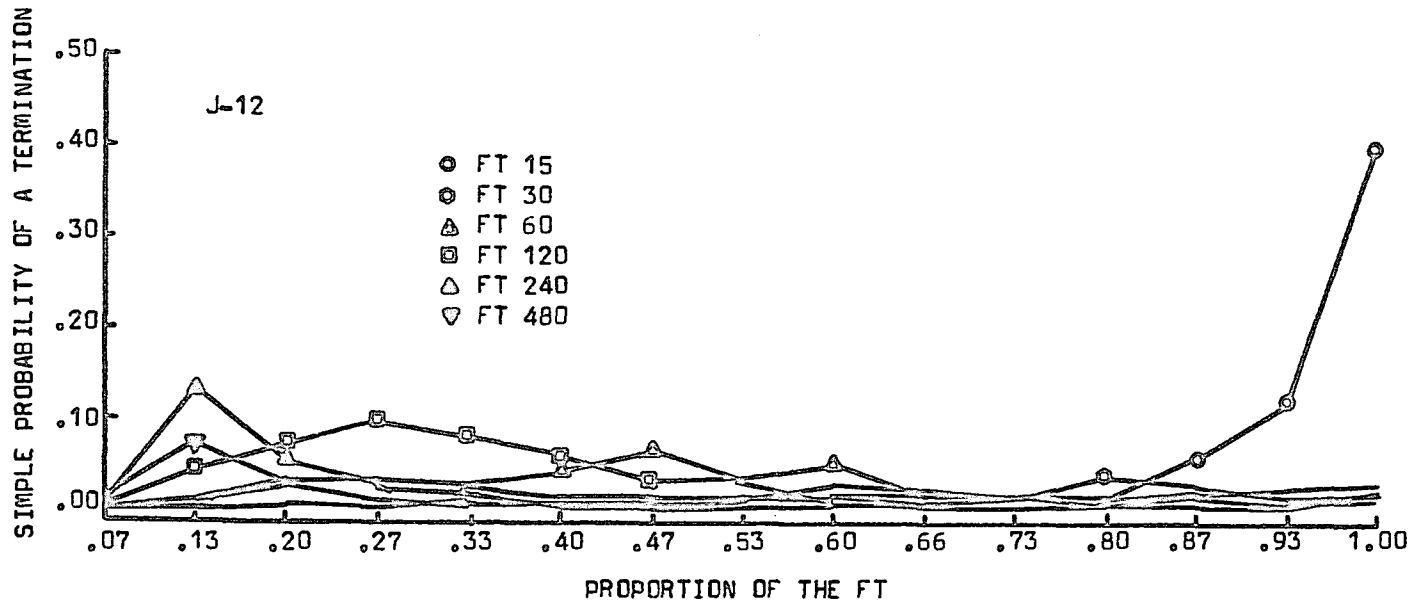

Figure 26e. Simple probability of a termination, for
Rat J-12, function of proportions of the FT.



Rats J-7 and J-10, these functions are skewed to the left with a tendency for the peak to be higher at lower FT values. There is also a trend in the first half of the interval for the larger FT values to exhibit probabilities higher than the shorter FT values. For Rats J-11 and J-12 the FT 15 distributions skewed to the left, and as the FT increased the distributions shifted to the right. A plot of the relative frequency of terminations, shown in Figure 27, reveals basically the same ordering of probabilities at a given time across FT values.

The measures of the probability of a termination shown in the last two figures are perhaps not the most informative measures: a termination cannot occur if an initiation has not occurred. In fact, in order for a termination to occur at a given time, two events are necessary: first, drinking must have been initiated; second, a termination must not have occurred. To handle this situation, the probability-per-opportunity statistic appears appropriate. In order to compute the termination per opportunity at time t , the number of terminations at time t is divided by the cumulative number of initiations up to and including time t minus the number of terminations prior to time t . This conditional probability of a termination is plotted in Figure 28 as a function of the proportion of the FT. (Note that the graph does not include the proportion, 1.00, since at that value the probability associated with any frequency greater than 0

Figure 27a. Relative frequency of terminations, for Rat J-7, first determination, plotted as a function of proportions of the FT.

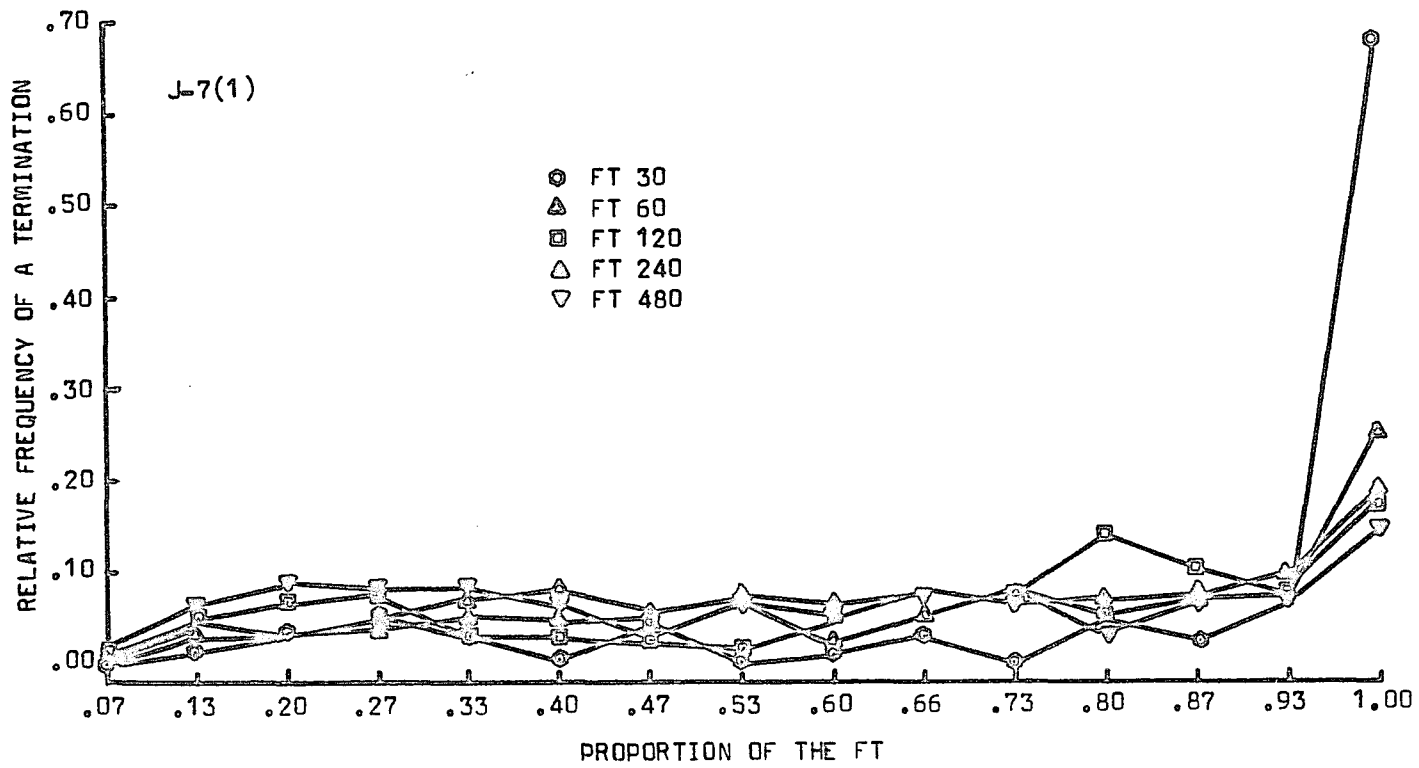

Figure 27b. Relative frequency of terminations, for Rat J-7, second determination, plotted as a function of proportions of the FT.

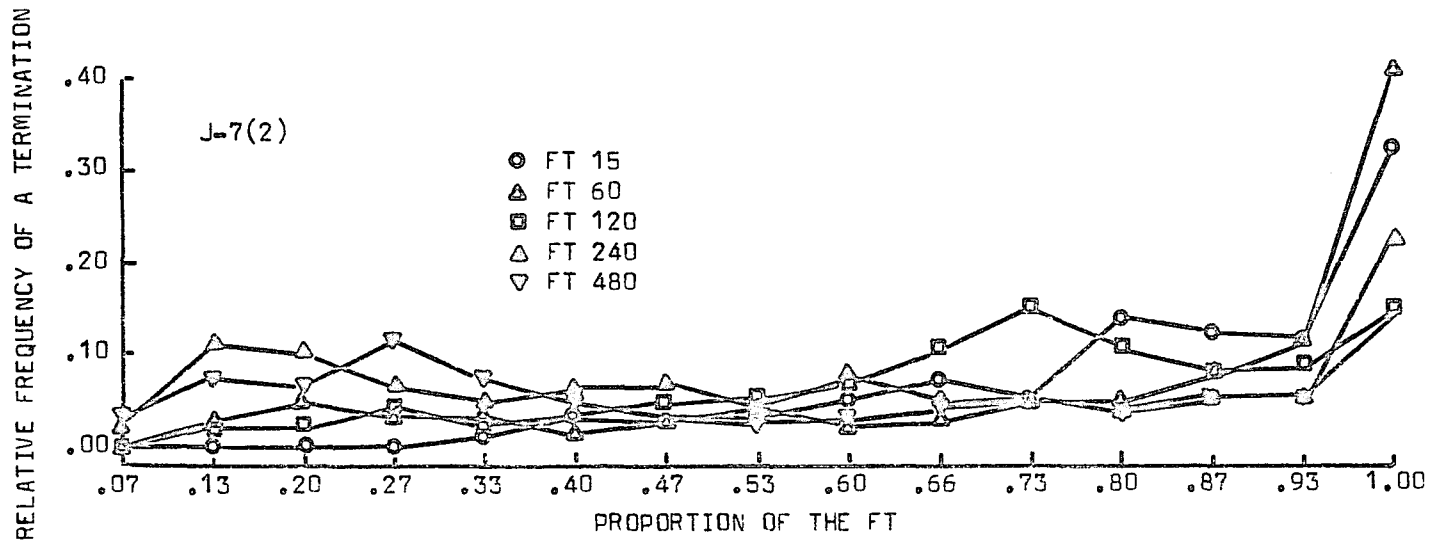

Figure 27c. Relative frequency of terminations for Rat J-10, plotted as a function of proportions of the FT.

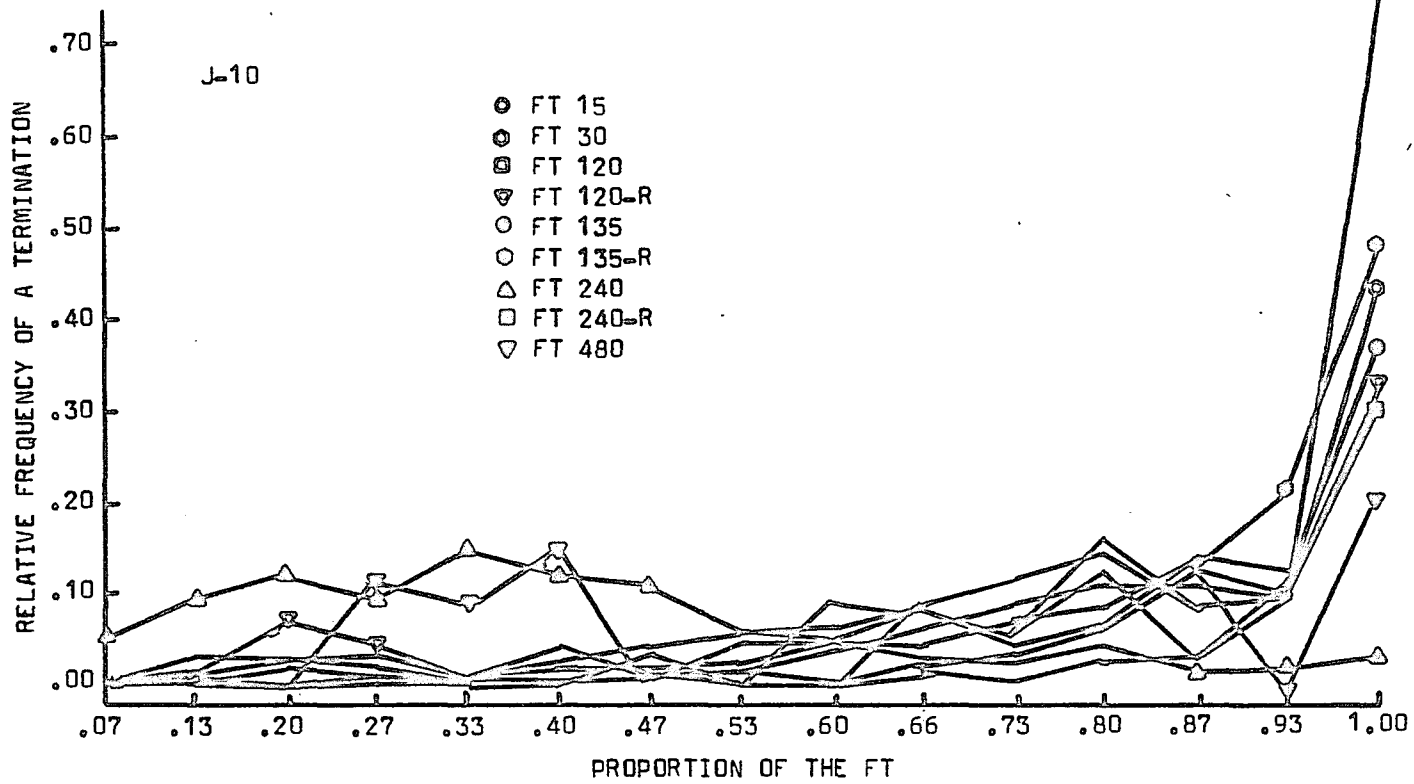

Figure 27d. Relative frequency of terminations, for Rat J-11, plotted as a function of proportions of the FT.

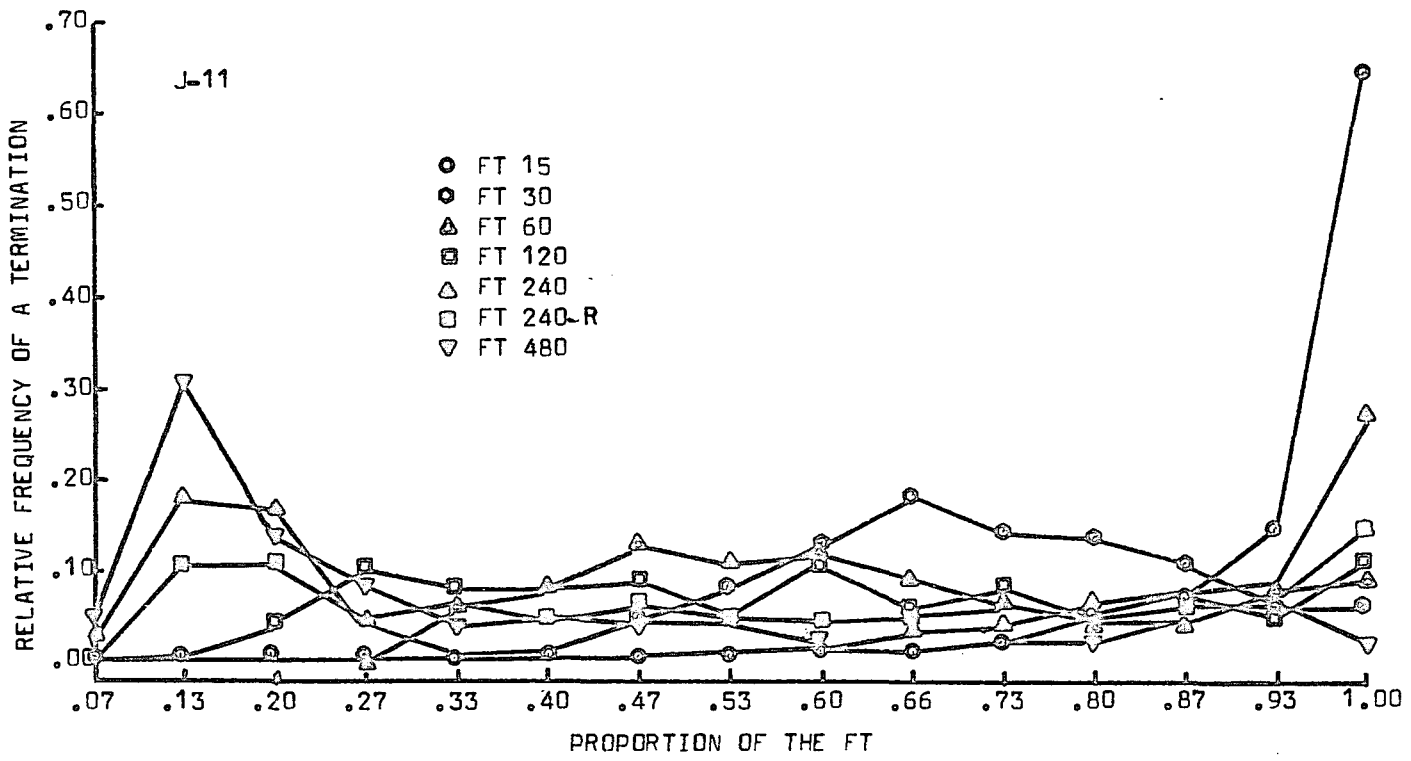

Figure 27e. Relative frequency of terminations, for Rat J-12, plotted as a function of proportions of the FT.

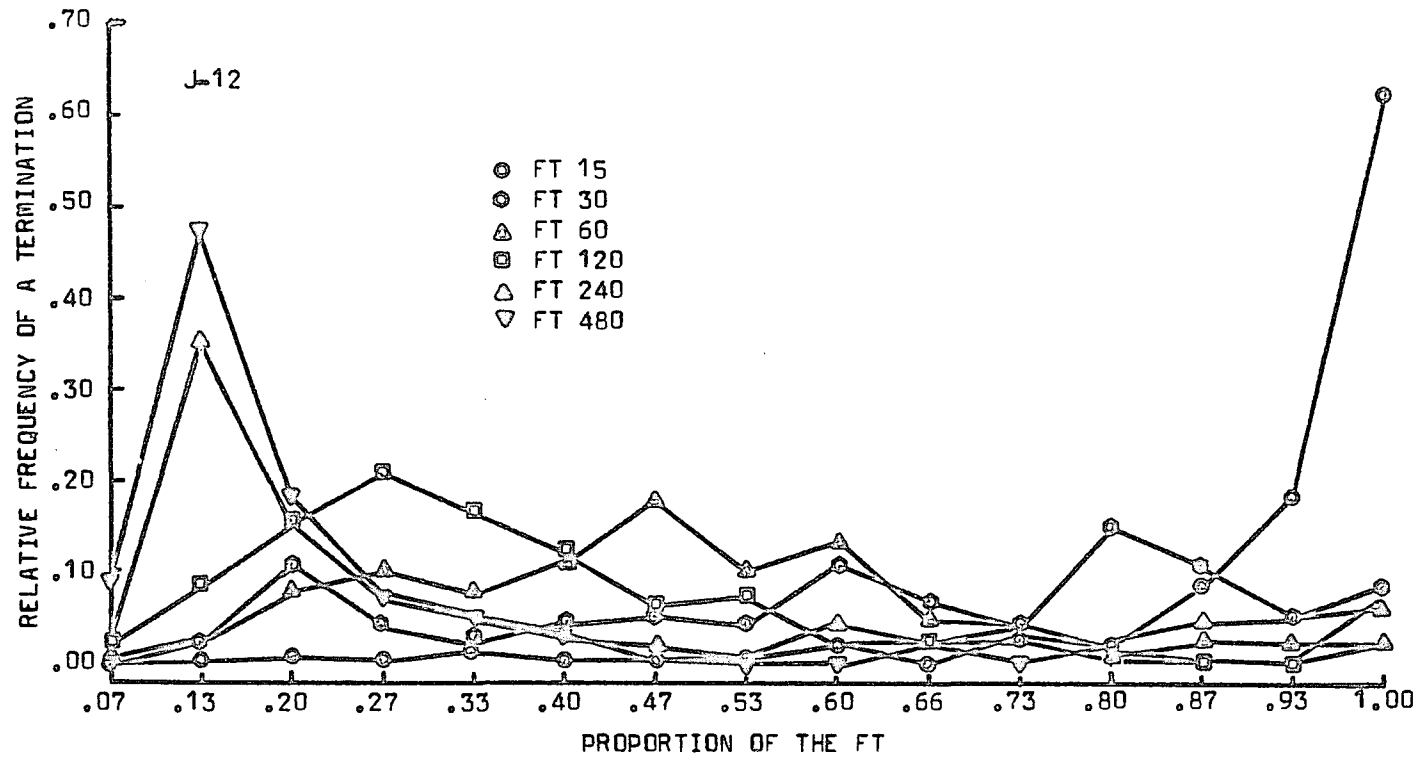

Figure 28a. Probability of a termination per opportunity, for Rat J-7, first determination, plotted as a function of proportions of the FT.

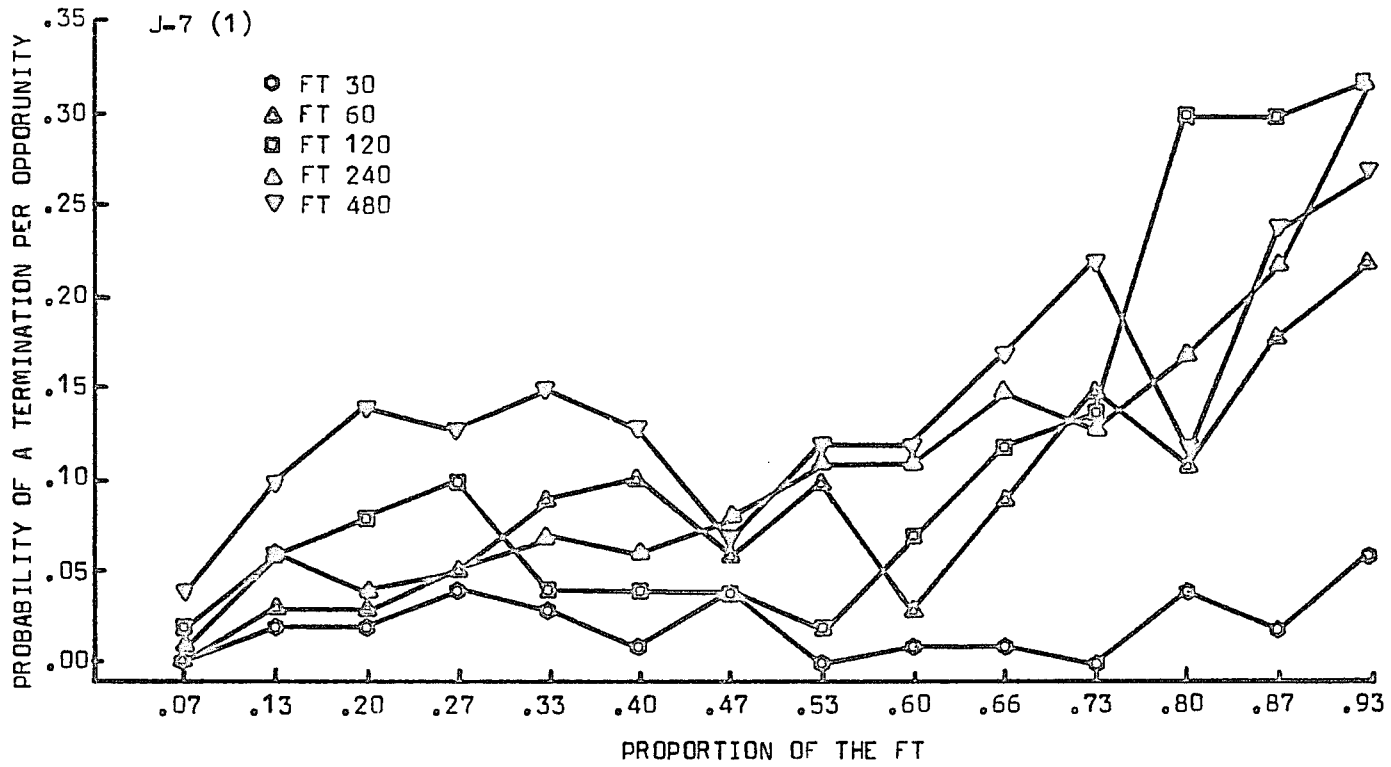

Figure 28b. Probability of a termination per opportunity, for Rat J-7, second determination, plotted as a function of proportions of the FT.

PROBABILITY OF A TERMINATION PER OPPORTUNITY

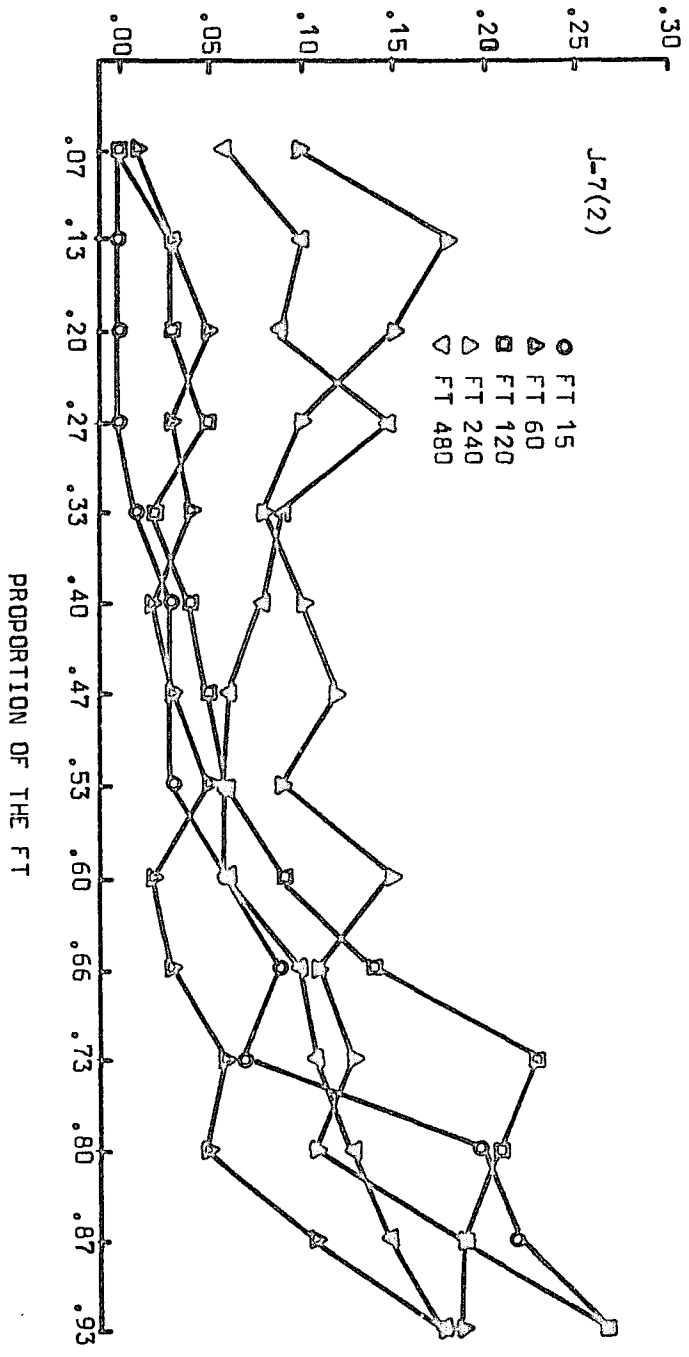

Figure 28c. Probability of a termination per opportunity, for Rat J-10, plotted as a function of proportions of the FT.

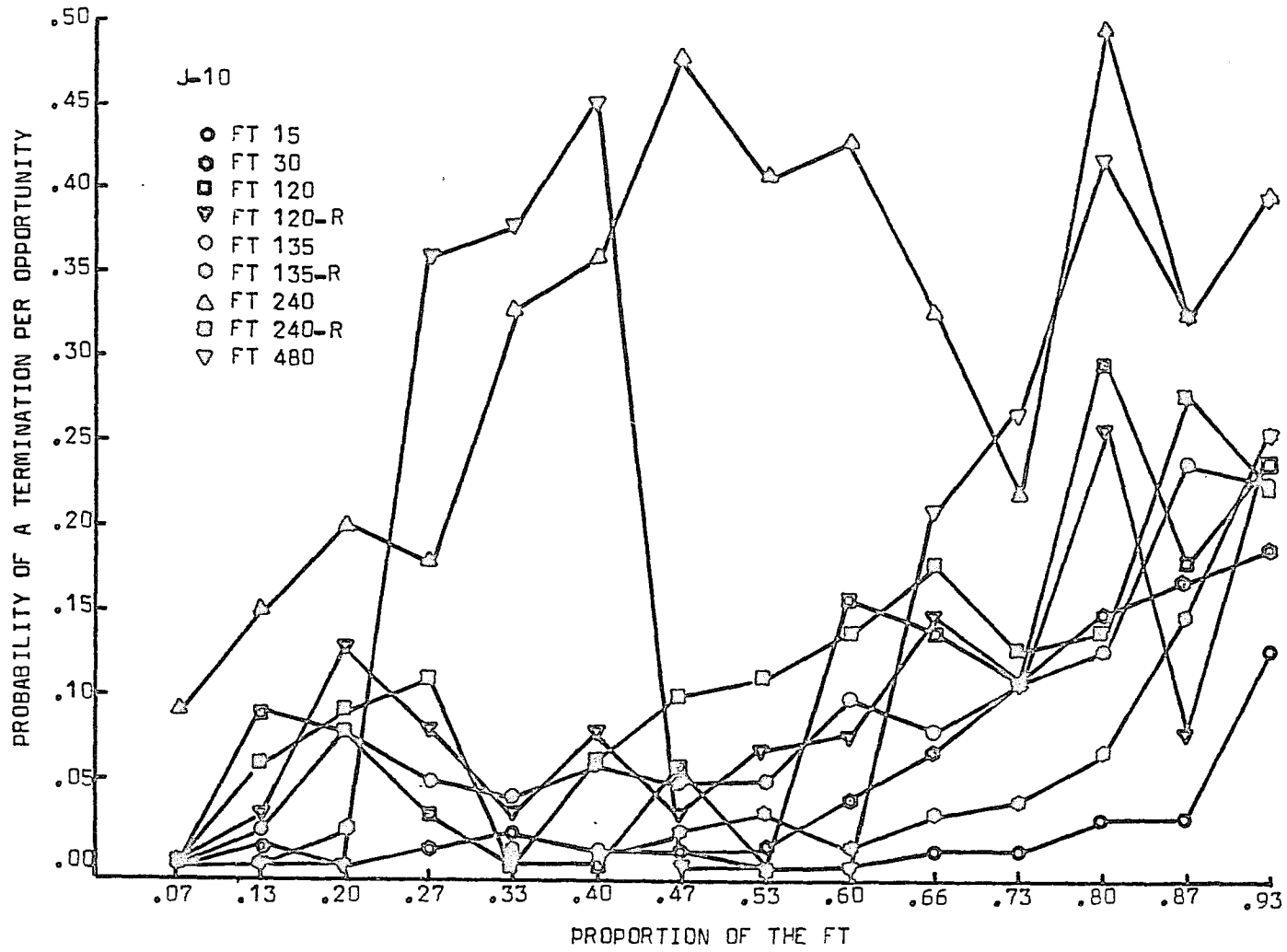

Figure 28d. Probability of a termination per opportunity, for Rat J-11, plotted as a function of proportions of the FT.

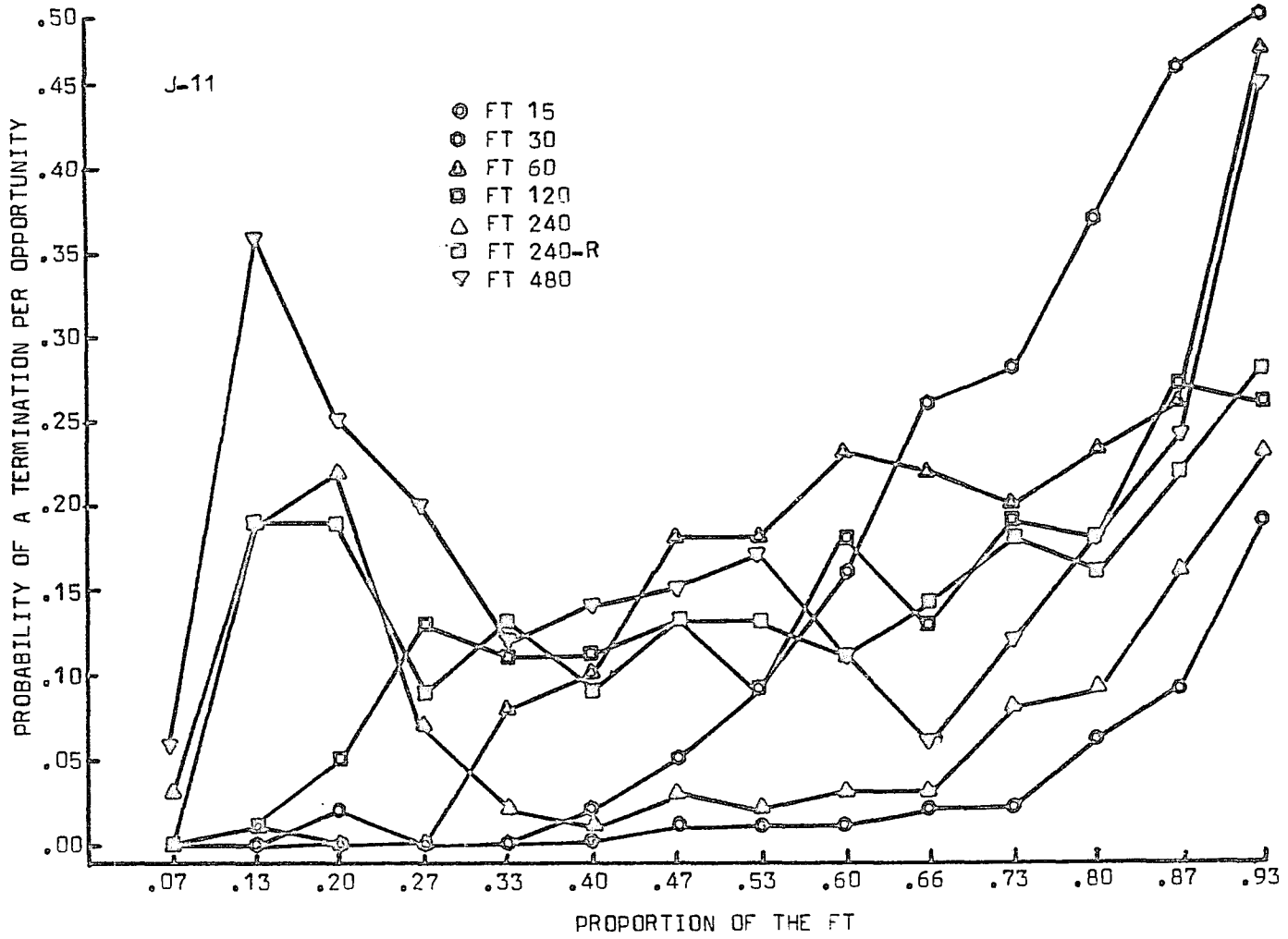
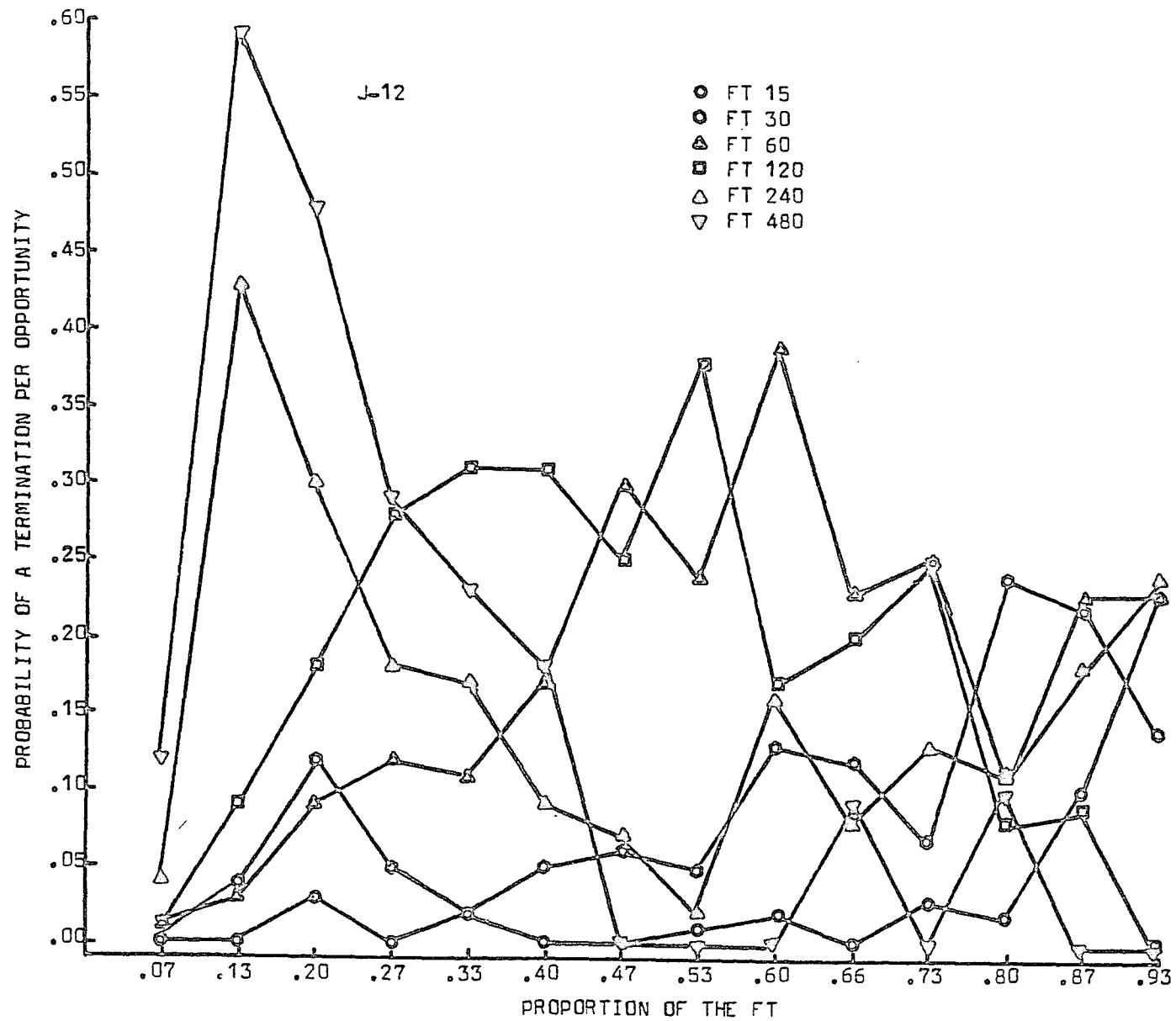

Figure 28e. Probability of a termination per opportunity, for Rat J-12, plotted as a function of proportions of the FT.



is 1.00.) For Rats J-7, J-10, and J-11, several trends are evident. In most cases, at the lower FT values, the conditional probability rises continuously throughout the FT. As the FT increases, the rise is less steep, often exhibiting several reversals. At the longer FT values, one of these reversals often appears as a prominent secondary peak. The maximal conditional probability, nevertheless, still remains at the end of the FT. During the latter half of the FT, the conditional probabilities appear unsystematically related to the FT value. During the first half of the FT, however, the conditional probabilities are directly related to the FT value. The functions for Rat J-12 follow the same trends except that as the FT increases the maximal peak probabilities do not occur at the end of the interfood interval, but rather become more proximal to the beginning of the interval as the FT increases.

In addition to examining the probability of a termination at time \underline{t} , another type of probability, which will be useful later in the paper, was examined. This is the probability that a termination had not occurred by time \underline{t} . That probability is obtained by subtracting from unity the cumulative relative frequency of terminations at each proportion of the FT. The resulting decreasing functions, shown in the right-hand panel of Figure 19 (see pp. 86-95), displayed positive, negative, or linear acceleration in the case of each animal except for Rat J-7, who did not exhibit any negatively

accelerated functions. Generally, the positively accelerated curves are associated with the smaller FT values and the negatively accelerated curves are associated with larger FT values.

The Relation between the Initiation and Termination Distributions

Does the time of occurrence of the first lick have an effect on the time until the last lick, or is the interim period independent of where it is initiated? This period of time between the first and last lick will be referred to as the "drinking state." The term "state" is used because drinking does not always occur uninterruptedly from the occurrence of the first lick to the time of the last lick. An assessment of whether the termination of the drinking state is affected by its onset is provided by a correlation between the onset time and the drinking state time. High correlations, positive or negative, indicate a dependence of the duration of the drinking state on its onset time, whereas a lack of a correlation indicates the duration is independent of the onset time. The actual correlations for each rat are shown in Table 7. The level of significance is shown in parentheses. In computing these correlations all durations in which the termination time equalled the FT value were excluded; inclusion of these values would have generated a spurious negative correlation. All of the correlations are negative, and, in 28 of the 32 cases, the correlations are significant at $p < .001$. For Rats J-7, J-10, J-11, the correlations

Table 7

Correlation between Initiation Time and Duration of Drinking State for Each Rat for Each Condition. Significance Level Indicated in Parentheses.

	J-7	J-10	J-11	J-12	
FT 30	-.37 (.001)	FT 15	-.54 (.001)	FT 15	-.55 (.001)
FT 60	-.30 (.001)	FT 30	-.57 (.001)	FT 30	-.39 (.001)
FT 120	-.38 (.001)	FT 120	-.73 (.001)	FT 60	-.40 (.001)
FT 240	-.49 (.001)	FT 120-R	-.59 (.001)	FT 120	-.32 (.001)
FT 480	-.40 (.001)	FT 135	-.70 (.001)	FT 240	-.22 (.003)
		FT 135-R	-.86 (.001)	FT 240-R	-.13 (.160)
FT 15	-.45 (.001)	FT 240	-.40 (.001)	FT 480	-.26 (.001)
FT 60	-.26 (.001)	FT 240-R	-.70 (.001)		
FT 120	-.38 (.001)	FT 480	0.53 (.001)		
FT 240	-.19 (.002)				
FT 480	-.33 (.001)				

varied unsystematically as a function of the FT. They varied from $-.19$ to $-.49$ for Rat J-7, from $-.40$ to $-.86$ for Rat J-10, and from $-.14$ to $-.57$ for Rat J-11. Rat J-12 exhibited a tendency for the degree of correlation to decrease as a function of the FT, varying from $-.55$ to $-.13$. These negative correlations indicate that the later the onset of the drinking state, the shorter its duration. They also rule out the possibility that the drinking state lasts for a fixed period of time, or for a constant proportion of the FT. Either case would have generated zero correlations.

Where in the interfood interval is the drinking state located? The left- and right-hand panels, respectively, of Figure 19 show the probability that the drinking state had been initiated and the probability that the drinking state had not been terminated. Multiplying the respective points on the curves provides the probability that the rat is in the drinking state at a given time. If licking occurred uninterruptedly throughout the drinking state, then the probability of being in the drinking state would actually equal the probability of drinking. Because drinking does not occur uninterruptedly, these probabilities, while providing the probability of being in the drinking state, provide an overestimate of the probability of licking. Assuming that the interruptions in drinking are random, a closer approximation to the probability of licking can be obtained by weighting these joint probabilities by an estimate of the percent of the interfood interval spent licking. Such a measure, obtained

by dividing the total session time spent licking by the product of the number of intervals containing a lick and the FT value, was previously described in connection with Figure 10. This estimate of the percent of the interfood interval spent drinking has been multiplied by the joint probabilities in Figure 19 and is plotted as a function of the proportion of the interfood interval in Figure 29. The products generally show an initial rise and subsequent decline at short FT values. As the FT increases the functions become less steep and gradually change to very shallow decreasing functions at longer FT values. Multiplying the proportion of the FT at the maximal values of these functions by the FT value determines the time at which it is most probable that the rat is in the drinking state. These values are shown as a function of the FT in Figure 30. The best-fit lines, \underline{r} , and \underline{r}^2 , are provided in Table 8. Four of the five equations have slopes less than 1.00, indicating that the proportion of the FT containing the maximal probability is inversely related to the FT value.

An examination of the actual duration of the drinking state is provided in Figure 31 showing the mean, mode, median, and first quartile of the frequency distribution of durations. The bold diagonal line represents ordinate values equal to abscissa values. Missing points for the modes indicate a value of zero. These functions are generally increasing, showing more deviation from the diagonal line with increases in the FT. The functions showing the first quartile tend to

Figure 29a. Probability of being in the drinking state, for Rat J-7, first determination, plotted as a function of the FT value.

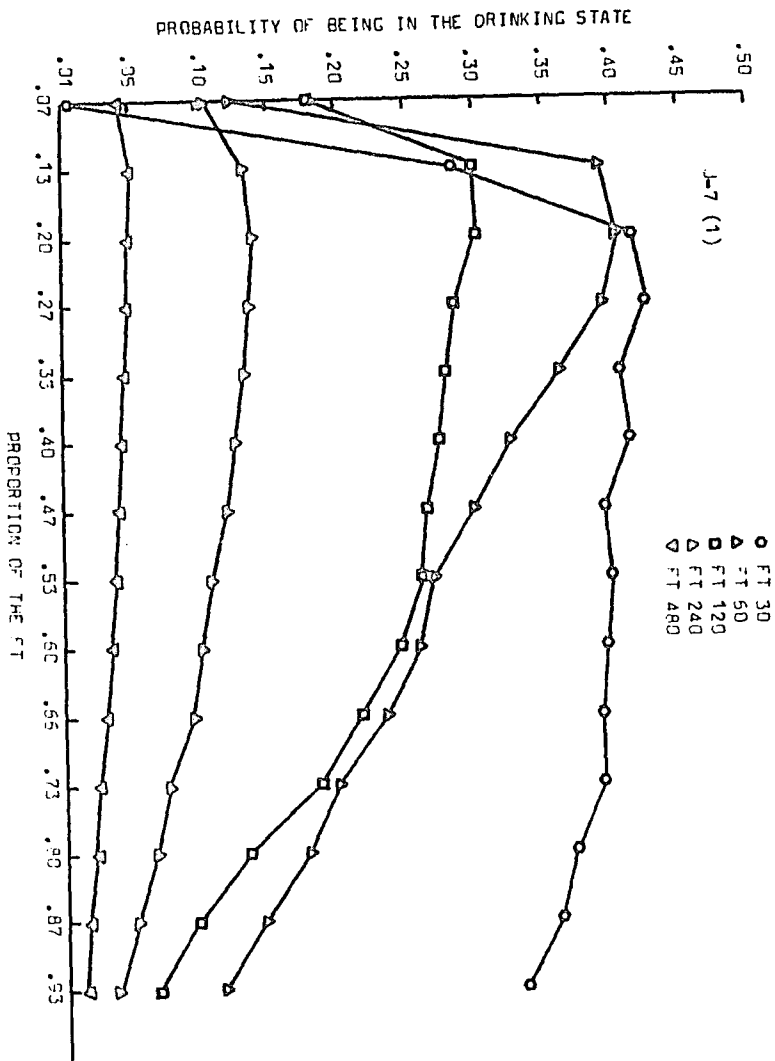

Figure 29b. Probability of being in the drinking state, for Rat J-7, second determination, plotted as a function of the FT value.

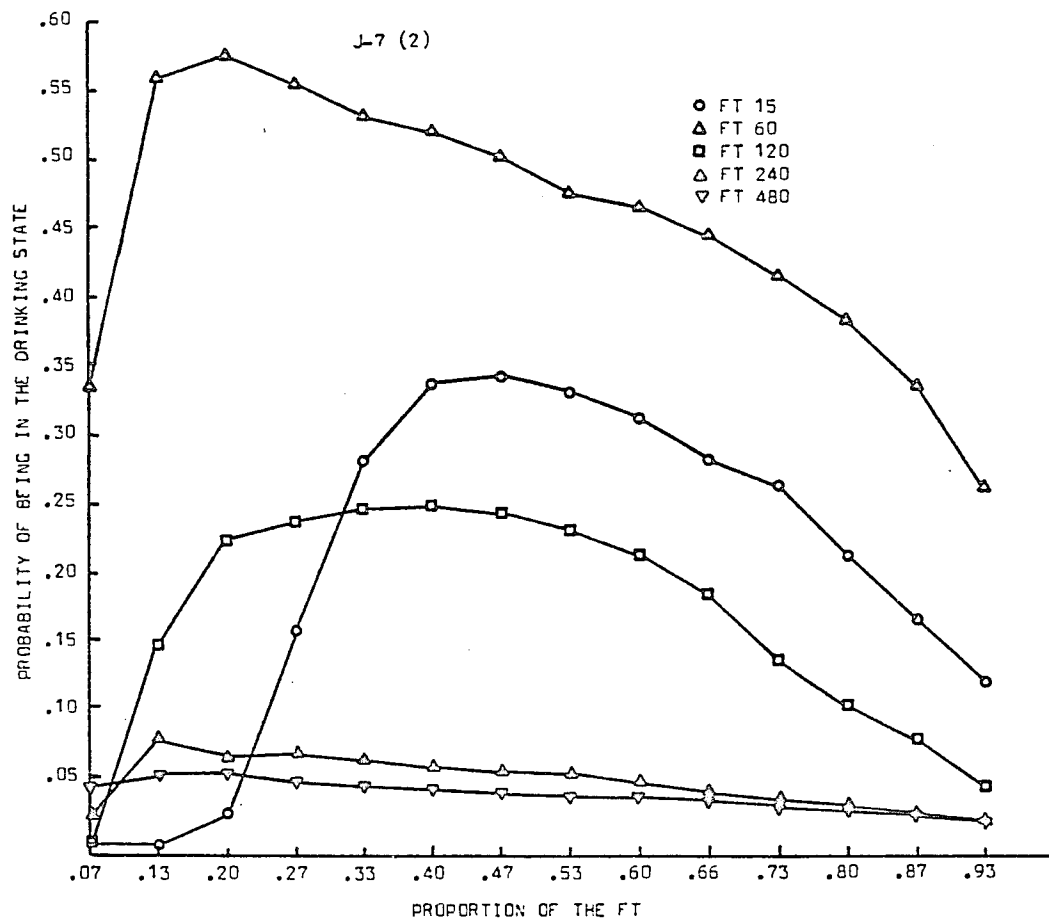

Figure 29c. Probability of being in the drinking state, for Rat J-10, plotted as a function of the FT value.

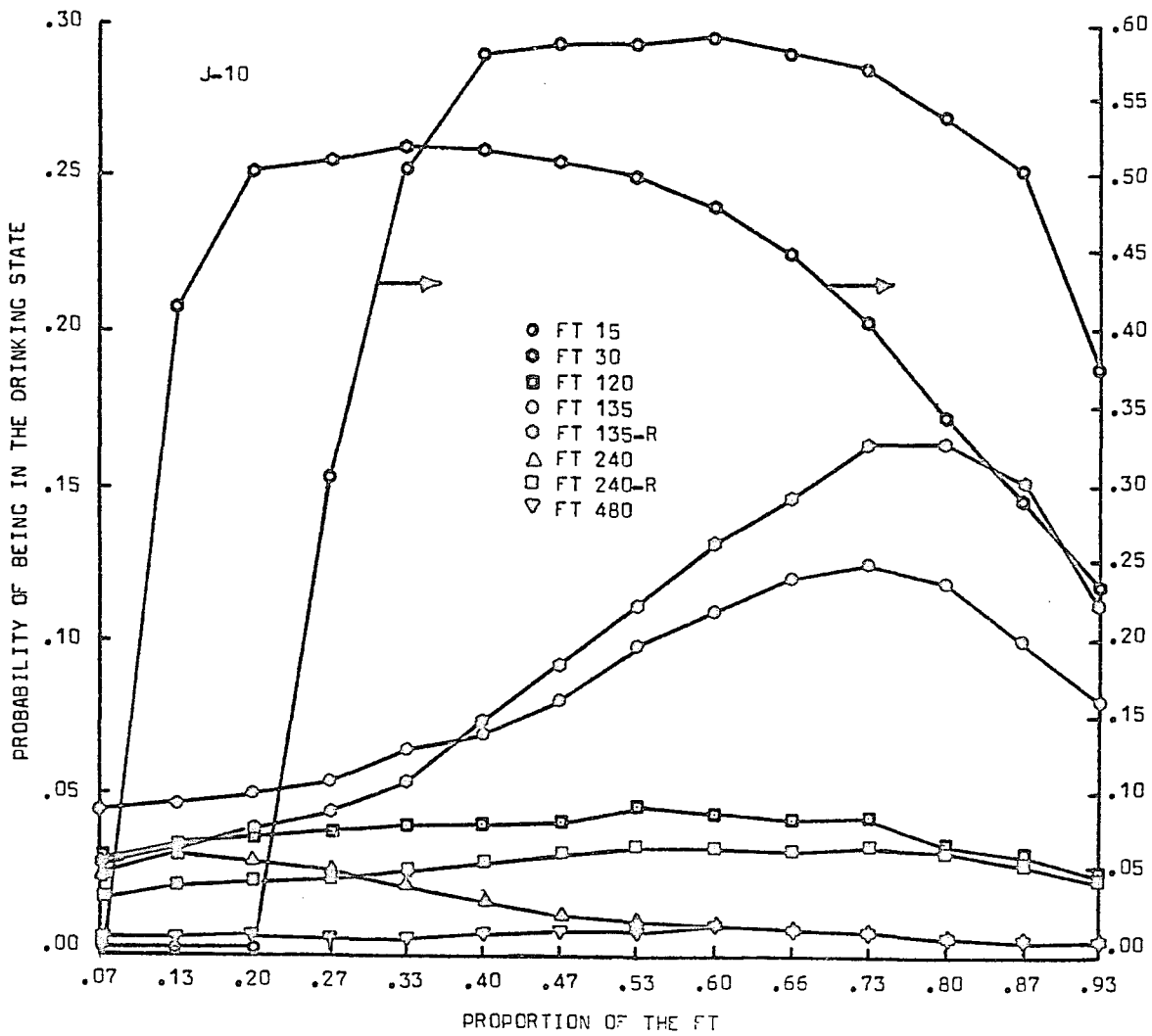

Figure 29d. Probability of being in the drinking state, for Rat J-11, plotted as a function of the FT value.

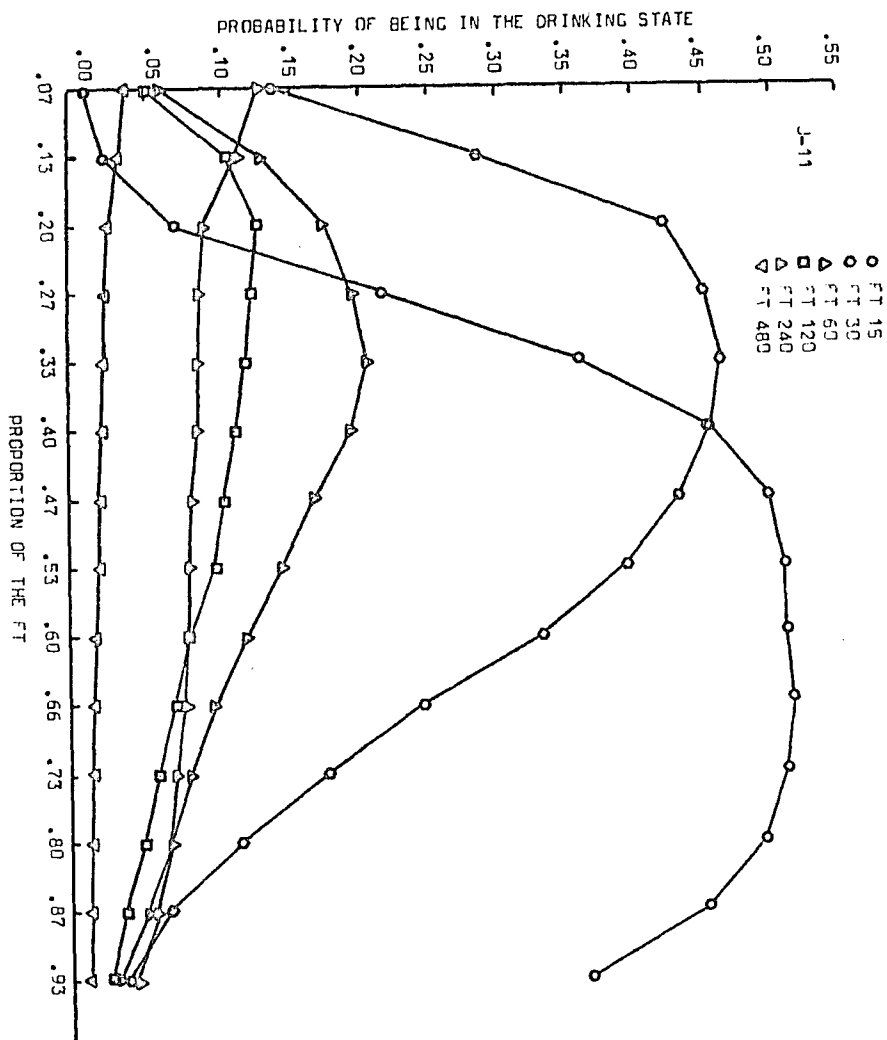

Figure 29e. Probability of being in the drinking state, for Rat J-12, plotted as a function of the FT value.

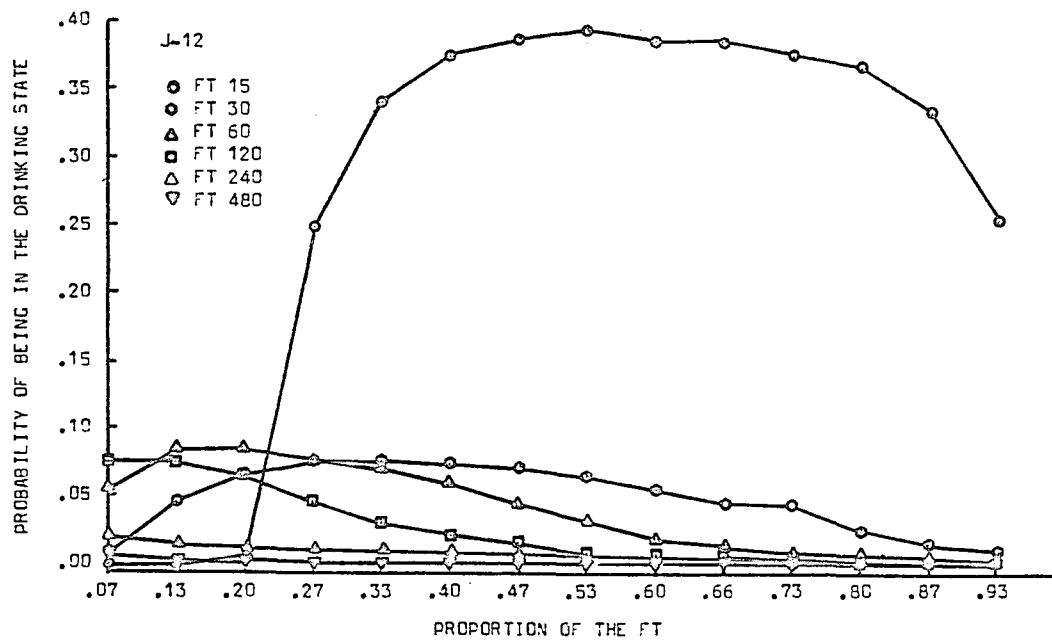

Figure 30. Absolute time at which being in the drinking state is most probable.

TIME (SECS) AT MAXIMAL PROBABILITY OF BEING IN DRINKING STATE

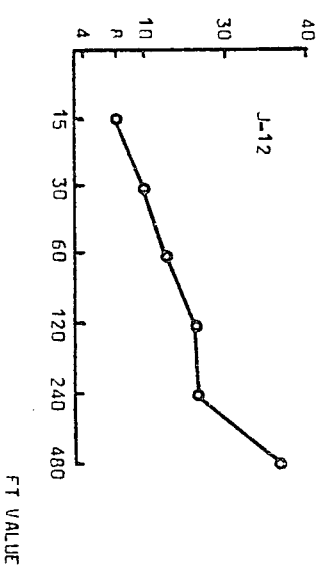
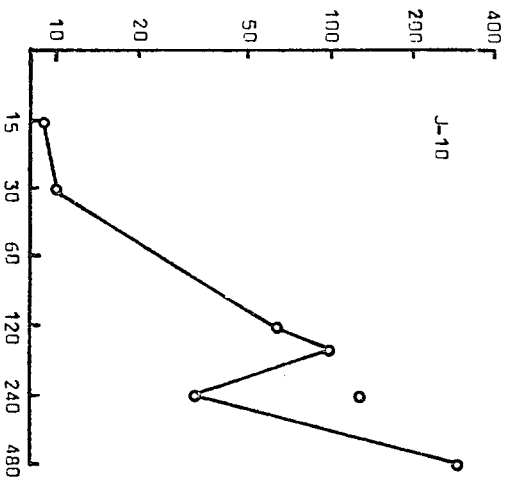
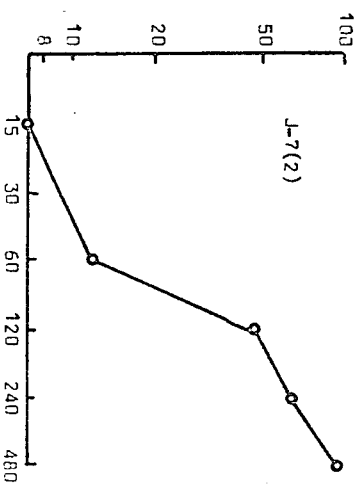
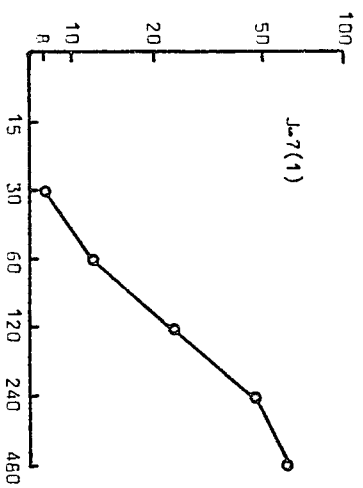

Table 8

Equations for Best-Fit Line, \underline{r} , and \underline{r}^2 for \underline{t} at Maximal Probability of Being in Drinking State for Each Rat

Rat	Equation	\underline{r}	\underline{r}^2
J-7(1)	$\underline{y} = .79\underline{x} - .27$.99	.98
J-7(2)	$\underline{y} = .82\underline{x} - .17$.96	.92
J-10	$\underline{y} = 1.02\underline{x} - .35$.97	.94
J-11	$\underline{y} = .42\underline{x} + .49$.93	.86
J-12	$\underline{y} = .35\underline{x} + .46$.95	.90

Figure 31a. Mean, mode, median, and first quartile of the frequency distribution of time between the initiation lick and termination lick, for Rat J-7, plotted as a function of the FT value.

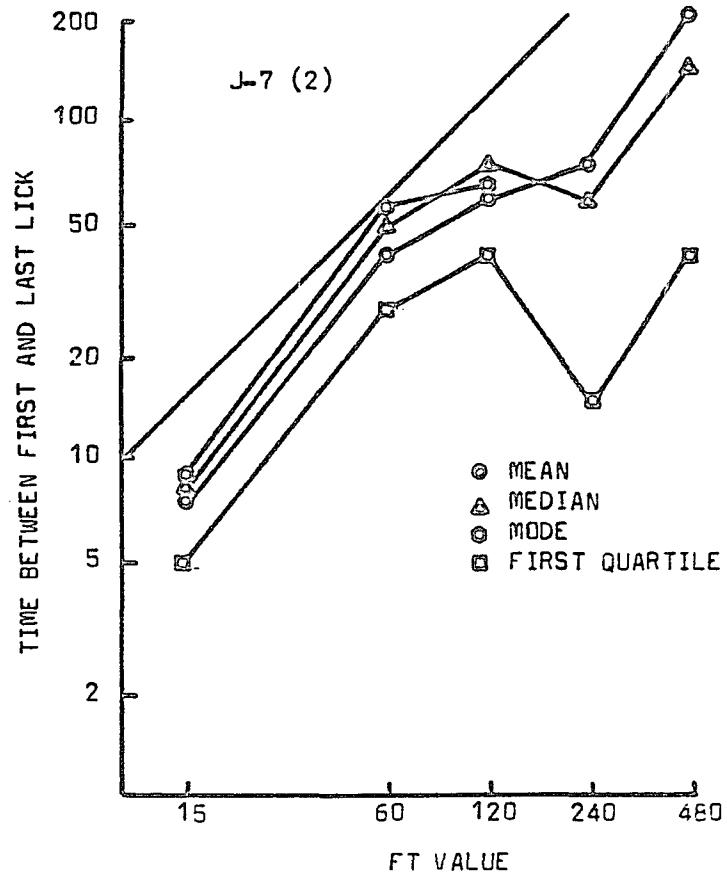
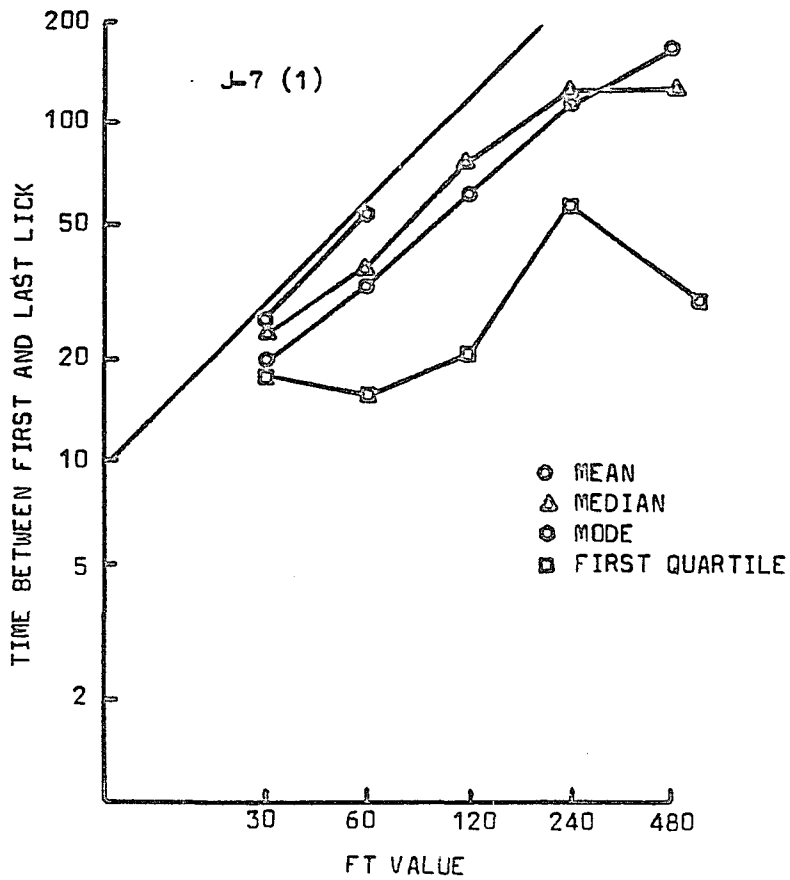

Figure 3lb. Mean, mode, median, and first quartile of the frequency distribution of time between the initiation lick and termination lick, for Rats J-10 and J-11, plotted as a function of the FT value.

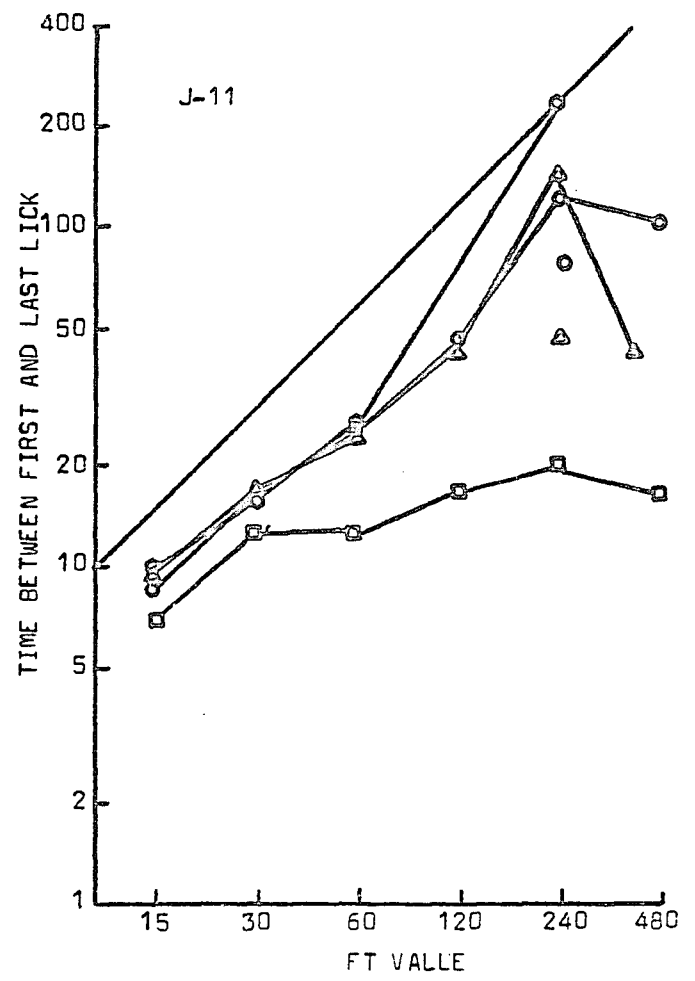
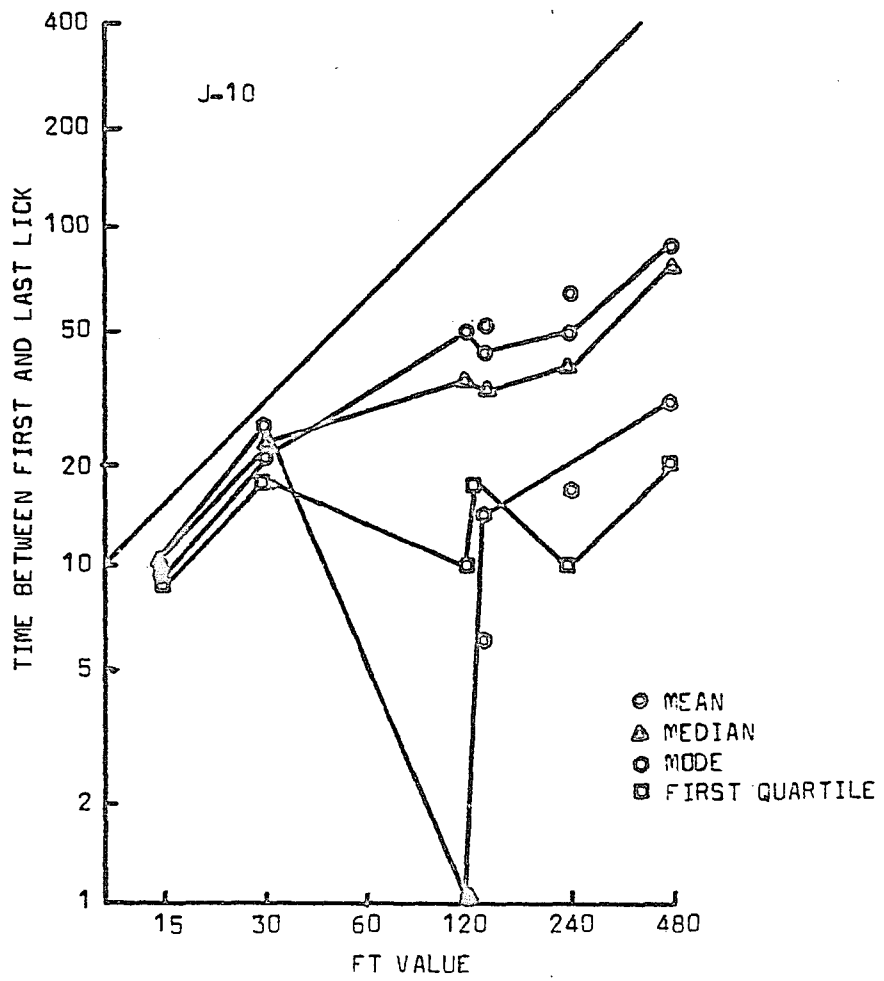
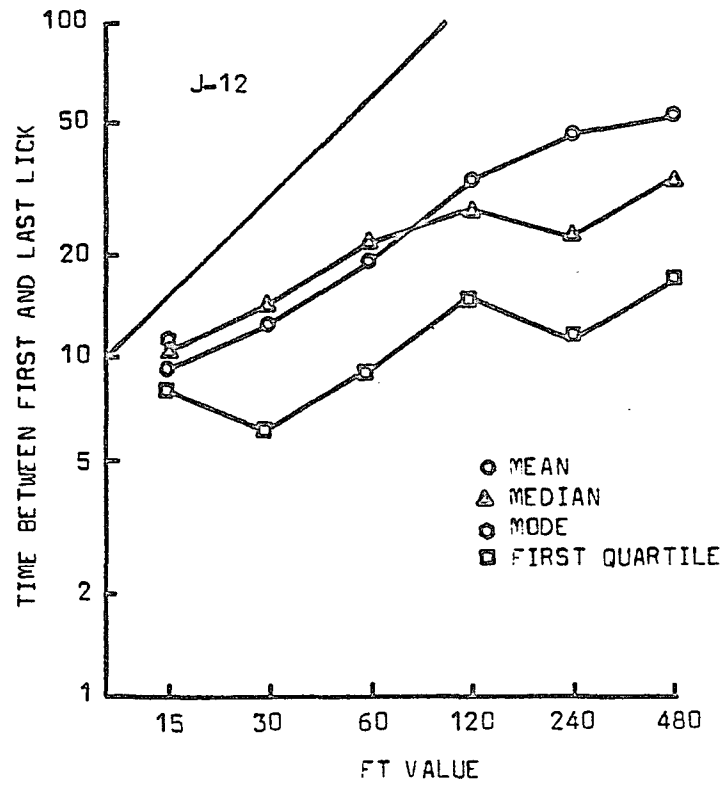

Figure 3lc. Mean, mode, median, and first quartile of the frequency distribution of time between the initiation lick and termination lick, for Rat J-12, plotted as a function of the FT value.



flatten at the last three or four FT values, indicating that 25 percent of the durations are of approximately constant duration. To determine the proportion of the interval occupied by the drinking state, the mean and median values have been divided by the FT. These values, plotted in Figure 32, decrease as a function of the FT. Note that the steeper functions reflect small changes in the absolute values in Figure 31.

Figure 32. Mean and median proportion of interfood interval spent in drinking state, plotted as a function of the FT value.

PROPORTION OF INTERNAL OCCUPIED BY DRINKING STATE

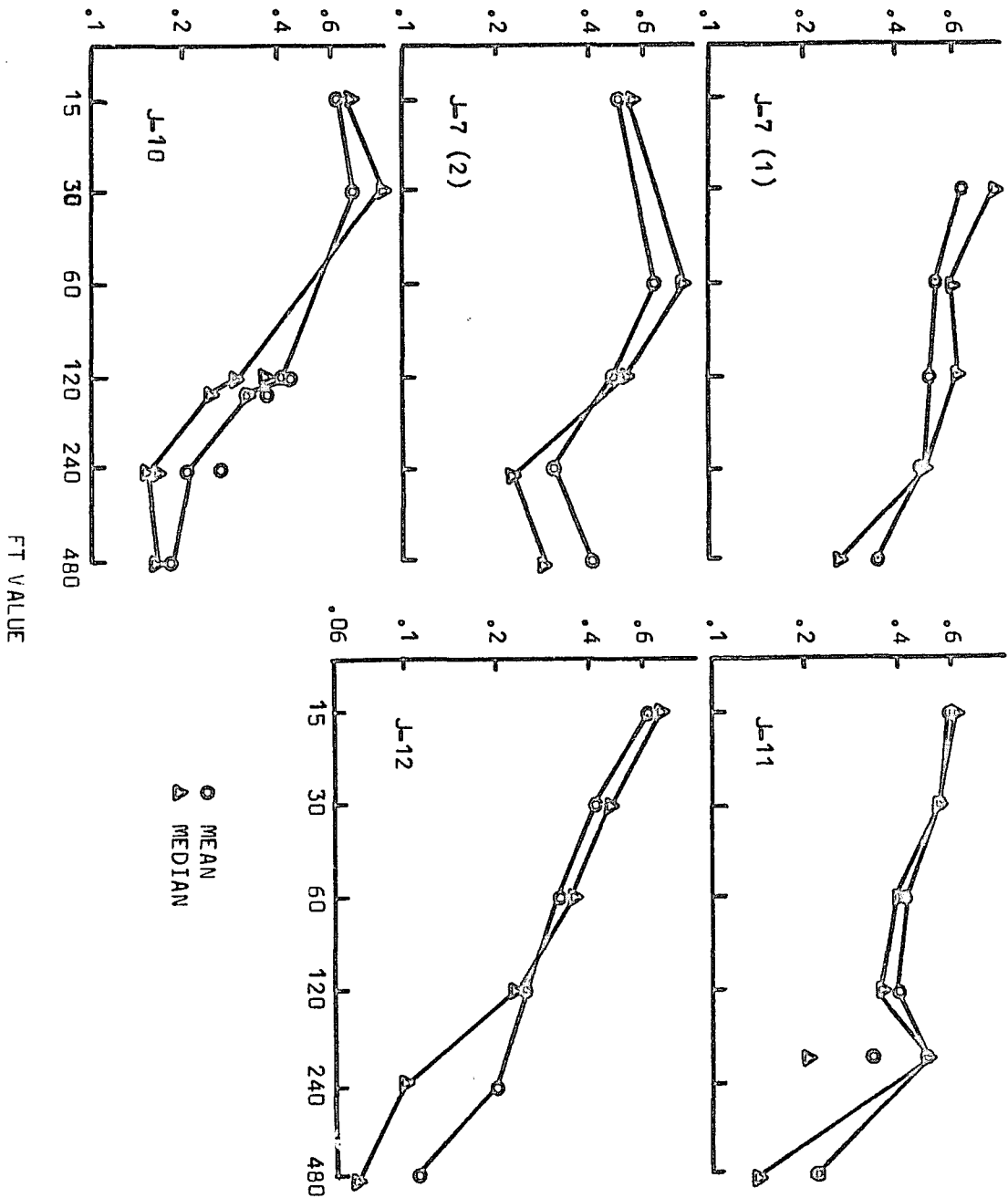

CHAPTER IV

DISCUSSION

The various measures of schedule-induced drinking reported in this paper are concerned with either the strength of drinking or its temporal location within the interfood interval.

The Strength of Schedule-Induced Drinking

Falk, in 1966, reported that the water intake of rats exposed to FI schedules increased as a function of the FI value and then declined, generating an inverted U-shaped function between water intake and FI value. This bitonic function also occurs with VI schedules (Hawkins, 1967). A bitonic function has also been reported for schedule-induced behavior other than drinking: Flory (1969) reported that in pigeons schedule-induced attack was a bitonic function of the FI value; similar findings have been reported with FI schedules (Cherek, Thompson, & Heistad, 1973); and Cohen and Looney (1973), using multiple fixed ratio schedules, reported that schedule-induced attack was a bitonic function of the fixed ratio requirement. A bitonic function has also been reported for schedule-induced escape, which is defined as the response-produced removal of stimuli associated with the schedule of reinforcement by Brown and Flory (1972); in that study schedule-induced escape in pigeons was a bitonic function of the FI schedule.

The dependent measures in these functions have differed and are related to the particular adjunctive behavior being studied. The dependent measure reported in the studies of schedule-induced drinking was water intake per session. The studies reporting attack and escape each used rate of the behavior as the dependent measure. Also, Brown and Flory (1972) reported the relative session time in escape; and Flory (1969) reported the relative session time spent attacking, the time spent attacking, and the number of attacks per session.

Although full accounts of these bitonic functions are currently unavailable, some explanations have been suggested for schedule-induced drinking. Staddon and Simmelhag (1971) have argued that the strength of adjunctive behavior is a direct function of reinforcer frequency. The appropriate measure of strength, they argue, is ingestion rate; the latter has been reported to be a direct function of reinforcer frequency (cf. Cohen, 1975; Hawkins, 1970; Figure 6). Staddon and Simmelhag (1971) attribute the bitonic function between water volume and the interfood interval to "an optimal balance between two factors: tendency to drink, which decreases as interval value increases, and time available for drinking, which increases with interval value" (p. 37). Cohen (1975) also has suggested that given the direct relation between ingestion rate and rate of reinforcement, the bitonic function between water intake and the interfood interval "is solely determined by the length of the interfood interval" (p. 43).

Essentially, then, both Staddon and Simmelhag (1971) and Cohen (1975) have argued that the bitonic relation between water intake and FT value derives from the more primitive decreasing relation between ingestion rate and the interval value. The notion that strength of drinking is best indexed as the rate of ingestion is consistent with Staddon and Simmelhag's (1971) view that the strength of adjunctive behavior and operant behavior are directly related. Inasmuch as operant behavior is directly related to reinforcement rate, adjunctive behavior also would be expected to be directly related to reinforcement rate. The fit of ingestion rate by a power function in the present study is consistent with findings that rate of operant behavior is a power function of reinforcement rate (Catania, 1963).

With regard to operant behavior, it has been noted that changes in response rates may result from changes in the allocation of time (Baum & Rachlin, 1969). If behavior occurs at a constant tempo, changes in rate could result from changes in the time spent engaging in the behavior. Strength of operant behavior, then, may be indexed by either response rate or relative time. This analysis may be extended to schedule-induced drinking. Recall that relative time spent drinking was a negative power function of the FT value. Given the constancy of licking tempo, the negative power function relating lick rate and the FT value could result from the negative power function between relative time and the FT value. The bitonic function between time spent drinking and

FT value could result from a combination of the declining strength of drinking, indexed by relative time, and the availability of time. Since licking tempo is constant, number of licks would also be a bitonic function. And since volume per lick is constant, the volume would also be a bitonic function. Such an analysis of the bitonic function parallels that of Staddon and Simmelhag (1971) and of Cohen (1975) except that relative time, rather than ingestion rate, is used to index strength. Whether one of these measures should be regarded as more primitive than the other is not clear, nor is it clear in the case of operant behavior.

Regardless of whether strength of drinking is measured as response rate or time allocation, explication of the bitonic function in terms of a decline in strength and increase in time available as a function of the FT value is not possible, if strength is a simple power function ($y=ax^b$) of reinforcement rate, without additional considerations. Recall that while the lick rate, ingestion rate, and relative time were well described by power functions, these measures did exhibit curvature at lower FT values. Perhaps strength is nevertheless appropriately regarded as a power function, but is calculated incorrectly. In computing these measures of strength, the assumption is made that the entire session time is available for drinking. Clearly, however, this is not the case, for some minimum time is required for obtaining the food pellet and subsequently making contact with the drinking tube. Perhaps this period of time should

be regarded as a time constant which should be excluded in the computation of rates and relative time. With this thought in mind this time constant was estimated for each rat and subtracted from the FT. The overall lick rate, overall ingestion, and relative time were then recomputed. The time constant was estimated by selecting from the frequency distribution of initiations the lowest initiation value having an appreciable frequency. The best-fit line, \underline{r} , and \underline{r}^2 for these corrected computations are shown in Table 9. For 12 of the 15 functions, the corrected values were better fitted by a power function than were the uncorrected values. For the other three functions, the proportion of variability accounted for by a power function was the same in both computations. This correction in the measure of available time serves also to generate the bitonic function. A bitonic function may result from weighting a simple power function by time available, where time available is not directly proportional to FT value.

There may be yet another source of error in the measurement of lick rate, ingestion rate, and relative time. Recall that drinking did not occur after every pellet delivery (cf. Figure 4). Computation of local lick rate, local ingestion rate, and relative local time, which excluded the time provided by pellets that did not generate drinking, yielded data for which power functions also provided a reasonable fit. In fact, these local measures were better fitted by a

Table 9

Equations for Best-Fit Line, \underline{r} , and \underline{r}^2 for Corrected
Overall Lick Rate, Overall Ingestion Rate,
and Relative Time for Each Rat

Rat	Equation	\underline{r}	\underline{r}^2
<u>Overall Lick Rate</u>			
J-7(1)	$\underline{y} = -.78\underline{x} + 1.73$	-.96	.92
J-7(2)	$\underline{y} = -.78\underline{x} + 1.60$	-.91	.85
J-10	$\underline{y} = -1.02\underline{x} + 1.84$	-.93	.86
J-11	$\underline{y} = -.74\underline{x} + 1.40$	-.99	.98
J-12	$\underline{y} = -1.07\underline{x} + 1.63$	-.96	.92
<u>Overall Ingestion Rate</u>			
J-7(1)	$\underline{y} = -.90\underline{x} - .32$	-.99	.98
J-7(2)	$\underline{y} = -.85\underline{x} - .51$	-.93	.86
J-10	$\underline{y} = -1.00\underline{x} - .38$	-.95	.90
J-11	$\underline{y} = -.77\underline{x} - .83$	-.99	.98
J-12	$\underline{y} = 1.08\underline{x} - .31$	-.98	.96
<u>Relative Time</u>			
J-7(1)	$\underline{y} = -.69\underline{x} + .90$	-.96	.92
J-7(2)	$\underline{y} = -.66\underline{x} + .72$	-.90	.81
J-10	$\underline{y} = -1.11\underline{x} + 1.32$	-.91	.83
J-11	$\underline{y} = -.79\underline{x} + .85$	-.98	.96
J-12	$\underline{y} = -1.04\underline{x} + .92$	-.96	.92

power function than were the overall measures. Comparison of the \underline{r} and \underline{r}^2 for the equations for the local measures (Table 3) with the \underline{r} and \underline{r}^2 for the corrected overall measures reveals that a power function provides an approximate equal fit for the two measures. This fact raised the possibility that a better approximation to a power function would be obtained if the local measures were corrected with the time constant; therefore, each of the local measures was recomputed, subtracting the time constants described above. Table 10 shows the best-fit lines, \underline{r} , and \underline{r}^2 when these corrections are made. A comparison of the proportion of variability accounted for by these equations with the corresponding proportions in Table 9 reveals that in 9 of the 15 equations the corrected local rates were better fitted by a power function than were the corrected overall rates. Of the remaining six pairs of equations, in five the \underline{r}^2 was equal, and for one the \underline{r}^2 was higher for the corrected overall measure.

Of the four methods of computing measures of strength--overall measures, corrected overall measures, local measures, corrected local measures--the computation that is best fitted by a power function is the corrected local computation. This computation differs from the overall computation in that it makes two corrections: one for a time constant and one for the variability in the number of pellets generating drinking. Table 10 shows that when these corrections are

Table 10

Equations for Best-Fit Line, \underline{r} , and \underline{r}^2 for Corrected Local Lick Rate, Ingestion Rate, and Relative Time for Each Rat

Rat	Equation	\underline{r}	\underline{r}^2
<u>Local Lick Rate - Corrected</u>			
J-7(1)	$\underline{y} = -.76\underline{x} + 1.82$	-.96	.92
J-7(2)	$\underline{y} = -.67\underline{x} + 1.54$	-.94	.88
J-10	$\underline{y} = -.58\underline{x} + 1.37$	-.97	.94
J-11	$\underline{y} = -.76\underline{x} + 1.47$	-.99	.98
J-12	$\underline{y} = -.84\underline{x} + 1.65$	-.99	.98
<u>Local Ingestion Rate - Corrected</u>			
J-7(1)	$\underline{y} = -.89\underline{x} - .22$	-.99	.98
J-7(2)	$\underline{y} = -.61\underline{x} - .87$	-.93	.86
J-10	$\underline{y} = -.52\underline{x} - .90$	-.90	.81
J-11	$\underline{y} = -.70\underline{x} - .89$	1.00	1.00
J-12	$\underline{y} = -.89\underline{x} - .24$	-.98	.96
<u>Local Relative Time - Corrected</u>			
J-7(1)	$\underline{y} = -.70\underline{x} + 1.01$	-.97	.94
J-7(2)	$\underline{y} = -.54\underline{x} + .63$	-.93	.86
J-10	$\underline{y} = -.58\underline{x} + .72$	-.97	.94
J-11	$\underline{y} = -.70\underline{x} + .76$	-.99	.98
J-12	$\underline{y} = -.81\underline{x} + .93$	-.99	.98

made, a power function accounts for 88 to 98 percent of the variability in local lick rate, 86 to 100 percent of the variability in ingestion rate, and 86 to 98 percent of the variability in relative time. It appears tenable, then, to maintain that strength of drinking is a power function of the FT value. The functions relating the overall measures to FT value are well described by a power function, but contain a slight curvature at the smaller FT values which results from using an inflated time base. The bitonic function occurs then because, as Staddon and Simmelhag (1971) and Cohen (1975) suggested, proportionately less time is provided by the shorter FT values than the longer FT values.

This analysis may illuminate the inconsistent findings with respect to schedule-induced escape and attack. Recall that the rates of these responses are each inverted U-shaped functions of the FT. Also, Flory (1969) reported relative time spent attacking to be a bitonic function, and Brown and Flory (1972) reported a similar relation with respect to escape. Although these data support the notion that the rate functions follow from the relative-time functions, or vice versa, why these functions are bitonic rather than declining, as in schedule-induced drinking, is unclear. Perhaps the time constant for these behaviors is longer than the time constant for drinking. Possibly this time constant may reflect not only the mechanical restraints of the experimental space but behavioral limitations regarding the structure of behavior

also. That is, perhaps for some reason yet unclear, animals do not attack or escape for x seconds after feeding. Since increases in the time constant result in proportionately less time available in the shorter schedules, computation of the overall measures could result in bitonic functions. Computation of these measures by subtracting the time constant could thus generate declining power functions.

The Temporal Location of Adjunctive Behavior

A major concern of the present experiment was to determine the temporal location of drinking within the interfood interval. In the literature schedule-induced drinking is usually characterized as a postfood phenomenon. This notion has typically implied that licking onset as well as offset is confined to the immediate postfood period. With regard to the notion that onset is temporally proximal to food, data reported by Segal et al. (1965) indicated that the mean initiation time increases as a function of the interfood interval. The present experiment also found increases in mean initiations (Figure 15), but the distribution of initiation times showed less dramatic shifts. Whether the distribution of drinking is measured as the simple probability (Figure 16), relative frequency (Figure 17), or conditional probability (Figure 18), drinking onset does appear to be confined to the early proportion of the interfood interval. The figures generally indicate that the maximal probabilities of licking occurred within the first one-third of the interfood

interval. This does not indicate, however, that drinking onset occurs at a constant proportion of the FT. An examination of the mean initiation times in the first 30 secs. after food reveals increasing functions which indicate that the increasing means observed in the entire distribution were not due solely to a few long initiations. The fit of a power function to the mean initiation values of the entire distribution (Table 4) accounts for 85 to 96 percent of the variability. For Rat J-7's first determination, the slope of the best-fit line is 1.07, and for Rat J-10 it is 1.22, indicating that the mean initiation time is approximately a constant proportion of the FT. This datum is consistent with Killeen's (1975) finding that the maximal rate of bar-pressing maintained by the opportunity to engage in schedule-induced drinking is a constant proportion of the FT across several FT values. It is then reasonable to expect that this control over rate by relative time in the interval would also be reflected in the initiation time. The slope for J-7's second determination and the slopes for J-11 and J-12 are less than 1.00, indicating that the proportion of the FT associated with the mean initiation becomes smaller as the FT increases. Killeen (1975) reported a similar finding for an operant response in pigeons (see also, Catania, 1970). He examined the rate of operant responding across several FI schedules and found that the time at which the mean maximal response rate occurred was a power function of the FI value with an

exponent less than 1.00. Interestingly, similar data from rats yielded exponents greater than 1.00. In the present study, the reason for the lack of consistency in the value of the exponent is not clear; but, inasmuch as Killeen (1975) and Catania (1970) have cited a variety of experimental procedures which suggest that the psychophysical scale of duration for operant behavior is a power function, the fit of the present data by a power function is encouraging. It indicates that the temporal properties of a schedule affect the temporal spacing of operant and adjunctive behavior in a similar manner.

Specification of the offset of the drinking state is more difficult than specification of its onset. Usually the first lick initiates a burst of licks, thus clearly indicating the onset of the drinking state. The last lick in the interval, however, does not always terminate a burst. Instead, an interval may contain several bursts of varying durations and varying interburst intervals. Often the last response terminates a very brief episode of drinking or even occurs singly. Perhaps the terminal lick should not be considered the last lick in the interval but rather the last response that terminates a prominent burst. But a problem remains in how to define a prominent burst and the occurrence of an interburst interval. This problem can be seen in the schematic of drinking in Figure 14. Although all interfood intervals do not show the disruptions in licking that are

shown here, this pattern is characteristic enough to present a problem in deciding when licking has terminated. Thus, while sometimes the last lick in the interval clearly marks the offset of the drinking state, often the last lick is less clearly characterized as terminating the drinking state. Because of the difficulty in determining when prominent bursts of drinking have occurred, the most practical method of determining offset of the drinking state, given the available instrumentation, is to measure the time of offset of the last response. The use of an on-line computer which could repeatedly redefine burst lengths and interburst lengths could perhaps permit a more precise quantitative estimation of which licks are best referred to as terminating the drinking state.

This notion that the drinking state may have terminated before the occurrence of the last lick in the interval arises not only from inspection of event records of drinking but is also suggested by analysis of the distribution of terminations. The functions showing the simple and relative frequency probabilities (Figures 26 and 27) show the maximal probability at the end of the interval. There are, nevertheless, some secondary rises in these functions earlier in the interval. This picture is clearest for Rats J-11 and J-12. For all rats, the trend is more evident when the probability functions are corrected for opportunities (Figure 28). All rats except J-12 still show high probabilities of a termination at the end of the interval, but there are one or more rises in probability earlier in the interval. Perhaps these earlier

rises more appropriately reflect the termination of the drinking state. If so, then perhaps for J-12, the last lick in the interval did reflect the termination of the drinking state since the maximal probabilities shift to the left with increases in FT value.

The shift in the distribution of termination times as a function of the FT is reflected in the mean, median, and modes of these distributions (Figure 25). It is interesting that despite the concern with appropriately measuring the termination of drinking, the mean termination times are well described by power functions having an exponent less than 1.00. Again, these data are consistent with other studies in showing that temporal patterning of behavior is a power function of duration. Especially interesting is that the exponents of the power functions are very similar to those reported for operant behavior (Catania, 1970; Killeen, 1975), thus showing another correspondence between operant and adjunctive behavior.

In the present experiment the time between the occurrence of the first and last lick is considered to define the drinking state. Several questions regarding the nature of this drinking state can be raised: (1) Is its duration dependent upon its onset time? (2) How long is it? (3) Where is it most likely to occur?

The first question was addressed by correlating the initiation time and the duration of the drinking state. The

resulting negative correlations indicate that the duration of the drinking state is inversely related to its onset time. Similar findings have been reported by Staddon and Simmelhag (1971), though they reported correlations that were smaller and less significant.

The correlations between initiation time and duration of the drinking state did not appear to be systematically related to the FT value, except in the case of Rat J-12, for whom the correlations became smaller as a function of the FT. Although the exclusion of the termination times equal to the FT value prevented a spurious negative correlation, such a correlation would still be expected if the terminations occur predominately at the end of the interval. Since J-12 showed less of a trend to drink near the end of the interval than did the other rats, perhaps the declining correlation as a function of the FT does accurately reflect increasing independence of the duration of drinking state on its onset time.

The correlation of the onset of the drinking state with its duration suggests that the duration of the drinking state does not occur for either a fixed period of time or for a constant proportion of the FT. Either case would have resulted in a zero correlation. Although these correlations are significant, however, they are very low and account for very little of the data variance. The question regarding the length of the drinking state is more directly answered by examining the distribution of drinking-state durations. Figure 31 indicates that the duration increases as a function of the FT,

though the first 25 percent show little sensitivity to the FT value. Expressing the means and medians as a proportion of the FT (Figure 32) reveals that as the FT increases, the drinking state occupies a smaller proportion of the interval. This decrease is consistent with the decrease found in the proportion of the interfood interval spent drinking (Figure 10), thus providing additional support for the notion that strength of drinking is a direct function of the rate of pellet delivery.

The answer to the question regarding where in the interval the drinking state is most likely to occur is provided by examining the joint probability that an initiation has occurred and a termination has not occurred. Weighting these probabilities by the proportion of the interval spent drinking permits the probabilities to reflect more directly the strength of drinking. Otherwise, the ordering of the functions on the y-axis would reflect the number of pellet deliveries followed by drinking. The shapes of these functions varied, but in general they indicate that the probability of being in the drinking state is low immediately after food, increases to a maximum, and then declines. Although there is a tendency for the maximal probabilities in the longer FT schedules to occur in the early proportion of the interval, examination of these probabilities as a function of absolute time during this time period would have revealed low probabilities immediately after food.

These functions are relevant to the measure of response rate reported by Killeen (1975) in the study described above in which bar-pressing was maintained by the opportunity to engage in schedule-induced drinking. Response rate was obtained by accumulating responses in time bins that advanced throughout the interval, and was found to be an inverted U-shaped function of the proportion of the FT. Because licking occurs at a constant tempo, changes in response rate could reflect location of the allocation of time to the drinking state. The low response rates during the early and late proportions of the interval would reflect the low number of intervals in which time was being allocated to drinking. The high response rates would reflect a high number of intervals in which time was being allocated to drinking.

The functions showing the probability of being in the drinking state directly reflect the allocation of time to the drinking state. Given the constancy in licking tempo, and assuming that the interruptions in actual drinking during the drinking state are random, the shape of these functions should closely correspond to the response rate functions had they been determined.

Killeen found that the maximal response rates occurred at a constant proportion of the FT. In the present experiment, the functions relating the time of the maximal probability of being in the drinking state to the FT value would indicate that these times were a constant proportion of the

FT if the slope of the best-fit lines were 1.00. In four of the five equations, the slopes were less than 1.00, indicating an inverse relation between the FT value and the proportion of the FT associated with the maximal probability. As noted earlier, Killeen found an inverse relation between the time of occurrence of pigeons' maximal operant response rate and the FI value. The factors which determine whether the temporal spacing of behavior is proportional to the temporal parameters of the schedule, or are power functions with the exponent less than 1.00 are still unclear. The present analysis determines time allocated to drinking by considering only the first and last lick. A more molecular examination of time allocated to drinking might result in a still closer correspondence with Killeen's results.

CHAPTER V

SUMMARY

Strength of drinking, whether indexed by lick rate, ingestion rate, or relative time, was inversely related to the FT value. A negative power function provided a good fit to these measures when computed in several ways. The best fit was obtained by making two corrections, one for the number of pellets followed by drinking and the other for the minimum time delay between food delivery and the initiation of drinking. The rising limb of the bitonic relation between licks, volume, and time spent drinking and the FT value appears to result from proportionately less time being actually available at the shorter FT values than at the longer FT values. That factor could also account for the finding that the strength measures of schedule-induced attack and escape are reported to be bitonic functions of the FT value rather than monotonic.

The means and medians of both the frequency distribution of initiations and the frequency distribution of terminations were positive power functions of the FT value; therefore, neither the onset nor the offset of drinking were purely post-food events in the strict sense of occurring immediately after food and remaining constant as the FT value was manipulated. Other data nevertheless suggest that these events

may still be considered as postfood occurrences. First, the exponents of the power functions were less than 1.00, indicating that initiations and terminations became relatively more proximal to the prior food delivery as the FT increased. Also, the medians of the initiation distributions indicated that 50 percent of the initiations occurred within the first 30 seconds after food. Finally, examination of the termination distributions as corrected for opportunities revealed a shift of the termination distribution to the left as the FT increased. It appears, then, that despite the increases in the initiation and termination times, these events still remain relatively proximal to food delivery as the FT value is manipulated.

The proximity of the initiation and termination distributions to the prior food delivery was further reflected in the probability of the rats being in the drinking state. The functions involved were inverted U-shaped functions of the FT value, with the time associated with the maximal probabilities of the functions described by a power function. The functions had exponents less than 1.00, indicating that the maximal probability of being in the drinking state occurred relatively more proximal to the prior food delivery as the FT increased. The proportion of the interfood interval occupied by the drinking state decreased as a function of the FT, providing additional support to the prior indications that strength of drinking decreases with the FT value.

BIBLIOGRAPHY

- Anger, D. The dependence of interresponse times upon the relative reinforcement of different interresponse times. Journal of Experimental Psychology, 1956, 52, 145-161.
- Azrin, N. H. Time-out from positive reinforcement. Science, 1961, 133, 382-383.
- Azrin, N. H., Hutchinson, R. R., & Hake, D. F. Extinction-induced aggression. Journal of the Experimental Analysis of Behavior, 1966, 9, 191-204.
- Baum, W. M., & Rachlin, H. C. Choice as time allocation. Journal of the Experimental Analysis of Behavior, 1969, 12, 861-874.
- Brown, T. G., & Flory, R. K. Schedule-induced escape from fixed-interval reinforcement. Journal of the Experimental Analysis of Behavior, 1972, 17, 395-403.
- Catania, A. C. Concurrent performances: Reinforcement interaction and response independence. Journal of the Experimental Analysis of Behavior, 1963, 6, 253-263.
- Catania, A. C. Reinforcement schedules and psychophysical judgments: A study of some temporal properties of behavior. In W. N. Schoenfeld (Ed.), The theory of reinforcement schedules. New York: Appleton-Century-Crofts, 1970. Pp. 1-42.
- Cherek, D. R., Thompson, T., & Heistad, G. T. Responding maintained by the opportunity to attack during an interval food reinforcement schedule. Journal of the Experimental Analysis of Behavior, 1973, 19, 113-123.
- Cohen, I. L. The reinforcement value of schedule-induced drinking. Journal of the Experimental Analysis of Behavior, 1975, 23, 37-44.
- Cohen, P. S., & Looney, T. A. Schedule-induced mirror responding in the pigeon. Journal of the Experimental Analysis of Behavior, 1973, 19, 395-408.
- Falk, J. L. Production of polydipsia in normal rats by an intermittent food schedule. Science, 1961, 133, 195.
- Falk, J. L. The motivational properties of schedule-induced polydipsia. Journal of the Experimental Analysis of Behavior, 1966, 9, 19-25.

- Falk, J. L. Conditions producing psychogenic polydipsia in animals. Annals of The New York Academy of Sciences, 1969, 157, 569-593.
- Falk, J. L. The nature and determinants of adjunctive behavior. Physiology and Behavior, 1971, 6, 577-588.
- Flory, R. Attack behavior as a function of minimum interfood interval. Journal of the Experimental Analysis of Behavior, 1969, 12, 825-828.
- Gentry, W. D. Fixed-ratio schedule-induced aggression. Journal of the Experimental Analysis of Behavior, 1968, 11, 813-817.
- Hawkins, T. D., Schrot, J. F., Githens, S. H., & Everett, P. B. Schedule-induced polydipsia: An analysis of water and alcohol ingestion. In R. M. Gilbert & J. D. Keehn (Eds.), Schedule effects: Drugs, drinking, and aggression. Toronto, University of Toronto Press, 1972. Pp. 95-128.
- Hutchinson, R. R., Azrin, N. H., & Hunt, G. M. Attack produced by intermittent reinforcement of a concurrent operant response. Journal of the Experimental Analysis of Behavior, 1968, 11, 489-495.
- Killeen, P. On the temporal control of behavior. Psychological Review, 1975, 82, 89-115.
- Levitsky, D., & Collier, G. Schedule-induced wheel running. Physiology and Behavior, 1968, 3, 571-573.
- Mendelson, J., & Chillag, D. Schedule-induced air licking in rats. Physiology and Behavior, 1970, 5, 535-537.
- Segal, E. F., Oden, D. L., & Deadwyler, S. A. Determinants of polydipsia: IV. Free-reinforcement schedules. Psychonomic Science, 1965, 3, 11-12.
- Staddon, J. E. R., & Ayres, S. L. Sequential and temporal properties of behaviors induced by a schedule of periodic food delivery. Behavior, 1975, 54, 26-49.
- Staddon, J. E. R., & Simmelhag, V. L. The "superstition" experiment: A reexamination of its implications for the principles of adaptive behavior. Psychological Review, 1971, 78, 3-43.
- Taylor, D. B., & Lester, D. Schedule-induced nitrogen drinking in the rat. Psychonomic Science, 1969, 15, 17-18.

Thompson, D. M. Escape from S^D associated with fixed-ratio reinforcement. Journal of the Experimental Analysis of Behavior, 1964, 7, 1-8.

Villareal, J. Schedule-induced pica. Paper read at Eastern Psychological Association, Boston, April, 1967.